

WIRELESS WORLD

AND

RADIO REVIEW

VOL. X. No. 23.

2nd SEPTEMBER, 1922.

Registered at the G.P.O.
as a Weekly Newspaper.

The Name "BURNDEPT" GUARANTEES Cent. Per Cent. QUALITY & EFFICIENCY.

The BURNDEPT ULTRA III RECEIVER

SUPPLIED TO AIR MINISTRY — INDIA OFFICE (FOR USE ON H.R.H. PRINCE OF WALES TOUR)
GREENWICH OBSERVATORY — AND VARIOUS COLONIAL Etc., GOVERNMENTS.



SOME POINTS OF SUPERIORITY OVER OTHER 3 & 4 VALVE RECEIVERS

- (1) The rectifying valve can be used alone or in conjunction with either the H.F. magnifier valve or L.F. amplifier valve, or both— This feature allows signals to be suitably magnified for comfortable reception according to original signal strength and economises valves and filament current.
- (2) Each valve is furnished with a separate rheostat thus allowing valve to be operated at its most sensitive point. As all valves have different properties, this feature enables the best use to be made of the valve, so that signals can be thus received at almost the same strength as if 3 valves were used. By suitable arrangement of the rheostats selectivity of signals can be much improved.
- (3) The magnification of the third note or magnifying valve is obtained by intervalve transformer of finest manufacture—giving as much magnification as 2 valves used with resistance capacity coupling and economising filament current and valves.

PRICE (without valves) - - - £25

FOR FURTHER PARTICULARS AND DETAILS OF OUR COMPLETE RECEIVING SETS
AND ALL ACCESSORIES SEE OUR ILLUSTRATED CATALOGUE 6d. POST FREE

All BURNDEPT Valve Apparatus is duly licensed under Marconi Patents for amateur use in Great Britain.
Visit our STAND No. 12a. All British Wireless Exhibition, Horticultural Hall, SEPT. 30th to OCT. 7th.

BURNDEPT

Ltd. AERIAL WORKS & EASTNOR WORKS,
BLACKHEATH VILLAGE, LONDON, S.E.3

WESTON ELECTRICAL MEASURING INSTRUMENTS

THE WESTON MODEL 280 VOLT-AMMETER

Triple Range. 150/15/3 Volts. 15/1.5/0.15 amps.

This Precision Instrument is especially suitable for Wireless Research Work, i.e.

3 Volt Range.—Testing accumulator cells, dry batteries, measuring fall of potential across potentiometers.

15 Volt Range.—Testing 8 or 12 volt accumulator supplying voltage to valves, etc.

150 Volt Range.—Testing H.T. Batteries, etc.

0.15 Amp Range (150M.A.)—Measuring H.T. current to transmitting valves, determining resistance of Transformers, chokes, telephones, rheostats, etc.

1.5 Amp Range.—Adjusting filament currents, etc.

15 Amp Range.—Measuring output or charging current of accumulators, etc.

NOTE.—The 3 volt range may be used as a sensitive low range Milli-Ammeter.

SEVEN INSTRUMENTS IN ONE CASE.

PRICE £15, less 20 per cent. Leather Case 15/-

Write for further particulars.

WESTON ELECTRICAL INSTRUMENT CO., LTD.

Audrey House, Ely Place, Holborn, E.C.1

Telephone: Holborn 2029.

Telegrams: "Pivoted, Smith, London."

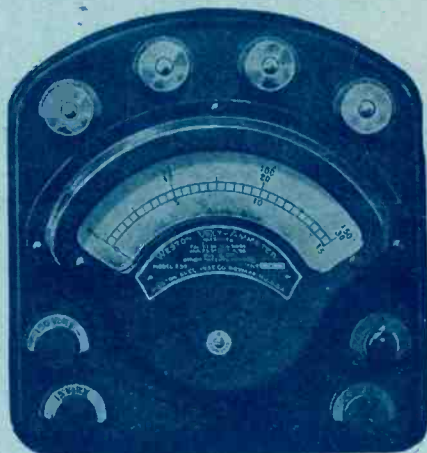

MODEL 280

RADIO INSULATION

AS SPECIFIED AND USED BY THE BRITISH ADMIRALTY

BRITISH MADE

PAXOLIN

BRITISH MADE

TUBES DISCS PLATES, &c.

MANUFACTURED IN ALL FORMS, SIZES AND THICKNESSES

BY

THE MICANITE & INSULATORS CO. LTD.

EMPIRE WORKS

WALTHAMSTOW

LONDON, E.17

TELEGRAMS:—"MYTILITE, PHONE, LONDON."

TELEPHONES:—WALTHAMSTOW 738, 739

STAMPINGS FOR RADIO INSTRUMENTS

TRANSFORMER CORE LAMINATIONS AND
DIAPHRAGMS FOR HEAD-PHONES

(IN OUR PATENT HIGH RESISTANCE MATERIAL)

“STALLOY”

STALLOY WIRE FOR TRANSFORMER CORES

CONDENSER VANES

TRADE ENQUIRIES SOLICITED

JOSEPH SANKEY & SONS, Ltd., BILSTON

Representative: Robert Jenkins, 168, Regent St., London, W.1

THE
Crystophone
REGISTERED

is ALL you require
for ALL purposes and may be
used in the following combinations

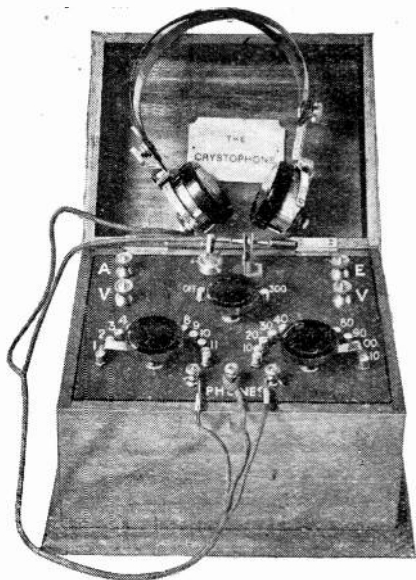

Crystophone Type 20 TT

Crystal Detector Solus - £5 10 0
or in conjunction with
Crystophone V.1 (single valve Detector)
£2 10 0 extra.

Or Crystophone V.1. L.F. Crystal
Detector and single valve £4 10 0
extra (L.F. Amplifier.)

Or Crystophone V.1. H.F.
H.F. Amplifier and Crystal Detector
£4 10 0 extra.

Or Crystophone V 2. L.F. (Crystal
Detector and two valves Amplifier.)
£7 10 0 extra.

Or Crystophone V.3. H.L.F.
H.F. Amplifier, Crystal Detector and
Double L.F. Amplifier £12 0 0 extra.

Separate Sterling Headphones
£1 12 0 extra.

Above prices do not include Valves
H.T. and L.T. Batteries.

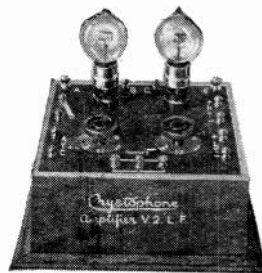

Write for full details to—

**WIRELESS
SUPPLIES CO.**

**64 Mortimer Street,
LONDON, W. 1**

Telephone: MUSEUM 2672.
'Grams:
"Adragonx, Wesdo, London."

Visit our Stand No. 1. All British Wireless Exhibition, Horticultural Hall, September 30th to October 7th.

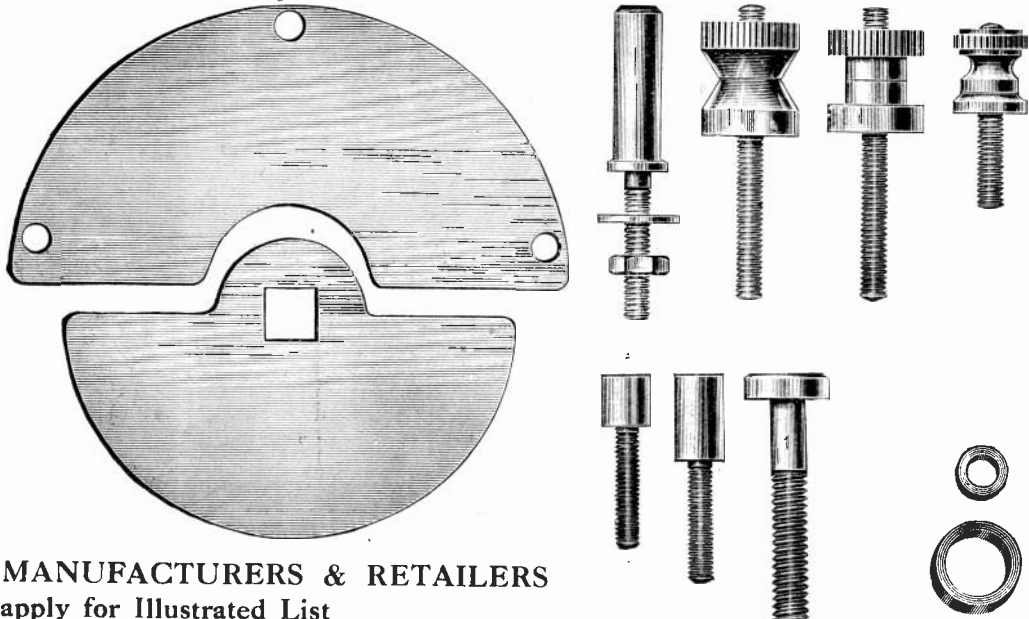

MANUFACTURERS & RETAILERS
 apply for Illustrated List
 and **TRADE TERMS.** **KEEN PRICES. PROMPT DELIVERY.**

Phone—
Holborn 1812 **ORMOND ENGINEERING CO., 199, Pentonville Rd., King's Cross, N.1.**

LESLIE McMICHAEL LTD.

PROVIDENCE PLACE, WEST END LANE, KILBURN, N.W. 6

Bus Services 1, 8, 10, 28, 51 all pass West End Lane

Telephone: **HAMPSTEAD 1261** Nearest Tube Station: **KILBURN PARK (BAKERLOO)**

BROWNS' PHONES

New, Unused, Ex-Government All-Aluminium Diaphragms

Reconditioned and Guaranteed by Mfs., S. G. BROWN, Ltd.

HIGH RESISTANCE LOW RESISTANCE

55/- Per Pair 50/-
(Prices include Cords)

We also have a **LARGE** stock of unused ex-Government **BROWNS' PHONES**, which have *not* been reconditioned by Mfs. S. G. BROWNS'. These we purchased direct from the Government.

	120 ohms	4000 ohms
	37/6	43/6
	PER PAIR	
	<small>(Prices include Cords)</small>	

VISIT OUR STAND—No. 38
 ALL-BRITISH WIRELESS EXHIBITION
 HORTICULTURAL HALL
 September 30th —to— October 7th

A SPLENDID TWO-VALVE SET . . . £6 5 0
 See our further advert. in this issue.

Send for our **ILLUSTRATED CATALOGUE.**

16 Pages, 100 Illustrations.

Post free. Sixpence.



---CQ Std bi
for ERICSSON PHONES

WHEN you instal your wireless set—crystal or valve —you'll get maximum results if you fit Ericsson Phones—clarity, sensitivity, strength of signals and absence of "click." Specially suited to telephony. Ericsson Phones embody the accumulated experience of telephone manufacture for a generation. Easy to the head, light and comfortable. The magnets never lose their strength and "shorts" are non-existent.

Write for Particulars

The BRITISH L. M. ERICSSON
MANUFACTURING Co., Ltd.

Head Office :
60, Lincoln's Inn Fields, E.C.2



"K" RADIO EQUIPMENT "B"

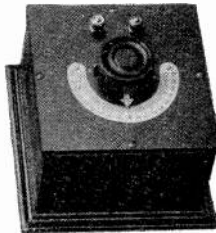
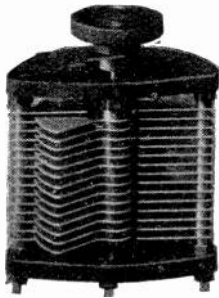

We hold large stocks of complete Receiving Sets, Coilholders, Coils, Variable Condensers (Assembled and in Parts), Valve Holders, Filament Resistances, H.T. Batteries, Accumulators, Aerial Insulators; in fact ALL AMATEUR REQUIREMENTS.

TRADE ENQUIRIES INVITED.

CATALOGUE POST FREE 4d.

COME AND "LISTEN IN" AT OUR SHOWROOMS. OPEN DAILY from 9 a.m. till 7 p.m.

THE "K. B." RADIO EQUIPMENT COMPANY,

Head Offices & Showrooms : 109, High Rd., Kilburn, N.W.6. Telephone :
Bus Services—3, 16, 28 & 57, pass door. 3 mins. Kilburn Park Sta. (Bakerloo Rly.) Hampstead 7803

Visit our Stand No. 8. All British Wireless Exhibition, Horticultural Hall, Sept. 30th to Oct. 7th.



HEADGEAR RECEIVERS

Designed and manufactured by leading Telephone Manufacturers Backed by many years' experience.

Highest efficiency, concentrated magnetic field, instantaneously adjusted to the ears, comfortable in wear, either receiver detachable from headband, protected terminals, light weight, twin series cord.

A.T.M. LOUD SPEAKING RECEIVERS

Three types of amplifying horn.

A.T.M. Crystal Detector Sets

Highest Grade. Maximum Efficiency. Moderate Cost.

Ask your dealer for
A.T.M.

Broadcasting Apparatus

Visit our Stand No. 52. All British Wireless Exhibition. Horticultural Hall, September 30th to October 7th

Automatic Telephone Manufacturing Co., Ltd.

Head Office & Works: Milton Rd., Edge Lane, Liverpool.
London Office: 60 Lincoln's Inn Fields W.C.2.

HIGH-CLASS VARIABLE CONDENSERS

THESE Condensers designed for panel mounting, are of the highest MECHANICAL accuracy and ELECTRICAL efficiency. The rotary aluminium vanes are carried by a SQUARE BRASS spindle, for which top and bottom bearings are provided. Individual, not cast, spacers are used, which are gauged with a micrometer before assembly.

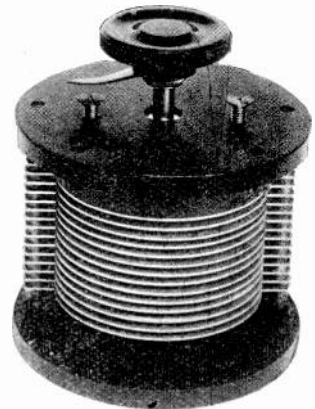

Capacity in mfd.	Price.
'001	24/-
'00055	17/9
'0003	13/6
Vernier Condenser '00005	5/6

London Agents—

Messrs. H. D. Butler & Co., Ltd., 222, Gt. Dover St., Borough, S.E.
Messrs. W. J. Henderson, 2, Hollywood Rd., S. Kensington, S.W.

ACTUAL MANUFACTURER—

M. FOSTER

1, Brunswick Street West, HOVE

F. WIGGINS & SONS

MICA Telephone: Avenue 2248
Largest Stock in the World.

FOR CONDENSERS AND ALL PURPOSES.

102, 103 & 104, Minories, London, E.1

DUBILIER

A New Condenser for Wireless Receivers

THE DUBILIER TYPE 600 MICA CONDENSER

The illustrations show two types of this new condenser for wireless receiving circuits. The condensers have the same perfect mica insulation, the same high efficiency and the same permanence of capacity as the larger Dubilier Mica Condensers used in wireless transmitters. Distortion when receiving telephony is often due to bad design of the components of the receiver—therefore use efficient Dubilier Condensers in your receiver to obtain the best out of your set.

PRICES:

Capacity between: 0'0001 and 0'0009 mfd 2/6 each
 " " 0'001 " 0'005 " - 3/- "
 (inclusive)
 Condensers complete with Grid Leaks - 7/6 "

TRADE TERMS ON APPLICATION.

With Clips for Grid Leak.

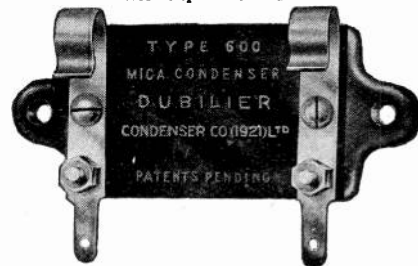

Without Clips for Grid Leak.

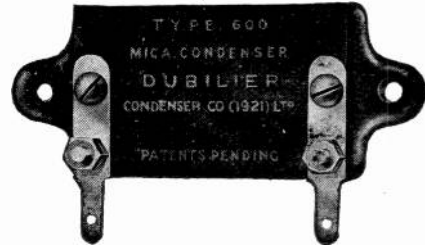

THE WAY TO DUBILIERS.

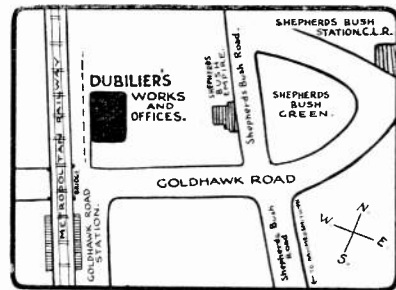

Visit our Stand No. 36. All British Wireless Exhibition, Horticultural Hall, September 30th to October 7th.

THE DUBILIER CONDENSER CO. (1921), LTD.,
DUCON WORKS, Goldhawk Road, Shepherd's Bush, London, W.12

Telephone—Hammersmith 1084.

Telegrams—Hivoltcon, Phone, London.

Code—Marconi International.

"FORS" ACCUMULATORS

NOT SURPLUS GOVT. STOCK

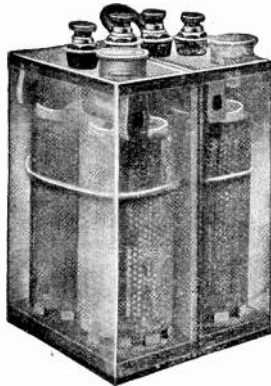
LONG
LIFEOUTPUT
GUARAN-
TEED

RETAIN THEIR CHARGE WHEN NOT IN USE

If you only use your accumulator occasionally, do not risk being disappointed just when you want it. The "FORS" will not run down when not in use, and cannot short internally. WRITE FOR LIST (free) to sole Selling Agents—

G. H. T. PETERSEN (Engineers' Merchants) Ltd.
59, SHOE LANE LONDON, E.C.4.

The *Evora* Co.

Surbiton Park Terrace, Kingston

High-Class Single Valve Receiving Station
£10 0 0 Complete with ALL Accessories.

Complete 3-Valve Receiving Station £24 0 0

All Parts for Wireless Supplied.

EBONITE

SHEET, ROD, TUBE & MOULDINGS
In reliable consistent qualities — FROM STOCK

Send us your enquiries, and let us put you on our mailing list, so that particulars of new specialities may be sent you from time to time.

WHOLESALE ONLY

RADIO EBONITE SUPPLIES,
4, Little College St., London, E.C.4
(Minute from Cannon Street Station.)
Telephone—Central 4711

CONDENSERS

ALL TYPES AND VALUES.
EVERY ARTICLE GUARANTEED.

FINEST

WORKMANSHIP AND FINISH.
BRASS WORK
POLISHED AND LACQUERED.

Valve in M.F.	Panel Mount- ing in Parts	Panel Mount- ing As- sembled	Cabinet Mount- ing in Parts	Cabinet Mount- ing As- sembled	Cabinet Mount- ing As- sembled in Cabinet	Pol- ished Mahog- any Cabinet
-0015 ..	23/-	25/6	24/-	26/6	33/-	6/3
-001 ..	16/9	19/6	17/9	21/-	26/-	5/6
-0075 ..	13/6	16/3	14/6	16/6	22/-	5/6
-0005 ..	10/6	13/-	11/9	13/9	18/-	4/6
V-0004 ..	10/-	12/6	11/-	13/3	17/6	4/6
-0003 ..	9/-	11/6	10/-	12/-	16/-	4/-
-0002 ..	7/-	9/-	8/-	9/6	13/6	4/-
-0001 ..	6/-	8/-	7/-	8/6	12/6	4/-
Vernier..	—	4/6	—	5/-	9/-	3/6

SPECIAL SIZES MADE TO ORDER.

ALL SUNDRIES AND COMPONENTS IN STOCK.
ALL ORDERS OVER 20/- CARRIAGE PAID.

The "Broadway" Radio Works,
Devonshire Road, Bexley Heath, Kent
H. L. LIDINGTON.

The most reliable and efficient
Batteries for Wireless Work are

D.P.

STORAGE BATTERIES

D.P. Batteries are made to fit al-
most any size of box. The output
of our Works runs to hundreds
of thousands of plates yearly.

Write us for particulars

The D. P. BATTERY CO., td.
BAKEWELL — DERBYSHIRE
& 11 Victoria St., London, S.W.

FITTED WITH OUR GREAT CRYSTAL "Hertzite"	"CASTAPHONE" (REG. TRADE MARK) CRYSTAL W/T RECEIVING SET.	PRICE 65/-
Complete with D.H. 'Phones (4,000 ohms), 100 ft. Aerial Wire, &c., 90/-		
RUSSELL & SHAW, 38, Great James Street, Bedford Row, W.C.1		

THE WIRELESS WORLD AND RADIO REVIEW

THE OFFICIAL ORGAN OF THE WIRELESS SOCIETY OF LONDON
A MAGAZINE DEVOTED TO WIRELESS TELEGRAPHY AND TELEPHONY

CONTENTS

Practical Data for Building the Armstrong Super-Regenerative Circuit. By Edgar H. Felix, Associate I.R.E.	711
Experimental Station Design. By F. H. II. (<i>Continued</i>)	715
A Broadcast Receiver. By A. J. Bull	720

Contents continued on next page.

Coventry Wireless Supplies Co.

Telephone
1343

CLAY LANE, COVENTRY.

Aerial Wire, 7/22	Copper, 5/-	100'
Condensers, Variable, .001	16/-	each
.0005	11/6	"
.0003	9/6	"
" Vernier	4/-	"
" Fixed and Grid Leak	2/3	"
" Bushes, without nut	1/9	doz.
" Vanes, Aluminium	11d.	"
" Dial Ebonite	2/6	each
" Spacing Washers, small	3d.	doz.
" Spacing Washers, large	6d.	"
" Rods, brass, round screwed each		
end, 4 B.A.		
4" long, screwed $\frac{1}{4}$ " x $\frac{1}{4}$ "	2/-	doz.
3" " " $\frac{1}{4}$ " x $\frac{1}{4}$ "	1/6	"
2 $\frac{1}{2}$ " " " $\frac{1}{4}$ " x $\frac{1}{4}$ "	1/4	"
" Rods, brass, square screwed 2		
B.A., 3/16"		
5" long, screwed $\frac{1}{4}$ " x $\frac{1}{4}$ "	2/2	doz.
3 $\frac{1}{2}$ " " " $\frac{1}{4}$ " x $\frac{1}{4}$ "	1/-	"
2 $\frac{1}{2}$ " " " $\frac{1}{4}$ " x $\frac{1}{4}$ "	1/-	"
Contact Studs	1/10	doz.
Ebonite Knobs, 2 B.A. Tapping	6d.	each
Ebonite Knobs, 2 B.A. Tapping, with brass bush	7d.	each
Filament Resistances		
First Quality	4/6	"
Second quality	3/6	"
Third quality	3/-	"

INTERVALVE TRANSFORMERS, Improved Design, Guaranteed. British made 29/- each
 Ivorine Scales, 0°-180° 1/-
 Terminals with washer and 2 nuts, 2/5 doz.
 Valve Holders 1/2 and 1/3 each
 Valve Legs, Brass, with 2 nuts, Set of four 8d., (per doz. 1/9)
 Double Head Phones, with cord
 Western Electric, 4,000 ohms, 32/-
 Superior French, 4,000 ohms, 35/-
 Carriage paid on orders over £2.

ACCUMULATORS. Fully Guaranteed.

4 Volt 20 amp.	16/-
4 " 40 " "	18/6
4 " 60 " "	20/-
4 " 80 " "	20/6
4 " 100 " "	29/6
6 " 20 " "	22/-
6 " 40 " "	26/6
6 " 60 " "	32/-
6 " 80 " "	38/6
6 " 100 " "	42/-

60 Volt High Tension Batteries, 3 Volt Steps, 15- and 19/6.
 Carriage Forward.

3-VALVE RECEIVING SET £17 10 0

CARRIAGE PAID.

SET COMPLETE WITH ALL ACCESSORIES, READY FOR USE, INCLUDING 60-VOLT BATTERY, 6 VOLT ACCUMULATOR, AERIAL WIRE, AND INSULATORS, AND ONE PAIR PHONES 4,000 OHMS. VALVES 45/- EXTRA.

WE GUARANTEE THIS SET TO BE OF THE HIGHEST EFFICIENCY

*COMPARE OUR PRICES.
YOU CANNOT GET BETTER VALUE*

MEN IN THE WIRELESS SERVICES DESIRING RAPID ADVANCEMENT
 should train in spare time with the College which ensures this
 "U.E.C." (Regent's Park, London, N.W.1) has in Twelve Years secured hundreds of successes by
 Individual Postal Training for Engineering Examinations and Professional Work.
 State YOUR ambition in confidence, to—SECRETARY'S DEPT. (Desk W.).
UNIVERSITY ENGINEERING COLLEGE, WESTGATE-ON-SEA, KENT.
 and expert advice with the New prospectus, No. 8, will be sent you without obligation.

CONTENTS *(Continued)*

A New Rectifier. By V. Bush and C. G. Smith	- - - - -	726
A Microphone Amplifier	- - - - -	729
The Equipment of 2 PV. By G. Smith Clarke	- - - - -	730
Notes	- - - - -	731
Calendar of Current Events	- - - - -	733
Wireless Club Reports	- - - - -	734
Questions and Answers	- - - - -	737
Share Market Report	- - - - -	744

THE WIRELESS WORLD AND RADIO REVIEW is published weekly on Saturdays.
 All correspondence relating to contributions should be addressed to THE EDITOR,
 THE WIRELESS WORLD AND RADIO REVIEW, 12-13, Henrietta Street, London, W.C.2.
 No responsibility can be taken for MSS. or photographs sent without stamps to defray
 cost of return postage.
 Editorial and Publishing Offices 12-13, Henrietta Street, Strand, London, W.C.2.
 Telegraphic Address: "Radionic, Rand, London." Telephone No.: Gerrard 2807.
 Advertisement Managers, Bertram Day & Co., Ltd., 9 and 10, Charing Cross, S.W.1.
 Telephone No.: Gerrard 8063 and 8064.

SUBSCRIPTION RATES.—

28s. per annum, post free. Single Copies 6d., or post free 7d.
 Registered at the G.P.O. for transmission by Magazine Post to Canada and Newfoundland.

HOLLOW STEEL MASTS FOR AERIALS

These masts are light, strong, easily erected, and will last a lifetime. All lengths over 15ft. are made in sections and each mast is supplied complete with baseplate, finial, rope cleat, pulley sheave, guy clips, three steel guy ropes and strainers, painted one coat ready for immediate erection. Being made of steel, no lightning conductors are required

PROMPT DELIVERY.

PRICES F.O.R. FOR CASH WITH ORDER, EACH

10ft. ...	32/6	15ft. ...	42/6	20ft. ...	45/-
25ft. ...	57/6	30ft. ...	84/-	40ft. ...	126/-

Other Lengths supplied at equally Low Prices.

Trade Inquiries Invited

THE WIRELESS STEEL MAST & ACCESSORY COMPANY
 Lombard Street West, West Bromwich Telephone No. 447

VALVES

DELIVERY FROM STOCK.

RECEIVING.

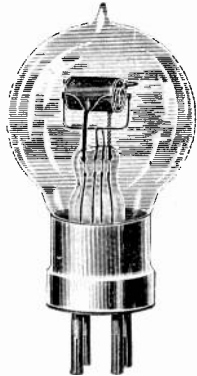

Type.	Filament Voltage.	Anode Voltage.	PRICE.
R	4	60	£1 6 6
R4B	4	50	1 10 0
V24	5.2	36	1 4 0
Q	5.2	50	1 4 0
		(150 as amplifier)	
QX	5.2	50	1 4 0

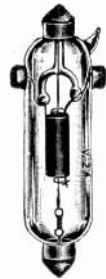

SPECIAL LOW TEMPERATURE VALVES.

Type.	Filament Voltage.	Filament Current.	Anode Voltage.	PRICE.
L.T.1	1.8	.4	36-50	£2 10 0
L.T.3	1.8	.11	„	„

TRANSMITTING.

Type	Filament Voltage.	Anode Voltage.	PRICE.
A.T.25	5.5	UP TO 1,000	£1 10 0
A.T.40X	7	„ 1,000	2 15 0

Visit our Stand No. 32. All British Wireless Exhibition, Horticultural Hall, September 30th to October 7th

THE
MARCONI SCIENTIFIC INSTRUMENT CO., LTD.

40 DEAN STREET, SOHO, W.1

TELEGRAMS: THEMASINCO, WESTOENT
 TELEPHONE: GERRARD 774

WATES

ONE-VALVE PANEL

—An Excellent Investment—

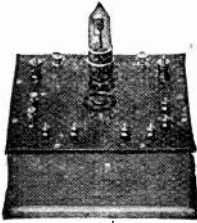

PRICE (without valve) £4

“WRITTLE comes through quite loudly and as clear as a bell. EIFFEL TOWER is apparently a near neighbour.

The wide range and clearness both in Morse, Music and Speech means that the Single Valve Panel of your own make, which I bought of you three weeks ago is well thought out and carefully put together. With proper accessories the panel makes a set entirely sufficient for the average listener-in.”

(EXTRACT FROM UNSOLICITED TESTIMONIAL).

An Ideal Valve Accumulator

6-Volt 50-amp. PRICE 35/-. Carriage 3/-
(In wooden case with leather strap handle)

4-Volt. 50-amp. PRICE 24/-. Carriage 2/-

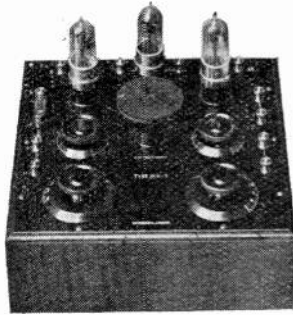

3-Valve Panel

WATES THREE-VALVE PANEL, 1 H.F., 1 Rect. 1 L.F. Complete with Condensers, Filament Rheostats, in handsome Mahogany Cabinet as illustrated. PRICE, without valves or plug-in transformer, £14 14 0. H.F. Transformer for broadcast wavelengths, 5/6 extra.

Why not call at our Showrooms and inspect our varied display of complete sets, also have them demonstrated to you?

Visit our Stand No. 15. All British Wireless Exhibition, Horticultural Hall, September 30th to October 7th.

We invite your attention to our Illustrated Advertisement on page xxvii this issue.

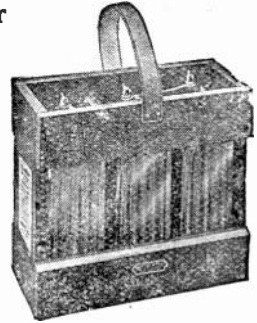

SEND THREE STAMPS FOR ILLUSTRATED CATALOGUE

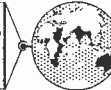

MANUFACTURING

FOR THE
TRADE

We specialise in the manufacture of **WIRELESS** and **INSULATING** parts, and solicit your enquiries.

The production of Variable Condensers, Handles, Resistances, etc., is being continued and we can deliver large numbers **FROM STOCK**

J. BURNS, LIMITED,
Chadwell Heath, Essex.

DAVIS & TIMMINS,

LIMITED.

34a, York Road, King's Cross, N.1

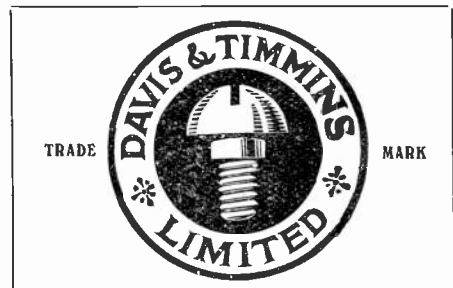

**SCREWS & TERMINALS
FOR WIRELESS SETS.**

TRADE ENQUIRIES INVITED.

Tele. No.: NORTH 580.

Telegrams: CONDUCTIVITY, LONDON.

THE WIRELESS WORLD AND RADIO REVIEW

THE OFFICIAL ORGAN OF THE WIRELESS SOCIETY OF LONDON

VOL. X. No. 23. SEPTEMBER 2ND, 1922.

WEEKLY

Practical Data for Building the Armstrong Super-Regenerative Circuit

By EDGAR H. FELIX, Associate I.R.E.

AS soon as Major Armstrong demonstrated his discovery of the super-regenerative circuit before the Institute of Radio Engineers, there was an immediate rush to build sets embodying the principles he had explained. "As soon as" is not exaggeration, for at the close of the meeting several enthusiastic engineers hailed taxicabs and hastened to their laboratories to try the new circuits.

Lacking detailed information as to constants of circuits, many of the most skilled engineers have had difficulty in getting satisfactory results.

Since the article¹ describing the super-regenerative circuit appeared in *The Wireless World and Radio Review*, I have received letters from British amateurs requesting constants of the various instruments used in the circuits. Because of their desire for information, I here describe in detail the set built by Major Armstrong and used for demonstration at the Institute of Radio Engineers. Fig. 1 is a photograph of the equipment.

The set employs three valves and secures results approximating those obtainable with a super-heterodyne set employing ten valves. Of the super-regenerative circuits, it is the most easily operated because each function

of the circuit—regeneration and amplification, variation of negative resistance and detection—is performed by a separate valve and a separate valve circuit, each adjusted independently of the others.

It is inadvisable for an amateur to attempt the operation of a super-regenerative set except he be thoroughly familiar with the operation of an ordinary regenerative circuit. Super-regeneration adds a new series of sounds. The amateur must learn to recognise these and become experienced in making the proper adjustment called for by each sound. With the three valve circuit it is less difficult to analyse the cause of these and make the proper adjustment to correct them than it is with sounds representing frequencies caused by the interaction of the various circuits combined in one or two valves.

Major Armstrong recommends that super-regeneration be attempted only with a loop antenna. In adjusting the circuit, numerous frequencies which interfere with reception by other stations are radiated from an antenna. Therefore, the suggestion that an antenna for receiving with the Armstrong super-regenerative circuit should not be used and that the loop should be employed.

Only "hard" valves should be used—that

is, valves without any appreciable gas content. Since the limit of amplification with this circuit is the maximum output of the valves themselves, five-watt power valves are recommended instead of receiving valves.

In my first article, explaining the principles of the circuit, I stated that the efficiency of the super-regenerative system increases inversely as the square of the wavelength. The upper limit of satisfactory working is 1,000 metres. Extraordinary efficiency is obtained on the 360 metre wave upon which

coupler. A typical vario-coupler is $3\frac{1}{2}$ inches in diameter with a winding of 100 turns tapped at each ten turns.

The amplifier or regenerative valve circuit includes the secondary vario-coupler, shunted by a variable capacity. The rotor of the vario-coupler is used as the reaction or feed back coil. The reaction coil should be double the usual inductance of a reaction coil. 125 turns of 26 wire is satisfactory for the purpose.

The variable capacity, C_1 , for tuning, is of 0.001 mfd. capacity. Nevertheless, half that

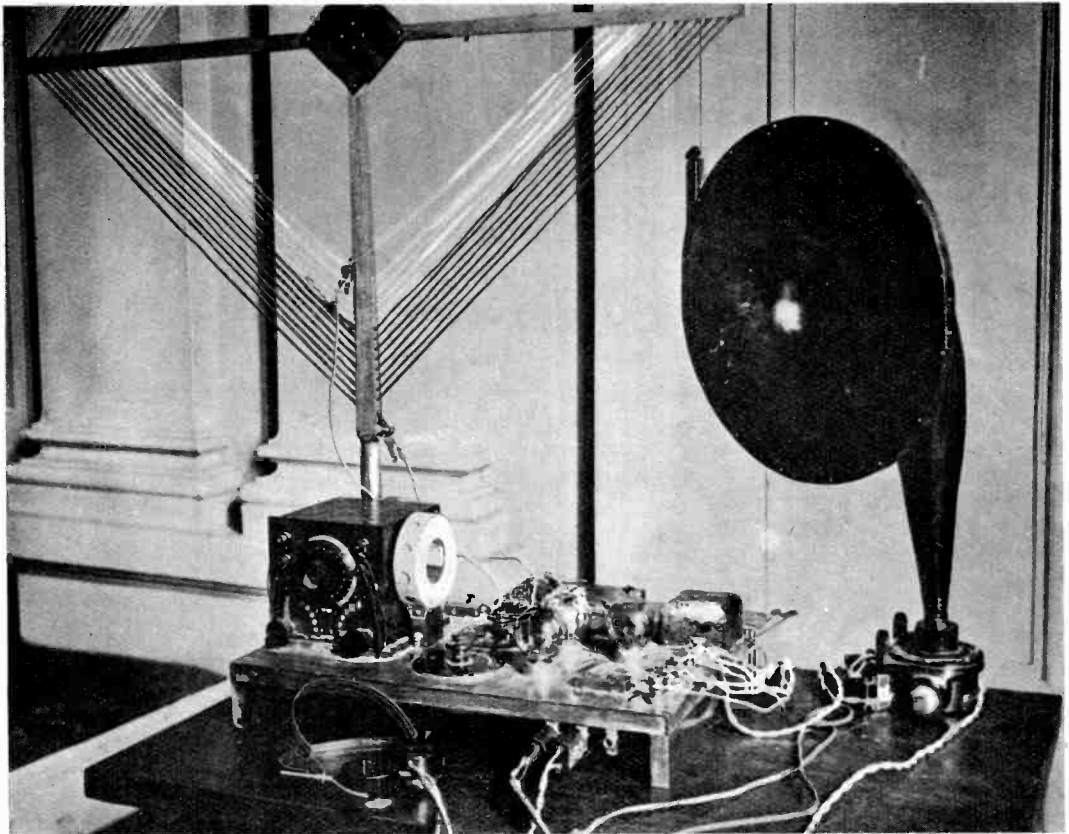

(Photo by courtesy American Radio Journal.)

Fig. 1. Receiving Set embodying the Super-Regenerative Circuit.

American broadcasting operates. At 50 metres efficiency is greatly augmented.

Fig. 2 is a diagram of Major Armstrong's receiving set. The loop in these tests consists of ten turns mounted on three foot square frame.

The tuning element consists of the stator of the conventional vario-coupler. The one shown in the photograph is a "Grebe" vario-

capacity is sufficient with most sets. A negative battery, B_1 , is substituted for the usual grid condenser and grid leak. This battery should be variable from zero to five volts, in order that the value most effective for the particular valve used may be determined.

Because of the periodic action of the oscillator valve in preventing the generation of oscillations by the oscillator valve circuit

and the consequent prevention of valve paralysis, unusually high plate voltages are used. The limit of plate voltage useable is determined by the voltage capacity of the valve itself. For this reason, use a plate battery supplying from 80 to 100 volts.

The oscillator valve circuit is coupled to the amplifier valve circuit through the tap at the top of the vario-coupler. In most cases, the best results are obtained by tapping the very top turn of the vario-coupler. However, if the utmost is desired, test each turn from the top to the fifth turn from the top after the circuit is operating properly. In some cases better results are obtained slightly below the top of the coil. The coupling to the oscillator circuit is completed by the filament connection.

by the second valve is determined by the adjustment of L_3 and C_3 . Once a proper value has been determined it does not require readjustment.

Major Armstrong uses a duolateral coil of 1,250 turns, shunted by a variable capacity of 0.0025 mfd.

The plate circuit of the oscillator valve is coupled to the grid circuit through C_2 , a variable condenser of 0.001 mfd. capacity. A 5 millihenry air choke coil keeps out the audio-frequency oscillations. The adjustment of C_2 determines the amplitude of the oscillations generated.

The plate potential for the oscillator valve is supplied through the filter circuit from the generator valve.

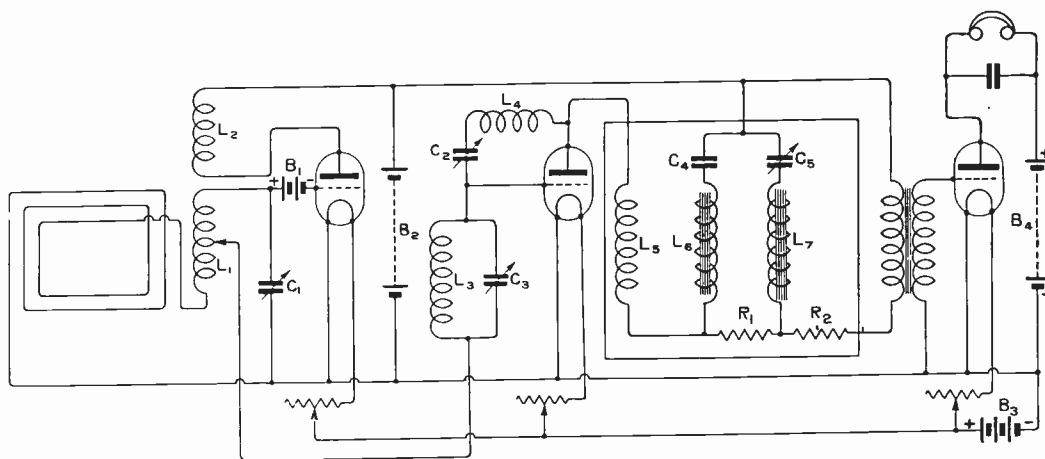

Fig. 2. Three-Valve Super-regenerative Circuit.
 L_1 = Tuning inductance.
 L_2 = Reaction coil.
 C_1 = Tuning condenser, 0.001 mfd.
 B_1 = Grid battery, 0.5 volts.
 B_2 = Plate potential battery, 80-100 volts.
 C_2 = Oscillator tube circuit coupling capacity, 0.001 mfd.
 L_3 = Oscillator inductance, DL. 1,250.

C_3 = Oscillator capacity, 0.0025 mfd.
 L_4 = Choke coil, 5 milli-henries.
 L_5 = Choke coil, DL. 1,500.
 L_6, L_7 = Iron core choke coils, 1 henry.
 B_3 = Filament lighting battery.
 B_4 = Plate potential battery, 200 volts.
 R_1, R_2 = Resistances, 12,000 ohms.
 C_4 = Fixed condenser, 0.005 mfd.
 C_5 = Variable condenser, 0.005 mfd.

In this circuit the negative resistance of the regenerative circuit is varied by changes in the positive resistance of the circuit. When the oscillator valve is conductive, it practically short circuits the secondary inductance; when the oscillation reverses in the oscillator valve circuit, its resistance rises to a high value.

The frequency of the oscillations generated

The filter circuit consists of a 1,500 turn duolateral coil in series with two 12,000 ohm non-inductive resistances. Two iron core choke coils of one henry inductance, in series, respectively, with a 0.005 fixed capacity and a 0.005 variable capacity, complete the filter circuit. Satisfactory results may be obtained without choke coil L_6 . Any suitable

filter circuit may be substituted for the one shown in Fig. 2. For this reason it is enclosed with lines.

The output of the generator and oscillator valve is supplied to the usual audio-frequency transformer, which, in turn, makes the audio-frequency currents available to the detector tube. The detector circuit is conventional, except that an unusually high plate potential is supplied by a 200-volt plate battery.

The first adjustment in operating this circuit is tuning to the incoming signal by means of C_1 . The oscillator valve is then set into action by a correct adjustment of C_2 . The reaction coupling is gradually increased as soon as the familiar click, indicating that oscillations are being generated by the oscillator valve is heard in the telephone receivers. A re-adjustment of C_1 is usually required to effect more exact tuning. Adjustments of C_3 and C_5 need be made only once; when the correct values are found no subsequent adjustment is necessary.

In some cases, a reversal of the filament lighting battery, B_3 , improves the signal strength. If satisfactory results are not obtained at a time when the circuit is otherwise operating properly, try reversing the battery connections.

Fig. 3 shows a super-regenerative circuit in which all the functions are performed by a single valve. This circuit was set in operation in a steel frame building, 25 miles distant from the nearest broadcasting station transmitting at the time of the test. Employing a loop antenna, the signals received were so loud that they completely "paralysed" the head telephones. Using a loud speaker, music was easily heard in all parts of a large lecture hall.

This circuit requires the utmost delicacy of adjustment and it will satisfy the most insatiable appetite for feats of technique in adjustment. The same vario-coupler as previously described was used for L_1 and L_2 ; L_3 and L_4 are duo-

lateral coils of 1,250 and 1,500 turns respectively, shunted by 0.005 mfd. variable capacities. The plate potential is 80 volts. C_4 is fixed of 0.005 capacity; C_5 of 0.001 capacity; the resistances are 12,000 ohms; the iron core choke of one henry inductance.

No doubt within a few months hundreds of successful super-regenerative receivers will have been built by amateurs and descriptions of simpler circuits and more specific data will be available. Although considerable patience is required in learning to adjust the circuit, the almost incredible results obtainable make the effort well worth while.

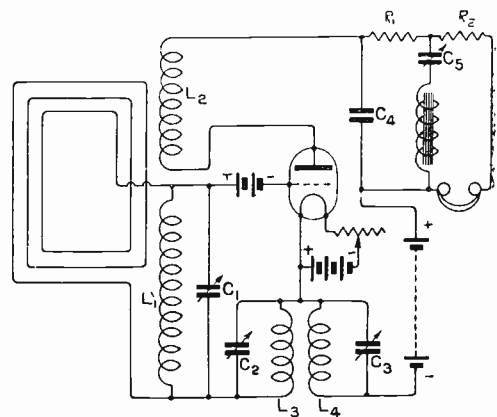

Fig. 3. One Valve Super-regenerative Circuit.

L_1 = Tuning inductance.

L_2 = Reaction coil.

C_1 = Tuning capacity, 0.001 mfd.

C_2 = First oscillator circuit capacity, 0.005 mfd.

L_3 = First oscillator circuit inductance, DL.1,250.

C_3 = Second oscillator circuit capacity, 0.005 mfd.

L_4 = Second oscillator circuit capacity, DL.1,500

C_4 = By-pass capacity, 0.005 mfd.

C_5 = Filter circuit capacity, 0.001 mfd.

R_1, R_2 = Resistances, 12,000 ohms.

DO NOT FORGET THESE DATES!

SEPTEMBER 30th TO OCTOBER 7th, 1922

The Wireless Exhibition and Convention

AT THE HORTICULTURAL HALL

WESTMINSTER, S.W.

Experimental Station Design

Continued from page 662, August 19th, 1922.

These articles, which appear in alternate issues, are intended not only to be a complete guide to those new to wireless, but to give explicit details on the construction of all the components of the Experimental Station. Actual designs are of necessity in some instances be somewhat crude, in order that they can be made up without elaborate workshop equipment. Practical working instructions are given where necessary for the help of those unacquainted with the more simple processes of instrument making. Of course, where good workshop facilities exist, the designs may be readily modified.

Economy is made an essential feature, bearing in mind always that where low-priced component parts can be obtained their use has been embodied in the designs. For those who do not desire to make their own apparatus, the descriptions will assist them in selecting the equipment for their stations.

The information contained in the first few articles under this heading is to help those new to wireless and whose first aim is to build a simple set capable of receiving broadcasted telephony, and consequently may cover ground already familiar to many readers. The succeeding instalments, however, advance by easy stages, and in the course of the series the construction of an elaborate station will be evolved.

XI.—HIGH FREQUENCY INTERVALVE TRANSFORMERS.

WHEN great receiving range is desired it is necessary to adopt amplification at radio frequency, that is, the amplitude of the oscillations is increased prior to rectification by the detector valve. High frequency amplification does not produce such an increase in signal strength for each high frequency valve circuit added as low frequency amplification. The former will bring in signals though perhaps weak, which any amount of low frequency amplification alone would not render audible, because a certain oscillation strength is required to operate a detector valve.

One of the simplest forms of H.F. transformer is shown in Fig. 1. This consists of two basket coils of the type described on page 328, June 10th, 1922, issue. The coils are held together by means of a small bolt passing through the centre which also serves as a support. Two coils, one for primary and one for secondary, will give a transformer suitable for use on wavelengths of about 220 metres, whilst two coils in series for the primary, and two for the secondary, is suitable for wavelengths of 300-450 metres. A piece of waxed paper should be placed between the coils and when four or more coils are used primary and secondary coils should be assembled alternately, taking care that the direction of winding is not reversed in consecutive primary or consecutive secondary coils. A good way of doing this, when assembling four coils, is to lay them out with their beginning ends all pointing in the same direction. Two coils are then lifted, one over the other, a hole being pierced in the top one for the purpose of passing through the inside end of the lower one. Another coil is then pierced with two

holes, turned over, and placed on the other two coils passing the two inside wires through the holes. The lead which passes from the bottom coil is then connected to the inside lead of the

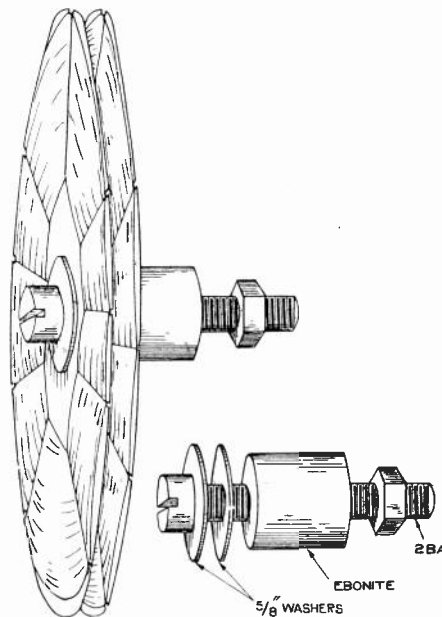

Fig. 1. Transformer consisting of two basket coils wound on card support and clamped together.

third coil and the joint wrapped with insulating material. The last coil, having one hole pierced in it, is then turned over and placed on the other three with the inside lead from the second coil passing through the hole. This lead is then connected to the inside lead

of the last coil and insulated. The insulating paper must, of course, be placed between the coils as they are assembled. A 2 B.A. brass bolt now passed through the centre, taking care to avoid the connecting wires, will clamp

the coils closely together and provide tight coupling. It is desirable, in high frequency transformers, that they shall have reasonably

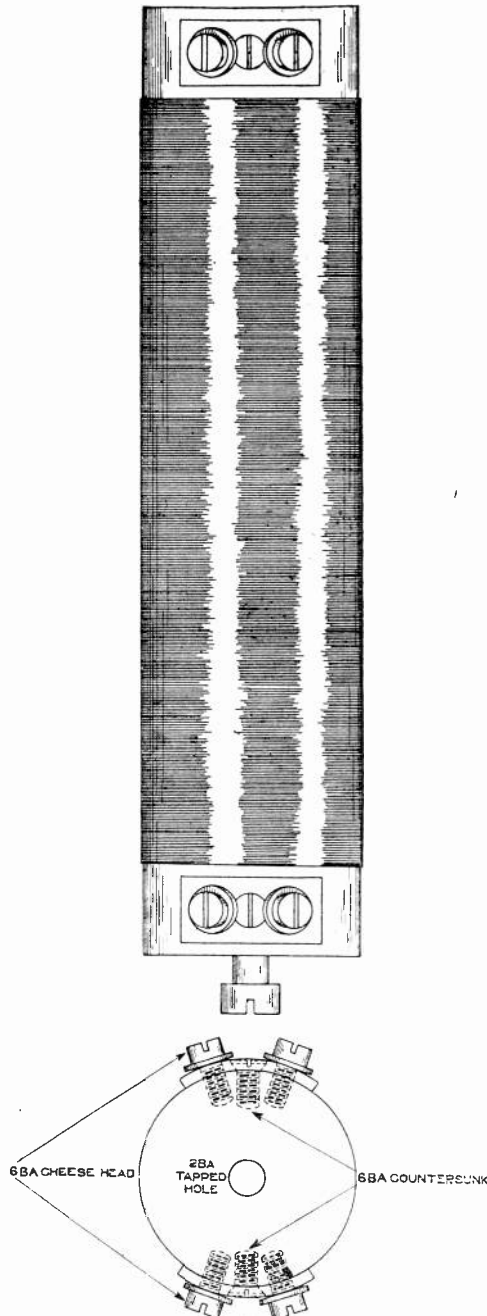

Fig. 2. The single layer type, wound on ebonite rod.

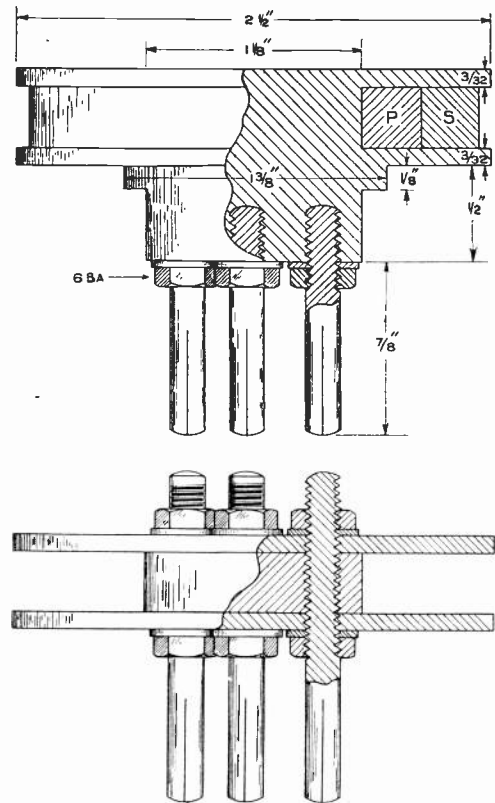

Fig. 3. Two types of interchangeable H.F. Transformers.

low self capacity in order that they may operate over as wide a band of wavelengths as possible. Basket coils are well known to possess very low self capacity whilst the method of assembling just described eliminates any appreciable increase in self capacity owing to the spacing between consecutive primary or secondary coils. On the other hand, the particular arrangement not only gives very tight coupling but gives maximum capacity between primary and secondary windings which is a very desirable property in H.F. transformers. Insulation between primary and secondary is very important as there is a difference of potential between them equal to that of the H.T. battery, and the particular design permits of good insulation being ensured.

The method of connecting high frequency transformers in circuit is shown in most of the very many circuits given in this journal,

but the direction in which the windings are connected up is important, in order to obtain maximum grid potential fluctuation and also to provide maximum capacity coupling between plates and grids of consecutive valves.

be slightly broadened by winding with No. 44 S.W.G. or finer, S.S.C. resistance wire. Fine resistance wire is somewhat stronger than copper wire of a similar gauge and hence its use may be recommended as it is not so difficult to handle. A primary and secondary,

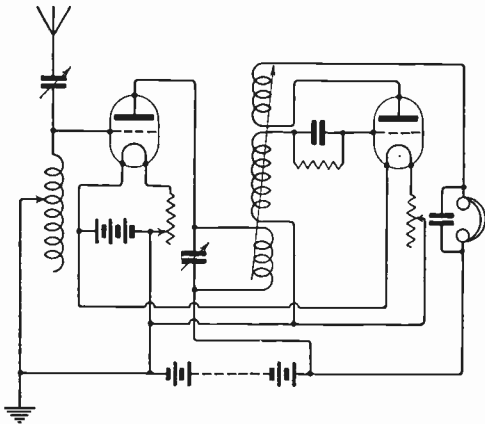

Fig. 4. A non-radiating circuit. The reaction coil is coupled to the H.F. Transformer windings.

In the case of the transformer just described, all leads will pass out from the outer edges of the coils. The lead from the first coil is taken to H.T. +, the lead from the next to L.T. - or potentiometer or in special circumstances to the L.T. +, the next to plate and the last to grid.

A high frequency amplifier making use of several high frequency valve circuits must have its transformers of such a design that they can be relied upon to all have identical inductive values or otherwise, one slightly different to the remainder, will filter out signals on which the others would give best amplification. H.F. transformers consisting of basket or single layer coils can be relied upon to be identical. In the case of windings that are run on into slots, the inductance will depend not only on the number of turns but very considerably upon the method and tightness of the windings, consequently it is only possible to give accurately, transformer windings for particular wavelengths when of the type described above or in the form of single layers.

Another type of transformer is shown in Fig. 2. The former on which the windings are arranged is a piece of $1\frac{1}{8}$ ins. diameter polished ebonite rod. The windings terminate on screw tags and consist of single layers of fine single silk-covered copper wire, between 36 and 42 S.W.G. The wavelength range can

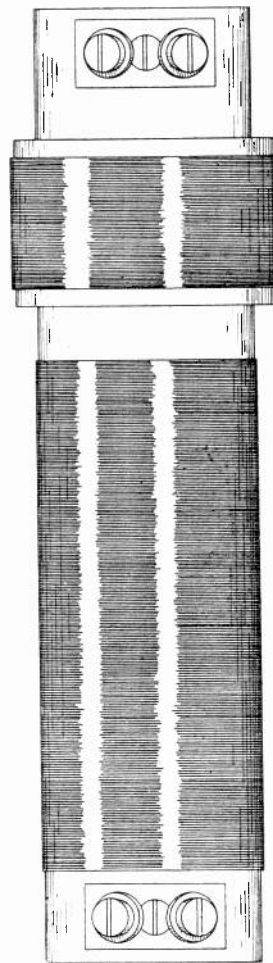
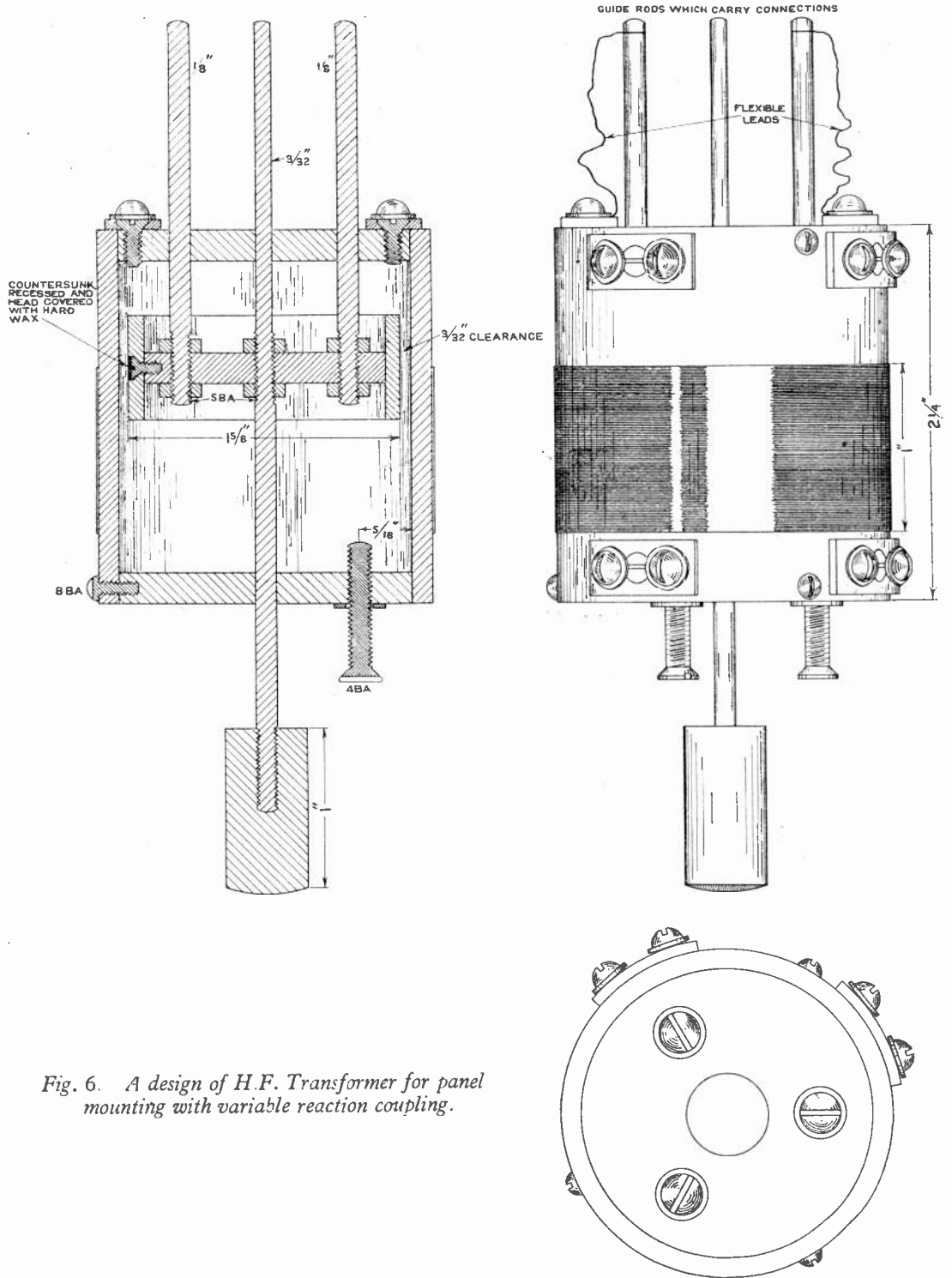

Fig. 5. Transformer with reaction coil

each of 280 turns, will give good amplification on wavelengths between 200 and 350 metres, whilst 450 turns is suitable for 300-500 metres, and 600 turns has an optimum wavelength of 600 metres. More than 600 turns in the form of a single layer will produce a transformer of excessive length and for greater wavelengths 2 ins. or $2\frac{1}{2}$ ins. ebonite tube must be used. With this style of transformer the two windings should be insulated from one another with a single layer of empire cloth, and both wound



in the same direction. The leads which terminate at one end are connected to grid and plate.

Mention might be made of the type of transformer which has now become very popular, having a slot to carry the windings and a four-pin base for the purpose of rendering it interchangeable with others (Fig. 3). With this type of transformer it is much better to wind the primary and secondary separately instead of running the two wires on together, in order to maintain good insulation between primary and secondary as mentioned above. The two windings should be in opposite directions, the two leads which pass out between the windings being taken to grid and plate.

A type of transformer giving very good results can be made with the use of a coil winding machine by running on two wires simultaneously. Care must be taken to avoid the wires crossing, and if primary and secondary wires are of different colours the winding can be easily watched. Thus wound each successive turn of the primary winding is spaced with a turn of the secondary and consequently the self capacity is kept as low as is possible, whilst the capacity between the two windings is a maximum. If the transformer is of a mean diameter of $1\frac{1}{8}$ in. and has primary and secondary each of 120 turns of No. 28 D.S.C., it will be suitable for operation on wavelengths between 300 and 470 metres. The two leads passing from the outside of the transformer are for connection to grid and plate. This type of transformer can be conveniently mounted between ebonite discs as shown in the lower drawing in Fig. 3.

Apart from the advantages already mentioned, H.F. amplification permits of the provision of inductive reaction in a receiving set without causing radiation. This is effected by providing a H.F. transformer between the first and second valves, to the windings of which is coupled a coil connected in the plate circuit of the second valve, as shown in Fig. 4. By extending the length of the transformer shown in Fig. 2, in order to allow a space of one or two inches free of winding and slipping over the transformer, a closely fitting ebonite tube carrying a single layer winding (Fig. 5) reaction can be arranged on to the transformer windings as indicated in the circuit diagram. With such an arrangement the secondary should be the outer winding of the two windings on the rod. The leads to the

connectors can be buried in grooves cut in the surface of the former and filled in with hard black insulating compound.

An alternative design is shown in Fig. 6, so arranged that the extent of reaction can be readily varied when the transformer is mounted in the panel of a receiver. It is not necessary to give constructional advice in the making of this instrument, as the drawing is sufficiently detailed and the methods of working ebonite and brass have been explained in previous articles under this heading. Attention might be drawn, however, to the great care necessary in drilling and tapping the thin walls of the ebonite tube. The grid circuit winding is beneath the primary, both windings being in the same direction. The grid and plate connections are taken from the front end of the transformer. For a wavelength range of 300-450 metres, 170 turns of No. 38 S.S.C. is suitable for primary and secondary windings. When it is intended to tune the primary with a low capacity condenser which, it might be mentioned, should be of the air dielectric type, with a capacity of not more than 0.0002 mfd., the secondary or grid circuit may consist of an additional 20 turns to the number on the primary. The reaction coil should be wound with 120 turns of No. 42 S.S.C. Modifications in the dimensions of the formers can be made to suit various wavelengths up to 2,000 metres, beyond which the resistance capacity method of intervalve coupling is usually adopted.

F.H.H.

A Broadcasting Concert Platform.



Miss Olive Jenkins, the famous Cornish Soprano, broadcasting from Marconi House, accompanied by Signor Mancio de Veroli.

A Broadcast Receiver

Continued from p. 683 of issue of August 26th, 1922.

By A. J. BULL.

A glance at the photograph of the instrument, back view, Fig. 5, may assist to convey the idea of the spacing. Having wired the filament circuits, the intervalve transformer should be fixed in the position over the H.F. valve, as indicated in the double page diagram (pp. 680—681 of August 26th issue). A simple method of doing this with most transformers is to obtain a piece of brass, 4 ins. long \times $\frac{3}{8}$ in. wide \times 1/16-in. thick.

angled brass in position, it should stand out $3\frac{1}{4}$ ins. perpendicular to the panel. To this the transformer is secured by means of two 4 BA screws. Underneath this transformer on the opposite side a 0.001 mfd. fixed condenser is fastened to the angle brass by a single 1-in. 4 BA screw. This screw first passes through the insulation of the condenser as shown in the top right-hand corner of the double page diagram. The function of this condenser, which is con-

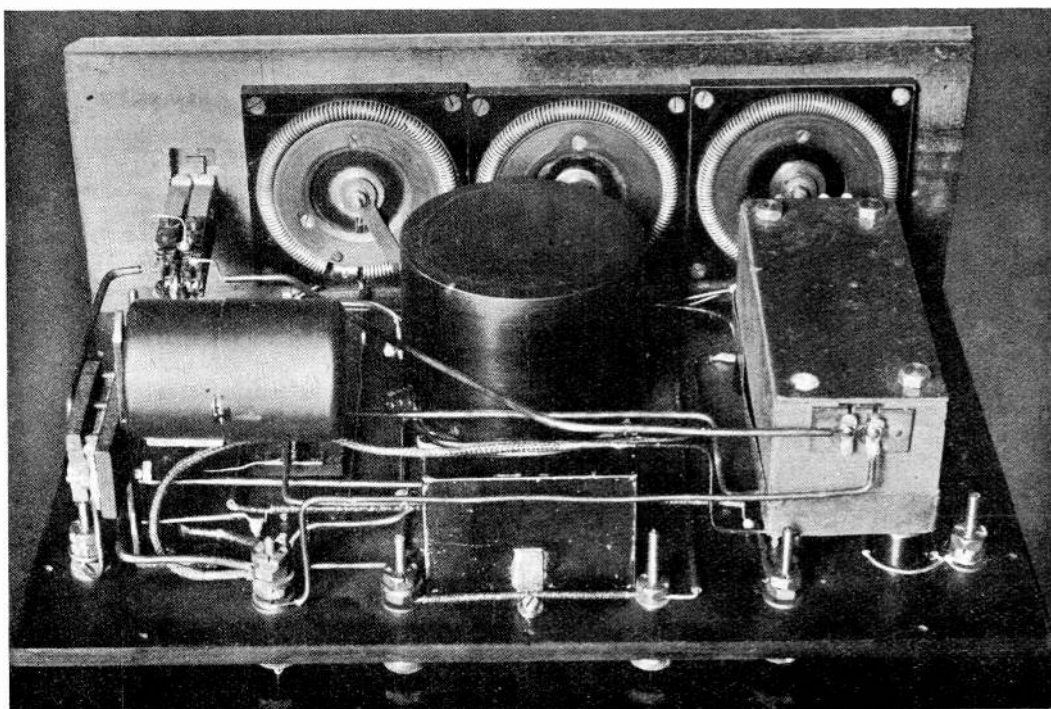

Fig. 5. Inside view of the instrument.

Measure off $\frac{3}{4}$ in. and make a right-angle bend. In the $\frac{3}{4}$ in. portion of the brass, drill two holes to take two 4 BA screws. With a 7/64-in. drill, bore two holes nearly through the ebonite panel in the position shown near the grid socket of the H.F. valve. As the reader views the panel in the double page diagram, this position will appear as about $3\frac{1}{2}$ ins. immediately above the sketch of the Dewar switch.

As stated earlier in the article, by drilling with a 7/64-in. drill, the 4 BA screws may be made to cut their own thread in the ebonite, thus ensuring a tight fit. Having screwed the right-

connected across whichever transformer is switched in circuit, is to provide a path for H.F. currents; when the reaction coil is employed, which current would otherwise be stopped owing to the impedance of the transformer.

The telephone transformer now calls for consideration. This can be secured to the panel in a manner similar to that followed for the intervalve transformer, or by a method to be now described. The transformer depicted in the full-sized diagram near the telephone terminal is a captured German one, purchased from disposals, and is enclosed in

an iron case, which case provides a return path for the flux.

Four iron bolts, $2\frac{7}{8}$ ins. long, threaded 4 BA for $\frac{1}{4}$ inch, pass through the case at the corners into the ebonite panel to a thread cut to receive them. Four spacing washers of ebonite $\frac{5}{8} \times \frac{1}{2}$ in. diameter, through which the bolts also pass, space the transformer $\frac{5}{8}$ in. from the panel. In place of the telephone transformer, however, a pair of H.R. telephones could be inserted in the circuit. The disadvantage of doing so is that, if 60 or 80 volts plate potential are employed, an unfair strain is placed on the insulation of the telephone windings.

Although there are losses in all transformers due to magnetic leakage the author is of opinion that for experimental work with the thermionic valve, a pair of L.R. telephones, say 60 ohms each earpiece, of good make, employed in conjunction with a properly designed transformer, is efficient and most economical for the experimenter.

The statement of the dealer, therefore, that "any old transformer will do," should not be accepted.

A very good combination is a pair of Brown's 60 ohms telephones and a "valve to telephone transformer" from a service C. Mark III amplifier. The excellent results obtained with this combination is largely due, I believe, to the fact that the impedances of the two components are of a similar value.

An experiment was made somewhat hurriedly by the writer and two independent observers, to ascertain to what degree signals would be reduced in strength. An ordinary crystal set was employed in the test. The comparison was made between a transformer with L.R. telephones and three pairs of H.R. telephones, switched separately in circuit. Observations were made with very weak signals and all listening failed to detect any appreciable difference in signal strength.

To return to the instrument under construction. The variable condenser should now be fixed in position by means of suitable screws, and if a condenser from a Mark III receiver is employed it is advisable to slightly raise it off the panel, so as to permit of any wiring as shown in pp. 680-681 being passed between it and the panel. Four ebonite washers, approximately $\frac{3}{8}$ in. diameter $\times \frac{1}{8}$ in., will serve this purpose. The twelve terminals, two-way switch, coil plug for H.F. circuit, 0.0002 mfd. grid condenser and leak, 0.03 mfd. condenser, and all wiring should now be added, the

four wires, *A, B, C, D*, being left until last. The particular lugs of the switch to which these four wires, *A, B, C, D*, should be soldered, may not be clear at first sight to some, and therefore the following method of procedure may prove helpful.

First, check the position of the switch in the panel. The correct position is as indicated in the full-sized diagram, viz., the four screws in the switch being visible, as shown. Fig. 6 is an end view of the Dewar switch, and for clearness the lugs are shown as circles. The end of the actual switch should now be compared, side by side with Fig. 6, and a mental note made that *D* and *B* are two of the longest springs in the switch.

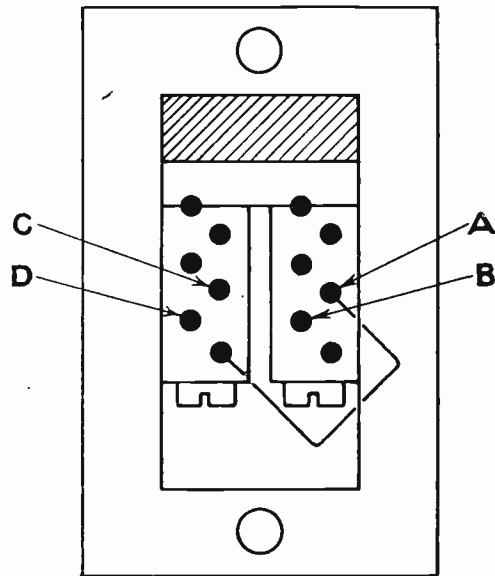

Fig. 6. Enlarged end view of Dewar switch showing connections.

The next step is, with the switch in the neutral position, to trace out on the instrument the path the wires *D, C*, are to follow.

The track is from H.T. + to primary of telephone transformer through the primary of the transformer to the lug *D* on the switch, thence through the tiny contact on *D* to lug *C*, and finally to the plate terminal of the third valve.

Follow the same method with wires *A, B*, and trace from H.T. + to primary intervalve transformer, through the transformer to lug *B*, thence through the contact on *B* to lug *A*, thence to the reaction terminal thence through the strap bridging the two reaction terminals, and finally to the plate terminal of the detecting valve.

These connections *A*, *B*, *C*, *D*, must be well spaced, and it is advisable to use comparatively stiff wire. One strand of No. 7/22 phosphor bronze aerial wire meets the purpose admirably, sleeving insulation being employed as in the case of all the other wiring.

With the exception of the coil holder, the instrument is now practically finished, and it is left to the constructor's good judgment to add those little details which will help to give a professional appearance to the instrument.

For those interested in building the instrument by three stages, Fig. 2b. p. 679 was prepared. This diagram shows the panel and *only* the wiring connections of a single valve. A few minutes' comparison between Figs. 2b and the full-sized diagram pp. 680 and 681 should enable the reader to realise that the H.F. valve can be added to the panel without disturbing to any appreciable extent the wiring seen in Fig. 2b.

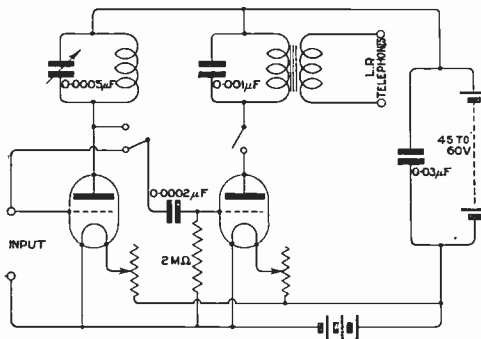

Fig. 7. Circuit diagram with two valves.

The only alterations are :—

The grid leak should be disconnected from the wire connected to terminal *A*, Fig. 2b, and transferred to terminal *E*.

The wire connecting terminal *A* to the grid condenser is to be disconnected at the condenser end, and joined to the grid of the H.F. valve.

The wiring of the H.F. circuit can then be proceeded with. This wiring should be traced and reasoned out from the full-sized diagram, pp. 680 and 681 and Figs. 7 and 2b. The following are the parts required to complete the high frequency valve circuit :—

- 1 Filament resistance.
- 1 Valve socket.
- 1 Two-way switch.
- 1 0.0005 mfd. variable condenser.
- 1 Standard plug as shown on panel in Fig. 1.
- 1 0.03 mfd. fixed condenser.

From the experience gained in the building of the first and second valve in the panel, there should be no difficulty in adding the remaining valve and circuit if the full-sized diagram is again referred to, this time in conjunction with Fig 3, p. 679, and due care is exercised with the wiring of the Dewar switch.

OPERATION OF THE SET.

Before passing to the operation of the instrument a few remarks are thought necessary with regard to the following :— Coilholder and coils, valve adaptor and the alternative use of a non-inductive resistance for the H.F. circuit.

In order that coils of the duo-lateral, Burndept, or similar types may be employed for the aerial and reaction circuit respectively, a coilholder must be provided. This is a device for supporting two or three coils, usually in a vertical plane, as can be seen in Fig. 1, p. 678, one coil being plugged to a stationary position, and the other pivoted, and capable of turning about a vertical axis through an angle of 90 degrees.

There are several designs of coil-holders advertised for sale ready for attaching to instruments. As, however, throughout this article it has been considered that the reader wishes to construct his set as cheaply as possible, with due regard to efficiency, the following suggestion is given for the construction of a coil-holder to accommodate two coils, with space for the addition of a third coil if required.

Two standard coil plugs, as shown in Figure 1, p. 678, should first be obtained, together with an ebonite rod about 6 ins. long by $\frac{1}{2}$ in. in diameter, one ebonite knob, two small brass terminals, and a piece of brass rod, $\frac{1}{4}$ in. in diameter by $1\frac{1}{4}$ ins. long. Having obtained these, prepare a piece of planed hard wood, 4 ins. in diameter by $\frac{1}{2}$ in. thick. By means of a tenon saw cut this into two semi-circular pieces, and if possible smooth the edges left rough by the saw.

Cut off a piece of the ebonite rod, $2\frac{1}{2}$ ins. long, and place a pencil mark on the rod, $1\frac{1}{4}$ ins. from one end, or in other words, at the centre of the rod. At points $\frac{9}{32}$ ins. on either side of this mark (in a direct line), bore holes through the rod, $\frac{1}{8}$ in. diameter.

By means of two screws which are provided with the plug, screw the plug to the ebonite rod through holes just bored. A brass terminal now be suitably cut down to form a pivot and screwed tightly into one end of the rod. This will increase the length of the rod

by about $\frac{3}{8}$ of an inch, the exact increase depending upon the type of terminal chosen for the purpose.

To the other end of this rod, the ebonite knob and $\frac{1}{4}$ in. diameter brass rod are fastened.

A simple means of doing this is to bore a small hole, $\frac{1}{2}$ in. deep, in the end of the ebonite rod, and into this hole screw tightly the shank of a Mark III or similar terminal from which the nuts have first been removed and the total length of the terminal reduced to $1\frac{3}{8}$ in.

The remaining end of the terminal which originally carried a thumbscrew, is soldered into a hole bored to receive it in one end of the $\frac{1}{4}$ in. brass rod.

An easy means of fastening the knob to this brass rod is to drill a hole, $\frac{7}{32}$ in. diameter full by $\frac{1}{4}$ in. deep in the knob, force the knob on, and secure in position by means of a $\frac{1}{16}$ in. pin passing through the diameter of the knob and rod. The two semi-circular pieces of wood should now be bushed, the bottom one to receive the pivot and the top one to allow the $\frac{1}{4}$ in. rod to pass through it. Simple bushes can be made from $\frac{1}{16}$ in. brass strip, measuring 1 in. by $\frac{1}{2}$ in., countersunk in the wood and held by wood screws.

The position of these and the rods carrying the plugs can be gathered by a consideration of the coil-holder shown in Fig. 1.

The stationary plug is secured to the remaining piece of ebonite rod by the same method as was adopted for the moving one, and fastened in a central position between the semi-circular pieces of wood by screws passing into its ends.

Having adjusted the length of this rod to suit the moving one, all that remains is to provide a backing piece of wood to fasten the semi-circular pieces to, and a $\frac{1}{4}$ -in. spring washer, to be included with the moving rod, in order to prevent it moving too freely.

After the coil-holder has been screwed in position on the end of the instrument, wire connections are made from the screws of the stationary plug to the reaction terminals and from the moving plug to terminals *A* and *B*.

COILS.

In order that a large range of wavelengths may be covered, it is recommended that for compactness, coils of the duo-lateral or similar type should be employed for the H.F. and aerial circuits respectively, and purchased from firms who guarantee the inductance of each coil supplied.

Possessed of this information, the experi-

menter can calculate with certainty the range of wavelengths covered with each coil and known condenser.

For those who wish to experiment with basket coils the dimensions of the spider shown in Fig. 8 is given.

The centre is $\frac{7}{8}$ in. by $\frac{3}{8}$ in. thick, the spokes are $\frac{1}{8}$ in. diameter and eleven in number. The complete spider can be constructed of metal with threaded spokes, or the hub may be of ebonite and the spokes of tapered wood, simply pushed into holes drilled in the periphery of the hub.

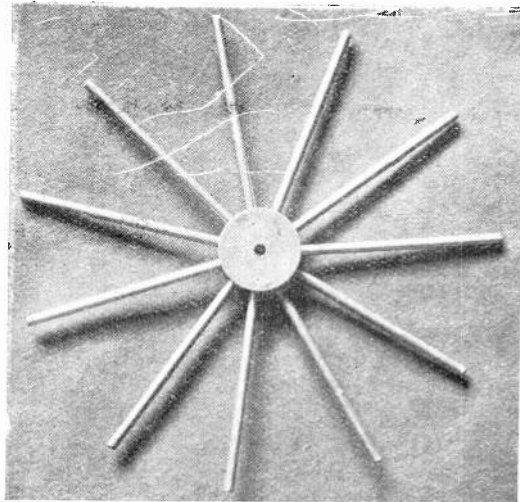

Fig. 8. Former for basket coil winding.

Obviously, if the dimensions of these coils are to be kept within reasonable limits, a wire of small cross sectional area must be employed. The disadvantage of employing a small wire however, is its resistance to high-frequency currents, for, as its diameter decreases, its resistance increases, resulting in damping and loss in signal strength. It is suggested, therefore, that the basket coils should be wound with No. 36 D.S.C. copper wire.

Using this gauge wire, and the above former, a coil wound to a diameter of $2\frac{7}{8}$ in. for use in the H.F. circuit, employed in conjunction with the 0.005 mfd. condenser functioning near its minimum value, gives a wavelength of 1,050 metres approximately. If, however, this coil is tapped at points 1 in., $1\frac{1}{4}$ in. and $1\frac{3}{8}$ in. radius, wavelengths to the value of 350, 450 and 600 metres respectively are covered.

These values are also obtained with the

condenser functioning near its minimum value.

However, it is reiterated that the purchase of coils is recommended.

VALVES AND VALVE ADAPTOR.

Suitable valves for use with the instrument are :—

A good French or V.24 for H.F.

A good French or V.24 for L.F.

A Qx, Q or captured German valve with cylindrical anode (shown in the photograph) for detecting.

For those who may have purchased captured German valves from the Disposal Board, the valve adaptor shown in Fig. 9 will be found useful.

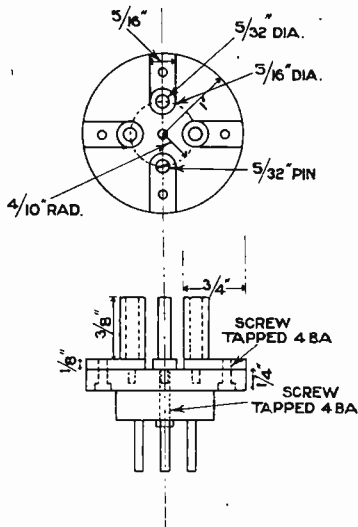

Fig. 9. Details of the adaptor for German type valve.

It is mentioned that the lower part of the adaptor is part of a broken French valve, otherwise the drawing is self-explanatory.

THE ALTERNATIVE USE OF A NON-INDUCTIVE RESISTANCE FOR THE H.F. CIRCUIT.

Experimenters who wish to avoid the trouble of tuning the anode circuit of the H.F. valve for wavelengths greater than 1,200 metres, should suitably mount a resistance rod of 0.05 megohms resistance and plug this in, in place of the coil.

This, however, will necessitate the disconnection of the 0.0005 mfd. condenser, which would otherwise shunt the resistance. With the introduction of this resistance, the

H.T. voltage must be raised to allow for the voltage drop across the resistance.

For example: Supposing that with the tuned anode circuit, a French valve is employed with 25 volts H.T., the valve functioning about the centre of its characteristic with zero grid potential and 0.7 milliampere flowing in plate circuit.

Now, in order to ensure that the valve shall function on its selected characteristic after the tuned anode circuit has been replaced by a resistance of the value mentioned, the plate voltage must be increased to 60 volts, owing to the fact that 35 volts is dropped across the resistance, viz., $C = 0.7 \text{ mA}$, $R = 50,000$ ohms, $E = CR$.

Therefore $0.7 \times 10^{-3} \times 50,000 = 35$ volts.

It is evident then, that this 35 volts must be added to the 25 volts which is required to force through the filament anode path the current of 0.7 mA.

RECEPTION.

As it is the ambition of many experimenters to receive the Dutch concert, a few hints as to the adjustment of the instrument for that purpose may be useful.

The aerial is connected to terminal A, and the earth wire in series with a variable condenser to terminal E. Suitable inductances are plugged in the coil-holder, their values depending upon dimensions of the aerial in use.

For the H.F. circuit, Burndept Coil No. 200 is recommended, if 0.0005 mfd. condenser is employed.

After the batteries and other necessary components have been connected, the switch on the front of the instrument is placed to neutral, the "two-way" switch turned to the left, and the strap bridging the reactance terminals opened. Proceed to switch the three filaments on (the H.F. valve not too brightly at first).

With the moving coil set at an angle of 45 degrees, rotate the A.T.C. and H.F. condenser simultaneously until the music is picked up. The filament current of the H.F. valve should then be gradually increased and coupling etc., adjusted for maximum signals, taking particular care that the set does not oscillate. If desired, and in order to reduce number of adjustments, the reaction coil can be shorted and the set brought to its most sensitive point (viz., just on verge of oscillation) by gradually brightening filament of the H.F. valve.

As a matter of interest to readers, it may be mentioned that the concert was received well in London on August 6th with the instrument described and a very poor aerial. There were three pairs of telephones in circuit. It was also quite good with two valves and the same number of telephones in use.

For the transition to the "two-valve" position, viz., one H.F. and one detecting, the Dewar switch is turned to upward position (opposite to the position shown in photograph) and the L.F. valve filament switched off. This last movement being optional.

It may be pointed out that the vacant terminals or lugs of the Dewar switch can be utilised for other switching combinations. For instance, for reversing the reaction leads,

etc., etc.; however, for the sake of wiring simplicity such refinements have been purposely omitted.

If now only one valve is required, viz., the detecting one, the Dewar switch is turned upwards, the two-way switch to the right, and the leads to the reaction terminals reversed.

If it is desired to add the L.F. valve behind this one the Dewar switch is replaced to neutral position and last valve filament switched on.

In conclusion, the writer hopes that he has not been over explanatory and trusts that this article may be of use, especially to those amateurs who make use of the "Questions and Answers" column of this journal.

An Experimental Wireless Station

By G. W. MORTIMER.

THE accompanying photograph shows my wireless station at 1, King Street, Yeovil. As it might interest other amateurs I give a short description as follows:—

At the right of photograph is a single valve set with loose coupler, using V24 or "R" valves and also arranged for crystal reception should the accumulators fail at any time. In the centre of photograph can be seen the set I have just completed, using two valves and honeycomb coils for tuning. This set is extremely good, and signals are sometimes too loud to keep the telephones on your head. It is arranged to use either two V 24 or "R" valves. Those seen in photo are one French "R" and Ediswan EC2, this combination giving good results. The two large coils shown on the set are specials for the Dutch concert, etc., the usual coils, eight in number, are seen at the extreme left of photograph in front of the

H.T. battery box. On the top of the battery box is a short wave crystal set on which I get ships, etc. All the apparatus is of my

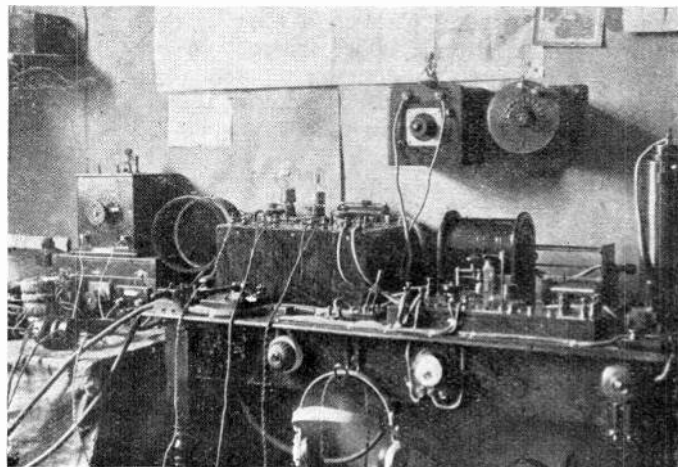

own construction with the exception of telephones, which are Brown's 4,000 ohms, I can get all the usual stations, telephony, etc., quite loud.

A New Rectifier

By V. BUSH and C. G. SMITH.

The following abstract of a paper presented to the Institute of Radio Engineers, New York, describes an entirely new form of rectifier with cold electrodes. The tube is developed from the phenomenon that in order to produce ionisation there must be sufficient space between electrodes to allow collision to take place. If the electrodes are arranged close together, collision may still take place if the mean free path is extended by the application of a magnetic field.

THE purpose of this paper is to introduce a new form of rectifier. Briefly described, it consists of a pair of electrodes surrounded by a moderate pressure of gas, the conduction between the electrodes being definitely under the control of a magnetic field. The electrodes may both be cold, as thermionic emission is not utilised. The device has no definite current limit, except such as is imposed by the heating due to losses. It is adapted for high voltage purposes and has a very long life.

Only one of the simplest forms of these tubes will be described and its theory developed, for a complete analysis is very involved. However, such theory as is here presented can be quite accurately checked with such a tube of the type to which it strictly applies.

Gaseous conduction between electrodes in a gas at low pressure is usually considered an erratic and unreliable phenomenon. When such conduction takes place in a glass tube with widely separated electrodes, the phenomenon decidedly earns its undesirable reputation. The problem in the development of this rectifier has been to bring this conduction under control.

Conduction between widely separated electrodes in a gas at low pressure, assuming that the electrodes remain sufficiently cold to bar effects due to the thermionic emission or vaporisation of the metal, takes place by reason of ionisation by collision. In a gas there is always a certain small amount of spontaneous ionisation and under a potential gradient of sufficient magnitude, the number of ions rapidly increases, for the speed attained by the freed electrons becomes sufficient, so that upon impact with neutral molecules they knock them apart, producing ions and more electrons. The process is thus cumulative until sufficient current flows to reduce the potential between the electrodes to a definite value, depending upon many factors.

In order to produce gaseous conduction proper, therefore, two factors are necessary; first, a potential gradient sufficient to produce ionisation, and second, sufficient distance between electrodes for collision to take place.

If two electrodes are so situated in a gas that they are nowhere separated by a length of discharge path of the order of magnitude of the mean free path of an electron in the gas used, and at the pressure present, and if there is no magnetic field present, then there can be no gaseous conduction proper between such electrodes at any potential difference whatsoever. Ionisation by collision cannot become cumulative, for in the great majority of cases a spontaneously freed electron drops into the anode without impacting with a neutral molecule. The space between the electrodes is thus kept clear of free electrons and ions.

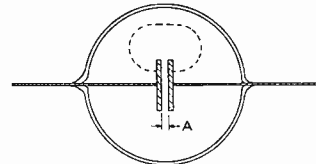

Fig. 1.

The conduction which takes place due to the spontaneous formation of ions is extremely minute, and is the same sort of conduction as takes place between electrodes in air at atmospheric pressure and at potentials below the point of corona formation, which conduction can only be detected with difficulty.

It is, in fact, sufficient to prevent conduction that all lines of electrostatic stress between the electrodes be either short compared to the mean free path of the electron, or else be interrupted by an isolated body capable of accumulating a charge. Very many forms of electrodes may be constructed to utilise this principle, one or two of which will be illustrated in this paper.

The tube of Fig. 1 will conduct at a comparatively low potential if filled with, say, hydrogen to a pressure of 0.1 mm., even although the distance of separation *A* be much less than the mean free path of an electron in hydrogen at this pressure. The conduction will take place along paths such as the one shown dotted.

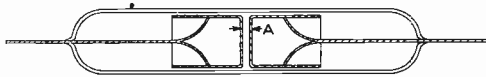

Fig. 2.

However, a tube such as shown in Fig. 2 will not so conduct; for the only long lines along which an electron may be propelled by the potential difference are interrupted by the glass walls, which will accumulate a charge and reduce the gradient in the gas to a low value.

Such a tube, constructed with properly cleaned electrodes, will not pass a microampere at a potential difference of ten thousand volts. Of course at very high potential gradients, of the order of magnitude of a million volts to the inch or so, very peculiar effects may be produced; but not gaseous conduction proper.

A tube which insulates by reason of the short path principle may be rendered conducting by the introduction of a magnetic field of proper value, and in direction perpendicular to the lines of electrostatic stress.

When an electron, moving in the short distance between two electrodes, is acted upon by a magnetic field, its path is curved and thereby lengthened. Moreover, the increase in length of path of an electron starting from the cathode is gradual, with increasing magnetic field strength up to a certain value, and after that it becomes very sudden. This sudden increase occurs when the path curvature is such that the electron completely misses the opposite electrode. The electron paths between plane electrodes for various field strengths are plotted in Fig. 3 to render this clear.

The magnetic field strength necessary just to make the electron thus miss the opposite electrode can be calculated. Its value depends upon the potential *E* between electrodes, their separation *a*, and the electron ratio of charges to mass *m*, thus .

$$H = \frac{1}{A} \sqrt{\frac{2Em}{e}} \dots (1)$$

or, if *E* is in volts, and *a* in centimetres, we may insert the value of *e/m* and write :

$$H = \frac{3.35 \sqrt{E}}{A} \text{ gauss} \dots (2)$$

for the critical field strength.

Let us now construct a tube such that the distance straight between electrodes is too short to ionise, but such that the path of an electron is just made to miss the opposite electrode sufficiently long to ionise. Assume a high potential in accordance with the short path principle. Apply a magnetic field to this tube parallel to the electrode surface. Then when this field is increased to the critical value, the tube will very suddenly conduct freely. The electrons fly in long paths and ionise by impact. The positive ions thus formed drop into the cathode and produce secondary emission of electrons from the surface. The new electrons also pursue long paths and ionise in turn. Since one ion may knock several electrons from the cathode, and each electron may make several ions, the process is cumulative; and the discharge builds up to a point determined by the external circuit.

It may be noted in passing that the critical nature of this phenomenon gives a simple method by which the value of *e/m* may be checked experimentally.

A rectifier may now be constructed. Construct a short path tube and place it in one of the usual rectifier circuits. Apply to the tube an alternating field and a uni-directional field superposed. Adjust the field such that during one half cycle it is correct for conduction, and during the next half wave, not. The tube will then rectify completely.

This, however, is not the simplest construction. By using curved electrodes instead of

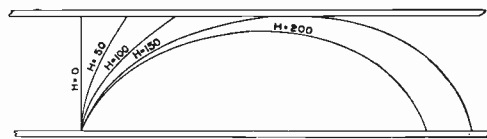

Fig. 3.

plane electrodes, a permanent magnet may be used to supply a uni-directional field, and the alternating field dispensed with.

If concentric cylinders are used for electrodes and suitable arrangements made to render the end paths also short, an axial field of proper strength will render the tube conducting. However, it may be shown, that the critical field strength is now different

for conduction in the two directions. In fact the critical field strengths bear the same ratio as the diameters of the cylinders, that is :

$$\frac{Hh}{Hg} = \frac{g}{h} \dots \dots \dots (3)$$

Thus for conduction with the outer cylinder negative, the critical magnetic field is smaller than when the inner is negative.

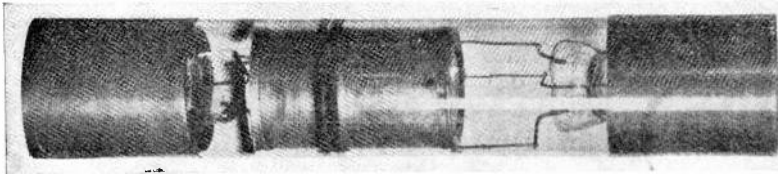

Fig. 4.

A tube arranged with cylindrical electrodes and supplied with a permanent axial field, intermediate between these two critical values, will then conduct in one direction but not in the other. This gives a very simple rectifier indeed.

By suitable choice of diameters and field strength, the tube may be so arranged that it conducts in one direction as soon as the potential across the tube rises to a value sufficient to give ionisation by collision and secondary emission, that is to one or two hundred volts depending upon the gas and electrode material used. It may also be arranged so that when the potential in the opposite direction rises to this same value the field will be already too weak for conduction. The tube will not then conduct in the wrong direction for any value of voltage up to that which destroys the insulation or otherwise allows the tube to flash over.

Certain other benefits may be obtained by the use of non-uniform fields; but the consideration of these effects will be reserved for later treatment.

Another model of the tube is shown in Fig. 4, and in Fig. 5 it is shown supplied with a permanent magnet and pole pieces for producing the axial field. A section of this design is also shown in Fig. 6.

The inert, monatomic gases are preferable for filling these tubes, because of their lack of chemical action and low potential drop. Using helium and aluminium electrodes, the drop in the tube is in the neighbourhood of 150 volts. Under these conditions the disintegration of the electrodes is very slight when operating normally.

Since the cooling of the electrodes occurs largely by reason of the heat conductivity of the working gas, it is unnecessary to run the electrodes very hot in order to dissipate a considerable amount of loss. A tube 7 ins. (17.8 cm.) long, of the type illustrated

above, will handle 230 milliamperes continuously with the electrodes well below a red heat. There will then be about 40 watts loss in the tube.

The output depends, of course, on the voltage being rectified. At 4,000 volts a current of 250 milliamperes represents an output of 1 kilowatt. Several amperes may be passed through such a tube for a short interval.

The voltage current characteristic of a tube

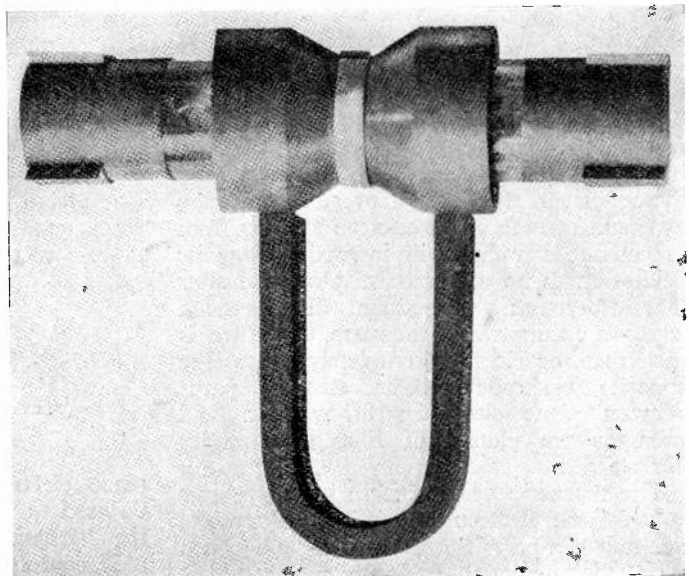

Fig. 5.

depends largely upon its design. With the arrangement shown above, the voltage drop will rise about 10 per cent. from no load to full load.

The wave form of potential delivered by a rectifier depends, of course, upon the circuit in which it is used. The "S" tube is a complete rectifier, as no appreciable current passes in the reverse direction. A practically constant drop of 150 to 200 volts is inherent in this particular design. By using polyphase connections, or condenser and inductance combinations, the ripple in the delivered voltage may be reduced.

As a rugged, long-lived, relatively inexpensive rectifier there will probably be many uses to which this tube can be put. In particular, it should serve as a convenient source of direct current for use in thermionic valve transmitters, particularly for high powers. It should make also a convenient piece of laboratory apparatus.

This paper is necessarily limited in its

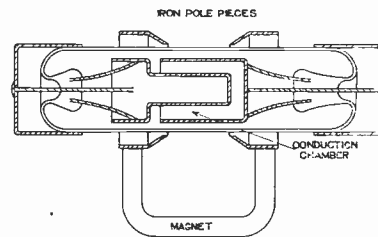

Fig. 6.

treatment to merely an introduction of the device. The authors will very much welcome any suggestions as to ways in which it will be possible to make this new instrument of greatest service to the practice of radio telegraphy and telephony.

A Microphone Amplifier

THE instrument illustrated in Fig. 1, which is now on the market, is deserving of special attention. It is a new type of microphone amplifier, which is particularly suitable for use where it is desired to amplify speech or music before conveying it to a loud speaker. The instrument has the special feature of giving very great amplification without any serious distortion.

The instrument is operated with a 6-volt

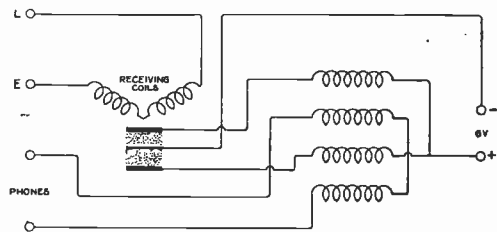

Fig. 2.

battery of dry cells, and the only other terminals are those for connecting direct from the output terminals of the wireless receiver and those provided for connecting a loud speaker of 120 ohms resistance. A diagram of the internal wiring of the amplifier is given in Fig. 2.

The microphone amplifier consists of a differential microphone connected to a reed, which is operated by an electro-magnet. The magnet is adjustable, so that its position can be varied in order to bring it as near as possible to the reed without actually touching.

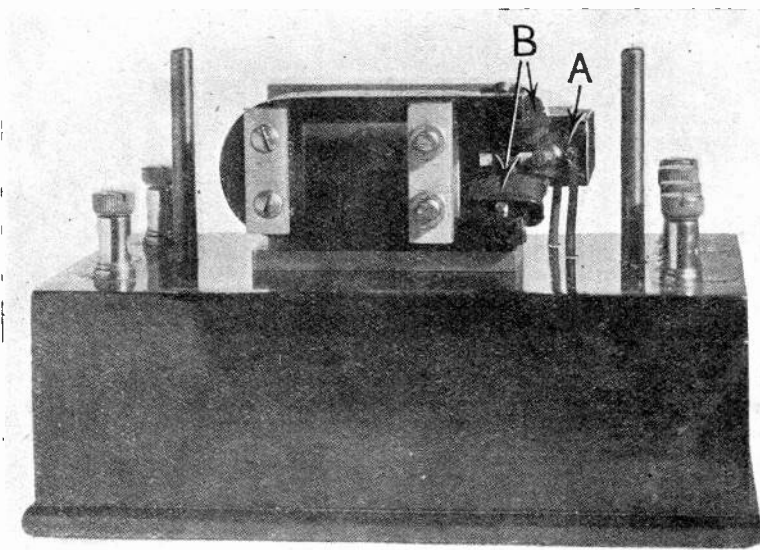

Fig. 1.

The Equipment of 2 PV.

By G. SMITH CLARKE.

THIS station is of home construction, and may be described as a "universal" station as far as the wavelength range of the receiver is concerned.

RECEIVER.

In the receiving apparatus one to six valves may be used without the employment of any switches. There are three stages of high frequency amplification, using either transformer, resistance capacity, or reactance capacity coupling, easily interchangeable. Next comes the detector valve, followed by two

A switch is provided which gives either loose or direct coupling to the aerial, and a reversing switch is employed for reversing the direction of the reaction coil though reaction is seldom employed when H.F. amplification is used.

The aerial tuning condenser is of 0.0011 mfd. capacity, and the closed circuit condenser 0.00055 mfd. with a vernier 0.000001 in parallel. The condensers are Sullivan type.

THE TRANSMITTER.

The transmitter is built on the lines of the

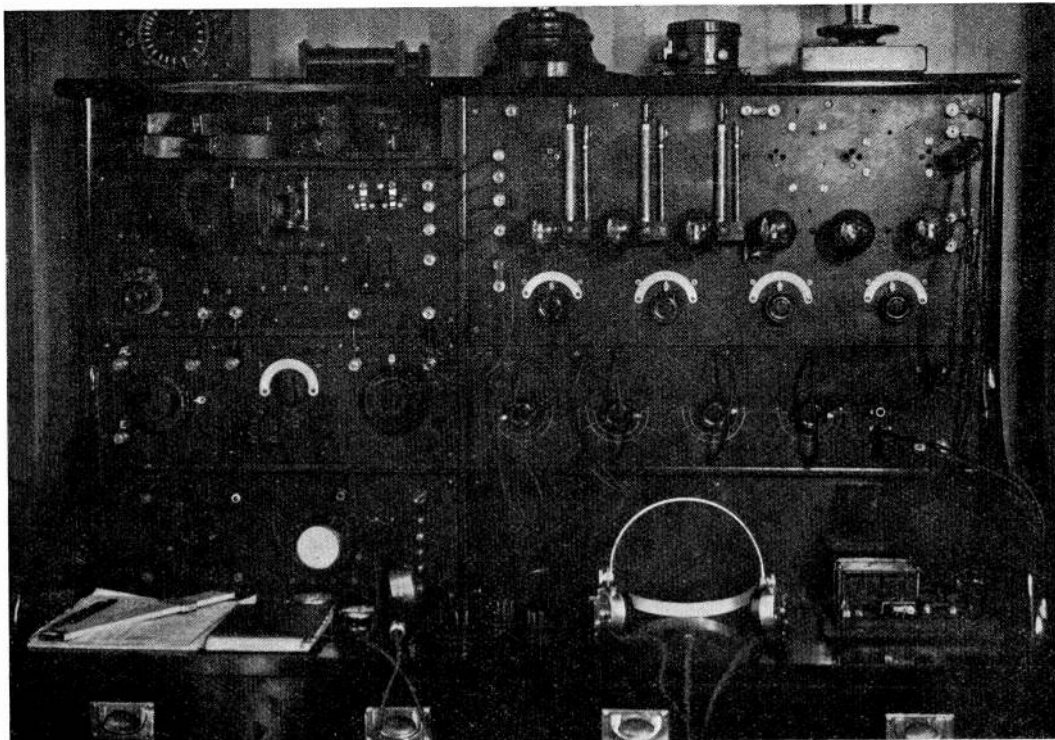

Station 2 PV, Kenilworth.

stages of low frequency amplification brought into circuit by means of jacks and plugs.

Condensers for transformer tuning may be plugged in across either primary or secondary.

Long wave tuning is done on home-made honeycomb coils available up to 30,000 metres. Short wave coils up to 500 metres are single layer *Litz* wound.

R.A.F. choke control set. It is licensed for use with artificial aerial only at present.

The circuits in use have been accurately calibrated.

All English and European stations can be read without the use of "phones," the Western Electric loud speaker (rewound to 120 ohms), working directly off the phone transformer. Several American stations can be

read with phones on table. FL comes in with aerial cut off.

Telephony is very loud and clear; on six valves FL concerts and weather reports can be heard in the garden. The Dutch concert can be clearly heard 100 yards from the loud speaker, that is, just about as loud as Croydon, but much clearer. I have received telephony from the following amateur stations: 2 AW, 2 QU, 2 OQ, 2 HF, 2 KD, 2 IQ, 2 NA, 2 LG, 2 KO, 2 SP (or B), 2 NC, 2 DL, 2 ML, 2 KO, 2 ND, 2 FH and 2 UY.

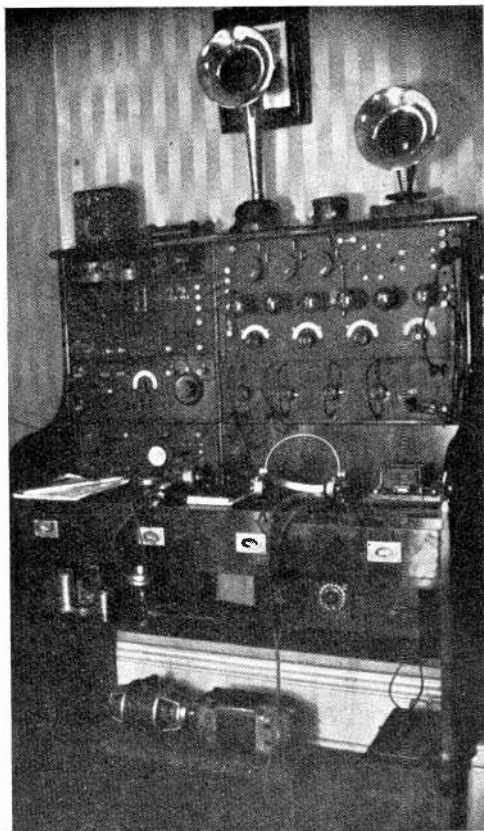

2 PV. Showing H.F. Intervalve Transformer in position.

2 MT was very good on 700 metres, but is subject to a great deal of interference on 400 metres. Amateurs on 440 metres are coming in very strongly, while Marconi House on 360 metres is very nearly perfect in all respects.

Ever increasing numbers of "howling" sets are a great nuisance, and I think that at

present this is the greatest problem in amateur radio, and one which should receive the earnest attention of every wireless society.

After much trouble with dry cells, I am now using Siemen's H.T.3 Leclanche batteries for high tension supply. These are excellent, and during the six months they have been in use have given no trouble of any sort. I shall never go back to dry cells.

Notes

A Visit from America.

Mr. Milton B. Sleeper, whose name is so well known in this country, as well as in the United States, has recently paid a short visit to England.

There is no doubt that Mr. Sleeper was much impressed with the quality and finish of wireless apparatus of British manufacture, and he expressed regret at being unable to extend his visit to the provinces owing to lack of time. Mr. Sleeper is a keen advocate of closer association between British and American amateurs, and we may be sure that on his part he will do all that is possible to bring this about.

Mr. Leon Deloy in London.

Mr. Leon Deloy, of 8 AB, Nice, is visiting this country. His programme includes a number of calls on personalities in the world of amateur wireless, even so far afield as Aberdeenshire, where he is visiting Mr. Spence. We understand that after leaving England Mr. Deloy will go to Holland for the purpose of inspecting PCGG. We have had the pleasure of meeting Mr. Deloy in the company of Mr. W. J. Crampton.

Radio Telephone Range Tests.

The United States Bureau of Standards is planning to conduct comprehensive tests to determine the effective working ranges of radio telephone communication when using various kinds of transmitting and receiving sets. Preliminary plans have been outlined for this work, and some correspondence conducted in regard to it.

Dutch Concerts.

In view of the fact that changes in the wavelengths, etc., of the *Daily Mail* concerts from the Hague are anticipated, details are omitted from our calendar this week; though it is understood that there will be no interruption of these concerts.

Competition at the Concours Lepine.

Competitions of Industrial inventions are held annually at the Concours Lépine which was founded by the late Prefect of the Seine in 1901. This year wireless will form the subject of one of the competitions. Exhibitions will be held on the Champ de Mars from August 25th to October 2nd, of all kinds of wireless receiving apparatus and of processes of manufacture. Experts are to lecture on wireless subjects.

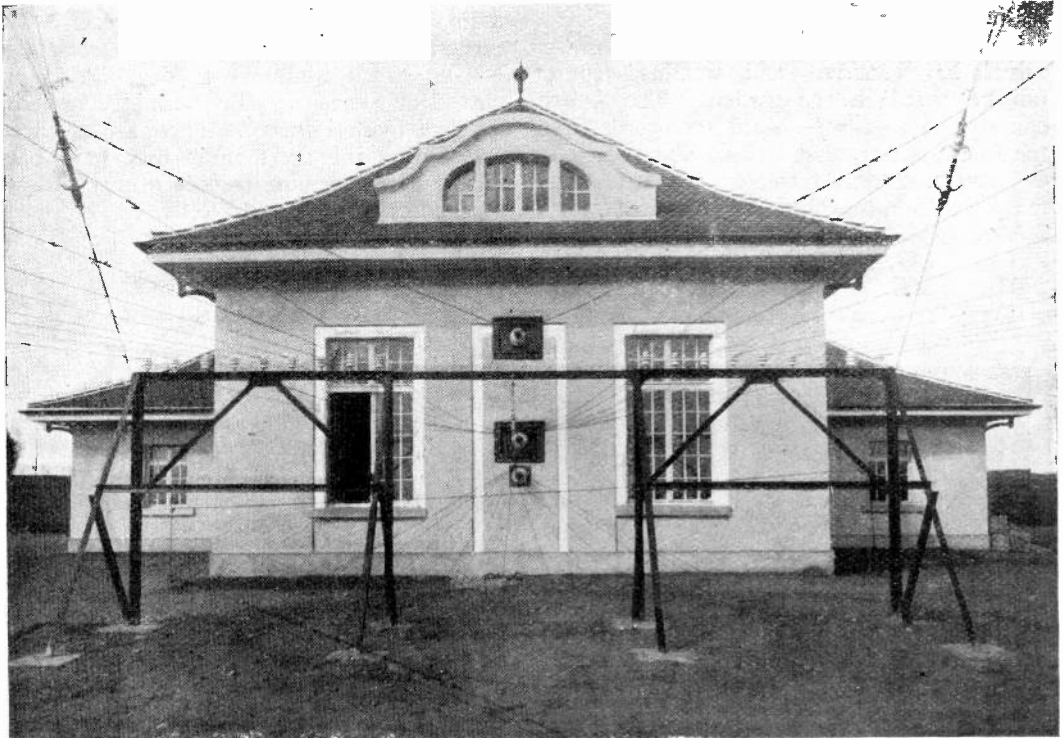

Berne Wireless Station. The "Leading-in" Insulators for Aerial and Earth Screen and Ordinary Ground Earth.

New American Direction Finding Stations.

Nine American companies interested in the manufacture of radio direction finders met at the Bureau of Standards to confer with the Assistant Secretary of Commerce, the Bureau of Lighthouses, and the Bureau of Standards, regarding the production, cost, installation, calibration, and maintenance of radio direction finders on ships.

It was announced that the Department of Commerce has decided to install the following stations for the purpose of direction finding: Boston, Nantucket, Cape Charles, Columbia River, Puget Sound, and, if funds are still available, Delaware Bay, Los Angeles, and Blunt's Reef. These are in addition to the two new stations at Diamond Shoal (off Cape Hatteras) and San Francisco Light Vessel. Three other stations have been in operation in the vicinity of New York Harbour for over a year at Ambrose, Fire Island and Sea Girt.

As a result of the conference, arrangements will be made through the Bureau of Lighthouses, between the manufacturers of radio direction finders and the operators of steamships for the trial and demonstration of direction finding equipment produced by the several manufacturers under conditions of practice.

Eiffel Tower Weather Warnings.

When the weather reports are received by the Eiffel Tower the forecast is issued locally by bell. Three strokes announce rain, six frost, ten storm or hail. Meteorological reports are issued by

wireless telephone daily, at the following hours, 0450, 1215, 1810. The wavelength used is 2,600 metres.

Shipping Conference Report on Wireless at Sea

At the International Shipping Conference three Committees were appointed one of which was to examine the question of life-saving appliances and wireless telegraphy. The reports of these Committees are now issued.

With regard to wireless, it was decided to recommend amendments for the purpose of allowing partial as well as total exemption for coasting and short sea trade vessels, and for permitting of the installation of an automatic calling apparatus under prescribed tests as to efficiency. With regard to the choice of navigational instruments for directional wireless, the Committee think that shipowners may, without risk, be left to choose their own time and method for its adoption, and that the fewer Government regulations that are applied to it the more satisfactory will be its development.

Book Received

TECHNICAL ELECTRICITY. By H. T. Davidge, B.Sc., M.I.E.E., and Robert W. Wutchinson, M.Sc., A.M.I.E.E. (London: *W. B. Clive, University Tutorial Press, Ltd., High Street, New Oxford Street, W.C.* Pp. 514. 8½" × 6". 10s. 6d.)

Wireless Class Formed at Huddersfield.

Wireless telegraphy and telephony are to be taught at a special class to be formed at the Huddersfield Technical College providing a minimum of fifteen students agree to attend. Such is the decision of the Education Committee of that town.

Cost of Swedish Station.

A Stockholm report says that the wireless station which the Radio Corporation of America will erect on the West Coast of Sweden is to cost 3,700,000 crowns. It is expected that the station will be completed next year.

French Army Grand Manœuvres.

Experiments are to be conducted in wireless telegraphy and telephony in conjunction with the grand manœuvres of the French Army, which will take place between September 10th and 18th.

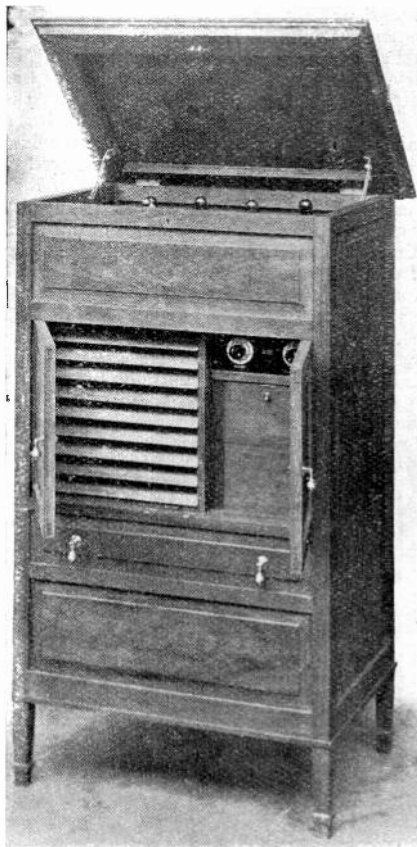

A Broadcast Receiver de Luxe.

The accompanying photograph is of a Broadcast Receiver which is being manufactured by Marconi's Wireless Telegraph Company, Ltd. As can be seen from the illustration, the valves and other apparatus are contained in the top where the turntable of a cabinet gramophone, which the instrument resembles, would ordinarily be located.

Useful Wireless Plugs and Jacks.

The accompanying illustration shows a very useful design of plug to be used in conjunction with jacks of a type of which a number of different designs are marketed.

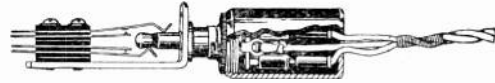

The use of plugs and jacks gives a very neat appearance to a finished set, and this particular type requires only one hole for fixing in the panel. All sorts of switching can be condensed into small space, and plugs and jacks may be used for such purposes as switching in filament, connecting across different valves, disconnected intervalve transformers at the point of insertion, etc. The jacks illustrated have nickel silver springs with sterling silver contacts, and the plugs, which are soundly constructed, have a special type of grip for taking the flexible leads.

New Companies.

Among the new private companies which have just been registered are the following:—Messrs. G. F. Sugden & Co., Ltd., capital £5,000 in £1 shares, electrical engineers, telegraphy, telephony, radio-telegraphy and radio-telephony engineers, etc. Secretary, Mr. G. F. Sugden, 9, Albert Square, Manchester. Scottish Wireless Telephone Supplies, Ltd., capital £1,500 in £1 shares, to manufacture buy and sell apparatus appertaining to wireless installations (telephone or telegraphic), etc. Registered office, 82, Crown Street, Aberdeen. South Wales Wireless Installation Co., Ltd., capital £2,000 in £1 shares. To carry on business as indicated by the title. Secretary, Mr. W. H. Liles, 18, West Bute Street, Cardiff.

Calendar of Current Events

Saturday, September 2nd.

CROYDON WIRELESS AND PHYSICAL SOCIETY.
Meeting.

Monday, September 4th.

ILKLEY AND DISTRICT WIRELESS SOCIETY.
8 p.m.—At Regent Café, Cowpasture Road, Ilkley, Morse Practice.

Tuesday, September 5th.

Transmission of Telephony at 8 p.m., on 400 metres, by 2 MT, Writtle, near Chelmsford.

Friday, September 8th.

LEEDS AND DISTRICT AMATEUR WIRELESS SOCIETY.
8 p.m.—Lecture on "Automatic Telephony," by Mr. H. Mortimer.

BELVEDERE AND DISTRICT RADIO AND SCIENTIFIC SOCIETY.

8 p.m.—At Erith Technical Institute, General Meeting and enrolment of members.

Secretaries of Societies are reminded that Notices of forthcoming Meetings must be received at least ten days before the date of publication of the issue in which the Notice is to appear.—[ED.]

Wireless Club Reports

NOTE.—Under this heading the Editor will be pleased to give publication to reports of the meetings of Wireless Clubs and Societies. Such reports should be submitted without covering letter in the exact form in which they are to appear and as concise as possible, the Editor reserving the right to edit and curtail the reports if necessary. The Editor will be pleased to consider for publication papers read before Societies. An Asterisk denotes affiliation with the Wireless Society of London.

The Wireless Society of Hull and District.*

Hon. Secretary, 16, Portobello Street, Hull.

On August 14th, Mr. J. Nicholson gave a most instructive lecture on "Accumulators, their Use and Abuse." The chair was occupied by Mr. Hy. Strong, Acting Vice-President, and there was a fairly good number of members present. At the outset the lecturer apologised for not being in a position to impart some information on the subject that he had specially wished to obtain, that is with regard to the process of the manufacture of the plates, etc., but he hoped to do so in the future. After speaking about the various component parts of a modern type of accumulator, he then dwelt at some length upon the treatment which this article should be given if one wished to obtain the best out of it. He related a number of cases in which accumulators had been completely ruined by the first charge and emphasised the fact very strongly to all present that it is the first charge given to this article which determines its future usefulness. Mr. Nicholson knows his subject well as he daily comes in contact with all classes of this work.

The lecture proved very instructive to all present, and a number of members joined in the discussion which followed.

Mr. Nicholson was accorded a vote of thanks for his lecture.

Several new members were elected, including the first lady. They were accorded a hearty welcome.

Meetings of the Society are now held on the second Monday and the fourth Friday in each month, at the Signal Corps Headquarters in Park Street, where intending members will be welcomed.

Radio Experimental Association (Nottingham and District).*

Hon. Secretary, Mr. F. E. Bailey, 157, Trent Boulevard, West Bridgford, Notts.

A monthly general meeting of the above Association was held on July 27th, in Room 74, Mechanics' Institute, Nottingham.

Mr. Carpenter had consented to lecture during the evening, and very kindly continued his lecture on "Wireless during the War," dealing this time, however, with C.W. work only. From the drawings and diagrams which Mr. Carpenter presented, it was evident that he had spent considerable time in compiling same, and the lecture was most interesting and instructive. The lecturer clearly explained the functioning of each component part of the C.W. sets used chiefly in France during the war.

Mr. Carpenter also exhibited a German transmitting and receiving set combined, and explained details of construction which were very interesting.

At the close of the meeting Mr. Thornton proposed

a hearty vote of thanks to the lecturer, in which all heartily concurred.

The next meeting will be held in Room 74, Mechanics' Institute, Nottingham, at 7.30 p.m. on Thursday, August 31st.

Any persons in the Nottingham district who are interested in Radio-telegraphy and telephony, and are not yet members, will receive full particulars on application to the Hon. Secretary.

Wireless Society of Highgate.*

Hon. Sec: Mr. D. H. Eade, "Gatra" 13a, Sedgemere Avenue, East Finchley, N.2.

On Fridays, July 21st and August 4th, Mr. J. F. Stanley, B.Sc., gave the fifth and sixth of his series of lectures on the theory of wireless. In these he dealt very fully with the valve and its action, outlining the electron theory and then going on to deal with characteristic curves. He showed how by operating the valve on various points of its curve, rectification or amplification could be obtained. After going thoroughly over this ground, Mr. Stanley explained and contrasted amplification at high and low frequencies, and finally described the special methods of reception necessary to receive continuous wave signals.

On July 28th, Mr. F. L. Hogg gave the second of his lectures on the construction of wireless apparatus. He dealt with the various methods by which a one-valve set could be increased to form a multi-valve set, and described fully the various types of high and low frequency amplifiers.

Membership of the Society is still increasing and there are now over 50 members. Meetings are still being held regularly each Friday evening at the Highgate Literary and Scientific Institution, South Grove, Highgate, N., and will continue throughout the summer; and as soon as the holiday season is over the autumn programme will be arranged, and should prove of considerable assistance to members, especially those who are comparatively beginners in the subject.

The Honorary Secretary will be pleased to receive enquiries regarding membership, or will be pleased to see intending members at the Institution on Friday evenings between 7 and 9.30 p.m.

Stoke on Trent Wireless and Experimental Society.*

Hon. Sec. Mr. F. T. Jones, 360, Cobridge Road, Hanley.

At a meeting of this society on Thursday, August 17th, Mr. R. W. Steel (Asst. Hon. Sec.) was appointed as third member of the Technical Committee. It was decided to appoint another member on the Working Committee, and as there is a fairly large Students' section, to have a Students' representative on the Committee. Mr. Schofield was accordingly elected as the Students' representative.

A resolution was passed to co-operate with the

Y.M.C.A. and assist them in every possible way on the occasion of a lecture and demonstration on Wireless which they propose to hold in November. The Society also proposes to hold an Exhibition and Demonstration late this year, or early in the new year.

Arrangements are to be entered into to secure the services of lecturers from several Wireless Societies during the coming season.

Several members complained of the interference caused by some local amateurs, who when listening-in to wireless concerts, cause their sets to "oscillate" and so interfere with the reception of the concerts by other amateurs in the district. It was thought that these amateurs were doing a great deal of harm to amateurs in general, and, if the practice continued the Postmaster-General would prohibit the use of regenerative circuits altogether. This needless annoyance was, no doubt, not caused purposely, but was due to the ignorance of the owners, for while a set is oscillating it is impossible to receive properly. If these unwitting defaulters consulted their friends who had wireless receiving sets and knew how to use them, or joined a wireless society, they would soon learn how to avoid this trouble, with satisfaction to themselves, and to those with whom they were interfering. It was suggested that, with the aid of direction finding apparatus, to locate these offenders and to warn them of the nuisance they were causing, and if the practice continued after that, to report them to the Postmaster-General. It was decided to send an official protest to the Wireless Society of London.

It was much regretted that up to the present the necessary permission to proceed with the erection of the aerial had not been received. It is hoped that this will be remedied in the near future.

The meeting closed after a little buzzer practice.

Stockton and District Amateur Wireless Society.

Hon. Secretary, Mr. W. F. Wood.

The usual monthly meeting was held in the Concert Hall in the Malleable Workmen's Institute, Stockton, on Thursday, August 10th, under the presidency of Mr. J. Mulcaster, supported by Mr. S. G. Marston, Vice-President, and members of the Committee. After the usual business had been transacted the President distributed the prizes given by members of the Society for the most expert readers of the Morse code, open to members under the age of eighteen years, and which were deservedly won by Mr. R. Burnand and Mr. J. E. Laven.

The rest of the evening was taken up by a lecture given by Mr. W. B. Ward (of the Middlesbrough Wireless Society) on "High Frequency," which was illustrated by apparatus kindly brought specially by the lecturer for this meeting.

A vote of thanks was proposed by Mr. Mulcaster and seconded by Councillor Elliott which was enthusiastically endorsed by the many members present.

The Beckenham and District Radio Society

Secretary: Mr. J. F. Butterfield, 10, The Close, Elmers End, Beckenham.

The above Society is now in full swing. Although such a short time has elapsed since the inaugural meeting over thirty members have been enrolled, and many applications for membership are being

received. At a general meeting held on Thursday, August 17th, it was decided to hold the meetings at 114, High Street, Beckenham (at the side of the "Dorothy" Tea Rooms), on Thursday evenings at 8.15 p.m.

A Committee was appointed to draw up Rules and also to arrange a syllabus of Lectures and Demonstrations.

On Saturday, August 19th, the Society gave a very successful demonstration at the Annual Fete of the Beckenham Allotment Society held at the Technical Institute, when by Special Permission of the P.M.G. Lieut Walker (2 OM), Brentford, kindly transmitted music at various intervals which were received perfectly and with marked satisfaction by a very large number of "listeners-in" of all ages.

This Society bids fair to be very popular in the district, many applications for membership being received at this demonstration. A junior section has been formed for those under the age of 18. Ladies are also welcomed as members.

All applications for membership should be addressed to the Hon. Sec.

Barnoldswick Wireless and Technical Society.

Hon. Sec. Mr. J. Balderston, 6, Clough Terrace, Barnoldswick.

A meeting of the above Society was held on August 16th at the Gladstone Liberal Club. At the termination of the usual 30 minutes buzzer practice, a Lecture was given by Mr. A. G. Petty, B.Sc., entitled "Magnetism."

The lecture was delivered to a very enthusiastic audience, and was augmented throughout by very interesting and highly instructive experiments. The members are exhibiting a keen appetite for technical knowledge. Rapid progress is anticipated, and thanks to the fact that several of the members are skilled in scientific matters, the provision of suitable lectures does not present any difficulty.

The Secretary solicits applications for membership from any gentlemen in the locality.

Bridlington and District Wireless Society.

Hon Sec. Mr. M. Horspool, Darley, Marton Road, Bridlington.

The first meeting takes place at the Liberal Club, Quay Road, Bridlington, at 8 p.m., on Thursday, August 31st. All who are interested are invited to attend.

Fulham and Chelsea Amateur Radio and Social Society.

Secretary, Mr. R. S. V. Wood, 48, Hamble Street, Fulham, S.W. 6.

A meeting was held on August 15th. The minutes of the previous meeting were passed and the rules of the Society read, each rule being dealt with separately and passed unanimously, except rule 10. A suggestion that the entrance fee from a continuing visitor, if finally becoming a member, should be deducted from his account was agreed upon.

A visitor, Mr. Witts, asked as to the liberty of a visitor speaking at any meeting, and Mr Martin (the Financial Secretary) suggested an addition to rule 15, which was carried and will appear in the rules.

Mr. Cox was elected Treasurer. Mr. Martin, Financial Secretary, Messrs Saunders, Hawthorn, Johnson and Reginald Wiggins to the Committee.

The electing of one lady for the Committee was postponed until sufficient ladies were present.

Mr. Mather and Mr. Butterworth were elected Auditors.

All the above elections were passed unanimously. The meeting then closed with a vote of thanks to the Stanley Ward Conservative Club for once again loaning their room.

The nett receipts for the evening were £4 17s. 6d. Members enrolled, 37 gentlemen, two ladies, and 4 juveniles. From Fulham 20, Chelsea 12 and outside area 11.

St. Barnabas Wireless Club

Hon. Secretary. Mr. B. H. Hardy, 26, Pound Lane, Epsom.

This Club has changed its name from the Epsom and District Radio Society to St. Barnabas Wireless Club.

On August 7th, Bank Holiday, a Fete was held at Woodcote House, Epsom, in aid of the Epsom and Ewell Cottage Hospital, and the St. Barnabas Wireless Club gave Demonstrations in Radio Telephony from 3 p.m. until 8 p.m.

The set used on this occasion was a five-valve (1 H.F., 1 Rect., 3 L.F.) receiver loaned to the Club by a member, Mr. H. Penfold, the results obtained being highly successful. Unfortunately the clubs loud speaker went out of action immediately before the demonstration with the result that about eight pairs of phones had to be utilised in its place. With this arrangement, however, 150 to 200 people were able to listen-in during the course of the afternoon to telephony including the two excellent Marconi concerts at 5 p.m. and 6 p.m.

It is hoped that the efforts of the Club added to the success of the Fete.

The club holds meetings on Mondays and Thursdays from 8 to 10 p.m. in the Parish Room, Hook Road, Epsom.

Otley and District Wireless Society.

Hon. Secretary, Mr. N. Weston, 24, Guycroft, Otley, Yorks.

The meeting on Thursday, August 17th, was not very well attended, due no doubt to holidays.

In the absence of the Chairman, the Hon. Sec. opened a discussion on type of set to be built for the Club's use. After an interesting discussion it was decided to start on a five-valve set, 2 H.T., rectification and 2 L.T., with a multiple tuner. The scheme is an ambitious one, as even transformers are to be wound by amateur members. It is earnestly requested that all members endeavour to find more suitable quarters than those at present occupied, as facilities for proposed aerial are restricted.

Bishop's Stortford and District Amateur Wireless Association

Hon. Secretary, Mr. J. Cooper, Halfacres, Bishop's Stortford.

A meeting was held at Halfacres, Bishop's Stortford, on Friday last, when Mr. W. S. Filby occupied the Chair. A paper was given by the Secretary, Mr. J. Cooper, entitled, "Notes upon the Construction of a Simple Receiving Station." This was illustrated by blackboard sketches and dealt with aerial and earth systems, tuning apparatus and crystal rectifiers. Parts of the apparatus described were passed round for inspection, and

it was shown that any amateur with ordinary mechanical skill could make up an efficient set capable of receiving distant morse signals, the Writtle concerts and telephony within a radius of 30 miles. The apparatus designed for use with the crystal was such as could be adapted later for use with valves, and this conversion will be the subject of a subsequent lecture. On the motion of Mr. Attree, seconded by Mr. Rose, a vote of thanks was accorded Mr. Cooper for his paper.

Communications should be addressed to the Hon. Secretary.

The Durham City and District Wireless Club.

Hon. Secretary, Mr. Geo. Barnard, 3, Sowerby Street, Sacriston, Durham.

The fourth meeting of the above was held at headquarters (Y.M.C.A., Claypath), on Friday, August 18th. The meeting was well attended, several new members were enrolled. It was very pleasing to note the presence of lady members, and also to hear that more are coming along. The chair was very ably taken by the Rev. T. H. Perkins, of Shadforth.

After the minutes were read and passed a most interesting lecture was given by Mr. Geo. Barnard, the Hon. Secretary, on "The Production of High Frequency Oscillations." He confined his remarks chiefly to the "spark" method, leaving the more advanced "valve" transmission to be discussed at a future meeting. After pointing out clearly the difference between static charges of electricity and electro-dynamics, he demonstrated the effects of static induction and described thoroughly the action of a condenser.

Frequency, amplitude, wavelength and damping were shown diagrammatically upon the blackboard. Inductance and capacity were explained in a most elementary fashion, the lecturer using several helpful analogies. Open and closed oscillatory circuits were shown upon the blackboard. The methods adopted to vary the amount of inductance and capacity, hereby varying the wavelength produced, were also shown.

The lecturer was heartily thanked. After the announcements a most lively discussion took place. Questions were asked concerning the last lecture on "The Electro-Magnetic Theory," and also upon the lecture just given. Atmospheric effects were discussed, and the secretary pointed out the advantage of a "double pole change-over switch," so that the apparatus could be disconnected from the aerial at will, at the same time connecting the aerial to earth, the aerial when so connected acting as a first-class lightning conductor.

Mr. Sargent, F.R.A.S., of the observatory, Durham, has consented to give a lecture at some future date.

It was decided to hold the meetings every Friday. The fourteen days interval, however, would still be adhered to between the important meetings, leaving the alternate Fridays for Morse buzzer practice, demonstrations and discussions of minor importance.

The meetings are still open for intending members. It is hoped shortly to organise a field day also a social evening. Another meeting held on Friday, August 25th, consisted of buzzer practice, five-minute speeches and small demonstrations with apparatus kindly lent by Mr. S. Kelly (Hon. Treasurer). The merits of a free library for the members will also be discussed.

Questions and Answers

NOTE.—This section of the magazine is placed at the disposal of all readers who wish to receive advice and information on matters pertaining to both the technical and non-technical sides of wireless work. Readers should comply with the following rules:—(1) Each question should be numbered and written on a separate sheet on one side of the paper, and addressed "Questions and Answers," Editor, THE WIRELESS WORLD AND RADIO REVIEW, 12/13, Henrietta Street, London, W.C.2. Queries should be clear and concise. (2) Before sending in their questions readers are advised to search recent numbers to see whether the same queries have not been dealt with before. (3) Each communication sent in to be accompanied by the "Questions and Answers" coupon to be found in the advertisement columns of the issue current at the time of forwarding the questions. (4) The name and address of the querist, which is for reference and not for publication, to appear at the top of every sheet or sheets, and unless typewritten, this should be in block capitals. Queries will be answered under the initials and town of the correspondent, or, if so desired, under a "nom de plume." (5) In view of the fact that a large proportion of the circuits and apparatus described in these answers are covered by patents, readers are advised before making use of them, to satisfy themselves that they would not be infringing patents. (6) Where a reply through the post is required every question sent in must be accompanied by a postal order for the amount of 1s., or 3s. 6d. for a maximum of four questions. (7) Four questions is the maximum which may be sent in at one time.

In view of the serious interference which an oscillating receiver can cause to all other receivers in its neighbourhood, it is understood that for broadcast wavelengths, certainly, and possibly for all wavelengths, the Postmaster-General will in future allow no type of circuit which is capable of oscillating and so energising the aerial, either directly or through any circuit coupled to it.

The necessary consequence of this restriction is that if reaction of the type commonly used in the past is still employed, it must be in such a way that the oscillation point cannot be reached over the wavelength range of the receiver, however tightly the reaction coil is coupled, and with whatever values of filament voltage or plate voltage the set is worked.

In order to comply with this requirement, it is essential that the reaction coil should be sufficiently loosely coupled to the aerial inductances as not to set up oscillations or alternatively the reaction might be arranged between the grid and plate circuits of a high frequency amplifier as shown on p. 715 of this issue.

We strongly urge readers who are making or using sets of the usual reacting type to either (1) reduce the amount of reaction which they can employ to such an extent that they are perfectly satisfied that the set can never oscillate; or (2) to cut out their reaction entirely.

"C.L.B." (South Norwood) makes enquiries about four previous questions submitted.

These questions were dealt with in reply No. 44 of this series.

"J.B." (Dublin) asks (1) For criticism of a four-valve set. (2) If any advantage would be gained by using a grid potentiometer as well as, or in place of a grid condenser. (3) How to arrange for reaction in a resistance capacity circuit given to "W.D." on page 303 of June 3rd issue. (4) What telephony and Morse stations should be heard on four valves.

(1) Quite O.K. (2) Potentiometer might with advantage be added to the first two valves, condenser and leak being retained for the third. (3) Put the reaction coil in the anode circuit of the third valve and couple it to the loading coil. (4) Not many at present. You might hear 2LO, 2MT and PCGG with an open aerial, but hardly with a frame.

"CAUTIOUS" (Essex).—We regret that we cannot advise you on questions relating to patents.

"R.G.W." (Wimbledon) asks (1) If H.F. variable transformers give the best all-round efficiency. (2) For a circuit to fulfil certain requirements. (3) Using a 6-volt accumulator what is the minimum number of filament resistances required.

(1) Quite a good method, but not capable of covering as long ranges of wavelength as either resistance capacity coupling or interchangeable plug-in transformers. (2) A suitable circuit is shown in Fig. 7, page 438, July 1st issue, which includes the switching arrangement asked for. (3) One only is needed, although an additional separate control to the rectifier is sometimes useful.

"C.L.W." (Johannesburg).—(1) Two H.F. and one detector would be best, but we know of very little telephony in prospect which will have an effective range of 1,000 miles. (2) The use of resistance-capacity coupling saves the provision of a number of interchangeable transformers to cover various wavelengths, but it is very insensitive below 1,000 metres.

"A.L.W." (Sheffield) asks (1) With reference to a reply to "L.H." (Mansfield), in June 10th issue, what would be a suitable A.T.I. (2) If a potentiometer referred to in the reply is correctly connected. (3) Data for making the transformer in the same diagram. (4) Range of set described, and if it would receive 2MT and PCGG.

(1) 9" x 6" of No. 22. (2) Potentiometer is quite correctly wired in. It need not be added if zincite-bornite is used. (3) For the intervalve transformer use a core $\frac{1}{2}$ " x 4" of iron wires, with windings of 1 oz. and 3 ozs. of No. 44. An additional telephone transformer of normal type must be provided if L.R. telephones are to be used. (4) Up to about 30 or 40 miles from a broadcasting station. This set is unsuitable for 2MT or PCGG at the distance. The circuit of Fig. 3, page 501, July 15th issue, is much better.

"IRIS" (Derby).—The aerial arrangement submitted appears to be the best that can be done in regard to the tram lines, but we are afraid that induction may be bad, particularly with a five-valve set. We do not think you will be near enough to any broadcast station to get good results on a single valve set.

"M.G." (Clifden).—We are afraid your requirements are rather vague. We cannot give detailed instructions for making a set in these columns, but the circuit might be as in Fig. 1, page 404, June 24th issue. A.T.I., 9" x 6" of No. 22. Coupling coil, 3" x 3" of No. 22. Closed circuit coil, 7" x 5" of No. 26. Condenser, 0.0005 mfd. Crystal—carborundum. Aerial as long and high as possible, up to 100'.

"A.W.M." (Peckham) has a Type 2846, serial 74, Marconi Wireless Set, and asks if it is possible to convert it into a crystal receiving set.

We are unable to identify this set from the figures you give, which do seem possible to use. If you will let us have some description of the instrument, giving as much electrical information as possible, we shall be pleased to advise you.

"W.B." (King Williamstown) asks (1) For a diagram to convert a type 16 Marconi crystal set into a one-valve set. (2) If 220 volts A.C. transformed down to 8 or 3 volts to put through a motor-car induction coil would be suitable for short range transmission. (3) If there is such a thing as being screened from a station, the cause of it and if it can be overcome. (4) If his crystal battery terminals should be shorted when no battery is used.

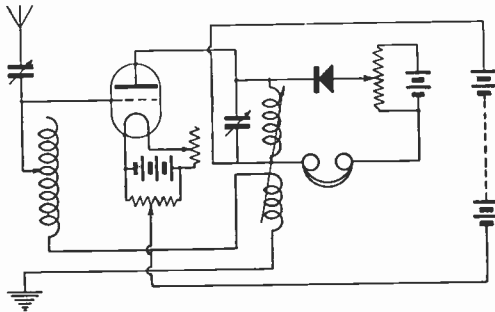

Fig. 1.

(1) Alter the set to the diagram shown (Fig. 1). (2) Probably, but we cannot give exactly voltage to step down to, as this would depend on the winding of the coil. (3) Screening does occur in special cases as, for instance, by the presence of a mountain mass between transmitter and receiver. In other cases cause may be very difficult to ascertain, and when ascertained it may be difficult to remove. (4) Present arrangement of crystals is O.K. It is not necessary to short the battery terminals when no battery is employed.

"R.G.P." (Salford) asks (1) Winding data for certain slab inductances. (2) If a variometer tuner is suitable for receiving telephony with a three-valve amplifier. (3) Winding details for certain H.F. transformers.

(1) With a series condenser of 0.001 mfd. the coils should have the following number of turns—25, 50, 80, 125 and 150. (2) Yes. (3) We cannot give the exact data, as the values vary considerably with slight differences in the way the wires fit on. Try ebonite formers 1½" diameter, with windings varying from 30 turns per coil to about 220, winding one coil over the other with insulation of varying thickness of paper.

"OSMOSIS" (Leeds) asks (1) Amount of No. 26 wire and size of former for H.F. inter-valve transformers of broadcasting wave. (2) For diagram of a one-valve telephone transmitter for five miles range. (3) Where to purchase a Johnson-Rahbek loud speaker. (4) How to listen-in on his own transmission with a telephone transmitter.

(1) About 40 turns on a former 5½" diameter for each winding, windings separated by two or three layers of paper. Exact adjustment must be made by experiment. (2) See diagram (Fig. 2).

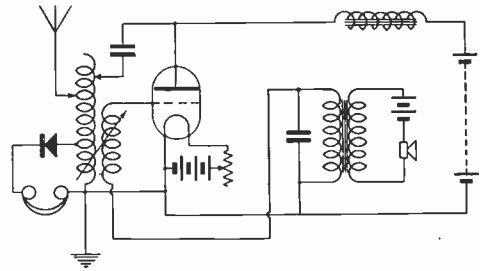

Fig. 2.

(3) We do not think this instrument, which is covered by patents, is on the market, at any rate in this country. (4) Crystal and telephones might be tapped across a few turns of the A.T.I. as shown in the diagram.

"A.C.M." (Brazil) asks (1) How to add slab inductances to the Marconi 70a tuner to obtain a wavelength up to 20,000 metres. (2) How to insert a crystal in place of a "Q" valve in the Marconi 55F amplifier. (3) Address of agent for reliable firm of American wireless telegraphy instrument makers.

(1) The tuner is not suitable for alteration in this way without opening up and introducing suitable coils in each circuit. It would be much simpler to make an entirely fresh tuner for the purpose. (2) This also cannot be done without extensive structural alterations to the instrument. You might, of course, tap off a lead to the anode of the last H.F. valve through a crystal and telephones and back to the H.F. positive. (3) We do not know of agents holding stocks of American goods.

"G.B." (Acton) asks (1) For a diagram of his two-valve circuit and panel. (2) If it would receive PCGG.

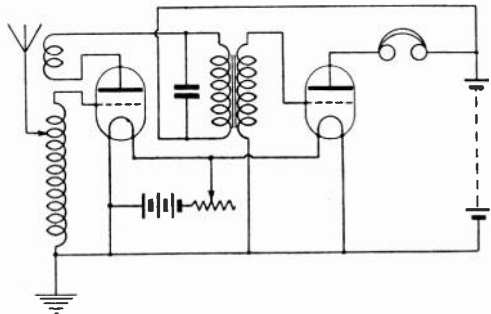

Fig. 3.

(1) We cannot say how your panel is wired up, but it might be wired as in the diagram (Fig. 3), which gives the complete circuit as requested. (2) It should do so on the new power to be used.

EXPE **RI** ENCE

Distortionless Audio Frequency
**INTERVALVE
TRANSFORMER**

designed and built on scientific lines

25/-

Telephone Transformer 20/-

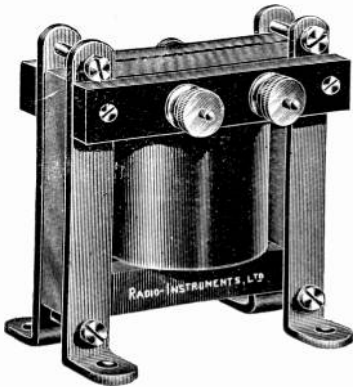

WINDING AND INSULATION is by a patent-
ed process, every individual turn being specially
insulated from adjacent turns as well as between
layers. Tested at 1,000 volts.

DIMENSIONS are reduced to the smallest limit
consistent with absolute reliability: 3½" wide,
2½" over feet, 3½" deep. The usually heavy
wire eliminates a common weakness in other
designs where efficiency and reliability are
sacrificed to space.

CONSTRUCTION is on exactly similar lines to
power transformers. The closed core is built up
from best quality Stalloy iron laminæ.

IMMUNITY FROM BREAKDOWN is assured
by scientific design and careful construction
coupled with high insulation, large gauge wire
and efficient dimensions. Comparative tests
confirm the superiority of our designs.

Order at once to secure immediate delivery.
TELEPHONE TRANSFORMERS at 20/- each.
Why pay more for imported articles of less
efficiency? Get wireless equipment of latest
improved designs made by British radio engineers
of established reputation.

OTHER PRODUCTS include Short Wave Anode
Reactances, Efficient Tuning Inductances, Pre-
cision Air Condensers, H.F. Transformers and
all wireless components.

RADIO INSTRUMENTS Ltd

Managing Director: J. Joseph, M.I.E.E.
Late Manager to Mr. H. W. Sullivan.
Chief Designer: W. A. Appleton, M.I.E.E., M.I.R.E.
Late Admiralty Technical Research Officer.

ONLY ADDRESS:

Works, Offices, Showrooms:

12a, Hyde Street,
NEW OXFORD ST., W.C.1
'Phone: Regent 1908. 'Grams: Instradio, London.
Visit our Stand No. 37. All-British Wireless
Exhibition, Horticultural Hall, Sept. 30 to Oct. 7.

(E.F.S.) 2a.

**Buy of the Actual
MANUFACTURERS**

Saving ALL Intermediate Discounts.

Compare Prices and Remember

WE GUARANTEE

There is nothing on the market that can approach
our instruments and accessories for finish, accuracy,
sensitiveness, or value.

SATISFACTION

B.R.M. Set No. 1 Crystal. Entirely complete
for receiving, with H.R. 4,000 Ohm 'Phones.
Slide inductance, condenser, Crystal Detector Aerial,
Insulators, Lead-in, pulleys, etc., and mounted
neatly in polished, lid-closing walnut cabinet;
£4 15s. Postage and packing free.

OR

B.R.M. Set No. 1 Single Valve. Comprising Valve
holder, Grid leak and condenser, H.R. 4,000 Ohm,
'Phones, .002 condenser, low wave tuner, fila-
ment resist, Aerial, Insulators, Lead-in, pulleys,
etc., and mounted complete on ebonite panel, encased
in neat, lid-closing, polished mahogany cabinet,
ready for receiving £5 19s. 0d. Postage and packing
free. There is nothing on the market at this figure.

FULL COST

OF

PURCHASE REFUNDED.

.001 Condensers Assembled	17/6
Vanes, 3½"	2d.
Spacers, Large	doz. 4½d.
Spacers, Small	doz. 2½d.
Condenser Spindles, .0001 to .001	3d. upward.
Fixed Condensers, .0001 to .001	each 1/9
Complete Valve Panels	22/6
Terminals, neat, polished	doz. 1/9
Valve Sockets, complete	four 9d.
Aerial Wire, 7/22, 100'	4/9
Slider Rods, 12" lengths ¼ sq.	7d.
Crystal Cups	5d.
4,000 Ohm 'Phones	28/6
Sullivan Headphones, 8,000 Ohms, few only	36/6
Etc., etc.	

Postage free over £1.

We will have much pleasure in forwarding you a free
catalogue on application. Trade supplied. Enquiries
invited for any branch of special instrument manufacturing,
or parts of any description.

British Radio Manufacturing Co.
(Desk 3), ATHENÆUM WORKS,
HAMPSTEAD, LONDON, N.W.

Also at Heath Street, Hampstead. Tel.: Hampstead 3287.

MAGNAVOX

THE WORLD'S FINEST

LOUD SPEAKER

RADIO
brings it
MAGNAVOX
tells it.

*Broadcasting faithfully reproduced
with marvellous clarity and volume*

Sterling Telephone & Electric Co., Ltd.

TELEPHONE HOUSE,
210/212, Tottenham Court Road, London, W.1
Telephone No.: 4144 Museum (7 lines). Telegrams: "Cucumis, Wesde, London."

Works: DAGENHAM, ESSEX.

BRANCHES: NEWCASTLE-ON-TYNE: 9, Clavering Place.
CARDIFF: 8, Park Place.

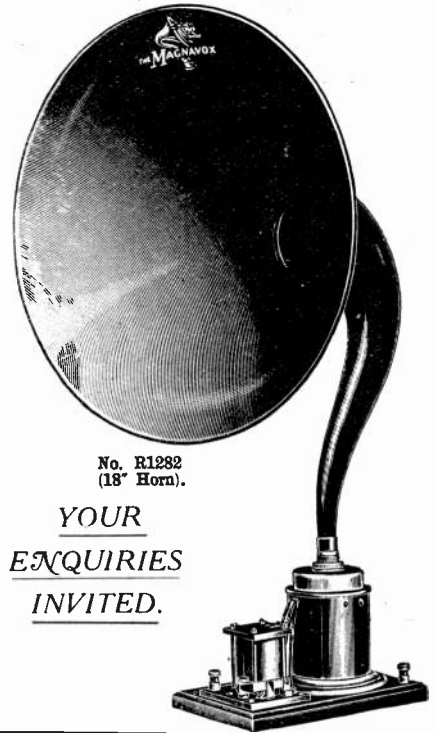

No. R1282
(18" Horn).

YOUR
ENQUIRIES
INVITED.

JUST PUBLISHED

NEW PRICE LIST

AND

WIRELESS GUIDE

FOR

AMATEURS

Sent on receipt of 3d. (stamps).

Manchester Electric Warehouse
1 & 5, Lever Street, Manchester

Buy The Best Phones
SPECIAL OFFER

STERLING-BROWN 1922

Manufactured under License Patent No. 134353/18.

FIRST QUALITY, NEW,
NOT RE-CONDITIONED

120 ohms, in series	£1 15 0	per pair
2,000 }	1 17 6	..
4,000 }		
8,000 }	2 20	..

Complete with best quality cords 6 ft. post free.

Valve Holders 8/- doz. Valve Legs 12/6 gross.
Inductance Sliders 6/- doz. Fixed Condensers 27/- doz.
1/4 sq., 12" Brass Rods 48/- gross, ends drilled.
Barrel Insulators 6/6 per doz. Condenser Discs 3 1/2
9/- doz. Filament Resistances 42/- per doz. best
quality.

WATFORD RADIO CO.
VALE ROAD, WATFORD, HERTS.

"H.W.P." (Birmingham) is having difficulty in short wave reception, and asks (1) For alterations in the connection of his three-valve receiver, to admit of either one valve being used alone, or all three. (2) For criticism of his circuit and way of getting improvement in the reception of amateur telephony. (3) Switching arrangements for connecting aerial tuning condensers either in series or parallel. (4) Probable reason why he does not receive signals sufficiently loud for operating a loud speaker.

(1) See Fig 4. (2) Your diagram is rather involved and somewhat difficult for us to follow. Why have you connected your two condensers in parallel? A closed circuit condenser is much too large for use as a Vernier. The smaller condenser might be used with advantage for tuning reaction circuit and should be bridged across its ends. I think your main trouble is due to inability to tune critically, mainly because your plate circuit is not provided with a tuning condenser. Ebonite extension handles on the condensers would facilitate critical tuning. (3) This is shown in the diagram. For short wave telephony reception it is essential that you should connect the variable condensers in

brightness nearly equal to that of the usual metal filament lamp. Condensers must be moved until signals are heard, and then further varied to improve the signal strength. Increases in the value of the aerial tuning condenser should be accompanied by increases in the value of the reaction tuning condenser and closed circuit tuning condensers. The reaction coil should be moved away from the closed circuit coil as far as possible, as this will eliminate re-radiation, and at the same time probably produce greater signal strength, and finally, readjustment of the various condensers may be made during reception. (2) Yes. A 3 or 4-valve low frequency amplifier can be connected in place of the ordinary telephone receiver of the ordinary land line telephone, and the output terminals connected to the loud speaker as you propose; or if it is only your desire to produce speech of great intensity, a microphone battery and step-up induction coil are connected in series. The secondary of the coil is taken to the grid of the first low frequency valve the remainder of the connection being as is usual in a low frequency amplifier. For producing speech by this method of intensity considerably above that

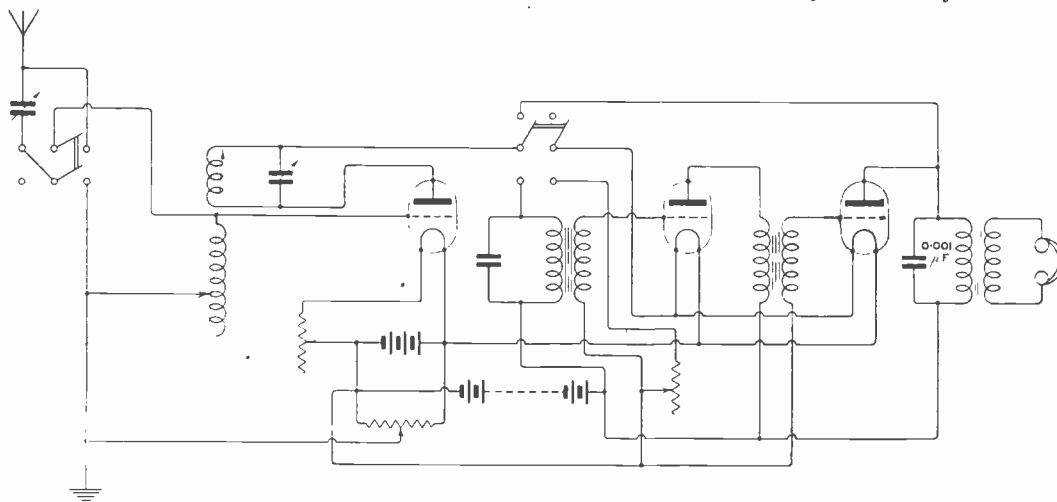

Fig. 4.

series with the aerial tuning inductances. (4) Your aerial is not very high, and is lower than both house and tree, which is not the best arrangement. Cannot you arrange to erect a light mast on the roof, as shown on p. 260, May 27th issue? And cannot you arrange to erect a two-wire aerial?

"J.H.C." (W.4) asks (1) For an explanation of the process of "tuning in." (2) Whether a low frequency valve amplifier can be used for increasing the strength of signals in an ordinary telephone receiver (not wireless).

(1) To completely describe the process of "tuning in" signals is rather beyond our scope. If you could find a friend who could give you a few minutes' tuition, you would easily grasp the whole process, and the help that you would gain from him would be far more than we could give you in ten pages. In brief, you should insert tuning coils in the three-coil holder whose wavelength ranges tally with one another. The filaments should be of

of the ordinary voice, you will require at least five valves, and as a result there may be some distortion, unless specially designed intervalve transformers are used. Of course, telephony is always considerably distorted by the loud speaker itself.

"J.E.R." (Kingsbury) wishes to make a crystal set and asks (1) If the coil in the Reinartz Tuner can be oval or rectangular, using the same quantity of wire as given in the issue of May 13th. (2) If a crystal could be used with this tuner and valve added later. (3) Can celluloid be used as an insulator. (4) Would three wireless stations within five miles give a beginner any trouble.

(1) Yes, if desired. The wavelength range will come out slightly different according to the shape employed. (2) No, not at all effectively. (3) Celluloid is not a very good wireless insulating material, but may be used if nothing better is available. (4) Probably not, at any rate on a

crystal set, but we should advise using a two-circuit loose coupled receiver.

"A.T.I." (Ealing) asks (1) *Of what height must his aerial be to be efficient.* (2) *If a twin or single wire aerial is the better.*

(1) The aerial must not be less than 20' high, preferably 30'. *N.B.*—You cannot use reactance with a crystal set. (2) Use a twin wire, 7/24 or similar size of silicon bronze or galvanised steel will be suitable.

"T.H.B." (Holyhead) gives a list of parts and asks if they can be made into a set; if so for suitable dimensions.

0.0005 mfd. condenser. Potentiometer former, 6" x 1" wound with No. 36 Eureka. Tuning inductance, double slide, 9" x 6" of No. 22.

"A.W.S." (Tooting) asks for criticism of a circuit and whether the values employed are correct.

The circuit is O.K. and the values are quite suitable except that the parallel A.T.C. should not be used at short wavelengths.

"C.F.H." (Nottingham) asks (1) *For a circuit diagram of a five-valve receiver embodying 2 H.F., 0 rectifier, and 2 L.F.* (2) *A diagram of a seven-valve receiver using 3 H.F., 1 rectifier, and 3 L.F.*

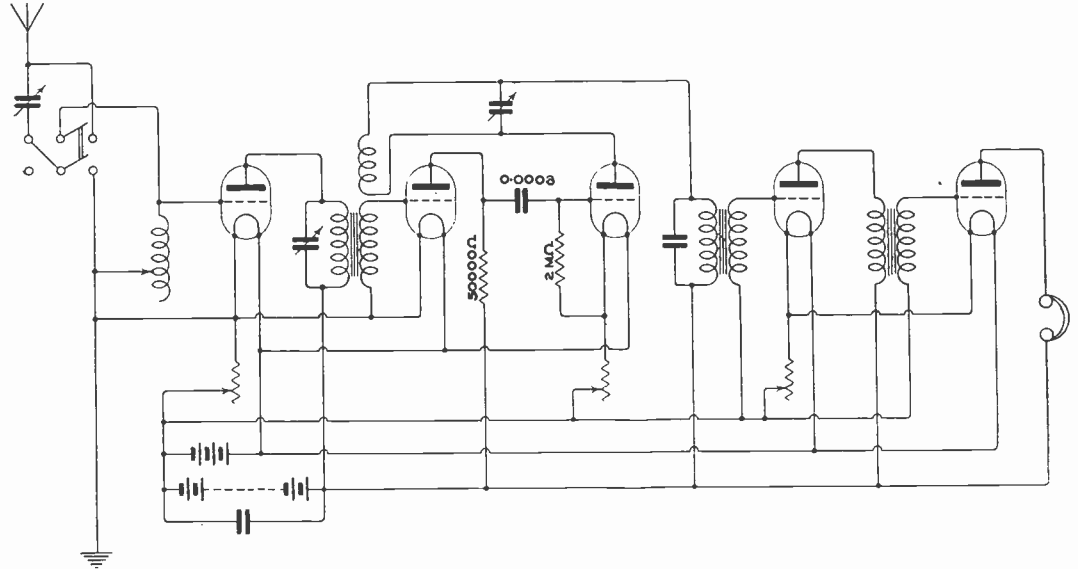

Fig. 5.

(1) See Fig. 5. (2) The method adding H.F. and L.F. circuits is easily apparent.

"V.H.T.L." (Hampstead) asks (1) *The name of a wireless society in his district.* (2) *The maximum wavelength of his aerial when connected to a tuning coil consisting of 167 turns, 4½" in diameter.* (3) *The dimensions of a loading coil required to tune to 6,000 metres.* (4) *Why it is that he is able to hear all of the more important London amateur stations (and particularly 2FQ), and yet is unable to receive the transmissions from Marconi House as loud as from the amateurs.*

(1) The nearest Society would probably be Highgate Wireless Society, and the address of the Secretary is Highgate Literary and Scientific Institution, South Grove, Highgate, N. (2) Your

set will probably not tune beyond 1,700 metres. When the aerial tuning condenser is connected in parallel the reaction coil with its tuning condensers will probably tune to 2,500 metres. (3) To load the aerial we would recommend you to use a number of basket coils, assembled along an ebonite tube, and spaced from one another by about ¼". If these coils have an internal diameter of 2" and an external diameter of 4" and are wound with No. 26 D.S.C., you will require from 8 to 10 to load your aerial to a wavelength of 6,000 metres. The closed circuit need not necessarily be further loaded, as it will probably function aperiodically, but if you want precise tuning in this circuit, and are desirous of working with fairly loose coupling between aerial and reaction circuits, it will need to have a few basket coils connected in series with it. (4) We cannot understand why you are able to receive amateurs' stations located in various parts of London, and yet have difficulty in receiving 2LO. In our experience 2LO can be received in London on the simplest type of crystal set, whilst if more than a few miles away, for many of the amateurs you mention a single valve receiver at least is required. Make two special basket coils

for short wave work, consisting of 44 turns of No. 26 D.S.C., and having a mean diameter of 2½". Bridge the reaction coil with a tuning condenser, and place one over the other to give reaction effects, and we think you will find it difficult to miss the signals which you complain you are unable to receive successfully.

"J.R." (Newcastle-on-Tyne) asks (1) *For criticism of a crystal set.* (2) *For criticism of aerial.* (3) *If certain 2,000 ohm telephones are suitable for telephony.* (4) *What concerts he should hear.*

(1) O.K., except that the potentiometer should be wound with eureka, or similar wire, instead of copper. Range probably up to about 3,500 metres. (2) Not good. Bring down lead from the end of the aerial nearest to the house. (3) Yes. (4)

For they are jolly good- -FELLOWS



Fellows Head Telephones,
4,000 ohms.

two earpieces in light die cast
non-ringing metal.

Price 30/- per pair.

Deliveries. Immediate against cash
with order.

Manufacture. The same high
grade workmanship as the Fellows
Magneto.

Send your order to-day. (Cheques,
P.O., P.O.O. or M.O. to be crossed
London Joint City & Midland
Bank, Ltd.)

Trade terms for quantities on request.

FELLOWS MAGNETO Co. Ltd.

LONDON, N.W.10.

Telephone:
Willesden 1560-1.

Telegrams:
Quixmag, Phone, London

*For all Radio Apparatus and Com-
ponents.*

Visit our Stand No. 10. All British Wireless Exhibi-
tion, Horticultural Hall, Sept. 30th to Oct. 7th.



To ensure the
earliest attention
send this page
with your order.

And so say all of us

THE "BROWN" LOUD SPEAKERS

WITH NEW IMPROVED CURVED HORNS.



The requisites of a Loud Speaker are pure tone, clear articulation, and good volume of sound. The "BROWN" Loud Speaker possesses these qualities, and they are enhanced by the new improved curved horn.

THE AMATEUR does not always need the full sized Loud Speaker (H.1) as used in Lecture Halls, and a small type (H.2) has been designed to meet his more modest home requirements.

THE NEW HORN used with both H.1 and H.2, is constructed on the logarithmic law of increasing openings and is acoustically perfect.



PRICES:

H.1 (Large) Low Resistance, 120 ohms	£6 5 0
H.2 (Small) " " " " "	£3 0 0
The "BROWN" Standard Pattern (with upright funnel)				
Low Resistance, 120 ohms	£5 10 0
(High Resistances for all patterns 2/6 to 5/- extra)				
<i>Catalogues post free on application.</i>				

SOLE MANUFACTURERS: **S. G. BROWN, LTD.,**
 SHOWROOMS: 19 MORTIMER STREET, LONDON, W.1 Telephone: Museum 4950
 Works: Victoria Road, North Acton, London, W.3. Sole Agent for the Argentine: Horacio D. Guerrero, Las Heras 2480, Buenos Aires
 Telegrams: "Sibrownix, London." Telephone: Chiswick 14,69.
Brown's Wireless Apparatus can be purchased from all Wireless Suppliers.
EARLY DELIVERY of Telephones and Loud Speakers can now be given.

Visit our Stand No. 43. All British Wireless Exhibition, Horticultural Hall, September 30th to October 7th.

ELECTRICAL DISPOSALS SYNDICATE

GOVERNMENT SURPLUS.

200 TONS STILL LEFT

SELECTIONS FROM OUR STOCK.

TOWNSEND WAVEMETER PARTS.

Buzzers	...	3/6
Outer Frames, Wound	...	2/-
Ebonite Tops	...	6d.
Choke Formers (Ebonite)	...	1/-
Etc., etc., etc.		

SEPARATORS.

Containing Cabinet 5 $\frac{3}{4}$ " x 7" x 6", Hinged hollow lid, choke coil, wound with over $\frac{1}{2}$ lb. D.S.C. 36-gauge wire, one 1 $\frac{1}{2}$ mfd. and two $\frac{1}{2}$ mfd. H.T. condensers, 6 S.P. plugs, 1 D.P. plug, with flex, 6 fuses and holders, 6 lightning protectors, several sheets $\frac{1}{8}$ " polished ebonite, etc., etc. 12/6

INSULATORS.

Porcelaine, with straight spindle	...	1/6
Porcelaine, with curved spindle	...	1/9
Ebonite, with straight spindle	...	2/6
Litholite, with straight spindle	...	2/-

SCREWS.

0 B.A., 2 B.A., 3 B.A., 4 B.A., 6 B.A., 8 B.A., etc. Various heads and lengths from 2d. to 6d. per doz.

DUPLIX TELEGRAPH SETS .. £7 (Listed £25).

6" DIA. VOLT-AMP. METERS.

Various readings	...	30/-
WESTON RELAYS	...	42/-
JACK SWITCHES (14-point)	...	3/6
PLUGS AND CORDS	...	2/-
JACKS	...	2/-
TELEPHONE MAGNETOS	...	10/6
G.P.O. KEYS	...	5/6
MICROPHONE IN SETS	...	5/-
Etc. etc. etc. etc. etc.		

WRITE—6, MARKET PLACE, W.1.

CALL—84, GLENGALL ROAD, PECKHAM.

Phone: Museum 648.

TECHNICAL ADVICE FREE.

Probably none until the broadcasting station at Newcastle starts operations.

"F.T.G." (Kensal Rise) is constructing a long range multivalve receiver, and asks (1) for a circuit diagram comprising two H.F. valves, one detector and one L.F., with series parallels for the aerial tuning condenser, switching for arranging either transformer or resistance capacity coupling between the H.F. valves, separate filament resistances for each valve, separate potentiometer control where necessary and switches to cut out (a) one H.F. valve; (b) one H.F. and one L.F. He also requires values of condensers and resistances. (2) Particulars for the construction of the high frequency interchangeable transformers. (3) Details of construction of the low frequency transformer and telephone transformer. (4) The best type of valves as H.F. detector and L.F. amplifiers.

(1) See diagrams Figs. 6 and 7. (2) Use 1" polished ebonite rod as a former on which to wind the transformers. Four valve legs can easily be screwed into one end by making tapped holes. If you are desirous of using transformers of various values and having them interchangeable. Where more than one H.F. transformer is used, it is essential that they shall all have exactly the same values, or otherwise one transformer will filter out signals on wavelengths on which the other will operate best. Wind on the required number of turns for the wavelength required in the form of a single layer, and insulate primary from secondary with a single layer of empire cloth. As an approximate guide, 600 turns of No. 40 S.S.C. give 600 metres. Make primary and secondary windings both in the same direction, and the two leads passing from one end of the transformer are taken to grid and plate. (3) The bobbin should measure $1\frac{3}{4}$ " long by $1\frac{1}{4}$ " in diameter. The core, which should consist of fine soft iron wire, should have a diameter of $\frac{5}{16}$ of an inch, and the primary should be wound to a depth of $\frac{3}{4}$ " with No. 46 S.S.C.,

and the secondary up to $1\frac{1}{4}$ " with No. 48 S.S.C. The core wires should be bent back along the sides of the transformer, those from one end being intermeshed with those from the other. For the telephone transformer wind the primary of the same

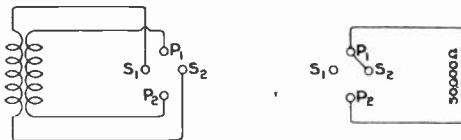

Fig. 7.

dimension as just given, but with No. 48 S.S.C., and the secondary also to the same diameter, but with No. 34 S.S.C.

"J.H.J." (Rotherham) asks (1) Whether his circuit is suitable for the reception of telephony with a single head telephone receiver and "R" valves, and (2) the capacity of the variable condensers in aerial and reaction circuits.

Your circuit is incorrect. The amplifier is built up on the resistance capacity principle, and you should therefore include high resistances of the order of 50,000 ohms in the plate leads. Resistance capacity coupling, however, is not efficient for use on short wavelengths, and you will be well advised to use a single valve receiver with tuned reaction circuit, followed by one low frequency amplifier, and if this does not satisfy your requirements, you might add one stage of high frequency amplification. (2) For short wave reception, the aerial tuning condenser should have a maximum value of 0.001 mfd., and a small blocking condenser of value of about 0.001 might be connected in series with it to provide fine tuning. The condenser which bridges the plate circuit should have a value of 0.0005 mfd. Both condensers should be of the air dielectric type.

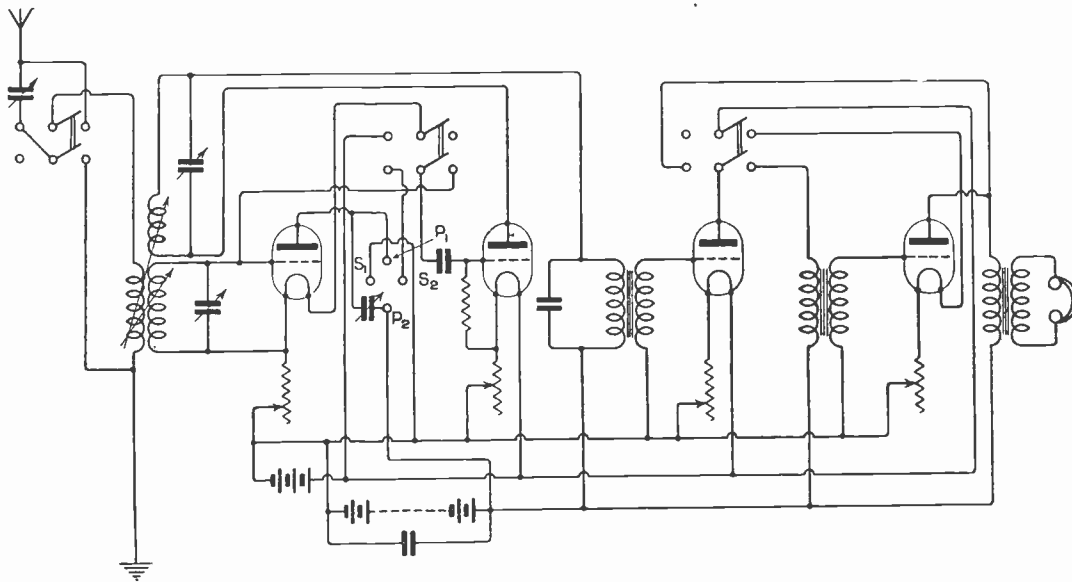

Fig. 6.

"J.D.B." (Kintyre) asks if a circuit which he submits, consisting of the usual tuned aerial circuit with coupled plate circuit, is suitable for the reception of C.W., and with the addition of amplifying valves, broadcasted telephony. (2) Whether the addition of one H.F. and one L.F. would permit of reception from PCGG and 2MT. (3) If not, how many valves would be required, and (4) Suitable circuit.

(1) Yes. (2) and (3) Yes. (4) See Fig. 8.

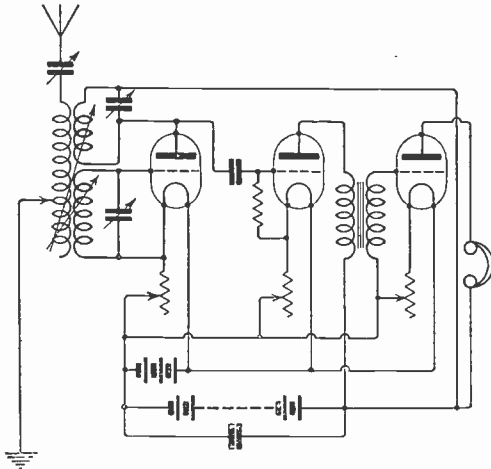

Fig. 8.

"ELECTRON" (Gloucester) asks (1) If the enclosed diagram of circuit is correct. (2) If the Writtle and Paris music can be received in Gloucester. (3) How to make a telephone transformer for 300 ohm telephones. (4) What value grid leak to use with this circuit.

(1) Yes. (2) Possible, but doubtful in the case of Writtle. (3) Use a core of $\frac{1}{2}$ " x 4" of iron wires; for the primary winding 3 ozs. of No. 44 and secondary 6 ozs. of No. 32 (No. 28 is too thick). (4) About 1 megohm. Adjust by experiment.

"J.L.S." (Huddersfield) asks (1) With reference to a five-valve circuit why is No. 5 called a "telephone transformer," and Nos. 3 and 4 L.F. transformer. (2) Where he can obtain the plugs and jacks. (3) Types of coils and condensers recommended to use with his set.

(1) We cannot say without detailed information, but unless the set is to be very inefficient it is probably designed for H.R. telephones. There is no hard and fast distinction between inter-valve and telephone transformer. (2) Try the makers of telephone apparatus, such as the G.E.C., or various wireless dealers advertising in this magazine. (3) Any of the normal types should be satisfactory.

"RECORDER" (Isle of Man) has trouble with his relay and asks for advice.

Your aerial is very poor. Your single 73' wire would probably give better results than the combination. There are various possible explanations of the unsteadiness of your circuit, e.g.—(1) Variation in voltage of either battery. (2) A disconnection, partial or complete, in one of your grid windings. (3) A soft valve. (4) Leaky windings of your relay. Almost all arc stations work on a double note in the way you mention for Leafield.

This is because they signal by making a slight change of wavelength, not by switching on and off their power.

"L.R.H." (Birmingham) asks (1) If the diagram submitted is suitable for a beginner and correct. (2) What wavelength range would a certain winding give. (3) What type and capacity condenser should he use.

(1) Quite O.K. and suitable. (2) About 1,200 metres. (3) Variable, air di-electric. Capacity about 0.0005 mfd.

"A.L." (New Brighton) asks if a certain circuit is correct.

The circuit shown is quite O.K. except that when the A.T.I. and A.T.C. are in series the first valve is tapped across both. The valve should be tapped across A.T.I. only, and this should be on the earth side of the A.T.C.

"T.K.R." (Norwich) asks the gauge of a sample of wire and whether suitable for an aerial. (2) Whether crystal circuit sketched is correct.

(1) No. 7/26 cable. The wire is quite suitable, but we do not care for the braided cotton covering for an aerial, as it is liable to lead to dielectric losses and is very unsightly. (2) Quite O.K.

"AMPLIFIER" (Folkestone) encloses a diagram of a three-valve circuit and asks where the reaction condenser should be introduced.

The circuit shown is O.K., except for the direct connection between the first grid and the last plate. The reaction condenser should be introduced in this lead, and can be fitted with a series switch if desired.

"G.J." (Leicester) asks for advice as to installing a one-valve 10-watt transmitter.

Your question is too general for us to assist you much. We might say apply to the P.M.G. for a licence, buy a set from a reputable maker and erect as large and unscreened aerial as possible and then start work, but this is possibly not the advice you require. If you will let us know the actual points, e.g. (type of circuit, price, method of construction, insulation or adjustment, type of aerial, etc., etc.) in which you are in difficulty, we should be happy to advise, but a treatment of all the possible questions arising out of your enquiry would require about one complete issue.

"B.A.W." (Ealing) asks for criticism of one-valve set. (2) Capacities for various condensers in it. (3) If it can be made of mica and foil.

(1) Circuit is O.K. except that when the plug is inserted in either II or III the corresponding grid winding should be broken, and all valves not in use should have their filament current switched off. (2) A and B 0.0005 mfd. C and D 0.001 mfd. (3) A and B should be variable, of air dielectric. C and D might be mica and foil, say 4 mil. mica 5 sq. cms. of overlap per pair of foils, and four foils.

"J.A." (West Somerset) asks two questions about his aerial.

(1) By all means erect a 40' mast at B. The raising of any part of an aerial is almost always advantageous, whatever the general configuration of the land or aerial may be. (2) We should prefer the single one.

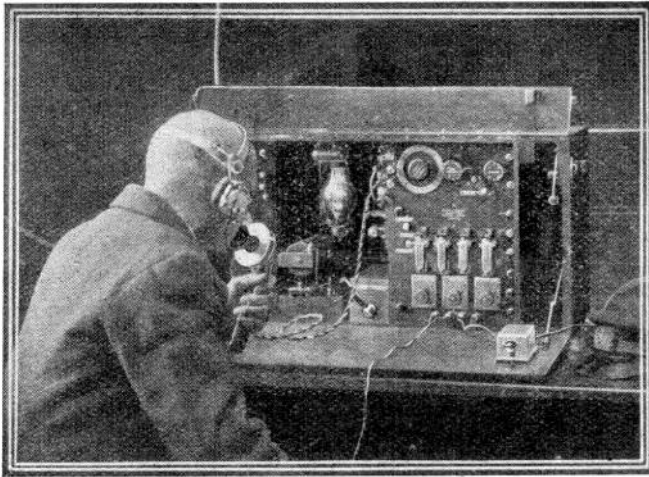

The First Commercial Wireless Telephone Service in Great Britain

is used for

Communications between the offices of the Mersey Docks & Harbour Board in Liverpool and the Bar Lightship beyond the mouth of the Mersey. The Marconi apparatus in each case is operated by the ordinary Harbour Board staff and has been in continual use since its installation over a year ago. — "Calling up" is performed by means of the

❖ ❖ Marconi wireless bell ❖ ❖

MARCONI'S WIRELESS TELEGRAPH CO., LTD
 MARCONI HOUSE, STRAND, LONDON, W.C.2
 Telephone: CITY 8710.

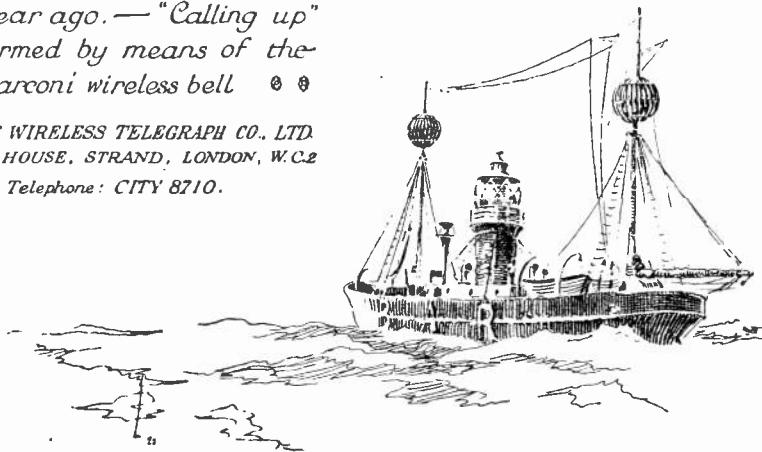

Visit our Stand No. 24. All British Wireless Exhibition, Horticultural Hall, Sept. 30th to Oct. 7th.

“BRITWIRE” CONDENSERS.

OWING to the demand for a good condenser, which at the same time is cheap, we are now manufacturing a Balanced Condenser for panel mounting, replacing the imported condensers hitherto sold. The plates are die-cast into the supporting columns, and are counterbalanced so that they will remain in any position when mounted on an upright panel. At present only two capacities are being manufactured, viz.: '0005 and '001, but other capacity condensers will be made in due course. Orders booked and executed in strict rotation.



PRICE

WITH EBONITE REVOLVING SCALE :

'0005	17/6
'001	25/-

*Liberal Discounts to the Trade.
Send for Illustrated List, post free 3d.*

POST ORDERS TO—

BRITISH WIRELESS SUPPLY COMPANY

6 BLENHEIM TERRACE, LEEDS.

Telephone : 26926

LTD.

And at
11 Church St., West Hartlepool. Tel. 373. 18 Eldon Sq., Newcastle-on-Tyne. Tel. City 360.
33 High Street, Southampton. Telephone 403.

Visit our Stand No. 42. All British Wireless Exhibition, Horticultural Hall, Sept. 30th to Oct. 7th

“Exide” BATTERIES FOR WIRELESS

WE specialize in the manufacture of batteries for filament current supply to Valves and high-tension batteries for application of Anode Potential. We can supply these batteries in glass, ebonite or celluloid containers to any desired voltage.

Exide batteries can be relied upon for wireless work and retain their charge over very long periods.

Prices and Particulars on Application.

THE **Chloride** ELECTRICAL STORAGE COMPANY LIMITED.

Head Office : London Showrooms :
Clifton Junction, 219/229 Shaftesbury Av.
Nr. Manchester. W.C.2

Visit our Stand No. 30. All-British Wireless Exhibition
Horticultural Hall, September 30th to October 7th.

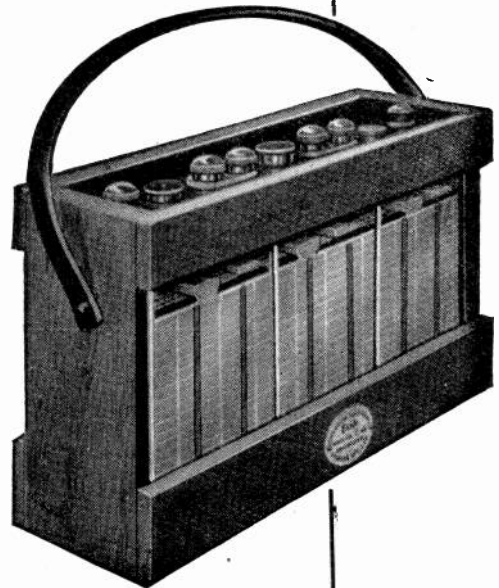

6 Volt 80 Amp. Hour Exide Battery.

"C.H.T." (Mildenhall) asks for a diagram of a five-valve set suitable for reception of short wave telephony, for making use of several components he has on hand.
See Fig. 9.

We recommend you to add one high frequency valve and an additional note magnifier, as shown in the circuit diagram, Fig. 10. We regret we cannot advise you on questions relating to patents, and the circuit we recommend to you obviously embodies

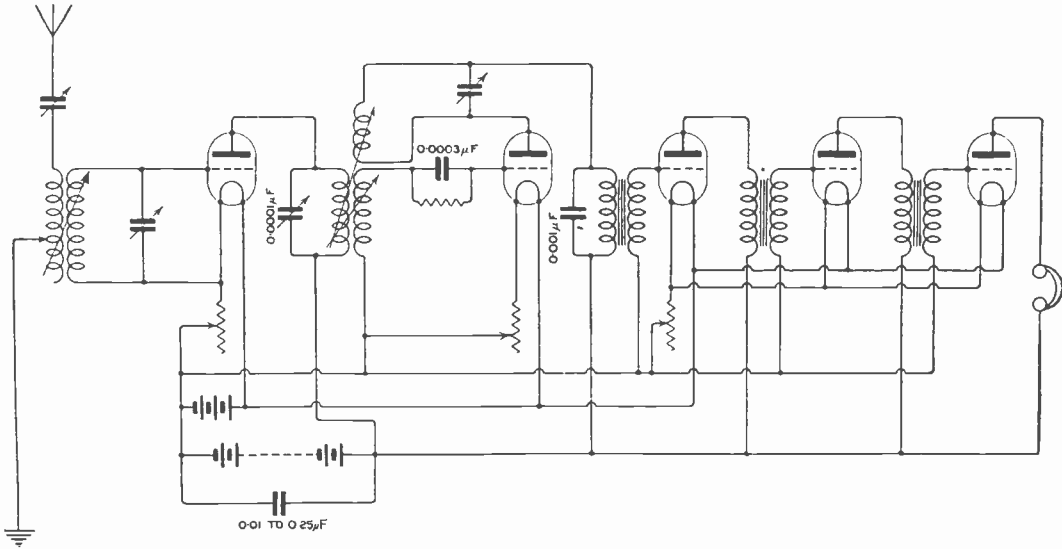

Fig. 9.

"H.A.H." (Rotherham) has a two-valve receiver consisting of the usual detector to oscillator valve, followed by one note magnifier, and asks how to add two additional valves in the most efficient manner, and whether the circuit we recommend

the use of patents held by the Marconi Company, but we believe that the Marconi Company will have no objection to you making use of their patents for experimental and research purposes. A statement on the subject appeared on page 479 of the July 15th

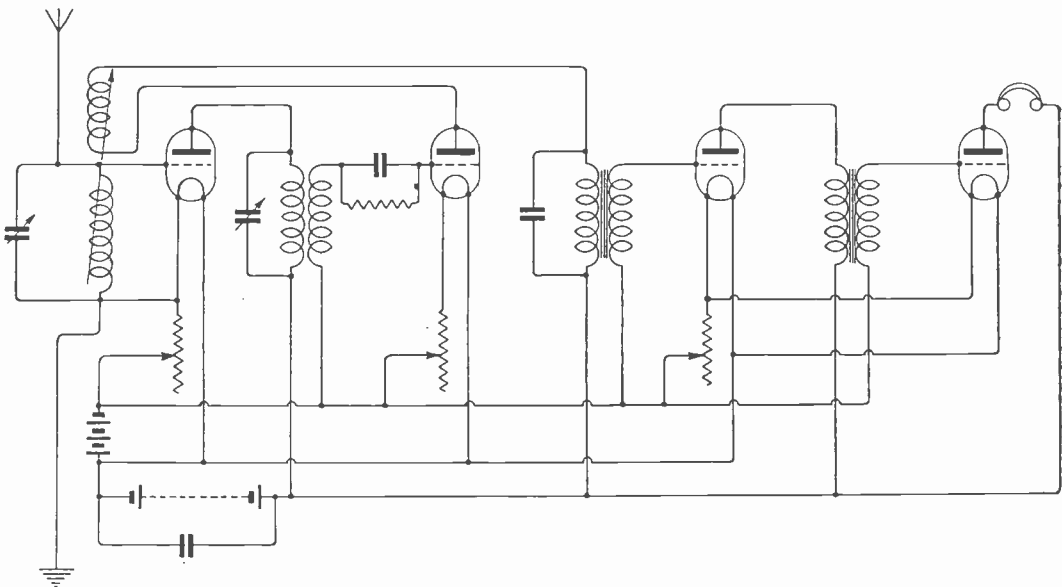

Fig. 10.

would infringe Marconi patents. He also asks for times and wavelength for transmission by the various stations.

issue. The list of regular transmissions which we publish from time to time has been revised and accompanied the issue of August 5th.

“**RADIX**” (Nottingham) asks (1) For criticism of a circuit sketched. (2) If an H.F. transformer and telephones would give better results. (3) Where can he obtain a chart of wireless stations and their wavelengths. (4) If a certain arrangement of aerial is satisfactory.

(1) The circuit is incorrect. Alter as in diagram given to **J.S. (Liversedge)** below. (2) Yes, it should definitely improve results. (3) See chart in issue of August 5th, 1922. (4) No, this is undesirable.

“**J.S.**” (Liversedge) asks (1) For criticism of a circuit. (2) How to add two L.F. valves. (3) For dimensions of a loose coupler to tune down to between 150 and 600 metres with a 0.001 mfd. condenser.

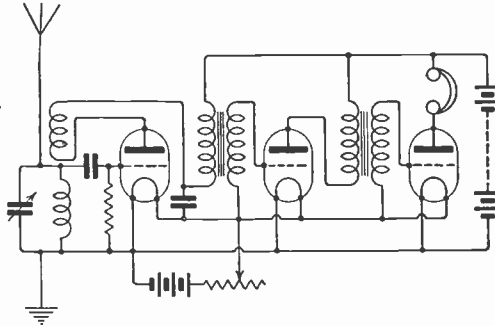

Fig. 11.

(1) Circuit is quite O.K. except that a parallel condenser of 0.001 mfd. is highly undesirable for short waves. (2) See diagram (Fig. 11). (3) 0.001 mfd. is too big, and 0.0005 mfd. for the closed circuit dimensions might be primary 5" x 3" of No. 22, and secondary 5" x 2 3/4" of No. 24.

“**R.E.B.**” (Bristol) asks (1) If a certain arrangement of his aerial is O.K. (2) If a tramway system will interfere with his reception. (3) If he will be able to receive 2 MT with his aerial. (4) How many valves will be required to receive 2 MT.

(1) It would be better to bring the aerial lead outside the building as close as possible to the instruments, staying it as far as possible from the walls all the way. The bathroom waterpipe might be used for the earth, but under the circumstances an earth buried outside the receiving room would probably be better. (2) It may give some induction trouble, particularly if much amplification is employed. (3) Probably, especially if modified as suggested. (4) Three valves should be sufficient.

“**A.S.**” (Bayswater).—(1) See Fig. 2, page 313, May 13th issue. (2) Core 1/2" x 4" of iron wires, H.R. winding 3 ozs. No. 44, L.R. winding 6 ozs. No. 32. (3) Range would probably be up to about 20,000 metres. You should get all the larger European stations, and American stations under favourable conditions.

“**D.W.T.**” (Cambridge) sends a characteristic of a valve and asks (1) Best grid potential for (a) oscillation, (b) rectification, (c) amplification. (2) How the grid potential is applied.

(1) (a) Almost anywhere. (b) Without grid condenser about minus 4, i.e., the lower bend of the curve. From the characteristic the valve would appear bad as a rectifier. (c) About zero, i.e.,

the straight part. (2) By means of potentiometer across the L.T. battery, with additional series cells if necessary.

“**J.D.B.**” (Greenock) submits a single valve circuit for criticism and asks (1 & 2) If two-valve will be sufficient to enable the Dutch Concert to be heard at Greenock, or if three valves will be necessary. (3) What arrangement of valves to use. (4) Indicate additions necessary to circuit to obtain H.F. amplification.

(1) No. The side of the closed circuit condenser remote from the grid of the valve should be connected to the negative end of the filament battery. (2) At least three valves will be required for satisfactory results. (3) One H.F., one detector and one L.F. is a very good arrangement. (4) Fig. 2, page 304, June 3rd issue, shows a very good circuit for a complete receiver, the first valve of which is arranged for H.F. amplification, the same arrangement being suitable for your set.

“**E.T.**” (Seaham Harbour) asks (1) For a diagram of a two-valve note magnifier to be added to a single valve panel with switch mounted on the note magnifier, to use either one or two valves. (2) Name of the station on 2,600 metres, having a carrier wave and audible 20 feet away from the telephones with a two-valve set.

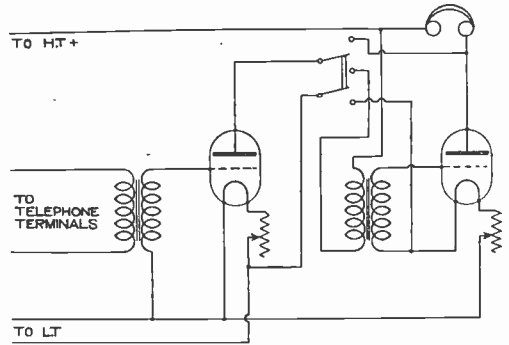

Fig. 12.

(1) See diagram (Fig. 12) (2) Information is rather limited to reply with certainty. It might be FL, but we should hardly expect this station to be so strong at such a distance.

SHARE MARKET REPORT.

Prices as we go to press, August 25th, are:—

Marconi Ordinary	£2 6 0
„ Preference	2 2 6
„ Inter. Marine..	1 9 6
„ Canadian	10 6

Radio Corporation of America:—

Ordinary	1 3 6
Preference	14 3

GREAT PRICE REDUCTIONS

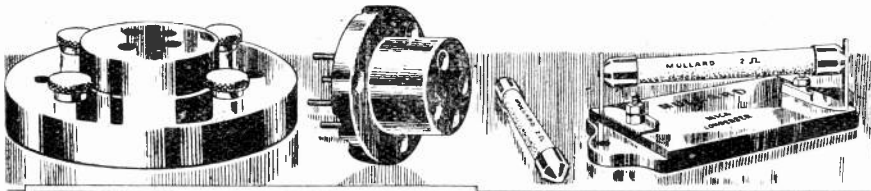

GREAT REDUCTIONS
in PRICES of
MULLARD ACCESSORIES

VALVE BASES. Specially designed with four convenient terminals. Moulded from the best materials. Internal connections completely enclosed.

GREATLY REDUCED PRICE, 5/- each

VALVE SOCKETS. Eminently suitable for constructing complete valve receivers, amplifiers, etc. Moulded from the best materials. Impossible to insert the valve the wrong way.

GREATLY REDUCED PRICE, 1/3 each

MULLARD PATENT RESISTANCES. Absolutely 'silent' and constant in use. Grid A. Grid B.

Anode A. or Anode B.

GREATLY REDUCED PRICE, 5/- each

B.A. CONDENSER. .0003 mfd., mica insulated 2/6 each

NEW DESIGN COMBINED CONDENSER AND GRID LEAK. Grid B Resistance with .0003 mfd.

B.A. Condenser 7/6 each

RESISTANCE CLIPS 9d. per pair

MULLARD TELEPHONE HEADSETS 4000 ohm., immediate delivery

30/- each

All Mullard accessories are **BRITISH MANUFACTURE** throughout. These **BIG REDUCTIONS** in price will cause a greatly increased demand for Mullard accessories.

To ensure early delivery, send coupon to-day.

Visit our Stand No. 41. All British Wireless Exhibition. Horticultural Hall, September 30th to October 7th.

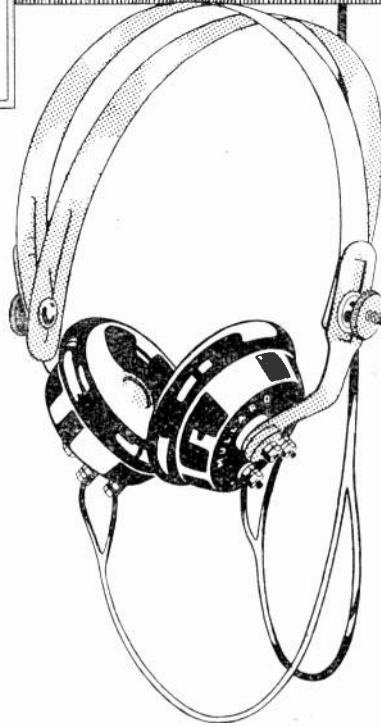

Mullard Radio Valve Co. Ltd.

Claybrook Road, Hammersmith, W.6.

Contractors to H.M. Admiralty.
War Office, Royal Air Force & Post Office.

Telephone: Codes: Telegrams:
Hammersmith 312 ABC (Ed) Radiovolve Hammer Lond.



Name and Address.....
To the MULLARD RADIO
VALVE CO., LTD.,
35, Claybrook
Road,
Hammersmith,
London,
W. 6

Please send me post free.....

Quantity.....	Description and Price.....
.....	Telephone Head Sets 30/- per set
.....	Grid A Valves 15/- each
.....	Grid A Resistances 5/- each
.....	Anode A or B Resistances 5/- each
.....	B.A. Condensers, .0003 mfd. 2/6 each
.....	Combined Condenser and Resistor 7/6 each
.....	Valve Bases 5/- each
.....	Valve Sockets 1/8 each
.....	Terminal Clips 9d. per pair

I enclose (cheque) Money
Order. P.O. value
.....
to cover the
cost.

Name of usual Wireless Dealer:

SEND THIS TO-DAY

THE WIRELESS WORLD EXCHANGE AND MART

THE UNIQUE N.M.C. (Wireless Patents)
Two-valve Receiving Unit, combining Filament Resistance, Aerial Tuning Inductance, Aerial Tuning Condenser, Grid Tuning Inductance, and Oscillating Condenser complete in polished case, 12" x 8" x 6", £6 6s. less valves.
The Set to obtain maximum efficiency.
N.M.C. 4,000 W., Double Head Gear, 35/- Inductance Tubes.
All Experimenters' Supplies in stock.
N. M. CO., 145, Northcote Road, Trade Supplied. London, S.W.11.

I Buy Wireless Gear of every description.
Send your particulars to :
WILKINSON,
Lonsdale Rd., Kilburn, N. W. 6
SAME ADDRESS SINCE 1900.

RADIOPHONE TUNERS,
200-1,400ms. 38/-
Valve Panels for above . . . 21/-
*0005 Variable Condensers . . 18/6
Above 3 make an Ideal Receiver.
Broadcast Concert Coils pair 2/-
Grid Leaks and Condensers 3/6
Fixed Condensers 2/6
5-Plate Condensers 6/6
2-Valve H.F. Amplifier Panels 32/-
Get our New Bargain List.

AMATEUR SUPPLIES,
184, COTEFORD STREET,
TOOTING, LONDON, S.W.

Your Case Work
Let us quote you for your wireless casework. We are specialists in this class of work and feel sure our workmanship and prices will interest you.
Phone: L.W. 2720.
CARRINGTON & NEWBERRY LTD.,
18/20, Normans Buildings, Old Street, E.C.

AN EFFICIENT ADJUSTABLE LOUD SPEAKER AT 40/- EACH.
Giving perfect reproduction of Speech and Music. 22" Horn. Equal to others at higher prices. Cash refunded if not approved. Order at once to ensure immediate delivery. High resist. 5/- extra. Postage 1/6.
SIMPSON, 233, Gipsy Road, W. Norwood, S.E.27.

HEATH & Co., Ltd.
Instrument Works, New Eltham, S.E.9
are prepared to undertake in their fully equipped works—Wireless Apparatus and Parts for the trade. Quotations given to Blue Prints. Immediate attention.
Phone—Lee Green 301. Wire—Polaris, London.

FOR SALE.

High Tension Batteries.—Fully Guaranteed Long life 15-Volt 11 cell. Not "Surplus" stock 2s. 11d. post free. For three, 7s. 6d., post free. Orders in strict rotation.—LITCHFIELD & Co., Wireless Specialists, 12, Great Castle Street, London, W.1.

Aerial Masts.—Jointed tubular with base flange, complete with 3 galvns., stranded stays, band, strainers and ground anchors, pulley, pinnacle, painted, halyard and spreaders assembled with insulators ready for erection, free on rail, 30 ft. 75s., 40 ft. (with 6 stays) £6 12s. 6d. each. Write for blue print and specification, higher masts to order. Spreader, insulators, halyard and pulley assembled complete, for house end, 18s. 6d. aerial wire, 150 ft. 3s. 6d.—GOSWELL ENGINEERING CO., LTD., 12A, Pentonville Road, N.1.

Wireless Masts. Don't wait for the winter Put them up NOW. Twopence per foot. Particulars of Masts and all fittings, send stamp.—DOWNES, 61, Arthur Street, Derby.

T.F. Receiver with 3 Valves, perfect, £12.—KILLBOURNE, Blue Boar, Abingdon, Berks.

Brown's Genuine A 'Phones, £1 10s. Burndept Coils on plugs, Nos. 400, 8s.; 300, 7s.; 250, 6s.; 200, 5s. 6d.; 35, 4s.; 25, 4s.; 6-volt voltmeter, 5s. 6d.—MONKS, Norbora Road, Doncaster.
4,000 Ohm Headphones, well finished, 25s., cash with order.—LONDON FACTORS & AGENTS, LTD., 39, Parliament Street, S.W.1.

Wireless Batteries.—16-Volt units; superior to any other, the result of 10 years scientific research, only 3s. 6d. each, postage extra.—CLEMMENTS, 50, Noel Street, London, N.1.

Wireless 20' Poles, 2" diameter, suitable aeriels, light, strong, 5s. 9d. each. Ropes, pulleys, spreaders, wires, speciality.—FRED MOORE, Park Lane, Liverpool.

Variable Condenser.—001 mfd. for panel fixing, ebonite top with scale, excellent finish, 20s. Also '0005, similar construction, 15s.—BENNETT, 81, Somerset Road, Farnborough, Hants.

"Multi" Panel Unit Crystal and Valve Set, with nine coils, tuner £5 (with valve). Specifications, photograph, stamp.—RADIO COIL CO., 20, Maybank Avenue, Harrow.

Wireless Headphones, 4,000 ohms, latest model for valve or crystal set, 29s. 6d. post free. Money returned if not satisfied. P.O. to Dept. W., 18, De Crespigny Park, S.E.5.

Aerial Wire.—Our Speciality. 7/22 Hard-drawn stranded copper, guaranteed, 100' 5s. 3d., 140' 7s., 100 yards 13s. Carriage paid.—FAIRBROTHER & Co., Vulcan Street, Leeds.

Valve Receiver, 3 coils, holder, condenser, ORA Valve, £5. Valve receiver, wired for experiments, 8 coils, holder, condenser, ORA Valve, £8. Both new. Telephony excellent. No offers. First cash secures.—BOX L.2, BERTRAM DAY'S ADVERTISING OFFICES, 9/10, Charing Cross, S.W.1.

Several Wireless one-valve Experimental Receiving Sets, perfect, complete, cheap.—RADIO COMPONENTS, 7, Jamaica Row, Birmingham.

Two-Valve Receiving Set, Marconi Valves, Telephones, Batteries and Aerial. Complete, £12 10s. Excellent results.—PETTY, Second Avenue, Westcliffe-on-Sea.

Lahmeyer Dynamors for Charging, right for wireless. Highest quality, sizes to 200 watts, stamp, specifications, photographs. State requirements.—GEORGE SMITH, 22, Quantock Road, Weston-super-Mare.

NEW HEADPHONES.

Sullivan's 120 ohms, Double. Complete with Cords, Adjustable Headbands. ONLY 15/9
Telephone Transformers with Condenser for 120 Ohms. 'Phones 8/6
Wireless Telephone Transformers. Wound to give Greatest Efficiency 14/3
Whilst Stock Lasts. Post Free. Send Cash with Order.

D. TAPPER, 82, Gladstone Road, Sparkbrook, BIRMINGHAM.

Electradix Radios PHONES! PHONES! PHONES!



Marconi Standard (Brown's Patent) 2,000 ohms, 51/- per pair; 4,000 ohms, 52/- per pair; 120 ohm L.R. Brown's 'Phones, 40/- per pair; Sullivan L.R., ditto, with 6' cord, plug and jack, 18/- per pair. High Resistance Head Sets, 1,500 ohms, 25/- per pair. Second-hand Head Sets, guaranteed, L.R., 12/- per pair. Single L.R. Receivers,

4/6. Cords for double Head 'Phones, 3/6, new. Used, 1/6. Four-way plugs, 2/-
Microphone Transmitters, breast plate, 10/6; Hand, 2/6; Insets, 9d. each.

Aeriels. Wire and every accessory in stock.
Condensers. Fixed and variable in all sizes.
Relays. Weston M.C., brand new, £2 10s.
Morse Inkers, 45/-. Sounder Set for making rectifiers, 12/6 each.

Panel Switch Flush Fitting, D.P. 3/6.
Plugs and Jacks, 1/6 per pair. 60-volt battery polished mahogany cases. Six sockets two plugs, 7/-.

Transformers. Intervalve, 21/-; 'Phone, 15/-.

Receivers. All new Marconi Trench, 50 D.C. Cost £40, complete £5 10s., in polished case, sloping front.

Amplifier Receiver, Mark 2B, valve with variable condenser, £7 10s. Single valve panel, 35/6.

H.T. Motor Generators to 1,000 volts, £15.
1 K.W. 220 to 25 volts, £30.

Amp. and Volt meters at lowest prices.
Call at our Electrical Showroom and inspect our large stock.

LESLIE DIXON & CO.,
9 Colonial Avenue, Minorities, E.1.
Near Aldgate Station Met. Rly. First turning on left down Minorities.

Contracts Wanted!

The
Wellington Engineering Works,
ALDERSHOT.

INVITE ENQUIRIES FROM FACTORS, MERCHANTS, SHIPPERS AND AGENTS FOR THE MANUFACTURE OF WIRELESS APPARATUS.

1, 2, 3 or 4 VALVE RECEIVING SETS. VALVE PANELS ON THE UNIT SYSTEM, L.F. AND H.F. INTERVALVE TRANSFORMERS, VARIABLE CONDENSERS, AND FILAMENT RESISTANCES. COMPLETE CRYSTAL RECEIVING SETS. SUPERIOR FINISH. PROMPT DELIVERY. KEEN QUOTATIONS.

THE WIRELESS WORLD EXCHANGE AND MART

PHONES!	PHONES!	PHONES!
4,000 w. Headgear, complete	28/6	
Sullivan's Head Phones, 120w. with cords, second-hand	15/-	
Do. want cleaning and cords	12/6	
G.P.O. Receivers with Head Bands, Low Res.	10/-	
Single P.O. Receivers, 150w. with cord	3/6	
Phone Plug and Jack	1/6	
Sheet Fibre, Panel Size, 7" x 5" x 1/8"	8d.	
Crystal Detectors (Silicon)	4/6	

All Post Free.

ROBERTS & CO.,
2, MIDMOOR ROAD, BALHAM

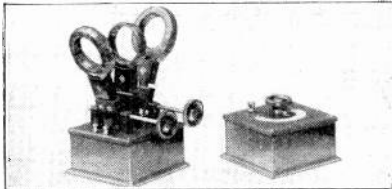

COIL HOLDER, as illustrated.
BEST GRADE Ebonite Mahogany Case, Price 21-
CONDENSERS, Best Grade, Ebonite Mahogany
Case. Satisfaction Guaranteed or money returned

" Nominally, 0003	17/6
" " " 0005	22/6
" " " 001	27/6
AERIAL WIRE, 7 22 Copper, 100'	4/6
INSULATORS, 3d. each. Ebonite Knobs, 6d. each.	
IVORINE SCALES, 9d. each. Contact Switches, 1/6 each.	

SPECIAL QUOTATIONS TRADE.
Cash with order. Postage Extra.

M.F.E., Wireless Supplies, 29, High Street,
CLAPHAM, S.W.4 Telephone: Brixton 1925.

WE CAN SUPPLY FROM STOCK

- CONDENSER VANES.
- TERMINALS.
- CONTACT STUDS.
- SPACERS SPINDLES.
- VARIABLE CONDENSERS.
- DETECTORS.
- POINTERS.
- LAMINATIONS, ETC.
- WRITE FOR LIST.

Also Spinnings, Stampings and Press Tools
made to specifications.

THE GLENFIELD ENGINEERING
CO., LTD.

225, Pentonville Rd., London, N.1
Telephone: Holborn 4714.

CHELMSFORD ENGRAVING CO.

21, BROOMFIELD ROAD,
CHELMSFORD, ESSEX.

WIRELESS PANELS A SPECIALITY. ALL
ORDERS PROMPTLY EXECUTED AND
DESPATCHED. QUOTATIONS FREE.
WRITE US STATING YOUR REQUIRE-
MENTS.

FOR SALE—continued.

Small Parts Supplied from Stock.—Condenser
plates, crystal detectors, terminals, spacers,
washers, nuts, contact studs and stops, valve
legs. List free.—FRASER, Sentinel House, South-
ampton Row, London.

All Wireless and Electrical Goods stocked at
9, Colonial Avenue, Minories, near Aldgate
Station. Handiest place for City buyers.—LESLIE
DIXON & Co., Telephone No. Avenue 4166.

Two £4 H.P. Motor Generators, one 40' Mast
Direction Finders, Drafting Instruments, etc. ex
Admiralty surplus. Half prices.—THE LONDON
ELECTRIC FIRM, Croydon.

Wireless Masts.—Improved Girder Type. Light
and strong, 30 to 50 ft. at 1s. ft. 50 to 100 ft.
at 1s. 6d. ft. Cash with order, carriage for-
ward.—F. ARMSTRONG, Weybridge.

B.A. Screws, Nuts and Washers, assorted gross
2s., lists 2d.—J. H. BENNETT, Station Road,
Willesden Junction.

For Sale.—Pair high-class Phones by Lucas
2,000 w. never used, sacrifice 30/-, Iron cored
Choke 5/-, Grid Leak (2Ω) and Condenser (0003μ
F) 2/-, New "Change over" panel by Gamage
15/-, Mansbridge Condensers, one .05μ F 1/-, four
.5μ F 1/6 each, two 2μ F 2/- each. Siding
Vernier Condenser, ebonite dielectric 3/-, Wrie
R. WESTON, Whitelea, Seiborne Road, Croydon.

TRADE ENQUIRIES.

Advertisers Request Quotations from manu-
facturers for all parts used in construction of
wireless instruments, also condenser scales, knobs
rheostats, switches, etc.—TEXALO MANUFACTURING
CO., South Shore, Blackpool.

Firm of Wireless Engineers desire best trade
quotations, from actual manufacturers of all wire-
less components.—Box P.2, BERTRAM DAY'S
ADVERTISING OFFICES, 9/10, CHARING CROSS, S.W.1.

Catalogues Required.—Wireless Apparatus,
parts, Electric Novelties, etc.—JAMES & WILLIAMS
31, Queen's Road, Battersea, S.W.

Contracts Wanted for the manufacture of com-
ponent parts of wireless receiving sets.—Write,
GOSWELL ENGINEERING CO., LTD., 12A, Pentonville
Road, N.1.

Designs of Receiving Sets, Motors, Etc., supplied.
Technical information given.—O.S., PUCKLE,
Buckhurst Hill, Essex. Lancashire Representative,
Mr. J. ATKINSON, 2, Butler Street, Chorlton-
on-Medlock, Manchester.

Wireless Parts made to any Pattern.—Keen
Repetition Prices. General engineering under-
taken.—THE ENDELL MANUFACTURING CO.,
18, Castle Street, Long Acre, W.C.2.

Griffin Wireless Supplies, 80, Newington Cause-
way, London, S.E.1 will be pleased to receive
factors terms on all Wireless Supplies. Agencies
solicited.

Actual Makers of Basket and Duolateral Coils,
small buzzers, ivory scales and wireless ac-
cessories, please quote lowest cash prices.—S.S.
WIRELESS CO., 50, Spion End, Coventry.

BOOKS.

Radio Magazines, all the latest, "Radio
World," 10d.; "Popular Radio," 10d.;
"Radio Broadcast," 1s. 6d.; "Radio News,"
1s. 6d.; "Science and Invention," 1s. 9d.;
"Scientific American," 2s. 6d. Post Free.—
INTERNATIONAL NEWS COMPANY, LTD., 15,
Bream's Buildings, London, E.C.4.

MISCELLANEOUS.

East Ham, Wanstead, Ilford, Manor Park and
Forest Gate. Amateurs should not fail to come
to the **RADIORENDEZVOUS**, 709, Manor Park
Broadway (over Liptons). Club open till 10 p.m.
nightly.

REPRESENTATIVE WANTED.

Gentleman with thorough commercial
knowledge and capable salesman to travel
London and Provinces. Must be of smart
appearance and supply unquestionable proofs
of ability. Letters only to **WIRELESS
MANUFACTURERS, BOX NO. Q.2, BERTRAM
DAY'S ADVERTISING OFFICES, 9 10,
CHARING CROSS, S.W.1.**

DISPOSAL BOARD STORES AGAIN.—

15' Steel tubular masts, complete with stays,
etc., from 15/- Brown's type A H.R. 8,000w.
phones, 45 - L.R. 120w., 35/-, new and
unused. Sullivan's L.R. 120w. new French
Phones, 4,000w., 32/6, new Federal phones,
2,000w., 35/-, Brown's loud speakers IN
STOCK, usual prices. "R" valves guaranteed
unused, "Metal" "Cossor," "Osram,"
"Ediswan," etc., 15/-, Marconi, V24 and Q.
15/-, B Valves, 17/6. Lucas Daylight
signalling lamps, complete, without battery,
15/-, Breastplate microphone transmitters,
10/-, Power Buzzer Amplifier, £8. Amplifiers
only, C.M.K. III, from £6. Ex-army pattern
transformers, earth to valve, 15/-. Telephone,
16/6. German four-valve amplifier, £8. German
Tuner, 180 to 8,000 metres, £12. Condenser
plates, aluminium, 9d. per doz. Valve holders
from 1/3, switch arms from 1/6. All enquiries
should be accompanied by stamped addressed
envelope. Valves are packed carefully and
sent by registered post, but no responsibility
can be accepted by us for any breakage occurring
in transit. Postage paid on all orders above £2.

WHALE & CO., 201, POWIS STREET,
WOOLWICH, S.E.18.

TO THE TRADE

Most of the big Manufacturers of Receiving
Sets are using OUR Skeleton Condensers
for Panel Mounting. Verb Sap. Write
for trade terms.

FALLON CONDENSER MANUFACTURING
230a, Hermitage Road, London N.4. CO.

SANDBLAST

Your Ebonite Panels to prevent all leakage.
Perfect Matt Surface. Inexpensive process
far superior to sandpapering with oil, etc.
Full particulars with prices for single
panels or quantities. No delay.

ALBEMARLE RUST PROOF CO., LTD.,
10, ALBEMARLE ST., CLERKENWELL.

THE MOTOR HOUSE WIRELESS STATION SUPPLY DEPOT, MALVERN LINK, WORCESTERSHIRE.

H.F. Transformers, No. 1, 300 to 580 metres,
2/10; 600 to 890, 3/-; 900 to 1,800, 3/2;
1,700 to 3,500, 3/4; 3,500 to 5,000, 3/6.
Condenser, .001, 16/-; .0005, 12/-; .0003
10/-. Induction Tuners, £2 10s. Complete
Receivers, less valves, batteries, telephones,
£6 15s. to £16 16s. Aerial Wire, 7/22,
100', 5/6. Condenser Vanes, 1/- doz.
Valves, Phones, Batteries. Send postage on
all orders, with cash. Twelve years'
experience. Advice Free.

THE WIRELESS WORLD EXCHANGE AND MART

ARTISTS WANTED

PROMINENT Wireless Advertising Studio has *immediate* vacancies for *two or three* more artists able to turn out accurate sketches of wireless apparatus for commercial purposes. Splendid opportunity for men with ideas and ability.

Apply in writing with specimens, particulars of experience, age and salary required to Box—K-3. BERTRAM DAY'S ADVERTISING OFFICES, 9/10, Charing Cross, London, S.W.1.

SITUATIONS WANTED.

Wireless Engineer, desiring greater scope wishes to change his present position. Expert in valve transmitters and receivers, offers his services to manufacturers who require competent designer.—Write Box M2, BERTRAM DAY'S ADVERTISING OFFICES, 9/10, Charing Cross, S.W.1.

Young Man, 22, First-Class Postmaster's Certificate, desires position in wireless firm.—SPARKS, 46, Claverdale Road, Brixton Hill, S.W.

SITUATIONS VACANT.

Gentleman. Practical Wireless Assistant for a commercial house for indoor and outdoor work. One with knowledge of engineering preferred. Apply Box S.3, BERTRAM DAY'S ADVERTISING OFFICES, 9/10, Charing Cross, S.W.1.

EXCHANGE.

Wanted Wireless Apparatus, exchange small portable caravan, sell £35.—9, Kilmaine Road, Fulham.

Bamboo Poles for Aerials

AND BAMBOO OF EVERY DESCRIPTION
:: FROM TWIGS TO YACHT MASTS ::

Large Stocks always on hand.

A. E. DAVIES & CO. (Importers)
164, LEVER ST., CITY RD., LONDON, E.C.1

FOR SALE

Tubular Steel Masts with finial, rope cleat, guy clips and baseplate. Painted, light and durable.

12', 25/- (2 Sections), 40/-.

40' (3 Sections), 80/-.

100' 7/22 copper wire, 6 insulators, halyard, pulley and lead in tube, 10/6. Carriage forward.

Trade Supplied.

Works, 5, Kramer Mews, Earl's Court.
L. S. COMPTON, 17, Fernshaw Road, S.W.10.

<p>GRIFFIN'S BUSINESS FORMULA: QUALITY + EFFICIENCY + DESPATCH = CONFIDENCE</p>			
<p>"GRIFFIN" Super Crystal Sets Approx. Range, 300/2,000 mcs PRICE 38/-. A Real Bargain. Accumulators, Fuller Block. 4 Volts, 40 Amps. £1 12 6 6 " 40 " 22 8 9 8 " 40 " 23 5 0 10 " 40 " 24 1 3 12 " 40 " 24 17 6 Other makes at Standard Prices. TELEPHONES—High Resistance Ex. Value, 4,000 Ohms 30/- Sterling's, 120 Ohms 48/- 4,000 " 52/- Brown's, 120 " 60/- 8,000 " 67/6 Sullivan's, 4,000 " 42/6</p>	<p>MAGNAVOX LOUD SPEAKERS Junior £10 10 0 Senior £20 0 0 Order Quickly CONDENSERS—Ebonite Mtd. Griffin Circular, Celluloid or Square Mahogany Box Type .001 .0005 .0003 28/6 25/- 22/- Partly assembled for Panel Mts. .0003, 12/9 Condenser Vanes, 2/- doz., 3d. pair. Coilholders, 3 Coils 21/- Aerial Wire per 100' bare copper stranded, 7/22, 4/- Enamelled 5/-</p>	<p>Inductance Tubes—Wound, 12 X 4, 7/-; 12 X 3, 6/-. Crystal Detectors— Griffin latest design 10/- Reliable Type 5/6 Insulators— Shell 1/6, Egg 10d., Reel 2d. and 14d. each. Resistances for Panels 4/9 Ebonite Knobs each 6 1/2d. " Sheet and Rod 1b. 4/6 Terminals—Small 2/-. Large 3/- doz. 2 BA Brass Rod 3/16 per ft. 1/6. Spacers, doz. 7d. and 4d. Spindles for Condensers, 9d. and 4 1/2d. each.</p>	<p>Sliding Plungers, 6 1/2d. each. Superior Quality, 2/-. "Griffin" Cabinets to your own specification in Mah., Oak, etc. Valve Panels, Amplifiers, etc., made up to your require- ments. LET US QUOTE YOU. VALVES—All makes at Standard Prices. WIRE Enamelled— .24 .28 .30 .32 .34 S.W.G. 2/8 3/6 3/10 4/2 4/4 per lb. WIRE d.c.c. .28 .30 .34 .36 .38 .40 S.W.G. 4/7 5/6 3/8 3/10 2 13/2 18/- per lb. Other Gauges see our List</p>
<p>Terms Cash. Delivery Free over £2. Write for comprehensive List of all Accessories, post free, 3d. (returned on first order). GRIFFIN WIRELESS SUPPLIES Co., 80, Newington Causeway, London, S.E.1. (2 mins. from Elephant & Castle Tube Station.) Telephone: HOP 1806. Telegrams: IFFINGRACO, London. Trade Inquiries Invited.</p>			

THE FIRST ALL-BRITISH WIRELESS EXHIBITION

AND CONVENTION

HORTICULTURAL HALL
Vincent Sq., Westminster, S.W.1
SPECIAL TRADE DAY
OCT. 2nd : 1/3 (including tax)
Public admitted after 6 p.m. at usual price

ADMISSION
1/3
INCLUDING TAX

SEPT. 30th to OCT. 7th
(Saturday) (Saturday)
10 a.m. to 10 p.m. daily
SPECIAL PUBLIC DAY
OCT. 3rd : 5/- (including tax)
Public admitted after 6 p.m. at usual price

The only Exhibition whose CONVENTION will be held under the auspices of the WIRELESS SOCIETY of LONDON.

For full list of Exhibitors see "Wireless World," page 38, Aug. 26th issue.

ORGANISERS :

BERTRAM DAY & CO., LTD.
9 and 10, Charing Cross, London, S.W.1 Gerrard 8063/4

WE SPECIALISE
IN
EBONITE
EQUIPMENT
FOR
WIRELESS SETS

SHEETS : TUBES : PANELS
KNOBS, CONDENSER COVERS
WHOLESALE ONLY
FROM STOCK

HIGHTENSITE LTD.
Normandy St., Custom House, E. 16

'Phone : EAST 3153.

SPECIAL OFFER
LOW RESISTANCE TELEPHONES 150 ohms.



12/6
per
Pair

(Postage 9d.)

These Telephones are fitted with aluminium headbands and are extremely sensitive. They are very suitable for the reception of speech and music. Satisfaction is guaranteed, each pair being tested before despatch.

Delivery from Stock—All orders by post will be despatched on day of receipt. A large quantity of these telephones is available, and Trade enquiries are invited. A small quantity can be supplied, complete with cords, at an extra cost of 2/6 per pair.

W. J. HENDERSON, 2 Hollywood Rd S. Kensington
(Nearest station, Earl's Court. Bus routes, Nos. 31, 14, 9c.)

WIRES AND CRYSTALS

As soon as the wireless boom started I ceased advertising, because supplies became difficult to obtain, and it was as much as I could do to satisfy my former customers. I am now in a position to give prompt delivery of every class of wire, copper, resistance, stranded (Litzendraht) in all coverings. All wire specially wound to order, so if you want, say, 5½ ounces that is as easily and promptly sent as any other quantity.

I also hold large stocks of Bornite, Zincite, Chalcopyrite, Copper Pyrites, Galena, Carborundum, Tellurium, Selenium, Wood's Metal, Gold Wire, all at 6d. per box.

COPPER WIRES.

S.W.G.	COTTON.		SILK.		ENAMEL.
	Single	Double	Single	Double	
		Prices per lb.			
20	2/2	2/3	4/8	6/2	2/5
22	2/6	2/8	5/-	6/8	2/6
24	3/-	3/6	5/6	7/4	2/8
26	3/7	4/-	6/8	8/2	2/9
28	4/2	4/8	7/2	9/-	2/11
30	5/-	5/4	8/-	9/9	3/5
32	5/8	7/-	9/2	12/9	3/11
34	6/8	8/-	11/-	13/6	4/4
36	8/-	10/-	13/-	15/-	4/8
38	10/8	11/4	16/-	19/-	5/9
40	13/4	14/8	19/-	22/-	8/6
		Prices Per Ounce.			
42	—	—	2/-	2/2	—
44	—	—	2/9	3/5	1/-
46	—	—	4/4	6/-	1/8
47	—	—	6/-	7/6	2/-
48	—	—	13/-	15/-	10/-
49	—	—	16/-	21/-	—
50	—	—	23/-	30/-	—

Terms.—Nett Cash with Order. Postage extra on orders under 10/-. Bobbins for 4 ozs. and less, free, otherwise 3d. deposit.

A. HINDERLICH,

CENTRAL HALL, SOUTHALL. Phone : Southall 121

GENTS' MAKE FITMENTS

SEND FOR OUR
SUNDRIES
PAMPHLET

MAKE USE
OF OUR
STOCKS

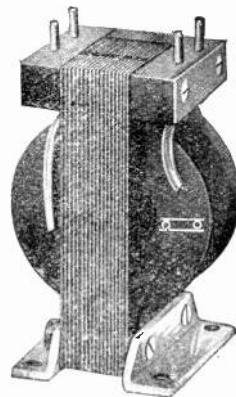

ASK US
TO QUOTE
FOR YOUR

WHOLESALE REQUIREMENTS

GENT & CO. LTD. FARADAY WORKS LEICESTER

LONDON : 25, Victoria Street, S.W.1

NEWCASTLE-ON-TYNE : Tangent House, 52, Blaekett Street

THOR Variable Condenser



Worth 2 of any other make!

The THOR costs no more than an ordinary condenser, but design, workmanship, and efficiency, accuracy in construction, thorough examination, and the exhaustive test it passes through before you receive it, make it worth two of any other make.

Ask to see the reliable THOR. We are probably the largest manufacturers of Condensers and Filament Resistances in the U.K., certainly of the best, and the name THOR is your guarantee.

Prices: Vernier Condenser, 6/0; Variable Condenser, .0003, 13/-; .0005, 16/-; .001, 22/6; .0015, 27/- Mounted in polished teak or mahogany boxes, with scale, 9/9, 16/6, 20/-, 27/-, and 32/- respectively.

Stocks held by London Rep.: Mr. J. O. MADDOCK, 11, Bayham Road, Bedford Park, W.

Of all agents, or send P.O. to—

H. E. ASHDOWN (Birmingham)
LIMITED
Perry Barr, Birmingham

Phone: Northern 859
Tel: Segment, Birmingham

The Cheapest and Most Efficient 3-Valve Set on the Market

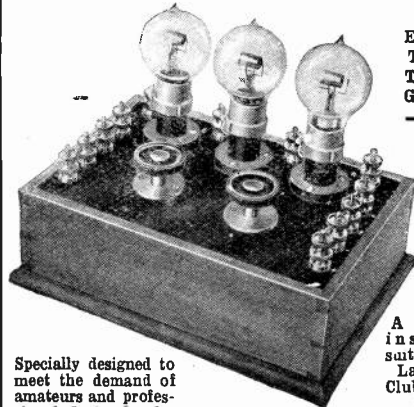

Every Set
Thoroughly
Tested and
Guaranteed.

A portable
instrument
suitable for
Laboratory,
Clubroom or
Home.

Specially designed to
meet the demand of
amateurs and profes-
sionals for a 3-valve
detector - amplifier
unit giving simplified
operations

In conjunction with our 'Universal Tuner, this constitutes the most efficient, compact and easily operated 3-valve receiving station ever offered.

Beautifully finished and fitted in handsome polished light oak case. Range of reception for Wireless Telephony, about 500 miles.

£5 15s.
Valves Extra.

**J. LIPOWSKY, ELECTRICAL AND
WIRELESS ENGINEER.**
614, OLD FORD ROAD, BOW, LONDON. E.3
Telephone: East 3345.

IMPORTANT NOTICE

A. C. COSSOR, Limited, hereby give notice that the order of Mr. Justice Russell of the 1st March, 1922, continually advertised by the Marconi Co., was an order ARRIVED AT BY SENT.

Being engaged at the time in the production of an improved and different type of valve, A. C. COSSOR, Limited, did not consider the patents in question of sufficient importance to warrant the expense of litigation.

A. C. COSSOR, Limited, respectfully leave the public and the Trade to judge whether the constant repetition of the notification of the judgment referred to is necessary or expedient in the circumstances.

Visit our Stand No. 29. All British Wireless Exhibition. Horticultural Hall September 30th to October 7th.

A. C. COSSOR, LIMITED
Aberdeen Works, Aberdeen Lane,
Highbury Grove, N.5

MITCHELL-PHONE HEADGEAR.



Over 27,000 pair distributed to the trade in three months, is sufficient guarantee to quality. Although not quite as illustration (a new mechanical improvement being fitted) they are comfortable, highly efficient, and sold on a money back basis.

35/- Pair.

IMMEDIATE DELIVERY FROM STOCK, and the trade should grasp the opportunity without delay. GOOD DISCOUNTS, and the quality is such that you will obtain many REPEAT ORDERS.

SHIPPING ORDERS A SPECIALITY.

MITCHELL'S ELECTRICAL & WIRELESS Ltd.
McDermott Road, Peckham, S.E.15.
Retail Store, 188, Rye Lane, Peckham, S.E.15.
Phones: NEW CROSS 1540/1.

North Wales Wireless College & Amateur Supplies

COLWYN BAY. Phone 407.

Most Complete Stock of all Wireless Instruments and Accessories.
PROMPT DELIVERIES.

Students prepared under ideal conditions as Wireless and Cable Operators
POSTAL AND RESIDENTIAL TUITION.
SPECIAL POSTAL COURSE FOR AMATEURS.
PROSPECTUS POST FREE.

LIST BY RETURN. 1/4d. STAMP.

FIRM of Electrical Manufacturers are prepared to buy outright or manufacture on royalty, Wireless Apparatus of protected designs.

Write to BOX H.3, BERTRAM DAY'S ADVERTISING OFFICES, 9 & 10, CHARING CROSS, S.W.1

SPEARS and COMPANY

FOR

TERMINALS

SCREWS, NUTS, WASHERS, PLUGS and SOCKETS, CONTACT STUDS, BUSHES, VALVE LEGS, CONDENSER VANES and TURNED and PRESSED PARTS OF EVERY DESCRIPTION.

Actual Manufacturers to TRADE ONLY

WE REGRET WE CANNOT SUPPLY SMALL LOTS TO AMATEURS

CAPSTAN REPETITION WORKS,
PARK ROAD, HOCKLEY, BIRMINGHAM
Telephone: 3265 Central. Telegrams: "Firettes," Birmingham

The "CLIMAX"

SUPER THREE-VALVE SET enclosed in beautifully finished solid mahogany polished cabinet with hinged lid. To see it is to be astounded at its value. Actual makers.

	£	s.	d.
Set alone	7	15	0
Ora Valves	0	15	0
4,000 Ohm 'Phones	1	2	6
4v. 40 A.H. Accumulators	0	18	6
H.T. Battery	0	7	0
Other items of special interest—			
·001 Condensers	1	1	0
·0005 Condensers	0	15	0
Fl. Resistances	0	3	9
Marconi 2,000 ohm 'Phones	0	18	6

THE CLIMAX ENGINEERING CO.,
182, CHURCH ST., KENSINGTON, W.8.
Phone: Park 2023.

THE PARAGON RUBBER MANUFACTURING CO.

SCULCOATES, HULL.

E B O N I T E	W I R E L E S S
Sheet, Rod & Tube	KNOBS
ELECTRICAL	V A L V E S
MOULDINGS	SLIDERS, Etc.

Wholesale only.

London Office: **PERCY W. C. TRICK,**
20, LITTLE PORTLAND STREET, W.1
Telephone: MUSEUM 2043.

PHONES (Pair complete. Guaranteed) 30/- CRYSTAL SET 37/6

Special Wireless Telephones, 4,000 ohms, 30/- post free. Receiving Set on Mahogany base, single slide Tuning Inductance, Fixed Condenser, Crystal Detector, Terminals, 40/- post free. Valveholders in Ebonite, first quality only, 1/-. Paris is received quite easily on this set.

I. K. STEVENS & Co. Wireless Section, 32a, Chester St., Grosvenor Place, S.W.1
Trade Inquiries Invited. Phone—Victoria 5837

I HAVE IN STOCK
5000 BROWN'S
PAIRS (120 ohms) "A" PHONES
NEW AND UNISSUED

POST FREE CASH WITH ORDER
40/- PER PAIR

WILKINSON, Lonsdale Rd., Kilburn,
TRADE SUPPLIED (Same address since 1900) N.W.6

Questions and Answers

COUPON

To accompany Questions sent in during the week commencing Sept. 2nd, 1922.

VOL. X, NO. 23.

See Conditions on Page 737.

SPECIAL This Week Only

AERIAL WIRE (Bright Drawn), 3/6 100 ft.
 " " (Enamelled), 4/6 100 ft.
 —Including 2 Insulators—
Postage extra.

HENRY J BREWSTER & CO.
 11, Queen Victoria St, London, E.C.4.
 'Phone: City 788.

SENSATIONAL REDUCTIONS.
 Valve Holders, 2 nuts on each leg. 1/- Post 3d.
 Condenser Plates. Fixed or moving. 1/- per doz. Post 3d.
 Washers for fixed plates 3d. per doz. For moving 5d. per doz.
 Post 2d.
 Threaded Rod for Spindles, etc. 5d. per foot. Nuts for same 3d. per doz.
 3" Semi-Circular Scales 0-180 degrees. 8d. each. Post 2d.
 1 1/2" Ebonite Knobs with threaded centre, 6d. post 2d. Pointers 2d.
 Stop-pins 1/- doz. Bush and Lock Nut 5d. Extension Handle 4d.
 Valve Legs or Sockets 1/10 per doz. Post 3d. (complete with screw or nuts.)
 Mark III Terminals with nuts 2/3 per doz. Post 4d.
 Vernier Condensers, 3-plate 6/-; 5-plate, 7/- Post 9d.
 7-Strand Silicon Bronze Aerial Wire, per 100 ft. 4/-; per 150 ft. 5/9. Post 9d.
 Filament Resistances for panel mounting 3/9. Post 3d.
 These are only a few of the numerous items contained in our Catalogue which will be sent free with order.
SCIENTIFIC SUPPLY STORES, 8, Newington Causeway, LONDON, S.E.1
 'Phone—Hop 4177.

W. A. C. SMITH
 236, Argyle Street,
GLASGOW,
 are Sole Scottish Agents for the
Famous Burndept Receivers



TUBE, SHEET, WIRE, STRIP, ROD & CASTINGS
 IN
PHOSPHOR BRONZE, COPPER, BRASS, &c., &c.
CHARLES CLIFFORD & SON, LTD., BIRMINGHAM.

THE TINGEY UNIT SYSTEM
 HAS PROVED ITS EFFICIENCY
Write for
ILLUSTRATED CATALOGUE
 (3d. post free)
 which contains an article on Wireless Made Easy and a Complete List of all Wireless Goods in Stock
 Visit our Stand No. 25. All British Wireless Exhibition, Horticultural Hall, September 30th to October 7th.
W. R. H. TINGEY, 92, Queen Street, Hammersmith, London, W.6.



SKINDERVIKEN BUTTON.
 A Supersensitive Microphone. Known all over the world and patented in every civilized country. Over 60,000 sold. ENGLISH Manufacture. Make up your own Loud Speaker. Transmit your GRAMOPHONE music to any room in your house.
 The only practical Microphone for use in Detectophone Sets.
Price 5/- each
 Special Low Resistance Receivers (for use with Skinderviken Buttons) 10/- each
 Special Gramophone Attachments 1/- "
 Write for 16 page BOOKLET fully illustrated and containing much useful information for all interested in Electrical Sound Transmission. 6d. Post free.
Sole Proprietors:
MIKRO LTD., 274/6, Pentonville Rd., London, N.1
 (Opp. King's Cross (Met.) Rly Station).



The **Universal Electric Supply Co. Ltd.**
 4 BROWN ST OFF MARKET ST
MANCHESTER
WIRELESS SUPPLIES
 and ALL ACCESSORIES for
MAKING OWN SETS
 OUR 80 PAGE CATALOGUE
 Contains full particulars and illustrations of the most complete and comprehensive range
POST FREE, 6d.

- Variable Anode Resistance. 20,000 to 100,000 ohms, 7/6
- Filament Rheostat, 5/-
- Condenser Parts, Fixed & Moving Vanes, 2/6 doz.
- Centre Rod, 4 1/2", 4/6 each.
- Laminated Switch Arms, 2/6
- Insulite Sliders, 1/-
- Knife Switches S.P. 1 way, 1/9; 2 way, 2/4. D.P. 1 way, 3/9; 2 way, 5/-
- Grid Condenser and Leak, 7/6
- Blocking Condenser, 5/-
- Grid Leak, 3/-
- Aerial Insulators Reel type, 2" 4d., 2 1/2" 10d. Egg type, 6d.



BROWN'S Famous Army Pattern
 Accurately Adjusted "A" Type
RECEIVERS
 8 000 ohms
£2 9s.
 without Coils
 With Coils £2 11 6
 Finest Quality U.E.S.
 4,000 ohms; do.
 £1 10s.

ACCUMULATORS

Absolutely Guaranteed Best Quality

CELLULOID CASES.

4 volt 40 amp. 18/6	4 volt 80 amp. 28/2
4 " 60 " 21/6	4 " 100 " 30/-
6 " 40 " 26/3	6 " 80 " 37/3
6 " 60 " 31/9	6 " 100 " 41/6

PACKING FREE.

TRADE PRICES NOW REDUCED
Write for Latest List.

SPECIAL OFFER.

6 volt 44 Actual amp. Set three Glass Cells, sealed tops in well-made Teak Crate, a handsome set - - - **49/6**
4 volt 24 amp., Celluloid Case, **11/9** Postage 1/-
2 " 16 " Ebonite " **3/9** Post Free.
Aerial Wire - - - per 100 ft. Coil **5/-**

All Sizes of Accumulators Quoted for.

EXIDE ACCUMULATORS STOCKED
(Trade supplied)

Dynamos, Motors, Electrical Accessories,
Sulphuric Acid (write for lists) Stocked.

F. YATES & Son, Ltd

WHOLESALE ELECTRICIANS,

144, Church St., Kensington, London, W.8
One Min. from Notting Hill Gate Sta. 'Phone—Park 4276.

H.F. TRANSFORMERS to fit Valve Sockets

	No.	Range	No.	Range
	0	150	5	2500
	1	300	6	6000
	2	600	7	8000
	3	1200	8	24000
4	1800	7/6		

There is a good latitude on these coils for higher & lower ranges.

H.B. COIL HOLDER

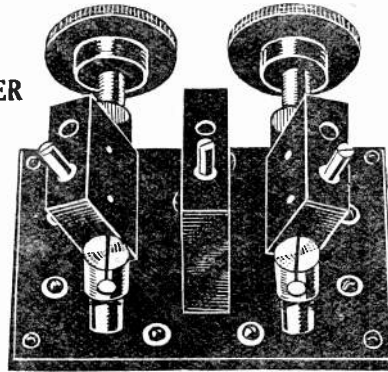

Standard fitting suitable for our "H.B." or any de Forest pattern coil. To take 3 coils **£1 1 0**
" " 2 " **17 6**

Fully Illustrated List post free 4d.

H. D. BUTLER & CO., LTD

Office & Showrooms:
Bank Buildings, 222, Gt. Dover Street, Borough, S.E.1
Telephone: Hop 3029. Works: Canonbury, London, N.7.
Works North 1838. Telegrams: "Ingenuity Phone, London."

A WATES' SPECIALITY.



PRICE **3/6** EACH

Trade Enquiries Invited. (Size 9 1/2" x 7" x 2 1/2") **Immediate Delivery.**

WATES BROS., 13/14, Gt. Queen Street, Kingsway, W.C. 2. 'Phone Gerrard 576

Visit our Stand No. 15. All-British Wireless Exhibition, Horticultural Hall, Sept. 30th to Oct. 7th.

A SIMPLE SYSTEM OF MEMORISING OF THE MORSE CODE

Morse Made Easy

By ARTHUR L. RYE

—EXPLAINS IT ALL!

Printed on strong linen card, this valuable Illustrated Explanation can be carried about ready for use, anywhere and everywhere.

PRICE: **3 1/2 D.** Post free.

THE WIRELESS PRESS LTD., 12-13, Henrietta Street, Strand, London, W.C.2

All-round Engraving

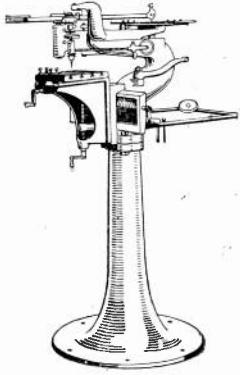

Nothing comes amiss to the Taylor-Hobson Engraving Machine.

Moulds for tyres or tiny seals come within its scope.

Bold lettering for Name-plates, Indicators, Scale or Clock Dials—all are cut quickly and accurately.

The output of the Taylor-Hobson Engraving Machine is uniform and of high quality. Its speed alone earns it a place in every efficient factory.

It costs little to run. It pays for itself quickly.

It is used all over the world for work on Metals, Hard Rubber, Wood and Celluloid.

Write for fullest particulars immediately.

TAYLOR, TAYLOR & HOBSON, LTD.

74a, Newman Street, London, W.1

Works: LEICESTER.

AS USUAL WE'RE HERE!

Aerial Wire, 7/22's, Enamelled Hard Drawn Copper, 6/- per 100'.

Aerial Pulleys, 2 1/2" 1/-, 5" with tackle hook and bicket, 2/6.

Aerial Insulators, Shell Type, 2 1/2" x 2 1/2", 1/6 each.

Aerial Insulators, Reel Type, 2" diam. white, 4d each.

Batteries. For H.T. Make your own. Flash Lamp Batteries, 5/- doz.

Condenser Discs, Ebonite, 3 1/2" diam., 1/- each

Condenser Dials, engraved, fine finish, 2 1/2" diam., 1/9 each.

Condensers. Fixed. Exceptional quality. Made with copper foil. From 000r to 001. 2/6 each.

Condenser Vanes. Not rubbish. Best strong aluminium. Fixed 3 1/2", Moving 2 1/2". 1/- doz.

Condenser Spacing Washers. Remember they must be accurate. Small 4d. doz. large 6d. doz.

Condenser Screwed Rod. Brass 12" lengths, 2 B.A. or 4 B.A. 6d. each, 2 B.A. and 4 B.A. nuts 7d. doz., 2 B.A. and 4 B.A. washers 2d. doz.

Contact Studs. Studs, not rubbish, 1/6 doz.

Copper Foil Sheets. 12" x 3" 6d. each.

Core Wire. Soft iron, 2/4 per lb.

Ebonite. Best quality. Any size, rod or sheet, 5/- per lb.

Filament Resistances. For Panel mounting with knob pointer and good contact. A speciality. 4/- each.

HEAD RECEIVERS. Light, sensitive, of good design and superior finish. Tested and guaranteed perfect. Complete with cords. 140 ohm 30/- each., 4,000 ohm 32/- each., 8,000 ohm 33/- each. Postage 9d. each.

Inductance Tubes. 12" long. Specially impregnated, 2 1/2" 6d., 3" 7d., 3 1/2" 8d., 4" 10d., 4 1/2" 1/-, 5" 1/2, 6" 1/6 each, Postage 9d. each.

Inductance Sliders with springs and plungers, 1/-

Inductance Slider Rod. 1/2" square in 13" lengths. Not jagged but smooth. 6d. each, Insulating Tubing 6d. per yard.

Ivory Scales. 0 to 180°. Engraved (Not printed), 1/2 each.

Ivoryine Tablets. Strong, Engraved not printed. Aerial, Earth, Primary, Secondary, On, Off, Reactance, Phones, H.T., H.T.—, L.T., L.T.—, A.T.I. 2d. each.

Knobs. Ebonite. 1 1/2" diameter. Superior finish. Knurled 7d. each.

LOUD SPEAKERS. Exceptionally efficient. 70 ohm, 2,000 ohm, 4,000 ohm £2 10s. each.

Mica. Pure Ruby. Pieces, 3" x 3" x .002" thick, 6d. each.

Paraffin Wax, 1/- per lb.

Resistance Wires. Advance brand 22' (1.1 ohm per yard), 24's (1.8 ohms per yard) and 28's enamelled (4 ohms per yard), 2d. per yard.

Switch Arms Exceptionally strong and well made, 2/6 each.

Terminals. A very neat wireless terminal. Polished. Complete with nut and washer. 2/6 doz.

Tin Foil. Free from lead. Sheets, 26" x 13", 4d. each.

Valve Sockets. With nut and washer. Fine finish, set of four, 9d.

Valve Holders. Best quality ebonite, with nuts, 1/4 each.

Wood's Metal, 6d. per packet.

CRYSTALS. Carborundum, Silicon, Pyrites, Galena, Bornite, Iron Pyrites, Copper, Manganese, 8d. per packet.

SUPERIOR QUALITY WIRE. British made. All wire wound free. Post extra.

S.W.G.	S.C.C.	D.C.C.	Single		Silk	Enld.
			Silk	Enld.		
12	1/10	1/11	4/-	5/4		1/8
14	1/11	2/-	4/-	5/4		1/9
16	2/-	2/1	4/2	5/6		1/10
18	2/1	2/2	4/4	5/6		1/11
20	2/2	2/3	4/8	6/2		2/6
22	2/6	2/11	5/-	6/8		2/8
24	3/-	3/6	5/6	7/4		2/8
26	3/7	4/1	6/8	8/2		3/2
28	4/4	4/7	7/2	9/-		3/6
30	5/-	5/6	8/-	10/-		3/10
32	6/-	7/3	9/2	13/-		4/2
34	7/-	8/3	11/6	14/-		4/4
36	8/8	10/2	14/-	15/6		4/8
38	11/3	13/2	16/-	19/-		5/3
40	15/-	18/-	18/6	22/6		6/6
42	17/3	21/-	31/6	34/-		9/-

At per lb.

Carriage extra. Please remit ample postage, balance returned. Orders over £2 carriage paid. Money back if not satisfied.

J. L. CARTWRIGHT & CO., Manufacturing Electrical and Radio Engineers

Phone—Cent. 4209.

Dept. W. 130/132, LONDON ROAD, MANCHESTER.

Grams—Pladwam, Manchester.

Special Terms to the Trade.

Works: BERRY STREET

Price Lists 3d. post free.

TEC

**HIGH TENSION DRY BATTERIES
for WIRELESS SETS**

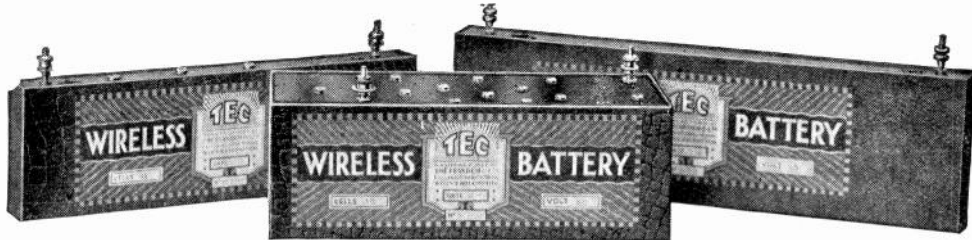

NORMAL SIZE, No. W 70 V, 15 Volts
Price 5/-

W 71 V, 50 Volts
Price 15/-

GIANT SIZE, No. W 73, 15 Volts
Price 6/6

SUPPLIED IN TWO SIZES FOR 15, 50 or 60 VOLTS.

and with Tappings in 3 Volt Steps.

ALL BATTERIES FITTED WITH PLUG SOCKETS AND MOVABLE TERMINALS.

Complete Illustrated Price List on Application.

**THE EFANDEM CO., LTD., FALLINGS PARK WORKS,
DRY BATTERY MANUFACTURERS — WOLVERHAMPTON**

**HENDON PATENT
POTENTIAL BATTERY ACCUMULATOR**

25 VOLT UNITS,
FOR USE AS GRID
BATTERY, CABLE
TESTING AND
LABORATORY
TESTING

Forms one complete
unit without inter-cell
connections.

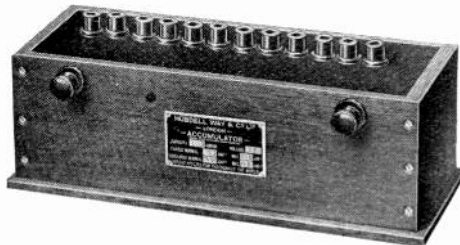

Maximum insulation
is obtained, reducing
leakage to a negligible
quantity.

Designed and Manufactured with particular regard to the
Requirements of Wireless Telegraphy and Telephony

by

HOBDELL, WAY & CO., LTD., 124 MINORIES, LONDON, E.1

DESCRIPTIVE MATTER ON APPLICATION

Telegraphic Address : Hobnails, Ald, London.

Telephone : Avenue 3810.

AGENTS REQUIRED

Sole Agencies for the productions of the Ashley Wireless Telephone Co., Ltd., will be granted to substantial firms in the principal towns of the British Isles.

Correspondence is invited from responsible principals.

Address—SALES MANAGER,

ASHLEY WIRELESS TELEPHONE CO., LTD.

69, Renshaw Street ————— LIVERPOOL

'Phone: 4628 Royal

Telegrams: Rotary, Liverpool

BEWARE !!

OF GOODS SOLD WITHOUT A GUARANTEE. ALL OUR INSTRUMENTS ARE GUARANTEED. TELEPHONY TUNERS. Range 300-1,100 metres. Perfect for DUTCH CONCERTS and all telephony. A complete tuning and reaction unit (angular motion). Price 25/-.

Postage 1/-.
SINGLE VALVE RECEIVER. First quality components only used. Ideal for use with above or any other tuner. (Less valve). Price 38/6. Postage 1/-.

TWO-VALVE L.F. AMPLIFIER. A perfect amplifier. Speech distortion entirely absent. Price £4. Postage 1/6 (less valve).

THREE-VALVE AMPLIFIER. 1 H.F., Rect. 1 L.F. The finest receiver constructed. RANGE UNLIMITED. Details per request. (Less valves) Price £8 8s. 0d., post free.

PANELS (EBONITE) CUT AND DRILLED TO YOUR PLANS. ADVICE GRATIS TO PURCHASERS.

EAST LONDON INSTRUMENT COMPANY (Postal Dept.)
26, NORTHBANK ROAD, WALTHAMSTOW, LONDON, E.17.

HEAD SETS.

4,000 Ohm, best value in London 28/-
Complete set of parts for 0005 Variable Condenser, unassembled, easy to assemble. 8/9
Aerial Wire, 100' lengths, No. 7/22 stranded, 4/3
No. 18 copper 2/9
Crystal Detector, mounted on ebonite base 3/3
Valve Holders, Ebonite, best finish 1/6

Carriage paid on all orders of £1 or over.
The above are an example of all our prices, send for our price list of complete sets and spare parts, post free.
All above articles in stock.

TRADE SUPPLIED.

THE HOLBORN RADIO CO.
8, HIGH HOLBORN, LONDON, W.C.1

Phone—Chancery 7278. 5 doors from Gray's Inn Road

MORGAN & TAYLOR'S RADIO ELECTRIC LTD.

The Pioneers of "Wireless" in South Wales.

We can give prompt delivery of the following

Low Resistance 'Phones, new and fully guaranteed	25/-
Crystal Detectors	6/6
Switch Arms	2/9
Contact Studs	per doz.	1/6
Coil Stands	21/-
Egg Insulators	9d.
Condenser Plates	per pair	2½d.
„ Small Washers	per doz.	3d.
„ Large	9d.
Condenser Dials	3/9
Filament Rheostats	5/6
Variable Condensers '001	37/6
Ebonite Valve Holders	1/8 & 1/9

Postage Extra.

Crystal Sets, Ebonite Sheet, Ebonite Rod, Brass Rod and all other "Wireless" accessories in stock. Send for Catalogue.

10a, Sneyd Street, Cathedral Road, CARDIFF.

Sole Agents for South Wales & Mon. for G. Z. Anckland & Son. Applications for Sub-Agencies invited.

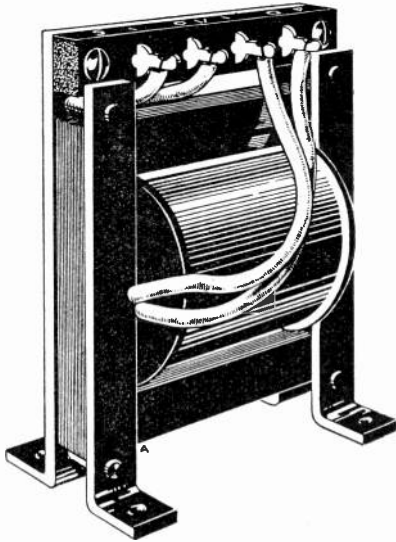

30/- each

After exhaustive experiments we are now able to offer immediate delivery of Intervalve Transformers designed specially for the reception of perfect speech and music.

DIMENSIONS

Height 3½". Width 2½". Dimension over feet 2"

TELEPHONE TRANSFORMERS

These Telephone Transformers have been thoroughly tested and found highly satisfactory, they are built on similar lines to our famous Intervalve Transformer.

Price 22/6 each

Owing to the large demand for these Transformers there are only a limited number for immediate delivery.

Orders will be dealt with in strict rotation.
 Terms—Cash with Order.
 Orders over £5 carriage paid.
 Trade terms on application.

OTHER SPECIALITIES

We shall shortly be able to give delivery of our new patent Coil Mount and Gearing Handle, Filament Resistances and Variable Condensers.

We also hold a stock of Mullard and Dubilier accessories and Exide Clifton Accumulators, of which we can give immediate delivery.



The Manchester Radio Co., Ltd.

F. H. McCREA, Managing Director.
 W. R. BURNE, Director of Experimental Dept.
 (Winner of Transatlantic Test.)

155, OXFORD ROAD

(Entrance Boundary Street East)

MANCHESTER

Telephone: Central 4935.

'Chase Radio Products'

ONLY THE BEST SUPPLIED.

Tuner Unit	80/-
Detector	80/-
Radio F. Unit	80/-
Audio F.	90/-
Filament Rheostat	6/-
Lead In Tubes	9"	2/-
" "	12"	2/6
" "	18"	3/-
Var. Condenser with Knob and Specially Engraved Scale	30/-
Telephone Transformers	15/-
Audio F. Transformers	27/6

We are the Actual Manufacturers.

The Chase Motor Co. Ltd

Office & Works: *Showrooms:*
 Sandyford Square, Barras Bridge,

Newcastle-on-Tyne.

Trade Supplied - - Best Discounts.

TRADE ONLY

WIRES

**COTTON
 SILK &
 ENAMEL**

FROM STOCK

Wound to your requirements

**Kent Bros. Electric Wire Co.
 & E. H. Phillips,**

15, Berners St., London, W.1

Phone: Museum 2826.

Works: Catford S.E.

EFFICIENCY

Inductances

A series of highly efficient Inductances having very low self capacity and very low effective resistance. They can be supplied with double plug as illustrated or to fit standard plug and socket.

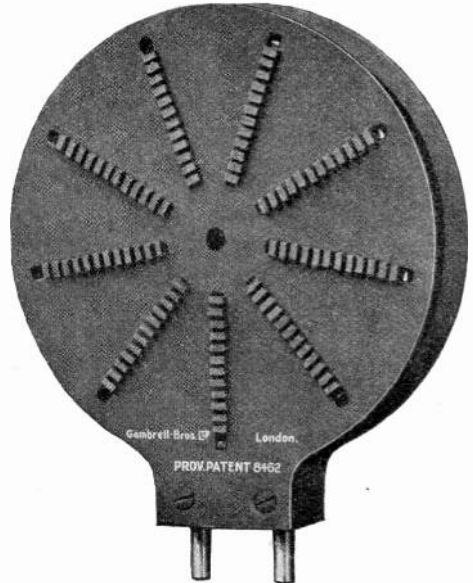

PROVISIONAL PATENT 8462.

	On 100 ft. P.M.G. Aerial with ·00065 Microfarad Maximum condenser.				Secondary circuit with ·00024 Microfarad Maximum condenser.		Self capacity of coil.
	Series.		Parallel.				Microfarads.
A	175	260	325	510	110	275	·000004
B	275	415	495	825	175	430	·000005
C	380	530	690	1150	255	610	·000006
D	530	750	975	1625	365	875	·000006
E	880	1200	1600	2700	600	1400	·000008
F	—	—	2550	4200	950	2275	·000009
G	—	—	3650	6200	1400	3250	·000011
H	—	—	5800	10000	2350	5300	·000014

Full particulars and prices from

GAMBRELL BROS., LTD.

**MERTON ROAD
SOUTHFIELDS
LONDON, S.W.18**

EFFICIENCY

Tuners

This tuner fitted with our new coil holder, together with our detachable inductances, forms a tuning unit of highest efficiency.

Its features are as follows:

1. Coil holder (Prov. Pat. 17095) which enables the coupling to be gradually and smoothly reduced to zero, a very necessary feature for efficient and selective working.

2. A series parallel switch is fitted for aerial condenser.

3. The instrument and inductances are fully shielded so that full advantage can be taken of the highly efficient results and remarkable selectivity obtainable.

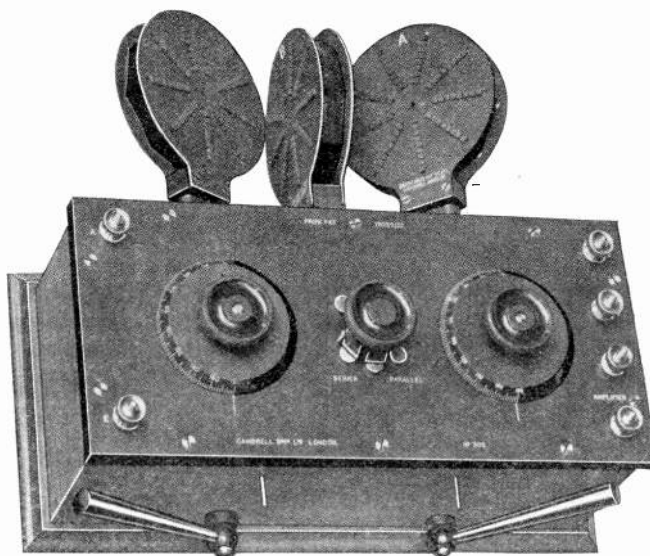

Provisional Patent 17095.

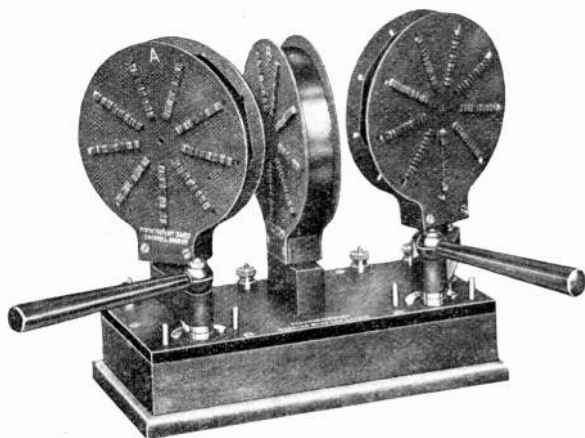

Coil Holders

We can now supply our coil holders as a separate unit so that users of our coils who have other tuners may fit these holders to their tuners and so be able to increase the efficiency and selectivity of their sets. These holders can be supplied with double socket or with standard plug and socket, single or double circuit, mounted on polished mahogany tray as illustrated or for panel mounting.

— FULL PARTICULARS AND PRICES FROM —

GAMBRELL BROS. LTD

MERTON ROAD, SOUTHFIELDS, LONDON, S.W.18

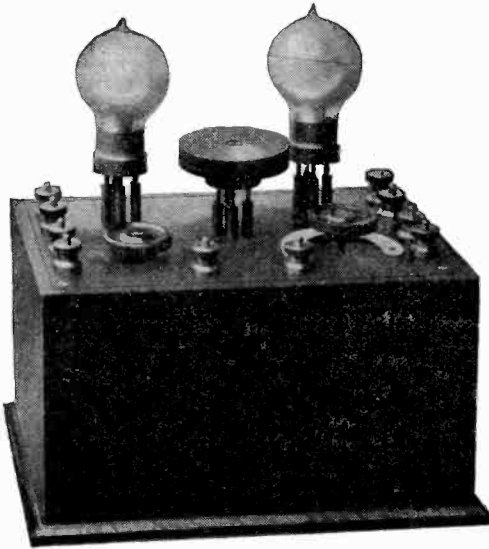

The R.F.H. 2 Valve Receiver.

R.F.H. RADIO SETS

If you are expecting Perfect Reception
You must have an R.F.H. Set

For super-excellence and simplicity in
operation R.F.H. Receiving Sets are
amateur's delight, Clear, Loud and
Distinct Reception.

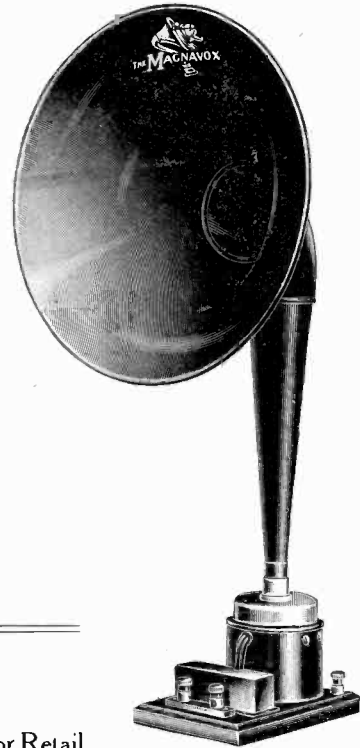

We supply a complete set comprising
Aerial, Spreaders, Insulators, one 2 Valve
Receiving Instrument, with polished
cabinet, one improved Tuning Set, also
with polished mahogany cabinet, and
H.T. 60 volt Battery, a 4 volt. 40 amp.
accumulator, one pair of Head Phones,
an H.F. Transformer for

£12 12 0 VALVES
EXTRA.

SEND FOR LIST.

THE "MAGNAVOX"

PRICE **£10 10 0**

We can supply this magnificent Instrument as Factors or Retail

R.F.H. SETS may be obtained through dealers in photograph apparatus, Electrical Instrument Dealers,
or from the manufacturers.

BUYING AGENTS WANTED EVERYWHERE. We are factors of and retail agents for the
"Magnavox," the King of Loud Speakers. We can supply immediately, Price £10 10s.

ROGERS, FOSTER & HOWELL, LTD.
EDWARD RD., BALSALL HEATH, BIRMINGHAM.

R.F.H.



40, GLOUCESTER ST., LONDON, E.C.1

**ACTUAL MANUFACTURERS OF
VULCANISED FIBRE PARTS
USED IN RADIO**

**BLACK FIBRE PANELS, $\frac{1}{8}$ ", $\frac{3}{16}$ ", and $\frac{1}{4}$ " thick
cut to any size.**

DISCS—ALL SIZES—RED, BLACK or GREY

**BUSHINGS—WASHERS—PUNCHED PIECES
COIL-HEADS—RODS—STRIPS—BASES
SMALL BLOCKS—SPECIAL SHAPES**

We Guarantee a High and Uniform Grade of Material.

ELECTRICAL RUPTURE

200-400 volts per .001 inch of thickness.

Prices on Application. Wholesale Only.

**WITH GOOD APPARATUS YOU
CAN GET GOOD RESULTS**

THE "W.P."

Morse Practice Key

Well Made. First-class Finish. Thoroughly Reliable

Price 7/6 Post Free

THE WIRELESS PRESS, LTD.
12-13 HENRIETTA STREET, LONDON, W.C.2

BE UP-TO-DATE

**READ THE
WIRELESS TRANSMISSION
OF PHOTOGRAPHS,**

By MARCUS J. MARTIN.

143 pages. 139 Diagrams and Illustrations.

Price 5/- net. Post free 5/6

THE WIRELESS PRESS, LIMITED,
DEPT. W.W.
12/13, HENRIETTA ST. STRAND LONDON W.C.2

The
**A B C
OF WIRELESS**

BY

PERCY W. HARRIS

EDITOR OF "CONQUEST"

(The British Magazine of Popular Science.)

Price **6^{D.}** net. Post free **8^{D.}**

**THE BOOK for the
'MAN IN THE STREET'**

This wonderful little book has been specially prepared for those who are desirous of getting a good knowledge of Wireless without delving into text books.

No technical expressions
to puzzle over.
No hard thinking to be done.
No mathematical formulæ
to be elucidated.

What is Wireless? How does it Work?

The A.B.C. Will Tell You

Wireless is the Topic of the Day

The Up-to-date man needs to be conversant with it.

An evening spent in reading this book will put you in a position to appreciate to the full the wonders of the latest and greatest of sciences.

The Wireless Press, Ltd.
12-13, Henrietta St., Strand, London, W.C.2

CONQUEST THE MAGAZINE OF POPULAR SCIENCE

Written for all the family to understand.

SCIENCE :: INVENTION :: INDUSTRY

ON SALE EVERYWHERE. PRICE **1/-** MONTHLY

DON'T WORK in the Dark

If you have a Wireless Set and know but little of the principles of its working, you are missing a great amount of the interest and pleasure which the man obtains who has this knowledge.

It is nice to get good results but where is the satisfaction if you know not how they are obtained?

The Elementary Principles of WIRELESS TELEGRAPHY BY R. D. BANGAY

tells in the simplest possible manner, the theory and practice of wireless.

The Author makes the subject intelligible to persons who do not possess much technical knowledge, and at the same time it is brief and accurate.

The book is so arranged as to be useful as a reference book for students and amateurs. It is published in two parts

PRICE **4/-** EACH (post free 4/5)

or combined in one volume

PRICE **7/6** NETT (post free 8/3)

THE WIRELESS PRESS, LIMITED, DEPT. W.W., 12-13, HENRIETTA ST., STRAND, LONDON, W.C.2

THE CONSTRUCTION OF AMATEUR VALVE STATIONS

By ALAN L. M. DOUGLAS. Price **1/6** nett. 78 pages. 55 Diagrams and Illustrations. Postage 2d.

The aim of the author in compiling this volume has been to place within the reach of the amateur who is interested in Wireless Telegraphy and Telephony a Handbook which will enable him to obtain data that he has otherwise difficulty in acquiring, in order that he may construct for himself apparatus which he desires to make, but does not quite know how to design correctly.

THE WIRELESS PRESS, LTD., 12-13, Henrietta St., Strand, London, W.C.2

OUR EASY PAYMENT SYSTEM

For the PURCHASE OF BOOKS is still open to ALL READERS

FOR FULL PARTICULARS WRITE THE MANAGER, MAIL ORDER DEPT.,
THE WIRELESS PRESS, LTD., 12-13, Henrietta Street, London, W.C.2

BEFORE YOU CAN STUDY WIRELESS TELEGRAPHY AND TELEPHONY YOU MUST HAVE A KNOWLEDGE OF MAGNETISM AND ELECTRICITY

Dear Sir,

A READER'S APPRECIATION.

I received in good condition a copy of "Mag. and Elec. for Home Study" on Saturday last, and I am very highly pleased with it. I have much pleasure in enclosing a P.O. for 6/- which I trust you will find in good order. Again thanking you for the value offered and the prompt attention.

Yours faithfully.

To many who are anxious to gain a knowledge of Magnetism and Electricity some text books on the subject have a very forbidding appearance.

The formulæ and equations too frequently haunt the non-mathematical reader and cause him to abandon his intention.

Such fears, however, need no longer deter anyone from acquiring the knowledge desired as in **MAGNETISM & ELECTRICITY FOR HOME STUDY** By H. E. PENROSE will be found **FIFTY COMPLETE LESSONS** prepared in such a form that the reader ceases to regard them as a study.

The various facts and theories are elucidated subtly but surely. No effort has been spared by the Author to explain the subject so clearly and thoroughly that no one can misunderstand him.

At the conclusion of each lesson is placed a series of questions which enable the reader to test his progress and assure himself that his knowledge is

well grounded. In this way he will know that his future study of Wireless Telegraphy and Telephony will be based upon a solid foundation.

A copy of the book will be sent ON APPROVAL to all who complete the request form below.

**The Manager, Mail Order Dept.,
THE WIRELESS PRESS, LIMITED,
12-13, Henrietta St., LONDON, W.C.2**

I enclose 6d. for postage.

*Please send me a copy of
**MAGNETISM & ELECTRICITY
FOR HOME STUDY. By H. E.
Penrose.***

If I retain it I will remit the sum of 6/-. Otherwise I will return the book in good condition within 5 days of its receipt.

Name

Postal Address

Date 1922

W.W. 22/7/22

The YEAR BOOK of WIRELESS Telegraphy and Telephony 1922

1476 Pages.

Price 15/- Nett.

Demy 8vo.

Postage 1/-.

Abroad 1/4.

CONTENTS

Record of the Development of Wireless Telegraphy—National and International Wireless Laws and Regulations—Directory of the World's Land and Ship Wireless Stations—International Allocation of Call Letters—Alphabetical List of Call Letters—Meteorological Section—International Time and Weather Signals—National Résumés of Progress in Wireless Telegraphy—Particulars of Wireless Telegraph Patents, 1921—Aviation Section—Tabular List of Aviation Stations—Useful Data Section—Wireless Terminology—Conventional Signs used in Wireless Diagrams—Companies Engaged in the Commercial Development of Wireless Telegraphy—Biographical Section—Literature on Wireless Telegraphy and Telephony—Directory of the World's Wireless Societies—Directory of Wireless Colleges and Schools—List of Licensed Amateur Transmitting Stations—Code Section—Special Articles on "The Earthing Resistance of Antennæ," by Dr. Miessner—"The Recording of Wireless Signals," by Dr. Abraham—"The Birth and History of Long Distance Wireless Telegraphy"—"The Rectification Effect in its Reaction to the Composition and Structure of Crystals."

A valuable feature of the present issue is the specially drawn map, which gives, for the first time, a simple means of finding the distance and true direction of Wireless Stations in all parts of the World, from London as the centre.

THE WIRELESS PRESS, LIMITED,

DEPT. W.W. 12-13 HENRIETTA
ST. STRAND, LONDON. W.C.2

Hoyle's Book Saves Time

The tables and equations are compiled in book form and reference to the detailed index speedily puts one in possession of the information desired.

**NO OTHER COMPLETE BOOK
EXISTS FOR THE USE OF
RADIO WORKERS.**

Send at once for a copy of

**STANDARD
TABLES & EQUATIONS
IN
RADIO TELEGRAPHY**

By
BERTRAM HOYLE, M.Sc., Tech., A.M.I.E.E.

Price **9/- nett.**

Post free **9/9**

THE WIRELESS PRESS, LTD.
Dept. W.W. 8/4
12-13 Henrietta St., London, W.C.2

IF YOU WANT A

GOOD

BOOK ON RADIOTELEPHONY

GET

**TELEPHONY
WITHOUT WIRES**

BY

PHILIP R. COURSEY, B.Sc. (ENG.), A.M.I.E.E.

Price **15/- Nett**
(Postage 9d.)

It contains a complete collection of information on the various schemes, proposed and tried, relative to the electrical transmission of the sound of voices through space without wires.

An excellent list of references to papers and articles, forms a complete bibliography of the whole subject.

THE WIRELESS PRESS, LTD.
Dept. W.W. 8/4
12-13, Henrietta St., London, W.C.2

Just Received!

AMERICA'S LATEST PUBLICATIONS FOR THE WIRELESS EXPERIMENTER.



HOW TO MAKE COMMERCIAL TYPE RADIO APPARATUS

By M. B. SLEEPER.

Price 4/- net (post free 4/3).

The experimenter will be able to get a world of ideas for the design and construction of his wireless apparatus from the very clear descriptions and ninety-eight illustrated figures.



CONSTRUCTION OF RADIO PHONE AND TELEGRAPH RECEIVERS FOR BEGINNERS

By M. B. SLEEPER.

Price 4/- net (post free 4/3).

Each piece of apparatus described was first made, tested and found efficient before the final design was accepted. Working drawings prepared especially for the novice and the man who wants to receive the wireless broadcast.



RADIO EXPERIMENTER'S HANDBOOK

By M. B. SLEEPER.

Price 5/- net (post free 5/3).

A book which tells in a very concise way the "Why" of radio and answers many of the "Practical Questions of the Beginner," and even the more advanced student of Wireless.

To follow shortly

THE ABC OF VACUUM TUBES USED IN RADIO RECEPTION

By E. H. LEWIS.

Price 6/- (post free 6/5).

Written particularly for those who know nothing about wireless, but who desire an understanding of the elementary principles of operation of vacuum tubes, and various circuits in which they are used for reception of wireless telegraph signals, music and speech by wireless telephone.

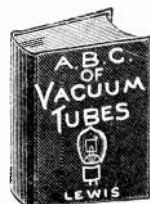

THE WIRELESS PRESS, LTD., Dept. W.W.
12-13, HENRIETTA STREET, STRAND, LONDON, W.C.2

WIRELESS BOOKS FOR THE LIBRARY

MAGNETISM AND ELECTRICITY FOR HOME STUDY. By H. E. Penrose. Contains 50 complete lessons. Price 6/- net. Post free 6/6. 515 pages, 224 diagrams.

THE ARMATURE MODEL FOR 1½ K.W. ROTARY CONVERTER. Price 1/3 net. Post free 1/6. Shows every winding of the Converter Armature.

THE RADIO EXPERIMENTERS' HANDBOOK. By Philip R. Coursey, B.Sc. Eng., F.Inst.P., 113 pages, 99 diagrams and illustrations. Price 3/6 net. Post free 4/-.

SELECTED STUDIES IN ELEMENTARY PHYSICS: A Handbook for Wireless Students and Amateurs. By E. Blake, A.M.I.E.E. Price 5/- net. Post free 5/6. 176 pages. Crown 8vo. Cloth. 43 diagrams and illustrations.

WIRELESS TRANSMISSION OF PHOTOGRAPHS. By Marcus J. Martin, Second Edition. Revised and Enlarged. Price 5/- net. Post free 5/6. 143 pages. Demy 8vo. Cloth. Diagrams and illustrations.

CALCULATION AND MEASUREMENT OF INDUCTANCE AND CAPACITY. By W. H. Nottage, B.Sc. Price 3/6 net. Post free 3/11. Demy 8vo. 144 pages. Over 50 illustrations and diagrams.

THE A.B.C. OF WIRELESS. By Percy W. Harris. A simple outline of Wireless written for all to understand. 64 pages. Price 6d. net. Post free 8d.

TEST QUESTIONS AND ANSWERS ON WIRELESS TELEGRAPHY. Price of each Series of Questions 2/6 net. Postage 3d. Answers 2/6 net. Postage 3d. Invaluable for self-examination. Series 1. The Elementary Principles of Wireless Telegraphy. Part I.—Series 1a. Book of Model Answers. Series 2. Covering the Ground for the Postmaster-General's Examination. Series 2a. Book of Model Answers. Series 3. The Elementary Principles of Wireless Telegraphy. Part II.—Series 3a. Book of Model Answers.

THE ELEMENTARY PRINCIPLES OF WIRELESS TELEGRAPHY. By R. D. Bangay. Crown 8vo. Published in two parts or bound in one volume. Price per part 4/- net. Post free 4/4. In one volume 7/6 net. Post free 8/3.

MAINTENANCE OF WIRELESS TELEGRAPH APPARATUS. By P. W. Harris. Price 2/6 net. Post free 2/10. 127 pages. 52 diagrams and illustrations.

A SHORT COURSE IN ELEMENTARY MATHEMATICS AND THEIR APPLICATION TO WIRELESS TELEGRAPHY. S. J. Willis. Price 5/- net. Post free 5/6. Demy 8vo. 182 pages. 120 diagrams.

ALTERNATING CURRENT WORK. An Outline for Students of Wireless Telegraphy. By A. Shore, A.M.I.E.E. Price 3/6 net. Post free 3/10. Crown 8vo. Cloth. 163 pages. 86 diagrams and illustrations.

THE OSCILLATION VALVE. The Elementary Principles of its application to Wireless Telegraphy. By R. D. Bangay. 6/- net. Post free 6/6. Crown 8vo. 215 pages. 110 diagrams and illustrations.

USEFUL NOTES ON WIRELESS TELEGRAPHY. By H. E. Penrose. Crown 8vo. 1/4 each. Post free 1/6. Book 1. Direct Current. Book 2. Alternating Current. Book 3. High Frequency Current and Wave Production. Book 4. The 1½ K.W. Ship Set. Book 5. The Oscillation Valve.

THE CONSTRUCTION OF AMATEUR VALVE STATIONS. By Alan L. M. Douglas. The ideal book for those contemplating the making of a wireless set. 78 pages, 55 diagrams and illustrations. Price 1/6 net. Post free 1/8.

Visit our Stand No. 40. All-British Wireless Exhibition, Horticultural Hall, Sept. 30th to Oct. 7th.

THE WIRELESS PRESS, LIMITED,
12-13, HENRIETTA STREET, STRAND, LONDON, W.C.2.



AN ENTIRELY NEW WORK.
The ABC Telegraphic CODE 6th Edition

FIVE-LETTER CODE.

An up-to-date Work, containing Five-letter Artificial Code Words with at least a TWO-letter difference and a **TERMINAL-INDEX** of the words at the end of the Book.

Cost of Cabling brought to a Minimum :: Simple to Use.

PRICE **£3 3s. 0d.** net (U.K. and Colonies.)

Publishers:— *Inland Parcel Post 1/6 per copy. Continental Book Post 2/- per copy.*

EDEN FISHER & CO., LTD., 6, 7 & 8, Clements Lane, E.C.4
And 95, 96 and 97 Fenchurch Street, London, E.C. 3.

WARNING.

MARCONI'S WIRELESS TELEGRAPH CO., LTD.,
v.
A. C. COSSOR, LTD.

Marconi's Wireless Telegraph Company, Limited, GIVE NOTICE that an ORDER was made in the High Court of Justice, Chancery Division, by Mr. Justice Russell on the 1st March, 1922, restraining Messrs. A. C. Cossor, Ltd, from infringing the Marconi Company's Letters Patent Nos. 28413 of 1913 and 126658, except so far as Messrs. A. C. Cossor, Ltd. manufacture for H.M. Government.

Messrs. A. C. Cossor, Ltd., were further ORDERED upon oath to DESTROY all articles and apparatus (other than those constructed to the order of H.M. Government) made or used by them in INFRINGEMENT of these patents, and TO PAY THE MARCONI COMPANY DAMAGES AND COSTS.

The M-O Valve Company, Limited, of Osram Works, Brook Green, Hammersmith, London, W.6, is the only firm in this country licensed to manufacture thermionic valves under the patents belonging to the Marconi Company.

Any valve similar to those generally known as the "French type" constitutes an infringement of the above patents whether manufactured in this country or imported from abroad. Marconi House, Strand, London, W.C 2.

LIST OF
Regular Transmissions
 OF
WIRELESS STATIONS

Giving Time, Call Sign, Wavelength, System, etc.
 PRICE **6d.** POST FREE.

THE WIRELESS PRESS, LIMITED
Dept. W.W.,
12-13 Henrietta Street, London, W.C.2.

WIRELESS

RECEIVERS
 CAN BE
REWOUND
 TO
 4000 Ohms
 PER **12/-** SET

G. TURNOCK, 41 High St. Aston, Bham.

Registered "NIPHAN" Trade Mark.
WATER-TIGHT PLUGS
and CABLE COUPLINGS
TO MEET HOME OFFICE REQUIREMENTS



COUPLING CONNECTING CABLES

Phones:
 2600 Gerrard, 12061 Central.

Telegrams:
 Niphan, London.

As used by H.M. War Office, Electric Supply Companies, Railway Companies, Marconi's Wireless Telegraph Company
SIMMONDS BROS., LTD.
 4, 6 & 8, NEWTON STREET, HOLBORN, W.C.



SIX WAY TEE CONNECTORS

Patented in England and Abroad.

“ THE RESULTS ”

OF INCREASED OUTPUT BY MODERN METHODS

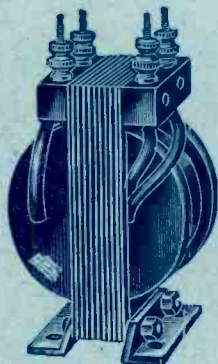

INTERVALVE TRANSFORMERS
Thoroughly Guaranteed
Each - - **20/-**
Good Deliveries



OUR STANDARD
By reason of increased output can now offer
At - - **3/9** each

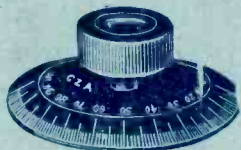

CONDENSERS DIALS
0-130 - Bevelled Scale
With Knob and Brass Bush
Price **3/9**

TELEPHONE TRANSFORMERS

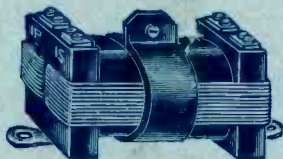

Telephone (Hedgehog pattern)
For use with 120w. Phones
Most Efficient Over 5,000 sold
Price **13/6**



VALVE LEGS
With 2 Nuts and Washer
Cleaned and Lacquered
Price **2d.** each.

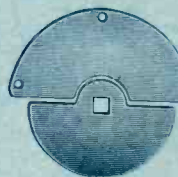

CONDENSER PARTS

- Vanes **2d.** pair
- Spindles '0002 **7d.**
- .. '0005 **9d.**
- .. '001 **1/-**

OUR CATALOGUE IS READY

Over 100 illustrations of Real Components at Ridiculous Prices

Post Free 4d.

N.B.—All persons who have previously applied for same will have no doubt received it by time this appears

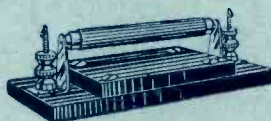

- GRID LEAKS, Etc.**
- Leak and Condenser - - - **4/6**
 - Leaks with Clips - - - **2/-**
 - Anode Resistances Clips - **2/6**



ALUMINIUM PULLEY BLOCKS
Non-Rusting — Strong
Last for years
Price **1/9**



NON-HYGROSCOPIC INSULATORS
Composition $3\frac{1}{2} \times 1'$
Price **1/3**

ALTHOUGH ALL OUR PRICES ARE CONSIDERABLY REDUCED, THE QUALITY IS MAINTAINED.



CRYSTAL CUPS
with 3 grip screws
Cleaned and Lacquered
Each **6d.**

CRYSTAL DETECTORS 6/6

G. Z. AUCKLAND & SON, 395, St. John Street, E.C.1

(MANUFACTURERS—NOT AMATEURS)

'Phone - - 3173 CLERKENWELL
'Grams: "ZAUCKADIO" SMITH, LONDON

Visit our Stand No. 46. All British Wireless Exhibition, Horticultural Hall, Sept. 30th to Oct 7th.

WIRELESS WORLD

AND

RADIO REVIEW

VOL. X. No. 24.

9th SEPTEMBER, 1922.

Registered at the G.P.O. as a Weekly Newspaper.

A New Condenser for Wireless Receivers THE DUBILIER TYPE 600 MICA CONDENSER

The illustrations show two types of this new condenser for wireless receiving circuits. These condensers have the same perfect mica insulation, the same high efficiency and the same permanence of capacity as the larger Dubilier Mica Condensers used in wireless transmitters. Distortion when receiving telephony is often due to bad design of the components of the receiver—therefore use efficient Dubilier Condensers in your receiver to obtain the best out of your set.

With Clips for Grid Leak.



Without Clips for Grid Leak.



PRICES.

Capacities between 0.0001 and 0.001 m.f.	...	3/4 each
0.001 .. 0.005 .. inclusive	...	7/6 ..
Condensers complete with Grid Leaks	...	7/6 ..

TRADE TERMS ON APPLICATION.

Both types of condenser (with or without clips for a grid leak) are fitted with screw terminals as well as tags for making soldered connections.

DUBILIER

THE DUBILIER CONDENSER CO. (1921), LTD.,

DUCON WORKS, Goldhawk Road, Shepherd's Bush, London, W.12

Telephone—Hammersmith 1084

Telegrams—Hivoltcon, Phone, London.

Code—Marconi International

Visit our Stand No. 36. All-British Wireless Exhibition, Horticultural Hall, September 30th to October 7th.



STERLING No. 1 CRYSTAL W/T RECEIVING SET

Specially designed for use in connection with the Wireless Telephony Broadcasting Scheme, and is suitable for a range of about 25 miles.

PRICE £7-12-6

Visit our Stand No. 34. All-British Wireless Exhibition, Horticultural Hall, September 30th to October 7th.

STERLING TELEPHONE & ELECTRIC CO., LTD.

210-212, Tottenham Court Road,
LONDON : : : W.1

Telephone No. : 4144 Museum (7 lines)
Telegrams : "Cucumis, Wesdo, London."

Works : DAGENHAM, ESSEX.

BRANCHES :

NEWCASTLE-ON-TYNE : 9, Clavering Place.
CARDIFF : 8, Park Place.

IMMEDIATE DELIVERY

"Wireless for all"

Before you decide on the construction of your set. It will pay you to have particulars of—

Condensite Celoron

For PANELS and OTHER PARTS.

This material is waterproof, immune to atmospheric and climatic conditions, will not warp, has high surface and volume resistivity, high di-electric strength, low specific gravity.

LET US QUOTE YOU

SEND PARTICULARS OF YOUR EXACT REQUIREMENTS TO
THE MANUFACTURERS

DIAMOND FIBRE CO. LTD.

DIAMOND-FIBRE
WORKS

HIGH ROAD
SOUTH TOTTENHAM, N.15.

NOTE:—"Simplex" Wireless Phones and Accessories may be obtained from Hamley Bros. Ltd., John Barker & Co., Ltd., A. W. Gamage, L. Zambra, Selfridge & Co., Ltd., and all electrical dealers.

"LISTEN-IN" WITH THE BEST.

"SIMPLEX" SINGLE VALVE BROADCAST RECEIVING SET

Your protection £5:5:0



This instrument is the result of over two years research work. H. P. R. Wireless, Ltd., were the pioneer designers and manufacturers of fine valve receiving instruments. The "Simplex" is perfectly simple to operate and simply perfect in results and workmanship. More **BROADCASTING** Stations will very shortly be in operation. You can hear all the concerts and telephony in your zone by simply turning a switch. No electrical or wireless knowledge required. Sketch and instructions for the erection of aerial included. The accessories (Headphones, Valve, Batteries and Aerial) can be secured through your dealer. The price of the "Simplex," complete with all accessories, is £10 15 0. Two or more persons can "listen in."

TRADE ENQUIRIES INVITED

Visit our Stand No. 35. All-British Wireless Exhibition, Horticultural Hall, September 30th to October 7th:

H.P.R. WIRELESS, LTD. (*Members of the British Broadcasting Company.*)

CARLTON HOUSE, GREAT QUEEN STREET, W.C.2
(Opposite the Kingsway Theatre.) Telephone: Regent 1719.
Works at Ealing and Waterloo.

WE OFFER **PROMPT DELIVERY**
of complete Receiving Sets and all apparatus required
by the Amateur Experimenter.

ONE TO THREE VALVE SETS COMPLETE. "K.B." UNIT SYSTEMS.
COMPLETE SETS OF PARTS to build Valve Panels, Condenser Panels,
Variable Condensers, etc.

AERIAL WIRE INSULATORS FILAMENT RESISTANCES ACCUMULATORS	H.T. BATTERIES VALVE HOLDERS SWITCHES KNOBS	TERMINALS, &c., &c. EBONITE SHEET, ROD AND TUBE
---	--	--

Trade Enquiries Invited. Catalogue post free, 4d.

VISIT OUR SHOWROOMS (open 9 a.m. to 7 p.m.), WHERE YOU CAN "LISTEN IN" ON OUR RECEIVING SETS AND INSPECT OUR LATEST PRODUCTIONS.

THE
"K.B." RADIO EQUIPMENT COMPANY
HEAD OFFICES & SHOWROOMS : 109, HIGH ROAD, KILBURN, LONDON, N.W.6.
WORKS : QUEEN'S PARK, N.W.

Bus Services 8, 16, 28 and 51 pass the door. 3 minutes Kilburn Park Station (Bakerloo Railway).
Visit our Stand No. 8. All-British Wireless Exhibition, Horticultural Hall, Sept. 30th to Oct. 7th.

EXTRACTS FROM OUR CATALOGUE (3d. POST FREE).

Aerial Wire, 7/22's, Enamelled Hard Drawn Copper, 6/- per 100'.
Aerial Pulleys, 2 1/2" 1", 5" with tackle hook and bucket, 2/6.
Aerial Insulators, Shell Type, 2 1/2" x 2 1/2", 1/6 each.
Aerial Insulators, Reel Type, 2" diam. white, 4d. each.
Batteries. For H.T. Make your own. Flash Lamp Batteries, 5/- doz.
Condenser Discs, Ebonite, 3 1/4" diam., 1/- each
Condenser Dials, engraved, fine finish, 2 1/2" diam., 1/9 each.
Condensers. Fixed. Exceptional quality. Made with copper foil. From .0007 to .001. 2/6 each.
Condenser Vanes. Not rubbish. Best strong aluminium. Fixed 3 1/2", Moving 2 1/2". 1/- doz.
Condenser Spacing Washers. Remember they must be accurate. Small 4d. doz., large 6d. doz.
Condenser Screwed Rod. Brass 12" lengths, 2 B.A. or 4 B.A. 6d. each, 2 B.A. and 4 B.A. nuts 7d. doz., 2 B.A. and 4 B.A. washers 2d. doz.
Contact Studs. Studs, not rubbish, 1/6 doz.
Copper Foil Sheets. 12" x 3" 6d. each.
Core Wire. Soft iron, 2/4 per lb.
Ebonite. Best quality. Any size. rod or sheet, 5/- per lb.
Filament Resistances. For Panel mounting with knob pointer and good contact. A speciality. 4/- each.

HEAD RECEIVERS. Light, sensitive, of good design and superior finish. Tested and guaranteed perfect. Complete with cords. 140 ohm 30/- each, 4,000 ohm 32/- each, 8,000 ohm 33/- each. Postage 6d. each.
Inductance Tubes. 12" long. Specially impregnated, 2 1/2" 6d., 3" 7d., 3 1/2" 8d., 4" 10d., 4 1/2" 1/-, 5" 1/2, 6" 1/6 each. Postage 9d. each.
Inductance Sliders with springs and plungers, 1/-
Inductance Slider Rod. 1/2" square in 1 1/2" lengths. Not jagged but smooth. 6d. each.
Insulating Tubing 6d. per yard.
Ivory Scales. 0 to 180°. Engraved (Not printed), 1/2 each.
Ivory Tablets. Strong, Engraved not printed. Aerial, Earth, Primary, Secondary, On, Off, Reactance, Phones, H.T.+, H.T.-, L.T.+, L.T.-, A.T.I. 2d. each.
Knobs. Ebonite. 1 1/2" diameter. Superior finish. Knurled 7d. each.
LOUD SPEAKERS. Exceptionally efficient. 70 ohm, 2,000 ohm, 4,000 ohm £2 10s. each.
Mica. Pure Ruby. Pieces. 3" x 3" x .002" thick, 6d. each.
Paraffin Wax, 1/- per lb.
Resistance Wires. Advance brand 22's (11 ohm per yard), 24's (18 ohms per yard) and 28's enamelled (4 ohms per yard). 2d. per yard.
Switch Arms. Exceptionally strong and well made, 2/6 each.
Terminals. A very neat wireless terminal. Polished. Complete with nut and washer, 2/6 doz.

Tin Foil. Free from lead. Sheets, 26" x 13", 4d. each.
Valve Sockets. With nut and washer. Fine finish, set of four, 9d.
Valve Holders. Best quality ebonite, with nuts, 1/4 each.
Wood's Metal, 6d. per packet.
CRYSTALS. Carborundum, Copper Pyrites, Galena, Bornite, Iron Pyrites Silicon, Manganese, 8d. per packet.

SUPERIOR QUALITY WIRE. British made. All wire wound free. Post extra.

S.W.G.	S.C.C.	D.C.C.	Single		Silk	Silk	Enld.
			Silk	Dble.			
12	1/10	1/11	4/-	5/4			1/8
14	1/11	2/-	4/-	5/4			1/9
16	2/-	2/1	4/2	5/6			1/10
18	2/1	2/2	4/4	5/6			1/11
20	2/2	2/3	4/8	6/2			2/6
22	2/6	2/11	5/-	6/8			2/8
24	3/-	3/6	5/6	7/4			2/8
26	3/7	4/1	6/8	8/2			3/2
28	4/4	4/7	7/2	9/-			3/6
30	5/-	5/6	8/-	10/-			3/10
32	6/-	7/3	9/2	13/-			4/2
34	7/-	8/3	11/6	14/-			4/4
36	8/8	10/2	14/-	15/6			4/8
38	11/3	13/2	16/-	19/-			5/3
40	15/-	18/-	18/6	22/6			6/6
42	17/3	21/-	31/6	4/-			9/-

At per lb.

Carriage extra. Please remit ample postage, balance returned. Orders over £2 carriage paid. Money back if not satisfied.

J. L. CARTWRIGHT & CO., Manufacturing Electrical and Radio Engineers
'Phone—Cent. 4209. Dept. W. 130/132; LONDON ROAD, MANCHESTER.
Special Terms to the Trade. Works: BERRY STREET Grams—Pladuram, Manchester. Price Lists 3d. post free.

BIRMINGHAM:
133 NEW STREET.
□
LIVERPOOL:
10. SOUTH JOHN
STREET.

BURNDEPT

MANCHESTER:
61, BRIDGE STREET.
DEANSGATE.
□
LEEDS:
48, GT. GEORGE
STREET.

WIRELESS APPARATUS

LONDON OFFICE & SHOWROOMS
15 Bedford Street, Strand, W.C.2.

Visit our Stand No. **12A**. All-British Wireless Exhibition, Horticultural Hall, Sept. 30th to Oct. 7th.

ILLUSTRATED CATALOGUE

post free
6d.

This gives full details of our complete one to four valve Receiving Sets

Prices from:
£21

The Set De Luxe



ILLUSTRATED CATALOGUE

post free
6d.

This gives full details of our complete one to four valve Receiving Sets

Prices from:
£21

The Burndept Ultra IV. Receiving Set.

THE BURNDEPT ULTRA IV in addition to receiving all British Concerts will also receive loudly and clearly the Hague, Paris and Berlin Concerts as well as Morse Code Messages from all European, North African and some American Commercial Stations.

SHORT WAVE (CONCERT) COILS

These Coils have been specially designed for BROADCASTING and NEW AMATEUR WAVE-LENGTHS. They are 3" in diameter and mounted on standard BURNDEPT coil plugs so that they are interchangeable with BURNDEPT PATENT COILS. The new coils (4 in number) replace the Burndept Coils Nos. 25 and 50, which are now discontinued. Wavelength range approx. 150-750 metres in conjunction with '00075 mfd. variable condenser. **PRICE (set of 4 coils) 25/-**.

WE HAVE A COMPLETE STOCK OF ALL WIRELESS ACCESSORIES BURNDEPT (Patent) COILS—COIL HOLDERS—TUNING PANELS—CONDENSERS—AMPLIFIERS—TRANSFORMERS—ACCUMULATORS—HIGH-TENSION BATTERIES—HEAD PHONES—VALVES—MASTS—SPREADERS—AERIAL WIRE—INSULATORS—SWITCHES—ALSO COMPLETE RECEIVING AND TRANSMITTING SETS.

All **BURNDEPT** Valve Apparatus is duly licensed under Marconi Patents for amateur use in Great Britain.

BURNDEPT, LTD., Manufacturers of **AERIAL & EASTNOR WORKS,**
Wireless Apparatus **BLACKHEATH, LONDON, S.E.3**

"WESTERN COUNTIES" ACCUMULATORS

Write for Complete Price List.

FOR WIRELESS USE

Write for Complete Price List.

The most Reliable and Moderate Priced Accumulator on the Market.

4 Volts.		6 Volts.	
80 amhours	£1 8 6	60 amhours	£1 17 6
120 (IGNITION RATING)	1 17 6	90 (IGNITION RATING)	2 5 0
150 "	2 5 0	120 "	2 12 6
180 "	2 12 0		

The Western Counties Electrical & Engineering Company,
Midland Bank Chambers,

Sole Agents for Messrs. **BURNDEPT LTD.**, for South-Midland and South-Western Counties (excepting the City of Bristol), to whom applications for sub-agencies for that area should be addressed.

Telegrams "Electron, Yeovil" **YEOVIL.** Telephone—**223, Yeovil.**

SHEET, ROD AND TUBE stocked in qualities suitable for all Wireless work.
KNOB (Moulded), various patterns stocked
CONDENSER DIAL AND KNOB.
 3" and 4" dia.—0°—100°

*Watch this Advert.
 for new mouldings.*

EBONITE
 (HARD RUBBER)

Enquiries Solicited.

WHOLESALE ONLY.

AMERICAN HARD RUBBER CO.

(BRITAIN) LIMITED

13a, FORE STREET, LONDON, E.C. 2
 Teleg. "Eboniseth, Ave., London." 'Phone: Central 12754

GENTS' MAKE FITMENTS

SEND FOR OUR
 SUNDRIES
 PAMPHLET

MAKE USE
 OF OUR
 STOCKS

ASK US
 TO QUOTE
 FOR YOUR
 WHOLESALE REQUIREMENTS

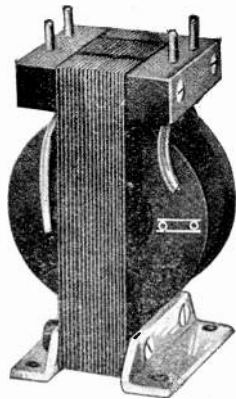

GENT & CO. LTD. PARADAY WORKS LEICESTER

LONDON: 25, Victoria Street, S.W.1
 NEWCASTLE-ON-TYNE: Tangent House, 52, Blackett Street

**HIGH QUALITY
 :: CONDENSERS ::**



'001 mf. 24/-

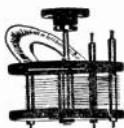

'0005 mf. 18/-
 Complete with scales, post free.



'0003 mf. 14/-



**UNIT
 COIL
 HOLDERS**



Shows method of fixing.

Made of Ebonite and brass throughout with excellent gun metal finish.
 Fixed Unit 4/2
 Moving Unit 5/8

Prices post free.

ASHLEY RADIO

69, Renshaw Street, LIVERPOOL

Telephone: 4623 Bank.

Telegrams: "Rotary, Liverpool."

"SEMAPHORE"

High Tension Dry Batteries for Wireless Receiving Sets



TERMINALS. — The 15 volt Batteries are supplied (unless otherwise ordered) with 2 Brass Connecting Strips as illustrated. All the other sizes have 2 Insulated Plugs. Brass Sockets are fixed to every other Cell so that Tappings can be taken at each 3 volts.

Other sizes can be supplied and quotations given on receipt of enquiries.

In order to prove that "SEMAPHORES" are THE BEST and induce a trial, we have reduced our price for 15-volt to 3/8 each.

Volts	Number of Cells	Price Each Carriage paid
15	11	3/8 3/8
30	22	8/6
36	24	9/3
50	36	13/6
60	44	16/6
90	66	24/6
100	72	26/6

Trade supplied promptly. Terms on application.

See our Batteries at Stand No. 5. All-British Wireless Exhibition, Horticultural Hall, September 30 to October 7.

SEMAPHORE, Ltd., DRY BATTERY SPECIALISTS

28, John Street, Bedford Row, London, W.C.1.

Telephones: MUSEUM, 5422 and 5423.
 Telegrams: ARWELIDITE, HOLB. LONDON.

GAMAGES

LEAD IN AMATEUR WIRELESS
FIRST IN 1908—FOREMOST TO-DAY

COMPLETE HOME RECEIVING SETS

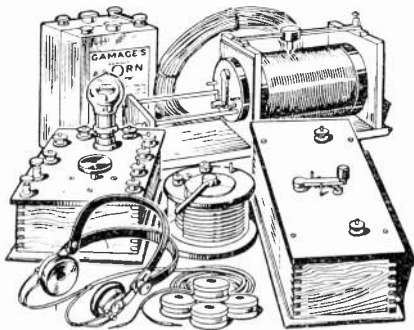

WIRELESS APPARATUS FOR VALVE RECEPTION

A highly sensitive and selective set, so designed that extra valves may be added from time to time for amplification purposes. Consists of a loose Coupled Tuner Valve Panel complete 60 v. H.T. battery, 4 v. 40 amp. Accumulator. Variable Condenser, roof. Aerial Wire, Aerial Insulators capable of receiving ordinary telegraphy over a distance of 1,000 miles, and telephony, Music, etc., up to 100 miles. An ideal set for the Valve beginner as all parts can be used in more complicated sets.

£12 12 0

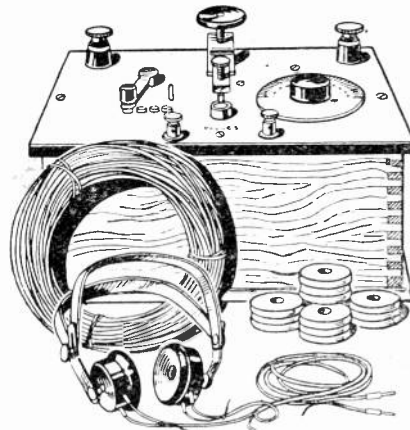

COMPLETE CRYSTAL RECEIVING SET

This set comprises a Special Tuning Coil, tapped in three places, Permanite Detector (undoubtedly the finest crystal obtainable) Variable Condenser, all enclosed in highly polished Mahogany Cabinet. In addition, 100 ft. of Aerial Wire, Aerial Insulators, and a very selective and sensitive pair of 'Phones are supplied. This set is capable of receiving ordinary telegraphy over a distance of 200 miles. Telephony, Music, etc., can be received up to 30 miles. The wavelength covered is 300 to 1,000 metres. A most compact little instrument, size 9" x 4" x 6".

£5 10 0

EXCEPTIONAL OFFER OF BROWNS 'PHONES

Unused, Solid Aluminium Diaphragms in the majority of cases, but where a small segment of parchment is used between the Aluminium Diaphragm proper and the Metal Case, it is our opinion that such a combination gives better results. Brown's Double Headband Receivers without leads,

1,200 ohms.

8,000 ohms.

42/6

49/6

SULLIVAN'S Double Head-piece receivers, 8,000 ohms. Without leads. In perfect condition and absolutely new.

36/6



Write for a copy OF GAMAGES WIRELESS CATALOGUE Sent post free on request.

Visit our Stand No. 31 at the ALL - BRITISH WIRELESS EXHIBITION Horticultural Hall, Sept. 30th—Oct. 7th

GAMAGES, HOLBORN, LONDON, E.C. 1.

JUST PUBLISHED

NEW PRICE LIST AND
WIRELESS GUIDE FOR

AMATEURS

Sent on receipt of 3d. (stamps).

MANCHESTER ELECTRIC WAREHOUSE
1 & 5, LEVER STREET—MANCHESTER

HIGH GRADE EBONITE

SHEETS RODS TUBES MOULDINGS

"Bakelite," "Wittonite" & Fireproof Mouldings

Suitable for Electrical, Wireless and Mechanical Requirements.

ENQUIRIES INVITED



REGD TRADE MARK.

THE GENERAL ELECTRIC CO., LTD.,

Insulation Dept., MAGNET HOUSE, KINGSWAY, LONDON, W.C.2

Insulation Works : WITTON and COVENTRY.



REGD TRADE MARK.



TRADE MARK

**The WHITECROSS
COMPANY, LIMITED
:: WARRINGTON ::**

Manufacturers of All Descriptions of

WIRE ROPES AND WIRES

W. & M.
VARIABLE

CONDENSERS

Made as a Scientific Instrument by High Class Instrument
Makers. All sizes in course of production. '0005 Mfd. Now Ready. **18/6 each.**

Securely packed. Ready for immediate use. State whether
required for Panel Mounting or as a separate Unit.

Send for General Price List of W & M Apparatus and Supplies.
Post free.

We sell on the distinct understanding that if the buyer is in
any degree dissatisfied with his purchase, he can return same
within 24 hours and money will be immediately refunded.

FREE ADVICE TO BUYERS.

All our apparatus is produced under the personal supervision
of our Technical Director, Mr. Henry A. Machen, A.M.I.E.E.
(late of Siemens Bros. & Co., Ltd.), whose experience in
the design and manufacture of Wireless Apparatus extends
over a period of 15 years.

If you have any difficulty in obtaining W. & M. Wireless Supplies,
write to us, giving the name of your dealer.

NOTICE TO THE TRADE.

We are prepared to appoint District Agents for the sale of
W. & M. Wireless Supplies and to refer all postal orders
and enquiries to such appointed Agents.

Terms and Discounts on application.

Manufactured solely by—

The Wainwright Manufacturing Co., Ltd.

25, VICTORIA STREET, S.W. 1.

WORKS : WALTHAMSTOW, Essex & BIRMINGHAM.

Telegrams : Nominatus Vic London. Telephone : Victoria 4319.

WIRELESS EQUIPMENT LTD.
 Tel: GERRARD 6785. RADIO ENGINEERS AND MANUFACTURERS
 :: APPARATUS AND SPARES ::
 WRITE FOR OUR ILLUSTRATED LISTS OF SETS AND COMPONENT PARTS. 3d. POST FREE
 Head Office: 90, CHARING CROSS ROAD LONDON, W.C.2

Visit our Stand No. 14. All-British Wireless Exhibition, Horticultural Hall, September 30th to October 7th

THE WIRELESS WORLD AND RADIO REVIEW
 THE OFFICIAL ORGAN OF THE WIRELESS SOCIETY OF LONDON
 A MAGAZINE DEVOTED TO WIRELESS TELEGRAPHY AND TELEPHONY

CONTENTS

Meteorological Wireless Codes. By W. G. W. Mitchell, B.Sc., F.R.A.S., F.R.Met.S. - 745
 On the Amplification of High-Frequency Currents. By Philip R. Coursey, B.Sc.,
 F.Inst.P., A.M.I.E.E. - - - - - 750
 Some Notes on the Transmissions from Writtle (2MT). By Captain P. P. Eckersley - 756
 A Portable Receiving Set. By A. Lovering - - - - - 759

Contents continued on next page.

WIRELESS TELEGRAPHY & TELEPHONY

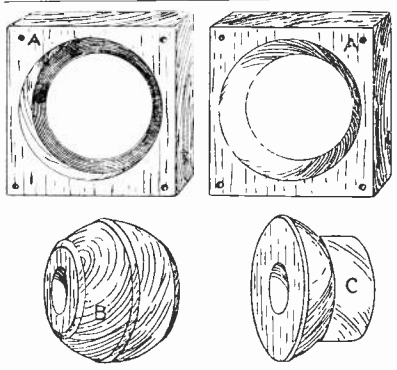

VARIOMETER FORMERS.
 made of beech wood in four sections as illustrated. A. Outer former in two parts, one showing winding. B Inside ball former. C. Former for winding coil to place inside A. Instructions: Wind former C with silk or cotton covered wire, shellac same and allow to dry; it will then be possible to remove the former C, and with a fresh coat of shellac secure the winding into former A. Care being taken that windings are all in the same direction. When wound these will be found to be exceptionally efficient for short wave work of all descriptions. Price per set, 10/-.



SLIDER.

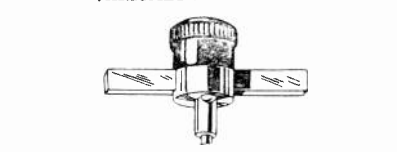

FILAMENT RESISTANCES for panel mounting, 4 ohms, complete with knob, collar, etc. Exceptional value, 4/6.



PROTECTOR SPARK GAP.



SLIDERS, as illustrated, brass fitted with spring and plunger, 1/6. Solid ebonite, with spring and plunger, 1/-.

PROTECTOR SPARK GAPS, capable of micro adjustment, thus making a permanent protection against lightning and other heavy static discharges when listening-in. No station should be without this precautionary instrument. Price 5/-.

RADIO SUPPLIES (DEPT. 1), 236, HIGH HOLBORN, LONDON, W.C. 1
 Phone—Museum 6894

NOW IS THE TIME to acquire a sound theoretical and practical knowledge of **THREE ELECTRODE VALVES**, (as applied to C.W. Radio-telegraphy and Radio-telephony), by means of my **POSTAL INSTRUCTION COURSE.**

Perfectly Simple
May I Send you Particulars?

2/Lt. E. REDPATH,
19, Niger St., BARROW-IN-FURNESS

CONTENTS *(Continued)*

A Universal Unit System. By 2CM	- - - - -	760
Development of Radio Broadcasting in the United States. By M. B. Sleeper	- - - - -	763
Notes	- - - - -	764
Correspondence	- - - - -	765
Calendar of Current Events	- - - - -	766
Wireless Club Reports	- - - - -	767
Questions and Answers	- - - - -	771
Share Market Report	- - - - -	778

THE WIRELESS WORLD AND RADIO REVIEW is published weekly on Saturdays.

All correspondence relating to contributions should be addressed to THE EDITOR, THE WIRELESS WORLD AND RADIO REVIEW, 12-13, Henrietta Street, London, W.C.2.

No responsibility can be taken for MSS. or photographs sent without stamps to defray cost of return postage.

Editorial and Publishing Offices 12-13, Henrietta Street, Strand, London, W.C.2.

Telegraphic Address: "Radionic, Rand, London." Telephone No.: Gerrard 2807.

Advertisement Managers, Bertram Day & Co., Ltd., 9 and 10, Charing Cross, S.W.1. Telephone No.: Gerrard 8063 and 8064.

SUBSCRIPTION RATES.—

28s. per annum, post free. Single Copies 6d., or post free 7d.

Registered at the G.P.O. for transmission by Magazine Post to Canada and Newfoundland.

HOLLOW STEEL MASTS FOR AERIALS

These masts are light, strong, easily erected, and will last a lifetime. All lengths over 15ft. are made in sections and each mast is supplied complete with baseplate, finial, rope cleat, pulley sheave, guy clips, three steel guy ropes and strainers, painted one coat ready for immediate erection. Being made of steel, no lightning conductors are required

PROMPT DELIVERY.

PRICES F.O.R. FOR CASH WITH ORDER, EACH

10ft. ...	32/6	15ft. ...	42/6	20ft. ...	45/-
25ft. ...	57/6	30ft. ...	84/-	40ft. ...	126/-

Other Lengths supplied at equally Low Prices.

Trade Inquiries Invited

THE WIRELESS STEEL MAST & ACCESSORY COMPANY
Lombard Street West, West Bromwich

Telephone No. 447
Telegrams: "Wireless Westbromich."

VALVES

DELIVERY FROM STOCK.

RECEIVING.

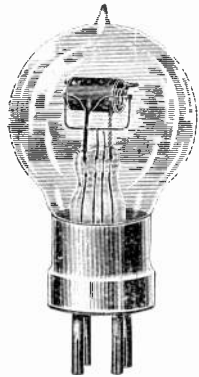

Type.	Filament Voltage.	Anode Voltage.	PRICE.
R	4	60	£0 17 6
R4B	4	50	1 10 0
V24	5.2	36	1 4 0
Q	5.2	50	1 4 0
		(150 as amplifier)	
QX	5.2	50	1 4 0

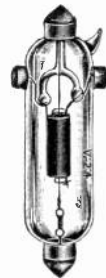

SPECIAL LOW TEMPERATURE VALVES.



Type.	Filament Voltage.	Filament Current.	Anode Voltage.	PRICE.
L.T.1	1.8	.4	36-50	£2 10 0
L.T.3	1.8	.11	„	„

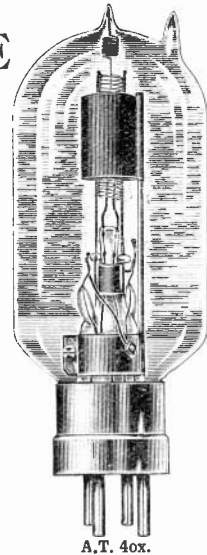

TRANSMITTING.

Type	Filament Voltage.	Anode Voltage.	PRICE.
A.T.25	5.5	UP TO 1,000	£1 10 0
A.T.40X	7	„ 1,000	2 15 0

L.T. 1.

A.T. 40x.

Visit our Stand No. 32. All-British Wireless Exhibition, Horticultural Hall, September 30th to October 7th

THE
MARCONI SCIENTIFIC INSTRUMENT CO., LTD.

40 DEAN STREET, SOHO, W.1

TELEGRAMS: THEMASINCO. WESTCENT
 TELEPHONE: GERRARD 774

WATES SPECIALITIES

Can ALWAYS be relied upon

Why not visit our showrooms, inspect all accessories and have our varied range of complete receiving sets demonstrated to you

VARIABLE CONDENSERS. These are "built up" and of first class manufacture. In polished mahogany case.

PRICES	'001	'0005	'0003
(Carriage gd. extra)	28 -	24/-	22/-

SEND THREE STAMPS FOR ILLUSTRATED CATALOGUE

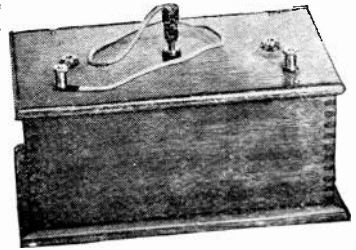
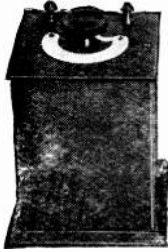

The Ideal Valve Accumulator

(In wooden cases with leather strap handles.)

6-VOLT ... 50-AMP. PRICE 35/- Carriage 3/-
 4-VOLT ... 50-AMP. PRICE 24/- Carriage 2/-

Exclusive features of these Accumulators:—

1. Basket pattern positives so constructed that it is impossible for active material to become displaced.
2. Glass containers specially constructed with rib separators.
3. Absolute absence of frothing.
4. Practically impossible for plates to sulphate due to special materials used.
5. Non-corrosive terminals.
6. Impossibility of acid creeping.
7. Last feature, but not least—LOW PRICE BUT HIGH QUALITY.

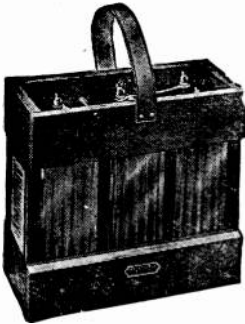

SPHINX H.T. BATTERIES

POLISHED MAHOGANY CASE, holding four Standard 15-volt Sphinx H.T. Batteries with tappings for either 30, 45, or 60 volts. Supplied with terminal connectors for 15-volt units. No soldering required.

Price, with 60-volt batteries .. 29/-
 Price without batteries .. 15/-

VISIT OUR STAND NO. 15, ALL-BRITISH WIRELESS EXHIBITION, HORTICULTURAL HALL, September 30th to October 7th.

WATES BROS., 13/14, Gt. Queen Street, KINGSWAY, LONDON, W.C.2
 'Phone : Gerrard 576

Price : 8/6 each

Price : 8/6 each

Code word, "WIRIT." 36 volts. Size, 6½ x 2½ x 3.

GENUINE HELLESEN DRY BATTERIES

FOR WIRELESS HIGH TENSION

SPECIAL TRADE AND WHOLESALE TERMS

Code word.	Volts.	Details.	Price.
"WIRON"	15	Screw terminals	4/- each
"WIRTO"	15	Strip	4/- "
"WIRIT"	36	2 insulated wander plugs	8/6 "
"WIRLN"	60	" "	14/- "

KNOWN THE WORLD OVER AS THE BEST.

ALL LISTS FREE ON APPLICATION.

A. H. HUNT, LTD.

H.A.H. Works, Tunstall Rd., Croydon, Surrey

EBONITE AND VULCANITE

TUBES-RODS-SHEETS

LARGE STOCKS

BRITANNIA RUBBER AND KAMPTULICON CO., LTD.

7, NEWGATE ST., LONDON, E.C.1

Telephone : 2168 Central Telegrams : Britannia, London

THE WIRELESS WORLD AND RADIO REVIEW

THE OFFICIAL ORGAN OF THE WIRELESS SOCIETY OF LONDON

VOL. X. No. 24.

SEPTEMBER 9TH, 1922.

WEEKLY

Meteorological Wireless Codes.

By W. G. W. MITCHELL, B.Sc., F.R.A.S., F.R.Met.S.

METEOROLOGICAL CODES.

1. The information reported in weather telegrams may conveniently be classified and referred to subsequently under the following six headings :—

- (a) Surface observations, including barometric pressure, wind force and direction, temperature, visibility, humidity and amount of cloud.
- (b) Upper-wind observations, including height, direction and force of the upper winds.
- (c) Upper-air temperature and humidity.
- (d) Reports from ships at sea (surface observations).
- (e) Information regarding ice conditions.
- (f) Forecasts.

2. Definitions in meteorology—*cyclone* and *anticyclone*.

The terms "cyclone" and "anticyclone" are so frequently used in weather reports that it is thought better to deal with them in a separate paragraph. Other terms, the meaning of which is obscure, will be explained as they occur. On the weather-maps published in the daily newspapers, places of equal barometric pressure (reduced to sea-level and latitude 45° for standard comparison) are joined by lines known as *isobars*. They are analogous to the contour lines on a map of land areas. The isobars enable us to readily see the shapes of the areas of high and low pressure. Areas of high pressure are called anticyclones or "highs," and areas of low pressure, cyclones or depressions or simply "lows." Where the isobars are packed closely together, the barometric gradient is steep and the winds powerful. Now it might appear at first as though the air would blow across

at right angles to the isobars from places of high pressure to "lows." Any such conditions would, however, be very short-lived, for in an interval of time, measured only perhaps in seconds, the "low" would become a high pressure area and *vice versa*. The effect of the earth's rotation under the moving

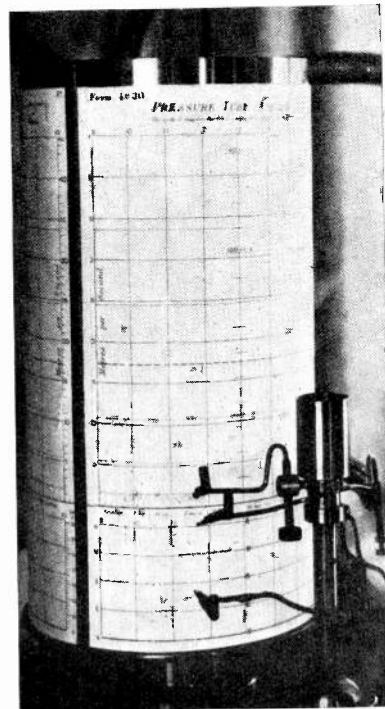
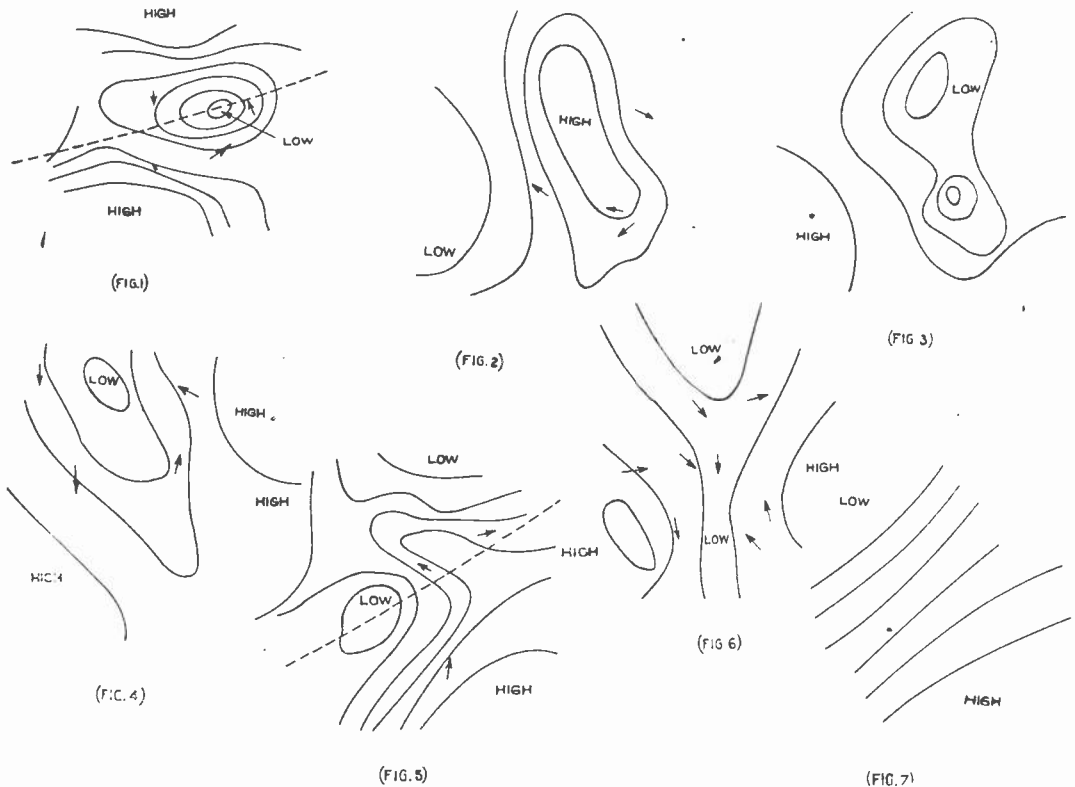

Fig. 1. Dine's High-pressure tube anemometer gives a continuous record of the direction and velocity of the wind. Every gust (however small) is recorded by the upper pen, whilst the lower, answering to the movements of the vane outside, records the direction.

Fig. 2. NATURE OF WEATHER TO BE EXPECTED.

(Fig. 1.)—Cyclone. *Typical Arrangement of Isobars.* North of the equator, the wind blows round the depression counter clockwise in accordance with Buys Ballots' Law. Strong winds are associated with closely packed isobars, in which case the depression is deep. Rain near the centre of the "low" especially heavy rain on the north-east side with dull and overcast sky to the east and south-east. Depressions usually come up from the south-west or west and move across towards the north-east or east. Signs of approaching cyclone, fall of barometer, strong south or south-west wind, overcast and cloudy sky. Signs of passing of cyclone, wind changes to north or north-west and increases in strength, barometer rises. Small arrows show wind direction.—N.B. The broken line shows the track of the observer. For the other positions, conclusions must be drawn from the diagram.

(Fig. 2.)—Anti-cyclone. In the case of an anti-cycle, the isobars are usually further apart and therefore winds are lighter than those associated with cyclones. Usually fine and bright weather, seldom any rain and then only light showers, some cloud. Anti-cyclones very often cover a very large area. Their chief characteristic is that they move but slowly and irregularly, often remaining about for weeks at a time, whereas all the phenomena associated with a cyclone may be passed through in 24 hours.



(Fig. 3.)—Secondary Depression. A secondary is usually found on the southern side of a "low," and when associated with a deep depression the secondary often causes strong winds by crowding together of the isobars. Heavy rain and thunderstorms are frequent.

(Fig. 4.)—V-shaped Depression. A more elongated "secondary." Signs of approaching V-shaped depression—strong southerly winds, much cloud and very heavy rain, with very marked change as the central portion of the depression passes over. Then rapid clearing of sky and falling temperature and change of wind from a northerly direction. The central portion is often a region of very heavy squalls.

(Fig. 5.)—Wedge. The long arrow points to a wedge of high pressure between two "lows." Signs of approaching wedge. A very rapid "clearing up" of weather and fall of wind after the passage of a depression. Sequence of weather changes during passage of wedge. Front of wedge, extremely fine weather with light winds from north, then as central line of wedge passes, a change of wind from a south or south-west direction followed by rain and clouds associated with the approaching "low." The weather is often comparatively calm as the central portion of the "wedge" approaches.

(Fig. 6.)—The "Col." The typical "col" is a narrow straight "pass" between two anti-cyclones. This region is the meeting place of winds from many different directions and consequently fog in cold weather and thunderstorms in hot weather are the phenomena associated with this type of isobar arrangement.

(Fig. 7.)—Straight Isobars. An arrangement of isobars not frequently met with in these latitudes. The weather experienced is usually cloudy and rainy on the "low" pressure side and fine and warm on the high pressure side.

air causes the latter to be apparently deflected to the right in the northern hemisphere. Thus the wind blows almost along the direction of the isobars and reaches the "low" by a kind of spiral course. In the case of an area of high pressure, the wind blows round the area of high pressure in a clockwise direction to the line joining the centres of high and low pressure.

Buys Ballots' Law conveniently summarises these issues thus: "stand with your back to the wind, the low pressure area will be

the central meteorological service. The amateur will then be in a position to de-code these (where necessary) and gain information several hours in advance of the approaching weather.

The "general inference" (page 612, *The Wireless World and Radio Review*, August 12th) is in plain language and needs no further comment at present.

CODED FORECASTS FOR DISTRICTS. A specimen forecast in code is given below, together with a brief explanation. For full information



Fig. 3. *Strato-cumulus clouds, taken from an aeroplane 5,000 ft. above the earth, and at 1,000 ft. above the cloud level.*

on your left hand." This applies only to the northern hemisphere, the reverse is true in the southern hemisphere.

Although the cyclone and anticyclone are the chief arrangements of isobars met with, there are other typical shapes. These are illustrated on page 746, together with a brief description of the weather associated with each type.

3. Having outlined the different types of weather associated with typical arrangements of isobars, the next step will be to give the codes used in the weather reports issued by

as to the method of decoding reference should be made to M.O. Publication, No. 244, "Forecast Code for the Abbreviation of Weather Forecasts transmitted by Telegraphy or Radio-telegraphy," which may be obtained from H.M. Stationery Office, Kingsway, price 1s.

Group 999, England and Southern Scotland, taken collectively (appended to the "general inference" issued at 2000 G.M.T.).

SPECIMEN. (For decode see Fig. 4.)
 09218. Baltic 16508 20042 19299 22457
 22455 32024 40405 52427 90447 91501

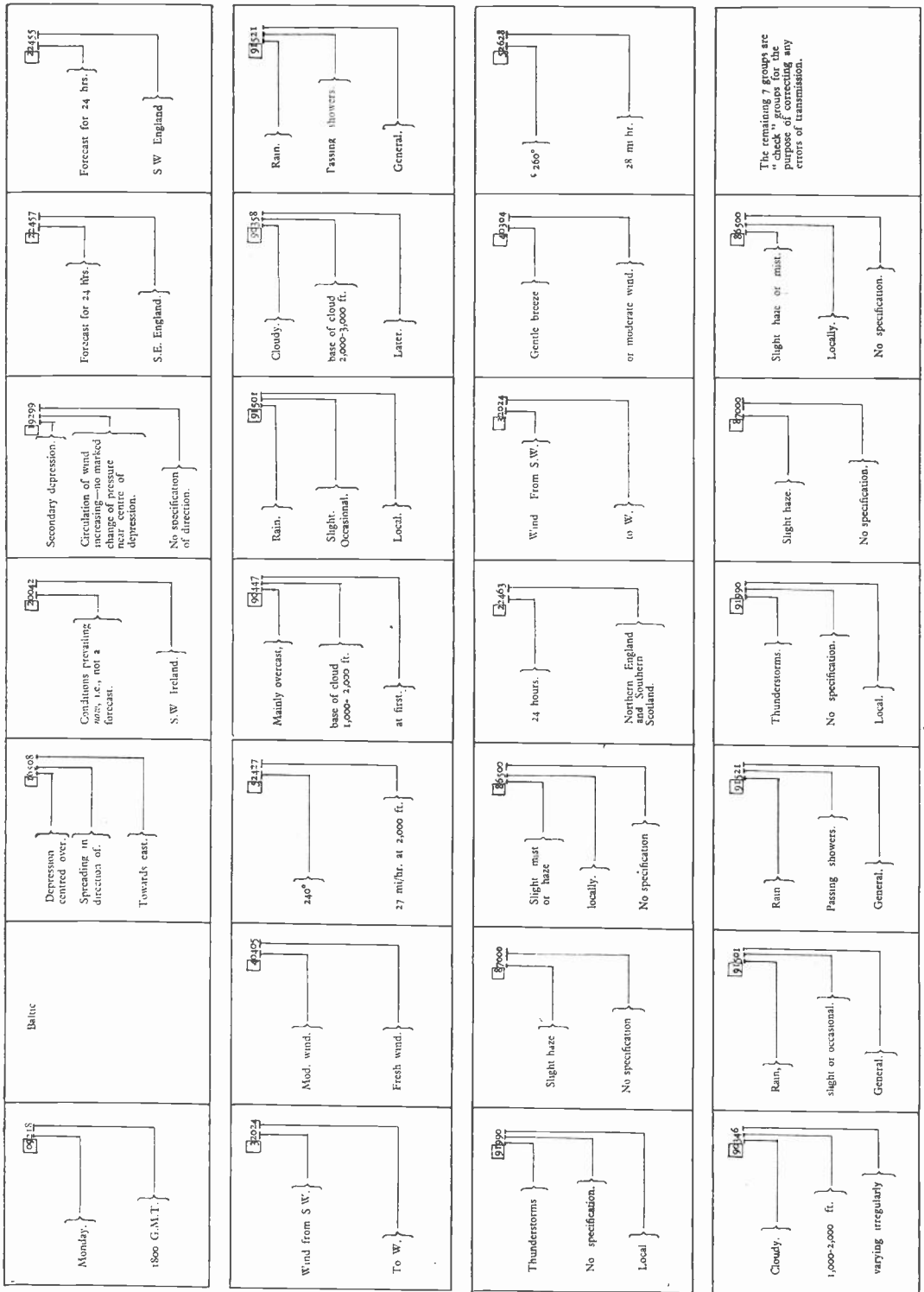

Fig. 4. Decode of Specimen Message.

90358 91521 91990 87000 86500 22463
 32024 40304 52628 90346 91501 91521
 91990 87000 86500 00800 81304 65885
 97113 26885 95— 70639

The "check" groups are obtained by writing down in vertical columns the preceding groups :

09218	0	} First group of check figures.
16508	0	
20042	8	
19299	0	
22457	0	
22455	8	} Second group of check figures.
32024	1	
40405	3	
52427	0	
90447	4	
91501	6	} Third group of check figures.
90358	5	
91521	8	
91990	8	
87000	5	
86500	9	} Fourth group of check figures.
22463	7	
32024	1	
40304	1	
52628	3	
90346	2	} Fifth group of check figures.
91501	6	
91521	8	
91990	8	
87000	5	
86500	9	} Sixth group of check figures.
70639	5	
Seventh group of check figures.		

The figures comprising the first six check groups, are obtained by adding the horizontal columns and writing down the terminal figure of the sum thus obtained (i.e., $0 + 9 + 2 + 1 + 8 = 20$; check figure = 0).

Similarly the seventh group is the terminal figures of each vertical column. The figure (5) of the sixth group is the "Key" figure. It is the terminal figure of the vertical column (a) of check figures and it must agree with the terminal figure obtained by adding the horizontal row (b). The key figure serves as a "check" on the check figures.

Now suppose an error of transmission (or

reception) occurs in the group 19299 and instead of this, 19499 is received. The error is first detected on adding the horizontal columns, the check figure 2 not agreeing with that transmitted in the check group. Any one or more of the figures 1, 9, 4, 9, 9, might be wrong, but the error can usually be placed by adding the vertical columns and noting the disagreement with the figures of the seventh check group.

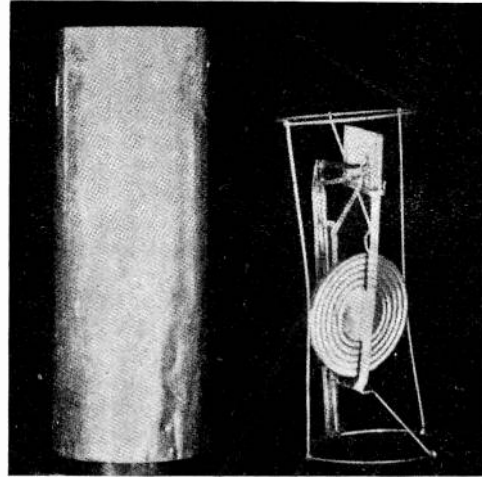

Fig. 5. The ingenious recording meteorograph used for making temperature, barometer and humidity readings in the upper air. The whole apparatus weighs but a few ounces and is carried by a small balloon.

COMPLETE DECODE OF ABOVE MESSAGE.

Weather report based on observations on Monday at 6 p.m. (18h. G.M.T.). Depression over the Baltic spreading East. Secondary depression off South-West Ireland. Forecast for 24 hours for Southern England—wind between S.W. and W., moderate or fresh, 27 m.p.h. at 2,000 feet from 240°. Mainly overcast at first with lowest cloud at a height of 1,000-2,000 feet, slight occasional rain, cloudy (cloud 2,000-3,000 feet) with passing showers later perhaps thunderstorms. Visibility good but slight local haze. Forecast for 24 hours for North England and South Scotland, wind between S.W. and W., light or moderate, 28 m.p.h. from 260° at 2,000 feet. Cloudy (lowest cloud 1,000-2,000 feet) varying irregularly in amount, slight occasional local rain or passing showers perhaps thunderstorms. Visibility good but slight local haze.

On the Amplification of High-Frequency Currents

By PHILIP R. COURSEY, B.Sc., F.Inst.P., A.M.I.E.E.

The general outline of the following article is based on a lecture delivered to the North London Wireless Association on January 30th, 1922, during which the apparatus referred to was demonstrated to the meeting.

ALTHOUGH historically the use of a thermionic valve for the amplification of high-frequency currents was effected at least as early as it was used for a similar purpose in audio frequency circuits, this aspect of the whole subject of valve amplification has on the whole received much less attention by radio amateurs in this and other countries than has its use for low frequency or note magnification. There are doubtless many reasons contributing to this state of affairs, but it will suffice to refer here only to the most important of them.

In the first place the low frequency amplifier possesses, from the amateur's point of view, the great advantage that it can be used for signals of any wavelength. In many spheres of commercial radio work the receiver is called upon to function almost exclusively on one wavelength, or at least on a very narrow band of wavelengths, so that in such cases high frequency amplification, with the greater selectivity that it can be made to introduce, is not only practicable but very valuable; with the large wavelength range necessary to meet amateur and experimental requirements, however, the problem becomes more complex.

In the first place, therefore, I propose to make a few remarks about amplification in general, and then to deal rather more in detail with the particular problem of high frequency amplification over a large range of wavelengths.

It will be no use at the moment to refer to the other properties of valves, and to the construction of valves in general, but I would like, however, to draw your attention to the fact that the valve, that is the three-electrode valve as we all know it, in any of its forms is an amplifier in three distinct senses. It can be a voltage amplifier or a current amplifier as well as an energy amplifier, and to a certain extent one can choose in which form to utilise the output energy. In reality the valve is always an energy amplifier, because

the energy in the output circuit is drawn practically entirely from the high tension battery, whereas the energy put in is not required to do more than to effect changes in the potential of the control electrode or grid. Fundamentally, therefore, the valve is an energy amplifier, but it is essentially a voltage operated device, since it has for its input circuit that joined to the grid or control electrode, which circuit is always of high resistance. We can, however, choose whether we take the output energy either in the form of voltage variations with small currents or current changes with smaller voltages. If we have a valve working under normal conditions, we apply, usually, the input energy in the form of voltage changes and require the output energy not in the form of current changes, but where we are concerned, as we usually are in receiving circuits, with the use of more than one valve in cascade for amplification, or where we require one valve for high magnification followed by another valve for detecting purposes, as the second valve in the case must be operated by voltage changes rather than by current changes, we require the output to be in the form of voltage changes. Hence, in all these cases which cover the essential requirements of most receivers both the input and output circuits of the valves are required to be arranged so as to deal with the energy in the form of voltage changes. It should not be forgotten, however, that the energy magnification is all important, as without it we should not gain anything by high-frequency amplification beyond what we could get by an ordinary high-frequency transformer, and when using note magnifiers to operate a loud-speaking telephone, it is the energy amplification which is vital. In the latter case we want the final output to be in the form of current changes instead of the voltage changes which are wanted at all the other stages of the amplifier. In this case the extra

energy is required to bring into operation the large mass of the loud-speaking telephone, and where such loud-speaking telephones are required for producing sounds to be audible over large areas, this extra energy has to be obtained by using larger valves or more valves in parallel for the end stages of the amplifier. To fill a very large hall with sound by means of valve amplifiers and loud-speaking telephones it is not uncommon to use firstly ordinary valves and then two or more valves in parallel for the next stages, and then to pass that output energy on to a 5-watt transmitting valve or even to a 50 or a 100-watt valve so as to get in the final plate circuit very much larger energy changes.

For our purpose, where we are using the valve as an amplifier between the aerial (input) and the detector (output) circuits there is one factor of fundamental importance connected with all valves which gives us a measure of the effectiveness of the valve. The factor to which I refer is the voltage amplification factor of the valve. Primarily that factor is a constant of the actual physical construction of the valve rather than of the circuits used with it, but those circuits must be properly suited to the valve if the voltage factor of the valve is to be utilised to best advantage. The voltage factor of the valve represents the maximum possible voltage amplification that we can get with the valve in question by applying our initial energy (be it from an incoming signal or from a land-line telephone, or of any other form) to the grid circuit of the valve, and arranging the plate (output) circuit for maximum voltage changes. The effective amplification that we get in practice does not necessarily equal the maximum possible in the valve. In many cases it is far lower, and in practice the effective amplification is often a more important quantity to consider in high frequency than it is in low frequency amplification, since the former presents the greater difficulties.

The voltage factor is primarily connected with the characteristic curves of the valve, and its value can be deduced from these characteristic curves if we have the means of plotting out a series of such curves for the valve in use. Fig. 1 shows a series of four such curves connecting the anode current I_a with the grid voltage V_g , for four different values of the anode voltage from the high-tension battery. Suppose we have our operating point at the position marked by C in

Fig. 1, we have the voltage AC on the grid with current OX flowing from the high-tension battery, through the plate circuit of

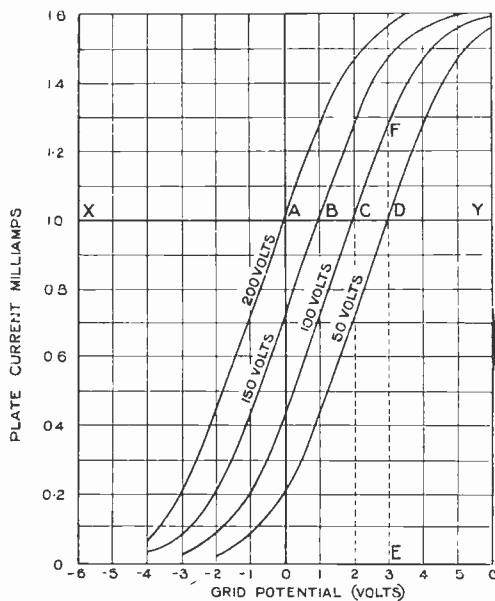

Fig. 1. Valve Characteristic Curves to illustrate Voltage Factor.

the valve. If we increase the grid voltage a small amount such as to OE the anode current will increase from ED to EF. The same would apply to whatever curves we take. We can bring the anode current down again to its initial value by reducing the voltage of the anode from the value corresponding to the curve passing through C to the value corresponding to the curve through D, and the ratio of the amount by which we must reduce the anode voltage when we increase the voltage of grid by a certain amount, the ratio of those voltages necessary to maintain the anode current constant is the voltage amplification factor of the valve. Hence, if we can draw out three or four characteristic curves we have the means of getting the maximum voltage amplification factor of the valve off those curves. In the case of the curves shown in Fig. 1 an increase of the grid voltage by 1 volt produces the same effect as a change of 50 volts on the anode—that is to say, the voltage amplification factor of the valve having the characteristics plotted in this figure is 50.

There are, however, two disadvantages attached to that method. Firstly, the plotting

out of curves is rather laborious, and secondly, a number of costly instruments, milliammeters and high resistance voltmeters, etc., are required. There are, however, simple methods of measuring the voltage factor by means of a single operation; in other words it is possible to devise an instrument, such that if you plug your valve into it and make the necessary adjustments, it is possible to read off the voltage factor of the valve directly from a scale. The general principles of one such method I described recently in *The Wireless World**, but it may be of interest if I here briefly describe the arrangement as the measurement is one which is of fundamental importance. Figure 2 shows an instrument built up to operate upon this principle.

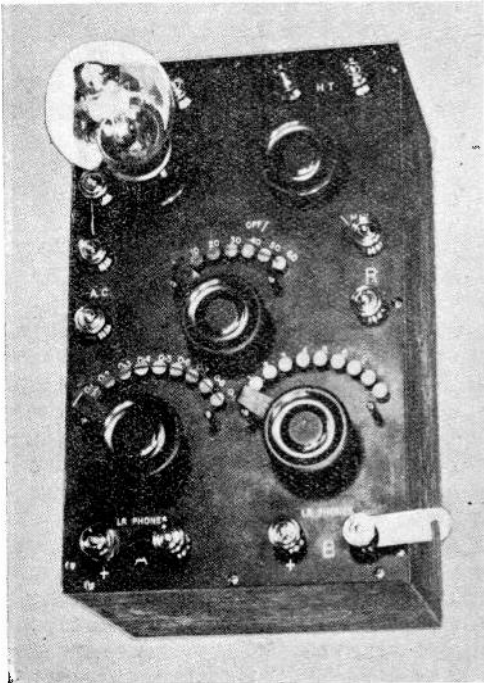

Fig. 2. Photograph of voltage-factor meter.

It has on top a holder for the valve, which is provided with the usual filament battery and filament resistance, and is connected up with a high-tension battery in its plate circuit, in series with a pair of telephones. The grid and anode circuits are also connected to the ends of a potentiometer, Fig. 3, the filament connection being taken to the

slider. This potentiometer is also joined across some suitable source of audible frequency A.C. If we have it available, this may be a

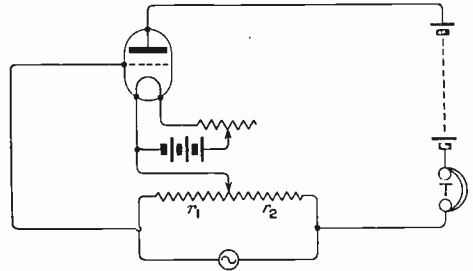

Fig. 3. Connection of voltage-factor meter.

300 or 400 cycle alternator, such as is often available in laboratories, but for private experimental purposes the use of a buzzer with a transformer is quite good. A little iron-cored telephone transformer with a buzzer and battery in series with its primary makes quite a useful arrangement for this purpose (Fig. 4). Alternatively a valve oscillating at an acoustic frequency can be employed, with the advantage that it gives a source of audible frequency of practically sine wave form and a pure note in the telephones. It has, however, the disadvantages that, firstly,

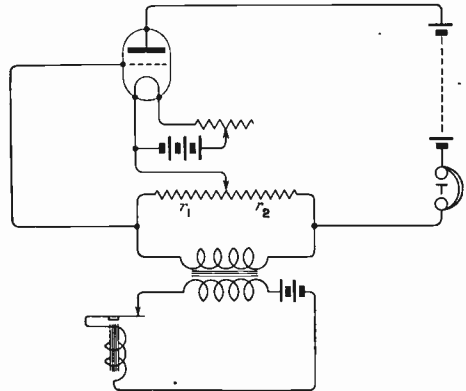

Fig. 4. Connections of voltage-factor meter using Buzzer as A.C. source.

* *Wireless World*, 9 pp. 675-677, Feb. 4th, 1922.

if only one valve is used it is difficult to get sufficient energy from it to operate the set satisfactorily so as to get good signals in the telephones, and secondly, the transformer necessary to provide the retroaction to make

the valve oscillate at this frequency has generally a large stray magnetic field which often causes very serious errors. Similar remarks, however, apply to many arrangements of buzzer, so that in practical work the source of A.C. should be some distance away and connected to the instrument by two parallel wires close together. If we arrange the apparatus in this manner, light up the valve and put a suitable high tension battery in the plate

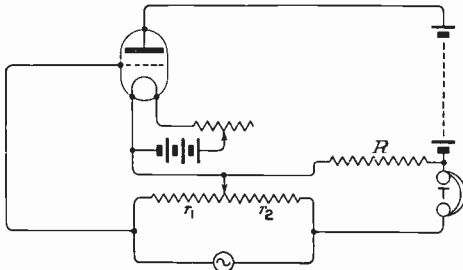

Fig. 5. Connections of voltage-factor meter as arranged for measuring the internal resistance of the valve.

circuit, a sound will be heard in the telephones due to the current flowing through them from the A.C. source. By adjusting the slider of the potentiometer (Fig. 3), a point will be found where the sound in the telephone practically disappears. If this is a uniformly wound potentiometer the ratio of the two lengths on each side of the slider is equal to the ratio of their resistances, and the voltage factor is given by the same ratio, viz., r_2/r_1 . In the instrument shown (Fig. 2) I have made the resistance marked r_1 in Fig. 3 a fixed one of value 1 ohm and the point of connection of the filament to the resistances is also fixed, but I have the anode tapping point variable. This tapping point is marked so as to be direct reading to give the voltage amplification factor of the valve in use. The instrument can be used for lecture demonstration with a two-valve note magnifier and loud speaker to render the telephone sounds audible over the room.

Another constant of the valve, viz., its internal plate-filament resistance, can also be readily measured by this same apparatus. The circuit arrangement is slightly different, as an extra high resistance must be included in part of the anode circuit (Fig. 5). A resistance of the order of 20,000 to 50,000 ohms is suitable, and an ordinary type of anode resistance rod will work quite well. I have used this instrument on an anode

resistance rod which is marked 50,000 ohms, but it is desirable to actually measure the value of the rod used on a Wheatstone bridge, as these resistances sometimes change and so render the marked values inaccurate. This particular resistance actually measures 68,000 ohms, although it is marked 50,000. By connecting this resistance on to two terminals provided for it when designing the instrument we get the desired connections for measuring the internal resistance of the valve. This constant of the valve is an important one, since for most efficient operation of the valve it is usually necessary to arrange the output circuit to have an impedance approximately equal to the internal resistance of the valve. The formula for calculating the resistance from the readings of the instrument is :

$$R_a = \frac{R(\nu r_1 - r_2)}{r_2}$$

where ν is the voltage amplification factor of the valve. In the instrument shown the resistances have been adjusted so that the formula simplifies to

$$R_a = R \left(\frac{S_1 - S_2}{S_2} \right)$$

where

- R_a = the internal resistance of the valve ;
- R = the large external resistance connected to the instrument ;
- r_1 & r_2 = resistances marked with these symbols in Fig. 3 ;
- S_1 = reading on scale of instrument when R not connected ;
- S_2 = reading on scale of instrument when R is connected.

As an example of the measurement, a resistance of 20,000 ohms was connected to the terminals marked R on the instrument, and a new balance position for silence in the telephones was obtained at 2.7, the original reading before R was connected being 8.0. Hence, in this case the internal resistance

of the valve $R_a = 20,000 \left(\frac{8 - 2.7}{2.7} \right) = 40,000$

ohms approximately. If the temperature of the valve is altered, different values of this resistance R_a will be obtained, so that you can by this method very easily take a series of resistance values at different temperatures, and at different high tension voltages or under almost any other desired conditions. Hence, by means of this instrument we can very easily determine two factors which are

of great importance in connection with the use of the valve as an amplifier, whether for high or low frequency.

To pass on to the methods by which the voltage amplification of the valve can be utilised for the amplification of high frequency currents or rather for the amplification of high frequency energy, the most important thing to be considered is the coupling between the stages of the amplifier, and between the last high frequency valve and the detector. I have fitted up a circuit to arrange different ways of coupling the stages of the high frequency amplifier to show them in operation, and for this purpose I have a two-valve

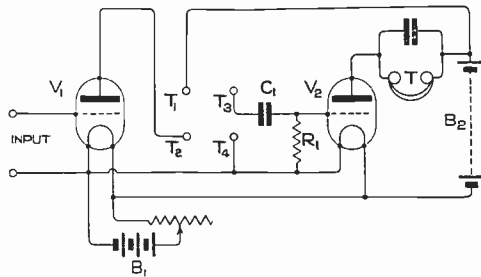

Fig. 6. Connections of Experimental Amplifier Panel.

arrangement provided with terminals to which various intervalve couplings can be connected. Incidentally it is a useful point to remember, in connection with the design of amplifying receivers for experimental work, that the valve holder and filament connections and the necessary leads to the high and low tension batteries can be mounted upon a board and kept quite distinct from all the rest of the apparatus. The coupling unit for use between any two valves can also be kept distinct, if desired, so that it becomes a simple matter to build up any type of amplifier. Fig. 6 indicates the scheme diagrammatically. For simplicity two valves only are shown, with common anode and filament batteries B₂ and B₁ respectively for the two valves. The first is a high frequency valve, and the second one may be either another high frequency valve or a detector valve. The input is taken to the first grid and the filament as usual, and if V₂ is a detector valve we may have our telephones in its plate circuit with the usual small bypass condenser. If we want to add any note-magnification stages, the coupling trans-

former will be put in place of the telephones. For the detector valve it is generally desirable to put a grid leak and condenser in its grid circuit, but rectification with a potentiometer can be arranged if preferred.

Any desired intervalve coupling unit can be connected into the four terminals marked T₁, T₂, T₃, T₄. For example, suppose we want to use a resistance-capacity coupling, the anode resistance should be inserted between T₁ and T₂, and the coupling condenser between T₂ and T₃, leaving T₄ free. In this case, the separate coupling condenser can evidently be suppressed, and the existing grid condenser (if of suitable capacity) can be used for the coupling. Again, suppose we wish to use a transformer coupling, all that is necessary is to connect the primary winding of the high-frequency intervalve transformer between T₁ and T₂, and its secondary between T₃ and T₄. Thus in a few minutes almost any one of the different types of intervalve coupling can be tested.

[Demonstration apparatus was arranged on the lecture table on these lines to show the operation of different types of intervalve coupling.]

I would now like to draw your attention to a method of coupling two valves which is probably the most direct that it is possible to have. The arrangement was, I believe, originally devised by A. Blondel, in France, as a means of coupling valves primarily for low frequency currents or for the amplification of small direct currents. As, however, the method

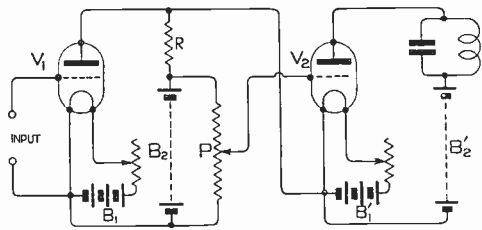

Fig. 7. Circuit of Blondel's Amplifier with "Potentiometric" coupling.

of coupling the valves directly gives a result which is practically independent of the frequency, apart from the effects of stray capacities, we can use the method for high frequency as well as for low. The arrangement is sketched in Fig. 7. In this diagram a resistance R is joined in the anode circuit of the first valve V₁, in series with the usual H.T. battery B₂. A potentiometer P

is shunted across the battery B_2 with its slider connected to the grid of the second valve V_2 . The potential changes across R and the portion of P tapped off by the slider are therefore applied directly to the second valve. We can look on that circuit in another way by considering it as a Wheatstone bridge, as shown in Fig. 8. The ratio arms are made up of the two parts of the potentiometer marked P_1 and P_2 respectively. The other arms are made up of the fixed resistance R and the anode circuit of the valve V_1 . The H.T. battery B_2 is joined across the ends of P_1 P_2 (as also shown in Fig. 7), the input circuit is connected to the grid of V_1 , and the grid circuit of the second valve takes the place of the usual "galvanometer arm" of the bridge. By adjusting the slider of the potentiometer P (Fig. 7), *i.e.*, adjusting the ratio of P_1 to P_2 (Fig. 8), the bridge can be balanced, and there will then be no potential in the "galvanometer arm"

wavelengths the problem of amplification becomes very much more difficult.

This direct coupling has the disadvantage of requiring two separate low-tension batteries and two separate high-tension batteries. The circuit sketched in Fig. 7 is the original scheme of Blondel's amplifier, but if we rearrange the circuit we can dispense with the use of two filament batteries. For this purpose we need merely to shift the resistance R to the other bridge arm and interchange the positions of the battery and galvanometer arms of the bridge, as shown in Fig. 9. The two valve filaments are then

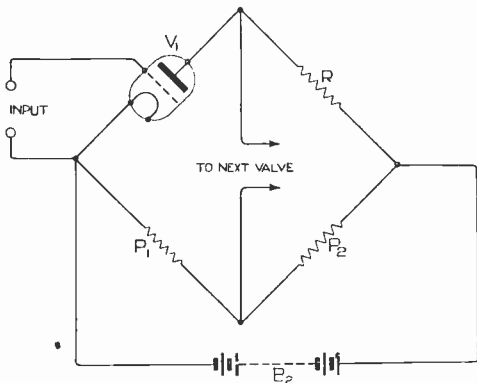

Fig. 8. Bridge Amplifier Coupling.

due to the bridge battery B_2 —*i.e.*, under these conditions there will be no steady D.C. potential (from B_2) applied to the grid of the second valve.

The coupling between the valves is not in this arrangement affected by the frequency of current applied to it, because there is in the coupling no circuit of an oscillatory nature. There will, of course, be a limit to the amplification obtainable with such an arrangement, at the higher frequencies, on account of the capacities between the various parts of the circuit. Such stray capacities may cause an appreciable loss of amplification with very high-frequency currents, *i.e.* with wavelengths of the order of 150 to 200 metres, and on such

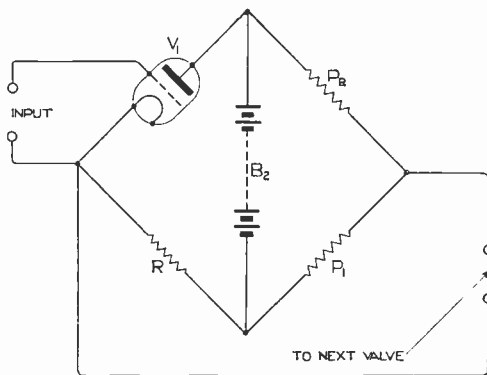

Fig. 9. Modified Bridge Amplifier Coupling.

joined together, and can therefore be fed from a common battery, as shown in Fig. 10.

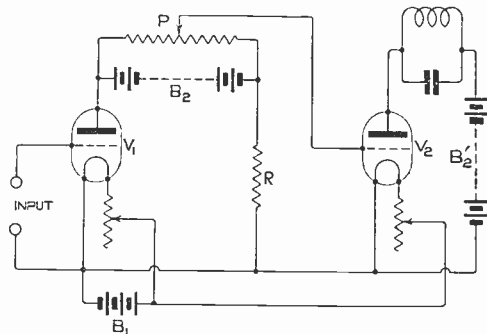

Fig. 10. Simplified Blondel Amplifier using common L.T. Battery.

This change, although two H.T. batteries are still required, is a simplification that enables the arrangement to be used for experimental purposes. The use of a common L.T. battery in this manner should reduce the stray

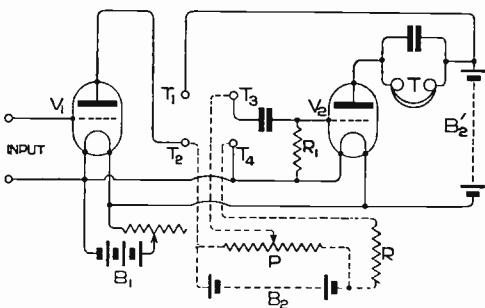

Fig 11. Connections of Fig. 10 adapted to Experimental Amplifier Panel.

capacities and enable the method to be employed for higher frequencies. This method can be adapted to the experimental amplifier panel outlined in Fig. 6, by leaving the terminal T_1 disconnected, and connecting a second H.T. battery and resistance R between T_2 and T_4 (Fig. 6). A potentiometer connected across the extra H.T. battery has its slider connected to terminal T_3 , which is joined to the second valve V_2 . These connections, adapted to the panel sketched in Fig. 6, are shown in Fig. 11.

(To be concluded.)

Some Notes on the Transmissions from Writtle (2 MT).

By CAPTAIN P. P. ECKERSLEY.

INTRODUCTION.

IT is the intention of this article to summarise the many reports on the Writtle transmissions, to give advice to the more amateur amateurs on a basis of really safe working, and to explain a little some of the difficulties at the transmitting end.

THE BROAD PRINCIPLES OF WIRELESS TELEPHONY.

The basic principle of wireless telephony is the radiation of a continuous electromagnetic wave of frequency n , which has superimposed upon it much lower frequencies p_1, p_2, p_3, p_n , resulting in the final emission of a complex band of frequencies $n, n_1, n_2, n_3, \dots, n_n$.* The frequencies $n_1, n_2, n_3, \dots, n_n$ are grouped about the "carrier wave" of frequency n . The state of affairs at any instant might be represented by the diagram shown in Fig. 1, which shows a bunch of resonance curves for the various frequencies $n, n_1, n_2, n_3, \dots, n_n$. In the middle stands the carrier wave, and grouped about it are the side waves caused by the voice modulation.

When this complex disturbance arrives at a receiving system tuned to the frequency n of the carrier wave, currents are set up in the receiving aerial proportional to the heights of the resonance curves of Fig. 1. It is the inter-heterodyning of the various frequencies which, when suitably detected, produce intelli-

gible speech or music in the receiving apparatus.

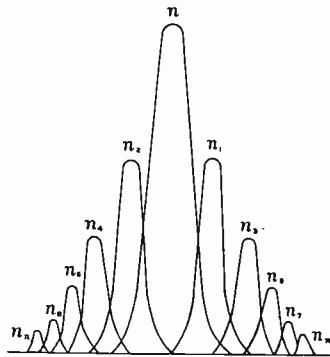

Fig. 1. Resonance curves for various frequencies.

THE BEST ADJUSTMENT OF RECEIVING SYSTEMS.

It will be realised, therefore, that the adjustment of the receiver, apart from its arrangement, has a great influence on the quality of the received speech or music.

REACTION.

- Consider first the effect of reaction. If intensive reaction is used, it will be obvious that undue prominence will be given to the carrier wave and the lower frequencies, while the higher frequencies will be dwarfed to insignificance beside them. Many may have noticed how, if reaction is pushed to the limit, the mellowness of really good speech is lost, albeit the intensity is enormously increased. This applies especially to signals

* Vide Proc. Electrical Engineers. Vol. 58, No. 293, July, 1920, a paper on "Duplex Wireless Telephony," by the author. Appendix.

which are initially weak and can only be detected by the furious use of reaction.

The best adjustment for getting really good quality (assuming, of course, a good transmitter, without which no good results can be obtained), is to use such magnification as to give a moderate signal without reaction, and to bring up to R.9 intensity by applying judicious reaction, but not to the oscillating threshold.

This is a counsel of perfection ; it is realised that valves are expensive, high frequency magnification a pitfall in many hands, low tension batteries of big capacity are things of profit only to the local garage, and that many difficulties stand in the way of the enthusiastic but impecunious amateur.

It cannot too strongly be emphasised that the use of intensive reaction is wrong theoretically and morally. Many and many a good concert is spoilt for others by those unskilled and unscrupulous people who will use reaction circuits up to and beyond the reaction threshold, thereby causing squealing heterodyne notes in nearby receivers, and so completely spoiling other people's pleasure. Anyone purposely making their set oscillate will fail to get good results and will prevent the possibility of others getting good results. Even though a system is used where reaction is applied to a coupled circuit tuner, the system will still re-radiate if made to oscillate.

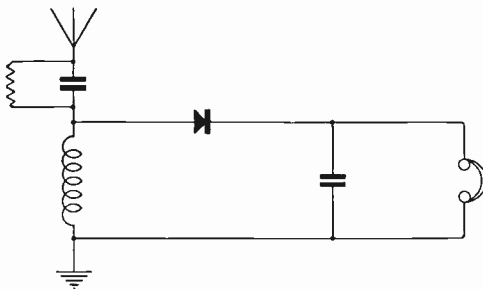

Fig. 2. Circuit for plain aerial reception.

THE TUNER.

Consider again Fig. 1. It will be realised that sharpness of tuning has a tendency again to give undue prominence to the lower frequencies. If the signal is loud enough, therefore, better quality may be obtained by mistuning slightly. This will mean that only half of Fig. 1 will be received, but this gives perfectly good results in practice.

SOME DISCUSSION ON THE ARRANGEMENT OF CIRCUITS.

Having suggested some general principles for the best adjustments, it might be helpful to many to discuss particular arrangements of receiving circuits.

It is extremely difficult to generalise on this subject because conditions are so very variable, one wants only to hear Writtle perhaps, and lives 100 miles away, another wants to receive any station between 15 and 25,000 metres, and lives 3,000 miles away from one station and 20 miles from another. It will be assumed, however (and it is trusted with some justification), that Writtle is the centre of attraction. To clarify the subject, let us take under appropriate headings, stations distant between 1 and 10 miles, 10 and 50 miles, 50 and 100 miles, 100 and 200 miles, and stations further than 200 miles.

Before starting, it is realised that the enthusiastic band of "one valvers" living sometimes 400 miles away will be shocked at the conservatism of the remarks, but this article is intended to give sound advice on something like a commercial basis for new amateurs who are not particularly skilled, and want to hear the concerts comfortably.

STATIONS WITHIN 10 MILES. (Assuming a full P.M.G. aerial.)

Crystal or single valve every time. A crystal may give rather weak stuff at 10 miles, but there are several installations distanced 30 miles who have received our concerts very well—40 miles is about the record. The tuning circuits with a crystal need not be elaborate, because jamming will be non-existent. The great thing to be realised in crystal reception is that a crystal is a potential operated device, and that the inductance connected across it should be as large as possible. If plain aerial reception is used, as shown in Fig. 2, and it is desired to receive 400 metres, it is best to use a series condenser in order that the inductance may be made large. This, however, can be carried too far because the series condenser, if made too small, prejudices sensitivity, albeit the extra inductance enhances it. Thus the experimenter should choose a nice balance between the two variables.

It is better, of course, to use coupled circuit for crystal reception at short waves with a P.M.G. aerial, because the secondary circuit can be made of very large inductance with a correspondingly small condenser to tune it.

While on the subject of receiving at close ranges, amateurs are warned very strongly against the prevalent disease of valveitis. By this is meant the use of too many valves for the given strength of signal without due precautions being taken. So often one hears of an installation with a full P.M.G. aerial direct coupled, four tuned high frequency magnifications, one detector and six note magnifiers (all R valves), and an ordinary ear piece thrust into a jam tin to make a loud speaker, station distant from Writtle $2\frac{1}{2}$ statute miles. This is, of course, an exaggeration, but it indicates a frequently met with trend of development, which leads to the very worst results and gets "Broadcasting" a very bad name through no fault of those commercially interested. The use of too many valves always results in distortion, since saturation may easily be attained, or commoner, heavy grid currents clip off the tops of the intenser disturbances to the detriment of good quality. The question of loud speakers is a subject in itself. For the present it should be clearly understood that there is an intensity of signal which the usual receiving valve will not deal with properly, and there is a limit to the capabilities of the earpiece itself. The only excuse for using a lot of valves is when jamming at a different, but close, wavelength is likely to be experienced when very loose coupled tuners can be used. These will cut down sensitivity in proportion largely to their selectivity, and so the use of more amplification becomes necessary. Too great note magnification with iron transformers is a frequent source of trouble. Never use more than two note magnifiers and in general use only one. There is nothing so prejudicial to good quality as the usual design of note magnifier. So many amateurs seem to like signals to be extra loud and not to care a hang about quality. A robust receiving system with judicious reaction mistuned to give R6 signals is my ideal.

STATIONS BETWEEN 10 AND 50 MILES.

Full P.M.G. aerial. A single valve and reaction is probably the best arrangement up to 50 miles, but at the limit of range the addition of one note magnifier should make a simple, cheap and easily adjustable set. We have many and many a report of single valves being successful at 100 miles and more, but I cannot help feeling that the signals cannot be exactly loud, and that the adjustments must be critical, that the least jamming must spoil

results, and that the sets may inadvertently slip into oscillation; the most selfish of sins in this broadcasting world. For real safe working at 50 miles then, a single valve might just do, but the addition of a note magnifier is certainly advisable. Jamming may begin to get troublesome at this range, but it is fundamental that if selective tuning circuits are to be used, the sensitivity must suffer. We have had reports of single valve reception at St. Austell, in Cornwall, and a few words have been heard on a single valve at the Forth Bridge.

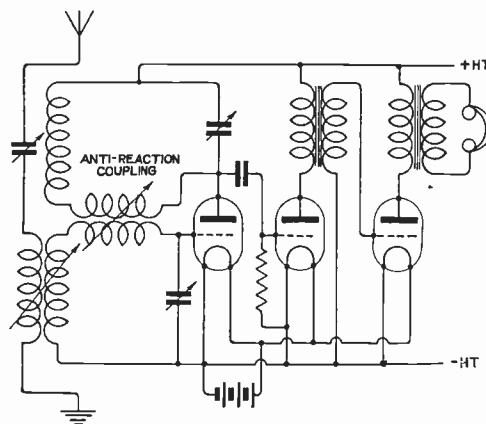

Fig. 3. A suggested circuit for telephony reception.

STATIONS BETWEEN 50 AND 100 MILES.

At 100 miles the difficulties are vastly multiplied. Jamming is the chief source of trouble, especially as many amateurs live at about 100 miles distance on the sea coast (say the Channel) and are keen on receiving Writtle, but are often prevented from getting results because of the interference from ship installations working in the narrow waters.

Coupled circuit is therefore advisable, and loose coupling should be used. To get good sensitivity the amplification must be fairly good. I suggest that tuned anode with one rectifier and one note magnifier is as good an arrangement as any, but great care will have to be taken to prevent the set from oscillating. It might be best to apply an anti-reaction arrangement between the tuned anode circuit and coupled circuit, this being reduced as more reaction is required. The basic diagram of connections is shown in Fig. 3. This is a typical circuit that would give good results. It is put forward as a suggestion, but there are plenty of other circuits that would do equally well probably. The idea of

these remarks is to indicate the type of tuner and amount of amplification advisable.

STATIONS AT OVER 100 MILES DISTANCE.

For really good results high frequency amplification is advisable at this range. High frequency amplification may be done in all sorts of ways. It is a subject beset with pitfalls and "doctors disagree" on the question, so "'tis folly to be wise." My own impression is that for amateurs some form of tuned high frequency magnification is advisable, but beyond that I will not commit myself lest heated argument should arise.

SUMMING UP.

It may be said that the arrangement of the receiver must be chosen to suit the particular conditions under which reception is to take place. The usual tendency among amateurs is to use too little amplification at large ranges, and too much at short ranges, although the latter tendency is less marked than the first. It is very admirable to get results on single valves at long ranges, but the tendency for such sets to re-radiate is not in their favour, and the necessary small amplification gives little scope for using selective tuning.

With regard to the competition in connection with our transmission of August 15th, it has been somewhat difficult to choose the winners. One hundred and sixty replies were sent in, and the top marks came very close together.

After mature consideration, however, it has been decided to award the prizes as follows:—

1st prize C. W. Clarabut, The Bedford Physical and Radio Society, Beechcroft, Beverley Crescent, Bedford.

2nd prize. J. P. Beeson, Southwell, Notts.

3rd prize. C. G. Williams, 22, Scholar Street, Sefton Park, Liverpool.

A Portable Receiving Set

By A. LOVERING.

THE following description and accompanying photograph of a portable set which I have recently finished will perhaps be of interest to other readers.

The set is entirely self-contained, with the exception of the low tension battery. Two valves are used, the circuit being a standard two-valve low-frequency one. By using a flexible lead with a plug (coming from the transformer primary), one or two valves can be used as desired.

I think the photograph is more or less self-explanatory.

The two sides of the box are hinged at the bottom and the deep lid closes down over the knobs on the front panel. The centre knob is the filament resistance, and those on either side are primary and reactance tuning condensers respectively. The smaller knob immediately above is the main aerial circuit condenser. Shunted with this is the smaller one already mentioned, which is used for the more critical adjustments, the total capacity of the two being about 0.0013 mfd.

All three condensers are sliding, the problem of "space" being always uppermost. The two smaller ones are operated from the knobs by cranks, this giving fairly sensitive adjustment. Besides having the coil holders, transformer, and an "off" switch for the second valve, the panel on the right is fitted with a series-parallel switch for the A.T. condenser.

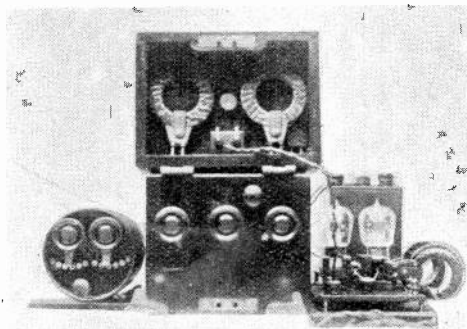

Photograph of the Portable Set.

For waves above 2,000 metres I use a set of five slabs, taped and fitted plug mountings. By using either one or two coils in the aerial circuit, and by working either series or parallel condenser as the case may be, I have practically a complete range of wavelengths up to 26,000 metres.

The loose coupled tuner on left is used for waves below 2,000 metres. I can get down to approximately 4,000 metres on this.

The 30-volt H.T. unit is accommodated in the lid, likewise the two larger coils. Of course, telephones are taken from headbands to facilitate packing.

The set was primarily designed for long range work, and by testing out in progressive stages of making, I have arrived at fairly good results. I originally intended having an H.F. transformer for the short waves, but space would not permit.

A Universal Unit System

By 2 CM.

THE Unit system is almost essential to the experimenter who is limited as regards time and money. It avoids the continual scrapping and reconstruction of apparatus, and provided it is properly designed, it enables almost any circuit to be tried without complex switching.

The system described in this article has been designed not only to be universal, but also to be simple of construction. It requires

transformer, as shown in Fig. 2 at *A*; a resistance-capacity as *B*, or an iron core intervalve transformer as *C*. Two battens *D* (shown dotted in Fig. 1) are screwed to the base to support this transformer, which is mounted on wood and may be boxed in with a wooden or sheet metal cover if desired, the prong-plug being on the underside of the transformer platform.

Clips *E*, *F* and *G* are for the purpose of introducing a grid condenser and leak if it is desired to detect on the particular valve, the combined condenser and leak being clipped between *E* and *F*, or, if leakage is desired direct to the filament negative (or to a potentiometer, via terminal *GP*), the condenser alone is put between *E* and *F* and the leak between

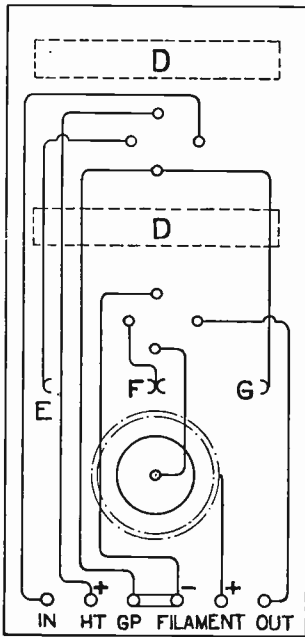

Fig. 1. The Main Valve Unit.

no elaborate woodwork or boxmaking, and may be made either in ebonite or hard wood. The latter is quite satisfactory for wireless reception purposes, provided it is well dried and varnished.

The main valve unit is shown in Fig. 1, and is simply duplicated for any number of valves. It consists of a baseboard, resting on two strips of wood ($\frac{3}{4}$ in. deep) at the back and front, thus giving space underneath for all the permanent wiring and the filament resistance. The front valve holder is for the valve, while that at the back of the unit takes the intervalve pass-on. This may consist of a high frequency

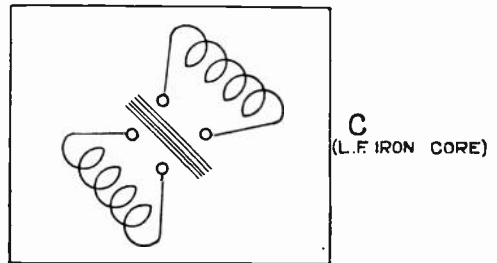
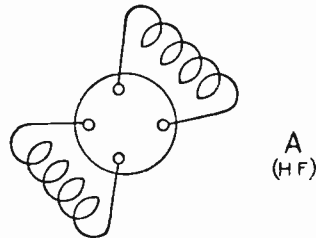
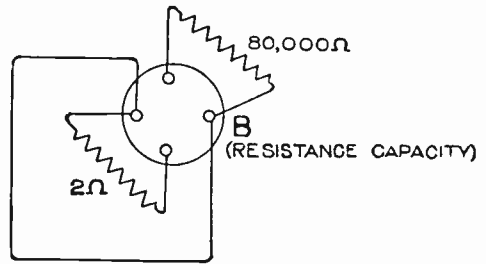

Fig. 2. Showing interchangeable couplings.

F and *G*. Normally, when the valve is acting as an amplifier, clips *E* and *F* are shorted by a metal bar put in in place of condenser.

The terminal *GP* on the valve unit, which is normally bridged to filament negative, is for the purpose of controlling the grids if it is desired to put a negative potential on them when using a high voltage on the plates, or for separate control when the valve is in use as a detector.

are required. The primary tuning and secondary tuning inductances *K* and *L* are normally close together, but units may be separated if coupling is found to be too tight when using more than one H.F. valve between. Low frequency valves are put in by switching on their filaments and putting switch *M* to an appropriate position. Thus any number of valves may be used without disturbing the wiring of the set.

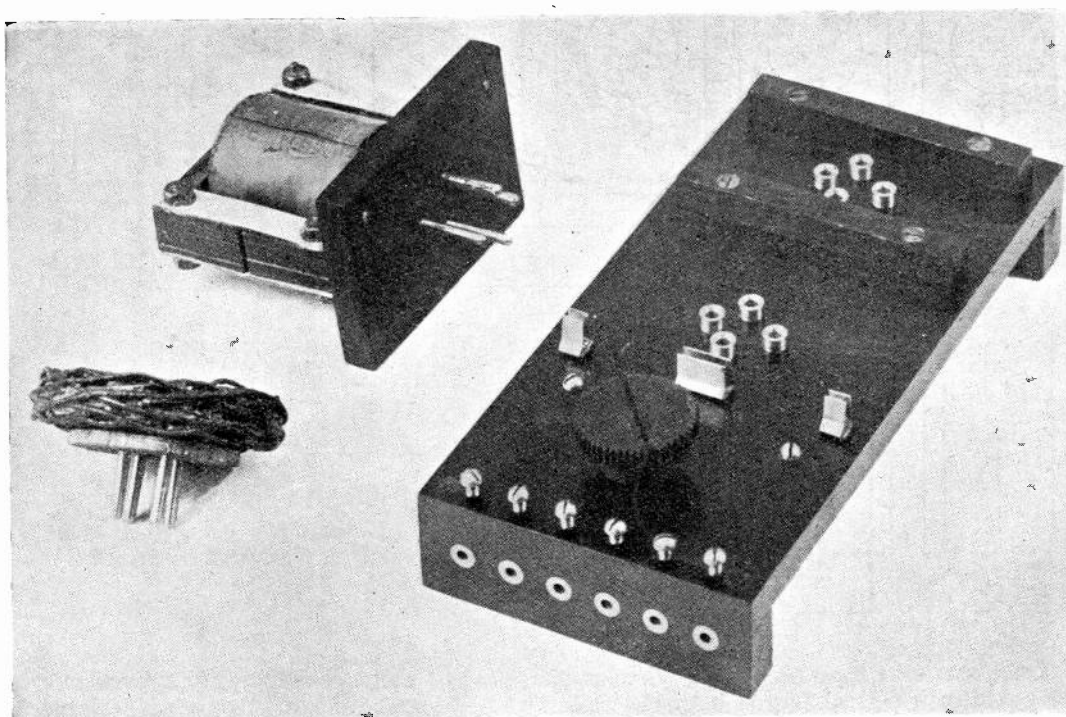

Fig. 3. Showing the main unit. It will be seen that the terminals consist of $\frac{1}{4}$ in. brass rod, drilled $\frac{3}{8}$ in. and let into the front of the unit. An $\frac{1}{8}$ in. Whit. screw is tapped into the side of the tube to grip the wire, the head coming through the top of the unit. This construction saves a great deal of space, and enables prong plugs to be used if desired for connections. The photograph also shows the Iron Core Transformer (cover removed) mounted for plugging in, and a high frequency pass-on which is used alternatively.

The complete arrangement is shown in Fig. 4. It will be seen that the units requiring adjustment are placed to the front of the table, while the valve units are out of the way at the rear. This arrangement enables adjustment to be easily made and also allows of the circuit being easily changed as occasion demands.

The arrangement shown gives two valves, high frequency, crystal detection, and three valves low frequency. The plug *H* is plugged in in the place of transformer at *I* or *J*, depending on whether one or two H.F. valves

are required. If it is desired to utilise more units for high frequency it is only necessary to bridge terminals "in" and "out" at *N* and transfer leads *O* and *P* to one of the corresponding positions to the right.

For valve with grid condenser detection, the high tension battery is disconnected from the secondary tuning unit and the lead *Q* transferred from "out" to "H.T.+", thus giving the standard circuit for the purpose. The crystal point is, of course, taken off and, if the high tension positive is connected to

terminal "Out," the blocking condenser will be connected across the primary of the first intervalve transformer.

Many other connections are possible and will easily be arranged as occasion arises.

may be spaced to any desired degree if reaction is troublesome. "Dis" transformers may be instantly replaced with others or with resistance-capacities, which when demonstrating, is an important point.

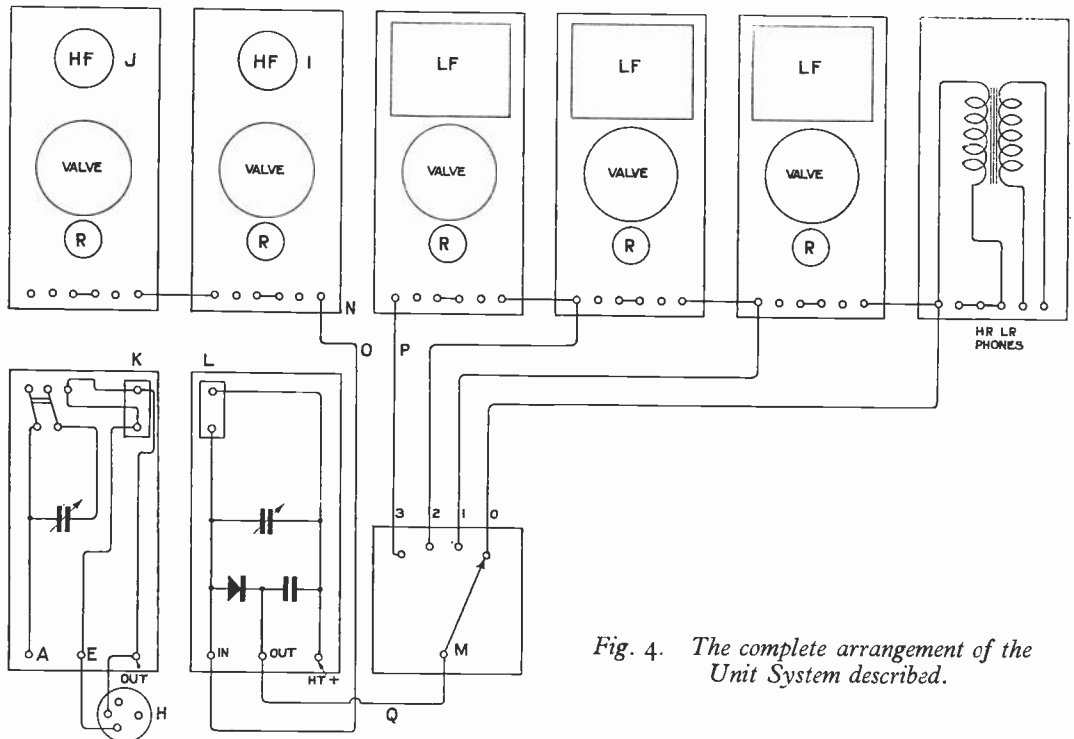

Fig. 4. The complete arrangement of the Unit System described.

Once the units have been made, they may be boxed in if desired or may be made up in any convenient form (either vertically or horizontally) as they take practically no more space than any similar multivalve amplifier. They have the additional advantage that they

In addition to being a great convenience to the advanced worker, this system will enable the beginner to extend his apparatus as funds permit, and will necessitate no remaking as he advances towards his "nth" valve amplifier.

DO NOT FORGET THESE DATES !
SEPTEMBER 30th TO OCTOBER 7th, 1922
The All-British Wireless Exhibition & Convention
AT THE HORTICULTURAL HALL
WESTMINSTER, S.W.

Development of Radio Broadcasting in the United States

By M. B. SLEEPER.

The author of the following article, Mr. M. B. Sleeper, is so well-known amongst amateur circles in America, that it is felt that the following account of the development of Broadcasting in America cannot but prove of special interest at the present time, coming from one who has watched the growth in the popularity of wireless from inside. Mr. Sleeper has just returned to America from a visit to this country.

ALTHOUGH Radio Telephone Broadcasting was conducted with a regular daily and nightly programme from the Westinghouse station at Pittsburgh, Pa., for many months prior to the summer of 1921, the interest in broadcast reception was only felt locally. Almost a year ago, experimenters, particularly in the New England States and New York, suddenly awoke to the fact that the centre of radio had formed around Pittsburgh, and an investigation of radio manufacturers' sales revealed that quietly, under the stimulus of radio telephony, that section had outstripped all others in receiving sets *per capita*.

Right at that time the Dempsey-Carpentier bout was held in New Jersey. Without any public announcements the Westinghouse Company had erected and perfected the operation of a $\frac{1}{2}$ -kW. telephone set at Newark, New Jersey, just across the Hudson River from New York. Just before the contest was to take place, notice was given that the fight returns would be broadcasted, blow by blow, from Newark, now so widely known as WJZ.

It was a most appropriate time to catch the attention of the public, for interest in the bout was keen. In public places and private homes thousands of people were intensely thrilled by the reception of each detail, given out by radio, even to the ringing of the gong and the applause of the spectators.

New York, acting characteristically as a distributing centre, sent out the news of this achievement far and wide through the mediums of the newspapers and travellers from other cities who witnessed, or rather heard, the demonstration. At that time, too, WJZ took up the reporting of baseball games and, later, football. Facilities of the *Newark Call* newspaper were made available to the operator,

who despatched by radio résumés of press reports. Then a daily programme was adopted. Music was sent out each hour on the hour, starting at 10.0 a.m. In the evening a special entertainment, starting in the bed-time stories for the children and ending with music or singing by the best known artists, was scheduled.

The radio business, always slow between June 1st and September 1st, started up with a jump. Before the dealers knew what had happened their shelves were empty. Insistent demands for broadcasting stations came from all sides, but no company was prepared to turn out heavy duty equipment. Then, as always, the experimenters set to work. In different cities all kinds and types of transmitters were erected for radio shops, department stores, newspapers, furniture stores, and similar companies. Anything that would speak was called a broadcasting station.

By Christmas there was no such thing as a rush order, or perhaps it should be said that all were rush orders. In January it almost seemed that only through personal friendship with the manufacturers could dealers get supplies. February brought offers of premium prices. And so it went.

The first real radio show was held at New York City in March, 1922. Instead of the scattered attendance of 1921, thousands of people came to learn of this new wonder. Thousands, too, were unable to obtain admission. Radio companies were formed all over the country, dozens of them every week. Magazines sprouted on the news-stands like mushrooms. Announcements of radio shows in other cities followed in quick succession. At electrical stores where, six months back, the buyers had refused to talk with radio salesmen, established wireless departments which in many cases exceeded in volume all

their other business. It became quite the usual thing to sell £200 worth of apparatus a day over the counter. Equipment appeared in the windows of drug stores, hardware stores, millinery and tailor shops, seed stores, pawnshops, and, of course, department stores took it up. Some enterprising radio companies arranged to stock and operate radio sections in department stores, paying 10 per cent. for the space and accommodations. They had the special advantage of being able to get the supplies.

During this time conditions in the air became badly muddled. Those who were interested in hearing the broadcasting complained that different telephone stations interfered with each other, or were interfered with by experimenters on 200 metres and commercial stations at 600 metres and above. Others carrying on long distance or DX transmission and relay work at 200 metres complained that telephone stations made their work impossible.

Before long however, by Government regulation through the Department of Commerce, which controls radio as the Post Office does in England, and the co-operation of radio clubs, particularly those affiliated in the American Radio Relay League, the difficulties became quite well adjusted. Between Messrs. Warner and Schnell, Editor of *Q.S.T.* and Traffic Manager of the A.R.R.L., respectively, the experimenters were made to realise that they could not interfere in the legitimate broadcasting if they did not respect the rights of the telephone on the air. Since telephone stations generally close down by 10 p.m., sufficient time is left for the "Boiled Owls" to carry on their DX work. Then came the arranging of broadcasting schedules, with the result that one station follows another all day and all evening, thus replacing with continual entertainment the irregular interference of the spring. These schedules are planned in cities where two to six broadcasting stations are in operation.

The expense of broadcasting too, has worked itself out. Obviously it would be too great an undertaking for one company to operate any number of stations. Such expense must be borne by the individual company and charged off as advertising, as there is no Government support. Neither is there a charge for transmitting licences. No receiving licence or regulations are imposed. Consequently the Western Electric Company, by agreement with Westinghouse and General

Electric, the only concern building telephone transmitters under full patent protection, has and is making sets to sell to such companies as can afford to carry a broadcasting station in their advertising appropriations. In that way those corporations profit by the sale of the sets, and reap a double profit through the sale of apparatus to experimenters.

Perhaps the greatest hardship to the public and the legitimate companies are the "boot-leg" manufacturers who, seeing a chance to profit by the under-production of equipment, copied various standard advertised instruments and cut the prices. That situation has largely taken care of itself. The dealers, anxious to get goods about the time the boot-leggers were showing samples, ordered far and wide, assuming that deliveries would be slow. Those concerns got into full production about May, just before buying stopped for the summer months of June, July and August. Right at that time dealers cancelled all their orders except those placed with reputable companies, whose goodwill they will need this fall. The boot-leggers were thus caught with big stocks and no market, bills to pay and no accounts to collect. As a result they went out of business by the dozen in all parts of the country.

Here, then, you have a sketch of broadcasting and developments from it, viewed by the public and the manufacturer. If there is here a suggestion or two for the English radio man, I shall feel that I have to a small degree repaid those who have made my stay in England so pleasant and interesting.

Notes.

The Radio Club d'Algerie.

The Secretary of the above Club, Mr. A. Moisan, Boulevard Carnot, Algiers, will be pleased to receive communications from British amateur societies. His Club is at present interesting itself in particular in problems of static interference. It is proposed to publish a journal of the Society next October.

Society Formed at London County Hall.

As the result of a meeting held at the new County Hall, a wireless society has been formed which is seeking affiliation with the Wireless Society of London. Mr. S. E. MacKeown has been elected President, and the Hon. Secretary is Mr. H. W. Fuller. The membership comprises those members of the L.C.C. staff at the County Hall who are interested in wireless matters. The Society meets monthly in Room 38 on the first Tuesday, at 5.30 p.m.

Edinburgh Society's New Station.

A transmitting station, 2FT, has been equipped by the Edinburgh and District Radio Society. C.W. and telephony transmissions are conducted on 150-200-440 metres.

Herschel Centenary.

On August 25th, at Slough, the centenary of the death of Sir William Herschel was commemorated. As first President of the Royal Astronomical Society and a great scientist he is remembered with profound respect by all.

Weather Reports for Canadian Farmers.

Broadcasted weather reports are to be furnished by the United Farmers of Ontario for the benefit of farmers generally. Transmission will be effected from the headquarters in Toronto. Market reports will also be sent out in this way.

Broadcasting from Arlington for U.S. Shipping Board Vessels.

It is announced that Arlington (NAA), immediately after broadcasting the time signal, will give the call letters of all ships for which Arlington has traffic, and, at the conclusion of the broadcasting schedule, will broadcast messages for those vessels previously designated.

Saint Assise in Operation.

Trouble in Ireland has affected cables to America and the result is pressure on the French-American communications. Saint Assise is reported to have risen to the occasion by speeding up to full working order and transmitting a million words a day.

A High Power Station Wanted.

Tristan da Cunha, a British possession in the South Atlantic, is 1,700 miles from the nearest inhabited land, and is in need of an installation which will place the island with its 120 or so inhabitants in communication with the outside world. This lonely spot is midway between Cape Horn and the Cape of Good Hope. A receiving set has been given by the South African people, and meteorological equipment has been introduced, but no means of transmission is as yet available. A system of communication across the South Atlantic, using Tristan da Cunha as a link station, would overcome the islands difficulty, but the cost would hardly justify the experiment, unless some further purpose could be served by the station.

British Association Meeting. September 6th to 13th, 1922.

During the meeting of the British Association this year, a temporary branch of the Meteorological Office, Air Ministry, will be opened at the Guildhall, Hull. Synoptic weather charts will be prepared daily and exhibited, together with forecasts based on them, on a large specially constructed blackboard in the Reception Room of the Association. In addition a "Local Daily Weather Report," containing the morning's synoptic chart with forecasts and local weather information, will be duplicated, and copies posted in the various buildings occupied by the Association and in certain prominent places in the City.

These reports will be prepared solely from data contained in the routine weather messages issued broadcast daily by wireless telegraphy in Great Britain and other European countries. For the

reception of these messages an ordinary standard receiver will be installed consisting of a single rectifying valve and two low frequency amplifying valves with variometer tuning circuits. Members of the Association will be admitted to the room in which the messages are received and will be able to see the whole process of reception, decoding, construction of weather charts and preparation of forecasts.

It is hoped that this demonstration will be of assistance to many who may wish to receive this up-to-date weather information, either through interest alone or for its practical use or in the case of Colleges, Schools, etc., for educational value.

Exhibition at the Central Hall, Westminster.

A wireless exhibition was opened on Saturday, September 2nd, at the Central Hall, Westminster. The exhibition closes on September 8th.

The exhibits include wireless apparatus and parts, whilst a considerable number of wholesale suppliers of wireless accessories are represented.

Competitions are being run in connection with the exhibition, one of which consists in attempting to solve a crime by means of wireless, and another is a competition in operating speed.

The organisers of this exhibition are Messrs. Dale, Reynolds & Co., Ltd., of 46, Cannon Street, E.C.4., who are to be congratulated on the large attendance which the exhibition is drawing.

Correspondence

To the Editor of THE WIRELESS WORLD AND RADIO REVIEW.

SIR,—With reference to Mr. Harris's article entitled "Wireless Without an Aerial," which appears in the August 26th issue of *The Wireless World and Radio Review*, the attention of experimenters should be drawn to the danger arising from using ordinary types of aerial condensers in the manner there described. Many of the ordinary patterns of variable air condensers have short-circuit positions at one or both ends of the scale, so that a dead short circuit of the supply mains might easily occur if the condensers are not handled carefully. Small specks of dust on the condenser plates are also liable to cause a flash over on 200 volts circuits. The only safe way of experimenting in this direction is to employ condensers properly designed for this use, and having high insulation resistance. Fixed condensers can be used in lieu of two of the variables described, leaving the tuning to be effected by the series condenser in the ordinary way.

PHILIP R. COURSEY,
Chief Engineer, Dubliner Condenser Co., Ltd

To the Editor of THE WIRELESS WORLD AND RADIO REVIEW.

SIR,—As one greatly interested in the wireless telephony movement so prominently before the public at the present time, I am anxious, before installing one of the many receiving apparatus now on the market, to know somewhat definitely the prospects of the wireless telephony service in the immediate future.

I have made inquiries of several manufacturers of and retail dealers in wireless telephone receiving

apparatus, and I have read a good many paragraphs in the daily press on the subject. The net result I have arrived at is that in return for a considerable outlay on the purchase of apparatus, erection of aerials, etc., I may have the great privilege of hearing nightly concerts, bed-time tales—whatever they may be—occasional lectures on subjects of interest (to whom?) and on Sunday sermons of an undenominational nature not likely to cause offence to any religious sect. No prospects of receiving any news of real interest such as important foreign and home news, election results, parliamentary news, stock market closing prices, foreign exchange rates, racing or other sporting results, is even hinted at; in fact, in one instance, I was told (with what amount of accuracy I do not know) that broadcasting centres were definitely pledged not to distribute anything in the nature of daily news. This reduces wireless telephony receiving apparatus to the level of an ingenious toy somewhat inferior to the gramophone, and I, for one, am certainly not inclined to incur the expense of £100—the amount of the estimate for installing the wireless telephony receiving apparatus in my country house—for the very doubtful privileges offered. I do not care for indifferent music: the lectures I prefer to read (or not) in my daily or weekly paper; and even the inoffensive sermon does not strongly appeal to me.

Surely an epoch-making invention such as wireless telephony can be put to more useful purpose and have a greater commercial utility. Why not make it a means of rapidly disseminating real news, or would this infringe the vested interest of the press, such as the introduction of the railway locomotive did to the mail coach business, or the reaping machine to the agricultural industry some time ago?

ENQUIRER.

[The question of the broadcasting of news items, etc., is one which we understand the Government now has under consideration, and the decision which will be arrived at will no doubt depend largely upon the attitude of the press.

The cost of installation of a wireless receiving station, as quoted by Enquirer, does not seem to us to be a reasonable average estimate.—ED.]

To the Editor of THE WIRELESS WORLD AND RADIO REVIEW.

SIR,—In recent issues of your paper you have published letters from various amateurs reporting successful reception, but in nearly every case you fail to give an idea of the location of the station.

For instance, in last issue you publish a letter from an amateur who receives Croydon without H.F. amplification. If this gentleman is up North here (except Aberdeen) it is very good reception, but if he should be down in the Midlands it is nothing to shout about.

A short time ago a correspondent reported good reception of the Halifax telephony. Our heads went up in the air for about a week until we found that we could have reached the man with a decent sized megaphone, he only being a short distance away.

If your correspondents do not wish to have their addresses published, at least the town could be inserted. To those of us who specialise in long

distance reception it is not much use to read of an amateur hearing 2KD, 2GU, or 2YF, if there is no indication as to whether he is 10 or 100 miles away.

I should like to raise another point on which I have written you before, and that is, to ask amateurs transmitting to say who they are. Up North here on changing over we always start "Hello 2AB, 2CD replying 2CDover."

Down South of us, the practice seems to be "Hello, old bean, your speech is O.K. changing over," and "Well, I'm shutting down now, call you up to-morrow," giving no indication as to whether the experimenter is transmitting well, 100 miles away, or badly, 10 miles away.

A few Sundays ago I heard a magnificent musical programme on about 950 metres. At the conclusion a request was made that listeners-in would send reports as to reception, but during the whole 35 minutes of the programme there was never the slightest indication given as to who the experimenter was.

By the way, is there any hope that the P.M.G. will prohibit the use of reaction to the "ether abusers." We could equip a splendid drum and fife band in Halifax and district.

LOUIS J. WOOD, *Hon. Secretary,*
Halifax Wireless Club.

Book Received

RADIO RECEIVING FOR BEGINNERS. By Rherly T. Snodgrass and Victor F. Camp, London: Macmillan and Co. Pp. 100 7 $\frac{3}{4}$ " x 5 $\frac{1}{4}$ ".

Calendar of Current Events

Friday, September 8th.

LEEDS AND DISTRICT AMATEUR WIRELESS SOCIETY.

8 p.m.—Lecture on "Automatic Telephony," by Mr. H. Mortimer.

BELVEDERE AND DISTRICT RADIO AND SCIENTIFIC SOCIETY.

8 p.m.—At Erith Technical Institute, General Meeting and enrolment of members.

RADIO EXHIBITION AND WIRELESS CONVENTION, CENTRAL HALL, WESTMINSTER.

(*Last Day of Exhibition*).

Sunday, September 10th.

Daily Mail concert from the Hague (PCGG) 8 to 9 p.m. B.S.T., on 1,085 metres.

Monday, September 11th.

HORNSEY AND DISTRICT WIRELESS SOCIETY.
Lecture on "Practical Construction of an Amateur Receiving Station." By H. Davy.

Tuesday, September 12th.

Transmission of Telephony at 8 p.m. on 400 metres by 2 MT (Writtle).

Thursday, September 14th.

Daily Mail Concert, 8 to 9 p.m. (as above).

Wireless Club Reports

NOTE.—Under this heading the Editor will be pleased to give publication to reports of the meetings of Wireless Clubs and Societies. Such reports should be submitted without covering letter in the exact form in which they are to appear and as concise as possible, the Editor reserving the right to edit and curtail the reports if necessary. The Editor will be pleased to accept for publication papers read before Societies. An Asterisk denotes affiliation with the Wireless Society of London.

Wireless Society of London.

The New Session of the above Society is about to commence, and announcements will appear in due course.

Applications for affiliation or for membership should be addressed now to the Hon. Secretary, Mr. L. H. McMichael, 32, Quex Road, N.W.6.

Stoke-on-Trent Wireless and Experimental Society.*

Hon. Secretary, Mr. F. T. Jones, 360, Cobridge Road, Hanley.

At a meeting of this Society on Thursday, August 24th, it was announced that permission to utilise the mast over the "Dew Drop" Inn to support the free end of the aerial had been refused by Messrs. Worthington. A fresh scheme is being devised, and this is being left in the hands of the Technical Committee.

An interesting discussion took place on several points raised by some of the newer members concerning the working of their apparatus.

The proposed Exhibition which the Society hopes to hold in Hanley at the end of the year or the beginning of the new year was discussed, and enquiries are now being made to find a suitable hall in which it can be held.

An interesting programme is being drawn up for the next few weeks. A demonstration was held a few days ago with the aid of an indoor aerial and the Society's three-valve set.

Wolverhampton and District Wireless Society.*

A meeting of the above Society was held at Headquarters, 26, King Street, Wolverhampton, on Wednesday, August 23rd, when a lecture was given by Mr. D. P. Baker on "Tape Recording by Wireless."

The lecturer dealt very ably and lucidly with the subject, explaining the necessity for rectification and the use of two relays to operate the inker, also demonstrating with the actual apparatus and with diagrams. It was evident the lecturer had had considerable experience in recording. The meeting was well attended, and the members present were greatly interested. It is hoped to secure the services of Mr. Baker again at an early date.

The resignation of the Secretary, Mr. G. W. Jones, was tendered and received with regret, Mr. Jones feeling reluctantly compelled to relinquish the secretarial duties owing to pressure of business. The meeting passed a very hearty vote of thanks to Mr. Jones for his past services, special reference being made to his work as one of the founders of the Society.

The newly appointed Secretary is Mr. J. A. H. Devey, 232, Gt. Brickkiln Street, Wolverhampton, who would be glad if correspondents would kindly note.

Wireless and Experimental Association.*

On Wednesday, August 23rd, The Wireless and Experimental Association, at the Central Hall, Peckham, had the pleasure of listening to a very interesting and instructive lecture by Mr. F. H. Haynes, on the Johnsen Rahbek Loud Speaker. Starting from the very beginning, the lecturer went through every point of the construction of the apparatus, giving enough of the theory to enable his listeners to appreciate the various parts and their uses.

Full instructions were given to enable one to cut and polish their own agate cylinders—if they had the right sort of agate. The necessity for a polarising battery to make the apparatus sensitive to weak signals was well brought out.

The Association's installation engineer was unfortunately not present, and the wireless receiving set not available for purposes of demonstration of the capabilities of the loud speaker, but a couple of orators and a songster in another room made up a scratch broadcasting programme, though they did not tell the tale of the stuffed dog.

The lecturer afterwards demonstrated the use of the Neon tube as a generator of oscillations, and more than one present had an idea that it might be very useful in the installation of an Armstrong receiving circuit.

The meeting closed with a cordial vote of thanks to the lecturer.

Hon. Secretary, Mr. G. Sutton, A.M.I.E.E., 18, Melford Road, S.E.22.

North Middlesex Wireless Club.*

The 97th meeting of the Club was held on Wednesday, August 23rd, at Shaftesbury Hall, Bowes Park. Before the meeting was formally opened, Mr. Holton gave a lecture to the more elementary members who had assembled on the subject of aerial construction. He explained the reasons for the different types of aerials, and showed why the single wire type was to be preferred for receiving short waves, although the two-wire type was better for longer waves. Mr. Holton answered many questions put to him and cleared up several knotty points.

The meeting was then formally opened by the Chairman taking the chair at 8.30, and calling on Mr. A. J. Dixon for his talk "Commercial Wireless Instruments and How they Work." Mr. Dixon explained the principles on which the Magnavox, the Brown loud speaker, the Brown head receiver, and several other well-known instruments work. The Chairman, Mr. Evans, also contributed to the evenings discussion, and the meeting closed by a vote of thanks moved by the Chairman to Mr. Dixon.

Several new members were enrolled, and the

Librarian was kept busy attending to the demands of members for books.

Particulars of the Club may be obtained from the Hon. Secretary, Mr. E. M. Savage, "Nithsdale," Eversley Park Road, N.21.

The East London Radio Society.*

A very successful and well attended meeting was held in the Society's lecture hall in Woodstock Road, on Tuesday, August 22nd, 1922, at 7.30 p.m.

The meeting opened with the usual buzzer practice.

Mr. J. Lipowsky lectured upon the construction of a cheap and efficient loud speaker, using mechanical connection between an ordinary earpiece and a gramophone reproducer. This idea proved so novel and efficient that we hope to pass on full detailed account through the medium of this journal for the benefit of all amateurs at an early date.

intercepted from 2 LO, 2 LZ, and many other local stations, in spite of the atmospheric conditions which were absolutely abnormal here.

To obtain results on the short aerial in use at the time it was necessary to add capacity in large amounts in series with A.T.I. and this cut down the efficiency of the circuit so much that signals on the Brown loud speaker were not loud enough to be heard all over the tent, so that the five-valve circuit with 2 H.F. will be used on a future occasion, so as to have some reserve of power to cope with changed conditions.

Messrs. Bridge & Son, showed a very compact and efficient three-valve receiver of the unit system, and their exhibition of component parts was of interest to many that evidently were just commencing reception of W.T.

A single valve portable receiver by the Leigh Wireless Stores was much admired, and in fact



Members of the Sheffield and District Wireless Society photograph in the Blue John Mine, Castleton, to which a visit was paid recently for the purpose of conducting underground experiments.

In conclusion the speaker was bombarded with many questions relating to telephones and loud-speakers' generally, all of which he dealt with in a very able manner to the satisfaction and enlightenment of everyone present.

Several new members were accepted and the meeting closed with a hearty vote of thanks to the lecturer and the Chairman at 10.15 p.m.

The Hon. Secretary, Mr. L. E. Lubbock, King George's Hall, East India Dock Road, Poplar, invites inquiries from all interested amateurs in the East London district.

The Southend and District Wireless Club.*

Hon. Secretary, Mr. D. L. Plaistowe, 21, Oakleigh Park Drive, Leigh-on-Sea.

On August Bank Holiday last, a very interesting and successful event took place at the Rectory Grounds, in Leigh-on-Sea.

The exhibition and demonstration of reception on Club Members' apparatus, was well attended by the public, and messages and concerts, etc., were

all club members that were in connection with the trade had made a good show in spite of short notice. It is hoped in October next to give a large exhibition, and to admit the public to a radio concert on proper lines which, being held in a building, should be successful, as it is difficult to carry the sound far in the open air or in a tent.

A general meeting was held on August 18th, at Club Headquarters, St. John's Ambulance Depot, in Queen's Road, Southend.

Mr. Davies took the chair in place of Mr. Mayer who was unable to attend owing to business. The meeting opened at 8.10 p.m., and the Chairman called on the Hon. Secretary to read the minutes of the previous meeting. After the approval of the same, and following business arising therefrom, he called on Mr. Plaistowe to give his lecture on "The Fleming Valve and the Electron Theory in General."

The method of taking the characteristic curve was given, and the usual description of the popular theory of electronic action explained.

After a hearty vote of thanks Mr. Jackson was called upon to talk on "Direction Finding." He explained very concisely the method of procedure and gave a typical instance and working by trigonometry. A general discussion then took place on the subject of the lecture, and Mr. Jackson was plied with questions which he very ably dealt with.

The meeting was declared closed at 10 p.m.

In common with most wireless societies at the present time we are being inundated with queries and demands for particulars of membership from people who are just commencing the reception of signals, etc., on apparatus purchased from some firm or other. We shall be very pleased to have them in the Society as members when we commence our winter session on October 6th.

In the past the Club of course consisted of "pre-boom" experimenters who all more or less had at least a knowledge of the fundamentals of electricity, so that it was no difficult matter for them to understand wireless theory and practice.

The people to-day, however, do not appear to have at all an extensive knowledge of electricity but yet are keen enough to purchase a "set" and commence operations, usually to the accompaniment of whistles, moans and shrieks, and other phenomena. In this town, particularly, there is too much of this sort of thing going on at the present time, and we want to help these people, and in doing so help ourselves.

Accordingly, we invite all amateurs in Southend and district to come along on October 6th to the Club-room and give their views in writing to the Hon. Secretary, so that the future policy of the Club can be adapted to suit the needs of the times.

Ramsgate, Broadstairs and District Wireless Society.

Joint Hon. Secretaries, Mr. F. Harrison, Rochester Cottage, High Street, St. Lawrence, Ramsgate, and Mr. F. C. Marshall, 6, Ramsgate Road, Broadstairs.

The following gentlemen have kindly consented to become Vice-Presidents:—Hon. E. C. Harmsworth, M.P. (Thanet), Lieut.-Col. Sir T. B. Robinson, K.C.M.G., K.B.E., Sir Cecil Hertslet, K.B.E., J.P., Sir Edward Rigg, C.B., C.V.O., I.S.O., H. Bing, Esq., J.P., Rev. F. G. Ridgeway, M.A., James Emery, Esq., H. C. Flowerdew, Esq., W. G. Riddle, Esq., C. F. Grossmith, Esq.

Following an informal meeting held in July, a committee meeting was held on August 24th, at Ramsgate, under the chairmanship of the President, Mr. H. C. Norman, B.A., for the purpose of drawing up the rules and discussing the necessary details for the formation of the Society. The Committee of Management, composed of Messrs. H. C. Norman, B.A., E. Guy, M.Sc., E. P. Pester, B.Sc., C. E. Hume, P. F. Weeks, M.B.E., P. E. Stanley (Ramsgate), P. F. Cotton and F. C. Marshall (Broadstairs and District), considered the necessary rules and details for the formation, which were finally agreed and adopted. It was decided to divide membership into three sections: "Members," "Associates," and "Student Associates." Subscriptions to be 10s., 5s. and 2s. 6d. per annum. "Members" having two votes and the privilege of bringing a friend to meetings, etc., once a month. "Associates" having one vote but not the latter privilege. "Student Associates," being junior

members still attending school. A full programme of weekly meetings is being arranged, of which either of the Hon. Secretaries will be very pleased to give full information. The list of members is increasing rapidly and much encouragement is being received locally. The first meeting will be held during September, at the close of the holiday season.

Bishop's Stortford and District Amateur Wireless Association.

Hon. Secretary, Mr. J. Cooper, Halfacres, Bishop's Stortford.

Owing to increasing attendances the monthly meeting of the above was held at the Institute, Bishop's Stortford, on Friday, August 25th. There was a good attendance of members and visitors, presided over by Mr. W. A. Field, and a lecture was delivered by Mr. L. G. Attree, upon "Accumulators." The lecture which was full of technical information was delivered in a manner readily understood by the tyro, and dealt with the types, voltage, capacity, etc., best suited to radio work. Mr. Attree, whose experience of his subject is an exceedingly wide and long one, insisted upon the superiority of glass containers over those of celluloid or even of ebonite, and emphasised the need of care and maintenance in order to obtain maximum results. A vote of thanks, proposed by the Vice-President and seconded by Mr. Filby, was accorded Mr. Attree for his instructive lecture.

Communications should be addressed to the Hon. Secretary.

Coventry and District Wireless Association.

Hon. Secretary, Mr. J. E. Bolus, Iona, 14, Coundon Road, Coventry.

A meeting of the above Society was held at the Club Room, Charlesworth Buildings, 128, Much Park Street, Coventry, on August 23rd, 1922, for the purpose of enrolling members into the Society which was reconstructed at the last meeting.

The Chairman, Mr. A. M. Sidley, addressed the meeting and pointed out the absolute necessity for a Radio Club in Coventry, and said that judging from the attendance there that evening amateur wireless appeared to be very popular in Coventry.

The Committee had been into the matter of entrance fees and annual subscriptions, and have fixed them at 5s. and 10s. respectively for senior members, and 2s. 6d. and 5s. for juniors.

There were 42 members enrolled, and it is hoped that this number will in the near future be considerably increased.

The club room is open to all members on any night, and arrangements are being made for a work bench and also a library of periodicals and technical books to be installed as soon as possible.

The Secretary will be pleased to give any further information on request; notices of lectures, etc., are published in the local newspaper, and are also shown in the various electrical contractors shops throughout the town.

Newark and District Wireless Society.

Hon. Secretary, Mr. Geo. T. Sindall, 6, Beech Avenue, Hawtonville, Newark, Notts.

The above Society will resume their meetings for the winter session on Wednesday, September 20th, at the Magnus Grammar School, at 7.30 p.m.

The Committee are hoping to make this session a greater success than the last, and hope all interested will make an effort to come along and join them, whether they are in possession of receiving-sets or not.

A transmitting licence has been applied for, and in the event of this being granted much interesting work can be looked for which will be of great benefit to local amateurs.

Hornsey and District Wireless Society.

Hon. Secretary, Mr. H. Davy, 134, Inderwick Road, Hornsey, N.8.

This Society, which was recently founded, has now a membership of over 30, and is anxious to increase its numbers still further. Full particulars can be obtained from the Hon. Secretary at the above address on receipt of a stamped addressed envelope.

A full meeting was held on Friday, August 18th, and a programme was formed for future meetings.

It was arranged that the Club set should consist of three valves—one high frequency, one detector, and one low frequency. Mr. Pugh consented to make the panel, while Mr. Webster volunteered to make the cabinet to hold it. The whole of the Club members meet every Friday to construct various items to include in the set, which it is hoped will be in use by September 11th.

On Tuesday, August 22nd, the members present enjoyed music and speech from 2 OM and 2 FQ as well as Morse signals from various stations, including loud signals from GFA, and a two-valve set loaned by Mr. Webster for the evening. Other members have kindly consented from time to time to lend their sets for demonstration purposes.

The Walthamstow Amateur Radio Club.

Hon. Secretary, Mr. R. Cook, 49, Ulverstone Road, Walthamstow, E.17.

The Society is now well established and the membership is still steadily increasing, and an Assistant Hon. Secretary was appointed a short time ago in order to cope with the increasing business of the Club. On August 23rd, Mr. Tyler gave a lecture to the advanced members of the Club on "Ionization of Valves," and Mr. Webb lectured to the more elementary members on the approximate cost of constructing a valve panel and the necessary apparatus used.

The Committee are hard at work arranging the lectures for the Winter sessions.

The Secretary will be pleased to welcome any prospective member. Meeting nights, every Wednesday, from 7.30 p.m. to 10, at the Y.M.C.A. Church Hill, Walthamstow, E.17.

The Durham City and District Wireless Club.

On Friday evening, August 25th, the fifth meeting of the above was held. It proved to be a very enjoyable and intensely interesting evening for the members.

The Morse buzzer class, conducted by Mr. G. Nurthen, assisted by Mr. W. Rushworth, was quite exciting, the ladies particularly enjoying themselves.

After Morse practice the Hon. Secretary, Mr. Geo. Barnard, gave a short lecture on "Diagram Interpretation," using 22 diagrams upon the blackboard to represent various apparatus. These diagrams were copied by the members.

After the announcements, the Chairman, Mr. S. Kelly (Hon. Treasurer), commenced the question

period by asking the Secretary to review briefly the last lecture on the relationship between inductance and wavelength of a closed oscillatory circuit. At the request of a lady member Mr. Barnard gave a condensed explanation of the function of a crystal detector in a receiving circuit. Mr. R. W. Holmes at this point drew and explained the curve representing the relationship of the resistance offered by a crystal to the E.M.F. applied.

A lively discussion then followed. Several new members were enrolled. There was no time to discuss the merits of a free library.

Mr. Ainsley, of the Henley Cable Co., is the lecturer for the next meeting, which is to be held on Friday, September 1st, at headquarters (Y.M.C.A., Claypath).

Intending members are always welcome.

The Wireless Society of Liverpool.

Hon. Secretary, Mr. C. L. Lyons, 76, Old Hall Street, Liverpool.

A highly successful meeting of the above Society was held on Thursday, August 24th, at the Royal Institution, Colquitt Street, Liverpool.

Special arrangements had been made with The Ashley Wireless Telegraph Co., Ltd., of Renshaw Street, Liverpool, whereby they would transmit telephony and musical items from their experimental station, 2 KH, the same being received on a five-valve receiving set of their own manufacture (2 H.F., 1 Rect., 2 L.F. valves).

The programme commenced promptly at 8 p.m., and continued until 9.30, there being six-minute transmissions with intervals of five minutes duration each. The receiving set was operated by Mr. C. G. Williams, of Messrs. Ashleys (who is also a prominent member of the Society and on the Advisory Committee). The whole of the items were received extremely satisfactorily (especially in consideration of the fact that the set was worked in conjunction with the Society's indoor aerial which is of but moderate dimensions) and were made clearly audible to all present through a "Brown" loud speaker. The programme was very varied, containing amongst other items, selections from Gilbert and Sullivan, "Annie Laurie," "The Policeman's Holiday," a "Pot-Pourri" and then inimitable Tom Foy in a speaking record.

The five-minute intervals were occupied in answering the questions deposited previously in the question box, Mr. S. Lowey rendering great assistance, illustrated with very clear blackboard diagrams.

The next General Meeting of the Society will be held at 7.30 p.m. on Thursday, September 14th, at the same address, and all amateurs or interested persons of either sex are extended a hearty invitation.

A meeting of the General and Advisory Committee has also been arranged for September 7th, for the purpose of arranging an interesting and instructive winter syllabus. All intending members are therefore advised to apply at once to the Secretary for application forms, so that none of the special meetings which are being arranged, will be missed.

Proposed Wireless Society for Tottenham and District.

Will all interested please communicate with Mr. R. A. Barker, 22, Broadwater Road, Bruce Grove, Tottenham, N.17.

Questions and Answers

NOTE.—This section of the magazine is placed at the disposal of all readers who wish to receive advice and information on matters pertaining to both the technical and non-technical sides of wireless work. Readers should comply with the following rules :—(1) Each question should be numbered and written on a separate sheet on one side of the paper, and addressed "Questions and Answers," Editor, THE WIRELESS WORLD AND RADIO REVIEW, 12/13, Henrietta Street, London, W.C.2. Queries should be clear and concise. (2) Before sending in their questions readers are advised to search recent numbers to see whether the same queries have not been dealt with before. (3) Each communication sent in to be accompanied by the "Questions and Answers" coupon to be found in the advertisement columns of the issue current at the time of forwarding the questions. (4) The name and address of the querist, which is for reference and not for publication, to appear at the top of every sheet or sheets, and unless typewritten, this should be in block capitals. Queries will be answered under the initials and town of the correspondent, or, if so desired, under a "nom de plume." (5) In view of the fact that a large proportion of the circuits and apparatus described in these answers are covered by patents, readers are advised before making use of them, to satisfy themselves that they would not be infringing patents. (6) Where a reply through the post is required every question sent in must be accompanied by a postal order for the amount of 1s., or 3s. 6d. for a maximum of four questions. (7) Four questions is the maximum which may be sent in at one time.

In view of the serious interference which an oscillating receive can cause to other receivers in its neighbourhood, it is understood that for broadcast wavelengths, certainly, and possibly for all wavelengths, the Postmaster-General will in future allow no type of circuit which is capable of oscillating and so energising the aerial, either directly or through any circuit coupled to it.

The necessary consequence of this restriction is that if reaction of the type commonly used in the past is still employed, it must be in such a way that the oscillation point cannot be reached over the wavelength range of the receiver, however tightly the reaction coil is coupled, and with whatever values of filament voltage or plate voltage the set is worked.

In order to comply with this requirement, it is essential that the reaction coil should be sufficiently loosely coupled to the aerial inductances as not to set up oscillations or alternatively the reaction might be arranged between the grid and plate circuits of a high frequency amplifier as shown on p. 715 of the issue of September 2nd.

We strongly urge readers who are making or using sets of the usual reacting type to either reduce the amount of reaction which they can employ to such an extent that they are perfectly satisfied that the set can never oscillate or to cut out their reaction entirely.

"R.M." (Coventry) wishes to obtain a temporary post as operator next summer, and asks (1) If he could acquire sufficient theoretical and practical knowledge by self-preparation. (2) What books are recommended for studying purposes.

(1) Theoretical knowledge, yes; practical efficiency, very unlikely. Moreover, we think it unlikely that you would get a berth under these conditions, as the supply of thoroughly qualified operators appears to be at least equal to the demand. (2) We should recommend Bangay's "Elementary Principles" and his "Oscillation Valves" for a start, and more advanced books and the P.M.G. handbook later.

"L.S." (Stretford) has a set of which he encloses a diagram, which gives no results, and asks for assistance.

The set appears fairly good although results are poor. Condenser D should go from the other

side of reaction coil to earth, and should be about 0.001 mfd. The reaction coil should couple with secondary instead of the primary, and should be small enough to slide right inside it. Examine all aerial and earth connections and insulation very carefully.

"W.V." (Fulham) asks (1) For an efficient two-valve receiving circuit which can be constructed at reasonable cost, and covering a wavelength range of 180/200 metres, with values of capacities, resistances, etc., and (2) Whether this will work satisfactorily in a horizontal position.

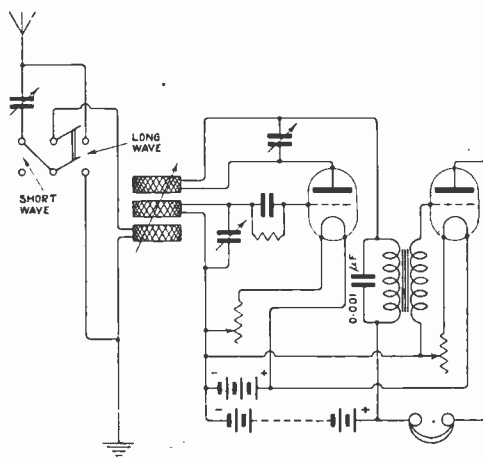

Fig. 1.

(1) See Fig. 1. (2) Receiving valves are usually so constructed that they can be operated in any position. This does not apply to large transmitting valves and rectifying valves however.

"W.G.A." (Southampton) asks two questions relating to winding coils for his set.

(1) The A.T.I. internal diameter 1", external 7". For the reaction coil 4" internal, 5" external diameter, wound with the same wire. (2) It is impossible to give at all accurate values. In this case we should recommend tappings at equal numbers of turns from the inside to the outside.

"C.E.P." (Battersea) asks (1) Will four solo receivers of 750 ohms each, connected in series, be efficient for telephony. (2) What current does a zincite-bornite combination need. (3) What additions does he need to a list of apparatus to make a crystal detector and valve amplifier. (4) For a diagram of a circuit for use with the above.

(1) Yes, if of good make. (2) No polarising E.M.F. is necessary with this combination. (3) For the simplest type of circuit two batteries, L.F. and H.F., grid condenser and leak and L.F. inter-valve transformer. (4) See Fig. 2, page 336, June 10th issue, omitting the potentiometer and battery.

"J.W.A." (Northallerton) is contemplating the construction of a three-valve receiver, and asks (1) The best simple circuit for making use of three valves for reception of spark, C.W. and telephony, up to wavelengths of 3,000 metres. (2) Whether the apparatus will be suitable to operate a loud speaker. (3) Whether resistance capacity or transformer coupling is recommended, and (4) The capacities of the various condensers.

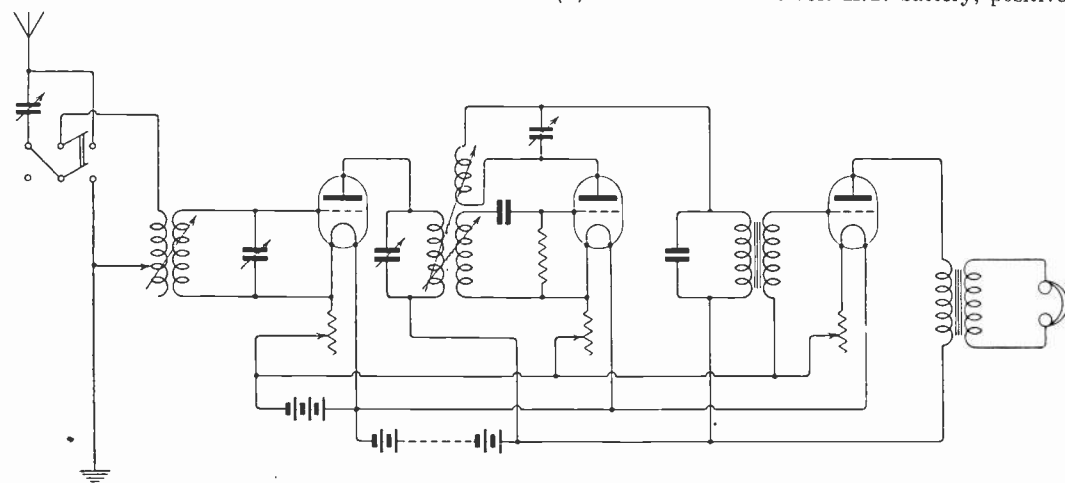

Fig. 2.

(1) See circuit, Fig. 2. For reception on wavelength up to 450 metres you had better make a special set of coils. (2) No; the addition of one or two stages of low frequency amplification is required. (3) As you do not require to receive on wavelengths above 3,000 metres, transformer coupling will be found satisfactory. (4) These are indicated in the diagram.

"R.C.W." (Clapham) asks for details for adding one amplifying valve to the school set in the October 29th issue.

The simplest way of doing this would be by adding an additional valve as L.F. amplifier, for which you would only require an inter-valve transformer and the extra valve and socket. The transformer might be 1 oz. and 3 ozs. of No. 44 on a core $\frac{1}{2}'' \times 4''$ of iron wires. The circuit may then be as in Fig. 3, p. 738, September 2nd issue.

"J.D." (S.E.18) asks how to adjust Brown's "A" type telephones.

To carry out the adjustment, screw up until a click is heard and signals become inaudible, then

screw back until the point is reached where signals reappear.

"P.K." (Paris) asks (1) If he should hear English stations with a two-valve set. (2) What English stations will he be able to hear. (3) If any English station sends telephony like FL.

(1) and (2) You should hear some of the larger stations, such as Leafield, Carnarvon, etc., but probably not any telephony. (3) There is no corresponding station at present.

"———" (Bayswater) encloses a sketch of circuit and asks (1) If A is a grid leak, and if so what should be its value for Mullard "Ora" valves. (2) If one variable condenser is sufficient. (3) What is to be connected at points D and C on the sketch. (4) Which of three coils should he use for reactance, and which for primary and secondary.

(1) A is a grid leak. Its value should be about 2 megohms. (2) One variable circuit set is sufficient for a simple single circuit set. It should be used in series with the A.T.I. for short waves, and in parallel for long waves. 0.001 mfd. is O.K. (3) Connect at B a 40-volt H.T. battery, positive

to the anode of the valve. At C connect a pair of H.R. telephones. (4) If the stated coil is used in the closed circuit the next larger may be used for the primary and the next smaller for the reactance.

"K.P.S." (Marlborough) refers to the simple C.W. and telephony transmitter described on page 292, June 3rd issue, and asks for winding details of the induction coil for use on a wavelength of 400 metres.

A suitable value for the inductance would be 40/50 turns of No. 20 D.C.C. on a 3" diameter former. We cannot give the exact number of turns as this will depend on the capacity of the aerial which may lie anywhere between fairly wide limits.

"C.M." (Camberwell) asks if the Marconi $1\frac{1}{2}$ kW. ship set is still the same as that given in the 1918 edition of Hawkhead, and if not what are the most important alterations that have been made.

The standard rotary converter, asynchronous spark set, is obsolete, although very large

MAGNAVOX

THE WORLD'S FINEST

LOUD SPEAKER

RADIO
brings it
MAGNAVOX
tells it.

*Broadcasting faithfully reproduced
with marvellous clarity and volume*

IMMEDIATE DELIVERY.

Visit our Stand No. 34. All-British Wireless Exhibition,
Horticultural Hall, September 30th to October 7th.

Manufacturers & Sole Licensees for Europe

Sterling Telephone & Electric Co., Ltd.

TELEPHONE HOUSE,

210/212, Tottenham Court Road, London, W.1

Telephone No.: 4144 Museum (7 lines). Telegrams: "Cucumis, Wesde, London."

Works: DAGENHAM, ESSEX.

BRANCHES: NEWCASTLE-ON-TYNE: 9, Clavering Place.

CARDIFF: 8, Park Place.

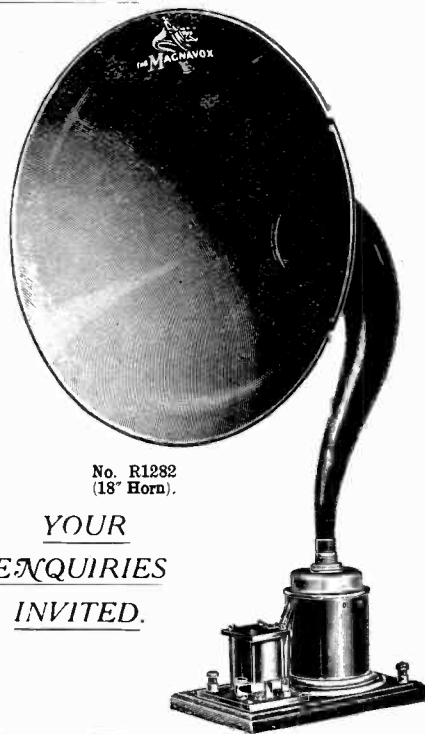

No. R1282
(18" Horn).

*YOUR
ENQUIRIES
INVITED.*

YOUR WIRELESS SET IS ONLY AS EFFICIENT
AS YOUR BATTERY IS RELIABLE,
THEREFORE ALWAYS USE

HART BATTERIES

SUITABLE FOR
HIGH AND LOW TENSION CIRCUITS.

IMMEDIATE DESPATCH FROM STOCK OF FOLLOWING TYPES:—

TYPE	Voltage	AMPERE HOUR CAPACITY		APPROXIMATE OVERALL DIMENSIONS			TYPE OF BOX	NET PRICE EACH	
		Contin-uous	Inter-mittent	WIDTH	LENGTH	HEIGHT		Cash with Order.	Carriage Paid
P.L. 3	2	I	2	27/32"	2 1/8"	3"	CELLULOID	3s. 0d.	2s. 6d.
"	2	I	2	1 5/32"	2 11/16"	3 1/2"	EBONITE	6s. 0d.	5s. 8d.
"	2	I	2	1 1/2"	1 1/2"	4 1/2"	GLASS	5s. 6d.	5s. 0d.
E 5	2	5	10	1 1/2"	1 1/2"	6"	GLASS	6s. 9d.	6s. 3d.
A.P. 7	2	11	22	1 1/2"	1 1/2"	6 1/2"	EBONITE	6s. 0d.	5s. 9d.

THESE CELLS CAN BE SUPPLIED MADE UP IN BATTERIES OF ANY REQUIRED VOLTAGE. SPECIAL PRICES FOR SUCH BATTERIES WILL BE QUOTED ON APPLICATION.

Visit our Stand No. 17. All-British Wireless Exhibition Horticultural Hall, September 30th to October 7th.

HART ACCUMULATOR CO., LTD.
STRATFORD, LONDON, E.15

BRANCHES:

BELFAST	...	41, CHICHESTER STREET	GLASGOW	...	107, WELLINGTON STREET
BIRMINGHAM	...	174, CORPORATION STREET	LONDON	...	36, VICTORIA STREET, S.W.1
BRISTOL	...	37, VICTORIA STREET	MANCHESTER	...	4, VICTORIA BRIDGE

YORK—6, BRIDGE STREET

SIEMENS DRY BATTERIES

for
**H.T.
Circuits**

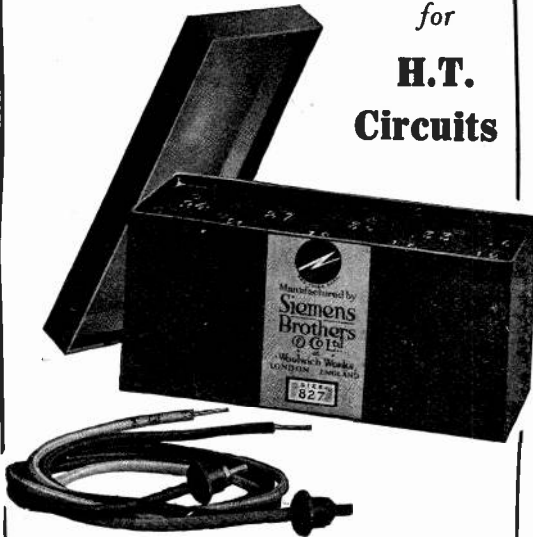

15 volts (11 cells)	} Fitted with end connection strips in brass.
30 " (21 ")	
36 " (24 ")	
50 " (36 ")	
60 " (44 ")	
90 " (66 ")	
100 " (72 ")	} As illustrated, fitted with plug socket connections at the end terminals, and at intermediate positions. For use with suitable removable plug terminals supplied at a small extra charge.

Visit our Stand No. 48. All-British Wireless Exhibition.
Horticultural Hall, September 30th to October 7th.

Full descriptive pamphlet and prices on application to
THE MANUFACTURERS:

**SIEMENS BROTHERS
& CO., LIMITED**

General Offices & Works:

WOOLWICH, LONDON, S.E. 18

Telegrams:
SIEMENS, WOOLWICH.

Telephone:
CITY 6400 (7 lines)

and at

Belfast, Birmingham, Bristol, Cardiff, Glasgow,
Leeds, Manchester, Newcastle, Sheffield, Southampton.

EXPERIENCE

DISTORTIONLESS AUDIO FREQUENCY INTERVALVE TRANSFORMER

DESIGNED AND BUILT ON SCIENTIFIC LINES

25/-

Telephone Transformer - - 20/-

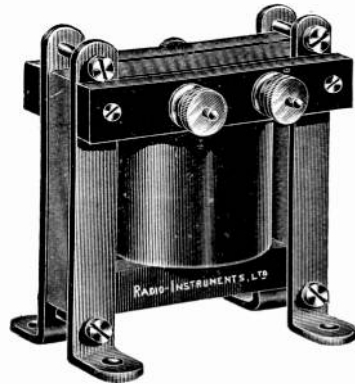

Many testimonials received from satisfied customers (originals of which can be seen at our works) prove this transformer to be considerably in advance of anything previously designed for audio frequency amplification. It is the ideal transformer for amplification with a crystal set.

WINDING AND INSULATION is by a patented process, every individual turn being specially insulated from adjacent turns as well as between layers. Tested at 1,000 volts.

DIMENSIONS are reduced to the smallest limit consistent with absolute reliability: 3 1/2" wide, 2 1/2" over feet, 3 3/8" deep. The unusually heavy wire eliminates a common weakness in other designs where efficiency and reliability are sacrificed to space.

CONSTRUCTION is on exactly similar lines to power transformers. The closed core is built up from best quality Stalloy iron laminae.

IMMUNITY FROM BREAKDOWN is assured by scientific design and careful construction, coupled with high insulation, large gauge wire, and efficient dimensions. Comparative tests confirm the superiority of our designs.

Order at Once to secure Immediate Delivery.

TELEPHONE TRANSFORMERS at 20/- each. Why pay more for imported articles of less efficiency? Get wireless equipment of latest improved designs made by British radio engineers of established reputation.

OTHER PRODUCTS include Short Wave Anode Reactances, Efficient Tuning Inductances, Precision Air Condensers, H.F. Transformers and all wireless components. Every article is manufactured at our own works under the direct supervision of the directors.

Radio Instruments, Ltd.

Managing Director: J. Joseph, M.I.E.E., late Manager to Mr. H. W. Sullivan. Chief Designer: W. A. Appleton, M.B.E., M.I.R.E., late Admiralty Technical Research Officer.

ONLY ADDRESS: Works, Offices, Showrooms:

12a, Hyde Street,

NEW OXFORD STREET, W.C.1

Telephone: Regent 1908. Telegrams: Instradio, London.

We have the largest wireless works in Central London. We are wireless engineers of established reputation.

Our name on wireless apparatus is a guarantee of satisfaction. Visit our Stand No. 37. All-British Wireless Exhibition, Horticultural Hall, September 30th to October 7th.

numbers are still in use. It has been superceded by quenched spark set, with a motor alternator as source of power, and also by a C.W. valve set.

"R.S.M." (Croydon) asks (1) Why do crystal detectors rectify. (2) If celluloid varnish is any good as an insulator.

(1) If you wish to know how the actual process by which it works we are afraid we can give you little help, as the action is really not understood and various theories are in existence. We really understand as much about it as we know why such and such a crystal is black, or any other colour. On the other hand most elementary text-books give simple explanations of the process, which give some idea of the action. (2) We have not had extended experience with this material for the purpose, but such work as we have done would point to it being satisfactory.

"NOTSEW" (London) sends a sketch of his set and asks (1) What would be the maximum distance from which amateur telephony, high power telephony and high power telegraphy would be received clearly. (2) Are any improvements possible in the set sketched. (3) On what wavelength Croydon now works. (4) What would be the difference in wavelength if a 0.0005 mfd. condenser is used instead of a 0.001 mfd.

(1) Amateur telephony, perhaps 20 miles; Broadcasting telephony, 40 to 50 miles; telegraphy, almost any distance, depending on the power of the transmitting station. (2) A condenser (0.001 mfd.) across the telephones is very desirable. (3) Not very different from 900 metres.

"PIP" (Manchester) refers to the American short wave receiver described in the issue of June 3rd, and asks (1) What is the value of the variable condensers in the diagram (a) in the grid circuit of the valve and (b) across the telephones, and if these should be variable. (2) If there is no grid leak in this circuit. (3) Would this receiver be suitable for receiving broadcasting. (4) What is the highest wavelength from which this set would receive telephony.

(1) (a) 0.0003 mfd.; (b) 0.001 mfd. Neither need be variable, but the grid condenser may be with some advantage. (2) A leak should certainly be introduced between the grid side of the condenser and the filament. (3) Quite. (4) No definite limits. Should be O.K. up to say 1,200 metres.

"LITTLE LEVIS" (Ilkeston) asks (1) For a list of apparatus for constructing a set capable of receiving telephony 150 miles. (2) Would a certain type of aerial be O.K. (3) Which of two aerial systems is preferable. (4) Which is the best receiving set on the market.

(1) If you wish to receive FL or similar stations at this distance, your set may be quite simple, say three valves. If, however, you wish to receive broadcasting stations at this distance you will require at least three valves, with tuning coils, two variable condensers, H.F. and L.F. transformers, batteries, grid condenser and leak, telephones and variable filament resistance. (2) Yes. (3) 40 ft. high and 40 ft. long single wire. (4) We cannot answer this for obvious reasons, but the best sets, costing say £35 to £50, of most of our advertisers are all very good.

"T.L.H." (Cardiff) asks (1) For advice as to how to stop his set oscillating. (2) If he can receive broadcasting without any alteration to wiring.

(3) If it would be of any benefit to connect the H.T. battery in series with the L.T. instead of in parallel.

(1) Try reversing the windings one at a time, also vary the positions of the transformers, or fit each transformer into a closed iron box; also make sure that your reaction coupling is not too tight.

(2) Yes, provided that your H.F. transformers and tuning coils are O.K. (3) Your present arrangement is not a parallel connection, as only the negative ends are common. There is very little difference in action between the two ways shown.

"R.St.Q.L." (Harlech) asks (1) If a three-electrode thermionic valve can be used as an amplifier on an ordinary telephone circuit in conjunction with a loud speaker. (2) If so, would the ordinary wireless type do. (3) What circuit would be suitable and what accessories needed to amplify the current from an ordinary telephone with induction coil.

(1) and (2) Yes. (3) The circuit should be an ordinary L.F. amplifier, with a special input transformer with its primary adjusted to suit the conditions of the telephone line. N.B.—The making of any experimental modifications of this nature on the Post Office system is illegal without express permission from the P.M.G.

"G.A.M." (Kensington) sends a sketch of his set and asks (1) If the grid leak and condenser will act as reaction between the secondary and the valve. (2) If he could receive a wavelength of 250/3,000 metres with this set. (3) For criticism of circuit.

(1) No, you will not get any reaction in this way. (2) If your coils are wound with about No. 26, you should get this range, but 0.001 mfd. is too high a value for the grid condenser. (3) The set would work as shown, but would be better with the variable condenser across the secondary, and with a slider to the primary. The addition of a reaction coil would also give greater sensitivity.

"J.M.G.W." (Godalming) sends sketch of his set and asks (1) If the circuit is correct. (2) If one lattice coil will do for a reactance for the set. If so, what should be its inductance in mhs. (3) What size series condenser should be used to tune to 300 metres. (4) If telephony from FL, 2 MT, GED, 2 LO, and GEG could be heard.

(1) Quite O.K. (2) Yes, about 1,000 mhs. should be sufficient. (3) About 0.0002 mfd. should be satisfactory. (4) FL probably, 2 MT possibly, GED and GEG doubtful, 2 LO yes.

"RED SUEZ" (s.s. "Mansourah") sends sketch of circuit and asks (1) If it will operate with reaction. (2) If it would operate with heterodyne. (3) If it would be difficult to operate. (4) If it would operate off common batteries.

(1) Yes. We think the scheme suggested should be quite satisfactory. (2) Certainly. (3) The circuit might need very careful adjustment for successful results, but we have no actual experience of its behaviour. (4) We can see no reason why it should not.

"J.G.B." (Brighton) sends diagram of set and asks (1) If values for H.T. and L.T. are correct. (2) If he should hear 2 MT and PCGG. (3) If tramways, which run about twenty yards from the house, will affect reception.

(1) Circuit is quite O.K., but you should interchange the 0.003 mfd. grid condenser and the 0.0005 mfd. anode by-pass condenser. (2) Reception of PCGG and 2 MT on a single valve set

at Brighton are both very unlikely. (3) You may have considerable trouble through induction from trams.

"CENTIGRADE" (Bury) asks (1) If a valve amplifier may be used with crystal set. (2) If he would be able to receive telephony from FL with a crystal set made as shown in the "Amateur Mechanic." (3) If zincite-bornite is the best crystal to use.

(1) Yes. (2) Unlikely at such a distance, but not impossible with a really good aerial. (3) Zincite-bornite is one of the most sensitive combinations. (4) Ordinary valve 4 volts, 0.5 to 1 amp. Low temperature valve, 2 volts, 0.1 to 0.4 amps.

"F.P.O." (Liverpool) asks for a diagram arranged with switches for effecting (a) A.T.C. series parallel; (b) L.T. and H.T. on and off; (c) Crystal reception only, valve H.F. magnifier followed by crystal rectifier. For circuit see Fig. 3.

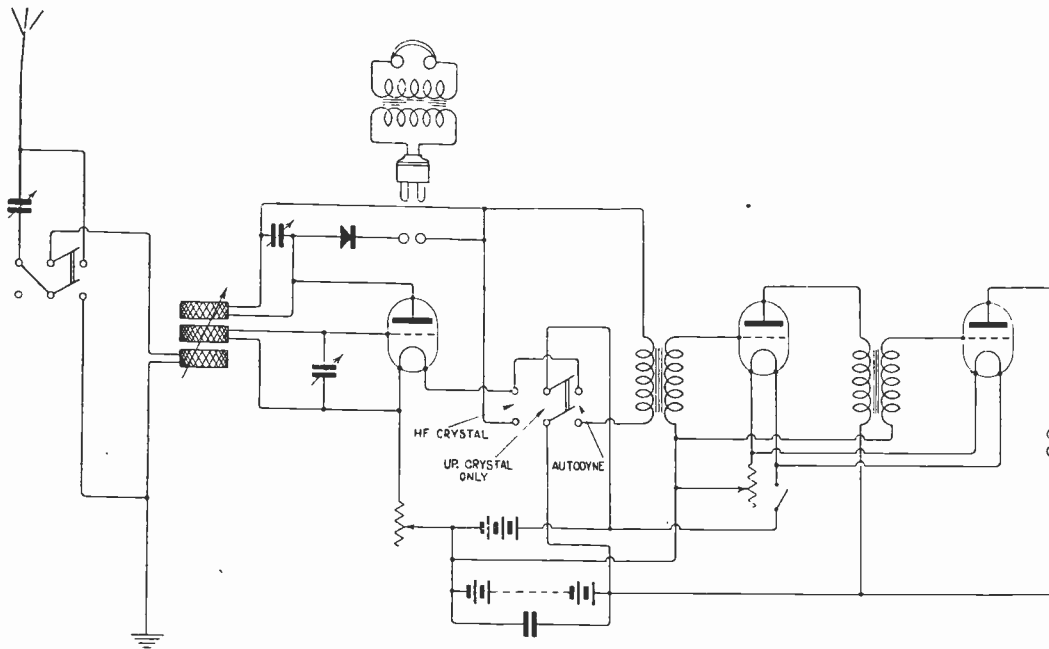

Fig. 3.

"2 BAH" (Dartford) asks (1) For a formula for calculating the wavelength of a single layer coil for use in a wavemeter. (2) If two pancake coils placed parallel and concentric are connected in series so that the induction is maximum, what is the effect of separating the coils. (3) For a formula for calculating a self capacity of single layer and pancake coils. (4) If it would be possible to hear FL with the crystal circuit sketched.

(1) It is impossible to calculate the wavelength of a coil used in this way, as the wavelength depends on the self capacity of a coil, which cannot be calculated. A true inductance coil having no self capacity would have no wavelength. (2) As above, a good coil has no wavelength. If, however, the coils would each tune the circuit to 600 metres, placing the two together in the circuit would give a wavelength of approximately 1,200 metres.

Separating them would then gradually reduce the wavelength to about 850 metres. (3) There is no suitable formula in existence. (4) No, it will not tune up to the wavelength.

"J.O.B." (Westcliff-on-Sea) asks (1) What is the advantage, if any, in using a crystal detector with a local potential, such as zincite-bornite, over one without any potential. (2) Why he gets no results with a certain circuit sketched. (3) If better results can be obtained by using a crystal detector and valve amplifier. (4) How tuning is performed without a sliding contact.

(1) Zincite-bornite does not require a local potential. In general the crystals which require applied local potential are more steady but somewhat less sensitive than those which do not need it. (2) The circuit appears O.K. and we can suggest no reason from the diagram for it not working, except

that 4 volts is rather a low value for the filament battery for this valve. (3) See Fig. 3, page 501, July 15th issue, for a suitable circuit. (4) Tuning can be carried out by a variable shunt condenser, or by a variometer action between two coils connected in series.

"L.S.G.H." (Fulham) asks for a diagram of connections for a five-valve set.

Circuit should be as in Fig. 5, page 62, April 8th issue, with additional H.F. and L.F. valves switched in exactly the same way as shown, if desired.

"W.S.F." (Darlston) asks (1) If a sample of wire will be suitable for a telephone transformer for Sullivan's telephones used in a valve set; also if a certain sample of tinfoil will do for a core. (2) What size former should be used to wind certain specimens of wire upon, and how many turns of each should be used.

WIRELESS

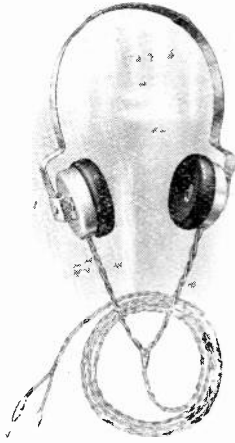

SPECIFICATION

CORDS. Twin Conductor Tinsel 3 ft. long between butt and fork, 12 ins. long from fork to each receiver, Instrument end fitted with 2 plug Type Metal Tags.

RECEIVERS arranged in series and wound to 2,000, 4,000 ohms, or as required.

MAGNETS of specially treated Tungsten steel, mounted in Aluminium cases and fitted with adjustable steel headband of extremely light but serviceable pattern

2,000 ohms	24/-
4,000 "	25/-

SPECIFICATION

RESISTANCES - 120, 1,000, 2,000, 4,000, 8,000 ohms
Other windings to order.

INSULATION - Highest possible.

MAGNETS - Selected Tungsten steel, manufactured under our own special process and guaranteed for ten years.

CORDS - Heavily insulated Tinsel Conductors.

FINISH - Polished Aluminium case and fittings, with Oxydised Relieved Coppered Head Bands, simple and comfortable adjustment. Ebonite Ear Caps fitted as standard.

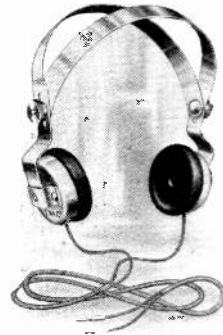

DE LUXE 'PHONES.

2,000 ohms	...	34/-
4,000 "	...	35/-



CRYSTAL SET

(including DE LUXE Head 'Phones)

£4 5 0 Post free.

AERIALS

Complete with Insulators and instructions for erecting.

6/- Post free.

Visit our Stand No. 20, All-British Wireless Exhibition, Horticultural Hall, September 30th to October 7th.

THE LONDON TELEPHONE CO. LTD.
Donington House, Norfolk Street, London, W.C.1

Tel.: CITY 8612.

The Present Wireless Boom

has given an enormous impetus to the manufacture of wireless apparatus. The tendency has been to sacrifice quality to quantity in endeavouring to keep pace with the demands. Throughout this period of increasing wireless activity **S. G. BROWN, LTD.**, have wisely refused to lower their high standard of quality even at the expense of occasional delay in fulfilling orders. As a result they have more than maintained their enviable reputation as **RELIABLE** wireless manufacturers, and to-day it continues to be recognised by amateur and professional alike that wireless instruments and parts manufactured by and bearing the name "**BROWN**" can be bought with absolute confidence in their quality, value and efficiency.

The "Brown" Super-sensitive Telephones

These Telephones are unquestionably the clearest and most sensitive made, and, consequently, increase the distance over which wireless can be heard.

BROWN'S are recognised as the **most comfortable** to wear, due to their extreme lightness in weight and adaptable adjustment.

There is no wireless head phones in the world to compare with **BROWN'S**.

IMPORTANT NOTICE.—When purchasing **BROWN'S** you should see that the name **BROWN** is stamped on the back of each ear piece. This is the **hall-mark and proof** of their **genuineness, excellence of finish and highest efficiency.**

In Universal Use. As supplied to British, Allied and Foreign Governments.



"A" TYPE,
Low Resistance, 58/-
High Resistance, 62/- to 66/-
"D" TYPE,
Low Resistance, 48 -
High Resistance, 52/-
(all above prices include cords).

The "Brown" Microphone Amplifier

This Amplifier magnifies signals, speech, or music, without distortion, and is of considerable interest to amateurs and scientific investigators. The magnification is much greater than that obtained from a two-valve amplifier. In construction, this instrument is much more robust than other relays. This instrument satisfies the urgent demand for a reliable, inexpensive amplifier, which the most inexperienced amateur can use, and which the most experienced requires. The necessary transformers are included in the base.

The "Brown" Loud Speakers with new improved Curved Horns

The requisites of a Loud Speaker are pure tone, clear articulation, and good volume of sound. The "**BROWN**" Loud Speaker possesses these qualities and they are enhanced by the new improved curved horn.

AMATEURS do not always need the full sized Loud Speaker (H. 1.) as used in Lecture Halls, and a small type (H. 2.) has been designed to meet their more modest home requirements both as to volume of sound and price.

THE NEW HORN of dull blacked aluminium used with both H. 1 and H. 2 is constructed on the logarithmic law of increasing openings and is acoustically perfect

NOTE THIS.—The strength and clearness of all music, speech and Morse heard by one person wearing headphones is broadcasted to a whole room full of people when a Brown Amplifier and Loud Speaker are used with your set.

The most popular and perfect loud speakers ever offered to the public.

Thousands already in use in all parts of the world.

CATALOGUE POST FREE.

Visit Our London Showrooms: 19, MORTIMER STREET, W.1.

Visit our Stand No. 43 at the All-British Wireless Exhibition, Horticultural Hall, Sept. 30th to Oct. 7th.

SOLE MANUFACTURERS—

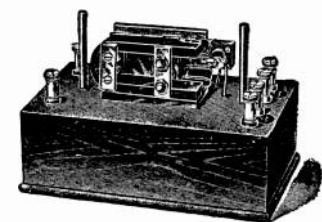

PRICES:
Low Resistance (120 ohms) input, £6
High Resistance (2,000 ohms) input, 2/6 extra.



PRICES:
H. 1. (Large) Low Resistance, 120 ohms Height 21", £6 : 5 : 0 (High resistance 2/6 to 5/- extra).
H. 2. (Small) Low Resistance, 120 ohms Height 12", £3 : 0 : 0 (High Resistances 2/6 to 5/- extra)

Telegrams—
"Sidbrownix, London."

Telephone—
Chiswick 1469.

Sole Agent for the Argentine—

Horacio D. Guerrero.
Las Heras 2480, Buenos Aires.



Head Office and Works:
VICTORIA ROAD, NORTH ACTON, LONDON, W.3

London Showrooms:
19, MORTIMER STREET, LONDON, W.1

(1) The sample of tin might be used, but will be inefficient, especially for telephony in comparison with stalloy iron. If used, it will be better to put tissue paper between sheets. (2) The wire is too thick, even for L.R. winding, but if used try about 2,500 turns.

"J.E.W." (Great Berkhamsted) sends a sketch of his single valve set, and asks (1) Why he gets no results. (2) What should be the maximum and minimum wavelength. (3) What is the approximate capacity of the variable condenser.

(1) We can see no reason why the set should not work. It would, however, be improved by the addition of some reaction. (2) We cannot say, as you do not give the dimensions of the A.T.I. former, but from the length of wire used the maximum is probably several thousand metres. (3) 0.00035 mfd.

"C.S.H." (Harlesden) sends a sketch of his set and asks (1) What is its wavelength range. (2) Capacity of two certain condensers. (3) If a certain coil is suitable for use with a two-valve resistance capacity coupled set, and also with the set in his diagram.

(1) Approximately 6,000 metres. (2) Condenser No. 1, 0.0007 mfd., No. 2, 0.00015 mfd. (3) Yes, but in your sketched circuit it is better to put the reaction coil on the anode side of the inter-valve transformer.

"H.H.T." (South Kensington) asks (1) For a diagram of connections for a four-valve receiving set, with loud speaker, range from 150 to 25,000 metres. (2) What valves are recommended for this set. (3) Winding data for transformers. (4) If the inductances and condensers could be made as shown in "A long range Receiving Set," of Vol. 8.

(1) See Fig. 7, page 438, issue for July 1st. (2) Any good modern type will do. Cylindrical tube valves of "V.24" type are electrically somewhat more efficient than French type, but for certain purpose are, perhaps, not mechanically so good. (3) In order to cover such a large range you will have to have a number of H.F. transformers, the windings of which must be determined experimentally. For the L.F. transformers, the values usually quoted may be used. (4) They might be, but we do not particularly like this arrangement. We should recommend a three-coil holder with a set of honeycomb coils.

"L.J.B." (Sheffield) sends diagram of a crystal set he is using with an indoor aerial and asks why he cannot get signals. (2) What crystal to use. (3) If 60 ohm telephones can be used. (4) If using German silver wire for his potentiometer explains lack of signals.

(1) and (4) Circuit is quite correct and use of an indoor aerial is the only apparent reason for loss of signals. (2) Carborundum is perfectly satisfactory (3) Yes, if a telephone transformer is used, but your circuit does not show one.

"F.J.A." (Mile End) asks (1) How he could construct a set of basket coils and what number of pins and turns to use. (2) How can he make reaction coils for these. (3) How many fixed and moving vanes are necessary to construct a 0.001 mfd. variable condenser. (4) In what text-book can he find similar practical information.

(1) Any reasonable odd number of pins may be used, say between 9 and 19. The number of turns will depend on the wave-range required, which you

do not state. (2) Reaction coils may be made in the same way as tuning coils. (3) It depends on the size and spacing of the plates. If the plates are 4" diameter spaced 1 mm. apart, 17 fixed and 16 moving will be required. (4) See Alan Douglas' Text-book on the "Construction of Valve Sets."

"OZONE" (Kensington) asks (1) From what places in the British Isles and Europe are concerts and other information sent out for reception, and on what wavelengths. (2) For details of a complete valve circuit for receiving telephony.

(1) The most important are Writtle (2 MT) on 400 metres, Marconi House, London (2 LO) on 360 metres. (This is experimental at present.) Eiffel Tower on 2,600 metres. Nauen on 3,100 metres (POZ). The Hague (PCGG), 1,050 metres, and a number of small power stations in the London District. (2) The four-valve set, of which descriptive articles started in the issue of July 15th, should be very suitable for this work.

"E.D.B." (South Croydon) asks for a switching arrangement to cut out the last valve in the diagram on page 37, April 8th issue when required.

Arrangement may be as in the diagram in which only the altered parts are shown (Fig. 4).

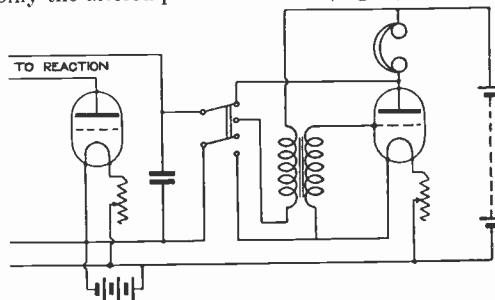

Fig. 4.

"J.H.K." (Mortimer) asks (1) For a diagram of a good one-valve circuit. (2) If an "Ora" valve will give good results in this circuit, and should it be hard, medium, or soft. (3) What length of wire and what resistance, using No. 26 S.W.G., would be suitable for a filament resistance. (4) If a German "A.E.G." valve would give as good results as the Mullard "Ora."

(1) See Fig. 2, page 537, issue for July 22nd. (2) Yes; hard. (3) About a couple of feet will be necessary, resistance of which would be 5 ohms. (4) We cannot say.

"DART" (Devon) asks (1) If a certain method of constructing an aerial would give any results. (2) If so, how many valves would be required. (3) What is the approximate range of the 10-watt transmitting power usually granted by the P.M.G.

(1) It is very unlikely that results of any use will be obtained. (2) At least five valves would probably be necessary. You have a difficult problem to solve. (3) The range varies enormously with locality and conditions. 10 to 20 miles might be an average figure, but much greater distances could be obtained under specially favourable circumstances.

"L.D." (West Ewell) asks why he cannot get any telephony with his set.

You give practically no useful information to enable us to say what is wrong, e.g., you do not

state the diameter of coils, material of formers or type of circuit. We see no reason why there should be anything wrong with the coils, but from your remark on howling we should imagine that you are using one as reaction, and that the coupling is too tight.

"W.J.T." (Norbiton) asks (1) *What is the wavelength, call sign and time of working of the station at Cairo working with Leafield.* (2) *Who is the arc station on about 6,800 metres, louder than Leafield.* (3) *If 2 MT has reduced his power since operating on 400 metres.* (4) *Particulars of how to make a loud speaker using a Skinderviken microphone button.*

(1) SUC. We are unacquainted with programme of working. (2) Probably Northolt. (3) No; but is quite likely that the shorter wavelength does not carry so well over London, although we have received no systematic reports to this effect. (4) This could probably be arranged on the lines of the sketch, but the loud speaker itself would be quite distinct from the microphone and of normal type, but with windings adjusted to suit the resistance of the microphone through a transformer if necessary. A diagram of a simple microphone relay will be given in an early issue.

"P.E.P." (Warrington) asks (1) *If a two-wire aerial instead of a single wire would compensate for lack of height at one end.* (2) *If a long earth wire would be detrimental to the working of a single wire receiver.*

(1) The addition of a second wire will not compensate for lack of height. (2) This length of earth wire will weaken signals considerably. Cannot you connect it to a waterpipe nearer the house?

"A.R.O." (Chester) asks (1) *Where he can obtain a valve of the low temperature type, and at what price.* (2) *If certain wires would be suitable for telephone transformer for 120 ohm telephones.* (3) *If so, how much would be required.* (4) *If a certain diagram is correct for deriving H.T. for an "R" valve from a 210 volt D.C. main.*

(1) This valve will be handled by the Marconi Department of the Marconi Company. No supplies are yet available for distribution to the public. The price will probably be £2. (2) They might be used for the L.R. windings, but are undesirable even for this. (3) About 6 ozs. for the L.R. winding. The H.R. winding should be 3 ozs. of No. 44. (4) No; better to put three lamps in series and tap the required H.T. across one of them.

"M.R.C." (Alexandria) asks (1) *If we know of any wireless amateur in Egypt or Alexandria.* (2) *If any telephony can be heard in Alexandria with a seven-valve amplifier.* (3) *If the Wireless Society of London accept affiliation of foreign members living abroad.* (4) *Where can he find information for constructing a tuner with range 600/25,000 metres to be used with an amplifier and a separate heterodyne.*

(1) We do not know of an experimenter to whom we could refer you. Why not advertise in a local newspaper? (2) We do not think this is at all likely, but we believe the question of establishing broadcasting stations in that part of the world is under consideration. (3) We think it is most probable that the Society would consider this. Apply to the Secretary for full information. (4)

If you already have a suitable amplifier the construction of a tuner should afford you little difficulty. Make or buy a three-coil holder and use a set of honeycomb coils, tuning both the aerial and secondary circuits with variable condensers.

"R.J.K.H." (Walton-on-Thames) asks (1) *Why, on pressing the key of a simple valve transmitter, the valve filament decreases in brilliancy slightly.* (2) *What qualifications are necessary to become a member of the Wireless Society of London.*

(1) Without a knowledge of the circuit employed it is not possible to say exactly, but one possible cause is a decrease of potential along the filament of the valve due to an increase in the plate filament current. The plate filament current runs out through filament back through the circuit to the plate, and if in opposition to the filament heating current may give the effect noticed. (2) You should apply for full particulars to the Secretary of the Society.

"ERIN" (Upton Manor) asks (1) *How he can remedy howling.* (2) *If it would be possible to receive The Hague and Eiffel Tower telephony with a Mark III Tuner loaded with a proper coil.* (3) *Which of two samples of wire would be better for lengthening the aerial.* (4) *If it would improve signals to use insulated wire as per sample attached.*

(1) Howling is evidently due to too much reaction; do not use so much. (May we remind you that whenever your set howls in this way, you are spoiling the reception of every other amateur within a range of perhaps two miles). (2) The wavelength of the closed circuit should also be brought up to the desired values. (3) Either should be quite satisfactory. (4) No. The 7/22 would be slightly the better of the two.

"A.F.W.A." (North Woolwich) asks (1) *The number of turns for four coils.* (2) *To what wavelength will a coil 10" x 1½" tune with a certain aerial.* (3) *For winding data for a certain H.F. transformer.* (4) *If a variable condenser is necessary if there are four tappings in the H.F. transformer primary.*

(1) For 400/600 metres, 100 turns. For 500/1,000 metres, 150 turns. For 900/1,500 metres, 250 turns. 1,500/3,000 metres, 400 turns. These should be approximately correct, but the exact value should be determined by experiment. (2) About 1,200 metres. (3) It is very difficult to predict this at all accurately. Try about 200 turns for each winding, with taps at 30, 60 and 100, but considerable adjustment may be found necessary. (4) This would be desirable for the range suggested.

"F.H.W." (Madeira) refers to the article on the American short wave receiver in the issue of June 3rd, and asks (1) *If there would be any advantage in winding the coils with a coil winder.* (2) *If it would be better to use a telephone transformer instead of connecting the telephones in the H.T. circuit.* (3) *If a telephone transformer is used should the variable condenser be connected across the transformer primary or across the telephones.* (4) *What type of transformer would suit the instrument.*

(1) Not for short wavelengths. (2) It can be done, but there is no appreciable advantage. (3) Across the primary. (4) Any normal type of telephone transformer will do.

"FLAX" (Persore) asks (1) *For details of telephone transformer for Brown's 120 ohm telephones.* (2) *If L.R. telephones with transformer*



MARCONI
GIVES
UNRIVALLED
WIRELESS
SERVICE

The MARCONI INTERNATIONAL
MARINE COMMUNICATION CO. LTD.
MARCONI HOUSE, STRAND, LONDON.

“BRITWIRE” CONDENSERS.

OWING to the demand for a good condenser, which at the same time is cheap, we are now manufacturing a Balanced Condenser for panel mounting, replacing the imported condensers hitherto sold. The plates are die-cast into the supporting columns, and are counterbalanced so that they will remain in any position when mounted on an upright panel. At present only two capacities are being manufactured, viz.: '0005 and '001, but other capacity condensers will be made in due course. Immediate delivery.

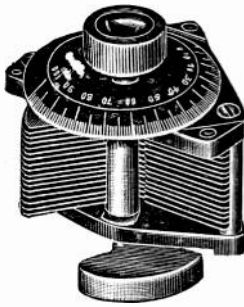

PRICE

WITH EBONITE REVOLVING SCALE:

'0005 mfd.	17/6
Mounted in solid mahogany case, ebonite top	30/-
'001 mfd.	25/-
Mounted in case	37/6

Retail Orders over 40/- carriage paid.

Send for Illustrated List of all Component Parts, post free 3d.

POST ORDERS TO—

BRITISH WIRELESS SUPPLY COMPANY

6 BLENHEIM TERRACE, LEEDS.

Telephone: 26926

LTD.

And at

11 Church St., West Hartlepool. Tel. 373. 18 Eldon St., Newcastle-on-Tyne. Tel. City 360.
33 High Street, Southampton Telephone 403.

Visit our Stand No. 42. All-British Wireless Exhibition, Horticultural Hall, Sept. 30th to Oct. 7th.

“Exide” BATTERIES FOR WIRELESS

“I don't think that sufficient insistence is placed on the fact that the usual cheap Accumulator is unfitted for more or less prolonged illumination of more than one valve.”—*Amateur Wireless, 9th August, 1922.*

Exide batteries can be relied upon for wireless work and retain their charge over very long periods.

Prices and Particulars on Application.

THE **Chloride** ELECTRICAL STORAGE COMPANY LIMITED.

Head Office : London Showrooms :
Clifton Junction, 219/229 Shaftesbury Av.
Nr. Manchester. W.C.2

Visit our Stand No. 30. All-British Wireless Exhibition,
Horticultural Hall, September 30th to October 7th.

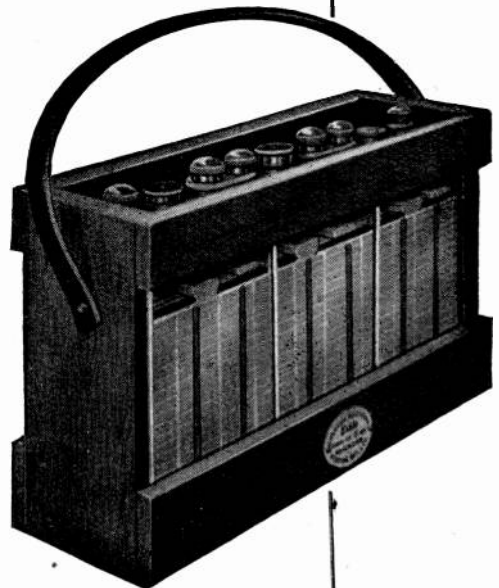

6 Volt 80 Amp. Hour Exide Battery.

are as suitable for one, two or three-valve sets as H.R. telephones.

(1) Use a core 4" x 1/2" of soft iron wires. For the L.R. winding, 6 ozs. of No. 32, and the H.R. winding, 3 ozs. of No. 44. (2) L.R. telephones are quite suitable. They are slightly less sensitive but somewhat less liable to break down.

"ACK EDWARD" (Ferndale) refers to the Armstrong super-regenerative circuit recently described, and asks (1) Winding data of the inductances L.1, L.2, L.3, L.4 and L.5. (2) For the capacities of the variable and fixed condensers in the secondary circuit Fig. 1. (3) The capacity of the variable condenser in the oscillator circuit.

(1), (2) and (3) The values of inductance and capacity in L.1, L.2 and L.3 circuits, should be those normally used for short wave work. The L.4 and L.5 circuits should have constants suitable for about 30,000 metres. The best proportion should be determined by experiment with the particular valves used. We consider that it is unlikely that an amateur will be able to get a circuit like this to work satisfactorily unless he has sufficient experience to construct circuits from the above data. See page 648, August 19th issue.

"N.H.E." (Four Oaks).—It is preferable to put the rectified oscillations through an earlier valve for re-amplification. For one of the various possible circuits see Fig. 5. A 1/3 transformer as suggested will be suitable.

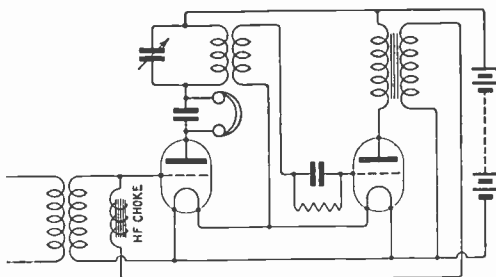

Fig. 5.

"R.S.C." (Bath) asks for directions and a diagram for making a set with a range of 500/800 miles.

We are afraid your requirements are too vague for us to help you much. For instance, the range depends on the transmitting stations power. You could get 800 miles on Eiffel Tower with a crystal, while there is no set in existence capable of the distance on short wave broadcasting telephony. For all round purposes you might adopt a three-valve set described by Harris in the issue of July 15th, and the following numbers. The aerial should be as high and as long as possible, subject to the P.M.G.'s restrictions of a maximum length of 100 ft.

"R.A." (West Derby, Liverpool) refers to the Armstrong circuit, and asks (1) If the two inductances L.4 and L.5 must be of the same wavelength as the A.T.I. or does the condenser tune them to any wavelength. (2) Could the tapping at the top of the secondary be taken to the top of the A.T.I. instead.

(1) The inductances of the L.4 and L.5 need not be the same as that of the A.T.I. For satisfactory work the circuits in which they are placed should

oscillate on a wavelength considerably longer than that on which signals are being received, say 30,000 metres. For this purpose these coils should therefore be considerably larger than the A.T.I. (2) The tapping could be taken to the A.T.I. as you suggest, but results will not probably be so good. You will also probably get curious re-radiation results.

"E.M." (Ipswich) asks where he can obtain single layer inductances for the set described on page 471 of July 15th issue.

We do not know of any makers who are turning out coils exactly suitable for this set, as in general anyone using a set prefers to wind his own coils—a quite easy matter. You could, of course, obtain suitable formers from most dealers, or you might obtain the finished coils to order from such firms as advertise their willingness to make up articles to clients' specifications.

"M.B." (N.19) asks for advice in the construction of his aerial.

Your aerial might be run across the roof as suggested, but it will not be very efficient unless its supporting masts are fairly high, as the effective height will only be approximately the height of the wires above the roof, and not the height above the ground. See Article on Aerial Construction on page 259, May 27th issue.

"D.G.N." (Harpenden) asks (1) If a circuit using reactance capacity for H.F. amplification is more efficient than a circuit using a plug in the H.F. transformers. (2) If a single layer coil or various proprietary types are most suitable for short wave reception. (3) For winding details of certain coils. (4) If there is any definite ratio between the primary and the secondary of honeycomb coils.

(1) There is very little to choose between good examples of these two types. (2) For short waves we prefer single layer coils, the remaining types are all of approximately the same efficiency on short waves. (3) In order to tune to 11,000 metres, the A.T.I. should be 6" long, wound with No. 22; closed circuit, 5" of No. 24; reaction, 4" of No. 28. (4) No.

"C.W.N." (East Croydon) asks (1) What is the wavelength range of a certain aerial loading coil. (2) The wavelength range of a certain loose coupled tuner. (3) What capacity air condenser is needed to tune "STI" coil to 3,500 metres. (4) If he would get better results on long wavelengths by using "STI" coils wound with No. 26 or No. 28 wire with more tuners.

(1) The inductance should be 6,000 mhs. This will tune the P.M.G. aerial to about 2,250 metres. (2) The inductance should be 2,000 mhs. (3) 0.002 mfd. (4) Yes.

"E.J.B." (Bath) asks (1) For a diagram of a four-valve set for receiving telephony and C.W. up to 10,000 metres. (2) The values of inductance capacity, etc., for this set. (3) What is the best type of valve to use. (4) If a 220 volt main, with suitable resistance, will answer as H.T. instead of usual dry cell battery.

(1) See Fig. 7, page 438, July 1st issue. (2) The A.T.C. 0.001 mfd., secondary condenser 0.0005 mfd. For tuning we should recommend a set of honeycomb coils with the number of turns ranging from 30 to 750. (3) Any good class valve now on the market should be O.K. (4) D.C. mains

can be used if desired, the method being as given in the issue for June 17th issue.

"H.F.C." (Birmingham) encloses a diagram of his four-valve circuit and asks (1) For criticism. (2) For full details of constructions of the four transformers in sketch. (3) For the names of three of the most distant stations this set will receive.

(1) The set is O.K., except that too much L.F. amplification is used. We should prefer the circuit of Fig. 7, page 438, issue for July 1st. (2) We regret we have not the required information available. (3) You should hear London and other British broadcasting stations at similar distances; also the higher power stations FL and probably PCGG.

"T.M." (—) asks (1) For winding data for a tuner, wavelength 180/700 metres. (2) If a certain arrangement of aerial will give increased range and louder signals on wavelengths over 1,000 metres. (3) Number of foils as per sample required for the condensers described; also a formula for calculating their capacity. (4) If a certain transformer would be any use as an intervalve or telephone transformer.

(1) The A.T.I. 6" x 4" of No. 22, with four tappings, say about $\frac{1}{4}$ lb. of wire. Closed circuit 5" x 2 $\frac{1}{2}$ " of No. 28 with four tappings. Reaction 4" x 3" of No. 22 with two tappings. (2) We cannot say as you do not describe the present aerial. Probably not much difference. (3) Your samples have not come to hand. For formula see reply to "Radio 3 UC," August 5th. The area of overlap means "the area (measured on one side only) of the part of each piece of mica which has foils on both sides of it." The formula will enable you to determine the capacities required. (4) Impossible to say from the few particulars supplied. If you could let us have sizes of wire and resistances of various windings we could advise you.

"JUST COME UP" (Halifax) refers to the four-valve set described in the July 15th and 22nd issues, and asks (1) How to connect the two instruments together. (2) What coils to use from 180 ms. up to the Dutch concert. (3) The respective uses for stand-bi and tune. (4) If the primary coil is between the reactance and the secondary.

(1) Connect the detector terminals of the tuner to the input terminals of the amplifier, and the reaction terminals on the two instruments together. (2) Use coils with about 40 turns on each for the shortest lengths, and about 120-150 turns for the Dutch concerts. (3) "Stand-bi" is used for finding the required station, as the receiver in this condition is much less selective than when on tune side. When the desired station is found it is generally best to switch over to tune, in order to get the extra selectivity. (4) The secondary should be between the primary and the reaction coil.

"J.H.D." (Hollingbourne Manor) asks if the amplifier described by Mr. Campbell Swinton in the issue of June 25th is suitable for short wave telephony.

The circuit suggested should be quite satisfactory for your purpose. The reason for the increased spacing required is probably that your coils themselves are bigger than the originals. Possibly poor results with PCGG are due to the inefficiency of the H.F. transformers at this wavelength,

although the transmitting station is not very good at the time of writing.

"E.H.L.S." (New Jersey) asks (1) For a diagram of a three-valve receiver with a range of 150/15,000 metres. (2) What kind of valves should he use with this receiver. (3) Where he can obtain French "R" valves. (4) What should be the voltage of the H.T. battery for this set.

(1) See Fig. 1, page 435, July 1st issue, but omitting the reaction there shown. (2) Any standard hard valve on the market will be suitable. (3) We are afraid we are not sufficiently conversant with the sales position in the U.S.A. to advise you. You might consult the Radio Corporation of America, but you will probably find some difficulty in getting these valves in the U.S.A. (4) It depends on the voltage of the valve used, which will be stated by the makers or vendors. The values vary from 30 to 80 volts.

"TYRO" (Chelsea) sends a diagram of his single valve set and asks (1) How to add a four-valve amplifier with H.R. telephones or loud speaker; also capacities of condensers, types of valves, etc. (2) If a second variable condenser in parallel with the secondary coil would improve results.

(1) In view of the drastic alteration proposed it would be best to scrap the present panel and incorporate the components in a five-valve set on the lines of Fig. 1, page 570, issue for July 29th. Suitable values for the component parts have been repeatedly quoted. (2) The condenser, as suggested, would not greatly improve results, but a fixed condenser across the telephones would be desirable.

"P.H." (Esher).—Full information for the construction of a set of the type you require with four valves will be found in the issues for July 15th and 22nd.

"RECTIFIER" (Tottenham) asks what battery voltages to employ with "Ora" valves.

Forty volts should be sufficient for the plate, and 4 volts for the filament, but a 6-volt battery allows rather more latitude for filament lighting.

SHARE MARKET REPORT.

Prices as we go to press on September 1st are:—

Marconi Ordinary	£2	5	0
„ Preference	2	2	6
„ Inter. Marine..	1	9	0
„ Canadian	10	0	

Radio Corporation of America:—

Ordinary	1	2	0
Preference	14	0	

MANUFACTURING
FOR THE
TRADE

We specialise in the manufacture of **WIRELESS** and **INSULATING** parts, and solicit your enquiries.

The production of Variable Condensers, Handles, Resistances, etc., is being continued and we can deliver large numbers **FROM STOCK**

J. BURNS, LIMITED,
Chadwell Heath, Essex.

Super VII*

The most efficient Receiver

Price

£4 2s. 6d.

less Valve.



You require this Receiver

Write for full particulars.

GORDON CASTAGNOLI
MANUFACTURER OF WIRELESS APPARATUS
15, Rayne Road, Braintree, Essex

30 YEARS' REPUTATION

Built to "Stand the Racket"

For all his light-weight, easy-running qualities, Blick is hard as nails and guaranteed for three years to stand up against hard knocks in every part of the globe.

The wireless man on board ship or in a lonely outpost of the Empire finds in his Blick a working companion always ready to help. Blick types messages, signals, reports or writes personal letters home with equal facility. Extremes of climate never put him "out of condition." He requires little elbow-room and packs neatly into his travelling case when not in use.

Write Now for Full Particulars

Blick's cost is moderate. You can buy him, complete in Handsome Travelling Case, for £13 : 13 : 0. Write for Booklet 68, which gives full particulars of easy payments, specifications, etc.

THE BLICK TYPEWRITER COMPANY, LTD.
9 & 10, CHEAPSIDE, LONDON, E. C. 2.



The **Blick**
UNIVERSAL

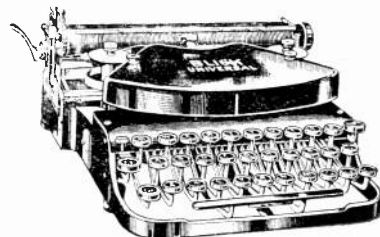

3 YEARS' GUARANTEE

“Ever-Ready” *British Made*

DRY CELLS BATTERIES

were the first in the field, and their fine qualities make them peculiarly suited for wireless installations.

THE ‘UNIT’ DRY CELL

“Build up your batteries as you build up your Marconi sets.”

Unlimited flexibility in size, voltage and intermediate tappings. Each cell is fitted with brass screw terminal and looped wire, and they are efficiently insulated to prevent current leak.

No. UW1 7/6 dozen
EMF. 1½ volts Weight 3½ ozs.
Dimensions 2¾ ins. × 1 5/16 ins. Diam.

Art catalogue of standard sizes and list of accumulators for valve filament supply sent on request.

The EVER-READY Works, Hercules Pl., Holloway, LONDON, N.7
Visit our Stand No. 11. All-British Wireless Exhibition, Horticultural Hall, September 30th to October 7th.

HIGH TENSION BATTERIES

Any size or voltage with any tappings or sockets at 3 or 6 volt intervals for use with wander plugs can be supplied to order.

With 13 Sockets

No. W. 19, 36 volts, 24 cells, 8/6 each.
Size 6½ × 2½ × 3½. Weight 2 lbs. 8 ozs.
Wander plugs for use with above, 1/- per pair.

With 2 Spring Contacts. As illustrated.

No. W. 11, 15 volts, 11 cells,
3/6 each. Size 9½ × ¾ × 2½
Weight 1 lb. 2 ozs.

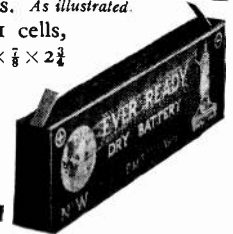

---CQ Std bi for ERICSSON PHONES

WHEN you instal your wireless set—crystal or valve—you'll get maximum results if you fit Ericsson Phones—clarity, sensitivity, strength of signals and absence of “click.” Specially suited to telephony.

Ericsson Phones embody the accumulated experience of telephone manufacture for a generation.

Easy to the head, light and comfortable. The magnets never lose their strength and “shorts” are non-existent.

Write for Particulars

The BRITISH L. M. ERICSSON
MANUFACTURING Co., Ltd.

Head Office:
60, Lincoln's Inn Fields, E.C.2

Ericsson

Telephones

IMPORTANT— —NOTICE

A. C. COSSOR, Limited, hereby give notice that the order of Mr. Justice Russell of the 1st March, 1922, continually advertised by the Marconi Co., was an order ARRIVED AT BY CONSENT.

Being engaged at the time in the production of an improved and different type of valve, A. C. COSSOR, Limited, did not consider the patents in question of sufficient importance to warrant the expense of litigation.

A. C. COSSOR, Limited, respectfully leave the public and the Trade to judge whether the constant repetition of the notification of the judgment referred to is necessary or expedient in the circumstances.

Visit our Stand No. 29. All-British Wireless Exhibition. Horticultural Hall, September 30th to October 7th.

A. C. COSSOR, LIMITED
Aberdeen Works, Aberdeen Lane,
Highbury Grove, N.5

WIRELESS	
CRYSTAL RECEIVING SET.	
Specification.—Solenoid type inductance with tappings, .0005 variable condenser, perikon detector or galena, the whole being assembled on 1" ebonite, and mounted in a highly polished cabinet. This receiver is ideal for the reception of telephony. Wavelength, 180/1,800 metres approx. Price, complete with phones (4,000)	
	£5 12 6
CRYSTAL RECEIVING SET.	
Specification.—Double slide tuning inductance, galena detector with dustproof case, blocking condenser, the whole being assembled on a highly polished mahogany base, being an ideal receiver for the reception of telephony. Price, complete with phones (4,000)	
	£4 10 0
Filament Switches, under panel type, ebonite	3/9
Aerial Insulators	3d.
Valve Legs with two nuts	per set of 4 10 1d.
Ex-Govt. 2-valve Receiver (less valves etc.) ..	£7 5 0
Variable Condensers (21 plate) ..	17/-
H.T. Units, 15v.	3/3 & 3/9
H.T. Battery Boxes, complete with switch and fuses, etc.	6 6
Condenser Spindles with knob	1-
Grid Condensers	2/6
Valve Holders	each 1/-
Fuller Inert Cells, 1 1/2v.	9d
All Condenser Plates	per doz. 1/8
Crystals	per piece 6d.
Zincite	per piece 9d.
Valve Pins with nut	per doz. 1/9
Single-valve and 2-valve panels	16 6
Accumulators for Valves	from 4/6
Dutch Concert Coils	per pair 4/8
Inductances wound on formers	4/8
Aerial Wire, 7/22	per 100 ft. 5/8
Microphones with replaceable insets	2/6
H.T. Leads (red and black)	each 4d.
Phones, new (4,000 m.), double	30/-
Ebonite Knobs	each 6d.
Switch Arms, laminated with bush	2/-
Carriage Free on £1 and over.	

C. S. SWAN, 191 Bishopsgate,
(NEXT TO BRANDON'S).
and 65 Windsor Road, Leyton, E.10 E.C.2

RADIO INSULATION

AS SPECIFIED AND USED BY THE BRITISH ADMIRALTY

BRITISH MADE

PAXOLIN

BRITISH MADE

TUBES DISCS PLATES, &c.

MANUFACTURED IN ALL FORMS, SIZES AND THICKNESSES

BY

THE MICANITE & INSULATORS CO. LTD.
EMPIRE WORKS

WALTHAMSTOW

LONDON, E.17

TELEGRAMS: "MYTILITE, PHONE, LONDON."

TELEPHONES:—WALTHAMSTOW 738, 739

SPECIAL OFFER! Crystal Receiving Sets from 37/6.
 46 Silk Covered Wire 2/6 oz. Parts and Complete Sets.
Stamp for List.
I. K. STEVENS & CO., Wireless Section, 32a, Chester Street, Grosvenor Place, S.W.1
 Trade Inquiries Invited. Phone—VICTORIA 5837.



SKINDERVIKEN BUTTON.
A Supersensitive Microphone.
 Known all over the world and patented in every civilized country. Over 60,000 sold. ENGLISH Manufacture.
Make up your own Loud Speaker.
 Transmit your GRAMOPHONE music to any room in your house.
 The only practical Microphone for use in Detectophone Sets.
Price 5/- each
 Special Low Resistance Receivers (for use with Skinderviken Buttons) 10/- each
 Special Gramophone Attachments 1/- ..
 Write for 16 page BOOKLET fully illustrated and containing much useful information for all interested in Electrical Sound Transmission. 6d. Post free.
Sole Proprietors:
MIKRO LTD., 274/6, Pentonville Rd., London, N.1
 (Opp. King's Cross (Met.) Ry Station).

SENSATIONAL REDUCTIONS.
 Valve Holders, 2 nuts on each leg. 1/- Post 3d.
 Condenser Plates. Fixed or moving. 1/- per doz. Post 3d.
 Washers for fixed plates 3d. per doz. For moving 5d. per doz. Post 2d.
 Threaded Rod for Spindles, etc. 5d. per foot. Nuts for same 3d. per doz.
 3" Semi-Circular Scales 0-180 degrees. 8d. each. Post 2d.
 1 1/2" Ebonite Knobs with threaded centre. 6d. post 2d. Pointers 2d.
 Stop-pins 1/- doz. Bush and Lock Nut 5d. Extension Handle 4d.
 Valve Legs or Sockets 1/10 per doz. Post 3d. (complete with screw or nuts).
 Mark III Terminals with nuts 2/3 per doz. Post 4d.
 Vernier Condensers, 3-plate 6/-; 5-plate, 7/- Post 9d.
 7-Strand Silicon Bronze Aerial Wire, per 100 ft. 4/-, per 150 ft. 5/9. Post 9d.
 Filament Resistances for panel mounting 3/9. Post 3d.
 These are only a few of the numerous items contained in our Catalogue which will be sent free with order.
SCIENTIFIC SUPPLY STORES, 8, Newington Causeway, LONDON, S.E.1
 Phone—Hop 4177.

THE
PARAGON RUBBER MANUFACTURING CO.
SCULCOATES, HULL.

E BONITE Sheet, Rod & Tube ELECTRICAL MOULDINGS	WIRELESS KNOBS V A L V E S SLIDERS, Etc.
--	---

Wholesale only.
 London Office: **PERCY W. C. TRICK,**
 20, LITTLE PORTLAND STREET, W.1
 Telephone: MUSEUM 2043.

I HAVE IN STOCK
5000 BROWN'S
PAIRS (120 ohms) "A" PHONES
 NEW AND UNISSUED
 POST FREE **40/-** PER PAIR
CASH WITH ORDER

WILKINSON, Lonsdale Rd., Kilburn,
 TRADE SUPPLIED (Same address since 1900) N.W.6

THE TINGEY UNIT SYSTEM
 HAS PROVED ITS EFFICIENCY
Write for
ILLUSTRATED CATALOGUE
 (3d. post free)
 which contains an article on
 Wireless Made Easy and a
Complete List of all Wireless Goods in Stock
 Visit our Stand No. 25. All-British Wireless Exhibition, Horticultural Hall, September 30th to October 7th.



W. R. H. TINGEY, 92, Queen Street, Hammersmith, London, W.6.

LISTEN - IN — on the
 A complete Installation at a low cost
"AEROWAVE" RECEIVER



Price **£6 : 6 : 0**
 with complete Equipment

HENRY J. BREWSTER & CO.
 11, Queen Victoria Street, LONDON, E.C.4

North Wales Wireless College & Amateur Supplies
COLWYN BAY. Phone 407.

Most Complete Stock of all Wireless Instruments and Accessories.
PROMPT DELIVERIES.
LIST BY RETURN. 1/4d. STAMP.

Students prepared under ideal conditions as Wireless and Cable Operators.
POSTAL AND RESIDENTIAL TUITION.
SPECIAL POSTAL COURSE FOR AMATEURS.
PROSPECTUS POST FREE.

The London Telegraph Training College, Ltd.

Telephone
WESTERN 2696.

Morse House, Earl's Court, S.W.

ESTABLISHED
25 YEARS.

OFFICIALLY RECOGNISED BY THE WAR OFFICE AND POST OFFICE AUTHORITIES

CABLE AND WIRELESS TELEGRAPHY.

PARENTS desirous of placing their sons in either of the above Services and of affording them the best training facilities should apply for particulars of Courses and the methods of instruction which place this Institution in the first rank. **Cable Telegraphy** offers at the present time excellent prospects to youths from 15 years of age and upwards, and **the College has exclusive facilities** for obtaining posts for qualified students in the leading Cable Companies at **commencing salaries** of £150 to £300 per annum, with yearly increments of £12 to £25, and ultimate possibilities of obtaining positions as Supervisors, Assistant Superintendents, Managers, etc.

In the Wireless Telegraph Service the commencing remuneration at the present time is approximately £150 per annum, and Operators, when qualified by obtaining the Postmaster-General's Certificate of Proficiency, are nominated by the College for appointments.

No Correspondence Classes or Branches.

DAY AND EVENING CLASSES.

Prospectus containing all information will be forwarded on application to

THE SECRETARY (Dept. H.), 262, Earl's Court Road, Earl's Court, London, S.W.5

Sole Proprietors of the "Scott" Training Disc, which contains useful formulæ and other information for Wireless Telegraph Operators and is invaluable to Army Signalling Officers for range finding, etc.

Price, complete with instructions for use, 1/-. Postage 2d.



VERNIER ADJUSTMENT FOR SLIDERS

Complete with 13 in. bar.
Bar and Slider - **4/6**

TELEPHONE TRANSFORMERS

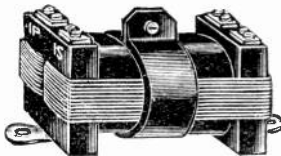

Unmounted (as illustration),
Suitable for 120 w Phones.

Unmounted - - - - - **15/-**
In Box with Terminals - - **18/6**

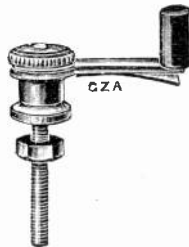

Neat "ON" and "OFF" Switches

As illustrated - - - **2/3**

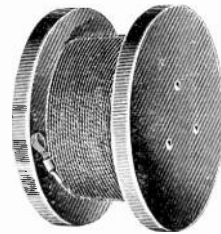

AERIAL WIRE

7/22 Enamelled Stranded.
100 ft. - - - - - **6/-**
150 ft. - - - - - **9/-**



CONDENSER SCALES

Engraved 0-18)
With Knob and Bush - - - **3/9**

SINGLE LAYER, COILS

4½ in. diam. 9 in. long.
Wound with 24 Enamel.

Price - **6/6**

Visit our Stand No. **46.** All-British Wireless Exhibition, Horticultural Hall, Sept. 30th to Oct. 7th.

G. Z. AUCKLAND & SON, 395, St. John Street, E.C.1
'Phone - - - **3173 CLERKENWELL**

H.F. TRANSFORMERS to fit Valve Sockets

No.	Range	No.	Range
0	150	5	2500 8/3
1	300	6	6000 9/9
2	600	7	8000 12/-
3	1200	8	24000 14/3
4	1800		

There is a good latitude on these coils for higher & lower ranges.

H.B. COIL HOLDER

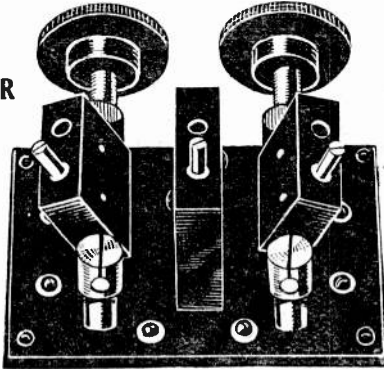

Standard fitting suitable for our "H.B." or any de Forest pattern coil. To take 3 coils £1 1 0

Fully Illustrated List post free 4d.

H. D. BUTLER & CO., LTD

Office & Showrooms:
Bank Buildings, 222, Gt. Dover Street, Borough, S.E.1
Telephone: Hop 3029. Works: Canonbury, London, N.7.
Works North 1838. Telegrams: "Ingenuity Phone, London."

The Cheapest and Most Efficient 3-Valve Set on the Market

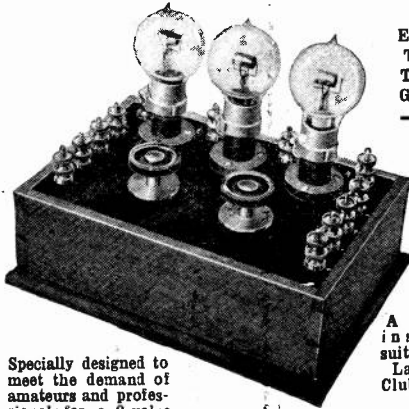

Every Set Thoroughly Tested and Guaranteed.

A portable instrument suitable for Laboratory, Clubroom or Home.

Specially designed to meet the demand of amateurs and professionals for a 3-valve detector - amplifier unit giving simplified operations

In conjunction with our Universal Tuner, this constitutes the most efficient, compact and easily operated 3-valve receiving station ever offered.

Beautifully finished and fitted in handsome polished light oak case. Range of reception for Wireless Telephony, about 500 miles.

£5 15s.
Valves Extra.

J. LIPOWSKY, ELECTRICAL AND WIRELESS ENGINEER.
614, OLD FORD ROAD, BOW, LONDON, E.3
Telephone: East 3345.

NEW DESIGN COIL MOUNT COMPONENT

THIS component has been designed as a result of numerous enquiries we have received, and it has been our endeavour to produce an efficient and simple design at a reasonable price.

The Coil Mount is so designed as to enable it to be fixed to almost any existing instrument, and is such that the operator can make any adjustment of the coils without having the necessity of placing the hands near them. The advantages of this arrangement will be readily appreciated on the use of short wavelengths.

The method of adjusting is very simple, the rod being moved backward or forwards, as required, to an approximate position and a final adjustment being made by bringing the threaded portion into action on the holder.

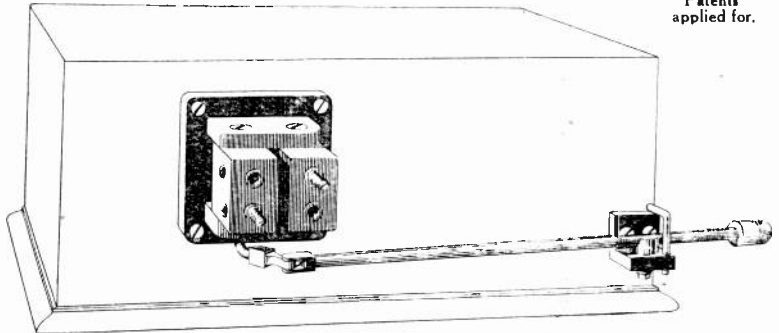

Patents applied for.

Dimensions—Actual Fitment, 2½" x 2½". Length of Adjusting Rod, 6½"
The coil mounts themselves are arranged to take any standard make of coil plugs.

PRICE **22/6 EACH. POST FREE**

Delivery upon receipt of Cash with Order.
Orders executed in strict rotation
TRADE TERMS UPON APPLICATION.



The Manchester Radio Co., Limited
155, OXFORD ROAD, MANCHESTER
(Entrance Boundary St. East). Telephone—Central 4935

F. H. McCREA, Managing Director.
W. R. BURNE, Directing Experimental Dept., Winner of Transatlantic Test.

ONE QUALITY ONLY
THE BEST.

EBONITE

FROM STOCK.

Sheets, Rods, Tubes, Panels, Bevelled Dials, Fil. Resist, Bases, Knobs, 4" discs., Slider Knobs, Head Phones, Aluminium Vanes, Variable Condensers.

Wholesale only.

SYDNEY JONES, 31a, SPRAY STREET, WOOLWICH, S.E. 18

SPEARS and COMPANY

FOR

TERMINALS

SCREWS, NUTS, WASHERS, PLUGS and SOCKETS, CONTACT STUDS, BUSHES, VALVE LEGS, CONDENSER VANES and TURNED and PRESSED PARTS OF EVERY DESCRIPTION.

Actual Manufacturers to TRADE ONLY

WE REGRET WE CANNOT SUPPLY SMALL LOTS TO AMATEURS

CAPSTAN REPETITION WORKS,
PARK ROAD, HOCKLEY, BIRMINGHAM
Telephone: 3265 Central. Telegrams: "Firettes," Birmingham

3

Three Points we ALWAYS watch
QUALITY—PRICE—SPEED

Send two stamps to-day for our Lists
and test our service for yourself.

ELECTRICAL SUPPLY STORES,
5, ALBERT TERRACE, KING CROSS,
HALIFAX.

Halley Single Valve Receiver, will receive telephony C.W. and spark	50/-
Halley 2-valve Receiver, gives excellent results on telephony	£4/4
Low Frequency Transformers	16/6
Valve Sockets	1/6
Ebonite Knobs	81.
Gridleak Condensers	2/6
2 Megohm Leaks	3/-
Set of 7 Slab Coils, 300 to 10,000 metres	7/6
Lead-in Insulators	2/6
Egg Insulators	6d.
Pillar Insulators	91.
Filament Resistances	3/6

Send now for our New List of Bargains.

A. & J. THOMPSON,
5, Westborough, Scarborough

Do not Waste your Money

ON INFERIOR GOODS. OUR MANUFACTURES ARE ALL HIGH CLASS AND ARE FULLY GUARANTEED.

VALVE AMPLIFIER, 39/-. DETECTOR, 29/6.
CRYSTAL DETECTOR (OF UNIQUE DESIGN), 5 -.
TELEPHONE TRANSFORMER (UNMOUNTED), 17/-.
STRONGLY MADE 5 OHM. FILAMENT RESISTANCE, 4/6.
EBONITE SHEET, ROD, TUBE, ANY SIZE CUT.
AERIAL WIRE, SILK AND COTTON COVERED COPPER WIRE, RESISTANCE WIRE, ANY QUANTITY SUPPLIED.

SPECIAL. AMATEURS ARE SPECIALLY INVITED TO SEND THEIR EBONITE BASES TO BE ENGRAVED. DIAGRAM SHOULD BE INCLUDED. VERY LOW PRICES.

EVLINS Mail Order Office—
126, FOREST ROAD,
DALSTON, LONDON, E8

Price List Post Free on application. TRADE SUPPLIED.

BEWARE !!

OF GOODS SOLD WITHOUT A GUARANTEE.
ALL OUR INSTRUMENTS ARE GUARANTEED.
SINGLE VALVE RECEIVER. First quality components only used. Polished instrument case. 38/6, post 1/-.
TWO-VALVE RECEIVER Note Magnifier. Our star turn. A perfect amplifier at a moderate price. £4. post 1/6.
THREE-VALVE AMPLIFIER. 1 H.F., Rect. 1 L.F. The ideal amplifier for spark, C.W. and telephony. Range unlimited. The instrument for demonstrations. 28 8s. post free.
TELEPHONY TUNERS. Improved pattern. 300, 1, 100 metres. Single layer type, rotary magnetic reaction coil. A two-guinea instrument at 25 -, post 1 -
VALVE SOCKETS on 1" Ebonite.
1 Valve, 1 6; 2 Valve, 2 9; 3 Valve, 4 6. Post 6d. extra.
Ebonite panels cut and drilled to your plans.
ADVICE GRATIS. TRADE AND RETAIL.
AT YOUR SERVICE:

EAST LONDON INSTRUMENT CO. (Postal Dept.).
28, NORTHBANK ROAD, WALTHAMSTOW, LONDON, E.17.

NO. 1. JUST OUT! NO. 1.

1/- RADIO CHART

Post Free

"The Care and Maintenance of Accumulators."

By G. D. HINKS, A.M.J.Inst.E., A.I.RadioE.

In addition to being full of comprehensive matter concerning Accumulators, there are also several diagrams relating to Wireless Receiving Circuits. Obtained direct from the Publishers:—

PUBLISHING BRANCH,
G. D. HINKS, HARDINGTON, YEOVIL.

THE WIRELESS AGE

THE AMERICAN MONTHLY JOURNAL OF WIRELESS TELEGRAPHY AND TELEPHONY

A "Go-a-head" Magazine for Operators and Amateurs.

Sole European Agents: THE WIRELESS PRESS LTD., 12-13 Henrietta St., Strand, London, W.C.2

**G. R. C. 25
AMPLIPHONE™**

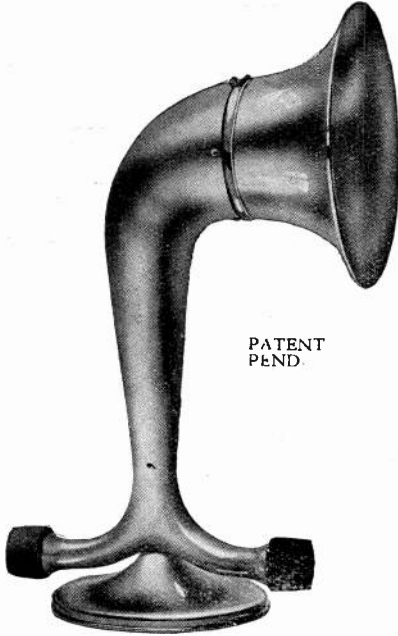

LOUD SPEAKER.

Just slip your headphones on the "Ampliphone" and you have a perfect Loud Speaker. Nothing further required. Most Loud Speakers are merely a single receiver attached to a horn. With the "Ampliphone" the volume is doubled because two headphones are blended into one powerful, tone—and you save half the usual cost when you buy the "Ampliphone."

Polished cast Aluminium body with nickel-plated base and horn—a fine addition to any receiver.

PRICE £2 : 2 : 0

When you forward your order, request a copy of our Catalogue. It will interest you.

Factors and Dealers.—We protect you with reasonable discounts and prompt deliveries.

Manufactured by

GENERAL RADIO COMPANY

Affiliated with The

COX-CAVENDISH ELECTRICAL CO., LTD.

Twyford Abbey Works,

HARLESDEN, N.W.10.

SHOWROOMS:
105, Great Portland Street,
LONDON, W.1.

Branches:
Danefield, Church Street,
BRADFORD.
15, Hanover Street,
EDINBURGH.

AGENTS:
WIRELESS SUPPLY CO.,
High Street,
BIRMINGHAM.

MOTTERSHEAD & CO.,
7, Exchange Street,
MANCHESTER.

And all Principal Countries.



Wireless Apparatus and Accessories of high efficiency and precision.

Order only goods bearing the Stuart insignia. This is a guarantee of satisfaction.

BE READY for General
BROADCASTING
Of CONCERTS, SPEECHES, Etc.

PLACE YOUR ORDER NOW FOR

**THE STUART
3-Valve Family Set**

Price Complete **£26-10-0** Early Deliveries

You cannot buy a better Wireless Receiving Set. Absolute efficiency, Enormous Range, supplied ready for installation.

Wireless installation of the high quality of the STUART is a necessity in all homes, public buildings, etc. Special requirements catered for. We draw your careful attention to our

HIGH - GRADE SPARES & ACCESSORIES.

The Stuart Transformers. Accumulators and Batteries.
The Stuart High Frequency Anode Tuners. All Sundries.

THE FINEST IN THE WORLD.



Brown Loud Speaker.

**BROWN
AND
MAGNAVOX
Loud Speakers**

Telephone Head Sets, Valves, Etc., Etc.

Immediate Deliveries from our own stocks.

Write or call for prices and full particulars. You are cordially invited to our showrooms for demonstrations and advice.

Cash or credit terms arranged.

Trade Supplied.

The Stuart Wireless Telephony Co.

Kingsway Corner Buildings,

Telephone :
Holborn
857
(4 lines).

**109, KINGSWAY,
LONDON, W.C. 2.**

Telegrams :
Phonetel,
Westcent,
London.

CONDENSERS

ALL TYPES AND VALUES.
EVERY ARTICLE GUARANTEED.
FINEST WORKMANSHIP
AND FINISH.
BRASS WORK
POLISHED AND LAQUERED.

Value in M.F.	Panel Mounting in Parts	Panel Mounting Assembled	Cabinet Mounting in Parts	Cabinet Mounting Assembled	Cabinet Mounting Assembled in Cabinet	Polished Mahogany Cabinet
.0015 ..	23/-	25/6	24/-	26/6	33/-	6/3
.001 ..	16/9	19/6	17/9	21/-	26/-	5/6
.00075 ..	13/6	16/3	14/6	16/6	22/-	5/6
.0005 ..	10/6	13/-	11/9	13/9	18/-	4/6
.0004 ..	10/-	12/6	11/-	13/3	17/6	4/6
.0003 ..	9/-	11/6	10/-	12/-	16/-	4/-
.0002 ..	7/-	9/-	8/-	9/6	13/6	4/-
.0001 ..	6/-	8/-	7/-	8/6	12/6	4/-
Vernier ..	—	4/6	—	5/-	9/-	3/6

Bevelled Dial 2/- extra. Special Sizes Made to Order.

FILAMENT RESISTANCES

IMPROVED PATTERN. RELIABILITY GUARANTEED.
PRICE 4/- EACH. Delivery by Return

ALL SUNDRIES AND COMPONENTS IN STOCK.
ORDERS OVER 20/- CARRIAGE PAID.

The "Broadway" Radio Works,
Devonshire Road, Bexleyheath, Kent
H. L. LIDINGTON.

THIS IS THE BOOK!

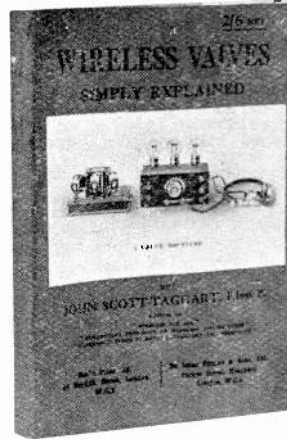

Price 2/6 Net. Cloth 3/- Net.

From all Dealers or post free direct from :

RADIO PRESS, LTD.

Publishers of Authoritative Wireless Literature,
34/35 Norfolk St., London, W.C.2

THE Crystophone

is all you require for any given range or degree of audibility.

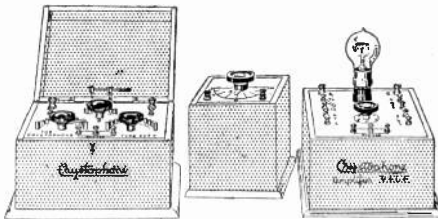

The Crystophone Combination, 20V., L.F.A., has a broadcasting range of 50 miles, and a degree of audibility 2-300 per cent. greater than any single-valve receiver on the market. Consists of:—

- Crystophone Type 20 T.T. ... £2 10 0
- .. V1 L.F. Amplifier ... £4 10 0
- .. Variable Condenser ... £2 0 0

The Crystophone complete Wireless Receivers range from £2 10 0 to 85 Guineas.

Catalogue on request.

WIRELESS SUPPLIES Co.

64, Mortimer Street, London, W.1.

Telephone—Museum 2672.
Telegrams—"Adragonax, Wesdo, London."

Crystor COWL INSULATORS

(Prov. Patent)
Guarantee 100% Efficiency
from Aerial to Receiver.

Crystor Aerial Outfits.

Single Wire Aerial. Containing 2 Crystor Cowl Aerial Insulators, 1 Crystor Cowl Lead In (vertical or horizontal), 100ft. Best Quality stranded copper Aerial Wire, 100ft. best Hemp Rope and one pulley block, packed in box. Price complete ... 21/-
Postage 1/6 extra.

Two Wire Aerial. Containing 4 Crystor Cowl Aerial Insulators, 1 Crystor Cowl Lead-In (vertical or horizontal type), 100ft. Best Quality stranded copper Aerial Wire, 100ft. best Hemp Rope, and one pulley block, packed in box. Price complete 25/-
Postage 1/6 extra.



Horizontal Wall or Window
LEAD IN
Price 10/6 Post Free



Vertical Roof
LEAD IN
Price 10/- Post Free

Compare these
**DRASTIC REDUCTIONS
IN PRICES**

- Aerial Wire, stranded hard-drawn, per 100', 3/6
- Aerial Pulleys, 1/6 each.
- Aerial Insulators, reel type, 2" diameter, white, 4 1/2d.
- Condenser Vanes, best aluminium, 10d. per doz.
- Spacing Washers, small, 3d. per doz.
- Spacing Washers, large, 6d. per doz.
- Condenser Screwed Rod, 2 B.A., brass, per ft., 6d.
- Contact Studs, 1/2" head, nut and washer, highly finished, 1d. each, 11d. per doz.
- Ebonite, finest quality, 3/9 per lb.
- Filament Resistances, best quality, 3/6 each.
- Inductance Slider Rod, 1/2" brass, per ft. 5d.
- Silk Insulating Tube, all colours, 1 m/m, per yard, 5d.
- Ivoryine Tablets, 6d. per set of 6.
- Knobs, ebonite, 1 1/2" diameter, 7d. each.
- Knobs, brass bushed, to take 2 B.A. rod, 4 1/2d. each.
- Valve Legs, set of 4, highly finished, 8d.
- Valve Sockets, ebonite, 1/2.
- Tin Foil, pure sheets, 24 x 12, 2 1/2d. each.
- Switch Arms, 2/6 each.

The Home of Wireless Bargains
THE SCIENTIFIC WIRELESS CO.,
188 BRUNSWICK STREET,
OXFORD ROAD,
MANCHESTER.

Phone : Cent. 6839

WARNING.

MARCONI'S WIRELESS TELEGRAPH CO., LTD.,

A. C. COSSOR, LTD.

Marconi's Wireless Telegraph Company, Limited, **GIVE NOTICE** that an **ORDER** was made in the High Court of Justice, Chancery Division, by Mr. Justice Russell on the 1st March, 1922, restraining Messrs. A. C. Cossor, Ltd., from infringing the Marconi Company's Letters Patent Nos. 28413 of 1913 and 126658, except so far as Messrs. A. C. Cossor, Ltd. manufacture for H.M. Government.

Messrs. A. C. Cossor, Ltd., were further **ORDERED** upon oath to **DESTROY** all articles and apparatus (other than those constructed to the order of H.M. Government) made or used by them in **INFRINGEMENT** of these patents, and **TO PAY THE MARCONI COMPANY DAMAGES AND COSTS.**

The M-O Valve Company, Limited, of Osram Works, Brook Green, Hammersmith, London, W.6, is the only firm in this country licensed to manufacture thermionic valves under the patents belonging to the Marconi Company.

Any valve similar to those generally known as the "French type" constitutes an infringement of the above patents whether manufactured in this country or imported from abroad. Marconi House, Strand, London, W.C. 2.

**2,000 CONDENSERS
at £1 0 0 each. Cost £6 0 0**

THE MARCONI COMPANY

have in stock a large number of second-hand Condensers, particulars of which are:—

Container.—Teak, lead lined, fitted with two brass terminals, insulated with heavy ebonite bushes.

Insulation.—36 sheets of 21 oz. glass, 15 1/2" x 7 1/2", and oil (oil not included in price).

Overall Dimensions.—Height, 15". Length, 19 1/2". Breadth, 7 3/4".

The capacity as at present arranged is .0084 mfd., and will stand a pressure of 10,000 volts, but with slight extra expense these Condensers could be arranged to have a capacity of .03 mfd., and stand a pressure of 5,000 volts. As the Condensers are second-hand we can give no guarantee as to capacity or voltage.

These Condensers should appeal to engineers wishing to improve the power factor of alternate current supply systems.

These Condensers must be sold immediately so as to allow more room for storage purposes, and, in consequence, they are offered at the **GREATLY REDUCED PRICE** of £1 each for single Condensers, and a **REDUCTION ON THIS PRICE FOR QUANTITIES.** Packing and Carriage extra.

As the cost of these was over £6 each, it will be appreciated that they are now offered at **Bargain Prices**, particularly as a good number of them have had very little use and are practically equal to new. These Condensers can be viewed at the **Marconi Works, Chelmsford.**

MARCONI'S Wireless Telegraph Co., Ltd.,

MARCONI WORKS, CHELMSFORD.
grams.—"Expense, Chelmsford." Phone—141 Chelmsford.

ACCUMULATORS

Absolutely Guaranteed Best Quality

CELLULOID CASES.

4 volt 40 amp. 18/6	4 volt 80 amp. 28/2
4 " 60 " 21/6	4 " 100 " 30/-
6 " 40 " 26/3	6 " 80 " 37/3
6 " 60 " 31/9	6 " 100 " 41/6

PACKING FREE.

TRADE PRICES NOW REDUCED
Write for Latest List.

SPECIAL OFFER.

6 volt 44 Actual amp. Set three Glass Cells, sealed tops in well-made Teak Crate, a handsome set - - - - -	49/6
4 volt 24 amp., Celluloid Case, 11/9	Postage 1/-
2 " 16 " Ebonite " 3/9	Post Free.
Aerial Wire - - - per 100 ft. Coil	5/-

All Sizes of Accumulators Quoted for.

EXIDE ACCUMULATORS STOCKED
(Trade supplied)

Dynamos, Motors, Electrical Accessories,
Sulphuric Acid (write for lists) Stocked.

F. YATES & Son, Ltd

WHOLESALE ELECTRICIANS,

144, Church St., Kensington, London, W. 8

One Min. from Notting Hill Gate Sta. Phone—Park 4276.

Purchase from PETO at Popular Prices.

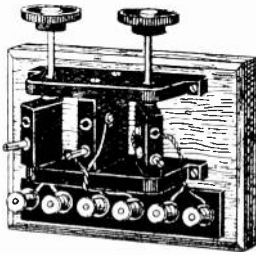

3 COIL TUNING STAND Price 20/-

THIS WEEK'S SPECIAL OFFER!

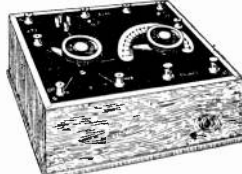

THE V.C. RECEIVER
(as illustrated)
PRICE £2 7 6
FULL SET OF PARTS TO CONSTRUCT Price 1 8 8
POLISHED MAHOGANY CABINET
4/- extra.

Consists of Complete Detector Panel and '0003 Condenser.

THE VELVET FILAMENT RHEOSTAT. Price 4/-

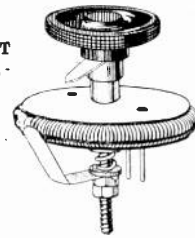

Visit our Stand/No. 18. All-British Wireless Exhibition, Horticultural Hall, Sept. 30 to Oct. 7.

The PETO Coil Holder supplied with bands for any diam. coil Price 2/-

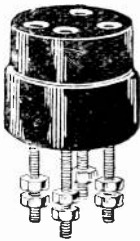

Solid Ebonite Valve Holders Price 1/6



The Condenser King.

Send for Illustrated Catalogue (W/W). Post Free 6d.

Featherstone Buildings, 64, High Holborn, London, W.C.1

Also at 17 Frome Road, Wool Green, N.

BATTERIES FOR WIRELESS

High Tension Block Accumulators

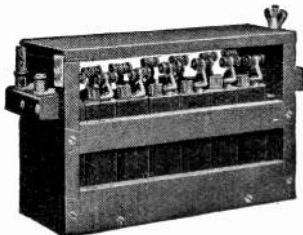

Block Accumulators, unlike the ordinary Plate Type, retain their energy for **12-18 months on one charge.** Unequaled for use with Wireless Thermionic Valves. Standardised sizes—1½ and 3 A.H. capacity.

Type	No. of cells	Voltage.	Capacity	Price
A 12/Z	12	24	1½ A.H.	£4 15 0
A 30/Z	30	60	1½ A.H.	£10 0 0
A 12/K	12	24	3 A.H.	£5 15 0
A 30/K	30	60	3 A.H.	£12 10 0

EBONITE—Rod, Sheet and Tube

Fuller Plate and Patent Block Cells (4 and 6-volt sets) are eminently suitable for Wireless Work.

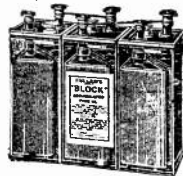

Fuller "Chad" Batteries



Designed for use in supplying the anode (sheath) circuit of thermionic valves for reception purposes. Expert tests in every case confirm its superiority over the Standard Battery usually employed.

Last much longer than ordinary Dry Cells, free from risks of leakage and short circuits.

Type	No. of cells	Voltage	Capacity A.H.	Price
A	8	12	1 approx.	5/-
	10	15	1 approx.	7/-
B	8	12	4½ approx.	11/9
	10	15	4½ approx.	16/-

FULLER'S UNITED ELECTRIC WORKS, LTD.

WOODLAND WORKS, CHADWELL HEATH, ESSEX.

Telegrams: "Fuller, Chadwell Heath."

Telephone: Ilford 171 (4 lines). London Telephone Area.



THE WIRELESS WORLD EXCHANGE AND MART

TARIFF. Advertisements are accepted for this Section at the rate of twopence per word, with a minimum charge of two shillings. The advertiser's name and address will be charged for and single letters and single figures will be counted as words. Compound words will be counted as two words.

DEPOSITS. All advertisements must be prepaid in the form of Postal Orders, the remittance being forwarded to Messrs. Bertram Day & Co., Ltd., 9 & 10, Charing Cross, S.W.1.

Intending purchasers may deposit the purchase money of any article advertised or sold by advertisers with Messrs. Bertram Day & Co., Ltd., who will acknowledge its receipt to the vendor and the depositor, the full addresses of whom should be given. Subject to special agreement between the parties, it is understood that all goods are sent on approval, each party paying carriage one way in the event of the goods being returned. The deposit will be retained until due advice of the completion of the purchase has been given or until the articles have been retained and accepted. In order to cover postage, etc., a fee of 6d. in respect of sums of £1 and under and 1s. for sums in excess of £1, must be paid at the same time as the deposit. For persons not resident in the United Kingdom these fees are doubled. We cannot undertake to receive any deposit less than 2s. 6d.

FOR SALE.

Two 15' Aerial Masts, wood, guys twin copper, P.M.S., aerial 6' spreaders, insulators, £2 10s. also wireless oddments. View any time.—7, Alma Square, St. John's Wood, N.W.8.

Lahmeyer Dynamos for charging, right for wireless. Highest quality, sizes to 200 Watts, stamp specifications, photographs, state requirements.—**GEORGE SMITH, 22, Quantock Road, Weston-Super-Mare.**

Valves, Valves, Marconi Osram, new. Unequaled reception telephony, C.W., Spark, 12s. 6d. Money returned if not satisfied. Write list.—**WEBB, Chidcock, Dorset.**

Two-Valve and Crystal Set, £5. Particulars **FORSTER, 56, Lucan Road, Aigburth, Liverpool.**

Two 24 H.P. Motor Generators, one 40' Mast Direction Finders, Drafting Instruments, etc., ex Admiralty surplus. Half prices.—**THE LONDON ELECTRIC FIRM, Croydon.**

Complete Wireless Installation, valve. In use, trial, particulars, photo, stamps, £6 10s.—**38, Balfour Road, Bromley, Kent.**

Polished Walnut Boxes, 13½" x 10½" x 5", dovetailed joints, tops and bottoms removable, fitted 9 brass sockets and 4 connecting plugs. 6s. plus 1s. 6d. postage, also 300' potentiometers, mounted on ebonite, Dewar switch, complete in teak case, 7s. 6d., plus 1s. postage.—**MOORE, 25, Eltham Hill, Eltham, S.E.9.**

Agate Cylinders, etc., for loud speaking apparatus from **JAMES R. GREGORY & Co., Mineralogists, 139, Fulham Road, S.W.3.**

Wireless Masts.—Improved Girder Type. Light and strong, 30 to 50 ft. at 1s. ft., 50 to 100 ft. at 1s. 6d. ft. Cash with order, carriage forward.—**F. ARMSTRONG, Weybridge.**

B.A. Screws, Nuts and Washers, assorted gross 2s. lists 2d.—**J. H. BENNETT, Station Road, Willesden Junction.**

Telephone Transformers and Condensers, complete units, four terminals, 7s. 6d. each, postage 9d.—**OSTICK BROTHERS, Long Eaton, Notts.**

Morse Inker, with key and buzzer, mounted on polished mahogany base, new condition, £5.—**HUSKINSON, 67, Crystal Palace Park Road, S.E.26.**

Amplifier, Four-Valve, L.F., five transformers, perfect. Price, £10 10s. P.C. full particulars.—**JAGO, Chertsey.**

For Sale, Complete Cabinet type four-valve Receiver, H.F. and L.F., complete with Brown's telephones, valves, H.T. batteries, two accumulators, price £20.—**Box S.2, BERTRAM DAY'S ADVERTISING OFFICES, 9 and 10, Charing Cross, S.W.1.**

Wireless Aircraft Telephones, 120 ohms, complete with headband and cords, 15s. Telephone transformers, 12s. 6d. Variable condensers, 5 plate 4s., 25 plate 10s. 6d., 59 plate 17s. 6d. Telephones, 4,000 ohms with headband and cords, 27s. 6d. Lot of sundries to clear, cheap.—**LASSMAN, 429, Barking Road, East Ham.**

Marconi Mark III Receiving Set, converted to Valve, offers wanted.—**RACKHAM, "Littlecot", Windsor Road, Slough, Bucks.**

Terminals, Valve Sockets, Legs, Vanes, etc., etc. Largest makers to the trade. Dealers send your requirements. Aerial Wire, 100' special hard drawn stranded copper, 4s. 6d. Enamelled, 6s. 6d. Trade discounts.—**BRITISH WIRELESS Co., Hearsall Works, Coventry.**

High Tension Batteries.—Fully Guaranteed Long Life 15-Volt cell. Not "Surplus" stock 2s. 11d. post free. For three, 7s. 6d., post free. Orders in strict rotation.—**LITCHFIELD & Co., Wireless Specialists, 12, Great Castle Street, London, W.1.**

ELECTRADIX WIRES

Highest Conductivity at Lowest Prices.			
Gauge.	D.C.C.	S.S.C.	D.S.C.
16	1 7	—	3 6
18	1 9½	—	3 9
20	1 11	4 0	4 6
22	2 5	4 6	5 0
24	3 0	5 0	5 9
26	3 6	5 6	6 6
28	4 2	5 9	6 10
30	5 2	6 6	8 1½
32	6 0½	8 2	9 0
34	7 9	9 6	10 7
36	9 2	11 3	12 3½
38	11 10	13 6	17 3
40	16 2½	17 0	23 5

Prices at per lb. Postage Extra. Earth Clips, 6d. each. 7/22 Aerial Wire, 7/- per 100 ft.

EVERYTHING FOR WIRELESS IN STOCK.
LESLIE DIXON & CO.,
 9, Colonial Avenue, Minories, E.1
 (near Aldgate Station Telephone Avenue 4166.)

- RADIOPHONE TUNERS,**
 200-1,400ms. 38/-
 Valve Panels for above . . . 21/-
 .0005 Variable Condensers . . 18/6
 Above 3 make an Ideal Receiver.
 Broadcast Concert Coils pair 2/-
 Grid Leaks and Condensers 3/6
 Fixed Condensers 2/6
 5-Plate Condensers 6/6
 2-Valve H.F. Amplifier Panels 32/-

Get our New Bargain List.
AMATEUR SUPPLIES,
 134, COTEFORD STREET,
 TOOTING, LONDON, S.W.

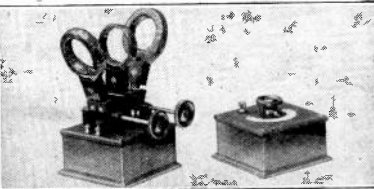

COIL HOLDER, as illustrated.
BEST GRADE Ebonite Mahogany Case, Price 21/-
CONDENSERS, Best Grade, Ebonite Mahogany Case. Satisfaction Guaranteed or money returned
 "Nominally," .0005 17/6
 .0005 22/6
 .001 27/6
AERIAL WIRE, 7/22 Copper, 100' 4/6
INSULATORS, 3d. each. Ebonite Knobs, 6d. each.
IVORINE SCALES, 9d. each. Contact Switches, 1/6 each.
SPECIAL QUOTATIONS TRADE.
 Cash with order. Postage Extra.
M.R.E., Wireless Supplies, 29, High Street, CLAPHAM, S.W.4 Telephone: Brixton 1925.

TRADE **Grelco** MARK

RELIABLE

NOISES

A.E.G. SIEMENS HALSKE

Valves for Radio Reception. Excellent for Rectifying and Amplifying. Best make and finish. Can easily be adapted to fit the Standard Holder. Fil. Current, 3-4 volts, Plate 60-80 Price 10/6 each
 Adapter as shown Price 3/- each

WHY NOT GIVE THEM A TRIAL

Perikon Detectors, mounted on ebonite, complete Price 4/- each
 Egg Insulators (Best) 6d. each
 Interval Transformers 21/- each
 Postage Extra.

The above are just a few items from the large stock we hold at our Show-rooms. You are invited to inspect. Catalogue now in preparation.

Grafton Electric Company
 Showrooms—54, GRAFTON STREET,
 TOTTENHAM COURT ROAD,
 LONDON, W.1. Telephone—Museum 241.

THE WIRELESS WORLD EXCHANGE AND MART

CONNOLLY, BROTHERS

WIRELESS APPARATUS MANUFACTURERS,
LOSTOCK RD., URMSTON, MANCHESTER.
Spares & Complete Components at Trade Prices.
 Examples: 50' x 6' Double Wire Aerial, 40' Lead in, ready for fixing, 17/8. 7/22 Stranded Wire, 1d. per foot. 2" Reel Insulators, 4 1/2d. each. 4" x 12" Wound Inductance Coil, 4/9. 28's Enamelled Wire, 1/1b., 2/-, 1b., 3/6.
CARRIAGE PAID ON ORDERS OVER £2.

HEATH & Co., Ltd.

Instrument Works, New Eltham, S.E.9
 are prepared to undertake in their fully equipped works—**Wireless Apparatus and Parts for the trade.** Quotations given to Blue Prints. Immediate attention.
Phone—Lee Green 301. Wire—Polaris, London.

STEEL MASTS

Tubular Steel Masts with finial, rope cleat, guy clips and baseplate. Painted, light and durable.
 12', 25'—25' (2 Sections), 40/-.
 40' (3 Sections), 80/-.
 100' 7/22 copper wire, 6 insulators, halyard, pulley and lead in tube, 10/6. Carriage forward.
 Trade Supplied.
 Works, 5, Kramer Mews, Earl's Court.
 L. S. COMPTON, 17, Fernshaw Road, S.W.10.

EBONITE "A" TYPE 4 PRONG VALVE HOLDERS

1/6 each, post free.

WILKINSON,
 LONSDALE RD., KILBURN, N.W.6
 TRADE SUPPLIED. Established 1900

Your Case Work

Let us quote you for your wireless casework. We are specialists in this class of work and feel sure our workmanship and prices will interest you.
Phone: L.W. 2720.

CARRINGTON & NEWBERY LTD.,
 18/20, Normans Buildings, Old Street, E.C.

KEYSTONE WIRELESS SUPPLIES

WHOLESALE ONLY.

Ebonite, cabinet work, engraving, expert designers in amplifiers. Slab inductances, basket coils, etc. Switch arms, contacts. Terminals. Scales.

Low Prices Offices: High Finish.
33, Trinity Road, Tooting, S.W.

RADIO CONCERTS.

Two-valve Receivers designed for broadcast music, resistance coupling. Two honeycomb coils for low wavelengths supplied with same. Price 55s. One valve receiver, fl. rheostat, grid condenser and leak, telephone condenser, two coils, as above, price 30s. Acc. Reg. Telephones, Valves, H.T., L.T., Variable Condenser 0-0005.

WIRELESS APPARATUS,
 4, CUMBERLAND ROAD, GRAVESEND.

FOR SALE—continued.

Aerial Masts.—Jointed tubular with base flange, complete with 3 galvs., stranded stays, band, strainers and ground anchors, pulley, pinnacle, painted, halyard and spreaders assembled with insulators ready for erection, free on rail, 30 ft. 75s., 40 ft. (with 6 stays) £6 12s. 6d. each. Write for blue print and specification, higher masts to order. Spreader, insulators, halyard and pulley assembled complete, for house end, 18s. 6d. aerial wire, 150 ft. 3s. 6d.—GOSWELL ENGINEERING CO., LTD., 12A, Pentonville Road, N.1.

Loud Speaker, mounted on polished mahogany base, 4,000 ohms, 24" horn, perfect order, 35s. First P.O. secures.—"T", 16, Lordship Park, London, N.16.

BOOKS.

Technical Books.—Second-hand and New Books on every conceivable subject. Catalogue free. State wants. Books sent on approval. Books bought.—FOYLE, 121, 125, Charing Cross Road, London.

Radio Magazines, all the latest, "Radio World," 10d.; "Popular Radio," 10d.; "Radio Broadcast," 1s. 6d.; "Radio News," 1s. 6d.; "Science and Invention," 1s. 9d.; "Scientific American," 2s. 6d. Post free.—INTERNATIONAL NEWS COMPANY, LTD., 15, Bream's Buildings, London, E.C.4.

SITUATIONS WANTED.

Morse Telegraphist (15 years), Wireless Operator, 4 years First Class P.M.G. Radio Cert. Spare time instruction and assistance to individuals or clubs, etc.—"MOLECULE," BERTRAM DAY'S ADVERTISING OFFICES, 9 and 10, Charing Cross, S.W.1.

SITUATIONS VACANT.

Travellers for Broadcast and other receiving instruments. Two wanted for London. Public school preferred. Must have some knowledge of wireless and prove previous successful selling record. Nominal salary, but opportunity to make big commission. Write for appointment—SALES MANAGER, H.P.R. Wireless, Carlton House, Great Queen Street, Kingsway, W.C.2.

Technical Assistant required in London office, having a thorough acquaintance with practical and experimental wireless telegraphy. Applicants should give detailed particulars of experience and state salary required.—Apply Box V.2, BERTRAM DAY'S ADVERTISING OFFICES, 9/10, Charing Cross, S.W.1.

TRADE ENQUIRIES.

City Firm of Electrical Engineers with well-equipped workshop would undertake manufacture or assembling of complete sets or units in any quantities, also toolmaking, jig and experimental work.—BROOKER & JACKSON, LTD., 24, Farringdon Avenue, E.C.4.

Wanted.—Large quantity of telephone ear pieces, ex-Government. Offers to Box R.2, BERTRAM DAY'S ADVERTISING OFFICES, 9 and 10, Charing Cross, S.W.1.

Contracts Wanted for the manufacture of component parts of wireless receiving sets.—Write GOSWELL ENGINEERING CO., LTD., 12A, Pentonville Road, N.1.

Advertisers Request Quotations from manufacturers for all parts used in construction of wireless instruments, also condenser scales, knobs, rheostats, switches, etc.—TENALO MANUFACTURING CO., South Shore, Blackpool.

MISCELLANEOUS

East Ham, Wanstead, Ilford, Manor Park and Forest Gate. Amateurs should not fail to come to the RADIORINDEZVOUS, 709, Manor Park Broadway (over Liptons). Club open till 10 p.m. nightly.

Designs of Receiving Sets, Motors, Etc., supplied. Technical information given.—O.S., PUCKLE, Buckhurst Hill, Essex. Lancashire Representative, Mr. J. ATKINSON, 2, Butler Street, Chorlton-on-Medlock, Manchester.

Instrument Wires

FROM STOCK

S.W.G.	S.C.C.	D.C.C.	S.S.C.	D.S.C.	En.
47	—	—	110/-	120/-	41/-
46	—	—	97/-	107/-	26/-
45	—	—	64/-	80/-	20/-
44	—	—	50/-	66/-	16/-
43	—	—	40/-	52/-	13/-
42	—	—	31/-	33/-	9/-
41	—	—	30/-	32/-	8/-
40	14/-	17/-	18/-	22/-	6/6
39	12/6	15/-	17/-	21/3	6/-
38	11/-	14/-	16/-	19/-	5/3
37	10/-	12/-	14/6	17/3	4/11
36	8/6	10/-	13/9	15/-	4/8
35	7/9	9/3	12/9	14/-	4/6
34	6/10	8/-	11/3	13/9	4/4
33	6/2	7/6	10/6	13/-	4/3
32	5/10	7/2	9/1	12/10	4/2
31	5/6	6/10	8/9	11/6	4/-
30	5/-	5/4	7/9	9/10	3/10
29	4/9	5/-	7/6	9/6	3/8
28	4/3	4/6	7/2	9/-	3/6
27	4/2	4/5	7/-	8/6	3/5

Prices per lb. Bobbins free.

Orders of £2 or over, Carriage Paid, G.B.

Terms—Cash with Order.

FINE WIRE SUPPLIES,

(A. E. DAVIS)

41, Arlingford Road,
 Brixton, S.W.2

THE UNIQUE N.M.C. (Wireless Patents)

Two-valve Receiving Unit, combining Filament Resistance, Aerial, Tuning Inductance, Aerial Tuning Condenser, Grid Tuning Inductance and Oscillating Condenser, complete in polished case, 12" x 6" x 6", £6 6s. less Valves.

The Set to obtain maximum efficiency. N.M.C. 4,000 W., Double Head Gear, 35/- Inductance Tubes.

All Experimenters' Supplies in Stock. N. M. Co., 145, Northcote Road, Trade Supplied. London, S.W.11.

TO THE TRADE ONLY.

WE SPECIALISE IN Condenser Plates and Washers, Switch Parts, Resistance Clips, and other stamped or pressed work. ALSO Capstan Lathe Work, such as Terminals, Contact Studs, Plugs and Sockets, Valve Legs, Bushes, Spindles, etc.

WILKINS & WRIGHT, LTD.,
 Kenyon Street, Birmingham.

GLASGOW WIRELESS SUPPLY CENTRE

ALL MATERIALS AND ACCESSORIES FOR AMATEURS. PANELS ENGRAVED.

PARTS MADE UP TO CUSTOMERS' OWN DESIGNS. CALL OR WRITE FOR PRICE LIST, ENCLOSING STAMP.

W. & J. JAMIESON, LTD.,
 68, Shamrock Street, W. Glasgow.

THE WIRELESS WORLD EXCHANGE AND MART

Electradix Radios.

Phones! Phones! Phones!



Marconi Standard Brown's Patent 2,000 ohms, 51/- per pair. 4,000 ohms, 52/- per pair. 120 ohm L.R. Brown's 'Phones, 37/6 per pair. Sullivan L.R. ditto, with 6' cord Plug and Jack, 18/- per pair. H.K. English head sets, 1,500 ohms, 25/- per pair. L.R., 16/- per pair. Single L.R. Receivers, 4/6 each. Cords for double head phones, 3/6 new; used, 1/6. 4-way plugs, 2/- each.

Microphone Transmitters, Panel Plate, 10/6; Hand, 2/6; Insets, 9d. each.

Aerials.—Wire and every accessory in stock.

Condensers.—Fixed and Variable in all sizes.

Relays, Weston M.C., brand new, 22 10s.

Morse Inkers, 45/-. Sounders for making rectifiers, 12/6 each.

Panel Switch Flush Fittings, D.P., 3/6.

Plugs and Jacks, 1/6 per pair. Polished Mahogany Cases for H.T. Battery, six sockets, two plugs, 7/-.

Transformers.—Intervale, 21/-; 'Phone, 15/-.

Potentiometers, 5/6 each

Receivers.—All new Marconi Trench 50 D.C. Cost 240.

Complete, 25 10s., in polished case, sloping front.

Amplifier Receivers, Mark 2.B. valve with variable condenser, 27 10s. Single valve panel, 35/-.

H.T. Motor Generator to 1,000 volts, 215.

Charging Sets 1 kW 220 to 25 volts, 230.

Amp. and Volt Meters at lowest prices.

Call at our Electrical Showrooms and inspect our stock of apparatus.

LESLIE DIXON & CO.

9, COLONIAL AVENUE, MINORIES, E.1.

Near Aldgate Station, Met. Rly. First Turning

on left down Minories.

Thompson's Surplus Depot

CRYSTALS. CRYSTALS. CRYSTALS.
Having purchased 2½ tons of the best Government Crystals, we can supply far below actual cost price and will do traders great benefit during the forthcoming season. Complete your stock for a few pounds. We give good discount to trade off these prices.

CARBORUNDUM Crystal, uncut, 12/- per lb. Carborundum Crystals, per gross, 10/- Special Crystals, per dozen, 3/-.

CHALCORPRITE, as used in all Army receiving sets. Bornite, Copper Pyrites, etc., unequal to it for sensitiveness. Chalcoprite, per lb., uncut, 10/-.

Chalcoprite Crystals, per gross, 8/- Special Crystals, per dozen, 2/6.

ZINCITE CRYSTALS, Special, 40/- per gross. Zincite Crystals, per doz., 5/-.

WOODS METAL. The real goods as sold at 21/- per lb. We are selling at 8/- per lb., per stick, 8d. 800 lbs. in stock.

We ask all traders hoping to do good business this winter to send for full list of Government goods for sale, free of charge. Amateurs will greatly benefit also.

T. W. THOMPSON & CO.
39, LONDON STREET, GREENWICH, S.E.10.

RESULTS

Whether as a source of practical information for the Amateur or as a valuable medium for every Advertiser, the best results are invariably obtained "Wireless World" through the

For full particulars and advertising rates apply to **BERTRAM DAY & CO., LTD.** Complete Advertising Service, 9 and 10 CHARING CROSS, S.W.1

Aluminium Condenser Vanes

We are open to quote low prices for the above to the trade. Wholesale only.

G. BROWN & Co. Berkley Street STAMPERS & PIERCERS Birmingham

TELEPHONE HEAD RECEIVERS

4000 ohms 32/- per pair with cords
120 " 30/- " " " "

Single Valve Panels
Complete - - - 30/- each

Bye-Pass Condensers
·002 mfd. - - - 3/- each

Grid Leaks & Condensers
3/- each

No waiting, all delivered from stock
Send 2d. for our latest Catalogue and Advice

Radio Experimental Co.,
103, GELL STREET, SHEFFIELD

Send us your enquiries for
BOXES, CABINETS,
SPREADERS, CONDENSERS and parts, LEAD-IN-TUBES, and all accessories, to the Trade.

COMPETITIVE PRICES
PROMPT DELIVERIES
The Central Aircraft Co.
179 High Rd., Kilburn, N.W.6
Phone—Hampstead 4403-4 8018.

LESLIE McMICHAEL LTD.

PROVIDENCE PLACE, WEST END LANE, KILBURN, N.W.6

Telephone HAMPSTEAD 1261 Nearest Tube Station: KILBURN PARK (BAKERLOO)

FOR EVERY WIRELESS REQUISITE

Illustrated Catalogue 6d. Post Free.

NOTICE

MESSRS. S. G. BROWN, Ltd., HEREBY GIVE NOTICE that the only Telephones of their make acquired by them from the Disposal Board this year, and which have been RECONDITIONED and GUARANTEED by them, are those advertised by Messrs. L. McMichael, Ltd.

All "Brown" Telephones advertised as "New and unused" at prices below their list quotations, if in fact "unused" are not "new," as they have been purchased from the Disposal Board, and the majority are of an obsolete type which is not fitted with the all-aluminium diaphragm. They have not been reconditioned by S. G. Brown, Ltd.

Please note that all "Brown" Telephones manufactured in 1922 bear numbers on the back of the cases above E. 29,900.

S. G. Brown, Ltd., can give prompt delivery of their Telephones.

S. G. BROWN, Ltd.

Works : Victoria Road, North Acton, London, W.3.

London Showrooms : 19, Mortimer Street, London, W.1. Telephone: MUSEUM 4950.

Visit our Stand No. 43. All-British Wireless Exhibition, Horticultural Hall, Sept. 30th to Oct. 7th.

This Book Will Help YOU.

The more generally useful formulæ and methods of measurement for inductance and capacity are brought together in a convenient form in

The Calculation and Measurement of Inductance and Capacity

By
W. H. NOTTAGE, B.Sc.

Price **3/6** *Nett.*
(Postage 5d.)

The Wireless Press, Ltd.,
Dept. W.W., 8/4,
12-13, Henrietta Street, London, W.C.2

LIST OF Regular Transmissions OF WIRELESS STATIONS

Giving Time, Call Sign, Wavelength, System, etc.

PRICE **6d.** POST FREE.

THE WIRELESS PRESS, LIMITED
Dept. W.W.,
12-13 Henrietta Street, London, W.C.2.

Questions and Answers COUPON

To accompany Questions
sent in during the week
commencing Sept. 9th, 1922.

VOL. X, NO. 24

See Conditions on Page 771.

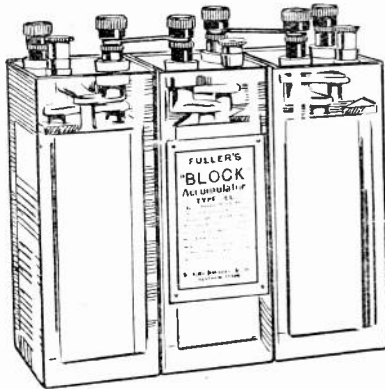

Whether for Lighting or Ignition
ALWAYS INSIST ON A
FULLER "BLOCK"
TYPE ACCUMULATOR

The only Accumulator which will hold its charge from 12 to 18 months when not in use

FOOL-PROOF :: NON-SULPHATING
UNAFFECTED BY SHORT CIRCUITS

For providing the current for lighting the filament in the Wireless Valve they are absolutely ideal

WHY WE CAN SELL BELOW THE MAKERS' PRICES.

Some time ago we purchased an exceedingly large stock of "Block" Type Accumulators from the Government on terms which permitted our re-selling them at a much reduced price. During the last two years, we have disposed of several thousands in all parts of the world and most of the largest and best known electrical firms are numbered amongst our customers.

During this period we have built up, on sound business lines, probably the largest Accumulator business in existence. We buy only on the largest scale and no opportunity escapes us so long as the quality of the stock is right. We have recently purchased outright a parcel of "Block" Accumulators, direct from the manufacturers' works, to the value of several thousand pounds and, being content with a small margin of profit on a large turnover, we are able to offer these world-famous cells for re-sale at a considerable saving to the customer.

It is our inevitable role to share any bargains with our customers, and our system of business will be to put money into the pockets of those who deal with us. It is on these principles that our business has reached its present magnitude.

A perusal of the following prices and comparison with the cost of the identical article, if bought in the ordinary way, will show the considerable saving which can be effected by dealing through us.

TYPE.	VOLTS.	Intermittent capacity at 20-hours rate.†	Maker's Price.	Our Price.	TYPE.	VOLTS.	Intermittent capacity at 20-hours rate.†	Maker's Price.	Our Price.
			£ s. d.	£ s. d.				£ s. d.	£ s. d.
2 B K	2	16	0 9 6	0 7 0	B L 255	2	110	2 0 6	1 7 6
4 B K	4	16	0 19 6	0 14 0	B L 455	4	110	4 1 0	2 15 0
6 B K	6	16	1 8 6	1 1 0	B L 655	6	110	6 1 6	4 2 6
240	2	40	1 7 6	0 16 3	B J 2120	2	120	2 4 0	1 8 0
440	4	40	2 15 0	1 12 6	B J 4120	4	120	4 8 0	2 16 0
640	6	40	4 2 6	2 8 9	B J 6120	6	120	6 12 0	4 4 0
B L 12a	4	50	2 12 6	1 16 0	B L 280	2	160	2 4 6	1 12 6
B L 13a	6	50	3 18 0	2 18 0	B L 480	4	160	4 9 0	3 4 0
					B L 680	6	160	6 13 6	4 16 0
2 A D 9/s	2	64	1 2 6	0 18 0	B L 2110	2	220	3 0 6	2 0 0
4 A D 9/s	4	64	2 5 0	1 16 0	B L 4110	4	220	6 1 0	4 0 0
6 A D 9/s	6	64	3 7 6	2 14 0	B L 6110	6	220	8 9 0	6 0 0
2 A D 9/c	2	70	1 6 3	1 0 0	For those who require a cheaper Accumulator of the plate type, we can offer FULLERS STANDARD PLATE TYPE BATTERIES as under.				
4 A D 9/c	4	70	2 12 6	2 0 0					
6 A D 9/c	6	70	3 18 9	3 0 0	S L 230	2	30	0 14 6	0 9 0
B L 240	2	80	1 15 0	1 4 0	S L 430	4	30	1 9 0	0 18 0
B L 440	4	80	2 10 0	2 8 0	S L 630	6	30	2 3 6	1 7 0
B L 640	6	80	5 5 0	3 12 0	S L 280	2	80	1 3 0	0 14 0
					S L 480	4	80	2 6 0	1 8 0
B L 21	4	94	3 8 0	2 12 0	S L 680	6	80	3 0 0	2 2 0

† Note : The Ignition Capacity is double the Actual Capacity taken at the 20-hour rate. Prices for Teak Carrying Crates or Cases on Application.

The name "FULLER" is behind every one of these batteries, a certain guarantee of quality, for nothing but the best and purest materials are used in the manufacture of their products.

THE CITY ACCUMULATOR CO., 79 Mark Lane, E.C.3

Phone : Avenue 91 (3 lines)

Telegrams : "TYCHE, FEN, LONDON."

Agents—London : A. W. GAMAGE, LTD., Holborn, E.C. SELFRIDGE & Co., LTD., Oxford Street, W. RICHFORD & Co., 153, Fleet Street, E.C.3.

Yorks : BARNSELY BRITISH CO-OPERATIVE SOCIETY, LTD., Barnsley.

Glos. : BRISTOL WIRELESS CO., 52, Cotham Hill, Bristol.

S. Wales : SOUTH WALES WIRELESS INSTALLATIONS CO., LTD., 18, West Bute Street, Cardiff.

N. Wales, Lancs., Ches., & I.O.M. : THE "ALL BRITISH" WIRELESS MANUFACTURES CO., LTD., 70, Central Buildings, 41, N. John Street, Liverpool.

Complete Catalogue now ready. Post Free on receipt of Postcard.

There is No Need to Pay More than our Prices for BROWN OR SULLIVAN RADIO HEADPHONES.

WE guarantee these 'phones to be in perfectly new condition and as efficient as any 'phone obtainable irrespective of the price paid. The 'phones were supplied to His Majesty's Government and every instrument has therefore passed the strictest test.

We have received **HUNDREDS OF TESTIMONIALS** from delighted and satisfied customers, many of which we have reprinted in our catalogue, and we earnestly commend them to the notice of the Wireless Public. These are convincing proofs from those who have actually tested the 'phones, and, together with our personal guarantee set out below, will, we feel confident, dispel any doubts in the minds of anyone as to the quality and efficiency of the goods we offer for sale.



BROWN HEADPHONES

("A" Type. Reed Pattern. Aluminium Diaphragms)

120 ohms **49/6** (Maker's Price 66/-)

8000 ohms **42/6** (Makers's Price 58/-)

Sullivan 8000 ohms **36/6**

Brand New Condition and Unused.

Important

Our stock must not be confused with the "reconditioned" phones at present on the market

Cards 2/9 extra. Packing & Postage (Regd.) 1/- extra.

WE GUARANTEE. That these 'phones are in brand new condition and have never been used. That they are equal in efficiency to any 'phone on the market at the present time. That if after these 'phones have been thoroughly tried and tested and compared with any other 'phone on the market, you are in the least dissatisfied, return same to us within seven days and **we will Refund the Full Amount paid forthwith.**



Read this Chartered Accountant's Certificate.

*Messrs. The City Accumulator Co. London, August 1st, 1922.
I have examined your Books and Records and certify that during the 11 days ended July 29th, 1922, the total orders for Brown and Sullivan Radio Headphones received by you amounted to £5,548 18s. 5d.
(Signed) T. P. ALDRED, Chartered Accountant.*

THE CITY ACCUMULATOR CO.,

'Phone : Avenue 91 (3 lines) **79, Mark Lane, E.C.3** Telegrams : "Tyche, Fen, London."

Agents—London : A. W. GAMAGE, LTD., Holborn, E.C. SELFRIDGE & Co., LTD., Oxford Street, W. RICHFORD & CO. 153, Fleet Street, E.C.3.
Yorks : BARNSELY BRITISH CO-OPERATIVE SOCIETY, LTD., Barnsley.
Glos. : BRISTOL WIRELESS CO., 52, Cotham Hill, Bristol.
S. Wales : SOUTH WALES WIRELESS INSTALLATIONS CO., LTD., 18, West Bute Street, Cardiff.
N. Wales, Lancs., Ches., & I.O.M. : THE "ALL BRITISH" WIRELESS MANUFACTURES CO., LTD., 70, Central Buildings, 41, N. John Street, Liverpool.

Complete Catalogue now ready. Post Free on receipt of Postcard.

WE ARE EXHIBITING AT THE FIRST ALL-BRITISH WIRELESS EXHIBITION AND CONVENTION

HORTICULTURAL HALL

Vincent Sq., Westminster, S.W.1

SPECIAL TRADE DAY

OCT. 2nd : 1/3 (including tax)

Public admitted after 6 p.m. at usual price

ADMISSION

1/3

INCLUDING TAX

SEPT. 30th to OCT. 7th

(Saturday)

(Saturday)

10 a.m. to 10 p.m. daily

SPECIAL PUBLIC DAY

OCT. 3rd : 5/- (including tax)

Public admitted after 6 p.m. at usual price

*The only Exhibition whose CONVENTION will be held under
the auspices of the WIRELESS SOCIETY of LONDON.*

Anode Wireless & Scientific
Instruments, Ltd.
Auckland, G. Z., & Son.
Automatic Telephone Manfg. Co., Ltd.
Bertram Day & Co., Ltd.
Bower, J. B., & Co., Ltd.
British Thomson-Houston Co., Ltd.
British Wireless Supply Co.
Brown, S. G., Ltd.
Burndept, Ltd.
Chloride Electrical Storage Co., Ltd.
Coomes & Co.
Cossor, A. C., Ltd.
Dubilier Condenser Co. (1912), Ltd.
Econ Manfg. Co., Ltd.
Economic Electric, Ltd.
Elwell, C. F., Ltd.
Ever Ready Co. (Great Britain), Ltd.
Fellows Magneto Co., Ltd.

Gamage, A. W., Ltd.
Gambrell Bros., Ltd.
General Radio Co.
Graham, A., & Co.
Hambling, Clapp & Co.
Hart Accumulator Co., Ltd.
Harwell, Ltd.
H. P. R. Wireless, Ltd.
Igranic Electric Co., Ltd.
Isted, T. H., Esq.
"K.B." Radio Equipment Co.
Marconi Scientific Instrument Co., Ltd.
Marconi's Wireless Telegraph Co., Ltd.
McMichael, L., Ltd.
Metropolitan-Vickers Electrical Co., Ltd.
Mitchell's Electrical & Wireless, Ltd.
Mullard Radio Valve Co., Ltd.
The M.O. Valve Co., Ltd.
Peto Scott & Co.

Pettigrew & Merriman, Ltd.
Radio Communication Co., Ltd.
Radio Instruments, Ltd.
Radio Press, Ltd.
Radio Service, Ltd.
Rogers, Foster & Howell, Ltd.
Siemens Bros. & Co., Ltd.
Stanley Prince & Co.
Sterling Telephone & Electric Co., Ltd.
Sullivan, H. W., Esq.
Telephone Manfg. Co., Ltd.
Tingey, W. R. H., Esq.
Wates Bros.
Western Electric Co., Ltd.
Wireless Equipment, Ltd.
Wireless Press, Ltd.
Wireless Supplies Co.
Zenith Manfg. Co., Ltd.

ORGANISERS :

BERTRAM DAY & CO., LTD.

9 and 10, Charing Cross, London, S.W.1 Gerrard 8063/4

Wireless Publicity Specialists.

CONQUEST

THE MAGAZINE OF
POPULAR SCIENCE

Written for all the family to understand.

SCIENCE :: INVENTION :: INDUSTRY

ON SALE EVERYWHERE. PRICE 1/- MONTHLY

BEFORE YOU CAN STUDY WIRELESS TELEGRAPHY AND TELEPHONY YOU MUST HAVE A KNOWLEDGE OF MAGNETISM AND ELECTRICITY

Dear Sir,

A READER'S APPRECIATION.

I received in good condition a copy of "Mag. and Elec. for Home Study" on Saturday last, and I am very highly pleased with it. I have much pleasure in enclosing a P.O. for 6/- which I trust you will find in good order. Again thanking you for the value offered and the prompt attention.

Yours faithfully.

To many who are anxious to gain a knowledge of Magnetism and Electricity some text books on the subject have a very forbidding appearance.

The formulæ and equations too frequently haunt the non-mathematical reader and cause him to abandon his intention.

Such fears, however, need no longer deter anyone from acquiring the knowledge desired as in **MAGNETISM & ELECTRICITY FOR HOME STUDY** By H. E. PENROSE will be found **FIFTY COMPLETE LESSONS** prepared in such a form that the reader ceases to regard them as a study.

The various facts and theories are elucidated subtly but surely. No effort has been spared by the Author to explain the subject so clearly and thoroughly that no one can misunderstand him.

At the conclusion of each lesson is placed a series of questions which enable the reader to test his progress and assure himself that his knowledge is

well grounded. In this way he will know that his future study of Wireless Telegraphy and Telephony will be based upon a solid foundation.

A copy of the book will be sent **ON APPROVAL** to all who complete the request form below.

**The Manager, Mail Order Dept.,
THE WIRELESS PRESS, LIMITED,
12-13, Henrietta St., LONDON, W.C.2**

I enclose 6d. for postage.

Please send me a copy of
MAGNETISM & ELECTRICITY FOR HOME STUDY. By H. E. Penrose.

If I retain it I will remit the sum of 6/-. Otherwise I will return the book in good condition within 5 days of its receipt.

Name

Postal Address

.....

.....

Date.....1922 **W.W. 2/9/22**

WIRELESS BOOKS FOR THE LIBRARY

MAGNETISM AND ELECTRICITY FOR HOME STUDY. By H. E. Penrose. Contains 50 complete lessons. Price 6/- net. Post free 6/6. 515 pages, 224 diagrams.

THE ARMATURE MODEL FOR 1½ K.W. ROTARY CONVERTER. Price 1/3 net. Post free 1/6. Shows every winding of the Converter Armature.

THE RADIO EXPERIMENTERS' HANDBOOK. By Philip R. Coursey, B.Sc. Eng., F.Inst.P., 113 pages, 99 diagrams and illustrations. Price 3/6 net. Post free 4/-.

SELECTED STUDIES IN ELEMENTARY PHYSICS: A Handbook for Wireless Students and Amateurs. By E. Blake, A.M.I.E.E. Price 5/- net. Post free 5/6. 176 pages. Crown 8vo. Cloth. 43 diagrams and illustrations.

WIRELESS TRANSMISSION OF PHOTOGRAPHS. By Marcus J. Martin, Second Edition. Revised and Enlarged. Price 5/- net. Post free 5/6. 143 pages. Demy 8vo. Cloth. Diagrams and illustrations.

CALCULATION AND MEASUREMENT OF INDUCTANCE AND CAPACITY. By W. H. Nottage, B.Sc. Price 3/6 net. Post free 3/11. Demy 8vo. 144 pages. Over 50 illustrations and diagrams.

THE A.B.C. OF WIRELESS. By Percy W. Harris. A simple outline of Wireless written for all to understand. 64 pages. Price 6d. net. Post free 8d.

TEST QUESTIONS AND ANSWERS ON WIRELESS TELEGRAPHY. Price of each Series of Questions 2/6 net. Postage 3d. Answers 2/6 net. Postage 3d. Invaluable for self-examination. Series 1. The Elementary Principles of Wireless Telegraphy. Part I.—Series 1a. Book of Model Answers. Series 2. Covering the Ground for the Postmaster-General's Examination. Series 2a. Book of Model Answers. Series 3. The Elementary Principles of Wireless Telegraphy. Part II.—Series 3a. Book of Model Answers.

THE ELEMENTARY PRINCIPLES OF WIRELESS TELEGRAPHY. By R. D. Bangay. Crown 8vo. Published in two parts or bound in one volume. Price per part 4/- net. Post free 4/4. In one volume 7/6 net. Post free 8/3.

MAINTENANCE OF WIRELESS TELEGRAPH APPARATUS. By P. W. Harris. Price 2/6 net. Post free 2/10. 127 pages. 52 diagrams and illustrations.

A SHORT COURSE IN ELEMENTARY MATHEMATICS AND THEIR APPLICATION TO WIRELESS TELEGRAPHY. S. J. Willis. Price 5/- net. Post free 5/6. Demy 8vo. 182 pages. 120 diagrams.

ALTERNATING CURRENT WORK. An Outline for Students of Wireless Telegraphy. By A. Shore, A.M.I.E.E. Price 3/6 net. Post free 3/10. Crown 8vo. Cloth. 163 pages. 86 diagrams and illustrations.

THE OSCILLATION VALVE. The Elementary Principles of its application to Wireless Telegraphy. By R. D. Bangay. 6/- net. Post free 6/6. Crown 8vo. 215 pages. 110 diagrams and illustrations.

USEFUL NOTES ON WIRELESS TELEGRAPHY. By H. E. Penrose. Crown 8vo. 1/4 each. Post free 1/6. Book 1. Direct Current. Book 2. Alternating Current. Book 3. High Frequency Current and Wave Production. Book 4. The 1½ K.W. Ship Set. Book 5. The Oscillation Valve.

THE CONSTRUCTION OF AMATEUR VALVE STATIONS. By Alan L. M. Douglas. The ideal book for those contemplating the making of a wireless set. 78 pages, 55 diagrams and illustrations. Price 1/6 net. Post free 1/8.

Visit our Stand No. 40. All-British Wireless Exhibition, Horticultural Hall, Sept. 30th to Oct. 7th.

THE WIRELESS PRESS, LIMITED,
12-13, HENRIETTA STREET, STRAND, LONDON, W.C.2.

WIRELESS BOOKS FOR THE LIBRARY

CONTINUOUS WAVE WIRELESS TELEGRAPHY. Part I. By W. H. Eccles, D.Sc. Price 25/- net. Post free 25/9. 407 pages. 306 diagrams and illustrations.

THERMIONIC TUBES IN RADIO TELEGRAPHY AND TELEPHONY. By John Scott-Taggart, A.M.A.I.E.E. Price 25/- net. Post free 25/9. 424 pages. 344 diagrams and illustrations.

THE THERMIONIC VALVE and Its Development in Radio Telegraphy and Telephony. By J. A. Fleming, M.A., D.Sc. Price 15/- net. Post free 15/9. 279 pages. 144 diagrams and illustrations.

WIRELESS TELEGRAPHY AND TELEPHONY.—First Principles, Present Practice and Testing. By H. M. Dowsett, M.I.E.E. Price 9/- net. Post free 9/9. 331 pages. 305 diagrams and illustrations.

TELEPHONY WITHOUT WIRES. By Philip R. Coursey, B.Sc. (Eng.), A.M.I.E.E. Price 15/- net. Post free 15/9. 414 pages. 250 diagrams and illustrations.

STANDARD TABLES AND EQUATIONS IN RADIO TELEGRAPHY. By Bertram Hoyle. Price 9/- net. Post free 9/6. 159 pages.

RADIO INSTRUMENTS AND MEASUREMENTS (Circular No. 74 of the Bureau of Standards, Washington, U.S.A.). Price 9/- net. Post free 9/5. Fully illustrated. 320 pages.

PRACTICAL AMATEUR WIRELESS STATIONS. By J. Andrew White. Price 5/- net. Post free 5/6. 136 pages. 110 diagrams and illustrations.

THE YEAR BOOK OF WIRELESS TELEGRAPHY AND TELEPHONY, 1922. 1,476 Pages. Price 15/- net. Post Free, 16/-. A special feature of this edition is a specially drawn map which gives for the first time a simple means of finding the distance and true direction of wireless stations in all parts of the world, with London as the centre.

Visit our Stand No. 40. All-British Wireless Exhibition, Horticultural Hall, Sept. 30th to Oct. 7th.

THE WIRELESS TELEGRAPHIST'S POCKET BOOK OF NOTES, FORMULAE AND CALCULATIONS. By J. A. Fleming, M.A., D.Sc. Price 9/- net. Post free 5/6. 352 pages. 39 diagrams and illustrations.

VACUUM TUBES IN WIRELESS COMMUNICATION. By E. E. Bucher. Price 12/6 net. Post free 13/3. 178 pages. 130 diagrams and illustrations.

RADIOTELEPHONY. By A. N. Goldsmith, Ph.D. Price 15/- net. Post free 15/9. 256 pages. 226 illustrations.

T.S.F. LA TÉLÉGRAPHIE SANS FIL. LA TÉLÉPHONIE SANS FIL. By G. E. Petit and Leon Bouthillon. Price 12/6 net. 13/- post free, paper cover. 15/- net. 15/9 post free, cloth bound. 304 pages, 197 diagrams and illustrations.

PREPARED RADIO MEASUREMENTS WITH SELF-COMPUTING CHARTS. By Ralph R. Batcher, E.E. Price 10/6 net. Post free 10/11. 132 pages.

PRACTICAL WIRELESS TELEGRAPHY. By Elmer E. Bucher. Price 12/6 net. Post free 13/3. 352 pages, 340 diagrams.

FIFTY YEARS OF ELECTRICITY—THE MEMORIES OF AN ELECTRICAL ENGINEER. By Dr. J. A. Fleming, M.A., D.Sc., F.R.S. Price 30/- net. Post free 31/-. 371 pages, 111 plates.

WIRELESS EXPERIMENTER'S MANUAL By E. E. Bucher. Price 12/6 net. Post free 13/3. 354 pages, 273 diagrams and illustrations.

THE WIRELESS PRESS, LTD.,

DEPT. W.W.

12-13, HENRIETTA STREET, STRAND, LONDON, W.C.2

Just Received!

AMERICA'S LATEST PUBLICATIONS FOR THE WIRELESS EXPERIMENTER.

HOW TO MAKE COMMERCIAL TYPE RADIO APPARATUS

By M. B. SLEEPER.

Price 4/- net (post free 4/3).

The experimenter will be able to get a world of ideas for the design and construction of his wireless apparatus from the very clear descriptions and ninety-eight illustrated figures.

CONSTRUCTION OF RADIO PHONE AND TELEGRAPH RECEIVERS FOR BEGINNERS

By M. B. SLEEPER.

Price 4/- net (post free 4/3).

Each piece of apparatus described was first made, tested and found efficient before the final design was accepted. Working drawings prepared especially for the novice and the man who wants to receive the wireless broadcast.

RADIO EXPERIMENTER'S HANDBOOK

By M. B. SLEEPER.

Price 5/- net (post free 5/3).

A book which tells in a very concise way the "Why" of radio and answers many of the "Practical Questions of the Beginner," and even the more advanced student of Wireless.

THE ABC OF VACUUM TUBES USED IN RADIO RECEPTION

By E. H. LEWIS.

Price 6/- (post free 6/5).

Written particularly for those who know nothing about wireless, but who desire an understanding of the elementary principles of operation of vacuum tubes, and various circuits in which they are used for reception of wireless telegraph signals, music and speech by wireless telephone.

THE WIRELESS PRESS, LTD., Dept. W.W.
12-13, HENRIETTA STREET, STRAND, LONDON, W.C.2

Visit our Stand No. 40. All-British Wireless Exhibition, Horticultural Hall, Sept. 30th to Oct. 7th

For they are jolly good Fellows

THE
“FELLOCRYST”

(Registered)

**WIRELESS
 CRYSTAL RECEIVING SET
 BRITISH THROUGHOUT**

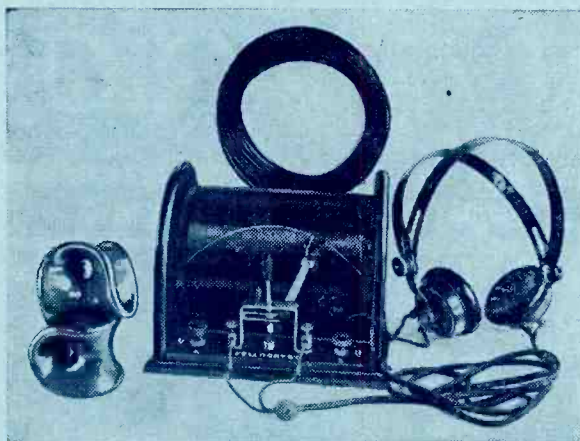

COMPLETE (as illustrated) £3 7 6
 with one pair of double headphones. *Postage 1/6*
NO BATTERIES REQUIRED

The set comprises tuning coil with a wavelength of approx. 300 to 1500 metres; Silicon Crystal Detector; 4000 ohms Double Headphones; 100 ft. Coil of 7/22 Stranded Copper Wire; 2 Shell Insulators, Terminals, etc.

Each set tested and guaranteed to receive broadcasting within a range of 15 to 20 miles, and morse signals from a much longer range.

Extra Headphones, complete 30/- per pair.

POSTAGE 1/-

FELLOWS MAGNETO CO., LTD.

Telephone:
 Willesden 1560-1.

LONDON, N.W.10.

Telegrams:
 Quixmag. Phone. London.

Visit our Stand No. 10.

*All-British Wireless Exhibition, Horticultural Hall,
 Sept. 30th to Oct. 7th.*

BROADCASTING

Sullivan Patent Telephone Receivers for Radio Telephony and Telegraphy

Of High and Uniform sensitivity and DISTORTION-LESS being thus specially adapted for receiving speeches, news and concerts from BROADCASTING and other stations.

WINDINGS highly insulated, durable and reliable in all climates and under all conditions of service. This was strikingly evidenced during the Great War when a vessel carrying "SULLIVAN" phones shipped to the order of an Allied Government was sunk through misadventure, but at a later date was successfully raised and the cargo salvaged. The Telephones themselves were found to have sustained much damage through the action of sea water, but the coils proved to be perfect electrically and mechanically notwithstanding their long immersion, and all were again brought into requisition.

IMPORTANT NOTICE

These Telephone Receivers must not be confused with the old and comparatively insensitive "SULLIVAN" phones, sold by the Disposals Board and still being retailed by certain dealers, nor with those new but comparatively insensitive Radio Telephone Receivers of Continental and other origin bearing a misleading resemblance to my own pattern.

White Metal Headbands supplied if desired.

Visit our Stand No. 49, All-British Wireless Exhibition, Horticultural Hall, September 30th to October 7th

DEMONSTRATION AND SHOWROOMS:

Liverpool House, Middlesex Street,
London, E.1

(Two minutes' walk from Liverpool Street and Broad
Street Stations).

Without public advertisement of any kind, over one quarter of a million sets of "SULLIVAN" phones have been made and sold for "Wireless" alone.

Trade Terms on Application.

<p><i>Works.</i> "LIVERPOOL HOUSE" MIDDLESEX ST., LONDON, E.1 Phone: Avenue 4371</p>	<h1>H.W. SULLIVAN</h1> <p>TELEGRAMS: "DEADBEAT, STOCK, LONDON."</p>	<p><i>Offices.</i> WINCHESTER HOUSE LONDON, E.C.2., ENGLAND Phone: London Wall 3318</p>
---	---	--

WIRELESS WORLD

AND

RADIO REVIEW

11/0
11/10
12

VOL. X, No. 25.

16th SEPTEMBER, 1922.

Registered at the G.P.O. as a Weekly Newspaper.

THE TINGEY UNIT SYSTEM

HAS PROVED ITS EFFICIENCY

Write for

ILLUSTRATED CATALOGUE

which contains an article on Wireless Made Easy and a Complete List of all Wireless Goods in Stock

WRITE FOR ILLUSTRATED CATALOGUE 3d. POST FREE



		£	s.	d.			£	s.	d.
Q1.	CONDENSERS. One pair mounted in case..	5	0	0	I 1.	INDUCTANCES. B. Coil—1,000-8,500 metres with approximate calibration ..	1	17	6
R*	RECEIVER (for R. Valves) ..	4	17	6	I 1.	INDUCTANCES. C. Coil—5,000-24,000 metres with approximate calibration ..	3	2	6
R 1*	RECEIVERS (for Mullard Valves) ..	4	7	6	J 1.	JUNCT. ON BRACKETS (8 styles) from 3/- to 6/6 each	2	8	6
R.S.	SINGLE VALVE RECEIVER ..	3	10	0	P 2.	BROWN'S PHONES (D Type), 120 w. Per pair	2	8	6
R.V.	UNIT H.F. to follow R.S. Unit ..	2	0	0	BROWN'S RELAY UNIT (mounted in case), for rapid attachment to Tingey Units. No loose connections (2,000 ohms input) .. 6 15 0				
A 2.	MULTI H.F. AMPLIFIER UNIT, Choke and resistance type ..	3	15	0	BROWN'S RELAY (without Tingey adaptation) .. 6 2 6				
A 3.	MULTI L.F. AMPLIFIER UNIT ..	3	15	0	"ORA" MULLARD'S VALVES .. each 0 15 0				
A 4.	MULTI H.F. AMPLIFIER UNIT, without inductances or variable condenser ..	2	10	0	P 1. INDUCTANCE PLUGS .. 0 4 0				
A 24.	COMBINED UNIT, tuned or stand-by position	3	15	0	T 2. INTERCHANGEABLE TRANSFORMERS (300 to 24,000 metres) .. each 6/- to 12/-				
T 1.	MULTI TELEPHONE TRANSFORMER UNIT	2	0	0	TINGEY (3-Valve) RECEIVER, 1 valve H.F., 1 Rect. 1 L.F. (without valves) .. 8 10 0				
11.	INDUCTANCES. A. Coil—200-1,600 metres with approximate calibration. Price	1	5	0					

COMPLETE RECEIVING SETS (VALVE) From £14.

Showrooms Open 8 a.m. to 8 p.m.

Saturdays 8 a.m. to 1 p.m.

Offices & Works
Phone
HAMMERSMITH 4916
Telegs
TINGOIDAR LONDON

W.R.H. TINGEY.

Offices & Showrooms
92 Queen St.
Hammersmith,
London, W. 6.

SPECIALIST IN WIRELESS

Visit our Stand No. 25. All-British Wireless Exhibition, Horticultural Hall, September 30th to October 7th.

THERMAL INSTRUMENTS

for

Radio-Telegraphic Measurements

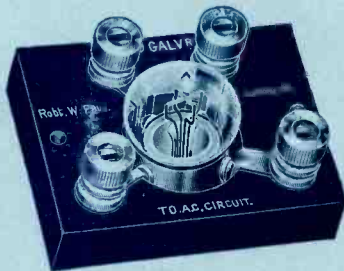

A Vacuo-junction, as illustrated, connected to a suitable reflecting galvanometer, will measure alternating currents of high frequency down to 30 micro-amperes. A unipivot galvanometer, a suspended coil pointer galvanometer, or a high sensitivity reflecting galvanometer can be used, according to the sensitivity required.

FURTHER PARTICULARS ON REQUEST

The Cambridge and Paul
INSTRUMENT CO. LTD.

WORKS -
LONDON &
CAMBRIDGE

Head Office &
Showrooms

45, GROSVENOR PLACE,
LONDON S. W. 1

47



STERLING No. 1 CRYSTAL W/T RECEIVING SET

Specially designed for use in connection with the Wireless Telephony Broadcasting Scheme, and is suitable for a range of about 25 miles.

PRICE £7-12-6

Visit our Stand No. 34, All-British Wireless Exhibition, Horticultural Hall, September 30th to October 7th.

**STERLING TELEPHONE
& ELECTRIC CO., LTD.**

210-212, Tottenham Court Road,
LONDON : : : W.1

Telephone No. : 4144 Museum (7 lines)
Telegrams : "Cucumis, Wesdo, London."

Works : DAGENHAM, ESSEX.

BRANCHES :

NEWCASTLE-ON-TYNE : 9, Clavering Place.
CARDIFF : 8, Park Place.

IMMEDIATE DELIVERY

GAMAGES

LEAD IN AMATEUR WIRELESS
FIRST IN 1908—FOREMOST TO-DAY

COMPLETE HOME RECEIVING SETS

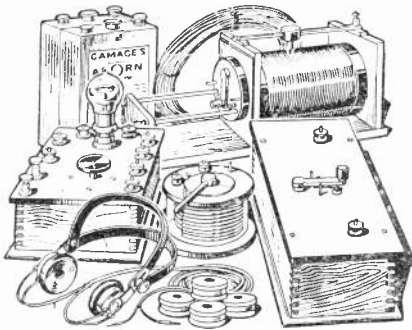

WIRELESS APPARATUS FOR VALVE RECEPTION

A highly sensitive and selective set, so designed that extra valves may be added from time to time for amplification purposes. Consists of a loose Coupled Tuner Valve Panel complete 60 v. H.T. battery, 4 v. 40 amp. Accumulator. Variable Condenser, 100ft. Aerial Wire, Aerial Insulators capable of receiving ordinary telegraphy over a distance of 1,000 miles, and telephony, Music, etc., up to 100 miles. An ideal set for the Valve beginner as all parts can be used in more complicated sets.

£12 12 0

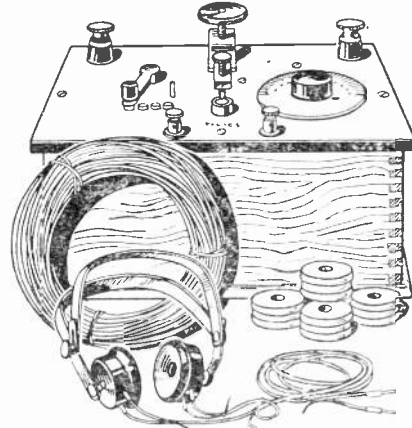

COMPLETE CRYSTAL RECEIVING SET

This set comprises a Special Tuning Coil, tapped in three places, Permanite Detector (undoubtedly the finest crystal obtainable) Variable Condenser, all enclosed in highly polished Mahogany Cabinet. In addition, 100 ft. of Aerial Wire, Aerial Insulators, and a very selective and sensitive pair of 'Phones are supplied. This set is capable of receiving ordinary telegraphy over a distance of 200 miles. Telephony, Music, etc., can be received up to 30 miles. The wavelength covered is 300 to 1,000 metres. A most compact little instrument, size 9" x 4" x 6".

£5 10 0

EXCEPTIONAL OFFER OF BROWNS 'PHONES

Unused, Solid Aluminium Diaphragms in the majority of cases, but where a small segment of parchment is used between the Aluminium Diaphragm proper and the Metal Case, it is our opinion that such a combination gives better results. Brown's Double Headband Receivers without leads.

1,200 ohms.

8,000 ohms.

42/6 49/6

SULLIVAN'S Double Head-piece receivers, 8,000 ohms. Without leads. In perfect condition and absolutely new.

36/6



Write for a copy OF GAMAGES WIRELESS CATALOGUE

Sent post free on request.

Visit our Stand No.

31 at the

ALL-BRITISH WIRELESS

EXHIBITION Horticultural Hall, Sept. 30th—Oct. 7th

GAMAGES, HOLBORN, LONDON, E.C. 1.

BIRMINGHAM:
133 NEW STREET.

LIVERPOOL:
10, SOUTH JOHN
STREET.



MANCHESTER:
61, BRIDGE STREET,
DEANSGATE.

LEEDS:
48, ST. GEORGE
STREET.

LONDON OFFICE & SHOWROOMS
15 Bedford Street. Strand. W.C.2

Visit our Stand No. 12A. All-British Wireless Exhibition, Horticultural Hall, Sept. 30th to Oct. 7th.

THE NEW POST OFFICE REQUIREMENTS

specify that valves capable of oscillating must not be connected direct to the aerial circuit. This means that the reaction coil **MUST** be coupled to a secondary coil which in turn is loosely coupled to the primary coil or aerial tuning inductance—REGENERATION by means of a reaction coil is the most simple and most efficient way to magnify telephony or spark signals and AUTODYNE by means of a reaction coil is the most efficient way of receiving continuous wave telegraphy up to 10,000 metres and the simplest way on longer wavelengths.

THE REACTION PRINCIPLE IS PATENTED BUT **BURNDEPT** instruments are duly licenced under this and other patents, so that we can offer our customers EFFICIENCY and PROTECTION.

The **BURNDEPT** TUNER MK. V. fulfils all above requirements and uses the principle of reaction adapted to obtain utmost efficiency. In connection with the triple coil holder with the new springsockets are two **BURNDEPT** Precision Condensers one fitted in series with the primary coil holder and another in parallel with the secondary coil holder, a **BURNDEPT** Vernier Condenser is also fitted to the secondary coil holder so as to obtain exceedingly fine tuning and selectivity. The usual high-class **BURNDEPT** finish is put into this tuner which can be fixed by 4 wires to any **BURNDEPT** Receiver or other good make of apparatus.

PRICE in flat case - - - £7 0 0

in sloping cabinet - - - £8 0 0

IN STOCK.

IMMEDIATE DELIVERY.

CONVERSIONS :

As the two coil circuit using reaction is banned we have arranged to convert our old pattern Mk. I. and II. 2 coil tuners into Mark V Tuners at a nominal price, which will be quoted by return if the registered number of the tuner is sent to us with the application.

It is understood that when reaction is used on broadcast wavelengths (325-425 metres) that the Post Office requires that the experimenter should take the greatest care not to allow his valves to oscillate, which means the reaction coil must not be tightly coupled.

All **BURNDEPT** Valve Apparatus is duly licenced under Marconi Patents for amateur use in Great Britain.

BURNDEPT, LTD., Manufacturers of **AERIAL & EASTNOR WORKS,**
Wireless Apparatus **BLACKHEATH, LONDON, S.E.3**

BURNDEPT COILS

BURNDEPT COILS provide the simplest and most efficient means of using the triple circuit system of tuning. Plugged in the registered design **BURNDEPT** Coil holder by means of the spring plugs and sockets (allowing easy handling) the coils can be accurately coupled by means of the geared adjusting knobs. **BURNDEPT** coils are wound on a patented principle (Patent 168249) and are quite different from any other coil on the market, and are the most efficient, being used by the Post Office, Royal Observatory, Greenwich, National Physical Laboratory and other Government Departments, by many scientific institutions and most prominent experimenters at home and abroad.

The short wave coils 1, 2, 3, 4, are designed for all wavelengths to 600 metres—for triple circuit working on ordinary aerials to receive amateur and broadcast telephony we recommend Coil No. 4 in primary, No. 3 in secondary, and No. 1 in reactance. For very short waves No. 2, No. 1 and Nos. 3 or 4 respectively,

BURNDEPT Patent Coils for 750-24000 metres. **IN STOCK—IMMEDIATE DELIVERY.**

Coil No.	Primary Tuning with Average P.M.G. Aerial and Burndept Condensers or Tuners.				Secondary Tuning with Burndept Condenser or Tuner.		Price Mounted.
	Condenser in Series.		Condenser in Parallel.		Condenser in Parallel.		
	Min.	Max.	Min.	Max.	Min.	Max.	
S.1	160	260	310	380	135	330	£1 5s. set of four Concert Coils.
S.2	175	290	350	470	170	420	
S.3	210	360	430	640	230	575	
S.4	270	470	600	900	340	810	
75	350	570	700	1100	450	1000	Set of 9 £5 5s.
100	450	750	950	1450	600	1340	
150	650	1050	1300	2100	830	1900	
200	900	1450	1900	3000	1200	2700	
300	1250	2000	2600	4100	1600	3840	
400	1750	2900	3700	5800	2300	5400	
500	2600	4300	5500	9000	3500	8100	
750	4000	6600	8500	13500	5400	12500	
1000	6000	10000	12500	21000	7900	18000	

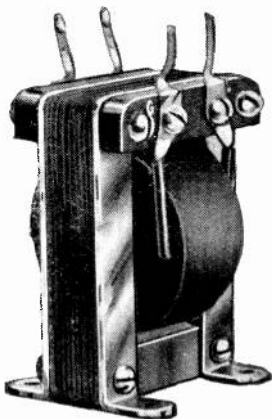

BURNDEPT Intervalve Transformers.

After much research, we are now able to offer a carefully designed transformer for low frequency magnification, and which we are now using for our valve apparatus, Due attention has been given to the following points

1. Correct impedance to ensure maximum amplification per valve, having special regard to the "R" type valve.
2. Most thorough insulation between primary and secondary coils, coils to frame and terminal to terminal.
3. Correct design of stalloy core to obviate distortion of magnified speech
4. Correct design of primary coil to prevent burn-outs when sufficient current is passed to ensure maximum amplification.

There are many other technical features which have been duly considered, Each transformer before being sold has to pass a test of 500 volts direct current, winding to winding and winding to frame, after which it must show a minimum insulation resistance of 100 megohms, A steady current of 10 milliamps is then passed through the primary and secondary for half an hour, We therefore fully guarantee each transformer against breakdown, Mass production enables us to offer these very high-class transformers at reasonable cost,

PRICE 24/- EACH.

BURNDEPT Telephone Transformers.

As used in our own apparatus, 120 ohms PRICE 20/- EACH.

ALL IN STOCK—IMMEDIATE DELIVERY.

BURNDEPT, LTD., Manufacturers of **AERIAL & EASTNOR WORKS,**
Wireless Apparatus **BLACKHEATH, LONDON, S.E.3**

BURNDEPT

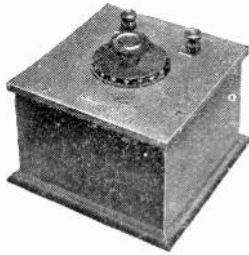

Precision

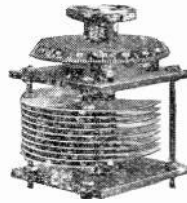

Condensers

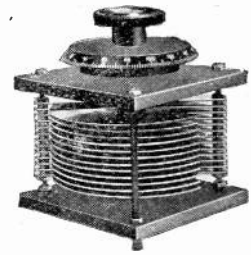

The design of this instrument is such that it can be produced in large quantities at a reasonable price, whilst retaining a high standard of technical excellence.

Specification. Vanes of hard thick aluminium. Bearings metal to metal. Contact to moving plates by phosphor bronze soldered strip. Adjustable operating tension. Spacing between plates sufficient for pressure up to 1,000 volts. Built upon Bakelite. Suitable for mounting on any panel from $\frac{1}{4}$ " to $\frac{1}{2}$ " thick, by drilling $\frac{3}{4}$ " clearing hole for spindle and three $\frac{1}{8}$ " holes for fixing screws. Each instrument supplied complete with a high-class engraved and polished Ebonite dial and substantial knob assembled, and the necessary fixing screws. The maximum capacity is '0008 and the minimum capacity negligible.

We recommend this size condenser as being the most suitable for both A.T.I. and secondary tuning. It is the same condenser which is built up into all our new **BURNDEPT** tuners.

PRICES. For Panel mounting, No. 141 **£2 0 0**. Mounted complete on Ebonite Panel and polished walnut case No. 142 **£2 15 0**. A smaller size condenser capacity '000275 for high frequency amplification, Vernier tuning, reactance tuning, etc. No. 144 for panel mounting only. The specification of this condenser is precisely the same as the large one **£1 12 0**.

IN STOCK—IMMEDIATE DELIVERY.

NOTICE

Owing to the completion of the installation of our new additional Factory EASTNOR WORKS, BLACKHEATH, we can now deliver from stock COILS (all sizes), PRECISION CONDENSERS, INTERVALVE TRANSFORMERS, etc.

All **BURNDEPT** Valve Apparatus is duly licensed under Marconi Patents for amateur use in Great Britain

BURNDEPT, LTD., Manufacturers of AERIAL & EASTNOR WORKS,
Wireless Apparatus BLACKHEATH, LONDON, S.E.3

LONDON OFFICE & SHOWROOMS: 15, BEDFORD STREET, STRAND, W.C.2.

Visit our Stand No. 12A. All-British Wireless Exhibition, Horticultural Hall, Sept 30th to Oct. 7th.

The Daily News

THE ONLY NEWSPAPER
WHICH GIVES REGULARLY
THE PROGRAMS OF BRITISH
WIRELESS CONCERTS

W. A. C. SMITH

236, Argyle Street,

GLASGOW,

are Sole Scottish Agents for the
Famous Burndept Receivers

DUBILIER

A New Condenser for Wireless Receivers

THE DUBILIER TYPE 600 MICA CONDENSER

The illustrations show two types of this new condenser for wireless receiving circuits. The condensers have the same perfect mica insulation, the same high efficiency and the same permanence of capacity as the larger Dubilier Mica Condensers used in wireless transmitters. Distortion when receiving telephony is often due to bad design of the components of the receiver—therefore use efficient Dubilier Condensers in your receiver to obtain the best out of your set.

PRICES:

Capacity between 0'0001 and 0'0009 mfd 2/6 each
 " " 0'001 " 0'005 " - 3/- ,,
 (inclusive)
 Condensers complete with Grid Leaks - 7/6 ,,

TRADE TERMS ON APPLICATION.

With Clips for Grid Leak.

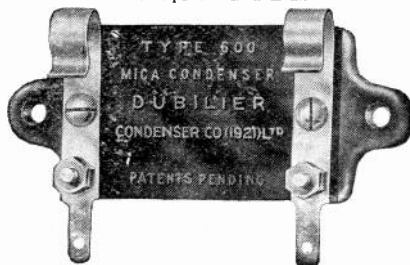

Without Clips for Grid Leak.

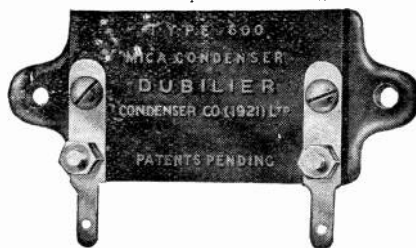

THE WAY TO DUBILIERS.

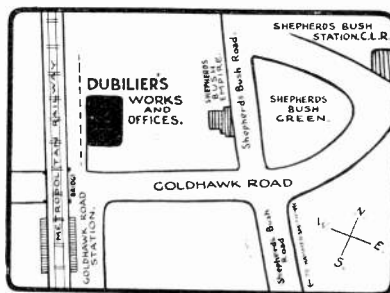

Visit our Stand No. 36. All-British Wireless Exhibition, Horticultural Hall, September 30th to October 7th

THE DUBILIER CONDENSER CO. (1921), LTD.,
DUCON WORKS, Goldhawk Road, Shepherd's Bush, London, W.12

Telephone—Hammersmith 1084.

Telegrams—Hivolcon, Phone, London.

Code—Marconi International.

STAMPINGS ^{FOR} RADIO INSTRUMENTS

TRANSFORMER CORE LAMINATIONS AND
DIAPHRAGMS FOR HEAD-PHONES

(IN OUR PATENT HIGH RESISTANCE MATERIAL)

“STALLOY.”

STALLOY WIRE FOR TRANSFORMER CORES.

ALUMINIUM CONDENSER VANES.

TRADE ENQUIRIES SOLICITED

JOSEPH SANKEY & SONS, Ltd., BILSTON

Representative: Robert Jenkins, 168, Regent St., London, W.1

THE HALL MARK of EFFICIENCY

Prices
on
Application



00005
0003
0005
01 mfd.

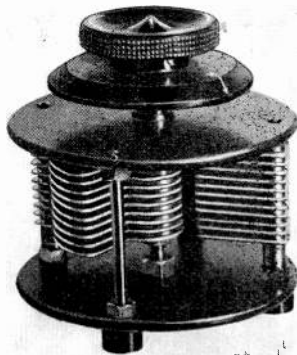

J. BURNS, LIMITED
Wangye Works, Chadwell Heath, Essex

The most reliable and efficient
Batteries for Wireless Work are

D.P.

STORAGE BATTERIES

D.P. Batteries are made to fit almost any size of box. The output of our Works runs to hundreds of thousands of plates yearly.

Write us for particulars

The D. P. BATTERY CO., Ltd.
BAKEWELL — DERBYSHIRE
& 11 Victoria St., London, S.W.

AFA "DUROS" CELLS

The only accumulator supplied in a charged state. They retain their charge for very long periods.

Stocked by all leading dealers in "Wireless Supplies."

E. G. LIND & CO., 58a, BUCKINGHAM PALACE ROAD, WESTMINSTER, S.W.1

THE WIRELESS WORLD AND RADIO REVIEW

THE OFFICIAL ORGAN OF THE WIRELESS SOCIETY OF LONDON
A MAGAZINE DEVOTED TO WIRELESS TELEGRAPHY AND TELEPHONY

CONTENTS

The Unit System as Applied to a Wireless Receiving Installation. By W. Forbes Boyd	779
On the Amplification of High-Frequency Currents. By Philip R. Coursey, B.Sc., F.Inst.P., A.M.I.E.E.	783
Is News by Wireless Really Wanted? By Captain Ian Fraser	789
Experimental Station Design. By F. H. H. (Continued.)	791

Contents continued on next page.

TO ADVERTISE 8000^{ohm} HEAD-RECEIVERS at 27/6 each

SENSITIVE, LIGHT, EFFICIENT.

OUR USUAL PRICES ARE:

140 ohms	30/- each.
4000 "	32/- "
8000 "	33/- "

POSTAGE 9d.

To bring our receivers before wireless people we will supply the first 1000 orders received at the following prices:—

140 ohms	23/6 each.
4000 "	25/- "
8000 "	27/6 "

POSTAGE 9d.

These are our standard type and are not job lines or special cheap stock. In fairness to customers who have already ordered we shall supply at these prices. This special offer is STRICTLY FOR THE FIRST 1000.



WELL FINISHED.

MONEY BACK IF NOT ENTIRELY SATISFIED.

J. L. CARTWRIGHT & CO., Manufacturing Electrical and Radio Engineers,
DEPT. W.

'Phone—Cent. 4209.

130/132, LONDON ROAD, MANCHESTER.

'Grams—Pladuram, Manchester.

Special Terms to the Trade.

WORKS: BERRY STREET.

Price Lists 3d. post free.

MEN IN THE WIRELESS SERVICES DESIRING RAPID ADVANCEMENT
 should train in spare time with the College which ensures this
 "U.E.C." (Regent's Park, London, N.W.1) has in Twelve Years secured hundreds of successes by
 Individual Postal Training for Engineering Examinations and Professional Work.
 State YOUR ambition in confidence, to—SECRETARY'S DEPT. (Desk W.),
UNIVERSITY ENGINEERING COLLEGE, WESTGATE-ON-SEA, KENT.
 and expert advice with the New prospectus, No. 8, will be sent you without obligation.

CONTENTS (Continued)

Electrons, Electric Waves and Wireless Telephony	- - - - -	795
The Damp Proofing of Coils and Formers. By G. P. Kendall, B.Sc.	- - - - -	796
Wireless Society of London	- - - - -	797
Air Race Reports	- - - - -	799
Notes	- - - - -	800
Correspondence	- - - - -	801
Calendar of Current Events	- - - - -	801
Wireless Club Report	- - - - -	802
Questions and Answers	- - - - -	805
Share Market Report	- - - - -	812

THE WIRELESS WORLD AND RADIO REVIEW is published weekly on Saturdays.

All correspondence relating to contributions should be addressed to THE EDITOR, THE WIRELESS WORLD AND RADIO REVIEW, 12-13, Henrietta Street, London, W.C.2.

No responsibility can be taken for MSS. or photographs sent without stamps to defray cost of return postage.

Editorial and Publishing Offices: 12-13, Henrietta Street, Strand, London, W.C.2.

Telegraphic Address: "Radionic, Rand, London." Telephone No.: Gerrard 2807.

Advertisement Managers, Bertram Day & Co., Ltd., 9 and 10, Charing Cross, S.W.1.
 Telephone No.: Gerrard 8063 and 8064.

SUBSCRIPTION RATES.—

28s. per annum, post free. Single Copies 6d., or post free 7d.

Registered at the G.P.O. for transmission by Magazine Post to Canada and Newfoundland.

HOLLOW STEEL MASTS FOR AERIALS

These masts are light, strong, easily erected, and will last a lifetime. All lengths over 15ft. are made in sections and each mast is supplied complete with baseplate, finial, rope cleat, pulley sheave, guy clips, three steel guy ropes and strainers, painted one coat ready for immediate erection. Being made of steel, no lightning conductors are required

PROMPT DELIVERY.

PRICES F.O.R. FOR CASH WITH ORDER, EACH

10ft. ...	32/6	15ft. ...	42/6	20ft. ...	45/-
25ft. ...	57/6	30ft. ...	84/-	40ft. ...	126/-

Other Lengths supplied at equally Low Prices.

Trade Inquiries Invited

THE WIRELESS STEEL MAST & ACCESSORY COMPANY
 Lombard Street West, West Bromwich

Telephone No. 447
 Telegrams: "Wireless Westbromich."

VALVES

DELIVERY FROM STOCK.

RECEIVING.

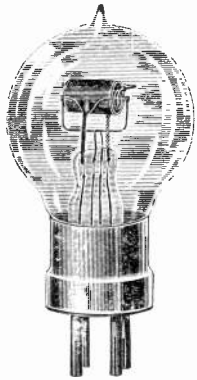

Type.	Filament Voltage.	Anode Voltage.	PRICE.
R	4	60	£0 17 6
R ₄ B	4	50	1 10 0
V ₂₄	5.2	36	1 4 0
Q	5.2	50	1 4 0
QX	5.2	50	1 4 0

(150 as amplifier)

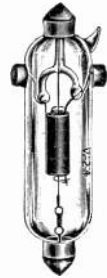

SPECIAL LOW TEMPERATURE VALVES.



Type.	Filament Voltage.	Filament Current.	Anode Voltage.	PRICE.
L.T.1	1.8	.4	36-50	£2 10 0
L.T.3	1.8	.11	„	„

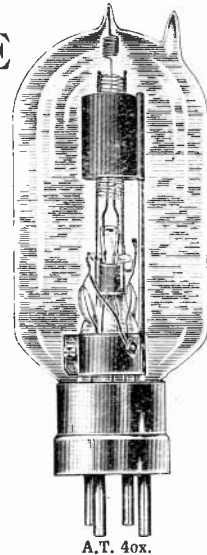

TRANSMITTING.

Type	Filament Voltage.	Anode Voltage.	PRICE.
A.T.25	5.5	UP TO 1,000	£1 10 0
A.T.40X	7	„ 1,000	2 15 0

I.T. 1.

A.T. 40x.

Visit our Stand No. 32. All-British Wireless Exhibition, Horticultural Hall, September 30th to October 7th

THE
MARCONI SCIENTIFIC INSTRUMENT CO., LTD.

40 DEAN STREET, SOHO, W.1

TELEGRAMS: THEMASINCO, WESTOEST
 TELEPHONE: GERRARD 74

WATES SPECIALITIES CAN ALWAYS BE RELIED UPON

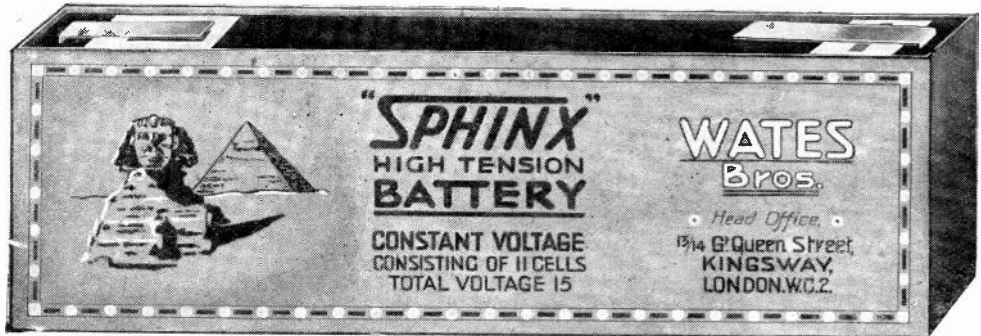

STANDARD 15-Volt Price 3/6 each (Size 9½" × 4" × 2½")

The Ideal Valve Accumulator

(In wooden cases with leather strap handles.)
 6-VOLT ... 50-AMP. PRICE 35/- Carriage 3/-
 4-VOLT ... 50-AMP. PRICE 24/- Carriage 2/-

- Exclusive features of these Accumulators:—
1. Basket pattern positives so constructed that it is impossible for active material to become displaced.
 2. Glass containers specially constructed with rib separators.
 3. Absolute absence of frothing.
 4. Practically impossible for plates to sulphate due to special materials used.
 5. Non-corrosive terminals.
 6. Impossibility of acid creeping.
 7. Last feature, but not least—LOW PRICE BUT HIGH QUALITY.

Extra for polished mahogany case suitable for 4 units. Tappings for either 30, 45 or 60 volt. PRICE with 60 volt batteries 29/-
 PRICE without batteries 15/-

VISIT OUR STAND NO. 15, ALL-BRITISH WIRELESS EXHIBITION, HORTICULTURAL HALL, Sept. 30th to Oct. 7th.

SEND THREE STAMPS FOR ILLUSTRATED CATALOGUE. TRADE ENQUIRIES INVITED

WATES BROS., *Manufacturers of best quality Wireless Apparatus*
 13/14, Gt. Queen Street, Kingsway, London, W.C.2
 Phone : Gerrard 576.

E **C** **ONOMI** **C** **E** **L** **E** **C** **T** **R** **I** **C** **L** **I** **M** **I**
 ESTAB. 1896
 Telephone : MUSEUM 1055.



THE NEW THREE ELECTRODE VALVE The "XTRAUDIION"

is the latest development of the Thermionic Triode and gives exceptionally fine results.
Oscillates—Rectifies—Amplifies.
 Filament consumption 5 amps at 4volts; Anode potential 50 volts. Standard Fitting, High Amplification, Characteristic, Silent Working.

PRICE 15/-

Visit our Stand No. 51. All-British Wireless Exhibition, Horticultural Hall, September 30th to October 7th.

Obtainable from the patentees
Economic Electric Ltd.



Wholesale Agent
 Mr. H. S. TYLER,
 23b Balham Hill, London, S.W.11

DAVIS & TIMMINS, LIMITED.

34a, York Road, King's Cross, N.1



SCREWS & TERMINALS FOR WIRELESS SETS.

Illustrated Lists sent Free on Request.

Tele. No.: NORTH 580.

Telegrams : CONDUCTIVITY, LONDON.

THE WIRELESS WORLD AND RADIO REVIEW

THE OFFICIAL ORGAN OF THE WIRELESS SOCIETY OF LONDON

VOL. X. No. 25. SEPTEMBER 16TH, 1922.

WEEKLY

The Unit System as applied to a Wireless Receiving Installation

By W. FORBES BOYD.

THE great advantage of the unit system as applied to the design of Wireless apparatus is the flexibility that the system offers.

This system, where each section is designed separately, should present an attractive feature not only to the novice who prefers to build up a receiving set gradually, but also to the experienced worker who desires to increase amplification with additional valves or experiment with a particular section to improve signal strength.

As is well known, a wireless receiving set can be divided into two sections:—

- (1) Tuner Section.
- (2) Amplifier Section.

TUNER SECTION.

Originally it was arranged that the tuner section would be as described in *The Wireless World and Radio Review*, July 29th, 1922, but a more simple type of tuner has been designed and is described below for the benefit of those who wish to keep the size of the set to a minimum, or who require a tuner with the smallest number of complications.

The tuner section is therefore described as one unit, and has an open oscillatory and reaction circuit only. If a closed oscillatory or loose-coupled circuit is required in addition, it is a simple matter to embody this as a separate unit.

AMPLIFIER SECTION.

The amplifier section, consisting of the valves and their attendant accessories, can be arranged to include any number of valves, but for the purpose of explanation, and to give a variety of the uses of the valve, a four-

valve amplifier is described below made up as follows:—

- (1) High Frequency Amplifying Unit.
- (2) Rectifying Unit.
- (3) Low Frequency Amplifying Unit.
- (4) Telephone Unit.
- (5) Terminal Unit.

DETAILS OF TUNER SECTION.

Reverting back to the tuner section; in order that this section should be reasonably narrow in width, it was decided that the plug-in method of obtaining different wavelengths by means of aerial inductances and reaction coils should be adopted, and in order that reaction should be obtained at short wavelengths the single layer coil in the form of flat pancakes is introduced for coils up to 75 turns. Beyond this range the standard duo-lateral coil is used.

The advantage of a series condenser being established for reaction at short wavelengths, and in order that only one variable condenser be used in the aerial circuit, experiments were made to retain the variable series condenser, and at the same time embody a fixed condenser so as to increase the range of wavelength covered by the variable condenser.

It was found that a 0.001 mfd. variable condenser in the earth lead and a 0.001 mfd. fixed condenser between aerial and earth gave these results, and whilst this arrangement scarcely alters the minimum wavelength for a particular inductance it increases the maximum wavelength about 60 per cent. as compared with the series condenser only.

Different values of fixed condensers were tried, e.g., 0.0005 and 0.002 mfd., but it was

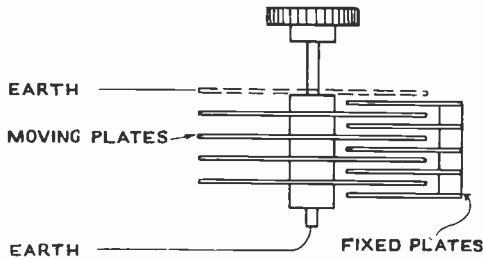

Fig. 1. Variable condenser.

found that whilst the former was satisfactory, giving critical adjustment for telephony, the wavelength range of the variable condenser was rather small, and when using the latter, it was impossible to critically tune-in telephony owing to the adjustment of the variable condenser being too coarse, and so a 0.001 mfd. fixed condenser is recommended.

The only other point of special interest

is to connect the moving system to the earthed side of the circuit.

Now, when the hand is brought near the condenser it is equivalent to supplying another earthed plate to the moving system as shown dotted, consequently the capacity of the condenser is altered with a corresponding alteration in the wavelength.

The result is that very annoying characteristic of condenser tuning when a signal may be perfect with the hand on the condenser knob, but weakens or even disappears when the hand is taken away. And so a shield is introduced on the face plate of the panel which permanently provides the extra capacity to earth with the result that there is not the slightest difference in tuning, no matter in what position the operator's hand is.

Apart from these features the tuner unit introduces no special points.

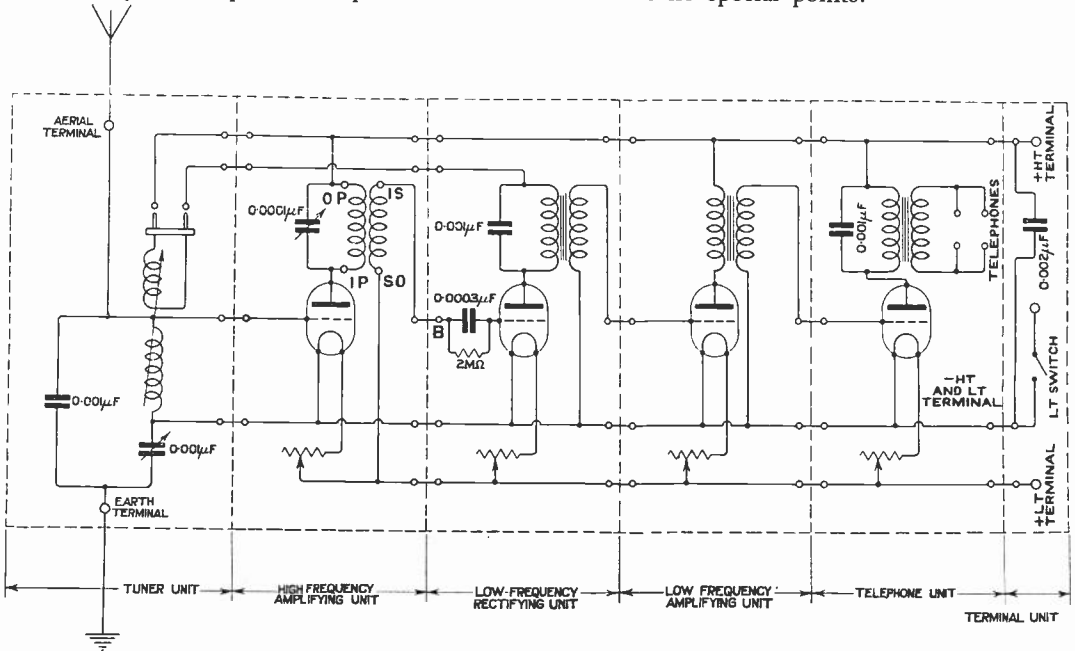

Fig. 2. Diagram of connections of units.

in connection with the tuner unit is the shield over the variable condenser.

It is well known that the capacity effect of the hand in operating a condenser alters the tuning, and is especially noticeable with telephony where critical tuning is essential.

The reason for this is obvious when reference is made to Fig. 1.

Usually a variable condenser is manufactured with the fixed system overlapping the moving system, and the common practice

A small or vernier condenser is provided below and in parallel with the 0.001 mfd. variable condenser on the tuner unit for final adjustment, but in practice it has been found unnecessary, since the screening plate overcomes all critical adjustment troubles.

Fig. 2 shows a diagram of connections of the tuner with four-valve amplifier units, and Fig. 3 gives the principle dimensions of the tuner unit, whilst Fig. 4 shows a photographic view of this unit.

In general, the units are designed to fit into the instrument section of a short wave tuner box and a width of $2\frac{3}{4}$ ins. was chosen as a general width of panel so that four of them would just fit into the box. With the tuner unit it was found necessary to increase the width to $4\frac{1}{4}$ ins., but it will be found that this odd dimension is brought to a multiple

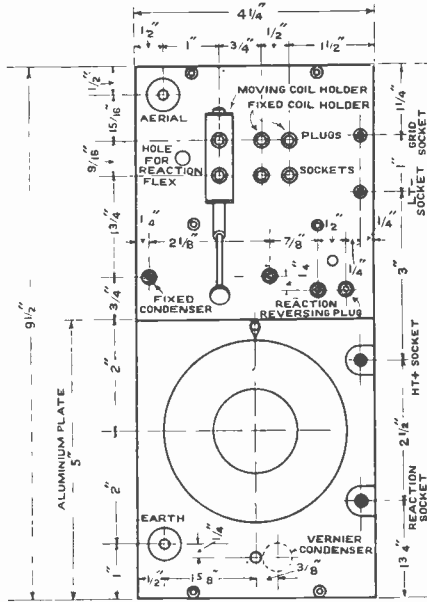

Fig. 3. Dimensions of tuner unit.

of $2\frac{3}{4}$ ins. by the terminal unit which is $1\frac{1}{4}$ ins. wide.

Adjacent panels are connected by means of small brass hoops or links which fit into link sockets on each panel, thus providing not only electrical, but also mechanical connection between panels.

DETAILS OF THE AMPLIFIER SECTION.

It has been stated above that for purposes of explanation four different types of amplifier units will be described, although of course it must be understood the unit system is adaptable for any method of valve coupling including resistance and reactance-capacity coupling, but in this article the more usual double wound transformer coupling is described.

The allocation of the various parts of the amplifier next comes under consideration, and perhaps this is the most important part in the design of any amplifier.

Usually the amateur designs an amplifier by sketching on paper how he can allocate

the various items on a panel and giving no thought to the final connecting up of these components.

The result is that there is a maze of connections at the back of the panel with innumerable crossing of leads which gives a maximum number of leakage paths due to the condenser effect of the adjacent leads.

In this design the connections are considered first and positions of the various parts of apparatus are secondary.

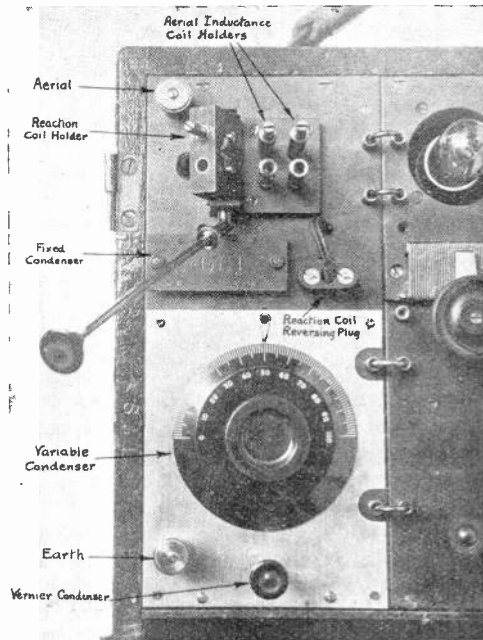

Fig. 4. Details of tuner unit.

If we look at the diagram Fig. 2 and take the telephone unit it will be seen that it is an advantage that:—

- (1) The Grid Link be near the valve.
- (2) The L.T. Negative Link be near the valve.
- (3) The L.T. Positive Link be near the filament resistance.
- (4) The H.T. Positive Link be near the transformer.
- (5) The Phone Plugs be near the transformer.

Of course, in designing on the unit system, it is necessary to consider all the types of units that may be introduced, and keep in mind that certain parts which are not variable, such as the valve and iron core transformers, be placed as far away as possible from parts

which are variable, such as filament resistances, condenser on H.F. unit, etc.

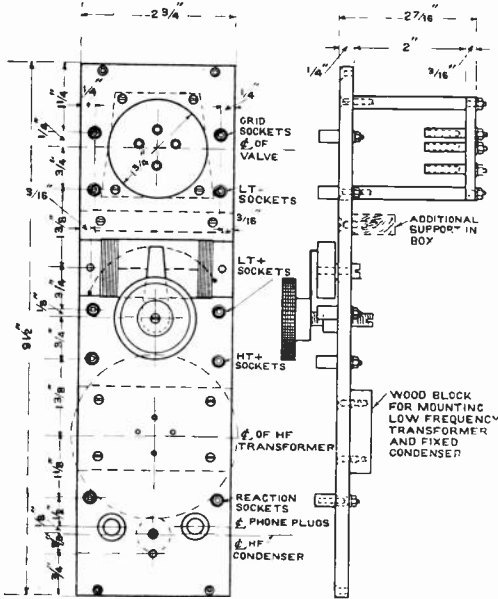

Fig. 5. Showing position of apparatus on panels.

Considering all these points, a composite drawing is evolved as shown in Fig. 5, which shows the position of all the apparatus on the various panels, whilst Fig. 6 shows the drilling of each respective panel.

It will be noticed that the valves are sunk below the level of the panel and yet not too far down to prevent the use of the "R" type of valve. This allows the lid of the box to be shut with the valves in place, and also it is an advantage that the

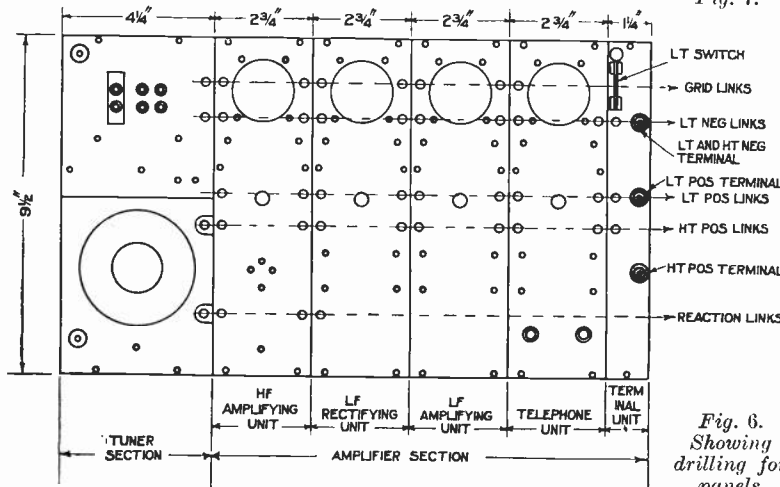

Fig. 6. Showing drilling for panels.

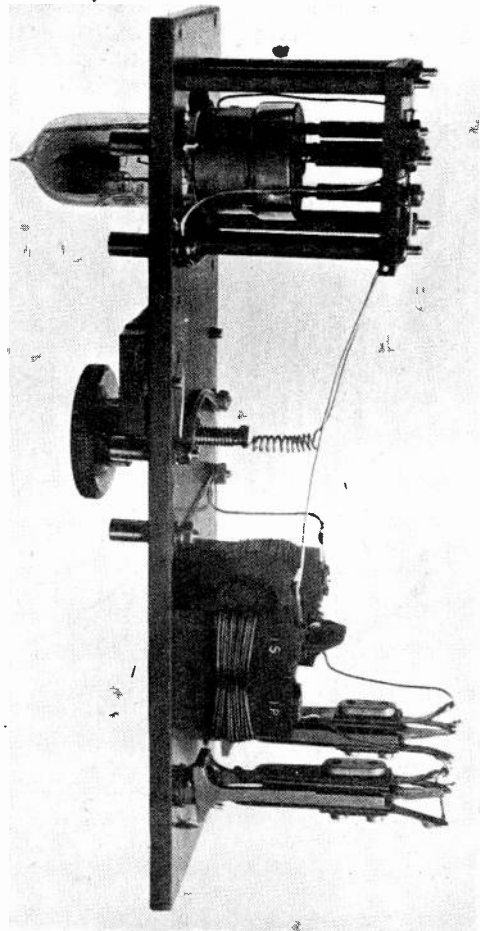

Fig. 7. Details of telephone unit.

connections from the valve leg sockets to the filament resistance and the transformer are in a different plane, or in other words are much lower than those connections immediately at the back of the panel. Thus, where any crossing does occur there is a distance of about 2 ins. between the leads.

Fig. 7, which gives the details of the telephone unit, shows this clearly.

(To be concluded).

On the Amplification of High-Frequency Currents

(Continued from page 756.)

By PHILIP R. COURSEY, B.Sc., F.Inst.P., A.M.I.E.E.

A very simple modification of the arrangement shown in Fig. 11, page 756, gives us an amplifier which was invented by L. B. Turner, and called the "Kallirotron." The Kallirotron amplifier is actually this inverted Blondel amplifier (Fig. 10) with a back coupling. Turner's Kallirotron, as described by him* is shown in Fig. 12. In this case the two valves are coupled together by the same scheme as that just described, except that the potentiometer is not used, and an extra battery B_3 is employed, so that the grid of V_2 can be brought to the same potential as its filament, just as was done with the potentiometer in Fig. 10.

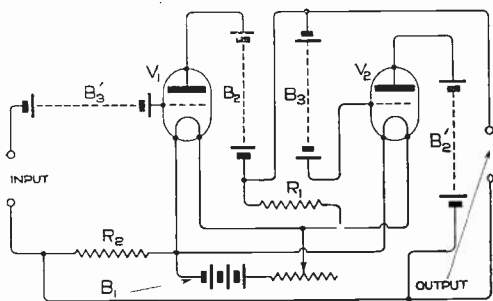

Fig. 12. Turner's Kallirotron Amplifier.

The Kallirotron also uses an exactly similar coupling from the anode circuit of the second valve back to the grid circuit of the first one, V_1 . This therefore provides a back coupling from the second valve to the first for the amplified energy, so that it can be reamplified by the valves.

The Kallirotron, as described by Turner, is primarily a very sensitive amplifier, giving enormous amplification with two valves, an amplification of several thousands, since by reason of the back coupling effected by the resistances the apparatus can be got to the point where regenerative amplification is

taking place, without it tending to oscillate readily, since there is nothing in the coupling in the nature of an oscillatory circuit, and there need be no oscillatory circuit connected to the anode of the second valve.

We thus see that Turner's Kallirotron and Blondel's amplifier, turned upside down in the manner here described, are identical except for the addition of the back coupling in the former. They form two rather uncommon methods of coupling two valves to enable them to amplify high frequency currents, and for that reason I have drawn your attention to them.

A scheme has been patented recently by Mr. Gossling, of the General Electric Company, slightly modifying this style of arrangement, so as to use one high tension battery only, but the circuits are much more complicated and involve the use of constant current resistances to keep constant the currents flowing round parts of the circuit. It is not an amplifier that can easily be set up for experimental purposes.

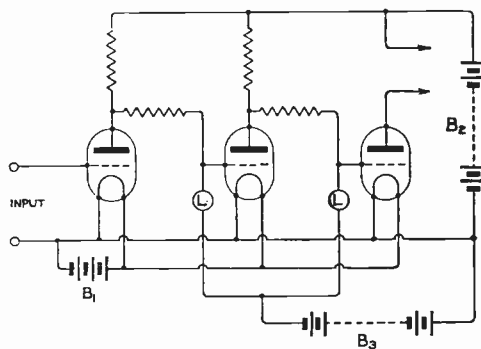

Fig. 13. Gossling's Amplifier, using common batteries. L, L, = current limiting devices such as saturated valves

A diagram of one of these arrangements is reproduced in Fig. 13.

The next arrangement I wish to refer to is a very common form of coupling used between

* Radio Review, 1, pp. 317—329, April, 1920.

two or more valves for the magnification of high frequency currents—viz., the resistance-capacity coupling which is sketched in Fig. 14. By putting an anode resistance between the terminals T_1 and T_2 of Fig. 6, and joining T_2 and T_3 we obtain the desired circuit. The anode resistance may be of the order of 50,000 to 100,000 ohms, and the leak from $1\frac{1}{2}$ megohms to 4 or 5 megohms, according to the valve in use. Loss of amplification at high frequencies, to which I referred just now, also occurs with this arrangement. It is due to the stray capacities which must exist between different

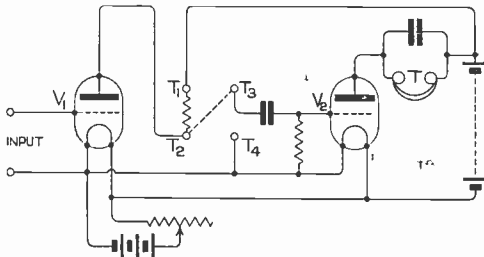

Fig. 14. Resistance-Capacity Coupling arranged on experimental amplifier panel.

points in the circuit. Any capacity across the anode resistance will shunt off the high frequency currents from that resistance, and will prevent their being passed on to the next grid. The H.T. battery should not have any appreciable resistance, but it is usually advantageous to shunt it with a condenser of one or more microfarads, so that the high frequency impulses will go through the condenser rather than through the battery.

It may be asked why it is necessary to have an anode resistance if its use creates difficulties. The reason, I think, will be obvious if we consider what it does in the circuit. If we apply a voltage to the grid of the first valve and if its anode is connected to the H.T. battery with no resistance in series, when the grid is made positive, the internal resistance of the valve will be lowered and a larger anode current will flow, but the anode potential is held constant by the battery and there is no point in the anode circuit where we can find an amplified change of voltage. In order to operate the second valve we need to so arrange the first that it will amplify the voltages applied to its grid so that these amplified voltages can be applied to the grid of the next valve. We can obtain the desired result by keeping the anode current constant, then whether we make the first grid positive or negative, we shall then

get the corresponding changes in internal resistance of the valve repeated in the voltage changes across the terminals of the valve. Although the valve has a characteristic which is not entirely linear, and is therefore in consequence often said not to obey Ohm's Law of Current = Voltage divided by Resistance, this law applies rigorously for any given point on the characteristic, and the anode current is dependent upon the total resistance of the anode circuit, since the applied voltage from the H.T. battery is constant. The anode circuit resistance is partly made up by the valve and partly by the resistance of the outside circuit. If the internal resistance of the valve at any instant is R_a the voltage across the valve will be the anode current I_a multiplied by this resistance. Now if we can put in the circuit anything to keep the current practically constant, any change in R_a , the effective resistance of the valve, such as may be caused by changes in the grid potential applied to the valve, will be repeated in the voltage across the valve and will be applied to the grid of the next valve by means of the coupling condenser.

Supposing we want to keep this anode current constant, how can we do it? If we make the total resistance in the circuit constant, of course the current will remain constant. But here we have a constant supply voltage and a variable resistance, so that we cannot actually maintain the current quite constant, but we can get somewhere near it. If we make the remaining resistance in the circuit very large compared with the resistance of the valve, we can keep the current nearly constant. For example, if the valve has an internal resistance of 40,000 ohms, and we put in series with it four million ohms, the total resistance would be 4,040,000 ohms. If, then, this 40,000 ohms became 30,000 or 20,000, or even 60,000, it would only make one or two per cent. difference to the whole resistance value, and we would get the anode current almost constant. Any changes in the internal resistance of the valve would then be repeated as variations of voltage across the valve. Well, that could be done, but other points must be considered. Supposing that valve was passing a current of 1 milliampere, what voltage must be put in the anode circuit if we have to get 100 volts on the valve with one milliampere passing through the above-mentioned anode resistance? We should want 4,040 volts, which would be rather unpractical. Hence, when we are using resistance coupled

amplifiers we have to make a compromise, since we cannot put anything like 4 megohms in the anode resistance, and we must put something of the order of 50,000 or 60,000 ohms so as to limit the total voltage which must be put into the anode circuit in order to get the necessary current through it. Then when we change our grid voltage we shall get a change in the anode voltage, but it will not be as big as if there were a very large series resistance. It is therefore not possible to hand on a voltage change to the next valve without introducing some loss in amplification, or in other words, the voltage amplification that will be obtained is less than it theoretically would be were the anode current maintained constant, by the voltage that is dropped by the current change through the series resistance.

Hence there are some practical disadvantages in the resistance-capacity coupling, and on that account attention has been given on many occasions to obtaining some other coupling method. The great advantage of the resistance-capacity coupling is that there is no part of the intervalve coupling which varies with the frequency (other than stray capacities), so that the amplifier is suitable for use on most frequencies, except when the stray capacities become troublesome.

By fitting up one of these amplifiers and connecting a variable condenser across the anode resistance, it is easily possible to demonstrate this loss in amplification due to the shunting off from the anode resistance of the high frequency amplified current changes. With very short wavelengths the loss due to that condenser becomes more and more important, because the current which it draws off from the resistance is proportional to the frequency.

In practical work with short wavelengths a means is wanted of getting over this difficulty. What we require is a method which will make the valve capacity and other stray capacities useful rather than harmful. We can do this if we make the capacity either tune or help to tune a circuit. This cannot be done with a resistance in the anode circuit, but if a coil is used instead of a resistance the circuit can be tuned. This effect can be obtained with a transformer coupling. For this we do not want a grid leak if the transformer is connected to the terminals T_1 , T_2 , T_3 and T_4 in Fig. 6, so that one coil is in the plate circuit of the first valve, and the other coil is in the

grid circuit of the second, just like an ordinary transformer-coupled low frequency or note magnifying amplifier, except that a transformer suitable for the high frequency currents must be used. These connections are shown in Fig. 15.

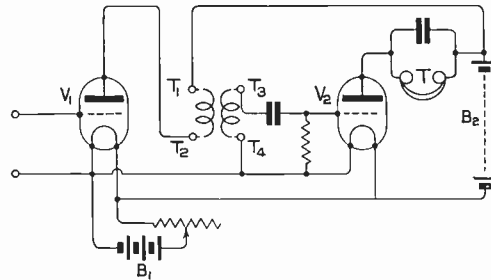

Fig. 15. Transformer-Coupled H.F. Amplifier adapted to the experimental panel.

Consider the effect of the valve capacity, which will behave as a condenser across the transformer winding. Obviously we obtain a tunable circuit, and therefore there will be maximum voltage across the transformer winding for one particular frequency.

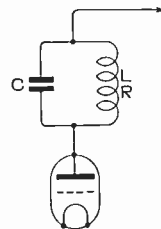

Fig. 16. "Parallel Resonance" or "Rejector" Circuit in the anode circuit of a valve.

The effective resistance of a parallel circuit of this type (Fig. 16) is an important quantity, because such a circuit at the frequency to which it is tuned behaves simply and solely as a non-inductive resistance. I do not know whether you are familiar with the vector representation of currents and voltages, but probably most of you have heard the statement that if you put an inductance in an A.C. circuit it makes the current lag behind the voltage, while if you put a condenser in it makes it lead the voltage, so that in the case of the parallel circuit sketched in Fig. 16, relative to the voltage across that circuit, the current through the inductance is lagging, and the current through the condenser is leading. Actually the inductance has some resistance,

and the current does not lag at exactly 90° from the voltage; it lags at some less angle, such as 80° for example, as sketched at ϕ_1 in Fig. 17. The vector representing the current through the condenser leads on the voltage by the angle ϕ_2 which, with good condensers, is to all intents and purposes 90° . If we find the resultant of these two vectors by the usual parallelogram method, we find that its length is much less than either of the other current vectors, and that it is much more nearly in phase with voltage than is either of the other

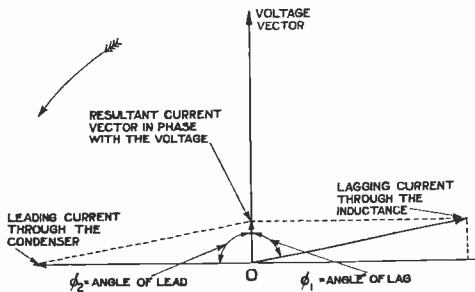

Fig. 17. Vector diagram of "Parallel Resonance Circuit."

current vectors. Obviously, therefore, it is possible to adjust the value of the leading vector representing the current through the condenser by altering its capacity until we arrive at a resultant vector which is in phase with the voltage. When that is the case the circuit is said to be tuned, or in resonance with the supply frequency. The total current through the circuit is then in phase with the voltage, although the currents in each branch of it are not in phase. I think by reference to Fig. 17 you can see that if this inductance is a bad one as an inductance, that is to say, it has a high resistance, and therefore does not make the current lag very much (such, for example, as when its resistance is approximately equal to its inductive reactance), then the resultant vector is quite large for a given voltage on the circuit. If the resultant current is large, the circuit has not a large effective resistance, although we have an inductance with a high resistance. If the inductance is good, so that it makes the current lag nearly 90° on the voltage, the resultant is very small, and the better we make our inductance, the less will be the size of the resultant vector. If we could get a perfect inductance we should have no resultant current flowing through the whole circuit, or in other words the effective resistance of the circuit would be infinite.

Actually the effective resistance of the circuit is represented by $R' = L/CR$, R being the resistance of the coil, L its inductance, and C being the capacity of the condenser. That indicates that the higher the ratio of the inductance to the capacity the bigger is the effective resistance of the whole circuit, and if the ratio is small, the effective resistance of the whole circuit becomes smaller. Hence, if we use a good inductance, *i.e.*, a coil of low resistance and tune it by the valve capacity, or by the valve capacity plus a small variable condenser put on in parallel, we get an arrangement which, at a certain frequency, offers a very high resistance to the flow of alternating current through it, although as regards the D.C. high tension battery it is offering very little resistance. Hence we can in this way keep the steady voltage on the anode of the valve at its normal value, almost identical with the voltage of our battery, whereas at the particular wavelength to which the circuit is tuned, the effective resistance becomes very large, and therefore the changes in current flowing through the circuit become very small, and consequently a maximum alternating (H.F.) voltage is built up across the coil. Hence, under these conditions, if there is a maximum of voltage across the primary of the transformer there will likewise be a maximum of voltage across the secondary winding, since in all ordinary transformers of this type the coupling between the two windings is a close one.

Many types of high frequency intervalve transformers have been built for use in this manner. Those Mr. Campbell Swinton described recently at the Wireless Society of London were of this type, and were designed to operate on a range of wavelengths with a small tuning condenser across one of the windings.

In all these transformers, however, the two wires are wound close together so that actually these transformers act very little as true transformers. They are called transformers and wound as transformers, but they do not behave as transformers. To obtain true transformer action the two coils must be well separated out so that it is possible to tune the secondary as well as the primary, and in that way to build up in the secondary much higher voltages than we could obtain without such tuning. Thus by making this intervalve coupling like an ordinary loose coupled tuner with primary and secondary

circuits both tuned, obviously we shall build up in the secondary circuit, when using a very small capacity, a maximum voltage and thus get large voltage amplification between the two stages of the amplifier.

When the two coils are wound as in the Sullivan and many other makes of H.F. transformer, and as in the transformers described by Mr. Campbell Swinton, the windings are so tightly coupled that they act as one circuit, and tuning one circuit tunes both. It does not much matter whether you tune only one circuit or tune both circuits simultaneously to get the desired wavelength, the result is the same. Thus when building up such an H.F. intervalve coupling transformer, it is not possible to tune up one of the circuits, or to adjust one of the circuits to the desired wavelength until the second winding is in place and joined up. For instance, with a transformer of this type adjusted to give maximum amplification on 600 metres, it will be found that the wavelength of the primary circuit alone, even when connected to the valve and other capacities, will be only 150 to 200 metres before the secondary winding is put on. Therefore an amplifier of this type must always be adjusted when the transformers

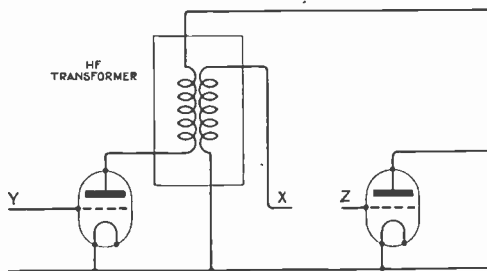

Fig. 18. Method of adjusting wavelength of H.F. intervalve transformer.

etc., are connected properly in circuit. A simple way of effecting this tuning is to take out the second valve from its socket and take back the wire X (Fig. 18) from the grid connection Z of the second valve, to the connection Y of the grid of the first valve. The first valve will then oscillate, and its wavelength can be measured, so that the transformer windings can be adjusted accordingly to give the desired wavelength. It is a very simple way to do it, and it works quite well in practice.

On account of the close coupling between them, the two windings thus behave as one coil, and although some of the energy is handed on

to the next valve by ordinary transformer action, a considerable portion of the whole available energy is handed on by the electrostatic capacity between two windings.

In this case, therefore, we can obtain similar results by using one winding only and tuning it by means of a small variable condenser when, as I said just now, we get a maximum voltage built up across the coil

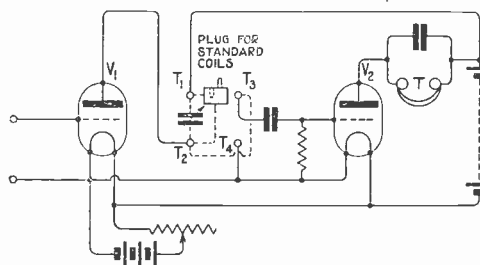

Fig. 19. Arrangement of H.F. amplifier with interchangeable plug-in coils.

when it is in tune with the working frequency. We then have only one circuit, one coil to tune, and can build up across it a voltage which is the maximum that it is possible to obtain, being limited only by the amplification factor of the valve, and the resistance of the coil winding. This, then, is a further simplification in the evolution of a simple high-frequency amplifier. With this change, however, we must once again introduce our grid leak, but the grid leak is not a very complicated piece of apparatus and it will do for all frequencies, and hence, whatever coils we use in the plate circuit of the valve any convenient coil, such as a Burndept, or a Duolateral, or similar coil, and thus easily build up an amplifier in this simplified form. With the experimental panel arrangement that has already been described, the grid condenser and grid leak can be left in position and an ordinary standard coil plug connected in the anode circuit with a small variable condenser across it, as shown in Fig. 19. This condenser can have any desired value, but it is advisable to keep its maximum value small, say, 0.0001 to 0.0002 microfarad. We can then plug in any one of our standard coils into the circuit and make up an amplifier that will amplify any frequencies we like. It will amplify frequencies up to the highest

it is possible to get in wireless circuits, and the maximum possible amplification can be obtained in this way.

With an amplifier of this type it is possible to demonstrate the physical reality of the above-mentioned expression for the effective resistance of the circuit by using a variable condenser of the ordinary type with a considerable range of capacity in the anode circuit of the valve and various plug-in coils. Either a large coil and a small value of condenser can be used or a small coil and a bigger condenser capacity, and the difference in the amplification often becomes quite pronounced, the small coil with the larger capacity giving weaker signals.

I have not so far said anything about introducing a reaction coil into the amplifier. This is easily done by inserting a suitable coil in the plate circuit of the detecting valve and bringing it back to couple on to the aerial circuit. It may also be pointed out that one need not with such an arrangement react back to the aerial circuit, but when using a tuned anode circuit of the type just described we can couple the reaction coil with our intervalve coupling coil and so make the detector valve oscillate without worrying so much about radiation from the aerial circuit.

One slight disadvantage of this type of amplifier is that some extra means is necessary for preventing self-oscillations of the high frequency valve. With most valves, tuning of the anode circuit to the same wavelength as that to which the grid is tuned, causes the valve to set up oscillations continuously, the reaction being provided by the inter-electrode capacities of the valve. The amplifier must therefore be stabilised, either by applying a positive voltage of 3 or 4 volts to the grid of the H.F. amplifying valve, or by dimming the filament, or by providing some form of *reverse* magnetic reaction to stop the oscillations. Either the first or the last of these methods is usually the more satisfactory.

Before concluding, I would like to refer to the additional problems which are involved in very short wave amplification. A great deal has been published about them and I thought it might be of interest to draw your attention to them.

As I have just indicated, the tuned anode H.F. amplifier can be made to amplify any frequency within reason so that it will amplify both long wave and short wave signals, provided the proper coils are used. Its one disadvantage in practical use is its selectivity ;

it mainly amplifies for the frequency to which it is tuned, and gives very little amplification for other wavelengths. When there is much jamming, this additional selectivity is useful. The tuning range can be broadened out a little and made to cover a wider band of wavelengths by using high resistance coils, which lowers the effective resistance of that circuit and broadens out the amplification over a wider range of wavelengths. The total amplification is somewhat reduced by this means, but at the same time it is broadened out so as to enable searching to be carried on over a wider range of wavelengths. The effective resistance of the circuit can be lowered by winding the coil of resistance wire, or by connecting a suitable resistance in series or in shunt to the coil. For many experimental purposes it is rather useful to connect up both a resistance-capacity coupling and this other tuned anode one, then if we want to search over a range of wavelengths we can switch in the resistance, and then when the signal is found we can make our arrangement much more selective and cut out some of the jamming if any is present.

For the amplification of very short wavelengths the arrangement which one can unquestionably recommend is either this tuned anode or the tuned transformer used in conjunction with the principle of Armstrong's supersonic heterodyne, that is to say heterodyning the incoming signals not to give an audible note in the telephones as one ordinarily does, but heterodyning to a much higher frequency, and then amplifying this intermediate frequency by some other form of radio-frequency amplifier. Thus for the reception of 200 metre signals, we can set our heterodyne to about 214 metres, thus giving us a beat note or heterodyne note frequency of 100,000 cycles. We cannot hear a note of 100,000 cycles, but it is an oscillation of 3,000 metres wavelength. Thus with this scheme we can heterodyne our incoming signal to a longer wave signal and then amplify it in the ordinary way, finally obtaining an audible note with a second separate heterodyne.

I do not know whether the members present have seen the description of the apparatus used by Mr. Godley, the American who was sent over here in connection with the Transatlantic Tests, but he used such a scheme with a nine-valve amplifier, the first one being a detector valve and the next one a high frequency oscillator, using the remaining set of valves for the long wave amplification, for detection

of the long wave signals with a note magnifying valve at the end.

This Armstrong super-heterodyne does enable you to get very high amplifications on very short wavelengths, and although amateur experimenters in this country have up to the present mostly confined their transmissions to 1,000 metres, there are considerable ad-

vantages in the prevention or reduction of jamming between various stations in using the shorter wavelengths round about 180 metres, which most of us are licensed to use. If we should develop the use of such wavelengths it might be important to consider such a scheme as the Armstrong super-heterodyne.

Is News by Wireless Really Wanted?

By CAPTAIN IAN FRASER.

NEWSPAPER reports from America, and evidence from various quarters in this country, make it clear that in the not far distant future the broadcasting of wireless telephony to thousands of homes will become a feature of life in England. Mr. Kellaway's statement in the House of Commons the other day indicated that a settlement of the dispute that had arisen between the Post Office and the various firms who desired to manufacture wireless receiving sets was in sight, and this of course brings very near at hand the day when broadcasting in the United Kingdom will become a reality.

Without doubt there will be a boom in this country in the sale of wireless receiving sets, and a gallant attempt will be made by the firms who undertake broadcasting to supply an interesting and useful service of news, concerts, etc.

I write this article because I believe that the profuse publicity which has been given to this new development in the science of wireless telephony has led the man in the street to an entirely wrong conception of its usefulness. I believe that the novelty and wonder of receiving news from a distant source without any visible means of connection between the sender and the receiver has filled people with an exaggerated view of the value and usefulness of such a service.

That news can be transmitted and received simultaneously in thousands of homes I know, of course, and that the reception, with only a moderate outlay for apparatus, can be really good, I know too, from personal experience. But I venture to think that when

calculating the development of a news service by wireless telephony one very important factor has been overlooked, and this factor occurs to me with unusual emphasis on account of the fact that I have been compelled to receive all my news by means of the ear instead of by means of the eye for the past five years. I was blinded at the battle of the Somme in 1916, and since that time, though I have kept very closely in touch with the news of the great world outside, I have had it brought home to me every day what a clumsy and inefficient organ the ear is for this purpose, as compared with the eye. And yet I who have had to listen for my news have had two great advantages over him who proposes to hear it through a wireless telephone receiver. Firstly, I am able to have the newspapers read when I desire to hear them, and not at a particular time, such as would be imposed upon the listener to a broadcasted news service which at best could only be convenient to the majority of the listeners, and not to the individual. Secondly, my reader can pick out the particular newspapers which I like to hear, and by reading through the headlines and waiting for me to say yes, or no, before proceeding with the article or paragraph, can approximate in some measure to the efficiency and facility with which a sighted person glances at his paper and chooses what he wishes to read. I have a Secretary who can read to me at from 240 to 250 words a minute. There are probably quite a number of people who can read aloud well at this speed, but there are not many who can listen to it, and take in what is being read. People who can see are not used to having books

or newspapers read aloud to them, and without long practice I do not believe the ear and brain could be expected to take in information read at anything like this rate. However, supposing with practice the many thousands of people whom we are lead to believe are going to receive their news by wireless telephony attain this speed, they will still be spending twice or thrice as much time in gathering any particular piece of news than would be required if the eyes were used.

I do not deny that there may be some hundreds of people living in the country who desire to hear some particular piece of news which the broadcasting station will send them at a particular time, and who—desiring it sufficiently much to make them put up with the inconvenience of listening to it, or perhaps not being able to obtain a newspaper for some hours after the event—will become regular users of the system. For example there will undoubtedly be a regular service announcing the winners of races, and as there are no regular evening papers in the depth of the country there will be a number of people who would be willing to install a wireless telephone receiver for the purpose of receiving this information earlier than would otherwise be possible, with the additional attraction, of course, of having concerts available in their homes.

But, comparatively speaking, these people will not be very numerous, and I am therefore strongly of the opinion that when the initial interest has evaporated it will be found that the news service by wireless telephony is not wanted.

The acceptance of this theory would lead to a reduction of the estimate which would otherwise be made as to the number of wireless receiving sets which will remain in use after the first novelty which led to their installation has passed away. But it by no means indicates that there is nothing in the idea of broadcasted wireless telephony.

In my view there will always be a demand for broadcasted wireless telephony, if a really first class concert, and occasional lectures and perhaps speeches by eminent politicians or others on matters of interest and importance are supplied.

And this will be much more the case when the science of amplified or loud-speaking telephony reaches a stage when it is possible to throw the speech or music received by the wireless instruments into a small sized drawing-room or sitting-room without much cost or difficulty. At the present time this stage has not been reached, for whereas instruments for the reception of wireless telephony with headphone can be purchased for a few pounds, the outlay is two or three times as much if a volume of sound comparable with that given by an ordinary gramophone is desired.

With the best amplifying apparatus concert items can be produced as loudly or even more loudly than by gramophone, and rather more perfectly, for there is usually an entire absence of the mechanical noises which take away from the perfection of the best gramophone record. Further, with the concert item transmitted by wireless telephony there is, I think, a curious psychological effect. Though it does not sound very different from the rendering of a record by a gramophone, the listener has nevertheless a feeling that there is more vitality about it. This is probably so because he is conscious of the fact that almost at the moment of listening the living artist is performing, whereas with the gramophone, however good it may be, there is ever present the thought that the particular rendering to which he is listening is not new, and is not a thing of the present. If one were permitted to use the phrase in connection with the mechanical production of the human voice or the strains of an instrument one would say that there is more personality in the wireless concert item than the gramophone record.

THE WIRELESS EXHIBITION AND CONVENTION
SEPTEMBER 30th TO OCTOBER 7th, 1922
AT THE HORTICULTURAL HALL
WESTMINSTER, S.W.

Experimental Station Design

Continued from page 719, September 2nd, 1922.

These articles, which appear in alternate issues, are intended not only to be a complete guide to those new to wireless, but to give explicit details on the construction of all the components of the Experimental Station. Actual designs will of necessity in some instances be somewhat crude, in order that they can be made up without elaborate workshop equipment. Practical working instructions are given where necessary for the help of those unacquainted with the more simple processes of instrument making. Of course, where good workshop facilities exist, the designs may be readily modified.

Economy is made an essential feature, bearing in mind always that where low-priced component parts can be obtained their use has been embodied in the designs. For those who do not desire to make their own apparatus, the descriptions will assist them in selecting the equipment for their stations.

The information contained in the first few articles under this heading is to help those new to wireless and whose first aim is to build a simple set capable of receiving broadcasted telephony, and consequently may cover ground already familiar to many readers. The succeeding instalments, however, advance by easy stages, and in the course of the series the construction of an elaborate station will be evolved.

XII.—HIGH FREQUENCY AMPLIFIERS.

SUGGESTED methods for incorporating the high frequency transformers already described, in high frequency amplifiers are shown in Figs. 1 and 3. Easy modifications can be effected for making use of any

particular type of transformer, though with transformers of bigger external diameter than those shown a larger ebonite panel will have to be used in order to obtain sufficient spacing to prevent inter-action, which is a common

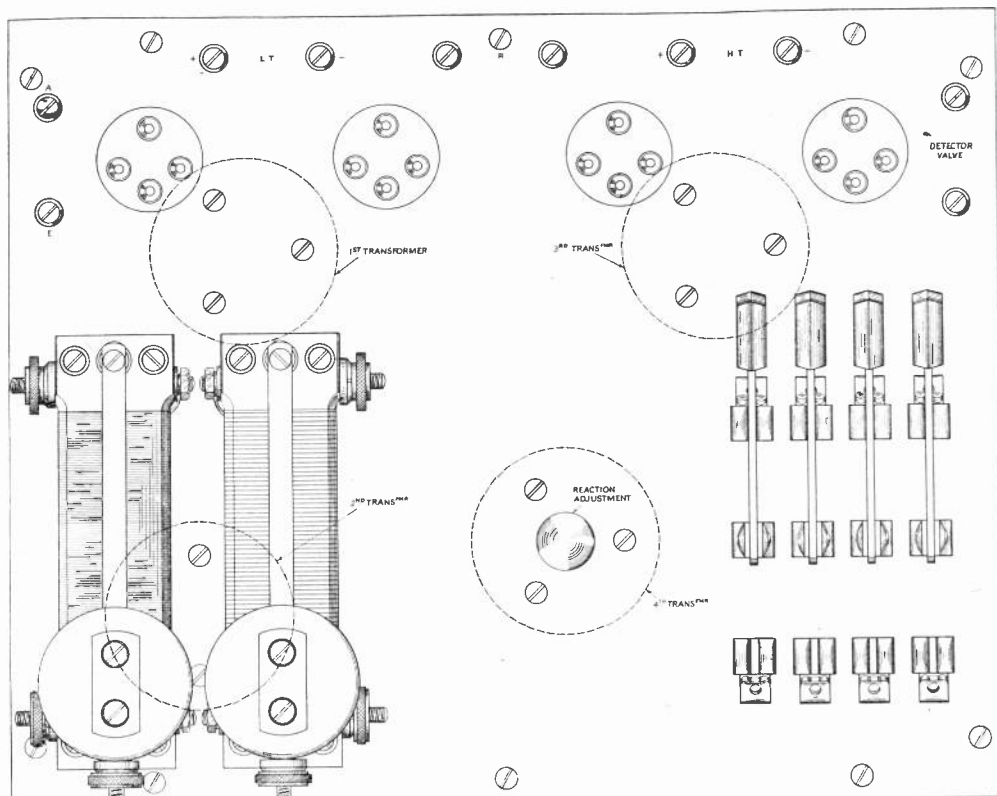

Fig. 1. Lay-out of panel of H.F. Amplifier provided with valve switching and reaction designed for use with "R" valves. Scale $\frac{1}{4}$ actual size.

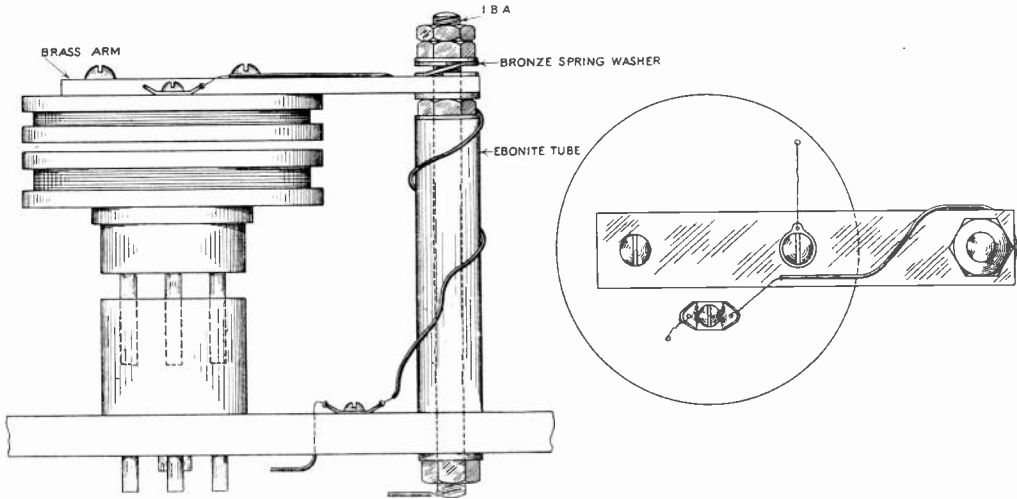

Fig. 2. Front and side views of plug-in transformer with swinging reaction coil. Scale $\frac{1}{3}$ actual size.

cause of parasitic noises. The drawings are made to scale, and the transformer spacing is ample for the types shown. If many stages of amplification are to be employed, the reader is advised to use transformers of small diameter in order to limit the dimensions of the panel on which they are to be mounted. Panels of the sizes illustrated may be $\frac{5}{16}$ in. in thickness, but should any increase in area be necessary the thickness of the ebonite should be correspondingly increased

to $\frac{3}{8}$ in. Other modifications may be necessary when purchased components are made use of, should they differ in size from those shown. For instance, should purchased rheostats be larger in diameter, they should be laid out on a sheet of paper and carefully measured in order to ascertain the increase in length and breadth of the panel, and careful consideration given to margin and spacing, if symmetry is desired.

The design given in Fig. 1 is for the use

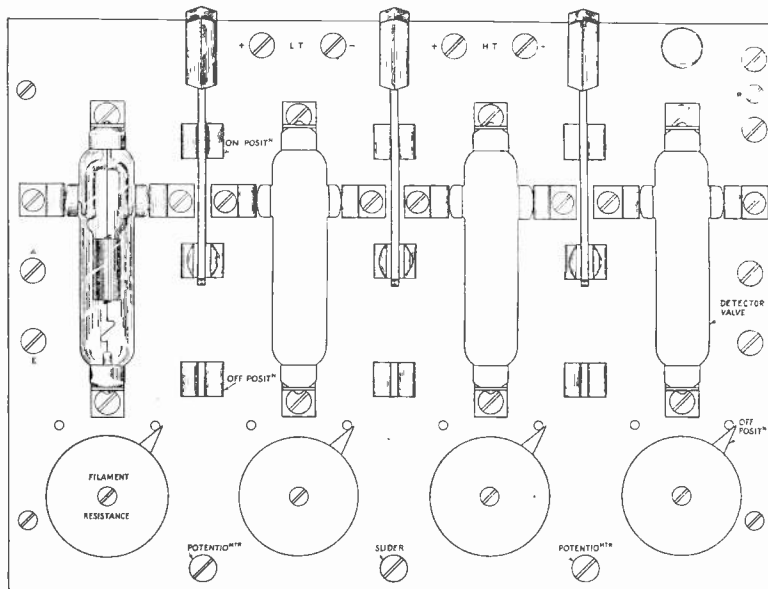

Fig. 3. 4-Valve amplifier using valves of the "V 24" type, and having separate filament control for each valve. Scale $\frac{1}{3}$ actual size.

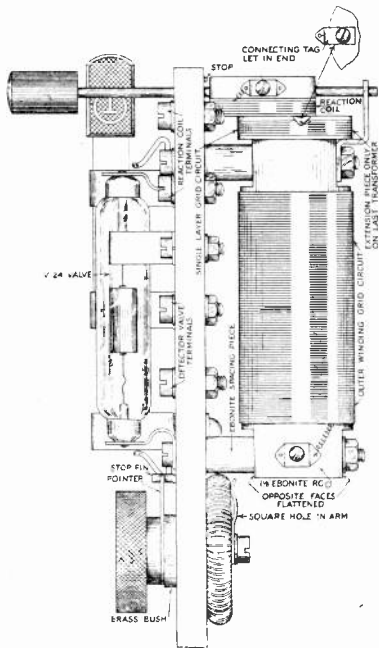

Fig. 4. Side view of Amplifier employing "V.24" valves. Scale $\frac{1}{2}$ actual size.

of valves with the "R" type socket, and it is intended that it should form the lid of a shallow box, that is, the amplifier will be operated in a horizontal position. Its transformers are shown in Fig. 6, page 718, only the last one in circuit being fitted with sliding reaction coil. Scratch marks are made on the brass rod which operates the reaction

to indicate the extent of coupling of the reaction coil. The filament current of all valves is controlled by a rheostat common to all, and a potentiometer is fitted for controlling the grid potentials which is a very essential feature in the design of a multi-valve H.F. amplifier. Its critical adjustment will not only result in maximum amplification, but will give additional control for the elimination of howling. With certain types of valves, however, it may not be found essential, but when omitted, terminals should be fitted to permit of its introduction. For this purpose the transformer secondary leads must be joined together and taken to a terminal which can be strapped across to another terminal which is connected to the junction between filaments and filament resistance, the resistance being connected in the negative lead of the battery. The rheostats and switch parts shown are of well-known types, the latter having been removed from their china bases. The four switches in the four-valve set provide for throwing all valves out of circuit in any order, but where it is desired to keep reaction always in circuit it will not be necessary to switch off the last valve, and consequently one switch less than the number of valves only, will be needed.

The wiring up may be very much simplified by omitting the switches, but the use of a varying number of valves is always a great convenience, particularly where filament current is a consideration, and moreover, switching permits of the testing of valves and transformers

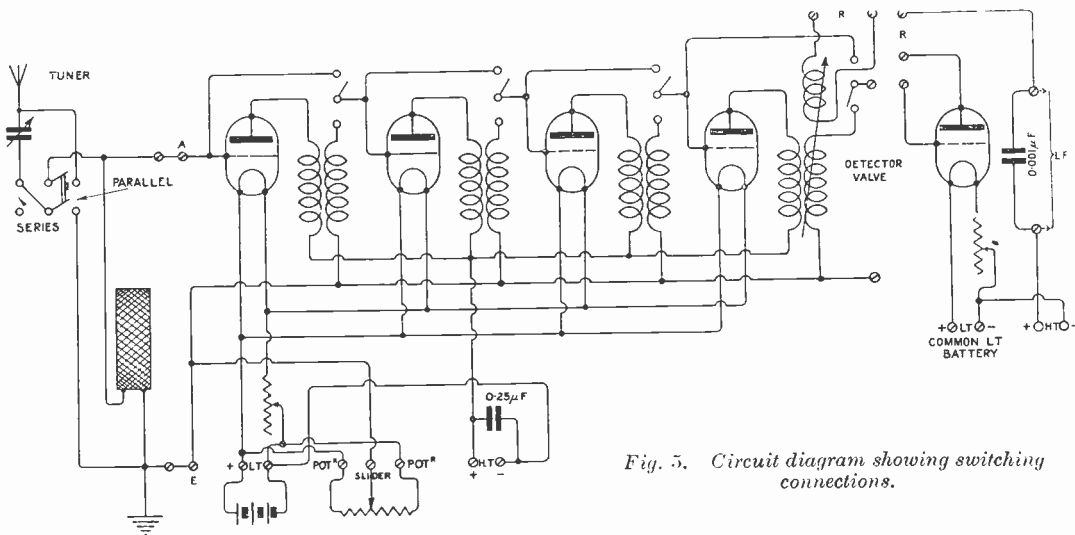

Fig. 5. Circuit diagram showing switching connections.

one against another. When making use of the interchangeable transformers of the plug-in type, the panel may be operated in a vertical position, and an ebonite top piece with valve holders may be arranged to take the valves, whilst those on the front may now carry the transformers. A method of arranging reaction in this case is shown in Fig. 2. It consists of a bracket carrying a swinging brass arm, to which is attached either a slab inductance or a turned ebonite disc with groove to carry a winding. The pillar consists of a piece

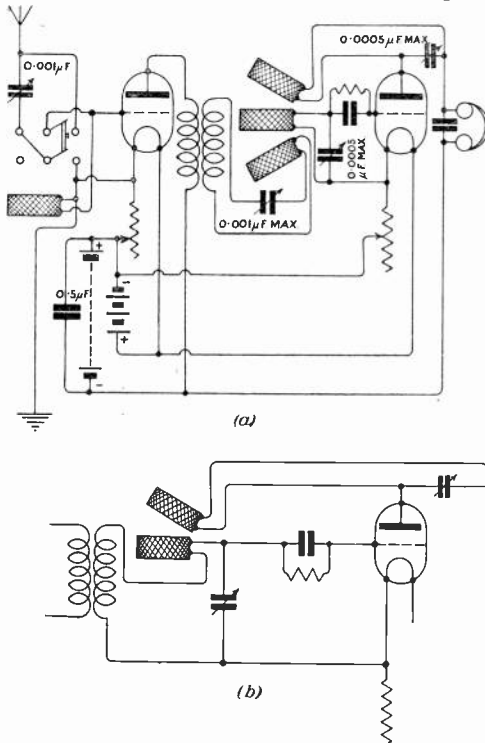

Fig. 6. Circuit diagram showing method of arranging reaction after H.F. amplification.

of $\frac{1}{2}$ -in. ebonite or fibre tube with $\frac{1}{4}$ -in. hole through which is passed a piece of $\frac{1}{4}$ -in. brass rod. Washers and nuts clamp it securely to the panel, whilst an additional nut and spring washer serve to make a friction turning point for the arm. The spindle may serve to carry contact from the coil to the internal connections of the instrument together with a flexible lead wrapped round arm and pillar and passing through a hole by its base. In mounting this on the front of the panel the arm should be vertical at the position of half-coupling so as to obviate any tendency it may have to drop round owing to insufficient friction.

Fig. 3 is a design suitable for use with valves of the "V24" type, which are specially intended to function efficiently in high frequency amplifying circuits. Separate filament control is arranged which has the advantage of allowing for individual adjustment for each valve, and in addition, the brightness of filaments left in the circuit will not fluctuate when other valves are switched off. Filament resistances should always have an "off" position. The transformers used are similar to those shown in Fig. 2, page 716. To take up less space, the transformers are arranged parallel to the face of the panel, and are attached by means of long 3 B.A. screws, which also serve to attach the spring clips for holding the valves. The clips can be made from No. 22 $\times \frac{3}{8}$ in. wide phosphor bronze strip. The dimensions of the transformers are as shown in the drawing, there being sufficient length for winding up to 600 turns of No. 40 S.S.C. in a single layer. In spite of the very tight coupling between primaries and secondaries, it is advisable to make the inside winding the plate circuit to prevent inter-action between the transformers. The side view (Fig. 4) shows the method of mounting the transformers, and in particular, the sliding inductance for providing reaction. This consists of a small piece of circular ebonite carefully drilled right through to carry the adjusting rod which is held in place by a set screw or pin. It slides over the end of the transformer, making light contact in order to prevent its turning. A piece of stiff brass held down under the nut which clamps up the transformer forms a bracket to act as a guide for the rod. Flats are filed on opposite faces of the transformer formers, and spacing is effected by small pieces of ebonite tube. If the reader cannot obtain screws sufficiently long for holding the transformers he will, of course, tap a piece of $\frac{3}{16}$ -in. brass rod with a 2 B.A. thread and use nuts at both ends. In the transformer shown it is the outside winding that is the grid circuit, which is extended so as to be coupled to the reaction coil. The reaction winding should consist of a single layer of No. 42 S.S.C. for use on short wavelengths, and be extended as near to the edge as is possible. A convenient way of terminating the lower end of this winding is to make a hole vertically through its former connected to a slight recess on the under side. The lead can be sealed in with a little hard wax. If the reaction effects are too great,

even at the position of minimum coupling, a few turns may be removed from the top end of the transformer or, alternatively, the end portion may be wound with slightly heavier gauge wire. If insufficient coupling is obtained, though this is improbable if the right type of valve is used, it can be increased by very cautiously piling the end turns of both transformer and reaction coil.

Fig. 5 is the wiring diagram showing the joining up of the switches. Using transformers operative over a wide band of wavelengths, very little is gained excepting, perhaps, a step-up of potential when only a few turns are used in the aerial circuit for

tuning. With this type of circuit, as with crystal circuits, where there is no reaction directly coupled back, a certain amount of efficiency is lost by the use of a series condenser, though, of course, circumstances may be such that its use is essential to tune down to a desired wavelength. Instead of providing reaction in the amplifier itself, the amplified oscillations may be passed to an inductance to which is coupled a reaction inductance. In this case, the secondary of the last transformer is only about one quarter the turns of its primary, and the coupling between primary and secondary, somewhat loosened by increased spacing. F.H.H.

Electrons, Electric Waves and Wireless Telephony

A SERIES OF ARTICLES BY DR J. A. FLEMING, F.R.S., SHORTLY TO COMMENCE
IN THIS JOURNAL.

DR. J. A. FLEMING requires no introduction to readers of this journal. His work in connection with "wireless" stands out so prominently that his name is associated with almost every phase in the development of the science.

In addition to his most unusual scientific capabilities, Dr. Fleming is at the same time extraordinarily popular as a lecturer. It would be difficult to imagine a more enthusiastic audience than that which filled to overflowing the lecture theatre of the Royal Institution on the occasion of the series of lectures delivered by Dr. Fleming last Christmas, the subject being "Electric Waves and Wireless Telephony." These lectures dealt in succession with waves in various media and concluded with a delightfully clear exposition of the propagation of electric waves in the aether and wireless telephonic speech.

At the present time, with the prospect of a wonderful development in the popularity and usefulness of wireless telephony resulting from the advent of broadcasting, there is probably no subject which is calculated to make a stronger appeal than a lucid explanation of wireless telephony introduced with an

explanation of wave formation and an insight into modern views on the nature of atoms, electrons and the aether—that hypothetical medium invoked as a basis for the propagation of wireless waves.

It is with considerable pleasure, therefore, that we are able to announce that the lectures delivered before the Royal Institution are to form the basis for a series of articles which this journal has been fortunate in securing from the pen of Dr. Fleming, entitled "Electrons, Electric Waves and Wireless Telephony."

The series will be commenced in the issue of *The Wireless World and Radio Review* for October 7th, which will be the first number of the second half-yearly volume. This series will form the distinctive feature of the volume and there is no doubt that it will constitute one of the most attractive contributions yet made to wireless literature.

The articles will be elaborately illustrated with figures and diagrams, and whilst they will cover the subject in the fullest detail, the gradual development from one phase to another will ensure that even the new reader is never carried out of his depth.

The Damp-Proofing of Coils and Formers

By G. P. KENDALL, B.Sc.

ONE of the most important factors in the efficiency of a receiver is the proper damp-proofing of the tuner windings and formers, for upon this depends the constancy of the results obtained. Many of those annoying vagaries of fluctuating signal strength of which beginners sometimes complain can be laid at the door of damp in the coils or the tubes upon which they are wound. It is therefore a matter of considerable importance to make a correct choice of an insulating and proofing agent, and to use an effective method of impregnation.

Those amateur constructors who can afford to use ebonite tubes for their inductances will find it a fairly simple matter to render their windings damp-proof. The former itself being impervious, all that is necessary is to impregnate the cotton or silk covering of the wire, and shellac varnish is perhaps the most convenient agent. It gives very good results, provided that it is thoroughly dried by baking, and that varnish of good quality is used. This last should be noted; the varnish should be obtained from an electrical firm, and not from an ordinary paint and colour merchant, whose product may have very poor insulating properties.

The necessary baking of the varnished coil should be done about ten minutes after the application of the shellac, and should be carried out in a *moderately* hot oven. Care must be taken not to overheat the coil, lest the ebonite tube be damaged or the varnish scorched.

Most amateurs, however, regard ebonite tubes as much too expensive for ordinary purposes, and therefore use cardboard ones. The substitution is justifiable, and does not lead to appreciable loss of efficiency if tube and winding are properly impregnated. Shellac is not quite so suitable in this case, since it is difficult to get it to soak well into the cardboard. Paraffin wax is the better material for treating formers of this type, because the tube with the coil upon it can be soaked in a bath of the melted wax until thoroughly impregnated. To obtain the best results with this material there are one or two points to be noted, however. First, care must be taken not to heat it too fiercely or it may "scorch," or, when melted, boil.

Should it be allowed by accident to boil, take it off the fire and keep it away from lights until it has stopped (it gives off considerable quantities of inflammable vapour when boiling). Second, it should be realised that it is possible by means of the wax bath to expel moisture from the cardboard and the covering of the wire and to replace it with wax, provided that the wax is heated to a temperature above the boiling point of water. If it is raised to, say, 130° centigrade the water will be driven out as steam, bubbles of which can be seen rising through the wax. When the bubbles come to an end the process is complete and the coil can be taken out, drained as completely as possible, and put aside to cool.

The careful worker uses a thermometer for these operations, but for the benefit of those who do not possess a suitable centigrade thermometer, and do not care to go to the expense of buying one, it may be as well to explain that the desired end can be attained fairly well by heating the wax in some form of double boiler, such as a jam-pot standing in a saucepan. If the outer vessel is filled with very strong brine and kept boiling briskly, a temperature will be reached in the inner one which will be capable of expelling moisture if given time.

The preceding notes have particular reference to single-layer windings, and they should not be applied too literally to all coils. It is very difficult to bake the moisture out of some types of multi-layer coils, such for example as those produced by pile-winding, and for these the wax bath should be used. In general, the experimenter must use his judgment to decide which is the method best suited to a particular case.

It should be remembered that all the insulating materials used for impregnation purposes have a fairly high dielectric constant, and hence they increase the internal capacity of the coil somewhat. To keep this objectionable increase down as much as possible be very sparing with your varnish and wax; use only just sufficient varnish to completely impregnate the covering of the wire, and in the case of wax, drain off as much as you can when lifting out the coil.

The Wireless Society of London

RESUMPTION OF MEETINGS AND WORK IN HAND.

WEDNESDAY, September 27th, is the date fixed for the opening meeting of the new session of The Wireless Society of London. The meeting will be held at 6 p.m. on this date at the Institute of Electrical Engineers, Victoria Embankment.

During the summer vacation, although general meetings have not been held, it should not be supposed that the activities of The Wireless Society of London have been curtailed. The Officers and Committee have met together, as occasion required, and have kept in view many points of general interest, and have taken every step necessary to keep in touch with the events which have been happening during the past few months.

At the General Meeting to be held on September 27th, it is hoped that Senatore Marconi will be present to address the meeting. Senatore Marconi, who is at present in Italy, has promised to be present if he returns to England in time.

BUSINESS OF THE OPENING MEETING.

Among the matters which will receive special attention at this meeting will be the subject of Broadcasting, and also the forthcoming All-British Wireless Exhibition to be held at the Horticultural Hall from September 30th to October 7th.

The President, Admiral of the Fleet Sir Henry B. Jackson, has promised to make an announcement with regard to certain resolutions passed at the recent Conference held in Brussels, at which Conference he represented Great Britain.

FUTURE MEETINGS OF THE SESSION.

The Society is again indebted to the Council of the Institute of Electrical Engineers for having kindly placed the Lecture Hall of the Institute at the disposal of the Society for their monthly lectures.

Arrangements have been made for lectures to be held in that building on the fourth Wednesday in each month until the close of the new session in June, 1923. Particulars of lectures to be held will be announced as far in advance as possible.

On October 25th, a joint lecture will be given by Mr. R. S. Smith Rose, and Mr. R. H. Barfield of the National Physical Laboratory, the subject of the lecture being "The Effect of Underground Metal Work on Radio Direction Finders."

THE ALL-BRITISH WIRELESS EXHIBITION.

Some further information regarding the All-British Wireless Exhibition, and the arrangements made by this Society in connection therewith, may be of interest. A special room at the Horticultural Hall has been placed at the disposal of the Society for the purpose of short popular lectures on wireless each afternoon and evening during the period of the Exhibition.

The Hon. Secretary will appreciate the offer of assistance in this direction from any member of the Society or affiliated societies who is not already in correspondence with him on the subject.

This room will serve also for the purpose of social meetings for members of this Society and members and officers of affiliated societies.

The Hon. Secretary of the Wireless Society of London will appreciate a notification beforehand from the Hon. Secretaries of Societies who may arrange for parties to visit the Exhibition.

AFFILIATION OF SOCIETIES AND ENROLMENT OF NEW MEMBERS.

The Committee are pleased to report that many new societies and clubs have applied for affiliation and have been accepted.

The Hon. Secretaries of new societies and clubs are asked to write for particulars of affiliation to the Hon. Secretary, Mr. L. McMichael, 32, Quex Road, N.W.6, and the same invitation is extended to those who are desirous of becoming Members or Associate Members of the Society.

Since the last session the following societies have been accepted for affiliation. :—

- Middlesbrough and District Wireless Society.
- Ilford and District Radio Society.
- Shrewsbury and District Radio Society.

Ramsgate, Broadstairs and District Wireless Society.

Redhill and Reigate Wireless Society.

Durham City and District Wireless Club.

Smethwick Wireless Society.

Bishop's Stortford Wireless Society.

Radio Club de Brussels, Belgium.

Malta Radio Society.

In addition, a large number of new members and associate members will be balloted for at the General Meeting on September 27th.

AMATEUR TRANSATLANTIC TRANSMISSIONS.

In connection with Amateur Transatlantic Transmissions, the Society has certain announcements to make. By way of introducing the subject it may be of interest to quote from a letter received by the Hon. Secretary of the Wireless Society of London from Mr. F. H. Schnell, Traffic Manager of the American Radio Relay League.

The following is a quotation from Mr. Schnell's letter:—

"In view of the success of our Transatlantic Tests of December, 1921, we desire to conduct another series of tests to include transmission from American and Canadian Amateur Stations, and, if possible, the reception of signals from British and French Amateur Stations

"Arrangements can be made with the Dutch Amateurs for reception and with the French Amateurs for both transmission and reception.

"I am taking the liberty of writing the Wireless Society of London with the purpose of determining with what British organisation arrangements should be made to handle the tests in England."

In view of this application on the part of the American Radio Relay League for the co-operation of the Wireless Society of

London in the conduct of Transatlantic transmissions, the Committee of the Society has undertaken to co-operate in the arrangements for the transmission, which will be controlled by amateurs in this country.

It is understood that the Manchester Wireless Society has already made good progress with the erection of a station for Transatlantic amateur communication, and that they will shortly be in a position to conduct preliminary tests.

Arrangements are being made by the Wireless Society of London for transmissions by amateurs to take place from a station in or near London, and further announcements regarding this matter will be made shortly.

A committee has been appointed to deal with this subject and the names of those who will serve on this committee are: Major H. Hamilton, D.S.O., Commander C. F. Phillips, A.M.I.E.E., Mr. P. R. Coursey, B.Sc., A.M.I.E.E., Mr. G. G. Blake, M.I.E.E., and Capt. Norman Lea, B.Sc., A.M.I.E.E.

Mr. W. H. Shortt has resigned from the Committee of the Wireless Society of London, as, having left London, he finds it impossible to give the necessary time to the affairs of the Society. The Committee have invited Mr. H. S. Pocock, who is the Editor of *The Wireless World and Radio Review*, the official organ of the Wireless Society of London, to fill the vacancy on the Committee.

All communications regarding the Society should be addressed to the undersigned:—

L. McMICALHAE

(Hon. Secretary, Wireless Society of London),

32, Quex Road, W. Hampstead, N.W 6.

DO NOT FORGET THESE DATES!

September 30th to October 7th, 1922.

**The All-British Wireless Exhibition,
Horticultural Hall, Westminster, S.W.**



Air Race Reports.

BROADCASTING BY 2LO AND RECEPTION EVERYWHERE SUCCESSFUL.

FROM all over the country letters and telegrams from amateurs describing their reception of the air race reports pour in. There is not a doubt that the arrangements were satisfactorily carried out and reception was possible, so clearly that all the excitement of the race could be enjoyed. Reports were made by the Air Ministry on behalf of the Royal Aero Club from various places along the 800 miles course, which ran through Birmingham, Newcastle, Glasgow, Manchester, Bristol and back to Croydon. The reports were received at the Marconi Broadcasting station, and within a few minutes of their reception were broadcasted.

As far as the wireless arrangements were concerned, both as regards transmission and reception, the event was highly interesting. This was broadcasting. Moreover, it was broadcasting of news but a few minutes old. As an experiment there was complete success, but, of course, these are early days in broadcasting, and what may be possible in the near future is but foretasted as yet.

It must be borne in mind that the event reported did not take place on a small field. A report of a football match which could be watched and the information provided by one person from one instrument would be a very much more simple problem than that of reporting during progress the events taking place on so large a course as was covered by the aeroplanes competing for the King's Cup.

In the first place considerable organisation was necessary. But although the scheme was a big one, complications were avoided as far as possible. Of course, like all new things, there was a certain amount of experiment in the effort, and the Air Ministry and 2LO were working on new ground. Fortunately,

atmospheric conditions in most places did not seriously interfere with the reception, and from the reports which were asked for, of the transmissions, it is obvious that a good deal of keenness prevailed.

One telegram from Diss, in Norfolk, stated that the transmissions had been duly heard on a simple crystal set, using a P.M.G. twin aerial. Considering the distance this was an excellent performance. Another receiver at Whittlesey, a boy of 16, also obtained the hourly reports on a single valve set. Letters from Leeds and Birmingham congratulate the broadcasting station, but congratulation is also due to those who received, for good reception of telephony broadcasting depends largely upon the efficiency of the receiving set.

From Cheshire a letter was received from a man with a home-made set using a Mullard "Ora" valve. He says his aerial is about 80 ft. long and averages about 18 ft. high only. It has the usual two wires spaced 6 ft. The apparatus is mounted on an old box and ebonite is conspicuous by its absence. His grid condenser consists of two pennies with waxed paper between. He received the details of the race so clearly that to use his own words:—"If the speaker had been, say, one of my personal friends I feel sure I could have identified him by his voice."

An amateur at Hull reports that the 5 o'clock transmission was slightly interfered with by an arc station, and that repetitions were very useful for that reason. The set used in this case had one valve, and the aerial sloped from the roof of the house to a point 10 ft. above an out-house. The average height of aerial was 25 ft. All of the other transmissions were received without trouble.

A report from Brighton states that reception was made on one V.24 valve and a Reinartz tuner. The aerial in this case was 60 ft. long including lead-in, twin wire spaced only 2 ft. apart, the horizontal portion being 30 ft. above ground.

From Southsea, Hants, a letter was received from an amateur who used a single valve H.F. amplifier and crystal detector, aerial twin 50 ft. long 25 ft. high. He heard the transmitted progress of the race very clearly until he was badly jammed by a very loud spark station on 300 metres.

Another letter of interest states that the writer received the reports strongly and clearly at Leytonstone with a short indoor aerial. His crystal set is contained in a safety razor case measuring $1\frac{3}{4}$ ins. by $1\frac{3}{4}$ ins. by $\frac{1}{2}$ in., but the parts would comfortably fit in a case half that size. Two 42 S.W.G. enamel wire basket coils, $\frac{7}{8}$ in. in diameter are the tuning unit, and results are surprisingly effective.

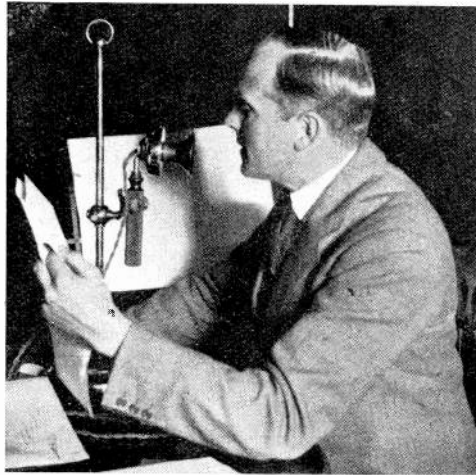

How the Air Race results were broadcasted from 2LO.

Air racing has hitherto been difficult to follow. Machines started from the ground at given times according to their handicap, and they were soon out of range of the best field glasses. There was an air of expectancy tinged with a mixture of hope and doubt, but the race could not be watched. At certain points along the route observations were made, the competing aeroplanes were singled out, the time of their passing accurately noted and a few privileged persons heard on the telephone how things were progressing. The vast majority of people had no means of gaining intelligence of the race until the newspapers published the result, or the result of a part of the race.

On Friday and Saturday of last week the race for the King's Cup proved that any number of people could "watch," as it were, the race from start to finish.

At the Royal Aero Club a special receiving set was erected for the occasion

Notes

Cost of Wireless on Trawlers.

A deputation from Hull is seeking the consideration of the Admiralty in respect of the requirement to install apparatus on trawlers. It is stated that the cost of upkeep will be £900 a year, and in view of the present state of affairs in the fish trade the question is serious.

Reception of Air Race News at a Fete.

A fete which was held in aid of the funds of the St. Pelagia's Home, was provided with a receiving set from which was obtained the broadcasted reports of the air race round Britain.

Reduction in Price of Valves.

It is gratifying to observe from the advertisement columns of this journal the very substantial reduction in the price of valves which is announced by manufacturers. One might have been justified in fearing that the increased demand for wireless apparatus would have resulted in an upward

tendency in prices, so that the news is all the more welcome.

Landlords and Wireless Aerials.

From notes which have recently appeared in the daily press it is apparent that in some instances the attitude of landlords towards the erection of aerials on buildings will not be an encouraging one.

A reasonable attitude for a landlord to adopt would be to obtain an undertaking that any damage resulting from the erection of an aerial would be made good by the tenant. Beyond that it is difficult to see any reason for landlords to interfere.

For those unfortunate amateurs who may be domiciled in a building owned by the London County Council, it appears that the method of erecting the aerial and many other details must first receive the approval of the council, whilst amongst other formalities a deposit of £1 must be left with the council as security against damage.

Concerts by 2 LO on September 16th.

Marconi House Broadcasting Station will transmit concerts on Saturday, September 16th, at 5-5.50 p.m., 6-6.30 p.m., and 7-7.30 p.m.

These transmissions will be for the Southgate Fête, in aid of the Royal Northern and Passmore Edwards Hospitals, and a fete in aid of the Croydon General Hospital.

French Wireless Telegraphy Congress.

A congress was opened a few days ago at Marseilles Colonial Exhibition to discuss matters relating to wireless telegraphy in France and her colonies, and the colonies among themselves.

Norwegian Regulations for Foreign Vessels.

According to the *Anglo-Norwegian Trade Journal*, the following regulations regarding the use of wireless stations on vessels belonging to foreign powers not at war, while in Norwegian territorial waters in times of peace, have been approved by Government resolution, and came into force on September 1st.

1. In Norwegian territorial waters wireless telegraph or telephone stations on foreign vessels may not be used, except by special permission, unless for the following purposes:—

(a) Communications concerning vessels in distress or for the prevention of accidents.

(b) Communications with the nearest Norwegian coastal station, and

(c) Communications with other ships' stations when each vessel is at least 10 nautical miles distant from the nearest Norwegian coastal station.

In the cases of (a) and (b) communication must at once be stopped on request from the Telegraph Administration, the Naval Department, or a station belonging to either of these authorities.

2. In Norwegian ports where there is a state wireless station and within certain prohibited districts laid down by the Norwegian authorities (regarding which information may be obtained from the nearest state coastal station), the ship's station may not be used except for communications as under 1 (a), unless special permission has been obtained.

3. Application for permission to use a station in Norwegian territorial waters for other communications than above-mentioned should be sent to the Telegraph Administration (Telegrafstyret), which will give its decision after consultation with the Naval Administration.

4. (This paragraph concerns war vessels).

5. When a ship's station is used while in Norwegian waters this must be done with the observance of the provisions of the International Telegraph Convention and its regulations.

6. The foregoing regulations remain in force only when Norway is not at war, and are applicable only to vessels of nations not at war.

Mr. Skeet informs you that he heard 2PF working to me on an indoor aerial. This is rather a wonderful feat, especially as I do not remember ever having the pleasure of working to 2PF.

On referring to my log I find I was working to 2PS of Nottingham on the date mentioned.

Evidently Mr. Skeet has made a mistake.

LEONARD M. BAKER
(operating 2FN).

Calendar of Current Events

Saturday, September 16th.

Concerts by 2 LO on 6.30 metres at 5-5.30, 6-6.30, 7-7.30 p.m. See also Note on this page.

SOUTHWARK WIRELESS TELEPHONE ASSOCIATION. At King's Hall, London Road, S.E.1. Home-made crystal set competition.

Sunday, September 17th.

Daily Mail Concert from The Hague (PCGG), 8 to 9 p.m. B.S.T., on 1,085 metres

Monday, September 18th

IPSWICH AND DISTRICT WIRELESS SOCIETY. At 55, Fonnereau Road, Ipswich. Lecture by Mr. Stanley Lewis.

BOROUGH OF TYNEMOUTH Y.M.C.A. RADIO AND SCIENTIFIC SOCIETY.

7.30 p.m. Annual General Meeting.

Tuesday, September 19th.

Transmission of Telephony at 8 p.m. on 400 metres by 2 MT (Writtle).

Wednesday, September 20th.

NEWARK AND DISTRICT WIRELESS SOCIETY. 7.30 p.m. At Magnus Grammar School. First Meeting of Winter Session.

Thursday, September 21st.

Daily Mail Concert from The Hague (PCGG), 8 to 9 p.m. B.S.T., on 1,085 metres.

Sunday, September 24th.

Daily Mail Concert as above.

Monday, September 25th.

IPSWICH AND DISTRICT WIRELESS SOCIETY. At 55, Fonnereau Road, Ipswich. Sale and exchange of apparatus.

Tuesday, September 26th.

Transmission of Telephony at 8 p.m. on 400 metres by 2 MT (Writtle).

Wednesday, September 27th.

REDHILL AND DISTRICT Y.M.C.A. WIRELESS SOCIETY.

At 111, Station Road, Redhill. Lecture on "Phones and Loud Speakers," by Mr. White.

Thursday, September 28th.

Daily Mail Concert, 8 to 9 p.m. (as above). RADIO EXPERIMENTAL ASSOCIATION (NOTTINGHAM AND DISTRICT).

At Room 74, Mechanic's Institute. Discussion on Mr. Ford's lecture on "Radio Measurement." Subscriptions due.

Friday, September 29th.

WIRELESS SOCIETY OF HIGHGATE. At Highgate Literary and Scientific Institute, South Grove, Highgate, N.6. Annual General Meeting, election of officers, annual report, etc.

Correspondence

To the Editor of THE WIRELESS WORLD AND RADIO REVIEW.

Sir,—I beg to call your attention to a letter addressed to you and published in *The Wireless World and Radio Review*, of August 19th, from Mr. T. S. Skeet, of Leicester.

Wireless Club Reports

NOTE.—Under this heading the Editor will be pleased to give publication to reports of the meetings of Wireless Clubs and Societies. Such reports should be submitted without covering letter in the exact form in which they are to appear and as concise as possible, the Editor reserving the right to edit and curtail the reports if necessary. The Editor will be pleased to consider for publication papers read before Societies. An Asterisk denotes affiliation with the Wireless Society of London.

The Wireless Society of Highgate.*

Hon. Secretary, Mr. David H. Eade, "Gatra," 13a, Sedgemere Avenue, East Finchley, N.2.

The Annual General Meeting of the Society will be held at the Highgate Literary and Scientific Institution on Friday, September 29th, 1922, at 7.45 p.m.

The agenda is as follows:—(1) Election of officers. All the Society's officers retire, and are eligible for re-election. The following officers do not wish to stand for re-election to their respective offices: Mr. D. H. Eade, Hon. Secretary; Mr. L. R. Rowlands, Hon. Treasurer; Mr. L. Grinstead, Vice-Chairman. It is further proposed that the Committee should be increased by the addition of two more members. Proposals for filling these vacancies and proposals for the Society's officers should be sent to the Hon. Sec. as soon as possible. (2) Annual report and statement of accounts. (3) New headquarters for the Society. (4) Future policy of the Society. (5) Any other business.

Members are requested to let the Secretary know whether they will be able to be present.

The East London Radio Society.*

Hon. Secretary, Mr. L. E. Lubbock, King George's Hall, East India Dock Road, Poplar.

A meeting was held on Tuesday, August 29th, 1922, in the Society's Lecture Hall, in Woodstock Road.

Although the attendance was not so large as the previous week there was a fair number present. After the usual half-hour's buzzer practice the evening was devoted to open discussion for the benefit of the newer members. The Society's apparatus was laid on the table together with one of the member's crystal set, and a large number of matters were dealt with by the Society's expert and many members just starting were relieved of their difficulties. The meeting closed at 10 p.m. after a hearty vote of thanks to the chairman.

All interested amateurs in East London are invited to communicate with the Secretary.

Radio Experimental Association (Nottingham and District).*

Hon. Secretary, Mr. F. E. Bailey, 157, Trent Boulevard, West Bridgford, Notts.

A general meeting of the above Association was held on Thursday, August 31st, at the Mechanics Institute, Nottingham.

The lecture for the evening was entitled "Radio Measurements." Mr. Ford, the lecturer, exhibited expert skill and a convincing manner.

He had brought with him a considerable amount of apparatus used for calculating various measurements, and his explanations of the respective instruments were ably and clearly put before the audience. The lecturer illustrated the method of

calculating unknown resistances by means of the Wheatstone bridge. The finish and construction of the lecturer's apparatus was deserving of special praise.

It was illustrated that many calculations, seemingly difficult, can be accomplished quite successfully with fairly simple apparatus, care and accuracy only being necessary to ensure successful results.

Commencing October 12th, meetings will be held at the new headquarters.

The next meeting will be held on Thursday, September 28th, in Room 74, Mechanics Institute, when a discussion on Mr. Ford's lecture will take place. It should also be noted that subscriptions fall due on this date, after which the new winter session commences.

The Hon. Secretary will be pleased to meet at the meeting any amateurs in the district who are not members.

Wakefield and District Wireless Society.*

Hon. Secretary, Mr. Ed. Swale, 11, Thornes Road, Wakefield.

A meeting of the above was held at the Y.M.C.A., Grove Road, on Friday, September 1st, the chair being taken at 8 p.m. by Mr. Wrigley, who called upon Mr. Burbury, jr., to deliver his lecture on "The Two-valve High Frequency Amplifier," which is designed to obviate interference, to meet with future requirements of the P.M.G., viz., prohibition of interference.

Questions were asked, followed by a lengthy discussion regarding various circuits, and valve oscillation, thereby energising the aerial, which proved very interesting to all.

A hearty vote of thanks was accorded to Mr. Burbury, jr.

Borough of Tynemouth Y.M.C.A. Radio and Scientific Society.*

Hon. Secretary, Mr. G. J. S. Littlefield, 37, Borough Road, North Shields.

On Monday, September 18th, at 7.30 p.m., the Annual General Meeting of the above Society will be held in the Y.M.C.A. Buildings, Bedford Street, North Shields.

Woolwich Radio Society.*

Hon. Secretary, Mr. H. J. South, 42, Greenvale Road, Eltham, S.E.9.

The above Society opened its winter session on Wednesday, September 6th, 1922, at headquarters, the Y.M.C.A., Woolwich.

Two new features are being inaugurated, which should be of great assistance to beginners. A series of elementary lectures has been arranged on the construction and use of the fundamentals of a wireless set, e.g., aeriels, earths, inductances, condensers, crystals and valves, and will be given

in a most simple way by one of the members, Mr. Houghton, from 8 to 8.30 p.m., each Wednesday evening. Also a buzzer class for beginners will be held from 7.30 to 8 p.m. on each evening. For the more advanced there is a six-valve set in operation, and much telephony and music are generally obtained. An attractive series of lectures and demonstrations is being arranged for the monthly meetings, which are held on the last Friday in each month.

Enquiries as to conditions of membership will be welcomed by the Hon. Secretary.

Burton-on-Trent Wireless Club.*

Hon. Secretary, Mr. A. J. Selby, 66, Edward Street, Burton-on-Trent.

A most enjoyable and interesting afternoon was spent by the members on Saturday, August 26th, in a visit to the Burton electricity power station.

Mr. T. Hall, the borough electrical engineer, conducted the party and explained the whole working of the plant. The boilers were examined and the methods of coaling the fires were explained. The steam turbines and electricity generators were next visited and the working of them explained. The rotary converter, which converts the alternating current to direct current, to run the tram-cars, attracted much interest. Switchboards to the tram service were inspected.

At the instrument and testing shops it was seen how the electricity meters were tested and set accurately to a standard meter. Especially interesting was a new type of power switch designed by Mr. Hall, which is to be installed at all the large works where electricity is used. With this switch it is possible to change over in case of a breakdown of the electricity main to another main without having to send to the power station for a man from there to come and alter the connections to the mains. The switch is so constructed that there is no danger whatever in the operation of changing over to the new main.

Mr. Hall was bombarded with questions, which he very ably answered.

Mr. A. J. Selby proposed a very hearty vote of thanks to Mr. Hall, and Mr. L. G. A. Sims seconded. The vote was heartily endorsed.

Mr. Hall suitably replied.

Otley and District Wireless Society.

Hon. Secretary, Mr. N. Weston, 24, Guycroft, Otley.

At the fifth meeting of the above Society, at Queen's Hall, Otley, on August 31st, further component parts of proposed five-valve amplifier were examined, the two air core H.F. transformers being voted very neat and efficient. A vote of thanks was unanimously passed to Mr. A. Gibson for his skill in winding. It will only be a matter of a week or two before the set is in operation. A further lecture was given by Mr. N. Weston, on induction, primary cells and H.F. oscillating waves. A series of valve set lectures will be delivered by Mr. H. Johnson at a later date. It is earnestly desired that members of similar societies who would give advanced lectures to the above Society would communicate with the Hon. Secretary. Thanks are rendered for the way the local paper has helped the publicity campaign for the above. A number of members have not quite got to the

action stage. It is requested that they come forward at an early date. Lectures are given each Thursday at Queen's Hall until further notice.

Barnoldswick Wireless and Technical Society.

Hon. Secretary, Mr. J. Balderston, 6, Clough Terrace, Barnoldswick.

A meeting of the above Society was held on August 30th, at the Gladstone Liberal Club. Preceded by the usual 30 minutes "buzzer" practice, a lecture was given by Mr. G. Balderston, entitled "Electro Magnetism." The lecture was delivered to a most appreciative audience. Another meeting took place on Wednesday, September 13th.

Ipswich and District Wireless Society.

Hon. Secretary, Mr. F. T. G. Townsend, 46, Grove Lane, Ipswich.

An interesting excursion under the auspices of the above Society took place on August 26th, when, by kind permission of the Great Eastern Railway Co., a party of 20 members visited the Company's land station at Parkeston Quay. The party was met and escorted round the station in relays by Mr. Child, the resident engineer, and all appreciated his kindness, and also that of the operator in charge, who spared no effort to demonstrate his set. Tea was afterwards partaken of at Dovercourt and the return journey made by train *via* Manningtree, where a two hours' discussion took place—thanks to an engine breakdown.

The winter session is opening with a lecture by Mr. Stanley Lewis on September 18th.

There will be a sale and exchange of apparatus on Sept. 25th. Local non-members are invited on any Monday evening at 55, Fonnereau Rd., after Sept. 11th.

Swinton and District Amateur Radio Society.

Secretary, Mr. Geo. T. Bultitude, "The Slade," Swinton, near Rotherham.

The inaugural meeting of the above Society was held on August 25th, when a good number of amateurs attended. The Secretary (*pro tem.*) explained that he had been pressed by interested wireless students to call the meeting. Mr. A. Hammerton presided. The meeting resolved to inaugurate a Radio Society.

The Hon. President and Vice-Presidents were nominated. The Committee elected were:—Messrs. Woods, Oxby, Finn, Henson, Greenfield, Twigg, Hammerton and Trowbridge. Mr. A. Hammerton was elected as Treasurer. Mr. Geo. T. Bultitude, Secretary and Librarian. The fixing of fees and subscriptions was adjourned for the Committee to decide at the meeting on September 4th. New members will be welcomed at the weekly meetings.

Southampton and District Wireless Society.

Hon. Secretary, Mr. T. W. Cutler, 24, Floating Bridge Road, Southampton.

A general meeting of the above Society was held on Wednesday, August 23rd, for the election of officers for the ensuing three months; all the old officers were re-elected. Elaborate plans are being made for the benefit of the members for the coming winter months and a competition is being held within the next few weeks. Dr. MacDougall has offered a substantial prize for the best single valve set made by any member of the Society. A committee is being appointed to make the

necessary arrangements. Arrangements are also being made for a lecture every other week and followed the next week by a demonstration on various sets.

The membership is steadily increasing, a large percentage of new members coming in from the country districts. Any amateur in Southampton and district requiring particulars of the above Society can have same by applying to the Hon. Secretary.

Redhill and District Wireless Society.

Hon. Secretary, Mr. J. S. B. Clarke, 41, Hatchlands Road, Redhill.

A meeting of the Society was held on August 2nd, when an excellent lecture on aerial systems by Mr. Ross was read by Mr. W. Pope, M.I.R.E., Mr. Ross being unavoidably absent.

The paper gave practical methods of erecting aerials and will be of great value to the members. The half-yearly list of lectures which has just been issued includes the following items:—September 27th, "Phones and Loud Speakers," Mr. White; October 11th, "Condensers," Mr. Edwards; October 25th, "Inductances," Mr. Pescett; November 8th, "Tuning"; November 22nd, "Operating," Mr. Ross; December 6th, "Gadgets," Mr. Clarke; December 20th, "Calculations"; January 3rd, 1923, "Direction Finding."

It is particularly requested that members will support the Society by attending these lectures, which will be found to benefit both the beginner and the more advanced amateur.

Questions can be placed in the "Question Box" in the wireless room any time during the week and will be answered by a competent member of the Society during the discussion following the lectures.

Halifax Wireless Club and Radio Scientific Society.

Hon. Secretary, Mr. L. J. Wood, Clare Hall, Halifax.

The club-room is now open three nights a week with a steward in charge and members and others interested are turning up well.

The syllabus for the winter session is in course of arrangement and includes, apart from lectures for members, a "Popular Lecture," and a "Sale and Exchange, with Demonstrations."

All in the district who are interested, are advised by the Society to pay a visit to this latter event, and full details of the sale will be sent to anyone interested.

Membership steadily increases and associates are also coming in well.

Fulham and Chelsea Amateur Radio and Social Society.

Secretary, Mr. R. S. V. Wood, 46, Hamble Street, Fulham, S.W.8.

A general meeting was held on August 30th at 8 p.m. at the Social Centre, Townmead Road, Fulham (headquarters for a period of three weeks, where a meeting is held each Wednesday at 8 p.m.).

The minutes of the previous meeting were read and accepted.

Mr. Hawthorne kindly took over the management of the Morse class, which was conducted satisfactorily. A discussion was invited from the remaining members as to the best or phenomenal results obtained on any aerial, insulating being especially dealt with by the Secretary.

Numerous interesting items were discussed and the Secretary gave his experience on one and two valves, and answered a number of questions. New members were proposed by Mr. Cox and seconded by Mr. Gauntlett, the meeting accepting their enrolment. Fourteen new members were enrolled. There was an attendance of 43. The total membership is now 57.

The meeting closed until the following Wednesday.

Hornsey and District Wireless Society.

Hon. Secretary, H. Davy, 134, Inderwick Road, Hornsey, N.8.

A meeting of the above Society was held on Friday, September 1st, when many members brought up their sets, which were arranged on the table, and a photograph of the whole apparatus together with members was taken. Afterwards an informal demonstration was held by members on their respective sets and a good opportunity was afforded for comparing various methods of valve and crystal circuits, tuners, etc. The construction of each set showed considerable ingenuity, and the owners were heartily congratulated by all present.

Also a further programme was arranged to carry on from that arranged to September 11th, to consist of listening-in, lectures, Morse practice, etc.

It was hoped that the Club set, which was almost completed, would be in use by September 11th.

A hearty vote of thanks was given to Mr. Pugh for his lecture on Tuesday, August 29th, on the theory and practice of crystal sets. The meeting then closed.

Meetings are held every Tuesday and Friday and applications for membership are cordially invited.

Southwark Wireless Telephony Association.

Hon. Secretary, Mr. W. Helps, King's Hall, London Road, S.E.1.

On Sunday, September 3rd, a meeting was held at headquarters, King's Hall, London Road, S.E.1, when Mr. Winston ably answered questions. An instructive time was spent in this way.

It was announced by the Hon. Secretary that he was still open to receive entries for the "Home-made Crystal Set Competition," which was open to members of the Association, and also to members of kindred associations. The competition is to be held on Sunday, September 17th, and will be judged by Mr. Read. All enquiries should be directed to the Hon. Secretary at the above address.

The objects of this association are: "To assist members in furthering their knowledge of all methods appertaining to receiving of wireless telephony, by mutual interchange of views and lectures from time to time by wireless experts, also to help members by co-operation in buying their sets or spare parts."

Meetings are held every first and third Sunday of the month. Fees are as follows: 1s. to join, and 6d. per month, payable in advance.

The Thanet Radio and Experimental Society.

The above Society is going well, and the membership is increasing weekly.

Meetings are held every Tuesday at 7 p.m., at 119, Northdown Road, Margate, and visitors will be welcomed.

President, Mr. G. W. May, 75a, Trinity Square. Press Secretary, Mr. F. McCurdle, 4, Grange Villas, Margate.

Questions and Answers

NOTE.—This section of the magazine is placed at the disposal of all readers who wish to receive advice and information on matters pertaining to both the technical and non-technical sides of wireless work. Readers should comply with the following rules:—(1) Each question should be numbered and written on a separate sheet on one side of the paper, and addressed "Questions and Answers," Editor, THE WIRELESS WORLD AND RADIO REVIEW, 12/13, Henrietta Street, London, W.C.2. Queries should be clear and concise. (2) Before sending in their questions readers are advised to search recent numbers to see whether the same queries have not been dealt with before. (3) Each communication sent in to be accompanied by the "Questions and Answers" coupon to be found in the advertisement columns of the issue current at the time of forwarding the questions. (4) The name and address of the querist, which is for reference and not for publication, to appear at the top of every sheet or sheets, and unless typewritten, this should be in block capitals. Queries will be answered under the initials and town of the correspondent, or, if so desired, under a "nom de plume." (5) In view of the fact that a large proportion of the circuits and apparatus described in these answers are covered by patents, readers are advised before making use of them, to satisfy themselves that they would not be infringing patents. (6) Where a reply through the post is required every question sent in must be accompanied by a postal order for the amount of 1s., or 3s. 6d. for a maximum of four questions. (7) Four questions is the maximum which may be sent in at one time.

In view of the serious interference which an oscillating receiver can cause to other receivers in its neighbourhood, it is understood that for broadcast wavelengths, certainly, and possibly for all wavelengths, the Postmaster-General will in future allow no type of circuit which is capable of oscillating and so energising the aerial, either directly or through any circuit coupled to it.

The necessary consequence of this restriction is that if reaction of the type commonly used in the past is still employed, it must be in such a way that the oscillation point cannot be reached over the wavelength range of the receiver, however tightly the reaction coil is coupled, and with whatever values of filament voltage or plate voltage the set is worked.

In order to comply with this requirement, it is essential that the reaction coil should be sufficiently loosely coupled to the aerial inductances as not to set up oscillations or alternatively the reaction might be arranged between the grid and plate circuits of a high frequency amplifier as shown on p. 715 of the issue of September 2nd.

We strongly urge readers who are making or using sets of the usual reacting type to either reduce the amount of reaction which they can employ to such an extent that they are perfectly satisfied that the set can never oscillate or to cut out their reaction entirely.

"TEC" (Ealing) asks (1) The cause of a continuous note heard in the telephones. (2) Why he obtains no results, and if the connections are right. (3) If Sullivan's telephones marked "A" are 8,000 ohms. (4) To what wavelength would a certain tuning coil tune.

(1) Probably an induction from A.C. lighting or power supply in the vicinity. (2) Your connections are fairly good, and you should get some results. You ought to get broadcasting, although your coil is rather large for the purpose. (3) We believe 6,000 ohms. (4) Maximum about 3,000 metres, minimum difficult to say. Probably inefficient below 600 metres.

"B.P." (Bombay) asks (1) What is the natural wavelength of a certain loose coupler. (2) and (3) Questions relating to pile-wound inductances.

(1) Loose couplers do not have natural wavelengths in any useful or predictable sense, but your loose coupler would be suitable for tuning to about 4,000 metres with the larger coil in the aerial circuit. (2) You will find pile winding of

wires of these gauges a terribly tedious and unsatisfactory operation, and we should strongly recommend the use of honeycomb coils for the purpose. (3) Neither of the suggested schemes give pile winding at all. For guidance, see article in the issue for October 2nd, 1920, obtainable from the publishers.

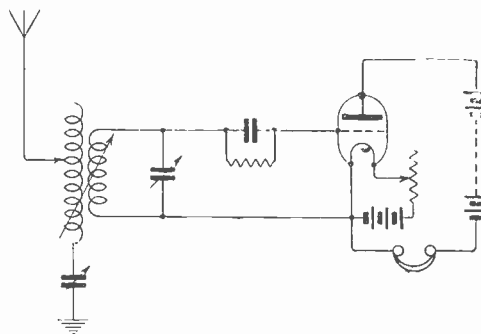

Fig. 1.

"P.T." (Maldon) asks for a diagram of a certain receiving unit. (2) How to calculate the capacity of condensers.

(1) See diagram (Fig. 1). (2) See reply to "Radio 3 UC" in the August 5th issue.

"C.M." (Oldham) asks (1) Which of four tuning systems is the best. (2) If a certain coil would receive telephony. (3) For advice with regard to his aerial. (4) If a microphone button would be suitable for a loud speaker.

(1) It is almost immaterial which of the last three. The slab coils would be less efficient. (2) Your coils are too big to give satisfaction on short wavelengths, for which you would probably only want about 20 turns with these diameters. (3) Nearness to the roof explains poor signals, also possibly your earth is less efficient. Raise your wires as suggested. (4) The suggested arrangement would not be of any use. Use the H.R. earpiece.

"J.E.M." (Rotherham) has a single valve panel and (1) Wishes to convert it to a four-valve set. (2) Whether a three-valve receiver will be suitable for reception of FL, 2MT, and PCGG on his aerial

in an open position. (3) What values the tuning condensers should have. (4) Whether he should make use of reaction.

(1) See diagram Fig. 2. (2) Yes. (3) For short wave work the aerial tuning condenser need not have a larger value than 0.0005 mfd., but for long wave work a value up to 0.002 mfd. may be found convenient. For tuning direction coil or closed circuit, a suitable value is 0.0005 mfd. (4) The use of reaction is recommended, as shown in the circuit diagram.

"W.T.O." (Cheshire) encloses a diagram of his single valve receiver and asks if it is O.K. (2) What maximum wavelength can he obtain with a certain A.T.I. (3) If a certain A.T.I. is suitable

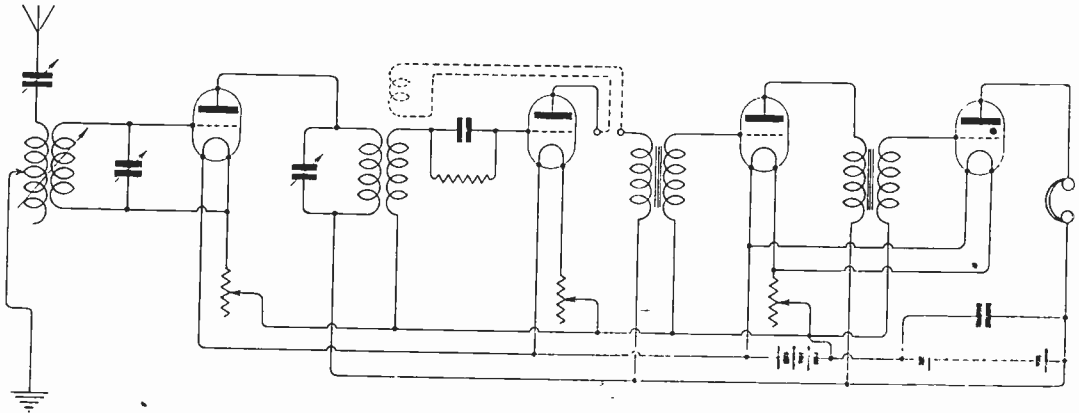

Fig. 2.

for connecting to a five-valve amplifier for receiving broadcasting.

(1) Yes, but it would be better to connect the two sliding inductances as in the Fig. (N.B.—Reaction of type suggested is not now allowed.) (2) 4,000 metres. (3) Yes, fairly efficient for the purpose.

"SUBSCRIBER" (Birmingham) asks if enamelled or ordinary 7/22 is the most efficient for the aerial, and rubber covered for the earth wire.

There is little to choose between plain and enamelled for the aerial, although the latter is slightly preferable. Any of the three may be used for the earth wire but rubber covered is best.

"A.G.W." (Camden Town) asks (1) For winding data for certain coils. (2) For criticism of a diagram of a three-valve note magnifier.

(1) Reaction of the type indicated is no longer to be permitted. The A.T.I. might be 6" x 3" of No. 24. The L.F. transformer, core 1/2" diameter of iron wire, windings 1 oz. and 3 ozs. of No. 44 S.S.C. (2) We have no criticism except that the set is not a three-valve note magnifier.

"NOVICE" (Newhaven) asks (1) If the circuit shown on page 554 of July 29th issue is suitable for reception with honeycomb coils and a single wire 100' aerial. (2) If a tapped H.F. transformer is necessary.

(1) Yes, but reaction of the type indicated is no longer permitted by the P.M.G. (2) If a considerable range of wavelengths is required a tapped H.F. transformer is very desirable.

"INDUCTANCE" (Salford) asks for certain information about a set described in "Practical Amateur Wireless Stations."

Statements of this nature are calculated to deceive. You might possibly get a range of 8,000 metres with a 500 k.W. station at the transmitting end, but 7,000 miles would be unlikely even under these conditions. Your broadcast range might be 100 miles, but for this purpose we should prefer a set of smaller coils than the type you suggest.

"S.M.P." (Wellingborough) asks (1) If it will be better to buy parts of a receiving set in France where he is going for his holiday, or to buy them in England. (2) If a receiving licence is necessary in France, and may an English licence be used on the

Continent. (3) If the condenser should be put across the H.R. telephones alone, or across telephones and H.T. battery. (4) If the A.T.C. should be on the earth side of the A.T.I.

(1) It depends on how long you are going to be there. If you purchase in France you will have to pay a heavy duty on returning, and may even find yourself prohibited from bringing the goods into this country. If you are just going for a holiday we should advise you to do without the pleasures of wireless, unless you are prepared to incur considerable expense. (2) Apply to the Department of Posts and Telegraphs. No. (3) Put it across both telephones and battery. (4) In most valve circuits the A.T.C. should preferably be on the aerial side of the A.T.I.

"W.G.P." (Barnes) asks certain questions regarding the super-regenerative circuit

(1) The values of the condensers suggested will be satisfactory. (2) The value of inductances for the tuning circuit should be the same as normally used for short wave work. For the oscillating circuits values should be suitable for about 5,000 metres. (3) For the grid battery flashlamp dry cells will be sufficient, the exact voltage required in each particular case being determined by experiment. The value will probably not exceed 12 volts.

"J.S.F." (Herne Hill) asks (1) For circuit diagram of a telephony transmitting set suitable for working on wavelength from 400 to 450m. and using 10 watts. (2) Whether the diagram given will eliminate the transmission of carrier wave when no speech

The Present Wireless Boom

has given an enormous impetus to the manufacture of wireless apparatus. The tendency has been to sacrifice quality to quantity in endeavouring to keep pace with the demands. Throughout this period of increasing wireless activity **S. G. BROWN, LTD.**, have wisely refused to lower their high standard of quality even at the expense of occasional delay in fulfilling orders. As a result they have more than maintained their enviable reputation as **RELIABLE** wireless manufacturers, and to-day it continues to be recognised by amateur and professional alike that wireless instruments and parts manufactured by and bearing the name "**BROWN**" can be bought with absolute confidence in their quality, value and efficiency.



"A" TYPE.
Low Resistance, 58/-
High Resistance, 62/- to 66/-
"D" TYPE.
Low Resistance, 48/-
High Resistance, 52/-
(all above prices include cords).

The "Brown" Super-sensitive Telephones

These Telephones are unquestionably the clearest and most sensitive made, and, consequently, increase the distance over which wireless can be heard.

BROWN'S are recognised as the **most comfortable** to wear, due to their extreme lightness in weight and adaptable adjustment.

There is no wireless head phone in the world to compare with **BROWN'S**.

IMPORTANT NOTICE.—When purchasing **BROWN'S** you should see that the name **BROWN** is stamped on the back of each ear piece. This is the **hall-mark and proof** of their **genuineness, excellence of finish and highest efficiency.**

In **Universal Use.** As supplied to British, Allied and Foreign Governments.

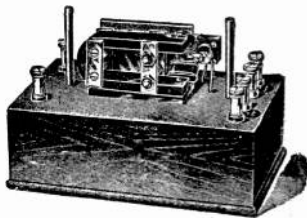

The "Brown" Microphone Amplifier

This **Amplifier** magnifies signals, speech, or music, without distortion, and is of considerable interest to amateurs and scientific investigators. The magnification is much greater than that obtained from a two-valve amplifier. In construction, this instrument is much more robust than other relays. *This instrument satisfies the urgent demand for a reliable, inexpensive amplifier, which the most inexperienced amateur can use, and which the most experienced requires.* The necessary transformers are included in the base.

The "Brown" Loud Speakers with new improved Curved Horns

The requisites of a Loud Speaker are pure tone, clear articulation, and good volume of sound. The "**BROWN**" Loud Speaker possesses these qualities and they are enhanced by the new improved curved horn.

AMATEURS do not always need the full sized Loud Speaker (H. 1.) as used in Lecture Halls, and a small type (H. 2.) has been designed to meet their more modest home requirements *both as to volume of sound and price.*

THE NEW HORN of dull blacked aluminium used with both H. 1 and H. 2 is constructed on the logarithmic law of increasing openings and is acoustically perfect.

NOTE THIS.—The strength and clearness of all music, speech and Morse heard by one person wearing headphones is broadcasted to a whole room full of people when a Brown Amplifier and Loud Speaker are used with your set.

The most popular and perfect loud speakers ever offered to the public.

Thousands already in use in all parts of the world.

CATALOGUE POST FREE.

Visit Our London Showrooms: 19, MORTIMER STREET, W.1.

Visit our Stand No. 43 at the All-British Wireless Exhibition, Horticultural Hall, Sept. 30th to Oct. 7th.



PRICES:
H. 1. (Large) Low Resistance, 120 ohms Height 21", £6 : 5 : 0 (High resistance 2/6 to 5/- extra).
H. 2. (Small) Low Resistance, 120 ohms Height 12", £3 : 0 : 0 (High Resistances 2/6 to 5/- extra)

SOLE MANUFACTURERS—

Telegrams—
"Sibbrownix, London."
Telephone—
Chiswick 1469.



Sole Agent for the Argentine—
Horacio D. Guerrero,
Las Heras 2480, Buenos Aires.

Head Office and Works:
VICTORIA ROAD, NORTH ACTON, LONDON, W.3

London Showrooms:
19, MORTIMER STREET, LONDON, W.1

The attention of Manufacturers and the Trade is specially drawn to this Announcement.

EXPERIENCE

AMPLIFICATION

RADIO FREQUENCY AUDIO FREQUENCY

Whether you wish to amplify before or after rectification, we can supply you with scientifically designed apparatus for obtaining the maximum efficiency. This is backed up by the reputation of our engineers and designers who have received universal recognition for their work in the wireless industry.

Our complete range of radio and audio frequency transformers and reactance coils covers all requirements. Detailed information is given below, and we invite you to call and inspect the various items at our showrooms.

NOTE.—A complete working diagram is sent out wherever necessary.

IMPROVED ADJUSTABLE REACTANCE COIL.—This is recommended where one or two stages of radio frequency amplification are required. It is more stable than a radio frequency transformer and is therefore easier to operate. Twelve tappings are provided and the instrument is self-tuned, no variable condenser being required.

Suitable for wavelengths of 100-20,000 metres.

PRICE 25/-

WITH 12-POINT SWITCH 16/- EXTRA

For multi stage radio frequency amplification we recommend our improved **RADIO FREQUENCY TRANSFORMER.** This is made in two ranges:—

(A) 100-4,000 metres, with 9 tappings.

PRICE 25/-

WITH 12-POINT SWITCH 16/- EXTRA

(B) 100-30,000 metres, with 12 tappings.

PRICE 40/-

WITH 12-POINT SWITCH 16/- EXTRA.

(B is approximately twice the size of A.)

TWELVE POINT SWITCH. This is a well-made laminated switch with extra large contacts. It is exactly as fitted to our own instruments and is the best switch it is possible to obtain for wireless work. The contacts are absolutely certain.

PRICE 16/-

AUDIO FREQUENCY TRANSFORMERS. For intervalve audio frequency amplification and note magnifiers. The many testimonials received and the large number of these transformers sold prove this design to be considerably in advance of any previously available.

This transformer is suitable for use with the Magnavox as a pressure of 250-300 volts may be applied direct across the windings.

PRICE 25/-

TELEPHONE TRANSFORMER. For use with any type of loud speaker.

PRICE 20/-

DELIVERY FROM STOCK.—We hold stocks at present but it is advisable to lose no time in placing your orders.

RADIO INSTRUMENTS, LTD.

Managing Director: J. Joseph, M.I.E.E., late Manager to Mr. H. Sullivan.
Chief Designer: W. A. Appleton, M.B.E., M.I.R.E., late Admiralty Technical Research Officer.

ONLY ADDRESS. Works, Offices, Showrooms:

12a, Hyde St., NEW OXFORD ST., W.C.1

Telephone: Regent 1908. 'Grams: "Instradio, London."

We have the largest wireless works in Central London.

We are wireless engineers of established reputation.

Our name on wireless apparatus is a guarantee of satisfaction.

Visit our Stand No. 37. All-British Wireless Exhibition, Horticultural Hall, September 30th to October 7th.

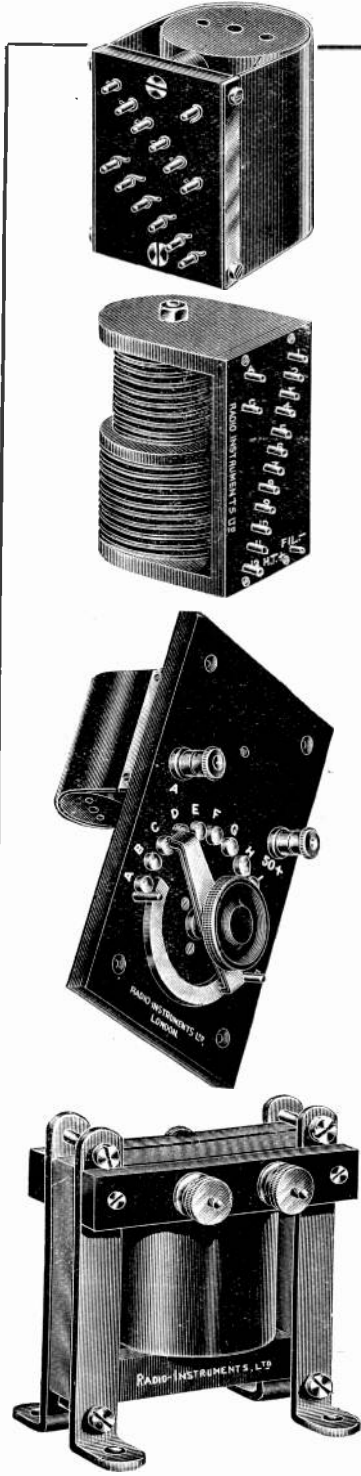

is taking place. (3) Whether A.C. supplied at 50 frequency is suitable when stepped up and rectified as a source of H.T. and (4) Types of valves suitable for (a) low power transmission, and (b) rectification for H.T.

(1) and (2) The most suitable telephony transmitting circuit is that embodying "choke control" and a suitable circuit is given in Fig. 3, making use of step-up transformer and rectifying valves for providing plate current. The system of quiescent modulation is not always to be recommended, and usually functions by some arrangement of grid potential control. (3) Yes: this can be done, but necessitates the use of high tension condensers of very large capacity for the purpose of smoothing out the ripple. A rectified plate current of about 1,000 to 1,400 volts should be aimed at in designing the transformer. (4) (a) T.15 to T.50. (b) U1.

(1) An increase in length somewhat increases signal strength, but not so much as a corresponding increase in height, moreover the P.M.C. does not allow more than 100' length to be used. (2) You might have some difficulty, and will probably need at least four valves, now that variable reaction on to the tuning circuits is not to be permitted. Interference from Carnarvon is not likely to be very serious unless this station should at any time revert to the use of arcs, which is unlikely. (3) "The Construction of Amateur Valve Stations," by Douglas. (Wireless Press, Ltd.).

"A.B." (Stoke-on-Trent) asks, among various other questions (1) The formula to calculate the capacity of an air condenser. (2) How to calculate the capacity of a cylindrical coil. (3) The wavelength a certain coil and condenser would tune to. (4) What happens when a long earth lead is used.

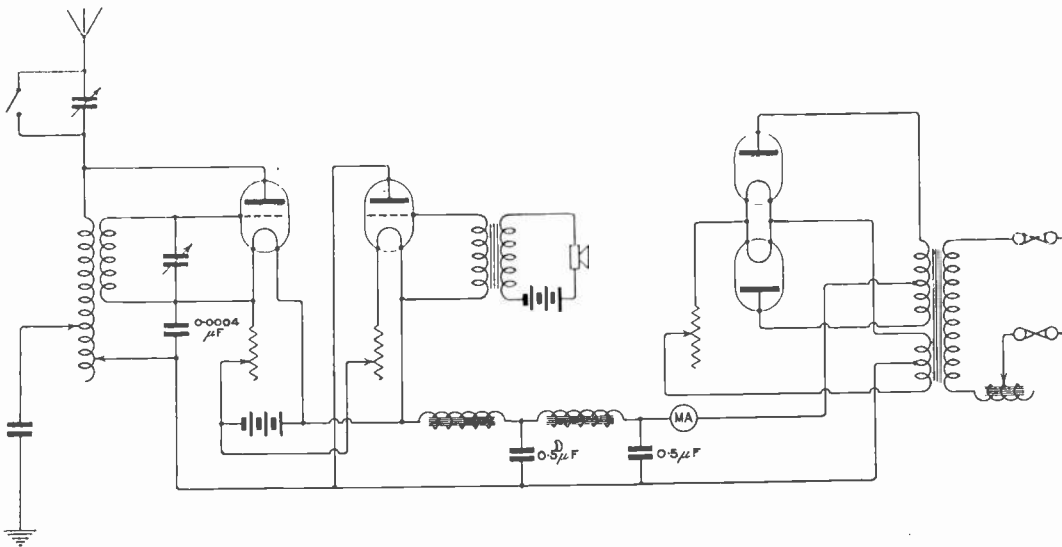

Fig. 3.

"A.M.W." (Hammersmith) asks for a working description of the Mk. III Tuner.

We have not space to give a full working description, but the instrument is a short wave tuner working up to about 700 metres. It contains two tuned circuits with tuned stroke stand-by switch. Tuning is effected by stud switches to inductances and variable condensers. Two crystals, carborundum with a battery and galena without, are fitted, as well as terminals for a detecting valve. The instrument, while of excellent design for its purpose, is unnecessarily elaborate for amateur construction. We should recommend you to purchase one of the Disposal Board instruments, now offered by various dealers, or at any rate to examine one of these instruments before deciding to make one.

"D.S." (Anglesea) asks (1) The effect of increasing the length of an aerial. (2) If the three proposed broadcasting stations within 100 miles range could be heard among the mountains within 7 miles of Carnarvon. (3) For a fairly simple book dealing with the construction of a two to four-valve set.

(1) See reply to "Radio 3 UC" in the August 5th issue. (2) Cylindrical coils do not have a capacity in any useful sense. The formula for their inductance has been repeatedly given. (3) About 800 metres. (4) Strength of signals is considerably reduced. From the remaining questions we should recommend you to study Bangay's "Elementary Principles."

"F.A." (Birmingham).—(1) Correct. (2) We should prefer 6 ozs. of No. 32 for the L.R. winding, but ¼ lb. of No. 36 will probably give fair results. (3) Doubtful, or very unlikely now that reaction from the oscillating point is not permitted.

"F.W.P." (Nottingham).—We are unable to answer your questions from the information supplied. If you will forward a diagram of your circuit we shall be pleased to advise you. It is quite possible to add either H.F. or L.F. amplification to the original tuner, or even both.

"J.C.D." (Much Wenlock) sends a sketch of two panels, and asks (1) How to connect them to the batteries and condenser. (2) For criticism of his set.

(1) Connect up as in diagram (Fig. 4). (2) As far as we can judge from the very rough sketches submitted this arrangement should be fairly satisfactory. Also move telephone connections on second panel to the positive side of the H.T. battery terminals.

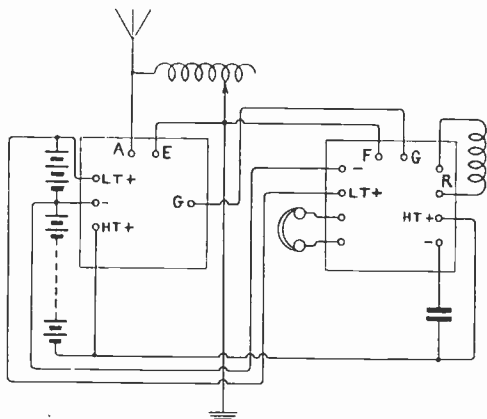

Fig. 4.

"S.H.S." (Liverpool) —(1) About 0.001 mfd. would be satisfactory, but reaction of this type is not permitted according to the regulations of the P.M.G. (2) Circuit shown is quite satisfactory. A potentiometer to the first grid would be an improvement. (3) We do not recommend "Lokap" wound coils for broadcasting wavelengths, as so few turns are required. With a diameter of 1", about 100 turns would be quite sufficient. You might make coils to the design shown on page 328, June 10th issue. (4) We are unable to give dimensions for suitable reaction coils as the P.M.G. will not allow reaction which is capable of energising the aerial. The amount which could be used without doing this varies so much with conditions—such as the type of aerial, characteristics of the valves, etc.—that it is impossible to predict a safe value.

"H.H." (Wimbledon) asks (1) For the most efficient single valve and crystal circuit for telephony. (2) How to adapt a circuit shown for this purpose. (3) A question with regard to his aerial.

(1) and (2) For diagram see Fig. 3, page 537, July 22nd issue. (3) If your house is at the high end of your aerial the addition of a mast on the roof will considerably improve signals. If, however, your house is at the low end the improvement will hardly be worth while.

"V.P.S." (Norbiton) asks (1) For a diagram of a set to fulfil certain requirements. (2) If L.F. telephones could be converted into a loud speaker by fitting a horn. (3) If he could get PCGG, 2 MT, 2 LO and Croydon Air Station at Chatham with receiver of question (1).

(1) The circuit of Fig. 5, page 573, July 29th issue, is a good one, particularly as it uses reaction in a way which is not prohibited by the new restrictions, provided that there is no coupling between the circuits of the second valve and the A.T.I. (2) This may be done if desired but the

results will not be very good, as the quality will be somewhat poor and the strength not very great. (3) All these stations should be possible with the exception of PCGG, which is very doubtful. (3) The values suggested will be quite satisfactory for a Vernier condenser.

"R.H.W." (Coventry) submits a circuit and asks (1) For criticism. (2) Whether it will receive 800/5,000 metres. (3) Values for plate resistance. (4) Best position and resistance of telephones.

(1) and (4) Circuit is O.K. except that the A.T.I. is much too small. It should be about 10,000 mhs. instead of 250 and no resistance is needed in the plate of the last valve. The telephones should be introduced in place of this resistance. (2) Yes, with the alteration to the A.T.I. suggested above. (3) About 50,000 ohms.

"A.L.D." (Manchester)—(1) A grid condenser and leak is not necessary, but it may be used if desired (a leak without a condenser is perfectly useless). If employed, it should be connected directly in the lead to the grid in the diagram on page 781. (2) FL probably; 2 MT very unlikely. (3) This set was never intended for short wave reception and it is impossible to make it efficient on such wavelengths while retaining the large coils suitable for long range reception. See note at head of these columns regarding reaction. The windings given in the article referred to will no longer be permitted.

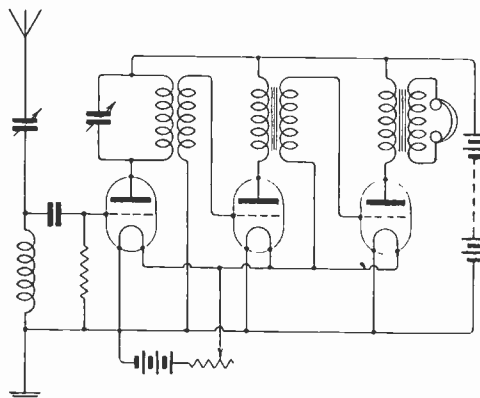

Fig. 5.

"CONCERT" (Woolwich) asks (1) If an amplifier, of which diagram is enclosed, will be suitable as regards lay-out and spacing of instruments. (2) Details for wiring up amplifier. (3) If the set will be suitable for receiving amateurs and Dutch concerts. (4) If a Sullivan L.F. transformer instead of the army type would give better results.

(1) Yes. (2) The circuit should be wired up as in diagram (Fig. 5). (3) Certainly. (4) Possibly a little better, but not likely to be much different.

"NEGATRON" (Coventry) asks (1) For criticism of a set sketched. (2) For the cause of noises in his set. (3) How many plates to use in a condenser for tuning H.F. transformers. (4) Windings for certain H.F. transformers.

(1) Circuit sketched appears quite satisfactory, but reaction in the form suggested is capable of

WIRELESS

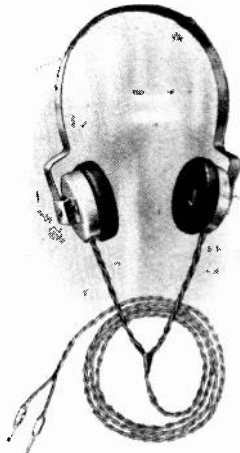

SPECIFICATION

CORDS. Twin Conductor Tinsel 3 ft. long between butt and fork, 12 ins. long from fork to each receiver, Instrument end fitted with 2 plug Type Metal Tags.

RECEIVERS arranged in series and wound to 2,000, 4,000 ohms, or as required.

MAGNETS of specially treated Tungsten steel, mounted in Aluminium cases and fitted with adjustable steel headband of extremely light but serviceable pattern

2,000 ohms	24/-
4,000 "	25/-

SPECIFICATION

RESISTANCES - 120, 1,000, 2,000, 4,000, 8,000 ohms
Other windings to order.

INSULATION - Highest possible.

MAGNETS - Selected Tungsten steel, manufactured under our own special process and guaranteed for ten years.

CORDS - Heavily insulated Tinsel Conductors.

FINISH - Polished Aluminium case and fittings, with Oxydised Relieved Coppered Head Bands, simple and comfortable adjustment. Ebonite Ear Caps fitted as standard.

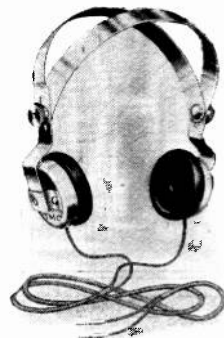

DE LUXE 'PHONES.

2,000 ohms	...	34/-
4,000 "	..	35/-



CRYSTAL SET

(including DE LUXE Head 'Phones)

£4 5 0 Post free.

AERIALS

Complete with Insulators and instructions for erecting.

6/- Post free.

Visit our Stand No. 20, All-British Wireless Exhibition, Horticultural Hall, September 30th to October 7th.

THE LONDON TELEPHONE CO. LTD.
Donington House, Norfolk Street, London, W.C.1

Tel.: CITY 8612.

The ESI-FIX AERIAL

Absolutely Weatherproof



CUT OUT TROUBLE by positively preventing aerial leakage.

Weak signals, reduced range, irregular and indistinct reception can all be traced to an inefficient aerial.

The "ESI-FIX" aerial has a patented continuous insulation over the entire length of aerial and lead-in.

IT CANNOT POSSIBLY LEAK. Rain, fog, sleet, soot, snow, hail or dirt cannot possibly affect it. Absolutely weatherproof and impervious to wet, rot, corrosion or mechanical damage.

The "ESI-FIX" aerial comprises aerial wire and insulators, lead-in wire, and insulating tube complete in one piece, together with fixing eye, adjustable shackle, terminal and clips.

FAR EASIER TO FIX than any other aerial. Can be thrown up anywhere, anyhow, without any precautions against leakage.

MAXIMUM EFFICIENCY GUARANTEED.—Conductor is composed of 40 strands, 30 S.W.G. hard-drawn copper wire. No joints, no soldering. Exceptionally low high frequency resistance.

"FIX IT LIKE A CLOTHES LINE."—Price, 50', 10/-; 75', 12/6; 100', 15/-. For twin or multiple wire aeriels use two or more short lengths.

THE "ESI-FIX" EARTHING SET, comprising change-over aerial-to-earth knife switch, lightning arrester, patented pipe grip, and 30' of "ESI-FIX" cable. Price complete, 10/-. Carriage paid in U.K. Trade inquiries invited.

SOLE PATENTEES and MANUFACTURERS:

CHAMBERS & ELLIS, 6-7, Craven House, Kingsway, London, W.C.2

Name

Address

I have difficulty in obtaining "ESI-FIX" Specialities at my local wireless dealers. Please, therefore, supply me direct with

..... ESI-FIX Aerials, length 50', at 10/- each.

..... ESI-FIX Aerials, length 75', at 12/6 each.

..... ESI-FIX Aerials, length 100', at 15/- each.

..... ESI-FIX Earthing Sets, at 10/- each.

I enclose...value

in payment of the above. To Messrs.

CHAMBERS & ELLIS,

Kingsway, London,

W.C.2

SEND THE COUPON TO-DAY

JUST PUBLISHED

NEW PRICE LIST AND WIRELESS GUIDE FOR

AMATEURS

Sent on receipt of 3d. (stamps).

MANCHESTER ELECTRIC WAREHOUSE

1 & 5, LEVER STREET

MANCHESTER

EASILY MADE WIRELESS OUTFITS

FOR THOSE WHO BUY OUR SPECIALLY DESIGNED COMPONENT PARTS.

10x6x1/4 Ebonite Panel drilled for Valve Holder, 10 Terminals, Fil. Resistance, and Variable Condenser, engraved any wording, 1d. per letter 6/6

4 Valve Legs to fit this panel 8d. 10 Terminals 2/-

Fil. Resistance for easy fixing 3/9

Our "Simplex" Remounting Variable Condenser '0005 12/6

With addition of our Acta Coil Mounting 10/6

4 Acta Plugs set 6/- 4 Concert Coils 4/-

You can make yourself a 10-guinea Valve Set.

We supply wiring diagram.

2, 3 and 4 Valve Sets can also be supplied in this way.

GET OUR BIG LISTS.

POST FREE 2 STAMPS.

TRADE SUPPLIED.

AMATEUR SUPPLIES, 134, Coteford Street, Tooting, S.W.

making the aerial oscillate and is therefore not allowed under the present P.O. restrictions. (2) From the information given we cannot state the causes of these noises, which may, however, be due to defective batteries. You should try and find out the cause by test. For instance, if you change the batteries and still get the noises, the cause is not the batteries—and so on with each other possible cause. (3) About 12 fixed plates will be desirable. (4) 300/500 metres—about 50 turns for each winding; 1,000 metres—100 turns; 2,000/3,000 metres—200 turns. These would be probable values, but they should be checked by experiment.

“I.S.D.” (Chiswick) asks re circuit on page 504 (1) If basket coils could be used for the oscillation tube. (2) Values for the batteries and condenser across grid inductance of oscillator.

(1) Basket coils could certainly be used. (2) H.T. batteries normal. The grid batteries determine by experiment up to about 10 volts. Condenser about 0.001 mfd. (3) Yes. This circuit may give serious reradiation if incorrectly adjusted and would therefore not be permitted by the P.M.C.

adjustment might be needed, and in particular we doubt if you will get the whole of the last range with a single transformer unless about No. 48 resistance wire is used. (1) 30 turns; (2) 60 turns; (3) 120 turns; (4) 500 turns. (4) This might be advantageous from the point of view of keeping down unwanted interaction in the circuits. If used the boxes should not be too small.

“S.W.R.” (London) asks three questions about a variable grid leak. (4) For particulars of the nearest broadcasting station to Rugby.

(1) (2) and (3) We do not know of any satisfactory leak of this nature on the market. Results could probably be obtained with either a graphite line resistance, with variable contact strips to alter the length of the line in circuit, or a liquid resistance, using some organic liquid of high resistance with movable electrodes. We do not think that the results would justify the trouble involved. (4) Birmingham, using 1½ k.W. The station has not yet started operations, and its exact wavelength is not fixed, although it will lie between 350 and 425 metres.

“G.H.” (Goteborg) asks (1) For criticism of

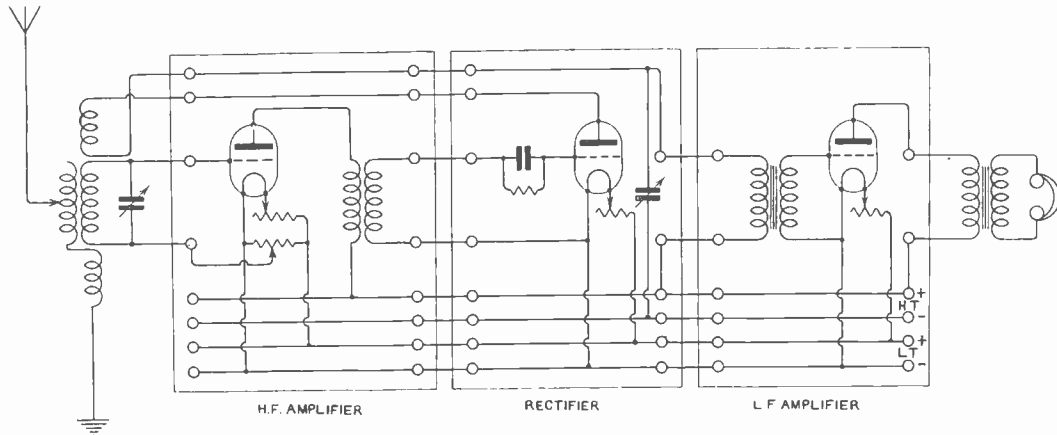

Fig. 6.

“R.A.Y.” (Glasgow) asks questions about a three-valve set.

(1) See Fig. 1, page 435, issue for July 1st, but note that reaction as shown in this diagram is no longer to be allowed. (2) Three coil holders will be required for a reaction set, but reaction of this sort, capable of energising the aerial, is no longer to be allowed, and a two coil holder will therefore be all that you require. (3) See diagram (Fig. 6).

“R.A.H.” (Hull) asks (1) For formula for calculating the capacity of condensers. (2) If “Ora” and “R” valves are interchangeable. (3) Windings for certain H.F. transformers. (4) If enclosing each panel in an iron box is advantageous.

(1) See reply to “Radio 3 UC” in the August 5th issue. (2) The “Ora” valve will work satisfactorily with less plate voltage than the “R” type, otherwise the characteristics are very similar. (3) Use formers 1½” diameter by 4” long. For the various ranges the turns for each winding may be as follows, but considerable experimental

adjustment might be needed, and in particular we doubt if you will get the whole of the last range with a single transformer unless about No. 48 resistance wire is used. (1) 30 turns; (2) 60 turns; (3) 120 turns; (4) 500 turns. (4) This might be advantageous from the point of view of keeping down unwanted interaction in the circuits. If used the boxes should not be too small.

(1) Set is O.K. except for the 0.004 mfd. condenser between plate and earth on the first valve, which is very undesirable. A leak should also be introduced between grid and filament of the second valve. (2) 10” x 8” of No. 24. (3) Use honeycomb coils, the makers of which generally quote wavelength for each coil with a stated condenser. With your aerial you will probably require a size larger for the A.T.L. than is needed for the closed circuit. (4) The indoor aerial will give you some results if it is as high as possible above your set. In any case it should give a spark station 5 miles away.

“M.T.G.” (Manchester) asks (1) For a diagram of a two-valve receiver with L.R. telephones and a transformer and L.F. intervalve transformer, and if possible a loud speaker. (2) If the coils X and Y in a diagram on page 217 of May 15th issue

bear any relation to each other. (3) If it will be possible to put 10 coils and a ten-way switch in place of the coil Y in the sketch. (4) The capacity of the variable condenser C and the fixed condenser C.1.

(1) If you want to use a loud speaker on near-by stations, we should recommend L.F. amplification. If, however, you want the maximum possible range we should prefer H.F. For a suitable circuit with L.F. amplification, see diagram (Fig. 7). (2) These coils should be coupled together, but there is no definite relationship between their sizes. The size of Y is determined by the wavelength required, X is then made of size large enough to give sufficient reaction with Y. (3) Yes, but not very efficient. (4) C = 0.0005 mfd., and C.1 = 0.0002 mfd.

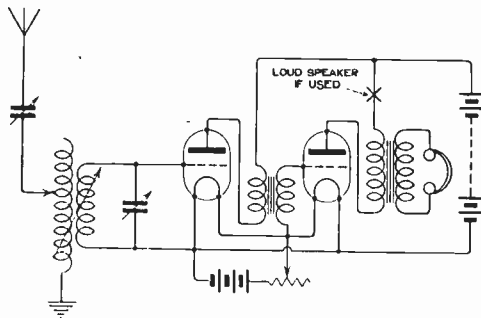

Fig. 7.

"C.W.B." (St. Leonards) refers to the super-regenerative circuit on page 305 and asks (1) Maximum capacity of the three variable condensers. (2) If one four-volt battery could be used to supply the three-valve filaments. (3) Correct sizes for the coils.

(1) Tuning circuit condenser 0.0005 mfd.; oscillator condensers about 0.002 mfd. (2) Probably, but the circuit might be more difficult to adjust. (3) Coils for tuning circuits should have normal values for short wave reception. L4 and L5 should have values suitable for about 5,000/30,000 metres.

"A.V.S." (Hull) asks (1) For diagram of three-valve set to fulfil certain requirements. (2) How many plates $1\frac{1}{2}$ " diameter would be required to build up a 0.001 mfd. condenser, with $1/16$ " between moving and fixed plates. (3) If two 0.005 mfd. condensers connected in parallel would be equivalent to one 0.001 mfd. condenser.

(1) See diagram on page 435, Fig. 1, July 1st issue, omitting reaction coil there shown, which is no longer allowed by the P.M.G. (2) With plates of this size almost 200 would be required. (3) Yes.

"T.R." (Barnsley) has a two-valve set which is giving trouble and asks (1) For advice. (2) If certain alterations to the connections would be satisfactory. (3) If a variable condenser in parallel with the plate and grid is an advantage. (4) If a 0.001 mfd. variable condenser is too large for tuning 440 metres telephony.

(1) and (3) The use of a condenser in the way you suggest is quite enough to explain the persistence of oscillations. It is very difficult to criticise your set in other respects as your diagram shows nothing of the internal connections. (2) Suggested method is useless. Condenser and leak, if used, should be

introduced between A and the grid of the first valve. (4) This is too high a value unless it is used in series with the A.T.I. This is much preferable to a parallel arrangement on such wavelengths.

"D.G.W." (Jersey) submits a circuit and asks if it is a super-regenerative one. (2) Values for certain coils. (3) If certain stations could be heard in Jersey with a three-valve set. (4) In what issue of "The Wireless World and Radio Review" tables of Nagaoka's correction factor K in the formula for calculating the inductance of single layer coils were given.

(1) The circuit shown bears some family resemblance to Armstrong's super-regenerative circuit, but we are unable to say whether it would function as it stands. L.1, L.2 and V in your circuit should have values suitable for tuning a single circuit receiver to 5,000/6,000 metres. (3) With luck all these stations might be received. (4) As this formula has not been recently given, we repeat it here with the tables asked for:—

$$L \text{ mHys} = \pi^2 d^2 n^2 l \times K.$$

Where d is the diameter of coil in cms. n = number of turns per cm.

l = length in cms., and K the correction factor, which varies according to d/l .

We quote a number of values from which a curve may be drawn, by means of which K may be found for any value of d/l .

d/l .	K .	d/l .	K .
0.1	0.96	1.5	0.59
0.2	0.92	2.0	0.53
0.4	0.85	2.5	0.47
0.6	0.79	3.0	0.43
0.8	0.74	4.0	0.37
1.0	0.69	5.0	0.32
1.25	0.64	7.0	0.26
		10.0	0.20

"F.C.K." (South Norwood).—(1) The first circuit shown is the better of the two, and not at all bad, but it has no advantages of the normal type illustrated, for instance, in Fig. 6, page 437, July 1st issue. (2) If the normal type referred to is used, the A.T.I. for 3,000 metres may be $9'' \times 6''$ of No. 22. A somewhat larger coil would be required for this wavelength with the arrangement you suggest.

"J.F." (Harlesden) sends a diagram of a valve and crystal set and asks (1) For criticism. (2) What results would be obtained on a rather poor aerial. (3) If polished mahogany, or other hard wood could be used for a base-board. (4) Dimensions of the coils to tune to 3,000 metres.

(1) O.K., but it would be much better to introduce a 0.005 mfd., variable condenser across B. (2) You should get London broadcasting, amateurs in the London district, ship sets, Croydon, Eiffel Tower, etc. (3) Hard wood may be used as a base, but if so it is preferable to use rubber insulated wire for connecting up through the base-board. (4) Coil A, $9'' \times 7''$ of No. 22; coil B, $7'' \times 5''$ of No. 24. According to the new Post Office regulations these two coils must not be coupled together.

"NEW READER" (Kirton Lindsey) asks (1) For criticism of an amplifier diagram. (2) For sketch of a tuning circuit and detector valve to use with it. (3) If we can recommend a more suitable circuit.

(1) Quite O.K. (2) Suggested type is quite feasible but you would get somewhat better results

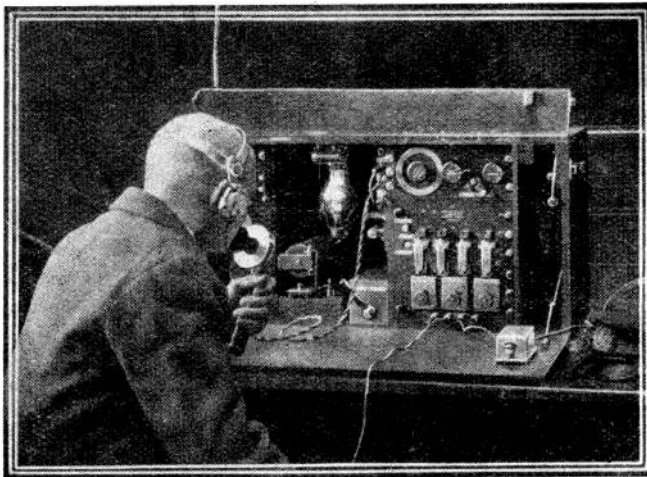

The First Commercial Wireless Telephone Service in Great Britain

is used for

Communications between the offices of the Mersey Docks & Harbour Board in Liverpool and the Bar Lightship beyond the mouth of the Mersey. The Marconi apparatus in each case is operated by the ordinary Harbour Board staff and has been in continual use since its installation over a year ago. — "Calling up" is performed by means of the

❖ ❖ *Marconi wireless bell* ❖ ❖

MARCONI'S WIRELESS TELEGRAPH CO., LTD.
 MARCONI HOUSE, STRAND, LONDON, W.C.2
 Telephone: CITY 8710.

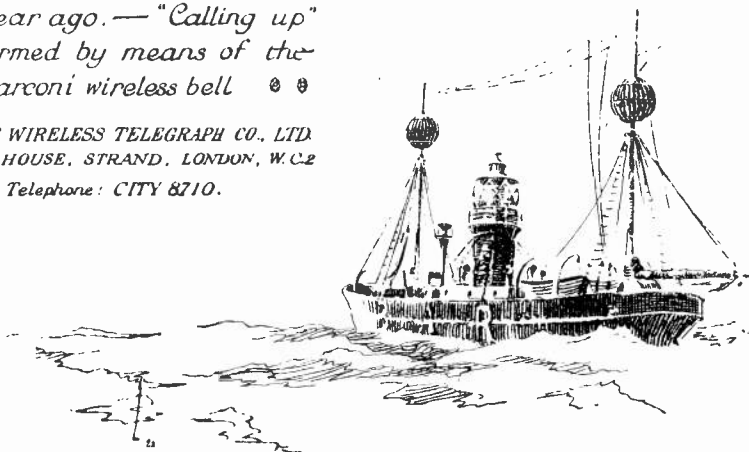

Visit our Stand No. 24. All-British Wireless Exhibition, Horticultural Hall, Sept. 30th to Oct. 7th.

MAGNAVOX

THE WORLD'S FINEST

LOUD SPEAKER

RADIO
brings it
MAGNAVOX
tells it.

*Broadcasting faithfully reproduced
with marvellous clarity and volume*

IMMEDIATE DELIVERY.

Visit our Stand No. 34. All-British Wireless Exhibition,
Horticultural Hall, September 30th to October 7th.

Manufacturers & Sole Licensees for Europe

Sterling Telephone & Electric Co., Ltd.

TELEPHONE HOUSE,

210/212, Tottenham Court Road, London, W.1

Telephone No.: 4144 Museum (7 lines). Telegrams: "Cucumis, Wesdo, London."

Works: DAGENHAM, ESSEX.

BRANCHES: NEWCASTLE-ON-TYNE: 9, Clavering Place.

CARDIFF: 8, Park Place.

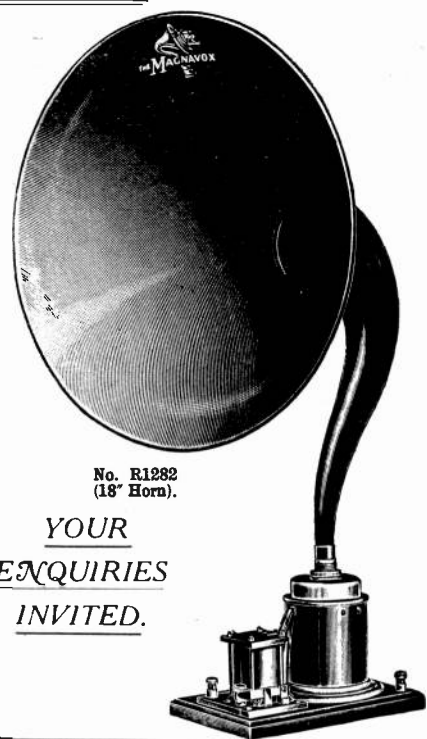

*YOUR
ENQUIRIES
INVITED.*

"BRITWIRE" CONDENSERS.

OWING to the demand for a good condenser, which at the same time is cheap, we are now manufacturing a Balanced Condenser for panel mounting, replacing the imported condensers hitherto sold. The plates are die-cast into the supporting columns, and are counterbalanced so that they will remain in any position when mounted on an upright panel. At present only two capacities are being manufactured, viz.: '0005 and '001, but other capacity condensers will be made in due course. Immediate delivery.

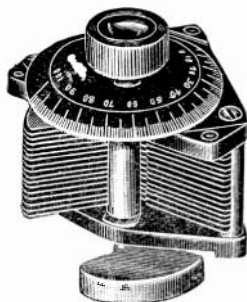

PRICE

WITH EBONITE REVOLVING SCALE:

'0005 mfd.	17/6
	Mounted in solid mahogany case, ebonite top					30/-
'001 mfd.	25/-
	Mounted in case					37/6

Retail Orders over 40/- carriage paid.

Send for Illustrated List of all Component Parts, post free 3d.

POST ORDERS TO—

BRITISH WIRELESS SUPPLY COMPANY

6 BLENHEIM TERRACE, LEEDS.

Telephone: 26926

LTD.

11 Church St., West Hartlepool. Tel. 373. 18 Eldon 'q., Newcastle-on-Tyne. Tel. City 360.
33 High Street, Southampton Telephone 403.

Visit our Stand No. 42. All-British Wireless Exhibition, Horticultural Hall, Sept. 30th to Oct. 7th.

from any of the three or four valve circuits, employing H.F. amplification, particulars of which have appeared in these columns recently.

"AMATEUR" (Little Sutton).—(1) Capacity 0.0013 mfd. (2) Gauge is No. 43, and might be used for either L.F. or H.F. transformers. (3) 8" x 6" of No. 22, with a tuning coil. We are unable to specify a suitable reaction coil. See note at the head of these columns. The only telephony you are likely to pick up at present would be local amateurs at irregular hours.

"T.W.O." (Preston) asks (1) If 60 ohm telephones would be satisfactory with a suitable transformer. (2) Constructional details for a suitable transformer. (3) If the above telephones will be less efficient than 120 ohm telephones.

(1) Yes. (2) Core $\frac{1}{2}$ " x 3" of iron wires. H.R. winding, 3 ozs. of No. 44; L.R. winding, 4 ozs. of No. 32. (3) Probably not so efficient as the 120 ohm telephones.

"G.W.R." (Southwark) asks type, size and number of Leclanche cells which will be most suitable for a multi-valve amplifier with "Ora" valves.

We much prefer dry cells owing to the tendency of the small wet Leclanche cells to "creep," giving messy and unsatisfactory working. You will require about 28 cells, and if wet batteries are used they might be about $\frac{1}{4}$ to $\frac{1}{2}$ pint size.

"X.Y." (London) has old-fashioned pull-wire bells in his house and asks if it would be possible to use these bell wires for an indoor aerial the house being four-stories high and bells running from top to bottom.

These might quite conceivably give useful results in London from London broadcasting, but you would not be likely to get much else, and you might get noises and other troubles from bad connections in your wires.

"NOVICE" (Bristol).—(1) It would be better to take your down lead from the point X. (2) You should receive FL and the broadcasting stations at Plymouth, Cardiff, Birmingham and probably London, well enough for the purpose you require, but broadcasting stations at greater distances and PCGG would hardly give sufficiently good results. (3) You should expect the current change you suggest from many stations, which would be enough for recording purposes. The cost of a suitable relay would be about £15, and an inker about £10 to £25, if suitable for ordinary hand speeds, and up to £100 to £120 for high speed Wheatstone recorders or undulators. (4) Further L.F. amplification with a second rectification after it will be advantageous for recording purposes.

"E.A.A." (West Ham) asks (1) For criticism of a set sketched. (2) Wavelength range to be expected. (3) If a different make of valve to that at present employed would be an improvement. (4) If he will lose signal strength by taking tappings with No. 30 from the coils wound with No. 22.

(1) The arrangement submitted is quite suitable for a simple set, but the A.T.C. should be used in series with the A.T.I. for short waves. (2) You do not give us enough information to say exactly, but the range is probably from a few hundred metres up to at least 3,000. (3) This will give very little difference. (4) Not seriously, if the tapping leads are short and carefully sweated to the original wire.

"E.C." (Southend) asks (1) What wavelength his set will tune to. (2) If the A.T.I. and condenser are O.K. (3) How to increase his wavelength to 3,000 metres. (4) Who is 2 MC and what is his wavelength.

(1) As you do not say the size of the condenser plates or their spacing we cannot give the information required, but if this condenser is about 0.0005 mfd. the range is probably up to about 600 metres with series A.T.C., and perhaps 1,500 metres with parallel A.T.C. (2) O.K., if the plates of the condenser are 3" to 4" in diameter, and spacing between fixed and moving plates not more than 1 mm. (3) Add a loading coil—for instance, a honeycomb coil with about 300 turns, in series with the A.T.I. (4) This station is located at Westcliff-on-Sea. [See note regarding reaction at the head of these columns.]

"R.B.L." (Guildford) asks (1) For criticism of a set. (2) How to most easily turn a single valve set into a two-valve set, without the use of an inter-valve transformer. (3) If H.F. coupling is best and easiest, what coils he will require.

(1) Set is of quite efficient type, but will not be allowed under the new restrictions of the P.M.G. See note at the head of these columns regarding reaction. (2) The best way of adding an extra valve is as in Fig. 5, page 573, July 29th issue. (3) This circuit, although it uses H.F. coupling, does not need inter-valve transformers. The easiest way of getting a big range would be by using honeycomb coils of assorted sizes for the coils on the anode side of the first valve.

"J.L." (Paris).—Grid condenser for this set may be about 0.0002 mfd., and telephone blocking condenser may be about 0.001.

"R.J.R." (Westcliff-on-Sea) has a three-valve receiving set and asks how he can connect up to receive short waves.

In order to get shorter wavelengths with this set, put the A.T.C. in series with the A.T.I. instead of in parallel with it.

"E.A.A." (Angle).—It is impossible, owing to the new restrictions on the use of reaction in a circuit of this nature, for us to give values. If any reaction is used it must be so little that the set cannot possibly oscillate. The safe amount must be determined by experiment, and effective precautions taken to see that it cannot be exceeded. See note on this subject at the head of our columns.

"W.H." (New Barnet) wishes to make a two-valve set and asks for a suitable circuit.

In view of the new Post Office restrictions the circuit of Fig. 5, page 513, issue for July 29th, will be about the best that you can do. Care should be taken to see that there is no coupling between the three coils on the anode side of the first valve and the A.T.I.

"R.J.S.C." (Sittingbourne) encloses diagram of a set which will not work satisfactorily and asks of (1) If the wiring is O.K. (2) How to remedy buzzing noises in the telephones. (3) If he can hear Writtle, Paris, London and The Hague with this set.

(1) Your diagram is not at all clear, but it appears to show the aerial and earth connected to the reaction coil instead of the A.T.I. This would be sufficient to explain poor results obtained. (2) Noise is apparently due to oscillation from the use of too much reaction. A set which can oscillate

in this way is now definitely prohibited by the P.M.G. See note at the head of these columns. (3) Writtle, London and Paris—yes. The Hague very doubtful.

“M.P.” (South Africa).—(1) This coil will tune the aerial to about 3,500 ms. (2) We should recommend the use of honeycomb coils for this purpose, but failing this, a coil, 12" × 9", wound with No. 28, would give the desired result if used with a parallel capacity. The closed circuit coil could be 12" × 8" of No. 32. (3) and (4) The best arrangement of apparatus would be as in the diagram (Fig. 8).

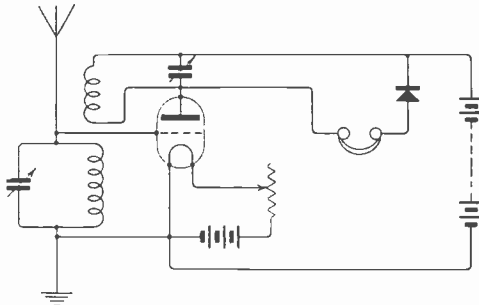

Fig. 8.

“D.H.C.” (Wallington) encloses a diagram of his set and asks (1) Why it will not work. (2) If there is a simple way of telling whether the valves are defective. (3) Gives details of an H.F. transformer and asks the approximate wavelength.

(1) Circuit shown is quite correct. Failure to work is probably either because your set is not actually wired to the diagram, or some part of your apparatus is defective. See note at the head of these columns re reaction sets of this type. (2) The easiest way is to fit them to some tried circuit and see if they give results. The only common faults are grid touching filament, or plate touching grid. These can generally be seen by careful inspection, or in the first plate if the grid lead is shorted a change in filament brightness may occur when the grid is opened or closed. (3) Your circuit does not show a transformer of this type. This transformer would probably be suitable for about 5,000 ohms.

“W.G.M.” (Bristol) describes a set which will only receive in an oscillating condition and asks (1) How to stop the howl. (2) Maximum and minimum wavelength. (3) If wavelength can be increased by adding a loading coil in the aerial circuit. (4) How large a loading coil to add for certain specified wavelengths.

(1) An oscillating set of this type is forbidden under the new Post Office regulations. Howling may be due to grid and plate leads being run too close together. The chief reason for loss of signals when reaction is removed, is the inefficiency of your aerial and also the fact that a 0.001 mfd. parallel condenser is grossly excessive for short wave reception. It is undesirable to use a parallel condenser at all. (2) Minimum approximately 300

metres; maximum about 1,100 metres. (3) Yes. (4) We cannot give the exact amount for each wavelength, but supposing the 0.001 mfd. condenser is removed, a loading coil 6" × 4" of No. 24 should be ample to go to 1,200 metres. The grid and filament of the valve should be tapped across both coils and not only the coil at present in existence.

“M.A.C.” (Glossop) asks (1) Where to find a description and circuits of the Marconi four-electrode valve. (2) For information on the self-capacity of coils. (3) Which is correct, Bangay's assertion on pages 142-3 of his book, that the L.F. valve should be worked well up the slope of the curve, or Penrose's that one of the bends should be used. (4) Which cartographic system should be used for D.F. calibration.

(1) See page 198, May 13th issue, and page 230, May 20th issue. (2) Self-capacity is reduced to a minimum when each turn is separated as far as possible from the consecutive turn on the winding, and the winding is so designed that no two turns, which are numerically well separated, are geometrically in proximity. You will observe that these conditions are fairly well fulfilled by solenoid coils, and even better still by basket coils. (3) The valve should be worked well up the characteristic in the middle of the straight portion. In all other positions considerable distortion is introduced. (4) For this purpose gnomonic projection should be used. Neither Mercator's nor the ordinary atlas give true bearings.

“R.B.” (Carlisle).—The set sketched should be satisfactory, except that a variable condenser is desirable across the grid circuit of the first valve. Secondly, reaction coil, if used, should be introduced in the plate of the first valve instead of the second. Thirdly, reaction of this type may only be used under the conditions laid out in our note at the head of these columns.

“H.L.H.” (S.E. 18) describes his crystal set and asks (1) If the set will work. (2) If a telephone condenser is necessary. (3) The wavelength of set. (4) For any suggested improvements.

(1) Yes, if correctly connected up. (2) Not essential, but will generally improve results. (3) Maximum about 3,000 metres. (4) A double circuit receiver with a loose coupler would give greater selectivity.

SHARE MARKET REPORT.

Prices as we go to press on September 8th are:—

Marconi Ordinary	£2	8	0
„ Preference	2	4	½
„ Inter. Marine..	1	9	6
„ Canadian	11	3	

Radio Corporation of America:—

Ordinary	1	2	0
Preference	∴	14	0	

MULLARD Wireless Accessories. GREAT PRICE REDUCTIONS.

Patent Resistances	list 5/-	Condensers	list 2/6
Combined Grid Leak and		Valve Sockets	1/3
Condenser - - - - -	7/6	„ Bases - 5/-	
		(with four terminals)	
Resistance Clips - - -	per pair 9d.	Telephones - - 30/-	
		(4000 ohms)	

LIBERAL DISCOUNTS TO THE TRADE.

Write for Leaflet—Number S.2

MULLARD RADIO VALVE Co. Ltd.
Claybrook Road, Hammersmith, W.6

Contractors to H.M. ADMIRALTY, WAR OFFICE, ROYAL
AIR FORCE & POST OFFICE.

Telephone : Hammersmith 312.
Codes : 5th Edition A.B.C.

Telegrams :
"Radiovalve, Hammer, London."

Visit our Stand No. 41. All-British Wireless Exhibition, Horticultural Hall, September 30th to October 7th.

[E.P.S.] 19.



Type A. Price complete—
£5 5 0
 including "3 Bee" Headphones,
 Complete Aerial, etc.,
 as illustrated.

BUY ON SPECIFICATION AND YOU CAN'T GO WRONG. Here's the actual specification of our machine, ask others to submit a complete specification of what they are selling before you part with your money, and thus avoid disappointments.

JUST LIKE THE PICTURE.

Type A Receiving Set comprises:—
 One Receiving and Detector Unit, mounted upon special panel, dove-tailed box 10.6 x 6.5 inches. **PERMANENT** crystal detector (patent applied for) always a constant point, no fooling or fiddling about to find a live spot on the crystal, a live spot is always there, mounted in a glass-covered case, protecting same from dust, moisture and all atmospheric changes. Retail selling price, 12/6.

Eborine coil, insulated, shellaced and enamelled, covered with cotton-covered copper wire, tapings, secured by own method of sealing with our lead seals (patent applied for), all

wires run in coloured insulated tubing and every join soldered to prevent leaks.

TUNING. Wires from insulated coil are run to brass studs. Right-hand unit of ten studs permits of fine tuning down to one turn per stud. Additional fine tuning for voice and music is secured by a vernier plate condenser made of aluminium plates. All leads and connections clearly marked on surface of plate, making operation perfectly plain and simple.

One pair "3 Bee" double earpiece telephones, the finest telephones in the world for wireless reception, with American type of self-adjusting headbands, rubber-covered, no catching the hair, light, easy and comfortable upon the head. Earpieces may be separated so that two persons can hear. Retail price of these telephones is **£2 2s.** alone.

One Dubilier Condenser, connected across telephone terminals. This is the standard of the world for wireless use and retails at **2/6.**

Four Insulators for the aerial.

100 feet of No. 14 Best Copper Wire, made by Siemens for aerial and lead-in wire, packed in covered 3-inch coil.

One Insulator Lead-in Tube.

One Copy of the "Daily Express" Book "Home Wireless for All," the best book for the beginner in wireless, as it explains in simple language all about wireless and how to erect your aerial and set.

Everything as above, **£5 5s.** complete. 2/6 extra for postage and packing.

Now, dealers, here's our proposition, we can supply you with these outfits, made in Great Britain by British Labour, with telephones and every part and parcel of this great set made here in Great Britain, at a dealer's price that will enable you to make large and substantial profits for yourself. Liberal discounts are offered to you, and the quickest selling outfit on the market to-day, in addition we can supply you at wholesale with everything you need to open a complete wireless shop. All parts, etc., as required by amateurs can be supplied to you, so you can start in the wireless business at once.

**BRITISH RADIO
 SALES CO. LTD**
 62, OXFORD STREET, LONDON, W.1



Type B "Radiofone"

HERE'S A SET THAT THE BUYER CAN BE PROUD TO OWN

Our 3-unit system has been designed for the beginner in wireless. Its greatest point is ease and simplicity of operation. You can't go wrong with this complete outfit. It brings in all the music, concerts, speeches, etc., now being broadcasted. Range, 300 miles.

Conforms to P.O. Regulations. Comprises a vari-coupler detector and sound magnification Unit No. 1. By adding Unit 2 you have a one-valve detector; by adding Unit 3 you have an additional two-valve amplifying unit giving loud signals; a loud-speaker may be attached and will easily fill a good-sized room. Prices: Unit 1, £5; Unit 2, £2 10s.; Unit 3, £5; the three Units as shown, £12 10s., including 1 pair "3 Bee" Telephones, 100 feet aerial wire, 8 insulators, lead-in tube, grounding clamp, Home Book on Wireless. Ready to erect (valves and accumulator extra). We can supply Mullard Ora Valves at 15/- each. 4-volt Storage Battery from 24/9 to 39/6. B Batteries are built into Unit 2, and are supplied without extra charge.

These Units have no bothersome filament control. Easy to connect up. No involved tuning. Only one knob to manipulate to get **exceptional** results. Money back under our money-back guarantee if not thoroughly satisfied.

NOTE.—Unit 2 may be attached to our Crystal Sets, Types A and C if desired.

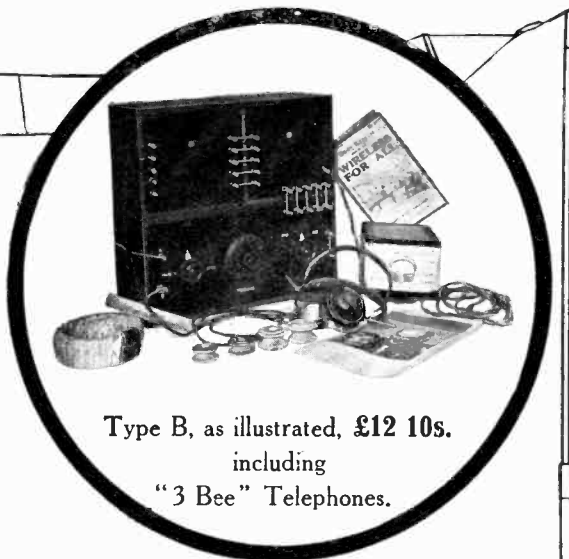

Type B, as illustrated, £12 10s.
including
"3 Bee" Telephones.



**BRITISH RADIO
SALES CO. LTD**
62, OXFORD STREET, LONDON. W.1.

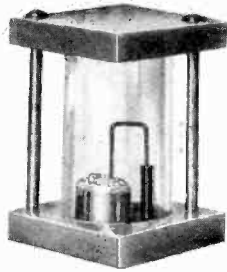

Permanent Crystal Detector,
Price **12/6**

*New Ideas from the Home of
the Latest "Radio" Inventions*

Permanent Crystal Detectors.

At last we have solved the problem of a permanent Crystal Detector, and we have fully protected our rights as Patents have been filed for all these improved types. No fiddling

about for a point, just hook on to your set and you get immediate results. No adjustment of any kind whatsoever required. Order one to-day.

Will work with any crystal set. Type A, Price **7/6**. Type D, **12/6**.

The greatest boon ever discovered for amateur experimenters.

Dealers and Manufacturers write for special prices.

"NOVELLO" AERIAL.

USE your House or Office Electric Light Circuit as an aerial. With this device no aerial is required, simply connect plug to your electric light socket, attach wire to the aerial terminal of your set and you are ready to receive.

Works on all *direct* current voltages. Order to-day.

Complete

25/-

**BRITISH RADIO
SALES CO. LTD**

62, OXFORD STREET, LONDON, W.1.



**USE
Your Gramophone
as a Loudspeaker.**

This new device (patents pending) fits any size telephone. Attach to your Gramophone tone arm, it fits on similar to your present sound box, and you have a loudspeaker.

Price only **7/6** complete.



“NOVELLO” INDOOR AERIAL

takes the place of a frame aerial, superior to all other devices. Can be easily packed into a very small space in a few moments. Operates anywhere, gives great results. Useful for your motor car, boat, canoe or in your home where it's impossible to erect an aerial. Price complete, ready to attach to your set

50/-

*Write to-day for our new illustrated Catalogue now in press. It's FREE
Dealers and Manufacturers, write for special low prices.
Agents Wanted Everywhere.*



**BRITISH RADIO
SALES CO. LTD**

62, OXFORD STREET, LONDON. W. 1.

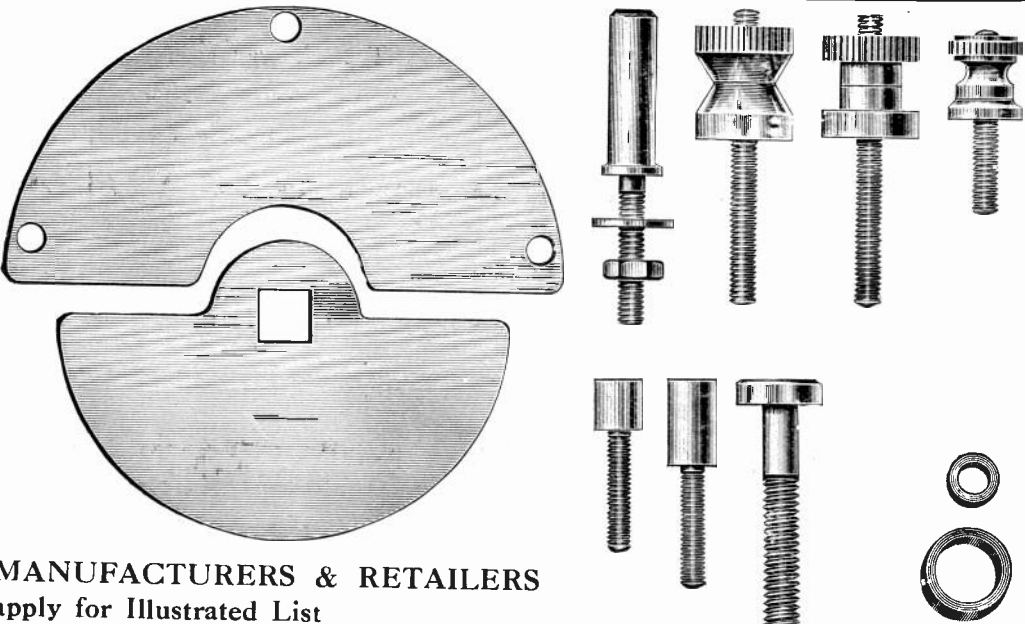

MANUFACTURERS & RETAILERS
 apply for Illustrated List
 and TRADE TERMS. KEEN PRICES. PROMPT DELIVERY.

Phone—
 Holborn 1812 **ORMOND ENGINEERING CO., 199, Pentonville Rd., King's Cross, N.1.**

TEC

HIGH TENSION DRY BATTERIES
 for WIRELESS SETS



NORMAL SIZE, No. W 70 V, 15 Volts Price 5/-	W 71 V, 50 Volts Price 15/-	GIANT SIZE, No. W 75, 15 Volts Price 6/6
--	--------------------------------	---

SUPPLIED IN TWO SIZES FOR 15, 50 or 60 VOLTS
 and with Tappings in 3 Volt Steps.

ALL BATTERIES FITTED WITH PLUG SOCKETS AND MOVABLE TERMINALS.

Complete Illustrated Price List on Application.

THE EFANDEM CO., LTD., FALLINGS PARK WORKS,
 DRY BATTERY MANUFACTURERS **WOLVERHAMPTON**



*Specially
designed
for
Broadcasting*

HEADGEAR RECEIVERS

Designed and manufactured by leading Telephone Manufacturers. Backed by many years' experience.

Highest efficiency, concentrated magnetic field, instantaneously adjusted to the ears, comfortable in wear, either receiver detachable from headband, protected terminals, light weight, twin series cord.

**A.T.M. LOUD
SPEAKING
RECEIVERS**
Three types of
amplifying horn.

**A.T.M. Crystal
Detector Sets**
Highest Grade.
Maximum Efficiency.
Moderate Cost.

*Ask your dealer for
A.T.M.*

Broadcasting Apparatus

Visit our Stand No. 52. All-British Wireless Exhibition, Horticultural Hall, September 30th to October 7th

Automatic Telephone Manufacturing Co., Ltd.

Head Office & Works: Milton Rd., Edge Lane, Liverpool.
London Office: 60 Lincoln's Inn Fields, W.C.2.

USE 4 PAIRS HEADPHONES
BY MEANS OF NEW PATENT
4-WAY PHONE CLIP

Send 1/3 P.O. for Sample Pair

WHOLESALE ENQUIRIES SOLICITED

GRIFFIN,
44, Romford Road, London, E.15

THE
PARAGON RUBBER MANUFACTURING CO.
SCULCOATES, HULL.

E B O N I T E	W I R E L E S S
Sheet, Rod & Tube	KNOBS
ELECTRICAL	V A L V E S
MOULDINGS	SLIDERS, Etc.

Wholesale only.

London Office: PERCY W. C. TRICK,
20, LITTLE PORTLAND STREET, W.1
Telephone: MUSEUM 2043.

IMPORTANT— NOTICE

A. C. COSSOR, Limited, hereby give notice that the order of Mr. Justice Russell of the 1st March, 1922, continually advertised by the Marconi Co., was an order ARRIVED AT BY CONSENT.

Being engaged at the time in the production of an improved and different type of valve, A. C. COSSOR, Limited, did not consider the patents in question of sufficient importance to warrant the expense of litigation.

A. C. COSSOR, Limited, respectfully leave the public and the Trade to judge whether the constant repetition of the notification of the judgment referred to is necessary or expedient in the circumstances.

Visit our Stand No. 29. All-British Wireless Exhibition, Horticultural Hall, September 30th to October 7th.

A. C. COSSOR, LIMITED
Aberdeen Works, Aberdeen Lane,
Highbury Grove, N.5

Sterling Wireless Receivers

Price 31/- pair

Specification.

Double Head Telephone Receiver. Specially designed for Wireless Telephony. Excellent articulation. Single Pole piece central operation diaphragm. Case of aluminium with swivel and trunnion movement. Headbands of steel cosletized to prevent corrosion and are adjustable. Each set complete with 6 ft. best quality flexible cord, weight 10 oz.



2000w.
First quality a moderate price

Visit our Stand No. 6. All-British Wireless Exhibition Horticultural Hall, Sept. 30—Oct. 7.

Immediate Delivery. Also 4000w. 32/-

Price 31/-. Postage 1/- LIBERAL TRADE DISCOUNT. Please write for our Price List.

RADIO SERVICE CO., LTD. Room 7, Dept. A, 62, OXFORD STREET, W.1.

Telephone: Museum 2136.

Work: Church St., Stoke Newington, N.16.

GENTS MAKE FITMENTS:

SEND FOR OUR SUNDRIES PAMPHLET

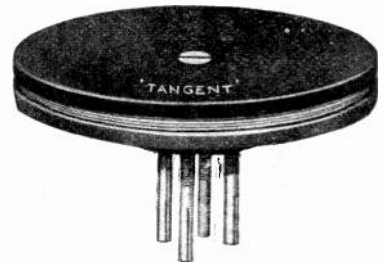

THE "DISCOL" H.F. TRANSFORMER.

MAKE USE OF OUR STOCKS.

ASK US TO QUOTE FOR YOUR WHOLESALE REQUIREMENTS.

GENT & Co., Ltd., FARADAY WORKS, LEICESTER.

LONDON: 25 VICTORIA STREET, S.W.1.

NEWCASTLE-ON-TYNE: TANGENT HOUSE, 52 BLACKETT ST.

Coil-Holder. Wireless

The Fraser Patent Coil-holder (Concentric variation). Adaptable for two or three coils. Very compact, and suitable for independent or panel mounting. Price 10/-. Extra coil blocks, 2/9.

SLAB COIL ADAPTER.—Invaluable for use with slab, or basket coils. Standard plug pitch. Fits any coil-holder. 2/6 each.

Condensers (assembled), 0-001, 21/-, parts 18/-.

Condensers (assembled), 0-0005, 13/6, parts 11/-.

Condensers (assembled), 0-0002, 9/-, parts 7/-.

Condenser Spindles, 9d., 10d. 1/2, 1/4.

Condenser Spacers, Large, 9d.; Small, 3d. doz.

Intervalve L.F. Transformers, 16/6.

Ebonite, 3 1/2" x 2 1/2" x 3/16ths, trimmed suitable for condenser tops, 7d.

Detector Panel, parts, 18/9. With Dulled Ebonite Top.

High Frequency Panel, parts, 23/6. ditto

Low Frequency Panel, parts, 23/6. ditto

Switch Arms, 2/3.

Contact Studs, per doz. 1/6.

Ebonite Knobs, 8d.

Valve Legs, 2 nuts, washer, 3d.

Condenser Vanes, per pair, 2 1/2d.

Marconi Phones, H.R., 15/-.

Terminals, each, 3d.

Ebonite Panels, Trimmed, 9" x 4 1/2" x 3/16ths, 2/-.

All other parts at standard prices. Orders of £1, carriage paid.

Revised Price List A. Gratis.

JAMES FRASER & CO.

(In collaboration with Electrical Training College, address below.)

SCHOOL INSTRUCTION.

Day, Evening and Postal Courses in Wireless, Valves, etc., P.M.G. (Exam.) and Amateur Classes. Also Cable and Telegraphy.

Phone, North 1036.

Prospectus Free.

PRINCIPAL:

ELECTRICAL TRAINING COLLEGE.

Radio House, Manor Gardens, Holloway, N.7

CONDENSERS

ALL TYPES AND VALUES. EVERY ARTICLE GUARANTEED.

FINEST WORKMANSHIP AND FINISH.
BRASS WORK
POLISHED AND LACQUERED.

Value in M.F.	Panel Mounting in Parts	Panel Mounting Assembled	Cabinet Mounting in Parts	Cabinet Mounting Assembled	Cabinet Mounting Assembled in Cabinet	Polished Mahogany Cabinet
.0015 ..	23/-	25 6	24/-	26 6	33/-	6 3
.001 ..	18/9	19 6	17 9	21/-	26/-	5 6
.00075 ..	13/6	16 3	14 6	16 6	22/-	5 6
.0005 ..	10/6	13 -	11 9	13 9	18/-	4 6
.0004 ..	10/-	12 6	11 -	13 3	17 6	4 6
.0003 ..	9/-	11 6	10 -	12 -	16/-	4 -
.0002 ..	7/-	9 -	8 -	9 6	13 6	4 -
.0001 ..	6/-	8 6	7 -	8 6	12 6	4 -
Vernier ..	—	4 6	—	5/-	9/-	3 6

Bevelled Dial 2/- extra. Special Sizes Made to Order.

FILAMENT RESISTANCES

IMPROVED PATTERN. RELIABILITY GUARANTEED. PRICE 4/- EACH. Delivery by Return

ALL SUNDRIES AND COMPONENTS IN STOCK. ORDERS OVER 20/- CARRIAGE PAID.

The "Broadway" Radio Works,
Devonshire Road, Bexleyheath, Kent
H. L. LIDINGTON. TRADE SUPPLIED.

A \$20,000 DEAL IN WHICH EVERY WIRELESS AMATEUR MAY PARTICIPATE

"BROWN" "A" TYPE RADIO HEADPHONES

Guaranteed new and unused. NOT re-conditioned.

120 ohms.
42/6

Maker's Price 58/-



8,000 ohms
49/6

Maker's Price 66/-

SULLIVAN 8,000 ohms ... **36/6**

Why pay the full price and wait weeks for delivery when we can supply from stock at less than trade price?

Terms cash with order. Postage 1/- extra. Approval for 7 days
Trade enquiries for quantities solicited.

FULLER "BLOCK" TYPE ACCUMULATORS 4 volts, 4 amp., **32/6**
the only practical battery for wireless.

THE CITY ACCUMULATOR CO.
79, MARK LANE, E.C.3.

Phone: Avenue 91. Telegrams: 'Tyche, Fen, London.'

CONDENSERS

BEST WORKMANSHIP AND ALL GOODS GUARANTEED

Capacity	Panel Mounting	Mounted in Mahogany Box & fitted with Scale	Mounted with Micrometer Attachment
·001	15/-	22/6	39/6
·0005	10/6	17/6	34/-
·0003	9/-	16/-	32/6
·00015	7/6	14/6	31/-
·00005	5/6	11/6	28/-

All Condenser Parts Manufactured for the Trade. Mahogany Cabinets to your own Specification.

HART ACCUMULATORS

6 Volt 60 Amps.	-	-	£2 0 0
4 " 80 "	-	-	£1 15 0

Amateurs supplied with all wireless parts at address below

Trade Terms on Application.

M.C.C. WIRELESS COMPONENTS

1a, Grandsen Ave., Mare St., Hackney, London E.8



---CQ Std bi
for ERICSSON PHONES

WHEN you install your wireless set—crystal or valve—you'll get maximum results if you fit Ericsson Phones—clarity, sensitivity, strength of signals and absence of "click." Specially suited to telephony.

Ericsson Phones embody the accumulated experience of telephone manufacture for a generation. Easy to the head, light and comfortable. The magnets never lose their strength and "shorts" are non-existent

Write for Particulars.

The BRITISH L. M. ERICSSON MANUFACTURING Co., Ltd.

Head Office: 60, Lincoln's Inn Fields, E.C.2

Ericsson
TELEPHONES

Intervalve Transformer

PRICE
19/6

Postage
6d

Orders
must be
accompanied
by
remittance.

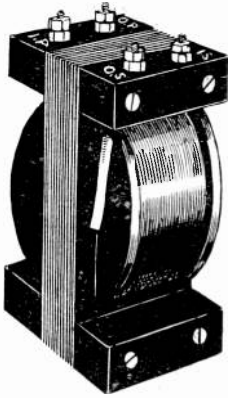

PRICE
19/6

Postage
6d.

Orders
must be
accompanied
by
remittance.

MADE WITH GENUINE STALLOY STAMPINGS.
BOBBINS TURNED FROM SOLID EBONITE.
PERFECT INSULATION, VERY EFFICIENT AND
SILENT. FIT ONE AND TRY IT. IF NOT
SATISFIED WE WILL REFUND MONEY.

The B. & A. WIRELESS Co.
VERULAM STREET, ST. ALBANS.
PHONE—323.

“CASTAPHONE”

(REG. TRADE MARK)

CRYSTAL W/T RECEIVING SET.

PRICE **65/-**

Complete with 'Phones, Aerial Wire, etc., 90/-
E.-in-C. DEPT., G.P.O.

“The reception was good and clear using a
headgear receiver of the A.T.M. make.

I consider the ‘Castaphone’ set offers good
value for money.”

(Signed) E. H. Baxter, A.M.I.E.E.

British Valves :—“R.M.R.” (new type), 15/-;
“Ora” 15/-.

H.T. Batteries :—36 volt, 8/- ; 60, 14/- ; 75, 16/-
4 Volt Batteries 6/6 post free.

“HERTZITE”

MOUNTED IN PATENT DETECTOR

5/6

POST FREE

RUSSELL AND SHAW,
38, Great James St., Bedford Row, W.C.1

2-Valve RECEIVING SETS

Are you prepared to Receive
the Concerts ? If not—

ORDER NOW

Complete 2-Valve Installation with Aerial, etc.
£15 15 0 (no ex.ras)

IMMEDIATE DELIVERY.

Complete 1-Valve Receiving Set with Aerial,
etc. (no extras) £12 12 0

Complete Portable Crystal Set, with Aerial,
etc. (no extras) £5 0 0

Complete Set of Parts to construct your own
Crystal Set £1 15 0 (Full instructions)

The Ideal Loud Speaker, 2000 ohms £3 0 0

H.T. Batteries, Fully Guaranteed - 15-volt, with
Terminals, 3/3 ; 36-volt, with Plug Sockets, 7/-;
63-volt, with Plug Sockets, 12/6.

Aerials Fitted at Minimum Cost.

Demonstrations Daily at our Showroom.

J. MACINTYRE & CO.
PREMIER HOUSE,
150 Southampton Row, London, W.C.1

THOR
Condenser
Readers
Kindly Note

IT!

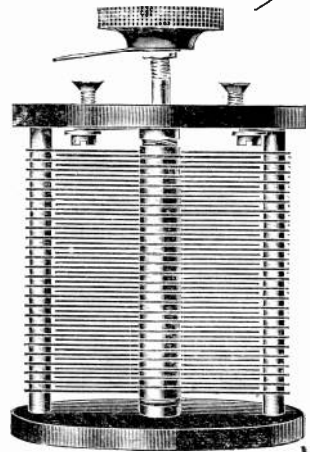

As so many well-known
manufacturers are incor-
porating our high-class
Condensers with their
complete wireless sets, we
shall forthwith discon-
tinue stamping the trade-
name “Thor” upon our
products.

This in no way affects
the sale of the famous
Ashdown goods, but to
avoid disappointment
look for the Ashdown
label—your guarantee of
the very highest class
workmanship. Our illus-
tration is guaranteed an
exact reproduction of
Condenser.

H. E. Ashdown (Birmingham Ltd.)
Perry Barr - - Birmingham
Telegrams : “Segment,” Telephone : Northern 859.

North Wales Wireless College & Amateur Supplies

COLWYN BAY. Phone 407.

Most Complete Stock of all Wireless Instruments and Accessories.
PROMPT DELIVERIES.

Students prepared under ideal conditions as Wireless and Cable Operators.
POSTAL AND RESIDENTIAL TUITION.
SPECIAL POSTAL COURSE FOR AMATEURS.
PROSPECTUS POST FREE.

LIST BY RETURN. 1½d. STAMP.

I HAVE IN STOCK
5000 BROWN'S
PAIRS (120 ohms) "A" PHONES
NEW AND UNISSUED

POST FREE **40/-** PER PAIR
CASH WITH ORDER

WILKINSON, Lonsdale Rd., Kilburn,
TRADE SUPPLIED (Same address since 1900) N.W.6



**TUBE, SHEET,
WIRE, STRIP,
ROD & CASTINGS**
IN
**PHOSPHOR BRONZE,
COPPER, BRASS, &c., &c.**

**CHARLES CLIFFORD & SON, LTD.,
BIRMINGHAM.**

LISTEN - IN — on the
A complete Installation at a low cost
"AEROWAVE" RECEIVER

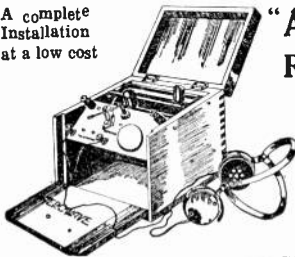

Price
£6 : 6 : 0
with complete Equipment

HENRY J. BREWSTER & CO.
11, Queen Victoria Street, LONDON, E.C.4

F. WIGGINS & SONS

MICA Telephone :
Avenue 2248
Largest Stock in the World.

**FOR CONDENSERS
AND ALL PURPOSES.**

102, 103 & 104, Minories, London, E.1

Halley Single Valve Receiver, will receive telephony C.W. and spark	50/-
Halley 2-valve Receiver, gives excellent results on telephony	£4/4
Low Frequency Transformers	16/6
Valve Sockets	1/6
Ebonite Knobs	8d.
Gridleak Condensers	2/6
2 Megohm Leaks	3/-
Set of 7 Slab Coils, 300 to 10,000 metres	7/6
Lead-in Insulators	2/6
Egg Insulators	6d.
Pillar Insulators	9d.
Filament Resistances	3/6

Send now for our New List of Bargains.

A. & J. THOMPSON,
5, Westborough, Scarborough

AWAY AHEAD!

Some firms pride themselves on being up-to-date. We go one better and claim that we are "AWAY-AHEAD."

Send two stamps to-day for our lists of Wireless Sundries and prove this for yourself.

ELECTRICAL SUPPLY STORES
5, ALBERT TERRACE, KING CROSS
HALIFAX, ENG.

BROADCAST CRYSTAL SET 27/6

On mahogany base, single slide tuning inductance, range 150 to 2750 metres, Fixed Condenser, Crystal Detector, Terminals. Post Free. Paris and Concerts are quite easily received on this set.
"PHONES, HIGH RESISTANCE, GUARANTEED, 25/- POST FREE.

I. K. STEVENS & Co. Wireless Section, 32a, Chester St., Grosvenor Place, S.W.1
Trade Inquiries Invited. Phone—Victoria 5837

RADIO INSULATION

AS SPECIFIED AND USED BY THE BRITISH ADMIRALTY

BRITISH MADE **PAXOLIN** BRITISH MADE

TUBES DISCS PLATES, &c.

MANUFACTURED IN ALL FORMS, SIZES AND THICKNESSES

BY

THE MICANITE & INSULATORS Co. LTD.

EMPIRE WORKS

WALTHAMSTOW

LONDON, E.17

TELEGRAMS :—"MYTILITE, PHONE, LONDON." TELEPHONES :—"WALTHAMSTOW 738, 739"

As quick as Writing

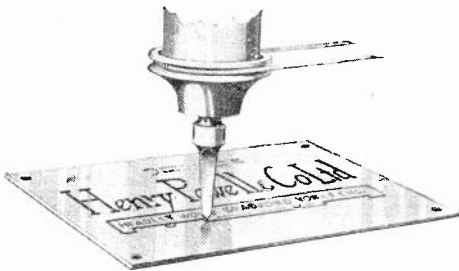

Cutter at work.

The Taylor-Hobson Engraving Machine reduces engraving to a speedy mechanical process.

It does high-class work, either sunk or in relief, on hard or soft surfaces at a fraction of the old cost.

It is used all over the world for work on metals.

We have just issued a New Catalogue. Send for it.

TAYLOR, TAYLOR & HOBSON, LTD.

74a, Newman Street, London, W.1

Works: LEICESTER.



**VERNIER
ADJUSTMENT
FOR SLIDERS**

Complete with 13 in. bar.
Bar and Slider - **4/6**

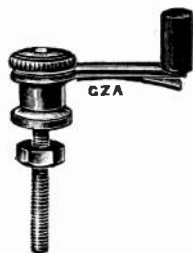

**Neat "ON" and
"OFF" Switches**

As illustrated - - - **2/3**

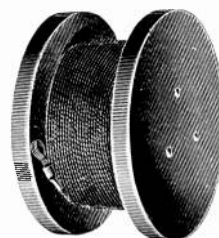

AERIAL WIRE

7/22 Enamelled Stranded.
100 ft. - - - **6/-**
150 ft. - - - **9/-**

**TELEPHONE
TRANSFORMERS**

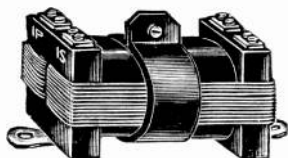

Unmounted (as illustration),
Suitable for 120 w Phones.

Unmounted - - - - - **15/-**
In Box with Terminals - - **18/6**



CONDENSER SCALES

Engraved 0-180°

With Knob and Bush - - - **3/9**

**SINGLE LAYER
COILS**

4½ in. diam. 9 in. long.
Wound with 24 Enamel.

Price - **6/6**

Visit our Stand No. **46**. All-British Wireless Exhibition, Horticultural Hall, Sept. 30th to Oct. 7th.

G. Z. AUCKLAND & SON, 395, St. John Street, E.C.1
'Phone - - - **3173 CLERKENWELL**

The Universal Tuner

The Universal Concert Tuner is the smallest, cheapest and most efficient tuner on the market for the reception of the Dutch Concert and Marconi Broadcasting.

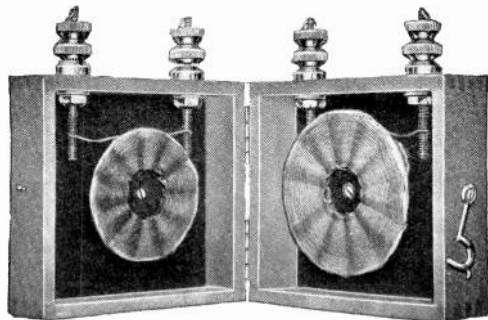

In light polished wood case, fitted highly lacquered brass terminals and fastenings catch, with 2 coils as illustrated. Size 4" x 3½" x 1½"

Complete with full instructions.

secure one of these Tuners to-day. You will be perfectly delighted.

PRICE

7s. 6d.

POST FREE

J. LIPOWSKY Electrical and Wireless Engineer
614, OLD FORD ROAD, BOW, LONDON, E.3
Telephone: East 3345

BUTLER'S RELIABLE MANUFACTURES

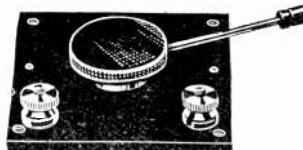

Vernier Condenser suitable for fine tuning on inductance or placing across primary of H.F. transformer. Best workmanship throughout **6/-, postage 6d.**



Lightning Arrester mounted on ebonite panel, varying adjustment **2/6**
postage 3d



Best quality Laminated Switch complete . . . **3/-**
postage 3d.

Terms cash with order. Fully illustrated list post free 4d.

H. D. BUTLER & CO., LTD
Office & Showrooms:
Bank Buildings, 222, Gt. Dover Street, Borough, S.E.1
Telephone: Hop 3029. Works: Canonbury, London, N.1.
Works North 1838. Telephone: "Ingenuity Phone, London."

Intervalve Transformer

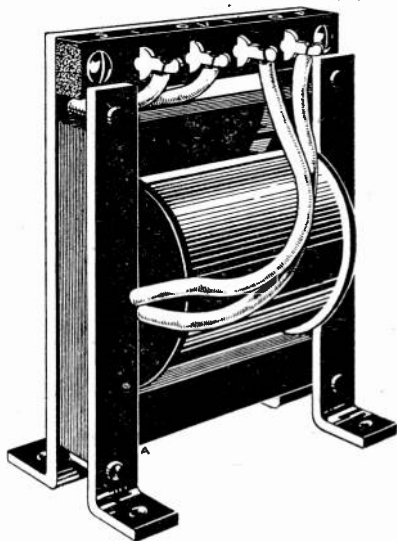

30/- each

After exhaustive experiments we are now able to offer immediate delivery of Intervalve Transformers as illustrated above, designed specially for the reception of perfect speech and music.

DIMENSIONS

Height 3½". Width 24". Dimension over feet 2"

TELEPHONE TRANSFORMERS

Similar in design to our Intervalve Transformer.

Price 22/6 each
OTHER SPECIALITIES

Filament Resistances, 5/9 each. Variable Condensers complete with dial and Knob, '001 mfd., 25/- each, Dubilier Condensers, '001 8/- each, '01 7/6 each, Duolateral Coils, prices on application, Clifton Accumulators, 6 volt 40 amps. £2 : 2 : 0, Bobbin Insulators 4/- per dozen, Brown's Loud Speakers, small size 120 ohms, £3 : 0 : 0 each, Brown's Telephones 120 ohms, £2 : 8 : 0 per pair.

Terms of Business.

Cash with Order.
Orders over value £5 carriage paid.
Orders executed in strict rotation.
Trade terms on application.



The Manchester Radio Co., Ltd.

F. H. McCREA, Managing Director.
W. R. BURNE, Director of Experimental Dept.
(Winner of Transatlantic Test.)

155, OXFORD ROAD

(Entrance Boundary Street East)

MANCHESTER

Telephone: Central 4935.

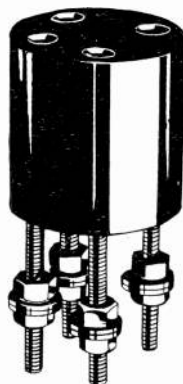

A NEW DESIGN of VALVE SOCKET

This new valve socket has several interesting features :

1. It is designed without any shoulder, to take up the absolute minimum of space.
2. It has long pins to accommodate any thickness of panel.
3. It is provided with two nuts and washers on each stem. This eliminates soldering, and makes connecting up easy, quick and certain.
4. It is brilliantly finished. No better finish is possible.
5. By a special process of manufacture the socket holes are perfectly clear and free from any moulding material so that perfect contact on the valve stem is assured.
6. It can be fixed firmly by a single cheese head screw or alternatively by one nut on each contact stem.
7. It is sold at the specially low price of

1/3 EACH

and will be sent

POST FREE FOR A SHORT PERIOD.

Trade Enquiries Invited.

**LARGE STOCKS HELD
AT ALL DEPOTS**

Call and see the socket or fill in this Coupon and send to us at once.

Please send me.....of your new design valve sockets for which I enclose.....at the rate of 1/3 each, post free.

Radio Communication Co., Ltd.

LONDON—Head Office: 34-35, Norfolk Street, W.C.2
(Telephone: Central 1021, 3005)

GLASGOW - - - - - 10, Blythswood Square,
NEWCASTLE-ON-TYNE 17 Sandhill
LIVERPOOL - - - - - 67, Dale Street.
CARDIFF - - - - - Atlas Chambers, James Street.

Visit our Stand No. 23. All British Wireless Exhibition, Horticultural Hall, September 30th to October 7th.

LESLIE McMICHAEL LTD.

PROVIDENCE PLACE, WEST END LANE, KILBURN, N.W.6

Bus Services 1, 8, 16, 28, 31 all pass West End Lane

Telephone: HAMPSTEAD 1261 Nearest Tube Station: KILBURN PARK (BAKERLOO)



To get the best from your set use the best phones: BROWN'S

The GUARANTEE of Messrs. S. G. BROWN, Ltd.

Messrs. LESLIE McMICHAEL, Ltd., having purchased our entire stock of re-conditioned Telephones, we beg to state that these are the only ones which have been RE-CONDITIONED BY US, and are provided with aluminium diaphragms and carry OUR full guarantee.

These Type A (Reed type of telephones) are excellent in every way. They are recognised as the finest produced, and guaranteed in perfect condition.

BROWN'S

HIGH RESISTANCE	LOW RESISTANCE
8,000 ohms.	120 ohms.
Price 55/- Per Pair	Price 50/- Per Pair

There is no Telephone Headgear in the World so Sensitive and so Comfortable to Wear.

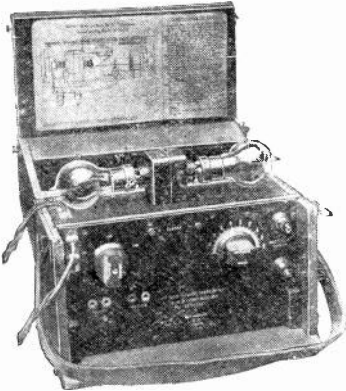

B. Mark II. Detector Amplifier Set. Price (less valves), £6 5 0. Price with Variable Condenser included, £7 5 0.



DUOLATERAL COILS

Complete with plug mountings

Number of turns	Minimum & Maximum Wavelengths in metres	Price
25	130—250	s. d. 5 6
35	180—450	5 9
50	250—700	6 6
75	400—1200	6 9
100	500—1600	7 0
150	600—1500	7 3
200	1000—3000	7 6

For higher wavelengths see full list in our Illustrated Catalogue (W)

DUOLATERAL COILS always in stock. The most efficient method of tuning and the cheapest. All sizes in stock.

LOUD SPEAKERS
(Low Resistance)
20" Horn. Exceptional Value.
Price 27/6

ILLUSTRATED CATALOGUE
16 Pages. 100 Illustrations.
Write for Catalogue (W)
6d. post free.

Catalogue (W) includes list of Complete Crystal and Valve Sets from 95/- post paid.

TO THE TRADE
Excellent selection and full stock for supplying trade. Advice and assistance in choice freely given if desired.

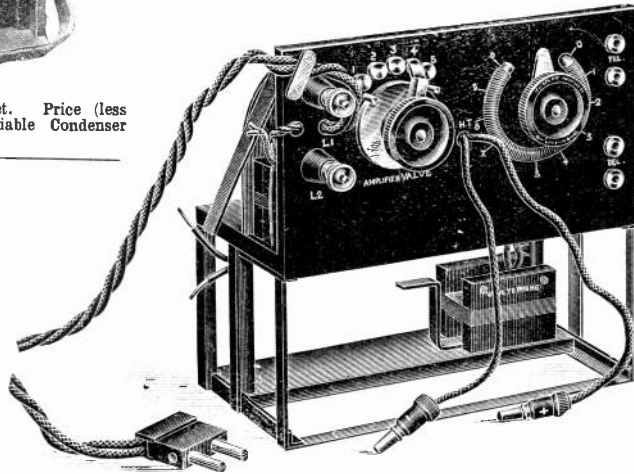

3-Valve L.F. C Mark III (without valve), condition perfect. Price £7 10 0

Visit our Stand No. 38. All-British Wireless Exhibition, Horticultural Hall, September 30th to October 7th.

THE WIRELESS WORLD EXCHANGE AND MART

TARIFF. Advertisements are accepted for this Section at the rate of twopence per word, with a minimum charge of two shillings. The advertiser's name and address will be charged for, and single letters and single figures will be counted as words. Compound words will be counted as two words.

DEPOSITS. All advertisements must be prepaid in the form of Postal Orders, the remittance being forwarded to Messrs. Bertram Day & Co., Ltd., 9 & 10, Charing Cross, S.W.1.

Intending purchasers may deposit the purchase money of any article advertised or sold by advertisers with Messrs. Bertram Day & Co., Ltd., who will acknowledge its receipt to the vendor and the depositor, the full addresses of whom should be given. Subject to special agreement between the parties, it is understood that all goods are sent on approval, each party paying carriage one way in the event of the goods being returned. The deposit will be retained until due advice of the completion of the purchase has been given or until the articles have been retained and accepted. In order to cover postage, etc., a fee of 6d. in respect of sums of £1 and under and 1s. for sums in excess of £1. must be paid at the same time as the deposit. For persons not resident in the United Kingdom these fees are doubled. We cannot undertake to receive any deposit less than 2s. 6d.

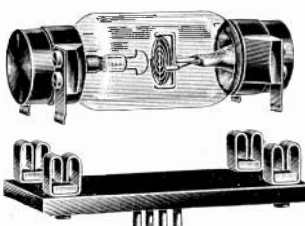

TRADE Grelco MARK

RELIABLE **No NOISES**

A.E.G. **SIEMENS HALSKE**

Valves for Radio Reception. Excellent for Rectifying and Amplifying. Best make and finish. Can easily be adapted to fit the Standard Holder. Fil. Current, 3-4 volts, Plate 60-80 .. Price 10/6 each
Adapter as shown .. Price 3/- each

WHY NOT GIVE THEM A TRIAL

Perikon Detectors, mounted on ebonite, complete .. Price 4/- each
Egg Insulators (Best) .. 6d. each
Intervalve Transformers .. 21/- each
Postage Extra.

The above are just a few items from the large stock we hold at our Show-rooms. You are invited to inspect. Catalogue now in preparation.

FOR SALE.

High Tension Batteries.—Fully Guaranteed Long life 15-Volt 11 cell. Not "Surplus" stock 2s. 11d. post free. For three, 7s. 6d., post free. Orders in strict rotation.—LITCHFIELD & Co., Wireless Specialists, 12, Great Castle Street, London, W.1.

Loud Speaker, mounted on polished mahogany base, 4,000 ohms, 24" horn, perfect order, 35s. First P.O. secures.—"T," 16, Lordship Park, London, N.16.

Fine Tesla Coil, as new (photo on request), Q Valve; Ora Valve (new), rotary magnetic reaction coil, etc., cheap.—Write GODDARD, jnr., 20, Westminster Mansions, Westminster, S.W.

Wireless Masts.—Thirty-two ft. mast, with six guy wires, Steel sleeve, Iron cap and ring, Pulley, Cleat, 100 ft. 7/22 enamelled copper aerial, Six porcelain insulators, Fifty-four ft. hemp rope, Carriage paid England, 40s.—BARKER, 61, Arthur Street, Derby.

Marconi Receiver, Type M.15., amplifying detector and tuner with V24 Valve, Nearly new. £14.—FREAKLEY, 36, Sherwood Street, Wolverhampton.

4,000 Ohm Headphones, new and guaranteed, 35s.—G. D. HINKS, Hardington, Yeovil.

Mark III Star Tuner, complete, as new, £10 or near offer.—ALEXANDER, 77, Lordship Road, N.

One-Valve Panel with Tuner, two condensers with coils for broadcasting and others for 1,000 metres. Price £6. Apply between 6 and 7, RICE, 213, Kensal Road, N. Kensington, W.10.

Marconi 5-Valve Receiver, complete with valves, as new, wonderful machine, guaranteed perfect, price £26.—HITCHCOCK, Sussex Lodge, Colchester.

Everything for Wireless.—Condenser plates, terminals, spacers, valve legs, studs, nuts. Cheapest in London. Trade invited.—WELL-LITE Co., 42, St. Martin's Lane (nr. Coliseum), W.C.

"D.C." Motors.—110 volt, ½ h.p.; 220 volt, ½ h.p.; 110 volt, ¼ h.p.; 250 volt, ¼ h.p.; 75 volt, ¼ h.p.; 65 volt, ¼ h.p. A.C. Motors.—220 volt, 50 periods, ½ h.p. brush; 100 volt, 50 periods, ½ h.p. rotor. All in good working order, cheap, to clear.—KEITH PROWSE & Co., LTD., 38, Berners Street, London, W.1.

Condenser Vanes.—Aluminium, 20 G., fixed or movable, 7d. dozen, 6s. gross. Spacer Washers, large 4½d. dozen, 4/- gross; small 2½d. dozen, 2/- gross. Postage extra.—R. DOUGHTY & SON, Cooke Street, Wolverhampton.

Superior Loose Coupled Crystal Receiver, highest quality workmanship throughout, £8. Particulars—W. HANSFORD, Poole.

Complete Three-Valve Station. Twelve guineas. Excellent results.—ROGERS, 23, South Road, Reigate.

Brown's Loud Speaker, new, 120 ohms, 47s. 6d.—F., 28, Holmwood Gardens, Church End, Finchley.

Three-Valve Receiver Unit System.—Mahogany boxes, 4 plug-in transformers. Very efficient, £8.—KENDRICK, Tasker Street, Walsall.

Ebonite Knobs, milled, polished, 4½d. each, 4s. dozen.—6, Peel Road, Woodford.

(1) Electric Motor, ½ h.p., alternating with starter, £14. (2) Handpress, best make, nearly new just the tool for wireless stampings, £5. (3) Gent's bicycle, brand new, 3-speed gear, £7 5s. (4) Mulard Valves from stock, "R" and "Ora" types. (5) Alternating to continuous crypto battery charger, 200/220 volts, 50 periods to 30 volts 15 amps, nearly new, £25.—THE "NEWTONIA" WIRELESS FACTORY, 13/15, Whitcomb Street, London, W.C.2, Regent 643 and 5469.

Wireless Instrument Cases, Walnut or Mahogany, finest finish, 12" by 7½" by 4" (outside), 8s. 6d. Second quality, 7s. 6d. Any size proportionately, prompt delivery. Trade inquiries invited.—HITCHCOCK, Colchester.

Two 24 H.P. Motor Generators, one 40' Mast Direction Finders, Drafting Instruments, etc., ex-Admiralty surplus. Half prices.—THE LONDON ELECTRIC FIRM, Croydon.

Wireless Masts.—Improved girder type, Light and strong, 30 to 50 ft. at 1s. ft., 50 to 100 ft. at 1s. 6d. ft. Cash with order, carriage forward.—F. ARMSTRONG, Weybridge.

Electradix Radios

Aerial Insulators.—You are having condensation leakage on your porcelain? Yes! Then use our R.A.F. type Ebonite Aerials with brass stem. Lightest and most efficient, 6d. each, 5/- per doz.

Earth.—You must have a good one and our Earth Clips at 6d. are the approved official pattern. An Earth Mat of copper mesh under the aerial is the most certain. Price with 10 cable .. 10/-

Potentiometers for Crystal or Grid. Small type for panels, 7/6. Condensers, variable and fixed, in all sizes Hundreds in stock. Marconi, Murdoch etc., lowest prices. Weston relays, Brand new, 42/-. Morse Inkers, S.H., 45/-. Aerial masts. Tubular, 15' with stays, etc., 10/6. McGruer Hollow, 40', £4 10s. Milliammeters, 30/-. Elliott Battery Testers, with ammeter to 3 amps., and Rheostat in case, 85/-.
Chatterton's Compound, 4 oz. stick, 1/-.
Panel Switches, Dewar Flush D.P. 2-way 12 contact, 3/6.
'Phone Plug and Jack, 1/6 per pair. Solo plug and socket, small, 9d. per pair. Five sockets mounted in engraved ebonite bar, and two solo plugs for H.T. Battery, 3/6.

Headset 'Phones. We carry a complete line of 'phone receivers from Sterling sets 2, 4 and 8,000 ohms, at 51/-, 52/-, and 59/-. Sullivans 8,000 ohms, 35/-. T.M.C., 2 and 4,000 ohms, 32/6. French 'Phones, 2,000 ohms, 27/6. L.R. 'Phones, 141-. Sullivan's 120 ohms, with Brown's Headbands, 14/-. Single Receiver strap headband, 4/6. All our 'phones are fitted with good cords.

Transformers.—We have had years of experience with all types, and ours have the max. efficiency possible. Immediate delivery of Intervalve, at 20/-. Valve to 'Phone, 15/- Mounted in mahogany case, ebonite top, 20/- 80 ohm Rheostats, 5/-.

Wavemeters. Heterodyne, £3 10s. Short-wave, 30/-.

Tuners 120 m. to 1,000 m., £3. Three coil Table Stand, 20/-.

Receivers. New Marconi, 50 D.C. sets with Variable Condensers, etc. Sloping panel, fitted one or two valve holders and crystal. Mahogany case. Bargain, £5 10s.

Charging Sets.—3½ K.W. Douglas, £40. 1, 2 and 2½ K.W. Lyon and Wrench, £38 Motor Generator to give 20 volts 12 amp. D.C. £18 H.T. 500 Watt sets for Valve transmission, 500 to 1,000 volts, £16 Tate Dynamos and Motors, all sizes. Cables and wires, all coverings at low prices. We have three large floors full of new and ex-Government apparatus, and welcome inspection by genuine customers.

LESLE DIXON & CO.,
The handiest depot in the City. Nr. Aldgate Station, Metropolitan Railway, 9, Colonial Avenue, Minories, E.1.



LESLE DIXON & CO.,
The handiest depot in the City. Nr. Aldgate Station, Metropolitan Railway, 9, Colonial Avenue, Minories, E.1.

THE WIRELESS WORLD EXCHANGE AND MART

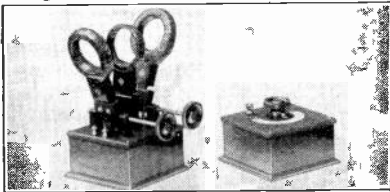

COIL HOLDER, as illustrated.
BEST GRADE Ebonite Mahogany Case, Price 21/-
CONDENSERS, Best Grade, Ebonite Mahogany
 Case. Satisfaction Guaranteed or money returned
 "Nominally, '0003 17/6
 " " " " '0005 22/6
 " " " " '001 27/6
AERIAL WIRE, 7/22 Copper, 100' 4/6
INSULATORS, 3d. each. Ebonite Knobs, 6d. each.
IVORINE SCALES, 9d. each. Contact Switches,
 1/6 each.
SPECIAL QUOTATIONS TRADE.
 Cash with order. Postage Extra.
M.R.E., Wireless Supplies, 29, High Street,
CLAPHAM, S.W.4 Telephone: Brixton 1925.

WE CAN SUPPLY FROM STOCK
 CONDENSER VANES.
 TERMINALS.
 CONTACT STUDS.
 SPACERS SPINDLES.
 VARIABLE CONDENSERS.
 DETECTORS.
 POINTERS.
 LAMINATIONS, ETC.
 WRITE FOR LIST.
 Also Spinnings, Stampings and Press Tools
 made to specifications.
THE GLENFIELD ENGINEERING
CO., LTD.
 225, Pentonville Rd., London, N.1
 Telephone: Holborn 4714.

GLASGOW WIRELESS
SUPPLY CENTRE
 ALL MATERIALS AND ACCESSORIES FOR
 AMATEURS. PANELS ENGRAVED.
 PARTS MADE UP TO CUSTOMERS' OWN
 DESIGNS. CALL OR WRITE FOR PRICE
 LIST, ENCLOSING STAMP.
W. & J. JAMIESON, LTD.,
 68, Shamrock Street, W. Glasgow.

Send us your enquiries for
BOXES, CABINETS,
SPREADERS, CONDENSERS
 and parts, LEAD-IN-TUBES,
 and all accessories,
 to the Trade.
COMPETITIVE PRICES
PROMPT DELIVERIES
The Central Aircraft Co.
 179 High Rd., Kilburn, N.W.6
 Phone—Hampstead 4403-4 8018.

THOMPSON'S SURPLUS DEPOT

CRYSTALS. CRYSTALS. CRYSTALS.
 Having purchased 3 1/2 ton of Crystals and Woods
 Metal at recent Government sale, we can do same,
 ridiculously cheap.

Carborundum.—The very best, uncut, per
 lb. 10/-
 Price per gross, crystals 9/-
Specially Selected Crystals, per doz. 2/6
Chalcopyrite.—This was used in great
 majority of Government sets, in
 combination with zincite. Price for uncut
 crystals, per lb. 8/-
 Cut crystals, per gross 7/-
Specially Selected, per doz. 2/-
Zincite.—Uncut crystals, per lb. 80/-
 Price per gross, crystals 35/-
Specially Selected, each 6d.
Copper Pyrites, in use with zincite. Price
 per lb., uncut 7/-
 Price per gross, crystals 6/-
Specially Selected, per doz. 2/-

We can quote for any crystals and give a huge
 discount to the trade for such low prices.
 Below—

Woods Metal.—The very best as used by the
 Government. Price in 10lb. lots 70/-
 Price per lb. 8/-
 Price packed in 1/- size sticks, for 60 sticks
 16/-

Mica.—The best Ruby Mica, .002, .003 thick,
 for building condensers, etc. Price per
 gross sheets, 4 1/2 x 3 1/2, per gross 20/-
 Price per dozen sheets 2/6

1 1/2" Spark Wireless Coils, all fittings mounted
 on ebonite. Beautiful coils, costing £4 each,
 our price 10/6 each, Post 1/-.

1" Sterling Spark Cells. Brand new and tested,
 perfect as used in W/D 44 Transmitting sets,
 Price 8/6 each. Post 1/-.

Telephone Ten-line Switchboards, containing
 30 Dewar Switches, 10 indicators 1,000 ohms
 Telephone Magneto, Telephone Transformer and
 other innumerable parts. These sets
 cost £50 each, absolute sacrifice at £3 each.

Dewar Ivory Handle Switches. Most valuable
 to wireless amateurs. Can be used on most
 circuits, 2/- each.

Telephone Magnetos, Brand new, 6/- each.
 Telephone Magnetos converted to dynamos,
 output, 6 volts 2 amps, 9/6 each.

Headphones, G.P.O. brand new, 150 ohms,
 suitable for telephony and wireless concerts,
 without transformer, 12/6 a pair.

Brown's Brand New 750 ohms each ear-piece,
 adjustable, 35/- pair.

Sullivan's, Brand New, 4,000 ohms, 35/- pair.

Accumulators.—Now is your chance for a good
 thing. Have a battery to last you weeks
 on one charge—

2-Volt, chloride, 100 actual amp. hrs. each 12/6
 4-Volt, chloride, 100 actual amp. hrs., each 24/-
 6-Volt, Chloride, 100 actual amp. hrs., each 32/-
 2-Volt, Chloride, 50 amp. actual hrs., each 9/-
 4-Volt, Chloride, 50 amp. actual, each . . . 17/6
 6-Volt, chloride, 50 amp. actual, each . . . 25/-
 2-Volt, 30 amps, chloride, each 6/-
 4-Volt 30 amps, chloride, each 12/-
 6-Volt 30 amps, chloride, each 16/-

For other lists and trade discount kindly write—

T. W. THOMPSON & Co.
 Government Surplus Department,
 39, London Street, Greenwich, S.E. 10.

F. E. BOYNTON
 Electrical and Scientific Instrument Maker,
 Wireless Component parts a speciality.
 Condenser Vanes, Spacing Washers, Screwed
 Rods, Two and three coil holders. Ebonite
 plugs for coils. The actual Manufacturer,
 send us your enquiries.
WORKS, 391, ST. JOHN STREET, E.C.1.

JOLLY & SON
 13 Myddelton St., Clerkenwell, E.C.1
 Press Tool Makers and Metal Stampers.
 Vanes, Terminals, Valve Legs, Studs, Panels
 Switch Arms, Condensers, complete sets
 of parts. Enquiries invited.

TO THE TRADE
 The firm of **ASTON & MANDER** was estab-
 lished 1789 and have been making scientific
 Instruments for over 133 years.
 We are now making all forms of **WIRELESS**
ACCESSORIES AND PARTS. Can we quote
 you for your Designs & Apparatus in **METAL,**
WOOD, EBONITE etc. ?
ASTON & MANDER (1917) LTD.
ALBANY WORKS, WILLESDEN, N.W.10.

THE POLYTECHNIC, 309, REGENT ST., W.1
RADIO-BROADCASTING
 Evening Courses in Elementary and Advanced
 "Wireless" by expert Engineers commence on
 25th September. Enrolments begin September
 13th. Accommodation in the Classes is
 limited. Particulars free on application to the
 Director of Education.

AGENTS WANTED
FOR THE PROVINCES.
 Write stating territory you guarantee
 to cover, mention best publication
 for your advertising, send references
 and apply by letter only *Agents Dept.*



Wireless Equipment, Ltd.
 90 CHARING CROSS ROAD,
 LONDON, W.C.2

For Wireless Cabinets
 SEND TO
J. A. JONES & CO., LTD.,
 CABINET CASE MAKERS,
 Progress Works, Park Road,
 Aston, BIRMINGHAM.
 *Phone—EAST 234

THE WIRELESS WORLD EXCHANGE AND MART

Your Case Work

Let us quote you for your wireless casework. We are specialists in this class of work and feel sure our workmanship and prices will interest you.

Phone: L.W. 2720.

CARRINGTON & NEWBERY LTD.,
18/20, Normans Buildings, Old Street, E.C.

THE UNIQUE N.M.C. (Wireless Patents)
Two-valve Receiving Unit, combining Filament Resistance, Aerial, Tuning Inductance, Aerial Tuning Condenser, Grid Tuning Inductance and Oscillating Condenser, complete in polished case, 12" x 6" x 6", 26 6s. less Valves.
The Set to obtain maximum efficiency. N.M.C. 4,000 W. Double Head Gear, 35/- Inductance Tubes.

All Experimenters' Supplies in Stock.
N. M. Co., 145, Northhoote Road,
Trade Supplied. London, S.W.11.

L.F. INTERVALVE TRANSFORMERS.

18/- Post Free.

Radio 5-1 Fitted with soldering tags & aluminium feet for fixing. Guaranteed STALLOY iron core and yoke. A very efficient component. Used in our own note-magnifiers.

SINGLE and TWO-NOTE MAGNIFIERS

£2 7s. 6d. and £3 18s. 6d. Less valves.

Exceedingly neat and efficient instruments.
SENT ON APPROVAL AGAINST CASH PROMPT DELIVERY.

WOODMASON, COLCHESTER.

Aluminium

Condenser Vanes

We are open to quote low prices for the above to the trade. Wholesale only.

G. BROWN & Co. Berkley Street
STAMPERS & PIERCERS Birmingham

RESULTS

Whether as a source of practical information for the Amateur or as a valuable medium for every Advertiser, the **best results** are invariably obtained through the **"Wireless World"**

For full particulars and advertising rates apply to **BERTRAM DAY & CO., LTD.**
Complete Advertising Service,
9 and 10 CHARING CROSS, S.W.1

FOR SALE—continued.

Telephone Transformers and Condensers, complete units, four terminals, 7s. 6d. each, postage 9d.—OSTICK BROTHERS, Long Eaton, Notts.

All Wireless and Electrical Goods stocked at 9, Colonial Avenue, Minorics, near Aldgate Station. Handiest place for City buyers.—LESLIE DIXON & Co. Telephone No. Avenue 4166.

Wireless Batteries.—16-Volt units; superior to any other, the result of 10 years scientific research. Only 3s. 6d. each, postage extra.—CLEMENTS, 50, Noel Street, London, N.1.

Contracts Wanted for the manufacture of component parts of wireless receiving sets.—Write, GOSWELL ENGINEERING CO., LTD., 12A, Pentonville Road, N.1.

Townsend Wavemeter R.A.F., Calibrated, range 300 to 4,000.—RADIO, 29, Argyle Street, Birkenhead.

SITUATIONS WANTED.

Ex-Naval Wireless Petty Officer, 27, desires position in wireless firm. Experienced in "Spark," "Poulsen Arc," "Valve" transmitters, "Crystal" "Valve" receivers, Experimental department preferred.—SPARKS, 81, Cowley Road, Brixton, S.W.9.

Wireless Man, First Class P.M.G., four years in charge of stations. Practical experience with internal combustion engines, desires engagement.—Apply Box R.3, BERTRAM DAY'S ADVERTISING OFFICES, 9 and 10, Charing Cross, S.W.1.

Enthusiastic Wireless Operator, age 22, three years' experience, seeks position as salesman or demonstrator, etc. First Class Certificate, good technical knowledge, excellent references, South England preferred.—"ALLOA," Bungalow Estate, Swanage.

SITUATIONS VACANT.

WIRELESS

An Important Firm of the City of London requires the services of a young energetic man to start and manage a Wireless Department. Permanent post and rising salary.—BOX A.4, BERTRAM DAY'S ADVERTISING OFFICES, 9 and 10, CHARING CROSS, S.W.1.

WANTED TO PURCHASE.

Wanted, Hand or Manually-driven Generator for wireless transmission. Send detailed particulars to Box V.3, BERTRAM DAY'S ADVERTISING OFFICES, 9 and 10, Charing Cross, S.W.1.

BOOKS.

Radio Chart.—"Care and Maintenance of Accumulators," 1s. Post free.—Publishing Branch, G. D. HINKS, Hardington, Yeovil.

Radio Magazines, all the latest. "Radio World," 104d.; "Popular Radio," 104d.; "Radio Broadcast," 1s. 6d.; "Radio News," 1s. 6d.; "Science and Invention," 1s. 9d.; "Scientific American," 2s. 6d. Post Free.—INTERNATIONAL NEWS COMPANY, LTD., 15, Bream's Buildings, London, E.C.4.

TRADE ENQUIRIES.

Old Established Firm requires agencies for first-class instruments or best trade terms.—MACE BROS., Birmingham.

Wireless Dealers are advised to stock parts for making radio apparatus, as so many amateurs prefer to make their own instruments. There is also the additional profit in making your own sets from stock parts. Raw materials and partly machined parts can be had direct from the factory at the right price.—THE "NEWTONIA" WIRELESS FACTORY, 13, 15, Whitcomb Street, London, W.C.2. Regent 643 and 5460.

Advertisers Request Quotations from manufacturers for all parts used in construction of wireless instruments, also condenser scales, knobs rheostats, switches, etc.—TEXALO MANUFACTURING Co., South Shore, Blackpool.

IMPORTANT NOTICE

THIS FIRM WAS ESTABLISHED BEFORE THE WIRELESS BOOM COMMENCED, THE PRINCIPAL HAS SPENT OVER 12 MONTHS STUDYING THE AMATEURS' REQUIREMENTS.

Aerial Wire, 100', 7/22 bare copper	5/6
Aerial Wire, 140', 12/22 enamelled copper	13/6
Reel Insulators	each 6d.
Ebonite Knobs	each 6d.
Valve Holders	each 1/6
4 BA Double Terminals	per doz. 3/6

Delivery from Stock.

CASH WITH ORDER. POSTAGE EXTRA.

These are just a few selections from my new Illustrated Price List. "Retail Prices DOWN, Trade Discounts UP, Quality THE BEST," is the standard maintained throughout.

LIST STOP FREE, 4d. Enclosed 1/- for RADIO CHART NO. 1, "Care and Maintenance of Accumulators."

G. D. HINKS, WIRELESS DEPARTMENT,
HARDINGTON, YEOVIL.

HEATH & Co., Ltd.

Instrument Works, New Eltham, S.E.9 are prepared to undertake in their fully equipped works—Wireless Apparatus and Parts for the trade. Quotations given to Blue Prints. Immediate attention.
Phone—Lee Green 301. Wire—Polaris, London.

I Buy Wireless Gear of every description.

Send your particulars to:

WILKINSON,
Lonsdale Rd., Kilburn, N.W.6
SAME ADDRESS SINCE 1900.

HIGH GRADE CONDENSERS

In Polished Oak Cases, Ebonite Moving Dials, .0015, 4s/-; .001, 40/-; .0005, 35/-, Immediate delivery. Postage extra. Write for List.

THORNTON & VOWLES,
WIRELESS SPECIALISTS,
BEAST MARKET HILL,
NOTTINGHAM.

PARTNERSHIP.

Partnership.—An excellent opportunity occurs for a young man not under 22, experienced in the designing and manufacturing of wireless parts to take up a financial interest and take charge of a Wireless Depot and Factory. He must have had a technical education, previous commercial experience and be resident within six miles Charing Cross.—Apply Box W.2, BERTRAM DAY'S ADVERTISING OFFICES, 9 and 10, Charing Cross, S.W.1.

For they are jolly good Fellows

THE
“FELLOCRYST”

(Registered)

WIRELESS
CRYSTAL RECEIVING SET
 BRITISH THROUGHOUT

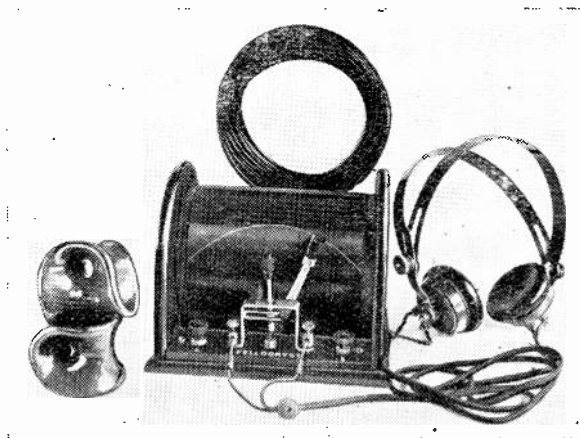

COMPLETE (as illustrated) £3 7 6
 with one pair of double headphones. *Postage 1/6*
NO BATTERIES REQUIRED

The set comprises tuning coil with a wavelength of approx. 300 to 1500 metres; Silicon Crystal Detector; 4000 ohms Double Headphones; 100 ft. Coil of 7/22 Stranded Copper Wire; 2 Shell Insulators, Terminals, etc.

Each set tested and guaranteed to receive broadcasting within a range of 15 to 20 miles, and morse signals from a much longer range.

Extra Headphones, complete 30/- per pair.

POSTAGE 1/-

FELLOWS MAGNETO CO., LTD.

Telephone:
 Willesden 1560-1.

LONDON, N.W.10.

Telegrams:
 Quixmag. Phone, London.

Visit our Stand No. 10.

*All-British Wireless Exhibition, Horticultural Hall,
 Sept. 30th to Oct. 7th.*



Price : 8/6 each

Price : 8/6 each

Code word, "WIRIT." 36 volts. Size, 6 $\frac{1}{2}$ x 2 $\frac{1}{4}$ x 3.

**GENUINE HELLESEN
DRY
BATTERIES
FOR WIRELESS HIGH TENSION**

SPECIAL TRADE AND WHOLESALE TERMS

Code word.	Volts.	Details.	Price.
"WIRON"	15	Screw terminals	4/- each
"WIRTO"	15	Strip "	4/- "
"WIRIT"	36	2 insulated wander plugs	8/6 "
"WIRIN"	60	" "	14/- "

**KNOWN THE WORLD OVER AS
THE BEST.**

ALL LISTS FREE ON APPLICATION.

A. H. HUNT, LTD.
H.A.H. Works, Tunstall Rd., Croydon, Surrey.

W. & M. VARIABLE CONDENSERS

Made as a Scientific Instrument by High Class Instrument Makers. All sizes in course of production. '0005 Mfd. Now Ready. 18/6 each. Securely packed. Ready for immediate use. State whether required for Panel Mounting or as a separate Unit. Send for General Price List of W & M Apparatus and Supplies. Post free.

We sell on the distinct understanding that if the buyer is in any degree dissatisfied with his purchase, he can return same within 24 hours and money will be immediately refunded.

FREE ADVICE TO BUYERS.

All our apparatus is produced under the personal supervision of our Technical Director, Mr. Henry A. Machen, A.M.I.E.E. (late of Siemens Bros. & Co., Ltd.), whose experience in the design and manufacture of Wireless Apparatus extends over a period of 15 years.

If you have any difficulty in obtaining W. & M. Wireless Supplies, write to us, giving the name of your dealer.

NOTICE TO THE TRADE.

We are prepared to appoint District Agents for the sale of W. & M. Wireless Supplies and to refer all postal orders and enquiries to such appointed Agents.

Terms and Discounts on application.

Manufactured solely by—

The Wainwright Manufacturing Co., Ltd.
25, VICTORIA STREET, S.W. 1.
WORKS: WALTHAMSTOW, Essex & BIRMINGHAM.
Telegrams: Nominatus Vic London. Telephone: Victoria 4319.

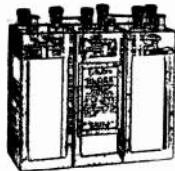

Important Announcement to the Trade

LIVE AGENTS WANTED IMMEDIATELY IN ALL PARTS OF THE COUNTRY TO STOCK

FULLER BLOCK ACCUMULATORS FOR WIRELESS PURPOSES.

There is an unprecedented opportunity for the retailer to build up a wide connection amongst wireless enthusiasts by supplying a really efficient Accumulator, one that is fool-proof, an important factor when the same is to be used by the Amateur.

Don't run the risk of making a dissatisfied customer by supplying a plate-type battery, which will not hold its charge when not in use. The E.M.F. of the "Block" cell will not fall below 2 volts even if left unattended for a period of 12 to 18 months.

We are about to establish reliable

ACCUMULATOR CHARGING STATIONS throughout the country in readiness for the rush of business which is sure to follow as soon as the broadcasting scheme is launched.

If interested, please write to "AGENCY"

THE CITY ACCUMULATOR CO. (Dept. 86)
79, MARK LANE, E.C.3

Phone: Avenue 91 (3 Lines) Telegrams: Tyche, Fen. London

IMPORTANT NOTICE

OWING to the great expansion of our business in wireless literature we have been compelled to move into very much larger premises. We propose to continue devoting ourselves exclusively to the production of technical literature in which those interested in wireless can have the fullest confidence.

Our products are written by experts, edited by a special technical staff, and published by a firm whose business is solely connected with wireless.

Consider these facts.

Radio Press Ltd.

Publishers of Authoritative Wireless Literature.

New Address—

Devereux Bldgs., Devereux Ct., Strand, W.C.2

(Opposite Law Courts.)

BRITISH EBONITE TO GOVERNMENT SPECIFICATION FOR BRITISH WIRELESS.

MANUFACTURED BY:

THE BRITISH EBONITE CO., LTD.
 HANWELL LONDON, W.7

APPLY FOR LIST "W."

**SPECIAL QUALITY RODS, TUBES,
 and SHEETS FOR WIRELESS.
 ALL USUAL SIZES KEPT IN STOCK.**

TELEGRAMS: "Ebonitical, Han, London."
PHONE: Ealing 1489.

WHOLESALE ONLY.

SPEARS and COMPANY
 FOR

TERMINALS

SCREWS, NUTS, WASHERS, PLUGS and SOCKETS, CONTACT STUDS, BUSHES, VALVE LEGS, CONDENSER VANES and TURNED and PRESSED PARTS OF EVERY DESCRIPTION.

Actual Manufacturers to TRADE ONLY

WE REGRET WE CANNOT SUPPLY SMALL LOTS TO AMATEURS

**CAPSTAN REPETITION WORKS,
 PARK ROAD, HOCKLEY, BIRMINGHAM**

Telephone: 3265 Central. Telegrams: "Firkettes," Birmingham

SENSATIONAL REDUCTIONS.

.0005 Variable Condenser, complete with engraved scale, and pointer, mounted on walnut cabinet, 17/6, post 9d.
Vario Coupler, consisting of 3" turned mahogany ball, mounted in 3 1/2" ebonite former, which is turned and grooved for wire, all contacts made complete with bush, boss, spindles, and knob, ready for panel mounting, 15/9, post 9d. Mounted on ebonite panel and base with shorting strap and four terminals, for use as Vario Coupler or Variometer, 21/-, post 9d.
Filament Resistances for panel mounting, 3/9, post 4d.
Murdoch's Headphones, 2000 ohms, 32/6 per pair, post 9d.
Mark III Terminals, with nuts, 2/3 per doz., post 5d.
Valve Detector Panel, complete ready for use, with all necessary terminals, grid leak, and condenser, Filament Resistance, and valve holder, with book of Instructions, 19/6, post 1/-.
Slab Inductances, per set of 8, 10/-, post 9d.
Basket Inductances, per set of 7, 7/-, post 5d.
Valve Sockets, with two nuts, 2d. each.

EVERYTHING GUARANTEED.

**THE SCIENTIFIC SUPPLY STORES,
 8, NEWINGTON CAUSEWAY, LONDON, S.E.**

TERMINALS

Contact Studs, Valve Legs, Condenser Vanes and other specials.

ACTUAL MAKERS:

Macradio Wireless Supplies

89a, Walworth Road, London, S.E.16

WHOLESALE.

**Questions and Answers
 COUPON**

To accompany Questions sent in during the week commencing Sept. 16th, 1922.

VOL. X, NO. 25.

See Conditions on Page 805.

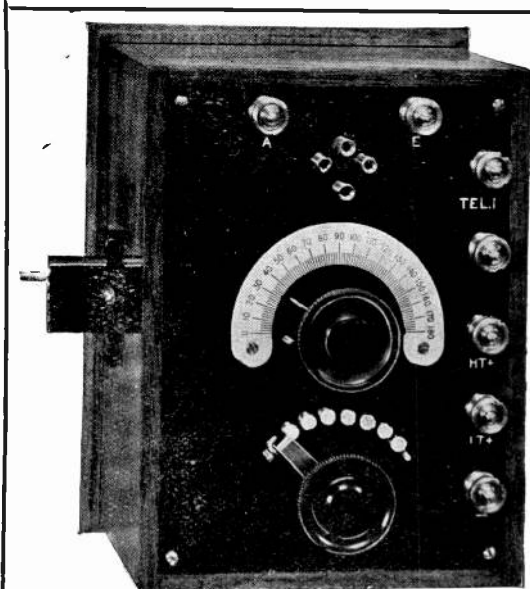

W.E.
LIMITED.
BROADCASTER.

FOR USE WITH
EXTERNAL or PLUG-IN
INDUCTANCES.

ANY WAVE.
UNIT "A"
£7 10s. 0d.

FITTED WITH
AERIAL TUNING CONDENSER
FILAMENT CONTROL.

ALL NECESSARY TERMINALS.
UNIT "B"

£5

Visit our Stand No. 14, All-British Wireless Exhibition, Horticultural Hall, September 30th to October 7th.

Write for Catalogue 3d. Post Free.

WIRELESS EQUIPMENT LIMITED,
90, CHARING CROSS ROAD, LONDON, W.C.2

Wireless
Apparatus and
Accessories of
high efficiency
and precision.



Order only
goods bearing
the Stuart
insignia. This
is a guarantee
of satisfaction.

BE READY for General

BROADCASTING

Of CONCERTS, SPEECHES, Etc.

PLACE YOUR ORDER NOW FOR

**THE STUART
3 - VALVE FAMILY SET**

Price Complete **£26-10-0** Early Delivers

(FREE DEMONSTRATIONS DAILY)

You cannot buy a better Wireless Receiving Set. Absolute efficiency, Enormous Range, supplied ready for installation.

Special requirements catered for. We also supply

HIGH - GRADE SPARES & ACCESSORIES.

WRITE FOR BOOKLET (W) POST FREE.

The Stuart Wireless Telegraphy Co.

Telephones : **109, KINGSWAY,**
Holborn **LONDON, W.C. 2.**
857
(4 lines).

Telegrams :
Phonetel,
Westcent,
London.

**SEA, LAND
and AIR**

THE AUSTRALIAN
MONTHLY JOURNAL
of Aviation, Radio-Tele-
graphy & Radio-Telephony

Price
1/9
Post Free

Annual
Subscription
21/-

THE WIRELESS PRESS LIMITED
12/13, Henrietta St., London, W.C.2

This Week's Special Offer!

Complete Sets of Parts for Constructing a REINARTZ TUNER.

Set of Parts contains—Ebonite Panel $12 \times 6 \times \frac{1}{4}$ drilled and tapped. 2 Sets of parts for .0005 Variable Condenser. 3 Laminated Switch Arms. 17 Studs and Nuts. 6 Stops. Iso Tube and D.C.C. Wire. Insulated Sleeving and Wire, Terminals, Tablets, and Assembly and Wiring Diagram.

**COMPLETE SET OF PARTS,
39/6**

NOTE—If required with Bevelled Dials add 3/9 per Dial. Polished Mahogany Cabinet to fit, add 7/8 extra. SEND FOR ILLUSTRATED CATALOGUE W/W. WITH LIST OF STATIONS, POST FREE 6/1. Trade enquiries invited.

Extract from *Wireless World*, page 381, June 24th, 1922.

... I have made up a Tuner of the Reinartz Type, working on the lines suggested by Mr. Harris... I find that its selectivity is splendid, it almost eliminates jamming, also the atmospheric troubles are reduced to a very remarkable extent, and I may instance my experience this morning when I heard both interference and atmospherics on a set using ordinary electromagnetic reactance, but avoided both these troubles with the Reinartz set.



ADJUSTABLE
TYPE "A"

4000 ohms.

PRICE

42/-

PER PAIR
With Cords.

PARAMOUNT Super Sensitive Phones

These Phones have 3 Features which we claim are not to our knowledge combined in any other Phone on the market. They are:

- Laminated Pole-Pieces.
- Magnetic Flux Shunt.
- Magnets Adjustable to Diaphragm.

DELIVERY EX-STOCK.

We have cheaper lines in stock from 10/6.

CALL AT HOLBORN & SELECT.



The Condenser King,
64, High Holborn, London, W.C. 1

Also at 17, FROME ROAD, WOOD GREEN.

Visit our Stand No. 16. All-British Wireless Exhibition, Horticultural Hall, September 30th to October 7th.

RELIABLE & EFFICIENT RECEIVING SETS FOR BROADCASTING

CRYSTAL RECEIVER	40/-
VALVE DETECTORS	From 29/6
VALVE AMPLIFIERS	38/6

Any Instrument or Part Supplied.

EVLINS Mail Order Office—
126, FOREST ROAD,
DALSTON, LONDON, E.8
Price List Post Free. TRADE SUPPLIED.

High Frequency Transformers

Turned former, best quality ebonite, fitted with four split pins to take standard valve socket.

Wound with 40 S.W.G. D.S.C. paraffin waxed copper wire.	
No. 1, Range 150-300 metres	3/6
No. 2, " 300-600 "	3/6
No. 3, " 500-1,000 "	3/9
No. 4, " 900-1,800 "	4/-
No. 5, " 1,700-3,000 "	4/6

Unwound formers, with pins fitted, 2 1/2" diameter, 1/8" slot, 1/2" deep, 2/- each.

Low frequency distortionless transformers, 16/9 each. Delivery immediately from stock. Post free. All above goods fully guaranteed.

Deal with the actual manufacturer and save money.

A. WOOD, Manufacturer of
Wireless Apparatus,
44, Bracebridge Street, NUNEATON.

THE MARK OF RELIABILITY

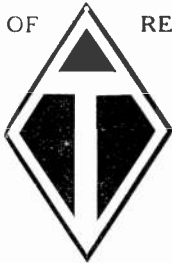

1 to 12 v.

1 to 35 a.

VOLT & AMMETER

Combined Dead Beat Pocket Type. New and not German. Splendid Instrument in Nickel Plated Case. Ideal for Testing Cells and Filament Current.

POST PAID **5/6** NUMBER LIMITED

OTHER EXCEPTIONAL VALUES.

- Aerial Wire. Enamelled Hard Drawn, 7/22's Copper, 5/- per 100'
- Aerial Wire. Bright Hard Drawn, 7/22's Copper, 4/- per 100'
- Aerial Insulators. Shell type, 2" x 2 1/2", green 1/2 each.
- Aerial Insulators. Reel type, 2" diameter, brown 3d. each.
- Filament Resistances. For panel mounting, 2/6 each.
- H.F. Transformers, plug in type, 300 and 700 metres, 4/- each.
- H.F. Transformers, plug in type, 1,000 m. 4/6; 2,600 m. 5/6 each.
- H.F. Transformers. Formers only, with pins, 3/- each.
- Tangent H.F. Transformers. All ranges, 6/6 each.
- Switch Arms. Complete fitted with knob, 1/- and 2/6 each.
- Dewar Switches D.P. Change over, panel type, 2/- each.
- Lightning Arresters. Carbon block type, 1/6 each.
- Valve Holders. Flanged "A" type, 1/-; Ebonite with 8 nuts, 1/5 each.
- Ebonite Panel, fitted with 3 Valve Holders, complete, 4/-.
- Ebonite Panel, fitted with 2 Valve Holders, complete, 2/3.
- Valve Sockets, per set of 4 with 8 nuts, 7d.
- Transformer Holder. With 4 terminals and wired, 3/6 each.
- High Note Buzzer (Army Type), worth treble, 2/6 each.
- Telephone Transformers (Army Type), 9/- each.
- Wireless Jacks. As illustrated, page 733, 1/- each.
- Brown's Type "A" Headphones. Guaranteed new and unused. 8,000 ohms, 49/6; 120 ohms, 42/6. With cords, 51/6 and 44/6.
- Ever Ready Batteries (all sizes). 16 volt, 3/6 each.
- Mica. Clear Ruby, .002" thick, 3" x 2", 1/- doz. pieces.
- Inductance Slider Rod, 1/4" square, 13" long, drilled 6d. each.
- Slider, complete with plunger for 1/4" rod 6d. each.
- Contact Studs. Fitted with nut and washer, 1/3 doz.
- Condenser Vanes. Best Aluminium, 3 1/2", 1/6 doz. pairs.
- Condenser Spacing Washers. Small 3d., large 6d. doz.
- Condenser Screwed Rod, Brass 12" long, 1.8" 4d., 3/16" 6d.
- Insulating Tubing. Assorted colours, 6d. per yard.
- Sheet Ebonite, 1/2" to 1/4" thick, 4/6 per lb.
- Terminals. Mark 3 N. Plated, 4B.A., 2/6 doz.
- Terminals. Small pattern, 9d. doz.
- Dubilier Condensers. All capacities at prices advertised.
- Grid Leaks. All resistances, 2/- and 5/- each.
- Vernier Condenser. Panel type .0005, 5/-.
- Radio Instrument L.F. Transformers, 25/- each.
- Tangent L.F. Transformers, 22/6 each.
- Ivoryine Scales. 0-180, good quality, 8d. each.
- Ivoryine Tablets. Set of seven, 1/-.
- Skinderviken Microphone Buttons, 5/- each.
- Burndept and De Forest. Coils in stock. Advertised prices.
- Small Plug and Sockets. Coil mounting type, 1/- set.

J. H. TAYLOR & CO.,
ELECTRICAL AND RADIO ENGINEERS,
Macaulay St., HUDDERSFIELD.
Telephone, 341. Telegrams: "Thorough," Huddersfield.

To all who mention the "Wireless World" and send 6d. for postage, we will send six back copies of the



free. This will prove to you that the PHILATELIC MAGAZINE is the best Stamp Collectors' Newspaper. All the news for 3d. a fortnight. Current issue from your newsagent 3d., or 4d. post free from:—
HARRIS PUBLICATIONS LTD., Balham
atalogue of Stamp Albums and Accessories free.

LIST OF
Regular Transmissions
OF
WIRELESS STATIONS
Giving Time, Call Sign, Wavelength, System, etc.
PRICE **6d.** POST FREE.

THE WIRELESS PRESS, LIMITED
Dept. W.W.,
12-13 Henrietta Street, London, W.C.2.

PARTS.

Our parts cannot be compared with the cheap lines being offered, those that look nice but refuse to function are dear at any price. Call and test them. For use with crystal or valve they cannot be beaten for giving maximum strength to signals, broadcasted music, etc.

4,000 ohms, two earpieces with double headbands and cords 27/-

Complete set of parts for making up .0005 condenser, including knob and scale, all ready and easy to assemble 8/9

BATTERIES, H.T. 3/6

15 Volt unit 6/9

30 Volt unit 12/3

60 Volt unit 4/3

BATTERIES, "FOR LIGHTING FILAMENT," SPECIALLY MADE, 4 Volt, Extra long life 19/-

Complete set of parts including ebonite panel, 9" x 6" x 1/4" 7/6

Polished mahogany cabinet to fit, allowing space for .0005 condenser

CRYSTAL SETS.

Set of parts, including coil, 10" x 4" wound, mahogany base, sidechecks, detector, etc., etc. 19/-

When ordering by post please allow sufficient postage, surplus returned. Everything in stock from a Terminal to a complete Valve Set. Send for our Price List. Post Free.

Trade Supplied.
THE HOLBORN RADIO CO., 8, HIGH HOLBORN, LONDON, W.C.1
(5 doors from Gray's Inn Road).
Telephone : Chancery 7278.

GRIFFIN'S BUSINESS FORMULA: QUALITY + EFFICIENCY + DESPATCH = CONFIDENCE		
"GRIFFIN" Super Crystal Sets Approx. Range, 300/2,000 mrs PRICE 38/- A Real Bargain. Accumulators, Fuller Block. 4 Volts, 40 Amps. £1 12 6 6 " 40 " £2 8 9 8 " 40 " £3 5 0 10 " 40 " £4 1 3 12 " 40 " £4 17 6 Other makes at Standard Prices. TELEPHONES—High Resist'ce Ex. Value, 4,000 Ohms 30/- Sterling's, 120 Ohms .. 48/- 4,000 " .. 52/- Brown's, 120 " .. 60/- 8,000 " .. 67/8 Sullivan's 4,000 " .. 42/6	MAGNAVOX LOUD SPEAKERS Junior £10 10 0 Senior £20 0 0 Order Quickly CONDENSERS—Ebonite Mntd. Griffin Circular, Celluloid or Square Mahogany Box Type .001 .0005 .0003 28/6 25/- 22/- Partly assembled for Panel Mts. .0003, 12/9 Condenser Vanes, 2/- doz., 3d. pair. Coilholders, 3 Coils .. 21/- Aerial Wire per 100' bare copper stranded, 7/22, 4/- Enamelled .. 5/-	Inductance Tubes—Wound, 12 X 4, 7/-; 12 X 3, 6/- Crystal Detectors— Griffin latest design.. 10/- Reliable Type .. 5/6 Insulators— Shell 1/8, Egg 10d., Reel 2d. and 1½d. each. Resistances for Panels.. 4/9 Ebonite Knobs .. each 6½d. Sheet and Rod 1/2 lb. 4/6 Terminals—Small 2/-, Large 3/- doz. 2 BA Brass Rod 3/16 per ft. 1 6. Spacers, doz. 7d. and 4d. Spindles for Condensers, 9d. and 4½d. each.
Sliding Plungers, 6½d. each. Superior Quality, 2/-. "Griffin" Cabinets to your own specification in Mah., Oak, etc. Valve Panels, Amplifiers, etc., made up to your require- ments. LET US QUOTE YOU. VALVES.—All makes at Standard Prices. WIRE Enamelled— .24 .28 .30 .32 .34 s.w.g. 2/8 3/6 3/10 4/2 4/4 per lb. WIRE d.c.c. .28 .30 .34 .36 .38 .40 s.w.g. 4/7 5/6 8/3 10/2 13/2 18/-per lb. Other Gauges see our List.		
Terms Cash. Delivery Free over £2. Write for comprehensive List of all Accessories, post free. 3d. (returned on first order). GRIFFIN WIRELESS SUPPLIES Co., 80, Newington Causeway, London, S.E.1. Telephone: Hop 1806. Telegrams: IFFINGRACO, London. (2 mins. from Elephant & Castle Tube Station.) Trade Inquiries Invited.		

ALL-BRITISH WIRELESS EXHIBITION

AND
CONFERENCE

ADMISSION **1/3** INCLUDING TAX

Sep. 30 (1922) Oct. 7

ADMISSION **1/3** INCLUDING TAX

SATURDAY SATURDAY

HORTICULTURAL HALL,

Vincent Square, Westminster, S.W.1.

Special Public Day, October 3rd Special Trade Day, October 2nd

ADMISSION **5/-** Including Tax ADMISSION **1/3** Including Tax

(Public admitted both days after 6 p.m. at the usual price.)

The Convention will be held under the auspices of
 The Wireless Society of London.

ORGANISERS :

BERTRAM DAY & CO., LTD.

9 and 10, Charing Cross, London, S.W.1 Gerrard 8063/4
 Wireless Publicity Specialists.

BEFORE YOU CAN STUDY WIRELESS TELEGRAPHY AND TELEPHONY YOU MUST HAVE A KNOWLEDGE OF MAGNETISM AND ELECTRICITY

Dear Sir,

A READER'S APPRECIATION.

I received in good condition a copy of "Mag. and Elec. for Home Study" on Saturday last, and I am very highly pleased with it. I have much pleasure in enclosing a P.O. for 6/- which I trust you will find in good order. Again thanking you for the value offered and the prompt attention.

Yours faithfully.

To many who are anxious to gain a knowledge of Magnetism and Electricity some text books on the subject have a very forbidding appearance.

The formulæ and equations too frequently haunt the non-mathematical reader and cause him to abandon his intention.

Such fears, however, need no longer deter anyone from acquiring the knowledge desired as in **MAGNETISM & ELECTRICITY FOR HOME STUDY** By H. E. PENROSE will be found **FIFTY COMPLETE LESSONS** prepared in such a form that the reader ceases to regard them as a study.

The various facts and theories are elucidated subtly but surely. No effort has been spared by the Author to explain the subject so clearly and thoroughly that no one can misunderstand him.

At the conclusion of each lesson is placed a series of questions which enable the reader to test his progress and assure himself that his knowledge is

well grounded. In this way he will know that his future study of Wireless Telegraphy and Telephony will be based upon a solid foundation.

A copy of the book will be sent **ON APPROVAL** to all who complete the request form below.

**The Manager, Mail Order Dept.,
THE WIRELESS PRESS, LIMITED,
12-13, Henrietta St., LONDON, W.C.2**

I enclose 6d. for postage.

*Please send me a copy of
**MAGNETISM & ELECTRICITY
FOR HOME STUDY. By H. E.
Penrose.***

*If I retain it I will remit the
sum of 6/-. Otherwise I will return
the book in good condition within
5 days of its receipt.*

Name

Postal Address

.....
.....

Date.....1922

W.W. 16/9/22

WIRELESS BOOKS FOR THE AMATEUR

MAGNETISM AND ELECTRICITY FOR HOME STUDY. By H. E. Penrose. Contains 50 complete lessons. Price 6/- net. Post free 6/6. 515 pages, 224 diagrams.

THE ARMATURE MODEL FOR 1½ K.W. ROTARY CONVERTER. Price 1/3 net. Post free 1/6. Shows every winding of the Converter Armature.

THE RADIO EXPERIMENTERS' HANDBOOK. By Philip R. Coursey, B.Sc. Eng., F.Inst.P., 113 pages, 99 diagrams and illustrations. Price 3/6 net. Post free 4/-.

SELECTED STUDIES IN ELEMENTARY PHYSICS: A Handbook for Wireless Students and Amateurs. By E. Blake, A.M.I.E.E. Price 5/- net. Post free 5/6. 176 pages. Crown 8vo. Cloth. 43 diagrams and illustrations.

WIRELESS TRANSMISSION OF PHOTOGRAPHS. By Marcus J. Martin, Second Edition. Revised and Enlarged. Price 5/- net. Post free 5/6. 143 pages. Demy 8vo. Cloth. Diagrams and illustrations.

CALCULATION AND MEASUREMENT OF INDUCTANCE AND CAPACITY. By W. H. Nottage, B.Sc. Price 3/6 net. Post free 3/11. Demy 8vo. 144 pages. Over 50 illustrations and diagrams.

THE A.B.C. OF WIRELESS. By Percy W. Harris. A simple outline of Wireless written for all to understand. 64 pages. Price 6d. net. Post free 8d.

TEST QUESTIONS AND ANSWERS ON WIRELESS TELEGRAPHY. Price of each Series of Questions 2/6 net. Postage 3d. Answers 2/6 net. Postage 3d. Invaluable for self-examination. Series 1. The Elementary Principles of Wireless Telegraphy. Part I.—Series 1a. Book of Model Answers. Series 2. Covering the Ground for the Postmaster-General's Examination. Series 2a. Book of Model Answers. Series 3. The Elementary Principles of Wireless Telegraphy. Part II.—Series 3a. Book of Model Answers.

THE ELEMENTARY PRINCIPLES OF WIRELESS TELEGRAPHY. By R. D. Bangay. Crown 8vo. Published in two parts or bound in one volume. Price per part 4/- net. Post free 4/4. In one volume 7/6 net. Post free 8/3.

MAINTENANCE OF WIRELESS TELEGRAPH APPARATUS. By P. W. Harris. Price 2/6 net. Post free 2/10. 127 pages. 52 diagrams and illustrations.

A SHORT COURSE IN ELEMENTARY MATHEMATICS AND THEIR APPLICATION TO WIRELESS TELEGRAPHY. S. J. Willis. Price 5/- net. Post free 5/6. Demy 8vo. 182 pages. 120 diagrams.

ALTERNATING CURRENT WORK. An Outline for Students of Wireless Telegraphy. By A. Shore, A.M.I.E.E. Price 3/6 net. Post free 3/10. Crown 8vo. Cloth. 163 pages. 86 diagrams and illustrations.

THE OSCILLATION VALVE. The Elementary Principles of its application to Wireless Telegraphy. By R. D. Bangay. 6/- net. Post free 6/6. Crown 8vo. 215 pages. 110 diagrams and illustrations.

USEFUL NOTES ON WIRELESS TELEGRAPHY. By H. E. Penrose. Crown 8vo. 1/4 each. Post free 1/6. Book 1. Direct Current. Book 2. Alternating Current. Book 3. High Frequency Current and Wave Production. Book 4. The 1½ K.W. Ship Set. Book 5. The Oscillation Valve.

THE CONSTRUCTION OF AMATEUR VALVE STATIONS. By Alan L. M. Douglas. The ideal book for those contemplating the making of a wireless set. 78 pages, 55 diagrams and illustrations. Price 1/6 net. Post free 1/8.

Visit our Stand No. 40. All-British Wireless Exhibition, Horticultural Hall, Sept. 30th to Oct. 7th.

THE WIRELESS PRESS, LIMITED,
12-13, HENRIETTA STREET, STRAND, LONDON, W.C.2.

Just Received!

AMERICA'S LATEST PUBLICATIONS FOR THE WIRELESS EXPERIMENTER.

HOW TO MAKE COMMERCIAL TYPE RADIO APPARATUS

By M. B. SLEEPER. Price **4/-** net (post free 4/3).

The experimenter will be able to get a world of ideas for the design and construction of his wireless apparatus from the very clear descriptions and ninety-eight illustrated figures.

CONSTRUCTION OF RADIO PHONE AND TELEGRAPH RECEIVERS FOR BEGINNERS

By M. B. SLEEPER. Price **4/-** net (post free 4/3).

Each piece of apparatus described was first made, tested and found efficient before the final design was accepted. Working drawings prepared especially for the novice and the man who wants to receive the wireless broadcast.

RADIO EXPERIMENTER'S HANDBOOK

By M. B. SLEEPER. Price **5/-** net (post free 5/3).

A book which tells in a very concise way the "Why" of radio and answers many of the "Practical Questions of the Beginner," and even the more advanced student of Wireless.

THE ABC OF VACUUM TUBES USED IN RADIO RECEPTION

By E. H. LEWIS. Price **6/-** (post free 6/5).

Written particularly for those who know nothing about wireless, but who desire an understanding of the elementary principles of operation of vacuum tubes, and various circuits in which they are used for reception of wireless telegraph signals, music and speech by wireless telephone.

CONSTRUCTION OF NEW TYPE TRANS- ATLANTIC RECEIVING SETS

By M. B. SLEEPER. Price **4/-** net (post free 4/3).

Complete information is given, with special drawings, on how to build and use the new types of trans-oceanic receiving sets, also on the use and external connections of the loud speaker and its application in receiving high speed signals from distant stations. The list of radio telegraph stations with their call letters and times of transmission appears at the end of this book.

**THE WIRELESS PRESS, LTD., Dept. W.W.
12-13, HENRIETTA STREET, STRAND, LONDON, W.C.2**

Visit our Stand No. 40. All-British Wireless Exhibition, Horticultural Hall, Sept. 30th to Oct. 7th

The YEAR BOOK of WIRELESS Telegraphy and Telephony 1922

1476 Pages.

Price 15/- Nett.

Demy 8vo.

Postage 1/-.

Abroad 1/4.

CONTENTS

Record of the Development of Wireless Telegraphy—National and International Wireless Laws and Regulations—Directory of the World's Land and Ship Wireless Stations—International Allocation of Call Letters—Alphabetical List of Call Letters—Meteorological Section—International Time and Weather Signals—National Résumés of Progress in Wireless Telegraphy—Particulars of Wireless Telegraph Patents, 1921—Aviation Section—Tabular List of Aviation Stations—Useful Data Section—Wireless Terminology—Conventional Signs used in Wireless Diagrams—Companies Engaged in the Commercial Development of Wireless Telegraphy—Biographical Section—Literature on Wireless Telegraphy and Telephony—Directory of the World's Wireless Societies—Directory of Wireless Colleges and Schools—List of Licensed Amateur Transmitting Stations—Code Section—Special Articles on "The Earthing Resistance of Antennæ," by Dr. Miessner—"The Recording of Wireless Signals," by Dr. Abraham—"The Birth and History of Long Distance Wireless Telegraphy"—"The Rectification Effect in its Reaction to the Composition and Structure of Crystals."

A valuable feature of the present issue is the specially drawn map, which gives, for the first time, a simple means of finding the distance and true direction of Wireless Stations in all parts of the World, from London as the centre.

THE WIRELESS PRESS, LIMITED,

DEPT. W.W., 12-13 HENRIETTA ST., STRAND, LONDON, W.C.2

BE UP-TO-DATE

READ THE

WIRELESS TRANSMISSION OF PHOTOGRAPHS,

By MARCUS J. MARTIN.

143 pages. 139 Diagrams and Illustrations.
Price 5/- net. Post free 5/6

THE WIRELESS PRESS, LIMITED,

DEPT. W.W.

12/13, HENRIETTA ST. STRAND, LONDON, W.C.2

Aerial Wire, Stranded, 7/25, 100'	3 6
Aerial Wire, Stranded, 7/22, 100'	5/-
Egg Insulators, Green	6d.
Reel Insulators, Best quality	3d.
Aluminium Pulleys, with cords	2/-
Valve Holders, screwed legs and nuts	1/-
Ivory Scales, 0-180 degs.	9d.
Filament Resistances, best quality. Panel Mounting	4/-
Crystals, Galena, Silicon, Bornite, Carborundum, C.	
Pyrites, etc.	6d.
Fusible Alloy	6d.

All Amateurs' Sundries in Stock.

The ESSEX WIRELESS Co.

(Wholesale and Retail.)

(Office and Showrooms)—

499, Grove Green Road, Leytonstone, E.11
Telephone: WANSTEAD 749. (1 min. from Station, G.E.R.)

NEW SUPPLY JUST RECEIVED FROM THE PRINTERS.

THE RADIO EXPERIMENTER'S HANDBOOK

By PHILLIP R. COURSEY,
B.Sc. (Eng.), F. Inst. P.

113 pages. 99 Diagrams and Illustrations.

PRICE **3/6** NETT.

(Postage 6d.)

CONTENTS—

General Considerations—Components of Wireless Installation—The Aerial Circuit—Receiving Tuners—Receivers, including detailed instructions on the making of the many types of inductances and useful Mark III tuner modifications, Amplifiers and Valve Detectors with circuits of high-frequency, low-frequency and resistance—Capacity Coupled Amplifiers—Heterodynes, giving working instructions for making up a long range heterodyne wavemeter—Appendix: High Frequency Measurements and Calculations with valuable data and tables.

The Wireless Press, Ltd.

Dept. W.W.

12-13, Henrietta St., Strand, London, W.C.2

The OHMER INSULATION TESTING SET (COX'S PATENT)

This is the lightest, cheapest and best instrument of its kind on the market. It consists of an Ohmeter and Generator mounted in one case. The Ohmeter is of the Electrostatic type, giving extreme lightness. Absolutely unaffected by external fields. It reads directly in Megohms and is independent of the voltage or speed of the generator.

NALDER BROS. & THOMPSON, LTD.,
97a, DALSTON LANE, LONDON, E.8.



WARNING.

MARCONI'S WIRELESS TELEGRAPH CO., LTD.,

A. C. COSSOR, LTD.

Marconi's Wireless Telegraph Company, Limited, GIVE NOTICE that an ORDER was made in the High Court of Justice, Chancery Division, by Mr. Justice Russell on the 1st March, 1922, restraining Messrs. A. C. Cossor, Ltd., from infringing the Marconi Company's Letters Patent Nos. 28413 of 1913 and 126658, except so far as Messrs. A. C. Cossor, Ltd. manufacture for H.M. Government.

Messrs. A. C. Cossor, Ltd., were further ORDERED upon oath to DESTROY all articles and apparatus (other than those constructed to the order of H.M. Government) made or used by them in INFRINGEMENT of these patents, and TO PAY THE MARCONI COMPANY DAMAGES AND COSTS.

The M-O Valve Company, Limited, of Osram Works, Brook Green, Hammersmith, London, W.6, is the only firm in this country licensed to manufacture thermionic valves under the patents belonging to the Marconi Company.

Any valve similar to those generally known as the "French type" constitutes an infringement of the above patents whether manufactured in this country or imported from abroad. Marconi House, Strand, London, W.C. 2.

"The Model Engineer"

A special paper for young Engineers, Apprentices, Students and Amateurs interested in Mechanics, Electricity and Model Making. It contains practical articles by experienced writers on Electrical and Mechanical subjects, Locomotives, Motor Cycling, Model Aeroplanes and Wireless Telegraphy.
Published every Thursday. 5d. post free.

"Junior Mechanics & Electricity"

The paper for beginners of all ages in Mechanics, Electricity and Model Making. All the articles are written in simple language so that everybody can read and understand them. It is well illustrated. There is also a Queries and Replies section, from which much valuable information can be obtained.
Published on 1st of each month. 4d. post free.

SOME USEFUL BOOKS.

Practical Lessons in Metal Turning .. 2/9	Small Accumulators .. 10jd
Engineering Mathematics Simply Explained .. 2/3	Electric Bells & Alarms .. 10jd
Practical Dynamo and Motor Construction .. 1/9	Electric Batteries .. 10jd
Practical Induction Coil Construction .. 1/9	Small Dynamos and Motors .. 10jd
Petrol Motors Simply Explained .. 1/9	Induction Coils for Amateurs .. 10jd
Workshop Wrinkles and Recipes .. 1/9	Small Electric Motors .. 10jd
	Alternating Currents .. 10jd
	Windmills and Wind Motors .. 10jd
	Wireless Telegraphy Simply Explained .. 10jd

Every Boy's Book of Electricity, 3d.

Every Boy's Book of Engines, 3d.

Book List sent post free on receipt of card.

PERCIVAL MARSHALL & CO.,
66m. FARRINGTON ST., LONDON, E.C.

Registered "NIPHAN" Trade Mark.

WATER-TIGHT PLUGS and CABLE COUPLINGS TO MEET HOME OFFICE REQUIREMENTS



COUPLING CONNECTING CABLES

Phones :
2600 Gerrard, 12061 Central.

Telegrams :
Niphan, London.
Patented in England and Abroad.

As used by H.M. War Office, Electric Supply Companies, Railway Companies, Marconi's Wireless Telegraph Company

SIMMONDS BROS., LTD.

4, 6 & 8, NEWTON STREET, HOLBORN, W.C.

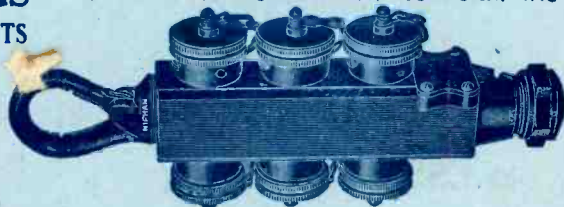

SIX WAY TEE CONNECTORS

1. Perfect insulation of grid connection ensures silent operation.

2. All connections shown in diagram ready made for you and brought out to terminals.

3. To add an amplifying stage, connect to terminals and insert valve.

4. Tapped holes in two sides and base make fitting easy.

To the man who is—

BUILDING a valve set.
 Do not buy intervalve transformers.
 The Elwell Amplifying Unit replaces them on all good sets.
 It saves time, money and trouble.

BUYING a valve set.
 See that the amplifying stages are carried out by Elwell Amplifying Units. They enable the manufacturer to give you a better job at a lower cost.

THE ELWELL AMPLIFYING UNIT

comprises valve socket and ironclad intervalve transformer, mechanically and electrically combined in one unit. When provided with a valve and connected as marked on the terminals, it is all that is necessary to give a further stage of amplification to an existing set. No soldering. Easily mounted.

The self-contained permanent connections embedded in compound are a big practical advantage, while the perfect insulation of the grid connection will appeal to all amateurs troubled with "noise."

Exclusive design covered by patents.

British made and guaranteed throughout.

PRICE : 39/6 only, for complete amplifying unit, less valve.

Deliveries from stock.

Call and see it.

Enquiries for all wireless components invited.

C. F. ELWELL, LTD., CRAVEN HOUSE, KINGSWAY, LONDON, W.C.2.

Telephone—REGENT 421.

WIRELESS WORLD

AND

RADIO REVIEW

VOL. X. No. 26.

23rd SEPTEMBER, 1922.

Registered at the G.P.O. as a Weekly Newspaper.



A FULL RANGE

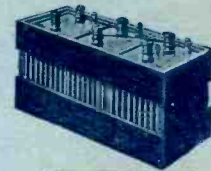

OF

HART

HIGH AND LOW TENSION

BATTERIES

INCLUDING VARIOUS NEW TYPES SUITABLE FOR

WIRELESS SYSTEMS

— WILL BE DISPLAYED ON — **STAND No. 17** — ALL-BRITISH WIRELESS EXHIBITION, HORTICULTURAL HALL, WESTMINSTER. — September 30th to October 7th, 1922. —



HART ACCUMULATOR CO., LTD.,
STRATFORD **LONDON, E.15**

BRANCHES { BELFAST, BIRMINGHAM, BRISTOL, GLASGOW;
MANCHESTER, WESTMINSTER & YORK.





STERLING No. 1 CRYSTAL W/T RECEIVING SET

Specially designed for use in connection with the Wireless Telephony Broadcasting Scheme, and is suitable for a range of about 25 miles.

PRICE £7-12-6

Visit our Stand No. 34. All-British Wireless Exhibition, Horticultural Hall, September 30th to October 7th.

STERLING TELEPHONE & ELECTRIC CO., LTD.

210-212, Tottenham Court Road,
LONDON : : : W.1

Telephone No. : 4144 Museum (7 lines)
Telegrams : "Cucumis, Wesdo, London."

Works : DAGENHAM, ESSEX.

BRANCHES :

NEWCASTLE-ON-TYNE : 9, Clavering Place.
CARDIFF : 8, Park Place.

IMMEDIATE DELIVERY

“Wireless for all”

Before you decide on the construction of your set. It will pay you to have particulars of—

Condensite Celoron

For PANELS and OTHER PARTS.

This material is waterproof, immune to atmospheric and climatic conditions, will not warp, has high surface and volume restivity, high di-electric strength, low specific gravity.

LET US QUOTE YOU

SEND PARTICULARS OF YOUR EXACT REQUIREMENTS TO
— THE MANUFACTURERS —

DIAMOND FIBRE CO. LTD.
DIAMOND-FIBRE WORKS HIGH ROAD SOUTH TOTTENHAM, N.15.

YOU CAN BUY H.P.R. INSTRUMENTS WITH ABSOLUTE CONFIDENCE --- READ THE GUARANTEE

Your protection

£5:5:0

(ACCESSORIES EXTRA)

Headphones, Valve, Batteries and Aerial can be secured through your dealer. The price of the "Simplex," complete with all accessories, is **£10 15 0**



CARLTON HOUSE
GREAT QUEEN STREET
KINGSWAY
LONDON

GUARANTEE THIS INSTRUMENT

is fully guaranteed by this Company to fulfil all requirements of the Postmaster-General's license to use Broadcast Wireless Receiving Instruments. It is warranted against all defects. It is manufactured by this Company under its own patent, No. 158455, and the purchaser is hereby indemnified against infringement of any patent rights. It is guaranteed to be of British design and manufacture throughout and to meet all the requirements of the Broadcasting Company.

H.P.R. WIRELESS Ltd.

SIMPLEX RECEIVING SET

This instrument is the result of over two years research work. H.P.R. Wireless, Ltd., were the pioneer designers and manufacturers of fine valve receiving instruments. The "Simplex" is perfectly simple to operate and simply perfect in results and workmanship. More BROADCASTING Stations will very shortly be in operation. You can hear all the concerts and telephony in your zone by simply turning a switch. No electrical or wireless knowledge required. Sketch and instructions for the erection of aerial included. Two or more persons can "listen in."

SOLD BY

Hamley Bros., Ltd., Selfridge & Co., Ltd., A. W. Gamage, Ltd., Negretti & Zambra, and all electrical dealers.

H.P.R. WIRELESS LIMITED

CARLTON HOUSE, GREAT QUEEN STREET, LONDON, W.C.2

(Opposite the Kingsway Theatre.) Telephone: Regent 1719.

Works at Ealing and Lambeth.

TRADE ENQUIRIES INVITED



ASK FOR PARTICULARS OF OUR OTHER WIRELESS INSTRUMENTS.

Visit our Stand No. 35 at the All-British Wireless Exhibition.

BIRMINGHAM:
133 NEW STREET.

LIVERPOOL:
10, SOUTH JOHN
STREET.



MANCHESTER:
61, BRIDGE STREET
DEANSGATE.

LEEDS:
48, ST. GEORGE
STREET.

LONDON OFFICE & SHOWROOMS
15 Bedford Street. Strand. W.C.2

Visit our Stand No. 12A. All-British Wireless Exhibition, Horticultural Hall, Sept. 30th to Oct. 7th.

THE NEW POST OFFICE REQUIREMENTS

specify that valves capable of oscillating must not be connected direct to the aerial circuit. This means that the reaction coil *MUST* be coupled to a secondary coil which in turn is loosely coupled to the primary coil or aerial tuning inductance—REGENERATION by means of a reaction coil is the most simple and most efficient way to magnify telephony or spark signals and AUTODYNE by means of a reaction coil is the most efficient way of receiving continuous wave telegraphy up to 10,000 metres and the simplest way on longer wavelengths.

THE REACTION PRINCIPLE IS PATENTED BUT **BURNDEPT** instruments are duly licensed under this and other patents, so that we can offer our customers EFFICIENCY and PROTECTION.

The **BURNDEPT** TUNER MK. V. fulfils all above requirements and uses the principle of reaction adapted to obtain utmost efficiency. In connection with the triple coil holder with the new springsockets are two **BURNDEPT** Precision Condensers one fitted in series with the primary coil holder and another in parallel with the secondary coil holder, a **BURNDEPT** Vernier Condenser is also fitted to the secondary coil holder so as to obtain exceedingly fine tuning and selectivity. The usual high-class **BURNDEPT** finish is put into this tuner which can be fixed by 4 wires to any **BURNDEPT** Receiver or other good make of apparatus.

PRICE in flat case - - - £7 0 0

in sloping cabinet - - - £8 0 0

IN STOCK.

IMMEDIATE DELIVERY.

CONVERSIONS:

As the two coil circuit using reaction is banned we have arranged to convert our old pattern Mk. I. and II. 2 coil tuners into Mark V Tuners at a nominal price, which will be quoted by return if the registered number of the tuner is sent to us with the application.

It is understood that when reaction is used on broadcast wavelengths (325-425 metres) that the Post Office requires that the experimenter should take the greatest care not to allow his valves to oscillate, which means the reaction coil must not be tightly coupled.

NOTICE.—All possessors of **BURNDEPT** Apparatus are invited to write for revised copy relating to **BURNDEPT** coils and 3 coil Tuners, also for amended instructions for operating the Ultra IV Receiver; enclosing stamped addressed envelope and quoting the number of their instrument.

All **BURNDEPT** Valve Apparatus is duly licensed under Marconi Patents for amateur use in Great Britain.

BURNDEPT, LTD., Manufacturers of AERIAL & EASTNOR WORKS,
Wireless Apparatus BLACKHEATH, LONDON, S.E.3

BURNDEPT

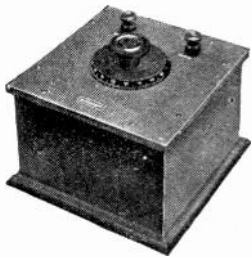

Precision

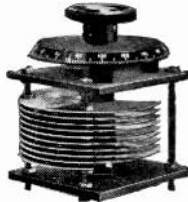

Condensers

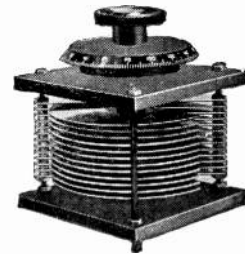

The design of this instrument is such that it can be produced in large quantities at a reasonable price, whilst retaining a high standard of technical excellence.

Specification. Vanes of hard thick aluminium. Bearings metal to metal. Contact to moving plates by phosphor bronze soldered strip. Adjustable operating tension. Spacing between plates sufficient for pressure up to 1,000 volts. Built upon Bakelite. Suitable for mounting on any panel from $\frac{1}{4}$ " to $\frac{1}{2}$ " thick, by drilling $\frac{3}{4}$ " clearing hole for spindle and three $\frac{1}{8}$ " holes for fixing screws. Each instrument supplied complete with a high-class engraved and polished Ebonite dial and substantial knob assembled, and the necessary fixing screws. The maximum capacity is '0008 and the minimum capacity negligible.

We recommend this size condenser as being the most suitable for both A.T.I. and secondary tuning. It is the same condenser which is built up into all our new **BURNDEPT** tuners.

PRICES. For Panel mounting, No. 141 **£2 0 0**. Mounted complete on Ebonite Panel and polished walnut case No. 142 **£2 15 0**. A smaller size condenser capacity '000275 for high frequency amplification, Vernier tuning, reactance tuning, etc. No. 144 for panel mounting only. The specification of this condenser is precisely the same as the large one **£1 12 0**.

IN STOCK—IMMEDIATE DELIVERY.

NOTICE

Owing to the completion of the installation of our new additional Factory EASTNOR WORKS, BLACKHEATH, we can now deliver from stock COILS (all sizes), PRECISION CONDENSERS, INTERVALVE TRANSFORMERS, etc.

All **BURNDEPT** Valve Apparatus is duly licensed under Marconi Patents for amateur use in Great Britain

BURNDEPT, LTD., Manufacturers of AERIAL & EASTNOR WORKS, Wireless Apparatus BLACKHEATH, LONDON, S.E.3

LONDON OFFICE & SHOWROOMS: 15, BEDFORD STREET, STRAND, W.C. 2.

Visit our Stand No. 12A. All-British Wireless Exhibition, Horticultural Hall, Sept. 30th to Oct. 7th.

The Baynton High Tension Unit Regd. No. 11896/22



Containing
45 Cells



ADVANTAGES:

- (A) Each Battery can be separately Tested. (B) Exhausted cells replaced at the cost of a few pence.
(C) No soldering required, exhausted Batteries replaced by undoing 2 screws. (D) Four Tapping, or more if required.
(E) A neat Polished Box, with Ebonite Top and Brass Terminals.

PRICES:

60 volts 27/6
75 volts 32/6

SEND FOR ONE TO-DAY
The Best Value on the Market

ALL BURNDEPT AP-
PARATUS IN STOCK

Sole Manufacturers—C. S. BAYNTON & SON, 133, New Street, BIRMINGHAM.

DUBILIER

A New Condenser for Wireless Receivers

THE DUBILIER TYPE 600 MICA CONDENSER

The illustrations show two types of this new condenser for wireless receiving circuits. The condensers have the same perfect mica insulation, the same high efficiency and the same permanence of capacity as the larger Dubilier Mica Condensers used in wireless transmitters. Distortion when receiving telephony is often due to bad design of the components of the receiver—therefore use efficient Dubilier Condensers in your receiver to obtain the best out of your set.

PRICES:

Capacity between 0'0001 and 0'0009 mfd 2/6 each
 " " 0'001 " 0'005 " - 3/- "
 (inclusive)
 Condensers complete with Grid Leaks - 7/6 "

TRADE TERMS ON APPLICATION.

With Clips for Grid Leak.

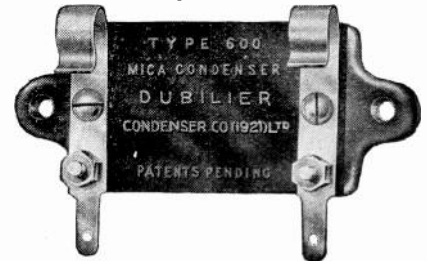

Without Clips for Grid Leak.

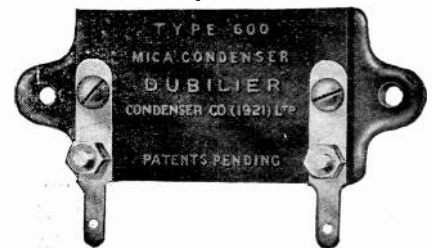

THE WAY TO DUBILIERS.

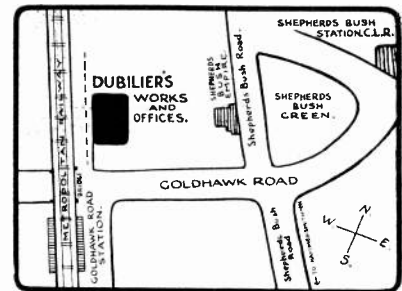

Visit our Stand No. 36. All-British Wireless Exhibition, Horticultural Hall, September 30th to October 7th.

THE DUBILIER CONDENSER CO. (1921), LTD.,
DUCON WORKS, Goldhawk Road, Shepherd's Bush, London, W.12

Telephone—Hammersmith 1084.

Telegrams—Hivoltcon, Phone, London.

Code—Marconi International.

W. MACKIE & CO.

(ESTABLISHED 1882.)

Works: THE PALACE ENGINEERING WORKS,
129, 131, 133, Lambeth Road, London, S.E.1.

Central Office: Sardinia House, Kingsway, London, W.C.2.

Telephone Nos.: Works—Hop 182.

Central Office—Holborn 2125.

*Manufacturers of Wireless Generators to the
Admiralty, War Office, and Air Force,
Marconi's Wireless Telegraph Co., Ltd., &c.*

HAVE just placed on the market the
latest machine for Wireless users.

80^{Watt} Rotary Transformer

L.T. 11 Volts 13·9 Amps.

H.T. 1150 Volts ·073 Amps.

SUITABLE FOR ALL WIRELESS ENGINEERS.

INSPECTION INVITED.

ENQUIRIES SOLICITED.

McGRUER

HOLLOW MASTS

are most easy to fix on either roof or ground. They have the least wave-disturbing mass consistent with rigidity.

Our 30' Mast with folding joint weighs only 16 lbs. It is supplied complete with Truck, Sheave, Insulators, Stays, Strainers and Anchors.

We specialise in light masts and spreaders.

Masts of any height supplied.

Write stating your particular requirements and we will quote you by return.

McGruer Hollow Spar Co. Ltd.

Commercial Road, Lambeth, S.E.1.

Telephone: Hop 718. Telegrams: Olloparsh, Watloo, London.



TRADE MARK

The WHITECROSS COMPANY, LIMITED

:: WARRINGTON ::

Manufacturers of All Descriptions of

WIRE ROPES AND WIRES

EXPERIENCE

A Loud Speaker WORTH HAVING

Absolutely
Distortionless.

Highest Efficiency.

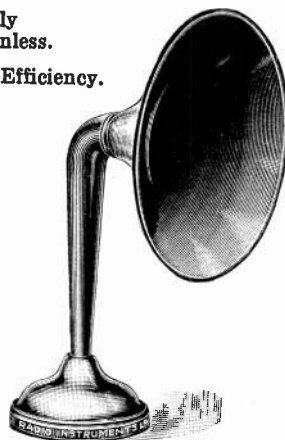

This elegant and efficient instrument is not assembled from oddments, but is an exclusive model designed and manufactured throughout by our staff of radio engineers of long experience and established reputation.

The two important points in the design of an efficient loud speaker are the magnetic system and the acoustic system.

THE MAGNETIC SYSTEM.—Bar magnets are employed made of cobaltchrom steel. They therefore retain a much higher magnetic strength than the ordinary type. They do not depreciate with use. The diaphragm is of stalloy. By thus combining maximum strength with greatest permanence, highest efficiency is assured.

THE ACOUSTIC SYSTEM.—Very careful attention has been given to the design of the sound chambers and horn. The form finally adopted has been shown by experiment to attain the best reproduction with a complete absence of distortion.

FINISH.—Pillar and standard are finished in bright or black nickel, and the horn is polished aluminium. The instrument has therefore a particularly attractive appearance. Bronze, oxydised silver and other finishes are supplied if desired.

RESISTANCE.—The winding is of high resistance. No transformer is required.

PRICE.—In bright or black nickel, £3 : 0 : 0.

Other finishes quoted on application.

OTHER PRODUCTS include Short Wave Anode Reactances, Efficient Tuning Inductances, Precision Air Condensers, H.F. Transformers and all wireless components. Every article is manufactured at our own works under the direct supervision of the directors.

Radio Instruments Limited

Managing Director: J. Joseph, M.I.E.E., late Manager to Mr. H. W. Sullivan. Chief Designer: W. A. Appleton, M.B.E., M.I.R.E., late Admiralty Technical Research Officer.

ONLY ADDRESS. Works, Offices & Showrooms

12a, Hyde Street,

NEW OXFORD ST., W.C.1

Telephone: Regent 1908. Telegrams: Instradio, London.

We have the largest wireless works in Central London.

We are wireless engineers of established reputation.

Our name on wireless apparatus is a guarantee of satisfaction.

Visit our Stand No. 37. All-British Wireless Exhibition, Horticultural Hall, September 30th to October 7th.

(E.P.S.)9.

WIRELESS EQUIPMENT LTD.
 Tel: GERRARD 6785. RADIO ENGINEERS AND MANUFACTURERS
 :: APPARATUS AND SPARES ::
 WRITE FOR OUR ILLUSTRATED LISTS OF SETS AND COMPONENT PARTS, 3d. POST FREE
 Head Office: 90, CHARING CROSS ROAD. LONDON, W.C.2
 Telegrams: WIREQUIP WESTCENT LONDON

Visit our Stand No. 14. All-British Wireless Exhibition, Horticultural Hall, September 30th to October 7th

THE WIRELESS WORLD AND RADIO REVIEW

THE OFFICIAL ORGAN OF THE WIRELESS SOCIETY OF LONDON
 A MAGAZINE DEVOTED TO WIRELESS TELEGRAPHY AND TELEPHONY

CONTENTS

2 MT Writtle : A Description of the Transmitting Plant. By Captain P.P. Eckersley - 813
 The Unit System as applied to a Wireless Receiving Installation. By W. Forbes Boyd
 (concluded) - 816
 Why I Should Join a Wireless Society. By F. Hope-Jones, M.I.E.E. - 818
 Meteorological Wireless Codes. By W. G. W. Mitchell, B.Sc., F.R.A.S., F.R.Met.S. - 819
Contents continued on next page.

MAGNAVOX

THE WORLD'S FINEST

LOUD SPEAKER

RADIO brings it MAGNAVOX tells it.

Broadcasting faithfully reproduced with marvellous clarity and volume

IMMEDIATE DELIVERY.

Visit our Stand No. 34. All-British Wireless Exhibition, Horticultural Hall, September 30th to October 7th.

Manufacturers & Sole Licensees for Europe

Sterling Telephone & Electric Co., Ltd.

TELEPHONE HOUSE,

210/212, Tottenham Court Road, London, W.1

Telephone No.: 4144 Museum (7 lines). Telegrams: "Cucumis, Wesde, London."

Works: DAGENHAM, ESSEX.

BRANCHES: NEWCASTLE-ON-TYNE: 9, Clavering Place.

CARDIFF: 8, Park Place.

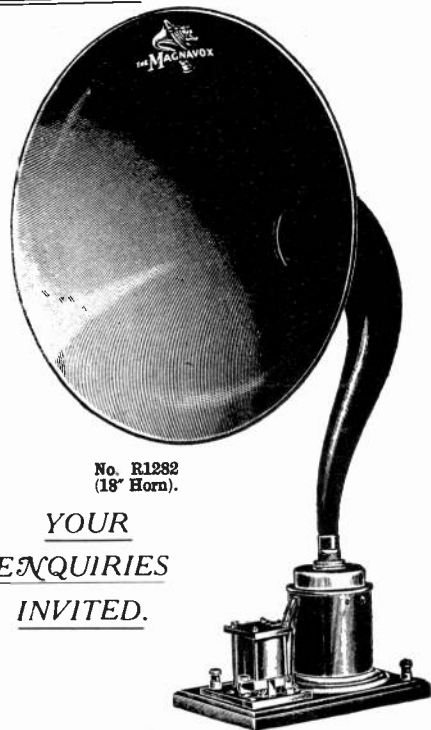

No. R1282 (18" Horn).

YOUR ENQUIRIES INVITED.

NOW IS THE TIME to acquire a sound theoretical and practical knowledge of **THREE ELECTRODE VALVES**, (as applied to C.W. Radio-telegraphy and Radio-telephony), by means of my **POSTAL INSTRUCTION COURSE.**
Perfectly Simple
May I Send you Particulars?

2/Lt. E. REDPATH,
19, Niger St., BARROW-IN-FURNESS

CONTENTS *(Continued)*

The All-British Wireless Exhibition - - - - -	822
The Radio Direction Finder and its Application to Navigation. - - - - -	825
A Variable H.F. Transformer. By L. W. C. Martin - - - - -	828
A Cheap Method of Obtaining H.T. for Telephony Transmission - - - - -	830
A Simple Form of High Tension Battery - - - - -	831
Notes - - - - -	832
Calendar of Current Events - - - - -	833
Wireless Club Reports - - - - -	834
Questions and Answers - - - - -	837
Share Market Report - - - - -	844

THE WIRELESS WORLD AND RADIO REVIEW is published weekly on Saturdays.
 All correspondence relating to contributions should be addressed to THE EDITOR, THE WIRELESS WORLD AND RADIO REVIEW, 12-13, Henrietta Street, London, W.C.2.
 No responsibility can be taken for MSS. or photographs sent without stamps to defray cost of return postage.
 Editorial and Publishing Offices 12-13, Henrietta Street, Strand, London, W.C.2.
 Telegraphic Address: "Radionic, Rand, London." Telephone No.: Gerrard 2807.
 Advertisement Managers, Bertram Day & Co., Ltd., 9 and 10, Charing Cross, S.W.1.
 Telephone No.: Gerrard 8063 and 8064.

SUBSCRIPTION RATES.—

28s. per annum, post free. Single Copies 6d., or post free 7d.
Registered at the G.P.O. for transmission by Magazine Post to Canada and Newfoundland.

HOLLOW STEEL MASTS FOR AERIALS

These masts are light, strong, easily erected, and will last a lifetime. All lengths over 15ft. are made in sections and each mast is supplied complete with baseplate, finial, rope cleat, pulley sheave, guy clips, three steel guy ropes and strainers, painted one coat ready for immediate erection. Being made of steel, no lightning conductors are required.

PROMPT DELIVERY.		PRICES F.O.R. FOR CASH WITH ORDER, EACH			
10ft. ...	32/6	15ft. ...	42/6	20ft. ...	45/-
25ft. ...	57/6	30ft. ...	84/-	40ft. ...	126/-

Other Lengths supplied at equally Low Prices. *Trade Inquiries Invited.*

THE WIRELESS STEEL MAST & ACCESSORY COMPANY
Lombard Street West, West Bromwich

Telephone No. 447.
 Telegrams: "Wireless Westbromich."

VALVES

DELIVERY FROM STOCK.

RECEIVING.

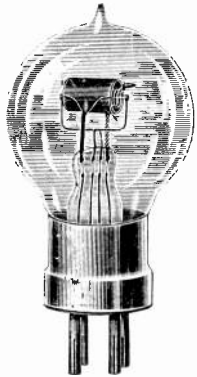

Type.	Filament Voltage.	Anode Voltage.	PRICE.
R	4	60	£0 17 6
R ₄ B	4	50	1 10 0
V ₂₄	5.2	36	1 4 0
Q	5.2	50	1 4 0
		(150 as amplifier)	
QX	5.2	50	1 4 0

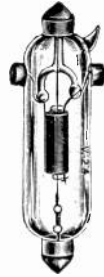

SPECIAL LOW TEMPERATURE VALVES.



Type.	Filament Voltage.	Filament Current.	Anode Voltage.	PRICE.
L.T. 1	1.8	.4	36-50	£2 10 0
L.T. 3	1.8	.11	„	„

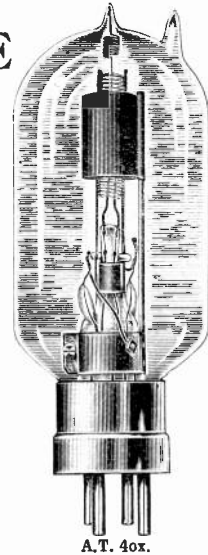

TRANSMITTING.

Type	Filament Voltage.	Anode Voltage.	PRICE.
A.T. 25	5.5	UP TO 1,000	£1 10 0
A.T. 40X	7	„ 1,000	2 15 0

L.T. 1.

A.T. 40x.

Visit our Stand No. 32. All-British Wireless Exhibition, Horticultural Hall, September 30th to October 7th

THE
MARCONI SCIENTIFIC INSTRUMENT CO., LTD.

40 DEAN STREET, SOHO, W.1

TELEGRAMS: THEMASINCO, WESTCENT
 TELEPHONE: GERRARD 774

WATES**SPECIALITIES INCLUDE THE RELIABLE—****Exclusive Features :**

1. Basket pattern positives so constructed that it is impossible for active material to become displaced.
2. Glass containers specially constructed with rib separators.
3. Absolute absence of frothing.
4. Practically impossible for plates to sulphate due to special materials used.
5. Non-corrosive terminals.
6. Impossibility of acid creeping.
7. Last feature, but not least—**LOW PRICE BUT HIGH QUALITY.**

WRITE FOR
ILLUSTRATED CATALOGUE.
PRICE 3d.

VISIT OUR STAND NO. 15,
ALL-BRITISH WIRELESS EX-
HIBITION, HORTICULTURAL
HALL, Sept. 30th to Oct. 7th.

WATES Bros.,
*Manufacturers of best
quality Wireless Apparatus*

**Ideal Valve Accumulators**

(In wooden cases with
leather strap handles)

PRICES—

6 volt 50 amp 35/-
Carriage 3/-

4 volt 50 amp 24/-
Carriage 2/-

2 volt 50 amp 10/-
(without case) Carriage 1/-

*Some provincial agencies
still vacant.*

13/14, Gt. Queen St.,
Kingsway, London, W.C.2
'Phone : Gerrard 576.

*The discerning Amateurs
and Experimenters require
apparatus and parts of
the highest quality and
efficiency. These can be
obtained only from :—*

RADIO SUPPLIES
(1920), 236, High Hol-
born, London, W.C. 1.
(The only address).

*The Firm with a long-
standing reputation
for superior Wireless
Apparatus.*

**EBONITE AND
VULCANITE**

TUBES—RODS—SHEETS

LARGE
STOCKS

**BRITANNIA RUBBER AND
KAMPTULICON CO., LTD.**
7, NEWCATE ST., LONDON, E.C.1

Telephone :
2168 Central

Telegrams :
Britannia, London

THE WIRELESS WORLD AND RADIO REVIEW

THE OFFICIAL ORGAN OF THE WIRELESS SOCIETY OF LONDON

VOL. X. No. 26. SEPTEMBER 23RD, 1922.

WEEKLY

2 MT Writtle

A Description of the Transmitting Plant

By CAPTAIN P. P. ECKERSLEY.

AT the outset it should be clearly understood that the transmitter at Writtle does not employ any novel circuits, the results, such as they are, are from an old telephone transmitter designed for other purposes. The set was erected and is maintained and run by a staff engaged principally on experimental commercial work, and the

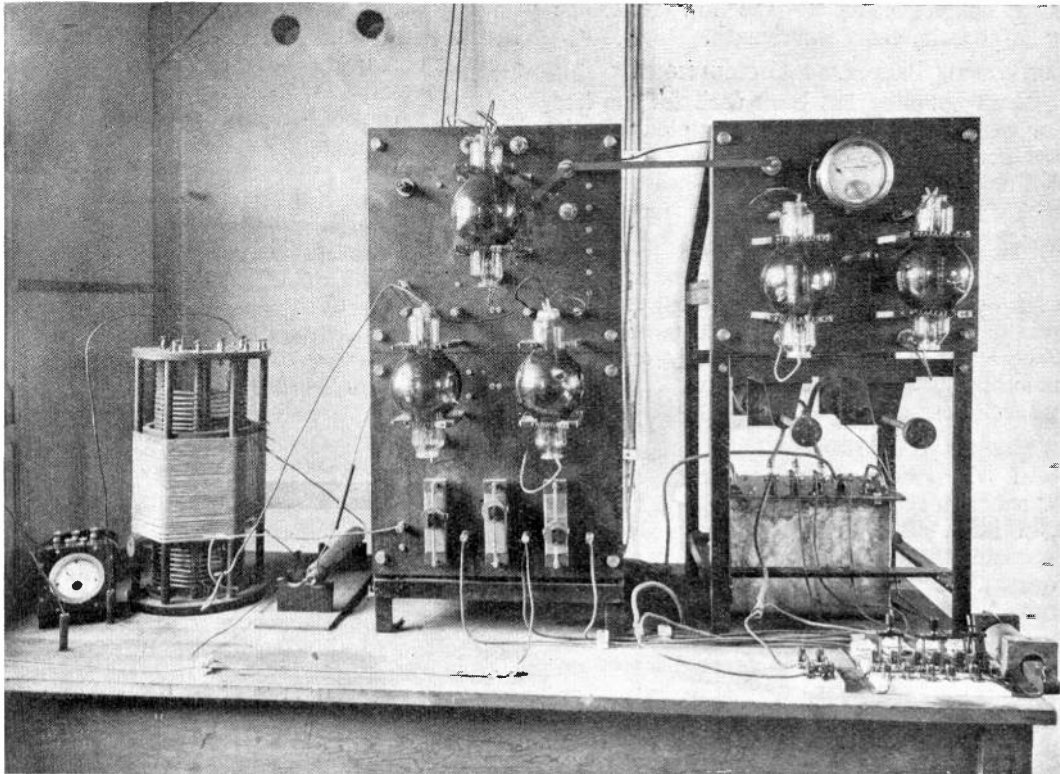

The $\frac{1}{2}$ k W set used for the Tuesday evening's telephony transmissions.

obtained by attention to detail rather than by resource to high falutin' and theoretically perfect methods. The set is in fact adapted

station is run out of hours, so that a great deal of time cannot be spared for further research and experiment on this particular transmitter.

THE AERIAL.

The aerial is of L construction, and consists of four parallel wires equally spaced on a 12-ft. spreader slung between two masts, 100 ft. high, 200 ft. apart. An earth screen is used in place of the ordinary earth, and this provides a low resistance aerial system.

The effective height of the aerial is about 20 metres, and this gives a radiation resistance at 400 metres of

$$\frac{1600 (20)^2}{(400)^2} = 4 \text{ ohms.}$$

POWER.

The power is $\frac{1}{4}$ kW, and this gives about 4 amps in the aerial. Assuming a 60 per cent. efficiency, this gives the total resistance of the aerial system as about 9 ohms, or 5 ohms for the aerial and aerial inductance, and 4 ohms for the radiation resistance, giving a radiation efficiency of nearly 50 per cent.; an extremely good figure, thanks to the low resistance aerial and the short wavelength.

METHOD OF PRODUCING OSCILLATIONS.

Direct coupling has been used for the last few weeks, but before this a coupled circuit was employed. It is not thought that the abolition of the coupled circuit has resulted in any deterioration of speech quality.

POWER SUPPLY.—H.T. VOLTAGE.

The H.T. voltage is produced in the standard way, by rectifying the alternating currents from the secondary of a 4,000 volt transformer. Double rectification is employed, and the smoothing is helped by a large condenser and iron core choke.

LIGHTING OF VALVES.

All valves, both control and oscillator, are lighted from accumulators, this giving freedom from hum. We have occasionally received complaints from some amateurs that hum was present, but from their descriptions this was probably not due to the alternator, but possibly to some breathing noises in a temporarily packed microphone. It is practically certain that the use of alternating current for producing the H.T. supply does not give any hum in the carrier wave, provided suitable precautions are taken. It is essential, however, to use D.C. lighting for the valve filaments if silence is to be obtained.

METHOD OF CONTROL.

The well-known method of choke control is used, and practically all the subsidiary

control circuits use iron in the circuits. From the point of view of strict theory, distortion should arise from the use of "iron circuits," but in practice it is not thought that this distortion is at all serious, and the simplicity and efficiency of the usual choke control circuit amply compensates for its theoretical disadvantages. Many argue that the necessary blocking condenser connected (as regards the speech circuits) across the choke, must bring in a measure of resonance, and may produce "wolf notes" in musical reproduction, but the heavy damping in the circuit makes the effect very slight. Undoubtedly, however, the unpleasant ringing or hanging-on sounds in musical production by wireless telephony are due to the partial resonance in the control circuits. (This effect, by the way, is often endemic to receivers, hence it is bad to use too much low frequency magnification. Again, phones are always semi-tuned, and produce the ringing quality in speech and music so often heard. Thick diaphragms heavily damped produce best quality, but are very insensitive.)

We have repeatedly proved that the ringing or hanging-on effect gets worse the greater the control; in fact the less the control the better the quality, but unfortunately we cannot please the single valveites at 100 miles if we cut down control too much. The London amateur, however, is better pleased with what is merely a ripple on top of strong C.W.

In the control system at Writtle, every care has been taken to damp out tuned circuits and to prevent any reaction in the amplification chain from the microphone to the main control valves. Spurious low frequency reaction in control circuits is a frequent cause of the "hanging-on" effect and the emission of wolf notes.

THE MICROPHONE.

An ordinary 6-volt Peel Connor has been used since the inception of the concerts. The microphone is probably at the root of most of the music distortion troubles, good as it is. Before touching the control circuits the microphone should be looked to. The microphone as it stands to-day was produced for speech; it was never intended for music. By dint of much research work it has been made to hear, close up to the mouth of the speaker, the sounds being concentrated by a small trumpet, what the human ear, complicated by holes and cavities, hears at a much greater distance. We are now asking

it to hear, still close up to the disturbance, sounds which may differ in frequency in the ratio of 8-1 exactly as the human ear hears them in a large room.

The diaphragm of a microphone has a natural period and tends to give prominence to sounds of that period, hence the awful hoarse grunt that a low piano note gives, the excellence of a violin or soprano, and the poor quality of instrumental harmonised works.

What we really want is an absolutely aperiodic diaphragm which will respond equally to any note within the eight octaves, will be fully sensitive, and will react to sound disturbances much as does the human ear.

So far this ideal can often only be obtained by very insensitive arrangements which require, therefore, electrical amplification, and unless this is very carefully done results in as much distortion as was originally present, due to the more sensitive but less distortionless microphone.

CONCLUSION.

Good quality in wireless telephony is as elusive as good character in human beings, and is as seldom met with. It depends upon such an enormous number of variables that it is marvellous that anything approaching faithful reproduction of music ever results. Sound impinges on a semi-tuned diaphragm casually pressing on small pieces of carbon, the changes of electrical current so produced influence an iron transformer which is greatly non-linear in effect. The secondary of the transformer is only effective in producing current changes in a valve for half its working period, and energy may be absorbed in grid current only for the greater intensities. More

iron transformers intervene, some semi-tuned by condensers before another non-linear and half-effective valve once more mars a chain that should be strictly linear. The voltage variations are applied to the high frequency medium and are radiated across miles of attenuating country and finally fall on an aerial tuned to only a few of the frequencies out of the many that are asking for recognition. The high frequency amplification is at least distortionless, but the rectifier necessarily cuts out one half of the disturbance which again is put through perhaps two or three iron transformers and finally manages to waggle semi-tuned diaphragms in the phones. These produce pressures and rarefactions of air in the confined space between ebonite earpieces and the flesh of the hearer's ears . . . and sounds are expected in this space, exactly corresponding to those impinging upon the microphone. Truly the human ear is a marvellous piece of apparatus!

In spite of this, exceedingly good quality can be obtained, but this will only result after strict attention has been paid to detail both at the transmitting and receiving ends. I would strongly impress on every amateur that good results are dependent upon his skill nearly as much as upon ours.

If broadcasting has done nothing else as yet, it has opened up a great field for the inventor, and a fascinating hobby for those with scientific leanings. It is hoped in time that research and experiment will bring the art to such a perfection that broadcast concerts will be a real aid towards musical appreciation throughout the country, and it is hoped that this ideal may be brought nearer by the efforts of British amateurs.

The Next Meeting of the Wireless Society of London will be held on Wednesday, September 27th, at the Institution of Electrical Engineers, Victoria Embankment, at 6 p.m.

The Editor will welcome additions to the Directory of amateur transmitting stations for early publication. There are still many holders of transmitting licences who have not supplied particulars.

The Unit System as applied to a Wireless Receiving Installation *(Concluded from p. 782)*

By W. FORBES BOYD.

REFERRING to the diagram Fig. 2, p. 780, it will be seen that most leads, with the exception of the grid leads, are carried across each panel so that the necessary connection can be made to the next panel. It will also be noticed that the plate circuit of the rectifying valve is connected to the reaction coil in the usual manner, except that the plate circuit is broken between the transformer and the positive high tension lead, instead of the more orthodox method of breaking the plate circuit between the plate and the transformer.

fitting into the instrument section of a short wave tuner box.

In comparison with Figs. 2 and 8, it will be seen that Fig. 9 omits the H.F. and L.F. amplifying units.

When using the four-valve amplifier with H.F. amplifier unit it is sometimes an advantage to convert it into a three-valve L.F. amplifier, especially for the longer wavelengths beyond the range of present-day telephony. This is very quickly done by connecting the grid link socket in the tuner

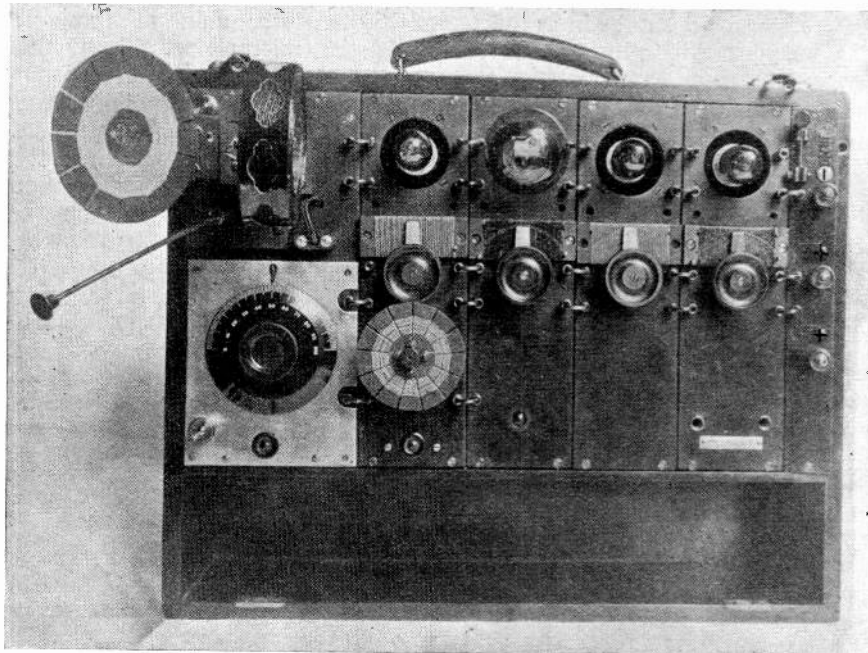

Fig. 8. Tuner with four-valve amplifier.

This is done so that only one extra reaction link tapping has to be brought back through the H.F. amplifying panel to the tuner, since the positive high tension lead is brought to the H.F. amplifying panel in any case. Apart from these features the amplifying section has no special points.

Fig. 8 shows a photographic view of the complete receiver with tuner and four-valve amplifier, and in order to show the flexibility of the system a two-valve amplifier with tuner unit is given in Fig. 9, this combination exactly

marked "A," Fig. 2, with the grid link socket of the rectifying valve marked "B," and switching off the filament of the H.F. amplifying unit.

A very useful accessory to the terminal unit could be added in the form of a flash lamp bulb in series with the positive high tension terminal unit to act as a fuse for the H.T. battery.

The writer invariably uses one on the H.T. battery, and it has many times saved the price of a new battery.

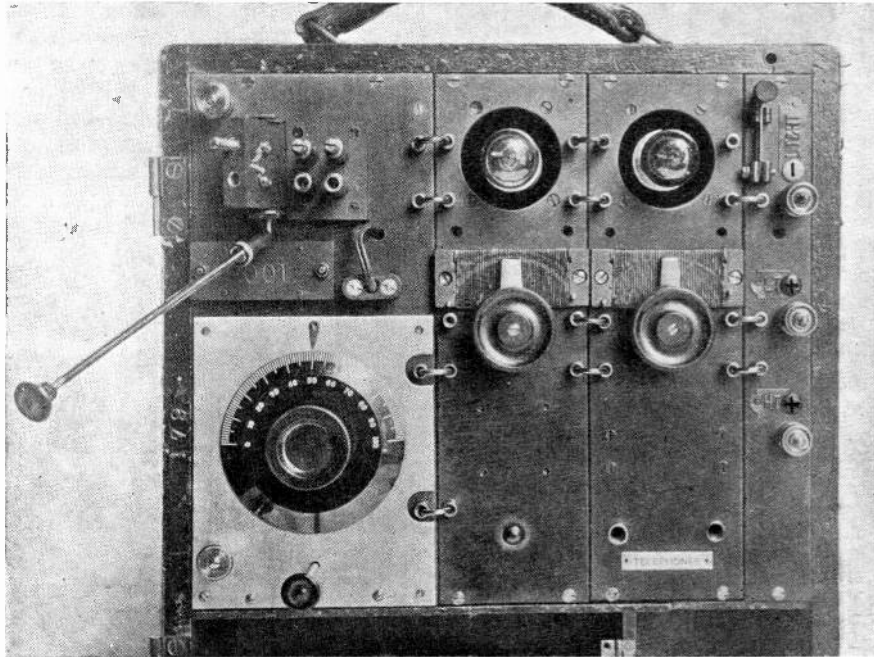

Fig. 9. Tuner, L.F. rectifying, telephone and terminal units. Illustrating the flexibility of the system.

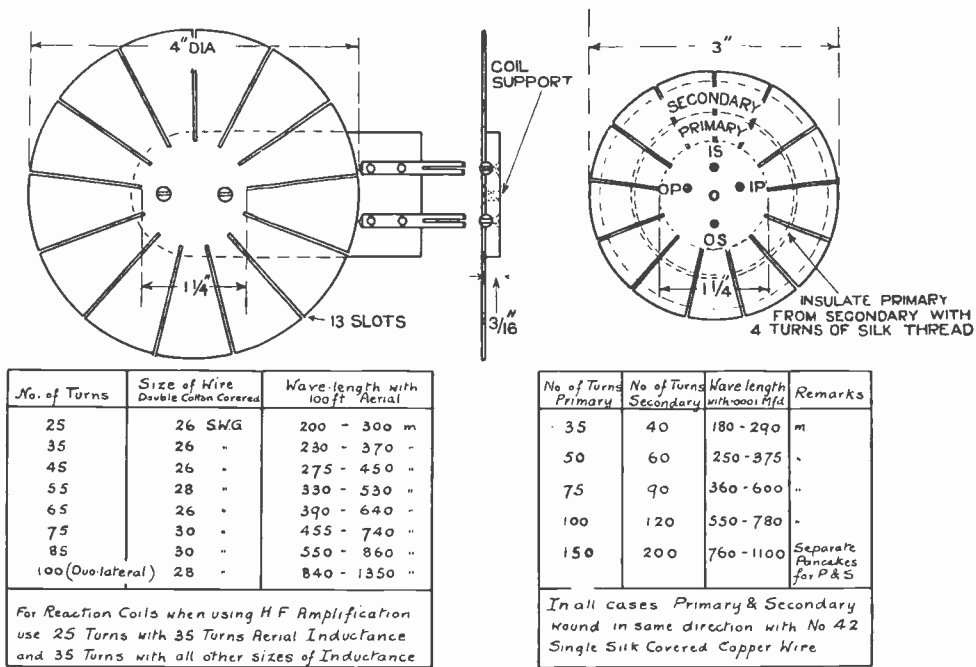

Fig. 10. Aerial inductances and reaction coil.

For example, a faulty valve was used in the H.F. amplifying panel in which the grid was touching the plate.

On any other panel this result would not be so apparent as the grid leak would provide a high resistance, but on the H.F. amplifying panel the faulty valve constituted a short circuit across the H.T. battery, and a twopenny flash lamp bulb is considerably less expensive than a new H.T. battery.

Fig. 10 gives particulars of the coils for the shorter wavelengths. It will be noticed that the aerial inductance and reaction coils are mounted on a 3/16-in. support, and provided with two pins. The grooves for these pins are made by drilling two supports that are clamped together, and if a pin and socket were provided it would be necessary to increase the thickness of the support.

In order that the two-pin mounting be suitable for the coil holders on the tuner, these top coil holders are provided with loose pins which are withdrawn when using the two-pin coil holder. It will be noticed that there are two pairs of fixed coil supports on the tuner. This arrangement is to allow for the difference in width between the pancake and the duo-lateral coils.

In conclusion, the writer has not the slightest hesitation in recommending the unit system to all wireless enthusiasts, from the novice who scarcely knows where to begin to the eardrum-hardened experimenter to whom the unit system should especially appeal, for not only is it an ideal experimenters' system, but also it is considerably more efficient than the single panel type of apparatus.

Why I Should Join a Wireless Society

By F. HOPE-JONES, M.I.E.E.

(Chairman of the Wireless Society of London).

BECAUSE man is a gregarious animal and identity of interest breeds friendship; because the easy and quick way of acquiring the special knowledge you want is to compare notes with others who are engaged upon the same problem.

Such reasons are the obvious ones, but there are others less conspicuous, and as is usually the case it is those below the surface that are the more important.

Your keenness in the new hobby may well lead you to consider who gave you radiotelegraphy. I am not thinking at the moment of the scientists; your text books will teach you what you owe to Clark Maxwell, Hertz, Lodge, Marconi, and Fleming, but do you realise that only six months ago it was technically against the law to transmit or receive wireless telephony in this country? Who fought for that very moderate degree of freedom which you now enjoy or are promised? *Your fellow amateur!* It was he, by joining his local society, who helped to establish the annual conference and enabled us to speak with a voice so unanimous and so authoritative that it had to be listened to. The petition presented to the Postmaster-General in December last was signed by sixty societies affiliated to the Wire-

less Society of London, and what rapid developments we have seen since then!

Of all the definitions of a gentleman, the one I like best is "he who puts more into life than he takes out." I think all wireless men must be gentlemen, for they are always helping each other and have an eye to the common good.

Apart from ever present technical details of absorbing interest there are many important matters for discussion at this season's meetings. The precise terms of the licences, broadcasting and experimental, are now "in the melting pot," and are of vital concern to us all; the attempt to communicate with the American amateurs on short wave, by way of return for their successful transmission last winter, is a job that can only be done collectively—unless you are a member of a Society you can have no share in it. The forthcoming exhibition will be as full of meat as an egg, and you will need help to assimilate it; and there is much more to be said about broadcasting in all its aspects. So seek out the Secretary of your local society, hear all about these interesting matters, and throw your talents into the common stock in return for the instruction tips, wrinkles, and other valuable help you will receive.

Meteorological Wireless Codes.

By W. G. W. MITCHELL, B.Sc., F.R.A.S., F.R.Met.S.

In the last instalment of this article (pp. 745-749) the coded forecasts for districts were considered. We will now pass on to the form of synoptic reports issued by the Air Ministry.

N.B.—The meaning of the Code letters is explained in the New International Code below. Groups of letters in inverted commas are not in code.

0200 message. (a) $I_n I_n$ BBBDD FwwTT
cbWVH ALaNh C_1 ddVV
0600 message. (b) "Pilot" $I_n I_n$ h_1 ddvv
 h_1 ddvv etc.
1400 message. (c) "Temp" $I_n I_n$ ddt
BBTTH etc.
(dd=day of month, tt=hour of observation G.M.T.)
(d) "Ships" QLLL x_1 llll x_2
BBDD x_3 FvKdx x_4
wwGG x_5 TTtx x_6 CNWrx x_7
 $y_1 y_2 y_3 y_4 z$.
(lll = long. in degrees and tenths; other symbols in New International Code.)

0800 message. (a) $I_n I_n$ BBBDD FwwTT
cbWVH ALaNh RRmmr
 C_1 ddVV (for Inland stations only). $I_n I_n$ BBBDD
FwwTT cbWVH ALaNh
RRSV r C_1 ddVV (for coastal stations only).
(b) (c) and (d) Same form as 0200 message.

1900 message. (a) $I_n I_n$ BBBDD FwwTT
cbWVH ALaNh RRMMr
 C_1 ddVV (for inland stations only) $I_n I_n$ BBBDD FwwTT
cbWVH ALaNh RRSV r
 C_1 ddVV (for coastal stations only).
(b), (c) and (d) as 0200 message.

The reporting stations with their index numbers ($I_n I_n$) are given in the map, p. 820, where C = coastal station, L = inland station. Stations usually reported are in capital letters.

Aviation Reports.

Messages at 0335 "Meteor" (four-figure group indicating time of observations, e.g., for 0335 message group = 0300).
0435 (a) (stations 61, 62, 66)
0535 } $x I_n I_n$ (Vs) wwVhL
0635 } NDDFW.
(Ob. at Croydon 5 min. before transmission of message) "CDN" wwVhL.

[Note.—x = units digit in sum of figures wwVhL.]

Messages at 0735 (a) "Meteor" 0700.
" 1335 (Stations 61 and 66) $I_n I_n$
(Vs) BBBDD FwwTT
cbWVH ALaNh C_n ddF $_1$ S.
(Stations 62, 75) $x I_n I_n$
(Vs) wwVhL NDDF
 C_n ddF $_1$ S. W
(b) (Stations 61 OR 66)
 $I_n I_n$ 49tt h_1 ddvv (tt = hour of pilot balloon ascent).
(Ob. at Croydon 5 min. before transmission of message). "CDN" wwVhL.

Message at 0835 (a) "Meteor" 0800 (stations 61, 62, 66) $x I_n I_n$ (Vs) wwVhL. NDDFW, followed by reports received too late for inclusion in general synoptic report issued at 0800 and in same code.

(f) "Forecast" (in same code as synoptic reports for districts). "CDN" wwVhL.

Message at 0935 (a) "Meteor" 0900 (stations 61, 62, 66, 75) $x I_n I_n$ (Vs) wwVhL NDDFW (station 76) $I_n I_n$ Vs.

(b) Same form as 0735 message (only included if no pilot balloon ascent was available for the 0735 message and one has become available since). "CDN" wwVhL.

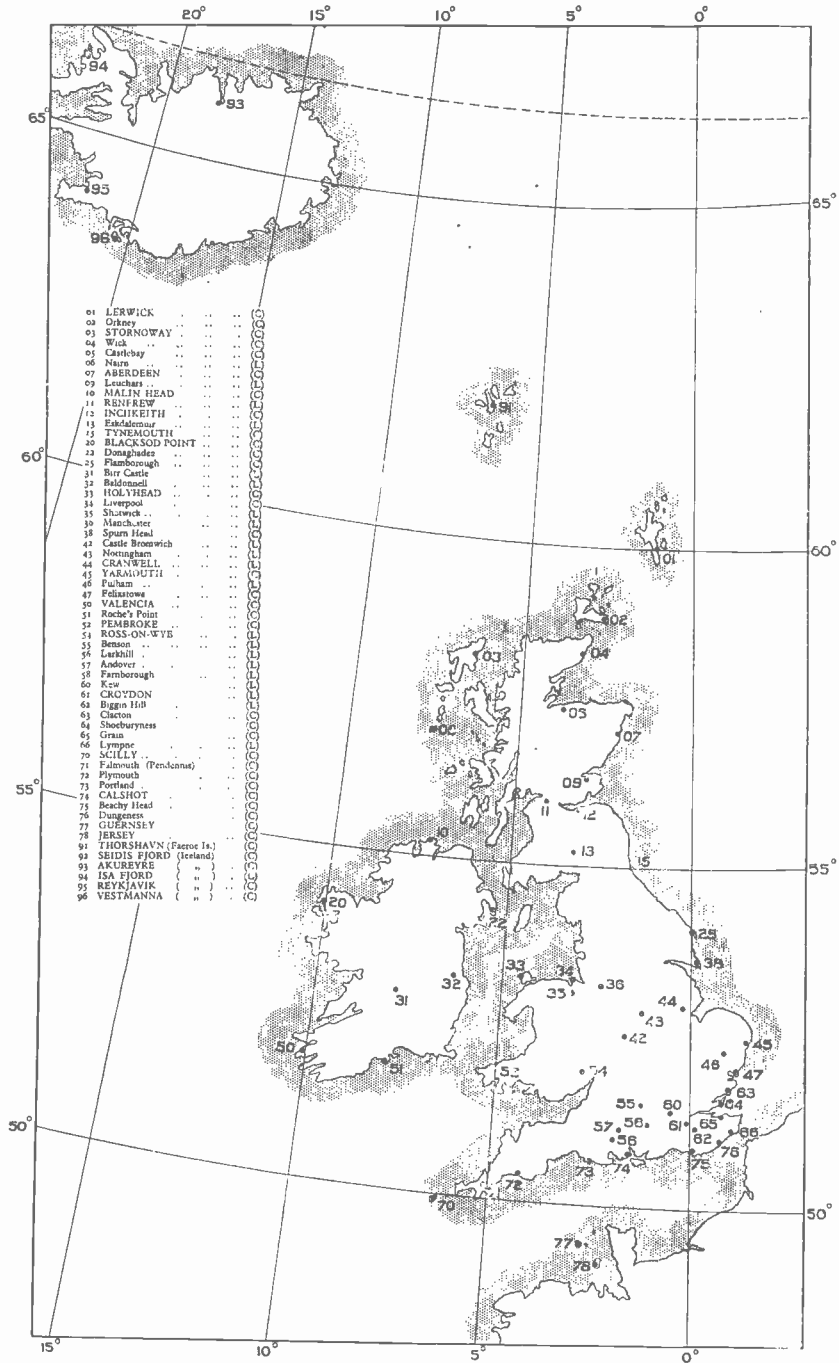

Map showing Reporting Stations with their index numbers.

Message at 1035 (a) "Meteor" 1000 (stations 61, 62, 66) same form as (a) 0735 message.

(Stations 50, 72, 74) I_nI_n BBBDD FwwTT cbWVH ALaNh.
"CDN" wwVh.

Message at 1135 (a) "Meteor" 1100 (stations 61, 62, 66, 75). x I_nI_n (V_n) wwVhL NDDFW.

(b) (Stations 61 OR 66) I_nI_n 49tt h₁ddv.

(f) "Forecast" [same code as 0835 (f)] "CDN" wwVh L.

Message at 1235 (a) "Meteor" 1200 (stations 61, 62, 66, 75, 76) in same code as 0935 (a) message. "CDN" wwVhL.

Message at 1435 (a) "Meteor" 1400 (stations 61, 62, 66) in same code as 0835 (a) message, followed by reports too late to be included in synoptic message at 1400 and in same code.

(f) "Forecast" [same code as 0835 (f)] "CDN" wwVhL.

Message at 1535 (a) "Meteor" 1500 (stations 61, 62, 66, 75, 76) in same code as 0935 (a) message "CDN" wwVhL.

Message at 1635 (a) "Meteor" 1600 (stations 61, 62, 66) in same code as 0735 (a) message. "CDN" wwVhL.

Note.—The word "Botley" when it occurs in a message is followed by a statement in plain language of the conditions on the North Downs (Botley Hill) as viewed from Biggin Hill, when such a statement adds material information to that contained in the rest of the message.

THE NEW INTERNATIONAL CODE.

- A = Form of *predominating cloud* lowest in the scale of cloud forms.
- a = Form of *predominating cloud* highest in the scale of cloud forms when more than one type of cloud exists.
- BBB = Pressure in millibars and tenths (initial 9 or 10 omitted) or millimetres and tenths (initial 7 omitted).
- BB = pressure in *whole* millibars or millimetres (initial 9, 10 or 7 omitted).
- b = amount of barometric tendency during the 3 hours preceding the time of observation expressed in half-mbs. or half-mm.

- C = form of predominating cloud when only one form is reported (see ship observations).
- C₁ = form of cloud observed by nephoscope.
- C_a = form of cloud observed by nephoscope in aviation reports.
- c = characteristic of barometric tendency during the period of 3 hours preceding observation.
- DD = direction of wind near the ground on the scale (01-32) in which 08 = east, 16 = south, etc. 00 = calm.
- dd = direction of wind in the upper air or of cloud movement on the scale (01-36), *i.e.*, degrees from North divided by 10 to nearest whole number, 00 = calm.
- d = direction from which swell comes, (0-8) in which 2 = east, 4 = south, etc., 0 = no swell.
- F = force of wind on Beaufort Scale.
- F₁ = approximate speed of low cloud.
- GG = Greenwich time of ob. (01 = 1 a.m.e 12 = noon, etc).
- H = relative humidity of the air.
- h = height of base of lowest cloud present.
- h₁ = height at which upper wind is reported.
- I_nI_n = index number of station.
- K = characteristic of the swell in the open sea.
- L = amount of sky (scale 0-10) covered by cloud form A.
- LLL = latitude in degrees and tenths, the tenths being obtained by dividing the number of minutes by 6 and neglecting the remainder.
- lll = longitude in degrees and tenths (as for LLL).
- MM = maximum temperature in the interval of 11 hours ending at 18h. G.M.T.
- mm = minimum temperature in the interval of 13 hours ending at 7h. G.M.T.
- N = Total amount of sky covered with cloud.
- Q = quarter of the globe in which ship is situated.
- RR = rainfall at 7 a.m. for preceding 13 hours. and at 6 p.m. for preceding 11 hours.
- R = amount of rainfall for the preceding 24 hours.
- r = time of commencement of precipitation.
- S = state of the sea and swell (coast stations).
- TT = temperature of the air in whole degrees F or C (50 added to negative values).

- tt = temperature of the sea (surface water) in whole degrees.
- TTT = temperature of the air in degrees and tenths F. or C. (500 added to negative values).
- ttt = temperature of the sea in degrees and tenths.
- V = visibility or distance at which objects can be seen in daylight or at which lights can be seen at night.
- v = visibility at sea from ships at sea.
- V_n = visibility towards the sea (from coast stations).
- VV = the relative speed of clouds as determined by nephoscope and such that the actual speed of the cloud will be given in km/hour by the equation
- $$VV = \frac{h}{1,000} VV, \text{ if } h, \text{ the height of the cloud is expressed in metres.}$$
- vv = speed of wind in the upper air in km/hour or mi/hour.
- W = weather in the interval since the preceding time of report.
- ww = the actual weather at the time of observation with which is combined, whenever possible, the general character of the weather.
- x₁ = a check figure obtained by adding the first four figures of the group and taking the units figure in the sum thus obtained.
- x₂ x₃ x₄ x₅ y₁ y₂ y₃ y₄ = check figures.
- z = key figure, obtained by adding all the x's or all the y's.

The All-British Wireless Exhibition

AS we go to press with this issue we learn that the arrangements for the forthcoming All-British Wireless Exhibition to be held at the Horticultural Hall, Westminster, are in full swing.

The hearty co-operation of all those who are taking part in the Exhibition ensures that the event will be one well calculated to absorb the interest of the public at a time when the popularity of wireless is likely to receive a tremendous impetus.

Those who attend the Exhibition are not likely to come away disappointed with the display of equipment which will be laid out for inspection.

There is little doubt that the exhibitors will confine their attention almost exclusively to the interests and requirements of the experimenter, the amateur and the general public, and therein will be noticed a distinction between this exhibition and those exhibitions not of an "all-wireless" category which have been held in the past where the apparatus shown has been principally of a type designed for handling commercial telegraph traffic.

All the most up-to-date designs of complete sets and parts will be on show, and just as the annual motor exhibition is regarded as the

opportunity for the public and prospective purchasers of automobiles to make their choice from all the best that can be displayed, so this Exhibition will fill the same place in affording similar opportunities to those who have interests in wireless.

One cannot help feeling that, to the general public at any rate, a visit to the Horticultural Hall during the week of the Exhibition will be somewhat of a revelation. There must be many who have hardly any acquaintance with wireless beyond perhaps what they have recently read in the daily press, and what they may have gleaned from this source will have served only as an inducement to take a fuller interest in the subject.

For those who already are associated with wireless, the Exhibition will afford an excellent opportunity for initiating friends into the fascinations of the science, and no doubt those who are members of societies especially, will see to it that visitors from their district are accompanied, as far as it is possible to arrange it, by some member who is competent to point out and explain wireless matters so as to add to the enjoyment and profit to be derived from the visit.

No doubt Secretaries of Societies, will

SCALE $\frac{1}{16}$ " to the Foot.

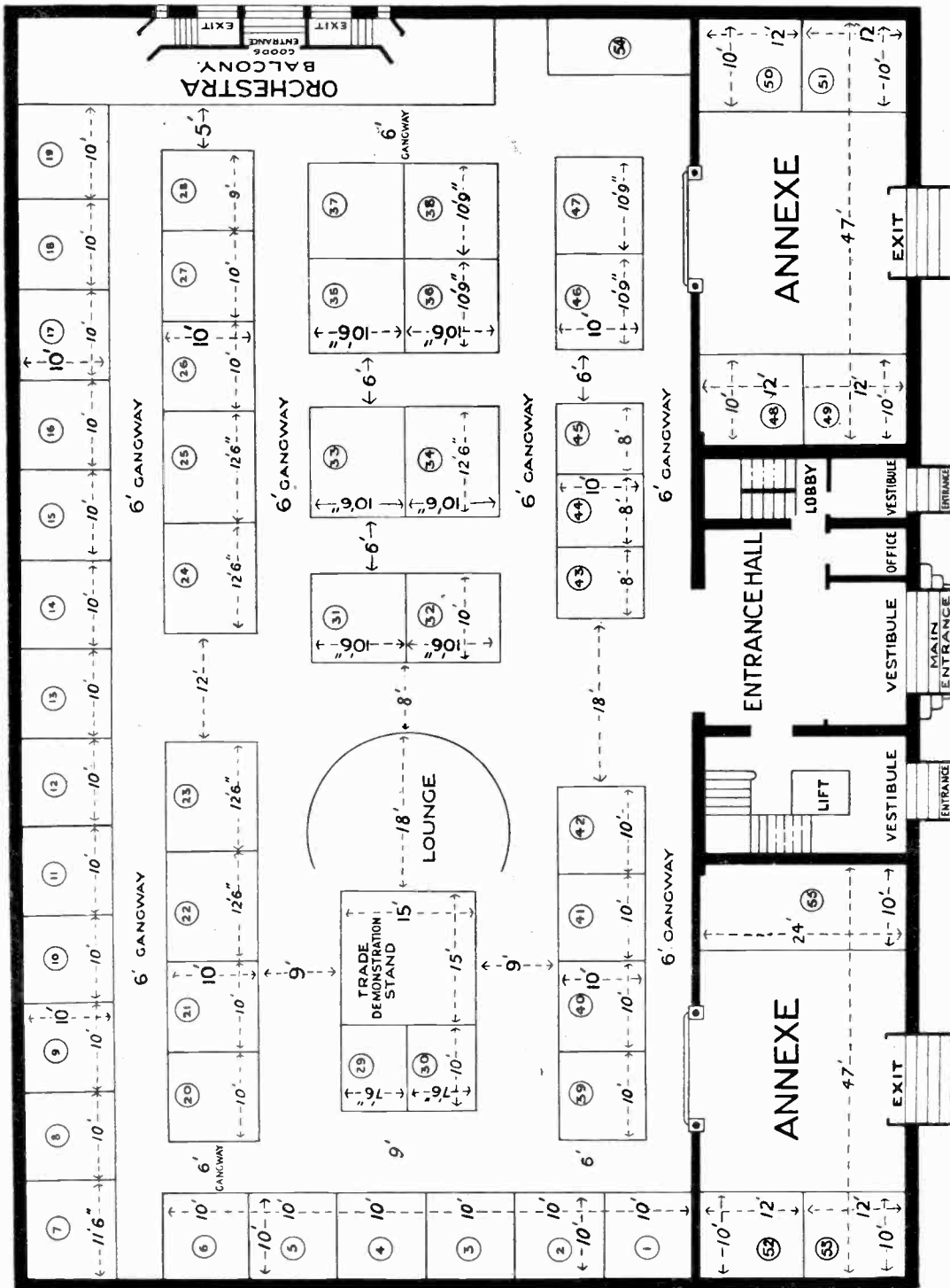

Plan of the Horticultural Hall. For Key see page 824.

endeavour to arrange for parties to visit the Exhibition with this object in view, and such an arrangement will no doubt result in a large influx of new members to the societies.

As has already been announced, the Wireless Society of London is making special arrangements in connection with the social side of the Exhibition, and will be prepared to welcome members of societies and particularly those of provincial societies for whom the Exhibition may afford an opportunity of meeting London society members which they might not otherwise have.

For those who come to London specially for the event and who may have only one day to spare, it is suggested that where possible some day other than a Saturday might be chosen, since on Saturdays it is likely that the Hall will be very full and some difficulty might be experienced in seeing everything as well as meeting socially some of their London friends.

The Wireless Society of London has obtained the services of a number of lecturers who will conduct special lectures, chiefly of a popular nature, for the benefit of visitors to the Exhibition. Such lectures will be held in a lecture room specially provided for the purpose. The following are the names of those who have already kindly promised to give lectures:—

Admiral of the Fleet, Sir Henry B. Jackson, G.C.B., K.C.V.O., F.R.S., D.Sc., M.I.E.E.
 Mr. A. A. Campbell Swinton, F.R.S.
 Mr. F. Hope-Jones, M.I.E.E.
 Mr. Maurice Child.
 Mr. G. P. Mair, A.M.I.C.E.
 Mr. G. G. Blake, M.I.E.E., A.Inst.P.
 Mr. E. Blake, A.M.I.E.E.
 Mr. Philip R. Coursey, B.Sc., A.M.I.E.E., F.Inst.P.
 Mr. W. R. H. Tingey.
 Mr. R. C. Clinker, M.I.E.E.
 Mr. John Scott-Taggart, M.C., A.Am.I.E.E., F.Inst.P.
 Mr. H. Walker, A.M.I.R.E.
 Mr. H. R. Rivers-Moore, B.Sc., A.M.I.E.E.

Below is given a list of the names of those firms who are showing at the Exhibition. This list is arranged in alphabetical order, and alongside each name appears the number of the stand allotted. These numbers form the key to the accompanying plan of the Horticultural Hall, whereon all the stands are given their appropriate numbers.

2 Messrs. Anode Wireless & Scientific Instruments, Ltd.
 46 Messrs. G. Z. Auckland & Son,
 52 Messrs. Automatic Telephone Manfg. Co., Ltd.

19 Messrs. J. B. Bower & Co. Ltd.
 7 Messrs. British Thomson-Houston Co., Ltd.
 42 Messrs. British Wireless Supply Co.
 43 Messrs. S. G. Brown, Ltd.
 12A Messrs. Burndept, Ltd.
 30 Messrs. The Chloride Electrical Storage Co., Ltd.
 29 Messrs. A. C. Cossor, Ltd.
 18 Messrs. Coomes & Co.
 36 Messrs. Dubilier Condenser Co., (1921) Ltd.
 55 Messrs. Bertram Day & Co., Ltd.
 11 Messrs. The Ever Ready Co., (Gt. Britain) Ltd.
 50 Messrs. Econ Manfg. Co., Ltd.
 51 Messrs. Economic Electric Ltd.
 45 Messrs. C. F. Elwell, Ltd.
 10 Messrs. Fellows Magneto Co., Ltd.
 47 Messrs. Gambrell Bros., Ltd.
 31 Messrs. A. W. Gamage, Ltd.
 44 Messrs. Alfred Graham & Co.
 26 Messrs. General Radio Co.
 5 Messrs. Harwell, Ltd.
 17 Messrs. Hart Accumulator Co., Ltd.
 12 Messrs. Hambling, Clapp & Co.
 35 Messrs. H. P. R. Wireless, Ltd.
 9 T. H. Isted, Esq.
 4 Messrs. Igranic Electric Co., Ltd.
 8 Messrs. "K. B." Radio Equipment Co.
 38 Messrs. L. McMichael, Ltd.
 41 Messrs. Mullard Radio Valve Co., Ltd.
 24 Messrs. Marconi's Wireless Telegraph Co., Ltd.
 32 Messrs. The Marconi Scientific Instrument Co., Ltd.
 33 Messrs. Metropolitan-Vickers Electrical Co., Ltd.
 21 Messrs. Mitchell's Electrical & Wireless, Ltd.
 28 Messrs. The M.O. Valve Co., Ltd.
 53 Messrs. Pettigrew & Merriman, Ltd.
 16 Messrs. The Peto Scott Co.
 23 Messrs. Radio Communication Co., Ltd.
 37 Messrs. Radio Instruments, Ltd.
 22 Messrs. Rogers, Foster & Howell, Ltd.
 6 Messrs. Radio Service, Ltd.
 27 Messrs. Radio Press, Ltd.
 54 Messrs. Stanley Prince & Co.
 48 Messrs. Siemens Bros. & Co., Ltd.
 49 H. W. Sullivan, Esq.
 34 Messrs. Sterling Telephone & Electric Co., Ltd.
 25 W. R. H. Tingey, Esq.
 20 Messrs. Telephone Manfg. Co., Ltd.
 15 Messrs. Wates Bros.
 39 Messrs. Western Electric Co., Ltd.
 14 Messrs. Wireless Equipment, Ltd.
 1 Messrs. Wireless Supplies Co.
 40 Messrs. Wireless Press, Ltd.
 3 Messrs. The Zenith Manfg. Co.

It is, of course, not possible at this stage to say anything in detail regarding the apparatus which will be exhibited. No doubt each manufacturer is holding back for the purpose of the Exhibition his most recent productions, and will observe secrecy as to the nature of his exhibits until they are available for inspection on his stand.

In further issues of *The Wireless World and Radio Review* will be described and illustrated some of these attractive features for the purpose of record and for the benefit of those unable to attend the exhibition.

The Radio Direction Finder and its Application to Navigation

SHIP owners, wireless engineers, government departments and others, are giving much attention to the importance of providing wireless direction-finding equipment on board ship by means of which the position of a ship can be quickly and accurately determined. This matter is receiving attention in various countries, especially in the United States. The provision of radio direction-finding equipment on a ship may eliminate serious delays caused by a ship being unable to enter port during a fog because its position, or the bearing of lighthouses, is not known. In case of a wreck, such equipment may be the means of saving many lives.

The wireless direction finder is a device for determining in a simple manner the direction of a radio transmitting station with reference to the point at which the direction finder is located. The direction finder has a considerable number of very practical applications, of which one of the most important is its use as an aid to navigation.

Sound and visual signalling devices have been employed for many years as aids to navigation. Lighthouses and lightships, with their characteristic light flashes and sound signals are established and maintained along the coasts and at harbour entrances in order that shipping may be carried on with maximum safety. During fog or thick weather, however, the sound and visual signalling devices often do not give reliable service.

The wireless direction finder is not affected by fog, and has the further advantage that it will operate over much greater distances than sound and visual signalling devices.

The Department of Commerce of the United States has developed a system of wireless direction finding which has proved to be very simple, practical, and dependable. This system has been developed by the Bureau of Standards in co-operation with the Bureau of Lighthouses: The first installations were made in the Third Lighthouse District, with headquarters at Tompkinsville, N.Y. A common type of direction finder which has been used for installation on shipboard, consists of a coil of ten turns of insulated copper wire wound on a wooden frame four feet square, which is mounted so that it may

be rotated about a vertical axis. Suitable receiving apparatus is used in connection with the coil, and in recent installations has consisted of a variable air condenser for tuning purposes, a balancing condenser for increasing the accuracy of observed bearings, a six-valve amplifier, having three stages of radio-frequency amplification, a detector, and two stages of audio-frequency amplification, batteries, and suitable telephone receivers.

As the coil is revolved about its vertical axis, the intensity of the signal which is being received from the station whose location is to be determined, diminishes until a minimum is reached, which occurs when the plane of

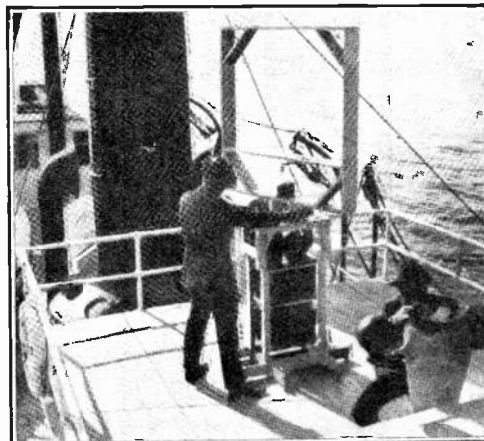

Experimental type of frame on board ship.

the coil comes to a position at right angles to the line of direction to the radio transmitting station. At this point of minimum signal, the bearing is read on a suitable scale, which may be either a fixed scale or the card of a magnetic compass.

In developing this system of direction finding, the Bureau of Standards has made a study of the distortion effects which may result from the presence of adjacent objects, such as the mass of a ship, and methods of eliminating errors which such distortion may cause in observed radio bearings. A particularly careful study has been made of distortion effects on board ship and methods for correcting for these effects by calibration.

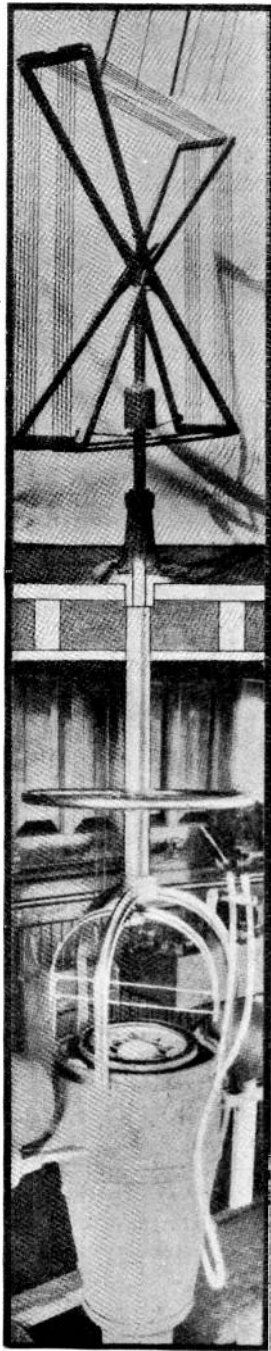

Magnetic compass with direction-finder attachment for direct reading of bearings.

Practical methods have been developed for simplifying the operation of the direction finder. The direction finder is essentially a nautical instrument and should be installed on board where it may be used directly by the navigator in taking bearings on wireless stations established on shore or on light vessels. This can be done with the simplified form. Bearings may thus be taken rapidly, at any time, and as often as desired.

This system should be carefully distinguished from the system of determining positions by wireless, in which the ship transmits signals to radio compass stations on shore, which report to the ship its position. This system avoids the delays and errors likely to occur in depending on radio compass stations on shore, since with the latter, even under the most favourable conditions, valuable time may be consumed in making a request for bearings, taking bearings, and getting the information back to the navigator on the ship.

The wireless direction finder as used by the Department of Commerce involves a number of unique features. It is designed to be installed over the ship's binnacle carrying the magnetic compass card, so that the bearings are read directly on the magnetic compass card. An additional scale is attached to the top of the binnacle and marked with the corrections obtained by calibrating the direction finder. By these means the bearings are obtained in a simple and direct manner. The electrical features have been made such that the only operations necessary when taking a bearing are one adjustment in the receiving set, and the rotating of the direction finder coil.

A transmitting station intended primarily for direction finding work is often called a "radio beacon." Radio beacons may be installed at small expense on lighthouses and light-vessels. The transmitting equipment may be designed to operate automatically by simply throwing a switch, so that no additional personnel is necessary. The radio transmitting equipment is set into operation by the lightkeeper, just as the other signalling devices at the light station. The expense of operation of the radio beacon is therefore small.

The Department of Commerce has established three radio beacons at the approaches to New York Harbour, and these are now in regular commission. A radio beacon is being installed on San Francisco Lightvessel No. 70. These beacons have automatic trans-

mitting equipment so that no operator is necessary.

The Bureau of Standards has recently issued a publication describing this system of radio direction finding.* This publication shows numerous photographs of a radio

cross-bearings on the three radio beacons, and courses were set for one of the lightvessel beacons by taking a radio bearing directly on the beacons. The paper deals briefly with the principles of the operation of the direction finder, but is primarily concerned with practical

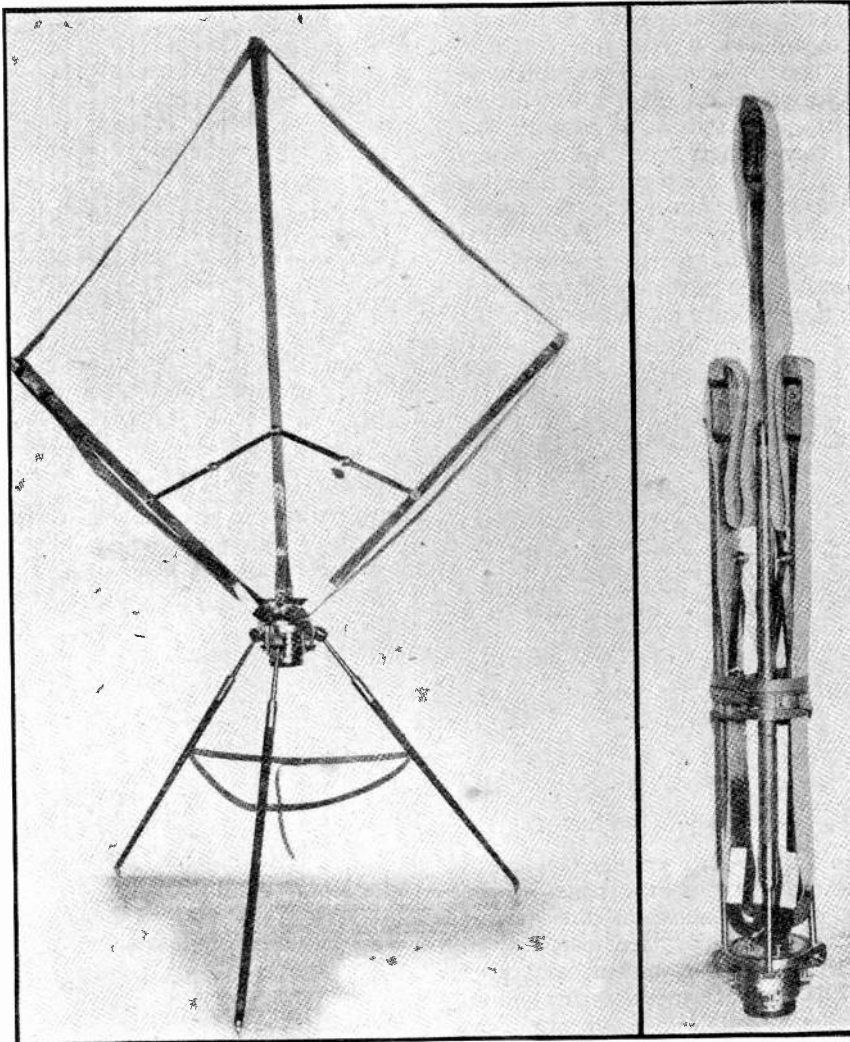

** Collapsible type of direction-finding frame aerial for field use.*

direction finder of the type mentioned above, as installed on the pilot house of a lighthouse tender. Actual courses are shown which were run by means of radio bearings taken by the ship's navigator, on the three beacons at the approaches to New York Harbour. In these tests, positions were determined by

development which has made possible a device sufficiently simple and accurate for use as an aid to navigation, and with practical applications which have been made.

* A new publication issued by the Bureau of Standards, No. 428.

A Variable H.F. Transformer

By L. W. C. MARTIN.

IDARESAY that in common with myself many amateurs have experienced difficulty in getting efficient reception on short waves such as are now being used. A difficulty arises in the limited wavelength range of H.F. transformers. Since a transformer designed for 350 metres cannot be so efficient on 500 metres, it stands to reason that many H.F. transformers will be necessary to cover, say, 150 to 1,000 metres, since the shorter the wave the closer the tuning required for efficient reception. If a variable condenser is used across the primary, the capacity must be kept extremely low, or when brought into use efficiency falls off very rapidly.

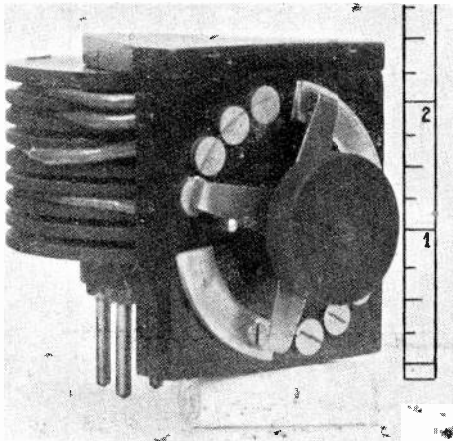

The finished Variable Transformer.

I myself use a three-plate vernier condenser, with one moving and two fixed plates spaced $\frac{1}{8}$ in. apart, $1\frac{1}{4}$ in. radius for the moving plate, $1\frac{1}{2}$ in. radius for the fixed plate. Even this is on the large size, but if only used quarter or half the movement, as maximum, it is satisfactory, and will cover any gaps between various wavelengths.

The H.F. transformer I have designed and will describe here with details of construction covers all wavelengths from 350 to 1,000 metres, and is much better to handle than half a dozen small plug-in transformers, whilst being equally efficient on any wavelength. Slight modifications can be made for covering a different range of wavelengths, shorter or longer.

Referring to Fig. 1, this should be as near as possible to dimensions given, and should be

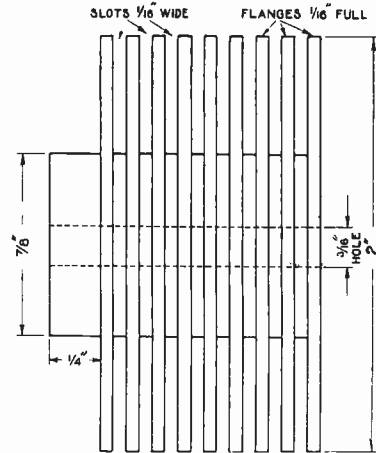

Fig. 1. Turned ebonite bobbin.

turned out of one piece of solid ebonite, 2 ins. in diameter and $3\frac{1}{2}$ ins. long. This will allow ample for holding in the chuck of the lathe.

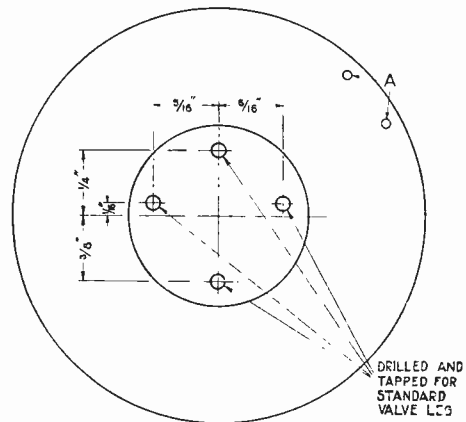

Fig. 2. View showing setting out of connector pins.

Fig. 2 shows the bottom of the former drilled and tapped to take ordinary valve legs, which can be purchased for a few pence, and will fit the standard "R" type valve holder.

Fig. 3 is the front of the switch, made of a piece of ebonite 2 ins. square, $\frac{3}{8}$ in. thick, studs $\frac{1}{2}$ in. long, screwed in, leaving $\frac{1}{8}$ in.

at the back for soldering connection. A small peg screwed in where shown will act as a stop for both ways.

drilled for fixing, one or both fixing screws projecting at the back of the ebonite for connections.

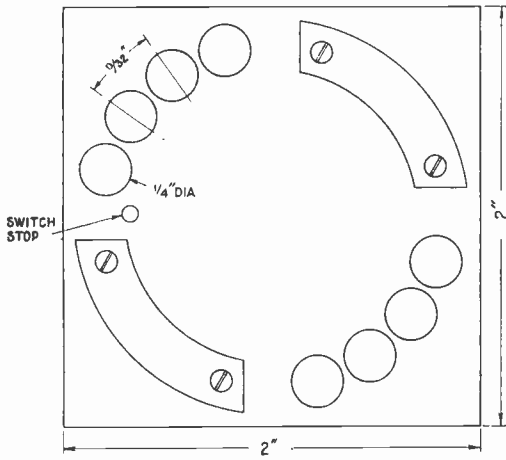

Fig. 3. Front piece with contact studs and plates.

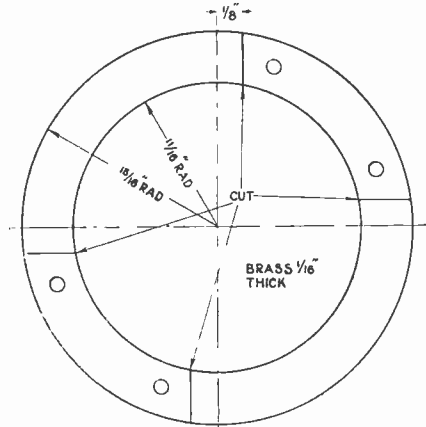

Fig. 4. Method of cutting contact plates.

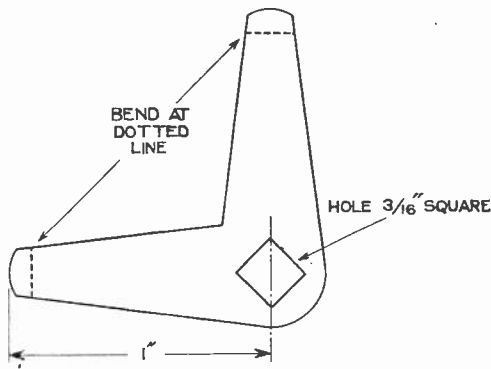

Fig. 5. A switch.

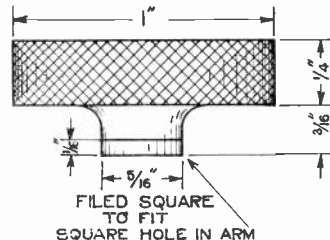

Fig. 6. Ebonite Knob.

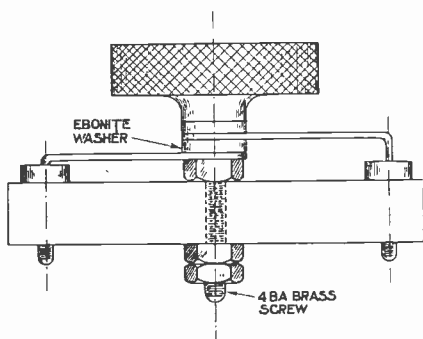

Fig. 7. Assembled switch parts

Fig. 4 is for the contact plates, and can be turned out of brass or bronze, and cut where shown, having two small holes

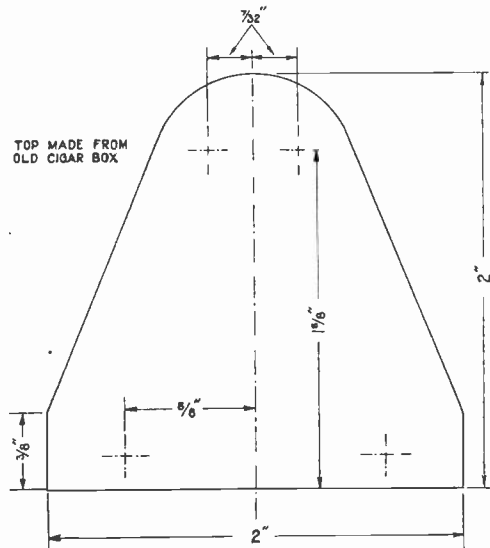

Fig. 8. End piece for attaching bobbin to switch plate.

Fig. 5 shows one switch arm. There must be two of these, the only difference being that one is $\frac{1}{16}$ in. longer, and a 4 B.A. round hole in the centre. These can be made of thin springy brass or bronze.

Fig. 6 is the ebonite knob. Great care must be taken in fixing the two arms to see that they do not touch one another. The arm with the square hole should fit on the square part of the knob, and a small ebonite washer $\frac{1}{16}$ in. thick, $\frac{5}{16}$ in. diameter, with a

4 B.A. hole must go between the arms, and be assembled as in Fig. 7.

Fig. 8, I think, will explain itself.

Now wind each slot in the former with 90 turns of 40 S.W.G., S.S.C., copper wire. Care must be taken to wind all slots in the same direction. Every other slot will be primary, secondary, primary, secondary, and so on. If two $\frac{1}{16}$ in. holes are drilled lengthways right through the edge of former, as shown at A, Fig. 2, the wire can be conveniently run from slot to slot, using one row of holes for primary and the other for secondary. Connect the first finish of primary with the second start of primary, and so on until the fourth. Then repeat the same way with the secondary, leaving about 1 in. of wire to spare for tappings, and connect as the diagram Fig. 9.

The first stud covers 350 to 370 metres with half the condenser value; *between* first and second stud 370 to 420 metres. The second stud gives 420 to 600 metres, the third stud 600 to 900 metres, and the fourth stud 900 to 1,100 metres. If this transformer is well made, it is well worth the little trouble involved.

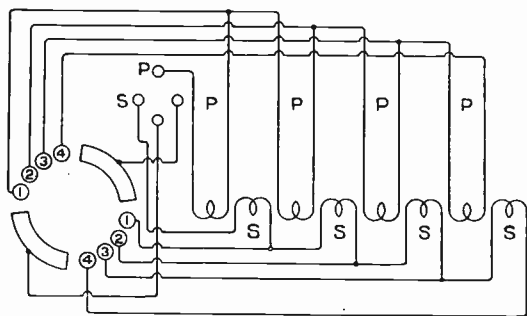

Fig. 9. Connecting up windings.

A Cheap Method of Obtaining H.T. for Telephony Transmission

MOST amateurs possessing transmitting licences are generally very much handicapped by the high cost of high voltage direct current, whether obtained by a generator or by dry batteries. The author has been conducting some experiments for obtaining smooth D.C. suitable for telephony from an induction coil and has met with great success, the cheapness of the method being extraordinary.

The way in which it is done is as follows: First obtain an old induction coil and rewind it for a primary voltage of about 6 to 10 volts, with a step up of about 100:1. The author uses an old Army T.V.T. unit, which is very satisfactory and does not require altering. Having obtained your high voltage alternating current the next step is to rectify it, and for this purpose the ordinary "R" valve will be found entirely satisfactory; to get ten watts,

two in parallel should be employed. The plates and grids of these valves are connected together and the current passed through them from filament to plate, taking care to see that the pulse of current at break is utilised as it is much larger than that obtained at make. The direct current thus obtained is very uneven and is of no use for telephony unless it is smoothed out by means of condensers; a condenser of sufficient size to stand 600 volts or more is, however, an expensive item, but quite a suitable condenser can be made for about five shillings by purchasing three 2 MF. Mansbridge condensers and connecting them in series. Using this arrangement the author gets 25 milliamperes at 400 volts and the C.W. is perfectly smooth, giving good telephony. This seems to be a satisfactory solution of the problem of obtaining cheap high tension for telephony transmission.

M. C. E.

A Simple Form of High Tension Battery

THE plates of this battery are made of sheet lead about $\frac{3}{32}$ in. thick. They may be cut out by means of shears or a wood chisel, the shape shown in Fig. 1 being the most economical as only the small cross-shaded pieces are waste.

To increase the capacity the surface of the lead is indented or roughened by squeezing it in the vice against a rough file or rasp, one face only of each plate being so treated.

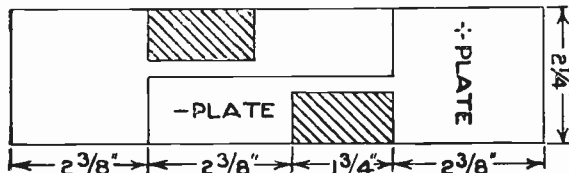

Fig. 1. Dimensions of the plates.

The plates are then formed into cylinders by bending them round rods of suitable size, the roughened surface being inside the larger cylinder and outside the smaller.

The most suitable containing vessels are round glass tubes known as "specimen tubes," about three inches high and one inch diameter, obtainable from dealers in chemical apparatus. A wood tray to contain any required number of these tubes is made, allowing about $\frac{1}{8}$ in. between the tubes for insulation, and drilling a number of holes through the bottom for draining spilt acid. The tray may be supported on four ebonite feet.

The inside of the tray is then painted with anti-sulphuric enamel and a framework of ebonite strips fitted into the bottom to support and insulate the cells. Lateral movement at the top of the cells is prevented and insulation secured by rods of glass or ebonite $\frac{1}{8}$ in. diameter, fitted into grooves in the sides of the tray.

When the tubes are in position a small piece of glass or ebonite rod is placed across the bottom of each cell to allow any sediment to fall clear of the plates. To keep the plates from contact with each other within each individual cell, thin perforated ebonite is used, cut to size with scissors, warmed, and bent round the smaller cylinder.

The plates are then fitted into the cells, beginning at the positive end with a single outer cylinder. The connecting strap of the next pair is then bent so that when the negative cylinder is placed in the centre of the first positive, the attached positive will just fit into the second cell. When all the plates are

in position, the strap of the last negative (a small single cylinder) and the first positive are fastened to terminals fixed to an ebonite plate screwed to the side of the tray.

The cells are then filled with dilute sulphuric acid (sp. gr. 1.180) to the level of the plates, and oil, known as Price's "Blancol," poured on the top to a depth of $\frac{1}{8}$ in., to prevent spraying and evaporation.

The plates are "formed" by the Planté process of charging in one direction and discharging, then charging in the opposite direction and discharging. After this has been done a number of times the cells will be found capable of maintaining a current of

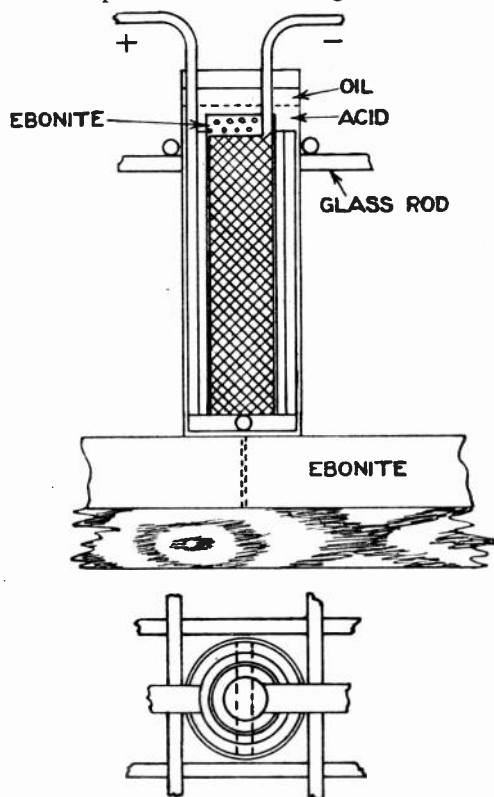

Fig. 2. The complete cell.

ten milliamperes for five hours or a smaller current for a longer time.

The rate of charge is from 20 to 30 milliamperes.

A number of these batteries have been in satisfactory use for some months in the wireless section of the Electrical Engineering Dept. of the City and Guilds Engineering College.

Notes

French Railway Experiments.

A committee of experts in France, who have been conducting research with telegraphy on moving trains on the Paris-Orleans line, report that their efforts have met with success. A small portable apparatus was used, and long distance signals were clearly received while the train was moving at full speed.

It is now hoped that with special aerials affixed to the roof of a coach telephony will also be received.

During their experiments members of the committee set up apparatus at some of the stations on the tour and invited farmers and others to listen-in.

Telephony Reports of Weather Forecasts.

Dr. G. C. Simpson, the director of the Meteorological Office, told the mathematical and physical science section at the British Association meeting that he anticipated that weather forecasts would soon be issued by telephony. A plan of this nature, he said, had already been prepared with details worked out for distributing the "general inference" by wireless telephone as soon as there was an organised scheme for broadcasting in this country. Forecasts would be issued in this way by the Meteorological Office immediately broadcasting was authorised.

British Association Demonstration.

As previously announced, the Meteorological Office and the Air Ministry provided a demonstration during the meeting of the British Association at Hull. It was shown by weather forecasts that anyone possessing a small receiving set can pick up the messages at the hours fixed by the Air Ministry, Eiffel Tower and other stations.

Although the messages received were in code, it was clearly demonstrated that the code was not secret and was decipherable by any amateur, and that the information could be utilised by all who cared to study the method. (See articles appearing in this journal).

Concerts by 2 LO.

Permission has been applied for to broadcast wireless concerts from Marconi House on Friday and Saturday, September 22nd and 23rd at the following times: 5—5.30; 6—6.30; 7—7.30 p.m.

These transmissions are dependent upon permission being received from the Postmaster-General. They will be in aid of the Ex-Services Welfare Society's Carnival at Holland Park Hall.

Dissolution of Partnership.

Mr. J. Griffin and Mr. J. O. Nichol, wireless specialists, trading under the title of the Star Delta Wireless Company, at 333a, Oxford Road, Manchester, have dissolved partnership. Debts will be attended to by Mr. Griffin.

Anglo-American Service.

Telegraph offices and cable company offices in the United States were opened on September 12th to accept messages for wireless transmission to Great Britain by the service conducted by the Radio Corporation of America and Marconi's Wireless Telegraph Co., Ltd.

Cost of French Weather Warning Stations.

Weather forecasts sent out by the National Meteorological Office of France for the benefit of agriculturists are received on sets installed at parish schools or gendarmerie stations at a cost of 200f. (£4). Weather warnings are given locally by sounding a bell.

Stolen Apparatus.

At Penge Police Court, William Thomas Hinton and James Watts were each sentenced to two months' imprisonment with hard labour for being concerned together in stealing from a railway truck at the goods depot at Penge Railway Station a wireless receiving set valued at £4 10s.

Coming Exhibition at Manchester.

Space is now being booked for a Wireless Exhibition to be held at the City Exhibition Hall, Manchester, in the last week of April.



The Fire resulting from the recent attack on MFT.

Clifden.

The accompanying photograph is a snapshot taken by Mr. A. J. May at the wireless station at Clifden, Ireland, and illustrates the burning of a part of the station during recent fighting in that district. The damage done to the station was referred to in our issue of August 5th, page 594,

Broadcasting Progress.

On Tuesday, September 12th, a meeting took place in London between the Committee of the proposed Broadcasting Company and certain officials of the General Post Office. As a result of this meeting it is understood that an official statement on the subject of broadcasting may be expected from the Postmaster-General very shortly.

Experimental Station Design: A Correction.

In Fig. 6(b), p. 794, the positive and negative connections of the H.T. battery have been shown reversed. The H.T. positive should, of course, go to the plates of the valves.

Edinburgh Society's New Station.

Edinburgh and District Radio Society's new transmitting station has the call sign **2TF** and not **2FT** as previously stated.

Elementary School Set at Southampton.

At the celebration of the coming of age of the Wittington Road School, Southampton, the formal inauguration of a wireless receiving apparatus took place.

Lost Postal Packets.

The Secretary of the Wireless Press, Ltd., having been advised that the mail intended for his company has been tampered with, he would be glad if any of our readers who have sent communications to the Company and who have not received replies, would forward, addressed to him, full particulars of such communications.

La Fayette.

At the new station to be opened at La Fayette, Bordeaux, the Société Française Radio-Electrique is to carry out the work of equipment. The type of apparatus will be the same as for Sainte Assise.

The West London Wireless and Experimental Association.

Mr. Horace W. Cotton, Hon. Sec., 19, Bushey Road, Harlington, Middlesex, has issued a special notice as follows:—On and after Friday evening September 22nd, 1922, and every subsequent Friday, the meetings of this Association will be held at its new headquarters at Stamford Brook Lodge, Ravenscourt Park, W.6 (close to Stamford Brook Station, District Railway), from 7 to 10 p.m.

Re-charging of Batteries.

In order to meet the requirements of suburban and other users of "Hart" portable batteries in London, the Hart Accumulator Co., Ltd., of Marshgate Lane, Stratford, intend inaugurating a motor service for re-charging. For a few shillings monthly, we are told, they would send regularly to various districts in and around London, and collect batteries, and promptly re-deliver them in a fully charged condition, ready for use. The scheme will mature if sufficient users take advantage of it. When communicating with the Hart Accumulator Company the voltage and capacity of the battery in question and the approximate number of times per annum the battery would be required to be recharged should be mentioned, and the letter marked "For Wireless Department."

Calendar of Current Events**Friday, September 22nd.**

BELVEDERE AND DISTRICT RADIO AND SCIENTIFIC SOCIETY.

Lecture on "Construction of Society's Apparatus," by Mr. S. Burman.

WAKEFIELD AND DISTRICT WIRELESS SOCIETY.

Lecture by Mr. H. E. H. Burbury.

LEEDS AND DISTRICT AMATEUR WIRELESS.

At 8 p.m. Second Annual General Meeting.

Sunday, September 24th.

Daily Mail Concert from the Hague PCGG 8 to 9 p.m. B.S.T., on 1,085 metres.

Monday, September 25th.

IPSWICH AND DISTRICT WIRELESS SOCIETY.

Sale and exchange of apparatus at 55, Fonnereau Road, Ipswich.

ILKLEY AND DISTRICT RADIO SOCIETY.

At 8 p.m., at Regent Café. Morse practice.

Tuesday, September 26th.

Transmission of Telephony at 8 p.m. on 400 metres by 2MT Writtle.

Wednesday, September 27th.

REDHILL AND DISTRICT Y.M.C.A. WIRELESS SOCIETY.

At 111, Station Road, Redhill. Lecture on "Phones and Loud Speakers," by Mr. White.

PORTSMOUTH AND DISTRICT WIRELESS ASSOCIATION.

A special lecture by Mr. Gall.

Thursday, September 28th.

Daily Mail Concert from the Hague PCGG, 8 to 9 p.m. B.S.T., on 1,085 metres.

RADIO EXPERIMENTAL ASSOCIATION. *

NOTTINGHAM AND DISTRICT.

Meeting at Room 74, Mechanics' Institute. Discussion on Mr. Ford's lecture on "Radio Measurements." Subscriptions due.

Friday, September 29th.

WIRELESS SOCIETY OF HIGHGATE.

At Highgate Literary and Scientific Institute, South Grove, Highgate, N.6. Annual General Meeting, Election of Officers, Annual Report, etc.

BELVEDERE AND DISTRICT RADIO AND SCIENTIFIC SOCIETY.

Lecture on "Oscillatory Circuits," by Mr. A. G. Warren, M.Sc.

Sunday, October 1st.

Daily Mail concert as above.

Monday, October 2nd.

ILKLEY AND DISTRICT WIRELESS SOCIETY.

At 8 p.m. at Regent Café. Morse practice.

Tuesday, October 3rd.

Telephony by 2MT Writtle, as above.

GREENWICH WIRELESS SOCIETY.

At 7.45 p.m. At Rangers House, Blackheath. Ordinary Meeting.

Wednesday, October 4th.

PORTSMOUTH AND DISTRICT WIRELESS ASSOCIATION.

Lecture on "Portable Receivers," by Mr. Donkin.

Thursday, October 5th.

Daily Mail concert as above.

Wireless Club Reports

NOTE.—Under this heading the Editor will be pleased to give publication to reports of the meetings of Wireless Clubs and Societies. Such reports should be submitted without covering letter in the exact form in which they are to appear and as concise as possible, the Editor reserving the right to edit and curtail the reports if necessary. The Editor will be pleased to consider for publication papers read before Societies. An Asterisk denotes affiliation with the Wireless Society of London.

West London Wireless and Experimental Association.*

Hon. Secretary, Mr. Horace W. Cotton, 19, Bushey Road, Harlington, Middlesex.

A meeting was held on August 31st. Buzzer practice was attended by a good number. Owing to several members still being on their annual holidays nothing exceptional was arranged for. "Listening in" on club's apparatus and an informal chat took place; many questions as to the restriction in connection with the use of reaction circuits were asked, and a question in form of a resolution was sent to the Wireless Society of London in connection therewith. A good attendance was made.

On September 7th another meeting was held. The Morse practice class was well attended. Mr. J. F. Bruce related his experiences in connection with the Armstrong circuit and loop aerial, and much information was given to the members present in connection therewith.

Members are asked to turn up strongly in future and to watch for forthcoming events. It is hoped to have many lecturers from the Wireless Society of London down during the winter session. The Secretary will have much pleasure in replying to any inquirers as to membership, etc.

Club rooms, Belmont Road, Chiswick, W.4.

The Wallasey Wireless and Experimental Society.*

Hon. Secretary, Mr. C. D. M. Hamilton, 24, Vaughan Road, Wallasey.

On Thursday, August 10th, Mr. Smith kindly read the Society a paper entitled "Useful Wireless Data."

The paper was most instructive and entertaining. A hearty vote of thanks to Mr. Smith was passed on the termination of his lecture.

On Saturday, the 19th, experiments were conducted at Irby Hill, with a two-valve receiver. Excellent results were obtained.

The Society's thanks are due to Mrs. Dodd, who kindly lent the field in which the experiments were made.

Members are requested to note that owing to the Hague concerts, the meeting night has been altered to Wednesday, starting at 7.30 p.m.

Smethwick Wireless Society.*

Hon. Secretary, Mr. Ralph H. Parker, F.G.S., Radio House, Wilson Road, Smethwick, Staffs.

A meeting was held on Friday, August 11th, Mr. J. Stoney, B.Sc., A.M.I.M.E., in the chair. After the usual buzzer practice the meeting was left open for discussion; it was also arranged that some of the senior members should give short and concise lectures bearing on the elementary principles of wireless for the benefit of a large number of new members.

Mr. C. Grew gave a short discussion on aerials on Friday, August 18th, which was very much appreciated.

A lecture entitled "That Little More Per Cent. Efficiency" was given on September 2nd, by Mr. McKerle. After a vote of thanks had been passed, Mr. Headley, of the Birmingham Club, gave some of his experiences of transmission and reception at Baggeridge Colliery at particular distances underground. A hearty vote of thanks was accorded to Mr. Headley who reciprocated.

Leeds and District Amateur Wireless Society.*

Hon. Secretary, Mr. D. E. Pettigrew, 37, Mexborough Avenue, Chapeltown Road, Leeds.

A general meeting was held at the Leeds University on Friday, September 8th, Mr. A. M. Bage (Vice-President) taking the chair at 8.0 p.m. The Chairman called upon Mr. H. Mortimer, of the P.O. Telephones (Leeds) to deliver a paper on "Automatic Telephony." Mr. Mortimer successfully conveyed to the meeting the principle upon which the complicated mechanism installed at the Leeds Exchange functioned. The lecturer briefly outlined the historical facts relating to his subject, and paid special attention to the work of Keith. The principles upon which the old hand-operated exchange worked were considered, in order that one could appreciate fully the great advantages attached to automatic operation. With the aid of lantern slides and the apparatus on view, the methods of automatic operation were explained and made clear to the meeting. The circuits were traced from a subscriber to the exchange by the open and underground wires. It is intended to substitute underground wires or cables for all overhead or open wires. The circuit in the exchange is completed by various apparatus, including the line switch, junctions, the selector switch, etc., and on to the called subscriber by underground and open wires. Most of the switches used seemed extremely delicate devices, being a combination of electrical and mechanical operations. The method of working public telephones was considered, and the means of rectifying faults treated. The lecture concluded with numerous lantern slides showing views of the Leeds Exchange.

The Chairman then opened a discussion, which undoubtedly resulted in the membership acquiring a much greater respect for the P.O. telephone than had hitherto been the case. Numerous practical and theoretical questions were ably dealt with by the lecturer. At the close of the discussion, a hearty vote of thanks was accorded to Mr. Mortimer, for his kindness and for the trouble he had been to in arranging so instructive and fascinating a paper.

The meeting then adjourned.

The second annual general meeting (for members only) will be held on Friday, September 22nd, at

8.0 p.m. Meetings next session will probably be held weekly, formal (general) and informal (instructional) meetings being held alternately. The Hon. Secretary is drawing up a syllabus of lectures, demonstrations, etc., for the approaching session, 1922-23, and will be pleased to hear from members of local societies, who would lecture before this Society. Intending members should apply to the Hon. Secretary.

The East London Radio Society.*

Hon. Secretary, Mr. L. E. Lubbock, King George's Hall, East India Dock Road, Poplar.

At a meeting held on Tuesday, September 5th, at the Lecture Hall, Woodstock Road, E.14, the matter of changing the Society's meeting night was discussed at length.

This Society is a large one. It is becoming larger every week and all the members are keen to attend regularly. So much so that it was difficult to find any one night to satisfy everyone. After a considerable amount of discussion it was unanimously decided that it would be absolutely necessary, in view of the increasing membership, to have the Society's accommodation and apparatus at the disposal of the members for at least two evenings every week; these to be Tuesday and Friday.

The first Tuesday in every month being Committee night, the Management Committee then adjourned to their own room, leaving the rest of the members, with the Society's four-valve set, listening in.

The Management Committee arranged the programme for the next month, reserving Tuesdays for lectures and debate, and Fridays for experimental work.

The new arrangement of meeting nights promises well, for on Friday, September 8th, even more members attended than on the previous Tuesday.

The meeting was opened with the usual buzzer practice, after which the Society's sets were put into operation and the members spent the rest of the evening in open discussion. A very pleasant evening ended at 10.15 p.m. with a hearty vote of thanks to the Chairman.

Wakefield and District Wireless Society.*

Hon. Secretary, Mr. Ed. Swale, 11, Thornes Road, Wakefield.

A meeting of the above was held in the Physics Laboratory of the Grammar School, at 8.0 p.m. on Friday, September 8th, Mr. Wrigley in the chair. The minutes were read, after which Mr. G. E. Welch was called upon to deliver his lecture on "Simple Facts and Experiments in Electricity."

For upwards of an hour Mr. Welch described the composition of batteries of various kinds, building of an ammeter, voltmeter, measurement of voltage and resistance, electro-magnetism, etc., together with apparatus and blackboard illustrations.

The Chairman moved a vote of thanks for his kindness in making the meeting such a success. Mr. Haig seconded, and the vote was passed very heartily.

The members are looking forward to Mr. H. E. H. Burbury's lecture on the 22nd, probably at the Y.M.C.A., Grove Road, to which intending members are cordially invited.

Wireless and Experimental Association.*

Hon. Secretary, Mr. Geo. Sutton, 18, Melford Road, S.E. 22.

At the meeting of the Association at the Central Hall, Peckham, on Wednesday, September 6th, Mr. Voigt, fresh from his holidays, detailed the various experiments which he had carried out with the Postmaster-General's permission on a portable receiving set at the hotel where he stayed.

From above the roof to the metal pipes below the cellar floor and every inch in between he carried out his researches, and even did not cease experimenting in the railway carriage which conveyed him home, and, as one might expect, some of the results he got were worthy of note.

His fellow members shared his successes with him on Wednesday, his failures they sympathised with, and few did not add to their sum of wireless knowledge as the result.

The Association went into committee to consider what should be done to meet the vague threats on their liberties, and the Secretary was instructed to write to the Postmaster-General to seek light upon their present and future position. A letter was written and sent to the Secretary, Wireless Section, G.P.O., on the subject of prohibition of the use of amateur constructed receiving apparatus. The letter offered the suggestion that all members of a properly organised and affiliated Wireless Society may be decent *bona-fide* experimenters, and stated that the Association's committee would do all in its power to assist in "keeping order in the ether."

Ilkley and District Wireless Society.

Hon. Secretary, Mr. E. Stanley Dobson, "Lorne House," Richmond Place, Ilkley.

The Fourth General Meeting of the Society was held at the premises of Mr. Francis Law, Tower Buildings, Ilkley, on September 11th. The chair was taken by the President, Dr. J. B. Whitfield. Following the reading of the minutes of the previous meeting a resolution was passed, deciding on the construction of a receiving set for the society. A committee was appointed to draw up a scheme and prepare estimates to be brought before the next general meeting.

The Chairman then called on Mr. Law to give his lecture on "The Theory, Use and Maintenance of Accumulators." The lecturer commenced by showing the difference between primary and secondary cells and demonstrated the principle of the accumulator in its simplest form by means of "Planté's Electrolysis experiment." The development of this was then traced up to the storage cell as used in practice at the present day. The different makes of cell were explained in turn, the construction of the plates being dealt with in detail. Mr. Law then proceeded to give some very useful hints on the care of cells. The allowable rates for charge and discharge were dealt with, with particular regard to the needs of the wireless amateur using one or more valves. Instructions for charging cells at home, where necessary supply of current is available were given, and the causes of sulphating and buckling were explained, together with the appropriate remedies where such are possible.

At the close of the lecture a hearty vote of thanks was accorded to Mr. Law, and an interesting discussion followed.

Belvedere and District Radio and Scientific Society.

Hon. Secretary, Mr. S. G. Meadows, 1, Kentish Road, Belvedere, Kent.

A successful meeting of the above society was held on Friday, September 8th, at the Erith Technical Institute, for the purpose of enrolling members, a preliminary meeting having been held in July. The President (F. J. Watson, Esq.) was in the chair.

The programme of weekly meetings for the month of September was arranged. Lectures were to be given by Mr. A. G. Warren, M.Sc., M.I.E.E., F. Inst. P., on "Scope of Wireless" and "Oscillatory Circuits." Mr. S. Burman will commence a series of lectures on "The Construction of the Society's Apparatus."

The Secretary was instructed to apply for affiliation to the Wireless Society of London.

There were 47 members enrolled and it is hoped that this number in the near future will be considerably increased.

The Secretary will be pleased to give full information to amateurs living in Erith, Belvedere and district.

Fulham and Chelsea Amateur Radio and Social Society.

Secretary, Mr. R. S. V. Wood, 48, Hamble Street, Fulham, S.W.6.

A general meeting of the above Society was held at their temporary headquarters at the Social Centre, Townmead Road, Fulham, attendance for the evening being 45 and new members enrolled numbered 8.

The crystal set was fully discussed by the members, and numerous question papers were handed in. The majority being dealt with by the Secretary.

Ladies are specially invited to join the above Society. Full particulars may be obtained from the Secretary.

The Fulham and Putney Radio Society.

Hon. Secretary, Mr. J. Wright Dewhurst, 52, North End Road, West Kensington, London, W.14.

The above Society started the autumn season with a meeting at their new headquarters on Friday, September 8th. The new headquarters is a large studio centrally situated, and has a large aerial fitted, and has been kindly lent by Mr. E. Vernon Barker, M.P.P.A.

As a prologue to the meeting Mr. Barker switched on his set and the members heard the result of the air race through a Brown loud speaker.

A considerable amount of business was done at the meeting, a new committee was formed to deal with the rules, etc. By a vote of the members it was found that Friday evening was a more suitable night for the meetings, and so the future meetings will be held on that night. A large number of new members were enrolled with promises of more to follow. It was decided that the first Friday in each month should be set apart for lectures and it is hoped to start with a well-known lecturer on the October meeting, the between meetings to be devoted to Morse buzzer practice and minor demonstrations and discussions.

At the conclusion of the business Mr. E. Vernon Barker, who is a member of this and the Willesden

Society, explained his apparatus to the members, and with five valves and the Brown loud speaker obtained music and singing that was rendered particularly clear and free from the usual disturbances. Mr. Barker was congratulated upon the completeness and arrangement of his apparatus and it was nearly 11 p.m. before the meeting closed.

All amateurs in the district are cordially invited to join the Society, and are assured of a continuance of instructive and entertaining meetings.

The Society has been formed purely as a Wireless Society devoted to the assistance of the amateur and novice in the science of wireless telegraphy and telephony.

Southampton and District Wireless Society.

Hon. Secretary, Mr. T. H. Cutler, 24, Floating Bridge Road.

The weekly meeting of the above Society was held on Wednesday, September 6th, at Kingsland Assembly Rooms. A fair attendance was recorded. Dr. MacDougall brought his three-valve receiver to the meeting and gave an interesting demonstration, which was thoroughly enjoyed by all present. Mr. Goodall, of Southampton, also gave from his experimental station for the benefit of the Society, a transmission of speech and music. At the conclusion of the meeting a hearty vote of thanks was accorded to Dr. MacDougall and Mr. Goodall. The Society are now organising demonstrations fortnightly, and lectures by well-known people, and a pleasant time should be in store for the coming winter. All particulars, etc., can be obtained from the Hon. Secretary.

Portsmouth and District Wireless Association.

Secretary, Mr. R. G. H. Cole, 34, Bradford Road, Southsea.

On Wednesday, September 6th, the usual monthly meeting was held at the Pile Memorial Rooms, Fratton Road. A large number were present and four new members were elected. In view of an anticipated large increase in membership, a Vice-President was also proposed, Mr. Stevenson being unanimously elected to fill the post.

In future it has been decided to hold two business meetings each month, the first and third Wednesdays sitting the majority of the members.

A visit was recently made to the local electric light and power station. This visit was arranged by Mr. Lawrence, a station engineer, and a most enjoyable afternoon was spent by all those present.

Forthcoming lectures include the following:—September 27th, a special lecture by Mr. Gall. October 4th, "Portable Receivers," by Mr. Donkin. October 11th, "Charging Accumulators by the Noden Valve off A.C. Mains," by Mr. R. Cole.

Barnes, Mortlake and Richmond District Wireless Society.

Hon. Secretary, Mr. Eric A. Rogers, 122, Wood Street, E.C.2.

The first meeting of the above was arranged to be held at Inglenook, Sheen Gate Gardens, East Sheen, on Wednesday, September 20th, by kind invitation of Mr. and Mrs. Davy.

Mr. Blake has kindly accepted the office of President of the above. The Society's future and its rules were discussed.

Questions and Answers

NOTE.—This section of the magazine is placed at the disposal of all readers who wish to receive advice and information on matters pertaining to both the technical and non-technical sides of wireless work. Readers should comply with the following rules.—(1) Each question should be numbered and written on a separate sheet on one side of the paper, and addressed "Questions and Answers," Editor, THE WIRELESS WORLD AND RADIO REVIEW, 12,13 Henrietta Street, London, W.C.2. Queries should be clear and concise. (2) Before sending in their questions readers are advised to search recent numbers to see whether the same queries have not been dealt with before. (3) Each communication sent in to be accompanied by the "Questions and Answers" coupon to be found in the advertisement columns of the issue current at the time of forwarding the questions. (4) The name and address of the querist, which is for reference and not for publication, to appear at the top of every sheet or sheets, and unless typewritten, this should be in block capitals. Queries will be answered under the initials and town of the correspondent, or, if so desired, under a "nom de plume." (5) In view of the fact that a large proportion of the circuits and apparatus described in these answers are covered by patents, readers are advised before making use of them, to satisfy themselves that they would not be infringing patents. (6) Where a reply through the post is required every question sent in must be accompanied by a postal order for the amount of 1s., or 3s. 6d. for a maximum of four questions. (7) Four questions is the maximum which may be sent in at one time.

In view of the serious interference which an oscillating receiver can cause to other receivers in its neighbourhood, it is understood that for broadcast wavelengths, certainly, and possibly for all wavelengths, the Postmaster-General will in future allow no type of circuit which is capable of oscillating and so energising the aerial, either directly or through any circuit coupled to it.

The necessary consequence of this restriction is that if reaction of the type commonly used in the past is still employed, it must be in such a way that the oscillation point cannot be reached over the wavelength range of the receiver, however tightly the reaction coil is coupled, and with whatever values of filament voltage or plate voltage the set is worked.

In order to comply with this requirement, it is essential that the reaction coil should be sufficiently loosely coupled to the aerial inductances as not to set up oscillations or alternatively the reaction might be arranged between the grid and plate circuits of a high frequency amplifier as shown on p. 715 of the issue of September 2nd.

We strongly urge readers who are making or using sets of the usual reacting type to either reduce the amount of reaction which they can employ to such an extent that they are perfectly satisfied that the set can never oscillate or to cut out their reaction entirely.

"E.P." (Bexley Heath).—(1 and 2) See various answers which have appeared in the last few issues to queries on this point. (3) 45 plates for 0.0005 mfd. Numbers for other capacities in proportion.

"F.M." (Sydenham) asks re the Armstrong super-regenerative circuit. (1) If crystal rectification is possible instead of one of the valves in this circuit. (2) What are the merits of potentiometer grid control. (3) If it is possible to determine the hardness of a valve by judging the type of discharge with a spark coil put across the plate and filament.

(1) Not possible, as is evident from the whole principle of the circuit. (2) Potentiometer control enables the adjustment of the working point to the best part of the valve characteristic more accurately than can be done by a fixed connection. (3) A hard valve in anything like condition is too hard to give results in this way—moreover, if obtained, the results would be seriously detrimental to the valve.

"INKY" (Newbury).—The amplifier may be as in Fig. 1, to be introduced instead of the telephones of your set, but why specify separate batteries which are wasteful and in no way improve results.

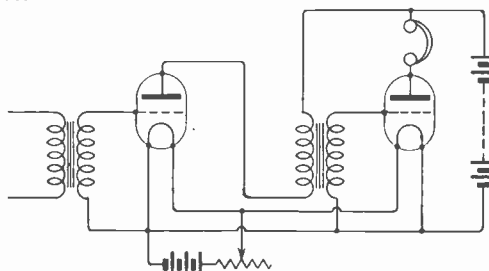

Fig. 1.

"W.E.R." (Histon) gives a diagram of a circuit which he wishes to adapt for short wavelengths and asks (1) For various windings and suitable capacities. (2) If using 4,000 or 8,000 ohm telephones in place of 2,000 ohm. would appreciably increase signal strength.

(1) For remarks on circuits of this type see note at the head of these columns. Parallel A.T.C. is worse than useless at short waves. L.1 might have 120 turns with a mean diameter of 2". L.2, 100 turns with a similar diameter. L.3 is best omitted. Suitable condenser values have been given repeatedly. (2) You might expect 15% to 25% improvement.

"M.N." (Prague) asks (1) The meaning of the abbreviation "O.K." (2) Actual sizes of certain gauges of wire. (3) Which of two possible sizes of wire to use in place of the one suggested. (4) What is the shortest wavelength on which a capacity resistance receiver is efficient.

(1) A phonetic abbreviation for "all correct." (2) See below. No. 10 = 3.25 mm., 12 = 2.64 mm., 14 = 2.03 mm., 16 = 1.63 mm., 18 = 1.22 mm., 24 = 0.56 mm., 32 = 0.27 mm., 34 = 0.23 mm., 38 = 0.15 mm., 42 = 0.10 mm., 44 = 0.081 mm., 46 = 0.061 mm., 47 = 0.051 mm. (3) We should prefer the thicker wire unless it is absolutely necessary to get the full range in which case the thinner wire should be used. (4) About 1,000 metres, but there is no definite or sharp limit.

"**JUMPER**" (Woking) asks (1) If a reactance condenser could be used instead of a reactance coil in the H.F. amplifier and detector circuit described in the issue of July 22nd, and if so, the capacity. (2) If telephone lines running at right angles about 10 ft. below his aerial affect its working.

(1) Yes, except for the limitations imposed by the P.M.G. on both these types of reaction. We are afraid we cannot state a "safe" value for the capacity required without experiment. (2) Probably not.

"**G.W.D.**" (Durham) asks for a diagram for a three-valve receiver. (2) Size of former and wire for reaction coil for use with this set.

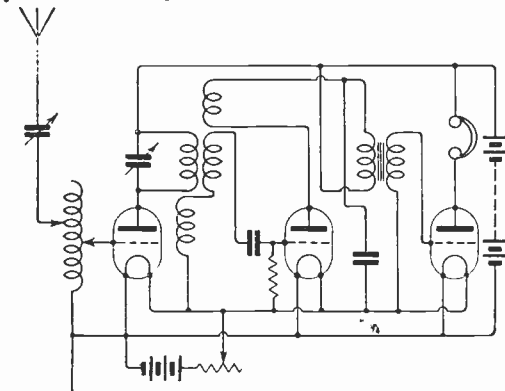

Fig. 2.

(1) See diagram (Fig. 2). (2) See note at the head of these columns on the subject of reaction, but with circuit given 4" x 3" of No. 26 should be all right provided that there is no coupling between the A.T.I. and the remaining coils.

"**W.R.G.**" (Tiverton) has a certain make of telephone transformer and asks how same is connected up, and why there are only three connections.

From the information you give there appears to be a H.R. winding across P and P', and a L.R. winding across the telephone terminals. Cross-connecting one side of each winding in the manner shown in fairly common practice—connections for each circuit should, of course, be made to the black lead. We cannot say whether a condenser is incorporated—probably not.

"**W.R.S.**" (Burgess Hill).—(1) A.—0.005 mfd. B.—0.002 mfd. C.—0.002 mfd. D.—0.001 mfd. (2) Yes. (3) 2 megohms. (4) No. For comments on reaction sets of this type, see note at the head of columns.

"**LUCK**" (Grimsby) asks (1) The resistance of a single telephone receiver wound full of wire of which he encloses sample. (2) Where to obtain diaphragms of any size or thickness.

(1) We are quite unable to say from the information furnished, but it is probably fairly high—say, 1,000/2,000 ohms. (2) You will find it very difficult to obtain diaphragms of any size or thickness, but you should be able to get common sizes from dealers in accessories, or from telephone makers, who might possibly agree to cut you special sizes.

"**GRID MODULATION**" (Liverpool) asks (1) With regard to a modulated grid circuit if it is necessary for both grid and plate circuit to be tuned. (2) With reference to a microphone transformer, page 132, in May 28th issue, if this transformer would be more efficient if enamelled wire were used for the secondary. (3) With reference to Fig. 6, page 131, May 28th issue, what is the value of the by-pass condenser C.

(1) In a grid modulated oscillator it is not in general necessary to tune the grid circuit as well as the plate, although in some cases it is desirable to do so. The best value of the grid coil for each case should be determined by experiment. (2) There is very little difference in efficiency, but enamelled wire needs rather more careful handling. About 3 ozs. should be sufficient. (3) About 0.001 mfd.

"....." (Kingston-on-Thames) asks (1) Reason for a sudden falling off and then increase in signal strength when receiving Leafield with a 6-volt accumulator which had run down. (2) If atmospherics would be of equal strength at two receiving stations with aerials of different heights.

(1) It is not possible to give an absolute reason without careful experiment, but it is probably due to the drop in filament voltage lowering the position of the upper bend of the characteristic and bringing it back to the point of grid potential on which the valve was operating. (2) We cannot give a hard and fast rule, but in general the atmospherics should be somewhat less troublesome with the lower aerial.

"**C.G.**" (London) sends some information about a tuner and asks (1) Wavelength it is suitable for. (2) If it can be used for crystal and valve. (3) If it is used in conjunction with the Armstrong super-regenerative circuit, whether music will be audible all over a room without a loud speaker.

(1) The information supplied is insufficient for us to identify the instrument or to state range, but from particulars given it would appear quite unsuitable in its present form for a two-circuit tuner. You might rewind secondary with about 250 turns, using pile winding. The instrument should then be suitable for about 2,000 metres. (2) In its present form it might be used for A.T.I. and reaction, but this arrangement is not to be allowed in future owing to the possibility of re-radiation. (3) This depends very much on the rest of the apparatus employed, but probably not.

"**J.C.B.**" (Cricklewood).—(1) and (3) You do not give us enough information to help you much. The components appear O.K., but as you give no diagram we cannot say whether your circuit is efficient. Try removing the reaction coil, which will not in future be allowed. (2) Yes. Put the H.R. telephones in series with the H.R. winding of the telephone transformer, which should be used with the L.R. telephones.

"**A.C.McA.**" (Birmingham) asks (1) How many honeycomb coils, with how many turns, should be used to tune to 10,000 metres with a 0.0015 condenser, the former being 2" x 1/2". (2) If it would injure the coils to soak them in shellac varnish.

(1) Assuming 2" to be the diameter of the former, about six coils, with numbers of turns ranging from 25/400, should be provided. (2) The coils may be

PUBLIC ANNOUNCEMENT.

A compliment has been paid to Messrs. RADIO INSTRUMENTS LTD., by a new Wireless Company, who have practically copied our designs in their entirety, and are now placing on the market instruments almost exactly similar to our own in external appearance. Intending purchasers of our instruments should therefore exercise the greatest caution when purchasing same.

RADIO INSTRUMENTS LTD.

Managing Director: J. JOSEPH. M.I.E.E. Late Manager to Mr. H. W. SULLIVAN.
 Chief Designer: W. A. APPLETON. M.B.E., M.I.R.E. Late Admiralty Technical Research Officer.

ONLY ADDRESS—Works, Offices, Showrooms :

12a, HYDE STREET, NEW OXFORD STREET, W.C.1

'Phone—REGENT 1908.

'Grams—INSTRADIO, LONDON.

Visit our Stand No. 37. All-British Wireless Exhibition, Horticultural Hall, Sept. 30th to Oct. 7th

BRITISH EBONITE TO GOVERNMENT SPECIFICATION FOR BRITISH WIRELESS.

MANUFACTURED BY:

THE BRITISH EBONITE CO., LTD.

HANWELL

LONDON, W.7

APPLY FOR LIST "W."

SPECIAL QUALITY RODS, TUBES,
 and SHEETS FOR WIRELESS.
 ALL USUAL SIZES KEPT IN STOCK.

TELEGRAMS: "Ebonitical, Han, London."
 PHONE: Ealing 1689.

WHOLESALE
 ONLY.

WIRELESS

SPECIFICATION

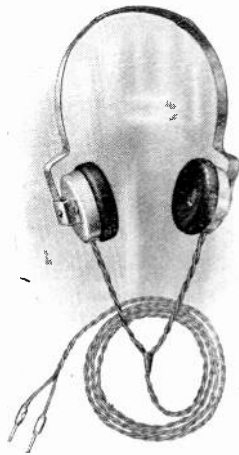

CORDS. Twin Conductor Tinsel 3 ft. long between butt and fork, 12 ins. long from fork to each receiver, Instrument end fitted with 2 plug Type Metal Tags.

RECEIVERS arranged in series and wound to 2,000, 4,000 ohms, or as required.

MAGNETS of specially treated Tungsten steel, mounted in Aluminium cases and fitted with adjustable steel headband of extremely light but serviceable pattern

2,000 ohms	24/-
4,000 "	25/-

SPECIFICATION

RESISTANCES - 120, 1,000, 2,000, 4,000, 8,000 ohms
Other windings to order.

INSULATION - Highest possible.

MAGNETS - Selected Tungsten steel, manufactured under our own special process and guaranteed for ten years.

CORDS - Heavily insulated Tinsel Conductors.

FINISH - Polished Aluminium case and fittings, with Oxydised Relieved Coppered Head Bands, simple and comfortable adjustment. Ebonite Ear Caps fitted as standard.

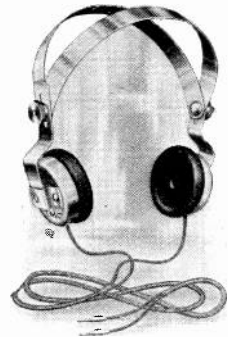

DE LUXE 'PHONES.

2,000 ohms	...	34/-
4,000 "	..	35/-



CRYSTAL SET

(including DE LUXE Head 'Phones)

£4 5 0 Post free.

AERIALS

Complete with Insulators and instructions for erecting.
6/- Post free.

Visit our Stand No. 20, All-British Wireless Exhibition, Horticultural Hall, September 30th to October 7th.

The London (New System) Telephone Co., Ltd.
Donington House, Norfolk Street, London, W.C.1
Tel. : CITY 8612.

dipped in thin shellac varnish if carefully dried afterwards, but they must not be left damp, or covered with an unnecessarily large amount of shellac.

“C.J.” (Leeds) asks the following questions about the Armstrong super-regenerative circuit. (1) Voltage of the various batteries. (2) If one battery can be used for the three filaments. (3) Data for the oscillation circuits. (4) Number of turns for a set of coils to cover all purposes on tuner and receiver. N.B.—As this circuit may radiate seriously when out of adjustment, it is almost certain to be prohibited by the P.M.G.

(1) Grid batteries may be dry cells, up to 12 volts. Plate and filament volts should have normal values for the type of valve used. (2) Yes. (3) Values suitable for about 5,000 metres, say 0.002 mfd. and 3,000 mhs. A two-coil holder might be used. (4) The tuner is only suitable for short waves. The tuner coils might be 80 turns, and the oscillator coils 300.

“H.O.W.” (Thames Ditton).—See diagram (Fig. 3) for the set required. The telephones should be H.R., and any recognised brand of hard valve may be used.

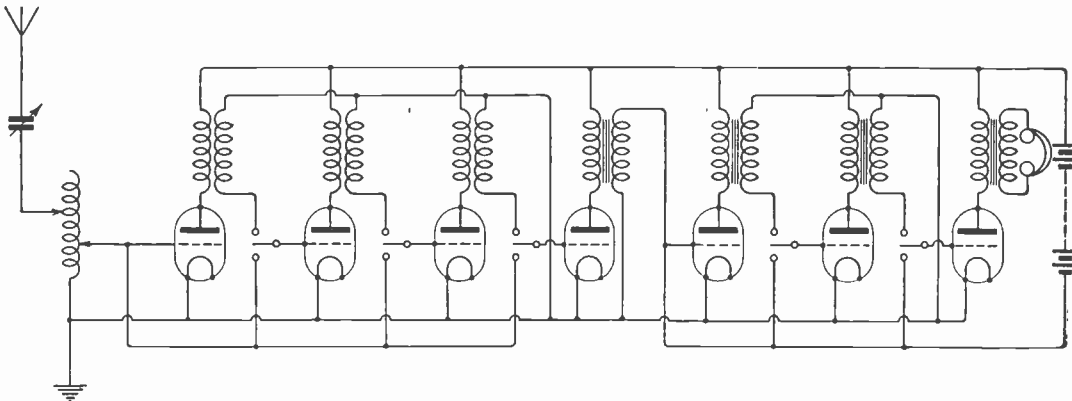

Fig. 3.

“S.F.H.” (Barnes) asks (1) Whether a separate heterodyne could be used with various types of crystal and valve sets. (2) For a diagram of a set to fulfil certain requirements. (3) Thickness of copper foil and what size 10 m/m mica must be to make a fixed condenser of 0.002 mfd. (4) Price of Berne List.

(1) A separate heterodyne might be used with any type of receiver. (2) Your statements are very vague. We presume you require a range of 300 metres upwards, instead of downwards as suggested. Type of circuit to employ will depend on range required, i.e., for broadcasting, a crystal set will do up to 20 miles, one valve 35 miles, two valves 50/60 miles, and so on. Circuits of each type have been repeatedly given. (3) 8 square cms. of overlap for the foils will be required. The thickness of the copper foil is immaterial. (4) About 20s. Amendments are published monthly.

“C.L.” (Malvern) asks (1) The best valve for L.F. amplification. (2) How much resistance to use to vary the plate voltage of a non-tapped H.T. battery. (3) If the L.F. transformer of a L.F. amplifier should be surrounded by an earth plate.

(4) If it would affect reception if the reaction and A.T.I. leads were carried by four-wire flex, and also if the L.F. transformer leads were carried in the same way.

(1) Special valves for this purpose, with very excellent performance, are being got out by the leading manufacturers, of whom you should make enquiries. We are obviously unable to single out any one valve in particular for favourable comment. (2) It depends on the type of valve and circuit. For a single valve circuit with a normal receiving valve, 1,000/2,000 ohms per volt would be needed. (3) Not usually necessary, but its use can do no harm. It should be of iron. (4) Yes. You would probably get serious howling trouble, particularly in the H.F. case.

“C.W.E.” (Streatham) submits a two-valve circuit and asks (1) For windings for 3,000 metres. (2) If the reaction coil and A.T.I. are inductively coupled in any way.

(1) A.T.I. might be 9" x 6" of No. 22. As you have no other method of tuning, provision of taps would not be sufficient. A slider would be necessary. Reaction of the type suggested is to be prohibited in future by the P.M.G. Your set

should therefore be much more efficient if arranged as in Fig. 5, page 573, July 28th issue. (2) In your circuit the A.T.I. and reaction coil should certainly be inductively coupled together, but see note above.

“J.B.” (Gt. Yarmouth).—(1) The sets submitted only differ in minor points, and there should be very little difference in their respective performances. (2) You might get various British broadcasting stations on a three-valve set if your aerial were increased in height and length, but seeing that the use of reaction is to be so much restricted, the results obtained are not likely to be very good. (3) A 6' length of 5/8" diameter brass tubing would make a fairly good earth if buried vertically in damp soil. (4) Additional L.F. amplification would be necessary for the use of a loud speaker.

“VERY INNOCENT” (London).—(1) The maximum wavelength with your aerial would probably be about 2,000 metres. Minimum 350 metres. This wavelength could be somewhat increased by adding a coil in series with the aerial.

"W.B." (Bradford) sends diagram of a set and asks (1) For comments. (2) What arrangement of valves to use with it. (3) The reason for a particular tuning effect. (4) How to get 200 metres wavelength with basket coils.

(1) The diagram sent is rather staggering. Your aerial is shown connected directly to earth, with the A.T.I. introduced somewhere in the grid lead. One side of your reaction coil is connected to the grid of the first valve, and the other side to nothing, and the remainder of your anode connections are wrong. We should advise you to consult carefully the many three-valve diagrams which have been given recently. (2) Probably best to use the "Ora" for the first valve, followed by the two "R" valves. (3) This is probably due to the set starting to oscillate, and the signals are improved gradually up to this point, and are then completely lost. For 200 metres the A.T.I. might have 50 turns with a mean diameter of $2\frac{1}{2}$ ", with a series aerial condenser.

"S.G.O." (Birmingham) asks (1) The probable wavelength of the proposed English broadcasting stations. (2) For a diagram of a set to fulfil certain requirements. (3) Maximum length of aerial allowed by the P.M.G.

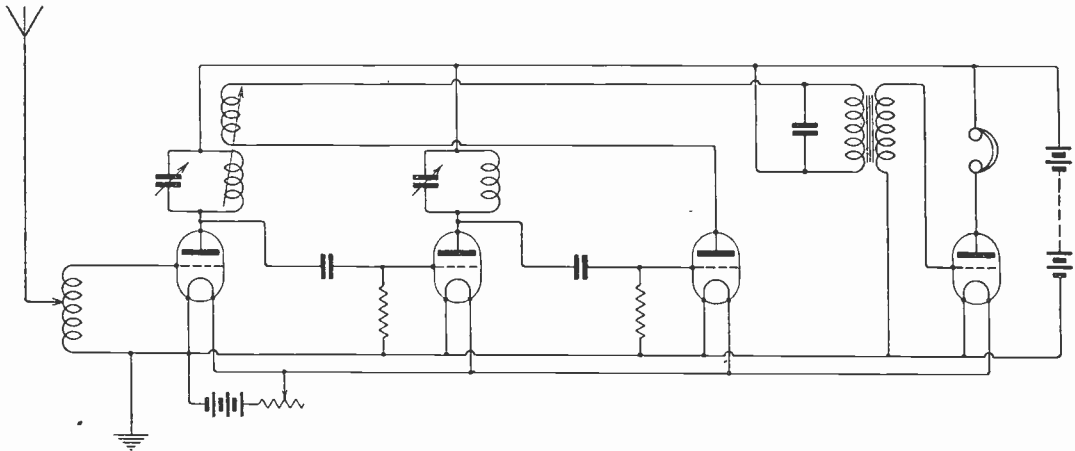

Fig. 4.

(1) Various values between 350 and 425 metres. (2) See diagram (Fig. 4). The loud speaker and various numbers of telephones may be introduced as desired in a position in which a pair of telephones is shown. (3) 100 ft.

"J.McV." (Belfast) asks (1) For a diagram of a set suitable for the reception of PCGG and English concerts in Belfast. (2) If we advise replacing resistance capacity amplification with transformer coupling for short wave work, and also putting the A.T.C. in series. (3) If we recommend the new Armstrong circuit for use in his position. (4) Whether a certain aerial would be O.K.

(1) See diagram given to "S.G.O." (Birmingham) above. (2) Yes, in both instances. (3) The set is capable of good results, but needs very careful and skilful attention. (4) Fairly good, but more than 20' of height is desirable.

"W.E.R." (Holloway).—(1) The tuner suggested would be quite satisfactory. (2) The above circuit is quite suitable for all wavelengths with interchangeable coils, the variable condensers used having capacities of about 0.005 mfd. for short wavelengths, and somewhat higher values for long waves. (3) There is no danger of burning out telephones on a five-valve amplifier unless excessive plate voltages are used. The average plate current passing through the last valve of a multi-valve amplifier is very little different from that passing through the first valve, and is generally of the order of a milliamp. (4) Either a change-over switch or the jacks may be used.

"R.Y.H." (Monkokehampton).—The probable reason for your oscillation trouble is running your grid and plate leads too closely together. You may be able to stop it by applying a little positive potential to the grid of the first valve; also, the H.T. lead from the first anode should go to the positive of the H.T. battery and not the position shown. (2) It is quite possible that you may have difficulty in getting 2 MT at such a distance, unless your set is in the best possible adjustment, particularly as you are using a comparatively large A.T.C. (3) From the information given we cannot

say what is the matter with your telephones, which have apparently developed some fault. We should advise returning them to the makers for overhaul. (4) This circuit is O.K. except for points commented on with your previous circuit.

"A.N.H." (Edinburgh) gets poor results with an aerial which is led in down a chimney, and asks for comments.

The running of a lead close to brickwork is never satisfactory, and is probably worse than usual when the brickwork is covered with soot. You do not say whether the chimney is used for its normal purpose. If so, the bad results are probably due to a deposit of soot on the glass insulating tube. You do not describe the insulation at the bottom of the tube, which is also possibly affected. Possibly, also, your earth is not as good as it might be.

The Present Wireless Boom

has given an enormous impetus to the manufacture of wireless apparatus. The tendency has been to sacrifice quality to quantity in endeavouring to keep pace with the demands. Throughout this period of increasing wireless activity **S. G. BROWN, LTD.**, have wisely refused to lower their high standard of quality even at the expense of occasional delay in fulfilling orders. As a result they have more than maintained their enviable reputation as **RELIABLE** wireless manufacturers, and to-day it continues to be recognised by amateur and professional alike that wireless instruments and parts manufactured by and bearing the name "**BROWN**" can be bought with absolute confidence in their quality, value and efficiency.



"A" TYPE.
Low Resistance, 58/-
High Resistance, 62/- to 66/-
"D" TYPE.
Low Resistance, 48/-
High Resistance, 52/-
(all above prices include cords).

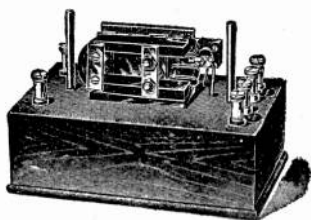

PRICES:
Low Resistance (120 ohms) input, £6
High Resistance (2,000 ohms) input, 2/6 extra.



PRICES:
H. 1. (Large) Low Resistance, 120 ohms Height 21".
£6 : 5 : 0
(High resistance 2/6 to 5/- extra).
H. 2. (Small) Low Resistance, 120 ohms Height 12".
£3 : 0 : 0
(High Resistances 2/6 to 5/- extra)

Telegrams—
"Siddbrownix, London."
Telephone—
Chiswick 1469.

The "Brown" Super-sensitive Telephones

These Telephones are unquestionably the clearest and most sensitive made, and, consequently, increase the distance over which wireless can be heard.

BROWN'S are recognised as the most comfortable to wear, due to their extreme lightness in weight and adaptable adjustment.

There are no wireless headphones in the world to compare with **BROWN'S**.

IMPORTANT NOTICE.—When purchasing **BROWN'S** you should see that the name **BROWN** is stamped on the back of each ear piece. This is the *hall-mark and proof* of their *genuineness, excellence of finish and highest efficiency.*

In Universal Use. As supplied to British, Allied and Foreign Governments.

The "Brown" Microphone Amplifier

This Amplifier magnifies signals, speech, or music, without distortion, and is of considerable interest to amateurs and scientific investigators. The magnification is much greater than that obtained from a two-valve amplifier. In construction, this instrument is much more robust than other relays. *This instrument satisfies the urgent demand for a reliable, inexpensive amplifier, which the most inexperienced amateur can use, and which the most experienced requires.* The necessary transformers are included in the base.

The "Brown" Loud Speakers with new improved Curved Horns

The requisites of a Loud Speaker are pure tone, clear articulation, and good volume of sound. The "**BROWN**" Loud Speaker possesses these qualities and they are enhanced by the new improved curved horn.

AMATEURS do not always need the full sized Loud Speaker (H. 1.) as used in Lecture Halls, and a small type (H. 2.) has been designed to meet their more modest home requirements *both as to volume of sound and price.*

THE NEW HORN of dull blacked aluminium used with both H. 1 and H. 2 is constructed on the logarithmic law of increasing openings and is acoustically perfect

NOTE THIS.—The strength and clearness of all music, speech and Morse heard by one person wearing headphones is broadcasted to a whole room full of people when a Brown Amplifier and Loud Speaker are used with your set.

The most popular and perfect loud speakers ever offered to the public.

Thousands already in use in all parts of the world.

CATALOGUE POST FREE.

Visit Our London Showrooms: 19, MORTIMER STREET, W.1.

Visit our Stand No. 43 at the All-British Wireless Exhibition, Horticultural Hall, Sept. 30th to Oct. 7th.

SOLE MANUFACTURERS—



Sole Agent for the Argentine—

Horacio D. Guerrero,
Las Heras 2480, Buenos Aires.

Head Office and Works:
VICTORIA ROAD, NORTH ACTON, LONDON, W.3

London Showrooms:
19, MORTIMER STREET, LONDON, W.1

**ACCESSORIES
FOR
PRIVATE WIRELESS
INSTALLATIONS**



**TELEPHONE HEAD SETS
AERIAL WIRE & INSULATORS
PROTECTORS FOR
AERIAL & BATTERY
EARTHING DEVICES
JACKS & PLUGS
H.T. BATTERIES,
ETC. ETC.**

Descriptive pamphlet and prices on application to

THE MANUFACTURERS:

**SIEMENS BROTHERS & CO., LTD.
WOOLWICH, LONDON, S.F. 18**

Telegrams: **SIEMENS, WOOLWICH.** Telephone: **CITY 6400.**

and at

Belfast, Birmingham, Bristol, Cardiff, Glasgow,
Leeds, Manchester, Newcastle, Sheffield, Southampton.

Visit our Stand No. 48. All British Wireless Exhibition,
Horticultural Hall, September 30th to October 7th.

THE LATEST BOOK ON VALVES.

Wireless Valves Simply Explained

By JOHN SCOTT-TAGGART, F.Inst.P.
140 pages, 56 diagrams.

Paper, 2/8 post free. Cloth, 3/3 post free.

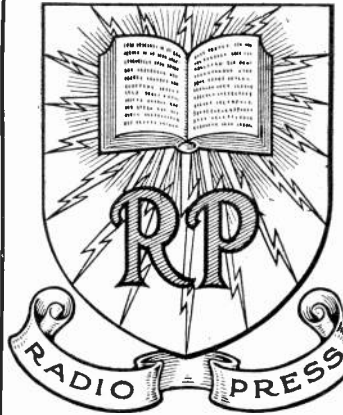

Written by an Expert, it contains exactly the information which an Amateur needs in simple, non-technical language.

Some of the contents: — Fleming Valves—The Three-Electrode Valve and its Application—Cascade Valve Amplifiers—Reaction Amplification and Self Oscillation—Reaction Reception of Wireless Signals—Continuous Wave Receiving Circuits—Valve Transmitters—Wireless Telephone Transmitters using Valves—Notes on Wireless Broadcast Receivers.

“Here are some 130 pages of clear, simple, elementary explanations, well illustrated. The little book should be welcome; it is well worth the money.”
The Electrical Times, September 7th.

SEND TO-DAY as the present Edition is being rapidly exhausted.

Radio Press, Ltd., Publishers of Authoritative Wireless Literature.
New Address—**DEVEREUX BUILDINGS** (opposite Law Courts),
DEVEREUX COURT, LONDON, W.C.2

Visit our Stand No. 27. All British Wireless Exhibition,
Horticultural Hall, September 30th to October 7th.

THE HALL MARK of EFFICIENCY

Prices
on
Application



Delivery
from
Stock

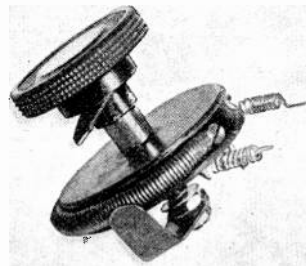

J. BURNS, LIMITED
Wangye Works, Chadwell Heath, Essex

"AMATEUR" (New Barnet).—(1) The wavelength range would depend on the circuit used as well as the wire with which the A.T.I. is used. Best results would be obtained with condenser in series and the A.T.I. wound with No. 24. Maximum wavelength would then be about 1,000 metres with a normal aerial. (2) For receiving up to 9,000 metres, basket or honeycomb coils are more convenient in size than solenoids, and their performance is satisfactory electrically. (3) The cable submitted might be used for aerial and earth connections, but is too stiff for other purposes.

"C.M.M." (Stockwell) asks (1) The gauges of three samples of wire. (2) Which is the most suitable for winding H.F. transformers. (3) Whether beechwood, boiled in paraffin wax, would be an efficient material for a H.F. transformer and, if not, for a good ebonite substitute. (4) How many transformers of the type indicated would be required to cover a range of 150/2,000 metres when used with a variable condenser.

(1) A = No. 26. B = No. 34. C = No. 41. (2) No. 41. (3) Not very good. Millboard tubes, dipped in shellac and carefully dried, would be better. (4) Three would be sufficient, or four to allow a good overlap.

"....." (Southport).—(1) Better results are probably obtained because the coils have a less distributed capacity. Signals are generally somewhat stronger on a single circuit than they are with a double circuit. The latter is used because the extra selectivity which is given eliminates much trouble from interference. (2) There is no simple formula. If the coils are not coupled together, their number would be approximate as the square of the wavelength, but owing to the fact that the coils are generally very closely coupled, much less than this is actually needed. (3) The method suggested may quite well be used. (4) See various replies since the issue referred to.

"T.S." (Sydenham) asks for a loose coupler to tune up to 3,500 metres.

Primary might be 9" x 7" of No. 23, preferably with a slider. Secondary may be 7" x 5" of No. 26, with taps at 1/2", 1", 1 1/2", 2", 4" and 5 1/2". Closed circuit condenser may be 0.0005 mfd. at maximum.

"J.P." (Spain) asks (1) If it is possible to receive FL telephony at 800 kilometres on a frame with a six-valve set, having 3 H.F. and 3 L.F. (2) If so, the size of the frame.

(1) We should not expect very good results at this distance, but by careful use of reaction you would probably obtain some results. (2) The frame might be 1.5 metres in diameter, and have 25 turns spaced 0.5 cms. apart.

"W.P.G." (Gloucester) sends a description of a set and asks (1) If a crystal would improve results. (2) If the reactance coil should be of finer wire than the A.T.I. (3) For windings for the H.F. transformer. (4) If results would be as good if the reaction coil is wound with No. 24 wire and the same number of turns as at present.

(1) It should improve results if connected as in the reply to **"D.C.M." (Dublin)**, July 22nd issue. (2) Not necessarily, but it may be, and it is often convenient to make it so. (3) Try 50 turns of No. 40 for each winding on a former

1 1/4" diameter with shellaced paper between the windings. (4) No, because the coupling between the coil would be less. *N.B.*—See recent remarks on reaction of this type.

"M.N." (Prague).—(1) The multi-wire aerial will be the better, but little advantage would be gained by the use of more than two wires. (2) The circuit of your Fig. 3 will be quite O.K. Values should be as follows:—A.T.C., 0.0015 mfd. Closed circuit condenser, 0.001 mfd. Coils—an assortment of honeycomb type, in sizes up to about 1,000 turns with a mean diameter of 2" (3) Scheme 2 would be very inefficient. Either 3 or 4 might be used—preferably 3.

"CONSTANT READER" (.....) asks (1) For a two-valve set to conform to certain requirements. (2) Capacities of the condensers. (3) Best kind of valve to use.

(1) and (2) See diagram (Fig. 5). (3) Any standard hard valve by a reputable maker would give good results.

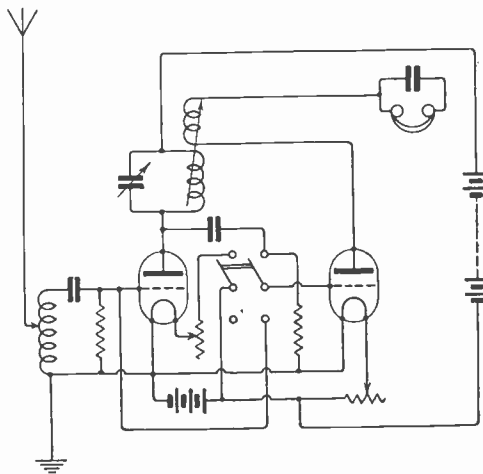

Fig. 5.

"R.B." (Carlisle) asks for criticism of a set, and what he may expect to receive on it.

The set is all right except (1) For short waves A.T.C. should be in series with the A.T.I. (2) The loose coupler should be tuned by a variable coil. (3) The reactance coils should be connected in the anode circuit of the first valve and not in that of the L.F. amplifying valve. (4) Reaction of this type is no longer to be permitted. You might possibly receive broadcasting from Manchester, Newcastle and Glasgow if these points are attended to, and you will also get stations such as Cullercoats and the larger Continental stations, and possibly ships.

"A.E." (Bournemouth) asks for advice with a four-valve set which howls and gives no other results.

The diagram submitted is quite correct and should give no trouble. Howling is probably due to coupling between the L.F. transformers. This might be cured by altering their position, or by screening them in iron boxes. It may also be due to the grid and plate leads of the H.F. valve being run too close together, remedy for which is obvious.

"**NOYZ**" (Tiverton).—The circuit shown is quite correct, and the winding up is also as it should be except that all the L.T. battery leads may be run to a common battery. Your arrangements are distinctly ingenious.

"**D.D.W.**" (Ebbw Vale) asks (1) For criticism of an amplifier. (2) For a circuit to use with it. (3) If the telephone terminals are shown in the right place. (4) If circuit will operate with valves taking 20/30 volts on the plate.

(1) Circuit is quite correct except for reaction, which will probably have to be omitted, but if used should be connected as in various recent diagrams. (2) Any simple two-circuit tuner might be used as, for instance, Fig. 1, page 670, August 19th issue, with the addition of a switch for paralleling the A.T.C. and A.T.I. for long wavelengths. For wavelengths up to 20,000 metres both the A.T.C. and the closed circuit condenser might be 0.003 mfd. (3) Yes. (4) Yes, but if so about a 45-volt battery should be used to allow for the drop through the anode resistance.

"**X.Y.Z.**" (Seaham Harbour) asks (1) For a circuit to fulfil certain requirements. (2) Values of condensers and resistance to use.

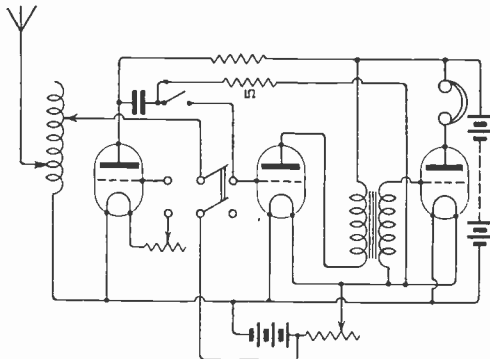

Fig. 6.

(1) See diagram (Fig. 6). (2) The anode resistance may be 50,000 ohms; grid leak 1 megohm and coupling condenser 0.002.

"**J.P.N.**" (Frieborg) refers to the article by G. P. Kendall in the issue of June 3rd, and asks under what condition it is possible to use reaction coil for amplification, and not for heterodyne. (2) If a frame aerial can usefully be connected to an outdoor aerial. (3) Since a certain amount of rectification occurs at each stage of resistance capacity amplifier, if the intervalle condensers should be increased in capacity to pass on the L.F. pulses arising. (4) Refers to the article on page 18, April 1st issue, and asks whether the intervalle capacity of 0.003 mfd. there quoted is not too great.

(1) Conditions on the use of reaction are given in the article referred to. For amplification without heterodyne effect reaction coupling must not be great enough to cause the set to oscillate. This can be assured either by using a very small reaction coil or by preventing too close coupling between it and the tuning coils. (2) Not as a rule, but special directional effects may be obtained by the use of frames in conjunction with external aerials. (3) No, this is undesirable as it introduces less efficiency

in the amplification of the H.F. component. (4) In our experience this is excessive except for very long wavelengths.

"**F.W.G.**" (Finchley) sends a sketch of his set and asks (1) If the coils are all connected, though only one is inserted for a time, would it result in "dead-end" losses (2) What type of reaction would be best with the set.

(1) Yes, probably of a fairly serious nature, even without the tapping scheme suggested, which is quite hopeless as it permanently connects the coils in a large number of ways. Whenever you switch for a particular connection of a particular coil you will find that you have a variety of sections of other coils in circuit at the same time. (2) Reaction could not be employed without the use of entirely separate coils for the purpose, and see recent notes on the subject. The best method of getting a range of this magnitude is by a set of interchangeable slab coils, not connected in any way.

"**RADIO**" (Bournemouth) refers to the article on an experimental station in the issue of June 10th, and asks (1) If the slab coils could be used as loading coils. (2) If No. 28 wire would do. (3) If the slab coils could be used with a switch and studs. (4) If an aerial 36' high and 48' long is good enough.

(1) It depends on the wavelength required, about which you say nothing. Some indications are given in the article referred to. (2) Enamelled covered wire is not recommended for this type of coil owing to the risk of the insulation being damaged in winding. (3) Certainly. (4) Quite good.

"**SOLWAY**" (Whitehaven) sends a sketch of a loose coupler and asks (1) For criticism and the maximum wavelength obtainable. (2) If a five-valve receiver, with aerial as sketched, will receive 2 MT, PCGG and FL. (3) If an alternative arrangement of aerial will give better results. (4) If any set on the market will receive these stations at Whitehaven.

(1) A 0.001 mfd. condenser across the A.T.I. is hopeless. None should be used on short waves, and only about 0.001 mfd. on long. Your coupler would be efficient up to about 2,000 metres. (2) FL probably, remaining stations very doubtful. (3) This aerial will give you a much better chance. We are doubtful whether this will give good results with the restricted reaction to be allowed in future. (4) We know of no set on which we should care to guarantee the desired results.

"**AMATEUR**" (Stoke-on-Trent) sends a sketch of his set and asks (1) For criticism. (2) How to add a third and fourth valve. (3) If a certain arrangement of his apparatus will give capacity interference, and if this can be obviated by screening. (4) What are the advantages and disadvantages of (a) plug-in type H.F. transformers or selective switch type; (b) A.T.I. basket coil or slider type.

(1) The circuit is O.K. except that the condenser marked 0.004 mfd. should be replaced by a leak of about 1 megohm. (2) See Fig. 1, page 303, issue for June 3rd. A three-valve set can be built up on exactly similar lines. (3) You may get some capacity troubles. We should advise you to get over them as far as possible by the attention to the exact position of parts and leads rather than by the

*Marconi's Wireless
Telegraph Co., Ltd.*

ARE EXHIBITING AT THE

FIRST ALL-BRITISH
WIRELESS EXHIBITION

AT THE HORTICULTURAL HALL, WESTMINSTER,

FROM SEPT. 30th. TO OCT. 7th.

*They are showing their
latest pattern Marconiphones,
together with apparatus
representative of other
branches of their industry.*

**DO NOT FAIL TO VISIT
STAND 24.**

MARCONI'S WIRELESS
TELEGRAPH CO. LTD.
MARCONI HOUSE, STRAND, LONDON.

IMMEDIATE DELIVERY

of complete Receiving Sets, for all Wave-lengths, also Amplifiers, Wireless Accessories, Tunings Coils, and all Wireless Sundries.

"BRITWIRE" Receivers, one to four valve.

"BRITWIRE" Amplifiers, one, two, and three valve.

"BRITWIRE" Balanced Condensers.

"BRITWIRE" Accessories.

All "BRITWIRE" valve apparatus is licensed under Marconi Patents for amateur use in Great Britain.

We have large stocks of Magnavox Loud Speakers, and can sell as factors or retail.

Send for Illustrated List, post free 3d.

POST ORDERS TO—

BRITISH WIRELESS SUPPLY COMPANY

6 BLENHEIM TERRACE, LEEDS.

Telephone: 26926

LTD.

And at

11 Church St., West Hartlepool. Tel. 373. 18 Eldon Sq., Newcastle-on-Tyne. Tel. City 360.
33 High Street, Southampton. Telephone 403.

Don't forget our Stand No. 42. All-British Wireless Exhibition, Sept. 30th to Oct. 7th.

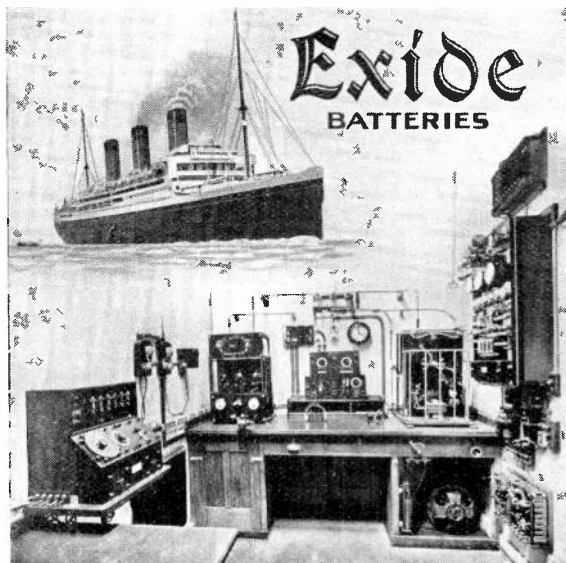

THE LARGEST SHIP IN THE WORLD

— the White Star Liner
"Majestic" — uses Exide
batteries for her wireless
installation.

No finer testimony to the
general reliability of Exides,
and their particular suitability
for wireless work, could be given

Visit our Stand No. 30. All-British
Wireless Exhibition, Horticultural
Hall, September 30 to October 7

THE **Chloride** ELECTRICAL STORAGE
COMPANY LIMITED.

Prices and Particulars on Application

HEAD OFFICE:

Clifton Junction, Nr. Manchester

LONDON SHOWROOMS:

219/229, Shaftesbury Ave., London, W.C.2

use of screens, which, however, may be some help. (4) (a) Performance as a rule is somewhat better for plug-in type. There are no dead-end effects. (b) The slider type gives almost continuous adjustment, and is preferable except from the point of view of saving of space.

"B.B.H." (Eastbourne) encloses a diagram of his set and asks (1) If he can receive C.W., spark and telephony on it. (2) How much and what kind

"IN DOUBT" (Staines).—Yes, for a short wave range set.

"E.T." (Newport).—(1) The reasons for the poorness of the demonstrations are various. It is possible to obtain perfect articulation by wireless with quite clear signals. In order to get this, the following conditions are essential. (a) The proper gear. (b) In the hands of someone thoroughly conversant with its use. (c) Reception

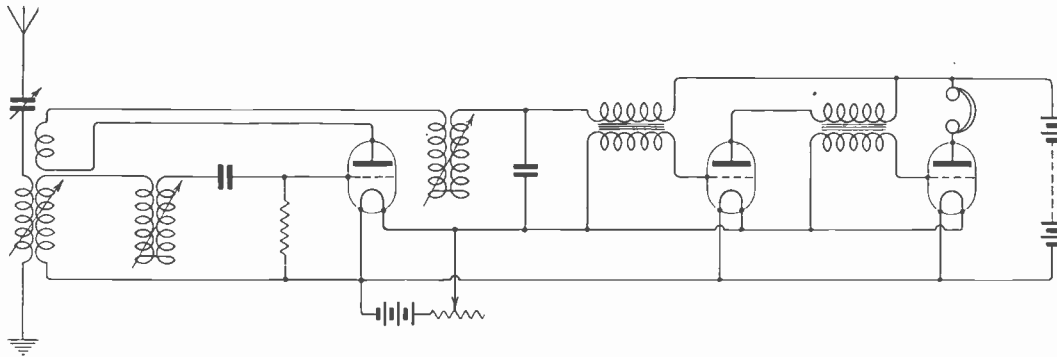

Fig. 7.

of wire should be used to wind the variometer formers to receive wavelengths of 300/3,000 metres. (3) Winding details for primary and secondary coils. (4) For a diagram of a circuit for two-step amplifier to be added to his set.

(1) No, we do not like this arrangement at all. The nearest satisfactory approach to it is the American short-wave tuner of June 3rd issue of which it appears to be a poor copy. The grid leak should go from the grid to the filament, not as shown. (2) and (3) This type of construction is unsuitable for such a range of wavelengths, and we cannot give the desired figures. (4) See diagram (Fig. 7) for a possible variation of this type.

from a distance well within the range of the transmitting station. We suggest that the poorness of the results you heard were due to the failure of (c), and faulty adjustment of the gear by the operator. For really good results, musically speaking, we do not recommend the reception of broadcasting stations at more than 100 miles. (2) PCGG very doubtful, 2 MT probably. Paris and Berlin possibly, as these stations use larger power. (3) It is impossible for us to recommend any one of the many advertised sets, but you should use several valves.

"G.J.W." (Coventry) describes his set and asks the maximum and minimum wavelength to which he can tune.

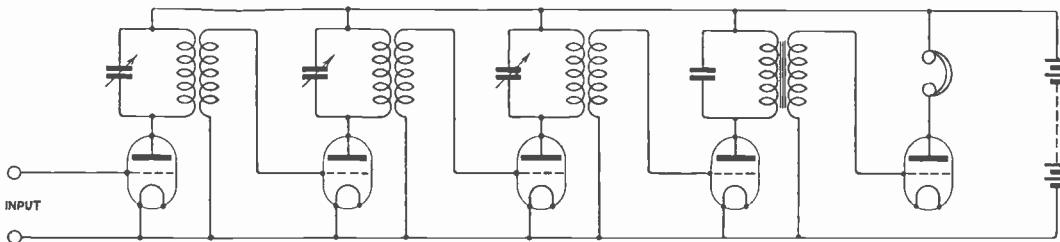

Fig. 8.

"RAGS" (Watford) asks for a diagram of a simple type of five-valve amplifier.

See diagram (Fig. 8), in which we have omitted reaction as this will probably not be allowed for broadcast wavelengths.

"GEORGIUS" (Crewe) asks three questions about his set.

(1) Arrange as in the circuit given to "G.B." (Fulham). (2) Capacity of condenser 0.0006 mfd. Probably the insulation of the glass condenser is in some way defective. (3) Very little, if at all.

Without taps on the secondary your minimum will probably be over 1,000 metres, and maximum 5,000 metres.

"W.P." (Plumstead) asks (1) Whether constructional details of a two-valve receiving set, not transformer coupled, have been given in past issues. (2) If not published, where such details can be obtained.

(1) Constructional details of such a set have not been given in a recent issue, but you will find a great deal of information in Alan L. M. Douglas's book, "The Construction of Amateur Valve Stations." A suitable circuit is given on page 12.

"H.A.C." (Rotherham) encloses a diagram of his set and asks (1) For any suggested improvements. (2) If the grid circuit should pass through the filament rheostat, or if it may be as shown in diagram. (3) If a 1/5 Sullivan transformer will be O.K. for this set. (4) If a grid potentiometer would improve the set.

(1) No, the set is quite O.K. We cannot suggest any considerable improvements, although filament switches to cut out the valves not required would be an advantage. (2) The suggested scheme is all right, but will give you a somewhat smaller range of potential. (3) Yes. (4) No, a potentiometer is unnecessary with grid condenser and leak.

"E.S." (Highbury) asks (1) If he can use 152 ohms telephones with a transformer on a crystal set; also particulars of windings for this transformer, using No. 25 and 36 S.W.G. enamelled wire. (2) For the best type of valve and connections for note magnifier with a crystal set.

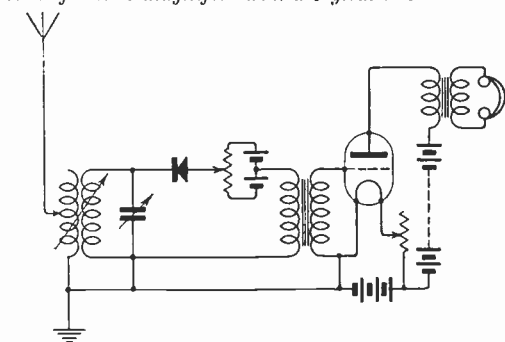

Fig. 9.

(1) The wires suggested are quite unsuitable for an efficient transformer of this type, but if used you might try a core of 1" diameter by 6" long, with 9 ozs. of No. 25 and 7 ozs. of No. 36 for the windings. (2) Any hard receiving valve will do. Connections may be as in the diagram (Fig. 9).

"NEGATRON" (Coventry) asks (1) Why a certain receiver will not work. (2) For more suitable values or windings for his set. (3) If PCGG should be strong enough to allow of the use of a loud speaker. (4) If results on this set would be as good as on a seven-valve receiver.

(1) We can only suggest unsuitable values for the components, particularly inductances 2 and 3, and the grid battery 6. The circuit is admittedly tricky in operation. (2) Two and three should be suitable for about 5,000 metres, and grid batteries anything up to 10 volts. (3) Doubtful. The circuit is intended particularly for shorter wavelengths. (4) This claim is rather far-fetched. The same may be said in a similar sense of any reaction circuit, but in practice a limit is imposed by the inherent stability of the valve. We should be extremely surprised if you got as good results as with a seven-valve set, except very occasionally when you happen to "fluke" a particularly lucky adjustment.

"S.J." (Stockholm).—(1) The approximate wavelength of your set will be 3,500 metres. We regret that we have no information about this receiver, additional to that given in the article referred to.

"G.B." (Fulham) sends a description of his set and asks (1) For a diagram of connections. (2) If it will receive Broadcasting and 2 MT. (3) How his wavelength could be increased. (4) If the apparatus described would be of any use in the assembling of a three-valve set.

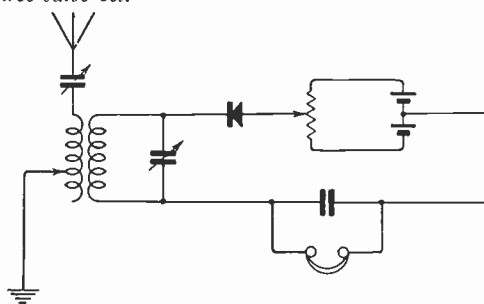

Fig. 10.

(1) See diagram (Fig. 10). (2) Quite satisfactory for London Broadcasting. If your aerial is a very good one, you may get Writtle very weakly. (3) By increasing the size of both coils. (4) Yes, all the parts except the crystal could be used for this purpose.

"E.G.V." (Woking) asks how to add a second valve to a circuit shown, using 2 H.T. and 2 L.T. batteries.

The circuit shown is of a very inefficient type, and could only give good results with a variable tuning condenser across the anode coil. The use of separate H.T. and L.T. batteries on a two-valve set is unnecessary, and would serve practically no useful purpose. A suitable set for your purpose has been given to "H.E.P." (North Greenwich). You can, of course, use separate batteries with each valve of this set if you prefer it.

"M.F." (Folkestone) asks re American short wave tuner described in June 8th issue (1) Suitable values for the condensers. (2) Whether fixed or variable. (3) If a crystal could be used in place of the valve.

(1) 0.0002 mfd. for the grid condenser and 0.001 mfd. for the plate. (2) Condensers may be fixed but some slight advantage might be obtained by making the grid condenser variable. (3) No.

SHARE MARKET REPORT.

Prices as we go to press on September 15th, are:—

Marconi Ordinary	£2 7 7½
.. Preference	2 3 3
.. Inter. Marine	1 8 3
.. Canadian	10 6
Radio Corporation of America:—		
Ordinary	1 1 6
Preference	14 0

30/-

with immediate delivery from stock
MULLARD TELEPHONE HEAD SETS

specially made for the reception of wireless broadcasting, are thoroughly well-made and fit securely and comfortably to the head.

British Manufacture.

The two high resistance ear pieces (4,000 ohms total) are flexibly attached to the fully adjustable, double head bands. The set is nicely finished in nickel plate and supplied complete with standard flexible cords.

A large stock is available at once but is being rapidly booked up. Send the coupon to secure immediate delivery to-day.

These telephones are made by the makers of the famous ORA valve and Mullard valve accessories.

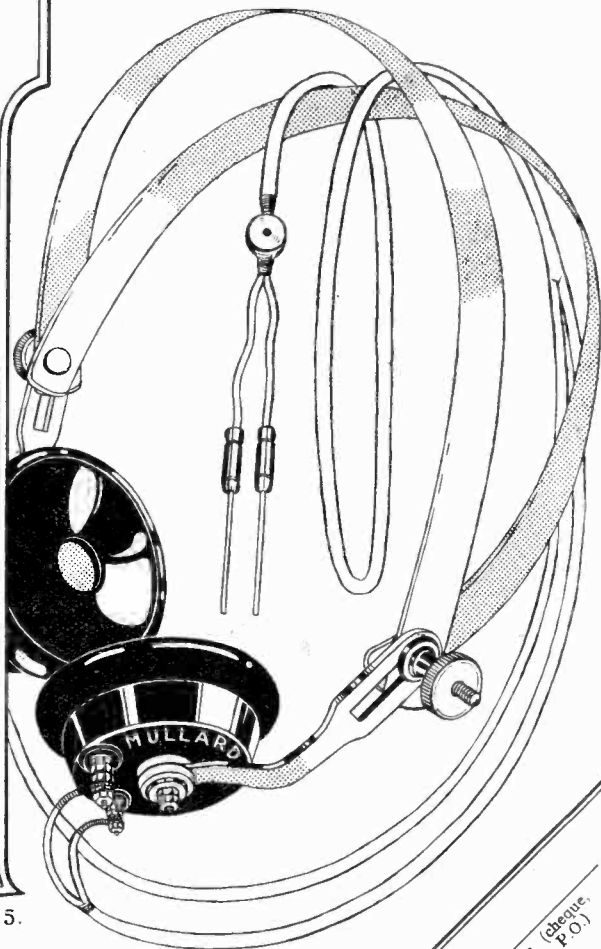

E.P.S.

15.

Mullard Radio Valve Co. Ltd.

Claybrook Road, Hammersmith, W.6.

Contractors to H.M. Admiralty,
 War Office Royal Air Force & Post Office.

Telephone: Codes: Telegrams:
 Hammersmith 312 ABC(5Ed) Radiovalve Hammer Lond



Name and Address
 To the
MULLARD RADIO VALVE Co. Ltd.
 35, Claybrook Rd.,
 W.6.

Please send me post free:
 Quantity. Description and Price.

Telephone Head Sets	30/- per set
ORA Valves	15/- each
Grid A Resistances	5/- "
Anode A or B Resistances	7/6 "
B Condensers 0005 mfd	5/- "
Combined res. and condenser	1/6 "
Valve bases with terminals	9d. per pair
Valve sockets	
Terminal clips	

Name of usual wireless dealer.

I enclose (cheque, Money Order, P.O.) to cover the cost.

SEND THIS TO-DAY.

Visit our Stand No. 41. All-British Wireless Exhibition, Horticultural Hall, September 30th to October 7th

A NEW LINE THAT WILL INTEREST YOU

K.B.

COMPACT CONSTANT

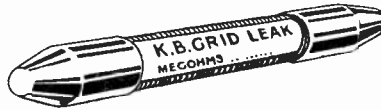

EFFICIENT ECONOMICAL

GRID LEAKS ACTUAL SIZE Price 2/6 each.

Immediate Delivery from Stock.

<u>SKELETON CONDENSERS.</u> —0001—0005 mfd.	1/- each
.0006—0001 "	1/3 "
.002 —005 "	1/6 "
<u>VARIABLE CONDENSERS.</u> —00005—0015 "	5/- to 30/- "
<u>K.B. COIL HOLDERS.</u> —3-way	21/- "

NUMEROUS OTHER ITEMS IN STOCK.

Send for our Illustrated Catalogue, Post Free 4d.

Also visit our Stand No. 8. All-British Wireless Exhibition, Horticultural Hall, Sept. 30th to Oct 7th.

THE

"K.B." RADIO EQUIPMENT COMPANY

HEAD OFFICES & SHOWROOMS : 109, HIGH ROAD, KILBURN, LONDON, N.W.6.

WORKS : QUEEN'S PARK, N.W.

Tel. : Hampstead 7803.

Bus Services, 8, 16, 28 and 51 pass the door.

3 minutes Kilburn Park Station (Bakerloo Railway).

Crystor COWL INSULATORS

(PROV. PATENT)

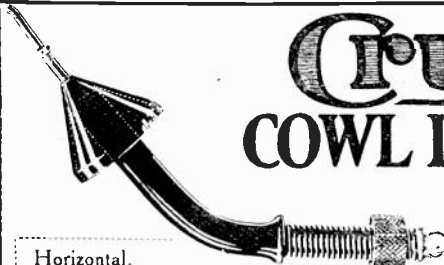

Horizontal, Wall or Window

LEAD IN Price 6/6 each



AERIAL INSULATOR

Price 1/9 each

The "Crystor Cowl" Insulators are absolutely essential to every wireless aerial, and by providing complete protection against surface leakage due to rain, hail, snow or fog, will immediately increase the efficiency of YOUR set. Send for full particulars without delay.



Vertical Roof LEAD IN

Price 6/- each

THE Crystophone

TYPE 20 TT

The Crystophone illustrated has a wave-length of 180-3,500 metres. No extra coils required. Desired range obtained by merely operating "fine," "coarse," or "long range" controls.

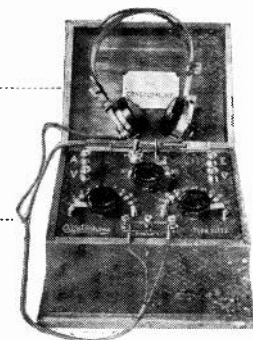

Prices and Catalogue on application to—

WIRELESS SUPPLIES CO.

64, Mortimer Street, London, W.1.

Phone : Museum 2672

Grams :

" Adragonax, Wesdo, London."

ELECTRICAL DISPOSALS SYNDICATE

RETAIL
BUSINESS

GOVERNMENT SURPLUS

WHOLESALE
PRICES

FURTHER SELECTIONS FROM OUR STOCK

TERMINALS (Brass Nickered)

OBA 2 on plate - - - each 4d.
OBA 1 on plate - - - „ 2d.
OBA 1 on angle plate - - - „ 3d.

9 HOLE H.T. PLUGBOARD 2/-

JAR CONDENSERS

14" - - - - - 1/-
2' - - - - - 1/6
2' 6" - - - - - 2/-

TEAK INSTRUMENT CASES

10" x 7½" x 9¼" Wood ½" thick,
two hinged doors - - - 3/6

TELEPHONE MAGNET

BOBBINS - - - - - 1d.

MORE TOWNSEND PARTS

Inner frames unwound - - - 9d.
Copper foil for condensers per doz. 3d.
Mica sheet for ditto „ 4d.
Ebonite choke formers - - each 1/-

MORSE SOUNDERS - - - 10/-

2000 OHM HEADGEARS

(Not Ex-Govt.) new - - - 23/6

3-WAY IGNITION SWITCHES

2/-
ETC., ETC., ETC., ETC., ETC.

If what you require is not on the list

PHONE: MUSEUM 643.

WRITE: 6, MARKET PLACE, W.1.

CALL: 84, GLENGALL ROAD, PECKHAM.

TECHNICAL ADVICE FREE.



CO Std bi for ERICSSON PHONES

WHEN you install your wireless set - crystal or valve - you'll get maximum results if you fit Ericsson Phones - clarity, sensitivity, strength of signals and absence of "click." Specially suited to telephony.

Ericsson Phones embody the accumulated experience of telephone manufacture for a generation.

Easy to the head, light and comfortable. The magnets never lose their strength and "shorts" are non-existent.

Write for Particulars.

The BRITISH L. M. ERICSSON
MANUFACTURING Co., Ltd.

Head Office:
60, Lincoln's Inn Fields, E.C.2

Ericsson
TELEPHONES

The London Telegraph Training College, Ltd.

Telephone
WESTERN 2696.

Morse House, Earl's Court, S.W.

ESTABLISHED
25 YEARS.

OFFICIALLY RECOGNISED BY THE WAR OFFICE AND POST OFFICE AUTHORITIES

CABLE AND WIRELESS TELEGRAPHY.

PARENTS desirous of placing their sons in either of the above Services and of affording them the best training facilities should apply for particulars of Courses and the methods of instruction which place this Institution in the first rank. **Cable Telegraphy** offers at the present time excellent prospects to youths from 15 years of age and upwards, and the **College has exclusive facilities** for obtaining posts for qualified students in the leading Cable Companies at **commencing salaries** of £150 to £300 per annum, with yearly increments of £12 to £25, and ultimate possibilities of obtaining positions as Supervisors, Assistant Superintendents, Managers, etc.

In the Wireless Telegraph Service the commencing remuneration at the present time is approximately £150 per annum, and Operators, when qualified by obtaining the Postmaster-General's Certificate of Proficiency, are nominated by the College for appointments.

No Correspondence Classes or Branches.

DAY AND EVENING CLASSES.

Prospectus containing all information will be forwarded on application to

THE SECRETARY (Dept. H.), 262, Earl's Court Road, Earl's Court, London, S.W.5

Sole Proprietors of the "Scott" Training Disc, which contains useful formulæ and other information for Wireless Telegraph Operators and is invaluable to Army Signalling Officers for range finding, etc.

Price, complete with instructions for use, 1/- Postage 2d.



EFESCA — High Tension DRY BATTERIES

For Wireless Work

Stocked in 15-volt slab units with insulated wire connections, brass strip contacts, or with screw terminals

Also "Wander Plug" type for 15 and 30 volts.

WRITE FOR PRICES

TRADE ONLY SUPPLIED

Falk, Stadelmann & Co. LTD.
EFESCA ELECTRICAL WORKS
LONDON · GLASGOW · MANCHESTER · BIRMINGHAM.

WIRELESS

Crystal Sets	from	£3
Phones, 4,000w. (Double headgear) .. .		27/-
Valve Holders	1/- and	1/6
Switch Arms, laminated brush, laquered .. .		2/-
Grid Condensers (ebonite with terminals) .. .		2/3
Aluminium Pulleys for Aerials		1/-
Contact Studs	per doz.	1/-
Terminals	from 2/- per doz.	
Filament Resistances, for under panel mounting .. .		3/6
Nickel-plated Ericsson Microphones .. .		5/-
Microphones, with replaceable insets .. .		2/6
Variable Condenser in Cabinet (21 plates) .. .		18/6
Intervalve Transformers (wound with silk wire, ratio 5:1) .. .		21/-
Condenser Plates (aluminium)	per doz. pairs	2/-
Reel Insulators, 1 1/2" diameter		3d.
Mk. III Crystals in Cups, Zincite and Bornite .. .	each	6d.
Ebonite Knobs, and knobs with 2 b.a. bush .. .	each	6d.
H.T. Batteries, 15v.		3/-
H.T. Battery Boxes, 10" x 5" x 8" with Switch and Fuses .. .		6/6
Mahogany Instrument Cases, 13" x 8" x 6", with carrying, lock and key		8/6
Wilson Transmitters, complete with interrupter, as new .. .		£6 10s.
Ex-Government Telephones, 1,500 w. (double headgear) .. .		10/6
Ivorine Scale 0°-180°		9d.
Egg Insulators		6d.
One only, Weston relay		£2
Sliders and Rod		1/4

ALL GOODS GUARANTEED.

Carriage paid on orders of £1 and over.

C. S. SWAN,
191, Bishopsgate

Phone, Bishopsgate 1155. (next to Brandons, Tailors).

CRYSTALS

Large Purchase of Government Tested Crystals.

ZINCITE & CHALCOPYRITE fitted in Brass Cups, with Wood's Metal.

ALL CRYSTALS GUARANTEED

6 for 2/-

C. S. SWAN,

191, Bishopsgate, E.C.1. 65, Windsor Road, Leyton, E.10.
(Next to Brandon's, Tailors). Phone: Bishopsgate 1155.

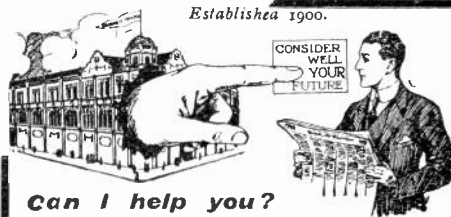

Can I help you?

I WILL GIVE YOU £50

if I fail to produce over 7,000 testimonials from others I have helped TO A SUCCESSFUL CAREER.

Yours to success,

Every man is the Architect of his own Fortune!

**ARE YOU QUALIFIED?
FOR THE JOB YOU SEEK?**

WE TEACH BY POST **ADVICE FREE.** **LEARN A TRADE**
Most moderate charges. PAYABLE MONTHLY. OR PROFESSION.

Write for one of our FREE BOOKLETS on any of the following subjects:

- | | |
|------------------------|-------------------------|
| Architectural Drawing | Matriculation |
| Building Construction | Metallurgy |
| Clerk of Works' Duties | Mining |
| Aviation | Mine Surveying |
| Boiler Engineering | Motor Engineering |
| Boiler Making | Naval Architecture |
| Chemistry | Pattern Making |
| Civil Engineering | Salesmanship |
| Concrete and Steel | Sanitation |
| Draughtsmanship | Shipbuilding |
| Electricity | Structural Engineering |
| Engineering | Surveying and Levelling |
| Foundry Work | Telegraphy & Telephony |
| Internal Comb. Engines | Wireless Telegraphy |
| Marine Engineering | Special Course for |
| Mathematics | Apprentices |

What proof do you carry? Your word to an employer is not proof that you are efficient, but a College Qualifying Diploma or Certificate, signed by the Professional Staff, is a proof of efficiency, and a valuable asset in seeking a remunerative position.

We specialise in all exams, connected with technical subjects. If you are preparing for any exam, ask our advice. All particulars FREE OF CHARGE. Parents should seek our advice for their sons. If you are interested in any of the subjects mentioned above, write, naming the subject, and we will send you our FREE BOOKLET.

Please state your age. Courses specially combined to meet all requirements.

DEPARTMENT 129 SHEFFIELD

HIGH GRADE EBONITE

SHEETS RODS TUBES MOULDINGS

"Bakelite," "Wittonite" & Fireproof Mouldings

Suitable for Electrical, Wireless and Mechanical Requirements.

ENQUIRIES INVITED

THE GENERAL ELECTRIC CO., LTD.,

Insulation Dept., MAGNET HOUSE, KINGSWAY, LONDON, W.C.2

Insulation Works: WITTON and COVENTRY.



SHEET, ROD AND TUBE stocked in qualities suitable for all Wireless work.
KNOBS (Moulded), various patterns stocked
CONDENSER DIAL AND KNOB.
 3" and 4" dia.—0°—100°

Watch this Advert.
 for new
 mouldings.

EBONITE
 (HARD RUBBER)

Enquiries Solicited.

WHOLESALE ONLY.

AMERICAN HARD RUBBER CO.

(BRITAIN) LIMITED

13a, FORE STREET, LONDON, E.C. 2
 Teleg. "Eboniteth, Ave., London." 'Phone: Central 12754

IMPORTANT— NOTICE

A. C. COSSOR, Limited, hereby give notice that the order of Mr. Justice Russell of the 1st March, 1922, continually advertised by the Marconi Co., was an order ARRIVED AT BY CONSENT.

Being engaged at the time in the production of an improved and different type of valve, A. C. COSSOR, Limited, did not consider the patents in question of sufficient importance to warrant the expense of litigation.

A. C. COSSOR, Limited, respectfully leave the public and the Trade to judge whether the constant repetition of the notification of the judgment referred to is necessary or expedient in the circumstances.

Visit our Stand No. 29. All-British Wireless Exhibition. Horticultural Hall, September 30th to October 7th.

A. C. COSSOR, LIMITED
 Aberdeen Works, Aberdeen Lane,
 Highbury Grove, N.5

GIVEN AWAY!

TO CELEBRATE THE INTRODUCTION OF OUR NEW HIGH GRADE VARIABLE CONDENSER, MOUNTED OR FOR PANEL MOUNTING, WE ARE GIVING AWAY

Two Ebonite Valve Holders

with every Order received on or before October 2nd.
SPECIFICATION—Rotary. Air Dielectric. Stout well cut Vanes. Adjustable bearing. Contact to moving Vanes by Copper Strip. Built upon moulded top and bottom supporting plates. Suitable for mounting on any panel from $\frac{1}{2}$ " to $\frac{3}{4}$ " thick by drilling 3 holes. Supplied with screws for fixing. In the following capacities—0005, 15/-; 2 for 28/6; 4 for 55/6; 0003, 12/6; 2 for 23/6; 4 for 45/6; assembled ready for mounting. The design of these Instruments is such that they can be produced en masse at a reasonable price while retaining a high standard of efficiency. They are suitable for any make of Panel.

Mounted Condensers.

SPECIFICATION as above. Mounted in polished Mahogany Cases, $4\frac{3}{4} \times 4\frac{3}{4} \times 3\frac{1}{2}$ " with Ebonite Top and Knob, Scale and Pointer, in the following capacities: 0005, 18/6; 2 for 35/6; 4 for 79/6; 0003, 16/-; 2 for 30/6; 4 for 59/6.
 Delivery from Stock. Post paid on orders of £1 and upwards in Great Britain and Ireland. Colonial and foreign postage extra. Trade supplied. Write for terms. Liberal discounts.

**FALLON CONDENSER
 MANUFACTURING CO.**
 230a, Hermitage Rd., London, N.4

Intervalve Transformer

PRICE
 19/6

Postage
 6d

Orders
 must be
 accompanied
 by
 remittance.

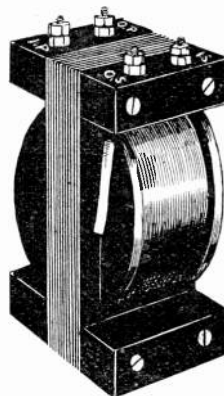

PRICE
 19/6

Postage
 6d.

Orders
 must be
 accompanied
 by
 remittance.

MADE WITH GENUINE STALLOY STAMPINGS. BOBBINS TURNED FROM SOLID EBONITE. PERFECT INSULATION. VERY EFFICIENT AND SILENT. FIT ONE AND TRY IT. IF NOT SATISFIED WE WILL REFUND MONEY.

The B. & A. WIRELESS Co.
 VERULAM STREET, ST. ALBANS.
 PHONE—323.

BROADCAST CRYSTAL SET 27/6

On mahogany base, single slide tuning inductance, range 150 to 2750 metres, Fixed Condenser, Crystal Detector, Terminals, Post Free. Paris and Concerts are quite easily received on this set. PHONES, HIGH RESISTANCE, GUARANTEED, 25/- POST FREE.

I. K. STEVENS & Co. Wireless Section, 32a, Chester St., Grosvenor Place, S.W.1
Trade Inquiries Invited. Phone—Victoria 5837

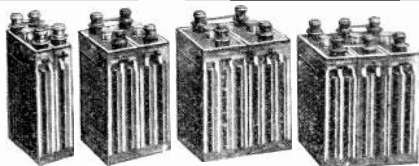

EFFICIENT—WELL FINISHED—
MAXIMUM CAPACITY—LOW PRICES.

Send for Complete Lists.

THE ESSEX ACCUMULATOR CO., LTD.
499, Grove Green Road, Leytonstone, E.11.
Telephone: Wanstead 749.



SKINDERVIKEN BUTTON.

A Supersensitive Microphone.
Known all over the world and patented in every civilised country. Over 60,000 sold. ENGLISH Manufacture.

Make up your own Loud Speaker.
Transmit your GRAMOPHONE music to any room in your house.

The only practical Microphone for use in Detectiphone Sets.

Price 5/- each

Special Low Resistance Receivers (for use with Skinderviken Buttons) 10/- each
Special Gramophone Attachments 1/-

Write for 16 page BOOKLET fully illustrated and containing much useful information for all interested in Electrical Sound Transmission. 6d. Post free.

Sole Proprietors:

MIKRO LTD., 274/6, Pentonville Rd., London, N.1
(Opp. King's Cross (Met.) Rly Station).

PROMPT SERVICE

Send two stamps for lists of wireless supplies. We can *and do* deliver promptly.

ELECTRICAL SUPPLY STORES,
5, Albert Terrace, King Cross,
HALIFAX, England.

SPEARS and COMPANY

FOR

TERMINALS

SCREWS, NUTS, WASHERS, PLUGS and SOCKETS, CONTACT STUDS, BUSHES, VALVE LEGS, CONDENSER VANES and TURNED and PRESSED PARTS OF EVERY DESCRIPTION.

Actual Manufacturers to TRADE ONLY

WE REGRET WE CANNOT SUPPLY SMALL LOTS TO AMATEURS

CAPSTAN REPETITION WORKS,
PARK ROAD, HOCKLEY, BIRMINGHAM
Telephone: 3265 Central. Telegrams: "Firettes," Birmingham

THE PARAGON RUBBER MANUFACTURING CO. SCULCOATES, HULL.

E BONITE	WIRELESS
Sheet, Rod & Tube	KNOBS
ELECTRICAL	V A L V E S
MOULDINGS	SLIDERS, Etc.

Wholesale only.

London Office: **PERCY W. C. TRICK,**
20, LITTLE PORTLAND STREET, W.1
Telephone: MUSEUM 2043.

I HAVE IN STOCK 5000 BROWN'S PAIRS (120 ohms) "A" PHONES

NEW AND UNISSUED

POST FREE **40/-** PER PAIR
CASH WITH ORDER

WILKINSON, Lonsdale Rd., Kilburn,
TRADE SUPPLIED (Same address since 1900) N.W.6

P. ORMISTON & SONS

(P. H. ORMISTON) :: ESTABLISHED 1793
79 Clerkenwell Rd., London, E.C.1
"Ormiston, London." :: :: 13259 Central.

Silk and Cotton Covered H.C. Copper Wire, Resistance Wires, Fuse Wire, Binding Wires, Charcoal Iron Core Wire, Asbestos Covered Wire, Braided and Twisted Wires, Bare Copper Strand and Flexibles of any Construction, Wire Ropes, and Cords (fine sizes) in Galvanized Steel, Phosphor Bronze, &c.

GENTS MAKE :: FITMENTS ::

SEND
FOR
OUR
SUNDRIES
PAMPHLET



THE "DISCOL" H.F. TRANSFORMER.

MAKE USE OF OUR STOCKS.

ASK US TO QUOTE FOR YOUR
WHOLESALE REQUIREMENTS.

GENT & Co., Ltd., FARADAY WORKS, LEICESTER.
LONDON: 25 VICTORIA STREET, S.W.1.
NEWCASTLE-ON-TYNE: TANGENT HOUSE, 52 BLACKETT ST.

NEW SUPPLY JUST RECEIVED FROM
THE PRINTERS.

THE RADIO EXPERIMENTER'S HANDBOOK

By PHILLIP R. COURSEY,
B.Sc. (Eng.), F. Inst. P.

113 pages. 99 Diagrams and Illustrations.

PRICE **3/6** NETT.

(Postage 6d.)

CONTENTS—

General Considerations—Components of Wireless Installation—
The Aerial Circuit—Receiving Tuners—Receivers, including
detailed instructions on the making of the many types of
inductances and useful Mark III tuner modifications,
Amplifiers and Valve Detectors with circuits of high-frequency,
low-frequency and resistance—Capacity Coupled Amplifiers—
Heterodynes, giving working instructions for making up a long
range heterodyne wavemeter—Appendix: High Frequency
Measurements and Calculations with valuable data and tables.

The Wireless Press, Ltd.

Dept. W.W.

12-13, Henrietta St., Strand, London, W.C.2





Price :
8/6
each

Price :
8/6
each

Code word, "WIRIT." 36 volts. Size, 6 1/4 x 2 1/2 x 3.

GENUINE HELLESEN DRY BATTERIES FOR WIRELESS HIGH TENSION

SPECIAL TRADE AND WHOLESALE TERMS

Code word.	Volts.	Details.	Price.
"WIRON"	15	Screw terminals	4/- each
"WIRTO"	15	Strip "	4/- "
"WIRIT"	36	2 insulated wander plugs	8/6 ..
"WIRIN"	60	" "	14/- "

**KNOWN THE WORLD OVER AS
THE BEST.**

ALL LISTS FREE ON APPLICATION.

A. H. HUNT, LTD.

H.A.H. Works, Tunstall Rd., Croydon, Surrey.

THE LARGEST STOCK of 4 B.A. TERMINALS IN ENGLAND.



Actual size

Price, 2/6 per dozen, plated, 3/- brass;
2 B.A. Single, 9d. per dozen.

One valve detector panel complete with filament resistance
valve holder, and grid leak and condenser, fitted with
insulated terminals, mounted on solid ebonite base
in mahogany instrument case .. PRICE 25/-

Leading-in Tube, ebonite, R.A.F. pattern with brass rod
and fittings. .. PRICE 3/6

Aerial Real Insulators, tested to 25000 volts PRICE 4

Accumulator Charging Resistances .. PRICE 25/-

Universal Tuners. These tuners have been designed to
tune in Marconi concerts, broadcasting, and Dutch
Concerts, so that a baby can use them. Wavelength
range, 300-1,500 metres, with .0005 m.f. condenser.
PRICE 7/-

4,000 ohm phones, new patent 3-magnet type, fitted
cords and tags, complete with nickel plated head
bands .. PRICE 35/-

Transmitting Keys, G.P.O. pattern, fitted platinum
contacts .. PRICE 5/-

Valve Holders, fitted in solid ebonite, fixing case drilled
fitted with valve earthing clip .. PRICE 2/6

Grid Leaks and Condensers, mounted on solid ebonite
PRICE 5/-

Instrument Cases, solid mahogany, 9" x 8" x 2 1/4", highly
finished, fitted ebonite panel, undrilled PRICE 8/-

Postage extra on all the above prices.
The trade supplied. Enquiries solicited.

J. LIPOWSKY, 614, OLD FORD RD. LONDON, E.3 'Phone: East 3345

Intervolve Transformer

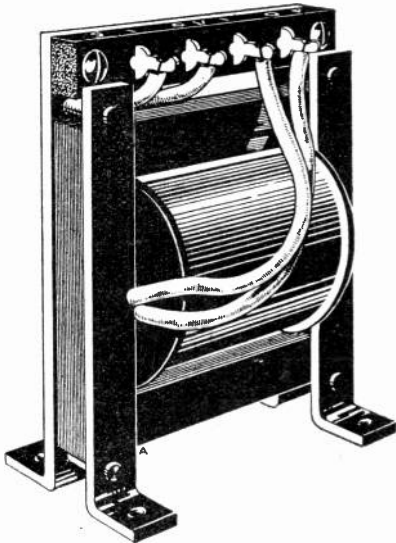

Price 30/- each
TELEPHONE TRANSFORMER
 Similar in design to our L.F. Transformer.

Price 22/6 each

VARIABLE CONDENSERS
 complete with Dial and Knob. Value .001 mfd.
 Price 25/- each.

FILAMENT RESISTANCES
 Improved design. Price 5/9 each.

DUBILIER CONDENSERS ALL TYPES
 We have been appointed agents for the Manchester District for the sale and distribution of this firm's well known specialities and are now in a position to deliver from stock all types of condensers.

TRADE TERMS ON APPLICATION.
 Terms of Business.
 Cash with Order.
 Orders over value £5 carriage paid.
 Orders executed in strict rotation.
 Delivery ex stock at time of going to press.



The Manchester Radio Co., Ltd.
155, OXFORD ROAD
 (Entrance Boundary Street East)
MANCHESTER
 F. H. McCREA, Managing Director.
 W. R. BURNE, Directing Experimental Dept.
 Telephone: Central 4935.

"SEMAPHORE"

High Tension Dry Batteries for Wireless Receiving Sets



TERMINALS. — The 15 volt Batteries are supplied (unless otherwise ordered) with 2 Brass Connecting Strips as illustrated. All the other sizes have 2 Insulated Plugs. Brass Sockets are fixed to every other Cell so that Tappings can be taken at each 3 volts.

Volts	Number of Cells	Price Each Carriage paid
15	11	3/9 3/8
30	22	8/6
36	24	9/3
50	36	13/6
60	44	16/6
90	66	24/6
100	72	26/6

Other sizes can be supplied and quotations given on receipt of enquiries.

In order to prove that "SEMAPHORES" are THE BEST and induce a trial, we have reduced our price for 15-volt to 3/8 each.

Trade supplied promptly.
 Terms on application.

See our Batteries at Stand No. 5. All-British Wireless Exhibition, Horticultural Hall, September 30 to October 7.

SEMAPHORE, Ltd., DRY BATTERY SPECIALISTS
28, John Street, Bedford Row, London, W.C.1.
 Telephones : : MUSEUM, 5422 and 5423.
 Telegrams : : ARWELIDITE, HOLB. LONDON.

LISTEN - IN — on the "AEROWAVE" RECEIVER

A complete Installation at a low cost

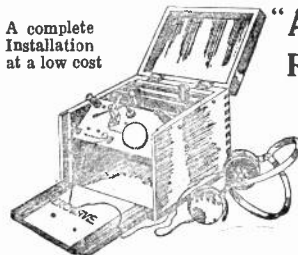

Price
£6 : 6 : 0
 with complete Equipment

HENRY J. BREWSTER & CO.
 11, Queen Victoria Street, LONDON, E.C.4

Questions and Answers COUPON

To accompany Questions sent in during the week commencing Sept. 23rd, 1922.

VOL. X, NO. 26.

See Conditions on Page 837.

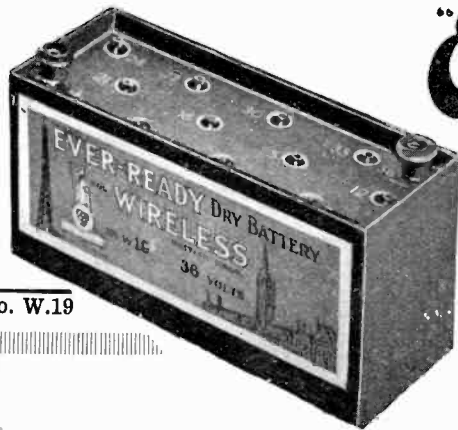

No. W.19

Ever-Ready™
British Made

DRY CELLS and BATTERIES for High & Low Tension

THE STANDARD OF QUALITY



UW.1

HIGH TENSION BATTERIES

Any size or voltage with any tappings or sockets at 3 or 6 volt intervals for use with Wander Plugs can be supplied to order. With 13 sockets as illustrated.

No. W.19, 36 volts, 24 cells, 8/6 each. Size 6½ × 2½ × 3½. Weight 2 lb. 8 ozs.

Wander Plugs 1/- per pair. With 2 Spring Contacts. No. W.11, 15 volts, 11 cells, 3/6 each. Size 9½ × ½ × 2½. Weight 1 lb. 2 ozs.

THE UNIT DRY CELL

"Build up your batteries as you build up your Marconi Sets."

Unlimited flexibility in size, voltage and intermediate tappings. Each cell is fitted with brass screw terminal and looped wire, and they are efficiently insulated to prevent current leak.

No. UW. 1, 7/6 per dozen. E.M.F. 1½ volts. Weight 3½ ozs. Dimensions 2½ × 1 5/16 diam.

Art Catalogue of Standard Sizes and Voltages and list of Accumulators for Valve Filament Supply sent on request. Dept. D.L.

THE EVER-READY WORKS, Hercules Place, Holloway, N. 7.

Visit our Stand No. 11, All-British Wireless Exhibition, Horticultural Hall, September 30th to October 7th.

Dependable Radio Supplies
—every article illustrated here
supplied from stock

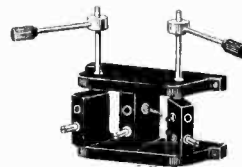
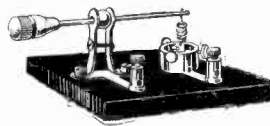
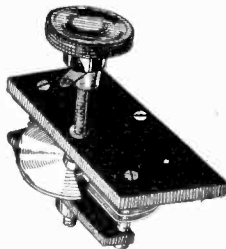

Vernier Condenser 4/6 Series Parallel Switch 3/6
Crystal Detector ... 3/6 Telephones (4000 ohms) ... from 27/6
3 Coil Holder (long handles) ... 19/- Filament Rheostat 4/-
These are a few items from our big 32-page Catalogue (6d. post free.)

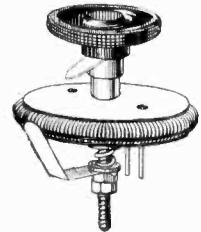

THE PETO SCOTT Co.

FEATHERSTONE HOUSE, 64, HIGH HOLBORN, W.C.1

Also at 17, FROME ROAD, WOOD GREEN

Visit our Stand No. 16. All-British Wireless Exhibition, Horticultural Hall, Sept. 30th to Oct. 7th.

ACCUMULATORS

Absolutely Guaranteed Best Quality
CELLULOID CASES.

4 volt 40 amp. 18/6	4 volt 80 amp. 28/2
4 " 60 " 21/6	4 " 100 " 30/-
6 " 40 " 26/3	6 " 80 " 37/3
6 " 60 " 31/9	6 " 100 " 41/6

PACKING FREE.

TRADE PRICES NOW REDUCED
Write for Latest List.

SPECIAL OFFER.

6 volt 44 Actual amp. Set three Glass Cells, sealed tops in well-made Teak Crate, a handsome set - - - **49/6**
 4 volt 24 amp., Celluloid Case, **11/9** Postage 1/-
 2 " 16 " Ebonite " **3/9** Post Free.
 Aerial Wire - - per 100 ft. Coil **5/-**

All Sizes of Accumulators Quoted for.

EXIDE ACCUMULATORS STOCKED
(Trade supplied)

Dynamos, Motors, Electrical Accessories,
Sulphuric Acid (write for lists) Stocked.

F. YATES & Son, Ltd

WHOLESALE ELECTRICIANS,
144, Church St., Kensington, London, W.8
One Min. from Notting Hill Gate Sta. 'Phone—Park 4276.

BE UP-TO-DATE

READ THE
**WIRELESS TRANSMISSION
OF PHOTOGRAPHS,**
By **MARCUS J. MARTIN.**

143 pages. 139 Diagrams and Illustrations.
Price **5/-** net. Post free **5/6**

THE WIRELESS PRESS. LIMITED,
DEPT. W.W.
12/13, HENRIETTA ST., STRAND, LONDON, W.C.2

**WITH GOOD APPARATUS YOU
CAN GET GOOD RESULTS**

THE "W.P."

Morse Practice Key

Well Made. First-class Finish. Thoroughly Reliable

Price **7/6** Post Free

THE WIRELESS PRESS, LTD.
12-13 HENRIETTA STREET, LONDON, W.C. 2

SENSATIONAL REDUCTIONS.

.0005 Variable Condenser, complete with engraved scale, and pointer, mounted on walnut cabinet, **17/6**, post **9d**.
Vario Coupler, consisting of 3" turned mahogany ball, mounted in 3½" ebonite former, which is turned and grooved for wire, all contacts made complete with bush, boss, spindles, and knob, ready for panel mounting, **15/9**, post **9d**. Mounted on ebonite panel and base with shorting strap and four terminals, for use as Vario Coupler or Variometer, **21/-**, post **9d**.
Filament Resistances for panel mounting, **3/8**, post **4d**.
Murdoch's Headphones, 2000 ohms, **32/6** per pair, post **9d**.
Mark III Terminals, with nuts, **2/3** per doz., post **5d**.
Valve Detector Panel, complete ready for use, with all necessary terminals, grid leak, and condenser, Filament Resistance, and valve holder, with book of Instructions, **19/6**, post **1/-**.
Slab Inductances, per set of 8, **10/-**, post **9d**.
Basket Inductances, per set of 7, **7/-**, post **5d**.
Valve Sockets, with two nuts, **2d**. each.

EVERYTHING GUARANTEED.
THE SCIENTIFIC SUPPLY STORES,
8, NEWINGTON CAUSEWAY, LONDON, S.E.

THE TINGEY UNIT SYSTEM

HAS PROVED ITS EFFICIENCY

Write for
**ILLUSTRATED
CATALOGUE**
(3d. post free)

which contains an article on
Wireless Made Easy and a
**Complete List of all Wire-
less Goods in Stock**

Visit our Stand No. **25**. All-
British Wireless Exhibition,
Horticultural Hall, September
30th to October 7th.

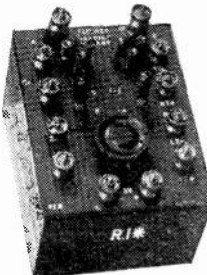

W. R. H. TINGEY, 92, Queen Street,
Hammersmith, London, W.6.

WIRELESS TRAINING COLLEGE LTD.

ST. MARY ST., CARDIFF, & NEPTUNE CHAMBERS, VICTORIA ST., BRISTOL.

The above Colleges are amongst the most successful in Great Britain for quickly qualifying Students for the Wireless Service. We have, since the outbreak of War, passed over 1,000 Students to Wireless Appointments. Two Systems are taught, the Marconi and Siemens Quench Spark System. We make a speciality in training ex-service men who have some knowledge of Wireless. **Ex-service men can have a free test to ascertain the time it would take to qualify them if they will call at the College.**

For Terms apply to—
LIBUT-COMDR. J. R. SCHOFIELD, M.B.E., R.N.V.R. (C), Principal.
P.S. Every student who qualified at our Colleges was placed in a permanent situation.

manufacture thermionic valves under the patents belonging to the Marconi Company. Any valve similar to those generally known as the "French type" constitutes an infringement of the above patents whether manufactured in this country or imported from abroad. Marconi House, Strand, London, W.C. 2.

Hollow Steel Aerial masts, complete with guys, etc., from 60 ft. to 100 ft. Mica, Ebonite (Sheet, rod, tube), Brass Rod, Insulating Tubing, Paraffin Wax, Foil, Aerial Wire, Copper Wire, Insulators, Terminals, Nuts and Screws, etc., etc., at lowest prices.

HESTIA ENGINEERING CO.,
32, Palmerston Road, Acton, London, W.3

IF YOU WANT A
GOOD
BOOK ON RADIOTELEPHONY
GET
TELEPHONY

Do not fail to visit our Stand No. 9

at the
ALL-BRITISH
WIRELESS EXHIBITION
Horticultural Hall

LESLIE McMICHAEL LTD.

PROVIDENCE PLACE, WEST END LANE, KILBURN, N.W.6

Bus Services 1, 8, 18, 28, 51 all pass West End Lane

Telephone: HAMPSTEAD 1261 Nearest Tube Station: KILBURN PARK (BAKERLOO)

The Truth about Brown's Phones

("A" type Reed Pattern.)

Some months ago the Disposal Board offered for tender some 15,000 pairs of un-issued Brown and Sullivan Head Telephones, which had been lying in Woolwich Dockyard and other stores for several years during the war. The Brown's Telephones were of obsolete pattern, that is to say had aluminium and paper diaphragms. These telephones were eventually purchased at a very low figure for these reasons.

We have acquired a large proportion of these telephones and are in the position to offer same at prices shown below. On the other hand Messrs. Brown have been re-conditioning, where necessary, and replacing the obsolete aluminium and paper diaphragms with new aluminium diaphragms, and rewinding where necessary. It therefore stands to reason that **these telephones are better in every way than unused, un-issued Government telephones.** We make a special offer of these Re-conditioned S. G. Brown's Headphones. *See prices below.*

OUR PRICES

New Condition and Un-
used Ex-Government
but not guaranteed by
the Makers.

120 ohms... **37/6**

8,000 ohms **43/6**

With Cords included.



To get the best
from your set use
the best phones:
B R O W N ' S

Re-conditioned and fully
guaranteed by

Messrs. S. G. Brown, Ltd.
(See their recent advertisement)

120 ohms ... **50/-**

8,000 ohms **55/-**

With Cords included.

Compare these prices with similar phones offered by other Firms. It stands to reason that telephones do not improve in Government Stores; the diaphragm, part parchment, part aluminium, is liable to deteriorate — magnets need attention and the reeds require delicate adjustment.

These telephones are the only ones acquired by Messrs. S. G. Brown from the Disposal Board this year and have been re-conditioned and guaranteed expressly for us by them. We sell to the public with the fullest belief that they will be entirely satisfied that they are worth the difference in price.

ILLUSTRATED CATALOGUE
18 Pages. 100 Illustrations.
Write for Catalogue (W)
8d. post free.

Catalogue (W) includes list of
Complete Crystal and Valve Sets
from 95/- post paid.

TO THE TRADE
Excellent selection and full stock
for supplying trade. Advice and
assistance in choice freely given
if desired.

Visit our Stand No. 38. All-British Wireless Exhibition, Horticultural Hall, September 30th to October 7th

150 VARIOMETERS
 at £1 15 0 each
50 VARIOCOUPERS
 at £2 0 0 each

Believed to be the only ones
 now available in Britain.

The use of Variometers and Variocouplers is acknowledged by all wireless experts to be the best and most advanced way to tune in sharp and close, thus tuning out atmospheric and other interferences. Made for 300 to 700 metre wavelengths.

Post orders only. Terms—Cash with order.

Money refunded if not satisfied, within 7 days, provided apparatus is returned.

Address—**M. ADAIR,**
 30, Bedford Place, London, W.C.1

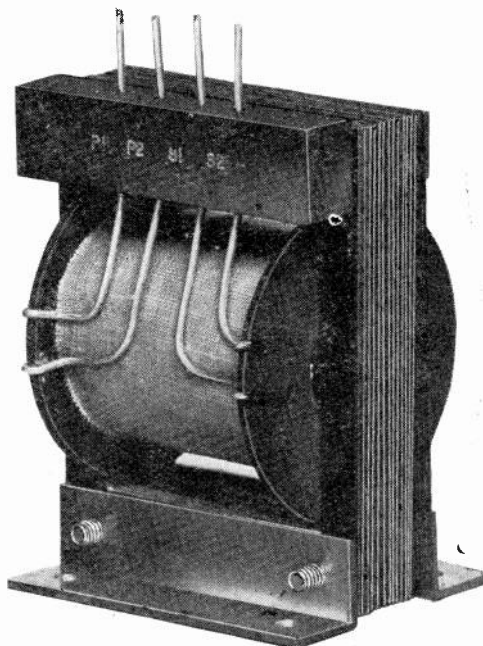

INTERVALVE TRANSFORMERS

Windings of best enamelled pure copper wire.

Primary wound to possess correct impedance when connected in plate circuit of average "hard" receiving valve.

Secondary Designed to deliver maximum voltage.

Insulation Each layer insulated by finest paraffined paper and guaranteed not to break down when correctly used.

PRICE **23/6** POST FREE.

Immediate Delivery from Stock.
Attractive Discounts to the Trade.

THE ASHLEY WIRELESS TELEPHONE CO. LTD.

DEPT. W.

69, RENSHAW ST., LIVERPOOL.

OUR GOODS NEED VERY LITTLE ADVERTISING

IN QUALITY AND PRICE
 THEY SPEAK FOR THEMSELVES.

SEE BELOW

Aerial Wire, 7/22, per 100'	5/-
Batteries, 15v. H.T., best make	each 3/3
Condenser Grid, mounted ebonite	each 2/6
Condenser Vanes, Aluminium	per pair 2d.
Condenser Washers, large	per doz. 6d.
Condenser Washers, small	per doz. 4d.
Contact Studs, with nut and washer	per doz. 1/6
Coils, mounted with ebonite push fittings:—Wavelengths		
175/400, 4/-; 250/550, 4/6; 325/750, 4/9; 450/1,200,		
5/9; 550/1,500, 6/6; 850/2,000, 7/-; 1,350/3,000, 7/6;		
1,500/4,000, 8/-; 2,000/6,500, 8/6; 3,000/9,500, 9/-, each.		
Knobs, 5d. each, with brass bush, 6d. each.		
Headphones, complete, 2,000 ohms	each 23/-
Headphones, complete, 4,000 ohms	each 25/-
Headphones, complete, 8,000 ohms	each 30/-
(Brand New)		
Switch Arms, laminated	each 1/6
Filament Switch	each 3/9
Terminals with Nut and Washer	per doz. 2/-
Ebonite, Best, 1" thick	per lb. 4/-

Cash with Order. Goods by return.

Carriage paid, £2 and over.

TRADE SUPPLIED.

ANGELL'S WIRELESS SUPPLY STORES,
Manufacturers.

95, Highbury New Park, LONDON, N.5

MORE Attractive Novelties

from

The Home of New Ideas in Wireless

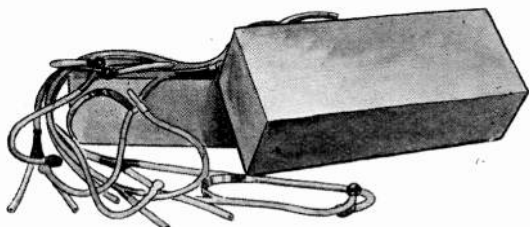

"NOVELLO" Listening-in Outfit.

PRICE :	2 Way	-	-	25/-
	4 Way	-	-	35/-
	8 Way	-	-	50/-

What you have been waiting for—a new device that enables from two to eight persons to hear the Broadcasting without extra telephones or the use of a Loud Speaker. Can be used on both CRYSTAL and Valve sets. Let your friends listen-in. Simple to operate, simply attach to your telephone terminals and it's ready for use. Unit contains special "3 Bee" type of loud speaking telephone—5 feet tubes with ebonite ear pieces and connections. Enclosed in a handsome mahogany box. Price complete—Two way 25/-; Four way 35/-; Eight way, enabling eight people to listen 50/-

Postage 1/6

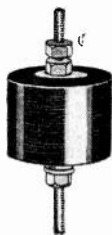

"NOVELLO" New Type Crystal Detector.

New type of Permanent Crystal Detector. No fooling about or fiddling trying to find active point. Simply attach to any crystal set and ready for immediate use. Device sealed in an Ebonite cartridge away from air, moisture, or climatic changes. Our own Detector upon which numerous patents have been applied for, the sensation of the Wireless World. Thousands being sold. Dealers, write for prices in quantities for this quick selling line. It sells on sight.

PRICE only 7/6

Other types 12/6. Postage 4½d.



Note the splendid tapering knob. Fits the fingers.

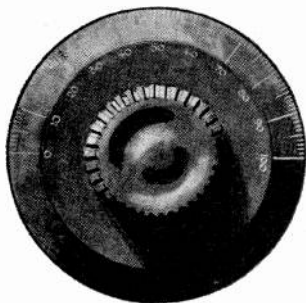

"NOVELLO" Standard 3½" Dial.

Here's a new and better designed Dial. Made of Ebonite with figures and degrees in white. Works to the right from 0° to 180° 3½" in circumference. Beautiful finish, Made to take British size standard nuts. New improved type of knob—fits the fingers. Easy to attach and at a price that defies competition. Our own original design.

PRICE only 3/6 each. Postage 3d.

Agents and Manufacturers, write for liberal discounts on quantities.

Write for Free Catalogue.

Now in Press.

BRITISH RADIO SALES CO. LIMITED
62, OXFORD STREET, LONDON, W.1

—LARGEST MAIL ORDER WIRELESS HOUSE IN EUROPE.—

WIRELESS SUPPLIES

Of a Better Grade and Class.

WE believe that there is a growing demand from the better class of Wireless Experimenters for Wireless Products useful in their work of a better grade, made better, of better materials and better finish than the general run of cheap shoddy products made by many who do not understand that it is highly important that Wireless Products must be made by master craftsmen so that they are made **Right**—tested **Right**—and work **Right**.

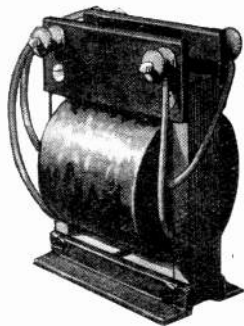

"Novello" Transformer.
Price 27/6.

Goods made by us fulfil all these requirements. Our mass production plan of manufacture enables us to offer our products at **popular** prices.

Here's a transformer of strong sturdy design, built on scientific principles. The Core composed of Stalloy stampings of sufficient size to obviate distortion. Specially wound to stand 1,000 volt test between windings. The solid impregnated coil has a low self capacity and is very quiet in operation. A bit higher in price but better built throughout, designed and made for the man who wants the best and is willing to pay a few shillings more to get **just** what he wants. Price **EACH 27/6**

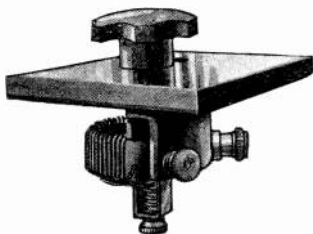

"Novello" Filament Resistance.
Price 6/-.

At last, a perfect type of Filament Resistance giving every variation of lamp control. Our new type of adjustment makes contact easy and light, therefore no danger of ruining tubes—contact adjustable by means of nicked steel wire spring. Easy to attach and an ornament to any set. Price complete **6/-** with knob and nicked terminals ready to attach. Postage 4d.

Special low discounts to dealers and manufacturers. Agents wanted everywhere.

BRITISH RADIO SALES CO. LIMITED

62, Oxford Street, London, W.1

All our Products are made in Great Britain throughout

1. Perfect insulation of grid connection ensures silent operation.

2. All connections shown in diagram ready made for you and brought out to terminals.

3. To add an amplifying stage, connect to terminals and insert valve.

4. Tapped holes in two sides and base make fitting easy.

To the man who is—

BUILDING a valve set.

Do not buy intervalve transformers.

The Elwell Amplifying Unit replaces them on all good sets.

It saves time, money and trouble.

BUYING a valve set.

See that the amplifying stages are carried out by Elwell Amplifying Units. They enable the manufacturer to give you a better job at a lower cost.

THE ELWELL AMPLIFYING UNIT

comprises valve socket and ironclad intervalve transformer, mechanically and electrically combined in one unit. When provided with a valve and connected as marked on the terminals, it is all that is necessary to give a further stage of amplification to an existing set. No soldering. Easily mounted.

The self-contained permanent connections embedded in compound are a big practical advantage, while the perfect insulation of the grid connection will appeal to all amateurs troubled with "noise."

Exclusive design covered by patents.

British made and guaranteed throughout.

PRICE : 39/6 only, for complete amplifying unit, less valve.

Deliveries from stock.

Call and see it.

Enquiries for all wireless components invited.

C. F. ELWELL, LTD., CRAVEN HOUSE, KINGSWAY, LONDON, W.C.2.

Telephone—REGENT 421.

ALL-BRITISH WIRELESS EXHIBITION

ADMISSION

1/3

INCLUDING TAX

AND

CONFERENCE

Sep. 30 (1922) Oct. 7

SATURDAY

SATURDAY

ADMISSION

1/3

INCLUDING TAX

HORTICULTURAL HALL,

Vincent Square, Westminster, S.W.1.

Special Public Day, October 3rd

Special Trade Day, October 2nd

ADMISSION **5/-** Including Tax

ADMISSION **1/3** Including Tax

(Public admitted both days after 6 p.m. at the usual price.)

The Convention will be held under the auspices of The Wireless Society of London

SPECIAL ATTRACTIONS

THE WIRELESS SOCIETY OF LONDON

Have arranged for officers of the Society to be available each day, at the room put at their disposal, to meet officials and members of Affiliated Societies from London and Provinces. A staff of experts will be in attendance to conduct visitors round the Exhibition.

The following are among the gentlemen who have kindly promised to give lectures, which will take place every afternoon and evening as announced during the Exhibition :—

Admiral of the Fleet Sir HENRY JACKSON.

A. A. CAMPBELL SWINTON, F.R.S., etc.

F. HOPE JONES, M.I.E.E.

MAURICE CHILD.

G. P. MAIR, A.M.I.C.E., etc.

G. G. BLAKE, M.I.E.E., A.Inst.P.

E. BLAKE, A.M.I.E.E.

PHILIP R. COURSEY, B.Sc., A.M.I.E.E., F.Inst.P.

W. R. H. TINGEY, late Royal Corps Signals, T.F.

R. CLINKER.

JOHN SCOTT-TAGGART, M.C., A.Am.I.E.E.,

F.Inst.P.

Lt. H. WALKER, A.M.I.E.E.

R. R. RIVERS-MOORE, A.M.I.E.E., B.Sc.

THE DEMONSTRATION STAND

will provide numerous concerts daily, including the reception of broadcast music, song and speech.

THE EXHIBITS

will include many instruments of entirely new design and novel apparatus never before shown to the public. At each stand highly experienced representatives will be on duty for the purpose of explaining the various exhibits.

OFFICIAL CATALOGUE

Price **6d.** Over 100 pages. Special article by F. HOPE JONES, Esq., M.I.E.E., and a complete List giving the Title and Secretary's name and address of all affiliated Wireless Societies and Clubs in Great Britain.

ORGANISERS :

BERTRAM DAY & CO., LTD.

9 and 10, Charing Cross, London, S.W.1

Gerrard 8063/4

Wireless Publicity Specialists.

BUILD YOUR OWN SET

WE CAN SUPPLY COMPLETE SETS OF PARTS TO BUILD THE FOLLOWING PANELS:—

TWO-VALVE DETECTOR AMPLIFIER, 12" × 8"	£5 0 0
TWO-VALVE H.F. AMPLIFIER, 12" × 8"	.. 4 0 0
THREE-VALVE AMPLIFIER, 12" × 12"	.. £8 0 0
FOUR-VALVE AMPLIFIER, 16" × 12"	.. 11 10 0

THE ABOVE PARTS INCLUDE: EBONITE PANEL DRILLED AND ENGRAVED, PLANS, VALVE HOLDERS, FILAMENT RESISTANCE FOR EACH VALVE, FEDERAL INTERVALVE TRANSFORMERS, SULLIVAN 'PHONE TRANSFORMER, MULLARD GRID AND CONDENSERS, TERMINALS, CONDENSER PARTS, SWITCHES, DIALS, STUDS, WIRE AND SLEEVING.

COMPLETE PANELS AND COMPLETE SETS SUPPLIED. PLEASE SEND STAMP FOR PRICES.

IMMEDIATE DELIVERY.

CASH WITH ORDER

TRADE ENQUIRIES INVITED.

NOTTINGHAM RADIO SUPPLIES

3, Poultry, Nottingham

WE PUBLISH WINNERS ISSUE 12th AUG., 1922

Question: Why did the Grid Leak?

A Parcel of Goods has been sent to Mr. W. Griffin, 17, Melvin Road, Anerley, S.E.20, for the following:—

"Because Filament 2 M.T. it but forgot."

(Mr. D. Short.—D. Good but too D. Short as you were "Ohmless." Besides, mother would be vexed.)

140 ohm phones for 23/6 4000 ohm phones for 25/-

Our offer of 8,000 ohm 'phones for 27/6 (postage 1/-) is still open. Have you taken advantage of it yet? Remember we "draw the line" after we have sold the first 1,000. Money back if not entirely satisfied. The Trade are invited to enquire. See last week's issue.

Catalogues 3d. Post Free.

Huge Reductions.

J. L. CARTWRIGHT & Co.

Mfg. Electrical and Radio Engineers,

Dept. W., 130/132, London Rd., Manchester.

'Phone: Works: Berry Street. 'Grams: Cent 4209. Pladurram, Manchester

W. & M. FIXED CONDENSERS

Accurately made to definite capacities.

All sizes ready for delivery.

·0002 to ·002 mfd. .. 2/8 each.

·003 and ·004 mfd. .. 3/- each.

Ready for immediate use. Securely packed.

Mounted in ebonite. Complete with knurled terminal nuts and correct capacity stamped on each condenser.

Send for General Price List of W. & M. Apparatus and Supplies, post free.

We sell on the distinct understanding that if the buyer is in any degree dissatisfied with his purchase, he can return same within 24 hours and money will be immediately refunded.

Free Advice to Buyers.

All our Apparatus is produced under the personal supervision of our Technical Director, Mr. Henry A. Machen, A.M.I.E.E. (late of Siemens Bros. & Co., Ltd.), whose experience in the design and manufacture of Wireless Apparatus extends over a period of fifteen years.

If you have any difficulty in obtaining W. & M. Wireless Supplies, write to us, giving the name of your Dealer.

NOTICE TO THE TRADE.

We are prepared to appoint District Agents for the sale of W. & M. Wireless Supplies, and to refer all postal orders and inquiries to such appointed Agents.

Terms and Discounts on Application.

MANUFACTURED SOLELY BY THE

Wainwright Manufacturing Co., Ltd.,

25, VICTORIA STREET, S.W.1

Works: WALTHAMSTOW, Essex, and BIRMINGHAM.

Telegrams: "NOMINATUS, VIC, LONDON."

Telephone: VICTORIA 4319.

IF YOU WOULD LIKE TO INSPECT THE BEST BOOKS

on

WIRELESS TELEGRAPHY & TELEPHONY

VISIT

STAND No. 40

at the

ALL-BRITISH WIRELESS EXHIBITION

Sept. 30th—Oct. 7th

HORTICULTURAL HALL
Vincent Sq., Westminster, S.W.1

THE WIRELESS PRESS LTD.
12-13, Henrietta St., Strand, W.C.2

THE WIRELESS WORLD EXCHANGE AND MART

TARIFF. Advertisements are accepted for this Section at the rate of twopence per word, with a minimum charge of two shillings. The advertiser's name and address will be charged for, and single letters and single figures will be counted as words. Compound words will be counted as two words.

DEPOSITS. All advertisements must be prepaid in the form of Postal Orders, the remittance being forwarded to Messrs. Bertram Day & Co., Ltd., 9 & 10, Charing Cross, S.W.1.

Intending purchasers may deposit the purchase money of any article advertised or sold by advertisers with Messrs. Bertram Day & Co., Ltd., who will acknowledge its receipt to the vendor and the depositor, the full addresses of whom should be given. Subject to special agreement between the parties, it is understood that all goods are sent on approval each party paying carriage one way in the event of the goods being returned. The deposit will be retained until due advice of the completion of the purchase has been given or until the articles have been retained and accepted. In order to cover postage, etc., a fee of 6d. in respect of sums of £1 and under and 1s. for sums in excess of £1, must be paid at the same time as the deposit. For persons not resident in the United Kingdom these fees are doubled. We cannot undertake to receive any deposit less than 2s. 6d.

FOR SALE.

Agate Cylinders, etc., for loud speaking apparatus from JAMES R. GREGORY & Co., Mineralogists, 139, Fulham Road, S.W.3.

Wireless Masts.—Improved Girder Type. Light and strong, 30 to 50 ft. at 1s. ft., 50 to 100 ft. at 1s. 6d. ft. Cash with order, carriage forward.—F. ARMSTRONG, Weybridge.

4,000 Ohm Headphones, new and guaranteed, 35s.—G. D. Hinks, Hardington, Yeovil.

C. Mark III Two-Valve Receiver, £10. or near offer. Telephones and valves extra, in good order; anyone near here is welcome to call and hear it. Brown's telephones re-conditioned, 120 ohms 50s., 8,000 ohms 55s., complete with cords. Condensers, 0.001 23s., 0.0005 17s. 6d., 0.0003 16s., for panel mounting. These condensers have four legs to stand on, so can be used without mounting. Sheet ebonite, 4s. lb. Terminals, 2s. 6d. and 3s. doz. (switch arms, 1s. 9d.). Filament resistances, 4s. Wire different gauges in stock. Telephones, 4,000 ohms, 37s. 6d. Intervalve transformers, 24s. Large assortment of wireless apparatus in stock.—R. LINDSAY, 2A, Gordon Road (two doors from the Bank), Aldershot.

A Few Shop-soiled Tapping Keys for Sale, 5s., originally 8s. 6d. Tapping key flash lights, 7s. 6d. Crystal detectors, 4s. 6d. Money returned if unapproved.—THE MILL HILL ENGINEERING Co., Edenbridge, Kent.

"EULOGY."

The Advertisement Manager, "Wireless World and Radio Review," 9 and 10, Charing Cross, London, S.W. August 29th, 1922.

Dear Sir, "We would like to advise you that owing to the tremendous number of replies we have received from our small advertisement which appeared on the 26th inst., we have completely sold out the line we were advertising, and have had to return large numbers of orders and remittances, being unable to cope with anything like the numbers of orders received.

"We would mention we have tried other mediums advertising from our Wireless Dept., with the result that we have given these all up in view of the extremely large number of replies we receive in comparison from The Wireless World and Radio Review."

"We feel you may like to publish this letter of appreciation from us as we are confident that others who have not tried your advertising column will do so in future, with splendid results."

Yours faithfully, R. L. NYE.

Service Sale & Exchange, 8, Gt. Southsea Street, Southsea, Hants.

Unlimited Number New Unmounted Honeycomb Coils, available to bona-fide amateurs. About third normal prices.—Specifications from Box R.4, BERTRAM DAY'S ADVERTISING OFFICES, 9 and 10, Charing Cross.

Loud Speaker Horns.—Guaranteed acoustically perfect. All sizes from 3s. 6d. Usual trade terms.—COVENTRY TANKERS, LTD., Hearsall Works, Coventry.

The Hestia Engineering Co. supply everything for wireless, see page xxxi.—32, Palmerston Road, Acton, London, W.3.

Telephone Transformers and Condensers, complete units, four terminals, 12s. 6d. each, postage 9d.—OSTICK BROTHERS, Long Eaton, Notts.

Polaris Single Valve Receiver and Tuner, to 25,000 metres. Three units, £12 10s. or offer.—DALRYMPLE, R.A. Mess, Bulford.

30 Cwts. New 1/2 in. Brass Screwing and Turning Rod. Lengths about 10 ft. Price 5 1/2d. per lb. net o. rail.—MCINTYRE & Co., 9/15, York Street, Liverpool.

High Aerials are Essential for good, clear reception. This means Masts' Poles, 16 ft. 2s. 6d., 13 ft. 1s. 8d. each. Carriage forward. Masts, complete for erecting, any height. 16 ft. 15s., 13 ft. 30s., 48 ft. 60s. Carriage half paid.—DOWNES Arthur Street, Derby.

Electradix Radios

Variable Condensers from 6/6 to 32/6. Plugs and sockets, great variety, solo 1/- per pair, with jack 1/6, 4-pin 2/-. H.T. generator, 750 volts 50 milliamperes, £15. 1 K.W. Motor Generator, 220/25 volts, with control panel, £30.

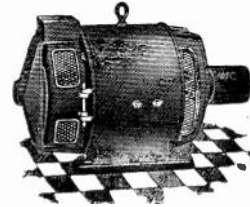

Relays.—Weston Moving Coil, 45/- new. Morse Inkers, S/H, 45/-. Vibrators, silk-wound magnets, 12/6. Choke Coils on ebonite, 2/6. Earth Switches, 2/9. Panel Dewar, 3/6. Polished mahogany battery cases, 6 sockets, 11" x 7" x 3", 7/-. Teak, ditto, 5" x 11 1/2" x 13 1/2", all new. **Transformers.**—Intervalve Amplifiers, 20/-, Valve to 'Phone, 15/-. Coil Holders, 15/- and 20/-. Sockets, 1/9.

Receiver Sets.—Brand new Marconi Trench for crystal and valves. Polished case, desk ebonite panel. £5 10s. Mark II.B, two-valve, with air condenser and three-coil holder, polished mahogany cabinet, few only left, £7 10s.



Large Delivery of Head 'Phones. Note Low Prices. Single L.R. Receivers, useful as an extra or fitting in loud-speaker horn, 3/6, with new cord 9d. extra. With strap headband and cord 4/6. G.P.O. 120 ohms pair, with plated headbands, 12/-. with cords 14/6. Sullivan's ditto, with Brown's headbands and long cords, 15/6. New 1,500 ohm G.P.O., plated

headbands and cord, 21/6. 2,000 ohm, 25/6. 4,000 ohm, 28/6. Best make, new, with cords. A few 8,000 ohm Sullivans, 32/6 pair.

The finest 'Phones are Sterling Marconi, Brown's patent. Cash prices, 2,000 ohms, 49/-; 4,000 ohms, 50/-; 8,000, 57/-. Complete with cords and guaranteed delivery by return post. Discount to trade.

List, four stamps. Instrument wires at lowest prices.

LESLIE DIXON & CO., 9, Colonial Avenue, Minories, E.1. The handiest Depot for City Buyers. Aldgate Station, Metropolitan Railway.

Valves! Valves! Valves! Thirty excellent receiving valves, to be cleared at 12s. each, worth double this price.—ROBBERS, 369, Hither Green Lane, S.E.

Single Valve Panel, first class finish, £1, guaranteed. Carriage extra.—PRESLAND, 1, Hill Street, Woolwich.

Motor Cycle, just overhauled, electric head lamp, good tyres, £25. Offers in wireless. Stamp particulars.—BARLETT, Milford-on-Sea, Hants.

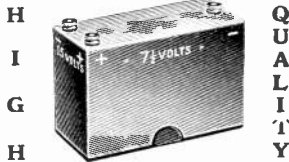

- 15v. H.T. BATTERIES.—Reliable and silent in working. Will retain their voltage. Supplied with two flexible leads, each 3/- Egg Insulators (highly glazed) . . . 6d. Knobs, 1 1/2", fluted with 2 BA brass bush inset, best finish . . . 4d. Aerial Wire, stranded, 7/25, 100' . . . 3/6 Aerial Wire, stranded, 7/22, 100' . . . 5/- Dewar Pulleys, Aluminium, with cord . . . 2/- Dewar Switches, 8-way . . . 4/6 Ebonite Lead-in Insulators . . . 2/- Perikon Detectors, complete, mounted on ebonite . . . 4/- Crystals, Bornite, Galena, Silicon, Graphite, Carborundum, Zincite . . . 6d. Crystal Cups, turned brass . . . 4d. Sliders, with Plungers . . . 6d. Filament Rheostats . . . 4/- A.E.G. and S. Halske Valves . . . 10/6 Adaptors for "R" Valves . . . 3/- Crystal Sets, from . . . 15/- We can supply all Amateurs requirements, ex-Stock.

Catalogue in Preparation.

Grafton Electric Company

Showrooms—54, GRAFTON STREET, TOTTENHAM COURT ROAD, LONDON, W.1. Telephone—Museum 241.

THE WIRELESS WORLD EXCHANGE AND MART

ELECTRADIX WIRES

Highest Conductivity at Lowest Prices.			
Gauge.	D.C.C.	S.S.C.	D.S.C.
16	1 7	—	3 6
18	1 9½	—	3 9
20	1 11	4 0	4 6
22	2 5	4 6	5 0
24	3 0	5 0	5 9
26	3 6	5 6	6 6
28	4 2	5 9	6 10
30	5 2	6 6	8 1½
32	6 6½	8 2	9 0
34	7 9	9 6	10 7
36	9 2	11 3	12 3½
38	11 10	13 6	17 3
40	16 2½	17 0	23 5

Prices at per lb. Postage Extra. Earth Clips, 6d. each. 7/22 Aerial Wire, 7/- per 100 ft. EVERYTHING FOR WIRELESS IN STOCK.

LESLIE DIXON & CO.,
9, Colonial Avenue, Minories, E.1
(near Aldgate Station. Telephone Avenue 4165.)

DISPOSAL BOARD STORES

15' Steel tubular masts, complete with stays, etc., 10/-. Brown's Type "A" 8,000w. 'phones, 42/-. L.R., 120w., 35/-. These 'phones are absolutely new. Sullivan's L.R. 120w., 10/-. absolutely new. French 'phones, 4,000w., 32/6. Federal 'phones, 2,000w., 35/-. Brown's loud speakers, in stock, usual prices. "R" valves, guaranteed unused, "Metal," "Cossor," "Osram," "Ediswan," etc., 15/-. Marconi, V24 and Q, 15/-. "B" valves, 17/6. A.T. 40's, 35/-. Lucas Day-light Signalling Lamps, complete, three bulbs and spares, etc., 6/-. would make fine headlamps for motor cycles, cars, etc. Breastplate microphone transmitters, 10/-. Amplifiers, CMK III, from 26. Ex-army pattern transformers, earth to valve, 15/-. Telephone, 15/-. German four-valve amplifier, 28. Condenser plates, aluminium, 9d. per doz., valve holders from 1/3, switch arms from 1/6. N.B.—Valves are packed carefully and sent by registered post, but no responsibility can be accepted by us for any breakage occurring in transit. Postage paid on all orders over 22.

WHALE & CO., 201, POWIS STREET, WOOLWICH.

■
■
■
■
■
■
■
■
■
■

EBONITE

RELIABLE GRADES ONLY

SHEET, ROD, TUBE,
PANELS, MOULDINGS

Enquiries attended to promptly.

RADIO EBONITE SUPPLIES,
4, Little College Street, London, E.C.4
Central 4711. (Nr. Cannon St. Station.)

■
■
■
■
■
■
■
■
■
■

FOR SALE—continued.

Marconi M15 Receiver, Brown's telephones, aerial, high tension, low tension, insulators, V24 valve, £25. Three 0-0005 variable air condensers, 13s. 6d. each. Three valve, low frequency amplifier, Brown's loud speaker and transformer, 10 guineas. One Magnavox loud speaker, 10 guineas. Three Ediswan-Marconi valves, 17s. 6d. each. All the above guaranteed new.—**COOMBER, 58, Tything, Worcester.**

Wireless Set, Complete, three valves, Brown's best telephones, Burndept coils, and Siemen's batteries. Seen working after 6.30.—12, Grosvenor Road, Westcliffe, or City by appointment.

Gamage Single-Valve Panel, as new, 30s., or exchange good magneto.—**DANIELS, 14, Crown Street, Leiston, Suffolk.**

Siemen's 8,000 Telephones, £2. Aerial with 7/22 enamelled, 6s. 100 ft. Insulators, 3d. ½ in. Ebonite, 3s. 10d. lb. ½ Brass (square) 4d. ft. Vanes, 3d. pair. All condenser parts. Terminals, 3d. Crystal Det., 5s. 6d.—**HOWDEN, 2, Tonbridge Street, Leeds.**

Mark III* Tuner, £2 10s. B. Mk. 11 two-valve receiver, £5. 50-Watt trench set, combined receiver and transmitter, £5. All splendid condition.—**BELL, 84, Melrose Avenue, Wimbledon Park, London.**

Amateur has for Sale Single Valve Set, tuning 300 to 5,000 metres. Less valve, £6. Polished cabinet, 11" x 9" x 3½", with ½" ebonite panel, 25s. Variable condenser, 0-001, 25s. Filament resistance, 4s.—"B," 58, Cresswell Street, King's Lynn.

One-Valve Set. Variable condenser, tuner, batteries, telephones, valve, £4 10s. lot, cheap.—**Brown, Little Sutton, Cheshire.**

4d. Polished Ebonite Knobs, 1½ ins. Postage 2d.—187, Woodhouse Lane, Leeds.

Loose Coupled Tuning Inductance Primary, 4" x 4" Secondary, 3½ x 4. Slider and tapings, new, 52s. 6d.—**WILLIS, 26, Worting Road, Basingstoke.**

Three-Valve Receiver Unit System. Mahogany boxes. Four plug-in transformers, very efficient. £8.—**KENDRICK, Tasker Street, Walsall.**

Ivoryine Tablets for Terminals, set of seven, 1s. Ivoryine scales, 8d.—**INDELIBLE PROCESS CO., 220, Albert Road, Peckham, London.** Liberal terms to agents.

Marconi 5-Valve Receiver, complete with valves, as new, wonderful machine, guaranteed perfect, price £26.—**HITCHCOCK, Sussex Lodge, Colchester.**

B.A. Screws, Nuts and Washers, assorted gross 2s., lists 2d.—**J. H. BENNETT, Station Road, Willesden Junction.**

WANTED.

Aircraft Generator, giving at least 600 volts, must be thoroughly sound and a reasonable price.—**NORBUK, 51, Chilwell Road, Beeston, Notts.**

BOOKS.

Technical Books.—Second-hand and New Books on every conceivable subject. Catalogue free. State wants. Books sent on approval. Books bought.—**FOYLE, 121, 125, Charing Cross Road, London.**

Radio Magazines, all the latest, "Radio World," 10½d.; "Popular Radio," 10½d.; "Radio Broadcast," 1s. 6d.; "Radio News," 1s. 6d.; "Science and Invention," 1s. 9d.; "Scientific American," 2s. 6d. Post free.—**INTERNATIONAL NEWS COMPANY, LTD., 15, Bream's Buildings, London, E.C.4.**

Radio Chart.—Care and Maintenance of Accumulators, 1s. Post free.—Publishing Branch, G.D. HINKS, Hardington, Yeovil.

EBONITE

Sheets, Rods, Tubes, Panels, Knobs, Sliders, Valve Holders, Graduated Dials, etc., ex stock.

Best Quality : : Low Prices

Complete Receiving Sets supplied.

C. OLIVER 207, Altmore Ave., East Ham, E.6.

LET US QUOTE YOU FOR

SWITCH STUDS, VALVE LEGS, TERMINALS and other BRASS WIRELESS COMPONENTS.

Special terms for large quantities. Samples and prices on request.

Nicholls & Wallis, BRAINTREE, ESSEX.

RESULTS

Whether as a source of practical information for the Amateur or as a valuable medium for every Advertiser, the **best results** are invariably obtained "Wireless World" through the

For full particulars and advertising rates apply to **BERTRAM DAY & CO., LTD. Complete Advertising Service, 9 and 10 CHARING CROSS, S.W.1**

Radio Accessories

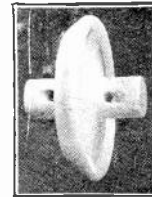

High Class Aerial Insulators. Following best High Tension Electrical Practice. High insulation under all conditions. Drip Ring: 3½" diam., weight 5½ozs., breaking load, 850 lbs. Price 2/- each, postage extra. Ordinary barrel type, ditto, length 2½".

diameter 1½", weight 4½ ozs; 1/- each, postage extra.

Aerial Wire. Bare copper.
Size 3/20, 4/- per 100, postage 9d.
Size 7/22, 5/- per 100, postage 9d.
Size 7/20, 7/- per 100, postage 1/-.

Galvanised Steel Stay Wire.
Size, 3/16, 2/6 per 100', weight 7 lbs.

Galvanised Malleable Pulley Blocks.
Size 1½" each 1/2
Size 2" each 1/8
Size 2½" each 3/-

Postage extra.
"Salunite" Fusible Alloy for Crystal Mounting. Non-oxidising. Melting point 195 deg. Fahr. In 1 oz. bars, 1/6 each, post free. Trade inquiries invited.

H. LONGTON, A.M.I.Mech.E.,
43, Johnson Street,
Westminster, S.W.1.

THE WIRELESS WORLD EXCHANGE AND MART

CONNOLLY, BROTHERS

Wireless Apparatus Manufacturers,
LOBSTOCK RD., URMSTON, MANCHESTER
 Spares and Complete Components at Trade Prices.
 Examples: 50' x 6' Double Wire Aerial, 40' Lead in, ready for fixing, 17/6. 7/22 Stranded Wire, 1/4d. per ft. 2" Reel Insulators, 4 1/2d. each. 4" x 12" Wound Inductance Coil, 4/9. 28's Enamelled Wire, 1/2lb., 2/-, 1lb. 3/6. Carriage paid on orders over £2.

HEATH & Co., Ltd.

Instrument Works, New Eltham, S.E.9
 are prepared to undertake in their fully equipped works—**Wireless Apparatus and Parts for the trade.** Quotations given to Blue Prints. Immediate attention.
 Phone—*Let Green 301.* Wire—*Polaris, London.*

STEEL MASTS

Tubular Steel Masts with finial, rope cleat, guy clips, and baseplate. Painted, light and durable.
 12'. 25/-; 25' (2 Sections), 40/-.
 40' (3 Sections), 80/-
 100' 7/22 copper wire, 6 insulators, halyard, pulley and lead in tube, 10/6. Carriage forward.
 Trade Supplied.
 Works, 5, Kramer Mews, Earl's Court.
 L. S. COMPTON, 17, Fernshaw Road, S.W.10.

EBONITE "A" TYPE 4 PRONG VALVE HOLDERS

1/- each, post free.

WILKINSON,
 LONSDALE RD., KILBURN, N.W.6
 TRADE SUPPLIED. Established 1900

Your Case Work

Let us quote you for your wireless casework. We are specialists in this class of work and feel sure our workmanship and prices will interest you.

Phone: L.W. 2720.

CARRINGTON & NEWBERY LTD.,
 18/20, Normans Buildings, Old Street, E.C.

KEYSTONE WIRELESS SUPPLIES

WHOLESALE ONLY.

Ebonite, cabinet work, engraving, expert designers in amplifiers. Slab inductances, basket coils, etc. Switch arms, contactors, Terminals, Scales.

Low Prices Offices: High Finish.
33, Trinity Road, Tooting, S.W.

SITUATIONS WANTED.

Wireless Operator, four years' First-Class Postmaster-General's Certificate. Sound knowledge of latest radio developments. Requires post as demonstrator, etc.—Box P.3. BERTRAM DAY'S ADVERTISING OFFICES, 9 and 10, Charing Cross, S.W.1.

Young Man, with 10 years' Radio Experience, and thorough commercial training, desires appointment as salesman or traveller. Southern countries preferred.—Letters to "COMMERCE," BERTRAM DAY'S ADVERTISING OFFICES, 9 and 10, Charing Cross, S.W.1.

Wireless.—Experienced American, British commercial and amateur apparatus. Wanted position designing, selling, fitting, or operating. First-Class P.M.G. Willing invest.—Apply Box S.4, BERTRAM DAY'S ADVERTISING OFFICES, 9 and 10, Charing Cross, S.W.1.

SITUATIONS VACANT.

Representative.—Energetic man required by wireless manufacturers, wholesale and retail. Knowledge of wireless essential.—Write full particulars, R.F.T., 8, Fisher Street, W.C.1.

Partner Required by Wireless Manufacturer.—£500 will secure half-share; smaller amounts *pro rata.*—ASKEW, 266, Longfellow Road, Worcester Park, Surrey.

TRADE ENQUIRIES.

John Banks & Sons, 14/18, Duke Street, Liverpool, request latest catalogues and best trade terms for all parts, also complete sets. Agencies considered.

Large London Factors require manufacturers' lists and keen quotations for all wireless accessories.—Write Box P.4, BERTRAM DAY'S ADVERTISING OFFICES, 9 and 10, Charing Cross, S.W.1.

Mica, Best Ruby, Condenser, large stocks. State requirements. Our price will get your orders.—COUNTY ELECTRICAL WORKS CO., Romford. Telephone 87.

Sets Designed and Blue Prints Supplied. Motors designed. Information supplied.—O. S. PUCKLE, 1, Epping New Road, Buckhurst Hill, Essex.

MISCELLANEOUS

Wireless Dealers are advised to stock parts for making radio apparatus, as so many amateurs prefer to make their own instruments. There is also the additional profit in making your own sets from stock parts. Raw materials and partly machined parts can be had direct from the factory at the right price.—THE "NEWTONIA" WIRELESS FACTORY, 13/15, Whitcomb Street, London, W.C.2. Regent 643 and 5469.

Bamboo Poles for Aerials

AND BAMBOO OF EVERY DESCRIPTION
 :: FROM TWIGS TO YACHT MASTS ::

Large Stocks always on hand.

A. E. DAVIES & CO. (Importers),
 184, LEVER ST., CITY RD., LONDON, E.C.1

Send us your enquiries for

BOXES, CABINETS, SPREADERS, CONDENSERS and parts, LEAD-IN-TUBES, and all accessories, to the Trade.

COMPETITIVE PRICES PROMPT DELIVERIES

The Central Aircraft Co.
 179 High Rd., Kilburn, N.W.6
 Phone—Hampstead 4403-4 8018.

JOLLY & SON

13 Myddelton St., Clerkenwell, E.C.
 Press Tool Makers and Metal Stampers.
 Vanes, Terminals, Valve Legs, Studs, Panels, Switch Arms, Condensers, complete sets of parts. Enquiries invited.

TO THE TRADE

The firm of **ASTON & MANDER** was established 1789 and has been making Scientific Instruments for over 133 years. We are now making all forms of **Wireless Accessories and Parts.** Can we quote you for your Designs and Apparatus in Metal, Wood, Ebonite, etc.?
ASTON & MANDER (1917), LTD., ALBANY WORKS, WILLESDEN, N.W.10.

For Wireless Cabinets

SEND TO
J. A. JONES & CO., LTD.,
 CABINET CASE MAKERS,
 Progress Works, Park Road,
 Aston, BIRMINGHAM.
 Phone—EAST 234.

RADIOPHONE TUNERS,

200-1,400ms. 38/-
 Valve Panels for above 21/-
 '0005 Variable Condensers 18/6
 Above 3 make an Ideal Receiver.
 Broadcast Concert Coils pair 2/-
 Grid Leaks and Condensers 3/6
 Fixed Condensers 2/6
 5-Plate Condensers 6/6
 2-Valve H.F. Amplifier Panels 32/-

Get our New Bargain List.

A MATEUR SUPPLIES,
 134, COTEFORD STREET,
 TOOTING, LONDON, S.W.

THE WIRELESS WORLD EXCHANGE AND MART

FOR SECURING YOUR AERIALS
and a Thousand Purposes where Great
Strength and Strain is needed

FLEXIBLE STEEL WIRE ROPE.

Aeroplane Cable made to Govt. specification to
specified breaking strain.



PRICES BELOW COST.			
No.	Dia.	Breaking Strain.	Price per 100 ft.
1	3/32"	10 cwt.	8/-
3	3/32"	20 cwt.	8/-
51	5/32"	25 cwt.	10/-
53	3/16"	45 cwt.	12/-
55	7/32"	70 cwt.	14/-
6	1/4"	80 cwt.	15/-
7	5/16"	100 cwt.	20/-
8	3/8"	120 cwt.	21/-
9	7/16"	140 cwt.	22/6
10	1"	160 cwt.	24/-

STRAINERS for use with above, right and left
hand threads, 9d. each, or 8/6 per doz.

Orders of 10/- and over carriage paid, other-
wise please add 1/- for postage.

SMITH & ELLIS
(Dept. 65), 11, LITTLE BRITAIN, E.C.1
Tel. No. City 8994.

WIRELESS SUNDRIES.

Aerial Wire, stranded, 7/25, per 100' .. 3/6
Aerial Wire, stranded, 7/22, per 100' .. 5/-
Aerial Insulators, green egg type, each .. 6d.
Aerial Insulators, reef .. each .. 3d.
Lead-in Insulators, ebonite, no soldering .. 2/-
Valve Holders, screwed legs and nuts, each .. 1/-
Grid Leaks (tubular encls), 2 megs. .. 2/-
Ivory Scales, 0-180 deg. .. 9d.
Condenser Tops and Bottoms, bushed .. 1/-
Condenser Vanes, aluminium .. per doz. 1/-
Condenser Spacers, large (true to '001") .. 4d.
Condenser Spacers, small (true to '001") .. 3d.
Inductance Tubes, 12" x 3" .. each .. 6d.
Inductance Tubes, 12" x 4" 9d.
Inductance Tubes, 12" x 5" 1/-
Inductance Tubes, 12" x 6" 1/3
Sliders, ebonite with plunger 6d.
Enam. Wire, 23 gauge per lb. 2/-
Sq. Brass Rod, 12" x 1/4" x 1/4" .. each .. 6d.
Crystals, Galena, Silicon, Bornite, Car-
borundum, Copper Pyrites, etc. .. 6d.
Fusible Alloy (for fixing crystals) .. 6d.
Crystal Cups (brass, with fixing screw) .. 4d.
Hellesen 36v. H.T. Batteries, with plug .. 8/6
Essex 15v. H.T. Batteries, best quality .. 3/-
Perikon Detectors on Ebonite, complete .. 4/-
"Ubique" Crystal Sets 15/-

Postage Extra.
THE ESSEX WIRELESS CO.,
Office and Showrooms,
499, Grove Green Road, Leytonstone, E.11.
Telephone: Wanstead 749.

WE SUPPLY EVERYTHING
FOR
WIRELESS
FROM STOCK.
SEND FOR OUR LISTS AND
SAVE MONEY

Receiving Sets, Two-Valve, from .. £6 8s.
Porcelain Insulators, Reel Type .. each .. 4d.
Porcelain Insulators, Shell Type .. 1/6
Spreaders, 6" x 1" diameter, best
quality ash .. each .. 2/6
100' 7/22 Enamelled Aerial Wire, 50'
10 G. Bracing Wire, 4 Wire Strainers,
1 doz. ferrules .. 18/-
Condensers, '0005 Vernier .. each .. 5/-
Condensers, '0002 Variable .. 10/6
Condensers, '0005 Variable .. 16/8
Panel Cases, polished mahogany, 7 1/2" x
5 1/2" x 3 1/2" .. 5/-
Panel Cases, polished mahogany, 6 1/2" x
5 1/2" x 2" .. 4/6
Spruce Aerial Masts, 10', fitted with
aluminium pulley .. 14/-
Ebonite Panels cut to your requirements
while you wait. Trade Supplied.

S. ALTON, LTD.,
165 High Road, KILBURN, N.W.6
Phone, Hampstead 8018.

SOMETHING NEW !!
"SEMAPHORE" REPLACEABLE
DRY BATTERIES for WIRELESS
RECEIVING SETS.



See It and other Smart Ideas at Stand 5,
Horticultural Hall, Sept. 30 to Oct. 7

ADVANTAGES—About 5 times life of ordinary batterie
Any 2 cells can be replaced at cost of 1/-.
Tappings at every 3 volts by means of Wander Plugs.
12 Cells (18 volts) complete with Connectors and Plugs 7/6 each.
24 " (36 ") .. 13/9 ..
For Higher Voltages place additional Boxes together.

SEMAPHORE, Ltd., DRY BATTERY
SPECIALISTS
28, John Street, Bedford Row, London, W.C.1
Telephones MUSEUM 5422 and 5423
Telegrams ARWELIDITE, HOLB. LONDON

**The Construction of
Amateur Valve Stations**

By ALAN L. M. DOUGLAS

78 pages. 55 Diagrams and Illustrations.

PRICE **1/6** NETT.
(Postage 2d.)

The aim of the author in compiling this volume has been to place within the reach of the amateur who is interested in Wireless Telegraphy and Telephony a Handbook which will enable him to obtain data that he has otherwise difficulty in acquiring, in order that he may construct for himself apparatus which he desires to make, but does not quite know how to design correctly.

The Wireless Press, Limited
12-13, Henrietta Street, Strand, London, W.C.2

A SIMPLE SYSTEM OF MEMORISING OF THE MORSE CODE

Morse Made Easy

By ARTHUR L. RYE

—EXPLAINS IT ALL!

Printed on strong linen card, this valuable Illustrated Explanation can be carried about ready for use, anywhere and everywhere.

PRICE: 3½^{d.} Post free.

THE WIRELESS PRESS LTD., 12-13, Henrietta Street, Strand, London, W.C.2

SIMPLICITY

IMMEDIATE DELIVERY

“K.B.” UNITS

EFFICIENCY

ECONOMY

IMMEDIATE SATISFACTION

By means of these units you can build up a complete one to seven valve receiving set in easy stages to suit your pocket; while in the meantime, the units already bought are in themselves a complete receiving set, whatever their number may be. All you have to do is to place the units side by side straight across with the brass links provided.

HERE THEY ARE:—

UNIT No. 1.
CONDENSER PANEL.
No. Reqd.: Optional.

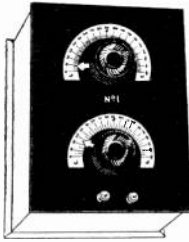

Price.

Complete (as above) 34/- each
Set of Parts (panel only). 22/6 per set.
Mahogany Cabinet 6/- each

UNIT No. 2.
DETECTOR PANEL.
No. Reqd.: One.

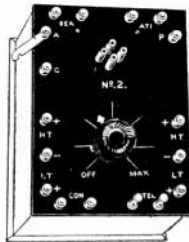

Price.

Complete (as above) 34/6 each.
Set of Parts (panel only). 20/- per set.
Mahogany Cabinet 6/- each.

UNIT No. 3.
L.F. AMPLIFYING PANEL.
No. Reqd.: 1, 2 or 3.

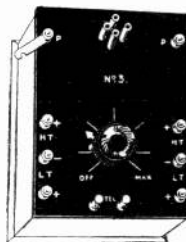

Price.

Complete (as above) 43/6 each.
Set of Parts (panel only) 33/- per set.
Mahogany Cabinet 6/- each.

UNIT No. 4.
H.F. AMPLIFYING PANEL.
No. Reqd.: 1, 2 or 3.

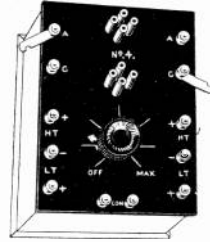

Price.

Complete (as above) 33/6 each.
Set of Parts (Panel only). 18/6 per set.
Mahogany Cabinet 6/- each.

We also hold large stocks of complete Receiving Sets, Coilholders, Coils, Variable Condensers (Assembled and in Parts), Valve Holders, Filament Resistances, H.T. Batteries, Accumulators, Aerial Insulators; in fact ALL AMATEUR REQUIREMENTS.

TRADE ENQUIRIES INVITED.

CATALOGUE POST FREE 4d.

COME AND “LISTEN IN” AT OUR SHOWROOMS. OPEN DAILY from 9 a.m. till 7 p.m.

THE “K. B.” RADIO EQUIPMENT COMPANY,

Head Offices & Showrooms: 109, High Road, Kilburn, N.W.6.

Bus Services—8, 16, 28 & 51, pass door.

3 mins. Kilburn Park Stn. (Bakerloo Rly.)

THE WIRELESS AGE

THE AMERICAN MONTHLY JOURNAL OF WIRELESS TELEGRAPHY AND TELEPHONY

A “Go-a-head” Magazine for Operators and Amateurs.

Sole European Agents: THE WIRELESS PRESS LTD., 12-13 Henrietta St., Strand, London, W.C.2

AT STAND 46

ALL - BRITISH WIRELESS EXHIBITION,
ROYAL HORTICULTURAL HALL, WESTMINSTER,

From SEPTEMBER 30th to OCTOBER 7th inclusive,

WE WILL BE SHOWING LARGE STOCKS AND VARIETIES OF WIRELESS APPARATUS,
BOTH COMPONENT PARTS AND COMPLETE SETS.

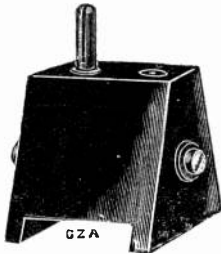

COIL PLUGS

As illustrated, with Connection
Screws.

Price 1/6 each.

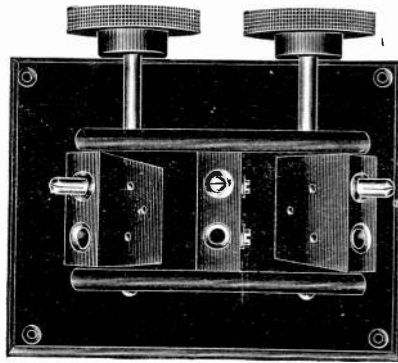

PANEL TYPE COIL HOLDERS.

Made of Ebonite throughout and Matt finished.

Price 12/6 each.



TABLE STAND FOR COILS

Registered Design 638454.

Exact as illustrated.

Price 21/- each.

2-Way 18/-



FIBRE STRIP FOR COILS

in lengths of 6' 6" stamped
as shown.

Per 1/6 Length.

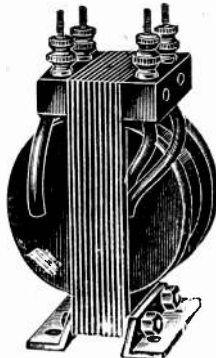

INTERVAL TRANSFORMERS

Layer Wound and Spaced.
Stalloy Cores, most efficient.

20/-

From Stock.



THE NEW UNI-WAVE INDUCTANCES.

Duo Wound.

Range from 300-30,000 m.
INDUCTIVE VALUES
are to be found in Catalogue.

Price per set of 8,

12/6

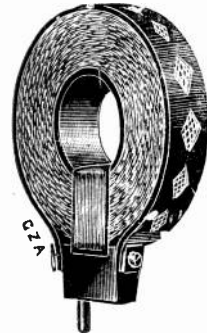

DUO LATERAL COILS

Made under De Forest Patents.
Supplied Mounted only.

Prices from 5/- each.

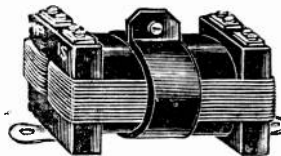

TELEPHONE TRANSFORMERS.

Unmounted (as illustration) suitable for
120 w. Phones.

Price 13/6 each.

CATALOGUE AND TRADE
TERMS can be obtained on
STAND 46 or from our
LONDON OFFICES.

G. Z. AUCKLAND & SON,

Factories—ISLINGTON, N.

WIRELESS INSTRUMENT MAKERS. 'Phone

LONDON OFFICES:

395, St. John Street, E.C.1

3173 CLERKENWELL

WIRELESS BOOKS FOR THE AMATEUR

MAGNETISM AND ELECTRICITY FOR HOME STUDY. By H. E. Penrose. Contains 50 complete lessons. Price 6/- net. Post free 6/6. 515 pages, 224 diagrams.

THE ARMATURE MODEL FOR 1½ K.W. ROTARY CONVERTER. Price 1/3 net. Post free 1/6. Shows every winding of the Converter Armature.

THE RADIO EXPERIMENTERS' HANDBOOK. By Philip R. Coursey, B.Sc. Eng., F.Inst.P., 113 pages, 99 diagrams and illustrations. Price 3/6 net. Post free 4/-.

SELECTED STUDIES IN ELEMENTARY PHYSICS: A Handbook for Wireless Students and Amateurs. By E. Blake, A.M.I.E.E. Price 5/- net. Post free 5/6. 176 pages. Crown 8vo. Cloth. 43 diagrams and illustrations.

WIRELESS TRANSMISSION OF PHOTOGRAPHS. By Marcus J. Martin, Second Edition. Revised and Enlarged. Price 5/- net. Post free 5/6. 143 pages. Demy 8vo. Cloth. Diagrams and illustrations.

CALCULATION AND MEASUREMENT OF INDUCTANCE AND CAPACITY. By W. H. Nottage, B.Sc. Price 3/6 net. Post free 3/11. Demy 8vo. 144 pages. Over 50 illustrations and diagrams.

THE A.B.C. OF WIRELESS. By Percy W. Harris. A simple outline of Wireless written for all to understand. 64 pages. Price 6d. net. Post free 8d.

TEST QUESTIONS AND ANSWERS ON WIRELESS TELEGRAPHY. Price of each Series of Questions 2/6 net. Postage 3d. Answers 2/6 net. Postage 3d. Invaluable for self-examination. Series 1. The Elementary Principles of Wireless Telegraphy. Part I.—Series 1a. Book of Model Answers. Series 2. Covering the Ground for the Postmaster-General's Examination. Series 2a. Book of Model Answers. Series 3. The Elementary Principles of Wireless Telegraphy. Part II.—Series 3a. Book of Model Answers.

THE ELEMENTARY PRINCIPLES OF WIRELESS TELEGRAPHY. By R. D. Bangay. Crown 8vo. Published in two parts or bound in one volume. Price per part 4/- net. Post free 4/4. In one volume 7/6 net. Post free 8/3.

MAINTENANCE OF WIRELESS TELEGRAPH APPARATUS. By P. W. Harris. Price 2/6 net. Post free 2/10. 127 pages. 52 diagrams and illustrations.

A SHORT COURSE IN ELEMENTARY MATHEMATICS AND THEIR APPLICATION TO WIRELESS TELEGRAPHY. S. J. Willis. Price 5/- net. Post free 5/6. Demy 8vo. 182 pages. 120 diagrams.

ALTERNATING CURRENT WORK. An Outline for Students of Wireless Telegraphy. By A. Shore, A.M.I.E.E. Price 3/6 net. Post free 3/10. Crown 8vo. Cloth. 163 pages. 86 diagrams and illustrations.

THE OSCILLATION VALVE. The Elementary Principles of its application to Wireless Telegraphy. By R. D. Bangay. 6/- net. Post free 6/6. Crown 8vo. 215 pages. 110 diagrams and illustrations.

USEFUL NOTES ON WIRELESS TELEGRAPHY. By H. E. Penrose. Crown 8vo. 1/4 each. Post free 1/6. Book 1. Direct Current. Book 2. Alternating Current. Book 3. High Frequency Current and Wave Production. Book 4. The 1½ K.W. Ship Set. Book 5. The Oscillation Valve.

THE CONSTRUCTION OF AMATEUR VALVE STATIONS. By Alan L. M. Douglas. The ideal book for those contemplating the making of a wireless set. 78 pages, 55 diagrams and illustrations. Price 1/6 net. Post free 1/8.

Visit our Stand No. 40. All-British Wireless Exhibition, Horticultural Hall, Sept. 30th to Oct. 7th.

THE WIRELESS PRESS, LIMITED,
12-13, HENRIETTA STREET, STRAND, LONDON, W.C.2.

Just Received!

AMERICA'S LATEST PUBLICATIONS FOR THE WIRELESS EXPERIMENTER.

HOW TO MAKE COMMERCIAL TYPE RADIO APPARATUS

By M. B. SLEEPER. Price 4/- net (post free 4/3).

The experimenter will be able to get a world of ideas for the design and construction of his wireless apparatus from the very clear descriptions and ninety-eight illustrated figures.

CONSTRUCTION OF RADIO PHONE AND TELEGRAPH RECEIVERS FOR BEGINNERS

By M. B. SLEEPER. Price 4/- net (post free 4/3).

Each piece of apparatus described was first made, tested and found efficient before the final design was accepted. Working drawings prepared especially for the novice and the man who wants to receive the wireless broadcast.

RADIO EXPERIMENTER'S HANDBOOK

By M. B. SLEEPER. Price 5/- net (post free 5/3).

A book which tells in a very concise way the "Why" of radio and answers many of the "Practical Questions of the Beginner," and even the more advanced student of Wireless.

'THE ABC OF VACUUM TUBES USED IN RADIO RECEPTION

By E. H. LEWIS. Price 6/- (post free 6/5).

Written particularly for those who know nothing about wireless, but who desire an understanding of the elementary principles of operation of vacuum tubes, and various circuits in which they are used for reception of wireless telegraph signals, music and speech by wireless telephone.

CONSTRUCTION OF NEW TYPE TRANS- ATLANTIC RECEIVING SETS

By M. B. SLEEPER. Price 4/- net (post free 4/3).

Complete information is given, with special drawings, on how to build and use the new types of trans-oceanic receiving sets, also on the use and external connections of the loud speaker and its application in receiving high speed signals from distant stations. The list of radio telegraph stations with their call letters and times of transmission appears at the end of this book.

**THE WIRELESS PRESS, LTD., Dept. W.W.
12-13, HENRIETTA STREET, STRAND, LONDON, W.C.2**

Visit our Stand No. 40. All-British Wireless Exhibition, Horticultural Hall, Sept. 30th to Oct. 7th

For they are jolly good Fellows

THE
"FELLOCRYST"

(Registered)

WIRELESS
CRYSTAL RECEIVING SET
BRITISH THROUGHOUT

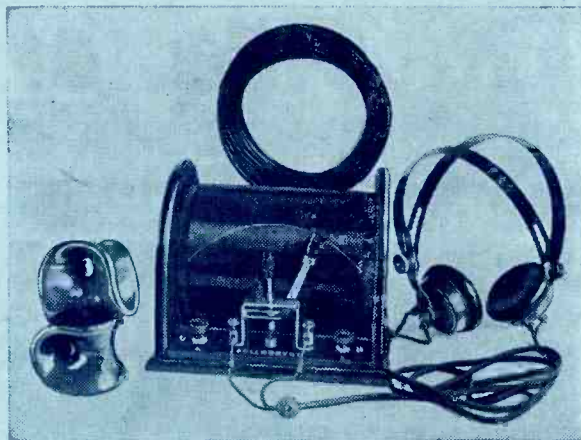

COMPLETE (as illustrated) £3 7 6
with one pair of double headphones. *Postage 1/6*
NO BATTERIES REQUIRED

The set comprises tuning coil with a wavelength of approx. 300 to 1500 metres; Silicon Crystal Detector; 4000 ohms Double Headphones; 100 ft. Coil of 7/22 Stranded Copper Wire; 2 Shell Insulators, Terminals, etc.

Each set tested and guaranteed to receive broadcasting within a range of 15 to 20 miles, and morse signals from a much longer range.

Extra Headphones, complete, 30/- per pair.

POSTAGE 1/-

FELLOWS MAGNETO CO., LTD.

Telephone:
Willesden 1560-1.

LONDON, N.W.10.

Telegrams:
Ojixmag. Phone. London.

Visit our Stand No. 10.

*All-British Wireless Exhibition, Horticultural Hall,
Sept. 30th to Oct. 7th.*

BROADCASTING

Sullivan Patent Telephone Receivers for Radio Telephony and Telegraphy

Of High and Uniform sensitivity and DISTORTION-LESS being thus specially adapted for receiving speeches, news and concerts from BROADCASTING and other stations.

WINDINGS highly insulated, durable and reliable in all climates and under all conditions of service. This was strikingly evidenced during the Great War when a vessel carrying "SULLIVAN" phones shipped to the order of an Allied Government was sunk through misadventure, but at a later date was successfully raised and the cargo salvaged. The Telephones themselves were found to have sustained much damage through the action of sea water, but the coils proved to be perfect electrically and mechanically notwithstanding their long immersion, and all were again brought into requisition.

IMPORTANT NOTICE

These Telephone Receivers must not be confused with the old and comparatively insensitive "SULLIVAN" phones, sold by the Disposals Board and still being retailed by certain dealers, nor with those new but comparatively insensitive Radio Telephone Receivers of Continental and other origin bearing a misleading resemblance to my own pattern.

White Metal Headbands supplied if desired.

Visit our Stand No. 49. All-British Wireless Exhibition, Horticultural Hall, September 30th to October 7th

DEMONSTRATION AND SHOWROOMS:

Liverpool House, Middlesex Street,
London, E.1

Two minutes' walk from Liverpool Street and Broad
Street Stations).

Without public advertisement of any kind, over one quarter of a million sets of "SULLIVAN" phones have been made and sold for "Wireless" alone.

Trade Terms on Application.

<p><i>Works.</i> "LIVERPOOL HOUSE" MIDDLESEX ST., LONDON, E.1 Phone: Avenue 4871</p>	<h2>H.W. SULLIVAN</h2> <p>TELEGRAMS: "DEADBEAT, STOCK, LONDON."</p>	<p><i>Offices.</i> WINCHESTER HOUSE LONDON, E.C.2., ENGLAND Phone: London Wall 3518</p>
--	---	---

h SEPTEMBER, 1922.

THE

PRICE 6D. NET.

WIRELESS WORLD

AND

RADIO REVIEW

VOL. X. No. 27.

30th SEPTEMBER, 1922.

Registered at the G.P.O.
as a Weekly Newspaper.

BURNDEPT

WIRELESS APPARATUS

LONDON OFFICE & SHOWROOMS
15 Bedford Street, Strand, W.C.2



BURNDEPT ULTRA IV

When you arrive at the EXHIBITION
see our **Stand 12A** opposite entrance

BURNDEPT, LTD., Aerial & Eastnor Works, Blackheath, S.E.3

WESTON ELECTRICAL MEASURING INSTRUMENTS

THE WESTON MODEL 280 VOLT-AMMETER

Triple Range. 150/15/3 Volts. 15/1.5/0.15 amps.

This Precision Instrument is especially suitable for Wireless Research Work, i.e.

3 Volt Range.—Testing accumulator cells, dry batteries, measuring fall of potential across potentiometers.

15 Volt Range.—Testing 6 or 12 volt accumulator supplying voltage to valves, etc.

150 Volt Range.—Testing H.T. Batteries, etc.

0.15 Amp Range (150 M.A.)—Measuring H.T. current to transmitting valves, determining resistance of Transformers, chokes, telephones, rheostats, etc.

1.5 Amp Range.—Adjusting filament currents, etc.

15 Amp Range.—Measuring output or charging current of accumulators, etc.

NOTE.—The 3 volt range may be used as a sensitive low range Milli-Ammeter.

SEVEN INSTRUMENTS IN ONE CASE.

PRICE £15, less 20 per cent. Leather Case 15/-

Write for further particulars.

WESTON ELECTRICAL INSTRUMENT CO., LTD.

Audrey House, Ely Place, Holborn, E.C.1

Telephone: Holborn 2029.

Telegrams: "Pivoted, Smith, London."

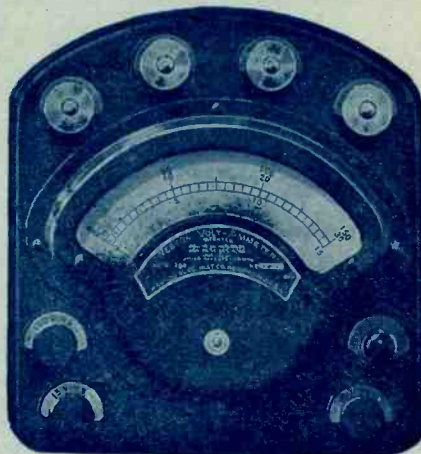

MODEL 280

Radio Panels AND RADIO PARTS

Before you decide on the Construction of your set it will pay you to have particulars of
CONDENSITE

CELORON

Start right. The panel is the foundation. Condensite Celoron is waterproof, immune to atmospheric conditions, will not warp, has high service and volume resistivity, high di-electric strength.

DIAMOND FIBRE CO., LTD.
HIGH ROAD, S. TOTTENHAM, LONDON, N.15

TEL.—TOTT. 2261-2.

Visit our Stand 31 at the All-British WIRELESS EXHIBITION, Horticultural Hall, Now On

GAMAGES

LEAD IN AMATEUR WIRELESS
FIRST IN 1908—FOREMOST TO-DAY



Gamage's Crystal Receiving Set

An efficient set designed to meet the requirements of the Postmaster-General with regard to wavelength. The tuning coil is wound with best quality wire and is tapped in four places. This, when used in conjunction with the Variable Condenser, which is of the best possible workmanship, gives a good variation of tuning. The crystal detector, designed to prevent dust from deteriorating the sensitivity of the crystal, contains our famous "Permanite" Crystal, which has given such excellent results. The task of finding a sensitive spot on the crystal is minimised by means of a buzzer. Will receive telephony for 30 miles and signals from Spark Stations using a wavelength of 300 500 metres for 150 to 200 miles. Complete in polished mahogany cabinet, with instruments mounted on polished ebonite, 'Phones, Aerial wire and insulators ready for use

£5 : 5s.

GAMAGE'S WIRELESS CATALOGUE is full of interest to all Experimenters. Well illustrated and supplying full details, prices, etc. You can have a copy free for the asking at our Exhibition Stand (31), or at Holborn, or a card will bring it by post

"Sonus" Model A Combination

With these instruments, as illustration, it is possible for the serious experimenter to obtain really excellent results. The combination employed is perhaps the best-known of any, namely, 1 High Frequency Amplifying, 1 Detecting and 1 Low Frequency Amplifying valve. Long distance work becomes a pleasure when this combination is employed, for in the construction of the panels the greatest care has been exercised in the selection of Transformers, etc., so that the familiar "howls" frequently met with may be eliminated as far as possible. The design of these panels is such that either a plain detector, 1 H.F., 1 Detecting—1 Detecting, 1 L.F.—or all three together may be used simply by strapping the panels together by means of brass strips. The workmanship, efficiency and finish of these instruments cannot be surpassed, and satisfaction is assured. This set, when complete

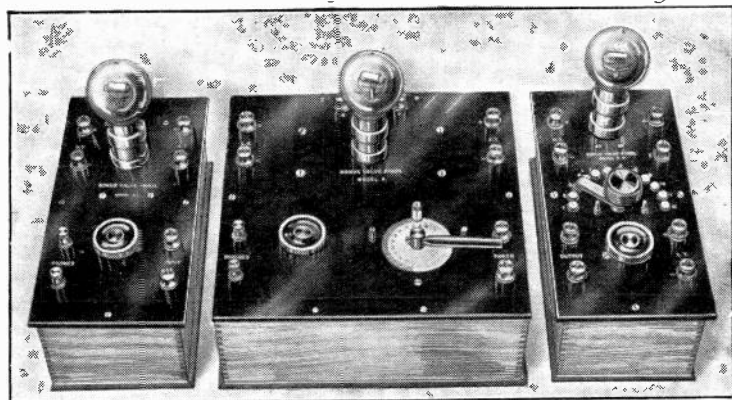

with H.T. battery, L.T. battery, 'phones, Aerial wire, insulators, etc., can be purchased at the extremely low cost of

£22 : 15s.

A. W. GAMAGE, LTD., HOLBORN, LONDON, E.C. 1

BUTLER'S RELIABLE MANUFACTURES

H.F. TRANSFORMERS to fit Valve Sockets



No.	Range	5/6	No.	Range
0	150	5/6	5	2500 8/3
1	300	6/-	6	6000 9/9
2	600	6/3	7	8000 12/-
3	1200	6/9	8	24000 14/3
4	1800	7/6		

There is a good latitude on these coils for higher & lower ranges.

H.B. COIL HOLDER

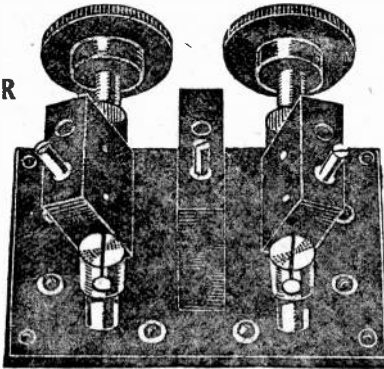

Standard fitting suitable for our "H.B." or any de Forest pattern coil. To take 3 coils £1 1 0
 2 .. 17 6

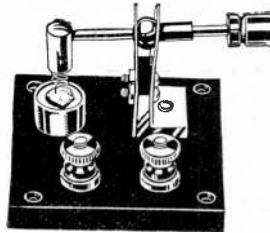

Crystal Detector. Super-sensitive contact, ebonite base, fully lacquered. 6/- each. Postage 6d.

Well finished brass valve socket, centre of thread bored for soldering. 3d. each. Postage extra.

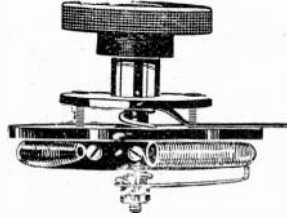

Best workmanship, ebonite throughout, filament resistance. For 1 to 3 valves, 6/- if mounted on panel with 2 terminals, 10/-



First-class finish. Cut out of the solid rod. Complete with fixing screw .. 1/8. Postage 3d.

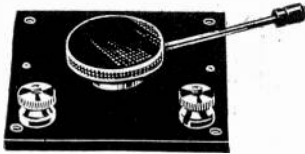

Vernier Condenser suitable for fine tuning or inductance on plating across primary of H.F. transformer. Best workmanship throughout .. 6/-, postage 6d.

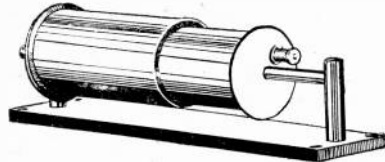

A useful condenser of small capacity with lacquered brass tubes, the whole mounted on ebonite base, 17/6, postage 1/-.

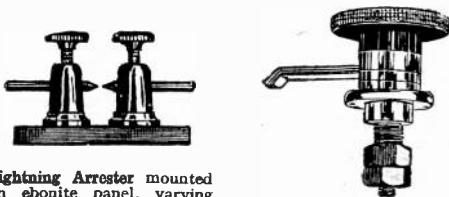

Lightning Arrester mounted on ebonite panel, varying adjustment .. 2/6 postage 3d.



Best quality Laminated Switch complete .. 3/- postage 3d.

A HIGH-CLASS NICKEL PLATED SWITCH.

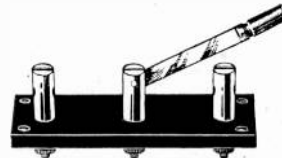

WILL CARRY UP TO 20 AMPS.

"OMEGA" SWITCH. ON EBONITE BASE.

Single pole, single throw	2/6
Double	4/-
Single .. double	3/6
Double	5/6

H.T. BATTERIES (Fully Guaranteed)

15 Volt strip connection 3/6 post 6d.	36 Volt Wander plug 3-
15 .. 3-terminal type 3/6 .. 6d.	volt Variation - 7/6 post 1/-
15 .. Wander plug 3-	60 14/6 .. 1/-
volt Variation - 4/- .. 6d.	108 22/6 .. 1/3

Terms cash with order.

Fully illustrated list post free 4d.

H. D. BUTLER & Co. Ltd.,

Telephone—Hop 3029 Works, North 1838

Office & Showrooms:—
 Bank Buildings, 222, Gt. Dover Street, Borough, S.E.1
 Works: Canonbury, London, N.1
 Telegrams—"Ingenuity Phone, London"

BURNDEPT

The Burndept Ultra III Receiver.

Amplifies at Radio Frequency.
Detects with Regeneration.
Amplifies at Audio Frequency.

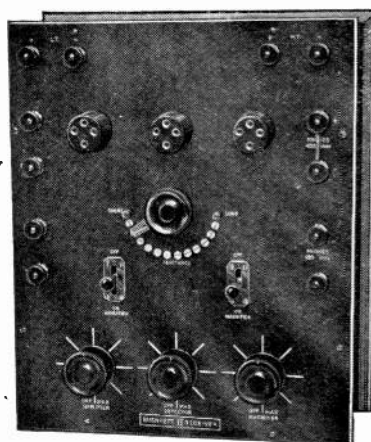

Radio Frequency Amplification 150 to 25,000 metres without a "Dead spot."

Price - - - £25 0 0
or in Sloping Cabinet £26 5 0

Absolutely silent in action ; reactance coil (for radio frequency) of new improved design.

Licensed under Marconi Patents.

◆ ◆ ◆ ◆ ◆
Stand 12A

BURNDEPT, LTD. London Office & Showrooms : 15, Bedford St., Strand, W.C.2
AERIAL & EASTNOR WORKS : BLACKHEATH, S.E.32

BURNDEPT

Broadcast Reception Apparatus

Burndept Broadcast Reception Apparatus is the last word in efficiency and simplicity. We refrained from offering these sets for sale until they had all been

Approved by the Postmaster-General



All sets have a wavelength range of 300 to 500 metres. All Valve sets contain reaction resulting in greatly increased signal strength.



Burndept Broadcast Sets are not designed to compete with cheap apparatus, which must be unsatisfactory in use. They represent a Rolls Royce standard as applied to Wireless Apparatus.



The prices are as reasonable as can be expected for first class workmanship and highest quality materials; we do not give away cheap accumulators and telephone receivers to enhance apparent value of our better quality sets.



Stand 12A

BURNDEPT, LTD. *London Office & Showrooms: 15, Bedford St., Strand, W.C.2*
AERIAL & EASTNOR WORKS: BLACKHEATH, S.E.3.

BURNDEPT

Broadcast Reception Apparatus

Ethophone Junior

Specially sensitive crystal set. Range 20-30 miles. In polished walnut cabinet (considerably improved over illustration).

Price

£4 10 0

Including one pair of 4000 ohm Sterling Telephones.



Valve Sets

Polished walnut cabinet with ebonite instrument board arranged desk style. Valves and high tension battery inside the cabinet. Terminals for Head Telephones and Loud Speaker with switch to select.

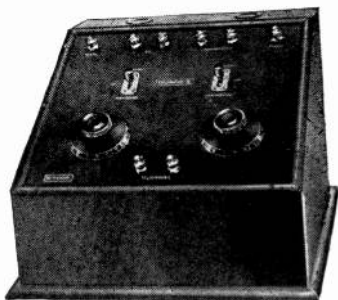

Ethophone II and III.

Ethophone No. II.—Two valve pattern. Range 100 to 120 miles for head telephones ; 40 to 50 miles for Loud Speaker. *Price*—**£28 0 0** including Valves and High Tension Battery.

Ethophone No. III.—Three valve pattern. Fitted with switch to give high or low power and special sound regulator. Range 150 to 200 miles for head telephones, 100 to 120 miles for Loud Speaker. *Price* **£37 10 0** including Valves and High Tension Batteries.

Stand 12A

BURNDEPT, LTD. *London Office & Showrooms: 15, Bedford St., Strand, W.C.2.*
AERIAL & EASTNOR WORKS: BLACKHEATH, S.E.3.

BURNDEPT

WIRELESS APPARATUS

A Transmitting & Receiving Station de Luxe



Receiver.

	£	s.	d.
Burndept II	12	10	0
Two M.O. "R" Valves	1	15	0
Tuner Mk. VI	8	10	0
Set of Concert Coils	1	5	0
Aerial and Insulators		7	0
Telephones 120 ohm	2	8	0
H.T. Battery	2	2	0

Transmitter.

	£	s.	d.
Transmitter (1 Valve)	25	0	0
A.T. 25 Valve	1	10	0
Generator 1000 V.	40	0	0
Smoothing Unit	10	0	0
Microphone	1	5	0
Key	1	5	0
Accumulator, Type B.P. 30	2	2	0

Stand 12A

BURNDEPT, LTD. London Office & Showrooms: 15, Bedford St., Strand, W.C.2

AERIAL & EASTNOR WORKS, BLACKHEATH, S.E.3

BURNDEPT

Tuners

3-circuit type to comply with latest rules of the Postmaster-General.

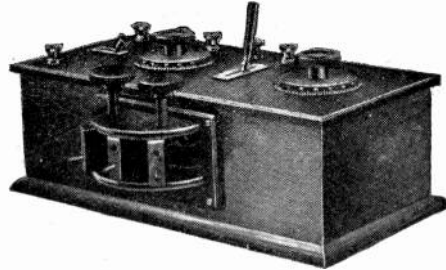

No. 125.	Mk. V.	Primary Condenser in Series	£7 0 0
No. 126.	Mk. VI.	Series parallel switch to Primary Condenser	£8 10 0
		Or in Sloping Cabinet	£1 extra.	



Burndept Accessories

Precision Air Condenser.

With Vernier as illustrated.

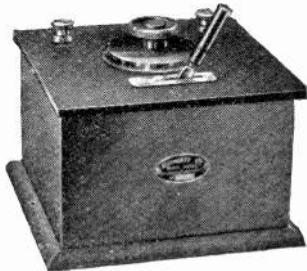

No. 143.	'00075 mfd.	£3 3 0
No. 142.	'00075 without Vernier	£2 7 6
No. 141.	'00075 unmounted	£1 12 6

Burndept Interval Transformer.

Ratio 6 : 1

Built to Last. Tested on 1,000 Volts.

Price £1 5 0

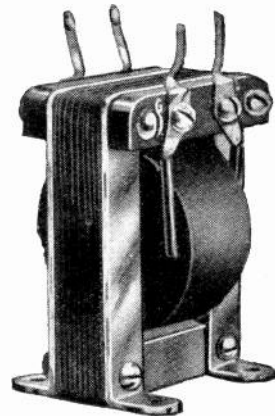

Stand 12A

BURNDEPT, LTD.

London Office & Showrooms: 15, Bedford St., Strand, W.C.2
AERIAL & EASTNOR WORKS: BLACKHEATH, S.E.3

WIRELESS "K.B." EQUIPMENT

A Selection from our Exhibits on Stand No. 8 at the All-British Wireless Exhibition, Horticultural Hall, September 30th to October 7th.

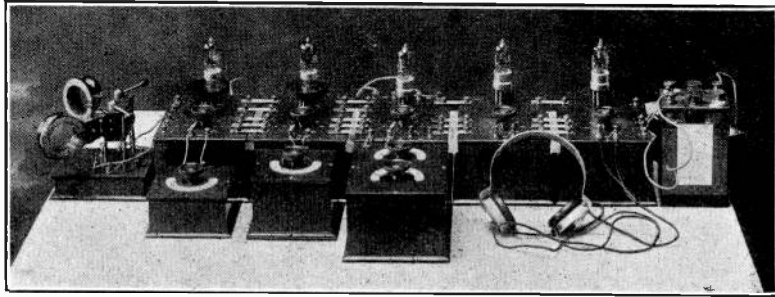

THE "K.B." UNIT SYSTEM.

A well-designed and efficient form of receiving apparatus by means of which a set containing any number of valves can be built up in easy stages without discarding any of the first purchases made. Prices of the various units are as follows:—

K.B. Unit No. 1. Condenser Panel.	K.B. Unit No. 2. Detector Panel.	K.B. Unit No. 3. L.F. Amplifying Panel.	K.B. Unit No. 4. H.F. Amplifying Panel.	3-Way Coil Holder.	Var. Condenser in Cabinet ·0003 mfd.
£1 . 14 . 0	£1 . 14 . 6	£2 . 3 . 6	£1 . 13 . 6	£1 . 1 . 0	£0 . 19 . 0

Parts for above, including Ebonite Panels, &c., engraved and drilled, Cabinets, Wiring Diagrams, and with all winding completed, can also be supplied.



"K.B." Filament

Rheostats.

Silent working, fitted with heavy stop pin giving dead "off" position.

Price 4/- each.

"K.B." Variable Condensers

In Polished Mahogany Cabinets,
·00005 to ·0015 mfd.

12/3 to 41/9 each.

Also supplied with scale and pointer, and for panel mounting.



TRADE SUPPLIED.

SHOWROOMS OPEN 9 a.m.—7 p.m.

Illustrated Catalogue, Post Free, 4d.

THE "K.B." RADIO EQUIPMENT COMPANY,

Head Offices & Showrooms: 109, High Rd., Kilburn, N.W.6. Telephone: Hampstead 7803

Bus Services—8, 16, 28 & 51, pass door.

3 mins. Kilburn Park Stn. (Bakerloo Rly.)

ANODE

WIRELESS & SCIENTIFIC INSTRUMENTS LTD.

*Contractors to the Post Office Wireless
Dept. and other Government Depts.*

Laboratories and Factories:
KING'S RD., ST. PANCRAS

Registered Office:
265, STRAND, W.C.2

**BE SURE AND VISIT
STAND NO.**

2

AT THE

ALL-BRITISH

WIRELESS EXHIBITION

Vincent Square, Westminster, S.W.1

SEPT. 30th to OCT. 7th

We have **18,000** sq. ft.
of Floor Space entirely
devoted to manufacture
of Wireless Instruments

Radio Receiving Sets
to suit all pockets
Trade enquiries invited

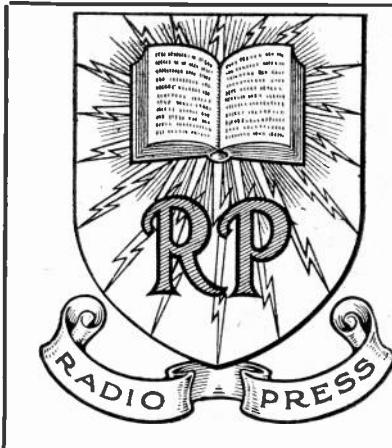

AUTHORITATIVE WIRELESS .. BOOKS ..

Sold and thoroughly recommended by us

Visit our Stand No. 27. All-British Wireless Exhibition, Horticultural Hall, September 30th to October 7th.

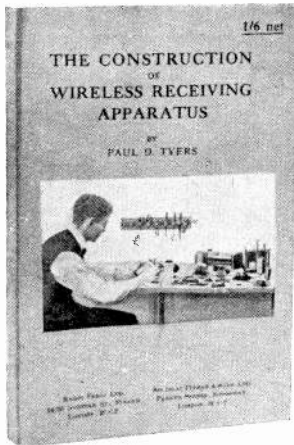

THE CONSTRUCTION OF WIRELESS RECEIVING APPARATUS.

3rd (Specially enlarged) Edition.
By PAUL D. TYERS.
Nearly 100 pages.
40 Illustrations.

The extraordinary sales of this very popular book are a proof that it contains just what everyone who makes his own apparatus wants to know. It tells you how to make all the parts of a set, such as Inductances—Resistances—Condensers—Grid Leaks—High-tension Batteries—Detectors—Potentiometers—High and Low Frequency Transformers, etc. without the use of a lathe or expensive tools.

Price 1/6 net.
Post Free, 1/7½

WIRELESS VALVES SIMPLY EXPLAINED

2nd Edition.
By JOHN SCOTT-TAGGART, F.Inst.P.
134 Pages. 56 Illus.

More than 50,000 copies of this very well-known author's works have been sold in the last two months. This new book on valves is selling in very large quantities.

CONTENTS.—Preliminary Remarks—Introduction; Fleming Valves—The Three-electrode Valve and its Applications—Cascade Valve Amplifiers—Reaction Amplification and Self-oscillation—Reaction Reception of Wireless Signals—Continuous Wave Receiving Circuits—Valve Transmitters—Wireless Telephone Transmitters using Valves—Notes on Wireless Broadcast Receivers—Conclusion.

Price 2/6 net.
Post Free, 2/8

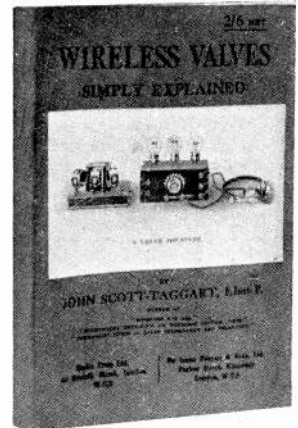

Cloth, 3/- net. Post Free, 3/3

WIRELESS FOR THE HOME.

87 Pages. By N. P. HINTON, B.Sc. Illustrated.
An excellent book for the beginner. It explains in very simple language what apparatus to use and how it works.
Price 2/- net. Post Free, 2/2

NEW ENLARGED EDITION—JUST OUT. ELEMENTARY TEXT-BOOK ON WIRELESS VACUUM TUBES.

By JOHN SCOTT-TAGGART, F.Inst.P.
250 pages. 140 Illustrations.
The standard book on valves. A complete non-mathematical treatise for all serious students of wireless. It is crammed with practical circuits and illustrations, and it is a complete course on Valves and C.W., containing much hitherto unpublished matter. Full particulars of Armstrong's super-regenerative circuits.
Price 10/- net. Post Free, 10/6

WIRELESS FOR ALL.

By JOHN SCOTT-TAGGART, F.Inst.P.
62 pages. Illustrated.
The book for those whose knowledge of wireless is nil. Its simplicity is such that anybody can understand its 60 pages even if they have never heard of electricity. It explains the "how" and "why" of wireless.
Price 6d. net. Post Free, 7½d.

- "Continuous Wave Wireless Telegraphy"—A very interesting little cloth bound volume.
By B. E. G. MITTELL. 111 pages. 58 Illustrations 2/6 net Post Free, 2/8
- "Directive Wireless Telegraphy"—The only book on the subject, as far as we know.
By L. H. WALTER. 124 pages. 57 Illustrations 2/6 net Post Free, 2/8
- "Marine Wireless Pocket Book"—A book chiefly for operators.
By W. H. MARCHANT. 180 pages. Fully Illustrated 6/- net Post Free, 6/2

Radio Press Ltd.

Publishers of Authoritative Wireless Books.
Telegrams—Radbooks, Estrand, London.

Dept. w.w.

New Larger Premises:
DEVEREUX BUILDINGS,
DEVEREUX COURT,
STRAND, LONDON, W.C.2
(Opposite Law Courts)

The Marconiphone

RECEIVING SETS.
INCORPORATING UNIQUE FEATURES WHICH
ENSURE PERFECT RECEPTION. FULL
COMPLIANCE WITH GOVERNMENT REGULATIONS.

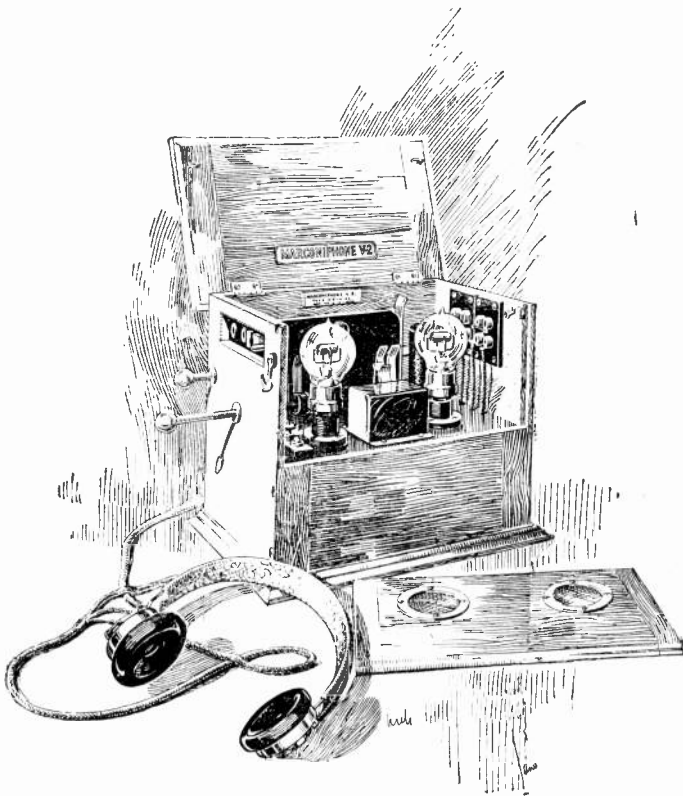

*The Marconiphone
V2 Model.*

2-VALVE
MODEL
FITTED WITH
A FINE TUNING
DEVICE, GIVING
EASY AND STABLE
ADJUSTMENT.
- - SPECIAL
LOW CURRENT
VALVES, GIVING
EXTRAORDINARY
MAGNIFICATION.
NO OSCILLATION.

CRYSTAL
MODELS
ONLY RECEIVING
SETS ON THE
MARKET
PROVIDED
WITH TWO
ALTERNATIVE
CRYSTALS.

NEAT, COMPACT
& INEXPENSIVE.

SIMPLICITY WITH EFFICIENCY

The **MARCONIPHONE DEPARTMENT,**
MARCONI'S WIRELESS TELEGRAPH CO., LTD.,
MARCONI HOUSE, STRAND, LONDON, W.C. 2.

DUBILIER

Radio Music from every Electric Lampholder

Every electric lampholder can now be used with safety for picking up radio signals, "Broadcasting," etc. The "DUCON" forms a perfect attachment between the radio receiver and the electric light wires.

Every "DUCON" is tested at 2000 volts A.C., and has the highest possible insulation resistance. Shocks and short-circuits are thus rendered impossible.

The "DUCON" fits directly into any standard B.C. electric lampholder, and is provided with terminals for connections to the radio receiver.

Simplicity with Perfect Safety is the Keynote of the "Ducon."

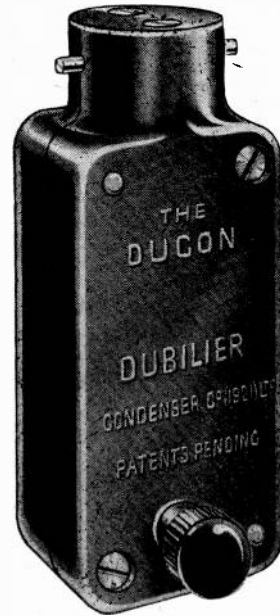

Price 10/- each

DUBILIER VARIABLE CONDENSERS FOR ALL PURPOSES

For full details of our various patterns of variable condensers, visit our Stand No. 36, at the ALL-BRITISH WIRELESS EXHIBITION and Convention, Horticultural Hall, S.W.1.

**THE DUBILIER CONDENSER CO. (1921), LTD.,
DUCON WORKS, Goldhawk Road, Shepherd's Bush, London, W.12**
Telephone—Hammersmith 1084. Telegrams—Hivoltcon, Phone, London. Code—Marconi International.

DUBILIER

A New Condenser for Wireless Receivers

THE DUBILIER TYPE 600 MICA CONDENSER

The illustrations show two patterns of this new condenser for wireless receiving circuits. The condensers have the same perfect mica insulation, the same high efficiency and the same permanence of capacity as the larger Dubilier Mica Condensers used in wireless transmitters. Distortion when receiving telephony is often due to bad design of the components of the receiver—therefore use efficient Dubilier Condensers in your receiver to obtain the best out of your set.

PRICES:

- Capacity below 0.001 microfarad - 2/6 each
- " " 0.001 & 0.005 ,, - 3/- ,,
- (inclusive)
- Condensers complete with Grid Leaks - 7/6 ,,

TRADE TERMS ON APPLICATION.

With Clips for Grid Leak.

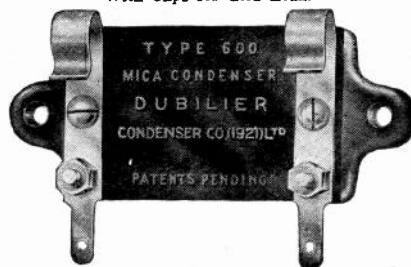

Without Clips for Grid Leak.

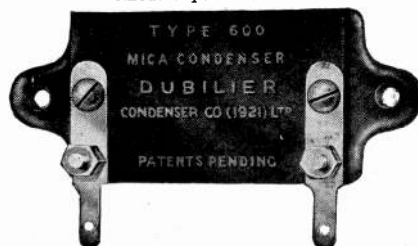

THE WAY TO DUBILIERS.

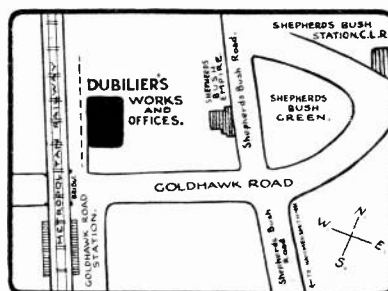

Visit our Stand No. 36.

THE DUBILIER CONDENSER CO. (1921), LTD.,
DUCON WORKS, Goldhawk Road, Shepherd's Bush, London, W.12

Telephone—Hammersmith 1084.

Telegrams—Hivolcon, Phone, London.

Code—Marconi International.

H. W. SULLIVAN

RADIO TELEPHONY TRANSMITTING APPARATUS.

Radio Telephone Transmitting Set (10—50 watts)

Wavelength ranges {150-200 metres} or {440 metres. A completely self-contained set ready for attachment to the Aerial. (LIST No. 240)

Radio Telephone Transmitting Set (10—80 watts)

Wavelength ranges 150-200 metres or 440 metres. In this set the various components are separately mounted on a horizontal panel for demonstration or experimental work.
(LIST No. 241)

Microphone and Microphone Transformers
for Radio Telephony Transmitter Modulation for any control system.

Modulation Choke

for use in the "Choke" control system of Radio Telephone Transmitter modulation.

Smoothing Chokes, Smoothing Condensers and Complete Smoothing Circuit Apparatus
for the H.T. supply of Transmitting sets.

Thermionic Valve Rectifying Apparatus
for Low Power Transmitting sets.

Thermal Ammeters

of all types and of all ranges for aerial current measurement.

Transmitting Inductances and Grid Anode Couplings

A variety of inductances for Aerial circuit, anode circuit and grid circuit coupling and tuning.

High Voltage Condensers

both variable air condenser and fixed mica, ebonite or glass condenser for tuning and other purposes in transmitting sets.

RADIO RECEIVING SETS AND AMPLIFIERS

Complete 4-valve Amplifying Receiver Cabinet

with tuning for all wavelengths. Two separate tuning circuits are employed for short and long wavelengths respectively. One radio frequency stage amplification is used, followed by a rectifying valve. One or two note magnifiers may be switched in as required.

High-Power 4-valve Amplifier (150—25,000 metres)

comprising one H.F. stage, one Detector and two L.F. Stages. One or both of the L.F. Valves may be switched out at will. An Amplifier of sufficiently high power and stability of adjustment to ensure the perfect reception of telephony and musical transmissions at all times. (LIST No. 300.)

6-valve High-Power Amplifier (200—25,000 metres)

This employs a very successful combination
Visit our Stand No. 49. All-British Wireless Exhibition, Horticultural Hall, September 30th to October 7th.

of radio and audio-frequency amplification. Retro-action is easily controlled by a reaction condenser in conjunction with grid potential control of the radio frequency valves. (LIST No. 201.)

5-valve Audio Frequency Amplifier

A powerful note magnifier entirely free from the disturbing noises and *speech distortion* which occur in the more usual transformer coupled magnifier when many stages are used. (LIST No. 200.)

Experimental Valve Amplifying Receiver Panels

of various types, arranged so as to test experimentally any of the circuits given in my "Book of Working Diagrams" a new and enlarged edition of which is now published.

3-valve Note Magnifier

arranged so that one, two or three valves may be used according to the strength of the signals being received.

Single-valve Note Magnifier

A complete unit for direct attachment to any receiving set for further amplification.

Single-valve Detector Unit and Complete Single-valve Receiver

Crystal Receivers

of various types and of new and entirely novel design.

WAVEMETERS AND HETERODYNES

**Standard Heterodyne Wavemeter
(150—20,000 metres)**

This Wavemeter is a self-contained standard for Precision Measurements of continuous and spark waves. (LIST No. 223.)

**Heterodyne Wavemeter
(150—4,000 metres)**

For the measurement of continuous and spark waves. It may also be used as a separate heterodyne in conjunction with non-oscillating receiving apparatus. (LIST No. 224.)

Apparatus for the determination of Effective Resistance, Inductance and Capacity at Radio Frequencies including the following :

Thermionic Valve Oscillation Generator, 600 to 20,000 metres.

Special Screened Radio Frequency Wheatstone Bridge with special fine adjustment.

Laboratory Standard Variable Air Condenser

with special fine adjustment.

Standard Variable Inductances of various ranges.

Standard Fixed Air Condensers, etc., etc.

COMPONENTS FOR THERMIONIC VALVE AMPLIFIERS & RECEIVERS

Condensers

Variable Air Condensers of various qualities, and with various types of fine adjustment devices. Three-Range Variable Air Condensers. Condensers of exceedingly small minimum capacity. Mica Condensers of all descriptions.

Tuners and Inductances

Single layer and bank wound Tuning Inductances with reaction. Loose coupled Tuning Inductances with variable coupling. Complete Loose Coupled Tuning Circuits.

Intervalve and Telephone Transformers

Radio Frequency Intervalve Transformer. This piece of apparatus is now well known; by its use radio frequency amplifying valves can be efficiently coupled at any wavelength. Audio Frequency Intervalve Transformers of 1 to 5 ratio of various new & improved types & sizes.

Patent Telephone Receivers for Wireless Telephony and Telegraphy

High sensitive and *distortionless* and of sound durable construction.

Adjustable Anode Reactance Coils

for Radio frequency intervalve coupling. These are constructed for any wavelength range, and attention is drawn to the new short-wave coil.

Filament Regulating Resistance and Grid Potential Regulators

Batteries

for H.T. and Filament supply, Adjustable voltage dry batteries. Wet Sac Leclanche Batteries and Accumulators.

Aerial Masts, Insulators and Fittings.

Heaters

(Electric) for Wireless Rooms and Laboratories.

Visit our Stand No. 49. All-British Wireless Exhibition, Horticultural Hall, September 30th to October 7th

<p><i>Works.</i></p> <p>"LIVERPOOL HOUSE"</p> <p>MIDDLESEX ST., LONDON, E.1</p> <p>Phone: Avenue 4871</p>	<p>HW. SULLIVAN</p> <p>TELEGRAMS: "DEADBEAT, STOCK, LONDON."</p>	<p><i>Offices.</i></p> <p>WINCHESTER HOUSE</p> <p>LONDON, E.C.2., ENGLAND</p> <p>Phone: London Wall 3318</p>
--	---	---



Telephone—
GERRARD
6785

Telegrams—
"WIRELOQUIP,
WESTCENT,
LONDON."

UNIT "A"
Broadcast Receiver
for All Wavelengths

Write for our Illustrated
LIST "B"
Post Free 3d.

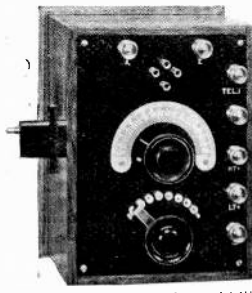
ADAPTED FOR
PLUG-IN COILS.

FITTED WITH
AERIAL SERIES
CONDENSER.

WIRELESS EQUIPMENT LIMITED,
90, Charing Cross Road, W.C.2.

Visit our Stand No. 14.
All-British Wireless Exhibition, Horticultural Hall, September 30th—October 7th.



No. W.19

Ever-Ready
British Made

**DRY CELLS
and BATTERIES**
for High & Low Tension

THE STANDARD OF QUALITY



U.W.1

HIGH TENSION BATTERIES

Any size or voltage with any tappings or sockets at 3 or 6 volt intervals for use with Wander Plugs can be supplied to order With 13 sockets as illustrated.

No. W.19, 36 volts, 24 cells, **8/6** each. Size 6 $\frac{1}{2}$ x 2 $\frac{1}{2}$ x 3 $\frac{1}{2}$.
Weight 2 lb. 8 ozs.

Wander Plugs 1/- per pair. With 2 Spring Contacts.

No. W.11, 15 volts, 11 cells, **3/6** each. Size 9 $\frac{1}{2}$ x $\frac{1}{4}$ x 2 $\frac{1}{2}$.
Weight 1 lb. 2ozs.

THE UNIT DRY CELL

"Build up your batteries as you build up your Marconi Sets."

Unlimited flexibility in size, voltage and intermediate tappings. Each cell is fitted with brass screw terminal and looped wire, and they are efficiently insulated to prevent current leak.

No. U.W. 1, **7/6** per dozen. E.M.F. 1 $\frac{1}{2}$ volts.
Weight 3 $\frac{1}{2}$ ozs. Dimensions 2 $\frac{1}{2}$ x 1'5/16 diam.

Art Catalogue of Standard Sizes and Voltages and list of Accumulators for Valve Filament Supply sent on request. Dept. D.L.

THE EVER-READY WORKS, Hercules Place, Holloway, N. 7.

Visit our Stand No. 11, All-British Wireless Exhibition. Horticultural Hall, September 30th to October 7th.

AUCKLAND'S

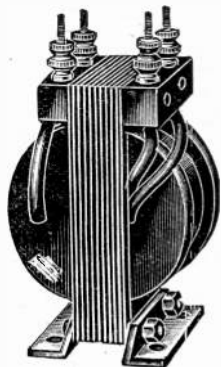

AUCKLAND'S INTERVALVE TRANSFORMERS

are guaranteed to give Maximum L.F. Amplification (giving no distortion of speech or parasitic noises), by reason of their careful design and manufacture.

The coil is layer wound and spaced, and the Stalloy Core is faced with Insulation on one side of each Lamination, to obtain the Maximum Magnetic Field.

Like all "Auckland Products" they are Unsurpassed.

PRICE 20/- EACH.

Liberal Discount to Trade.

Deliveries from Stock.

MADE BY INSTRUMENT MAKERS FOR INSTRUMENT USERS.

AUCKLAND CONDENSERS

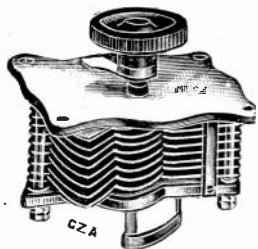

Our orders for these condensers required the whole output.

Having increased our factory space and improved the method of

manufacture, we can now offer from stock for panel mounting.

·0002 mfd.	15/-
·0003 "	16/-
·0005 "	18/-
·001 "	24/-

Specification.

1. Vanes are of hard Aluminium.
2. Spacing of plates .072".
3. Top plate die cast and fitted with Ebonite bush with brass centre as bearing.
4. Bottom plate 1/8" Aluminium and fitted as per No. 3.
5. Centre contact maintained by phosphor bronze strip.

Built to a universal standard.

TYPICAL AGAIN OF "AUCKLAND'S"

WATCH for future adverts. of Complete Sets and Amplifiers, manufactured under licence of Marconi patents.

G. Z. AUCKLAND & SON, 395, St. John Street, E.C.1

LONDON OFFICES :

Factories—ISLINGTON, N.

MANUFACTURERS OF WIRELESS APPARATUS.

'Phone—CLERKENWELL 3173-

STAND No. 25

THE TINGEY UNIT SYSTEM

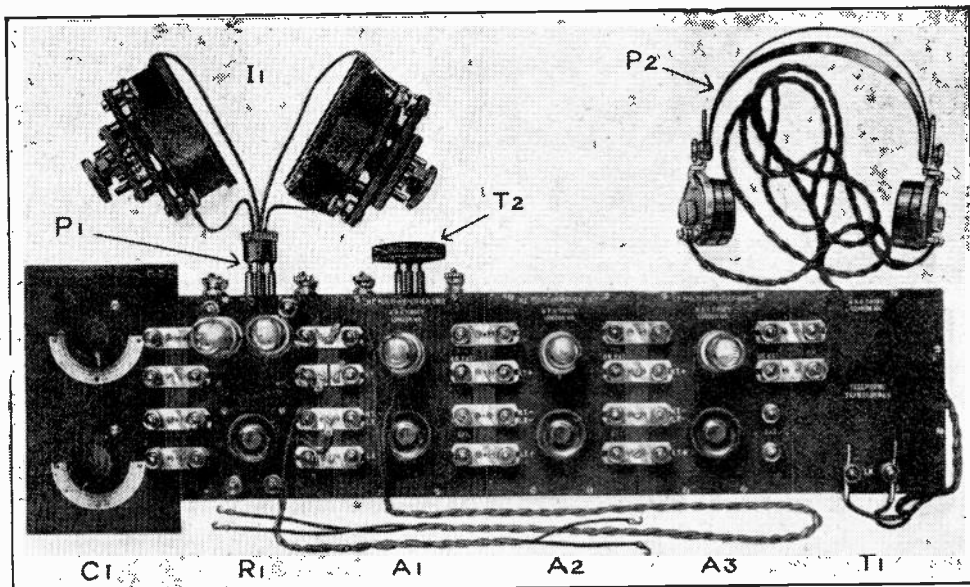

C1.	CONDENSERS. One pair mounted in case ..	£	s.	d.	I1.	INDUCTANCES. B. Coil—1,000-8,500 metres with approximate calibration ..	£	s.	d.	
R1*	RECEIVERS (for R. Valves) ..	5	0	0	I1.	INDUCTANCES. C. Coil—5,000-24,000 metres with approximate calibration ..	1	17	6	
R.S.	SINGLE VALVE RECEIVER ..	4	7	6	J1.	JUNCTION BRACKETS (8 styles) from 3/- to 6/6 each	3	2	6	
R.V.	UNIT H.F. to follow R.S. Unit ..	3	10	0	P2.	BROWN'S PHONES (D Type), 120 w. Per pair	2	8	6	
A2.	MULTI H.F. AMPLIFIER UNIT, Choke and resistance type ..	2	0	0	BROWN'S RELAY UNIT (mounted in case), for rapid attachment to Tingeey Units. No loose connections (2,000 ohms input) ..	6	15	0		
A3.	MULTI L.F. AMPLIFIER UNIT ..	3	15	0	BROWN'S RELAY (without Tingeey adaptation) ..	6	2	6		
A4.	MULTI H.F. AMPLIFIER UNIT, without inductances or variable condenser ..	2	10	0	"ORA" MULLARD'S VALVES ..	each	0	15	0	
A24.	COMBINED UNIT, tuned or stand-by position ..	3	15	0	P1.	INDUCTANCE PLUGS ..	each	0	4	0
T1.	MULTI TELEPHONE TRANSFORMER UNIT ..	2	0	0	T2.	INTERCHANGEABLE TRANSFORMERS (300 to 24,000 metres) ..	each	6/-	to	12/-
I1.	INDUCTANCES. A. Coil—200-1,600 metres with approximate calibration. Price ..	1	5	0	TINGEY (3-Valve) RECEIVER, 1 valve H.F., 1 Rect. 1 L.F. (without valves) ..	8	10	0		

COMPLETE RECEIVING SETS (VALVE) From £14.

All "Tingeey" Valve Apparatus is duly licensed under Marconi Patents for Amateur use in Great Britain.

TINGEY FOR COMPONENT PARTS

EBONITE, cut to size—	s.	d.	FILAMENT RESISTANCE, Unmounted ..	each	£	s.	d.
12 x 12 x 1/4 ..	5	3	FILAMENT RESISTANCE, Mounted ..	each	5	6	
12 x 9 x 1/4 ..	4	0	FILAMENT RESISTANCE and Valve Holder ..	each	15	6	
12 x 6 x 1/4 ..	2	8	SWITCHES, 5 point ..	each	5	0	
10 x 10 x 1/4 ..	4	0	SWITCHES, 10 point ..	each	7	6	
10 x 8 x 1/4 ..	3	3	SWITCHES, 19 point ..	each	10	0	
12 x 3 x 1/4 ..	1	4	EXPERIMENTAL VALVE PANEL ..	each	1	15	0
6 x 6 x 1/4 ..	1	4	THREE-VALVE PANELS ..	each	4	6	
GRID LEAKS, 1 to 5 megohms ..	each	2	CONTACT STUDS, small, cleaned and lacquered ..	doz.	1	3	
ANODE RESISTANCES, any resistance ..	each	2	CONTACT STOPS ..	doz.	1	6	
VARIOMETER OR REACTANCE FORMS ..	each	7	VALVE LEGS ..	doz.	2	6	
CONDENSER SCALES, Ivorine ..	each	1	VALVE PINS ..	doz.	2	6	
LAMINATED SWITCH ARMS ..	each	2	Various other component parts.				

Offices & Works

Phone
HAMMERSMITH 1916
Telegs.
TINGEY LONDON

W.R.H. TINGEY.

SPECIALIST IN WIRELESS

Offices & Showrooms

92 Queen St.
Hammersmith.
London, W.6.

THE Tingey Self-Contained Cabinet Set

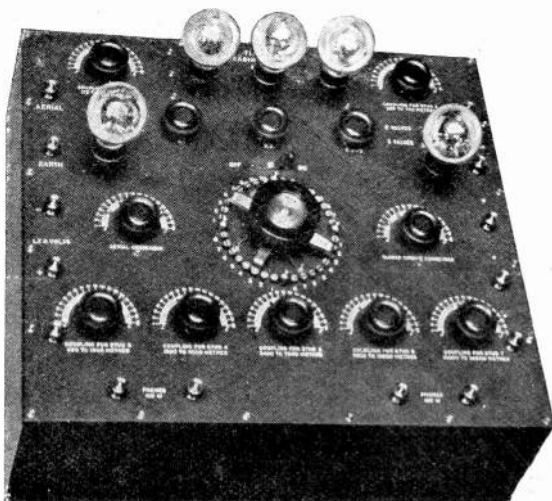

(REGISTERED DESIGN)

This is the last word in Self-Contained Sets.

It is only necessary to attach Earth, Aerial 6-volt Accumulator and Telephones or Loud Speaker to obtain loud clear signals or speech, on any wavelength. No Inductances are Tapped, entirely separate coils employed for each range of wavelengths, thus making the set particularly efficient on short waves.

The design of this Set makes it extremely suitable for fitting into gramophone cabinets.

IMPORTANT NOTICE.—This Set conforms to all requirements of the Postmaster-General.

The Set is being shown to the Public for the first time on our **STAND No. 25**. We shall also be showing a **FOUR-VALVE BROADCASTING SET** specially constructed and designed to meet the requirements of the Postmaster-General as for Broadcast Reception only. Range 100-500 metres. All Tingey Valve Apparatus is duly licensed under Marconi Patents for Amateur use in Great Britain.

TWO INSTRUCTIVE PRACTICAL PAMPHLETS

of great use to all desiring sound information on the erection and maintenance of home Wireless Stations.

Aerial and Earth. Fault Finding.

PRICE **8d.** EACH. POST PAID.

The above can only be purchased from the Author, **W. R. H. TINGEY**
(Capt. Royal Corps of Signals, T.F.). M.I.R.E.

W. R. H. TINGEY *SPECIALIST IN WIRELESS,*
92 Queen St., Hammersmith, London,

Telephone—HAMMERSMITH 1916.

Telegrams—"TINGOIDAR, LONDON."

W. 8

5,000

**DEALERS IN WIRELESS APPARATUS,
ELECTRICAL INSTRUMENTS,
PHOTOGRAPHIC INSTRUMENTS and
GRAMOPHONE DEALERS WANTED**

Those tradesmen who wish to participate in the approaching boom of wireless, and participate in the profit realisable from a big trade should immediately get in touch with the R.F.H. Company.

THE TRADE-MARK
R.F.H.:

Denotes High Quality, Latest
Designs, High Efficiency and
Splendid Service.

SEE OUR EXHIBITION at the All-British Wireless Exhibition, Horticultural Hall, Westminster, S.W.1.

Stand 22,

September 30th to October 7th.

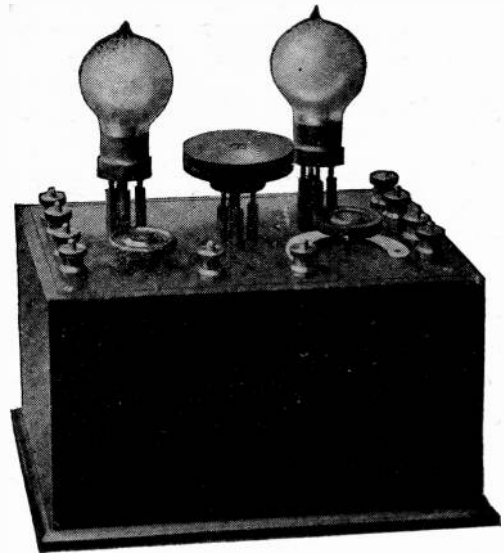

Prize Competition will be held during Exhibition Week. Full particulars from

ROGERS, FOSTER & HOWELL, LTD.
EDWARD ROAD, BALSALL HEATH, BIRMINGHAM.

AS SOON AS

the **BROADCASTING SCHEME** is in operation (and this may take place almost as soon as this advertisement appears) you will require all the Broadcasting Sets you can get hold of, for the **BOOM** will soon be in full swing.



People of all ages and in all districts will want to hear the Broadcasting Concerts and Speeches, and our boys coming home from School for the Christmas Holidays will give their parents little peace until they are provided with a **RADIO SET**. Consequently, there will be a demand for thousands of **CRYSTAL SETS**. The **R.F.H. CRYSTAL SETS**, like our **VALVE SETS**, are of the highest quality, latest design, highest efficiency and will give splendid service. Our prices are within the reach of all pockets. See our Specimens at Stand **22**, at the All-British Wireless Exhibition, Horticultural Hall, Westminster, Sept. 30th to Oct. 7th, 1922.

PRIZE COMPETITION WILL BE HELD DURING
EXHIBITION WEEK. FULL PARTICULARS FROM

ROGERS, FOSTER & HOWELL, LTD.,
188, Edward Rd., Balsall Heath, Birmingham.

McGRUER

HOLLOW MASTS

are simple to fix on either roof or ground. They have the least wave-disturbing mass consistent with rigidity.

Our 30' Mast with folding joint weighs only 16 lbs. It is supplied complete with Truck, Sheave, Insulators, Stays, Strainers and Anchors.

We specialise in light masts and spreaders.

Masts of any height supplied.

Write stating your particular requirements and we will quote you by return.

McGruer Hollow Spar Co. Ltd.

Commercial Road, Lambeth, S.E.1.

Telephone: Hop 718. Telegrams: Olloparsh, Watloo, London.

ACCUMULATORS

Absolutely Guaranteed Best Quality

CELLULOID CASES.

4 volt 40 amp.	19/6	4 volt 80 amp.	23/2
4 " 60 "	21/6	4 " 100 "	30/-
6 " 40 "	26/8	6 " 80 "	27/8
6 " 60 "	31/9	6 " 100 "	41/6

PACKING FREE.

TRADE PRICES NOW REDUCED
Write for Latest List.

SPECIAL OFFER.

6 volt 44 Actual amp. Set three Glass Cells, sealed tops in well-made Teak Crate, a handsome set - - - - - 49/6
4 volt 24 amp., Celluloid Case, 11/9 Postage 1/-
2 " 16 " Ebonite " 3/9 Post Free.
Aerial Wire - - - per 100 ft. Coil 5/-

All Sizes of Accumulators Quoted for.

EXIDE ACCUMULATORS STOCKED
(Trade supplied)

Dynamos, Motors, Electrical Accessories,
Sulphuric Acid (write for lists) Stocked.

F. YATES & Son, Ltd

WHOLESALE ELECTRICIANS,

144, Church St., Kensington, London, W.8

One Min. from Notting Hill Gate Sta. Phone—Park 4276.

GENTS MAKE FITMENTS

SEND
FOR
OUR
SUNDRIES
PAMPHLET

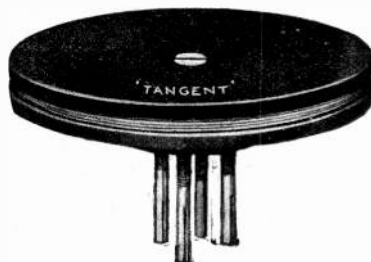

THE "DISCOL" H.F.
TRANSFORMER.

MAKE USE OF OUR STOCKS.

ASK US TO QUOTE FOR YOUR
WHOLESALE REQUIREMENTS.

GENT & Co., Ltd., FARADAY WORKS, LEICESTER.

LONDON: 25 VICTORIA STREET, S.W.1.

NEWCASTLE-ON-TYNE: TANGENT HOUSE, 52 BLACKETT ST.

STAND No. 9

Do not fail to visit our Stand at the

ALL-BRITISH
WIRELESS EXHIBITION
RECEIVERS, AMPLIFIERS, &c., OF
ALL DESIGNS

COMPLETE STATIONS OF ALL
DESCRIPTIONS

on view

FROM 1-VALVE STATION TO 5-
VALVE STATION

Ask to see our special

No. 1 and 2 DE LUXE 5-VALVE
CABINET COMPLETE STATIONS

and our

SIMPLEX 3-VALVE COMPLETE
STATION

Trade specially invited

T. H. ISTD

Wireless Instrument Manufacturers
TERLING, WITHAM, ESSEX

Since 1910—
Sole Source of
Supply for all

WIRELESS CRYSTALS

LIBERAL DISCOUNT TO THE TRADE. ESTABLISHED 1848.

RUSSELL & SHAW, 38, Gt. James St., Bedford Row, W.C.1

THE WIRELESS WORLD AND RADIO REVIEW

THE OFFICIAL ORGAN OF THE WIRELESS SOCIETY OF LONDON
A MAGAZINE DEVOTED TO WIRELESS TELEGRAPHY AND TELEPHONY

CONTENTS

On Heterodynes. By Philip R. Coursey, B.Sc., F.Inst.P. A.M.I.E.E.	-	-	845
The All-British Wireless Exhibition	-	-	853
Progress in the Broadcasting Scheme	-	-	865

Contents continued on next page.

FULLER WIRELESS COMPONENTS

Filament Batteries, Inductances, Insulators, High Tension Batteries, Variable Condensers, Aerial Wires, Electric Condensers, Filament Resistances, Valve Holders, Ebonite Sheet, Rod, Tube, Cables and Fine Wires.

By the courtesy of Messrs. C. F. Elwell, Ltd., our Wireless components are being exhibited at the **All-British Wireless Exhibition, Horticultural Hall, Westminster, STAND No. 45**

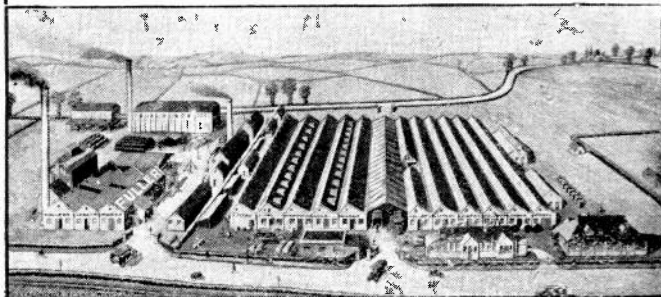

Fuller's United Electric Works, Ltd.
Woodland Wks., Chadwell Heath, London, E.
Telegrams: "Fuller, Chadwell Heath."
Telephone: Ilford 171 (4 lines).



ESTABLISHED 1875

MEN IN THE WIRELESS SERVICES DESIRING RAPID ADVANCEMENT

should train in spare time with the College which ensures this
 "U.E.C." (Regent's Park, London, N.W.1) has in Twelve Years secured hundreds of successes by
 Individual Postal Training for Engineering Examinations and Professional Work.

State YOUR ambition in confidence, to—SECRETARY'S DEPT. (Desk W.),
 UNIVERSITY ENGINEERING COLLEGE, WESTGATE-ON-SEA, KENT,
 and expert advice with the New prospectus, No. 8. will be sent you without obligation.

CONTENTS *(Continued)*

Experimental Station Design. By F. H. H. <i>(Continued)</i>	- - - - -	866
Notes	- - - - -	871
Calendar of Current Events	- - - - -	872
Wireless Club Reports	- - - - -	873
Questions and Answers	- - - - -	877
Share Market Report	- - - - -	884

THE WIRELESS WORLD AND RADIO REVIEW is published weekly on Saturdays.

All correspondence relating to contributions should be addressed to THE EDITOR, THE WIRELESS WORLD AND RADIO REVIEW, 12-13, Henrietta Street, London, W.C.2.

No responsibility can be taken for MSS. or photographs sent without stamps to defray cost of return postage.

Editorial and Publishing Offices 12-13, Henrietta Street, Strand, London, W.C.2.

Telegraphic Address: "Radionic, Rand, London." Telephone No.: Gerrard 2807.

Advertisement Managers, Bertram Day & Co., Ltd., 9 and 10, Charing Cross, S.W.1.

Telephone No.: Gerrard 8063 and 8064

SUBSCRIPTION RATES.—

28s. per annum, post free. Single Copies 6d., or post free 7d.

Registered at the G.P.O. for transmission by Magazine Post to Canada and Newfoundland

HOLLOW STEEL MASTS FOR AERIALS

These masts are light, strong, easily erected, and will last a lifetime. All lengths over 15ft. are made in sections and each mast is supplied complete with baseplate, finial, rope cleat, pulley sheave, guy clips, three steel guy ropes and strainers, painted one coat ready for immediate erection. Being made of steel, no lightning conductors are required.

PROMPT DELIVERY.

PRICES F.O.R. FOR CASH WITH ORDER, EACH

10ft. ...	32/6	15ft. ...	42/6	20ft. ...	45/-
25ft. ...	57/6	30ft. ...	84/-	40ft. ...	126/-

Other Lengths supplied at equally Low Prices.

Trade Inquiries Invited.

THE WIRELESS STEEL MAST & ACCESSORY COMPANY
 Lombard Street West, West Bromwich

Telephone No. 447.
 Telegrams: "Wireless Westbromich."

VALVES

DELIVERY FROM STOCK.

RECEIVING.



Type.	Filament Voltage.	Anode Voltage.	PRICE.
R	4	60	£0 17 6
R4B	4	50	1 10 0
V24	5.2	36	1 4 0
Q	5.2	50	1 4 0
		(150 as amplifier)	
QX	5.2	50	1 4 0

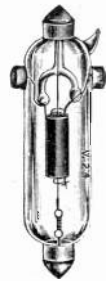

SPECIAL LOW TEMPERATURE VALVES.



Type.	Filament Voltage.	Filament Current.	Anode Voltage.	PRICE.
L.T.1	1.8	.4	36-50	£2 10 0
L.T.3	1.8	.11	"	"

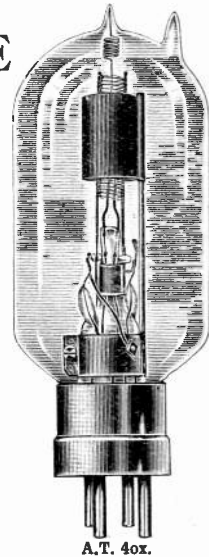

TRANSMITTING.

Type	Filament Voltage.	Anode Voltage.	PRICE.
A.T.25	5.5	UP TO 1,000	£1 10 0
A.T.40X	7	" 1,000	2 15 0

L.T. 1.

A.T. 40x.

Visit our Stand No. 32. All-British Wireless Exhibition, Horticultural Hall, September 30th to October 7th

THE
MARCONI SCIENTIFIC INSTRUMENT CO., LTD.

40 DEAN STREET, SOHO, W.1

TELEGRAMS: THEMASINCO. WESTCENT
 TELEPHONE: GERRARD 774

WATES Specialities

Give you the finest quality and value obtainable.

The SPHINX H.T. Batteries can always be relied upon.

Visit our
Stand No. 15

All-British Wireless Exhibition, Horticultural Hall, September 30th to October 7th.



Standard 15 Volt

Standard 15 Volt Price 3/6 each

Four standard 15 Volt Sphinx H.T. Batteries in polished mahogany case with tappings for either 30, 45 or 60 volts. Supplied with terminal connectors for 15-volt units.

No soldering required.

Price with 60-volt batteries 29/-

Price without batteries 15/-

Send three stamps for Illustrated Catalogue.

WATES BROS
13/14 Gt Queen St.
Kingsway, London, W.C.2

'Phone Gerrard 576

DAVIS & TIMMINS,
LIMITED.

34a, York Road, King's Cross, N.1



**SCREWS & TERMINALS
FOR WIRELESS SETS.**

Illustrated Lists sent Free on Request.

Tele. No.: NORTH 580.

Telegrams: CONDUCTIVITY, LONDON.

**EBONITE
AND
VULCANITE**

TUBES RODS SHEETS

LARGE
STOCKS

BRITANNIA

RUBBER AND KAMPTULICON
CO., LTD.

7 NEWGATE ST., LONDON, E.C.1

'Phone: 2168 Central. 'Grams: Britannia, Cent., London

THE WIRELESS WORLD AND RADIO REVIEW

THE OFFICIAL ORGAN OF THE WIRELESS SOCIETY OF LONDON

VOL. X. No. 27.

SEPTEMBER 30TH, 1922.

WEEKLY

On Heterodynes

THE CONSTRUCTION OF A HETERODYNE WAVEMETER.

By PHILIP R. COURSEY, B.Sc., F.Inst.P., A.M.I.E.E.

IN the earlier articles in this series, which were published in these columns a few months ago, details were given for the construction of several forms of heterodyne oscillator. In all of these, separate plug-in coils were used in order to obtain the necessary wavelength range for the instrument. While this is a very convenient method to employ for the ordinary purposes of a heterodyne, the wavelength calibration of the instrument does not remain constant, since any small change in the relative positions of the tuning and reaction coils will alter the oscillation wavelength independently of any change in the setting of the variable condenser. Further, unless the coils themselves are very rigid, slight distortions of the coil windings may occur from time to time, which will cause changes in their constants and therefore also changes in the calibration of the instrument.

These difficulties can only be overcome effectively by building the coils into the instrument, and fastening them securely so that no changes can take place. When this is done the simple heterodyne becomes a heterodyne wavemeter which can be employed not only for the accurate measurement of wavelengths but also for numerous other radio measurements and tests as well.

While there are many ways in which such an instrument can be constructed, it is not necessary for many purposes to build it with all the care or refinements necessary for a standard laboratory wavemeter. Hence the design of the instrument described below aims at providing a simple apparatus which will meet most ordinary requirements without entailing an excessive cost in its construction.

The general outline of the arrangement used follows that employed in the first type of heterodyne described in this series of articles, in that an ordinary type of inductively coupled oscillation circuit is employed, using separate reaction and tuning coils (Fig. 1).

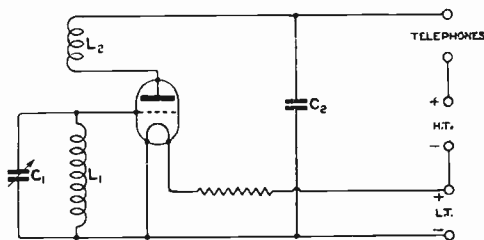

Fig. 1. Inductively coupled oscillation circuit.

The effective wavelength range is from rather under 150 metres up to approximately 30,000 metres, so that it covers most ordinary wavelengths encountered in radio working, and also overlaps the range of the short wave heterodyne, which has been described in these columns. It has also been found possible to enclose the apparatus in a box of the same outside dimensions as those of the above-mentioned short-wave heterodyne, so as to be uniform in style with that instrument.

The box is constructed of any convenient hard wood, $\frac{1}{4}$ in. thick, with outside dimensions of $9\frac{3}{4}$ ins. by 6 ins. by $4\frac{1}{2}$ ins. high, so that when the top panel of $\frac{1}{4}$ in. ebonite is fitted in position the instrument will be $4\frac{3}{4}$ ins. high over all.

The top panel should be cut out from ebonite $\frac{1}{4}$ in. thick, to the dimensions of $9\frac{3}{4}$ ins. by 6 ins., and needs to have holes drilled in it in the positions shown in Fig. 2.

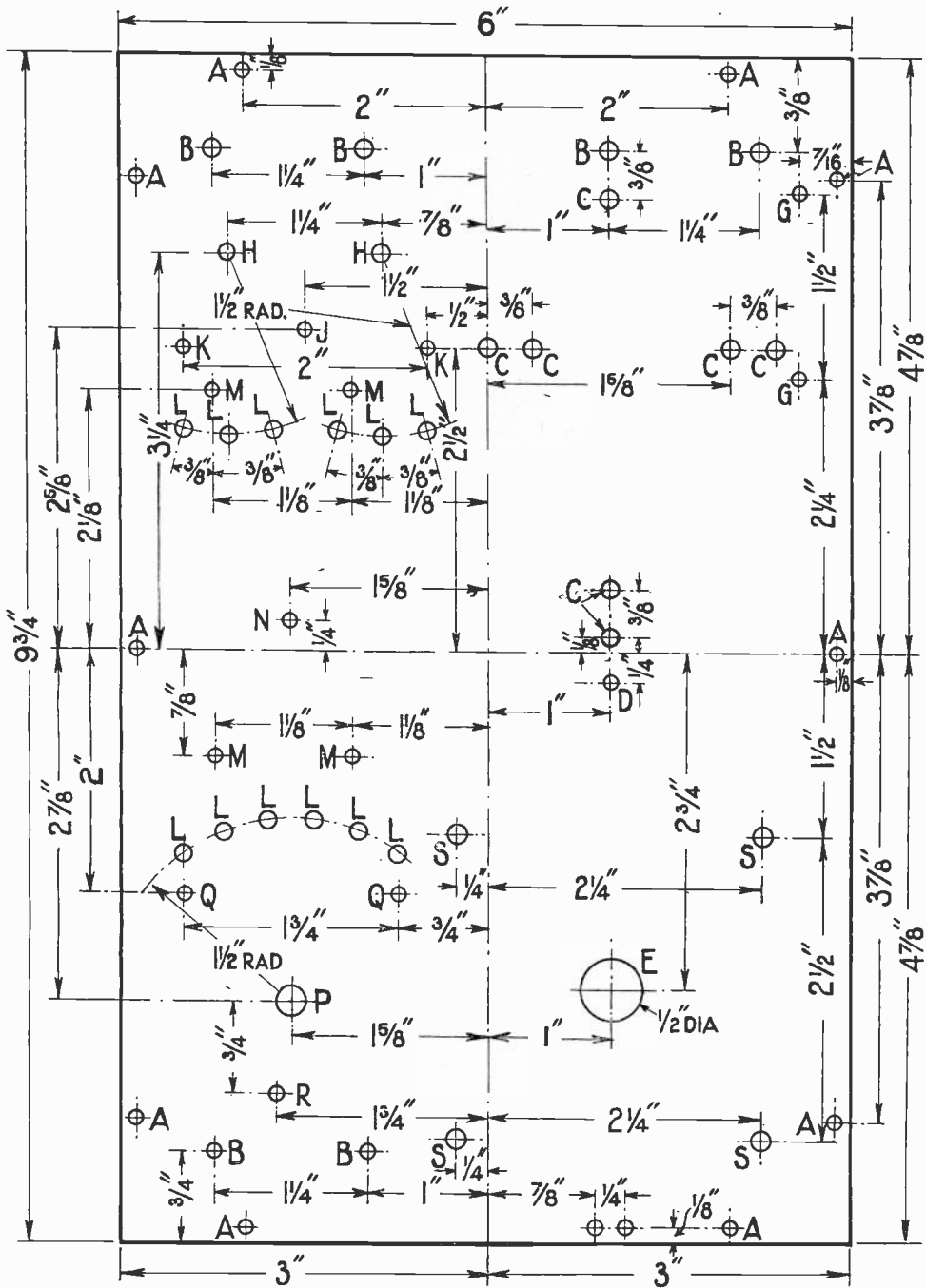

Fig. 2. Drilling diagram (back view of panel).

This drawing is arranged so that the positions are ready for marking out directly on the back or underside of the ebonite panel.

The sizes and uses of the various holes lettered from A to S in Fig. 2 are set out below, as it is not easy to label the individual holes on the drilling diagram itself without unduly complicating the drawing.

- A = Holes $\frac{1}{8}$ in. diameter, countersunk on surface for screws holding ebonite panel to box sides.
- B = Holes for terminals, tapped 4 B.A.
- C = Holes for screws for fixing valve holder contacts, tapped 6 B.A.
- D = Hole, 4 B.A. clear, countersunk on front surface for screw fixing pillar holding short-wave coils.
- E = Hole $\frac{1}{2}$ in. diameter for spindle and bushing of condenser.
- F = Holes tapped 8 B.A. for condenser scale pointer.
- G = 4 B.A. clearing holes, countersunk on surface for screws to hold ebonite frame for long-wave coils.
- H = 1 B.A. clearing holes for switch spindles.
- J = 6 B.A. hole for screw to hold brass bracket of long-wave coils.
- K = Two 4 B.A. holes for stop pins of switch.
- L = 4 B.A. holes for switch studs, at $\frac{3}{8}$ in. centres.
- M = Holes for bracket carrying condensers 6 B.A. clear, countersunk on surface.
- N = Centre of miniature tumbler switch for filament circuit.
- P = $\frac{1}{4}$ in. diameter hole for switch spindle (0 B.A.).
- Q = 4 B.A. holes for stop pins for switch.
- R = 5 B.A. hole for stud to support end of 0.01 μ F condenser.
- S = Four blank holes drilled and tapped 4 B.A. to a depth of 3/16 in. into the ebonite. These are used for fixing the variable condenser in position, and would be required in other positions for some patterns of condenser.

When all the holes have been drilled and tapped to the proper sizes, the edges and front of the ebonite panel should be cleaned up, and polished or dull finished as preferred.

The front surface can then be engraved, if desired, with the appropriate lettering, as

indicated in the plan of the instrument in Fig. 3.

For convenience in tuning, the inductances fitted into a wavemeter of this type should be subdivided into several coils. It has been found possible to limit the number of tuning coils to three in this instrument, and the number of reaction coils to two. For the longer wavelengths three duolaterally wound coils are used, two for tuning and one for reaction, while for the shorter waves two single layer solenoidal coils give good results.

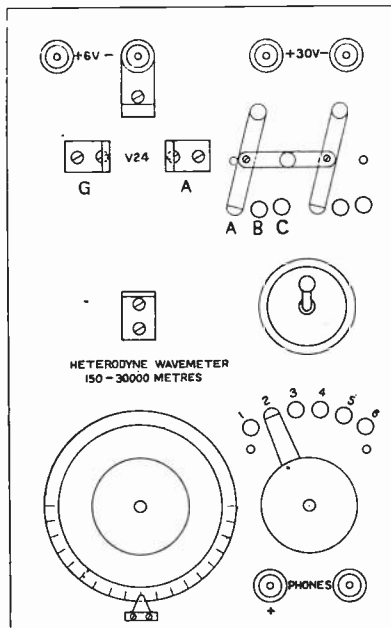

Fig. 3. Plan of the instrument, showing engraving.

The materials necessary for constructing this instrument are set out in the list below, from which it will be noted that it is proposed to utilise ready-made duolateral coils and variable and fixed condensers, since this method is usually the more satisfactory. The construction of the variable condenser and the duolateral coils, while quite easy, is a tedious process without the proper facilities, while the prices for which they can be purchased are not prohibitive.

MATERIALS USED IN CONSTRUCTION OF A WAVEMETER OF THIS TYPE.

No.	DESCRIPTION.
I	600-turn duolateral coil (inductance approximately = 24,000 microhenries).
I	150-turn duolateral coil (inductance approximately = 1,380 microhenries).

- 1 100-turn duolateral coil (inductance approximately = 620 microhenries).
- 1 Variable air condenser of maximum capacity = 0.0015 microfarad, with standard knob and indicating dial.
- 10 6 B.A. by 7/16 in. cheese-head brass screws.
- 14 6 B.A. by 3/8 in. countersunk-head brass screws.
- 10 6 B.A. by 5/16 in. round-head brass screws.
- 3 6 B.A. hexagon nuts.
- 6 4 B.A. by 5/8 in. countersunk-head brass screws.
- 4 4 B.A. by 1/4 in. cheese-head brass screws.
- 6 4 B.A. terminals, with nuts and washers.
- 2 1 B.A. by 1 1/4 in. cheese-head brass screws.
- 4 1 B.A. hexagon nuts.
- 4 0 B.A. hexagon nuts.
- 6 0 B.A. brass washers.
- 3 0 B.A. spring washers.
- 1 0 B.A. stud 1 1/8 in. long.
- 5 Fixed condensers of capacities of 0.0013, 0.0026, 0.0040, 0.0053, and 0.0065 microfarad. (Dubilier type 600A condensers are suitable.)
- 1 Fixed condenser 0.01 microfarad capacity (Dubilier type 577 condenser of this valve is suitable).
- 1 Miniature tumbler switch.
- 12 4 B.A. by 1/4 in. by 1/4 in. switch studs.
- 1 1 1/2 in. diameter ebonite knob for switch.
- 3 8 B.A. by 3/16 in. round-head brass screws.

Phosphor bronze strip for switches and valve holder—thickness approximately 0.015 in.

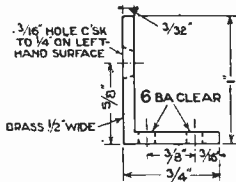

Fig. 4. The rigid contact for V24 Valve Holder.

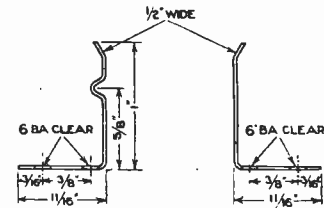

Fig. 5. Dimensions of the contacts for the V24 Valve Holder.

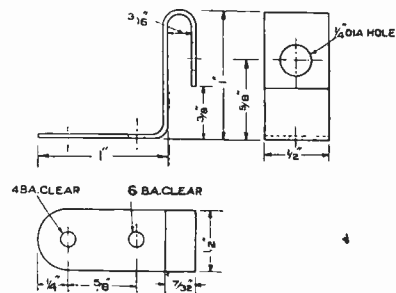

Fig. 6. Dimensions of the contacts for the V24 Valve Holder.

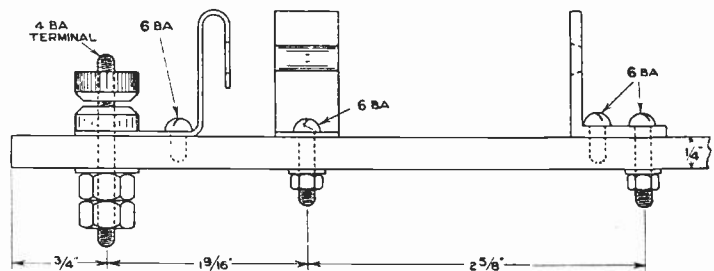

Fig. 7. Showing how to arrange the V24 Valve Holder contacts, one of which is held under the 4 B.A. terminal with a 6 B.A. screw for fixing.

The parts of the valve holder may next be prepared. Valves of the V24 type require four contacts, three at least of which need to be of springy material in order to retain good contact with the valve caps. The fourth is

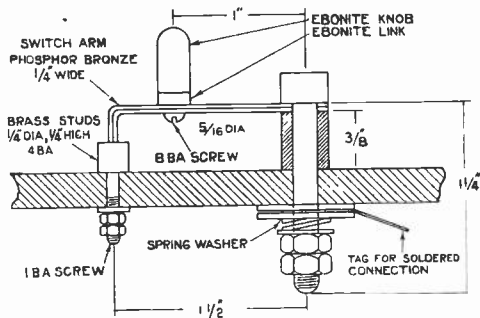

Fig. 8. Arrangement of double-pole range switch.

preferably a rigid contact. The last may be bent up of 3/32 in. brass strip, 1/2 in. wide to the dimensions shown in Fig. 4, while the springy contacts are made of phosphor bronze about 0.015 in. thick. The dimensions of these contacts are given in Figs. 5 and 6.

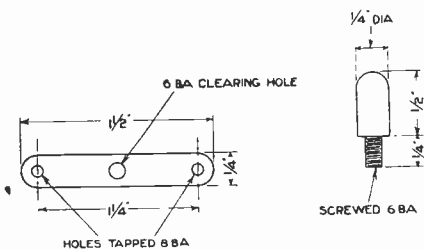

Fig. 9. Details of link and knob for double-pole range switch (ebonite).

One of the springy bronze contacts can be fixed in position under the 6 V - terminal, as indicated in Figs. 3 and 7, the latter giving

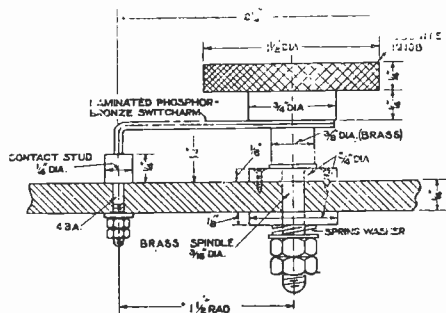

Fig. 10. The six-way range switch.

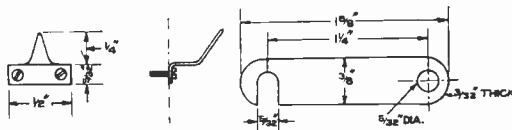

Fig. 11. Dimensions of pointer.

Fig. 12. Dimensions of link.

also the general arrangement and relative positions of the other contacts.

The double-pole range switch may next be prepared. The general arrangement of each arm is shown in Fig. 8. Each switch arm is built up of 5 phosphor-bronze strips 1/4 in. in width, three of these being bent round to press on the switch contact studs, and the two intermediate ones being cut short so as to space the contact laminations apart and give a better contact. The five strips should be rivetted together into a coherent whole at a distance of about 3/4 in. from the centre of the spindle. The spindle or pivot for this switch is a 1 B.A. cheese-head brass screw, 1 1/4 ins. long, which after passing through the switch arm, is supported by a brass sleeve 5/16 in. diameter by 3/8 in. long, having a 1 B.A. clearing hole drilled through it. After passing through hole H (Fig. 2) in the ebonite panel, washers, a spring washer, and nuts are fitted to this screw on the underside of the panel.

The two switch arms, pivoted through holes HH (Fig. 2), should be linked together by an ebonite link, the dimensions of which are given in Fig. 9. This link is pivoted to the switch arms by two No. 8 B.A. round-head brass screws. In the centre of this link a small ebonite knob is fitted. This may be made of the size given in Fig. 9.

The studs for this and the other (six-way) range switch should be 1/4 in. diameter by 1/4 in. high, with 4 B.A. screwed shanks.

The six-way range switch may also be built up with five phosphor bronze strips or laminations, to the dimensions shown in Fig. 10. The 1 1/2 in. diameter ebonite knob is screwed to the switch arm. A piece of No. 0 B.A. studding may be used for the spindle of this switch, and may be screwed into the underside of the ebonite knob.

For switching the filament of the valve on or off, a miniature tumbler switch may be used. No holes for this are shown on the

drilling diagram, Fig. 2, since these switches vary somewhat in style and dimensions. The position of the centre of the switch is, however, shown on that diagram.

In the filament circuit of the valve a fixed resistance of 1 to $1\frac{1}{4}$ ohms should be fitted so that a six-volt accumulator may be used as the

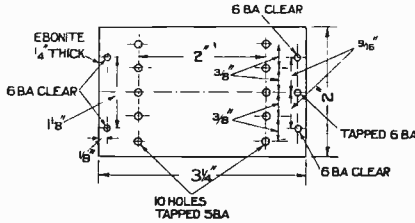

Fig. 13. Platform for condensers.

supply, giving about 5 volts on the valve terminals. A straight piece of No. 36 Ferry resistance wire slipped into a piece of sistoflex insulating sleeving may conveniently be used for this purpose, and may be used as one of the connecting wires in the circuit. A length of from 4 ins. to 5 ins. is about correct.

The variable air condenser should have a maximum capacity of approximately 0.0015 microfarad. This part is best procured ready made but can of course be built up if desired. In order that it may go conveniently into the available space its fixed plates should not exceed about $2\frac{3}{4}$ ins. or $2\frac{13}{16}$ ins. diameter. For a condenser of this size about 30 fixed and 29 movable plates usually gives about the correct capacity value. The overall depth of the condenser under the panel should not exceed $4\frac{1}{4}$ ins in order that it may go inside the box.

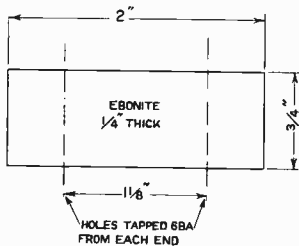

Fig. 14. Support for condenser platform.

The usual type of indicating dial fitted to these condensers requires a pointer fixed on the ebonite top of the instrument. Dimensions for such a pointer are given in Fig. 11. It should be fixed with two No. 8 B.A. round-head brass screws to the two holes marked FF in Fig. 2.

At the front of the instrument two terminals—marked "Phones" in Fig. 3—are fitted. These should be provided with a short-circuiting link so that the circuit may be closed if it is not desired to use telephones with the instrument. The dimensions of the link are given in Fig. 12.

The next consideration is the fixing of the additional condensers which are paralleled with the variable condenser by the six-way range switch in order to increase the capacity range of the set. In the instrument here described Dubilier Type 600 A condensers were used, since these take up very little mounting space, besides being of high insulation resistance and having great constancy of capacity. As there is insufficient space on the ebonite panel itself to mount these near the range switch, they must be screwed together on to an ebonite platform of the size given in Fig. 13. This should be

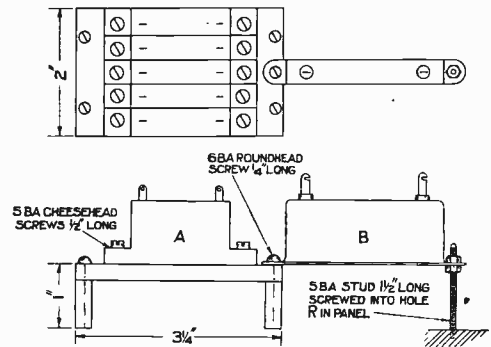

Fig. 15. Arrangement of the condensers when mounted on their platform.

supported from the panel by two strips of ebonite of the size shown in Fig. 14, these being secured to the instrument panel by 6 B.A. countersunk-head brass screws through the holes marked M M M M in Fig. 2. This platform also serves to support one end of another condenser (of capacity = 0.01 microfarad) which is shunted across the telephones and H.T. battery. The condenser used here was of the Dubilier Type 577 pattern. Its other end was supported by a No. 5 B.A. brass stud screwed into the instrument panel (hole R, Fig. 2) the metal case of the condenser being clamped to this stud by two 5 B.A. nuts.

The general appearance of these condensers when mounted up on their platform is shown in Fig. 15.

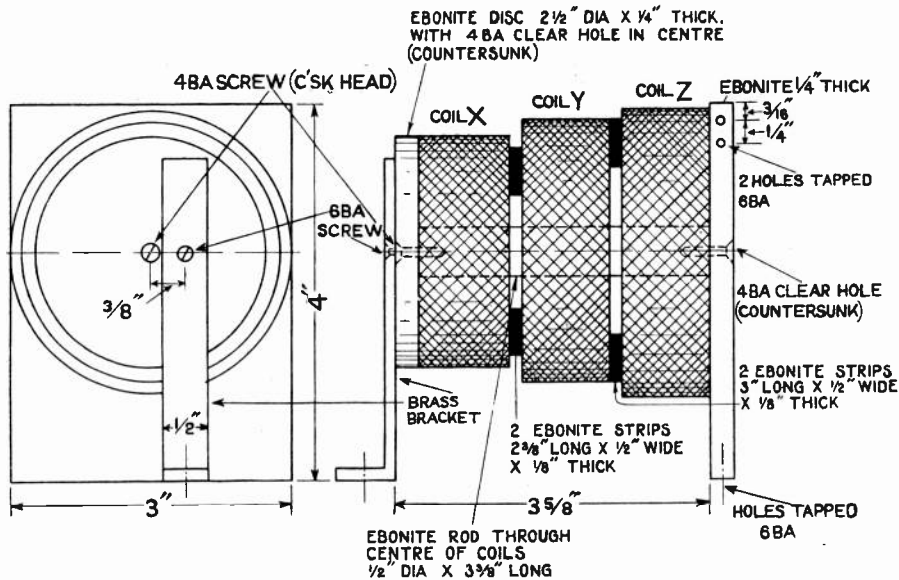

Fig. 16. Arrangement of mounting for long-wave coils.

The remaining points to be considered are the mounting of the tuning and reaction coils, and the wiring up of the set.

For the longer wavelength ranges the three duolateral coils are used. These are clamped between two pieces of ebonite as shown in Fig. 16. One of these is attached to the

by means of a brass bracket bent up from strip $\frac{1}{2}$ in. wide by $\frac{3}{32}$ in. thick to the dimensions given in Fig. 17. This bracket is secured to the ebonite disc at the ends of the coils by means of a single No. 6 B.A. countersunk-head brass screw as shown by the sketch on the left-hand side of Fig. 16. The lower part of the bracket is screwed to the instrument panel by a No. 6 B.A. brass screw into the hole marked J in Fig. 2. The coils marked X, Y and Z in Fig. 16 are separated from each other by ebonite strips $\frac{1}{2}$ in. wide by $\frac{1}{8}$ in. thick, two strips being placed between

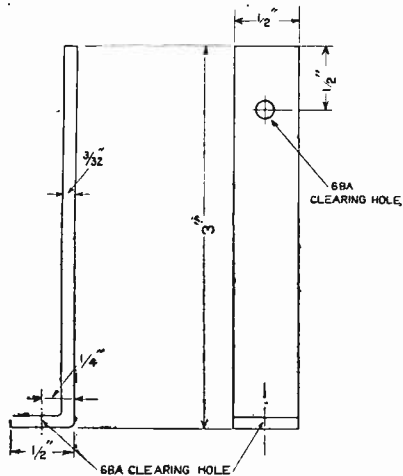

Fig. 17. Brass bracket for supporting long-wave coils.

instrument panel by two 6 B.A. countersunk-head brass screws through the holes marked GG in Fig. 2. The second piece of ebonite is in the form of a disc $2\frac{1}{2}$ ins. in diameter. This is supported from the instrument panel

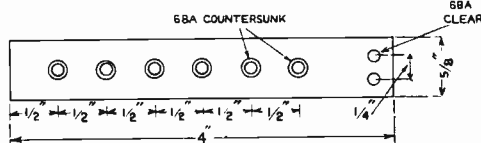

Fig. 18. Terminal strip for coils.

adjacent coils. In Fig. 16, coil X is the one having 100 turns, coil Y the one of 150 turns, and coil Z the one of 600 turns. The two pieces of ebonite at the ends of these coils are clamped together by two No. 4 B.A. countersunk head brass screws into an ebonite rod $\frac{1}{2}$ in. diameter by $3\frac{3}{8}$ ins. long, which passes up the centre of the coils.

It will be noted that near the top of the right-hand piece of ebonite in Fig. 16, two holes are shown tapped 6 B.A. These are to support a

strip of ebonite, carrying terminals to which the ends of the fine wire winding of the coils can be connected. The dimensions of the strip are given in Fig. 18. It has six holes in it through which are screwed six No. 6 B.A. countersunk-head brass screws, $\frac{3}{8}$ in. in length, these screws being provided with nuts and washers under which wires may be gripped. This row of screws and nuts provides a connecting means for the short-wave coils as well as for the duolaterally wound long wave coils.

The short-wave tuning coil consists of 25 turns of No. 20 S.W.G. double cotton covered bell wire, wound with adjacent turns touching on an insulating former $2\frac{1}{4}$ ins. in diameter by $2\frac{1}{4}$ ins. long, the ends of the wire being secured in place by passing through holes in the former. A stout paxolin tube forms a convenient support for this winding.

The short-wave reaction coil consists of 80 turns of No. 28 S.W.G. double silk covered copper wire, wound with adjacent turns touching, on an insulating former $1\frac{3}{4}$ ins. diameter by $2\frac{1}{4}$ ins. long, the winding being arranged to occupy the centre of the length of this tube. A paxolin tube may again be used for this purpose. These two coils when completed are arranged concentrically, and clamped between two ebonite discs $2\frac{1}{4}$ ins. diameter by $\frac{1}{4}$ in. thick, as shown in Fig. 19, the two

Before finally clamping up these coils the space inside the smaller coil and between the two coils should be filled up solid with paraffin wax so as to maintain the coils rigidly in the same relative positions.

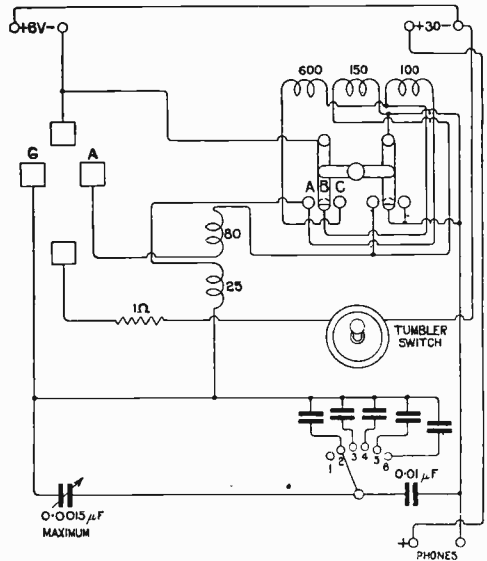

Fig. 20. Wiring for the wavemeter.

When completed this pair of coils is mounted with its common axis vertical by means of an ebonite rod $\frac{1}{2}$ in. diameter by $1\frac{1}{2}$ in. long, screwed to the lower ebonite disc by means of a No. 4 B.A. brass stud 1 in. long, which also serves to secure the lower disc to the ebonite rod passing between the two discs as sketched in Fig. 19. This lower ebonite rod carrying the coils is fastened to the instrument panel by means of a 4 B.A. brass screw through the hole marked D in Fig. 2. When in this position the centre of the length of these coils should be level with the axis of the long wave coils, which are mounted across the width of the box, so that the axes of the two sets of coils, being at right angles to one another, the mutual coupling between them is a minimum. If this precaution is not taken, the proximity of the long wave coils may prevent the production of oscillation on the shorter wavelength ranges. As a further aid to eliminating such disturbing action, it is desirable to short circuit any of the coils that are not in use. This can be done automatically by the double pole range switch, in the manner shown by the connection scheme of Fig. 20. This figure gives the wiring diagram for the

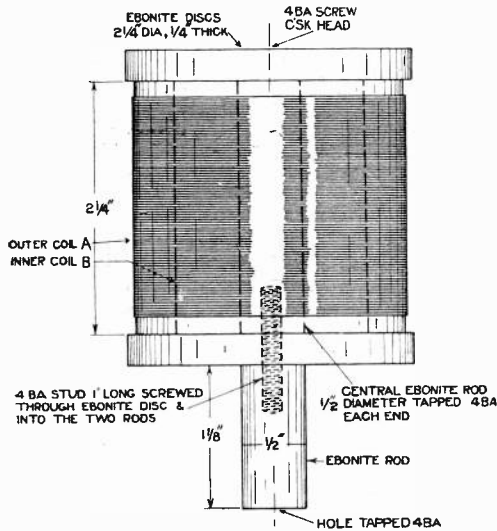

Fig. 19. Arrangement of short wave coils and supports.

discs being held together by an ebonite rod $\frac{1}{2}$ in. in diameter, passing up the centre of the coils and screwed to the discs at each end.

whole set, and it is desirable to arrange the connecting wires as nearly as possible in the manner sketched in this diagram, taking particular care to space the wires apart as far as possible and in particular to keep the path through which the unused portions of the windings are short-circuited as short as possible.

The five fixed condensers, of which the values have been given above, are connected up to contacts 2, 3, 4, 5, 6 of the six-way range switch, the condenser of lowest capacity (viz., 0.0013 microfarad) being joined to contact 2, and the largest condenser of 0.0065 microfarad capacity being joined to contact 6 of the range switch.

All wiring should be carried out in No. 18 S.W.G. tinned copper wire as this is sufficiently stiff to remain fairly rigid. Sistoflex insulating sleeving should be used where necessary, and

it is desirable to solder all joints and connections in an instrument of this type.

When the wiring has been completed the instrument should be tested for the production of oscillations throughout the entire tuning range. A simple way of effecting this test is to repeatedly touch the grid terminal of the valve with a moistened finger, when, if the valve is oscillating, a sharp click will be heard in the telephone receivers both on touching and removing the finger from the grid terminal. If oscillations are not produced on one of the ranges, the connections to the appropriate coil should be reversed, while in wiring up it is advantageous to bear in mind that when looking at the coils so that the windings run in the same direction, the connections to the grid and anode of the valve should go to opposite ends of the tuning and reaction coils respectively.

The All-British Wireless Exhibition.

NOTES ON SOME OF THE APPARATUS SHOWN.

THE present issue of this journal bears the date of September 30th. This is the date of the opening of the All-British Wireless Exhibition at the Horticultural Hall, Westminster.

As has already been announced in these columns, the Exhibition will remain open from September 30th to October 7th, inclusive. Everything wireless which the British manufacturer has produced will be represented at this Exhibition and whilst it will be the endeavour of this Journal to refer to the majority of the principal exhibits space will not of course allow for a detailed description of all of the very numerous pieces of apparatus, though most of them no doubt merit individual notice and description.

In the following pages reference is made to the apparatus to be seen on a number of the stands and in a later issue those products not referred to in the following descriptions will be dealt with in so far as space permits.

It is of course not possible, prior to the Exhibition, to obtain information concerning all the new types of apparatus which the Exhibition will disclose, as details concerning many of these will not be available until the opening of the Exhibition.

Arrangements have been made by the organisers of the Exhibition for wireless telephony transmissions to be conducted specially for the Exhibition, when, at the Horticultural Hall these transmissions will be received and made audible in the Hall. A special musical programme has been arranged. Half-hour telephony transmissions on 360 metres will take place daily at 11, 3, 6 and 8 o'clock.

No doubt the Exhibition will do much to add to the popularity of wireless by introducing the public to the possibilities which Broadcasting is about to open up. At the same time engineers and research students will find in the Exhibition an endless source of interest. A description of some of the exhibits follows:—

The Zenith Manufacturing Co. (Stand No. 3).

At this stand a complete range of regulating resistances is shown suitable for the adjustment of current and voltage in all wireless and similar circuits. These resistances incorporate many improvements.

A potentiometer resistance is shown arranged to permit the measurement of the voltage amplification factor of any given valve in accordance with the methods described by Mr. P. R. Coursey in *The Wireless World and*

Radio Review of February 4th. As this potentiometer resistance is a very moderate priced article it should be of particular interest to experimental workers.

New "Zenite" resistance units are also shown. This particular unit comprises a fire-resisting tube on which is applied a suitable winding of resistance wire ultimately embedded at high temperature in a vitreous enamel. As these resistances are then impervious to moisture or oxidisation, the value remains constant, and they are specially useful for various wireless circuits, especially as grid leaks for large transmitting valves.

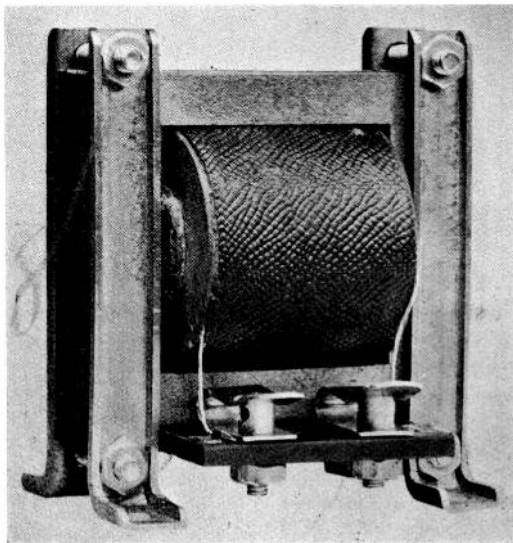

"Igranic" Intervalve Transformer.

Other exhibits include high tension transformers, choke coils and smoothing condensers such as are used for obtaining high tension rectified current for feeding the plate circuit of moderate power transmitting sets. These transformers, choking coils and condensers are made in a very large variety of ways to fulfil all requirements, and to minimise the humming noise so frequently associated with experimental telephony transmission.

Where continuous current is available, accumulator charging is a simple matter, and many types of regulating resistances are shown suitable for adjusting the charging current for the various types of accumulators in common use, but when an experimenter resides in a neighbourhood supplied only with alternating current power, the problem is a more difficult one, as in that case some form of

rectifier or converter is essential. A variety of rectifiers which will overcome all such technical difficulties are shown.

Amongst accessories exhibited may be mentioned grid leaks and condensers of all kinds.

Igranic Electric Co., Ltd. (Stand No. 4).

The salient feature of the exhibit of this firm is the manufacture of coils for wireless work. With a view to demonstrating the advantages of the honeycomb type of inductance coil an enlarged model of a coil is exhibited to clearly illustrate the duolateral formation.

The majority of radio enthusiasts know that this formation, by attaining the maximum spacing between the various turns of wire, reduces the self-capacity of the coil in comparison with that of concentrically wound coils, and makes sharper tuning possible with consequent increase in signal strength.

Slab inductance coils, wound by the self-forming cross-wind method, are also exhibited, as well as transformer coils, which embody two methods of winding, viz., the "paper interlay" and the "cotton interweave."

Three coil winding machines are actually at work on the stand. One of these is employed in making honeycomb coils, the second in winding transformer coils with paper interlay between successive layers, and the third in making transformer coils by the cotton interweave method.

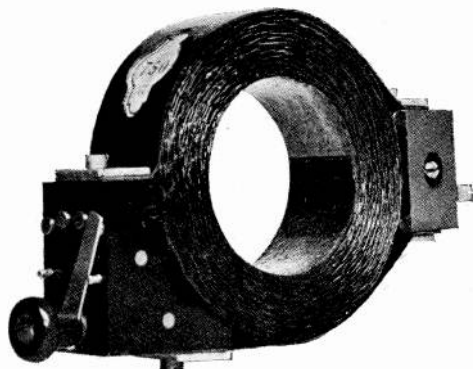

"Igranic" Tapped honeycomb coil with 4-contact switch.

The ingenious means by which the paper is interlaid between the layers as the winding proceeds, and exceptionally durable character of the transformer coils made by the cotton interweave method, is specially attractive.

Turning from coils, the exhibit is interesting also because of the display of various types of

coil-holders for tuners. The "Micro-Adjusta" coil-holder is designed for exceptionally fine tuning, where adjustment of coupled coils needs to be carried out very accurately, as in telephony. The "Triplug" coil-holder, is suitable for table use or for panel mounting.

The neat design and exceptional finish of these accessories will commend them to users.

A patented method of mounting both honeycomb and slab inductance coils is on view. In this method, which is called the "Gimbal" mounting, the coil is provided with pivots at right angles to its axis, so that when tuning the coil can be rotated about its own pivot as well as moved radially, thus affording what might be described as a vernier adjustment. A conspicuous advantage of this method of mounting is that two coils connected in series can be used as a variometer. A very interesting and new design of honeycomb-wound variometer is on view as well as one or two types of intervalve transformers.

Harwell, Ltd. (Stand No. 5).

A new Replaceable Dry Battery for wireless receiving sets is exhibited here. It is made by Semaphore, Ltd., for whom this firm acts as sales managers.

Each cell is stated to have about five times the life of the standard battery and they are made up in units of two cells, *i.e.*, three volts nominally. Each two-cell unit is connected together with a special brass coupling (with holes for tapping at any voltage) so that no soldering is required. Either six or twelve units are fitted in a box and any quantity of such boxes can be put together where more than 36 volts are required.

Any two-cell unit can be replaced at a very low cost if one gives out, thus avoiding any necessity of scrapping the whole battery.

The ordinary high voltage Semaphore Batteries are also being shown, but it is claimed that the new cell is distinctly novel and a decided improvement.

A brass coupling for connecting ordinary flash lamp batteries is also on view. Messrs. Harwell also control the sales of the Solidite Manufacturing Company, Ltd., who make moulded valve-holders of all types, knobs, sliders and various articles made out of Solidite Insulating Material.

Voltmeters and ammeters for wireless work are displayed and also an instrument termed a "radio-gramophone," which is a combined valve receiving set and gramophone, contained in a neat cabinet.

T. H. Isted (Stand No. 9).

The above firm show an instrument described as the Broadcast Receiver "De Luxe."

It is designed to stand on a table, in a vertical position, so that it may be moved to any part of a room into which the aerial is led.

It has five valves, one being the detector and the remaining four being L.F. amplifiers.

A filament resistance is fitted to each valve, which serves also to cut out valves that are not required. Any number can be used, from two valves up to five, by means of switches at the bottom of the panel.

A change-over switch is provided for telephones or loud speaker.

A distinctive feature is the utilisation of the off position of a filament switch to connect the aerial to earth.

The aerial and earth lead-in terminal are in a small ebonite panel on the right of the cabinet. The H.T. and L.T. batteries are accommodated inside and are easily accessible by means of a small door at the foot of the cabinet.

Everything being included in the cabinet, it forms a complete receiving station in itself. So simple is the operation, that once the station has been calibrated to its broadcast station and others that are within its receiving area, and a note made of their positions on the condenser, it only needs two actions of switching to receive the broadcasting.

Hart Accumulator Company, Ltd.
(Stand No. 17).

The following "Hart" exhibits are shown:—

High Tension Batteries.

1. "Hart" 50-volt "PL" type batteries, in specially insulated ebonite boxes of good design, contained in waxed wood cases with outside terminals and regulating switch (if required). Capacity 1.2 ampere hours.

2. Special 24-volt "DPL" 3-plate batteries, fitted in specially insulated glass boxes of latest design. This battery is entirely new, and has no equal for the high tension circuit of the wireless system. Capacity 2.5 ampere hours.

3. 24-volt "PL.3" type battery, fitted in specially insulated glass boxes, exactly as above, but 1.2 ampere hours capacity.

4. 2-volt "DPL.3" cell, in sealed glass box.

5. 2-volt "PL.3" cell, in sealed glass box. Items 4 and 5 are 2-volt cells as used in the above 24-volt sets.

6. Set of 17 cells (32 volts) for ship wireless installations, as supplied for transmission work. *Low Tension Batteries.*

7. Portable batteries in celluloid boxes of various voltages and capacities.

8. Portable batteries in sealed glass boxes of various voltages and capacities with wood crates and carrying handles. This is a type now greatly in demand.

9. "MEU" type "splash-protected" accumulators. These are specially used for portable wireless outfits, voltage 2, 4 or 6. Capacities 10-100 ampere hours.

10. 6-volt portable accumulators in sealed glass boxes fitted in wood crate with leather strap handle. This size is of larger capacity than usual, and is introduced to meet the growing demand for larger capacity cells for multi-valve circuits. Capacity 67 ampere hours.

General Types.

11. 6 and 12-volt "Hart" motor starter and lighting batteries as used for replacement on all makes of cars. Capacities 45-123 ampere hours.

12. 2-volt "AP.7" cells in ebonite boxes as largely used by the Admiralty. Capacity 11 ampere hours.

13. Portable hand lamps in case fitted with tumbler switch and 4-volt accumulator. Capacity 45 hours light on one charge.

14. 2-volt inspection lamp outfits, fitted with accumulator. In demand for meter reading work, inspectors, railway officials, electricity and gas undertakings, etc.

15. "PL.3" type cells in celluloid boxes. These represent the exact size to replace dry cells in the usual standard type of flash lamp case. They are a great saving in cost, and are easily recharged.

All capacities mentioned represent actual output based on continuous rating.

J. A. Coomes & Co., Ltd. (Stand No. 18).

A broadcasting receiving set of new design, styled the "Ionophone" is exhibited on this stand.

In the design of this receiver the variable condenser has been eliminated and tuning is done entirely by means of fixed condensers and variometers, the latter of their own design.

The variometer gives sharp tuning over a range from 200-3,000 metres wavelength, so that the Hague concerts and Eiffel Tower meteorological reports and time signals can be obtained as well as all the ordinary broadcasting wavelengths.

The set is so arranged, in view of the regulations of the P.M.G., that self-oscillation is impossible.

The receiver consists of two radio-frequency amplifying valves with a radio frequency intervalve transformer of the firm's own design, a rectifying valve, telephone transformer, and low resistance telephones.

Where extra amplification is required, a two-valve audio-frequency amplifier is supplied for attachment to the set.

In addition there are exhibited intervalve transformers, telephone transformers and variometers.



Cabinet "Aristophone" in Jacobean style.

C. F. Elwell, Ltd. (Stand No. 23).

Cabinet "Aristophones," for drawing-room use, having specially designed cabinets, which are accurate period reproductions and contain the whole of the wireless apparatus, including batteries and "loud-speakers" form a special feature of this exhibit.

The loud speaker has novel features, being hand moulded of a wood fibre compound to proportions which have been scientific-

ally ascertained for the greatest purity of tone, resulting in a shape resembling that of the human ear. The wireless receiver is unusually simple, and it is apparent that great care has been taken to design an instrument with very few adjustments.

One particularly interesting exhibit is a lacquer-work china cupboard and bureau of 1722, into which wireless apparatus characteristic of 1922 has been built.

"Aristophone" cabinets are shown in Cromwellian, Sheraton, Lacquer, and Adams styles.



An Elwell accessory. A "bull-dog" grip terminal.

Various types of special "Polar" receivers and amplifiers for long range reception and various wavelengths are also shown.

Marconi's Wireless Telegraph Company, Ltd. (Stand No. 24).

The exhibit includes several pieces of historical apparatus showing the advance which has been made in wireless science during the past 25 years, and also a number of the latest

and in numerous foreign aerodromes is shown. This is known as Type 12a and is designed for use on land in connection with the navigation of ships and aircraft. It provides a means for accurately determining the plane of received signals and the absolute direction of reception. The sensitiveness of this instrument is such that it may be used for ordinary reception with satisfactory results, and in this connection its directional properties are of very considerable value in the presence of "jamming." Change from directional reception to uniform all-round reception can be brought about instantaneously by the operation of a single switch, and the circuits are equally suitable for the reception of spark, tonic train, telephony or continuous wave signals. The wave range lies between 300 and 4,500 metres.

In conjunction with this instrument there is also shown the Aircraft Wireless Telephone Transmitter and Receiver, Type A.D.2, such as is fitted to British commercial aeroplanes flying between London and the Continent, and to machines in all parts of the world. This set is primarily designed for wireless communication—tele-

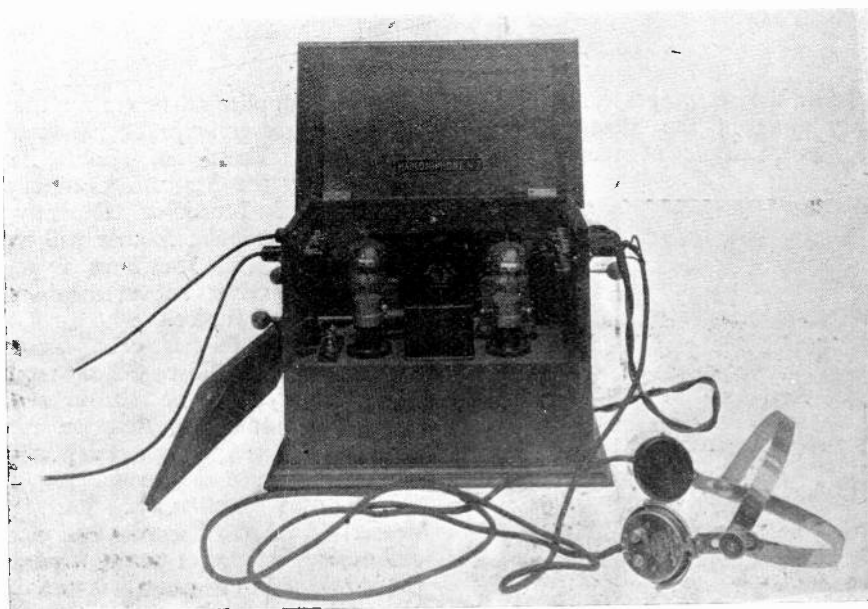

"Marconiphone" Type "V.2" Receiver.

wireless instruments. The latest pattern Wireless Direction Finder, as installed at the London Air Port for the Air Ministry, and as used by the British Post Office,

graphic or telephonic—between aircraft and ground stations or to other aircraft. Its chief characteristic is that it combines in one box both transmitter and receiver, connected per-

manently by cables to a small unit which carries all the handles necessary for controlling the set. This small unit, called the "Remote Control," can be mounted conveniently to the hand of

enables a pilot, while flying, to have all the necessary adjustments for both sending and receiving either telegraphy or telephony in a very compact space. A small wind-driven

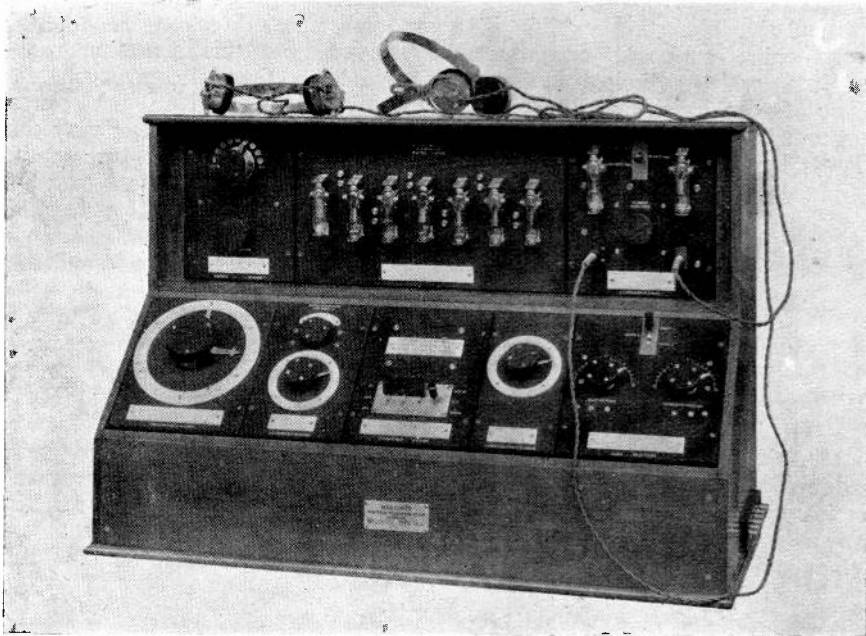

The Marconi Direction Finder.

the user, while the set proper can be stowed permanently away in the most convenient position. The principle of remote control

generator supplies all power for transmission.

There are several types of "Marconiphones" on view. These are special instruments designed by the Marconi Company for the reception of broadcast telephony in the home. The popular models will include the two-valve receiver known as Type V.2 and two Crystal receivers known as the Crystal "A" and the Crystal Junior.

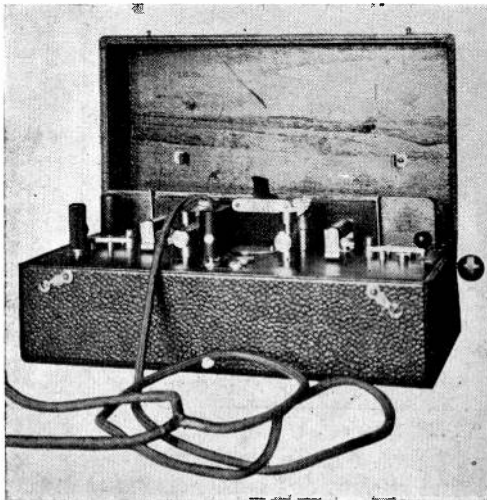

A "Marconiphone" Crystal Set.

The V.2 model has been constructed to meet the new Post Office requirements, which specify that the receiver must not be capable of radiation. Reaction is not employed, but a throw-back circuit is utilised by means of which additional low frequency magnification is obtained. The "grid condenser" method of rectification is employed, and a novel method of tuning is used in which the inductance of a fixed coil is varied by means of a copper spade. Inductance units are interchangeable. The set has been so designed that either "R" or "Dull Emitter" valves can be fitted, the latter permitting of the operation of the set from dry cells instead of accumulators. This receiver has a guaranteed

range of 50 miles from a broadcasting centre, on the broadcasting wavelengths.

The Marconi Crystal "A" is an attractive

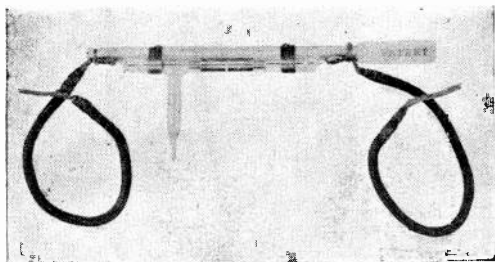

*A Marconi exhibit of historical interest—
An early coherer.*

crystal model fitted with two types of crystals, galena and carborundum. It employs the same system of tuning as the "V.2," and there is an automatic adjustment for the carborundum crystal. There is provision for two pairs of telephones.

The Marconi Crystal Junior has two interchangeable crystals, galena and carborundum, with automatic adjustment for the latter. It has a single circuit tuning system, employing the "spade" method, and the range is from 10 to 12 miles. There is provision for one single earpiece headphone.

W. Robert H. Tingey (Stand No. 25).

The special feature of the exhibits on this stand is undoubtedly the receiver, which covers the complete wavelength range with equal efficiency on all wavelengths and is possibly one of the first instruments put on the market designed to accomplish this.

H.P.R. Wireless, Ltd. (Stand No. 35).

Up to the present the wireless recruit has always been faced with two big difficulties—how to tune his instrument quickly and



A Tingey Universal Receiver.

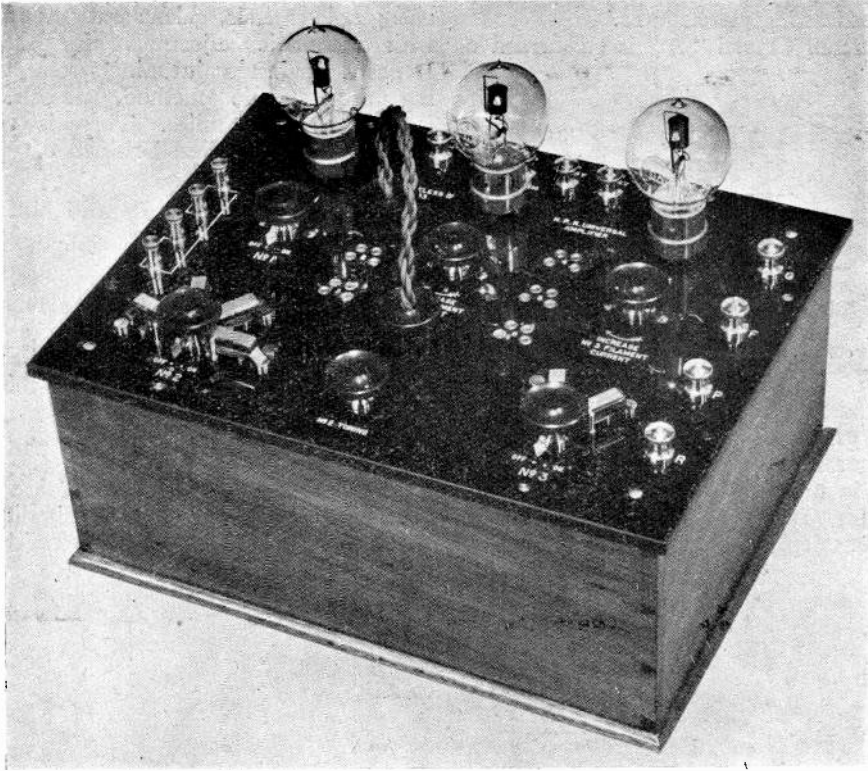

An H.P.R. Tuner and Amplifier.

accurately to the known wavelength of the stations he wants to pick up, and how to recognise from the signals he is receiving on his instrument the station which is transmitting them.

By the use of the H.P.R. Patent Automatic

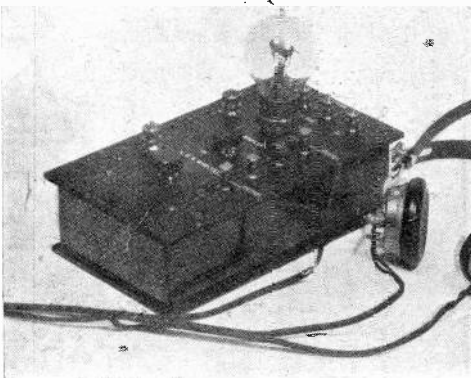

The "Simplex" Wireless Phone.

Wavelength Indicator, invented by Mr. H. Powell Rees, all these difficulties are cleared away. "Tuning-in" becomes as simple as turning on a gramophone.

Each H.P.R. Universal Tuner includes a specially calibrated wavelength indicator. By setting the pointer to the figure of the wavelength, the required station is immediately picked up. If unknown signals are coming through, it may usually be ascertained in an instant which station is sending. The operation is as certain as switching on an electric light.

The Automatic Wavelength Indicator may be described as an "indispensable guide to the ether."

The "Simplex" Wireless Phone which fulfils the conditions of the Postmaster-General for "broadcast receiving," is thoroughly efficient and no wireless knowledge is required for its manipulation. Gives the concerts, etc., at their best by turning a handle. Magnifying apparatus may be added if desired.

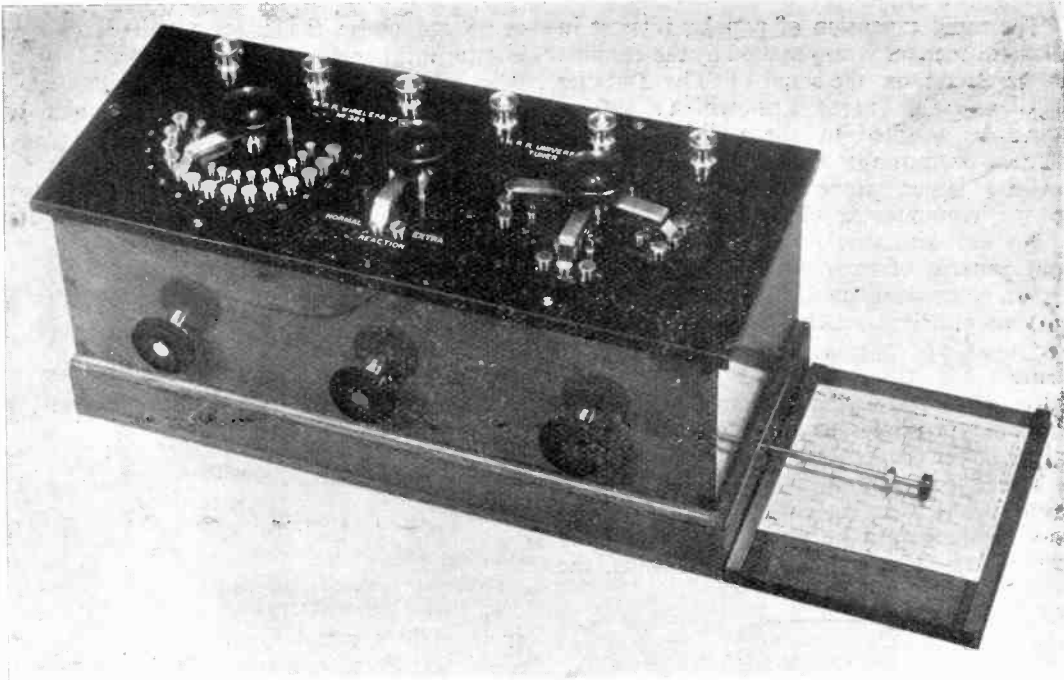

The Universal Tuner with wavelength indicator.

Economic Electric Co., Ltd. (Stand No. 51).

An instrument designed for recording wireless signals is of special interest. It employs the principle of two valves balanced in opposite links of a wheatstone bridge which

is a particularly efficient method for causing feeble oscillations to operate a relay.

Another instrument, termed an "Oscillator," is a device for adding in a receiving circuit to permit of the reception of continuous wave signals over a wavelength range of 3,500/25,000 metres.

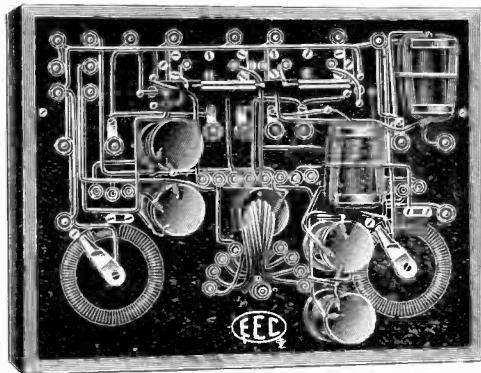
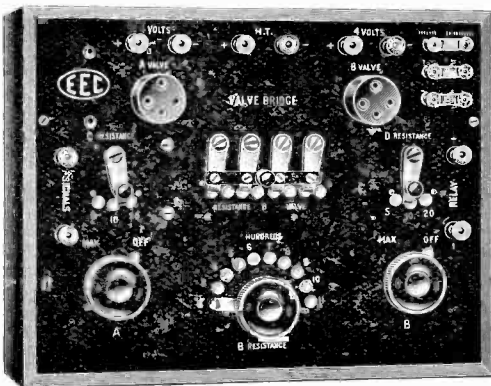

A Valve Bridge used for Recording Wireless Signals.

The Dubilier Condenser Co. (1921), Ltd.
(Stand No. 36.)

The rapid expansion of popular interest in all radio matters is emphasised by the exhibits to be found on the stand of The Dubilier Condenser Co. (1921), Ltd., which show the principles adopted in the well-known condensers manufactured by this firm for use on the larger wireless installations applied to the requirements of radio receivers.

For use with wireless receiving apparatus four patterns of fixed condensers are shown, known respectively as the Type 600, with and without grid leak attachment, the Type 600A and the Type 577 condensers. These condensers are all constructed with carefully selected mica dielectric and are built up on the same principles as those adopted for the larger power condensers.

The Type 600 condensers are made in two patterns, one carrying clips into which a grid leak resistance can be pushed, and the other having tag connections only, to which the



The "Ducon" attachment for enabling the electric lighting wires to be used for radio receiving with perfect safety.

external leads can be soldered. These condensers are enclosed in a moulded insulated case and have very high insulation resistance and the absolute minimum of losses.

The Type 600A condenser is of very similar type, but is designed for mounting on edge, so as to economise the space required on the instrument panel. It is not provided with clips for a grid leak, but merely with metal tags to which connections can be soldered. These three patterns of condensers are supplied in any value desired up to 0.005 microfarad.

The Type 577 Universal Condenser is also constructed with a mica dielectric and is

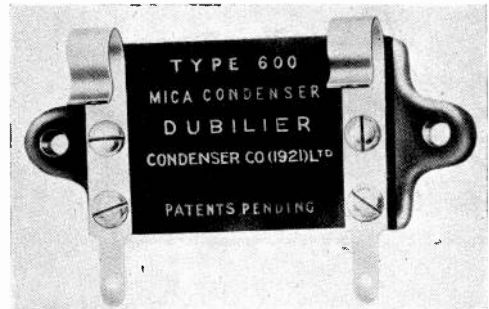

Condenser for use in receiving circuits fitted with clips to carry leak resistance.

enclosed in a metal case. It is suitable for use in wireless receiving and in low power wireless transmitting circuits, for the parts of telephone repeaters and many similar purposes. Extreme constancy of capacity is the main feature of this condenser, while the metal case which can be earthed also forms an efficient electrostatic screen. This type is available in any capacity up to 0.01 microfarad.

For the more elaborate types of receiving apparatus such as are used by amateur experimenters and in the better class of broadcast

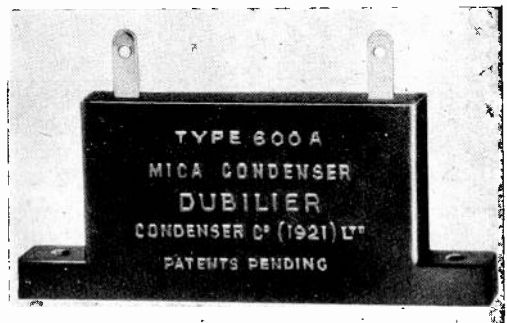

Designed specially for panel mounting, measuring only 2 3/8" x 3/8"

receiving apparatus, special patterns of variable air condensers were exhibited by this firm, Variable air condensers ("Varicons") of the moving vane type are shown in three patterns,

suitable respectively for panel mounting, for ordinary experimental purposes, and as a laboratory condenser, the difference being in the type of case fitted to the condenser.

A novel pattern of variable air condenser (known as the "Sphericon") is also shown, in which the electrodes are in the form of hemispherical shells, fixed and movable shells being interleaved with one another somewhat similar to the arrangement of the moving vane

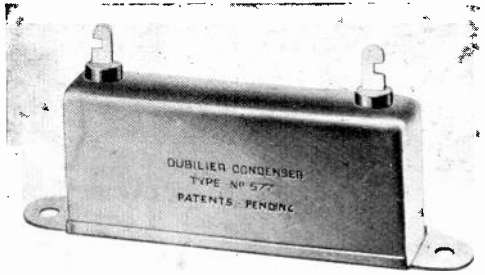

A Universal Condenser for use in receivers and low power transmitters.

condenser. This arrangement secures great mechanical rigidity and ensures constancy of calibration.

For the simpler types of broadcast receiver, such for example as the crystal receivers, where great mechanical rigidity and extreme constancy of calibration is not required, a very compact form of condenser has been devised.

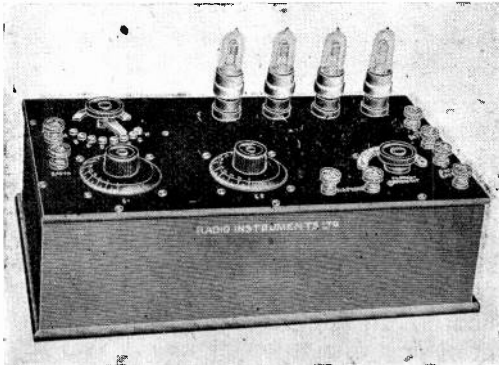

Self-contained 4-valve amplified receiver for broadcast reception, by Radio Instruments, Ltd.

This variable condenser has a mica dielectric which enables comparatively large capacities to be contained in a very small space.

An apparatus of special interest which is also exhibited, is a device for enabling the ordinary house electric lighting wires to be used as radio receiving aerials. In the ordinary

way it is not possible to utilise the house wiring as a receiving aerial without first switching off the current at the main switch where it enters the building, as otherwise a short circuit would result and the receiver would be damaged. The use of the "Ducon" attachment obviates this. It is tested to withstand 2,000 volts so that perfect safety is assured with no possible risk of shocks when handling the apparatus with the current switched on. The attachment is designed for inserting directly into an electric lamp-holder and is provided with terminals for attaching a wire to the aerial terminal of the receiving apparatus.

Various other patterns of standard laboratory condensers and condenser units suitable for

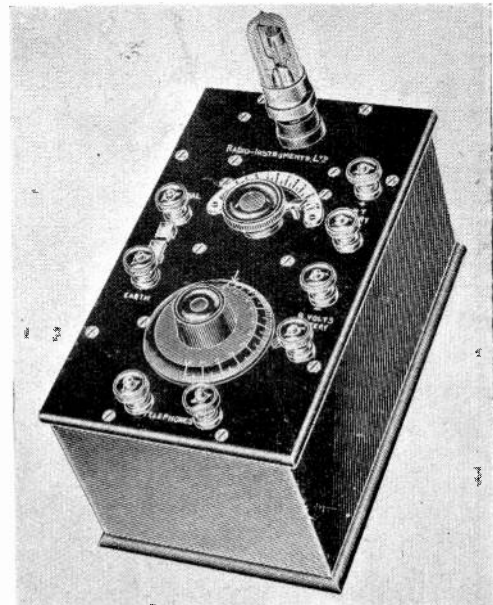

Complete single valve amplifying receiver for broadcasting on Stand 37.

both spark and C.W. wireless transmitters are also exhibited, the latter including a standardised condenser unit enclosed in an aluminium case, which can be employed for many patterns of transmitting equipment. This unit is fitted with a special type of mica terminal and can be used on circuits of which the voltage does not exceed about 10,000.

The patented construction adopted in the manufacture of this condenser ensures constancy of capacity and very low losses, even when carrying considerable high frequency currents.

Radio Instruments, Ltd. (Stand No. 37).

Residents in flats, hotels and places where the erection of a wireless aerial is out of the question, will be interested to learn that a complete wireless receiving set enclosed in a cabinet without any external wires or connections of any kind has now been designed by the above firm, and is exhibited at their stand. The receiver illustrated here comprises a 7-valve set with a frame aerial

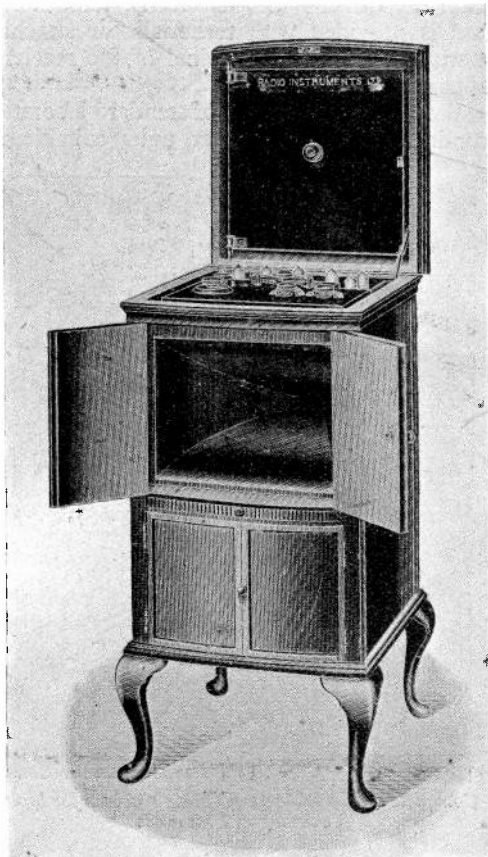

Frame Aerial Cabinet Receiver.

fitted to the lid of a cabinet of period or other design in which is included a powerful loud speaker, and the necessary high and low tension batteries, the latter being accommodated in a cupboard in a lower part of the cabinet. To receive broadcast telephony, it is only necessary to open the lid of the instrument and to manipulate three knobs which control the tuning circuits, when music can be heard in a large room by a number of people. Doors are fitted to the loud speaker which can be

opened or closed thereby reducing or increasing the sound as required.

Three specially designed high frequency interval transformers, fitted with tapping points on the windings and controlled by a coupled switch for simultaneous operation, are connected with the first three valves; the fourth valve acting as a detector, the last three valves being coupled through audio-frequency transformers, which are free from distortion so that the resultant magnified signal or speech is loud and clear. The frame or aerial coil fitted in the lid is hinged so that it can swing through an angle of 90 degs. for obtaining the maximum volume of sound according to the direction of the transmitting station.

The manufacturers inform us that a series of tests were recently carried out with the instruments fitted in a motor car while broadcasting was in operation, and the results

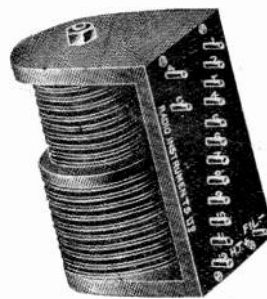

H.F. Transformer 150/30,000 metres, with 12 tapings.

observed with varying distances from transmitting stations. At 20 miles distance the music was quite clear; but much weaker than 10 miles distance, at which latter distance the music could be heard quite comfortably in the car. In London the volume of sound was sufficient to be heard outside the car.

The erection of an external aerial has undoubtedly prevented many people interested in wireless from installing a set. This objection has now been entirely overcome by this cabinet set.

Other apparatus exhibited by this firm includes 1, 2, 3, 4 and 7-valve sets complete with tuners and self-contained in one case, and crystal receivers of variometer type.

High frequency amplifying units, condensers, a loud speaker, and telephones of a new type are included amongst the accessories shown.

Experimental Station Design

(Continued from p. 795, September 16th, 1922).

These articles, which appear in alternate issues, are intended not only to be a complete guide to those new to wireless, but to give explicit details on the construction of all the components of the Experimental Station. Actual designs will of necessity in some instances be somewhat crude, in order that they can be made up without elaborate workshop equipment. Practical working instructions are given where necessary for the help of those unacquainted with the more simple processes of instrument making. Of course, where good workshop facilities exist, the designs may be readily modified.

Economy is made an essential feature, bearing in mind always that where low-priced component parts can be obtained their use has been embodied in the designs. For those who do not desire to make their own apparatus, the descriptions will assist them in selecting the equipment for their stations.

The information contained in the first few articles under this heading is to help those new to wireless and whose first aim is to build a simple set capable of receiving broadcasted telephony, and consequently may cover ground already familiar to many readers. The succeeding instalments, however, advance by easy stages, and in the course of the series the construction of an elaborate station will be evolved.

XIII.—SINGLE VALVE H.F. REACTING AMPLIFIER.

AN AMPLIFIER ARRANGED TO ELIMINATE INTERFERENCE BY RADIATION.

FOR a good range, or for reception from low power stations, it is necessary to employ at least one stage of high frequency amplification. The unit to be

A view of the top of the instrument is shown in Fig. 1, in which all essential dimensions are given. The panel is sawn from a sheet of $\frac{5}{16}$ -in. ebonite and all edges filed

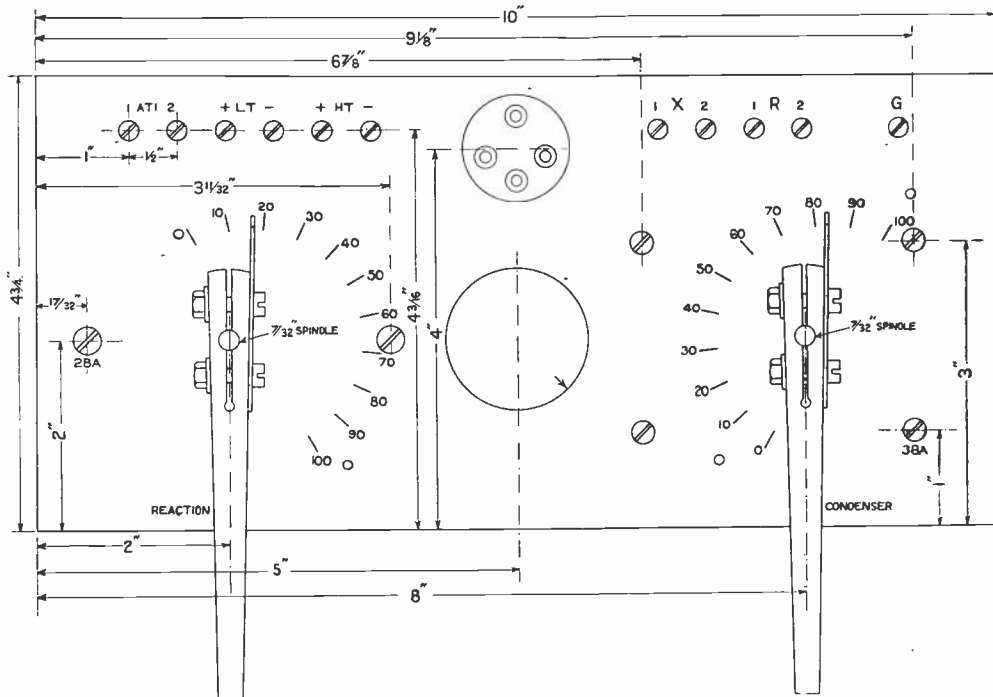

Fig. 1. Lay out of panel of H.F. Amplifier. The lever on the left will be replaced by a knob, if a sliding instead of revolving inductance is fitted to provide tighter reaction coupling. Half full size.

described is intended for adding to a detecting valve set, which may already be arranged with a reaction coil coupled to the aerial circuit and followed by one or more note magnifiers.

true and square to one another and exactly square to the front face. They are finished by carefully sliding the panel edgewise along a piece of fine emery cloth, nailed down

to the bench, keeping the panel at exact right angles to the face of the bench and exerting even pressure along the edge.

Before drilling the panel the reader must bring together any pieces of apparatus already made up which he proposes to incorporate in the set. He will require a variometer, loose coupler, or any arrangement of two formers that will provide a variable coupling, an air dielectric variable condenser having a maximum value of about 0.0004 microfarads, a variable filament resistance, a valve holder and terminals, wire, "sistoflex" insulating sleeving and miscellaneous screws.

Holes for attaching the filament resistance and valve holder can be made equidistant from the ends.

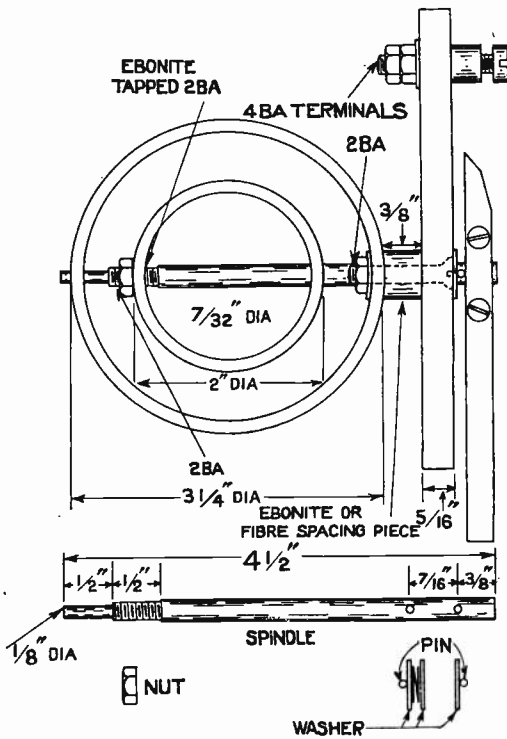

Fig. 2. Constructional details of revolving type variable coupling. End view.

The condenser shown in the figure is one the construction of which has been given in a former article.* It is attached by means of four 3BA screws and may consist of about one-third the number of plates shown in the illustration explaining its construction, provided the thickness of the plates and spacing washers are the same as those given. The

* Page 581, August 5th, 1922.

capacity in microfarads for any condenser of other dimensions, can be found by multiplying the area of one side of one of the moving

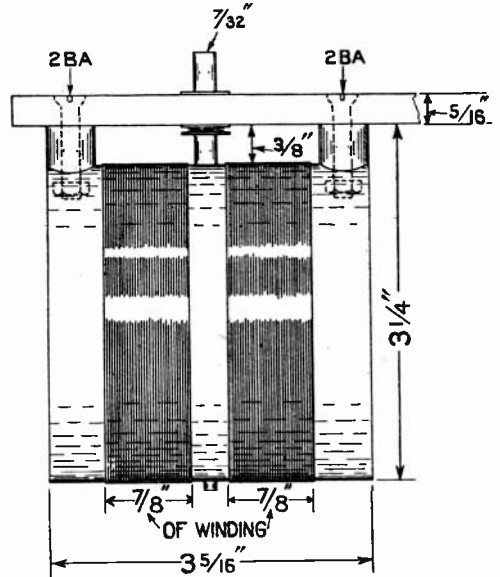

Fig. 3. Side view, showing arrangement of the inductance which is in the plate circuit of the H.F. valve.

plates (less the ineffective portion in the centre which is not overlapped by a fixed plate when in use) expressed in square centimetres by 1,768 times the number of moving plates and dividing this figure by the distance between the plates (that is, the thickness of the spacing washers less the thickness of the moving plates, and dividing the remainder by two), expressed in

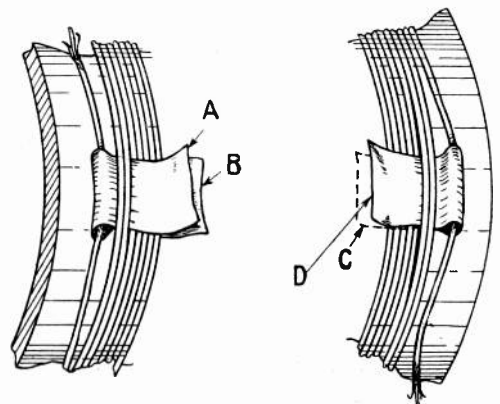

Fig. 4. Method of terminating inductance windings.

millimetres. The result obtained is divided by 1,000,000,000.

The variable reaction coupling is arranged at the other end of the panel, the controlling handle of which balances out in appearance that of the condenser. One form of construction is shown in Figs. 2 and 3. A piece of 3¼-in. external diameter ebonite tube is obtained with a wall thickness of from ⅛ in. to ⅝ in. and is carefully sawn to length, taking great care by sawing to pencil lines that the ends are true, and avoiding fracture while cutting. The ends are finished by rubbing on the piece of emery cloth which is nailed down to the bench. This tube is attached

of 2-in. tube and is 2 ins. in length. Holes are made in opposite sides at the exact centre point, one to exactly fit the 7/32-in. spindle and the other a 1/8-in. hole suitable for tapping to 2 BA. The spindle, also shown in Fig. 2, is made from a piece of 7/32-in. brass rod. If 7/32-in. is not easily available, 1/4-in. rod may be used. One end is reduced in size, as shown in the diagram, for tapping to 2 BA and for providing a bearing. If a lathe is not available the diameter can be reduced by filing, as described in the earlier article on condenser construction.

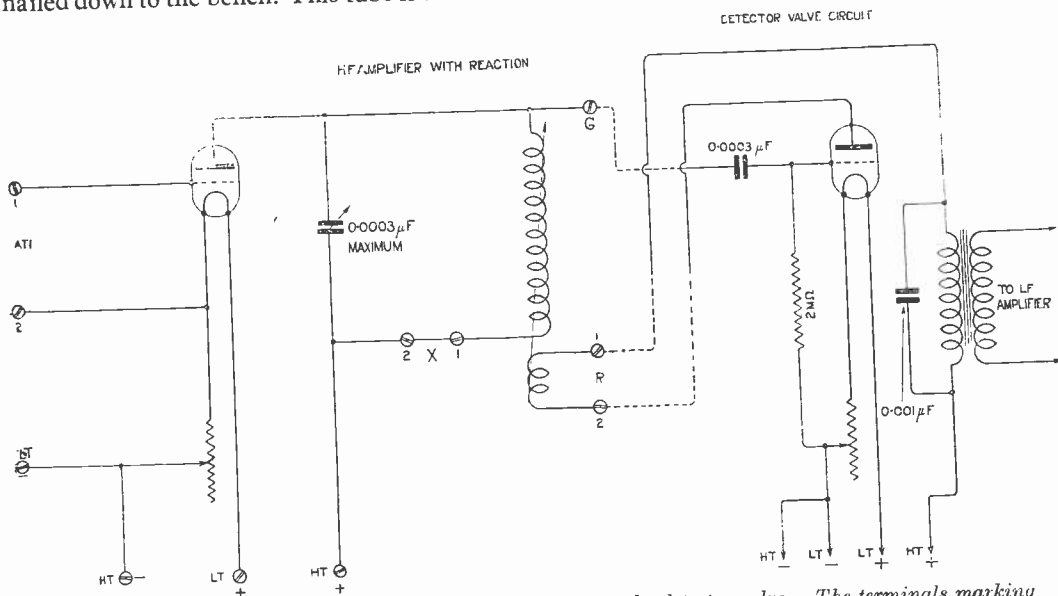

Fig. 5. Circuit diagram of reacting amplifier connected to the detector valve. The terminals marking "A.T.I." on the left are for connection to the secondary inductance or former reaction coil, coupled to the aerial circuit.

to the panel by means of two 2 BA brass screws with countersunk heads and 1¼ ins. in length. Ebonite spacing pieces fit over the screws to hold the coil away from the panel. These pieces have an external diameter of ½ in., a hole diameter of 3/16 in. to ¼ in., and are 3/8 in. in length. One end of each piece is filed away to a hollow shape to fit the cylinder. The reader is again warned that great care is necessary in working big diameter ebonite tube owing to its liability to snap. The drill used for making the holes for the 2 BA screws and spindle must be put through slowly and without excessive pressure. The hole for the larger end of the spindle gives clearance, the actual bearing for this end being the panel.

The inner cylinder is cut from a piece

Two small holes are drilled through the spindle to carry pins made from about 18 gauge hard brass wire. The exact spacing of these holes must be determined, as the dimension given in the diagram only applies when a particular size of split washer is used.

In fitting up the formers the smaller one is adjusted to a central position and held by means of a lock nut. It is essential in making this component that the holes in the formers which carry the spindle are exactly opposite to one another. An easy way of ensuring this is to mark the positions for the holes by standing the cylinders on squared paper so that one of the lines becomes a diameter and extending this line vertically up the opposite faces.

The larger former is wound with two

sections, each $\frac{7}{8}$ in. in width, of No. 20 D.C.C. wire. The few turns required are, of course, put on by hand, even though the reader may possess a lathe, as the wire is rather stiff. The method of fixing the ends of the wire is shown in Fig. 4. Three pieces of strong silk ribbon, $\frac{3}{4}$ in. in width, are laid on the former at equal distances around it. One turn of wire is then passed round over the three pieces and they are then bent back as shown in "A." Two more turns of wire, quickly and roughly put

except one turn are then wound on again, this time over the ribbon and securing down the ends "D." The last turn is tucked through the loops and by pulling on the ends "D" is brought down into position.

The smaller coil is wound with No. 26 D.C.C. in two sections, each $\frac{3}{4}$ in. The end turns are secured in the manner just described. Flexible wires are soldered to the ends and must be given two or three turns round the spindle and passed on for connecting in the circuit,

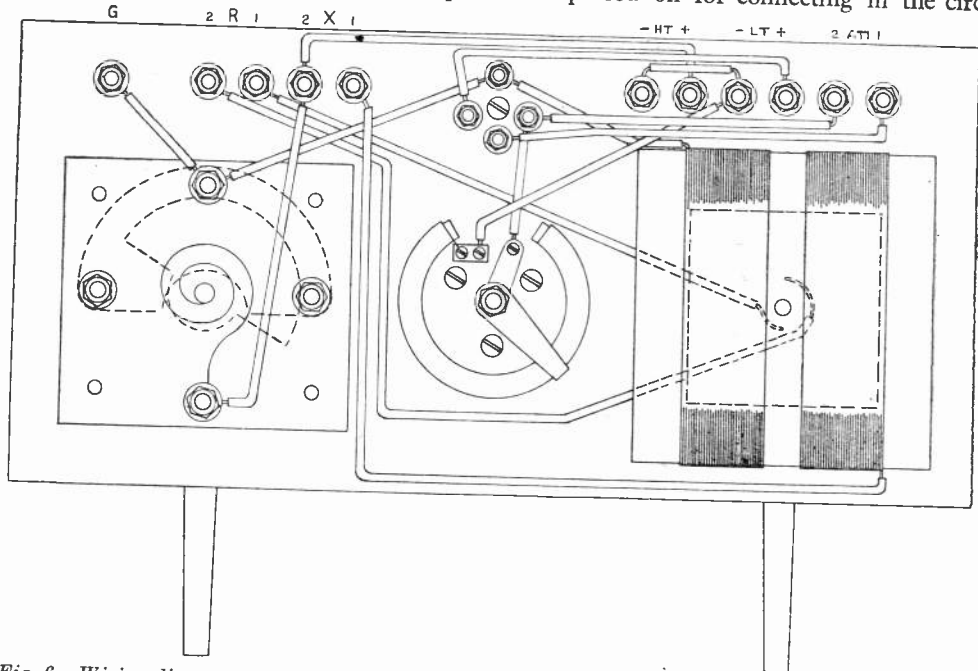

Fig. 6. Wiring diagram. Certain varieties of valves require tighter reaction coupling, which can be obtained by substituting a sliding inductance for the revolving pattern shown on the right. Half full size.

on, will hold the ribbons in place sufficient to secure the first turn. By pulling on the end "A" the first turn can be brought down in contact with the second turn and the three turns pushed up into position. Tension must of course be kept on the wire the whole time and the beginning end can be bent back to prevent it slipping through the loop in the ribbon. The end "B" is buried under subsequent turns. When the winding has progressed to within about $\frac{1}{2}$ in. of the required distance to which the coil is to be wound, three more ribbons are laid on the former so as to secure the ends "C." The full number of turns are then put on and the wire cut to length. Three or four turns are then unwound, taking care not to allow the whole winding to run slack. All

either through one end of the large former or through two holes made between the two sections of the outside winding, and on either side of the spindle.

If preferred, coupled coils may be built up to the design given for a high-frequency intervalve transformer with coupled reaction. Only one winding will be required on the outside former, which should consist of 44 turns of No. 24 D.S.C. wire, occupying $1\frac{1}{2}$ in. The inside former should be wound full with No. 34 enamelled or S.S.C. wire.

This arrangement is most convenient to operate and does not burst into oscillation with small changes of adjustment. At a position of medium coupling a very high

degree of amplification is obtained, entirely free from any tendency to howl.

The windings given are suitable for reception on wavelengths of 350 to 550 metres. For longer wavelengths finer wire may be used for winding the inductances, or the turns can be pile wound.

The components are assembled on the panel as shown in Fig. 1. The levers are of a type already described and the scale lines marked on the top of the instrument must be slightly staggered in order that the pointers may lie along them. The scales may be either scratched on the ebonite or carefully drawn on paper and pasted on. It is better, of course, to have the scales and other labelling engraved and this can easily be arranged by carefully marking all labelling exact as to size and position in pencil and putting the panel in the hands of a firm undertaking this class of work. The faces of the panel should be carefully rubbed down as previously described, with very fine emery paper before assembling.

The wiring diagram is given in Fig. 5, and shows the H.F. amplifying unit coupled to the detector valve, which was formerly the first valve in the receiving set. It is to be noted that the grid leak is not connected across the grid condenser. For the guidance of those not familiar with the wiring up of instruments, a practical wiring diagram is given in Fig. 6.

Using this amplifier with an "R" type valve, the coupling provided by the turning inductance is usually sufficient to give reaction effects, and produce amplification. With "V 24" valves, which are specially designed for high frequency amplification, the sliding method should be adopted in order to produce sufficient coupling. The amplifying unit, when used on short wavelengths, will give a marked degree of amplification and by its use the experimenter can be sure that he is causing no interference with neighbouring stations.

F.H.H.

A French Wireless Exhibition

AN exhibition of wireless apparatus has recently been held in Paris as a section of the Concours Lepine. The majority of the French manufacturers of amateur radio apparatus and accessories were represented, and had on show a number of interesting instruments.

Apart from complete sets, amplifiers, etc., of the usual types, attention appeared to have been devoted largely to the construction of many novel forms of frame aerial for indoor reception, in which the actual loop wires were concealed in the parts of articles of furniture.

Several arrangements of unit systems were exhibited, some being of fairly conventional type in polished wood boxes, but others being of much smaller size and forming very neat receiving sets when coupled together. By the use of these devices, in conjunction with concealed frame aerials, the installation of a receiver for broadcasting becomes an extremely simple matter.

P.R.C.

The Position of the Grid Leak

IN sets which employ the leaky condenser method of rectification the position of the grid leak has a considerable bearing upon the quality of the results obtained. Among amateurs of experience the practice is increasing of connecting the leak direct between the grid and one end of the filament, and this position has much to commend it. In the case of reactance—or resistance—capacity coupling it is of course essential. To which end of the filament the leak is to be connected is a matter of some importance, and depends upon the valve used; a few valves seem to work equally well to whichever end it is connected, but the majority have a definite right and wrong position, negative in some cases and positive in others. Hence, the experimenter should never be satisfied that his rectifier is doing its best until he has tried both. A desirable refinement on one's set is a single-pole two-way switch to enable one to make the change without altering the internal wiring each time.

G.P.K.

Progress in the Broadcasting Scheme

OFFICIAL STATEMENTS OF THE POSTMASTER-GENERAL AND OF THE MARCONI COMPANY

MANY statements have appeared in the general press with regard to the progress of arrangements for broadcasting since the Postmaster-General first gave his official sanction to the consideration of such a scheme in this country.

It has been realised by this Journal that this subject is one of the utmost importance and interest to all readers, and some impatience may have been felt at the absence of any detailed announcements of progress in this Journal. The reason for the absence of announcements up to the present time is a simple one, there having been no announcements to make which could be regarded as being in any way comprehensive or marking any definite step in progress towards the realisation of the broadcasting scheme.

The position to-day is, however, different, a real advance having been made, as indicated in the following official statement, made within the last few days by the Postmaster-General :

"A conference took place on September 12th between the Committee of Manufacturers and representatives of the Postmaster-General in regard to the criticisms which he has had occasion to make on the articles of association of the proposed broadcasting company, and on the terms of the proposed agreement between the company and the firms who will constitute its individual members. Several of the points raised by the Postmaster-General were satisfactorily met, and in two or three cases in which the Committee felt unable to accept his views they made alternative proposals. These have led to agreement in principle, and, so far as the Postmaster-General's criticisms are concerned, it only remains for his representatives and the Committee to settle certain details.

"It appeared at the conference that, apart from the Postmaster-General's criticisms, there were differences between members of the Committee themselves, which would have to be settled before the broadcasting company could be formed. It is understood, however, that considerable

progress has also been made towards the solution of these difficulties.

"It was agreed at the conference that, as soon as a settlement had been arrived at in regard to the above matters, the Committee of Manufacturers should call a meeting of all the firms who desire to join the broadcasting company (who, it will be remembered, must be *bona fide* British manufacturers), at which the whole situation will be explained to them.

"In the meantime, the Postmaster-General and the Committee desire it to be known that membership of the broadcasting company will not, of itself, entitle a member to use the patents of other members in the manufacture of receiving apparatus. In particular, the Marconi Company claim to hold patents which are necessary for the construction and use of "valve" receiving sets. The company have stated that they are prepared to allow members of the broadcasting company to use these patents on terms which can be obtained on application."

In addition, the Postmaster-General states that he proposes to withhold until the definite formation of the broadcasting company the issue of the simple form of licence for broadcast reception.

This delay in the issue of *broadcasting* licences is not to hamper the issue of *experimental* licences which are still being issued to all who satisfy the Postmaster-General that they have a sufficient knowledge of wireless to enable them to make proper use of the licences granted.

This attitude of the Postmaster-General towards the issue of *experimental* licences is one which can hardly be regarded with satisfaction by amateurs and experimenters generally. In the past it has been customary to issue licences to conduct experiments in wireless telegraphy without it being necessary to satisfy the Postmaster-General as to any special scientific qualifications or previous wireless experience. The Wireless Society of London especially, is taking up the cause of the amateur in this connection, and it is to be hoped that the considerate hearing which the Postmaster-General has always given to the expression of opinion made by wireless amateurs and

experimenters as a community, through the channels of the Wireless Society of London, will result in a modification of these unsatisfactory restrictions to amateur activities.

But to return to the subject of broadcasting and the progress made. Since, in the announcement of the Postmaster-General's referred to above, special reference is made to the attitude of the Marconi Company with regard to patents and the construction of valve receiving sets involving the use of patents of this company, this Journal sought out an official of the Marconi Company, Colonel Adrian Simpson, and was able to obtain a statement which puts clearly the position of the Marconi Company with regard to their patents.

The following is the text of the statement made officially by Colonel Adrian Simpson, Deputy Managing Director of the Company.

"In order to facilitate the formation of the British Broadcasting Company, Ltd., which will hold the Postmaster - General's licence for the conduct of the broadcasting service in Great Britain, my company has agreed to give to the British Broadcasting Company the free use of its patents for the purpose of erecting the necessary stations throughout Great Britain. Furthermore, my company has agreed to give to any *bona fide* British manufacturer who becomes a member of the Broadcasting Company a licence to use the Marconi patents for the purpose of manufacturing broadcasting receivers. Such receivers have to be of an approved type and conform with certain technical stipulations laid down by the Postmaster-General. A large number of the leading manufacturers have already approached my company and have accepted a licence. Full details regarding the terms on which these licences will be granted may be had by any *bona fide* British wireless manufacturer on direct application to my Company."

From an authoritative source, this Journal has been informed that only one or two minor points still remain to be settled before the Postmaster-General will be in a position to approve the Articles of Association of the Broadcasting Company. The moment that these Articles of Association have been approved, broadcasting will commence, and this Journal has good grounds for believing that it is now only a question of days before broadcasting in this country will become an established fact.

Notes

Broadcasting by the Prince of Wales.

His Royal Highness the Prince of Wales has graciously consented to "broadcast" by wireless telephony from York House through Marconi House 2 LO, London, on the evening of October 7th, an Address to the Boy Scouts of Great Britain. This Address will be specially directed to those scouts who for various reasons are unable to be present in the afternoon of that day, at the great Rally being held in his honour at the Alexandra Palace, London.

The Prince will speak by wireless between 7.30 and 8 p.m., the Marconi House wavelength being 360 metres.

In order that a maximum number of scouts may listen-in on this occasion special arrangements are being made with the Wireless Societies throughout Great Britain whereby they place their services at the disposal of local troops.

Railway Experiments.

A system of transmission of telephony on electric trains has been experimented with in America. Messages are transmitted electrically, partly over a wire and partly through space. The experiments which were conducted by wireless engineers and representatives of four railways, were carried out at Schenectady. Efforts were made to communicate from a moving train to a sub-station three miles away. The trolley wire, carrying current to the electric engine or trolley car, was used as a carrier of telephone communication by means of another current of different frequency, which was superimposed on the wire.

This was the first demonstration, says *Practical Engineer*, of the application of "carrier current" communication to the problem of communicating between the head and rear ends of long goods trains, or to expedite train operations held up by faulty block systems.

Expansion of Service between America and Europe.

As stated in our issue of September 23rd, a new service has been opened in America of acceptance of messages at telegraph and cable offices for transmission by the Radio Corporation Company.

The Radio Corporation of America announced that an agreement had been signed between that company and the Postal Telegraph-Cable Company whereby every office of the Postal Company in the United States becomes an agency of the Radio Corporation for the acceptance of radiograms for transmission across the Atlantic Ocean and for the delivery of radiograms received from overseas for points in the United States.

This important linking up of radio and wire line services reflects the rapid growth of the Radio Corporation's overseas telegraph traffic since the return of its high power stations by the Government after the close of the Great War.

These stations transmit and receive radiograms directly to and from England, France, Norway and Germany, and through connecting stations abroad, to and from all countries in Europe, Asia and Africa.

The contract just signed gives to the inland commercial centres and the thousands of small points reached by the postal system equal facilities with those now enjoyed by the eastern cities mentioned, the Postal Telegraph Company performing the same service for radiograms of the Radio Corporation of America as it does for cablegrams to be transmitted by submarine cable.

With the coming development of high speed wireless telegraphy the new arrangement will permit the Radio Corporation of America to carry out its plans for the inauguration of a low rate plain language radio letter service to and from all points in the United States and Europe.

It will be remembered that the Radio Corporation of America is the outgrowth of the Marconi Company of America.

Communication in Mines.

Interesting results were obtained by Birmingham experimenters at the Baggeridge Colliery a few days ago. Efforts were made to transmit messages from a depth of 700 yards to the surface. A three-valve set was used. The aerial was erected by slinging a wire from a steel hoisting gear 100 feet high to a girder of a railway bridge. The earth wire was clamped to the lower part of a railway rail. At first the transmitter and its aerial were installed in the steel cage, but considerable screening effect was experienced. Tests were made at various distances down the shaft, and reception was found to be clearer when transmission was made at the lower points. This was thought to be due to absence of structural steelwork, which might have caused screening higher up. Another experiment was made by taking the transmitter along the workings and earthing was effected by bringing a length of cable along the floor. The aerial was slung between pit props. Signals were clearly received at the pit mouth, although owing to limited power of the transmitter telephony was weak. It was suggested that the carbon in suspension in the air was having an absorbing effect on the signals.

Calendar of Current Events

Friday, September 29th.

WIRELESS SOCIETY OF HIGHGATE.

At Highgate Literary and Scientific Institute, South Grove, Highgate, N.6. Annual General Meeting, Election of Officers, Annual Report, etc.

BELVEDERE AND DISTRICT RADIO AND SCIENTIFIC SOCIETY.

Lecture on "Oscillatory Circuits," by Mr. A. G. Warren, M.Sc.

WEST LONDON WIRELESS AND EXPERIMENTAL ASSOCIATION.

At Brook Lodge, Ravenscourt Park, W.6. Lecture by Mr. F. E. Studt on "A Three-Circuit Variometer Tuner."

Saturday, September 30th.

Opening of First All-British Wireless Exhibition, to be held at Horticultural Hall, Westminster, S.W.1. Closing date, October 7th. Open daily, 10 a.m. to 10 p.m.

Sunday, October 1st.

Daily Mail Concert from The Hague, PCGG, 8 to 9 p.m. B.S.T., on 1,085 metres.

Monday, October 2nd.

ILKLEY AND DISTRICT WIRELESS SOCIETY.
At 8 p.m. at Regent Café. Morse practice.

Tuesday, October 3rd.

Transmission of telephony at 8 p.m. on 400 metres by 2MT Writtle.

GREENWICH WIRELESS SOCIETY.

At 7.45 p.m. At Rangers House, Blackheath. Ordinary Meeting.

Wednesday, October 4th.

PORTSMOUTH AND DISTRICT WIRELESS ASSOCIATION.

Lecture on "Portable Receivers," by Mr. Donkin.

WIRELESS AND EXPERIMENTAL ASSOCIATION.

"Gadgets" Competition.

WIRELESS SOCIETY OF EAST DORSETSHIRE.

At Branksome Liberal Club, Salisbury Road, Upper Parkstone. At 7 p.m. Formation of Winter Programme. First Lecture on "Construction of Single Valve Receiver."

Thursday, October 5th.

Daily Mail Concert as above.

GLASGOW AND DISTRICT RADIO CLUB.

At 200, Buchanan Street. First Ordinary Meeting of Winter Session. Ballot for Membership.

HOUNSLOW AND DISTRICT WIRELESS SOCIETY.

At 8 p.m. At H.Q., The Council House, Treaty Road, Hounslow. Lecture on "Wireless for the Man in the Street," by Mr. S. H. Nayler.

Sunday, October 8th.

Daily Mail Concert as above.

Monday, October 9th.

ILKLEY AND DISTRICT WIRELESS SOCIETY.

At 7.30 p.m. At Regent Café. General Meeting, followed by lecture on "Capacity and Condensers," by Mr. E. Stanley Dobson.

Tuesday, October 10th.

Telephony by 2MT Writtle as above.

RADIO EXPERIMENTAL ASSOCIATION.

(NOTTINGHAM AND DISTRICT.)

First Meeting in new H.Q.

Wednesday, October 11th.

REDHILL AND DISTRICT Y.M.C.A. WIRELESS SOCIETY.

At 111, Station Road, Redhill. Lecture on "Condensers," by Mr. Edwards.

PORTSMOUTH AND DISTRICT WIRELESS ASSOCIATION

Lecture on "Charging Accumulators by the Noden Valve off A.C. Mains," by Mr. R. Cole.

STOCKTON AND DISTRICT WIRELESS SOCIETY.

At 7 p.m. General Meeting.

Thursday, October 12th.

Daily Mail Concert as above.

Friday, October 13th.

WEST LONDON WIRELESS AND EXPERIMENTAL ASSOCIATION.

At Stamford Brook Lodge, Ravenscourt Park, W.6. A popular lecture and demonstration of latest apparatus made by Messrs. Burndept, Ltd., by Mr. A. O. Gibbons.

Wireless Club Reports

NOTE.—Under this heading the Editor will be pleased to give publication to reports of the meetings of Wireless Clubs and Societies. Such reports should be submitted without covering letter in the exact form in which they are to appear and as concise as possible, the Editor reserving the right to edit and curtail the reports if necessary. The Editor will be pleased to consider for publication papers read before Societies. An Asterisk denotes affiliation with the Wireless Society of London.

Wireless and Experimental Association.*

Hon. Secretary, Mr. Geo. Sutton, 18, Melford Road, S.E.22.

The meeting of the Association at the Central Hall, Peckham, on Wednesday, 23rd inst., was marked by a good attendance and quite an eagerness of the amateurs present to put up and discuss the little difficulties which they had encountered in their experiments since the last meeting. It was to have been a wireless "gadget" night, with a competition for a prize offered by the Chairman, but so few gadgets materialised that an extension was made for the event to take place on October 4th.

A member had sent in a communication descriptive of the methods of staining and finishing the woodwork of home-made apparatus, but when read, it was found to be less helpful than had been hoped. The Secretary stepped into the breach, and starting off with the dictum that "the whole art of French polishing lies in the knowledge of when to leave off rubbing," gave the meeting the benefit of his somewhat extensive experience. Questions put, and other experiences detailed, showed that the chat had served the purpose intended.

Quite a lot of business was done in the matter of the rumoured threats to the amateur's liberties, and the Secretary was further instructed.

The Finchley and District Wireless Society.

Hon. Secretary (*pro tem.*), Mr. A. E. Field, 28, Holmwood Gardens, N.3.

The first meeting of the above Society was held at Squire's Lane Schools on Wednesday, September 13th. The following elections were made:—Chairman, Mr. Trussler; Treasurer, Mr. Smith; Secretary, Mr. Field; and Committee, Mr. Bishop, Mr. Macdonald Brown, Mr. Storey, Mr. Cooper, Mr. Turner and Mr. Champion. The future meetings will be held on Monday evenings at 8 o'clock.

Twenty-eight members were present. A number of suggestions were proposed, many of which were accepted. At the close of the meeting, the Committee met, when rules and subscriptions were decided upon. It is hoped that all amateurs in Finchley and district will become members; full particulars can be obtained from the Secretary.

Stoke-on-Trent Wireless and Experimental Society.*

Hon. Secretary, Mr. F. T. Jones, 360, Cobridge Road, Hanley.

At a meeting of this Society at the Y.M.C.A., Hanley, on Thursday, September 14th, it was announced that permission had been received from Mr. Wenger to allow the members to use the roof of the Mecca Café building for the purpose of erecting an aerial.

Signals were received from several stations on the Society's single valve "Mediwave" set, only using a frame aerial inside the club-room.

Mr. A. Hackney (member) continued with his series of lectures on the construction of wireless apparatus. He demonstrated a new method of winding inductance coils for tuners, to receive the transmissions sent out on short wavelengths by the broadcasting stations and wireless amateurs holding transmitting licences. A sample coil was constructed and exhibited.

Members who have wireless receiving sets that are not giving the expected results are invited to bring them along to the club-room on Thursday night, when they can be tested and faults cleared.

Liverpool Wireless Society.*

Hon. Secretary, Mr. C. L. Lyons, 76, Old Hall Street, Liverpool.

A meeting of the above Society took place at the Royal Institution, Colquitt Street, Liverpool, on Thursday, September 14th.

A demonstration was made of the Society's instruments, Mr. C. G. Williams explaining the C. Mark III three-valve amplifier.

The question box was then sent round and a very interesting batch of questions resulted, which Mr. N. D. B. Hyde dealt with in his usual lucid manner, illustrating his explanations with very clear black-board diagrams.

Mr. F. P. Owen next demonstrated to the Society a very compact portable receiver, consisting of both crystal and single valve detector. This instrument was entirely home-made, including the outer case, switches, tuning coils, telephones, etc., and every item, including the L.T. and H.T. batteries, were housed in the one outer case. Although operated in conjunction with the Society's indoor aerial, signals were received on the valve detector. A vote of thanks was passed in favour of Mr. Owen, and the members were invited to bring along for demonstration at any subsequent meeting home-made apparatus of the same nature.

Mr. J. Coulton, who has been prominently associated with the Society for many years, gave a short address. All regretted to learn that Mr. Coulton has found it necessary to leave Liverpool for London for a considerable period, possibly for good. Mr. Coulton was elected the Society's accredited representative whilst in London.

Another meeting was held at the same address on Thursday, September 28th.

The first meeting of the winter session will be held on Thursday, October 12th, at the Royal Institution, Liverpool, when Professor E. W. Marchant, President of the Society, will deliver an interesting address.

Glasgow and District Radio Club.*

Hon. Secretary, Mr. E. Robert Carlisle, 40, Walton Street, Shawlands, Glasgow.

This Club resumed its activities with the Annual General Meeting which was held at the club's new premises, 200, Buchanan Street, on Wednesday, September 27th. At this meeting the election

of office bearers, etc., was carried out in accordance with the rules. Owing to pressure of private business the President and Hon. Secretary did not offer themselves for re-election, but suitable candidates for these posts were nominated by the Committee. There were some twenty-seven names before the Committee as candidates for membership, and these will be balloted for at the first ordinary meeting on Thursday, October 5th.

The club has arranged for a public exhibition and demonstration of wireless reception at the McLellan Galleries Hall, Sauchiehall Street, on Saturday, November 4th. The Exhibition will commence at 12 noon, and will continue till 9 o'clock p.m. The Committee hope to have a collection of both ancient and modern wireless apparatus, and trade firms who wish to be represented should send full particulars of offers to the Hon. Secretary as soon as possible. Two aeriols will be available.

Professor G. W. O. Howe, D.Sc., M.I.E.E., has kindly consented to deliver an address at 3 o'clock p.m., and special messages from continental stations have been arranged for.

Tickets for admission are .1s. each (including tax), and can be had from all club members and the principal wireless dealers in Glasgow.

A syllabus for the ensuing season is in the course of preparation, and the Secretary will be glad to have the name of any gentleman who can give a lecture or otherwise contribute to the winter's programme.

Hounslow and District Wireless Society.*

Secretary, Mr. A. J. Rolfe, 20, Standard Road, Hounslow, Middlesex.

Asst. Secretary, Mr. J. H. Donithorne-Clark, "Lorraine," Argyle Road, Hounslow.

A meeting of the above Society was held on Thursday, September 7th, 1922, at the Council House, Treaty Road, Hounslow, the President, Mr. A. R. Pike, in the chair. On the Committee's recommendation it was decided to devote half-an-hour on alternate meeting nights to Morse practice in accordance with the wishes of a large section of the members who are extremely anxious to increase their speed. The following members were also elected to form an entertainments sub-committee to relieve the general committee from the work entailed in organising fêtes, public demonstrations and other social engagements which the Society purposes holding during the forthcoming winter months:—Lieut. Walker, Messrs. Blakeley, Clark (Asst. Secretary), Fletcher, Ladley and Myland, with the President and Secretary *ex officio*. The Society has also in the course of preparation its syllabus of lectures, and in addition to lectures by the more advanced members on general meeting nights, the following dates have already been booked:—Lieut. Walker, October 19th and November 23rd, 1922; January 18th and March 8th, 1923.; Mr. S. H. Nayler, October 5th, "Wireless for the Man in the Street," November 9th, "Wireless for the Beginner," December 14th, "Valves for the Beginner," January 4th, "Wireless—Pastime and Profession," February 15th, "Hints for the Teacher and Student of Wireless," March 29th, "The Ideal Wireless Man: His Character and Training."

At a further meeting of the Society on September 14th, at their headquarters, Mr. A. R. Pike in the chair, a most enjoyable evening was spent. In

addition to a large number of new members being accepted, the Society had the pleasure of welcoming Mr. Fellows, of the "Fellows Magneto Co., Ltd.," as a Vice-President. He expressed his intention of assisting the Society in every way he could, and before leaving handed to the Treasurer ten guineas as an expression of goodwill. Lieut. Walker, also a Vice-President, then rose to address the meeting, stating that it was his intention to roughly explain some of the points which had recently been before the Committee. He described the necessity for an entertainments sub-committee, to which he strongly urged the members to bring their ideas. He explained to new members why arrangements for the working, etc., of the Society were submitted to the general meeting, the possibilities of amateur transatlantic transmission, and the still greater necessity for Morse practice. The rest of the evening was taken up with the demonstration of a portable set made by a member, Mr. Marchant, and included reception of telephony *via* the local Council's power mains.

The Secretary will always be pleased to receive applications for membership from any lady or gentleman.

The West London Wireless and Experimental Association.*

Hon. Secretary, Horace W. Cotton, 19, Bushey Road, Harlington, Middlesex.

The meeting held Thursday evening, September 14th, was well attended.

Mr. O. S. Puckle, of the Wireless Society of London, gave a lecture entitled, "The Less Known Forms of Telephone Receivers." This proved to be a deep and interesting subject. The lecturer divided telephone receivers into four sections, and in turn sub-divided each section upon which he gave a very fine detailed description as to their functions and results forthcoming from various experiments carried out by himself and others that he had seen made.

At the termination of the lecture Mr. Puckle was accorded a very hearty vote of thanks. Questions were then asked and replied to fully.

By the kind permission of Major A. S. Angwin, D.S.O., M.C., the club meetings will in future be held at Stamford Brook Lodge, Ravenscourt Park, W.6., close to Stamford Brook (District Railway) station, and furthermore the weekly meeting night will now be held on Friday evenings, from 7.10 p.m. instead of Thursdays. It is hoped that the members will support the Committee's action, as undoubtedly the better accommodation and facilities offered will give the association better results. The Secretary will be glad to give full particulars of the association on application.

Forthcoming events include: September 29th, Mr. F. E. Studt, "A Three-Circuit Variometer Tuner." October 13th, Mr. A. O. Gibbon, of Engineer-in-Chief's Dept., G.P.O., A popular lecture and Demonstration of Latest Apparatus made by Messrs. Burndep, Ltd.

Belvedere and District Radio and Scientific Society.

Hon. Secretary, Mr. S. G. Meadows, 1, Kentish Road, Belvedere, Kent.

At the Erith Technical Institute on Friday, September 15th, Mr. A. G. Warren, M.Sc., addressed

the weekly meeting of the above Society on "The Scope of Wireless." He mentioned that wireless, although in its infancy, was changing so rapidly that if one tried to construct the latest receiving apparatus it may be out of date before completion.

The speaker mentioned it was unfortunate that during his student days too little attention was paid to electrostatics, as this is the branch of the electrical science most in keeping with present-day wireless.

The President, in thanking Mr. Warren for his most interesting and instructive paper, remarked that in his early days he considered electrostatics, with its pith balls, etc., a confounded nuisance, but he now saw the usefulness of its application in wireless phenomena.

Plymouth Wireless and Scientific Society.

Hon. Secretary, Mr. G. H. Lock, 9, Ryder Road, Stoke, Devenport.

The second Annual General Meeting of the Society was held on September 15th. The reports of the Secretary and Treasurer, showing the Society to be in a satisfactory and flourishing condition, were adopted unanimously.

Election of officers for the coming year then took place with the following results:—Chairman, Mr. S. G. Monk, B.Sc., M.J.I.E.; Vice-Chairman, Mr. S. F. Heal; Hon. Secretary, Mr. G. H. Lock, A.J.I.E.; Assistant Secretary, Mr. P. Arbery; Treasurer, Mr. C. E. Harris; Librarian, Mr. W. Tregilgas; Committee, Messrs. L. Voss, L. Currah, S. F. Heal, H. J. George, H. F. Downes and Dr. E. McCulloch.

An Extraordinary General Meeting was called for Tuesday, September 26th to consider a complete revision of the rules.

Full particulars of the Society will be furnished on application to the Hon. Secretary, Mr. G. H. Lock, 9, Ryder Road, Devonport.

Sutton Wireless Society.

Hon. Secretary, Mr. E. A. Pywell, "Stanley Lodge," Rosebery Road, Cheam, Surrey.

The Rev. F. C. Lees, F.R.G.S., F.R.A.S., has very kindly accepted the Presidency of the Society, and his expert knowledge of radio and kindred subjects is of considerable benefit to the members. The roll now stands at 26, and is steadily increasing. A two-valve set on the unit system is to be installed, and the Society has already been presented with an L.F. transformer and 0.0003 variable condenser.

On Saturday, August 26th, by the courtesy of the Controller of Communications, Air Ministry, a party of 16 spent an extremely interesting and instructive afternoon at the Croydon Aerodrome. The wireless transmitting and receiving gear was seen, and the working explained to the visitors by the engineers in charge.

The members greatly appreciated the cordial reception accorded them.

The Fulham and Putney Radio Society.

Hon. Secretary, Mr. J. Wright Dewhurst, 52, North End Road, West Kensington, London, W.14.

At a meeting held on Friday, September 15th, which was well attended, several new members were admitted. Some of the members, notably Messrs. Hart-Smith, Winnett, H. A. Gardiner and Calver, offered the Society a collection of technical

books, and it was proposed that a librarian be elected. Mr. S. W. Martin was elected to this post, and he will in due course notify the members as to the books available.

The Morse buzzer class was started on September 22nd, and is in charge of Messrs. Winnett and Calver. The Society is to be congratulated on obtaining the services of two such highly technical instructors who have very kindly placed their services at its disposal.

After the close of the business, Mr. Calver introduced Mr. Adams, of Wandsworth, the winner of Messrs. Selfridge's wireless competition. Mr. Adams had brought with him the apparatus which had won the prize. This consisted of a very small and compact three-valve set with specially wound transformers, and coils, the whole being well made and finely finished. The time being limited, Mr. Adams could not go into much detail of construction, but with the assistance of Mr. Barker, with batteries and accumulator, the members present heard some signals which were rendered very loud and clear due to the special winding and wiring of the set. Mr. Adams has very kindly promised to explain the set in every detail at a future meeting. A very hearty vote of thanks was accorded to Mr. Adams for his very entertaining hour and offer. Mr. N. A. Brown had with him a two-valve set, also very neat and compact, which was tried with very good results. After more promises from members of sets and parts for trial, the meeting closed.

Judging by the liveliness of the proceedings, and the interest displayed, the future of the Society is well assured.

The Lowestoft and District Wireless Society.

Hon. Secretary, Mr. L. W. Burcham, "Gouzeacourt," Chestnut Avenue, Oulton Broad.

The above Society opened the winter session on Tuesday last, September 12th, when a very good muster of members were present.

Before the meeting started, the members' attention was drawn to the fact that the Society were indebted to Messrs. Chipperfield, Ltd., Radio Engineers, of Oulton Broad, for the excellent four-valve experimental panel, which measures about 2 ft. x 1 ft. 6 in., presented to the Society by them. The set is very quiet in working and gives excellent results, especially with telephony. When the members were finally drawn away from listening to "Writtle," Mr. R. J. Hudson delivered his lecture on "Wheatstone Receivers," which was thoroughly enjoyed by all present. Questions were numerous, but the expert knowledge of the lecturer enabled him to satisfy all queries.

Through the courtesy of Mr. C. Garrod a small party of members spent a very pleasant afternoon on August 20th in a motor boat on the river Waveney. A three-valve set was taken out and an aerial erected between two trees. Excellent telephony, etc., was received during the afternoon and Marconi House provided an hour's entertainment after tea, much to the delight of some farm hands working in a hayfield close by, also various owners of craft cruising on the river.

The Society now meets every other week as from the 12th inst. There is still plenty of room at the club-room, St. Margaret's Institute, Alexandra Road, Lowestoft, for more members.

Leamington, Warwick and District Radio Society.

Hon. Secretary, Mr. F. A. Sleath, 31, Archery Road, Leamington Spa.

The second general meeting of the above Society was held at the Spencer Street Schools on Thursday, August 24th with the Vice-President, Mr. G. H. Champ, in the chair. Mr. Marriott gave an excellent lecture on "Aerials and their Construction." The advantages and disadvantages of various types were dealt with, and methods of rigging up masts, spreaders, etc., explained. Mr. Champ operated one of his sets (two-valve), and some good results were obtained. The meeting terminated at 9.30 p.m.

The third general meeting was held on Thursday, September 7th, and in the absence of Mr. Hills, who was to lecture on the construction of a tuner, Mr. Sleath obliged with a few words on "Inductances," and explained the methods of winding various types. After discussion and questions on matters of interest, the meeting terminated at 9.30 p.m. Attendance at the last two meetings was poor. Any gentlemen in the district who are interested should communicate with the Hon. Secretary.

Fulham and Chelsea Amateur Radio and Social Society.

Hon. Secretary, Mr. R. S. V. Wood, 48, Hamble Street, Fulham, S.W.6.

A meeting was held on September 13th at the Society's temporary headquarters, the minutes of the previous meeting being read and accepted.

It was proposed by Mr. Saunders and seconded by Mr. Patterson that the Society should apply to become affiliated with the Wireless Society of London, this being generally accepted, the necessary steps will be taken.

During a discussion on reception Mr. Whitts, a member, kindly gave a short but exceedingly interesting lecture on the ether, which was much appreciated. There was an attendance of 37, of whom two were visitors. The total membership is now 60. Ladies are especially invited.

Swadlincote and District Radio Society.

Hon. Secretary, Mr. H. Shakespeare, 46, High Street, Newhall.

Inaugurated but a week or two ago, the Society is making rapid progress and already the membership numbers over 30. A meeting was held on Wednesday, September 13th, in the Hastings Road Schools at 7.30 p.m., when a discussion took place on the rules, which were passed as framed at the first meeting. It is hoped to find suitable headquarters shortly. As to the apparatus, the decision of the sub-committee that the members construct their own was endorsed. Six new members were enrolled, and more will be welcomed.

Wireless Society of Birkenhead.

Hon. Secretary, Mr. R. Watson, 35, Fairview Road, Oxtou, Birkenhead.

A Wireless Society of Birkenhead in conjunction with the Y.M.C.A. is under formation. Will all those in the Birkenhead district requiring particulars apply to the Hon. Secretary.

Huddersfield Radio Society.

Hon. Secretary, Mr. C. Dyson, 14, Y.M.C.A. Buildings, John William Street, Huddersfield.

A Society has been formed with headquarters at the above address. The following officers have

been elected:—President, Mr. Tom F. Brook; Hon. Secretary, Mr. C. Dyson; Hon. Treasurer, Mr. P. Priest.

The club rooms are open on Tuesdays, Thursdays and Fridays from 7 to 10 p.m. and the members hope to start making a receiving set for club use. Demonstrations and lectures are being arranged, prominent local amateurs having offered their services. Membership is open to all having reached the age of 18 years. The subscription is 10s. 6d. per annum.

A technical committee is to be appointed who will be in attendance on club nights to give advice and assist members in making sets and improving existing sets. The Secretary would be glad to hear of persons desiring to become members.

The Durham City and District Wireless Club.

The meeting held on Friday, September 15th, was devoted chiefly to actual receiving sets. It was decided that the lecture on "Accumulators" by Mr. Geo. Barnard should be held over for a more auspicious occasion, the intention being to hold another open public meeting on somewhat similar lines to the event on Friday, September 1st, as advertised.

The Chairman, Mr. S. Kelly, opened the proceedings by requesting Mr. R. W. Holmes, M.I.M.E., to give a short address, which took the form of some carefully chosen queries, thereby opening quite a lot of discussion. Mr. R. W. Rushworth was then called upon to describe his set. While thoroughly appreciating the benefits of valve reception, he still had a great respect for the much despised crystal, and pointed out the advantages of an ordinary crystal detector. Upon the invitation of the Chairman the Hon. Secretary answered questions spontaneously, during which he revised again the action and function of a condenser, also the spark method of producing high frequency oscillations. He drew and explained simple transmitting circuits upon the blackboard.

A question put to Mr. Barnard by the Rev. Bothamley regarding resistance offered by the insulation of an air gap compared with the inertia of a strong inductive circuit was very ably explained diagrammatically. It was shown and proved conclusively that although the resistance offered by an air gap was much greater than that of a large solenoid, yet this insulation was broken down, causing a spark at the gap terminals owing to the inertia, that is, inductance of the solenoid.

Mr. Barnard was requested to describe types of aerial insulators and lead-in tubes. He handled this controversial subject excellently and exhaustively, during which the types used in the R.A.F. and Navy were described fully. At the close of the question period the Hon. Secretary drew a diagram (his own arrangement) of a two-valve receiver, which was copied by all present.

A hearty vote of thanks was given to the members who had so ably placed their knowledge at the disposal of the meeting.

Several new members were enrolled. The lecture by Capt. Donisthorpe, of the Marconi Co., will undoubtedly prove a great success. No efforts are being spared. Lantern slides and first class apparatus will be used. A special concert is to be transmitted at 9 p.m. from Newcastle for this event.

MAGNAVOX

THE WORLD'S FINEST

LOUD SPEAKER

RADIO
brings it
MAGNAVOX
tells it.

*Broadcasting faithfully reproduced
with marvellous clarity and volume*

IMMEDIATE DELIVERY.

Visit our Stand No. 34. All-British Wireless Exhibition,
Horticultural Hall, September 30th to October 7th.

Manufacturers & Sole Licensees for Europe

Sterling Telephone & Electric Co., Ltd.

TELEPHONE HOUSE,

210/212, Tottenham Court Road, London, W.1

Telephone No.: 4144 Museum (7 lines). Telegrams: "Cucumis, Wesde, London."

Works: DAGENHAM, ESSEX.

BRANCHES: NEWCASTLE-ON-TYNE: 9, Clavering Place.
CARDIFF: 8, Park Place.

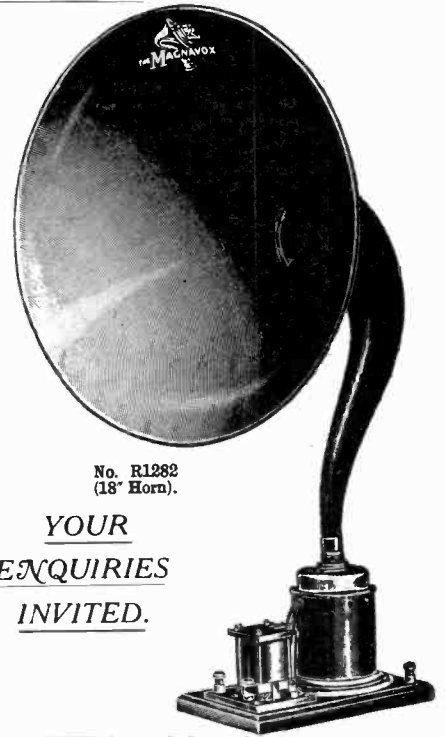

No. RL282
(18" Horn).

YOUR
ENQUIRIES
INVITED.

ECONOMIC ELECTRIC LIMITED

ESTAB.
1896

Telephone:
MUSEUM 1055.



CONDENSER DIALS. Turned and Polished with bevelled edge knob and engraved scale filled in white.

Diameter 3 1/4", 3/9 each.

Condenser Spindles. 1/4" square brass turned round one end and screwed. To take 1 vane, 9d.; 5 vanes, 1/-; 9 vanes, 1/3.

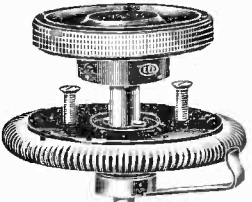

FILAMENT RESISTANCES. Specially designed for experimenters who are making their own Panels. First class finish. 3/9.



A NEW VALVE!
THE XTRAUDION.
15/-

Oscillates, Rectifies, Amplifies.

Filament consumption, 5 amps at 4 volts.

Anode potential, 50 volts.



TURNED, FLUTED, Polished and knurled EBONITE KNOBS, 1 1/2" diameter, 6d. each.

Head Office - 10, FITZROY SQUARE, LONDON, W.1.
Showrooms - - - - - 303, EUSTON ROAD, N.W.1.
Branch Showrooms - - - - - TWICKENHAM.



Spade Terminals, 3/6 grs., 5d. doz. No. T50. Actual size.



No. T52. Actual size. Spade Terminals, 2/- doz.



LOW FREQUENCY INTERVAL TRANSFORMERS (Hedgehog Type). Highly Efficient.

No. 1, 17/6. No. 2, 21/-.



INTERCHANGEABLE H.F. PIN TYPE TRANSFORMERS.

300 Metre Range	6/-
600 "	6/3
1,200 "	6/9
1,800 "	7/6
2,500 "	8/3
6,000 "	9/9
8,000 "	12/-
24,000 "	14/3
Bobbins only (with pins) for winding	3/-

APPLY AT ONCE FOR OUR 32 PAGE WIRELESS CATALOGUE, FULLY ILLUSTRATED, WITH CIRCUIT DIAGRAMS. POST FREE 4d.

Visit our Stand No. 51. All-British Wireless Exhibition, Horticultural Hall, September 30th to October 7th.

CROGROSS WOUND COILS

**PROMPT DELIVERY
HIGH EFFICIENCY
LOW PRICES**

These coils have been so designed that the overlap of range when shunted with a .0005 condenser is sufficient to enable some other number to be used for reaction purposes.

There is no need therefore to purchase a double set.

When used in the aerial circuit the wave lengths obtainable from each coil will be lengthened by an amount which will depend upon the properties of the aerial in use, this in many instances approximating about 120 metres.

The self-capacity of these coils is extremely low, and the wire

used is large enough to enable them to operate with success in sets not employing autodyne reception.

Used in crystal sets they replace the old style cumbersome cylindrical inductances.

These coils can be supplied either mounted or unmounted.

All coils are nicely taped and mounted coils are fixed to standard British gauge solid ebonite push fittings.

Each coil is tested in an oscillatory circuit before despatch.

No.	Ranges when used with .0005 variable condenser in parallel. In closed circuit.	Metres.	No.	Ranges when used with .0005 variable condenser in parallel. In closed circuit.	Metres.	PRICES. (Subject to Trade Discount.) Postage extra		No.
						Unmounted. Each.	Mounted. Each.	
1	175 — 400		1	175 — 300		s. d.	s. d.	1
2	250 — 550		2	250 — 400		1 6	4 0	2
3	325 — 750		3	325 — 550		2 0	4 6	3
4	450 — 1200		4	450 — 950		2 3	4 9	4
5	550 — 1500		5	550 — 1100		3 0	5 9	5
6	850 — 2000		6	850 — 1650		3 6	6 3	6
7	1350 — 3000		7	1350 — 2250		3 9	6 6	7
8	1500 — 4000		8	1500 — 3000		4 6	7 3	8
8a	2000 — 6500		8a	2000 — 4800		5 0	8 0	8a
9	3000 — 9500		9	3000 — 6750		5 3	8 3	9
						5 6	8 6	

If taken in complete set of 10 coils as above £3 0 0 per set mounted, or £1 15 0 per set unmounted.

Manufactured by

CROGGON & CO., LTD.,

230, UPPER THAMES STREET, LONDON, E.C.4

Telegrams:—CROGGON. CENT. LONDON.
Telephone:—CITY 4470.

Also Manufacturers of Enamelled Aerial Conductors, prices on application—Manufacturers of Electrical Apparatus to the Trade for over 35 years.

ALL-BRITISH WIRELESS EXHIBITION, Sept. 30th to Oct. 7th, 1922

(See further full page advertisement of interest in this issue.)

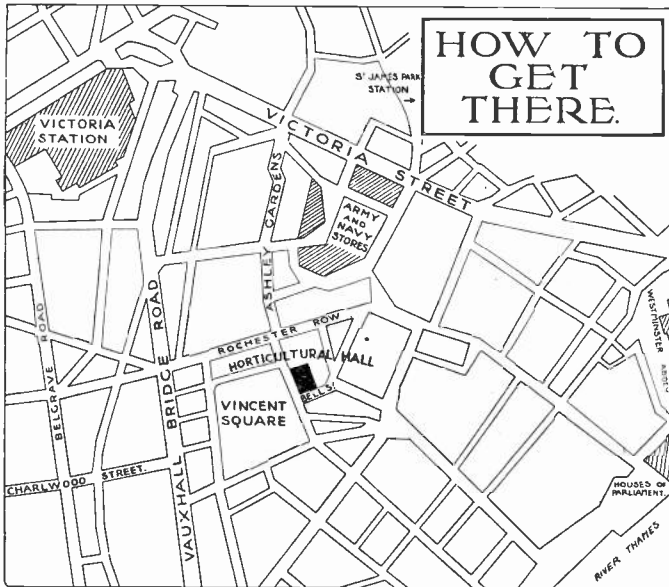

UNDERGROUND

Victoria, St. James' Park, Westminster.

BUS ROUTES

Alight at Army and Navy Stores,

Nos.—11, 24, 29, 29a, 39, 51, 76, 76a.

Alight at Bridge Street, Nos.—32, 80, 80a, 88, 89

Alight at Rochester Row, Nos.—2, 2a, 36, 36a.

Alight at Victoria (5 minutes walk) Nos. 16, 25, 25a, 25b, 38, 38a, 38b, 44, 46.

Organisers: **BERTRAM DAY & CO., LTD.,** 9/10, Charing Cross, London, S.W.1

Questions and Answers

NOTE.—This section of the magazine is placed at the disposal of all readers who wish to receive advice and information on matters pertaining to both the technical and non-technical sides of wireless work. Readers should comply with the following rules:—(1) Each question should be numbered and written on a separate sheet on one side of the paper, and addressed "Questions and Answers," Editor, THE WIRELESS WORLD AND RADIO REVIEW, 12/13, Henrietta Street, London, W.C.2. Queries should be clear and concise. (2) Before sending in their questions readers are advised to search recent numbers to see whether the same queries have not been dealt with before. (3) Each communication sent in to be accompanied by the "Questions and Answers" coupon to be found in the advertisement columns of the issue current at the time of forwarding the questions. (4) The name and address of the querist, which is for reference and not for publication, to appear at the top of every sheet or sheets, and unless typewritten, this should be in block capitals. Queries will be answered under the initials and town of the correspondent, or, if so desired, under a "nom de plume." (5) In view of the fact that a large proportion of the circuits and apparatus described in these answers are covered by patents, readers are advised before making use of them, to satisfy themselves that they would not be infringing patents. (6) Where a reply through the post is required every question sent in must be accompanied by a postal order for the amount of 1s., or 3s. 6d. for a maximum of four questions. (7) Four questions is the maximum which may be sent in at one time.

In view of the serious interference which an oscillating receiver can cause to other receivers in its neighbourhood, it is understood that for broadcast wavelengths certainly, and possibly for all wavelengths, the Postmaster-General will in future allow no type of circuit which is capable of oscillating and so energising the aerial, either directly or through any circuit coupled to it.

The necessary consequence of this restriction is that if reaction of the type commonly used in the past is still employed, it must be in such a way that the oscillation point cannot be reached over the wavelength range of the receiver, however tightly the reaction coil is coupled, and with whatever values of filament voltage or plate voltage the set is worked.

In order to comply with this requirement, it is essential that the reaction coil should be sufficiently loosely coupled to the aerial inductances as not to set up oscillations, or alternatively the reaction might be arranged between the grid and plate circuits of a high frequency amplifier as shown on p. 715 of the issue of September 2nd.

We strongly urge readers who are making or using sets of the usual reacting type to either reduce the amount of reaction which they can employ to such an extent that they are perfectly satisfied that the set can never oscillate or to cut out their reaction entirely.

"L. McM." (Maidenhead) asks for a diagram for a three-valve circuit to fulfil certain conditions. (2) If honeycomb coils may be used for FL. (3) Who are 5 DH and 5 DO. (4) If the circuit as suggested is the best way of using three valves.

(1) Circuit of Fig. 1, page 435, of July 1st issue, is quite a good one. The L.T. battery is not shown, but should be connected straight across any one of the filaments. (2) Certainly. (3) We do not know. These are recently allotted. (4) With interchangeable plug-in transformers this one is the best circuit possible. A potentiometer to the first grid would be of some advantage.

"M.J.D." (Brussels) asks (1) What resistance to use with a 4-volt battery and "Ora" valves. (2) What H.T. to use. (3) If 4,000 ohms telephones would be safe under such conditions.

(1) Very little will be required, say, 2 ohms as a maximum. (2) About 40 volts. (3) Tele-

phones may be put in the H.T. circuit without risk, but it is unwise.

"E.L.G.R." (New Eltham) asks re the super-regenerative circuit mentioned in the July 22nd issue (1) The maximum capacity of the variable condenser across the oscillation circuits. (2) What size basket coils to use for L1, L2 and L3 in the diagram. (3) If basket coils may be used for L4 and L5. (4) What should be the voltage of the grid batteries.

(1) 0.0005 to 0.001 mfd. (2) L1, 80 turns; L2, 60 turns; L3, 40 turns; all of No. 24 wire with an internal diameter of 2". (3) No, use honeycomb coils of about 1,000 and 1,250 turns. (4) Up to about 12 volts, adjusted by experiment.

"L.S.D." (Brockley) submits a sample of wire, and asks how much would be required to make a 300 metres flat basket coil on the lines described in the June 10th issue.

The wire submitted is quite unsuitable for the purpose, as both the wire itself and the insulation of it are rather too heavy and stiff. If used, however, about 60 turns should be sufficient.

"——"—(1) No, special provision for control of the grid potential of this valve is primarily due to the special grid battery. We should be surprised if the circuit could be made to work with much positive on this grid. (2) Yes, with suitable adjustments of the other voltages. (3) It is undesirable that the frequency of the oscillation should much exceed this value. (4) The valve mentioned is quite good, but almost any good hard receiving valve should be suitable.

"D.S." (Switzerland) asks (1) Whether his set would receive British broadcasting, Paris and Hague concerts. (2) If one detector valve, one H.F. and one L.F. would be a more suitable combination. (3) If a detector valve followed by two L.F. would be much improved by the addition of H.F. valve. (4) What voltages to use with one "R" and two "Ora" valves in this set.

(1) You omit to give any description of the set, but you are very unlikely to obtain PCGG or British broadcasting in Switzerland. Paris should, however, be O.K. with any really good set. (2) This combination is a very good one. (3) Yes. (4) Six volts L.T. and 50 volts H.T. will be sufficient, unless resistance capacity H.F. amplification is used, in which case 70 volts would be desirable.

The Present Wireless Boom

has given an enormous impetus to the manufacture of wireless apparatus. The tendency has been to sacrifice quality to quantity in endeavouring to keep pace with the demands. Throughout this period of increasing wireless activity **S. G. BROWN, LTD.**, have wisely refused to lower their high standard of quality even at the expense of occasional delay in fulfilling orders. As a result they have more than maintained their enviable reputation as **RELIABLE** wireless manufacturers, and to-day it continues to be recognised by amateur and professional alike that wireless instruments and parts manufactured by and bearing the name "**BROWN**" can be bought with absolute confidence in their quality, value and efficiency.



"A" TYPE.
Low Resistance, 58/-
High Resistance, 62/- to 66/-
"D" TYPE.
Low Resistance, 48/-
High Resistance, 52/-
(all above prices include cords).

The "Brown" Super-sensitive Telephones

These Telephones are unquestionably the clearest and most sensitive made, and, consequently, increase the distance over which wireless can be heard.

BROWN'S are recognised as the most comfortable to wear, due to their extreme lightness in weight and adaptable adjustment.

There are no wireless headphones in the world to compare with **BROWN'S**.

IMPORTANT NOTICE.—When purchasing **BROWN'S** you should see that the name **BROWN** is stamped on the back of each ear piece. This is the *hall-mark and proof* of their *genuineness, excellence of finish and highest efficiency.*

In Universal Use. As supplied to British, Allied and Foreign Governments.

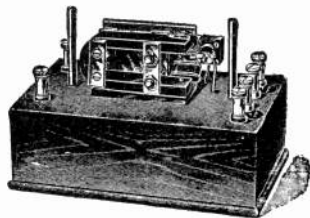

The "Brown" Microphone Amplifier

This Amplifier magnifies signals, speech, or music, without distortion, and is of considerable interest to amateurs and scientific investigators. The magnification is much greater than that obtained from a two-valve amplifier. In construction, this instrument is much more robust than other relays. *This instrument satisfies the urgent demand for a reliable, inexpensive amplifier, which the most inexperienced amateur can use, and which the most experienced requires.* The necessary transformers are included in the base.

The "Brown" Loud Speakers with new improved Curved Horns

The requisites of a Loud Speaker are pure tone, clear articulation, and good volume of sound. The "**BROWN**" Loud Speaker possesses these qualities and they are enhanced by the new improved curved horn.

AMATEURS do not always need the full sized Loud Speaker (H. 1.) as used in Lecture Halls, and a small type (H. 2.) has been designed to meet their more modest home requirements *both as to volume of sound and price.*

THE NEW HORN of dull blacked aluminium used with both H. 1 and H. 2 is constructed on the logarithmic law of increasing openings and is acoustically perfect.

NOTE THIS.—The strength and clearness of all music, speech and Morse heard by one person wearing headphones is broadcasted to a whole room full of people when a Brown Amplifier and Loud Speaker are used with your set.

The most popular and perfect loud speakers ever offered to the public.

Thousands already in use in all parts of the world.

CATALOGUE POST FREE.

Visit Our London Showrooms: 19, MORTIMER STREET, W.1.

Visit our Stand No. 43 at the All-British Wireless Exhibition, Horticultural Hall, Sept. 30th to Oct. 7th.

SOLE MANUFACTURERS—



PRICES:
H. 1. (Large) Low Resistance, 120 ohms Height 21".
£6 : 5 : 0
(High resistance 2/6 to 5/- extra).
H. 2. (Small) Low Resistance, 120 ohms Height 12".
£3 : 0 : 0
(High Resistances 2/6 to 5/- extra)

Telegrams—
"Sidbrownix, London."

Telephone—
Chiswick 1469.

Sole Agent for the Argentine—

Horacio D. Guerrero,
Las Heras 2480, Buenos Aires.



Head Office and Works:
VICTORIA ROAD, NORTH ACTON,
LONDON, W.3

London Showrooms:
19, MORTIMER STREET,
LONDON, W.1

JUST PUBLISHED!

Three Brand New Radio Press Books which every Wireless Man should buy.

THE RADIO PRESS WIRELESS DIRECTORY.

We believe that this is the first book which has been published in this country and gives in **handy form** a complete Directory of all the Wireless Stations of the World. The list gives the call signs of High Power Stations, Low Power Land Stations, Ship Installations and British Amateur Stations. **A Wireless Amateur without this book is like a telephone subscriber without his telephone directory.** Every amateur in the country will need this book, and he now has an opportunity of acquiring one at a reasonable price.

ABSOLUTELY THE MOST UP-TO-DATE LIST PUBLISHED

Price 2/6 Net. (Post Free 2/8.)

READY NEXT WEEK. ORDER NOW.

PRACTICAL WIRELESS VALVE CIRCUITS

By JOHN SCOTT-TAGGART, F.Inst.P.

Author of—

"Thermionic Tubes in Radio Telegraphy and Telephony."
"Elementary Text-Book on Wireless Vacuum Tubes."
"Wireless Valves Simply Explained," etc., etc.

This book will shortly be off the press and forms an excellent companion volume to any of the other books by this well-known author. It gives dozens and dozens of excellent practical valve circuits and explains the advantages and operation of each one. Particulars are also given of a number of crystal detector circuits and valve circuits in which crystal detectors are employed.

The circuits deal with both reception and transmission, and many of them have been specially inserted because of the Post Office Regulations regarding non-radiating valve circuits. The circuits employ from one to seven valves, and every one is guaranteed to be a thoroughly practical working example of what may be done with valves. The drawings are beautifully clear and well reproduced on good paper. No amateur can say that his little library of wireless books is complete if he does not possess this extremely useful volume.

Price 2/6 Net. (Post Free 2/8.)

SIMPLIFIED WIRELESS

By JOHN SCOTT-TAGGART, F.Inst.P.

Author of—

"Wireless For All."

This is the long awaited sequel to "Wireless For All," a booklet which has already run into between 50,000 and 100,000 copies. We expect this new book to be equally popular, if not more so. The first of the series, "Wireless For All," was for the man who knew nothing at all about wireless and wished to have some idea of the meaning of wireless waves, aerials, how messages are sent, and so on. This new book is quite self-contained, and is a very simple account of elementary electricity, oscillation circuits, wireless tuning apparatus, etc. No electrical knowledge whatever is assumed. The reader is told what a battery is, what resistance means, what an inductance coil is like and the use of a condenser. Crystal detectors are explained and the methods of tuning circuits receive adequate attention.

What will prove of most interest to many amateurs will be the complete instructions for making one or two broadcast receivers. By following the very simple directions it is possible for anyone to make their own broadcast receiver at a very small cost. Every piece of apparatus described has been actually made and has given excellent results. Another feature is the section relating to the erection of amateur aerials.

The book is unusually well illustrated for an inexpensive book of this sort; there are nearly 60 excellent drawings.

Price 1/- Net. (Post Free 1/1½.)

All the above three authoritative wireless books can be purchased at our Stand No. 27 at the All-British Wireless Exhibition. Buy a copy of these when you go there, or if outside London, buy a copy from your wireless dealer or bookseller. We will post you any book by return on receipt of remittance.

Radio Press Ltd. Dept. w.w.

Publishers of Authoritative Wireless Literature.

New Larger Premises:
DEVEREUX BUILDINGS,
DEVEREUX COURT,
STRAND, LONDON, W.C.2

(Opposite Law Courts)

"W.R.H." (Oldham) is constructing a single valve receiver, and asks (1) The direction of windings of the inductances; whether the use of $\frac{1}{8}$ " brass rod as a slider will have a detrimental effect; if the use of dead end switches will permit of reception of short wave telephony, and whether varnishing of inductances will be detrimental by way of increasing the capacity between the turns. (2) What tests should be made with a C. Mark II amplifier for the purpose of verifying that it is in good order, and what is the most suitable type of Osram valve for use with such a set. (3) Whether the three valves that he already possesses are suitable for use with the C. Mark II amplifier. (4) For the name of the manufacturer of a reliable type of H.F. transformer for addition at a later date to the three-valve L.F. set.

(1) It is difficult to state the direction of the winding of the coils, but all you have to do in the event of the set not functioning correctly is to reverse the wires to the reaction coil. A brass rod slider will have no serious detrimental effect. Ebonite sliders cannot be recommended, unless of substantial dimensions, owing to the tendency ebonite has to become distorted when used for such a purpose. Dead-end switches are to be highly recommended in aerial and reaction circuits for the purpose of efficient reception of short waves. The coils may be shellaced, and should be thoroughly dried out before the varnish is applied. The shellac will slightly increase the self-capacity of the coil, and for this reason you should use double cotton covered wire for winding. (2) If you are in possession of a sensitive galvanometer giving several degrees of deflection per milliampere it will be quite easy for you to make tests on the amplifier. Alternatively telephone receivers may be used in lieu of the galvanometer, but you may have difficulty in distinguishing between the difference in the intensity of the clicks you will get, indicating whether the circuit is complete or broken. By using a 4-volt battery with the meter or telephone receivers in series with it, connect one lead to the H.T. terminal and tap the other on to the valve plate sockets. A deflection or loud clicks will indicate that the circuit is not broken. Tapping round over all other parts of the circuit will indicate whether a contact exists. This confirms the correctness of the primary windings of the transformer. To test the secondaries, join one lead of the L.T. minus terminal and tap out along the grids. The primary of the first transformer should be tested for continuity across terminals L1 and L2, and the secondary of the telephone transformer should be similarly tested by placing the leads across the terminals marked "telephones." "R" type valves are recommended, though the "R4" will give very good results. The voltages as stated, although not agreeing with those given on page 489 of a recent issue, are as in the figures you quote, and derived from measurements taken directly across the valve filaments. To advise an amateur that he is to place 3·8 or 3·5 volts across the filament is of little value, as practically all instruments are fitted with filament resistance, and all he wants to know is the voltage of the battery he must connect to the L.T. terminals. In order that a difference of potential of 4 volts across the filament of an "R" valve may be obtained when working through a resistance, it is frequently necessary

to raise the accumulator potential to 6 volts, and particularly is this the case when a number of valves are in parallel across a low capacity accumulator. (3) If the valves you possess are in good condition they should be quite suitable. (4) We recommend you to wind your own transformers to data frequently given in these columns. The design of the transformer required depends upon the circuit in which you propose to connect it. We cannot advise the use of transformers produced by any particular manufacturer.

"REACTION" (Wood Green).—The loose coupler described is evidently part of a transmitter, and is not much use for reception, but might give fair results up to perhaps 400 metres. The aerial tuning condenser might be 0·002 mfd. in series with the A.T.I., and the closed circuit condenser could be 0·0007.

"J.G." (Paisley) asks the number of layers to use for duolateral coils, namely No. 28 D.C.C. for an inside diameter of 2" and the winding width $1\frac{1}{4}$ ", for tuning from 150 to 25,000 metres with a 0·001 condenser.

The number of layers required will be one for 150 metres up to 20 for 25,000 metres, with about six intermediate sizes to cover the whole range.

"G.S." (Marlborough) has a heterodyne wavemeter circuit with a range up to 1,500 metres, and asks (1) For windings to extend the range in both directions. (2) If slab inductances mounted on a former with four split pins for making connections will be satisfactory. (3) Why the 12-volt flash lamp battery supplied for H.T. runs down quickly. (4) For a semi-aperiodic reactance capacity coupling for use up to 1,200 metres.

(1) Various instruments of this type are made; you do not give us enough data to discriminate between them. We should advise the use of various honeycomb coils as listed by advertisers. The capacity of the condenser would probably be about 0·0015. This will enable you to choose suitable coils for any range you may require. (2) This mounting will be quite satisfactory, if it is so designed that the relative position of the coils can be kept rigidly fixed. (3) These cells should not run down rapidly unless there is a leak due to faulty insulation. We should advise you to test this out very carefully. (4) If you want any appreciable aperiodicity you should wind with about No. 47 Eureka—say 120 turns with taps at every 30—but we should much prefer No. 34 copper with variable tuning condenser.

"PILGRIM'S WAY" (Winchester) asks for information with regard to certain wireless recording apparatus.

We have no actual experience of the recorder you mention, but provided that it does not take more than 25 milliamps, the Weston relay should operate it satisfactorily. The signals to be recorded should be L.F. amplified up to the desired strength, preferably by means of your C. Mark III amplifier, in addition to the six-valve receiver, if this is mostly high frequency. After the L.F. amplification, you should again rectify through one or more valves in parallel with a suitable grid potential. The relay should be introduced in the anode circuit of these valves, and the recorder worked through a local battery, generally of about 24 volts, through the armature contacts of the relay.

"C.W.T." (Old Swinford) is desirous of receiving local amateur telephony, also Croydon, Paris, The Hague and Writtle, and asks (1) For a good four-valve circuit. (2) The best type of tuner for reception of telephony on 180/2,600 metres. (3) If it is possible to obtain a transmitting licence for telephony only for the purpose of experimental directional work up to 20 miles without the necessity of passing a test in Morse.

(1) See circuit Fig. 2. This is fitted with an intervalve H.F. transformer which is to be recommended, for although H.F. amplification does not magnify to the same extent as L.F., it will bring in signals which any amount of L.F. amplification would not render audible. As you are only desirous of receiving telephony, which, excepting Paris and Croydon, is always on 350 to 450 metres, one H.F. transformer specially wound for these wavelengths may be incorporated in the set. If you are desirous of tuning in telephony stations on other wavelengths, you must make the trans-

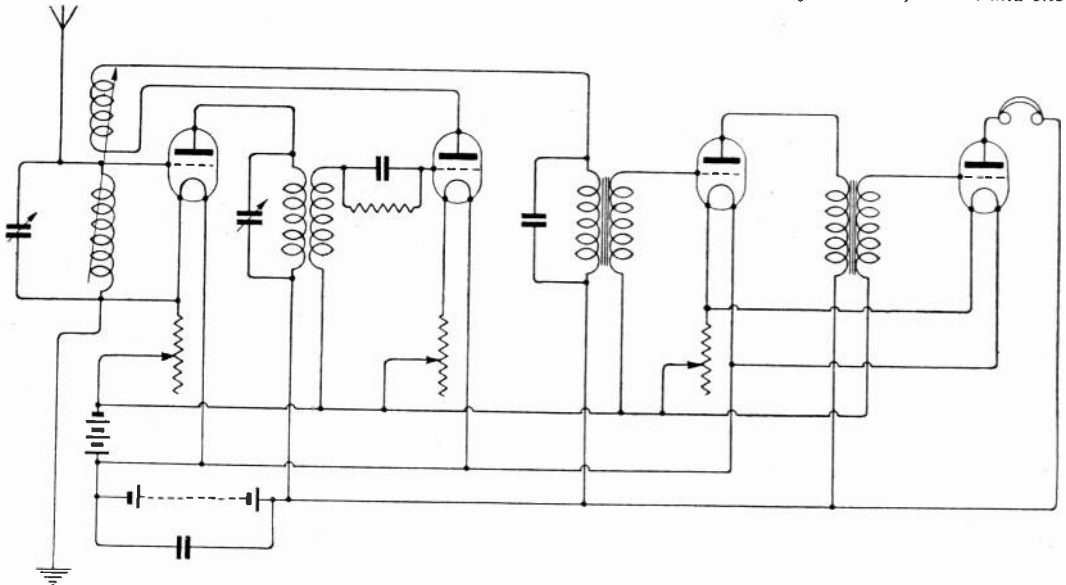

Fig. 2.

formers interchangeable. For 300/450 metres wind 250 turns of No. 40 S.S.C. wire on a 1" ebonite former, cover with a single layer of empire cloth, then wind on another 250 turns in the same direction for secondary; the finishing ends are taken to grid and plate. (2) Making use of the circuit given, you should wind the aerial tuning inductance with 25 turns of No. 22 D.C.C. on a 4" former, and the reaction coil with 40 turns of No. 26 S.S.C. upon a 3" former. (3) It is doubtful whether the P.M.G. would be prepared to grant you a telephony transmitting licence for directional experiments without you first satisfy him that you have a working knowledge of the Morse code. Why not write to the Secretary of the Post Office, stating the circumstances.

"ROMUS" (Brighton) asks how to cut out interference caused by the generator and arc of a near-by picture palace.

You might try screening the receiving circuits in an iron box; but the real method of cure would be the insertion of large condensers to earth in each lead of the picture-house arc supply. This however, you are not likely to be able to do. If possible, arrange your aerial pointing directly away from the offending picture-house.

"BERLICK" (Southend) asks whether reception on a single valve set would be seriously affected by an aerial running parallel to overhead tram wires 25' to 30' away.

This depends largely on the tram system. In some places induction under these circumstances would quite prevent reception; in others, some results might be obtained. The induction, of course, will not be quite so serious as that of a multivalve set. We should recommend you to turn the aerial at right angles to the tram wires, if this can possibly be done.

"KEEN" (West Kirby) asks for a diagram of a four-valve receiver, using one H.F., 2 L.F. and one

rectifying valve with A.T.I., C.C.I. and separate reactance coil.

See diagram (Fig. 2).

"BEGINNER" (Stanmore) encloses a diagram of his set, and asks (1) If it is suitable for all telephony. (2) For details of construction of transformers and the capacities of the condensers 1, 2, 3 and 4. (3) For details of construction of A.T.I. and the wavelength of same. (4) If a certain coil would be suitable for the L.F. Transformer for his set.

(1) Yes. (2) (1) 0.001 mfd.; (2) 0.0005 mfd.; (3) 0.0002 mfd.; (4) not strictly necessary. If used, should be 0.001 mfd. For transformer data see many recent replies. (3) For the A.T.I. 9" x 6" of No. 22. For closed circuit inductance, 7" x 5" of No. 26. (4) Core fairly satisfactory if wound with No. 46 S.S.C. Specimen wire quite unsuitable.

“AMPLION”

(Registered Trade Mark)

PATENT LOUD SOUNDING RECEIVERS, Table and Wall Types

HIGH EFFICIENCY TELEPHONE HEADGEARS

“GRAHAM” MICROPHONES FOR
WIRELESS TELEPHONY

“ALGRAPHONE” COMBINATION
For Wireless Transmission of Music

RADIO CABINETS
Incorporating Marconi Receiving Units
and the Graham Electravox
(By arrangement with the Marconi Company.)

“G.R.” (Graham-Rickets)
POWER AMPLIFIERS

INTERVALVE AND TELEPHONE
TRANSFORMERS

Improved Terminals for Experimental
and Standard Apparatus



ALFRED GRAHAM & COMPANY

(E. A. GRAHAM)

Specialists in Wireless Equipment

Head Office & Works :

ST. ANDREW'S WORKS, CROFTON PARK, LONDON, S.E.4

Branch Factory :

KILMORIE WORKS, FOREST HILL, S.E.23

West End Showrooms :

THE ALGRAPHONE SALON, 25-26, Savile Row, Regent St.

Visit our Stand No. 44. All-British Wireless Exhibition, Horticultural Hall, Sept. 30th to Oct. 7th.

T.M.C. Wireless

DE LUXE

ALL-BRITISH WIRELESS EXHIBITION AND CONVENTION
HORTICULTURAL HALL, WESTMINSTER, S.W.
SEPTEMBER 30TH TO OCTOBER 7TH, 1922

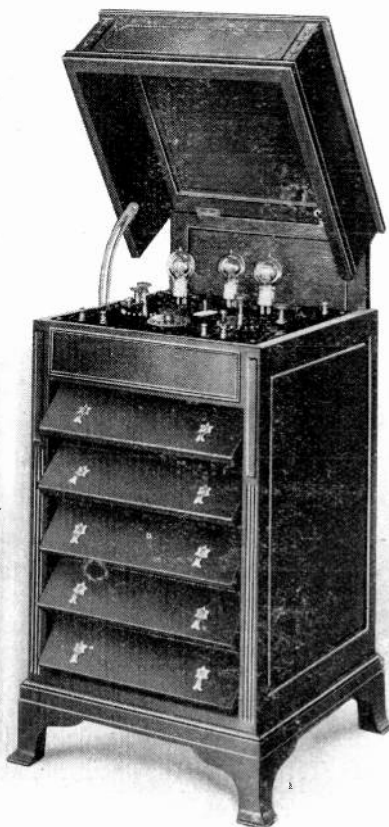

STAND
No. 20

STAND
No. 20

THE TELEPHONE MANUFACTURING CO. LTD
HOLLINGSWORTH WORKS, WEST DULWICH, S.E.21.
TELEPHONE: SYDENHAM 2460-1 TELEGRAMS: BUBASTIS DULCROX

"H.G.C." (Bristol) asks (1) Why his single valve set gives no signals, but only a continuous buzzing when the filament is brightened. (2) How to make a reactance coil to suit the A.T.I. of this set.

(1) The circuit diagram is quite correct, but the information does not give us much help to diagnose the trouble. We are inclined, however, to suspect a very faulty grid connection, or a bad grid condenser. It is also possible that the grid of your valve is making intermittent contact with the filament. See if the noises still obtain when the grid condenser is shorted. Your telephones also may have a bad connection. (2) It is unlikely that the reaction will be allowed with a circuit of this type in the future, but if you insist on trying it, 4" x 2" of No. 24 might be a suitable size for your coil. Reduce the number of turns immediately if you find this amount sufficient to make the set oscillate.

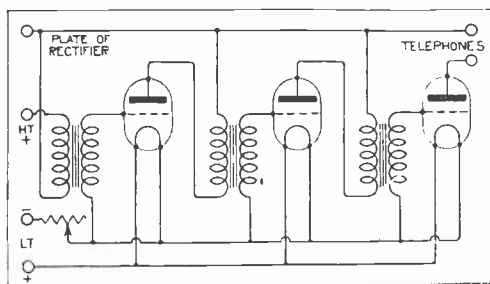

Fig. 3.

"A.E.F." (Finchley) asks (1) Whether separate H.T. batteries are required for a five-valve set, using some "V.24" and some "Ora" valves. (2) For a wiring for a three-valve L.F. panel to comply with certain requirements. (3) For a hook dealing with certain wireless control problems.

(1) No. (2) See diagram (Fig. 3). (3) There is no publication which deals at all fully with this subject.

"L.H." (Bristol) asks for data for constructing a tuner for use in aerial reaction circuits, and giving a range of 150/3,000 metres with his aerial.

The coil in the aerial circuit should consist of 7" of winding of No. 26 D.C.C. on a 4½" former, and might be provided with 19 tappings at increasing intervals along the inductances. The reaction coil should consist of 3" of winding of No. 30 S.S.C. on a 3" former, and may have five tappings. You may find it difficult to tune as low as 150 metres with this inductance, in which case you might construct two flat coils specially for short wave work as described on p. 328 of the June 10th issue.

"M.F." (Folkestone) submits a circuit diagram of a two-valve receiver, and asks for criticism and method of adding another valve circuit.

Your circuit diagram is quite correct. We would suggest that you might extend the tuning range, and also obtain increased signal strength on shorter wavelengths, by arranging to connect the aerial tuning condenser in series or parallel across the A.T.I. This can be done by means of a double coil change-over switch. Both secondary and reaction coils should be tuned with air dielectric variable condensers. When operating several

valves from a common H.T. battery, it is advisable not to connect one condenser right across the telephones and H.T. battery, but to use separate condensers, one having the value of about 0.001 mfd. for connection across the telephones and intervalve transformer, and the other of value up to 1 mfd. across the H.T. battery. The value of the grid condenser you show is rather high, and should be of the order of 0.0002 to 0.0003 mfd. There is no difficulty in adding a note magnifier by connecting an intervalve transformer in place of the telephone receivers, and taking the leads to grid and L.T. minus of the added valve, the telephones being connected between its plate and the H.T. plus. A wiring diagram making use of the circuits, very similar to the one you already have, is shown on page 37 of the April 8th issue.

"F.L." (Ilkley) is making use of a six-valve receiver, and has difficulty in the reception of Paris telephony, is unable to receive PCGG, shipping signals only very occasionally, whilst amateur telephony cannot be heard, and asks for criticism of his circuit.

Your circuit is in every way correct, and the use of tuning condensers across the secondary and reaction inductances is to be recommended. The condensers bridging the primaries of the H.F. transformers would certainly facilitate their action on the particular wavelength for which they are required. You might try connecting the reaction coil in series with the plate circuit of the third valve instead of with that of the first valve. You might try also connecting the leads from the transformer secondaries to the L.T. minus instead of L.T. plus as shown. Unfortunately you do not give the dimensions of your tuning coils. For the reception of short wave telephony we recommend you to construct some special coils to the design given on page 328 of June 10th issue. The detector valve should be one specially designed to give good rectification, such as an "R.4b" or "Q," and you should experiment with several grid condensers and leaks in order to get the grid potential correct. The use of a potentiometer to control the grid potential of the H.F. valves, and another to control the detector valve, may be found helpful.

"A.R.C.J." (Acton) has a Mark 1 C.W. set arranged for telephone transmission and reception, and asks (1) For method of adding one H.F. and two L.F. amplifiers to same, and (2) Whether an inductance coupled to the old circuit with a microphone connected across its ends is a satisfactory arrangement for telephony.

(1) We would recommend you to use an entirely separate circuit for reception, leaving your present set as it stands for use as a transmitter. A valve designed for transmitting purposes will not act as an efficient detector, as will be required for bringing in telephony. This journal is full of circuits comprising a great variety of H.F. and L.F. amplifiers. (2) This is quite a satisfactory arrangement for small power, though the extent of coupling between the two coils is critical.

"G.C.S." (Palmer's Green) asks (1) For a circuit to use certain gear. (2) How inductive reactance is obtained with slab inductances. (3) If 6 and 60 volts are too high for "Ora" valves.

(1) See Fig. 1, page 465, July 8th issue, and many similar circuits. (2) By bringing the coils close

together in almost any convenient way. (3) A filament resistance of say 5 ohms will be necessary. H.T. battery voltage is high but will do no harm.

"C.R." (North Devon) is constructing a five-valve receiver, and wishes to know the number of plates required for the construction of the various condensers.

The aerial tuning condenser should have a capacity of between 0.001 and 0.0015 mfd. If the space between the plates is $5/64$ " and the plates have a thickness of 20 gauge S.W.G., then 31 fixed and 30 movable plates will give a capacity of approximately 0.0014 mfd. The grid condenser should have a value of approximately 0.0003 mfd., and should consist of three plates, with an overlap of $1" \times \frac{3}{8}"$ separated with mica two thousandths of an inch in thickness. The middle plate will form one terminal of the condenser and the remaining the other. The condenser that bridges the primary of the first L.F. transformer should have a value of about 0.002 mfd. and should consist of 15 plates of similar dimensions to those of the grid condenser. The condenser that bridges the H.T. battery may have a value up to 0.5 mfd., and should consist of about 21 tin foil plates $2\frac{1}{2}" \times 4"$ with waxed paper dielectric.

"W.McN." (Stamford) refers to the Armstrong super-regenerative circuit, and asks (1) Whether honeycomb or duolateral coils are suitable for the inductances. (2) What make of valve is recommended for use in the circuit. (3) The values of the variable condensers across the inductances and the fixed condenser across the telephones. (4) Whether a Brown loud speaker may be interchanged with head telephones, retaining the same condenser.

(1) Coils of this type may be used. The inductances L1, L2 and L3 are of a suitable value for bringing in the required signals, and should preferably all be bridged with variable condensers. L4 and L5 are of large value such as will set up oscillations on wavelengths just above audible frequency. (2) This circuit was originally designed and recommended for use with special varieties of American valves, but it will work quite well with British valves of the usual "R" type. A "Q" or "R.4b" would give quite good results in the first valve circuit, whilst a "V24" might be connected in the oscillator circuit. (3) Maximum 0.0005 mfd. Telephone condenser 0.001 to 0.002 mfd. (4) The telephones may be interchanged with a Brown loud speaker, provided the loud speaker is of high resistance, though we do not think that by using this circuit you will obtain sufficient amplification for operating the loud speaker on telephony.

"T.T.C." (Southgate) refers to the circuit given on page 573 of July 29th issue, and asks for sizes of coils, condensers, etc.

Sizes of inductances depends entirely upon the range of wavelength to which it is desired to tune. We would recommend you to use interchangeable coils fitted with plugs and sockets. Within the aerial circuit may be a single coil arranged to plug into a socket fixed to the panel of the receiver, whilst the three in the second valve circuit may be the usual variety of three-coil holder to take the coil referred to. The condenser in the aerial circuit should be of the air dielectric type and have a maximum capacity of 0.001/0.0015 mfd., and should be arranged for connection either in series

or parallel with the inductances. When tuning to very short wavelengths, such as are used for telephony, connect your aerial tuning condenser in series with the inductance, and in addition another small condenser having a value of about 0.0001 may be connected between the variable condenser and inductance. The condenser in the plate circuit of the first valve should have a maximum value of 0.0005 mfd. Similar condensers may with advantage be connected across the inductance of the grid circuit of the second valve, and also the plate circuit inductance.

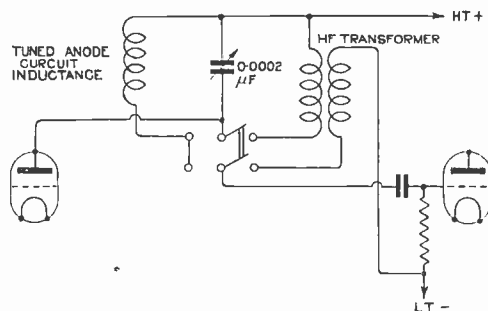

Switching arrangement for interchanging tuned anode inductance and transformer in H.F. amplifying circuit.

"R.E." (West Kensington) refers to the expression "loud speaker," and asks for details regarding the construction of such apparatus, and how it differs materially from a receiver with a trumpet attachment. (2) Whether it is practicable to use a frame aerial with six or more valve amplifier for the reception of broadcast telephony.

(1) Several varieties of loud speakers consist merely of a receiver earpiece with a trumpet attachment, and if wound to a low resistance a step-down transformer is required when operated from the plate circuit of an amplifier valve. If you propose to construct one of these instruments, we would suggest that you take an ordinary telephone earpiece, say of the "Brown" type, with adjustable armature, and fit to it a trumpet of a shape which you may find by experiment will not produce too much distortion. The trumpet must be an airtight fit over the diaphragm and the column of air between the base of the trumpet and the diaphragm must be as short as possible. (2) Until broadcasting stations are established, it is difficult to say the range of reception on various types of apparatus, but with present transmission from Marconi House, we think you should have no difficulty in receiving them satisfactorily on a frame aerial, using the 6-valve amplifier as you suggest. This amplifier should consist of three high frequency valves, detector, and two note magnifiers, and the frame should, if possible, have sides of at least 4 ft. We recommend strongly, however, the use of a small indoor aerial run across the room, and we think that with so many valves such an aerial would give results superior to the frame. However, it is just a matter of simple experiment in your locality. Circuits comprising H.F. and L.F. amplifiers are to be found in nearly every issue of this journal; see pp. 570 and 572 of July 29th issue, also p. 607

*Marconi's Wireless
Telegraph Co., Ltd.*

ARE EXHIBITING AT THE

FIRST ALL-BRITISH
WIRELESS EXHIBITION

AT THE HORTICULTURAL HALL, WESTMINSTER,
FROM SEPT. 30th. TO OCT. 7th.

*They are showing their
latest pattern Marconiphones,
together with apparatus
representative of other
branches of their industry.*

**DO NOT FAIL TO VISIT
STAND 24.**

MARCONI'S WIRELESS
TELEGRAPH CO., LTD.
MARCONI HOUSE, STRAND, LONDON.

TO THE TRADE.**REDUCED PRICES**

CONDENSER PLATES; CONDENSERS
OF VARIOUS SIZES AND DESIGNS;
SWITCH ARMS; SPACING WASHERS;
EBONITE KNOBS; POINTERS;
TRANSFORMER BOBBINS
(Wound and Unwound);
RHEOSTATS;
AND ALL WIRELESS ACCESSORIES.

QUICK DELIVERY. WRITE FOR PRICES.
WE SPECIALIZE IN DEEP DRAWN
WORK OF ALL KINDS.

MANCHESTER METAL STAMPING AND
ENGINEERING COMPANY, LIMITED.
CHESTER ROAD,
CORNBROOK, MANCHESTER.

Telephone—698 TRAFFORD PARK.
Telegrams—"TOGGLE MANCHESTER."

THE HALL MARK of EFFICIENCY

Prices
on
Application



Delivery
from
Stock



J. BURNS, LIMITED
Wangye Works, Chadwell Heath, Essex

BRITISH EBONITE TO GOVERNMENT
SPECIFICATION
FOR BRITISH WIRELESS.

MANUFACTURED BY:

THE BRITISH EBONITE CO., LTD.

HANWELL

LONDON, W.7

APPLY FOR LIST "W."

SPECIAL QUALITY RODS, TUBES,
and SHEETS FOR WIRELESS.
ALL USUAL SIZES KEPT IN STOCK.

TELEGRAMS: "Ebonitical, Han, London."
PHONE: Ealing 1689.

**WHOLESALE
ONLY.**

of August 5th issue. A variable condenser is connected across the ends of the frame, and leads taken to the grid and L.T. minus of the potentiometer.

"A.M." (Plaistow) has constructed the crystal receiver with flat coils as described in the article on Experimental Station Design in June 10th issue, and is able to receive 2 LO, and, weakly, 2 MT, and asks if there is any error in this arrangement.

This is a very simple crystal receiver, which embodies neither secondary circuit nor aerial condenser, and was designed for the reception of telephony broadcasted on high power, such as it is hoped will soon be available, and for which purpose it would be quite satisfactory. The fact that you are receiving the telephony transmitted from Writtle on low power indicates that your set is working very well indeed, and when a service is

struction of the intervalve oscillation transformer, but if the two windings are fairly tightly coupled, you will only need to bridge the primary, that is, the one in the plate circuit, with a variable condenser. (2) 1.—0.001/0.0015 mfd. 2.—0.0005. 3.—0.0002/0.0003. 4.—0.001/0.002. 5.—0.01 to 1 mfd. 6.—0.0001 mfd. All of the variable condensers should have air dielectric. (3) A tuning condenser is very helpful across the primary of the transformer. (4) You are quite correct in your suggestions as to types of valves. Use "R," "V24" or "QX" for the first, "R 4b" or "Q" for the second, and for the third "R."

"BROWNING" (Eastbourne) asks for numbers of French patents covering the construction and main features of the receiving valve.

It is regretted that we cannot undertake to give information relating to patents. The information

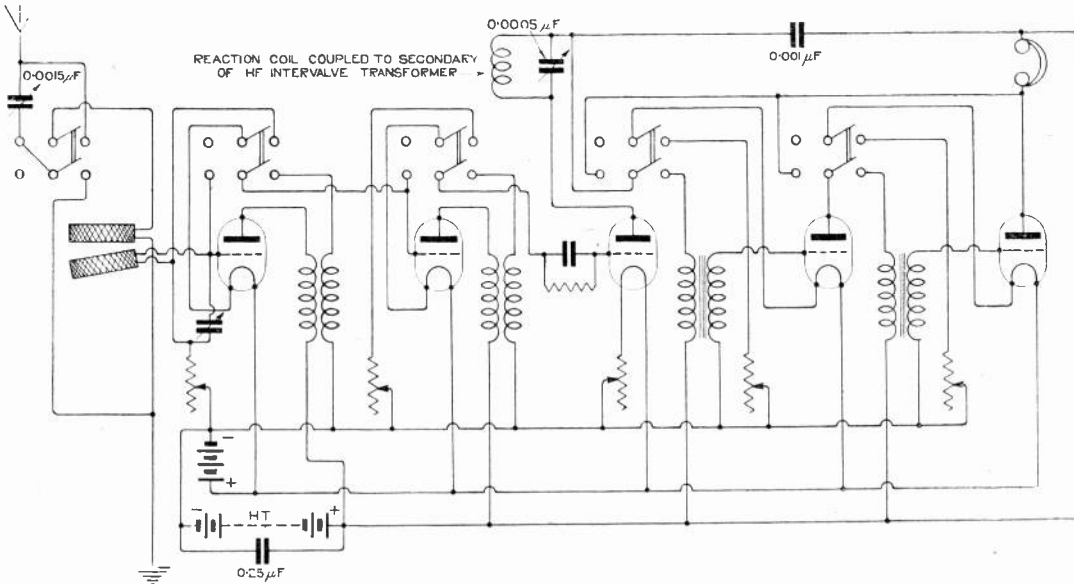

SWITCHING OF VALVE CIRCUITS.

Above is given a circuit diagram showing the method of switching in and out of circuit, high and low frequency amplifying valves. It gives the principle by which the number of valves in circuit is varied, and can easily be applied to circuits comprising any number of valves. The reaction coil can be coupled either to one of the H.F. transformers or to the closed circuit inductance.

organised making use of greater power, your present apparatus will prove quite useful for its reception. These articles have now described the construction of a single valve panel. If the range is as required, you might follow up your constructional work, and undertake to make all the apparatus described.

"S.T.N." (Windsor) submits a circuit and asks (1) For criticism. (2) For the capacities of the various condensers. (3) Whether a condenser is required across the secondary of a high frequency intervalve transformer and (4) Types of valves most suited for use in this circuit.

(1) The circuit is quite satisfactory, but you might arrange to connect your aerial tuning condenser either in series or parallel across the aerial tuning inductance. A condenser bridged across the reaction coil would facilitate fine tuning on short wavelengths. You do not describe the con-

struction of the intervalve oscillation transformer, but if the two windings are fairly tightly coupled, you will only need to bridge the primary, that is, the one in the plate circuit, with a variable condenser.

"H.W." (Bolton) is constructing a five-valve amplifier and asks (1) For criticism of the circuit he proposes to use. (2) Whether it is suitable for reception of 2 MT, PCGG and FL, and (3) If potentiometer control is recommended.

(1) The circuit is quite a good one, but the wiring up of the jacks and the high frequency circuits will require considerable care and jacks of the usual telephone type should not be used. A special type was advertised on the back cover of the July 22nd issue, and you should write to the manufacturers, asking them for jacks designed to suit your purpose, having very low capacity between the springs. The intervalve transformers must

be carefully made in order that those that are used together may cover identical wavelength ranges. (2) Yes. (3) Recommended.

"H.M." (Manchester) is constructing a low power transmitting set and asks (1) Size of aerial inductance for use on wavelength of 440 metres with an aerial 100' long and 30' high. (2) Size of aerial tuning condenser. (3) Dimensions of grid circuit inductance. (4) Whether speech could be transmitted successfully with a circuit designed to transmit tonic train.

(1) 25 turns on a 4" ebonite former. Use No. 20 D.C.C. for winding, or better still, special flat strip wire may be used with a winding of thin string between each successive turn. (2) Variable, with a minimum value of about 0.001 mfd. (3) 30 turns of No. 24 D.S.C. on a 2" former. You may find it helpful to bridge this inductance with a small tuning condenser. The extent of coupling between the grid and aerial inductance will depend upon the amount of power used, and if the size for this coil is 2" in diameter, it would provide ample coupling when used on 10 watts. For lower powers you will need to increase the diameter and make the grid circuit inductance slide inside the aerial inductance. (4) Speech cannot be transmitted from an interrupted source of H.T. unless the aperiodicity is fairly high and a rectifying valve with chokes and condensers is connected intermediately between the source of supply and the transmitting valve.

"W.S." (Victoria) refers to the reply given to "J.R.C." (Kilburn) on page 527 of the July 27th issue, and asks (1) Whether the secondary can be arranged at right angles to the A.T.I., inside which a coil is arranged to provide coupling, and also whether this coil should be made to swing through 60 degrees; whether a reaction coil wound on a spherical former and made to rotate inside the secondary would be satisfactory, or should the reaction coil be cylindrical and slide inside the secondary. (2) Whether we recommend the use of change-over switch for providing "tune" and "stand by." (3) Whether in making use of a three-valve low frequency amplifier he might break the plate circuit of his first valve and connect in a reaction coil. (4) Whether the set made up as indicated by his questions would be efficient for the reception of weak telephony on 1,000 metres.

(1) The aerial with closed circuit arrangement would be satisfactory. The coil that provides coupling between primary and secondary should be made a close fit and arranged to slide away from the aerial winding. If pivoted, it may not provide sufficient coupling, but it should be arranged to move through 90 degrees. A spherical reaction coil may not provide sufficient range, and also may perhaps not provide sufficient coupling on long wavelengths, and that also should be arranged to slide inside the aerial coil. In the diagram referred to, it was intended that a three-coil holder should be used with a set of interchangeable inductances. (2) Yes, the use of such a switch would be found very convenient. (3) It is better to break the plate circuit between the plate and the lead to the intervalve transformer. The primary of the transformer must also be abridged with a fixed condenser of value of about 0.001 mfd. You may certainly connect several stages of high frequency amplification in front of the first valve of the amplifier which functions as a rectifier. (4) Yes;

but we would recommend you to adopt coils of the type proposed in (1).

"H.E.S." (N.16) has access to a battery of 50 Leclanche cells and asks for an opinion on the superiority of such a battery over the usual type.

Such a battery is very bulky, and requires a good deal of attention as to maintenance, particularly with regard to corrosion, creeping and drying up of electrolyte, and for a single valve receiver you would be well advised to use the more convenient small type built up in 15 volt units. On a single valve receiver in frequent use, the usual small type of H.T. battery would have a life of about 12 months, and requires no attention. If, however, you are using a receiver with three or more valves, the use of the Leclanche battery may be found more economical and worth while, owing to the heavier load taken from it. When using such a battery for high tension supply, you must take good care that all cells are well insulated from one another and from earth. You might arrange them in sections in boxes standing on china insulators. Such a battery is practically useless as a source of filament current, unless, of course, you are prepared to connect it up in a number of parallel groups, such as connecting five cells in series, and all of these groups of five in parallel with one another. Even with this arrangement the battery would require considerable attention, and would not be as convenient as an accumulator.

"O.G." (Brierfield) submits a diagram of his set, comprising one H.F. (tuned anode) detector and L.F., with which he is not obtaining very good results, and asks for criticism.

Your circuit is quite correct, and should give satisfactory results, and the fault must lie in constructional details. If you wish to make a change in the circuit, however, you might connect your reaction coil between the low frequency transformer and the plate of the second valve, instead of coupling the tuned anode coil to the aerial circuit. It is essential to bridge the tuned anode coil with a variable condenser, and with the reaction arrangement proposed you will find it helpful to connect the condenser across the coil. Valves specially designed to function as H.F. amplifier, detector and low frequency amplifier will considerably improve results. The value of the grid condenser is important, and you might reduce it to a value of about 0.0003 mfd., with a leak of 2 megohms.

SHARE MARKET REPORT.

Prices as we go to press on September 22nd, are:—

Marcouli Ordinary	£2 5 6
„ Preference	2 2 6
„ Inter. Marine..	1 7 6
„ Canadian	10 4

Radio Corporation of America:—

Ordinary	1 0 3
Preference	13 9

ORA

The Valve for perfect reception

For receiving vocal and instrumental items you must have Mullard "ORA" Valves to get the best results.

Oscillates—Rectifies—Amplifies

Specially recommended where good detection and amplification are required.

15/- each

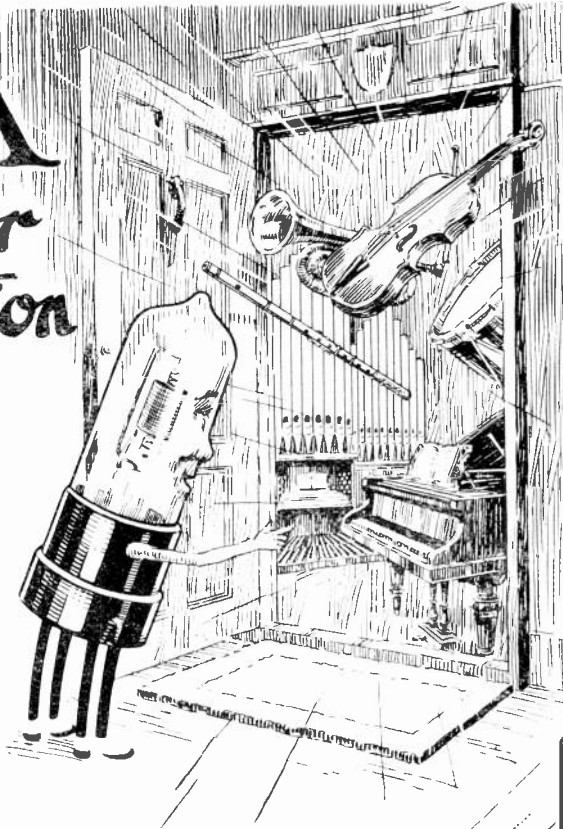

IMPORTANT NOTICE.—The great demand for Mullard ORA valves and other accessories has compelled us to open much larger works.

Mullard Radio Valve Co. Ltd.

45, Nightingale Lane, S.W.12.

Contractors to H.M. Admiralty.
 War Office Royal Air Force & Post Office.
 Telephone Codes Telegrams.
 Hammersmith 312 ABC(Ed) Radiovolve Hammer Londt.



Please write me per line

Quantity	Description and Price
.....	Telephone Head Sets 30/- per set
.....	ORA Valves 15/- each
.....	Grid A Resistances 5/- each
.....	Anode A or B Resistances 5/- each
.....	BA Condensers .005 mfd. 2/6 each
.....	Combined Resistances 7/8 each
.....	Valve Sockets with Terminals 5/- each
.....	Terminal Clips 1/8 each
..... 9d. per pair

I enclose (cheque) Money
 Order. P.O. value
 to cover the
 cost.

Name of usual Wireless Dealer:

SEND THIS TO-DAY

Glasgow Depot: 15, Woodside Terrace. Newcastle Depot: 17, Sandhill.

LESLIE Mc MICHAEL LTD.

PROVIDENCE PLACE, WEST END LANE, KILBURN, N.W.6

Bus Services 1, 8, 16, 28, 31 all pass West End Lane

Telephone: HAMPSTEAD 1261 Nearest Tube Station: KILBURN PARK (BAKERLOO)

M.H. Receiving Sets

As a result of lengthy experiments we are now in a position to place before Wireless Experimenters a series of sets ranging from ONE valve to FIVE valves which will appeal to them by reason of their efficiency, ease of operation, compactness and moderate prices.

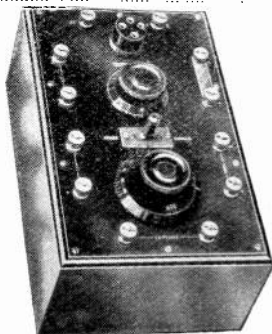

Size
9" x 6" x 4"

SINGLE VALVE DETECTOR RECEIVER PANEL

TYPE M.H.1. Price £5 - 5 - 0

This panel is fitted with: Valve Holder, Filament Rheostat, '0005 mfd. Variable Condenser, Series Parallel Switch, and all necessary Terminals. The Ebonite Panel is highly polished and fully engraved, being mounted in a well finished case of polished mahogany. A Coil Holder can be mounted on the side, the unit then being a complete receiving set requiring only the usual additions of Aerial, Batteries and 'Phones.

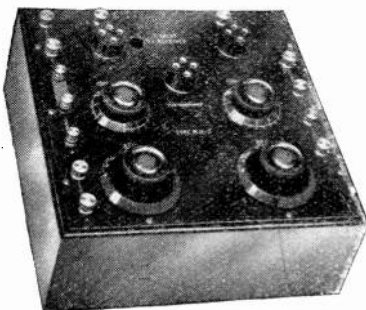

2-VALVE RECEIVER, TYPE M.H.2

Price £8 - 8 - 0

This instrument is a highly sensitive detector-amplifier operating as a Radio Frequency Amplifier, the Intervalve Coupling being plugged into a socket provided for this purpose. A Tuning Condenser is incorporated to work in conjunction with the High Frequency intervalve plug in transformer, which can be of variable or fixed type. Independent filament control is fitted to each valve, and a '0005 mfd. Aerial Tuning Condenser is fitted. The general layout, etc., is as illustrated, and it will be seen that the battery terminals are duplicated. This enables a Note Magnifier (M.H.2. B) to be added, thus providing a combination of 2, 3 or 4 Valves capable of great signal strength.

NOTE MAGNIFIER, TYPE M.H.2. B

Price £9 - 9 - 0

This instrument is applicable generally as a Note Magnifier, serving to increase the received signal (speech or morse). Independent filament control, a selector switch giving optional one or two valves, and the use of intervalve transformers (Type U.A.M.) having exceptional efficiency, make this instrument of great service, whether used in conjunction with Type M.H.1, M.H.2, or as an addition to any existing set (Valve or Crystal).

LESLIE Mc MICHAEL LTD.

PROVIDENCE PLACE, WEST END LANE, KILBURN, N.W.6

Bus Services 1, 8, 16, 28, 31 all pass West End Lane

Telephone: HAMPSTEAD 1261 Nearest Tube Station, KILBURN PARK (BAKERLOO)

Three Valve Detector Amplifier Type M.H.3.

This instrument is a 3 Valve Receiver unit, giving the range and clarity of reception characterised by the M.H.2 with the additional amplification provided by a Low Frequency stage of Amplification.



Price

£14 14s.

The extraordinary popularity of this set is sufficient proof of its capabilities, and is strongly recommended for general purposes where range and strength of reception, with great clarity and freedom from noise, is required. This set will operate efficiently a Loud Speaker.

Four Valve Set Type M.H.4.

This instrument is designed for those who require perfection in finish and performance.

The set is of highest grade finish, consisting of a four Valve Detector Amplifier fitted with a full range of controls and being provided with selector switches by which 2, 3 or 4 Valves can be used at will.

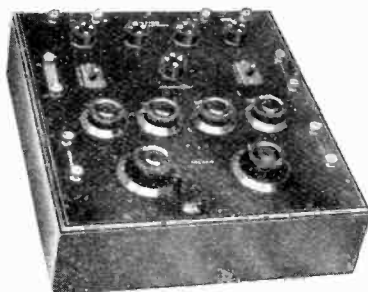

The strength of signals is such as to permit of an almost unlimited number of headphones to be used, or a Loud Speaker can be connected, thus making possible collective enjoyment of music, speech, etc.

Price - £25

LESLIE McMICHAEL LTD.

PROVIDENCE PLACE, WEST END LANE, KILBURN, N.W.6

Bus Services 7, 8, 10, 12, 51 all pass West End Lane

Telephone: HAMPSTEAD (261) Nearest Tube Station: KILBURN PARK (BAKERLOO)

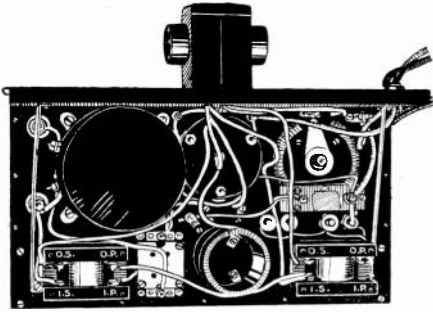

PRICE

£6 5s.

Price with Variable
Condenser (as
illustrated)

£7 5s.



£50 Competition

FOR THE MOST EFFICIENT CONVERSION OF
B. MARK II., 2 VALVE DETECTOR AMPLIFIER

HAVING purchased from H.M. Government a large number of the above sets, all new and unissued, we have decided to offer the prize of £50 0 0 for competition by the British amateurs for the most efficient and practical conversion of the above set. The present instrument is a 2-valve detector amplifier, suitable for very short waves only with fixed reactance and primary inductance. Amateurs can convert the instrument to either of the following :

- A.—A 2-valve detector amplifier suitable for all wavelengths.
- B.—A 3-valve high frequency detector amplifier suitable for all wavelengths.
- C.—A 2-valve note magnifier or any other combination which can be executed in the most practical way, either using internal or external tuning coils fixed to the instrument or loose.

The points which will be taken into consideration by the judges will be the efficiency and general utility of the converted instrument, smallest practical difficulties for converting a large number, lowest cost of conversion and smallest number of new parts required, and the simplest making of the finished apparatus.

LESLIE McMICHAEL LTD.

PROVIDENCE PLACE, WEST END LANE, KILBURN, N.W.6

Bus Services 1, 8, 16, 28, 51 all pass West End Lane

Telephone HAMPSTEAD 1261 Nearest Tube Station, KILBURN PARK (BAKERLOO)

CONDITIONS FOR ENTRY.

Only buyers of B. Mark 2 giving proof of having purchased either from us direct or from our wholesale customers will be allowed to compete.

The decision of the Directors of this Company, who will be assisted in judging converted sets by Maurice Child, Esq., Director of the London Telegraph Training College, Earl's Court, and H. S. Pocock, Esq., A.M.I.E., the Editor, *Wireless World*, will be final.

The winning set will become the property of this company, together with all rights of conversion and design. All other sets entered for the competition will be returned to competitors.

Ten consolation prizes of £1 will be allotted to those who in the opinion of the judges will have gained the greatest number of points.

Latest date of submitting converted instruments November 25th, 1922.

Amateurs desirous of entering the competition must send notice to us as soon as possible and obtain the necessary form.

The result of the competition will be announced in the *Wireless World*, December 16th, 1922.

Visit our Stand No. 38

Where you can inspect and purchase these instruments and also secure entry form.

LESLIE Mc MICHAEL LTD.

PROVIDENCE PLACE, WEST END LANE, KILBURN, N.W.6

Bus Services 1, 8, 16, 28, 31 all pass West End Lane

Telephone: HAMPSTEAD 1261 Nearest Tube Station: KILBURN PARK (BAKERLOO)

Five Valve Set Type M.H.5.

Price £35

A similar set to the M.H.4 with additional H.F. Amplification, full range of controls and following generally the lines of the M.H.4. Two Valves High Frequency, One Valve Detector and Two Valves Low Frequency, with specially designed switching arrangements to enable one or more valves to be used as required.

H.F.—L.F. Combination Amplifier.

Price £10 - 10 - 0

This design is one which, without sacrificing appearance or efficiency, is of more moderate price than the preceding types. It is confidently recommended for general reception between 350 and 7,500 metres.

The instrument incorporates a Reactance Capacity Coupling for the High Frequency stage, which, due to a special designed switch, gives extremely high efficiency at any wavelength within the range specified.

The Low Frequency stage is fitted with Type U.A.M. Transformer.

The general finish is as for preceding types.

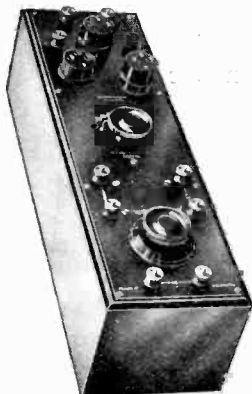

— Visit our —
STAND No. 38

All-British Wireless Exhibition,
Horticultural Hall,
September 30th to October 7th

In addition to the above standard sets which we supply we would remind our friends (both public and trade) that we hold the largest stocks in the country of ex-government wireless apparatus. The bulk of this stock is new and un-issued. In many cases by purchasing these you will save 50% on ruling prices.

SINGLE VALVE RECEIVING SETS—Comprising Tuner 100 1,300 m., Variable Condenser, Valve Panel with Filament Resistance, etc., £5.

TWO-VALVE SET—1 H.F. Valve, 1 Rectifier, Tuner, etc., as above, £7 10s.

THREE-VALVE SET—1 H.F. Valve, 1 Rectifier, and 1 L.F. ditto. Tuner, etc., as above, £9 10s. For use with L.S.

Headphones (Double), 8,000 ohms, 24/6 4,000 ohms, 22.6.

Accumulators, 4v. 40a., 21/-.

H.T. Batteries, 50v., 12/6.

L.F. Transformers 21/-.

H.F. Transformers. Plug in type, for various wavelengths, 6/-, 12 -.

'Phone Transformers, 15/-.

Valves ORA, 15/-, Dutch, 11/-.

Valve legs with two nuts and washers, 2d. each.

Valve Holders, complete with nuts, 1/3 each.

Filament Resistance, complete with knob for panel mounting, 3/9 each.

Filament Resistance, ebonite former, complete with screws, 1/3 each.

High Res. Wire, per yard, 2d.

Condensers, Variable, for panel mounting, .0001, 7/-, .001, 19/-, intermediate sizes pro rata.

Condenser Vanes, fixed and variable, 1/- per doz.

Condenser Washers, small, 3d. per doz., large, 5d. per doz.

2BA Screwed Rod for assembling, 6d. per ft.

Ebonite Knobs, 1 1/2" diameter, screwed 2 or 4BA, 6d. each.

Grid Condenser and Leak on ebonite base, 1/6 each.

Ivory Scales, 0 degs-180 degs., 71d. each.

Ivory Tablets marked Aerial, Earth, etc., 13d. each.

Hollow Steel Aerial Masts, complete with guys, etc., from 30 -.

Mica, Ebonite (Sheet, rod, tube), Brass Rod, Insulating Tubing, Paraffin Wax, Foil, Aerial Wire, Copper Wire, Insulators, Terminals, Nuts and Screws, etc., etc., at lowest prices.

HESTIA ENGINEERING CO.,
32, Palmerston Road, Acton, London, W.3

A NEW TYPE OF VARIABLE CONDENSER

A very compact form of Condenser, using a film of mercury as one element up to .0004 mfd. mounted on ebonite base **10/6**

BASKET COILS AND TUNING STAND

Coils mounted on ebonite formers and fitted with sockets for plug mounting. Set of five for use up to 1,200 metres **7/6**

Separate coils, 1/6, 1/9 & 2/- each.

Special Tuning Stand on ebonite base for use with these coils **12/-**

TELEPHONE TRANSFORMERS

For use with 120 ohm Telephones, unmounted **12/6**

Ditto, in wooden case, with Terminals **16/-**

Accessories, Panels, etc. Special apparatus made to customers' requirements.

REYNOLDS & BRADWELL,
41, CHURCH STREET, BIRMINGHAM

W. J. HENDERSON, 2 Hollywood Road, South Kensington.
(Nearest station, Earl's Court. Bus routes No. 31, 14, 96.)

Special Offers

PLUGS and JACKS, two way, suitable for "plugging-in" telephones, loud speakers, condensers, etc., etc.

Combined Plug and Jack **1/6**. Plug **1/-**. Jack **6d**.

H. T. Battery Cases, size 10 3/8" x 13 1/2" x 5", in polished teak, fitted with sockets up to 200 volts, 4 plugs and leads. These boxes are well finished, and besides their original purpose are very suitable for use as Instrument cases. Each **5/-**

STEEL MASTS, 15 feet, in six 2ft. 6in. sections, suitable for erection on roof or in garden; any number of these sections can be joined together if extra height is required.

Price, 15 feet, without guys **15/-**
" 15 feet, complete with rope guys and pulley **17/6**

Low Resistance Telephones
150 ohms.



12/6 per pair
(Postage 6d.)

These Telephones are fitted with aluminium headbands and are extremely sensitive. They are very suitable for the reception of speech and music. Satisfaction is guaranteed, each pair being tested before despatch. **Delivery from Stock**—All orders by post will be despatched on day of receipt. A large quantity of these telephones is available, and Trade enquiries are invited.

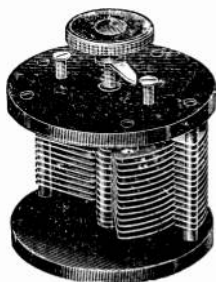

High Class
VARIABLE CONDENSERS
(for panel mounting.)

.001	43 vanes	23/6.
.00055	29 vanes	17/0.
.0003	15 vanes	13/6.
Vernier	3 vanes	5/0.

Hotpoint Handycac
FOR HOME COMFORT, CLEANLINESS & EFFICIENCY
Every family should have Hotpoint's...
Premier Electric Cleaner
SENSITIVE BEATER DEVICE
Demonstrations are being given DAILY at our Show-rooms. EVY 12 0
100 S.A.D. 63 0

Better Light with fewer Lamps—Everywhere.
The Astral Intensifier.
Electric Lighting 3/- EACH
EASE OF LIGHT UNDER THE LAMP
CHEAPER LIGHT AND THE REASON

Ahead of all Others. BRANDS LEADING
MAYFAIR WORKS

HAVE YOU YOUR TRUST IN SANDEMAN'S PORT
TAKE ALL

Royal Worcester and Bon Ton Knitting Corsets

White for our Corsets
CANADIAN WHISKY
JAMES WATSON & CO.

Write for our Corsets
Mackinnon & Co. INVERNESS

Are Like Silk!
FERSTRONG 196 White Cambray
FERSTRONG 287 Helene Quality Dyed Cambray
G. ARMSTRONG & CO. MANUFACTURERS
57 58 Ludlow St. Manchester

Some Doubt No Doubt
SANDEMAN'S PORT
When you're buying Port wine only a judgmentless man would refuse to take the trouble to get a quartet of what's made SANDERMAN'S PORT.

Our Reputation
THE NATIONAL FUR COMPANY
142, BROMPTON ROAD, LONDON.

If you want a
100% ADVERTISING SERVICE
We have it.
BERTRAM DAY'S
9&10 Charing Cross, S.W.1.

Bertram Day's for Wireless Advertising

STAND No. 55

ALL-BRITISH WIRELESS EXHIBITION

AND

ADMISSION

1/3

INCLUDING TAX

CONFERENCE

Sep. 30 (1922) **Oct. 7**

SATURDAY

SATURDAY

ADMISSION

1/3

INCLUDING TAX

HORTICULTURAL HALL,
Vincent Square, Westminster, S.W.1.

Special Public Day, October 3rd

ADMISSION **5/-** Including Tax

Special Trade Day, October 2nd

ADMISSION **1/3** Including Tax

(Public admitted both days after 6 p.m. at the usual price.)

At this Exhibition visitors are assured of several hours' pleasure as the exhibits include the finest and most efficient instruments ever manufactured, as well as many of historical interest.

At this Exhibition there are 52 Wireless Manufacturers and Suppliers, who, in every case, will show nothing but wireless goods.

At this Exhibition many Exhibitors will be showing for the first time wireless apparatus and accessories of new and novel design.

At this Exhibition two prominent Wireless Publishing Companies are placing before the public the finest selection of technical books on Wireless ever offered.

At this Exhibition there is one Stand occupied by the Organisers who have made every preparation to assure the pleasure and comfort of thousands of visitors.

At this Exhibition there will be "Broadcast" Wireless Concerts and Demonstrations throughout the day.

At this Exhibition there will be an orchestra to entertain you during the periods when Wireless demonstrations are not taking place.

At this Exhibition you will find a comfortable Lounge opposite the Demonstration Stand.

At this Exhibition the Wireless Society of London have made every arrangement for a Convention, having the full support of all the Affiliated Societies and Clubs.

At this Exhibition Lectures on Wireless will be given by many of the best-known Lecturers in Great Britain.

At this Exhibition you will find courteous and competent representatives of the Exhibitors ready and willing to give you advice and assistance at all times.

At this Exhibition you will at all times be able to secure light refreshments at popular prices, as well as lunches, teas and suppers.

At this Exhibition there will be an official catalogue containing over 144 pages.

At Stand No. 55 the Organisers will be displaying notices of times of Broadcast Wireless Concerts and Demonstrations as well as information regarding the Wireless Lectures.

ORGANISERS :

BERTRAM DAY & CO., LTD.

9 and 10, Charing Cross, London, S.W.1

AGENTS WANTED

**STAND
10**

HORTICULTURAL HALL,
Sept. 30th—Oct. 17th.

Sole Agencies for the Radio Productions
of FELLOWS MAGNETO Co., LTD.

Agencies will be granted to one
firm in each of the principal towns.

Address applications to:

WIRELESS MANAGER,

FELLOWS MAGNETO Co., LTD
CUMBERLAND AVENUE, PARK ROYAL, N.W.10

*Phones : WILLESDBN 1560, 1561.

*Grams : " QUIRMAG, PHONE. LONDON."

(E.P.S.) 4

CALL AT OUR STAND 53 ALL-BRITISH WIRELESS EXHIBITION

" FEDERAL " L.F. INTERVALVE TRANSFORMER

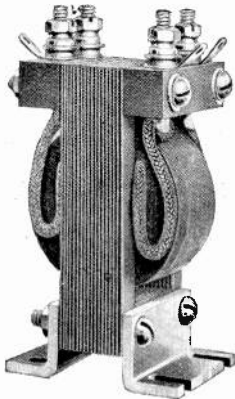

" FEDERAL "

Radio Accessories

Headphones

All parts for Crystal and Valve Receivers.

Complete Receivers, any type.

All Valve Sets licensed under Marconi patents for Experimental and Amateur use in Great Britain.

ANTI-CAPACITY SWITCHES
(Any combination of springs supplied)

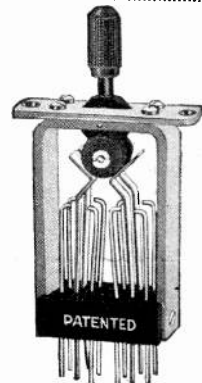

Call or write for full particulars :

PETTIGREW & MERRIMAN LD.
122-124, TOOLEY ST., LONDON, S.E.1

HOP 134

THE
LARGEST
STOCK IN
EUROPE

STAMPINGS FOR RADIO INSTRUMENTS

TRANSFORMER CORE LAMINATIONS AND
DIAPHRAGMS FOR HEAD-PHONES

(IN OUR PATENT HIGH RESISTANCE MATERIAL)

“STALLOY.”

STALLOY WIRE FOR TRANSFORMER CORES.

ALUMINIUM CONDENSER VANES.

TRADE ENQUIRIES SOLICITED

JOSEPH SANKEY & SONS, Ltd., BILSTON

Representative: Robert Jenkins, 168, Regent St., London, W.1

TEC

HIGH TENSION DRY BATTERIES

for WIRELESS SETS

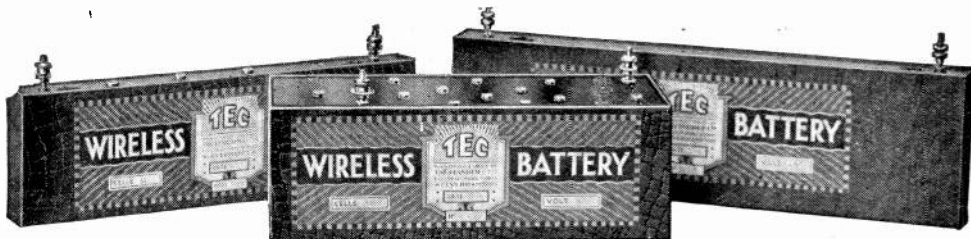

NORMAL SIZE, No. W 70 V, 15 Volts
Price 5/-

W 71 V, 50 Volts
Price 15/-

GIANT SIZE, No. W 75, 15 Volts
Price 6/6

SUPPLIED IN TWO SIZES FOR 15, 50 or 60 VOLTS
and with Tappings in 3 Volt Steps.

ALL BATTERIES FITTED WITH PLUG SOCKETS AND MOVABLE TERMINALS.

Complete Illustrated Price List on Application.

**THE EFANDEM CO., LTD., FALLINGS PARK WORKS,
DRY BATTERY MANUFACTURERS WOLVERHAMPTON**



WARNING

LETTERS PATENT NO 141344.
(DE FOREST)

INDUCTANCE COILS having a cellular structure and generally known as Honeycomb Coils are protected by Letters Patent as above. We are the Sole Licensees in this country under the Patent, and the Trade and Public should be careful to see that Coils of this type, sold or purchased by them, are of our manufacture, since there are on the market certain infringements of the Patent, and all dealers in or users of infringing coils are liable to action.



Honeycomb Inductance with Standard Plug Mounting.

The Honeycomb Coil possesses distinct advantages over other types. It is easy to change for different wavelengths, the full set having a range of from 100 metres to 30,000 metres with P.M.G. aerial. Silent operation is a further valuable feature. See them being wound on our Stand by patent machines.

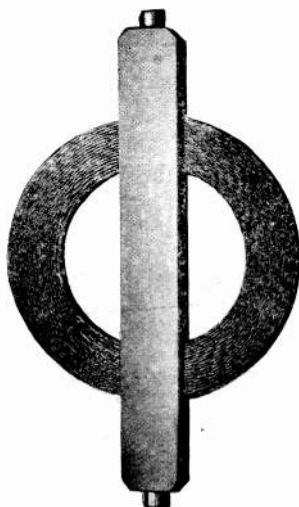

Slab Inductance.

The Slab Coil is wound by the "cross-wound" method and is self supporting without the use of wax or other binding material. This coil is wound with enamelled wire, and is very useful where cheap coils are required for experimental purposes.

We manufacture Intervalve Transformer Coils of all descriptions.

Also Telephone Transformer Coils, Basket Coils, &c., &c.

Coils

STAND No. 4
ALL-BRITISH WIRELESS EXHIBITION

IGRANIC
ELECTRIC CO., LTD.,

147, Queen Victoria Street, London.
Works : Elstow Road, Bedford.

IGRANIC

“TRIPLUG” COIL HOLDERS

Specially designed for use with Honeycomb Coils
SIMPLE ——— CHEAP ——— EFFECTIVE

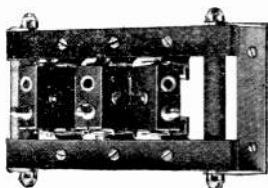

For mounting on panel.

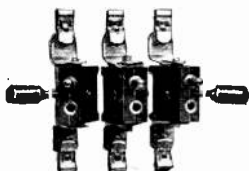

Independent Plugs.

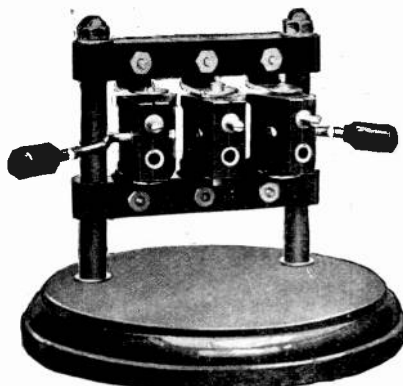

Completely mounted on pedestal.

“TRIPLUG” COIL HOLDERS

are supplied in three forms :

1. Completely mounted on base for table use.
2. Assembled for mounting on panel.
3. Independent Units for panel mounting.

MICRO-ADJUSTA COIL HOLDERS

These are of superior design, with worm adjustment for fine tuning. The worm can be engaged or disengaged by moving the operating knob to one side or the other, depending upon the coil to be adjusted. When disengaged, coils can be moved freely by hand. A spindle extension is supplied so that adjustments can be made without bringing the hand too near the coils.

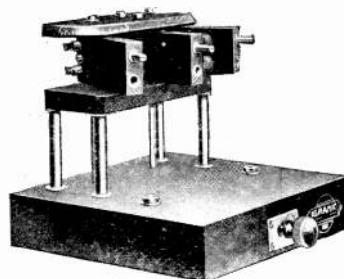
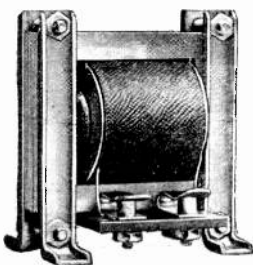

INTERVALVE TRANSFORMER

A very efficient design—the result of extensive research.

See our
STAND No. 4
All-British Wireless Exhibition
London

IGRANIC

ELECTRIC CO., LTD.,

147, Queen Victoria Street, LONDON.

Works : Elstow Road, Bedford.

ALSO

GLASGOW : 50, Wellington St.
MANCHESTER : 30, Cross St.
BIRMINGHAM : 73-4, Exchange Bgs.
CARDIFF : Western Mail Chambers.
NEWCASTLE : 90, Pilgrim St.
BRADFORD : 18, Woodview Terrace,
Manningham.

1912-1922

TEN years ago we started to manufacture and sell wireless apparatus, and though our activities were diverted into other spheres during the War, we are still the leading provincial wireless supply house.

To-day we describe some of the instruments we manufacture, and ask you not to forget to give us a call at **STAND 42**.

All our apparatus conforms to the Postmaster-General's Regulations, and is licensed for amateur use in Great Britain under Marconi's Wireless Telegraph Co's patents. You are therefore perfectly safe in purchasing our apparatus.

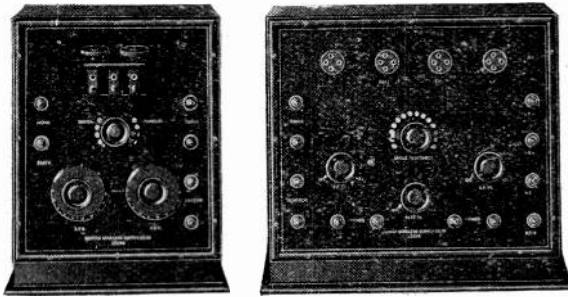

BRITWIRE Mk. III Receiver (three valve); for use on all wave-lengths. Will receive telephony or telegraphy on all waves from 100 to 20,000 metres without loss of efficiency.

BRITWIRE Mk. I Tuner. Three circuit, with series parallel switch, aerial cannot radiate.

Price—Receiver .. **£12 10 0**
 ,, Tuner .. **7 0 0**

BRITWIRE Mk. IV Receiver (four valve), with two note magnifying valves. By using this receiver telephony can be made audible over a large hall.

Price **£16 10 0**



BRITWIRE Single Valve Note Magnifier. By using this on your crystal or valve set an astonishing increase in signal strength is obtained

Price **£3 0 0**

BRITWIRE Two Valve Note Magnifier. Price .. **£5 5 0**

BRITWIRE Three Valve Note Magnifier. Price .. **£7 10 0**

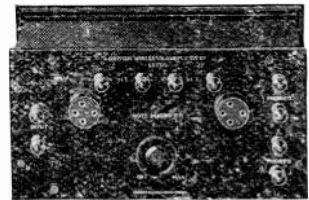

All the above valve apparatus licensed under Marconi patents for amateur use in Great Britain.

BRITISH WIRELESS SUPPLY CO., LTD.

6, BLENHEIM TERRACE, LEEDS.

Tel : 26926.

18, ELDON SQUARE, NEWCASTLE-ON-TYNE.

Tel : 360 CITY..

33, HIGH STREET, SOUTHAMPTON.

Tel : 403.

11, CHURCH STREET, WEST HARTLEPOOL.

Tel : 373.

WORKS : LEEDS.

Visit our Stand No. **42**. All-British Wireless Exhibition, Horticultural Hall, Sept. 30th to Oct. 7th.

1912—1922 (Continued).



BRITWIRE Precision Condensers.

Balanced for panel mounting, or mounted in solid mahogany cases.

·0002—Unmounted	15 0
Mounted	£1 6 6
·0005—Unmounted	17 6
Mounted	1 5 0
·001—Unmounted	1 5 0
Mounted	1 17 6

Owing to reduced manufacturing costs, we can now supply accessories at much reduced prices, while still maintaining our high standard of quality.

DUROS Cells, 2v. 45amps., ready charged	10/6	Valve Pins, per dozen	1/9
Ebonite knobs, finest quality	0/7	Valve Legs, per dozen	2/0
Engraved Condenser Dials, ebonite	3/3	Best Polished Ebonite Valve Holders	1/3
Intervalve Transformers	22/6	Switch Arms, Phosphor bronze laminated arm, lacquered	2/6
Heavy type	25/0	Lacquered Contact Studs, per dozen	1/0
Air Core Radio Frequency Transformers—300 metres	3/9	Anode Resistances, with clips, 50,000 to 80,000 ohms	2/6
600 „	4/9	Grid Leaks, resistance guaranteed, ½ to 5 megohms, with clips	2/0
1,000 „	5/3	Grid Condensers each	2/0
2,500 „	6/3	Condenser, with leak	4/0
Telephone Transformers for panel mounting	13/6	Ebonite, cut square, any size, per lb.	4/3
Reactance Formers	6/0	Enamelled Aerial Wire, 8'23 and 1/20 stranded per 100 ft.	6/0
Mounted in Mahogany Case	10/6 per 150 ft.	9/0
Polished Mahogany Battery Box, with wander plug and five sockets, for five Siemens units	12/6	Shell Insulators each	1/1
Filament Resistances, finest quality	4/6	Strain Insulators each	0/9
Knobs and Pointers, with brass bush, each	1/0	Egg Insulators each	0/6
Ivory Tabs, set of seven	1/10	Rotary Switches—5 point	4/0
Ivory Scales, 0 to 180 0/6, 0/10 and 1/6		10 point	6/0
		19 point	7 0

We also have a very large stock of MAGNAVOX Loud Speakers, and can sell either as factors or retail. Trade enquiries invited. We now have large stocks at all our branches. All retail orders over 40/- in value carriage paid.

Send for Illustrated List. Post free 3d.

POST ORDERS TO

BRITISH WIRELESS SUPPLY CO., LTD.

6, BLENHEIM TERRACE, LEEDS.

Tel: 26926.

33, HIGH STREET, SOUTHAMPTON.

Tel: 403.

18, ELDON SQUARE, NEWCASTLE-ON-TYNE.

Tel: 360 CITY.

11, CHURCH STREET, WEST HARTLEPOOL.

Tel: 373.

WORKS: LEEDS.

HELLO—C.Q.!!!

HAVE A LOOK AT THIS
SULLIVAN'S
120 ohm HEADPHONES

Complete with cords, **£1 7s. 6d.** per pair, carr. free!

In new condition.

Cash with order. Write at once or you may be too late
 —we will not have half enough.

ANOTHER SPECIAL:—

VARIABLE CONDENSERS

*001.	16/-	set of parts.	19/-	assembled
*0005.	10/-	"	13/-	"
*0003.	8/6	"	11/6	"
*0002.	7/-	"	9/-	"

Complete with knob and pointer. Other sizes pro rata.
 Complete in Polished Hardwood Cabinet 6/- extra.
 3" Engraved Dial and Knob applied in place of Knob
 and Pointer 3/3 extra.

COMPLETE AERIAL 10/6

Comprising:—100' 7/20 Copper Wire, 4 Insulators,
 24 yds. Rope, 12" Lead in Tube, 2 Pulleys, Post 1/-.

NOTTINGHAM RADIO SUPPLIES

3, THE POULTRY, NOTTINGHAM.

To the Trade Only

We are able to deliver the following FROM STOCK

R.M.C. Liquid Grid Leaks (Prov. Patent 12270).

Filament Resistances.

Aerial and Lead-in Insulators.

Switch Arms.

Set of Parts for Valve Panel.

L.F. Amplifiers, etc.

Please give Trade References with application for list.

Radio Manufacturing Co.,
 100, DALE END, BIRMINGHAM.

The Best Book about Wireless Telephony

Just Published

RADIO FOR EVERYBODY

By A. C. Lescarboua, Managing Editor
 of the *Scientific American*. Edited by
 R. L. Smith Rose, M.Sc., D.I.C. With
 170 Illustrations.

Crown 8vo.

7s. 6d. net.

METHUEN & CO., LTD.,
 36, ESSEX STREET, LONDON, W.C.2

WIRELESS RECEIVERS AND ACCESSORIES IN STOCK.

All Burndep apparatus in stock: batteries,
 'phones, etc.

Aerials erected at Moderate Charges.

ALL AMATEUR REQUIREMENTS

G. H. CHARD & Co.,

24a, Great Portland Street, London, W.1.

Phone: Gerrard 8602.

THE CONSTRUCTION OF AMATEUR VALVE STATIONS

By ALAN L. M. DOUGLAS. Price **1/6** nett. 78 pages. 55 Diagrams and Illustrations.
 Postage 2d.

The aim of the author in compiling this volume has been to place within the reach of the amateur who is interested in Wireless Telegraphy and Telephony a Handbook which will enable him to obtain data that he has otherwise difficulty in acquiring, in order that he may construct for himself apparatus which he desires to make, but does not quite know how to design correctly.

THE WIRELESS PRESS, LTD., 12-13, Henrietta St., Strand, London, W.C.2

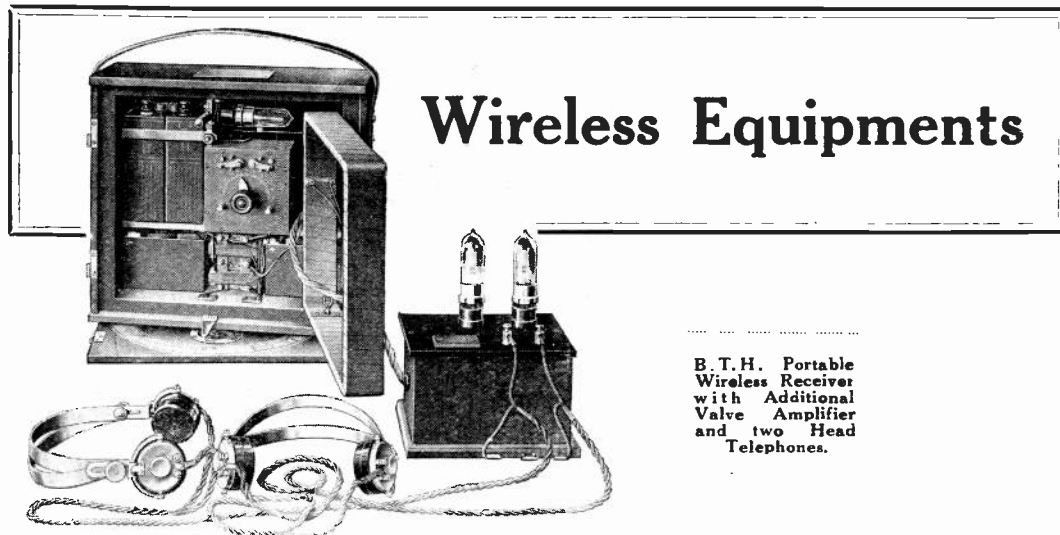

Wireless Equipments

B.T.H. Portable Wireless Receiver with Additional Valve Amplifier and two Head Telephones.

- B.T.H.**
Portable Receivers
Crystal Receivers
Amplifiers, High & Low Frequency
Head Telephones
Loud Speakers
Concertphones
Morse Inkers
Motor Generator Sets
Time Flashers
Aerial Equipments
Tuning Condensers
Morse Buzzer Sets
Valves
Tungar Rectifiers for charging Accumulators

B.T.H. Electrical Plant of every description — from the smallest electrical lamp to the largest turbine driven alternator — is universally characterised by the highest standards of design and workmanship. These qualities are equally evident in the large range of Wireless Equipment manufactured by this Company—the combination of scientific accuracy and simple construction ensuring perfect operation.

SEE STAND No. 7
 at All-British Wireless Exhibition

The British Thomson-Houston Co., Ltd.

Electrical Engineers and Manufacturers.

Head Office & Works



- RUGBY, England.

FOLLOW THE CROWD
TO
STAND NO.1.
AT THE
**ALL BRITISH
WIRELESS EXHIBITION
AND INSPECT
THE
Crystophone
REGISTERED
COMPLETE OUTFITS**

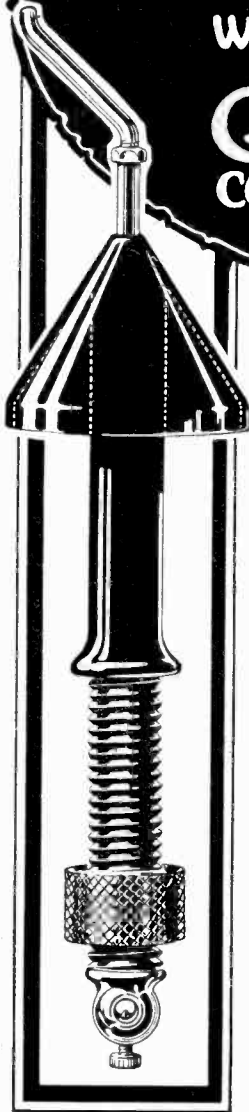

It will be to your own interest and future satisfaction to visit our stand before deciding on your wireless outfit.

THERE IS A
CRYSTOPHONE
FOR EVERY PURSE
AND PURPOSE

Wireless Supplies Co.,
64, Mortimer Street, London, W.1.

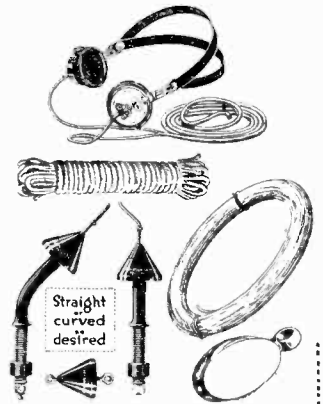

CALL AND INSPECT
OUR COMPLETE OUTFITS

Outfit No. 1. Crystophone Receiver Type 20 T.T., Crystor Aerial Outfit, a pair of Sterling Headphones, 4,000 ohms, packed in suitable box £7 12 6

Outfit No. 2. Crystophone Receiver, Type 21 T.T. Crystor Aerial Outfit, a pair of Sterling Headphones, 4,000 ohms, packed in suitable box £6 15 6

Outfit No. 3. Crystophone "Scout" Receiver, Crystor Aerial Outfit, a pair of British Headphones, 4,000 ohms, packed in suitable box . . . £5 12 6

STAND **37** STAND

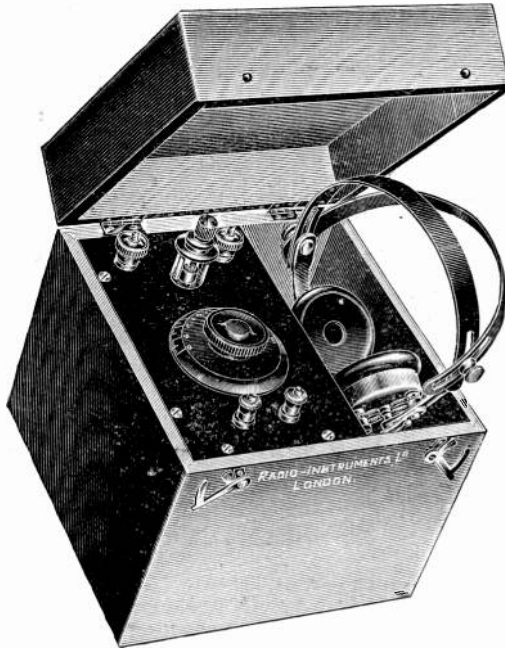

A really good CRYSTAL SET

This is the most efficient crystal set yet devised. It is of high-class scientific design.

The crystal is enclosed in a cylindrical glass case with a special form of adjustment to secure mechanical stability and quickness of setting.

The panel is of ebonite highly finished, and the case of polished mahogany.

The pair of double earpieces, high resistance telephones of very superior pattern, are contained in a separate compartment, additional terminals are provided.

The Variometer tuning is built up with an engraved ebonite bevelled dial.

This set is the most scientific and best finished crystal set on the market and is sold at a price within the reach of everyone.

£4 10s. 0d.

Complete with 100ft. of aerial wire and insulators.

A LOUD SPEAKER

Well worth having

This elegant and efficient instrument is not assembled from oddments but is an exclusive model designed and manufactured by our staff of radio engineers of long experience and established reputation.

The magnetic and acoustic systems, the two vital points in loud speaker design, have received very special attention in this model.

Cobaltcrom bar magnets, far superior to the ordinary type of magnets, are employed.

An absolutely distortionless acoustic system has been adopted.

High resistance winding. No transformer needed.

The appearance is particularly pleasing and a variety of finishes are available.

Price in standard bright or black nickel or gunmetal—

£3 0s. 0d.

Extra for oxydised silver, 2/6.

GET A COPY OF THE R.I. CATALOGUE.

Now ready. Full of valuable information. Up-to-date. Authoritative. Indispensable. 6d. per copy.

RADIO INSTRUMENTS LIMITED

Managing Director: J. Joseph, M.I.E.E., late Manager to Mr. H. W. Sullivan.
Chief Designer: W. A. Appleton, M.B.E., M.I.R.E., late Admiralty Technical Research Officer.

ONLY ADDRESS. Works, Offices, Showrooms:

12a, Hyde Street, New Oxford Street, W.C.1

Telephone: Regent 1908.

'Grams: "Instradio, London."

Visit our Stand No. 37. All-British Wireless Exhibition, Horticultural Hall, September 30th to October 7th.



The attention of Manufacturers and the Trade is specially drawn to this Announcement.

EXPERIENCE

AMPLIFICATION

RADIO FREQUENCY AUDIO FREQUENCY

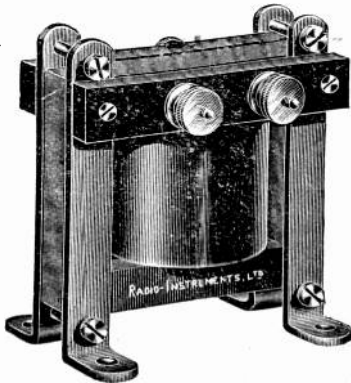
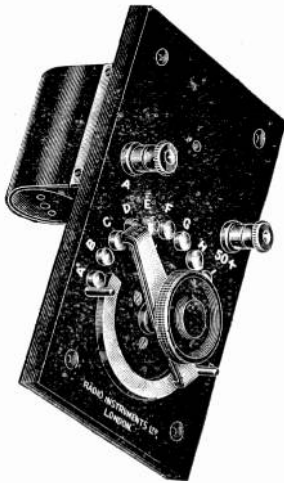
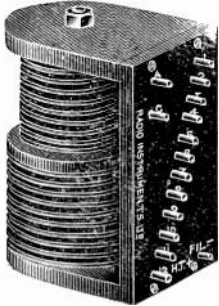
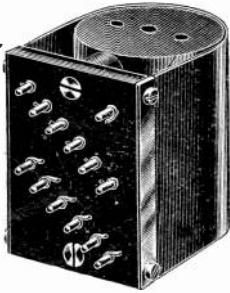

Whether you wish to amplify before or after rectification, we can supply you with scientifically designed apparatus for obtaining the maximum efficiency. This is backed up by the reputation of our engineers and designers who have received universal recognition for their work in the wireless industry.

Our complete range of radio and audio frequency transformers and reactance coils covers all requirements. Detailed information is given below, and we invite you to call and inspect the various items at our showrooms.

NOTE.—A complete working diagram is sent out wherever necessary.

IMPROVED ADJUSTABLE REACTANCE COIL.—This is recommended where one or two stages of radio frequency amplification are required. It is more stable than a radio frequency transformer. Twelve tapings are provided and the instrument is self-tuned, no variable condenser being required.

Suitable for wavelengths of 100-20,000 metres.

PRICE 25/-

WITH 12-POINT SWITCH 18/- EXTRA

For multi-stage radio frequency amplification we recommend our improved RADIO FREQUENCY TRANSFORMER. This is made in two ranges:—

(A) 100-4,000 metres, with 9 tapings.

PRICE 25/-

WITH 12-POINT SWITCH 18/- EXTRA

(B) 100-30,000 metres, with 12 tapings.

PRICE 40/-

WITH 12-POINT SWITCH 18/- EXTRA.

(B is approximately twice the size of A.)

TWELVE POINT SWITCH. This is a well-made laminated switch with extra large contacts. It is exactly as fitted to our own instruments and is the best switch it is possible to obtain for wireless work. The contacts are absolutely certain.

PRICE 16/-

AUDIO FREQUENCY TRANSFORMERS. For intervalve audio frequency amplification and note magnifiers. The many testimonials received and the large number of these transformers sold prove this design to be considerably in advance of any previously available.

This transformer is suitable for use with the Magnavox as a pressure of 250-300 volts may be applied direct across the windings.

PRICE 25/-

TELEPHONE TRANSFORMER. For use with any type of loud speaker.

PRICE 20/-

DELIVERY FROM STOCK.—We hold stocks at present but it is advisable to lose no time in placing your orders.

RADIO INSTRUMENTS, LTD.

Managing Director: J. Joseph, M.I.E.E., late Manager to Mr. H. Sullivan.
Chief Designer: W. A. Appleton, M.B.E., M.I.R.E., late Admiralty Technical Research Officer.

ONLY ADDRESS. Works, Offices, Showrooms:

12a, Hyde St., NEW OXFORD ST., W.C.1

Telephone: Regent 1908. 'Grams: "Instradio, London."

Get a Copy of the R.I. Catalogue.

Now ready. Full of valuable information. Up-to-date.

Authoritative. Indispensable. 6d. per copy.

Visit our Stand No. 37. All-British Wireless Exhibition, Horticultural Hall, September 30th to October 7th.

STAND **37** STAND

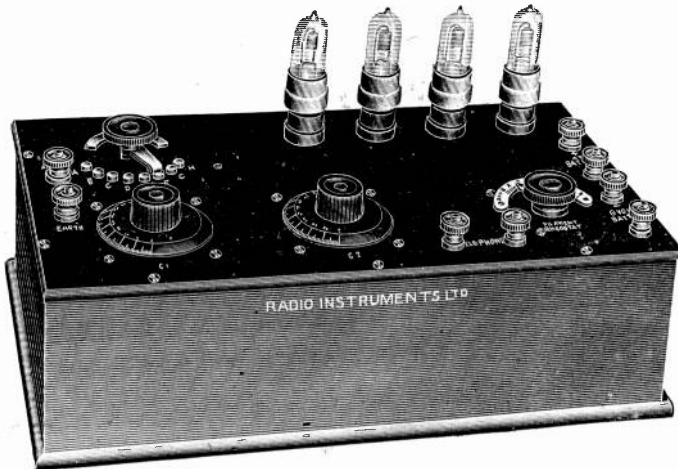

VALVE SETS

One, two, three,
four or seven
valves

Radio frequency
amplification
Audio frequency
amplification

We manufacture a complete range of valve sets comprising one, two, three, four or seven valves, operating with high and low frequency amplification as required. All our instruments comply with the new P.O. requirements and are fully licensed. Customers are therefore guaranteed against patent infringements. Full particulars on application. Call at our Stand and make a thorough inspection of these sets.

THE CABINET SET DE LUXE

This is a complete and self-contained cabinet model. No aerial or earth lead is required or external wires of any description. It is as completely portable as any ordinary piece of furniture. Simplicity of operation has been most successfully accomplished, no technical knowledge or skill being necessary. The model contains a powerful loud speaker which is of a most efficient design. The frame aerial in the lid is directional so that it can be swung into the position giving the best reception. This model will operate equally well in any room of the house, out on the lawn or wherever the broadcasting concert is required. Simply place the cabinet where you desire the music, open the lid and switch on the valves and the broadcast programme is immediately received. We are exhibiting this wonderful model and invite you to inspect it at our stand. Full particulars on application.

THE R.I. CATALOGUE

Now ready.

Contains all the information required for building up your own set. Comprises all receiving sets from the simplest crystal to the most elaborate country house cabinet model, with loud speaker and frame aerial. Specially prepared for wireless broadcasting. In full accordance with the latest developments in wireless science and broadcasting.

UP-TO-DATE.

AUTHORITATIVE.

INDISPENSABLE.

Get your copy at once. Limited edition. Price 6d.

CIRCUITS AND DIAGRAMS

In response to many requests we have prepared a book of wireless circuits specially for the amateur experimenter. Among the many up-to-date diagrams will be found circuits specially designed for broadcasting. Every circuit has been carefully selected. We invite you to inspect this very valuable little book at our Stand (No. 37) during the Exhibition. Price 1-.

GET A COPY OF THE R.I. CATALOGUE.

RADIO INSTRUMENTS LIMITED

Managing Director: J. Joseph, M.I.E.E., late Manager to Mr. H. W. Sullivan.
Chief Designer: W. A. Appleton, M.B.E., M.I.R.E., late Admiralty Technical Research Officer.

ONLY ADDRESS. Works, Offices, Showrooms:

12a, Hyde Street, New Oxford Street, W.C.1

Telephone: Regent 1908.

'Grams: "Instradio, London."

Visit our Stand No 37. All British Wireless Exhibition, Horticultural Hall, September 30th to October 7th.

The London Telegraph Training College, Ltd.

Telephone
WESTERN 2696.

Morse House, Earl's Court, S.W.

ESTABLISHED
25 YEARS.

OFFICIALLY RECOGNISED BY THE WAR OFFICE AND POST OFFICE AUTHORITIES

CABLE AND WIRELESS TELEGRAPHY.

PARENTS desirous of placing their sons in either of the above Services and of affording them the best training facilities should apply for particulars of Courses and the methods of instruction which place this Institution in the first rank. **Cable Telegraphy** offers at the present time excellent prospects to youths from 15 years of age and upwards, and the **College has exclusive facilities** for obtaining posts for qualified students in the leading Cable Companies at **commencing salaries** of £150 to £300 per annum, with yearly increments of £12 to £25, and ultimate possibilities of obtaining positions as Supervisors, Assistant Superintendents, Managers, etc.

In the **Wireless Telegraph Service** the commencing remuneration at the present time is approximately £150 per annum, and Operators, when qualified by obtaining the Postmaster-General's Certificate of Proficiency, are nominated by the College for appointments.

No Correspondence Classes or Branches.

DAY AND EVENING CLASSES.

Prospectus containing all information will be forwarded on application to

THE SECRETARY (Dept. H.), 262, Earl's Court Road, Earl's Court, London, S.W.5

Sole Proprietors of the "Scott" Training Disc, which contains useful formulæ and other information for Wireless Telegraph Operators and is invaluable to Army Signalling Officers for range finding, etc.

Price, complete with instructions for use, 1/- . Postage 2d.

BASKET COILS

New design, wound with silk covered copper wire and impregnated with a waterproof insulating varnish. These coils give results equal to any duo-lateral coil and have extremely low self capacity.

Price per set of eight coils mounted on ebonite supports with sockets for plug bases; wavelength range 200 to 10,000 metres **45/-**

Price per set of six coils, ditto, wavelength range 200 to 4,000 metres **30/-**

COIL MOUNTINGS

for the above coils, with rack and pinion adjustments, giving parallel motion to coils.

Price, double **16/-** Price, triple **30/-**

VARIABLE CONDENSERS

for panel mounting, with graduated ebonite dial; a first class instrument.

·00003 mfd. maximum capacity **6/6** ·0002 mfd. maximum capacity **15/-**

·0005 " " " **18/-** ·001 " " " **24/-**

VALVE DETECTOR PANELS

complete, price **30/-** each.

TELEPHONES

4000 ohms, price **32/-** per pair 120 ohms, price **30/-** per pair.

All Accessories and Parts of the Best Design and Construction at keen prices. Let us quote you. Trade Enquiries Solicited.

Send 3d. in stamps for our illustrated catalogue.

RADIO EXPERIMENTAL CO., 103, Gell Street, SHEFFIELD

MITCHELL'S

Electrical & Wireless, Ltd.

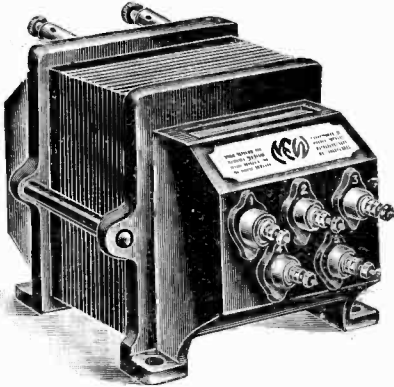

Wireless Transformers of many and all classes.

Being Specialists in Transformers since 1911, we can put before you our experience. Transmitting Transformers with multiple secondaries are a speciality, and our prices are right. Intervalve transformers—our "Hedgehog" has made wonderful progress and has been adopted by many prominent instrument manufacturers as their standard. Testing transformers for laboratory use can be built promptly. We now have completed our Tests, and can supply Transformers which enable you to obtain your Filament Supply and your Anode Voltage from the Alternating Current Mains. Ask at Stand No. 21 for Literature.

We will be showing a range of High Tension Generators as supplied to Commercial Undertakings, both Home and Abroad.



Valve Holders, manufactured in Peckham, are distinctive—ten patterns to select from. Trade specially invited to examine the whole range and obtain our keen quotations. Our prices are right.

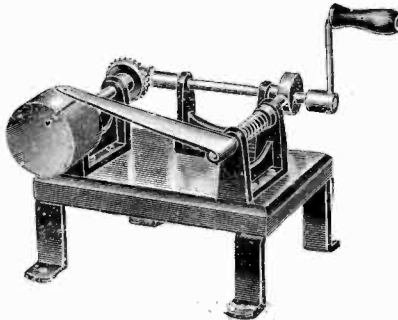

The "Lokap" Machine, and "Lokap" Patents (pending), a new system of Coil Winding and Mounting, that is a great improvement on any other systems. Worked out, manufactured and distributed from Peckham. Full particulars on Stand No. 21. Special book on Lokap Coils shortly available for Amateurs.



Turned ebonite parts for High Frequency Transformers, and other component parts. Our works are well equipped for small or large quantities. Sample of our workmanship on Stand No. 21.



Crystal Cups, general brass work, true to a "thou.," well turned, finely lacquered. Pass all your enquiries to Stand No. 21.

How to Erect an Aerial and Crystal Receiving Set. Booklet, 4d. post paid.

The "Symoplion" the wonder instrument. Booklet, 6d. post paid.

We want to make your personal acquaintance at Stand No. 21 to show you the celebrated instruments that we manufacture for all wireless purposes. Many new lines to see, including Valve Sets, that appeal to every trade of importance.

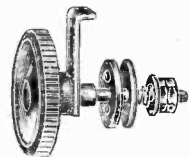

Selecting switches that are different. A Mitchell manufactured component adds to the appearance of your set, see samples on Stand No. 21.

Visit our Stand No. 21. All-British Wireless Exhibition, Horticultural Hall, September 30th to October 7th.



**McDermott Road,
Peckham, London,
S.E.15**



Western Electric

MAKERS OF OVER

Half the World's Telephones

THE evolution of Wireless Broadcasting is due only to the continual research work of the engineers of the Telephone Industry.

The success of Radio Telephony is the achievement of Telephone Engineers.

The Western Electric Company are the pioneers of the Telephone Industry. They have made over half the world's Telephones.

They transmitted speech over a distance of one mile in the year 1901.

They transmitted the first spoken word across the Atlantic Ocean in the year 1915—4 years before any others.

They transmitted the speech of the President of the United States of America, on the occasion of the burial of America's unknown soldier in November, 1921, to an audience of 100,000 gathered around the cemetery. At the same time the oration and the music were transmitted by Loud Speaking Apparatus to audiences of 30,000 in New York, 250 miles distant, and 20,000 people in San Francisco, 3,700 miles away.

The Western Electric Company, Limited, have developed a complete range of Radio Receiving Apparatus and Sets which are made only of the highest grade materials and embody the best workmanship possible.

All Valves used are of the enclosed pattern, which gives ample protection from accident and from dust, while the main feature of the apparatus is the absolute simplicity of adjustment and operation. No filament adjustment is necessary at any time, and a key switch is provided in each set to control the filaments.

All Western Electric Receiving Apparatus is mounted in compact polished mahogany cases and the fittings throughout are of oxidised brass.

Western Electric Company Limited.

62, Finsbury Pavement, LONDON, E.C.2

Works: NORTH WOOLWICH, LONDON, E.16
Branches: NEWCASTLE, BIRMINGHAM, CARDIFF, GLASGOW,
LEEDS, MANCHESTER.

Visit our Stand No. 39. All British Wireless Exhibition Horticultural Hall, September 30th to October 7th.

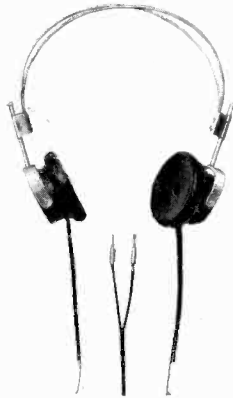

Western Electric No. 44011.

DOUBLE HEAD RECEIVERS

have been designed to give maximum efficiency coupled with a low cost of production. The regular characteristics of the windings have been fitted to the physical dimensions of the Receivers in a manner to ensure that the efficiency is practically uniform over the whole audible range of frequencies. This characteristic is in marked contrast to that of Receivers which employ the feature of resonance in order to obtain sensitiveness.



Western Electric No. 44000

CRYSTAL SET

is contained in a small polished mahogany box closed by a hinged lid. A partition is included which holds the double head receivers. The set is supplied complete with two spare crystals, and is capable of receiving within quite a large radius of a transmitting station.

Western

MAKERS

HALF THE WOR



Western Electric

VALVE DETECTOR and TUNER

is contained in a polished mahogany case and provides for the inclusion of Double Head Receivers, while a spring button is fitted on the top of the case to open the receiver compartments. The Valve filaments can be seen through a specially designed mica window, and ventilation discs are provided to fully ventilate the interior of the case. At one end of the case a small card is fitted which gives particulars of various wavelengths. The set is simplified by the use of only one handle for fine tuning, and the filament key is conveniently placed on the right hand side of the wavelength index. The valves used are specially made to Western Electric specification, and the whole set is built to give the greatest possible efficiency.

Western Electric

62, Finsbury Pave-

Works North

Branches Newcastle,
Glasgow,

Electric

OF OVER

LD'S TELEPHONES

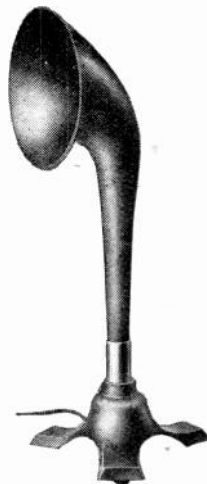
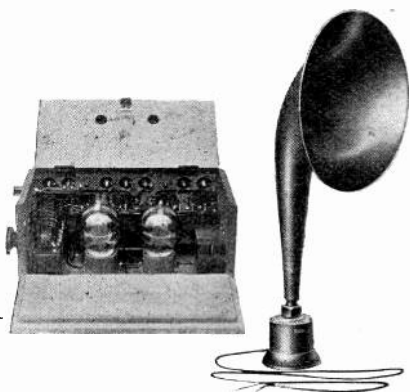

Western Electric No. 44003 LOUD SPEAKING RECEIVER

eliminates the necessity of wearing Head Receivers over the ears and can be utilised in all cases where speech or music is received in sufficient volume to be really loud on head receivers. It can be used with the valve detector alone or in conjunction with either the one stage or two stage low frequency amplifier. It has the advantage of the Head Receivers in allowing a number of people to listen-in at the same time. The Loud Speaking Receiver is supplied in three standard resistances, *i.e.*, 70, 2,000 or 4,000 ohms.

Western Electric

LOUD SPEAKING EQUIPMENT

consists of a specially designed Loud Speaking Amplifier and a Loud Speaking Receiver. Both Amplifier and Loud Speaking Receiver are so designed as to provide clear and true production over the entire musical range, *i.e.*, the outfit will receive clearly the low notes of a pipe organ and the high notes of a violin or soprano. The equipment is the result of many years research work, and there is no equipment in existence to-day which approaches it in efficiency and general reliability.

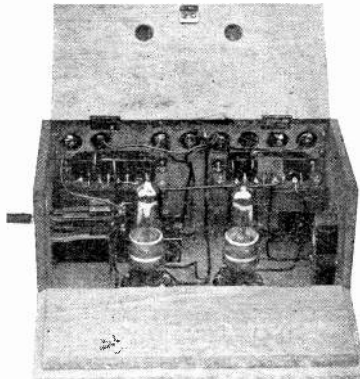

Company Limited.

ment, London, E.C. 2

Woolwich, London, E. 16
Birmingham, Cardiff,
Leeds, Manchester.

Western Electric

LOW FREQUENCY AMPLIFIER

is supplied in either one or two stages and is contained complete in a polished mahogany case. At one end of the case a key is fitted to control the stages of amplification. It is designed and constructed on the most simple lines, and the valves used are specially made to Western Electric specification. A window is inserted in the mahogany case through which the filament can be inspected, and a ventilation disc is also inserted to control the temperature of the compartment.

EVERYTHING GUARANTEED.

Scientific Wet Battery, in Walnut finished case. Nest of 50 cells, 74 volts, 22/6, post 3/6. Nest of 25 cells, 37 volts, 13/8, post 1/6.

The Popular .0005 Variable Condenser, mounted in mahogany cabinet, 17/6, post 9d. The finest value ever offered.

Vario Coupler, consisting of 3" turned mahogany ball, mounted in 3 1/2" ebonite former, which is turned and grooved for wire, all contacts made complete with bush, boss, spindles, and knob, ready for panel mounting, 15/8, post 9d. Mounted on ebonite panel and base with shorting strap and four terminals, for use as Vario Coupler or Variometer, 21/-, post 9d.

L.F. Amplifying Units for adding to Crystal, Valve sets, and Panels, for Loud Speakers, etc., mounted into walnut cabinet, 6 x 8, 1 valve 37/6, 2 valves £3 3s., post 1/-.

Black Indication Tablets, engraved White. Aerial, Earth, Phones, React., Prim., Sec., A.T.I., A.T.C., + LT—, + HT—, per set of 10, 2/6.

Tuning Stand, for Honeycomb and Duo-Lateral Coils, 2-coil stand, 10/6; 3-coil stand, 15/6; post 8d. Coil holders 1/3 each, 13/6 per doz. Standard pattern.

Sensitone Crystal. The perfect Mineral Detector, 1/- per specimen, post free.

Knife Switches on Ebonite, DPDT 2/3, SPDT 1/6, STDP 1/6. **Condenser Plates**, fixed or moving, 1/- per doz.

Spacing Washers, fixed or moving, 2/6 per gross. **Ivory Scales**, 0 to 180 degrees 6d., **Pointers 1d**, **Stop-pins 6d.** per doz.

Bushed and Tapped Ebonite Knobs, 6d. **Boss**, 2d. **Bush and Locknut**, 5d. **Threaded Rod** for spindles, 4d. per ft.

Valve Sockets, with 2 nuts, 2/- per doz. **Valve Legs**, with 2 nuts, 1/10 per doz.

Eyelet Terminals, 9d. per doz. **Pinch Clips**, 1/- per doz. **Contact Studs**, 6 B.A., 1/4 or 5/16 diameter, 6d. per doz.

Filament Resistances, for panel mounting, 3/6, post 4d. **Mark III Terminals**, with nuts, 2/3 per doz., post 4d.

Slab Inductances, per set of 8, 10/-, post 9d. **Basket Inductances**, per set of 7, 7/-, post 5d.

Systoflex Sleeving, in various colours, 4d. per yard length.

SCIENTIFIC SUPPLY STORES, 8, Newington Causeway, LONDON, S.E.1

*Phone—Hop 4177.

A GUARANTEE

Of money back, if unapproved, accompanies every Condenser we send out. Were we not confident that, at the price, our Instruments are absolutely the best Condenser value on the market, we could not afford to give such a guarantee.

FOR PANEL MOUNTING. Specification: Rotary. Air Dielectric. Stout, well cut Vanes. Adjustable bearing. Contact to moving Vanes by Copper Strip. Built upon Ebonite top and bottom supporting plates. Suitable for mounting on ANY Panel, from 1/4" to 1/2" thick by drilling three holes. Supplied with screws for fixing, in the following capacities: '0005, 15/-, 2 for 28/6, 4 for 55/6; '0003, 12/6, 2 for 23/6, 4 for 45/- Assembled ready for working.

MOUNTED CONDENSERS: Specification as above. Mounted in polished Mahogany case, 4 3/8 x 4 3/8 x 3 1/2 with Ebonite Top and Knob, Scale, Brass Terminals and Pointer in the following capacities: '0005, 18/6, 2 for 34/-, 4 for 69/6; '0003, 16/-, 2 for 30/6, 4 for 59/6.

VERNIER CONDENSERS for fine tuning: 3 plates, 4/-; 5 plates, 5/6

Delivery from stock. Postage paid on orders of £1 up. Foreign and Colonial orders postage extra. Trade supplied. Liberal discounts.

Fallon Condenser Manufacturing Co.
230a, HERMITAGE ROAD, LONDON, N.4

EBONITE

SHEETS, RODS, TUBES, MOULDINGS, PANELS
TONS OF SHEETS

in London Stock suitable for all requirements of the Wireless Trade.

ENQUIRIES INVITED.

RADION

This is the latest product of our Factories—a superior insulating material for high grade sets, which in grain and colour closely resembles mahogany. Manufacturers looking for something distinctive are invited to write us for further particulars.

AMERICAN HARD RUBBER Co. (Britain) Ltd.

13a, FORE STREET, LONDON, E.C.2

TELEPHONE—12754 CENTRAL.

**ACCESSORIES
FOR
PRIVATE WIRELESS
INSTALLATIONS**



**TELEPHONE HEAD SETS
AERIAL WIRE & INSULATORS
PROTECTORS FOR
AERIAL & BATTERY
EARTHING DEVICES
JACKS & PLUGS
H.T. BATTERIES,
ETC. ETC.**

Descriptive pamphlet and prices on application to

THE MANUFACTURERS:

**SIEMENS BROTHERS & CO., LTD.
WOOLWICH, LONDON, S.E. 18**

Telegrams :
SIEMENS, WOOLWICH.

Telephone :
CITY 6400-

and at

Belfast, Birmingham, Bristol, Cardiff, Glasgow,
Leeds, Manchester, Newcastle, Sheffield, Southampton.

Visit our Stand No. 48. All British Wireless Exhibition,
Horticultural Hall, September 30th to October 7th.

**W. & M.
FIXED
CONDENSERS**

Accurately made to definite capacities.

All sizes ready for delivery.

.002 to .002 mfd. 2/6 each.

.003 and .004 mfd. 3/- each.

Ready for immediate use. Securely packed.

Mounted in ebonite. Complete with knurled terminal nuts and correct capacity stamped on each condenser.

Send for General Price List of W. & M. Apparatus and Supplies, post free.

We sell on the distinct understanding that if the buyer is in any degree dissatisfied with his purchase, he can return same within 24 hours and money will be immediately refunded.

Free Advice to Buyers.

All our Apparatus is produced under the personal supervision of our Technical Director, Mr. Henry A. Machen, A.M.I.E.E. (late of Siemens Bros. & Co., Ltd.), whose experience in the design and manufacture of Wireless Apparatus extends over a period of fifteen years.

If you have any difficulty in obtaining W. & M. Wireless Supplies, write to us, giving the name of your Dealer.

NOTICE TO THE TRADE.

We are prepared to appoint District Agents for the sale of W. & M. Wireless Supplies, and to refer all postal orders and inquiries to such appointed Agents.

Terms and Discounts on Application.

MANUFACTURED SOLELY BY THE

**Wainwright Manufacturing Co., Ltd.,
25, VICTORIA STREET, S.W.1**

Works: WALTHAMSTOW, Essex, and BIRMINGHAM.

Telegrams: "NOMINATUS, VIC, LONDON."
Telephone: VICTORIA 4319.

"COSSORS"

invite you to

Stand No.

29

for

Latest Developments

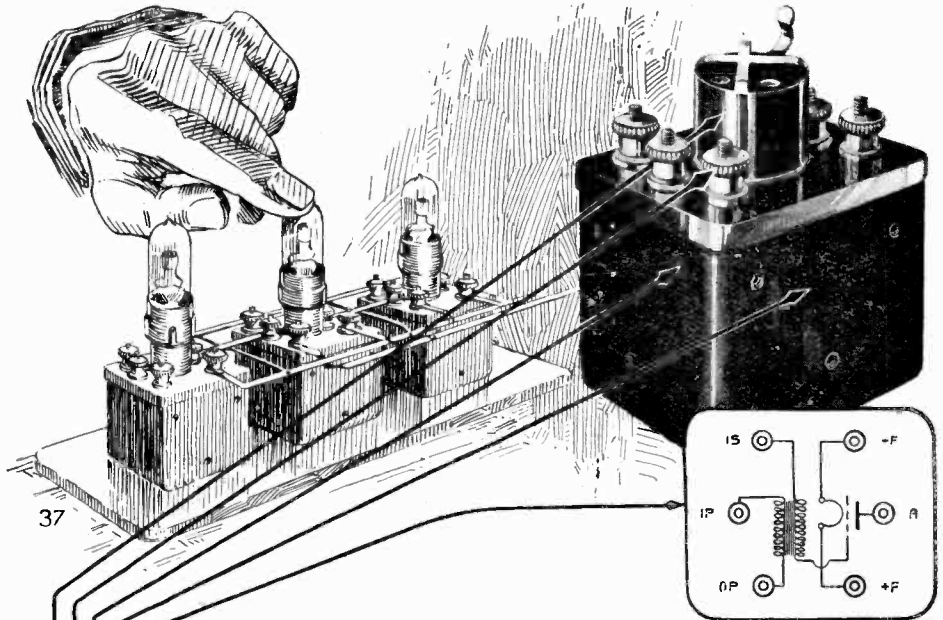
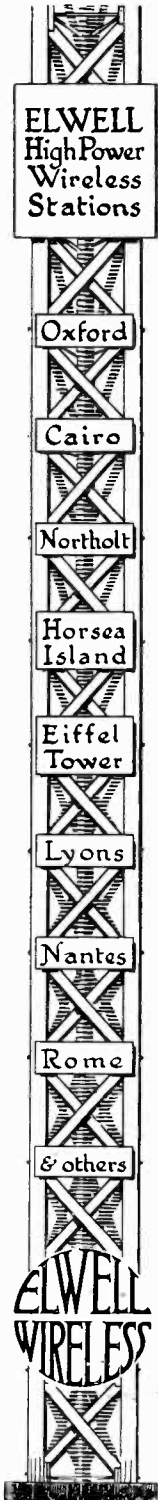

No need to spend time making these connections. The Elwell note magnifier contains them ready made.

The intervalve transformer is contained in an iron case, allowing units to be placed close together without howling.

Tapped holes in two sides and base make fixing easy. The unit will also stand alone.

All connections are embedded in compound and brought out to terminals. No soldering necessary. The perfect insulation of the grid connection ensures silent operation.

The valve holder has specially long leakage paths and an earth clip.

This patented amplifying unit, when provided with a valve and connected as marked on the terminals, is all that is necessary to give one stage of note magnification to your existing set.

Two, three or more units may be coupled as shown, to give as many stages of note magnification as required.

PRICE 39/6 each.

AMPLIFYING MADE EASY

When building a valve set, do not buy intervalve transformers. Use Elwell Amplifying Units. They save time, money and trouble.

When buying a valve set, select one using these units. They enable the manufacturer to give you a better job at a lower cost.

The unit featured is a note magnifier.

A similar design of unit is available as an oscillation amplifier and a third design as a rectifying unit.

WRITE US OR CALL.

C. F. ELWELL, LTD., *Radio Engineers,*
CRAVEN HOUSE, KINGSWAY, LONDON, W.C. 2
 Telephone: **REGENT 421.**

Visit our Stand No. 45. All-British Wireless Exhibition, Horticultural Hall, September 30th to October 7th.

Intervalve Transformer

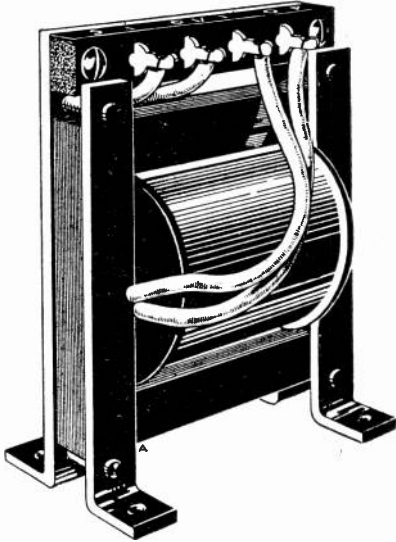

Price 30/- each

After exhaustive experiments these transformers have been found highly satisfactory, being distortionless and very suitable for the reception of speech and music, especially on low wavelengths.

TELEPHONE TRANSFORMERS

Similar in design to our Intervalve Transformer.

Price 22/6 each

Dimensions of Transformers :
Height 3½". Width 2½". Dimension over feet 2".

PATENT COIL MOUNT COMPONENT

Price 22/6 each

A very simple and effective device for the manipulation of the coils, ensuring a very fine tuning. This component is made for use with two coils, but can be supplied to carry three coils at slightly extra cost, according to customer's requirements.

DUBILIER CONDENSERS ALL TYPES

We have been appointed agents in Manchester and District for the sale and distribution of this firm's well known specialities and are now in a position to deliver from stock all types of condensers. Enquiries invited.

Terms of Business.

Cash with Order.

Orders over value £5 carriage paid.

TRADE TERMS ON APPLICATION.



The Manchester Radio Co., Ltd.
155, OXFORD ROAD

(Entrance Boundary Street East)
MANCHESTER

Telephone: Central 4955.

"Castaphone"

(Reg. Trade Mark)

Crystal Receiving Sets

ARE THE BEST FOR

TELEPHONY

Price 65/-

WRITE FOR PARTICULARS.

GORDON CASTAGNOLI

MANUFACTURER OF WIRELESS APPARATUS

15, Rayne Road, Braintree, Essex

"OOJAH" BASKET INDUCTANCES

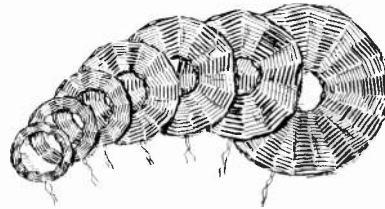

Set of 7, giving an approximate wavelength range of 150m to 4500m in conjunction with a .0011mf. condenser.

PRICE 7/- PER SET

POST FREE.

LIBERAL DISCOUNT TO FACTORS.

All "OOJAH" Inductances are wrapped in a transparent covering and sealed with the Registered Trade Mark "OOJAH."

The Seal is a guarantee of quality.

None are genuine without.

"OOJAH" Basket and Slab Inductances are being extensively copied, as most good things are, and purchasers are advised to not only specify "OOJAH" Brand in their orders, but to see that the seal is intact.

GREENSLADE & BROWN

LANSDOWN ROAD, CLAPHAM, S.W.9

Telephones—BRIXTON 639 & 3251.

If you want advice as to the books on Wireless Telegraphy and Telephony best suited to your requirements write to :

**The Radio Expert,
The Wireless Press, Ltd., 12-13, Henrietta Street, London, W.C.2.
THE PIONEER HOUSE FOR WIRELESS PUBLICATIONS.**

IF IT'S ABOUT WIRELESS

—ASK US—

We hold a complete stock of everything wireless and can usually supply by return post

Send to-day for complete lists

Electrical Supply Stores

5, Albert Terrace, King Cross,
Halifax, Eng.

SPEARS and COMPANY

FOR

TERMINALS

SCREWS, NUTS, WASHERS, PLUGS and SOCKETS, CONTACT STUDS, BUSHES, VALVE LEGS, CONDENSER VANES and TURNED and PRESSED PARTS OF EVERY DESCRIPTION.

Actual Manufacturers to TRADE ONLY

WE REGRET WE CANNOT SUPPLY SMALL LOTS TO AMATEURS

**CAPSTAN REPETITION WORKS,
PARK ROAD, HOCKLEY, BIRMINGHAM**
Telephone: 3265 Central. Telegrams: "Firettes," Birmingham

**THE
PARAGON RUBBER MANUFACTURING CO.
SCULCOATES, HULL.**

E B O N I T E	W I R E L E S S
Sheet, Rod & Tube	K N O B S
E L E C T R I C A L	V A L V E S
M O U L D I N G S	S L I D E R S, E t c.

Wholesale only.

London Office: **PERCY W. C. TRICK,**
20, LITTLE PORTLAND STREET, W.1
Telephone: MUSEUM 2043.

" EIFFEL TOWER TYPE."

MASTS

STRONG.	LIGHT.
WOOD LATTICE.	EASY TO ERECT.
ROT AND WATER PROOF.	

20 to 50 feet	- - -	1/-	per foot
55 ,, 100	- - -	1/6	,, ,,

FROM STOCK. CASH WITH ORDER.
WILKINSON, Lonsdale Road, Kilburn, N.W.6
Same Address since 1900. Trade Supplied.
Bankers—LONDON CITY AND MIDLAND, KILBURN, N.W.6.

**LISTEN - IN — on the
"AEROWAVE"
RECEIVER**

A complete
Installation
at a low cost

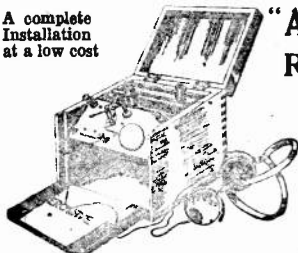

Price
£6 : 6 : 0
with complete
Equipment

HENRY J. BREWSTER & CO.
11, Queen Victoria Street, LONDON, E.C.4

WIRELESS.

GENTLEMEN of good address and superior education required in every large town in the British Isles as **SOLE REPRESENTATIVES** to call on Booksellers with latest books on Wireless, on commission basis. Excellent spare-time occupation for keen, energetic men.

Write fullest details and references to :
**Box 767, Sell's Advertising Offices,
Fleet Street, E.C.4.**

OUR EASY PAYMENT SYSTEM

For the PURCHASE OF BOOKS is still open to ALL READERS
FOR FULL PARTICULARS WRITE THE MANAGER, MAIL ORDER DEPT.,
THE WIRELESS PRESS, LTD., 12-13, Henrietta Street, London. W.C.2

WIRELESS BROADCASTING

3 Good receivers

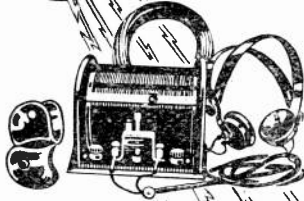

Fellocryst

A simple and reliable crystal receiver for all wavelengths from 300 to 1500 metres. Complete with one pair 4000 ohms double headphones, 100 ft. aerial and insulators.

£ 3 : 7 : 6 (Postage: 1/6 extra)

Fellocryst Super

For fine tuning for all broadcasting wavelengths from 300-500 metres. Mounted in oak cabinet and highly finished, complete with one pair 4000 ohms double headphones, 100 ft. aerial and insulators.

£4 : 7 : 6 (postage 2/- extra)



Fellophone

2 VALVE RECEIVING CABINET For all broadcasting wavelengths from 300-500 metres. In solid oak cabinet complete with H.T. battery, 6 volt accumulator, 4000 ohms double headphones, 100 ft. aerial and insulators, but without valves.

£9 : 0 : 0 (carriage 2/- extra)

2 Mullard "ORA" valves for Fellophone - - 30/- extra
Extra headphones complete, 30/- per pair.

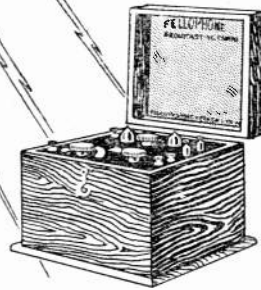

"for they are jolly good Fellows"

FELLOWS MAGNETO CO., LTD.

LONDON, N.W.10.

Telephone: Willesden 1560-1.

Telegrams: Quixmag. Phone, London.

Visit our Stand No. 10. All-British Wireless Exhibition, Horticultural Hall, Sept. 30 to Oct. 7th.

(E.P.S. 3)

GECOPHONE

RECEIVING SETS & AERIAL EQUIPMENT



for
**WIRELESS
 BROADCASTING**

An illustrated descriptive booklet, No. B.C. 2815, the most complete and comprehensive of its kind yet published, containing full particulars of Gecophone Wireless Apparatus, together with details and diagrams for erection of aerials, etc., will be forwarded post free on application to—THE GENERAL ELECTRIC CO., LTD., Dept. W/T, Magnet House, Kingsway, London, W.C.2.



"GECOPHONE" Receiving Sets are obtainable from Electrical Contractors, Stores & Ironmongers.
 MANUFACTURERS & WHOLESALE ONLY

THE GENERAL ELECTRIC CO., LTD., Magnet House, Kingsway, London, W.C.2

WE ARE VERY MUCH DISAPPOINTED

**LIGHT, SENSITIVE,
COMFORTABLE.
BRITISH NOT FOREIGN**



It would appear that so many cheap headphones have been offered that the public are dubious as to the genuineness of our special offer of our standard 'phones. May we assure our wireless friends that this special offer is an advertisement only, and that we cannot continue the offer after the first 1000 have been sold. We know that for every set sold we shall get many orders through recommendation. We frankly admit that we are disappointed, and as we can say nothing but praise for the *Wireless World* as an advertising medium, we can only surmise that the public think they are "cheap junk." In order therefore to make doubly sure of securing their custom we shall supply orders in hand and all orders received until the first 1000 have been sold at the prices below, and will gladly refund cash if not entirely satisfied.

- | | | | | |
|----------|---|------|---------|-----------------------------|
| 140 ohm | - | 23/6 | per set | } Postage
1/- per
set |
| 4000 ohm | - | 25/- | per set | |
| 8000 ohm | - | 27/6 | per set | |

The trade are invited to enquire, as although we shall lose on trade transactions during this special offer, we feel sure that it will be to our benefit in the end.

EXTRACTS FROM OUR CATALOGUE
3d. post free.
Centre Spindles for Condensers 5d. ea.
12" lengths screwed brass rod,
3½d. to 5d. each

J. L. CARTWRIGHT & CO.

Manufacturing Electrical Engineers

130/132, London Road, Manchester Works: Berry Street

Telephone: Central 4209,
Telegrams: "Pladuram," Manchester

The Universal Tuner

The Universal Concert Tuner is the smallest, cheapest and most efficient tuner on the market for the reception of the Dutch Concert and Marconi Broadcasting.

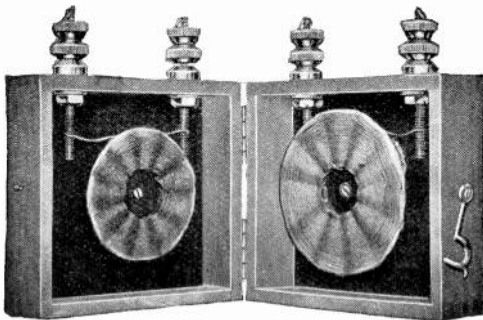

In light polished wood case, fitted highly lacquered brass terminals and fasteni g catch, with 2 coils as illustrated. Size 4" x 3½" x 1½"

Complete with full instructions.
secure one of these Tuners to-day. You will be perfectly delighted.

PRICE

7s. 6d.

POST FREE

J. LIPOWSKY Electrical and Wireless Engineer
614, OLD FORD ROAD, BOW, LONDON, E.3
Telephone: East 3345

W. A. C. SMITH

236, Argyle Street,

GLASGOW,

are Sole Scottish Agents for the
Famous Burndept Receivers



**TUBE, SHEET,
WIRE, STRIP,
ROD & CASTINGS**

IN

**PHOSPHOR BRONZE,
COPPER, BRASS, &c., &c.**

**CHARLES CLIFFORD & SON, LTD.,
BIRMINGHAM.**

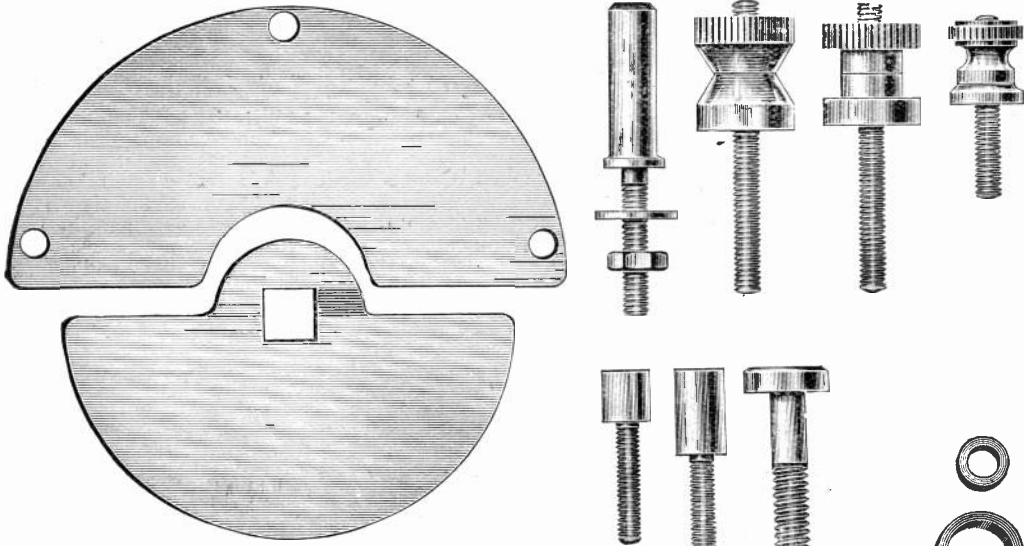

MANUFACTURERS & RETAILERS
 apply for Illustrated List
 and **TRADE TERMS.** **KEEN PRICES. PROMPT DELIVERY.**

Phone—
Holborn 1812 **ORMOND ENGINEERING CO., 199, Pentonville Rd., King's Cross, N.1.**



-----CQ Std bi
design. L.M.E.
for ERICSSON PHONES

WHEN you install your wireless set—crystal or valve
 —you'll get maximum results if you fit Ericsson
 Phones—clarity, sensitivity, strength of signals and absence
 of "click." Specially suited to telephony.
 Ericsson Phones embody the accumulated experience of telephone
 manufacture for a generation.
 Easy to the head, light and comfortable. The magnets never lose
 their strength and "shorts" are non-existent.

Write for Particulars.

The **BRITISH L. M. ERICSSON**
MANUFACTURING Co., Ltd.
 Head Office :
 60, Lincoln's Inn Fields, E.C.2

Ericsson
TELEPHONES

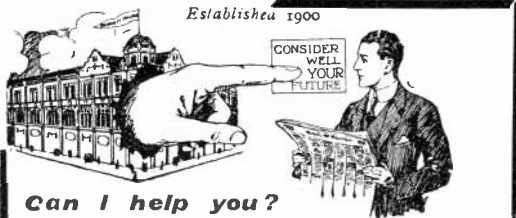

Can I help you?

I WILL GIVE YOU £50

If I fail to produce over 7,000 testimonials from others I have helped TO A SUCCESSFUL CAREER.

Yours to success,

Every man is the Architect of his own Fortune!

ARE YOU QUALIFIED FOR THE JOB YOU SEEK?

WE TEACH BY POST **ADVICE FREE.** Most moderate charges. **PAYABLE MONTHLY.** **LEARN A TRADE OR PROFESSION.**

Write for one of our **FREE BOOKLETS** on any of the following subjects:

- | | |
|---|---|
| <p>Architectural Drawing
Building Construction
Clerk of Works' Duties
Aviation
Boiler Engineering
Boiler Making
Chemistry
Civil Engineering
Concrete and Steel
Draughtsmanship
Electricity
Engineering
Foundry Work
Internal Comb. Engines
Marine Engineering
Mathematics</p> | <p>Matriculation
Metallurgy
Mining
Mine Surveying
Motor Engineering
Naval Architecture
Pattern Making
Salesmanship
Sanitation
Shipbuilding
Structural Engineering
Surveying and Levelling
Telegraphy & Telephony
Wireless Telegraphy
Special Course for Apprentices</p> |
|---|---|

What proof do you carry? Your word to an employer is not proof that you are efficient, but a College Qualifying Diploma or Certificate, signed by the Professional Staff, is a proof of efficiency, and a valuable asset in seeking a remunerative position.

We specialise in all exams connected with technical subjects. If you are preparing for any exam, ask our advice. All particulars **FREE OF CHARGE.** Parents should seek our advice for their sons. If you are interested in any of the subjects mentioned above, write, naming the subject, and we will send you our **FREE BOOKLET**

Please state your age. Courses specially combined to meet all requirements.



DEPARTMENT 129

SHEFFIELD

F. WIGGINS & SONS

MICA

Telephone :
Avenue 2248

Largest Stock
in the World.

FOR CONDENSERS

AND ALL PURPOSES.

102, 103 & 104, Minories, London, E.1

THE MARK OF



RELIABILITY

1 to 12 volts.

1 to 35 amps.

VOLT & AMMETER

Combined Dead Beat Pocket Type. New and not German. Splendid Instrument in Nickel Plated Case. Ideal for Testing Cells and Filament Current.

POST PAID **5/6** NUMBER LIMITED

OTHER EXCEPTIONAL VALUES.

- Aerial Wire. Enamelled Hard Drawn, 7/22's Copper, 5/- per 100'.
- Aerial Wire. Bright Hard Drawn, 7/22's Copper, 4/- per 100'.
- Aerial Insulators. Shell type, 2" x 2 1/2", green, 1/2 each.
- Aerial Insulators. Reel type, 2" diameter, brown, 3d. each.
- Filament Resistances. For panel mounting, 2/6 each.
- H.F. Transformers, plug in type, 300 and 700 metres, 3/- each.
- H.F. Transformers, plug in type, 1,000 m. 4/6; 2,600 m. 5/6 each.
- H.F. Transformers. Formers only, with pins. 3/- each.
- Tangent H.F. Transformers. All ranges, 6/8 each.
- Switch Arms. Complete fitted with knob. 1 - and 2 6 each.
- Dewar Switches. D.P. Change over, panel type, 2 - each.
- Lightning Arresters. Carbon block type, 1 6 each.
- Valve Holders. Flanged "A" type, 1 -. Ebonite with 8 nuts, 1/5 each.
- Ebonite Panel, fitted with 3 Valve Holders, complete, 4/-.
- Ebonite Panel, fitted with 2 Valve Holders, complete, 2/3.
- Valve Sockets, per set of 4 with 8 nuts, 7d.
- Transformer Holder. With 4 terminals and wired, 3 6 each.
- High Note Buzzer (Army Type), worth treble, 2 6 each.
- Telephone Transformers (Army Type), 9/- each.
- Wireless Jacks. 1 -, each.
- Brown's Type "A" Headphones. Guaranteed new and unused. 3,000 ohms, 49 6; 120 ohms 42 6. With cords, 51/6 and 44 2.
- Ever Ready Batteries (all sizes). 16 Volt, 3 6 each.
- Mica. Clear, Ruby. .002" thick, 3" x 2", 1 - doz. pieces.
- Inductance Slider Rod, 1" square, 13" long, drilled, 6d. each.
- Slider, complete with plunger for 1 1/2" rod, 6d. each.
- Contact Studs. Fitted with nut and washer, 1 3 doz.
- Condenser Vanes. Best Aluminium, 3 1/2", 1 6 doz. pairs.
- Condenser Spacing Washers. Small 3d., large 6d. doz.
- Condenser Screwed Rod, Brass 12" long, 1/8" dia., 3 16" 6d.
- Insulating Tubing. Assorted colours, 6d. per yard.
- Sheet Ebonite, 1" to 1 1/2" thick, 4/6 per lb.
- Terminals. Mark 3 N. Plated, 4B.A., 2 6 doz.
- Terminals. Small pattern, 6d. doz.
- Dubilier Condensers. All capacities at prices advertised.
- Grid Leaks. All resistances, 2/- and 5/- each.
- Vernier Condenser. Panel type .0005, 5/-.
- Radio Instrument L.F. Transformers, 25/- each.
- Tangent L.F. Transformers, 22/6 each.
- Ivoryine Scales. 0-130, good quality, 8d. each.
- Ivoryine Tablets. Set of seven, 1/-.
- Skinderviken Microphone Buttons, 5/- each.
- Burdopt and De Forest Coils in stock. Advertised prices.
- Small Plug and Sockets. Coil mounting type, 1 - set.
- Complete Illustrated Catalogue, post free 4d., allowed for off first order. Orders under 5/6 add 6d. for postage.

J. H. TAYLOR & CO.,

ELECTRICAL AND RADIO ENGINEERS,

Macaulay St., HUDDERSFIELD.

Telephone, 241. Telegrams: "Thorough, Huddersfield."

J. A. COOMES & CO., LIMITED

TRADE MARK.



Wireless Engineers,

2, & 4, EAST AVENUE,
MANOR PARK, LONDON, E.12

Regd.

Designers and Manufacturers of

THE IONOPHONE

THE NEW IDEAL BROADCASTING RECEIVING SET.

Perfect articulation and absence of disturbing noises. No interchangeable Tuning Coils. No troublesome Variable Condensers. No variable retroaction or self oscillation. Tuning by specially designed Variometer. Three valves (two H.F. and one rectifying).

COOMES' RADIO FREQUENCY INTERVALVE TRANSFORMERS.

COOMES' AUDIO FREQUENCY INTERVALVE TRANSFORMERS.

COOMES' TELEPHONE TRANSFORMERS.

COOMES' VARIOMETERS (Inductance range 6—1).

COOMES' LOUD SPEAKING TELEPHONE ADAPTOR.

Prices upon application
and at our Stand No. 18.

**SPECIAL TERMS
TO THE TRADE.**

Sets made up to special
designs for Patentees, etc.

Erection of Aerials to requirements of P.M.G. and Local Authorities.

As quick as Writing

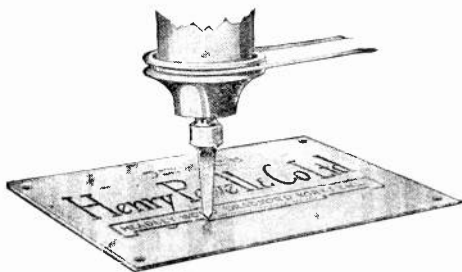

Cutter at work.

The Taylor-Hobson Engraving Machine reduces engraving to a speedy mechanical process.

It does high-class work, either sunk or in relief, on hard or soft surfaces at a fraction of the old cost.

It is used all over the world for work on metals.

We have just issued a New Catalogue. Send for it.

TAYLOR, TAYLOR & HOBSON, LTD.

74a, Newman Street, London, W.1

Works: LEICESTER.

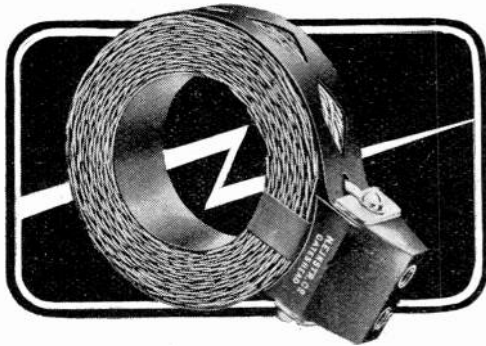

Essential Components of every
 :: Experimenter's Equipment ::

NORTH EASTERN INDUCTANCE UNITS

NEW SERIES.—Improved windings and mountings, giving higher efficiency and facilitating operating adjustments. Reduced prices.

SHORT WAVE UNITS.

List No.	Turns.	Price.
9251	15	6/6
9252	25	6/9
9253	35	7/-
9254	50	7/3

The set of four units will cover a range of about 150-1,000 metres with the average aerial. Excellent for telephony.

Price per set,
27s. 6d. Post Free.

D-L WOUND UNITS.

List No.	Turns.	Price.
9255	100	7/6
9256	150	8/3
9257	200	8/9
9258	250	9/6
9259	300	10/-
9260	400	10/6
9261	500	11/-
9262	600	11/6
9263	750	12/6
9264	1000	13/6
9265	1250	14/6
9266	1500	15/6

Price per set of 12 Units,
£6 13s. Post Free.

These Inductance Units are interchangeable with all standard holders and coils. Send for particulars of new Two and Three-coil Mountings.

OBTAIN A SET OF NORTH-EASTERN INDUCTANCE UNITS, THEN YOU WILL BE SURE YOU HAVE THE BEST TUNING APPARATUS. ASK THE EXPERT—HE USES THEM.

North Eastern Instrument Coy.
Radio Engineers, Designers, Manufacturers,
 DURHAM RD., LOW FELL, GATESHEAD,
 ENGLAND.

Radcom Rheostats

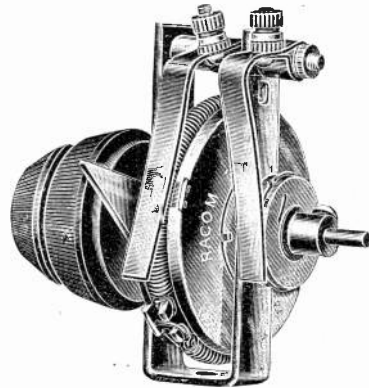

- Features—
- Panel Mounting
 - Positive Stops
 - Single Turn Control
 - Smooth and Quiet
 - Complete Voltage Range

VERNIER TYPE for Detector Valves.
PLAIN TYPE for Amplifying Valves.
 7/6 and 5/- each, respectively.

Radio

COMPONENTS LTD.

12/13, HENRIETTA STREET, W.C.2
 Telephone—GERRARD 792

The ESI-FIX AERIAL

(Patent applied for)

The famous "one-piece" continuously insulated Aerial. Maximum efficiency guaranteed or money returned. Just fling it up anyhow—like a clothes line. 100ft. 15/- 75ft. 12/6 50ft. 10/-

The ESI-FIX EARTHING SET comprising change-over aerial and earth switch; lightning discharge gap; patented pipe grip and connecting leads. Price 10/-

EASY TO GET

Your dealer can supply; or you can send this page with your requirements marked.

CHAMBERS & ELLIS
 Craven House .: Kingsway .: London, W.C.2
 Telephone—REGENT 1130.

MAKE YOUR OWN SETS.

1 Valve to 7 Valve Receivers together with

- Complete Parts for 1 Valve Set **£6 6 0**
- Complete Parts for 2 Valve Set **8 0 0**
- Complete Parts for 3 Valve Set **15 0 0**
- Complete Parts for 4 Valve Set **18 0 0**

As an advertisement and until withdrawn, we offer the complete parts for making full instructions at specially reduced prices.

Including Ebonite Panel and Terminals, Polished Wood Box, Filament Resistance(s), Vernier Condenser, Grid Leak and Condenser, Tuning Coils, 4000 ohm Telephones, H.T. Battery, 4 volt Accumulator, Aerial Wire Insulators, etc.

If you wish to enlarge your present set, write stating parts you have, when we will quote you for parts required and full instructions.

OUR PROFESSIONAL SERVICES ARE AT YOUR DISPOSAL.

Cash with Order—Delivery in Rotation, Carriage Paid.

WIRELESS COLLEGE, Amateur Supplies Dept., COLWYN BAY

CRYSTALS

Large Purchase of Government Tested Crystals.

ZINCITE & CHALCOPYRITE fitted in Brass Cups, with Wood's Metal.

ALL CRYSTALS GUARANTEED

6 for 2/-

C. S. SWAN,

191, Bishopsgate, E.C.1. 65, Windsor Road, Leyton, E.10.
(Next to Brandon's, Tailors). Phone: Bishopsgate 1155.



SKINDERVIKEN BUTTON.

A Supersensitive Microphone.

Known all over the world and patented in every civilised country. Over 60,000 sold. ENGLISH Manufacture.

Make up your own Loud Speaker.

Transmit your GRAMOPHONE music to any room in your house.

The only practical Microphone for use in Detectiphone Sets.

Price 5/- each

Special Low Resistance Receivers (for use with Skinderviken Buttons) 10/- each
Special Gramophone Attachments 1/- ..

Write for 16 page BOOKLET fully illustrated and containing much useful information for all interested in Electrical Sound Transmission. 6d. Post free.

Sole Proprietors:

MIKRO LTD., 274/6, Pentonville Rd., London, N.1
(Opp. King's Cross (Met.) Rly Station).

CONQUEST

THE MAGAZINE OF POPULAR SCIENCE

Written for all the family to understand.

SCIENCE :: INVENTION :: INDUSTRY

ON SALE EVERYWHERE. PRICE **1/-** MONTHLY

LIST OF
Regular Transmissions
OF
WIRELESS STATIONS

Giving Time, Call Sign, Wavelength, System, etc.

PRICE **6d.** POST FREE.

THE WIRELESS PRESS, LIMITED
Dept. W.W.,
12-13 Henrietta Street, London, W.C.2.

Questions and Answers
COUPON

To accompany Questions sent in during the week commencing Sept. 30th, 1922.

VOL. X, NO. 27.

See Conditions on Page 877.

Safeguard your Values

—A quality Rheostat at a moderate price

Originated by ourselves after much painstaking experiment, this Rheostat has proved so remarkably efficient that its design has been extensively followed by other manufacturers. We appreciate the compliment but wish to advise intending

purchasers to make quite sure that they are buying the actual P.S. product. Air cooled, no harsh contact to cause irritating noises, but a smooth velvet adjustable touch. Fitted with an "off" position.

EACH

4/-

POSTAGE 3d.

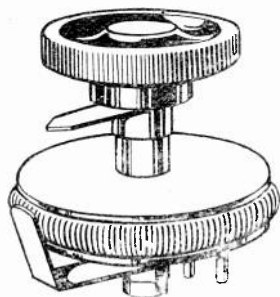

DEALERS

Being the actual manufacturers we can offer you the best terms of all.
WRITE NOW



And at
Wood Green, N.

Offices & Showrooms: Featherstone House, 64, High Holborn, W.C.1

HAMBLING CLAPP & CO.

IT WILL PAY YOU TO VISIT

STAND NO. 12

AT THE

All-British Wireless Exhibition

Horticultural Hall, Westminster, S.W.1

GERRARD 8806.

September 30th to
October 7th, 1922.

*All types of Wireless
Apparatus in stock.*

110, STRAND, W.C.2

THE WIRELESS WORLD EXCHANGE AND MART

TARIFF. Advertisements are accepted for this Section at the rate of twopence per word, with a minimum charge of two shillings. The advertiser's name and address will be charged for, and single letters and single figures will be counted as words. Compound words will be counted as two words.

DEPOSITS. All advertisements must be prepaid in the form of Postal Orders, the remittance being forwarded to Messrs. Bertram Day & Co., Ltd., 9 & 10 Charing Cross, S.W.1.

Intending purchasers may deposit the purchase money of any article advertised or sold by advertisers with Messrs. Bertram Day & Co., Ltd., who will acknowledge its receipt to the vendor and the depositor, the full addresses of whom should be given. Subject to special agreement between the parties, it is understood that all goods are sent on approval, each party paying carriage one way in the event of the goods being returned. The deposit will be retained until due advice of the completion of the purchase has been given or until the articles have been retained and accepted. In order to cover postage, etc. a fee of 6d. in respect of sums of £1 and under and 1s. for sums in excess of £1, must be paid at the same time as the deposit. For persons not resident in the United Kingdom these fees are doubled. We cannot undertake to receive any deposit less than 2s. 6d.

FOR SALE.

Two-Valve Variometer Receiver, 500-5,000 metres with valves, Marconi 4-volt, also 4-volt 7 amp. accumulator, £6.—SWALLGAV, Apseheath, Sandown, I.W.

Aerial Insulators, Shell pattern, 1s. 2d. each, Egg-shape, 4d. each. Sterling Telephones, brand new, never been used, 4,000 ohm, 47s. 6d.; 2,000 ohm, 45s. Aerial Wire, 7/22 copper, 4s. 9d. per 100 ft. Moulded valve holders, 9d. each. "De Luxe" 4,000 ohm Telephone Head Sets, guaranteed, 32s. 6d. pair. Crystal sets, 3,000 metre, all ebonite insulation, polished mahogany frame, 27s. 6d. each, guaranteed. "Broadcasting" crystal sets, on ebonite panel, fitted in oak box, 20s. each.—"RADIO," 8, Fairlight Avenue, Harlesden, London, N.W.10.

Scouters, Scooters, Scooters.—All boys and girls write for free particulars of how to obtain one.—GRAND, 114, Fernlea Road, Balham.

Surplus.—Three-valve amplifier boxes, with holders, resistance, battery box, etc., 7s. 6d. Valve holders, 10d. Telephone transformers, 6s. 6d. Transformer coils, 1s. H.T. Batteries, 36-volt, in polished case, terminals on ebonite, 9s. 6d. Crystal sets with telephones, 59s. Valve panel with resistance, 10s. 6d. Condensers in polished case, 16s. Large terminals, 2s. 3d. doz.—SAUNDERS, Morland Road, Croydon.

Loose-Coupler (primary and reaction), 350 to 3,000m, 45s., photo on request. 0003 Variable air dielectric condenser, 15s.—KING, 17, Kingsland Road, Birkenhead.

Mark III* Tuners, Marconi make, brand new, ex-Government, splendid instruments, £10 each.—TAYLOR, 41, Newlyn Road, Tottenham.

Red-Seal High Tension Batteries are Guaranteed, 15v. Standard size. Sample, 2s. 11d., three for 7s. 6d.—LITCHFIELD Co., 12, Great Castle Street, W.1.

Crystal Set Short Wave Coils, Variable Condenser. Complete, £3.—RAHA, 7, Seroop Terrace, Cambridge.

Marconi Units 1 and 2 (with coils), as new, £12.—"K," Brook Park, Northop, Flint.

Headphones.—Two pairs, 8,000 w., perfect condition with cords, 30s. each.—RUDRIN, 68, Constance Road, Leicester.

Amateur has for sale (1) Four-valve Receiver, 1 rect., 3 L.F. valves, fitted into stained oak writing bureau. All valves out of sight. Burndept coils and 3-coil holder with change-over switch to a Sullivan Inductance. Range 150-30,000 metres. Can also use L.F. as separate amplifier. Price £22 with valves. (2) Burndept "Ultra" II, in perfect condition, price £10. (3) Morse Inker and 20,000 ohm Siemens Relay, price £12, or would sell separately. (4) Brown's Loud Speaker, price £3. All in perfect condition. Apply in writing in first instance to G. SKINNER, Falconhurst, Parkside, Wimbledon Common.

Double-Slide Tuning Inductance, 300-4,000 m., polished mahogany ends, handsome instrument, 25s. 20 ft. Hollow Spar, weighs 11 lb., offers.—LOSCELYNE, Rushmere, Braintree.

Mark III* Tuner (New), converted single valve, £15. Another converted three-valve (two L.F.), £22 10s. Seen working appointment, evenings.—GILLET, Maddox Park, Bookham.

Fibre Sheet.—Best hard vulcanised, at greatly reduced prices, per square foot, 5/16 in., 2s. 6d.; 1/2 in., 4s.; 3/4 in., 5s.; 9/16 in., 6s. 6d.; other sizes pro rata. Postage extra. Trade enquiries invited.—F. W. HOLT, 120, Arbor Vale, Slough.

Wireless Masts.—Improved girder type, light and strong, 30 to 50 ft. at 1s. ft., 50 to 100 ft. at 1s. 6d. ft. Cash with order, carriage forward.—F. ARMSTRONG, Weybridge.

4,000 Ohm Headphones, new and guaranteed, 35s.—G. D. HINKS, Hardington, Yeovil.

Wireless Instrument Cases, Walnut or Mahogany, finest finish, 12 ins. by 7 1/2 ins. by 4 ins. (outside), 8s. 6d. Second quality, 7s. 6d. Any size proportionately, prompt delivery. Trade inquiries invited.—HITCHCOCK, Colchester.

25s.
with lead,
etc.
Postage
1s. extra



4,000 ohms Complete

Double HEADPHONES

THIS is another of our wonderful bargains. Send for a Set. Fully guaranteed and money refunded if dissatisfied. Only a few left. Everyone interested in Wireless should send for our lists, post free 4d. (purchase money refunded).

We are actual manufacturers. Trade enquiries solicited.

Wood's Model Shop
2, Palmerston Arcade,
SOUTHSEA :: :: HANTS.
*Phones: 4321 & 2800

TRADE **Grelco** MARK



FILAMENT RESISTANCES SUPERIOR MAKE AND FINISH. SMOOTH ACTION, EASY TO MOUNT, WILL NOT WORK LOOSE,

Knobs, Best Quality, with 2B.A. Brass Bush inset, excellent finish	4d.
Perikon Detectors, mounted on Ebonite complete.	4/-
Valve Holders, with Screwed Legs	1/-
Aluminium Condenser Vanes, per doz.	1/-
Inductance Tubes, 12" x 3"	6d.
" " 12" x 4"	9d.
" " 12" x 5"	1/-
" " 12" x 6"	1/3
Dewar Switches (Multiple Contact)	4/6
Condensers Panel Mtg., .001	18/6
" " .0005	12/6
H.T. Batteries, 15v. guaranteed	3/-
Brass Studs, 1/2 dia. x 1/4 high per doz.	1/-
" " 1/2 dia. x 1/2 "	1/3
" " 1/2 dia. x 3/4 "	1/3
Grid Leaks and Clips (2 Megohms)	2/-
Sliders, with Spring and Plungers	6d.
A.E.G. and Siemens Halske Valves	10/6
Adapters for R Type Holders	3/-

Postage Extra.

The above items only represent some idea of our various stock.

You are invited to inspect.
Catalogue in course of preparation.

Grafton Electric Company
Showrooms—54, GRAFTON STREET,
TOTTENHAM COURT ROAD,
LONDON, W.1. Telephone—Museum 241.

I Buy Wireless Gear of every description.
Send your particulars to:
WILKINSON,
Lonsdale Rd., Kilburn, N.W.6
SAME ADDRESS SINCE 1900.

Your Case Work

Let us quote you for your wireless casework. We are specialists in this class of work and feel sure our workmanship and prices will interest you.

*Phone: L.W. 2720.

CARRINGTON & NEWBERY LTD.,
18/20, Normans Buildings, Old Street, E.C.

HEATH & Co., Ltd.
Instrument Works, New Eltham, S.E.9
are prepared to undertake in their fully equipped works—**Wireless Apparatus and Parts for the trade.** Quotations given to **Blue Prints.** Immediate attention.
Phone—Lee Green 301. Wire—Polaris, London.

THE WIRELESS WORLD EXCHANGE AND MART

Radio Accessories

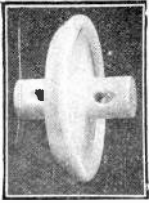

High Class Aerial Insulators. Following best High Tension Electrical Practice. High insulation under all conditions. Drip Ring: 3 1/2" diam., weight 5 1/2 ozs., breaking load, 860 lbs. Price 2/- each, postage extra. Ordinary barrel type, ditto, length 2 1/2", diameter 1 1/2", weight 4 1/2 ozs., 1/- each, postage extra.

Aerial Wire. Bare copper.
 Size 3/20, 4/- per 100', postage 9d.
 Size 7/22, 5/- per 100', postage 9d.
 Size 7/20, 7/- per 100', postage 1/-.
Galvanised Steel Stay Wire.
 Size, 3/16, 2/6 per 100', weight 7 lbs.
Galvanised Malleable Pulley Blocks.
 Size 1 1/2" each 1/2
 Size 2" each 1/8
 Size 2 1/2" each 3/-
 Postage extra.

"Salunite" Fusible Alloy for Crystal Mounting. Non-oxidising. Melting point 195 deg. Fahr. In 1 oz. bars, 1/6 each, post free. Trade inquiries invited.

H. LONGTON, A.M.I.Mech.E.,
 43, Johnson Street,
 Westminster, S.W.1.

Send us your enquiries for
BOXES, CABINETS,
SPREADERS, CONDENSERS
and parts, LEAD-IN-TUBES,
 and all accessories,
 to the Trade.

COMPETITIVE PRICES
 PROMPT DELIVERIES
The Central Aircraft Co.
 179 High Rd., Kilburn, N.W.6
 Phone—Hampstead 4403-4 8018.

F. E. BOYNTON,
 Electrical and Scientific Instrument Maker.
 Wireless Component parts a speciality. Condenser Vanes, Spacing Washers, Spindles, Screwed Rods, Two and Three-Coil Holders, Ebonite Plugs. Complete sets made to specifications. Prompt deliveries.
 The manufacturer with over 25 years experience.
 Works: 391, St. John St., Clerkenwell, E.C.1

Wireless Headphones
 4,000 ohms, 24/6, Post Free.
 Don't confuse these with the cheap foreign-made 'phones now on the market. These are BEST French Make. Satisfaction guaranteed or money returned. List Free. LIBERAL DISCOUNT TO TRADE
W. JOANES (PARIS AND LONDON)
 42 Jenner Rd., Stoke Newington, London, N.16

THOMPSON'S SURPLUS DEPOT.

CRYSTALS! CRYSTALS! CRYSTALS!
 Having purchased another huge stock of crystals of different types, we can do same at knockout prices—

- Bornite.**—Uncut crystal, best quality, per lb. 13/-
 Price per gross cut crystals . . . 10/-
- Silicon.**—Uncut crystal, Selected, per lb. . . 25/-
 Per gross cut crystals . . . 10/-
- Galena.**—Uncut crystal, the best, per lb. . . 7/6
 Price per gross crystals . . . 6/-
- Chalcopyrite** used in all government sets, per lb. 8/-
 Per gross crystals . . . 7/-
- Carborundum.**—The best as used in government sets. Price per lb. uncut . . 10/-
 Price per gross crystals . . . 9/-
- Zincite Crystals,** per gross, selected. . . 35/-

Wood's Metal.—The purest used by government. This will not destroy crystals like different alloys that are used. Per lb. 8/-
 All these prices are subject to a fair trade discount, and traders should be able to purchase a complete winter's stock for a small outlay.

For the benefit of amateurs wishing to experiment with various crystals, we are doing the undermentioned—

- Selected,** 2 Bornite, 2 Silicon, 2 Galena, 2 Chalcopyrite, 2 Carborundum, 2 Zincite, 4 sticks Wood's metal for setting, 6 sheets Ruby Mica .002 thick 4 1/2 x 3 1/2, 12 Patent Spring Interchangeable Crystal Holders. Price 6/- the lot. Worth 14/-
- Wireless Spark Coils,** 1 1/2" spark, beautiful fittings on ebonite. Leading makers, cost £4 each, our price 10/6, post 1/- Always useful.
- 1" Wireless Spark Coils** (by Sterling), same quality new, cost £3, our price 8/6, post 1/-.
- Mica.**—For condensers .002 and .003 thick, 3 1/2 x 4 1/2 sheets. 20/- per gross sheets. 2d. per sheet.

For French Units, Valves, 'Phones, Magnetos, Accumulators, Switches, Generators, Transmitters, Condensers, etc., send for list, free.

T. W. THOMPSON & CO.,
 Government Surplus Depot,
 39, London Street,
 Greenwich, S.E.10.

FOR SALE—continued.

Loud Speaker Horns.—Guaranteed acoustically perfect. All sizes from 3s. 6d. Usual trade terms.—COVENTRY TANKERS, LTD., Hearsall Works, Coventry.

Valves! Valves! Valves! Thirty excellent receiving valves, to be cleared at 12s. each. worth double this price.—ROBBERS, 369, Hither Green Lane, S.E.

120 Ohm Sullivan Headphones, with cords, 8s. pair. Carriage, 9d. 120 ohm Telephone Transformers, with condensers, 8s. each, carriage 1s. Siemens Polarised Relay, for recording, 50s., carriage 1s. 6d. Morse Sounder, Instrument finish, 8s., carriage 9d.—COTTNAM, Greta Hall, Newton Mearns, N.B.

Honeycomb, Duolateral, Basket Coils, with or without tuning curves. Wavemeters calibrated, Brown's telephones rewound, send for particulars to WIRELESS RESEARCH, 14, Purewell, Christchurch, Hants.

Single Valve Reaction Set, No. 141. By F. O. Read, complete with valve, £6. Scribo Morse learning instrument, complete with telephone, 30s. DEAN, 84, Hawley Road, Dartford.

Aircraft Three-way Crystal, with three-valve amplifying set, £10 10s. Aircraft crystal set, £5. Both splendid condition. Bargains. Also other sets for sale. Write or call after 6.30, 121, Adelaide Road, Chalk Farm, London.

Steel Tubular Masts, 10 ft., 15s.; 20 ft., 25s.; 30 ft., 35s. Painted, galvanised guy wires, pulley, base plate. Also fixing irons supplied.—ABBEY ENGINEERING WORKS, Walton, Norfolk.

B.A. Screws, Nuts and Washers, assorted gross 2s., lists 2d.—J. H. BENNETT, Station Road, Willesden Junction.

WE CAN SUPPLY FROM STOCK

- CONDENSER VANES.
- TERMINALS.
- CONTACT STUDS.
- SPACERS SPINDLES.
- VARIABLE CONDENSERS.
- DETECTORS.
- POINTERS.
- LAMINATIONS, ETC.
- WRITE FOR LIST.

Also Spinnings, Stampings and Press Tools made to Specifications.

THE GLENFIELD ENGINEERING CO., LTD.
 225, Pentonville Rd., London, N.1
 Telephone: Holborn 4714.

RADIOPHONE TUNERS,
 200-1,400 ms. 38/-
Valve Panels for above . . . 21/-
0005 Variable Condensers . . 16/6
 Above 3 make an Ideal Receiver.
Broadcast Concert Coils, pair 2/-
Grid Leaks and Condensers . . 3/6
Fixed Condensers 2/6
5-Plate Condensers 6/6
2-Valve H.F. Amplifier Panels 32/-

Get our New Bargain List.
AMATEUR SUPPLIES,
 134, COREFORD STREET,
 TOOTING, LONDON, S.W.

For Wireless Cabinets
 SEND TO
J. A. JONES & CO., LTD.,
 CABINET CASE MAKERS,
 Progress Works, Park Road,
 Aston, BIRMINGHAM.
 Phone—EAST 234.

TO THE TRADE
 The firm of ASTON & MANDER was established 1789 and have been making scientific instruments for over 133 years.
 We are now making all forms of WIRELESS ACCESSORIES AND PARTS. Can we quote you for your Designs & Apparatus in METAL, WOOD, EBONITE, etc.?
ASTON & MANDER (1917) LTD.
 ALBANY WORKS, WILLESDEN, N.W.10.

RADIO CONCERTS.
 Two-Valve Receivers, designed for broadcast music, resistance coupling . . 45/-
 One-Valve Receiver, with necessary condensers and rheostat, etc. 30/-
 Two broadcast basket coils supplied with above receivers.
 One-Valve Note Magnifier, complete . . 40/-
WIRELESS APPARATUS,
 4, Cumberland Avenue, Gravesend.

THE WIRELESS WORLD EXCHANGE AND MART

ONE QUALITY ONLY—THE BEST

Crystals, Bornite, Silicon, Carborundum, Galena, Copper Pyrites, etc., per packet	6d.
Crystal Cups with fixing screw	4d.
Inductance Slider and Plungers	6d.
Inductance Tubes, 12" x 3"	6d.
Inductance Tubes, 12" x 4"	9d.
Inductance Tubes, 12" x 5"	1/-
Inductance Tubes, 12" x 6"	1/3
Square Brass Rod, 12" x 1/4" x 1/4"	6d.
Enam. Wire, 23 gauge	2/- per lb.
Aerial Wire, stranded 7/25, 100'	3/6
Egg Insulators, highly glazed	6d.
Reel Insulators, highly glazed	3d.
Knobs with 2B.A. Bush inset	4d.
Valve Holders, with screwed legs	1/-
Dewar Switches, 4 and 8 way	4/6
Hellesen, 36 v. Batteries, with plug	8/6
Fil. Rheostats, superior make	4/-
Perikon Detectors (Zincite and Bornite) on ebonite, complete	4/-
A.E.G. Valves, tested	10/6
Gridleaks and Clips (2 megohms)	2/-
Postage Extra.	
All Sundries in Stock.	Advice given with pleasure.

THE ESSEX WIRELESS CO.,
Showrooms and Office:
 499 Grove Green Road, Leytonstone, E. 11
 (1 min. from station G.E.R.)
 Telephone: Wanstead 749.

Results

Whether as a source of practical information for the Amateur or as a valuable medium for every Advertiser, the *best results* are invariably obtained through the

"WIRELESS WORLD"

For full particulars and advertising rates apply to

BERTRAM DAY & Co. Ltd.
 Complete Advertising Service,
 9 & 10, CHARING CROSS, S.W. 1
 Gerrard 8063 and 8064.

WIRELESS TRADERS

requiring any information in respect of firms associated with the Trade should write in confidence to—

BERTRAM DAY'S WIRELESS TRADERS' ADVISORY BUREAU
 9 & 10, Charing Cross, London, S.W. 1

FOR SALE—continued.

Wireless Masts.—Thirty-two ft. mast, with six guy wires, steel sleeve, iron cap and ring, pulley, cleat, 100 ft. 7/22 enamelled copper aerial, six porcelain insulators, 54 ft. hemp rope, carriage paid England, 40s.—BARKER, 61, Arthur Street, Derby.

BOOKS.

Radio Magazines, all the latest, "Radio World," 10½d.; "Popular Radio," 10½d.; "Radio Broadcast," 1s. 6d.; "Radio News," 1s. 6d.; "Science and Invention," 1s. 9d.; "Scientific American," 2s. 6d. Post free.—INTERNATIONAL NEWS COMPANY, LTD., 15, Bream's Buildings, London, E.C.4.

Radio Chart.—"Care and Maintenance of Accumulators," 1s. Post free.—Publishing Branch, G. D. HINKS, Hardington, Yeovil.

SITUATIONS WANTED.

Wireless Operator (24), First-class P.M.G. desires position. Fitting, erecting or salesman demonstrator. Spark Valve, C.W. experience, at present in charge of C.W. station.—"Radio," 120, Sheldon Road, Edmonton, N. 18.

Young Man wishes to change his present position. Holder of 1st Class P.M.G. Certificates in Marconi, Poulsen Arc, and Telefunken Systems, also good practical knowledge of valve gear and engineering, offers his services as Demonstrator, Salesman, or any other capacity.—Box M.5, BERTRAM DAY'S ADVERTISING OFFICES, 9 and 10, Charing Cross, S.W. 1.

Gentleman requires position in London, thorough knowledge of wireless and manufacturing. Inventor.—Box M.4, BERTRAM DAY'S ADVERTISING OFFICES, 9 and 10, Charing Cross, S.W. 1.

SITUATIONS VACANT.

Smart Youth required for Engineer's Shop and office in W. London, conversant with wireless and electrical contracting, etc. (no others need apply). State full particulars and wages.—Box L.4, BERTRAM DAY'S ADVERTISING OFFICES, 9 and 10, Charing Cross, S.W. 1.

TRADE ENQUIRIES.

Radio Instrument Maker desires private orders for construction of apparatus or components to special requirements or dimensions. Repair work and telephones rewound. Thorough workmanship.—C. BOXWELL, Beech Hill, near Reading.

Wireless Parts to Pattern or Sketch. Special prices for quantities.—KYLE, 31, Riverview Grove Chiswick, W.

Wireless Sets designed and blue prints supplied. Sound advice and information given. All types of motors designed and windings calculated.—O. S. PUCKLE, Buckhurst Hill, Essex.

Man with Workshop and Plant would undertake manufacturing of radio parts. Filament rheostats made to any specification at lowest manufacturer's prices.—BEDFORD, 7, Thane Works, Seven Sisters Road, Holloway.

MISCELLANEOUS.

East Ham, Wanstead, Ilford, Manor Park and Forest Gate. Amateurs should not fail to come to the RADIORENDEZVOUS, 709, Manor Park Broadway (over Liptons). Club open till 10 p.m. nightly.

Wireless Exhibition.—Will be held by Glasgow and District Radio Club, on Saturday, November 4th, at McLennan Galleries Hall, Sauchiehall Street, Glasgow. Admission, 1s. including tax. Trade exhibits, ancient and modern, specially invited. Send particulars of offers to Hon. Secretary, ROBERT CARLISLE, 40, Walton Street, Shawlands, Glasgow.

AS A TEST WE OFFER—

4,000 ohm Double Head Band Phones at 21/6. Every pair fully guaranteed and money back if not satisfied. All goods sent by return of post.

E. GROVES & SONS,
Wireless Supply,

10, Kinnoull, Rowhill Rd., Clapton, E. 5.

To Manufacturers of Crystal Sets, etc.

We can quote you attractive prices for

STRAWBOARD INDUCTION TUBES

All diameters from 2" to 6". Enquiries Solicited

A. EATON LEE & CO.,
 4, Little College Street, London, E.C.4

— Save 60% on —

HEADPHONES!

Send your order now for **SULLIVAN HEADPHONES, NEW**

Condition, 120 ohms. Complete with cords and double adjustable headbands, each in box. Price, while stock lasts,

Post **15/9** Cash
 Free with
 order.

F. HARRISON, 46 BROOKE RD., E. 17

"EULOGY."

The Advertisement Manager,
 "Wireless World and Radio Review,"
 9 and 10, Charing Cross,
 London, S.W. August 29th, 1922.

Dear Sir,

We would like to advise you that owing to the tremendous number of replies we have received from our small advertisement which appeared on the 26th inst., we have completely sold out the line we were advertising, and have had to return large numbers of orders and remittances, being unable to cope with anything like the number of orders received.

We would mention we have tried other mediums for advertising from our Wireless Dept., with the result that we have given these all up in view of the extremely large number of replies we receive in comparison from The Wireless World and Radio Review.

We feel you may like to publish this letter of appreciation from us as we are confident that others who have not tried your advertising columns will do so in future, with splendid results.

Yours faithfully,
 R. L. NYE.

Service Sale & Exchange,
 8, Gt. Southsea Street, Southsea, Hants.

MISCELLANEOUS—continued.

Wireless Dealers are advised to stock parts for making radio apparatus, as so many amateurs prefer to make their own instruments. There is also the additional profit in making your own sets from stock parts. Raw materials and partly machined parts can be had direct from the factory at the right price.—THE "NEWTONIA" WIRELESS FACTORY, 13/15, Whitcomb Street, London, W.C.2. Regent 643 and 5469.

THE WIRELESS WORLD EXCHANGE AND MART

At York Terrace, Clapham. (20 yds. from Clapham Road Tube & Railway Stations.)
Valuable Stock of WIRELESS, ELECTRICAL GOODS, SURVEYING & other INSTRUMENTS, SAFES, &c., Comprising:—1, 2 & 3 Valve Sets, 300 small Transmitting Sets, 400 pairs Headphones, 200 Potentiometers, 250 Condensers, large quantities of earpiece parts and terminals, 300 buzzer sets, 30 Simplex Telegraph Sets, 1,000 Telephone and Battery Boxes, 150 S.H. Accumulators, 600 Handphones, 100 Telephone Sets, 250 Electric Fans (low volt), 70 Galvanometers, 80 Starters and Switches, 500 Electric Lamps, 220 Volt. Large quantities of Field Levels, Abney Pocket Levels, Sight Rules, Telescopes, Barographs, 1,000 max. and min. Thermometers, 300 Ship's Liquid Compasses, Logs, and Lamps, etc., etc., together with 30 Safes and Money Chests.
 To be sold by auction **WITHOUT RESERVE** on Wed., Oct. 4th, 1922, at 1.30 p.m.. Catalogues of the auctioneers:
THE SOUTH LONDON MERCHANDISE MART, 25 York Terrace, S.W.
 Phone: Chancery 7720. On view Mon. and Tues., Oct. 2nd and 3rd, and morning of sale.

The ROWCELL

Reg. No. 22588

HIGH TENSION "WIRELESS" BATTERY CABINET

1. No Internal Wiring, Soldering or other connections necessary.
2. 7 Tappings.
3. Capacity: 20 Flashlamp Batteries or less may be used.

SIMPLICITY.

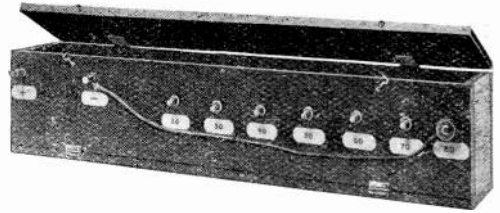

ECONOMY.

4. Volts obtainable: 20, 30, 40, 50, 60, 70, 80. 5. Spent Cells can be instantly replaced, singly or otherwise.
 6. PERFECT contact.
METHOD OF CHARGING. Open cabinet, slip in flashlamp batteries, close cabinet and an automatic and perfect connection is made.

PACKING & POSTAGE FREE 15/-.

Messrs. ROWCELL & Co., 28, Rendezvous Street, Folkestone.

ELECTRADIX RADIOS

Tate Dynamos and Motors of 100 to 60,000 Watts. British and best.

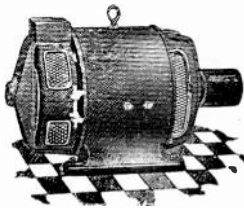

W.T. Alternators, £3 to £7.
Battery Charging Dynamos, 6v. to 20 v., £4 10s., £5 10s. and £8 10s.

12-Volt Motor Generator for H.T. 750 volts for transmission, quite new, £15.

1 K.W. 220 Volt Charging Set, £30.

Electradix Wires in all coverings. Highest Conductivity at Lowest Prices.

Gauge.	D.C.C.	S.C.C.	D.S.C.
16	1/9	—	—
18	2/1	1/9	2/7
20	2/3	1 11	3/3
22	2/9 1/2	2 1 1/2	3/8
24	3/2 1/2	2 5	4/3
26	3/10	2 7 1/2	5/2
28	4/4	3/-	5 10
30	4 11	3/2	7/-
32	6/-	4/4	8/6
34	7 1	6/2	10/-
36	8/7	—	11/8
38	11/6	—	16/6
40	—	—	22/2

All sizes in stock. Prices at per lb. Postage extra. 7/22 Aerial Wire, at 6/- per 100'.

Breast Plate Transmitter, in case, 10/6.

Receiving Sets.—Trench pattern, Calibrated Receivers, Marconi 300/600 metres. Crystal and 2 valves, £5 10s.

Mark 2B. two-valve in polished mahogany case, new and guaranteed, £7 5s. Crystal Sets, variable condenser, detector and fixed inductance, mahogany case, 45/-.
Pole Testers, 6d. Single Plug and socket, large, 1/6 pair. G.P.O. Galvos, Q. & L., 10/6, with shunt switch 15/-.

Plug Sockets and cord of all kinds, solo, 1/- pair, twin 1/6, four-way 2/-.
Terminals, dozen, 2/6 and 3/-.

Condensers, 2 M.F. 1/6, 4 M.F. 5/-. Variable for panel, 4/9, 10/- and 11/6. .001 Cabinet, 32/6. Murdoch rheos., for panels, 7/3, with Vernier extra lever, 8/-.
 Our make, 3/9.

Valve legs, 1d. each.
 Panel Potentiometers in case with switch, 12 6 each.

CASH PRICES



Marconi 'Phones in stock, 2,000 ohms, 49/-; 4,000 ohms, 50/-; 8,000 ohms, 57/-, per pair. Complete with cord and tags. Sullivan's L.R. head 'phones, with cords, 15/- per pair. Ex-Govt. L.R. set of head 'phones, 10/- per pair with cords. New 1,500 ohms, 20/- per pair. Single receivers, 4/6 each.

Large Stocks of ammeters and volt-meters, milliamps and hot wire.

Crystal Detectors, complete on ebonite base, 4/6.

Buzzers for Crystal Tuning, Townsend type, 4/- each.

Aerials, 7.20. Stranded copper, enamelled wire, 6/- per 100'.

Lightning Arrester parts, brass, 6d.
Rubber Aerial Cords, 35 40. copper, 12 yards, 1 6.

Pulleys, Duralumin, brass bush, 2/- and 1 9 each. Cord, 1 6 doz. yards.
Earth Clips, any pipe, 6d. each. Earth spikes, 1/- each. Earth Mats, 10/- each. Leading in Tubes, 12", Porcelain lined.
Switches, Aerial to earth, 2/9 each. Dewar flush type three-way lever switches for panel, 3/6. Eight-way Lever, for A.T.L., 8/-; 30 amp. D.P., 16/-.

Switch Arms, 2/-. Studs, 1 6 doz.
Transformers, Telephone 15/-, Intervalve 20' for panel mounting.

Connecting up wire, 23,40's, rubber covered, 1d. per yard.

R.A.F. light weight ebonite Insulators, 6d. each.

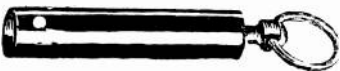

Bells, 4" Gong, on oak base, metal cover, 2 6.

Rubber Primed Tape, 6d. per roll.

H.T. Battery Boxes, 7/- and 5 -.

H.T. Battery Units, 4 1/2 volts, 6d. each.
One-Valve Accumulators, £1.

Catalogues 3d.

We have the Largest and Most Varied Wireless Stock in the City of London.

Thousands of component parts in stock.

LESLIE DIXON & Co., 9, Colonial Avenue, Minories

Close to Aldgate Station, Metropolitan Railway.

First on the left in Minories

ASHDOWN Wireless Goods

Aristocrats of their Class

ASHDOWN Wireless Goods are examples of the very finest workmanship, improved design, and high efficiency—the best made goods on the market to-day. Many leading manufacturers are building our condensers into their wireless sets, while our Filament Resistance is in great demand.

Now, owing to our exceptional manufacturing facilities and mass production, we are able to announce a

Reduction in Prices

in addition to fitting Ebonite Engraved Dials, while still maintaining the usual high quality.

Revised Prices: Filament Resistances, 4/6. Vernier Condensers, 5/9. Variable Condensers, '0003, 11/6; '0005, 14/-; '001, 19/6; '0015, 23/-. Same can be mounted in solid Mahogany or Teak boxes at a slight extra cost.

We also supply Ebonite Knobs, Mica and other Insulating Materials, Terminals, Switch Studs, and other Brass Parts.

Agents Wanted for Export.

H. E. Ashdown (Birmingham) Ltd.
Perry Barr — Birmingham.

Reg. No. 691772.

Tel.: Segment.

Phone: Northern 859.

Stocks held by London Rep.: **Mr. J. O. Maddock, 11 Bayham Rd., Bedford Park, W.**

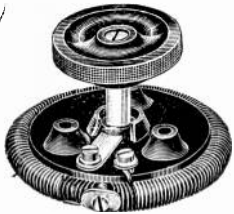
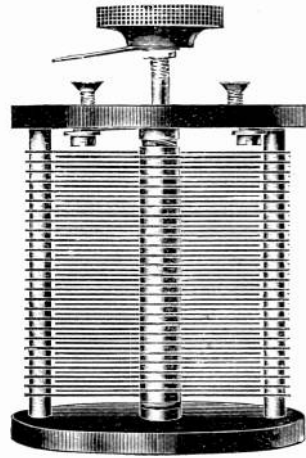

EBONITE PANELS

cut accurately to size, with clean square edges, or bevelled.

Enquiries Solicited for Quantities.

PROMPT DELIVERY.

RELIABLE QUALITIES ONLY.

Mouldings, Sheets, Tubes, Rods

Wholesale only.

RADIO EBONITE SUPPLIES,
4 LITTLE COLLEGE STREET
 (2 min. Cannon Street Station),
LONDON, E. C. 4
 'Phone—CENTRAL 4711.

THERE YOU ARE THEN!

QUALITY EFFICIENCY DESPATCH

COMPLETE SET OF PARTS TO BUILD
A SUPER VALVE PANEL FOR 17/-

Contains:—Ebonite Panel 1/4" Drilled, Filament Resistance, Grid Leak and Condenser, Telephone Condenser, Valve Holder, necessary Terminals and Insulated Wire. Postage, 6d. extra, "Griffin" Super Crystal Set (300-2,000 metres). PRICE: 13/- Wonderful value. Cabinets and Panels, made to your own requirements.

QUALITY PRICES

Accumulators, "Three Star" Volt. Amp.	Ebonite.
4 capacity 10 HRS. 19/3	"A" quality, sheet per lb. 4/6
4 " 20 " 25/9	" " tube (1/2) per ft. 3d.
6 " 10 " 49/-	Condensers, special quality for panels. '001, 25/-; '0003, 15/-; '0005, 20/-
6 " 30 " 28 11	Crystal Detectors, 4/6 and 9/6
Batteries, H.T. (Siemens)	Filament Resistance sup., 4/6
15 volt, 4 -; 30 volt, 9 -;	Headphones, 4,000 ohms, 25/-
60 volt " " 18.-	Brown's, Stirling, 52/-
Aerial Wire.	Coil-holders, 3 coils. 21/-
Bare Copper, 7/22, 100' 3/6	Inductance Coils, wound, 12" x 4", 3/9; unwound, 6d.
Enamelled, 7/22, 100' 4/6	Transformers, 35/-
Silicon Bronze, 184, 100' 3/3	

Send us your orders for all other accessories in stock at market prices. Terms—Cash with order and postage. Delivery free £2 and over.

GRIFFIN WIRELESS SUPPLIES Co.
80, NEWINGTON CAUSEWAY, LONDON, S E.1
 (Two minutes from Elephant and Castle Tube Station.)
 Phone: Hop 1806.

Write for List, 3d., postage free. Trade enquiries invited.

Just Received!

AMERICA'S LATEST PUBLICATIONS FOR THE WIRELESS EXPERIMENTER.

HOW TO MAKE COMMERCIAL TYPE RADIO APPARATUS

By M. B. SLEEPER. Price **4/-** net (post free 4/3).

The experimenter will be able to get a world of ideas for the design and construction of his wireless apparatus from the very clear descriptions and ninety-eight illustrated figures.

CONSTRUCTION OF RADIO PHONE AND TELEGRAPH RECEIVERS FOR BEGINNERS

By M. B. SLEEPER. Price **4/-** net (post free 4/3).

Each piece of apparatus described was first made, tested and found efficient before the final design was accepted. Working drawings prepared especially for the novice and the man who wants to receive the wireless broadcast.

RADIO EXPERIMENTER'S HANDBOOK

By M. B. SLEEPER. Price **5/-** net (post free 5/3).

A book which tells in a very concise way the "Why" of radio and answers many of the "Practical Questions of the Beginner," and even the more advanced student of Wireless.

THE ABC OF VACUUM TUBES USED IN RADIO RECEPTION

By E. H. LEWIS. Price **6/-** (post free 6/5).

Written particularly for those who know nothing about wireless, but who desire an understanding of the elementary principles of operation of vacuum tubes, and various circuits in which they are used for reception of wireless telegraph signals, music and speech by wireless telephone.

CONSTRUCTION OF NEW TYPE TRANS- ATLANTIC RECEIVING SETS

By M. B. SLEEPER. Price **4/-** net (post free 4/3).

Complete information is given, with special drawings, on how to build and use the new types of trans-oceanic receiving sets, also on the use and external connections of the loud speaker and its application in receiving high speed signals from distant stations. The list of radio telegraph stations with their call letters and times of transmission appears at the end of this book.

**THE WIRELESS PRESS, LTD., Dept. W.W.
12-13, HENRIETTA STREET, STRAND, LONDON, W.C.2**

Visit our Stand No. 40. All-British Wireless Exhibition, Horticultural Hall, Sept. 30th to Oct. 7th

The A B C OF WIRELESS

BY

PERCY W. HARRIS

EDITOR OF "CONQUEST"

(The British Magazine of Popular Science.)

Price **6^{D.}** net. Post free **8^{D.}**

THE BOOK *for the* 'MAN IN THE STREET'

This wonderful little book has been specially prepared for those who are desirous of getting a good knowledge of Wireless without delving into text books.

No technical expressions
to puzzle over.
No hard thinking to be done.
No mathematical formulæ
to be elucidated.

What is Wireless? How does it Work?

The A.B.C. Will Tell You
Wireless is the Topic of the Day

The Up-to-date man needs to be conversant with it.

An evening spent in reading this book will put you in a position to appreciate to the full the wonders of the latest and greatest of sciences.

The Wireless Press, Ltd.

12-13, Henrietta St., Strand, London, W.C.2

DON'T WORK IN THE DARK.

If you have a Wireless Set and know but little of the principles of its working, you are missing a great amount of the interest and pleasure which the man obtains who has this knowledge.

*It is nice to get good results
but where is the satisfaction
if you know not how they are
obtained?*

The Elementary Principles of Wireless Telegraphy

By R. D. BANGAY,

tells in the simplest possible manner, the theory and practice of wireless.

The Author makes the subject intelligible to persons who do not possess much technical knowledge, and at the same time it is brief and accurate.

The book is so arranged as to be useful as a reference book for students and amateurs.

It is published in two parts

PRICE **4/-** EACH
(post free 4/5)

or combined in one volume

PRICE **7/6** NETT
(post free 8/3).

The Wireless Press, Limited

Dept. W.W.

12-13 Henrietta St., Strand, London, W. 2.

**TWO NEW AMERICAN
"SLEEPER" BOOKS**

**Design of
Modern Radio
Receiving Sets**

Vol. I (The Brown Book)

Vol. II (The Blue Book)

By M. B. SLEEPER

Price **2/6** each

(Postage 3d)

Showing the construction of instruments so simple that they can be assembled in the "kitchen table workshop," yet so designed that they give the appearance and results of commercial equipment.

The unique feature of these books is that every instrument described is first built and tested in the laboratories of the Sleeper Radio Corporation.

*Visit Stand No. 40 at the
Wireless Exhibition and inspect
these books.*

The Wireless Press, Ltd.

12-13, Henrietta St., Strand, London, W.C.2

**NEW SUPPLY JUST RECEIVED
FROM PRINTERS**

AMATEURS This is just
what you want

THE VEST POCKET
DICTIONARY

OF

TECHNICAL TERMS

USED IN

WIRELESS WORK

By Harold Ward

Over 1500 definitions

Price **2/6** net. Post free **2/9**

The Wireless Press, Limited

Dept. W.W.

12-13, Henrietta Street, Strand, London, W.C.2

MORSE MADE EASY

By A. L. RYE.

Price **3d.** net. Post free **3½d.**

An excellent system for rapidly and easily memorising the Morse Code.

THE WIRELESS PRESS, LTD.

12-13 HENRIETTA STREET, LONDON, W.C. 2

BE UP-TO-DATE

READ THE

**WIRELESS TRANSMISSION
OF PHOTOGRAPHS,**

By MARCUS J. MARTIN.

143 pages. 139 Diagrams and Illustrations.

Price **5/-** net. Post free **5/6**

THE WIRELESS PRESS, LIMITED,

DEPT. W.W.

12/13, HENRIETTA ST. STRAND, LONDON, W.C.2