

47

The WIRELESS WORLD



FORTNIGHTLY

JANUARY 7th, 1922.

PRICE 6D. NET

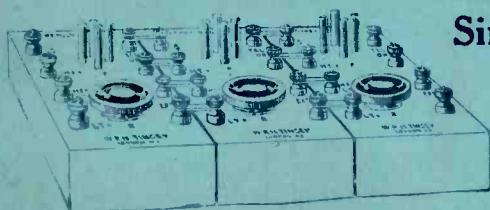

Single Valve Amplifier Units

These are so wired that without any loose connections they can be made into a multi-valve amplifier, both high and low frequency. The addition of an extra valve amplifier can be made by simply clipping on another unit. All connections are made through four solid straps. No loose wires whatever. This arrangement has the additional advantage of having a separate filament control for each valve.

PRICES ON APPLICATION



THREE VALVE RECEIVERS
1 Valve H.F. 1 Rect.—1 L.F.
PRICE OF RECEIVER
(Without Valves)

£8 10 0

Office and Works
Telephone:
1916 Hammersmith

Unmounted Resistances - Price 1/- Each

10,000 ohms to 10 megohm - - Made to any size

168, West Parade, Lincoln.

Dear Sir,

A few weeks ago I purchased one of your three valve receivers; after applying severe tests on all wavelengths, I really feel that the excellent performance of the set, merits the highest recommendation.

The reception of telephony is very fine, and the working of the apparatus exceptionally quiet. In addition to these advantages, the selectivity of tuning obtained by using tuned reactance circuit is so good that I should hardly have thought it possible without the use of a rejector circuit.

You have full permission to make any use you please of this letter. I should, in fact, be pleased if you would publish it, as I think that not only will it be of use to you, but it will be doing a service to a large number of amateurs who have not yet been fortunate in obtaining such an efficient piece of apparatus at a ridiculously low price.

Yours faithfully (signed) Allan L. Astill.

Have you received our New Price List.

W. R. H. TINGEY
:: Specialist in Wireless ::

Offices and Showrooms
92, Queen Street,
Hammersmith, W.6

HIGH "MITCHELL" TENSION

Generators — Motor Generators — Dynamotors

CAPACITY 20—2000 WATTS.

MACHINES MADE OR DEVELOPED FOR OVER 100 COMBINATIONS.

These are being adopted by several Radio Companies. A range of machines always in stock and progress, and in the majority of cases deliveries can be effected in 21 days. Our prices are right.

Important to Commercial Wireless Telephone Companies.

IMPROVEMENTS IN MEANS FOR REDUCING IRREGULARITIES IN THE VOLTAGE GENERATED BY DIRECT CURRENT GENERATORS. (Patent.)

In conjunction with the Patentee, we are developing the above new instrument, which we are willing to demonstrate to any wireless undertaking. Will add efficiency to any direct current generator, including any alternating current rectifying device such as rotary convertor, arc, thermionic valve, or a static or other rectifier.

Please write for particulars.

AMATEURS. DON'T BUY TRUE LATTICE COILS—MAKE THEM

The "LOKAP" Winding machine costs you only 25/-, and this together with five or six shillings' worth of wire, will make you a complete set of coils perfectly and cheaply. Look what you save! Call and see machine demonstrated. (The "LOKAP" Winder is protected.)

MITCHELL'S ELECTRICAL & WIRELESS Ltd.,

Great Britain's Great Wireless Stores, 118, Rye Lane, Peckham, S.E.15

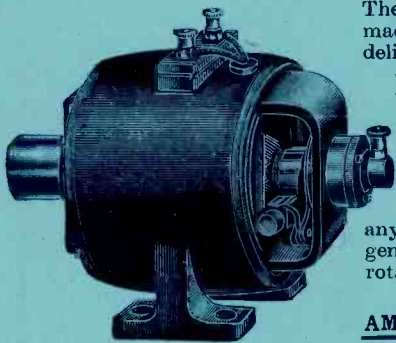

OUR EXPERIENCE

in the Manufacture of High and Low Tension Condensers for all Types of Wireless Installations

IS UNIQUE

IT IS AT YOUR SERVICE.

All enquiries other than American should be addressed to (Department W.)

**DUCON WORKS, Goldhawk Rd.,
Shepherds Bush, London, W.12**

Telephone: - - Hammersmith 1084.

Telegrams: HIVOLTCON, PHONE, LONDON.

Code: - MARCONI INTERNATIONAL.

DUBILIER

CONDENSER CO. LTD.

DUBILIER CONDENSER CO. (1921) LTD.

All American Enquiries to be addressed—

DUBILIER CONDENSER CO., Inc., 217 Centre Street, New York.

GAMAGES

**SPECIALISTS
IN WIRELESS**

"MULTIPLEX" Special Receiving Inductance Units

A NEW FEATURE IN WIRELESS APPARATUS

These Units are designed for use with all classes of valve receivers.

They offer many distinct advantages over the complete receiving sets inasmuch as, with a few accessories, a complete receiver of almost any type can easily be assembled, giving the enthusiastic experimenter the opportunity of testing for himself a wide range of circuits, modifications, etc. The "Multiplex" Units are made in three types covering the following ranges of wavelengths:-

- No. 1. 350—30,000 metres
- No. 2. 350—4,500 "
- No. 3. 3,500—30,000 "

These wavelengths are covered with the use of a variable condenser of .00045 mfd.

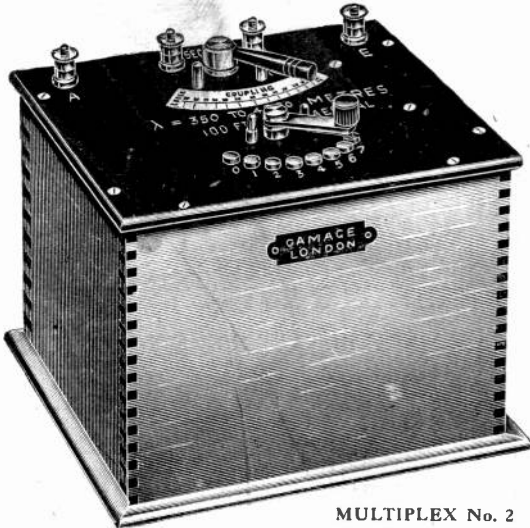

MULTIPLEX No. 2

No. 1 Unit, ranging from 350—30,000 metres, is arranged in two sections: short (350—4,500 metres) and long wavelengths (3,500—30,000 metres), each having a separate primary and secondary, thereby ensuring the maximum efficiency on all wavelengths.

Units Nos. 2 and 3 are made up separately for the convenience of those who wish to confine their experiments to the particular limits specified.

Used in conjunction with the special panel we supply and a variable condenser (.00045 mfd.), either of these Units comprise a complete single valve receiver for the reception of all classes of signals.

Without the panel the following apparatus is necessary:

Variable Condenser .00045 mfd., Grid Condenser and Leak, Blocking Condenser and Valve Panel with Filament Resistance.

Nothing is left to be desired in the construction and finish of these inductance Units and satisfaction is guaranteed.

The assembly of the internal windings and insulation are Ebonite throughout. The cabinet work is of polished Mahogany and the polished Ebonite top is fitted with an engraved Ivorine scale showing the degree of coupling.

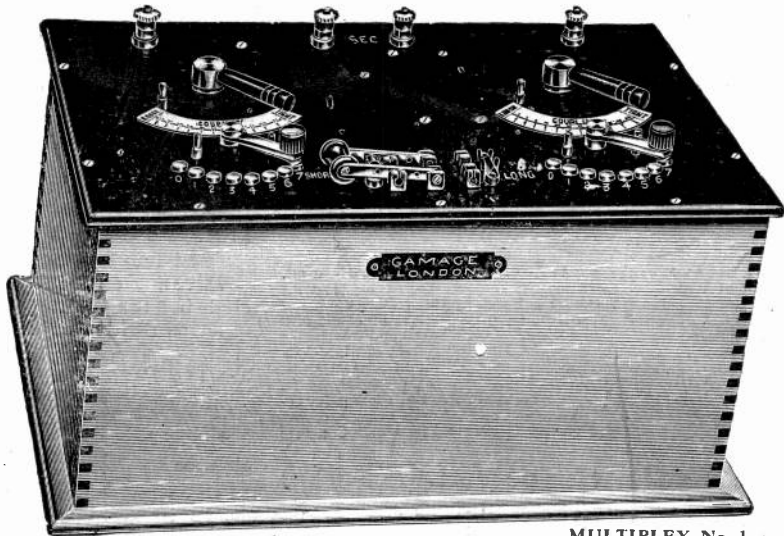

MULTIPLEX No. 1

PRICE — No. 1 **£11 : 11s.** No. 2 **£6 : 6s.** No. 3 **£7 : 7s.**

Write for our **NEW WIRELESS CATALOGUE**, Post Free on Request

GAMAGES • HOLBORN • LONDON • E.C.1

JANUARY 7, 1922

iii

Please mention the Wireless World

At Low Prices
SPLENDID
TELEPHONY
TRANSMITTERS

900 to 1,200 metre wavelengths
 Ebonite and Mica Insulation throughout

COMPLETE WIRING
 DIAGRAM WITH EACH

SINGLE SET £15

(not including valves)

Special quotations for quantities

If not satisfied money refunded within 10 days

L. JOHNSON
 Hindehouse Lane, SHEFFIELD

STEVENS'S AUCTION
ROOMS, LIMITED

WEEKLY SALE
EVERY FRIDAY

(On View THURSDAY AFTERNOON)

WIRELESS GOODS

IN

SUITABLE LOTS FOR AMATEURS

MARK III. TUNERS - WAVEMETERS
 TERMINALS - - - EBNONITE
 RECEIVING SETS - WIRE - Etc., Etc.

38 King Street,
COVENT GARDEN

SLAB INDUCTANCES.

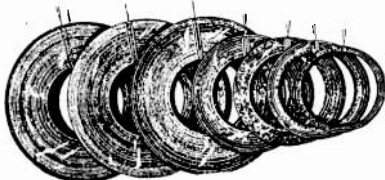

Per set of 8, range 300 to 30,000 metres, 15/-, postage 9d.
 Set of 8 Blue Print Curves, one for each slab, complete with
 4 useful circuits, 5/- per set complete, postage 9d.
 The Curves for use with these Inductances are the result of a
 lengthy series of observations on actual signals and wavemeter
 measurements. They were obtained from a set of Slab Coils
 used in conjunction with an inverted "L" P.M.G. Aerial, 50 ft.
 horizontal span, 20 ft. "lead in." Height of aerial, 45 ft.
 These Slab Inductances can be used as Aerial Tuning Induc-
 tances, Reaction Coils, Loose-Couplers, Variometers, etc.
BASKET INDUCTANCES, specially wound for Dutch Concerts
 and general telephony, 3/8.

FRENCH R Type VALVES 11/9



8 Stage High Fre-
quency Transformer.

STAGE.	
1	300
2	600
3	1,200
4	1,800
5	2,500
6	6,000
7	8,000
8	24,000

52/6

VERNIER CONDENSERS 6/8, postage 6d.

HIGH TENSION BATTERY

36-volt H.T. Battery with wander plug for varying voltage in
 steps of 3 volts. This Battery is made from a special formulae,
 giving exceptionally long life and silent working. Made specially
 to withstand climatic conditions. 7/6 each, postage 9d.

15 volt. — 3 Terminals, 3/6.
MARK III S.W. TUNERS — New, £4 10 0. Carriage Paid.
 United Kingdom. Immediate Dispatch.

PIN TYPE
TRANSFORMER

To fit into R
 Valve Socket.

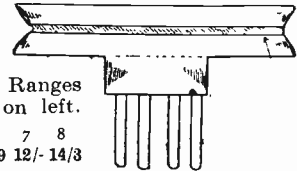

Made in 8 Stages. Ranges
 same as Switch on left.

1 2 3 4 5 6 7 8
 8/- 6/3 6/9 7/6 8/3 9/9 12/- 14/3

Our New List (over 100 Illustrations)
Post Free 4d.

Showroom and Works: 3 minutes from Borough Tube Station

H. D. BUTLER & Co.
 61, BOROUGH RD., BOROUGH, S.E.1

Telephone: HOP 3029 Telegrams: "INGENUITY, PHONE, LONDON."
 Office: BANK BUILDINGS, 222, GT. DOVER ST., S.E.1.
 (Opposite Borough Tube Station)

All our goods obtainable at the

Army & Navy Co-operative Society Ltd.
 105, VICTORIA STREET, S.W.

BURNHAM & CO
DEPTFORD, LONDON, S.E.8

WIRELESS BURNDDEPT APPARATUS

MANCHESTER DEPÔT
4, CORPORATION STREET

LONDON RETAIL DEPÔT
19, HAND COURT, HIGH HOLBORN, W.C.

THE BURNDDEPT ULTRA III RECEIVER

SUPPLIED TO AIR MINISTRY—INDIA OFFICE (FOR USE ON H.R.H. PRINCE OF WALES TOUR) — GREENWICH OBSERVATORY — and various COLONIAL, Etc., GOVERNMENTS

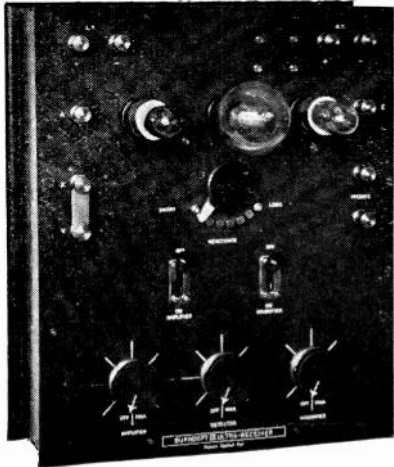

PRICE £25

SOME POINTS OF SUPERIORITY
OVER OTHER 3 & 4 Valve Receivers

- (1) The rectifying valve can be *used alone* or in conjunction with either the H.F. Magnifier valve or L.F. amplifier valve, or both—This feature allows signals to be suitably magnified for comfortable reception according to original signal strength and economises valves and filament current.
- (2) Each valve is furnished with a *separate rheostat* thus allowing valve to be operated at its most sensitive point. As all valves have different properties, this feature enables the best use to be made of the valve, so that signals can be thus received at almost the same strength as if 3 valves were used. By suitable arrangement of the rheostats selectivity of signals can be much improved.

- (3) The magnification of the third note or magnifying valve is obtained by intervalve transformer of finest manufacture—giving as much magnification as 2 valves used with resistance capacity coupling and economising filament current and valves.

**HIGH-CLASS MANUFACTURE AND FINISH (INSIDE AND OUTSIDE)
WHICH CANNOT BE SURPASSED**

For further particulars see our New Price List post free on application

VISIT OUR STAND No. 51

**MODEL ENGINEER EXHIBITION, Royal Horticultural Hall,
Westminster, S.W., January 7th to 14th inclusive**

We are exhibiting a full range of all our **BURNDDEPT APPARATUS** and shall also be showing specimens of apparatus manufactured by the **Nederlandsche Radio Institute**, including a Telephone Transmitter similar to that used for the well-known Concerts, and a Receiving Set with which they were successful in receiving the American Signals.

BURNHAM & CO., DEPTFORD, LONDON, S.E.8

SMALL QUANTITIES OF INSTRUMENT WIRES

I have just concluded arrangements with a large British Manufacturer to hold stocks of the copper wires mostly in demand, and to draw upon his main stocks for any size, material or covering not mentioned below.

I AM THEREFORE READY TO SUPPLY

(1) Any quantity from half an ounce upwards, wound upon a well-made wooden bobbin, and despatch day following receipt of order at the prices shown.

(2) Original reels (of 1 lb. or more) at still keener prices, with very little delay. Prices on application.

(3) Quotations for any size, material or covering.

By favouring me with your orders, you are certain of obtaining new wires of known pedigree, without having to lay in a stock far larger than your immediate requirements.

Allow one ounce per bobbin for packing etc. Postage is 3 oz. 2d., plus 1d. per ounce more, up to parcel rates, 2 lbs. 9d., and so on. Bobbins charged 3d. each, on orders under 10/- returnable with next order.

Terms:
Cash with order.
Postage extra.

PRICES PER OUNCE. High Conductivity Copper Wires.

S.W.G.	Single Cotton	Double Cotton	Single Silk	Double Silk
20	6d.	6d.	7d.	7d.
22	6d.	6d.	8d.	8d.
24	6d.	6d.	8d.	9d.
26	6d.	6d.	9d.	10d.
28	6d.	6d.	9d.	11d.
30	7d.	7d.	10d.	1-/-
32			1/1	1/3
34			1/2	1/5
36			1/3	1/7
38			1/6	1/10
40			1/9	2/2
42			2/3	3/-
44			3/1	3/10
45			3/11	4/5
46			4/10	5/3
47			6/4	6/7
48				on application
49				
50				

Prices on application

A. HINDERLICH,

Central Hall, Southall, Middlesex.
TELEPHONE SOUTHALL, 121.

"R" TYPE VALVES

Price 11/6 post free

Registered 4d. extra. Callers get them Cheaper.

"ORA" V. Filament Valves ... 15/-
Valveholders 1/9, 2/- Screw Legs 2/6
H.T. Batteries, 15 volt ... 4/-
" " 36 volt ... 8/-

RUSSELL AND SHAW,
38, Great James St., Bedford Row, W.C.1
From Holborn through Brownlow Street, or Hand Court

The
Universal Electric Supply Co. Ltd
4 BROWN STREET,
ONE DOOR FROM MARKET ST
MANCHESTER
Telephone: 3409 CITY
Established 1892

LARGE ILLUSTRATED CATALOGUE

Post free 6d.

The most Interesting, Instructive and Complete Catalogue Issued.

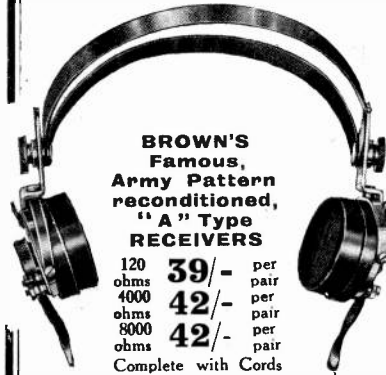

BROWN'S Famous, Army Pattern reconditioned, "A" Type RECEIVERS

120 ohms 39/- per pair
4000 ohms 42/- per pair
8000 ohms 42/- per pair
Complete with Cords

LIMITED NUMBER ONLY

ALUMINIUM VANES FOR CONDENSERS. Improved design. Dia. 3 1/2 ins. Thickness 0.40 ins. 4/6 doz. post free.
VANE HOLDER CENTRE ROD AND INDICATOR FOR CONDENSERS. Length 4 1/2" over all, 4/6.

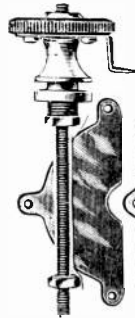

LAMINATED SWITCH ARMS

for making own sets. Complete with Insulated Knob, Brass Bush for Base Board and two clamping nuts 2/6



REVERSING SWITCH High-grade finish, mounted on polished hardwood base 8/-



MIN TWO PIN PLUG AND BASE neat and strong 2/- post free.



Lowest prices prompt delivery. Send your enquiry.

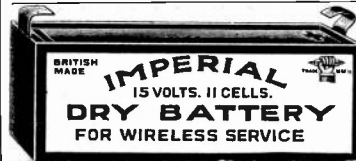

HIGH TENSION BATTERY 15 volts. For Plate Voltage. Price 4/6.

MORSE KEYS. Excellent finish, perfectly balanced enabling rapid transmission. No. N54/19 3/4. Medium Quality 7/6. Superior High-grade Quality 15/-.

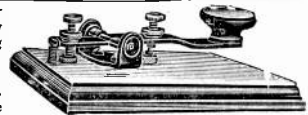



Valve Holder with Fil Resistance Mounted on ebonite panel in polished case. Suitably engraved. - - Price 15/6



G.Z. AUCKLAND & SON
395 ST. JOHN STREET
LONDON E.C.1



INTERCHANGEABLE TRANSFORMERS

Fit ordinary valveholders. Wound to a specified wavelength to obtain maximum results. The benefit of the use of these compact Transformers is obvious to the experimenter. A condenser value '0002 may be shunted across the primary to obtain the latitude.

PRICES:

✓ 300 .. 6/6 ✓ 600 .. 7/6
1,000 .. 8/6 4,000 .. 9/6
6,000 .. 10/6 12,000 .. 11/6

Also wound up to 27,000 m. FORMERS only, 4/6.

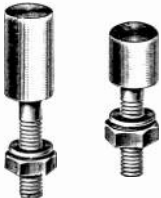

CONTACT STUDS

! To Suit our Switch Arms.
Small 2/- doz.
Large 3/- doz.



SWITCH ARMS.

Supplied with ebonite knob, Brass Bush and nuts, metal work lacquered, Complete 2/9



FILAMENT RESISTANCE

Resistance element wound on ebonite former. German-silver wiping contact.
S* Fitted with top pointer.
F* For panel mounting 5/6

OTHER "STOCK" ITEMS

- Shell Insulators .. . 1 11
- Valve Holders .. . 1 9
- Valve Legs .. . 0 4½
- Ebonite Knobs .. . 1 0
- 2 Mfd. Condensers .. 1 6
- H.F. 8 Slot Transformers 27 6
- Valve Detectors .. . 35 0
- Townshend Wavemeters 75 0
- Telephone Transformers 18 6
- '0006 Variable Con. .. 27 6
- '001 37 6
- Knobs with Pointer .. 1 3
- 3 Valve Panels .. . 5 0
- 5 " " .. . 7 6

A Valuable Asset to Any Receiver. FOR PANEL MOUNTING

A 5-plate Variable Condenser having a capacity of '000008 min. and '00005 max. Fitted with knob and pointer. No rubbing contacts, centre contact maintained by copper strip. Vane spacing = '062"

PRICE
6/9

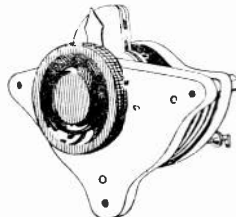

PRICE
6/9

A CONSTANT LEAK (Cartridge Pattern). Well made and neat in appearance. We have carried out extensive experiments with this article and guarantee each one to be tested up to 500 v.



1 to 5 megohms (with clips) .. . 2/6
50,000 to 80,000 (with clips) .. . 2/6
Leak with Condenser .. . 5/-

TERMINAL TAGS

Finish off your leads with Tags and secure efficient and quick connections.
With plain hole for soldering 8d. doz.
With screw and washer .. 10d. doz.

Actual Size.



FIXED CAPACITY CONDENSERS

'001, '002, '003, etc. 3/- each. New. Our own make.

IVORINE SCALES

Outside diameter 2½" .. . 1/6
Engraved 0°-360°.



REACTANCE FORMERS.

Most useful to the experimenter. May be wound to any wavelength. Inside diam. 3". Outside diam. 4". Complete as illustrated - 7/6
(For Panel Mounting)

In polished cabinet with terminals and pointer .. 12/6

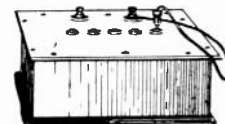

Polished Mahogany H.T. Box (New)

With 5 sockets, plug and terminals.
Arranged to take 5 Siemen's 15 v. units.

Price .. . 17/6

Set of Tablets for Indicating Terminals.

AERIAL, EARTH, H.T. + - :
L.T. + - : 'Phones : Cond.
Size 1½" x ½" .. per set 2/3

SLAB INDUCTANCES

Wound with silk covered wire.
Per set of 8 .. . 15/-

MANUFACTURERS OF ALL COMPONENT PARTS FOR TELEGRAPHY & TELEPHONY

SOMETHING NEW

Four Original Instruments of Outstanding Efficiency

SPECIAL SELF-CONTAINED PORTABLE C.W. TRANSMITTER, as illustrated. Adapted to operate directly from the D.C. lighting circuit, 250 volts. Speech range at 10 watts input, 40 miles. C.W. range double.

Exquisite workmanship.
Fully guaranteed.

PRICE **£15 15 0** NET

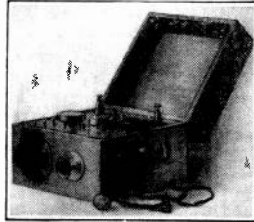

SPECIAL PORTABLE C.W. TRANSMITTER and 2-VALVE H.F. RECEIVER, of unique design. Fitted with voice modulation control and change-over switch. Receiving range 400-20,000 metres. Fitted in polished mahogany case with lock and key, and a most serviceable instrument.

PRICE **£30 0 0** NET

POWER TRANSFORMER, for using D.C. Power mains for H.T. supply. Absolutely steady current, no aggravating noises. Fitted with range switch giving 30, 50, 70, 100 and 250 volts. A little more expensive than H.T. batteries, but is everlasting and has no upkeep costs.

PRICE **£5 5 0** NET

Single valve receivers with all accessories, including valve, Aerial wire and batteries, from **£10 10 0**

Every component part. Any special apparatus, metal or ebonite machining, etc., done at very keen prices.

WRITE FOR LISTS

4-VALVE H.F. RECEIVER, with universal wavelength range. No howling, no hissing. Extraordinarily sensitive to weak signals. Fitted with separate filament control and Grid potential adjustment. 3 variable condensers and earthing switch. A remarkable instrument at a surprisingly low price. Fully guaranteed.

PRICE **£26 10 0** NET

SCOTTISH RADIO SUPPLIES

Works : 60, St. Vincent Crescent,
GLASGOW, W. Tel. : Central 2878

2, Royal Crescent, GLASGOW, W.
Tel. : Charing X 491



TRADE MARK

**The WHITECROSS
COMPANY, LIMITED
:: WARRINGTON ::**

Manufacturers of All Descriptions of
**WIRE ROPES
AND WIRES**

The most reliable and efficient
Batteries for Wireless Work are

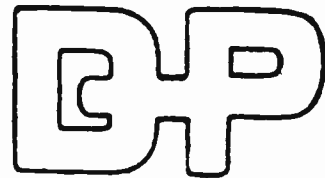

**STORAGE
BATTERIES**

D.P. Batteries are made to fit almost any size of box. The output of our Works runs to hundreds of thousands of plates yearly.

Write us for particulars

The D. P. BATTERY CO., Ltd.
BAKEWELL — DERBYSHIRE
& 11 Victoria St., London, S.W.

Established 1895.

'Phone : Stratford 651.

Students completely trained, qualified and examined for the P.M.G certificate at the College by modern progressive methods of Instruction. Equipped with Marconi 1½ K.W. No. 31A Crystal Receiver, etc. SPECIAL COURSE FOR AMATEURS.

THE EAST LONDON WIRELESS COLLEGE, 195, Romford Rd., E.7

THE WIRELESS WORLD

THE OFFICIAL ORGAN OF THE WIRELESS SOCIETY OF LONDON
A MAGAZINE DEVOTED TO WIRELESS TELEGRAPHY AND TELEPHONY

CONTENTS

The "B Mark I*" Receiver. Methods of Conversion.—III. By Philip R. Coursey, B.Sc., F.Inst.P., A.M.I.E.E. - - - - -	621
"The Other Fellow's Station." By "Weno" - - - - -	623
The Transatlantic Tests - - - - -	625
Duplex Wireless Telephony with Holland - - - - -	626
Wireless Club Reports - - - - -	629
Notes and News - - - - -	636

Contents continued on next page.

A NEW YEAR'S RESOLUTION:—

"To get out of the rut in 1922."

WHY ?

Because otherwise you will very soon be one of the "Also Rans" a "Back Number" Etc., Etc.



HOW ?

Just drop a Post Card in the nearest letter-box and leave the rest to me. Don't wait until to-morrow or next week.

DO IT NOW

Micawber waited "for something to turn up,"—but that won't do in 1922, and besides Micawber was not interested in Wireless.

2/Lieut. E. REDPATH, 19, Niger St., BARROW-IN-FURNESS.

(Late Instructor, C.I.P., W.T., R.A.F.)

IF YOU WANT A 1st P.M.G. You should place yourself in our hands. It is our business to help you. Our Students live in the College, and are rapidly trained by our special method under ideal conditions. **AMATEURS** Our Special Postal Course will enable you to get results which you now probably consider impossible.

Prospectus Post Free to any Address.

THE NORTH WALES WIRELESS SCHOOLS, COLWYN BAY. *Branch at CARNARVON.*

CONTENTS *(Continued)*

Book Reviews	- - - - -	636
Correspondence	- - - - -	638
Questions and Answers	- - - - -	639
Share Market Report	- - - - -	642

THE WIRELESS WORLD is published fortnightly on alternate Saturdays.

All correspondence relating to contributions should be addressed to THE EDITOR, THE WIRELESS WORLD, 12-13, Henrietta Street, London, W.C.2.

No responsibility can be taken for MSS. or photographs sent without stamps to defray cost of return postage.

Editorial and Publishing Offices, 12-13, Henrietta Street, Strand, London, W.C.2.

Telegraphic Address: "Radionic, Rand, London." Telephone No.: Gerrard 2807.

Advertisement Managers, Bertram Day & Co., Ltd., 9 & 10, Charing Cross, S.W.1.
Telephone No.: Gerrard 8063 and 8064.

SUBSCRIPTION RATES.—

17s. per annum, post free. Single Copies 6d. or post free 8d.,

Registered at the G.P.O. for transmission by Magazine Post to Canada & Newfoundland.

MEN in the WIRELESS SERVICES DESIRING RAPID ADVANCEMENT

Train in spare time in the subjects of your choice, or to obtain some recognised Engineering Qualification such as

A.M.I.E.E., A.M.I. Mech. E., A.M.I.C.E., B. Sc. Eng^t

During Twelve years hundreds of successes have been secured by "U.E.C.," (Regent's Park, London, N.W.1) by the "U.E.C." system of

Individualised Postal Training for Engineering Exams. & Professional Work

(Officially approved and adopted by Leading Engineering Firms.)

State YOUR ambition, in confidence to—SECRETARY'S DEPARTMENT, (Desk W.).

UNIVERSITY ENGINEERING COLLEGE, Westgate-on-Sea, KENT
and expert advice, with the New Prospectus, No. 8, will be sent you without obligation.

Have YOU inspected the large stocks of
MARCONI'S WIRELESS
 APPARATUS FOR RADIO ENTHUSIASTS
 EXHIBITED AT
40, DEAN STREET, SOHO?

LARGEST
 RADIO
 MANUFACTURERS
 IN THE
 KINGDOM.



Telephone:
 GERRARD 7745.
 (Pvt. Bcn. Ex)

Telegrams:
 THEMASINCO OX.



SALES AND
 ENQUIRIES HERE.

Telephone:
 GERRARD 7745
 (Extn. 4):

The most central Wireless Showrooms in London are open to all interested in the Wireless art.

We carry large stocks of Apparatus for Wireless Telegraphy and Telephony and also Landline Telegraphy.

Those who desire to assemble their own apparatus will find that we have **THE RIGHT GEAR.**

The MARCONI SCIENTIFIC INSTRUMENT Co. Ltd.



HART ACCUMULATORS

SPECIAL SALE OF SMALL ACCUMULATORS
AT LOW PRICES TO CLEAR STOCK

These Accumulators are suitable for all
Electrical Circuits. British Made Throughout.
Fully Guaranteed for 12 months. Easily Re-charged.
First-class Design and Workmanship.

Type.	Voltage.	Capacity Amp. Hrs.		Approximate Overall Dimensions.	Type of Box.	Net Price (each).	
		"Intermittent" Rating.	"Continuous" Rating.			Singly.	For 2 or more
PL 3	2	2	1	$\frac{27}{8}$ " \times $2\frac{5}{8}$ " \times 3" high	Celluloid	s. d. 3 6	s. d. 3 0
ABS 5	2	10	5	$1\frac{3}{4}$ " \times $1\frac{11}{16}$ " \times $4\frac{1}{8}$ " ..	"	4 6	4 3
AP 7	2	22	11	$1\frac{7}{8}$ " \times $1\frac{7}{8}$ " \times $6\frac{3}{4}$ " ..	Ebonite	6 0	5 9
ABS 5	4	10	5	$1\frac{3}{4}$ " \times $3\frac{7}{16}$ " \times $4\frac{1}{8}$ " ..	Celluloid	8 10	8 6

TERMS : CASH WITH ORDER. CARRIAGE PAID. Subject to being unsold on receipt of order.

HART ACCUMULATOR CO., LTD., STRATFORD, LONDON, E.15

ECONOMIC ELECTRIC LIMITED

ESTAB.
1896



NEW LACQUERED BRASS
TERMINALS, size as illus-
tration, 2/- doz.



EBONITE CONDENSER DIALS,
bevelled engraved scale filled in
white 3" diameter, 5/- each.



TURNED, FLUTED, Polished and
knurled EBONITE KNOBS, $1\frac{1}{2}$ "
diameter. 6d. each, 5/6 doz.

ILLUSTRATED
CATALOGUE
POST FREE
4d.

FITZROY SQUARE, LONDON, W.1

Telephone : MUSEUM 1055

Branch : TWICKENHAM

CASTAGNOLI

WIRELESS APPARATUS

will be shown at the

"Model Engineer" Exhibition

January 7th to 14th

ON THE STAND OF

Messrs. G. Z. AUCLAND & SONS

Do not fail to inspect—

SUPER VII RECEIVERS

G. 5. TUNERS

AND

L.F. AMPLIFIERS

GORDON CASTAGNOLI

Manufacturers of Wireless Apparatus

15, Rayne Road, Braintree, Essex

THE WIRELESS WORLD

THE OFFICIAL ORGAN OF THE WIRELESS SOCIETY OF LONDON

VOL. IX. No. 47.

JANUARY 7TH, 1922

FORTNIGHTLY

The "B Mark I★" Receiver

METHODS OF CONVERSION—III.

By PHILIP R. COURSEY, B.Sc., F.Inst.P., A.M.I.E.E.

IN addition to those already discussed attention may be drawn to still another method of converting the B Mark I* Rear type trench receiver into a double note magnifier. The arrangement resembles the one described at the end of the article on this subject in the last issue of *The Wireless World* in that it is arranged for a high resistance input, i.e., for joining directly in series with the plate circuit of an existing detector valve receiver. It differs from that one, however, in that it is designed for use with low-resistance telephone receivers instead of high-resistance ones. The former arrangement using high-resistance telephones in series with the plate circuit of the last valve was suited for cascading two or more of these two-valve units so as to build up a four or six-stage low-frequency amplifier, since to do this it is merely necessary to connect the input terminal of one unit to the telephone plug sockets of the preceding one, taking care that the connection is made the correct way round. The change-over switches on each unit enable that unit to be cut out of circuit at will, as already described,

so that if three units of this type are connected in cascade it is possible by manipulation of the switches to use at any time either 0, 2, 4 or 6 valves in cascade.

In order, however, to obtain the advantages of a telephone transformer in the output circuit, so as not only to separate the telephones from the valve circuit, but also to enable a low-resistance loud-speaking telephone to be used with the instrument, the change-over switch may be arranged to transfer the telephone transformer from the plate circuit of the second valve to the input terminals. A high-resistance input circuit with the intervalve transformer can thus be retained as shown in Fig. 1. Apart from the use of the telephone transformer, this diagram is similar to the arrangement outlined in Fig. 2 of the second part of this article in the last issue of *The Wireless World* (page 590). To convert the instrument in this way, the existing "Intervalve" and "Valve-to-Phone" transformers can be left in place, and the new "Intervalve" transformer fitted in the space cleared by the removal of the unwanted

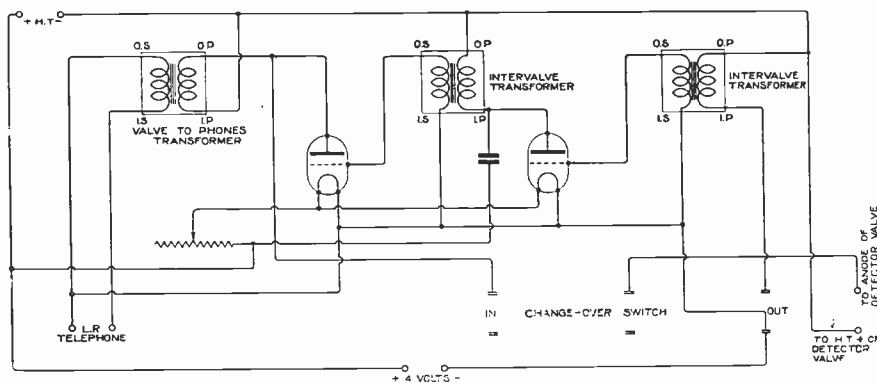

Fig. 1.

parts, the connections to it being made as shown in Fig. 1 herewith.

Of the two patterns of instrument, the "Front" and the "Rear" types, the latter as has been stated has advantages for conversion, in the ways described above, into a two-valve L.F. amplifier. The former pattern may be converted into a

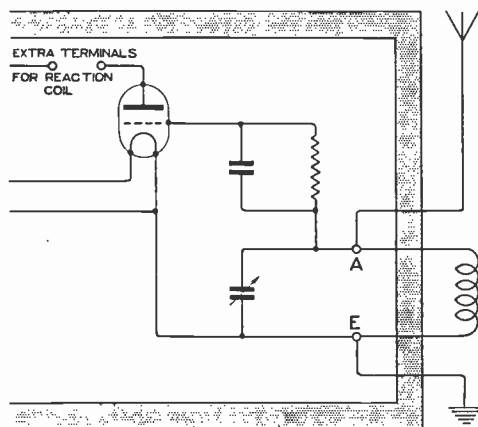

Fig. 2.

two-valve receiver, with one detecting and one note magnifying valve, on the lines shown in Fig. 2 on page 559 (*The Wireless World*, Dec. 10th, 1921), since this type contains some parts which will be found useful. In these "Front" type receivers designed for 65 metres there is fitted an additional fixed condenser besides the one connected to the anode of the first valve, as in the "Rear" pattern instrument. (See Fig. 1, page 558, *The Wireless World*, Dec. 10th, 1921.) This extra condenser (which, however, is not fitted in the sets designed for 80 metres instead of 65) can with same valves be used as the grid condenser, so that in conjunction with the grid leak also to be found in the instrument very little alteration is required in the wiring.

In this instrument there will be found also a small variable condenser marked Antenna Shunt, the function of which was to counteract any detuning that might arise if aerials of different capacity were used with the set. It consists of a number of fixed and movable zinc plates with thin discs of ebonite to form the insulating dielectric between them. The maximum capacity of the condenser is of the order of 0.00025 microfarad, so that after cleaning up of the ebonite, etc., it forms a useful tuning condenser for the coils which must necessarily be used with the apparatus to convert it into a complete receiver. For this purpose it should be left connected in its present position, across the Aerial and Earth terminals (marked on the instrument for connection to two aerial wires), so that it becomes a parallel condenser to any tuning coil connected across those terminals in the usual way, Fig. 2.

If it is desired to avoid the losses in the ebonite

dielectric in this variable condenser, the same framework and fittings may be used to build a variable air condenser by removing the ebonite disc. Greater rigidity may be obtained by cutting out new condenser plates from thicker metal and using them to rebuild the condenser. By using this condenser for the grid condenser of the set, some slight advantage may be obtained since it can be adjusted until best signals are heard.

Since in some of these instruments some of the transformer windings may be found to be faulty, it is worth while remembering that this need not necessarily render the transformer quite useless in the instrument. This applies particularly to the interval transformers, since if one of the windings remains good, it can be connected in series with the anode circuit of the first valve so as to act as an impedance, and a condenser used to pass on the amplified impulses to the grid of the next valve, as indicated in Fig. 3 which shows the essential elements only of this part of the circuit. R being the grid leak, and C the new coupling condenser. The grid leak which is to be found in the instrument, should of course be connected between the grid and filament of the second valve, so as to maintain the normal grid potential at the desired value. In this way it is possible to make use of the parts of an instrument that would otherwise be scrapped.

Thus suppose that one of the windings of the existing interval transformer is found to be faulty, such for example as an internal disconnection, but that the other winding is in good condition, the good

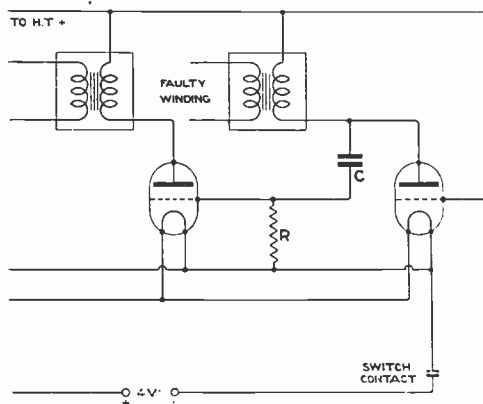

Fig. 3.

winding if it is the primary (IP-OP) should be left joined up between the anode of the first valve, and the H.T. positive as usual, and the secondary winding should be disconnected completely. If it is the secondary winding that is faulty, the wires found connected to the IS and OS terminals should be removed, and the wires from the IP and OP terminals transferred to IS and OS respectively. By reference to Fig. 1 on page 538 (*The Wireless World*, Dec. 10th) it will be seen that there is already a condenser joined to the anode terminal of the first

THE "B MARK I*" RECEIVER

valve, the connection from this anode terminal being usually taken from the anode terminal screw to one terminal of this condenser, and then back again to the IP terminal of the intervalve transformer. These leads to this terminal of the condenser should be left in position, but the wire running from its other terminal to the positive L.T. terminal should be removed from +L.T. and connected instead to the grid terminal screw of the second valve.

The grid leak already mounted in the instrument

is connected between the grid circuit of the first valve and the negative L.T. terminal. The latter connection should be left in place, but the former should be transferred to the grid terminal of the second valve, so that the leak is connected between the grid and filament of the second valve in the set.

A degree of amplification approximately equal to that obtained when the instrument has been converted to a two-valve amplifier with good transformers, has been obtained by this method.

"The Other Fellow's Station"

BY "WENO."

TO the wireless enthusiast the other fellow's station is always a source of interest. This is not surprising when one considers the number of possible variations in the arrangement of the essential apparatus, to say nothing of the numerous original devices beloved of the amateur.

Apart from those whose interest is transitory and does not survive the tennis season, and those who

buy expensive self-contained sets in the fond but seldom realised hope that without any skill on their part, they will be able to delight their friends with wireless music *via* loud speaker (with only a frame-aerial about as large as a pocket handkerchief), one may divide wireless amateurs into two classes—experimentalists and operators.

In the first class we have those whose chief delight

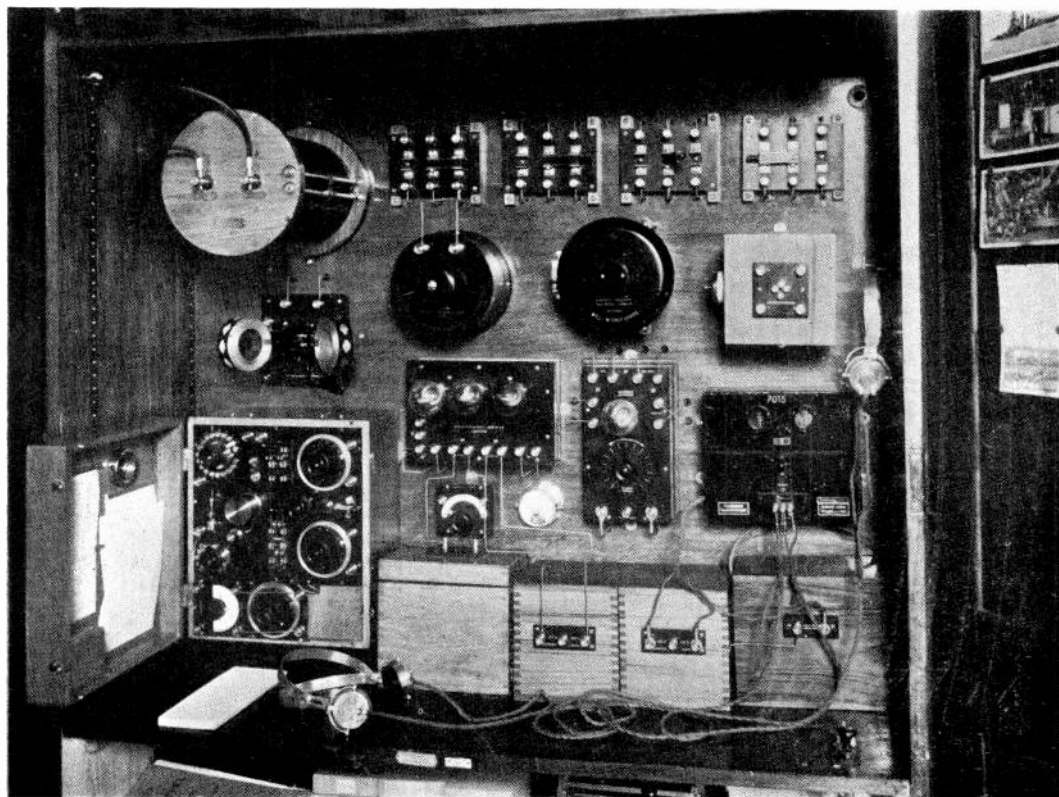

Photograph of the Station showing the arrangement of the various components

is in designing and making some new piece of apparatus or re-arranging existing apparatus with a view to greater effectiveness. Strictly speaking, these are amateur instrument-makers rather than wireless enthusiasts. In many cases they cannot even read the code. But, incidentally, you may have noticed that this doesn't prevent them from talking glibly of Annapolis and New Brunswick, as though they were old friends.

The other class consists of those whose chief delight is to intercept messages, and who judge the efficiency of their station not by the noise it makes when LP, YN, FL or POZ strikes up, but by the long distance traffic it enables them to copy. Of course, there are many in this class who do their share of experimenting also; but as this is principally to improve the receiving range, it does not affect the classification.

fellow doubts your veracity when you tell him it's not Moscow.

On the other hand, the keen operator maintains his set at concert pitch seven days a week, ready at all times to respond to any of the old favourites whose tuning adjustments he knows to a degree. He lets his dinner get cold while he checks his watch for the umpteenth time by POZ at 1 "pip emma," well knowing it gains perhaps thirteen seconds a day. He strolls in at 9-30 to listen for a few minutes to MPD; and, if he has time, changes over to 5,000 metres and copies the Bolshie press from MSK. But the real, serious work is done when he is able to devote a few uninterrupted hours to interception and copy Mediterranean traffic, call and reply, TR, preamble, text and signature. It is then that he experiences that glow of satisfaction known only to the real wireless "bug" when he

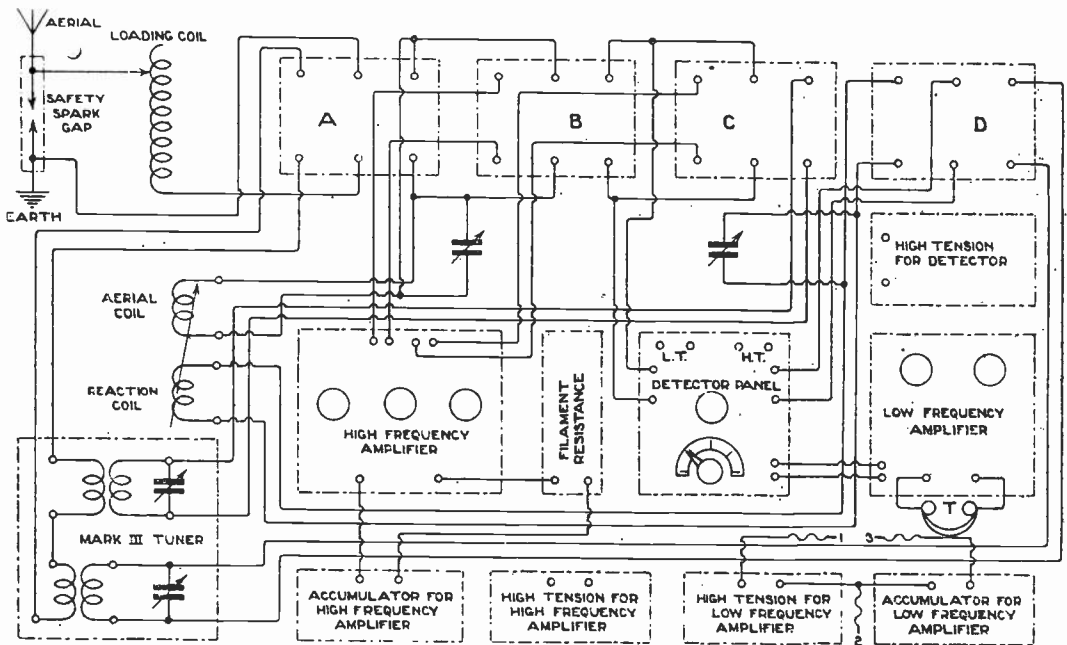

Circuit diagram of the Station.

A glimpse at the other fellow's station is generally sufficient to enable one to say to which class he belongs. The experimentalist's set is never finished, invariably looks like a junk heap, and needs a lot of persuasion before it can be coaxed into articulation. It never is doing as well when you happen to be there as it did last Wednesday week when, "Oh, you should have heard the sigs! They were readable two lamp-posts away." The accumulators are run down, or perhaps the slider on the inductance has sprung a leak. There's never any lack of excuses for its backsliding. If you have patience enough to look on while he solves the riddle, you may perhaps hear Cleethorpes after waiting a couple of hours; and then the other

hears one of the distant stations calling for a repeat and scans his faultless copy with its dotted i's and crossed t's, while his fingers itch to close over the knob of the key that the hard-hearted Postmaster-General has decreed must be dumb. The satisfaction to be derived from an evening thus spent makes the joy of hearing the 400 kilowatt stations on a "loud speaker" seem insignificant.

All of which, by the way, is preparatory to introducing to your notice as pretty an installation as ever you pictured to yourself in smoke-clouds when you sat back in the easy chair and let your imagination run riot.

It was designed and assembled by Mr. William Holmes, of Newcastle-on-Tyne, an ex-operator who

" THE OTHER FELLOW'S STATION "

saw a great deal of service during the war. Although the owner makes no claim to originality for any of its components, he admits that it represents the fruition of a great deal of patient experimentation.

The major part of the apparatus—including the 7 ft. by 4 ft. cabinet which houses it—was bought directly or indirectly from the Disposals Board, although some of the units have been made by the North Eastern Instrument Company, to suit the somewhat exacting requirements of the owner.

The backboard on which the apparatus is mounted is of polished mahogany; and all the connections, which are of single 16 hard-drawn copper, are taken through ebonite collets to the back and are carefully arranged so as to avoid undesirable capacity effects.

There are two tuners, one for short waves and the other for general service. The former is a Mark III with a tuned reaction circuit ingeniously fitted into the recess.

The long-wave tuner is of the honeycomb coil type, with "plug in" coils, as advertised in this magazine. Here again the tuned reaction circuit is used, the two variable condensers being clearly visible in the photograph.

The detector panel is a separate unit, and can be diverted from one tuner to the other by means of the change-over switches seen at the top of the back-board.

For all ordinary purposes, a single valve is used as detector-amplifier, with shunted grid condenser; but provision is made for amplification both before and after detection. The high frequency amplifier is of the resistance-capacity type, with three stages. The low frequency amplifier is a captured German two-valve type 89 D Telefunken, for which the owner has nothing but praise. It has absolutely no adjustments. The filament resistance is of the so-called "barretter" type,* consisting of an iron wire in a gas-filled tube. Any tendency towards an increase in the filament current is counteracted by an automatic increase in the ohmic resistance of the wire, due to its higher temperature; conversely, when the accumulator voltage falls and causes a decrease in filament current, the resistance falls and thus tends to keep things even. A double pole two-way switch (with an auxiliary contact) connects the receiver either to the telephones or to the input side of the amplifier, and, in the latter case, switches on the valve filament at the same time. The great advantage of this is that the amplifier can be introduced or cut out during reception, without the loss of a single word, by simply pressing down a small switch lever. From the point of view of sheer noise, this amplifier may not be able to compete with most of the two-valve low frequency amplifiers at present on the market; but in the eyes (and ears) of its owner—who is not out to impress his friends and neighbours—it has compensating advantages in the direction of accumulator and high tension economy, and complete absence of microphonic noises.

The wiring diagram shows the relation between

* The term "barretter" was first used by Fessenden in 1902 in connection with his thermal detector, and is now frequently misused in the manner indicated above. Actually it is a "Thermal Regulator," and is quite common in electrical engineering.

the component parts, and the functions of the change-over switches at the top of back-board may be followed easily from Table I, below.

TABLE I.

		A	B	C	D
Mark III reception	Left		Open	Right	Right
direct					
Long Wave reception	Right	Right	Open		Left
direct					
H.F. and Long Wave..	Right	Left	Left		Left

Some idea of the efficiency of the installation as a whole may be gained from the following list of stations, which can be read with a single valve:—

SUH	Spk.	Alexandria	600m.
PCGG	C.W.	The Hague (telephony)	1,100m.
ICII	C.W.	New Brunswick	13,400m.
WW	C.W.	Asmara (Red Sea)	
BYW	Spk.	Gibraltar	600m.
NAA	C.W.	Arlington	5,950m.

The Transatlantic Tests

AS the date fixed for sending in Reception Logs by competitors in the Transatlantic Tests does not expire until December 24th, a large number of these have not yet been received at the time of writing. It is therefore impossible to publish an analysis of the logs in this issue, nor can we yet state who is the most successful among the entrants, although, as already announced, a number have been successful in picking up the Test Signals with varying degrees of accuracy. Mr. Paul F. Godley has been good enough to give us the full story of his visit over here, for publication in *The Wireless World*, and readers may look forward to the first instalment of a very fascinating description of his experiences in our next issue. Photographs of Mr. Godley's station as set up at Ardrossan (Scotland) will be published, together with a diagram of his apparatus. If space permits Mr. Godley's complete log will be published as it is considered that this should be of general interest, since it covers the whole period of the Tests.

A preliminary investigation of the logs of Mr. Godley and those of the successful British amateurs who have already sent in their logs, indicates that the American stations were heard only on two or three particular nights, and it seems highly probable that this result may be intimately connected with the cyclonic disturbances which occurred in the Atlantic about this date, and to which reference has been made in the daily press.

The Meteorological Office has kindly promised to supply information regarding the weather conditions during the period of the Tests, and it is anticipated that some very valuable information may accrue from a comparison of the reception of the transatlantic signals with the record of the prevailing weather conditions.

H.S.P.

Duplex Wireless Telephony with Holland

A DEMONSTRATION ON SHORT WAVELENGTH

IT is becoming evident that the function of the wireless telephone is to supplement the ordinary system by the provision of a connection between metallic circuits in cases where there are insuperable difficulties in the way of the ordinary

The view, sometimes expressed, that the wireless telephone will ultimately replace the ordinary telephone is on a par with the suggestion that the airship will ultimately replace the railway and is unworthy of serious consideration, but although

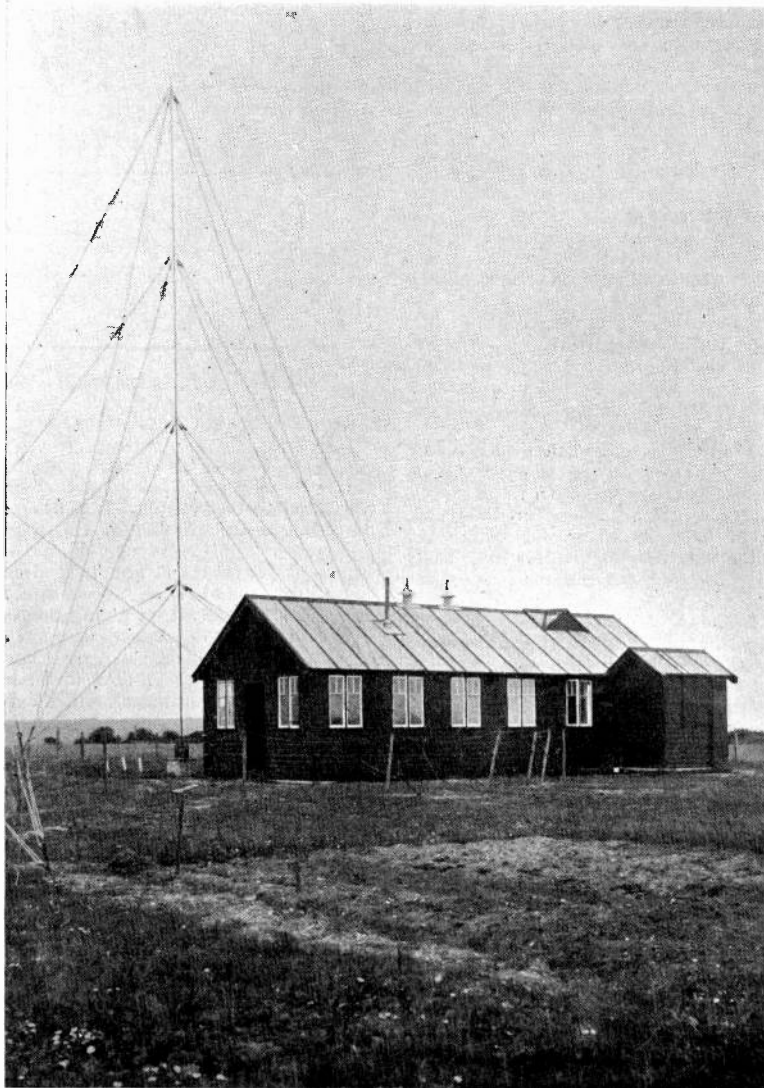

Transmitting Station at Southwold showing mast.

trunk or submarine cable connection, or where considerations of economy favour the introduction of a wireless link.

the uncontrolled use of the wireless telephone by individual members of the community is probably impracticable, in all but the most sparsely

DUPLEX WIRELESS TELEPHONY WITH HOLLAND

populated countries, there are occasions where it will be commercially profitable, as it is now technically possible, to arrange that the conversation of the ordinary telephone subscriber shall be conveyed by wireless over so much of the route as may be dictated by the circumstances of the case.

operated directly and not through the medium of a "land line."

On the occasion of this demonstration "duplex" working was provided as in the case of the ordinary telephone, and speech was conveyed to and from the wireless stations at Southwold and Zandvoort by means of wire circuits made available for the purpose

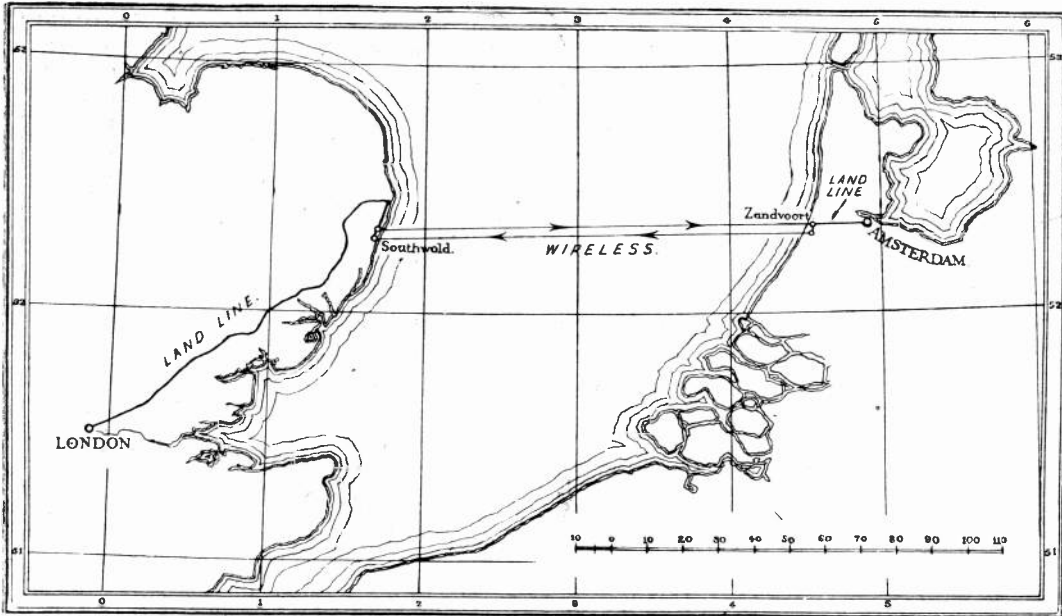

Map showing route of the London-Amsterdam circuit.

A practical example was provided in a demonstration given by the Marconi Company on Sunday afternoon, December 18th, when speech between London and Amsterdam was made possible by means of a wireless link connecting trunk lines in the two countries.

The practicability of telephonic communication by wireless has been amply demonstrated on previous occasions and wireless telephony is in daily use in this and other countries at the present time for communication with aircraft, lightships, etc., but "simplex" working only has been commercially available hitherto, and the transmitters have been

by courtesy of the Postmasters-General of the United Kingdom and of Holland.

The wireless transmission was made on an unusually short wavelength and, on this account, was relatively immune from atmospheric disturbance. The tuning was particularly sharp, there being only three metres difference between the outgoing and incoming waves used in duplexing, so that there is ample room in the ether for a multiplication of such circuits without the possibility of mutual interference.

At Southwold and at Zandvoort wireless transmitting stations are equipped with valve trans-

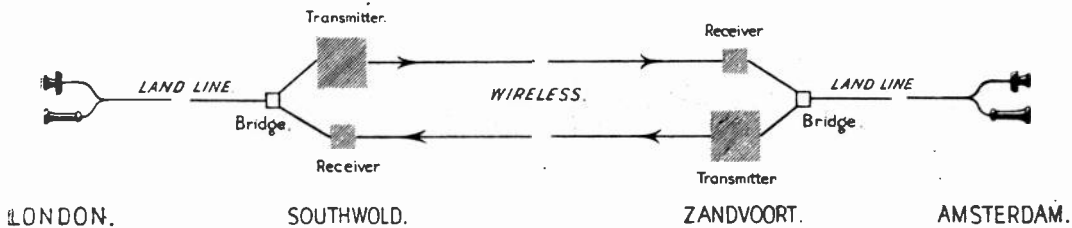

Diagrammatic sketch of the London-Amsterdam circuit.

mitters which are supplied with power by small petrol electric generating sets. The receiving stations in both cases are situated adjacent to the transmitting stations and experience has shown that a separation of the order of 100 yards is all that is required for effective duplex working.

Speech from London reaches Southwold over a metallic circuit, partially underground, and is received there in a much attenuated form. It is passed first through a special "bridge" circuit, and then amplified by valves to its original London strength, after which it modulates the carrier wave emitted from the transmitting station. At the Dutch receiving station, 115 miles away, the speech variations in the carrier wave are received and amplified and after rectification the speech currents are again on a local metallic circuit, at London strength. The local circuit at the Zandvoort receiving station is connected to the Amsterdam trunk line through a "bridge," similar to that at Southwold, thus completing the London Amsterdam circuit.

The circuit from Amsterdam to London is unaffected by the circuit from London to Amsterdam, so that conversation can be carried out in the ordinary way, one speaker breaking in and interrupting the other as in ordinary conversation. In other words the circuits are duplexed throughout. This is made possible firstly by working to Holland on a slightly different wavelength to that used for the return communication and by separating the transmitting and receiving stations at either end, and secondly by the special "bridge" connection to the trunk lines previously referred to.

A difference in wavelength and the separation

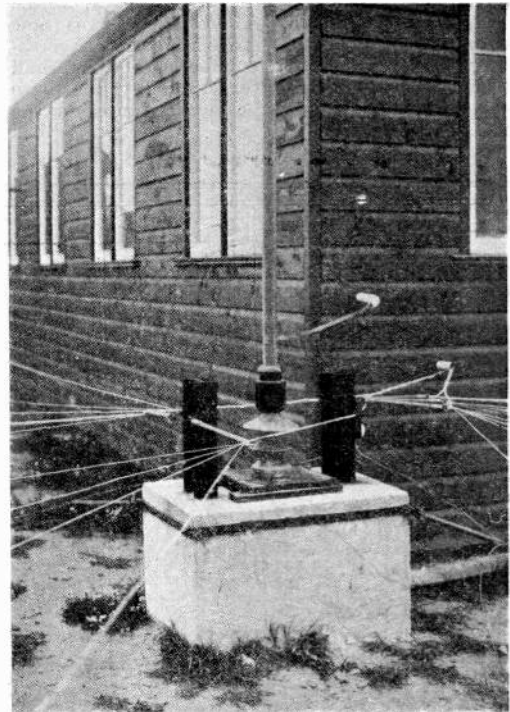

Base of insulated Transmitting Mast at Southwold.

The development of these circuits has depended upon the facilities obtainable for experimental work, and the entirely favourable conclusion of these experiments is in very great part due to the whole-hearted co-operation of the British and Dutch Post Office authorities.

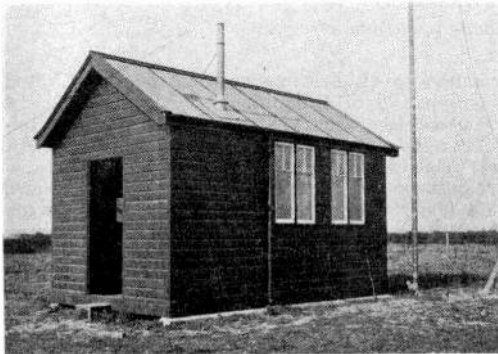

Receiving Hut at Southwold.

of the transmitting and receiving stations, together with certain other precautions, ensures that there shall be no interference between the incoming and outgoing speech while on the wireless portion of the circuit, and it is the function of the trunk line connecting bridges to prevent the strong speech at the wireless receiving stations, from affecting the transmitters which must be influenced only by the relatively weak speech from the trunk lines.

THE WIRELESS SOCIETY OF LONDON.

A PRESIDENTIAL ADDRESS will be delivered by Admiral of the Fleet Sir Henry B. Jackson, G.C.B., K.C.V.O., F.R.S., D.Sc., on Wednesday, January 25th, at 8 p.m., at the Institution of Electrical Engineers, Victoria Embankment. Tickets will be issued for the use of members and their friends by the Hon. Secretary.

The Society will hold its ANNUAL DINNER at 6.45 p.m. on the same date, and detailed arrangements will be announced later. Will all members and their friends who are desirous of attending the Dinner kindly make application to the Secretary before January 15th for tickets, price 10s.6d. each. Ladies are cordially invited.

THE ANNUAL CONFERENCE of Affiliated Societies will take place at 2.30 p.m., on Wednesday, January 25th, at the Institution of Electrical Engineers. Invitation tickets will be issued.

Wireless Club Reports

NOTE.—Under this heading the Editor will be pleased to give publication to reports of the meetings of Wireless Clubs and Societies. Such reports should be submitted without covering letter in the exact form in which they are to appear and as concise as possible, the Editor reserving the right to edit and curtail the reports if necessary. The Editor will be pleased to consider for publication papers of unusual or special interest read before Societies. An Asterisk denotes affiliation with the Wireless Society of London.

The West London Wireless and Experimental Association.*

Hon. Secretary, Mr. Horace W. Cotton, 19, Bushey Road, Harlington, Middlesex.

The Association held its first Annual General Meeting in its club-rooms at Belmont Road School, Chiswick, on Thursday evening, December 1st. A very large number of members, together with their friends, were present, and the whole of the evening was given over to business. The President (Mr. George Oxford), in his opening remarks, outlined the history of the Association from its commencement, when it was known as the "Chiswick, Acton and District Amateur Wireless Association," and the meetings used to be held in a room at his house. The roll of membership then was about twelve; now, he was more than pleased to see that we had reached the total of forty, and with every possible chance of adding to our numbers.

The Secretary then gave a brief report of the work accomplished during the past session, and referred to the increasing number of members also the inauguration of a Junior Section, and the course of Elementary Instructional Lectures which has been given and is to be continued by Mr. C. W. Hirst; also the Advanced Lectures and Demonstrations given by Mr. F. E. Studt. The Treasurer (Mr. W. Labran) then dealt with the Balance Sheet (audited by Messrs. R. Cole and W. T. Fair) and items contained therein, and it is very satisfactory to see that the association, after its heavy initial expenditure, is in a sound financial position.

The election of officers for the ensuing session resulted in the following appointments:—*President*, Mr. George Oxford (re-elected); *Vice-President*, Mr. F. E. Studt; *Hon. Secretary*, Mr. Horace W. Cotton (re-elected); *Treasurer*, Mr. A. Labran (re-elected); *Librarian*, Mr. W. T. Fair; *Committee*, Messrs. C. W. Hirst, H. Winnett, T. L. Mullings and R. Cole.

The Vice-President (Mr. F. E. Studt) was unanimously elected to represent the Association at the meetings of The Wireless Society of London. It was then arranged to hold a "Sale and Exchange" night on Thursday, the 8th inst., when the whole of the evening would be given up to this purpose in the hope that it will be beneficial to a large number of the members, and to enable them to mutually exchange apparatus for which they find very little or no further use.

During the latter part of the last session two competitions had taken place, and the following members were the successful recipients of the prizes offered—Mr. R. Cole, for paper entitled "Spark Transmitters," and Messrs. H. Palmer and L. Ritson for apparatus made by themselves.

It was the desire of the meeting that during the session 1921-22, further prizes should be offered, and it was decided that any members who for the

first time presents a paper, gives a lecture or demonstration, or exhibits a piece of useful apparatus made by himself, shall be awarded a prize, the committee being vested with the power to fix the value of the prizes. Further, that a special prize of Two Guineas be awarded to the member who, in the opinion of the committee and members, submits the most progressive asset to the science of wireless telegraphy, either scientifically or theoretically, or by apparatus demonstrated during the ensuing twelve months.

Again, it is hoped to start a good reference library for use of the members, and, with this idea in view, several books have been promised by members; by this means members may have access to standard works on wireless telegraphy and telephony.

Mr. F. E. Studt kindly brought along a quantity of apparatus to give a calibrating demonstration; but as business did not finish until 10 p.m., there was no time available after the meeting, so Mr. Studt promised to carry out the demonstration at one of the weekly meetings.

The Secretary was able, owing to the kindness of the Editor of *The Wireless World*, to give all those present particulars of the new arrangements and times of sending the French time signals from Paris, Lyons and Bordeaux.

A very hearty vote of thanks to the President, Vice-President, also other Officers and Committee, was given, with a volume of applause, for their untiring labours during the past twelve months.

Any gentleman who feels that the mysteries of "wireless" have an attraction for him will be heartily welcomed at any of the weekly meetings of the Association—held every Thursday evening from 7 to 10 p.m.

All enquiries will be gladly answered by the Hon. Secretary.

The Leeds and District Amateur Wireless Society.*

Hon. Secretary, Mr. D. E. Pettigrew, 37, Mexborough Avenue, Chapeltown Road, Leeds.

A General Meeting of the Society was held at the headquarters (Leeds University) on December 9th, at 7 p.m. Mr. P. O'Donohoe gave instruction in Morse code with a buzzer set to the junior members until 8 p.m., the senior members having a quiet talk amongst themselves. A Committee Meeting was held in the meantime and certain business attended to.

At 8 p.m. Mr. A. M. Bage (Vice-President) took the chair. Mr. W. R. Plowes, a member of the Society, offered to read a paper to the junior section, entitled "Samuel Morse," at this meeting; but owing to unforeseen circumstances Mr. Plowes had been obliged to postpone his lecture. The Chairman explained the position, and suggested that the time might be ably spent by the junior

members putting questions to the seniors. A senior member started the meeting by mentioning his reception at Ben Rhydding of some very, very mysterious "signals" on very short wavelengths—the converse (please note) to Senatore Marconi's observations—and after another member seconded this phenomena by reception in Leeds, both sections waxed enthusiastic, and at 9 p.m. the Hon. Secretary had considerable difficulty in obtaining order, and persuading the Chairman to set a good example to those present.

The Chairman then called upon Mr. G. P. Kendall, B.Sc. (Vice-President), to open a discussion on the "Fine Adjustment of Reaction." This debate was arranged primarily for the senior members, but the junior members also undoubtedly benefited by the proceedings. Mr. Kendall mentioned that the cylindrical inductance coil is being rapidly displaced by the ball type of coil, where reaction coupling is used. He also explained some circuits he had been using recently for the reception of PCGG, and, in particular, to the reaction adjustments of these circuits. (These were described in *The Wireless World* for November 26th, 1921).

The Hon. Secretary described briefly, with the aid of a blackboard diagram, how he obtained best C.W. signals on the longer wavelengths, with a very simple and successful arrangement of multilayer and cylindrical coils. The subject of capacity reaction was discussed, and Mr. Kendall pointed out why some amateurs could not get such reaction with one valve. He explained how it is done, by two diagrams. The Chairman spoke on the question of "overlap," and raised some very interesting questions. The Hon. Secretary advocated the use of a separate heterodyne to obtain best reaction adjustment for C.W.s of long wavelength, and has since come to the conclusion that this is infinitely better for short wave telephony also. Many amateurs who took their seats late, when a concert is in progress, have given rise to many a grumble with their "searching," using an autodyne. Using a heterodyne, this must be, of course, shut down when the speech, etc., is heard, and then finer adjustment of reaction may be obtained by a unit embodied in the receiver, adjusting to a point where the receiver is just going to oscillate, and you will get best speech, but do not let it oscillate!

The meeting terminated towards 10 p.m. Three new members were elected; attendance, very fair.

Birmingham Experimental Wireless Club.*

Hon. Secretary, Mr. Frank S. Adams, 110, Ivor Road, Sparkhill, Birmingham.

A meeting was held at the Club Headquarters on November 11th, the President being in the chair.

A resolution was unanimously passed, thanking the Lord Mayor of Birmingham for his kindness in consenting to open the Club's Exhibition in January, 1922.

On the motion of Mr. Campbell, it was decided that ladies should be invited to be present at all Club meetings. Mr. A. E. Campbell, A.M.I.E.E., then delivered a paper on "The Thermionic Valve."

Mr. Campbell explained in detail the necessity

for a high vacuum and a properly constructed filament in a valve. He strongly deprecated the practice of condemning a particular valve without first determining its characteristics. The methods of obtaining various curves were described and examples shown.

A vote of thanks closed one of the most informative meetings the Club has held.

Glasgow and District Radio Club.*

Hon. Secretary, Mr. R. Carlisle, 40, Walton Street, Shawlands, Glasgow.

At a meeting, held on October 12th, the President gave Part I. of his lecture on "The Theory of the Thermionic Valve." Mr. Snodgrass commenced with the emission of electrons from heated bodies, and, with the aid of diagrams on the blackboard, explained the theory of the working of a valve up to the point where it begins to oscillate. The lecturer's remarks were very interesting to all valve users, and were closely followed throughout by the thirty-six members present. A number of questions were asked, and answered, after which a hearty vote of thanks to Mr. Snodgrass concluded the proceedings.

At the meeting on October 25th Mr. Snodgrass favoured the members with Part II. of his lecture on Thermionic Valves. The attendance was not so large, but the interest shown was equal, if not greater, than at the last meeting. The lecturer had a wonderful grip of his subject and must have devoted a large amount of time in the preparation. The ever-recurring circuit diagrams on the blackboard enabled the audience to clearly follow Mr. Snodgrass's remarks, and he was heartily congratulated at the close on his lucid exposition of what, to the average amateur, is a somewhat difficult theory.

The meeting on November 9th was an "open" night, and after the conclusion of routine business the Secretary read a letter from the Wireless Society of London in reference to arrangements which are being made between the Marconi Company and the G.P.O. Authorities regarding proposed special weekly transmissions for the benefit of amateurs. We hope that the weekly transmissions will not be "weakly," but "strongly," so that the amateur wireless men in Scotland will have the pleasure of receiving these without the use of "umpteenth" valves. A point, we fear, often overlooked by our English comrades is that Glasgow is 400 miles away from London, and Aberdeen about 150 miles beyond Glasgow. As matters stand at present the Scottish wireless fans don't get a "look in" at low-power telephony in comparison to those fortunate friends south of the Tweed.

Mr. William R. Clark talked to us on the Electronic Theory of Electricity on November 23rd. He gave the relationship of electrons to atoms and molecules, explained the difference from an electronic view between conductors and insulators, how electrons caused a current to flow in a wire, or through a vacuum, etc., in fact, his remarks explained the most recent theory down-to-date. The inevitable questions were dealt with in a satisfactory manner to the questioners, after which the meeting terminated with a vote of thanks to the lecturer.

WIRELESS CLUB REPORTS

Some receiving apparatus is at present being rejuvenated by a sub-committee, recently appointed, consisting of Messrs. Dewar, McLennan, Gibson and Carlisle, and will be in use shortly. In this connection the Club is highly indebted to the following members for gifts of accessories: Messrs. W. Yuill, W. K. Dewar, D. C. Wright, D. B. McQuistan, A. Pick, J. T. McDade and E. Snodgrass. The practical interest shown by these gentlemen is much appreciated and augurs well for the future of the Club.

Buzzer practice is now available each meeting night between 7.30 p.m. and 8 p.m. for members desiring to avail themselves of these facilities.

There are still a few vacant dates on our syllabus, and the Hon. Secretary will be pleased to hear from any member or friend willing to assist in this direction.

Intending members can obtain all required particulars from the Hon. Secretary, Mr. R. Carlisle, 40, Walton Street, Shawlands, Glasgow, or call during daytime on Mr. W. K. Dewar at 206, Bath Street, Glasgow.

Woolwich Radio Society.*

Hon. Secretary, Mr. H. J. South, 42, Greenvale Road, Eltham, S.E.9.

The monthly meeting of the above Society was held at the Woolwich Polytechnic on Friday, December 16th, 1921, at 8 p.m. The meeting was of an unusual and quite informal character.

Captain C. T. Hughes, R.E., of the S.E.E., brought with him some very interesting and practical instruments, including a capacity bridge, an inductance bridge and a resistance bridge. The working of these instruments was lucidly explained to the members, and then an enjoyable and highly useful hour was spent testing and calibrating various capacities and inductances which had been brought up by various members. Various condensers were measured, including fixed, blocking, test tube sliding condensers and variable condensers. For the two variable condensers the Captain worked out calibration charts for the whole range. The coils included cylindrical, slab, honeycomb, basket and wave-wound coils, and their inductances in microhenries was worked out. The evening proved to be a very useful one to members, and it is hoped that at some future time Captain Hughes will kindly oblige again, when members will have an opportunity of testing their completed sets.

Bradford Wireless Society.*

Hon. Secretary, Mr. N. Whiteley, 8, Warrels Terrace, Bramley, near Leeds.

A meeting was held in the Club-room at 7.45 p.m. on December 16th, Mr. W. C. Ramshaw being in the chair.

The minutes of the previous meeting having been read and confirmed, the Chairman then called upon Mr. W. G. A. Daniels to give his lecture entitled "The Construction of a Single-valve Receiver." The lecturer very ably dealt with his subject, and illustrated his remarks by means of blackboard drawings and frequent references to a complete instrument of his own make, which was on view. This instrument was much admired by

those present, and Mr. Daniels is to be complimented upon a fine piece of work. At the conclusion of his remarks the lecturer connected the set to the Society's aerial, and good signals were obtained.

A hearty vote of thanks was carried unanimously.

Two new members were elected, and the proceedings then closed.

Wireless and Experimental Association.*

Hon. Secretary, Mr. George Sutton, 18, Melford Road, S.E.22.

As was naturally to be expected, the chief topic of interest for the Association at their meeting at the Central Hall, Peckham, on Wednesday, December 14th, was the reported success of their fellow-member, Mr. A. E. Greenslade, in the receipt of the American amateur wireless messages. He reported that for upwards of two hours on the previous Sunday morning he had "taken down" the messages, only very occasionally being jammed, and the result is a triumph for British pluck, plant and persistency.

We do not yet know whether our American friend, Mr. Godley, who came over for the purpose, got anything. We hope he has, but we most sincerely hope that our man got in first.

Mr. Greenslade will honour us early in the New Year with a descriptive account of how he did it. We promise him that we will not "jam" his speech.

Halifax Wireless Club.*

Hon. Secretary, Mr. Lewis J. Wood, Clare Hall, Halifax.

Our syllabus for the present session has so far worked without a hitch, every lecture taking place as arranged. Apart from our own members we are deeply indebted to Mr. A. F. Carter of Leeds, who gave us a splendid evening with a Mark III tuner converted to a 7-valve amplifier. Mr. W. Forbes Boyd, of Sheffield, who dealt very lucidly with "Wireless as applied to Aerial Navigation."

On Wednesday, November 30th, our friends, Mr. H. T. Burbury and Lieut. H. E. H. Burbury (2AW), of Crigglestone, gave us a lecture on "2 AW Station, with particular reference to the Receiver." This lecture was delivered by radio telephony from Crigglestone to Halifax. Our members, who have receiving sets, some thirty or more, listened-in at home and the rest crowded out of Club-room. The lecture was a great success, and reflected great credit on Messrs. Burbury, in spite of the persistent efforts of our local tramcars to spoil the show. We do not know how many amateurs did listen-in, but we do know that when we tried to inform Messrs. Burbury how the lecture was progressing by our 2GU low-power radio-telephone, we were completely wiped out by the radiating valves of the interested amateurs. The lecturer's remarks at the close of his lecture with regard to this nuisance were terse and to the point and heartily endorsed by all present. We received the lecture perfectly with crystal rectification and without reaction of any description. At the close of the lecture we were treated to a gramophone concert by 2KD (Mr. P. Denison), and our thanks and applause were conveyed to him by radio-telephone.

On December 7th Mr. P. Denison gave us a very interesting lecture on "Receiving Circuits," a lecture more constructive than theoretical, and sent many of our members home with fresh ideas and much scrapping and rebuilding has been the result of this lecture.

On December 14th we had a return visit from our old friend, Mr. J. R. Halliwell, of the City School of Wireless, Manchester. By special request Mr. Halliwell lectured on the "Mushroom" Valve. Mr. Halliwell very lucidly explained the theoretical functions of this interesting piece of apparatus, and at the close of his lecture showed how it was possible, by careful control of the lines of force inside the valve by the application of lines of force outside the valve, to bring in stations which could not be heard with careful tuning alone. Our members were greatly interested, and Mr. Halliwell was inundated with questions, with which he dealt in his usual lucid manner. Another field for experimentation was opened up to our members, and one can see a run on these interesting valves in this district, if any are now procurable.

Many secretaries will remember receiving a letter from our Club, asking for their co-operation with respect to a certain Petition. We are glad to say that the Wireless Society of London have considered this Petition of sufficient interest to take the matter up themselves, and by the time this report is in print the Petition will be in the hands of all the societies. The immense amount of correspondence which has been involved by our proposal is amply repaid by this official action, and we hope the various societies will respond as they did by the support offered to us.

Newcastle and District Amateur Wireless Association.*

Hon. Secretary, Mr. Colin Bain, 51, Grainger Street, Newcastle-on-Tyne.

A very successful public exhibition and demonstration of amateur wireless instruments was given by the Society on December 2nd and 3rd last. Over 500 people attended and much interest in the exhibits was shown. Signals were continuously received on as many as three separate receivers on different waves, using the one aerial available. All the usual stations were received and amplified so as to be audible practically all over the building. Members are very pleased with themselves, and the Club funds have received a welcome "boost up." Club meetings will be suspended over the Christmas and New Year holidays. The next meeting to take place on January 9th.

Plymouth Wireless and Scientific Society.*

At the meeting held on Wednesday, November 30th, at Plymouth Technical College, a demonstration was given by Mr. Nicholson of the Marconi 1½ kW transmitting set installed in the College. The demonstration and the accompanying lecture proved very interesting and instructive, particularly to the purely amateur members of the Society. Opportunity was taken at the same time by the lecturer to illustrate some very interesting points in relation to some of the curious vagaries of high-frequency currents. Fault-finding was also dealt with, the lecturer showing how quickly and easily

the position of faults can be determined if a systematic test is made. Transmission is particularly attractive to amateurs in this district, since we are, it seems, in a forbidden area, and there are no amateur transmitting stations within a radius of fifty or sixty miles.

Particulars of membership and copies of the rules will be gladly furnished to intending members by the Hon. Secretary, Mr. G. H. Lock, 9, Ryder Road, Stoke, Devonport.

North Middlesex Wireless Club.*

Hon. Secretary, Mr. E. M. Savage, "Nithsdale," Eversley Park Road, Winchmore Hill, N.21.

The eightieth meeting of the Club was held at the headquarters on December 14th, with the President, Mr. A. G. Arthur, in the chair. The meeting was of an informal character, and the Chairman had devised a competition which proved to be very interesting. The Club's set having been connected up to the aerial, several members took it in turns to obtain the best signals, starting with all control switches at zero and having a time allowance of four minutes. It was interesting to note the different results obtained by members in the time allotted, some preferring to search for long waves, while others went for loud signals.

Finally, Mr. Holton, the Installation Officer, was asked to withdraw, and the connections "faked" and other parts of the set disarranged in the manner of Army and other examinations; and, on his being recalled, he succeeded in clearing all faults and getting loud, clear signals in 3½ minutes. The applause which greeted this result brought to a close a very interesting evening.

Sussex Wireless Research Society.*

Hon. Secretary, Mr. Edward Hughes, B.Sc., A.M.I.E.E., The Technical College, Brighton.

The members of the above Society met on December 16th at Cottesmore School, when a lecture was given by the President, Captain E. A. Hoghton, F.P.S.I., on "Transmitter Circuits." The lecturer dealt fully with the theory and construction of aerials for transmitting purposes, and then passed on to the question of transmission systems of the spark type. The functions of the various component parts, especially of the rotary gap discharger, were fully discussed. Captain Hoghton then proceeded to explain the operation of the Alexanderson and of the Goldschmidt high-frequency alternator, pointing out the great difficulties that had to be overcome both from the electrical and mechanical standpoints.

The latest recruit to the membership of this Society is the pioneer in electrical developments—Mr. Magnus Volk, who constructed the first electric railway in this country—a railway that is well-known to all who have visited Brighton.

The 19th and 20th of January are anticipated to be red-letter days in the history of radiotelegraphy and telephony in Brighton and Hove. A great public demonstration is to be given at the Hove Town Hall, under the auspices of the Sussex Wireless Research and the Brighton Radio Societies.† The first day will be reserved for the members of the societies and others who are specially interested in this subject. On the second day

† See page 636 of this issue.

WIRELESS CLUB REPORTS

both the afternoon and evening sessions will be open to the public. Appropriate lectures will be given at the various sessions by Captain E. A. Hoghton, F.P.S.L., A.M.I.R.E. Every effort is being made to ensure the success of the demonstration.

Folkestone and District Wireless Society.*

Hon. Secretary, Mr. H. Alec. S. Gothard, A.M.I.R.E., 8, Longford Terrace, Folkestone.

NOTICE TO MEMBERS.—On and after Wednesday, January 4th, 1922, by courtesy of Mr. Jerome, the Society will meet at 20, Bouverie Road West, on the first Wednesday in the month, at 7.45 p.m.

Dartford and District Wireless Society.*

Hon. Secretary and Treasurer, Mr. E. C. Deavin, 84, Hawley Road, Wilmington, Dartford.

The members of the above Society held their usual fortnightly meeting at Dartford Grammar School on Friday, December 16th, 1921, with Mr. J. R. Smith, A.M.I.E.E., in the chair. The minutes of the previous meeting having been read and confirmed, the Vice-President called on Mr. B. P. Bezant (a member of the Society) to give his lecture on "Coal and Its Products." With a view to arousing local interest in the work of the Society, efforts are being made to arrange lectures on scientific subjects not directly connected with wireless, this lecture being the first. There was a good attendance of members and representatives of the School at this meeting which proved to be of an extremely interesting and instructive nature. The lecturer being thanked by the President (Mr. L. J. Miskin, M.B., F.R.C.S.) for his work in preparing same.

The Gloucester Wireless and Scientific Society.*

At a meeting of the above Society, held on October 24th, Mr. Hine showed a slide lantern of his own construction, and also a cinematograph attachment he had made for it. The light source was a 6v. $\frac{1}{2}$ watt bulb, and gave excellent results. It was suggested that, as the Club members had some expert lantern slide makers amongst its members, slides should be made of all member's sets, and slides of diagrams of them also, to be used for reference at any future lecture. A cordial vote of thanks was passed to the lecturer.

At a meeting held on November 10th, Mr. Gowing gave a very interesting talk on hydraulic machinery and some of its applications. He proved to know his subject very well, and an interesting hour was passed by all there. We are promised a lecture on crude oil and other engines by the same gentleman shortly.

A general discussion of wireless questions followed, and some interesting results arrived at on member's private installations were mentioned.

Any particulars of membership of this Club will be supplied on application to the Hon. Secretary, Mr. J. J. Pittman, 1, Jersey Road, Gloucester.

Newark-on-Trent and District Wireless Society.

Hon. Secretary, Mr. Geo. T. Sindall, 6, Beech Avenue, Hawtonville, Newark-on-Trent, Notts.

Considerable success attended the first Exhibition and Demonstration in connection with the above Society, which was held at the Magnus School, Newark-on-Trent, on Saturday, December 10th, and the Committee are to be congratulated on the venture, as the Society has only been formed some two months.

During the afternoon and evening some 300 people visited the Exhibition. The whole of the proceeds were devoted to St. Dunstan's Hostel. In a side room was fitted up the three-valve set owned by the Hon. Secretary, on which signals were continually being received during the afternoon, and were made audible throughout the room by the aid of a Brown's Loud Speaker, most kindly lent by Messrs. S. G. Brown, Acton, and which was the means of making the demonstration so successful. During the evening some fine telephony came in from an unknown source, and was much enjoyed by those present.

The Exhibition of instruments constructed by the members displayed no mean ability upon the part of many members, and much time and patience must have been bestowed upon the apparatus shown, many having a professional-like appearance. A fine collection of apparatus was also on view by The Wireless Equipment Co., Wickford, Essex.

Two new members were enrolled.

The Wireless Society of East Dorsetshire.

A General Meeting with an introductory lecture was held in the Wimborne Council Schools on Wednesday, December 7th, at 7 p.m., which was attended by over 50 enthusiasts.

After a short lecture on the fundamental principles of radio telegraphy, given by the Hon. Secretary, it was decided by the Committee that, in future, the Society would be known as the Wireless Society of East Dorsetshire, the previous area being too large to organise many meetings.

Demonstrations were given in the class room with an indoor aerial, and very good signals were heard from the Channel stations, ships and Warsaw, with a 2-valve audio frequency amplifier and loud-speaker.

Ten additional members were enrolled at the close of the meeting, and Mr. Wm. Kerridge elected Treasurer.

Secretary, Mr. E. T. Chapman, A.M.I. Radio E., Abbotsford, Serpentine Road, Poole.

Bristol and District Wireless Association.

Hon. Secretary, Mr. E. C. Atkinson, 5, Pembroke Vale, Clifton, Bristol.

A dozen new members have recently been elected to the Association. Meetings have been held on September 30th, October 28th, and November 25th.

On September 30th, Mr. E. A. Stinchcomb discussed "Potential and Current in Wireless Circuits and their Phase Relations." During an interval in this lecture Messrs. Marcuse and others gave a short concert transmitted from Mr. Marcuse's station at Westbury.

On October 28th, after various items of private business had been dealt with, Mr. E. C. Atkinson discussed "Inductance in Wireless Circuits." During an interval Mr. A. J. Clark gave a buzzer practice to the members after prefacing the signalling with some useful hints to learners.

On November 25th the Association met at Tower House, Cotham, to inspect a direction finding installation, the inspection being preceded by a lecture on the subject by Mr. M. G. Bennett, who is conducting systematic observations at this station.

After a hearty vote of thanks, the installation was visited in two parties.

The Cambridge and District Wireless Society.

Hon. Secretary, Camden House, Park Terrace, Cambridge.

A very successful meeting of the above Society was held in the lecture room of the Photographic Society, Ram Yard, on Wednesday evening, November 23rd, at 7.30. Mr. Farren was in the chair. Having no preliminary business the Chairman called upon Mr. H. Culpan to deliver his paper on "Wireless Gadgets." Mr. Culpan dealt with this subject in a very able manner.

At the close of the lecture Mr. Banyard proposed a hearty vote of thanks to the lecturer, and this was signified in the usual way. The meeting was then declared open to discussion, and many useful little hints were described by many members for overcoming the difficulties in erecting temporary apparatus. The meeting was then declared informal.

Wimbledon and District Wireless Society.

The First Annual General Meeting of the above Society was held at the Wimbledon Technical Institute, on Saturday, December 10th, 1921, Mr. W. A. Harwood, Principal, in the chair.

The Chairman called upon the Hon. Secretary (Mr. W. G. Marshall) to read the annual report for 1921. The report disclosed that 53 full members had been enrolled, and that the Society had been established on a fairly firm foundation.

The Treasurer (Mr. G. W. Leach) was next called upon to read the financial report. Both reports were adopted unanimously.

The following gentlemen were elected officers for the new session, 1922:—

President, Prof. A. Griffiths, D.Sc.; *First Hon. Member*, Mr. W. A. Harwood; *Secretary*, Mr. W. G. Marshall (re-elected); *Treasurer*, Mr. G. W. Leach (re-elected); *Committee*, Messrs. R. E. Miller, J. W. Smith, L. Biggs, W. R. Harris.

The new President, Prof. A. Griffith D.Sc., addressed the meeting choosing as his subject "The Historical Development of our Knowledge of Waves." In the course of his address he dealt with the researches and discoveries of numerous Scientists commencing with Hooke (1635-1703) down to Hertz, giving an outline of the work done by Young, Fresnel, Gilbert, Dufoy, Oliver Lodge, Faraday, and Kelvin.

The address was profusely illustrated with lantern slides.

A vote of thanks proposed by Mr. A. V. Ballhatchet was duly accorded to Prof. A. Griffith at the termination of his address.

A Wireless Telephony Demonstration arranged by Mr. G. W. Hale, assisted by Messrs. Miller and Munday in collaboration with Mr. B. Clapp, of Purley, was very successfully carried out, despite adverse conditions. This demonstration was greatly

appreciated by the meeting. The Society tendered its thanks through the Hon. Secretary for the trouble taken by the above mentioned gentlemen.

A short concert concluded the proceedings.

The informal meetings of the Society are being resumed on Thursday, December 15th, 1921, and will be conducted weekly on that evening until further notice. Buzzer practice and discussions relative to the construction of wireless apparatus will form features of these meetings.

The next monthly meeting of the Society takes place on Saturday, January 14th, 1922, when Mr. Hibberd will read a paper on "The Educational Value of Wireless."

Old members are reminded that subscriptions are now due. Those interested are invited to apply for further particulars to Mr. W. G. Marshall, 48, Warren Road, Merton, S.W.19, or Technical Institute, Wimbledon, S.W.19.

Bolton Wireless Society.

Hon. Secretary, Mr. H. Chadwick, 9, Raimond Street, Bolton.

The Annual General Meeting of the Society was held on December 16th at headquarters. Mr. Parkinson in the chair.

The Chairman outlined the progress of the Society during the last six months, stating that the Society had a good beginning, and good prospects of becoming a very successful Association. More interest and co-operation, however, was required on the part of many members, and he hoped they would pull together more in the future. The membership of the Society was given at about 30, but there is no reason why this number should not be increased considerably, the Chairman pointing out that this can be done if members would introduce new enthusiasts to the Society.

The election of officers for the coming year resulted as follows, all being unanimously elected:—

President, Mr. J. Scott-Taggart, A.M.A.I.E.E. *Vice-Presidents*, Dr. Reid, Mr. A. J. Hutchinson, A.M.I.M.E., M.I.E.S., Mr. G. Clapperton and Mr. J. Ashworth, A.M.I.E.E.; *Chairman*, Mr. A. Parkinson; *Vice-Chairman*, Mr. R. C. Walsh; *Hon. Treasurer*, Mr. J. Waller; *Hon. Secretary*, Mr. H. Chadwick; *Committee Members*, Messrs. A. B. Pilkington, O. Stott, and D. Heywood. *Auditors*, Messrs. Atkinson and A. Heywood.

A proposal was made to run a Whist Drive, which was carried, the date being fixed for January 25th. Details will be given later.

The proceedings then terminated at 9.45 p.m.

The Secretary will be pleased to receive any applications for membership, or to answer any questions relating to the Society.

Middlesbrough and District Wireless Society.

The inaugural meeting of this Society was held at the meeting room in Borough Road, East, on November 21st, with Mr. H. M. Mayfield in the chair. It was explained that some doubt existed as to whether there were a sufficient number of wireless amateurs in the district to carry on a wireless society with reasonable advantage to the members; but it was soon proved that there was much hidden enthusiasm in the persons of a number of wireless men here who have so far

WIRELESS CLUB REPORTS

been working and experimenting alone, and have so far had no previous opportunities for the interchange of helpful opinion and advice. As President, Mr. A. W. Marshall, M.I.E.E., was unanimously elected; Mr. H. M. Mayfield as Vice-President, and Mr. Cleveland Hood as Hon. Secretary and Treasurer. In the informal discussion which followed the objects of the Society were fully discussed, and as a preliminary measure, two of the more experienced members offered to draw up a layout for an efficient aerial to be erected over the meeting room. For this aerial sanction has already been obtained. The annual subscription has not yet been fixed, but it is intended to keep this as low as possible. Meetings are to be held on Tuesdays at 7.30 p.m., fortnightly.

Hon. Secretary, Mr. Cleveland Hood, Nunthorpe, S.O., Yorks., to whom further applications for membership should be addressed.

Redhill and Reigate Y.M.C.A. Wireless Club.

A meeting was held on Saturday, December 10th, to discuss the possibility of forming a club at the Y.M.C.A. A number of gentlemen being present, it was decided that a club should be formed, and officers and Committee were appointed, as follows:—

Chairman, Mr. H. J. White, of Homelands, South Merstham; *Committee*, Messrs. R. S. Ross, C. W. Johnson, J. S. Clarke, A. P. Fletcher and H. L. Grimes.

When the question of apparatus was discussed it was decided that as soon as possible a club set should be constructed. Until this set is in operation Mr. White was warmly thanked for his offer to lend his two-valve set, and Mr. Clarke for his offer to lend valves. The meeting closed with thanks to Mr. J. W. Johnson, the Secretary of the Y.M.C.A., for the help he gave in making the meeting a success.

All particulars regarding membership may be obtained from the acting Secretary, Mr. F. Howell, c/o Y.M.C.A., 111, Station Road, Redhill, Surrey, who will be very pleased to receive catalogues of apparatus and books from any firms interested.

The Cowes and District Radio Society.

Hon. Secretary, Mr. A. Ball, "Pretoria," Castle Street, East Cowes, I.O.W.

A wireless club has been formed in East Cowes, and on Thursday, December 5th, a lecture was given to a good gathering by H. A. Dabell, Esq., Assistant Superintendent of Telegraphs, North Borneo. A thoroughly enjoyable evening was spent and the lecturer was asked to become a honorary member, which he accepted.

Liverpool Wireless Association.

Hon. Secretary, J. Coulton, 98, Amphill Road, Liverpool.

The annual meeting will take place at the Royal Institution, Colquitt Street, at 8 o'clock on January 11th, 1922.

The Wireless Society of Highgate.

The above Society is now formed. Meetings are temporarily held at the Secretary's house, but it is hoped that a permanent club-room will soon be available.

The officers are: *President*, Mr. Philip R. Coursey, B.Sc., F.Inst.P., A.M.I.E.E.; *Chairman*, Mr. H. Andrews; *Hon. Treasurer*, Mr. D. H. Eade; *Hon. Secretary*, Mr. L. R. Rowlands; *Assistant Secretary*, Mr. L. Grinstead; *Librarian*, Mr. S. B. P. Barnes. These officers also comprise the Committee. There is already a large reference library contributed by members of the Society.

There have so far been two lectures, the first on Friday, November 25th, when Mr. L. Grinstead gave an interesting paper on "The Elementary Principles of the Valve," being the first of a series of papers on "Thermionic Valves"; while on Friday, December 2nd, Mr. F. L. Hogg gave a lecture with demonstration on "Wireless Telephony."

Lectures are held on alternate weeks, the intervening meetings being used for discussion.

East Ham, Barking and Forest Gate.

A wireless club for the above area is being formed, and those interested are asked to communicate with Mr. E. E. Forest, 66, Gillett Avenue, East Ham, E.6.

Sutton and District.

Mr. J. A. Tully, of "Elmwood Lodge," Benhill Avenue, Sutton, Surrey, will be glad to hear from any person interested in the formation of a Club for Sutton and District.

Wireless Club for Tipperary.

Mr. W. Mitchell, c/o Wireless, Tipperary, Ireland, is anxious to get into touch with any persons interested in the formation of a Wireless Club. For the time being Mr. Mitchell is prepared to do all that is necessary in the matter of secretarial work, but other officers are required.

Dewsbury and District.

Mr. S. S. Davies, 36, Crackenedge Lane, would like to hear from any amateurs in the district, with a view to forming a wireless club.

An Amateur Set.

2 KN.

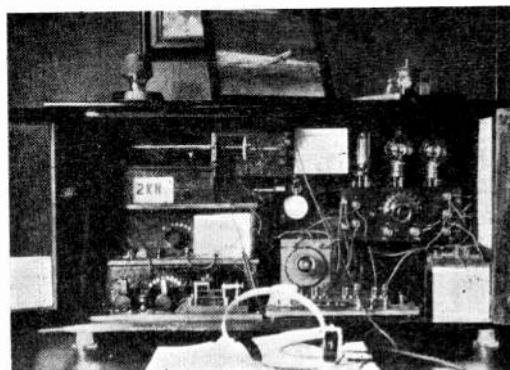

Mr. A. B. Day's set at Finchley.

Notes and News

The Wireless Society of London : Congratulations on Reception of American Signals.

The following telegram was received from Dr. Pierre Corret, and is published for the interest of all concerned :—

To { Erskine Murray,
Wireless Society,
Institution of Electrical Engineers,
Victoria Embankment, London.
Cordiale félicitations de Société Française Etude
T.S.F. à Amateurs Britanniques pour succes
reception signaux Americains.
CORRET, *Vice-President.*

To this telegram Dr. J. Erskine Murray replied as follows :—

To { Corret,
Vice-President Société Française Etude
Telegraphie sans Fils, Paris.
Most hearty thanks of Wireless Society for
congratulations on reception of American signals.
ERSKINE MURRAY,
President.

Eiffel Tower Telephony Transmissions.

General Ferrié, in replying to a letter from a prominent amateur in this country, has stated that the wireless telephone transmissions of the Eiffel Tower have not yet been organised as a regular service. Probably at a later date Press and financial news will be transmitted, and possibly concerts on Thursdays and Sundays. Details, and in particular the times of transmissions, cannot be fixed at present. General Ferrié expresses his intention of bearing in mind the suggestion put to him that, if possible, transmissions might take place in the evenings at a time when the majority of amateurs would be able to take advantage of them.

Wireless Exhibition in Birmingham.

The Birmingham Experimental Wireless Club is holding its Second Annual Wireless Exhibition from Wednesday, January 18th to Saturday, January 21st (inclusive) in the large Examination Hall, Birmingham Municipal Technical School. The Exhibition will be open on Wednesday from 6 to 10 p.m., and on Thursday, Friday and Saturday from 3 to 10 p.m. A large number of manufacturers of apparatus are exhibiting.

The Sussex Wireless Research and Brighton Radio Societies.

Demonstrations, with lectures upon wireless telegraphy, etc., will be given by members of the above Societies in the Town Hall, Hove, on Thursday, January 19th, at 7.30 p.m. There will also be an exhibition of wireless apparatus.

Phonetic Alphabet for Use in Radio-Telephonic Communication.

The following phonetic alphabet is recommended for the use of amateurs. It is used in the three Services and has been adopted for general use at Government Civil Aviation Wireless Telephone Stations :—

A	-	-	Ac.	N	-	-	Nuts.
B	-	-	Beer.	O	-	-	Orange.
C	-	-	Charlie.	P	-	-	Pip.
D	-	-	Don.	Q	-	-	Queen.
E	-	-	Edward.	R	-	-	Robert.
F	-	-	Freddie.	S	-	-	Sugar.
G	-	-	George.	T	-	-	Too.
H	-	-	Harry.	U	-	-	Uncle.
I	-	-	Iuk.	V	-	-	Vic.
J	-	-	Johannie.	W	-	-	William.
K	-	-	King.	X	-	-	X-ray.
L	-	-	London.	Y	-	-	Yorker.
M	-	-	Monkey.	Z	-	-	Zebra.

Good News for the American Amateur.

Some time ago we mentioned in *The Wireless World* that the United States Government had undertaken the transmission of market news for the information of farmers, and others. This transmission was by wireless telegraphy. It is now announced that this service is to be supplemented by a wireless telephone news service to be transmitted at regular hours daily. It is anticipated that this will be the signal for a very great increase in the popularity of wireless in the United States.

Koenigswusterhausen.

The official times of working of LL' (Telephony) are now given as :—

2,500 metres 0700—0725 G.M.T.	} Reduced
2,500 metres 1030—1055 G.M.T.	
4,000 metres odd times, experimental, full power.	

Book Reviews

PREPARED RADIO MEASUREMENTS WITH SELF-COMPUTING CHARTS. By Ralph Bateher, A.M.I.R.E., A.I.E.E. (New York: *Wireless Press Inc.*; London: *The Wireless Press, Ltd.* 10/6 net.)

This work consists of some 60 charts, some of which are drawn as curves, and others as nomographs, where the formulae introduce more than two variable quantities. The object of these

charts is to permit the experimenter in wireless to perform rapidly nearly all the more usual calculations concerning inductance, capacity, coil winding, decrement, antenna constants, wavelengths, reactance of condensers and inductances and so on, and that with virtually no knowledge whatsoever of higher mathematics or logarithms. In other words, coils can be designed, wavelengths calculated, etc., by merely selecting appropriate charts, laying a

BOOK REVIEWS

ruler across them, and reading off the result. On each chart is printed very detailed instructions as to its uses, and an actual example is given in nearly every case. Throughout the book the charts are printed on the odd numbered pages only, the even numbered pages being reserved for memoranda, some being blank and some printed as squared paper with 20 divisions to the inch; this is a most sensible feature, and ample space is thereby provided for the insertion of notes and formulae.

Most of the charts are built upon from what may be termed "Classic" formulæ, such as that of Nagaoka for the inductance of solenoids, that of Cohen for loaded aeri-als, and so on. To show the complexity of some of the formulæ used, it may be noted that Doctor L. W. Austin's formula for calculating the capacity of a multiple wire antenna is as follows:

When A = Area of top, h = height, l = length, w = width.

$$C = \left(4 \sqrt{A} + 0.885 \frac{A}{h} \right) \left(1 + 0.015 \frac{l}{w} \right) 10^{-5} \text{ mfd.}$$

On the chart to which this formula is reduced it is necessary only to place a ruler on two scales and read the capacity per meter directly from a third scale!!

The charts given for the reactance of condensers and inductances are invaluable to any experimenter seeking to design either resistance coupled amplifiers, or choke control radiophones. By ascertaining from the charts the reactance of the proposed coupling condensers, they can be regarded as simple resistances, and it is then easy to see whether they are reasonably proportioned to the wavelengths it is desired to receive.

Some of the charts introduce the Browne and Sharpe wire gauge, which might be thought a bar to their use in England where wires are numbered by S.W.G., but it is not so in reality, as from B. & S. numbers 18 to 28 inclusive, one only needs to remember that the corresponding S.W.G. number is just 1 higher, i.e., B. & S. 23 = S.W.G. 24, and so on.

No critique would be complete unless the critic had some fault to find—that is his job—but it has not been very easy in the case of Mr. Batcher's book to find any serious faults. The printing and paper are good, except that, in one or two instances, some of the straight line graphs have got badly bent!! Not, however, to a degree that introduces any serious error. On page 47 in the instructions for the use of the chart there is a bad misprint: the words "on the first line" connecting points on scales 1 and 5" should obviously read "scales 1 and 4." The author might well have stated that correction factors given on pages 49 and 51 for current sheet inductance formulæ need only be applied in the rarest cases, and we can honestly say never in average work. In the wavelength charts on pages 67 to 75, the inductance scales are expressed sometimes in microhenries and sometimes in millihenries; it would have been less confusing to stick to one unit throughout.

In conclusion we can most strongly recommend this book to the serious experimenter, and even more so to the professional radio engineer.

Mr. Batcher is evidently a practical man who,

over some considerable time, has constructed for his own use a series of most valuable time-saving devices, and who has now thought fit to save his confrères many hours of laborious calculation. Personally our log book is going to take a well earned rest!!

F. PHILLIPS.

THE PRINCIPLES OF RADIO COMMUNICATION. By J. H. Morecroft, assisted by A. Pinto and W. A. Curry. (London, 1921: Chapman and Hall. 42s. net.)

On account of the considerable "wireless" literature which already exists the advent of a new book of over 900 pages devoted to radio science and art is bound to be for the reviewer one of two things; a very interesting event or a private sorrow. In the present instance there is occasion to offer hearty congratulations to the author, the publishers and the public, for Professor Morecroft in our opinion has produced the radio book of the year, whether it be judged from the standpoint of the student, the engineer or the amateur.

The author has recognised and acted upon the fact that it is wisest not to assume students to be so thoroughly grounded in fundamentals that these may be either ignored or "scamped." There is a stage in any branch of learning to progress beyond which the student must flounder painfully if his understanding of fundamental phenomena is not so sound as to be almost akin to second nature. Hence this book begins with the ABC of its subject, but the author here again shows his good judgment by not taking the reader further back than that, into the region of the *kindergarten*; he speaks of electrons on the first page, and assumes that we are fairly educated in spite of our possible ignorance of radio communication. In fact, we have in this volume that *rara avis* of its genus, a technical exposition which neither insults the intelligence by telling us "how many beans make five," nor cloaks its virtues under a display of mathematical erudition.

It is evident that great pains have been taken to make contact with actual practice at as many points as possible, a feature which is presented without resort to the doubtful aid of photographs of apparatus, which, one notes with appreciation, form a scarcely noticeable percentage of the total illustrations, their places being much more usefully occupied by a series of excellent oscillographs. Not only is the practical side kept well in sight, but the author has not considered it necessary to fill up space with the very early methods of radiotelegraphy, and thus we are spared an explanation of the coherer, and other old wheezes, the special chapter on amplifiers being so much more to the point.

The chapter headings are as follows:—Fundamental ideas and laws. Resistance, inductance, capacity. General view of Radio Communication. Laws of oscillating circuits. Spark Telegraphy. Vacuum tubes and their operation in typical circuits. Continuous wave telegraphy. Radio telephony. Antennæ and Radiation. Wave-meters and their use. Amplifiers. Radio experi-ments.

The last of these I commend specially to the members of wireless clubs, in the belief that a course of systematic, quantitative experiments such as those described would be more interesting and instructive than hours of "listening in." As casual observation sometimes results in a great discovery, but the systematic plodding research of many slowly but more surely adds to the sum of human knowledge, one would wish to see the skill and time of wireless amateurs applied definitely to the solution of the problems which abound in their chosen field, rather than to the transformation of perfectly readable signals into bad noises by means of "loud speakers."

Professor Morecroft has not been unmindful of the amateur. He is a sympathetic teacher, and his book is a most welcome contribution, being a textbook and reference book in one, which to taste of is to covet.

E. BLAKE.

THE THERMIONIC TUBE IN RADIO TELEGRAPHY AND TELEPHONY. By John Scott-Taggart. (London: *The Wireless Press, Ltd.* 25s. net.)

The wireless experimenter who decides to take up valve work may well be pardoned a certain hesitation in his choice of a book to guide him. Already a considerable literature has grown up around the thermionic tube, many books being devoted entirely to the subject, whilst almost every wireless textbook has a section given up to its discussion.

However, a detailed examination of existing works shows that in the main they are theoretical treatises, valuable and informative in their own field, but of little help to the man who, understanding in a general way the functioning of the valve as a detector, amplifier and oscillator, wants to design and build an efficient instrument "all by himself." Briefly expressed, such a man wants information on *practical valve circuits*, about which the average book on the thermionic valve says little.

Mr. Scott-Taggart's book, then, will be widely welcomed by the experimenter with such desires, for in addition to describing the construction and working of practically all modern forms of thermionic tube, it deals very thoroughly with the circuits in which they are used. In a book of over four hundred pages there are nearly as many explanatory diagrams and illustrations, not the least valuable feature being the full references to patents and sources of information from which the reader can still further add to his knowledge. The treatment is of a non-mathematical nature, and is therefore not concerned with the more abstruse problems of valve work, but as other works deal fully with such problems (which, incidentally, do not greatly concern the practical man) their absence is rather an advantage in a work of this character.

In case the reader should think that explanations of valve theory are entirely absent from this work, it should be explained that sufficient theoretical explanation has been included to enable the reader to follow intelligently the explanations given. Thus valve characteristics and the way they are plotted, as well as the deductions that can be drawn from them, are quite adequately treated.

The first chapter is devoted to the two-electrode valve and the theory of thermionic currents. Many readers may perhaps be inclined to pass this chapter over, beginning their study at chapter 2 (The Three Electrode Vacuum Tube). To do so would be to commit a very great error, for in this portion of the book will be found explanations of many problems with which the beginner is faced.

Subsequent chapters deal with the valve as a detector, as an amplifier, retroactive or regenerative amplification, multi-stage high frequency and low frequency amplifiers, the reception of C.W. and telephony, and the transmission of C.W. with valves (including, of course, wireless telephony).

Altogether the book will be found very helpful to all who are engaged in practical wireless work, for it falls into the category of "intermediate" books—those books which, while they do not assume that the reader is completely ignorant of wireless matters, deal with their subject in a plain common-sense way within the comprehension of any intelligent experimenter.

P.W.H.

Correspondence

To the Editor of THE WIRELESS WORLD.

SIR,—I wish that through the influence of your Journal, it could be brought to the notice of various amateurs the necessity for and advisability of the periodical repetition of the call sign of any amateur station transmitting.

On Sunday morning last, for quite three-quarters of an hour, a station in the Midlands was operating speech and music. The operator stated he was radiating $3/4$ ths of an ampere, and jumped about from 930 to 1,020 metres.

Frames in various parts of Yorkshire were directed on him and his location found, but had it not been that there were three amateur stations in touch with each other at the time, those of us who were receiving him would have been in the dark as to who he was.

I take it that we are granted licenses purely for experimental purposes, and it is therefore up to every possessor of a license to state periodically who he is, and approximately what he is radiating. This practice is followed in Yorkshire, and makes reception much more interesting and assists experiments, but when one listens to a station for nearly an hour without knowing whether it is 10 or 100 miles away, one gets rather like wishing to get at the man.

I trust any amateur operators seeing this will kindly remember their numerous unknown listeners and not be so modest, but announce to the world who they are and what they are radiating.

LOUIS J. WOOD,

Hon. Secretary, The Halifax Wireless Club.

December 15th, 1921.

A THREE-VALVE AMPLIFIER FOR MARK III TUNERS.

This instrument consists of an ebonite panel fitting the left-hand compartment of the Mark III Tuner, (carrying a complete amplifier. (One H.F., one Rectifier, one L.F. Valve.)

The H.F. coupling is by Reactance-capacity, which in combination with a L.F. Transformer (Type U.A.M.) in the last stage, gives truly remarkable results.

Fivepins (Aerial, Reaction, and 'Phones), on the under side are provided for connecting to the modified windings of the Tuner, and terminals on the face provide for H.T. and L.T. batteries.

Fitted with Filament Rheostat, and fully engraved. Price **£5 10/-**

Extracts from a letter received from

C. A. Jamblin, Esq., (District Representative
Ipswich and District Wireless Society),
82, York Road, BURY ST. EDMUNDS.

"I am delighted with my Amplifier, and I
get stations 50 per cent. more clearly than before.

"The Dutch Concert is particularly good,
and can be heard with the 'phones hanging up
and not on the head.

"Speech from Croydon, Lympne and Pulham
is too strong, and has to be cut down, it is so
deafening.

"I have had messages sent me from Birmingham
by 2 F.H. and 2 L.G., and have received them
clearly and correctly both on 500 and 1,000 M.,
the distance being 112 miles."

(Signed) C. A. JAMBLIN.

Note.—Subsequent to the above, information
was received that the input in the case of one of
the Amateur Stations referred to during the
transmission was 9 watts.

A similar Amplifier for general use, cased in
Polished Mahogany. Price **£8 10/-**

Terms: Cash with Order. Post Free.
Guarantee: All goods are guaranteed.
If not found suitable, cash will be refunded
it returned in original condition, post paid,
within four days.

Direct from the Manufacturer—

B. HESKETH,
High Street, Chalvey, Slough.

FOR SALE.

Crystal Detectors, in case (Carborundum) - - -	4/8
New 60-Volt Battery Boxes, with Plugs - - -	3/6
Ditto, 100-Volt, Polished Mahogany, 11" x 7" x 3" - - -	5/-
Microphones, in case, with replaceable inserts - - -	2/6
Silk Wire Basket Coils, set of four - - -	2/6
New Mahogany Instrument Cases, with brass lock and key, 13" x 8" x 6" (Dovetailed) - - -	9/-
Mark III 19-way Switches - - -	8/6
Mark III 5-way Switches - - -	6/-
Ebonite Change-over Switches on Mahogany Base - - -	5/-
Marconi 16-Type Receivers - - -	120/-
Marconi Multipliable Tuner - - -	140/-
Ebonite Leading in Tubes - - -	2/6
Ditto, Glass, per pair - - -	1/3

All Carriage Paid. Apparatus of all kinds in stock.

C. S. SWAN, 65, Windsor Road, Leyton, E.10

ACCUMULATORS

ENTIRELY NEW STOCK

Specially manufactured for us by "Peto & Radford"

Thoroughly well-
made accumulators
with wooden
separators and non-
corrosive terminals



4 Volt, 44 Amp.	£1 7 0
4 " 66 "	1 15 0
6 " 44 "	2 0 0
6 " 66 "	2 12 6

WATES BROS.

Retail Branch - 5, High Street, Bloomsbury, W.C.2
Offices: 132, Charing Cross Rd., W.C.2 (Gerrard 576)

Our Representative

will be in attendance at the SECOND ANNUAL

Wireless Exhibition

of the

Birmingham Experimental Wireless Club
to be held at

The Birmingham Municipal Technical School
January 18th to 21st inclusive.

Our advice and assistance relating to general publicity, and the
advertising of Wireless and Scientific Apparatus (in particular),
is at your disposal.

BERTRAM DAY & CO., LTD.,
Complete Advertising Service,
9 & 10, Charing Cross, London, S.W.1

AERIAL INSULATORS

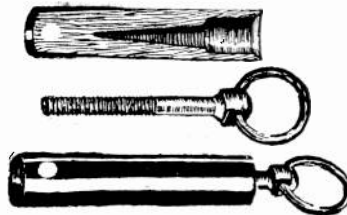

**LIGHT
AERIAL
INSULATORS**
Ebonite 2 1/2" long
with brass eye
bolt Price 6d.
each; 4/- dozen.
Postage extra.

**H.T. BATTERY
BOXES**
Highly polished
mahogany.

6 Plug Sockets and 2 Plug Leads. Size 11" x 7" x 3".
Price 5/- each. Trade Terms on Application.

LESLIE DIXON & CO.

9, COLONIAL AVENUE, MINORIES, E.1.

THE "BROWN" SUPER-SENSITIVE TELEPHONES FOR WIRELESS, ETC.

These Telephones are unquestionably the clearest and most sensitive made, and, consequently, increase the distance over which the wireless can be heard.

IN UNIVERSAL USE.

As supplied to British, Allied and Foreign Governments.

The "Brown" "A" Type Radio Headphones—	£ s. d.
Low resistance per pair	2 18 0
High resistance per pair	3 6 0
The "Brown" "D" Type Headphones (Improved flat diaphragm type)—	
Low resistance per pair	2 8 0
High resistance per pair	2 12 0

The above telephone prices include Cords.



THE "BROWN" MICROPHONE AMPLIFIER

This Amplifier magnifies signals, or music, without distortion, and is of considerable interest to amateurs and scientific investigators. The Magnification is much greater than that obtained from two valves, and the current consumption is about 50 milliamps. In construction, this instrument is simple, and it is much more robust than other sensitive relays of this class. This instrument satisfies the urgent demand for a reliable, inexpensive amplifier, which the most inexperienced amateur can use, and which the most experienced requires. It is much cheaper, ultimately, than a multi-valve amplifier, and the operator is relieved from many of the varied causes of breakdown. It includes a transformer suitable for low resistance telephones or loud speakers.

The price of the "Brown" Microphone Amplifier is £6 for low resistance (120 ohms) and £6 2s. 6d. for high resistance (2 000 ohms).

THE "BROWN" LOUD SPEAKER

With an Amplifier signals or telephony may be so magnified as to cause discomfort to wearers of head-phones, yet not be loud enough to be audible at any appreciable distance from the head. Every wireless experimenter sometimes wishes to let his friends hear, which would involve the use of several pairs of telephones simultaneously with consequent loss of signal strength, as well as considerable expense. The "Brown" Loud Speaker was designed to meet this need efficiently and economically, and is used in all up-to-date receiving stations. The sound is intensified by means of a horn.

The "Brown" Loud Speaker (80 ohms or 120 ohms) .. £5 10 0 Wound to special high resistance.. up to £5 15 0

Apply for Catalogue to Sole Manufacturers:

S. G. BROWN, LTD., Victoria Road, North Acton, W.3

Telegrams: "Siddrownix, London."

Telephone: Chiswick 1469.

London Show Rooms: 19, Mortimer St., W.1. Sole Agent for the Argentine: Horacio D. Guerrero, Las Heras 2480, Buenos Aire

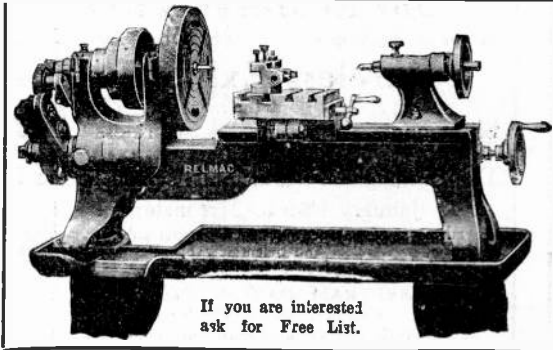
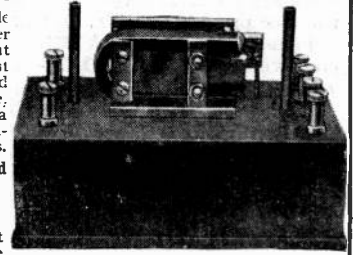

If you are interested ask for Free List.

RELMAC & SUPER RELM LATHES FOR THE WIRELESS ENGINEER

4 1/2" CENTRES, BACK GEAR, SCREWCUTTING, ETC.

Our aim is to ensure in these machines ACCURACY, RIGIDITY and RELIABILITY, and that is why THEY SELL. You cannot afford to buy any other Lathe, because in PRICE and SERVICE ours are CHEAPEST. PRICES FROM £14 8 0

COME AND SEE US.

CHELTENHAM LATHE WORKS,

PHONE: BRIXTON 2001.

86, ACRE LANE, BRIXTON, S.W.2

LEARN WIRELESS—CONSTRUCT YOUR OWN SETS

DETAILS OF OUR FAMOUS SETS OF PARTS

Our Famous "Atlantic" 2-Valve Receiver, New Design. Range 300-30,000 metres. Comprising Engraved, Ebonite Panel, Special Coil Holder, set of 8 plugs, fitted coils, large Variable Condenser, 2 Valve Holders and Fil. Resistance. Resistance Capacity Coupling (H.F.). Ready for use, tested on our aerial .. 145/-
 Set of Parts, easy to construct, no drilling required .. 100/-
 Our 3-Valve "Atlantic" Receiver, same design as above .. 175/-
 Set of Parts, easy to assemble .. 120/-
 Cabinet Valve Set, 500-5,000 metres, Receives Spark C.W. Telephony .. 90/-
 Set of Parts, to make at home. Made also as a Panel Set .. 70/-
 2-Valve High Frequency Amplifier, with 3 Pin Type Transformers, and Tuning Condenser. Range 600-4,000 metres .. 50/-
 Set of Parts to make this .. 35/-

Special 2-Coil Holder on Ebonite Base, with 2 Plugs complete .. 20/-
 3-Coil Holder, with 3 Plugs .. 23/6
 Special Plugs for above, fit any size .. 2/9
 Special New L.F. Transformer .. 25/-
 Set of Ivorine Tabs, Aerial, Earth, L.T. H.T. Reactance, Phone .. 2/3
 Small Ivorine Scales, 0-180 .. 1/3
 Large Ivorine Scales, 0-180 .. 1/9
 Condenser Plates, per dozen .. 2/-
 Fixed Spacers, 5d. per doz. Rotary Spacers, per doz. .. 7/9
 5 Plate Skeleton Variable Condensers .. 7/6
 3 Plate Skeleton Variable Condensers .. 6/6
 Special 1000 metre Concert Transformer .. 8/6
 Concert Basket Coils, per pair .. 2/9

GET OUR BIG BARGAIN LIST

AMATEUR SUPPLIES ASSOCIATION, 134, Coteoford St., Tooting, London, S.W.17

Questions and Answers

NOTE.—This section of the magazine is placed at the disposal of all readers who wish to receive advice and information on matters pertaining to both the technical and non-technical sides of wireless work. Readers should comply with the following rules.—(1) Each question should be numbered and written on a separate sheet on one side of the paper only. (2) Queries should be clear and concise. (3) Before sending in their questions readers are advised to search recent numbers to see whether the same queries have not been dealt with before. (4) The Editor cannot undertake to reply to queries by post. (5) All queries must be accompanied by the full name and address of the sender, which is for reference, not for publication. Queries will be answered under the initials and town of the correspondent, or, if so desired, under a "nom de plume." (6) Readers desirous of knowing the conditions of service, etc., for wireless operators will save time by writing direct to the various firms employing operators. (7) Four questions is the maximum which will be accepted at a time

S.B. (Herne Bay) has a two-valve set, and asks (1) Why the set does not oscillate. (2) If telephony will be received if a short wave tuning set is provided in place of the long range set. (3) Suggest condensers across the H.T. telephones and the transformer primary.

(1) Apparatus which comes after the rectifier does not alter the wavelength in the least. Therefore changing from resistance-capacity coupling to a L.F. transformer has not changed your wavelength. The set does not oscillate possibly because you have not sufficient reaction, and also because the condenser across the transformer primary is missing.

(2) It is not much use listening for short wave telephony on long wave sets. Make a set up to 3,000 ms. as you suggest, with suitable A.T.I. and reaction, and with an aerial condenser in series with the A.T.I.

(3) Transformer primary 0.001 mfd. Telephone primary 0.001 mfd. H.T. battery 0.005 mfd.

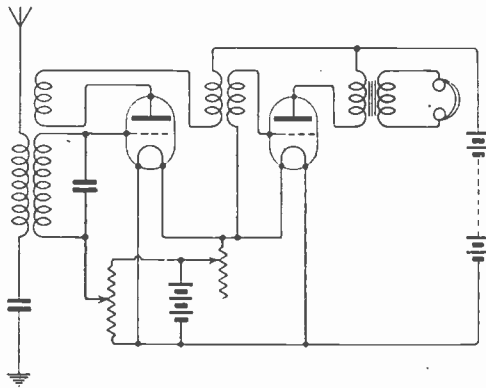

Fig. 1.

E.S.D. (Ikley) asks (1) For a two-valve circuit to comply with certain conditions. (2) Suitable H.T. voltage to use with it for R type valves.

- (1) See diagram Fig. 1.
- (2) 60 volts.

H.A. (East Greenwich) asks for a single valve circuit to use with a loose coupler and V24 valve.

Arrange the circuit as in Fig. 2.

Make a loading coil at least equal in size to the primary of the loose coupler, then with a 0.0005

condenser, arranged in parallel as shown, the wavelength range will be approximately 6,000 ms. at maximum.

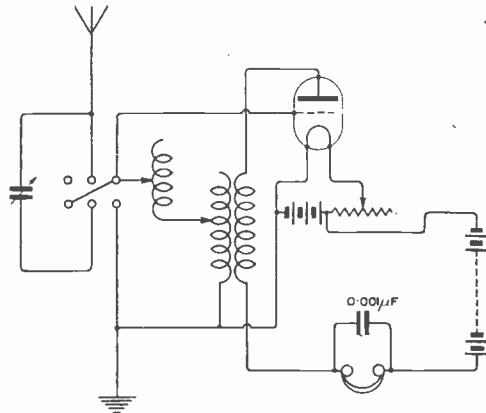

Fig. 2.

J.M. (Stepney) asks (1) For the regulations with regard to amateurs crystal sets. (2) If an inductance coil near a Marconi Type 16 receiver will have any effect on signals. (3) If ordinary telephone watch receivers can be converted into high resistance telephones. (4) If crystal battery can be dispensed with.

(1) Write to the Secretary of the C.P.O. for full particulars.

(2) Not likely to have any serious effect.

(3) Yes, if the coils are carefully rewound with No. 47 copper wire.

(4) Some crystals give good results without a battery, e.g., zincite bornite. In any case the crystal battery need only be two small dry cells.

W.S.M. (Kettering) has a crystal set and wishes to add a valve amplifier.

The valve can be added either as a note magnifier as shown on page 400, September 17th issue, or as a H.F. amplifier, as shown on page 528, November 12th issue. If a crystal detector is used, in neither case will a grid condenser be necessary. The apparatus required will be seen from the references given.

V.E.M. (Manston) wishes to make a single valve set, and asks (1) If a P.M.G. permit is required in the case of a man serving in the R.A.F. (2) The best capacity of the A.T.C. for slab coils from 800-10,000 ms.

(1) When using wireless telegraph apparatus

QUESTIONS AND ANSWERS

apart from your duties, you will find a permit is necessary.

(2) This depends to some extent on the inductance value of the coils. 0.002 mfd. is generally about right.

F.H.F. (Walsall) asks for a diagram of a three-valve set, with two H.F. and one rectifying valves.

The diagram (Fig. 3) is of a suitable set, with resistance capacity coupling.

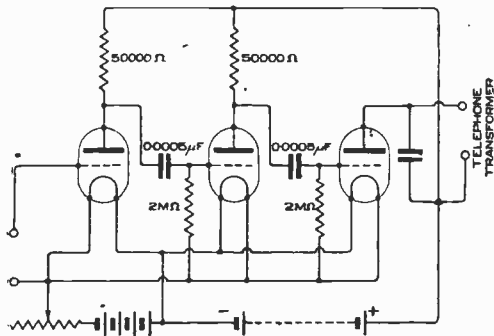

Fig. 3.

J.F.G. (Cambridge) asks (1) The filament current and voltage of R.M.R., O.R.A. and V24 valves. (2) The capacity of two condensers. (3) If a loose coupler is necessary for telephony. (4) If there is any payment necessary for changing a crystal permit into a valve permit.

(1) Voltage, 4.5; current, between 0.5 and 1.0 amps.

(2) 0.000007 mfd. per square inch of overlap of the foils.

(3) Coupled circuits give great selectivity. This is not essential for telephone reception.

(4) No; make application giving crystal license number, and stating the circuit it is proposed to use.

"CITROEN" (Gloucester) asks (1) for the best receiving valve regardless of price. (2) If a 6-volt, 30 amp-hour accumulator is suitable for lighting filaments. (3) The best form of coils to use. (4) Diagram of a single valve set.

(1) A true French type, or R type, is probably the best for general purposes.

(2) Yes.

(3) For a short wave set, coils on cylindrical formers are the best. For waves above 3,000 ms., honeycomb or similar coils are generally more convenient.

(4) Fig. 4, page 526, November 12th issue, shows a good circuit, in which two valves may be used if required.

"BEGINNER" (Merrow) refers to the school wireless set in the October 29th issue, and asks (1) The wavelength range. (2) The resistance of the telephones. (3) If, when two pairs of telephones are joined in series, the results will be the same. (4) The meaning of A.T.I.

(1) The range was stated in a previous issue as 600-6 000 ms.

(2) From 2,000 ohms upwards, without a transformer, or 120 ohms with a transformer.

(3) With two pairs in parallel for L.R. telephones, or in series for H.R., the difference is very slight.

(4) Aerial tuning inductance.

W.C.A. (Plymouth) asks (1) What is a continuous singing noise heard in his crystal set. (2) If the school receiving set of the October 29th issue will be successful on his aerial. (3) If 800 ohm telephones could be used in a single valve set without a transformer.

(1) This seems to indicate a break in the secondary winding, or the crystal circuit. The singing is probably due to induction from A.C. mains.

(2) It is a good beginner's set, and will be quite suitable

(3) Yes.

"BEGINNER" (Cockermouth) asks (1) Whether galvanised wire is suitable for aerial construction. (2) If galvanised sheets buried in moist ground would form a good earth. (3) If Rectanite requires a potentiometer. (4) If a Brown's transformer improves signals on 120 ohm Sullivan telephones.

(1) No, use copper or silicon bronze.

(2) Yes.

(3) We believe it works well without one.

(4) This can only be determined by actual test, which we are afraid we have not made.

E.G.H. (Hackney) is a beginner who asks (1) For suitable books. (2) Whether to have a cheap set as a beginning, or to wait for an elaborate one later on. (3) For advice as to type of set.

(1) Bangay's "Elementary Principles," and then his "Oscillation Valve," both published by the Wireless Press.

(2) and (3) Get some knowledge of the principles, then choose some form of crystal set for a start. After learning to use this, you will be more competent to manage a valve set

W.W. (Retford) asks (1) The wavelength of a set with 12" x 6" A.T.I., with No. 22 wire, and 12" x 5" secondary, with 26 wire. (2) Wavelength with an additional disc coil 6" in diameter, wound with No. 30. (3) If a separate earthed wire is necessary as a lightning conductor for a steel mast. (4) Name of an elementary book on valves.

(1) The wavelength of the aerial circuit is 2,500 ms.; the secondary circuit will probably be about the same, but we cannot say exactly, as you do not give the thickness of the dielectric of the condenser.

(2) If the coil is added to the aerial, one should also be added to the secondary circuit. The wavelength will depend on the thickness of the disc coil, which you omit to mention.

(4) Bangay's "Oscillation Valve."

"RADIO" (Gorton) asks if he will receive the Hague concerts on a single valve set described.

The A.T.C. should be connected in series with the A.T.I. for short waves. Spacing the winding of your A.T.I. is quite good theoretically, as long as it does not unduly reduce your wavelength. The reaction coil should not be spaced. Connect a 0.001 condenser across the telephone transformer high resistance winding. The set will then be efficient, but we doubt if you will get PCGG at such a distance.

QUESTIONS AND ANSWERS

A.K.W. (Oxford) asks (1) *If his aerial is suitable for a crystal set.* (2) *If the circuit is correct.* (3) *If the telephones and transformer are suitable.* (4) *For a crystal which does not require a battery.*

- (1) Yes.
- (2) No. The variable condenser should be connected across the inductance, with the crystal and telephones in series across it.
- (3) Yes. Connect 0.001 mfd. across the winding in the crystal circuit.
- (4) Zincite bornite combination.

G.W.D. (Sydenham) has added a L.F. mag to his single valve set, but has gained practically no advantage.

The grid of the second valve is connected to the positive side of the L.T. battery. Results will probably be much better if this connection is made to the negative side of the battery. Also try reversing the connections to one winding of the intervalve transformer. The average amplification from a single stage of L.F. mag is less than 4—say 2.3.

“CHAKAP HANTU” (Singapore).—(1) 3,000 ms. is probably near the natural period of your H.F. transformers, on which the set will probably oscillate weakly. We are inclined to think that the husky note is due to irregularities in the arc transmitter, due to such causes as unsteady supply volts. The particular tuning condition you do not understand is probably quite normal, and obtained by tuning the marking wave to the heterodyne silent point. An arc is usually signalled by changing the wavelength, and the set does radiate C.W. between the signals. It is this C.W. radiation, often known as “backlash,” which you are getting.

(2) There is nothing to indicate that your amplifier is defective.

(3) 0.001—0.002 mfd.

(4) This is apparently due to leakage from the batteries, or a bad joint causing a fluctuating current to flow through the telephones. Or if a valve is used for transmitting, the effect may be due to generator noises.

J.F.S. (Haverfordwest) asks a series of questions on electron theory.

We are afraid that if you wish to give a lecture on this subject (which is by no means easy, and as yet very little understood), it will be necessary for you to consult modern textbooks on the subject, and not to rely on the casual and often conflicting ideas which you will find in papers on wireless matters. An adequate treatment of your queries would require about half of an issue and cannot therefore be given in these columns. We should recommend a study of Campbell's “Modern Electrical Theory” as the most useful work in this language on the subject. You will find it thoroughly reliable, but by no means light literature. We may perhaps just remark that the chemical atom appears to consist of a positive nucleus together with a system of negatively charged particles—the electrons—the whole being in a state of approximate dynamic electrical equilibrium.

C.C.W. (Woolwich).—Convenient dimensions for the coils of a crystal receiver are as follows:—

A.T.I. 9" × 6", wound with No. 22. Loose coupler, 8" × 5", wound with No. 26, and 4" × 4", wound with No. 22, the former coil to be in the closed circuit, and the latter in the aerial circuit. The closed circuit condenser should be 0.0005 mfd. An aerial tuning condenser of 0.002 mfd. can be used if desired. This set can afterwards be adapted for valve work, with the introduction of a reaction coil, if desired.

C.S.B. (Cricklewood) asks (1) *Whether certain results are normal for a Marconi type 31a receiver.* (2) and (3) *Whether and how this receiver can be adapted for amplification and reception of C.W.*

(1) We are inclined to consider the results distinctly good. We should not have expected such a range.

(2) This receiver cannot very conveniently be adapted for H.F. amplification. There are two courses open to you; (a) to dismantle and use the parts for a combined receiver-amplifier, or (b) to build a separate amplifier to use in conjunction with the receiver as it stands, the crystals not being used. For C.W. it would be best to use a separate heterodyne, as there will not be much room inside the case to mount the reaction coil.

L.B.S. (Wallington) asks (1) *for criticism of a three-valve set.* (2) *How to add a stage of H.F. magnification.* (3) *Why he gets better result with a separate H.T. battery for the L.F. amplifying valve.*

(1) The general arrangement is quite good, but the telephones should be in series and not in parallel with the intervalve transformer primary when on the two-valve side of the switch.

(2) Your first valve is H.F. amplifying as it is shown. An additional valve may be connected in exactly the same way if desired.

(3) This should not be necessary. In a set of this type it would be better to use a little negative potential on the grid of the L.F. valve. This will enable you to use the same H.T. battery throughout.

P.M.P. (Southport) asks (1) *How to add another valve on a separate panel to a Marconi M9 panel.* (2) *If common L.T. and H.T. batteries may be used.* (3) *For receiver winding for 1,700 ms.*

(1) If you wish for a separate panel it will be best to use L.F. On the old panel connect the H.T. battery where the telephones are shown. Then put the primary of an intervalve transformer where the battery was shown. The amplifier connections are shown in the diagram (Fig. 4).

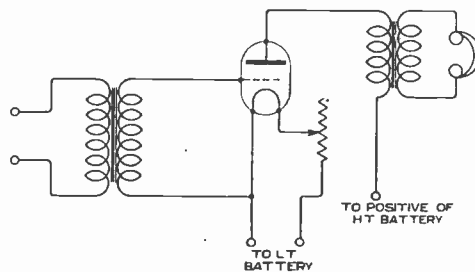

Fig. 4.

(2) With the simplified connections shown it is necessary that the same batteries should be used.

(3) A.T.I. 7" x 5" of No. 22, reaction coil 4" x 3" of No. 28.

F.L. (Grimsby) asks (1) Whether he can take H.T. for an R valve from a 230 volt D.C. supply. (2) and (3) Whether it needs a series resistance, and if so for windings for the resistance required. (4) How to use a crystal instead of a valve on a set shown.

(1) This could be done, provided that (a) the supply is reasonably free from irregularities such as commutator ripples which would lead to noises in the telephones, and (b) no harm will be done by earthing the negative pole of the supply.

(2) A series resistance will be of very little use owing to the very high impedance of the valve.

(3) Connect two 200 volt or similar lamps, of the smallest available candlepower, in series across the supply, and tap across the one on the negative side for the supply to the valve. Use a smoothing choke and condenser.

(4) Set is not very suitable for crystal work. If necessary connect the crystal and telephones in series across the 0.001 condenser.

H.V.W. (Walthamstow) asks (1) Whether to use a telephone transformer with 1,300 ohm telephones on a crystal set. (2) If so, design for the transformer. (3) The decimal equivalent of a 1/3 mfd. condenser. (4) When the construction of a tikker was described in "The Wireless World."

(1) and (2) A telephone transformer for such a resistance will be inefficient, and we should recommend you to do without one, although the resistance of the telephones is rather low for this.

(3) 0.33 mfd.

(4) We do not think that any detailed description has been given within recent years.

F.H.B. (Liverpool) asks (1) For connections for a set using certain apparatus. (2) The necessary capacities for the condensers. (3) An opinion of the merits of the set.

(1) Connect as in the diagram (Fig. 5).

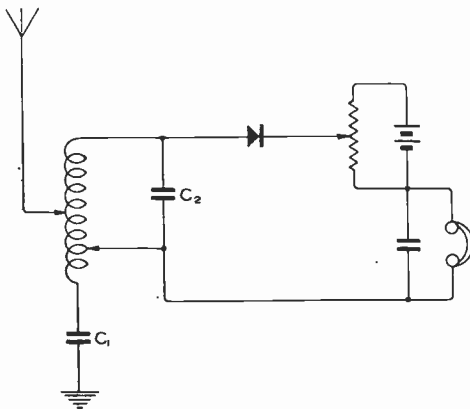

Fig. 5.

(2) C₁, 0.002 mfd.; C₂, 0.0005 mfd.

(3) The set is the best that can be done with the materials, but is not very good. Better results

would be obtained with a separate A.T.I., and preferably with a loose coupler instead of the coil shown.

W.F.B. (Leicester) asks (1) Whether the Dutch concerts can be received on the single valve long wave receiver described about six months ago. (2) What alterations, other than those of the batteries, are necessary to use R valves on this set. (3) The capacity of a condenser described.

(1) We doubt if you would get any results at such a distance with this set. Use at least a three-valve amplifier, with at least one stage of H.F. amplification.

(2) None, except of course the structural alterations necessary to mount this type of valve.

(3) 0.0011 mfd.

"XYZ" (Huddersfield) asks which is the better aerial, a single wire 100' long, or a twin, the length of each limb being 46', and the spacing of the wires being 6'.

The height and the lead-in are assumed the same in each case. The single wire is distinctly preferable.

W.H.L. (Huddersfield) asks for a criticism of a receiver, and suggestions for its improvement.

The receiver appears quite O.K. as it stands. The variable condenser might profitably be increased somewhat in size, as its capacity is only 0.0002 mfd. We cannot say the cause of the whistling noise. This may be due to interference from some C.W. source, or to induction from an A.C. power main.

SHARE MARKET REPORT.

Prices as we go to press, December 30th, are:—

Marconi Ordinary	£1 13 9
" Preference	£1 13 9
" Inter. Marine	£1 0 6
" Canadian	4 6

Radio Corporation of America:—

Ordinary	9 9
Preference	9 6

The Directors of Marconi's Wireless Telegraph Company, Limited, announce a Dividend of 7 per cent. less Income Tax, upon the 250,000 Seven per cent. Cumulative Participating Preference Shares, numbered 500,001 to 750,000, for the year ending 31st December, 1921; and an Interim Dividend of 5 per cent., less Income Tax, upon the 2,636,906 Ordinary Shares, numbered 1 to 500,000, 750,001 to 1,473,648, and 1,500,001 to 2,913,258, in proportion to the amount credited as paid up thereon at 16th December, 1921.

These Dividends are payable on the 1st February, 1922, to the Shareholders registered on the books of the Company on the 16th December, 1921, and to holders of Share Warrants to Bearer; and the Transfer Books will be closed from the 17th to the 23rd December, 1921, inclusive.

Warrants for the Dividends upon the Registered Shares will be forwarded by post on the 31st January, 1922.

1896 to 1921

The Experience
of twenty - five
years is embodied
in present - day
M A R C O N I
A P P A R A T U S
& E Q U I P M E N T

MARCONI'S WIRELESS TELEGRAPH CO., LTD.
MARCONI HOUSE, STRAND, LONDON, W.C.2:
Phone: CITY 8710. Cables: EXPANSE, LONDON.
Telegrams: EXPANSE, ESTRAND, LONDON.

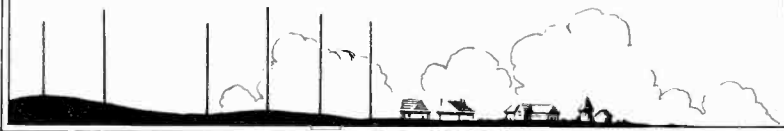

WIRELESS BOOKS FOR THE LIBRARY

CONTINUOUS WAVE WIRELESS Telegraphy. Part I. By W. H. Eccles, D.Sc. Price 25/- net. Post free 25/9. 407 pages. 306 diagrams and illustrations.

THERMIONIC TUBES IN RADIO Telegraphy and Telephony. By John Scott-Taggart, A.M.A.I.E.E. Price 25/- net. Post free 25/9. 424 pages. 344 diagrams and illustrations.

THE THERMIONIC VALVE and its Development in Radio Telegraphy and Telephony. By J. A. Fleming, M.A., D.Sc. Price 15/- net. Post free 15/9. 279 pages. 144 diagrams and illustrations.

WIRELESS TELEGRAPHY and Telephony.—First Principles, Present Practice and Testing. By H. M. Dowsett, M.I.E.E. Price 9/- net. Post free 9/9. 331 pages. 305 diagrams and illustrations.

TELEPHONY WITHOUT WIRES By Philip R. Coursey, B. Sc. (Eng.), A.M.I.E.E. Price 15/- net. Post free 15/9. 414 pages. 250 diagrams and illustrations.

STANDARD TABLES AND EQUATIONS in Radio Telegraphy. By Bertram Hoyle. Price 9/- net. Post free 9/6. 159 pages.

THE WIRELESS TELEGRAPHIST'S Pocket Book of Notes, Formulae and Calculations. By J. A. Fleming, M.A., D.Sc. Price 9/- net. Post free 9/6. 352 pages. 39 diagrams and illustrations.

VACUUM TUBES IN WIRELESS Communication. By E. E. Bucher. Price 12/6 net. Post free 13/3. 178 pages. 130 diagrams and illustrations.

RADIO TELEPHONY. By A. N. Goldsmith, Ph.D. Price 15/- net. Post free 15/9. 256 pages. 226 illustrations.

T.S.F. LA TÉLÉGRAPHIE SANS FIL. La Téléphonie Sans Fil. By G. E. Petit and Leon Bouthillon. Price 12/6 net. 13/- post free, paper cover. 15/- net. 15/9 post free, cloth bound. 304 pages. 197 diagrams and illustrations.

THE OSCILLATION VALVE. The Elementary Principles of its application to Wireless Telegraphy. By R. D. Bangay. 6/- net. Post free 6/6. Crown 8vo. 215 pages. 110 diagrams and illustrations.

YEAR BOOK OF WIRELESS TELEGRAPHY and Telephony, 1921. 1,355 pages. 21/- net. Post free 22/-.

The "W.P." MORSE PRACTICE KEY

A well-finished and reliable instrument made of
brass mounted on a Bakelite Base

PRICE **7/6** POST FREE

THE WIRELESS PRESS, LTD.,

DEPT. W.W.

12-13, HENRIETTA STREET, STRAND, LONDON W.C.2.

YOU COULD DO THIS

Messrs. Mullard Radio Valve Co., Ltd., Enfield, Middlesex,
Hammersmith.

Dear Sirs,

Regarding "ORA" Valves, using this valve alone I succeeded in receiving Panama on 9,300 m. and Java on 9,000 m. Panama is 7,000 miles west and Java is 9,000 miles east. For single valve reception these results must be approaching a record.

The "ORA" is undoubtedly a good valve which is offered at a reasonable price.

I am, &c., &c.

"ORA" VALVES

Price 15/- each.

Anode 30 volts. Filament 3.6 to 4.0 volts.

Forwarded on receipt of the coupon or can be obtained direct from high class wireless dealers.

Terms for quantities on application.

(The original of the above letter, with similar testimonials can be seen at our offices on request.)

Oscillate—Rectify—Amplify



None genuine without this Mark

Mullard Radio Valve Co. Ltd.

Claybrook Road,
Hammersmith, W.6.

Manchester Depot: 25 Market Street
Glasgow Depot: 206 Bath Street.

Contractors to

H.M. Admiralty, War Office

Royal Air Force & Post Office

Telephone: Hammersmith 312. Telegrams: Radiovalve, Hammer London.

Codes:
ABC(5722)

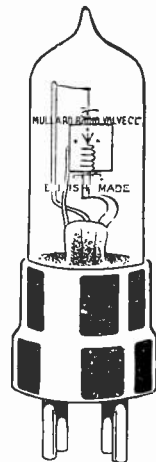

"ORA"
MULLARD VALVES
15/- Each



MULLARD PATENT
RESISTANCE
for Grid & Anode Circuits

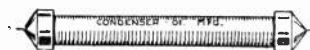

MULLARD CONDENSERS



Mullard
4-pin Sockets

To the
MULLARD
RADIO VALVE
CO., LTD.
35, Claybrook Road
Hammersmith,
London, W.6.

Please send me post free :

Quantity	Description and Price
	Mullard "ORA" valves ... each 15/-
	Mullard patent resistance combined with Mullard blocking condenser 12/6
	Mullard 4-pin Sockets Price 2/- each.

I enclose (cheque, money order, P.O.)
for..... to cover the cost.

Name.....

Address.....

THE "Meta" ELECTRIC FIRE

Here is the latest idea in Electric Fires—a very artistic, polished copper bowl Fire on Wrought Iron Stand, complete with three yards of flex and Adapter, ready for use in any Electric Lamp Holder.

Post free **18/6** By return

The "Meta" (manufactured under Patent Nos. 155662 and 126142), can be used for an infinite variety of purposes. It weighs only 1½ lbs. and a child can carry it from room to room.

For quickly warming a small Room (Nursery, Bathroom, Conservatory, Study, etc.) the "Meta" radiates an ideal heat in any direction desired.

For heating Baby's Milk, the early morning cup of tea, or shaving water.

As a Hot Plate the "Meta" keeps plates or dishes "piping hot" right up to the moment of serving.

The consumption is only a ½ unit per hour.

State voltage required:—100 and 120, 200 to 230 or 240 volts.

LET US QUOTE YOU FOR ANYTHING ELECTRICAL

Proprietors: WIMBLEDON
ELECTRIC CO., LTD.

BOWER & CO. *Manufacturing & Electrical Engineers*

15, KINGSTON ROAD, WIMBLEDON, LONDON, S.W. 19



LESLIE McMICHAEL, M.I.R.E.

PROVIDENCE PLACE
WEST END LANE

Telephone—
HAMPSTEAD 1261

KILBURN, N.W.6

Nearest Tube Station: Kilburn Park (Bakerloo)



YOU ARE MISSING

the greater part of your enjoyment and interest in your receiving set if you are not equipped with a

Townshend Wavemeter

(300—4000 metres range)

YOU CANNOT CARRY OUT ANY SERIOUS WORK—WHILE TO THOSE WHO TRANSMIT SUCH AN INSTRUMENT IS A NECESSITY. THESE ARE NEW DISPOSAL BOARD INSTRUMENTS AS AT PRESENT USED IN THE R.A.F.

OBTAIN ONE WHILE YOU CAN AT LESS THAN A THIRD COST.

Price **£3 15 0** Carr. Paid

SPECIAL TERMS TO THE TRADE

Wires :
"EXONERATOR"
LONDON

ARNOLD, MACK & CO.
14 SUN STREET, FINSBURY SQUARE,
LONDON, E.C.2

'Phone :
LONDON WALL
7725

AMPLIFIERS

Owing to having obtained a large stock, we are now able to offer our clients for the New Year the following well-known and highly efficient instruments at greatly reduced prices.

The desirability of obtaining these Amplifiers, while the opportunity lasts, cannot be too strongly emphasised, as apparatus of this calibre cannot again be obtained at such low prices.

A. Mark IV. - - - £5 10s. 0d.

C. Mark III. - - - £6 10s. 0d.

Note 1. The A. Mark IV. type used in conjunction with a simple tuning circuit constitutes a **complete Valve Receiver Amplifier**

Note 2, or again by a simple adjustment provided, this Amplifier may be used for Amplification **only** in conjunction with other apparatus.

Note 3. The C. Mark III. type is well-known for its high standard of efficiency as an **Amplifier.**

WESTON RELAYS

Price **£4 10s. 0d.** each.

The most sensitive moving coil Relay on the market. We guarantee that every Relay supplied by us passes the severest Laboratory tests before despatch.

VALVES

R.A.F. D. Type. Tubular—for detector and regenerative work.
Price **12/6** each.

Brown's 'Phones, 8000 ohms, new condition, complete with cords **39/-**

Enquiries for all classes of Wireless Material promptly dealt with.

Wires :
"EXONERATOR"
LONDON.

ARNOLD, MACK & CO.
14, Sun Street, Finsbury Square,
LONDON, E.C.2

'Phone :
LONDON WALL
7725



READ'S *for* WIRELESS

GERRARD
442

Registered Design

GERRARD
442

2/- EACH



2/- EACH

A new type of Valve Socket especially suitable for panel mounting, made of polished erinoid with brass parts highly lacquered, complete with nuts.

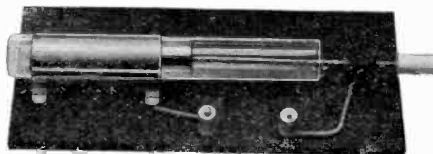

A new type Billi-Condenser for use in capacity reaction circuits. Brass parts lacquered, mounted on ebonite - - PRICE **9/6**

WE ARE EXHIBITING AT
THE 'MODEL ENGINEER' EXHIBITION
Stand No. 4

Royal Horticultural Hall : Westminster, S.W.

F. O. READ & CO., LTD.

Showrooms—
2nd FLOOR

Mechanical House,
13-14, GREAT QUEEN STREET,
KINGSWAY : : W.C.2

Showrooms—
2nd FLOOR

RAPID WIRELESS TRAINING

DAY AND EVENING CLASSES: Correspondence Classes with Instrument work at School if desired. **Postal Course on Valves.** Classes for Amateurs and Experimenters.

INLAND TELEGRAPHY: Sounder, Wheatstone Punching, Type-sending, etc. For details send P.C

'Phone : North 1036. **ELECTRICAL TRAINING COLLEGE, Radio House, Manor Gdns., Holloway, London, N.**

Sensational Development in Wireless Outfits!

A compact Single Valve Panel comprising Reactance Tuner, Filament Rheostat, Variable Condenser, 3-shunt Condenser, Range 400—14,000 with auxiliary adjustment for own Tuning. Including Valve, Accumulators, H.T. Battery, Brown's Phones and Aerial.

Have received Paris, Poldhu, Annapolis, etc.

£10 10s. Complete

**W. A. C. SMITH
236 Argyle St., GLASGOW**

COMMENCE THE NEW YEAR WELL by purchasing

"BRITWIRE" COILS

We can supply a set of nine duolaterally wound coils to cover all wavelengths from 300 to 24,000, using .0015 condenser, for **£2 12s. 6d.**, unmounted.

Coils are wound on formers 2" x 1" by the latest type of machinery, and have very low self-capacity.

Set of ebonite plugs to mount same 18/6

The "BRITWIRE" L.F. TRANSFORMER

We claim that this Transformer is the most efficient L.F. Transformer on the market. Each 27/6

POST ORDERS TO:—

THE BRITISH WIRELESS SUPPLY CO.,

6, BLENHEIM TERRACE, LEEDS.

Telephone: 26926

Also at:—

**18, Eldon Square,
NEWCASTLE-ON-TYNE**

TELEPHONE 360

**33, High Street,
SOUTHAMPTON.**

TELEPHONE 403

**11, Church Street,
WEST HARTLEPOOL.**

TELEPHONE 373

OUR EASY PAYMENT SYSTEM

IS STILL OPEN TO ALL READERS

FOR FULL PARTICULARS WRITE THE MANAGER, MAIL ORDER DEPT.,
THE WIRELESS PRESS, LTD., 12-13, Henrietta Street, London, W.C.2

The London Telegraph Training College, Ltd.

Telephone
WESTERN 2696.

Morse House, Earl's Court, S.W.

ESTABLISHED
25 YEARS.

OFFICIALLY RECOGNISED BY THE WAR OFFICE AND POST OFFICE AUTHORITIES

CABLE AND WIRELESS TELEGRAPHY.

PARENTS desirous of placing their sons in either of the above Services and of affording them the best training facilities should apply for particulars of Courses and the methods of instruction which place this Institution in the first rank. Cable Telegraphy offers at the present time excellent prospects to youths from 15 years of age and upwards, and the College has exclusive facilities for obtaining posts for qualified students in the leading Cable Companies at commencing salaries of £150 to £300 per annum, with yearly increments of £12 to £25, and ultimate possibilities of obtaining positions as Supervisors, Assistant Superintendents, Managers, etc.

In the Wireless Telegraph Service the commencing remuneration at the present time is approximately £150 per annum, and Operators, when qualified by obtaining the Postmaster-General's Certificate of Proficiency, are nominated by the College for appointments.

No Correspondence Classes or Branches.

DAY AND EVENING CLASSES.

An Illustrated Prospectus containing all information will be forwarded on application to THE SECRETARY (Dept. H), 262, Earl's Court Road, Earl's Court, London, S.W.5
Sole Proprietors of the "Scott" Training Disc which contains useful formulæ and other information for Wireless Telegraph Operators and is invaluable to Army Signalling Officers for range finding, etc.

Price, complete with instructions for use, 1/-. Postage 2d.

COSSOR RECTIFYING VALVES

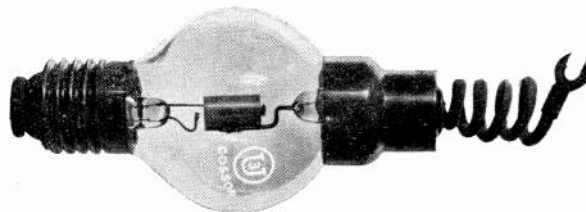

Price **18/6** Carriage Paid

DELIVERY FROM STOCK

A. C. COSSOR LTD., ABERDEEN WORKS, ABERDEEN LANE,
HIGHBURY GROVE, LONDON, N. 5.

Telegrams: AMPLIFIERS, PHONE, LONDON.

Telephone: NORTH 1885 & 1380.

CHAS. BAKER AND CO.'S STORES, LTD

LARGEST OUTFITTERS IN LONDON



High-class Tailoring

AT MODERATE PRICES

INDIAN COLONIAL &
FOREIGN OUTFITS

Regulation Uniforms

Head Depot 271-274 HIGH HOLBORN
City Branch 41, 43 LUDGATE HILL
37-140 Tottenham Court Rd., 256 Edgware Rd., &c.

WIRELESS

Accessories of Every Description in Stock.

ACCUMULATORS, best makes only supplied, all fully guaranteed, 4 volt. 40 amp. 29/4, 4 volt. 60 amp. 35/4, 4 volt. 80 amp. 42/4, 6 volt. 40 amp. 43/6, 6 volt. 60 amp. 53/4, 6 volt. 80 amp. 63/4.

H.T. BATTERIES, wander plug, 36 volt. units, in cardboard box, voltage may be varied in steps of 3 volts. Size of box, 6 1/2" x 3" x 2 1/2". Price complete 7/6.

CONDENSERS, fixed capacity, copper foil and mica, .001 to .003 mfd., 4/2. .001 to .005 mfd., 5/4. .01 to .05 mfd., 6/4 each. Capacities correct to within 4 per cent. Variable, air dielectric, in transparent case, with moulded ebonite top and bottom. Fitted with graduated scale, knob, pointer, etc. Cap. .001 mfd., 37/4. .0005 mfd., 27/6. Excellent value.

GRID LEAK AND CONDENSER in one complete unit, very neat, two types, round and oblong, 5/4 each.

MORSE INKER PAPER, per large roll, 1/6.

FOIL, copper, per sheet, 12" x 6" x .002" or .003" thick, 9d.

Tin, per sheet, 24" x 12", 4d.

SPREADERS, made from stout ash, very strong and durable, 3/4 each. Carriage on two, 1/4.

SOLDER, special acid free, needs no flux and only moderately hot iron. Specially made for wiring up where space is limited and owing to the low melting point the risk of damage to ebonite is minimised when soldering to terminals, etc., per foot, 4d.

TERMINALS, all sizes and types always in stock, from 3/4 per doz.

CONTACT STUDS, 1/4" high by 3/8" diameter, complete with back nut and washer, per doz., 2/4. Larger size, 2/6 per doz.

EBONITE, sheet, cut to any size, all thicknesses, best quality only supplied, per lb., 7/6. Rod and tube, in all sizes, at 7/6 per lb.

PARAFFIN WAX, per lb., 2/4.

Apply for our new illustrated catalogue, price 7d., post free.

RADIO SUPPLIES

Dept. 1

236, HIGH HOLBORN, LONDON, W.C.1

Telephone : Museum 6894.

CONDENSERS

OUR
OWN

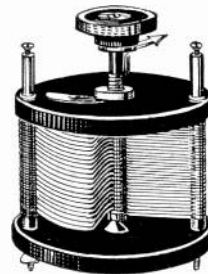

MAKE

PRICES

SIZE	PLATES	
.001 mf.	43	24/-
.0005 mf.	21	18/-
.0003 mf.	15	14/-

Complete with Scales, post free

E. M. ASHLEY, LIMITED
69 RENSHAW ST., LIVERPOOL

The Wireless Equipment Company

The Amateur Experimenter's aim is to have a highly efficient Station. Apparatus of high efficiency can only be produced after years of experimenting.

We can confidently recommend the following selection from our stock of instruments, the result of much experimenting and research.

Patent Radio Telephony Transmitter.

New Patent Control and Power Unit **£8 0 0**

Inductances for 1,000 metres, mounted on ebonite panel and cased in polished box **£5 0 0**

COMPLETE SET comprising: Control Unit and Inductances with microphone and key **£13 0 0**

Tuned Anode Receiving Panel, mounted and box **£3 0 0**

H.F. Amplifiers, specially designed transformers, complete, 3 valve, W/L 600 to 3,000m. with filament control and potentiometer (other sizes to order) (All valves extra) **£4 17 6**

Watch for our Adverts in these pages, new designs under construction. Illustrated Price List upon receipt of stamp

Works: Experimental Station: Offices and Test Dept.:

Wickford, Brentford, 22 Park Road, Essex, Colliers Wood, Merton, S.W.19
Agents for Holland "RATABOS" DAVENTER.

"The Model Engineer"

A special paper for young Engineers, Apprentices, Students and Amateurs interested in Mechanics, Electricity and Model Making. It contains practical articles by experienced writers on Electrical and Mechanical subjects, Locomotives, Motor Cycling, Model Aeroplanes and Wireless Telegraphy. Published every Thursday. 5d. post free.

"Junior Mechanics & Electricity"

The paper for beginners of all ages in Mechanics, Electricity and Model Making. All the articles are written in simple language so that everybody can read and understand them. It is well illustrated. There is also a Queries and Replies section, from which much valuable information can be obtained. Published on 1st of each month. 4d. post free.

SOME USEFUL BOOKS.

Practical Lessons in Metal Turning .. 2/9	Small Accumulators .. 10jd.
Engineering Mathematics Simply Explained .. 2/3	Electric Bells & Alarms 10jd.
Practical Dynamo and Motor Construction 1/9	Electric Batteries .. 10jd.
Practical Induction Coil Construction .. 1/9	Small Dynamos and Motors .. 10jd.
Petrol Motors Simply Explained .. 1/9	Induction Coils for Amateurs .. 10jd.
Workshop Wrinkles and Recipes .. 1/9	Small Electric Motors 10jd.
	Alternating Currents 10jd.
	Windmills and Wind Motors .. 10jd.
	Wireless Telegraphy .. 10jd.
	Simply Explained .. 10jd.

Every Boy's Book of Electricity, 3d.
Every Boy's Book of Engines, 3d.

Book List sent post free on receipt of card.

PERCIVAL MARSHALL & CO.,
66m, FARRINGTON ST., LONDON, E.C.

SEA, LAND and AIR

THE AUSTRALIAN
MONTHLY JOURNAL
of Aviation, Radio-Tele-
graphy & Radio-Telephony

Price
1/9
Post Free

Annual
Subscription
21/-

THE WIRELESS PRESS LTD.
12-13, Henrietta St., Strand, W.C.2

DIARY & NOTEBOOK FOR 1922 FOR WIRELESS OPERATORS & AMATEURS

Price **3/6** Net. :: Post **3/9** free.

In best leather cases, with two pockets, card and stamp divisions

Complete with Special Sections to meet requirements of Operators and Amateurs

When ordering please specify whether for Operator or Amateur

1922 REFILLS

FOR OPERATORS' & AMATEURS' DIARIES

Price **1/6** Net. Post **1/8** free.

THE WIRELESS PRESS, LTD.,
12-13, Henrietta St., Strand, London, W.C.2

For Winter Evening Amusement.

My ELECTRICAL WORKSHOP.

By *FRANK T. ADDYMAN.*

Contains a host of well illustrated original suggestions and explains very clearly the materials required and how to use them. An endless interesting entertainment can be had by following the hints and instructions contained in this book.

NO PREVIOUS KNOWLEDGE IS REQUIRED TO GET GOOD RESULTS.

It is an inexpensive pastime and one which makes a strong appeal to the curious and intelligent youth.

PRICE **7/-** NETT.

(Postage 9d.)

**The Wireless Press, Ltd., Dept. W.W.
12/13, Henrietta St., London, W.C.2**

GIVE YOUR FRIEND

A COPY OF

E L G I E ' S WEATHER BOOK

FOR THE

GENERAL READER

It explains in a most fascinating manner
The **SIGNS** and **CAUSES** of

WIND, CLOUDS, RAIN, HAIL, SNOW, ::
DEW, FOG, DEPRESSION, THUNDERSTORMS,
:: :: ANTICYCLONES, FROST, etc., etc.

PRICE **5/-** NET. POST FREE **5/6**

Numerous Photographic Illustrations
Complete Weather Vocabulary

THE WIRELESS PRESS LIMITED
12-13 HENRIETTA ST., LONDON, W.C.2

JUST PUBLISHED.

FIFTY YEARS of ELECTRICITY

The Memories of an Electrical Engineer
by **J. A. FLEMING, M.A., D.Sc., F.R.S.**

384 Pages.

111 Plates.

PRICE **30/-** NETT.

CONTENTS.

Introduction.

- Chap. I. Telegraphs and Telephones in the last Fifty Years.
- II. Dynamo, Alternators, Transformers and Motors 1870-1920.
- III. Electric Lamps and Electric Lighting.
- IV. Electric Heating, Cooking and Furnaces in Five Decades.
- V. Electric Supply Stations, Storage Batteries, Railways and the Transmission of Power.
- VI. Theory and Measurements.
- VII. Wireless Telegraphy and Telephony.

Conclusion.

Practically every phase of Electrical work is covered in this book.

THE WIRELESS PRESS, LIMITED
Dept. W.W.,
12/13, Henrietta St., London, W.C.2

To all who mention the "Wireless World" and send 6d. for postage, we will send six back copies of the



free. This will prove to you that the PHILATELIC MAGAZINE is the best Stamp Collectors' Newspaper. All the news for 3d. a fortnight. Current issue from your newsagent 3d., or 4d. post free from:—
HARRIS PUBLICATIONS LTD., Balham
Catalogue of Stamp Albums and Accessories free.

WITH GOOD APPARATUS YOU
CAN GET GOOD RESULTS

THE "W.P."

Morse Practice Key

Well Made. First-class Finish. Thoroughly Reliable

Price **7/6** Post Free

THE WIRELESS PRESS, LTD.
12-13 HENRIETTA STREET, LONDON, W.C.2

THE WIRELESS WORLD EXCHANGE AND MART

TARIFF. Advertisements are accepted for this Section at the rate of twopence per word, with a minimum charge of two shillings. The advertiser's name and address will be charged for, and single letters or single figures will be counted as words. Compound words will be counted as two words.

DEPOSITS. All advertisements must be prepaid in the form of Postal Orders, the remittance being forwarded to Messrs. Bertram Day & Co., Ltd., 9 & 10, Charing Cross, S.W.1.

Intending purchasers may deposit the purchase money of any article advertised or sold by advertisers with Messrs. Bertram Day & Co., who will acknowledge its receipt to the vendor and the depositor, the full addresses of whom should be given. Subject to special agreement between the parties, it is understood that all goods are sent on approval, each party paying carriage one way in the event of the goods being returned. The deposit will be retained until due advice of the completion of the purchase has been given or until the articles have been returned and accepted. In order to cover postage, &c., a fee of 6d. in respect of sums of £1 and under and 1s. for sums in excess of £1, must be paid at the same time as the deposit. For persons not resident in the United Kingdom these fees are doubled. We cannot undertake to receive any deposit less than 2s. 6d.

Deposits must be sent by either Postal Order or by Registered Letter; cheques will not be accepted. If the deposit is sent by Money Order it should be made payable to the advertiser of the goods, and the fee mentioned above should be sent in stamps or Postal Orders as a separate amount.

H.F. "Concertransformers" 1,000 metre, "Plug-in," 8/6.
 .0003 Variable Condenser for tuning above, 15/-. (Really fine results for telephony using these two.)
 Set of Seven "Compactum" Tuning Coils, 300-25,000 metres, 12/6.
 Complete Crystal Receiving Sets, 38/-, 42/-.
 Sets of parts to make amplifiers, 30/-, 40/-, 50/-.
 Fil. Resistance on ebonite bobbins, 3/3.
 Fil. Resistance and Valve Holder on ebonite, 6/6.
 Switch Arms, 1/6; Contacts, 1/6 doz.; Terminals, 2½d.

GET OUR LIST OF PARTS.
AMATEUR SUPPLIES, 134, Coteford Street, Tooting, London.

AGENCY WANTED.

Electrical Firm of good standing with several branches desires high class agency for the sale of Wireless Goods, Glasgow and District. Department controlled by Wireless Expert. Enquiries invited from manufacturing firms of good standing. Highest references.

POLLOCK & CO.,
36 BRIDGE STREET, GLASGOW

SOMETHING NEW.

POLE FINDERS

2 volt to 250 volt
 Post 5/6 free

WILKINSON, Lonsdale Road, Kilburn, N.W.6
 Every wireless experimenter should possess one

TECHNICAL BOOKS.—Second-hand and New Books on every conceivable subject. Catalogue free. State wants. Books sent on approval. Books bought.—**FOYLE, 21-125, Charing Cross Road, London.**

WIRELESS AND ELECTRICAL LIST.—55 huge pages full of useful information, post free.—**THOMSONS, 5, Westboro, Scarborough.**

SWITCHBOARDS, Enamelled and Plain Slate Panels, stocked in standard small sizes. Why not make up your own Switchboards? 25 amp. D.F. and 50 amp. D.P. Switches ready for mounting, 7s. 6d. and 10s. each. Ammeters and Voltmeters all sizes.—LESLIE DIXON & CO. (Dept. W.), 9, Colonial Avenue, Minories, E.

WIRELESS FARTHING MATS, Copper Gauze Brass Edges, 24" x 34", with 10' standard copper cable, 27s. 6d. each. 20-watt Trench Spark Transmitter Sets, with double key, complete, £2 5s. nett. Receivers and amplifiers at low prices. Dry cells round 4-volt, 6s. per dozen.—LESLIE DIXON & CO., 9, Colonial Avenue, Minories, E.I.

VALVE RECEIVER, 300-30,000 'Phones, .001 Condenser, H.T. Valve. Complete, £6 15s.—8, Burdett Avenue, Westcliff.

THREE-VALVE PANEL for Sale, complete 'Phones, H.T. Accumulator, Aerial, .0006 Condenser, £12.—Particulars from MOSS, 51, Wickham Avenue, Bexhill.

THREE-VALVE RECEIVER, complete, Accessories, Bargain, £8.—OWNER, 11, Hermitage Road, N.1.

HAVING excellently equipped Workshop in S.W. London, wish to meet practical wireless man to give whole or spare time with view to manufacture.—Box "F. P.", BERTRAM DAY'S ADVERTISING OFFICES, 9-10, Charing Cross, S.W.1.

WHAT OFFERS? Complete triple valve receiver or parts, sold separately.—"Wireless Cabin," Terry Street, York.

WANTED.—Tenders for the purchase of a wireless set, very powerful. Purchaser must dismantle.—Write W. & A. T. B. Eling Wharf, Totton, Southampton.

FOR SALE.—Single-valve Receiver, wavelength range 400-25,000 metres, Brown's A type Telephones, three R valves, one V21 H.T. battery, 60 volts, G.P.O. relay wound 8,000 ohms. Bargain, £23.—Box M.S., BERTRAM DAY'S ADVERTISING OFFICES, 9-10, Charing Cross, S.W.1.

TELEPHONY.—650 volt, 150 watt generator, petrol driven. Sell complete set or separate, or accept part exchange. Specification on request.—2 TF, 22, Scholar Street, Liverpool.

TO AMATEURS, owning Wilson 130 watt Service Transmitters. A few spare interrupter discs for free distribution. To avoid disappointment apply early, giving number of set.—WM. HAMILTON WILSON, 6, Bank Broadway, Kingston Hall, Surrey.

MARCONI M.9 Valve Panel; gets five American Stations. Good condition, £2 10s.—**LAWTON, Ford Street, Dukinfield.**

SIX Brown's A Head'phones, tested, 8,000 ohms, 30s. set. 1,500 ohms, 25s. set. S. W. Cabinet Receiver, in working order, £1 10s. Condensers alone worth more.—Photo, stamp. R.LAWRENCE, 19, Ashburn Road, Southsea, Hants.

Startling Reduction IN THE PRICE OF WIRES

Double Cotton Covered, and Enamelled, all orders wound on reels. Nos. S.W.G.
Double Cotton Covered.—16, 2/2; 18, 2/3; 20, 2/7; 22, 3/-; 24, 3/8; 26, 4/3; 28, 5/1; 30, 6/2; per lb., plus postage.
Enamelled.—20, 2/8; 22, 2/10; 24, 3/2; 26, 3/6; 28, 4/-; 30, 4/5; 32, 4/7; 34, 4/10; 36, 5/4 per lb., postage.

INSTRUMENT CASES.

We make any type of small cabinets for wireless work. Send rough sketch and measurements. Large or small orders.

Trade supplied at special cut prices.
BOWER & CO., 15, Kingston Road, Wimbledon, S.W.19.

"Peto Points"

Since giving prominence to our sets of Condenser Parts ready to assemble, we have many imitators, which is the sincerest form of flattery, but as usual with all imitations, the essential points are missed.

POINT No. 1. A genuine P.S. Variable Condenser has an adjustable bush to take the bottom bearing of the moving vanes. This ensures Perfect Contact and Allows for Wear. Send to-day for a Set. Satisfaction or Money Back.

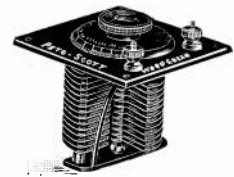

Complete SET OF PARTS ready to assemble. NO DRILLING REQUIRED. Supplied with engraved ebonite top.

'0015 '001 '0005 '0003 '0002 '00005
 27/- 21/- 14/- 11/- 8/- 5/-
 Cabinets to suit from 1/4. If required with bevelled indicating dial 3/6 extra.

THERE ARE BIG BARGAINS IN OUR CATALOGUE. Ask for List "W" and enclose two stamps.

INTERVALVE L.F. TRANSFORMERS. Closed Iron Core for Panel Mounting - 17/6
 Larger size, 1 1/2 times as efficient as ex-Army 21/
LAMINATED SWITCH ARMS. Heavy brass bush, lock nuts and spring washer (the only Switch with the "Velvet Fitting" - 2/9
CONTACT STUDS - per doz. 1/6
 Nuts to fit above - " " " " 4d.
VALVE LEGS, fitted with 2 nuts and washer, lacquered - per set of 4 1/-
FILAMENT RHEOSTATS, Ebonite former and Pointer, Knurled Handle, Screens, e.c., ready for panel mounting - 4/-

(This has a smooth action and does not produce thunder storms in the 'phones)
PETO SCOTT, 17, FROME ROAD,
 (The Condenser King) **WOOD GREEN, N.22**
 TRADE ENQUIRIES INVITED.

THE WIRELESS WORLD EXCHANGE AND MART

Delivery from Stock.

Terminals
Switch
Studs
Wing Nuts
Screws,
etc.



Illustrated
Lists
Post Free.

Electrical Supply Stores,
5, Albert Terrace, King Cross,
HALIFAX.

COMPLETE STATION FOR SALE.—Fifty-five thousand metres, containing 3 valve amplifier with valves, Mark III tuners, in two panels in big cabinet. Brown's relay, transformer, loud speaker, aerial wire, insulators, high tension, 100 amps, accumulator, valve box, 3 pairs telephones, reaction coils, etc. Stamp, full list. Great sacrifice. £26. Carriage free.—W. RAWSON, 235, Newhall Road, Sheffield.

WIRELESS WORLDS. Vols. 1 to 5, as new. First 50s. secures.—FUNNELL, "Southdown," Newhaven, Sussex.

BARGAIN 8,000 w. 'phones, excellent condition, with cords, as new, 30s. Approximately 0002 m.f. variable condenser, ebonite case, 10s.—CATER, 7, Hillside, Wimbledon, Surrey.

W. J. HENDERSON.

2, Hollywood Road, South Kensington.
Aerial Stay Wire (aero-cable) 15 cwt. breaking strain per 100 ft. 5/-
Strainers for above, each 10d. per dozen 9/-
German 4-valve L.F. Amplifiers (captured) fitted with adaptors for "R" Valves, less battery and valves . . . each 25 10/-
Condensers, variable, Mk III type, 9 fixed vanes, 8 moving, complete with scale and knob each 15/-
Leading-in Tubes, ebonite . . . each 1/6
Valve-holders each 1/6
Telephone Transformers, mahogany case with ebonite top, fitted with condenser across primary each 15/-
Postage Extra.

R U

looking for ex-army apparatus at rock-bottom prices

Two valve 80 metre receivers ... 45/-
C.W. Transmitter and receiver (one valve) ... 120/-
Wavemeters ... 30/- to 50/-
A MK IV Amplifiers ... 120/-
L.F. Inte valve Transformers ... 21/-
Spark coils in case, with key ... 40/-

Enclose 2d. stamp for further particulars to—

RADIO EXPERIMENTAL CO.
103, Gell Street, SHEFFIELD.

LATHES.

The 1921 Velox 2½" centre Baby Super lathe is designed for Turning, Boring, Milling, and Gear cutting. Price Complete £6 : 16 : 0. A. Plain lathe only. £2 : 16 : 0.

Further Particulars Stamp.

VELOX TOOL CO.
255, Westgate Road, Newcastle-on-Tyne.

I Buy Wireless Gear of every description.

Send your particulars to :

WILKINSON,
Lonsdale Rd., Kilburn, N.W.6

SOMETHING NEW IN ACCUMULATORS
Ready for use when filled with dilute acid. No tedious first charge required.

Manufactured by the "A.F.A." the oldest and largest accumulator makers in the world.

These accumulators will operate satisfactorily for many years in all climates, do not deteriorate in stock, can be charged in the ordinary way, occupy small space. Attention and upkeep negligible.

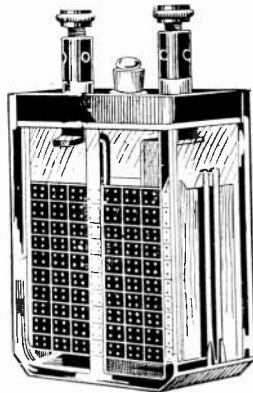

"DUROS" Cells

The only accumulator supplied in a charged state. Supersedes all primary cells.

The ordinary type of Accumulator must be recharged every 2 to 3 weeks even when left standing on open circuit owing to self-discharge.

This defect has been completely overcome in the "Duros" Cells, which retain their charge for very long periods.

"A.F.A." Accumulators

Anode and filament batteries of all types stocked by all leading dealers in "Wireless Supplies."

Wholesale only from the Sole Agents :

E. G. LIND & CO.

48a, BUCKINGHAM PALACE ROAD, WESTMINSTER, S.W.1

HARVEYS'

HOSIERY DEPARTMENT
OUTFITTING

:: 15 LONDON STREET.
:: 16 " " "

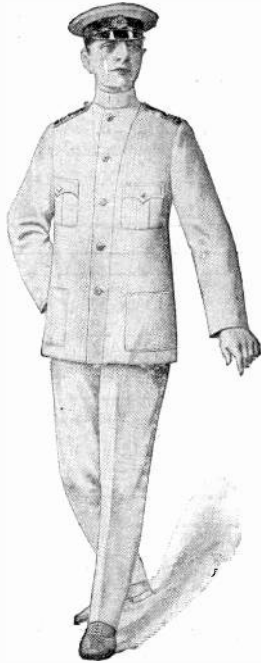

SPECIAL PRICES For OPERATORS



Uniform Serge Suit complete,
lace and buttons £5 5 0

Superfine Cloth Coat and
Trousers, lace and buttons
£8 8 0

Bridge Coat or Naval Warm
with shoulder straps and
buttons, complete £4 15 0

R.N. Cloth Cap, standard
badge and band ... 21/6

Standard Badge ... 12/-

Standard Buttons: Coat,
Mess, Vest, per dozen 3/-
2/6, 1/6

White Suits,
Naval Belted Coats, and
everything for NAVAL wear.



We hold the Largest Stock of WHITE SUITS in London, all sizes to be had here.

17, London Street, London, E.C. 3

FACING FENCHURCH STREET STATION.

Telephone:
Avenue 2200.

(Book to Mark Lane or
Fenchurch St. Station)

Business hours 9-6.
Saturdays 1.30.

Actual Size

Terminals (plated), 4 BA, per doz.	2/8
Marconi Balanced Crystal Receiver No. 18	£5
Dutch Concert Tuner, post free (see last advertisement)	7/-
Valves (Receiving) guaranteed	1/-
Valve Holders, each	1/9

**J. LIPOWSKY, 614, OLD FORD RD.
Bow,
LONDON, E. 'Phone: East 3345.**

URIAH BEATON'S BARGAINS.

Motor Generator, Input 27.5 volts, Output 350 volts, American make, for wireless work	140/-
Sullivan Phones, with cords, in order, 120 ohms.	3/9
Terminals, new, with washer and two nuts, 6 B.A., doz. Rubber-covered Flexible Wire for indoor aerials, etc. per yard	3/-
Headphone Leads, double, each	1/2
Condenser Vane Rotary and Fixed Zinc per doz.	1/-
Ring and Listening Key, P.O. Type, each	2/6
Flexible Leads, double, Black and Red, doz.	2/6
Leading in Tubes, Ebonite and Metal, with Terminal, each Packing and Postage Extra. Stamp for Reply.	1/-

ESTABLISHED 25 YEARS.
45, CHALK FARM ROAD, N.W.1

The OHMER INSULATION TESTING SET (COX'S PATENT)

This is the lightest, cheapest and best instrument of its kind on the market. It consists of an Ohmeter and Generator mounted in one case. The Ohmeter is of the Electrostatic type, giving extreme lightness. Absolutely unaffected by external fields. It reads directly in Megohms and is independent of the voltage or speed of the generator.

NALDER BROS. & THOMPSON, LTD.,
97a, DALSTON LANE, LONDON, E.8.



COME AND SEE THE MODEL ENGINEER EXHIBITION

Royal Horticultural Hall,
Westminster, London, S.W.1.

January 7th to 14th

**ALL THE LATEST WIRELESS
APPARATUS WILL BE ON VIEW**

Also a splendid show of model locomotives, model steam and electric railways at work, lathes, tools, electrical apparatus, and fascinating models and scientific exhibits of all kinds.

**DELIGHTFUL MUSIC.
REFRESHMENTS AT
MODERATE PRICES.**

Special Prizes offered to visitors.

Open 12 (noon) to 10 p.m. Daily.
Admission 1s. 6d. (Tax included).

Messrs. LONGMANS' LIST

New Edition in Two Volumes.

TEXT-BOOK ON WIRELESS TELEGRAPHY.
By Rupert Stanley, B.A. 8vo. With Illustrations.
Vol. I—General Theory and Practice. 15s. net.
Vol. II—Valves Apparatus. 15s. net.

**THE PRINCIPLES OF ELECTRIC WAVE
TELEGRAPHY AND TELEPHONY.** By J. A.
Fleming, M.A., D.Sc., F.R.S. Fourth Edition Re-
vised. With numerous Illustrations. 8vo. 42s. net.

**PRINCIPLES AND PRACTICE OF ELECTRICAL
TESTING.** As applied to Apparatus, Circuits and
Machines. By R. G. Allen, B.Sc., A.R.C.Sc.I.,
A.M.I.E.E. With Diagrams. 8vo., 18s. net.

MANUALS OF TELEGRAPH & TELEPHONE ENGINEERING
Edited by Sir William Slingo.

**TELEPHONIC TRANSMISSION,
THEORETICAL AND APPLIED.**
By J. G. Hill, Assistant Staff Engineer, G.P.O.
With Diagrams and Illustrations. 8vo. 21s. net.

LONGMANS, GREEN & CO.,
39 Paternoster Row, London, E.C.4

Registered "NIPHAN" Trade Mark

WATER-TIGHT PLUGS AND CABLE COUPLINGS TO MEET HOME OFFICE REQUIREMENTS

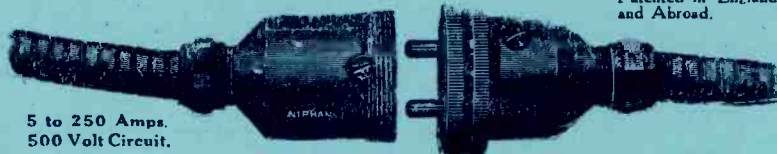

5 to 250 Amps.
500 Volt Circuit.

COUPLING CONNECTING CABLES

As used by H. M. War Office, Electric Supply Companies,
Railway Companies, Marconi's Wireless Telegraph Co.
SIMMONDS BROS., LTD.,
4, 6 & 8, Newton St., HOLBORN, W.C.

Phones: 2600 Gerrard
1201 Central.
Telegrams: "Niphan, London."
Patented in England
and Abroad.



3-WAY TEE.

JANUARY 7, 1922.

Please mention the Wireless World

THE
**WIDNES
FOUNDRY**

COMPANY, LIMITED.

ESTABLISHED 1841

BUILDERS OF STEEL BRIDGES,
PIERS, ROOFS, GIRDERS, & ALL
KINDS OF CONSTRUCTIONAL
STEEL AND IRON WORK

ELECTRICAL TRANSMISSION MASTS

CHEMICAL PLANT MANUFACTURERS
SEGMENT AND PIPE FOUNDERS
CASTINGS OF EVERY DESCRIPTION

Contractors to the Admiralty, War Office,
India Office, and Crown Colonies. The
leading British, Foreign and Indian Railways

Works :

WIDNES, LANCS.

Telegrams : "Foundry Widnes."

Telephone : No. 225 Widnes.

London Agents :

GEORGE F. WEST & CO.,
IDDESLEIGH HOUSE,

CAXTON STREET, S.W.1

Telegrams : "Westeelite, London."

Telephone : 4340 Victoria.

48

The WIRELESS WORLD



FORTNIGHTLY

JANUARY 21st, 1922.

PRICE 6D. NET

BURNHAM & CO.

WIRELESS BURNDIPT APPARATUS

MANCHESTER DEPOT: 4, CORPORATION STREET

DEPTFORD, LONDON, S.E. 8.

LONDON RETAIL DEPOT: 19, HAND COURT, HIGH HOLBORN, W.C.

LEEDS DEPOT: 48, GT. GEORGE STREET.

THE BURNDIPT ULTRA III RECEIVER—Supplied to Air Ministry, India Office (for use on H.R.H. Prince of Wales Tour, Greenwich Observatory, and various Colonial, etc., Governments.



THE BURNDIPT III. ULTRA RECEIVER
Price - - £25

The new 3-valve amplifier receiver is the outcome of a lengthy series of experiments and we claim that the results obtained are superior to any combination of three to five valves.

THE BURNDIPT II. RECEIVER (Optional Single Note Magnifier.)

This set is of original design and is in effect a single valve receiver, to which can be added by the movement of a single key switch a note magnifying valve and transformer, thus allowing very weak signals when tuned in to be sufficiently strongly magnified so as to be easily read. This set is also fitted with a 'phone transformer so that low resistance 'phones shall be used, this being the correct practice, but extra terminals are so arranged so that the receiver can be connected if desired with a further amplifier for working loud speaker, printer, etc., while the low resistance 'phones are in use thus allowing the careful tuning of the auxiliary apparatus.

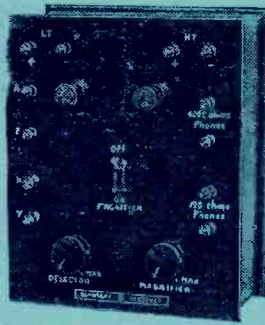

THE BURNDIPT II RECEIVER
Price - £12 10 0

NOTICE to readers in **LEEDS** and district—We are opening a Wireless Depot at 48, GT. GEORGE ST., LEEDS, and invite all wireless friends to examine the full stock of our apparatus, which will be demonstrated whenever desired, by our competent operators.

WESTON GALVANOMETER

Model 375 Galvanometer is a moving coil instrument with a uniformly divided scale 2.35 inches long. Its resistance is approximately 29 ohms and the current required for a millimeter (1 scale division) deflection is 20-25 micro-amperes.

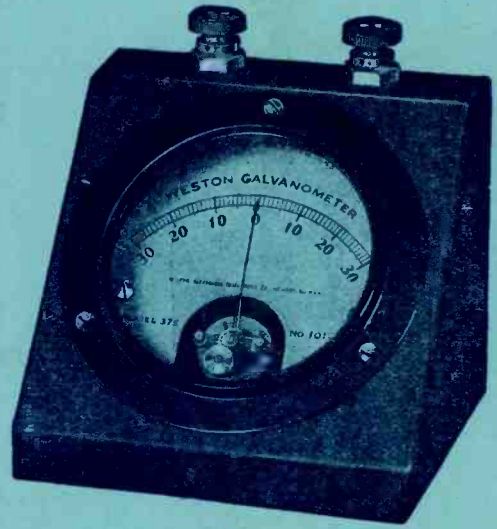

WESTON ELECTRICAL INSTRUMENT CO., LTD.



Audrey House, Ely Place, Holborn, E.C.

Telephone: HOLBORN 2029.

Telegrams and Cables: "PIVOTED, LONDON"

"ORA" Valves

15/- each

are obtainable from
all Wireless Dealers
or direct from:—



(13)

THE

Mullard Radio Valve Co. Ltd.

Claybrook Road,
Hammersmith, W.6.

Telephones: Hammersmith 312. Codes: ABC(5 Ed.) Telegrams: Radiotube, Hammers, London.
Contractors to H.M. Admiralty,
War Office, Royal Air Force & Post Office



JANUARY 21, 1922

Please mention the *Wireless World*

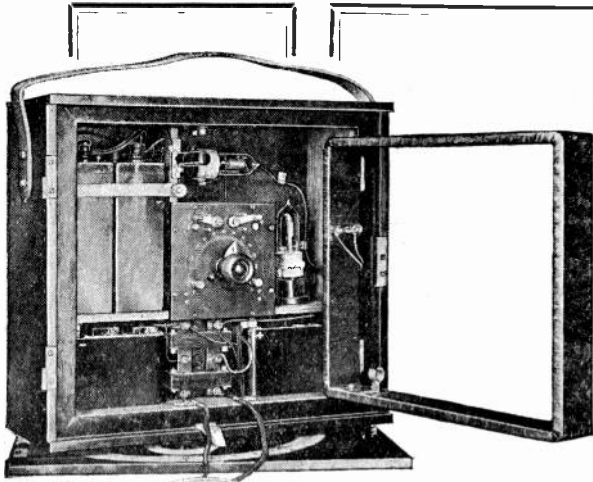

The B.T.H. Portable Wireless Receiver

A complete receiving station
in one small cabinet.

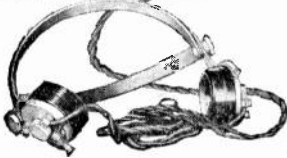

B.T.H. Receiver mounted on cover in position for receiving signals.

For use with this receiver the following B.T.H. Portable Equipments can be supplied:

Amplifiers,
Aerial Set,
Loud Speaker,
Morse Inker,
Morse Buzzer.

Each unit complete for immediate operation.

Write for particulars and quote WW. 122.

Measuring only about 13" x 14" x 5" and weighing but 18 lb. complete, this unique set will enable powerful European Stations to be heard perfectly—**without the use of an aerial or other connections**; and operates on a range of wavelengths from 300 to 20,000 metres.

With the requisite amplification and connected to aerial, this receiver enables **Wireless Telephony and Music** to be beautifully emitted from a Loud Speaker and Morse messages to be recorded by means of a **Morse Inker**.

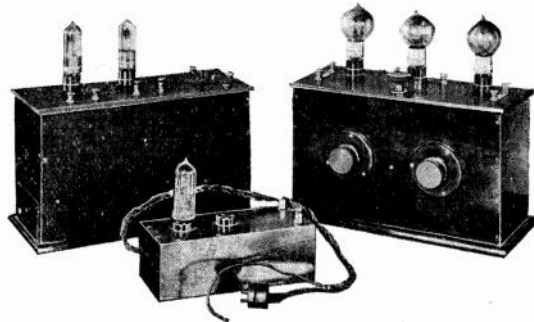

B.T.H. Additional Valve, two-valve and three-valve amplifiers which, with the B.T.H. Receiver, give totals of three, four and five-valve operation respectively with remarkable amplification.



The British Thomson-Houston Co., Ltd.

Electrical Engineers and Manufacturers

Head Office and Works - - - Rugby, England

YOUR OPPORTUNITY

CLEARANCE SALE of new and second-hand stock to make room for new apparatus of our own manufacture.

All goods carriage paid except where otherwise stated.

Terminals, B.A.4 ... doz. 2/- (post 6d.)	H. W. Ammeters ... 6/6 (post 4d.)
B.A.2, B.A.0 and B.A. 2 Double doz. 2/6 (post 9d.)	Portable Masts, telescopic, 35 feet 30/- (Carriage forward)
Sullivan's 'Phones, brand new and tested ... 9/6 (post 9d.)	Navy loose Couplers, very massive ... 70/-
'0004 Condensers, with knob and scale ... 18/6 (post 9d.)	50 watt Transmitters and Receivers 55/- (Carriage forward)
'0015 Condensers, ex Mk. III Tuners, new ... 35/- (post 9d.)	Portable Telephone Sets, F type ... 22/6
Mark III Tuners, brand new ... 90/-	'001 calibrated Navy wavemeter Condensers ... 65/-
C. Mk. III Amplifiers, guaranteed ... 110/-	French 6-valve Receivers, in new teak case ... 150/-
C. Mk. III Amplifiers, guaranteed for use with H.R. 'Phones ... 95/-	Reaction Formers, with ball coupling 6/6 (post 9d.)
C. Mk. III Amplifiers, guaranteed, converted to three-valve receiver ... 80/-	Insulating Sleeving, 4d. yd. doz. yds. 3/9 (post 4d.)
Potentiometers ... 6/- (post 9d.)	Brown's Telephone Relay Trans- formers ... 4/- (post 1/-)
Microphone Buttons, new, G.E.C. make ... 2/6 (post 2d.)	Ericsson's Microphones, perfect for radiotelephony ... 6/ (post 6d.)
H.F. Transformer Cores, eight slots 5/- (post 4d.)	Sounders (as new), heavy type, cost £10 ... 22/6 (post 1/3)
R.M.R. Valves, brand new 17/6 (post 9d.)	19 Point Switches, ex Mark III Tuners ... 7/6 (post 6d.)
Grid Condensers '0003, new 1/9 (post 2d.)	5 Point Switches, ex Mark III Tuners ... 5/6 (post 6d.)
Block of four '002 Condensers, new 5/- (post 6d.)	Rotary Switch Arms ... 2/4 (post 4d.)
Helsby '3 mfd. Battery Condensers 2/6 (post 3d.)	Power Buzzers ... 10/- (post 1/6)
Earth to Valve Transformers 15/6 (post 6d.)	Two mfd. Condensers ... 2/- (post 9d.)
B Mk. I Two-valve Receivers, guaranteed ... 52/6	Perikon Detectors ... 4/6 (post 6d.)
Mk. I Aircraft Tuner, new ... 75/-	Carborundum Detectors 2/6 (post 4d.)
Mackie Generator, 8 and 600 volts 250/-	Best French R Valves, "Metal" make ... 12/6 (post free)
Marconi Type 55 Receiver, 7 valve 290/-	

POST ORDERS TO:—

THE BRITISH WIRELESS SUPPLY CO.,

6, BLENHEIM TERRACE, LEEDS.

Telephone: 26926

Also at:—

18, Eldon Square,
NEWCASTLE-ON-TYNE
TELEPHONE 360

33, High Street,
SOUTHAMPTON.
TELEPHONE 403

11, Church Street,
WEST HARTLEPOOL.
TELEPHONE 373

ELECTRICAL AND Mechanical Engineers

Contractors to the Admiralty, War Office & Air Force

Manufacturers of . . .

MARCONI'S WIRELESS DISC DISCHARGERS.
ROTARY CONVERTERS. DYNAMOS.
ELECTRIC MOTORS. TRANSFORMERS.
BOOSTERS. BOX HIGH VACUUM PUMPS.

COMPLETE ELECTRIC LIGHT INSTALLATIONS

For Country Houses and Yachts.

Lighting Sets for Motor Cars and

Aeroplanes. Estimates Free.

AN EFFICIENT STAFF FOR REPAIRS

*Inventors' ideas carefully and skilfully
carried out from the preparation
of detailed drawings to the completion
of the finished article :: :: ::*

W. MACKIE & CO

ESTABLISHED 1882

THE PALACE ENGINEERING WORKS

129, 131, 133, Lambeth Road, London, S.E.1

TELEPHONE 182 HOP

TINGEY UNITS Important Notice TINGEY UNITS

An interesting and long detailed description of this latest development will appear in the next issue; also a description of the latest A. 4. Multi H.F. Unit, which, it is claimed, gives louder signals, sharper tuning, and is more quiet in action than the present interchangeable transformer type.

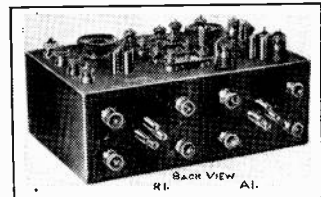
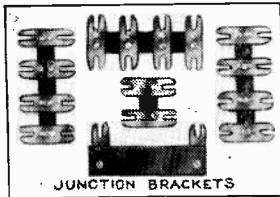
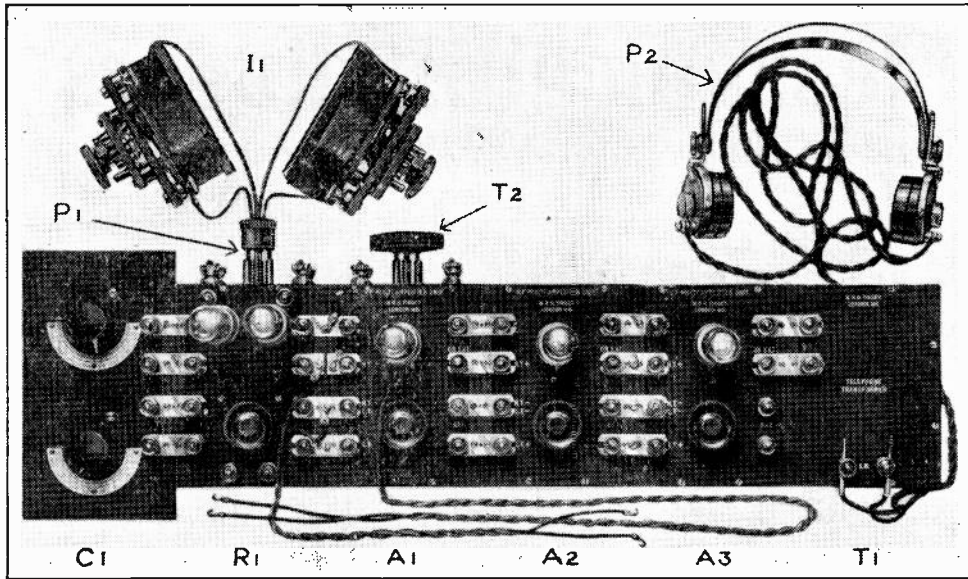

DETAILS AND PRICES OF APPARATUS ILLUSTRATED ABOVE:—

	£	s.	d.		£	s.	d.
C 1. CONDENSERS. One pair mounted in case	4	0	0	I 1. INDUCTANCES. C Coil—5000-24000 metres with approximate calibration. Price	2	10	0
R 1. RECEIVERS (without valves)	3	10	0	J 1. JUNCTION BRACKETS	5	0	0
A 1. MULTI H.F. AMPLIFIER TRANSFORMER UNIT, to be used with Interchangeable Transformers. Price, without Interchangeable Transformers	2	0	0	J 2. " " with four leads	6	6	0
A 2. MULTI H.F. AMPLIFIER UNIT, Choke and Resistance type	3	0	0	J 3. " " with two leads	6	0	0
A 3. MULTI L.F. AMPLIFIER UNIT	3	0	0	J 4. " " " " " "	3	0	0
A 4. MULTI H.F. AMPLIFIER UNIT, without inductances or variable condenser	2	0	0	J 5. " " " " " "	5	0	0
T 1. MULTI TELEPHONE TRANSFORMER UNIT	2	0	0	J 6. " " with four leads	6	6	0
I 1. INDUCTANCES. A Coil—200-1600 metres with approximate calibration. Price	1	0	0	J 7. " " " " " "	4	0	0
" B Coil—1000-8500 metres with approximate calibration. Price	1	10	0	J 8. " " with two leads	6	0	0
				P 2. BROWN'S PHONES (D Type), 60 ohms Per pair	2	8	6
				"ORA" MULLARD'S VALVES	each	15	0
				P 1. INDUCTANCE PLUGS	Prices on		
				T 2. INTERCHANGEABLE TRANSFORMERS	Application.		

Office and Works
Telephone:
1916 Hammersmith

W. R. H. TINGEY
:: Specialist in Wireless ::

Offices and Showrooms
92, Queen Street,
Hammersmith, W.6



THE Edison Swan Electric Company Ltd are manufacturers of all the following electrical supplies:

ACCESSORIES	INDUSTRIAL FITTINGS
ACCUMULATORS	INERT CELLS
BELLS AND ACCESSORIES	INSTRUMENTS, INDICATORS
CIRCUIT BREAKERS	INSTRUMENTS, METERS
DECORATIVE FIXTURES	IRONCLAD SWITCHGEAR
DRY CELLS	LECLANCHE CELLS
ELECTRIC FIRES AND RADIATORS	"LITTLE GLUTTON" VACUUM CLEANER
FANS AND VENTILATORS	OIL SWITCHES
HEATING AND COOKING APPLIANCES	TELEPHONES AND ACCESSORIES
SILK SHADES	WIRES AND CABLES

AND

ROYAL
"EDISWAN"

ELECTRIC LAMPS

FOR EVERY PURPOSE

(Fully Licensed under Patent Nos.
23499/09, 10918/13 and others.)

Let us know in which particular item you are interested and we will send you details.

THE EDISON SWAN ELECTRIC COMPANY LIMITED
PONDER'S END - - - MIDDLESEX

LONDON SHOWROOMS:

123/125, Queen Victoria St., E.C.4. 71, Victoria St., S.W.1

ASHLEY UNIT SYSTEM DETECTOR

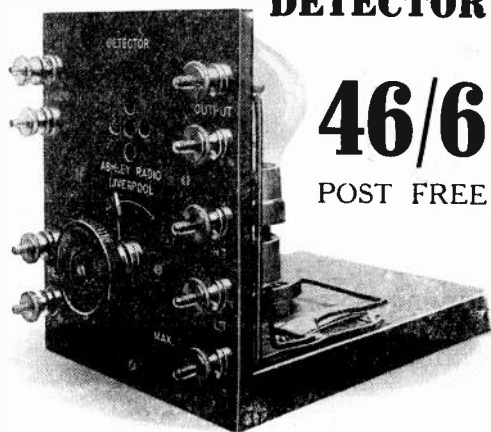

46/6

POST FREE

POLISHED MAHOGANY BOX 8/- extra.

ASHLEY RADIO,
69, RENSHAW STREET, LIVERPOOL.

The HETERODYNE RECEIVER

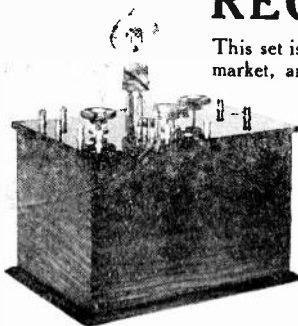

This set is the very best on the market, and includes all the latest improvements. It is fitted with Filament Resistance, Reactance, Aerial Tuning Inductance, &c., and is specially designed to receive long distance Telephony and Music. The following are some of those heard every day with

distinct clearness, and are easy to tune.

Paris Time Signals and Telephony. Le Bourget, Croydon, Lympe, Chelmsford. Aeroplanes crossing the Channel.

The Dutch Concerts can be enjoyed in your armchair every Sunday afternoon.

PRICE **£4 15 0** Complete with Valve
Send for my Illustrated List before buying elsewhere.

T. H. ISTD, *Wireless Engineer,*
TERLING, WITHAM, ESSEX.



TRADE MARK

**The WHITECROSS
COMPANY, LIMITED**
:: WARRINGTON ::

Manufacturers of All Descriptions of
**WIRE ROPES
AND WIRES**

At Low Prices

SPLENDID

TELEPHONY TRANSMITTERS

900 to 1,200 metre wavelengths
Ebonite and Mica Insulation throughout

COMPLETE WIRING
DIAGRAM WITH EACH

SINGLE SET £15

(not including valves)

Special quotations for quantities

If not satisfied money refunded within 10 days

L. JOHNSON
Hindehouse Lane, SHEFFIELD

RAPID WIRELESS TRAINING

DAY AND EVENING CLASSES: Correspondence Classes with Instrument work at School if desired. **Postal Course on Valves.** Classes for Amateurs and Experimenters. **INLAND TELEGRAPHY:** Sounder, Wheatstone Punching, Type-sending, etc. For details send P.C.

'Phone: North 1036.

ELECTRICAL TRAINING COLLEGE, Radio House, Manor Gdns., Holloway, London, N.

THE WIRELESS WORLD

THE OFFICIAL ORGAN OF THE WIRELESS SOCIETY OF LONDON
A MAGAZINE DEVOTED TO WIRELESS TELEGRAPHY AND TELEPHONY

CONTENTS

On The Tuning Range of Coils. By Philip R. Coursey, B.Sc., F.Inst.P., A.M.I.E.E.	643
The Transatlantic Tests — Success of British Amateurs and Prize Awards	646
Exhibition of the Physical Society of London and the Optical Society	648
Petition to the Postmaster-General	649
Some Hints on Soldering. By G. P. Kendall, B.Sc.	650
A Manchester Experimental Station	651

Contents continued on next page.

WIRELESS

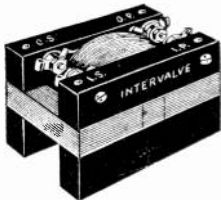

VALVE HOLDERS, in solid ebonite, with small flange at base, 2/3. Ditto, with large flange, 2/3. Valve legs, complete with back nuts, per set of four, 2/-.

BUZZERS, round type, adjustable, 5/-. Square type, adjustable, high tone brass case, 5/-. Both as illustrated.

H.T. BATTERIES, as illustrated, 15 volts, 4/6 each.

TRANSFORMERS, L.F., as illustrated, all tested and guaranteed perfect, 20/- each.

We have in stock a limited number of well known American made Variable Condensers, air dielectric, in transparent case with ebonite top and bottom, fitted with graduated scale, pointer, knob, etc. To clear at exceptional prices. Capacity .001 mfd., 30/-. .0005 mfd., 25/-. Also pattern as above for fixing in panels, self supporting, complete with fixing screws, scale, knob, long handle, etc. Capacity .001 mfd., 25/-.

Also a number of perfectly new Sullivan head phones, complete with cords. Resistance 120 ohms. All guaranteed in absolutely perfect condition. Per pair, 5/- Postage extra.

SPREADERS, stout ash, 6' long, 2" diam., 3/- each.
SWITCHES, on porcelain base, to carry 25 amps, as illustrated, S.P.D.T., 3/-; D.P.D.T., 6/-.

SHELL INSULATORS, the finest made, size A, 1/8 each; size B, 2/2 each.

Everything from present Stock.

Illustrated Catalogue, full of interest, price 7d. post free.

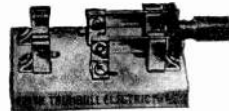

RADIO SUPPLIES DEPT. 1, 236, HIGH HOLBORN, LONDON, W.C. 1

'Phone—Museum 6394.

MEN IN THE WIRELESS SERVICES DESIRING RAPID ADVANCEMENT

should train in spare time with the College which ensures this.
"U.E.C." (Regent's Park, London, N.W.1) has in Twelve Years secured hundreds of successes by
Individualised Postal Training for Engineering Examinations and Professional Work.

State YOUR ambition, in confidence, to—SECRETARY'S DEPT. (Desk W.).
UNIVERSITY ENGINEERING COLLEGE, WESTGATE-ON-SEA. KENT.
and expert advice with the New Prospectus, No. 8, will be sent you without obligation.

CONTENTS (Continued)

The Reception of C.W. without Valves. By P. W. Harris	652
Transatlantic Tests (Mr. Paul F. Godley's Account of his Experiences)	660
A Provincial Club Set	663
Mounting Slab Coils	664
Wireless Club Reports	665
10th Wimbledon Boy Scouts' Wireless Section	670
Correspondence	670
Questions and Answers	671
Share Market Report	674

THE WIRELESS WORLD is published fortnightly on alternate Saturdays.

All correspondence relating to contributions should be addressed to THE EDITOR, THE WIRELESS WORLD, 12-13, Henrietta Street, London, W.C.2.

No responsibility can be taken for MSS. or photographs sent without stamps to defray cost of return postage.

Editorial and Publishing Offices, 12-13, Henrietta Street, Strand, London, W.C.2.

Telegraphic Address: "Radionic, Rand, London." Telephone No.: Gerrard 2807.

Advertisement Managers, Bertram Day & Co., Ltd., 9 & 10, Charing Cross, S.W.1.
Telephone No.: Gerrard 8063 and 8064

SUBSCRIPTION RATES.—

17s. per annum, post free. Single Copies 6d. or post free 8d.,

Registered at the G.P.O. for transmission by Magazine Post to Canada & Newfoundland.

COUBRO & SCRUTTON, LTD.

Telegraphic Address:
Coubro, Pen., London.

Head Office: 18, Billiter Street, London, E.C.3

Telephones:
East 7, 716, 717

MAKERS OF WIRELESS MASTS AND ACCESSORIES

*ENGINEERS & SMITHS. FOUNDERS.
MAST MAKERS AND RIGGERS*

Contractors to Admiralty, War Office, India Office, and Colonial Governments.

THE MARCONI SCIENTIFIC UNIT SYSTEM

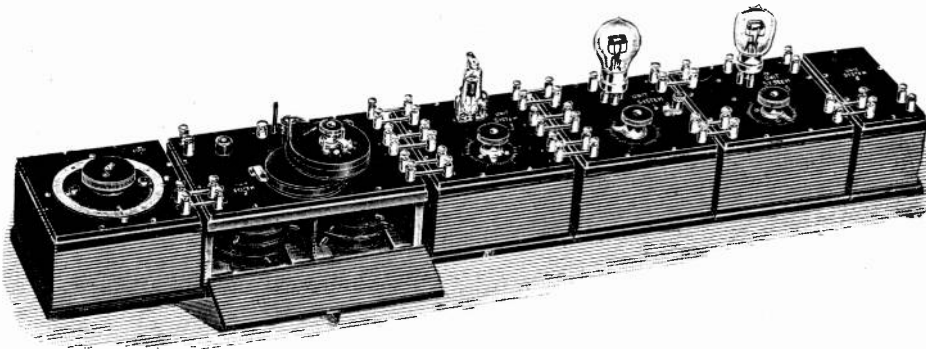

**GIVES YOU A FIRST-CLASS RECEIVER
BY DEGREES.**

IN the past, the amateur Radio experimenter has suffered by reason of a lack of flexibility on the part of his apparatus. That is to say, he has purchased an instrument of low price and consequently limited range, and at a later date when desirous to make additions he has found it impossible to do so, with the result that the apparatus has had to be scrapped and an entirely new one purchased. A realisation of this state of affairs led us to originate the Unit System, by taking advantage of which it is possible to BUILD UP A POWERFUL RECEIVER IN STAGES consistent with inclination and financial ability.

THERE are six Units, each of which accomplishes one of the functions that go to make up a modern valve circuit. *These Units may be purchased separately and worked together.* Unit 1, Condenser; Unit 2, Tuner; and Unit 4, Detector, form the nucleus of the set and represent an ultra-efficient single-valve combination. The range and sensitivity of this combination is considerably increased when a Unit 3 high-frequency Amplifier is connected between Unit 2 and Unit 4. Further units of this type may be linked into circuit, the amplification being geometrically progressive. Unit 5 Note Magnifiers may also be connected between Unit 4 Detector and Unit 6 Telephone Transformer. Any number of Unit 3 high-frequency Amplifiers up to six may be used, and one, two or three Unit 5 Note Magnifiers may also be employed.

THE terminal connections on all our instruments are so arranged that any of the Units may be connected into circuit by direct strapping with the copper pins provided. They may be ATTACHED TO ANY RECEIVER, valve or crystal. Upon receipt of a wiring diagram we shall be glad to indicate the external connecting scheme.

UNIT 1.—Variable CONDENSER, capacity .002 mfd.	£4 0 0
.. 2.—Retroactive TUNER, 550—26,000 metres (less Coils)	£6 15 0
.. 2. (with Coils)	£13 0 0
.. 3.—HIGH-FREQUENCY AMPLIFIER ..	£4 15 0
.. 4.—DETECTOR ..	£4 5 0
.. 5.—NOTE MAGNIFIER ..	£6 0 0
.. 6.—TELEPHONE TRANSFORMER ..	£1 10 0

SEND FOR FREE PAMPHLET
full of illustrations and interesting reading matter relative to these Units.

THE MARCONI SCIENTIFIC INSTRUMENT CO., LTD.

WORKS:—21/25, St. Anne's Court, Dean Street, Soho, W.1
SHOWROOMS:—40, Dean Street, Soho, W.1. Phone: Gerrard 7745.

THE "BROWN" MICROPHONE AMPLIFIER

This Amplifier magnifies signals, or music, without distortion, and is of considerable interest to amateurs and scientific investigators. The Magnification is much greater than that obtained from two valves, and the current consumption is about 50 milliamps. In construction, this instrument is simple, and it is much more robust than other sensitive relays of this class. This instrument satisfies the urgent demand for a reliable, inexpensive amplifier, which the most inexperienced amateur can use, and which the most experienced requires. It is much cheaper, ultimately, than a multi-valve amplifier, and the operator is relieved from many of the varied causes of breakdown. It includes a transformer suitable for low resistance telephones or loud speakers. The price of the "Brown" Microphone Amplifier is £8 for low resistance (120 ohms) and £8 2s. 6d. for high resistance (2,000 ohms).

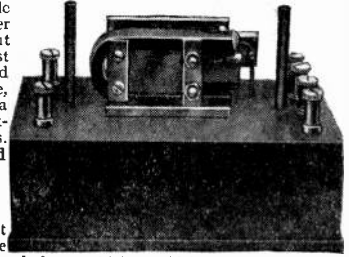

THE "BROWN" LOUD SPEAKER

With an Amplifier signals or telephony may be so magnified as to cause discomfort to wearers of head-phones, yet not be loud enough to be audible at any appreciable distance from the head. Every wireless experimenter sometimes wishes to let his friends hear, which would involve the use of several pairs of telephones simultaneously with consequent loss of signal strength, as well as considerable expense. The "Brown" Loud Speaker was designed to meet this need efficiently and economically, and is used in all up-to-date receiving stations. The sound is intensified by means of a horn.

The "Brown" Loud Speaker (80 ohms or 120 ohms) .. £5 10 0 Wound to special high resistance.. up to £5 15 0

THE "BROWN" SUPER-SENSITIVE TELEPHONES FOR WIRELESS, ETC.

These Telephones are unquestionably the clearest and most sensitive made, and, consequently, increase the distance over which the wireless can be heard.

IN UNIVERSAL USE. As supplied to British, Allied and Foreign Governments.

The "Brown" "A" Type Radio Headphones—		£ s. d.
Low resistance	per pair	2 18 0
High resistance	per pair	£3 2s. and 3 8 0
The "Brown" "D" Type Headphones (Improved flat diaphragm type)—		
Low resistance	per pair	2 8 0
High resistance	per pair	2 12 0

The above telephone prices include Cords.

Apply for Catalogues to Sole Manufacturers: **S. G. BROWN, LTD., Victoria Road, North Acton, W.3**

Telegrams: "Sibrownix, London." Telephone: Chiswick 1469.
London Show Rooms: 19, Mortimer St., W.1. Sole Agent for the Argentine: Horacio D. Guerrero, Las Heras 2480, Buenos Aires.

**EBONITE AND
VULCANITE**

TUBES—RODS—SHEETS

LARGE
STOCKS

**BRITANNIA RUBBER AND
KAMPTULICON CO., LTD.**
7, NEWGATE ST., LONDON, E.C.1

Telephone :
2168 Central

Telegrams :
Britannia, London

ESTABLISHED 1809.

**NORTH BRITISH
& MERCANTILE
INSURANCE COMPANY
LIMITED**

FIRE LIFE
ACCIDENT ANNUITIES
BURGLARY MARINE

FUNDS

£25,746,000

INCOME - - £9,110,000

Chief Offices :

LONDON : 61, Threadneedle Street, E.C. 2.

EDINBURGH : 64, Princes Street.

THE WIRELESS WORLD

THE OFFICIAL ORGAN OF THE WIRELESS SOCIETY OF LONDON

VOL. IX. No. 48.

JANUARY 21ST, 1922

FORTNIGHTLY

On the Tuning Range of Coils

By PHILIP R. COURSEY, B.Sc., F.Inst.P., A.M.I.E.E.

IN the "Questions and Answers" columns of *The Wireless World* for December 10th, 1921, page 587, an enquiry was printed with regard to the wavelength to which a coil will tune. From correspondence that has been received with reference to this subject it would seem of some interest to discuss the matter more fully.

Two, at first sight apparently conflicting statements, are frequently met with:—

The wavelength to which a coil will tune is proportional to the number of turns on the coil; and

The wavelength to which a coil will tune depends upon the square of the number of turns. Although inconsistent with each other, either of these statements may, in certain circumstances, be correct, under other conditions neither may be true. It is obvious therefore that the attendant conditions must be defined in connection with all such generalisations if they are to be in any way useful.

Firstly, in what way does the wavelength to which a coil can be tuned depend upon the coil's inductance? The most fundamental of all wireless formulæ tells us this, viz.:

Wavelength is proportional to the square-root of the product of the inductance and the capacity, or more simply:

$$\text{Wavelength} \propto \sqrt{\text{Inductance} \times \text{Capacity}}$$

Hence, we may say that if we have a given tuning condenser, the maximum wavelength to which any coil can be tuned by means of this condenser is approximately proportional to the square-root of the inductance of the coil.

In arriving at this statement we have neglected the effect of the self-capacity of the coil itself upon its tuning range. This effect will be to increase both the minimum and the maximum wavelengths to which our given tuning condenser will tune the coil, its effect on the former being much greater than on the latter. In the case of most well-designed coils, the self-capacity will usually not cause an increase in the maximum wavelength of more than 2 to 2½ per cent, when using a 0.001 microfarad tuning condenser. Generally its effect will be less than this amount. To a first approxi-

mation, therefore, we are justified in neglecting the self-capacity of the coil at the present stage.

Hence we find that, in order to determine the manner in which the maximum wavelength varies with the number of turns on the coil, we must determine the relationship between the inductance of the coil and the number of turns. For this purpose we can make reference to formulæ for the determination of the inductance of a coil from its dimensions. The number of such formulæ is very large, as the exact relationship depends upon the type of coil that is under consideration. It has been shown, however, by the present writer, both in this magazine and elsewhere, that Nagaoka's formula will with reasonable accuracy meet all practical requirements for any kind of coil, if the values of the correction factor "k" are suitably calculated and plotted in the form of a curve.

This formula, then, enables us to arrive at the desired relationship with reasonable accuracy for any kind of coil. It is:

$$L = \pi^2 D^2 n^2 k'$$

where L = Inductance of coil in centimetres.

D = Mean diameter of coil in centimetres.

" = Number of turns per centimetre length of the coil.

l = Length of the coil.

k' = Modified Nagaoka's correction factor.*

Let us now examine a few concrete cases and see what conclusions we can draw from this relationship.

1.—A single layer coil, of either the solenoid or pancake type, with fixed dimensions.

For this case, the crucial conditions are the constancy of all physical dimensions of the coil. Any changes in the inductance of the coil can therefore only be brought about by changing the number of turns of wire while keeping the space occupied by those turns the same. That is to say, we can only increase the number of turns by decreasing the gauge of wire used to wind the coil. For instance, if we had to begin with a coil wound with No. 22 d.c.c. wire, and we required to re-wind

*See *The Wireless World*, Vol. 7, page 383, October, 1919, for curves of this factor.

it in the same space with twice the number of turns, still keeping it as a single layer solenoid, we find from the wire tables that the diameter of No. 22 S.W.G. wire is 0.0280 inch, and therefore that if we allow the usual 10 mils. for a double cotton covering on this size of wire, its insulated diameter must be $0.0280 + 0.010 = 0.0380$ inch. To get twice the number of turns of wire into the space available we must use a wire having an insulated diameter of one half of this figure, viz. $\frac{1}{2} \times 0.038 = 0.019$ inch. Allowing again 10 mils for the insulation, we find that the diameter of the bare wire must be about 0.009 inch. From the wire tables we find that this corresponds sufficiently closely to No. 34 S.W.G. This gauge of wire is therefore the one that we should need to employ in order to get twice the number of turns on the coil into the same overall length.

Referring back now to our formula for the inductance of the coil, we see at once that if all the physical dimensions of the coil are maintained the same, i.e., D and l are constants, the factor k' will also remain constant, since it is a function only of D and l for a single layer coil (unless the wire is very thick relative to the diameter of the coil, which is an unlikely condition). Hence, the inductance of the coil is now proportional to n^2 and, therefore, since the length of the coil is constant, the inductance must be proportional to the square of the total number of turns on the coil. But we have already seen that the maximum wavelength to which the coil will tune with a given condenser is proportional to the square-root of the inductance ;

Hence,

$$\begin{aligned} \text{Wavelength} &\propto \sqrt{\text{Inductance}} \\ &\propto \sqrt{(\text{Turns per centimetre})^2} \\ &\propto \sqrt{(\text{Turns})^2} \\ &\propto \text{Turns} \end{aligned}$$

That is, THE MAXIMUM WAVELENGTH OF THE COIL IS PROPORTIONAL TO THE NUMBER OF TURNS PROVIDED THAT ALL DIMENSIONS ARE RETAINED THE SAME.

2.—A coil of any shape with fixed dimensions.

Similar arrangements apply to this case as to the one already given, since even with multilayer coils, if all the dimensions—length, depth, and mean diameter—are kept constant the value of k' will remain the same since the value of this factor depends only upon the two ratios, Length/Diameter, and Depth/Diameter. Therefore in this case also the maximum wavelength will be approximately proportional to the number of turns.

Since this conclusion applies to multilayer coils, it is interesting to note its application to the standardised series of multilayer coils of the Honeycomb, Duolateral, Burndept or similar type. These coils are generally all wound upon formers of the same size, while the overall dimensions of the complete coils do not vary very greatly in the larger sizes (say from coil No. 200 upwards). Hence to a very rough approximation we can say that for the larger sizes of these coils, the maximum wavelength to which they will tune with a given condenser will be roughly proportional to the num-

ber of turns on the coil. This relationship cannot of course be taken as an accurate one for serious work, but may serve only as a rough guide in choosing a coil for any particular purpose when the wavelength is known (see also Section 4 below.)

3.—Single-Layer Coil with fixed diameter and size of wire.

Provided, as stated in case (1), above, that the thickness of the wire is small compared with the mean diameter of the coil, it is immaterial whether the single-layer coil is of the pancake or of the solenoid type ; as if wound with the same wire to the same mean diameter their inductances will be equal.

The case now under consideration introduces another variable into the problem—viz., the length of the coil—but replaces it by the postulate that the size of wire must remain the same. We therefore need to refer again to our formula given above to see in what way these altered conditions will affect the conclusions already reached.

If the size of wire is to remain fixed, and the coils are wound with a single layer of wire only, the number of turns of wire per centimetre length of the coil must remain constant, since the number of turns of wire that it is possible to get into a centimetre length is the reciprocal of the insulated diameter of the wire. Hence we now have D and n both fixed, and l variable, since the total number of turns $N = nl$ can be changed, and consequently the inductance of the coil becomes proportional to lk' which is evidently also proportional to Nk' if we utilise the relation between N and l quoted a few lines above.

But as we know that the maximum wavelength is proportional to the square-root of the inductance, we can state at once that

$$\text{Wavelength} \propto \sqrt{Nk'}$$

A reference to the curves giving values of k' (to which reference has been made above) shows that for coils in which the ratio l/D is larger than about 3, the value of k' for single layer coils varies very little from unity. If then we neglect k' in the above relation we shall not commit a serious error. This error in the maximum wavelength will not exceed about 5 per cent. even if the length of the coil is only four times its diameter.

Hence for this case we may conclude that when the length of the single layer solenoid coil (or, its radial depth, in the case of a single-layer pancake) exceeds from four to five times the mean diameter of the coil, THE MAXIMUM WAVELENGTH IS APPROXIMATELY PROPORTIONAL TO THE SQUARE-ROOT OF THE NUMBER OF TURNS ON THE COIL, provided the mean coil diameter and size of wire remain the same. This means that to double the maximum wavelength to which a given coil will tune with a given condenser we must put on approximately four times the number of turns of wire. Actually slightly less than four times the number of turns will be required, especially if the coil is rather a short one to begin with, because as the length is increased, k' will be increased somewhat also, so that their product will increase more rapidly than the length alone.

Expressed in another way, this amounts to saying that in the case of shorter coils under these

ON THE TUNING RANGE OF COILS

conditions, the maximum wavelength of the coil is no longer proportional to the square-root of the number of turns but to a power of the turns which becomes greater the shorter the coil. The nature of this change may be seen roughly from the curve in Fig. 1 in which the ordinates represent the values of the index x in the relation

$$\text{Wavelength} \propto (\text{Turns})^x$$

for various lengths of coil.

It will be noted from the curve that the value of x falls towards the limiting value of 0.5 (which, of course, is the square-root) as the length of the coil is increased in relation to its mean diameter.

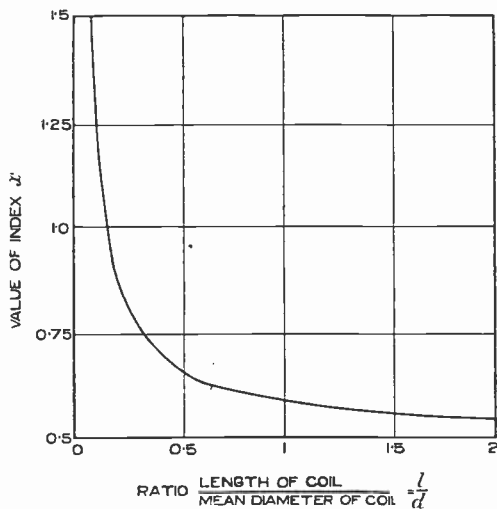

Fig. 1.

Hence we may more completely summarise this case (3) by stating that when the mean diameter and the size of wire are held constant, THE MAXIMUM WAVELENGTH IS ROUGHLY PROPORTIONAL TO THE SQUARE-ROOT OF THE NUMBER OF TURNS FOR LONG COILS, BUT VARIES MUCH MORE RAPIDLY WITH THE TURNS FOR SHORT COILS, reaching proportionality with the actual number of turns when the length of the coil is rather less than its diameter.

4.—Multilayer coil with fixed length and size of wire.

There is still a fourth case to which some attention may be given, viz., the dependence of the maximum wavelength upon the number of turns in a multilayer coil of fixed length, the stipulation being made that the gauge of wire is to remain the same when the number of turns is varied, but that the extra turns are to be added by increasing the number of layers in the coil, the layers being either very short, or suitably spaced in one of the ways well known in connection with multilayer coil windings.

This case is rather less easy of solution than the preceding, but we may obtain a preliminary approximation when there are only a few layers. With this limitation which means that the ratio of the radial depth of the coil d to its mean diameter

D is small, i.e., say less than 0.05. When this is the case, the effect of the depth d can be neglected to a first approximation, so that then the factor k' becomes Nagaoka's original factor k without modification just as in the case of single layer coils. Therefore with these assumptions, l is constant and D is approximately constant, so that the inductance becomes proportional merely to the square of the number of turns, since k' is unchanged under these conditions.

Hence the conclusion, will again be similar to that arrived at for cases (1) and (2) above, viz., that THE MAXIMUM WAVELENGTH IS PROPORTIONAL TO THE NUMBER OF TURNS ON THE COIL, PROVIDED THAT THE DEPTH OF THE COIL IS SMALL.

When, however, a large change is made in the number of turns on the coil, the consideration of this case is much more complex, since an increase in the number of turns involving as it does an increase in the number of layers, will cause an increase in the value of the depth d , and a slight increase in the mean diameter D . These two changes will tend to cancel each other in their effect on the value of the ratio d/D , but usually the increase in d will overbalance the increase in D , causing a resultant increase in the ratio d/D and a consequent decrease in the corresponding value of k' . The increase in D will also bring about a decrease of the ratio l/D and therefore as may be seen by reference to the curves giving values of k' (referred to above), it will cause a further drop in the value of k' . Since, however, in the formula for the inductance of the coil, the essential factors are now D^2k' since l is constant, the increase in the value of D just described may entirely offset the consequent drop in k' , so that the resultant effect on the product D^2k' may, in certain circumstances, not be large. Under these conditions again therefore the maximum wavelength will remain approximately proportional to the number of turns on the coil.

The magnitude of these various changes may be illustrated by the following example, which represents the case of a typical multilayer coil in which the number of layers is progressively increased, keeping the axial length of the coil the same. It has been assumed that each layer is spaced from the preceding one by an amount equal to the insulated diameter of the wire used, and the results have been calculated for various numbers of layers up to ten. The main conclusions can be drawn from the table on the next page.

By inspection of this table it can be seen that actually the inductance increases very nearly as the square of the number of layers on the coil, the number of turns in each layer being the same. This, of course, means that the inductance is very nearly proportional to the square of the number of turns on the coil, just as it would be if all the physical dimensions of the coil had remained unchanged when the number of turns was altered. The last column in the table headed "Percentage Deviation" gives the percentage variation of the inductance from strict proportionality to the square of the number of turns on the coil, and it can be seen at once that the variations from this proportionality are quite small.

The smallness of these differences merely serves to emphasise the statement made above to the effect that the decrease in k' due to the increase in the depth of the winding, as the number of turns is increased, is practically offset by the increase in the mean diameter of the coil brought about by the same cause, so that the product D^2k' remains practically a constant.

INDUCTANCES OF MULTILAYER COILS WITH VARYING NUMBER OF LAYERS.

No. of layers.	Total number of turns.	Mean diameter of coil (inches).	Inductance of coil (centi-metres.)	Percentage deviation.
1	25	2.00	37,800	-2.5%
2	50	2.06	155,000	+0.1%
3	75	2.12	348,000	-0.2%
4	100	2.18	614,000	-1.0%
5	125	2.24	950,000	-1.8%
6	150	2.30	1,430,000	+0.4%
8	200	2.42	2,540,000	+2.2%
10	250	2.54	3,990,000	+2.8%

Wire = No. 25 d.c.c. ; length of coil, $l = 0.75$ in.

This, of course, will not always be the case, as the figures given above represent but one example out of many that might be chosen. The proportions there given, however, are on the general lines of those commonly met with in practical multilayer coils, in that the axial length of the coil is about a third of the mean diameter, or less. The general indications of the figures given, however, point to the occurrence of a rather larger variation from the proportionality of the inductance with the square of the number of turns, as the number of turns is further increased beyond a ten-layer coil (250 turns). The reason for this is that as the coil becomes

deeper its shape approaches more closely to the square section, which is more economical of copper. As this shape is approached the value of k' suffers a smaller decrease, and consequently the increase in the value of D^2 overbalances the fall in k' . Unless, however, the coil is made very deep, the departure from the proportionality will not be very great, so that to a first approximation the above generalisation for the coil of few turns will also hold for the larger coils; viz., THAT THE MAXIMUM WAVELENGTH IS PROPORTIONAL TO THE NUMBER OF TURNS ON THE COIL.

The four cases of different, limiting conditions that we have just considered, while by no means exhausting the possibilities will doubtless serve to indicate the factors affecting any statement connecting the maximum wavelength with the number of turns on the coil. It will be evident from the above that the best generalisation is that the wavelength is proportional to the number of turns on the coil, but it must be carefully borne in mind that this does *not* apply to a single-layer coil whether of the solenoid or pancake type, if changing the number of turns alters the axial length or radial depth, respectively, of the coil. In most other cases the generalisation is at least approximately true, provided that it must not be forgotten that the self-capacity of the coil has been neglected in this consideration, and therefore that if a form of coil is used which has a very high self-capacity the conclusions that have been reached may be modified considerably.

The results that have been obtained above may also be found of some use when arranging tapping points on a coil to obtain different values of the maximum wavelength. Here, again, however, the self-capacity, and also the "dead-end" capacity of unused parts of the coil, will introduce modifications, which will affect the results. Use may be made of the k' curves in a very similar manner to that outlined above for the pre-determination of tapping points on coils of various shapes, either when the successive taps are to give equal increments of the wavelength, or equal increments of the inductance.

The Transatlantic Tests

SUCCESS OF BRITISH AMATEURS AND PRIZE AWARDS

AS announced in our issue dated December 24th, signals from several U.S. amateur stations have been heard in this country. An examination of the reception logs that have been received has brought to light many interesting facts and it is hoped to deal with these more in detail in later issues as space permits. It is possible to state at the moment that signals from American amateurs have been heard in this country at eight British amateur stations, these stations in some cases being operated jointly by more than one experimenter. Some of the signals were also heard at the Hague (Holland) and at Nice (France).

As may be remembered, the tests extended from midnight of December 7th-8th to 6 a.m. (G.M.T.) on December 17th, and lasted for six hours each night. The first two-and-a-half hours of each test period—viz., from midnight until 2.30 a.m., was a free-for-all period in which many transmitting stations were taking part, the different districts into which the U.S. amateur stations are divided for inspection purposes being allocated periods of 15 minutes in turn. Thus practically all the A.R.R.L. radio stations had in turn a chance of transmitting during one 15-minute period each night, the exact time of this ¼-hour period being changed on each night of the Tests. As some of

THE TRANSATLANTIC TESTS

the stations from which signals were intercepted were heard during this free-for-all period, it is not possible to verify their reception other than by the characteristics of the signals heard, and by the period during which they were heard. The other transmissions, however, during the remaining 3½ hours each night were each allocated a definite five-letter code word, by means of which the reception could be verified. Signals from five American stations were picked up complete with correct code-words, etc., viz. :—

1AFV
1ZE
2BML
2FP
and 2ZL.

Calls were also heard during the free periods from—

1RU
1UN
1XM
2ZC

and 2RU; the last one being a little uncertain.

In addition to the above regular schedule of transmissions, an additional special U.S. station was erected just before the beginning of the tests on Mr. Godley's recommendation after he had preliminarily investigated the receiving conditions on this side, and found them somewhat different to his expectations. This station, call letters **1 BCG**, was erected by a group of prominent U.S. Radio amateurs including E. H. Armstrong, the inventor of the well-known supersonic heterodyne receiver. This station was equipped with valve transmitters with an input of 1 kW, and giving about 600 watts of high frequency energy in the antenna circuit. It operated on a wavelength of close on 200 metres.

Although this station was allocated a definite position in the transmission schedule, by cabled information from the Traffic Manager of the American Radio Relay League, it also made special transmissions to Mr. Godley over prolonged periods, and despatched messages to him.

Very loud signals were heard from this station by five of the British competitors, while it was also heard in Holland.

While doubtless of considerable use to Mr. Godley, it is unfortunate that the signals from this station acted as a hindrance to some of the British amateurs, who picking them up, recognising that they were of American origin and not knowing the special nature of the station, copied the repeated calls and messages for hour after hour during the best nights of the tests, to the complete exclusion of possible signals from other American amateurs—signals which must have been there had they been tuned in if the exceptional transmission qualities of those particular nights is considered.

Of those who picked up the signals, by far the best reception was made by Mr. W. R. Burne, of Sale, Cheshire, who heard no less than seven different U.S. stations of those listed above (including **1 BCG**). Of these seven, three were individual period transmissions, and were picked up with the correct code-words, etc. The code word of a fourth was also very probably heard, but there was an

error in the letters which throws a slight doubt upon the reception of this station. It is therefore considered that he should be awarded the prizes allocated to the most successful reception of the signals. The prizes to be awarded to Mr. Burne are therefore as follows, as the conditions attached to these awards have been complied with:—

- Amateur Supplies Association :
A "Simplex" cabinet valve set.
- E. M. Ashley, Ltd. :
Prize value £8.
- G. Z. Auckland & Son :
Apparatus value £10.
- Burnham & Co. :
First prize—Burndept Ultra III Receiver.
- Butler & Co. :
Apparatus value £5.
- Dubilier Condenser Co., Ltd. :
Condensers value £10.
- Halliwell & Good, Ltd. :
Apparatus value £30.
- The International Electrical Trading Combine :
A "Concertone Magnephone."
- Marconi Scientific Instrument Co., Ltd. :
First prize value £25.
- H. W. Sullivan :
Sullivan Wavemeter, value £35.

Some of the other prizes that have been offered will not be awarded as the conditions that were attached to them as to the use of apparatus manufactured by the firms in question have not been complied with.

Next in order of merit is Mr. H. H. Whitfield, of Hall Green, Birmingham, who heard two stations, in each case with correct code words, in addition to **1 BCG**, although he was only able to listen in for two nights during the Tests. The second prize offered by the Marconi Scientific Instrument Co. (value £15) and by Messrs. Burnham & Co. (a Burndept II receiver) have therefore been awarded to him.

Messrs. W. Corsham, of Harlesden Gardens, Willesden, London, N.W.10, and R. D. Spence of Craighead House, Huntley, Aberdeenshire, each heard signals from one station with correct code words. Mr. Corsham's reception was, however, effected, using three valves, whereas Mr. Spence used six, and therefore in the opinion of the judges Mr. Corsham is more deserving of the award of the more valuable of the two third prizes that have been offered, viz., a Burndept I receiver (value £6). The third prize (value £5) offered by the Marconi Scientific Instrument Co., Ltd., will therefore be awarded to Mr. R. D. Spence.

Messrs. A. E. Greenslade and E. McT. Reece working together at the British School of Telegraphy, Clapham Road, London, S.W.9, heard one station during the free period, in addition to **1 BCG**.

Mr. J. R. Forshaw of Ormskirk, near Liverpool, heard **1 BCG**; and Mr. T. Cutler of Southampton, heard **2 ZC** calling during the Test period.

The decision with regard to the award of the prize offered by Messrs. B. Hesketh for the best designed circuit will be announced later.

Descriptions, illustrated with photographs and circuit diagrams, of the various receiving stations

at which U.S. Amateur signals were heard will be published shortly in these columns.

Elsewhere in this issue will be found an account of Mr. Godley's experiences in this country, written by himself—an account which we were fortunately able to secure from him during the few hours that he had to spare in London after the finish of the Tests and before he sailed for the States. It will be seen from this account that although he had exceptional facilities granted to him as regards size of aerial, and freedom of choice of location, he was greatly hampered by the atmospheric conditions and physical discomforts under which he worked. His choice of the location that he adopted—viz. near the shore at Ardrossan (near Glasgow) was made on recommendation of that locality made to him by a number of radio engineers in America and elsewhere, but his choice involved working in a tent out in a field with the attendant discomforts attached thereto. The dampness of our climate as compared with the one to which he is accustomed, together with the exposure to heavy rains and cold at night proved a great strain to him, but we sincerely hope that on his return to his own land he will soon regain his usual good health and cheerfulness.

It is of interest to note that in all cases the aerials

used by the successful British amateurs were within the limits imposed by the Post Office licenses, and were therefore very much smaller than the aerial system used by Mr. Godley.

Mr. Godley's aerial also possessed the advantage of eliminating some of the atmospheric interference as compared with an ordinary type of aerial.

It is indeed fortunate that the Tests on this occasion lasted for a longer period than last time (February, 1921), as the general results obtained by all the stations, including Mr. Godley's, show that the signals were heard on a few nights only. Apparently at the beginning of the Test period transmission was bad, but the signals gradually increased in strength during the next two nights and then faded right away again until nothing whatever was heard during the last nights of the Test.

Doubtless these changes were closely connected with the meteorological and other atmospheric conditions existing over the Atlantic at that time. This point is being investigated further, as the weather charts for that period are being collected. Had the Test only lasted the three days allocated on the previous occasion, it is quite likely that once again nothing would have been heard.

PHILIP R. COURSEY.

Exhibition of the Physical Society of London and the Optical Society

THE twelfth annual exhibition of the Physical Society of London and the Optical Society, was held on January the 4th and 5th at the Imperial College of Science, London.

Amongst the exhibits were several of special wireless interest. Marconi's Wireless Telegraph Company exhibited an automatic wireless alarm device which responds to a call from a vessel in

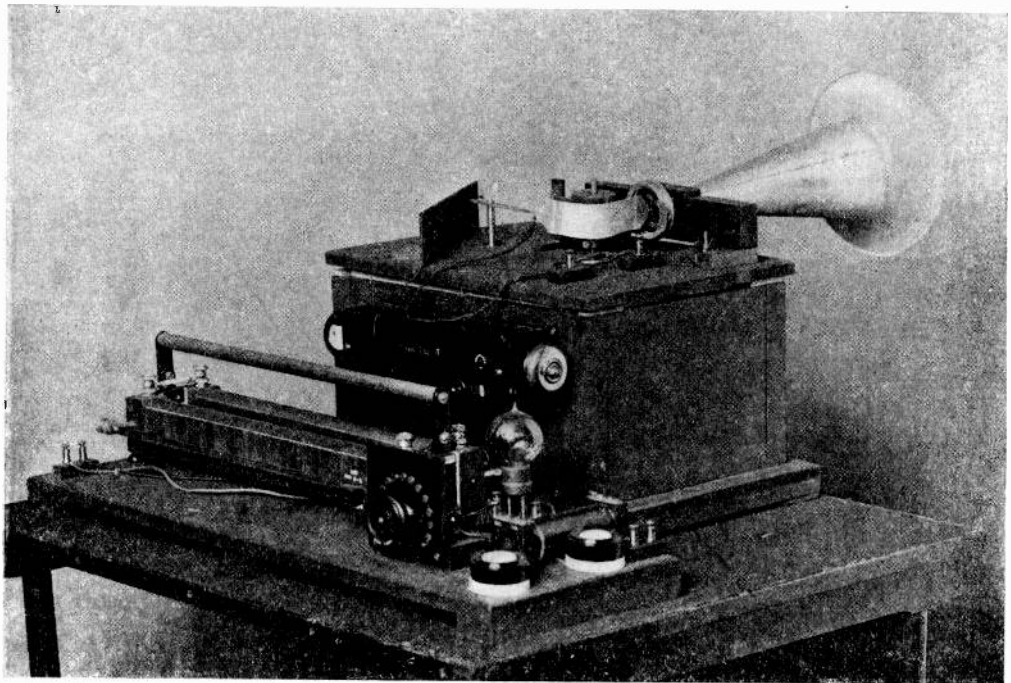

EXHIBITION OF THE PHYSICAL SOCIETY OF LONDON

distress, even though the receiver is left entirely unattended. The device is termed the "4 second" alarm apparatus, since it operates on a particular signal, having a duration of four seconds. The apparatus is unaffected by jamming from other stations or from atmospheric disturbances. In the event of a breakdown in the receiving apparatus, such as would be caused by the burning out of the valve employed in its operation, the alarm is automatically sounded so that the operator in charge may be called to replace the burnt-out valve.

Messrs. H. W. Sullivan had several exhibits of wireless interest and particular mention may be made of apparatus for radio frequency measurements, and standard heterodyne wavemeters.

Undoubtedly the most attractive item of the exhibition to wireless amateurs was the demonstration given by Mr. A. A. Campbell Swinton, F.R.S., on the electrostatic phenomenon recently described by two Danish engineers, Messrs. Johnsen and Rahbek, before the Institution of Electrical Engineers. Mr. Campbell Swinton included in his demonstration an historical account of the various discoveries made in connection with this phenomenon, and showed its importance in the light of present day knowledge. A description of the

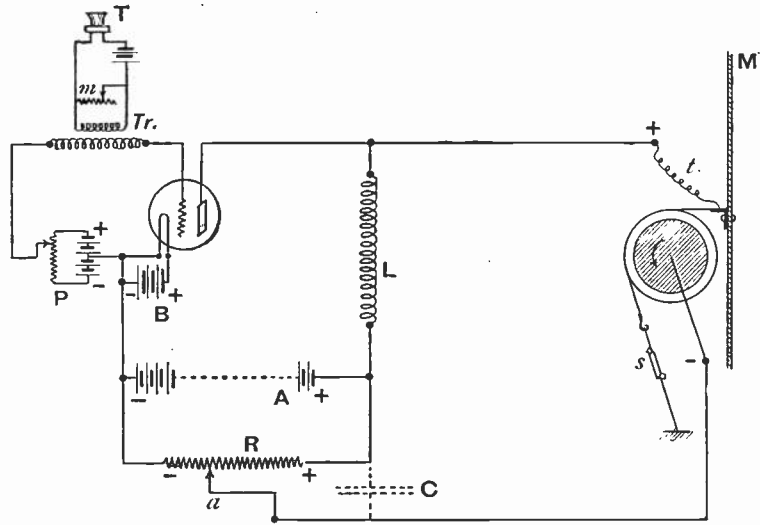

apparatus used by Messrs. Johnsen and Rahbek has already appeared in *The Wireless World*,* and the apparatus used by Mr. Campbell Swinton is shown in the photograph, whilst a circuit diagram is given above. A lecture and demonstration on this subject was given recently by Mr. Campbell Swinton before the Royal Society of Arts.

* Loud Speaking Telephones—II, by Philip R. Coursey (*The Wireless World*, pp. 225-228, 289-292 and 311-314, Volume 9, 1921).

Petition to the Postmaster-General

THE Petition to which reference was made at the meeting of the Wireless Society of London on December 28th*, when it was exhibited, was signed for and on behalf of The Wireless Society of London by Dr. Erskine Murray as President, Mr. A. A. Campbell Swinton as Past President, and Admiral Sir Henry Jackson as President Elect, also by Mr. F. Hope-Jones as Chairman, and Mr. Leslie McMichael as Secretary. Then followed the signatures of sixty-five Provincial Wireless Societies representing in all upwards of 3,300 amateur radio-telegraphists in Great Britain.

It was presented by the Chairman and the Secretary on December 29th, 1921, at St. Martin's-le-Grand to Captain Loring and Mr. de Wardt who received it on behalf of the Postmaster-General and gave a very sympathetic hearing to the Deputation.

It was pointed out that the only Societies whose signatures did not appear were those connected

with schools or colleges closed during the Christmas vacation.

Mr. Hope-Jones emphasised the National character of the Petition, not only with respect to the signatories, but also in its objects which were quite unselfish in their patriotic aspect.

They voiced a national resentment that public services such as wireless Time and Telephony should be left to our neighbours to provide, and that permission to transmit Weather Reports, news and music by wireless telephony should be refused to Companies competent and willing to do so without interference with the defensive services of the country.

They recognised that the Post Office was not the ultimate authority, but their only constitutional means of access to the Wireless Board was through the Postmaster-General and they avowed their intention to urge their plea with all the force of which they are capable consistent with constitutional methods.

* See page 665 of this issue.

Some Hints on Soldering

By G. P. KENDALL, B.Sc.

ONE of the most important rules which should be borne in mind by the man who wishes to construct sound, reliable electrical apparatus is this: so far as is practicable, every circuit should consist of a continuous metallic path, with no "contact" connections. This, however, really amounts to saying *solder all joints*. It is to be feared that many amateurs disregard this rule, not from ignorance of it, or of the troubles which come from its neglect, but simply because they lack the necessary skill with the soldering iron. I believe that many are deterred from trying to acquire that skill by the prevalent idea that soldering is mysterious and difficult, and it is the object of this article to show that with an understanding of the principles involved, and a very little practice, anyone may turn out work which may not be beautiful, but which is perfectly satisfactory from the electrical point of view.

Let us start, then, by considering what actually happens in the process of soldering. It all depends upon the fact that if a *clean* surface of molten metal be brought in contact with a *clean* surface of another metal which is merely hot, there is formed at the surface of contact an exceedingly thin film of an alloy of the two metals. If the molten metal is then allowed to cool down and solidify, it will be found that it is adhering firmly to the other, and that the two now form a continuous mass, having, electrically, no contact resistance. Here, of course, is the desired process, but there are certain provisos. First, I do not wish to imply that all metals exhibit these properties to the same extent; in practice it is found best to use for the molten metal an alloy of lead and tin, in varying proportions, usually about two parts lead to one of tin. Such an alloy has a conveniently low melting point (about 400° Fahrenheit), and adheres readily to all the commoner metals except aluminium. Second, note the emphasis upon the word "clean," for here is the crux of the whole matter. The dirt which may interfere with the process is of two kinds, one being the tarnish and grease usually found on metals, and the other the film of oxide which forms when metals are heated in air. The first is removed beforehand by scraping, filing, or rubbing with emery paper, but the second is a more difficult matter. To remove it we require what is called a "flux." This is a substance which has generally a two-fold action, since it dissolves off the oxide, and prevents the formation of more by providing a protective film over the hot metal to keep off the air.

Many fluxes are known and used for different purposes, but the electrician must be careful which he uses, because some are capable of dissolving not merely the metallic oxide, but the metal also. Consequently, if he solders two fine wires together with such a flux and chances to leave a little of it upon them they are likely to be corroded through in a short time.

I do not propose to go into the merits of all the rival fluxes, but shall just give the name of the one which I have found easiest to use, and most satisfactory for general purposes. I refer to "Fluxite,"

a proprietary article which can be obtained from most ironmongers in the form of tins of paste.

So much for theory, now for practice.

Here is a list of the articles required before making the first attempt.

8 oz. soldering iron.

Stick of solder.

Tin of Fluxite.

Piece of emery paper.

An old file which you don't value.

Pair of small clean pliers.

Some odd bits of copper wire.

For heating the iron I strongly recommend either a gas ring, a Primus stove, or a plumber's blow-lamp; don't put it in the fire if you can possibly avoid it. This matter of heating is one of the greatest obstacles in the beginner's way, for the exact temperature is of some importance, and can only be estimated by purely empirical methods. Some judge it by the amount of green colouration imparted by the hot iron to the heating flame, while others go by the "feel" of it when held a few inches from the palm of the hand. Perhaps the best plan for the novice is to test the iron at intervals during the heating process in this way:—Dip the point of it momentarily into the Fluxite and note whether the paste burns off at once, or merely melts and runs about on the iron. As soon as it begins to fizzle off in a moment the iron is ready for use, and should not be made any hotter, or it will become impossible to keep a bright surface of melted solder upon it; the excessive heat causes rapid oxidation of the solder and one has to be continually removing the film with applications of Fluxite.

If the iron is a new one it has now to be "tinned," for which operation the file is required. File up one of the faces of the iron from the point to a distance of about half an inch from it until it is quite clean and bright. This must be done as quickly as possible, so that the exposed hot copper surface may not have time to be oxidised and dulled by the air. Now dip it momentarily in the Fluxite and rub the prepared surface with the end of a stick of solder which has been dipped in Fluxite. If the stars are propitious the result will be a coat of bright melted solder, into which more can be melted and applied to the work in hand as required.

Now for the first attempt. Put the iron back to keep hot (that is, with only a moderate flame) and set about preparing two of the bits of wire for jointing. Two pieces about six inches long and of any gauge from twenty to thirty will be suitable. One end of each should be stripped of insulation for about half an inch and scraped with a knife until perfectly bright and clean. This is most important, for five minutes spent scraping may save a quarter of an hour trying to make the solder stick. Now smear the prepared ends with Fluxite, and don't get more of it on your fingers than you can help, for it doesn't wash off easily. Remove the iron from the gas and see whether the tinning is still bright. If it has become dull it may be freshened by dipping

SOME HINTS ON SOLDERING

it in the Fluxite. Enough solder is then to be melted upon it to give a good bead, and into this the two prepared ends are dipped and twisted about until they are well tinned. Dip the tinned ends in Fluxite, twist them together tightly with the pliers, and then dip the twist in the melted solder again for a few seconds. Upon removing it you will see your first soldered joint.

Here, then, we have the whole process: Scrape or file the surfaces bright, apply Fluxite, tin them, more Fluxite, place together and heat, either by dipping in melted solder, or placing in the flame. (The same end would have been attained if you had put the twist very cautiously into the flame for a few moments, taking great care not to make the wires red-hot. This method is the better one when the two pieces of metal are large, since the iron cannot supply enough heat to melt the solder over large areas.)

The example I have given is typical of all soldering operations, and the method there outlined will enable the amateur to deal satisfactorily with all the jobs he is likely to come across.

I add a few tips which the novice will do well to pay heed to.

- (1) When tinning a surface on a large piece of metal try to warm it up in the flame first.
- (2) When soldering a joint in an aerial use as cool an iron as you can, for much heat will seriously weaken the wire.

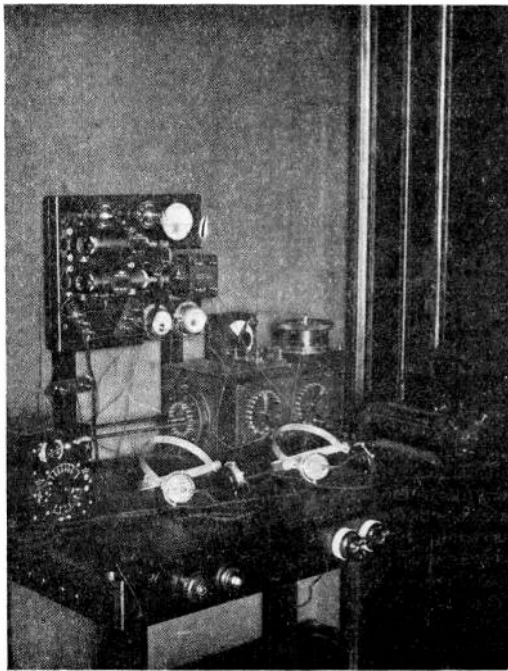

Fig. 1. Mr. J. R. Hoult's Station.

- (3) Devote all your care to cleaning, for therein is the secret of success; a trace of grease may make a joint impossible.
- (4) Don't put the iron on to heat and forget about it, for if you do you will find all the tinning will burn off.
- (5) Be sparing rather than lavish with your solder.

A Manchester Experimental Station

The accompanying photograph, Fig. 1, shows the experimental station belonging to Mr. J. R. Hoult, a member of the Manchester Wireless Society.

The panel at the back contains two valves, filament rheostat, and potentiometer, a low frequency transformer and a high frequency transformer either of which can be used by changing over

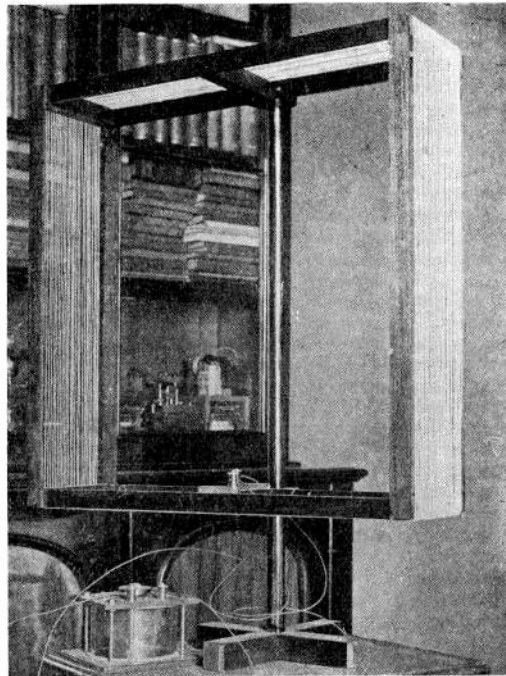

Fig. 2. An Indoor Frame Aerial.

the connections, filament ammeter and voltmeter, and a voltmeter for the H.T. battery. The tuner and condensers can be seen on the table top, also the wavemeter. The double pole switch on the right controls the valve filaments. The single pole switch has since been replaced by a D.P. switch to control, in addition, the H.T. The push-button is for taking readings of the H.T. with the voltmeter.

Fig. 2 shows a frame aerial 2 ft. square, which has been used successfully in the reception of signals from Nauwen, using one H.F. magnification stage and the potentiometer method of reaction.

The Reception of C.W. Without Valves*

By P. W. HARRIS.

THE subject of my paper this evening, "The Reception of C.W. without Valves," may appear to some members to be of historical interest rather than practical importance. As everyone knows, continuous waves are received nowadays practically entirely by the heterodyne method, the local oscillations for which are generated either by the receiving valve itself, or by means of a valve in a separate oscillator. So general is this method of receiving that I am not aware of any other device for the purpose being marketed at the present time.

A few weeks ago, in conversation with a wireless engineer who has had a great deal of experience in working and erecting C.W. stations I mentioned that I had been looking into the matter of receiving C.W. without valves, with a view to finding some interesting line of research. He remarked "why worry about any other method—the valve does all you require?" This position would seem to be a dangerous one. Why should we assume that finality in reception is to be reached by valve methods? Why should we assume that progress is only to be made with a device utilising electronic emission from heated filaments? As the premier Wireless Society of this country I think we should pay every attention to finding new methods of research, and the whole object of my paper this evening is not so much to tell you anything new (although I hope one or two small matters will be new), but to draw attention to this neglect of one aspect of wireless.

I think I may say that, since the Armistice, practically nothing has been done in seeking for new forms of detector, amplifier and oscillator for reception, other than the valve.

Before outlining a few suitable and interesting methods of receiving C.W. without valves I would like to take your time for a few moments to consider certain points regarding valves which will help us to understand other devices. First of all the valve is a very simple, easily acquired piece of apparatus (if you have the money) but its many advantages must not blind us to its numerous disadvantages. I do not know whether you have considered how very inefficient the valve is, if you count the efficiency as the ratio of electrical output to electrical input. We will say that the average valve takes about 0.6 of an ampere on 4 volts. In this way you have $2\frac{1}{2}$ to 3 watts of energy consumed, quite apart from that from the high tension battery. Now the output, of course, is very small and when you come to use 6 or 8 valve amplifiers the current consumption is considerable. The chief disadvantage of the valve then is that we require either an accumulator or some other form of low tension supply.

If you consider the valve purely as a detector (and not in a circuit, causing it to act both as an amplifier and detector), it is not very much more efficient so far as strength of signals is concerned

than the best crystals. It is, however, much easier to adjust and is more constant in action. As an amplifier it stands in a class of its own, and to find anything to excel the valve in this respect would appear to be a somewhat difficult task. As an oscillator it should not be, I think, difficult to beat the valve—there again its electrical inefficiency stands out. If you use a valve in a separate oscillator your ratio of output to input (that is, output of high frequency oscillations to input of energy) is very low. Indeed, electrically it is one of the most inefficient devices in existence.

There is another aspect of the question which is not always evident to amateurs in large towns. Take the case of the provincial amateur who, we will assume, is situated 10, 15 or 20 miles from the nearest source of electrical supply. Let us assume such an amateur desires to instal a receiving station. He either constructs or purchases a tuner having the necessary range of wavelengths from the amateur 180 metres to 23,450 metres of Bordeaux. Then he turns his attention to the detector and having decided on a valve, finds, of course, that he needs accumulators for his low tension supply and he also needs a high tension source. The country amateur can easily obtain the high tension supply from dry cells, but in the case of low tension, what is he to do if he wishes to charge his accumulator? Very many amateurs in the country are debarred from C.W. reception owing to the fact that they have no facilities in the way of low tension supply. If the amateur in such a case decides to confine himself to crystal reception he will find there is nothing for him over 5,000 metres and very few stations above 2,000.

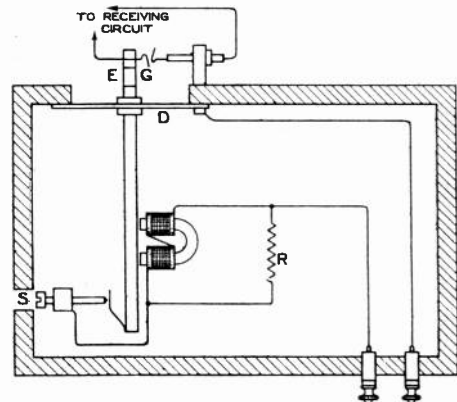

Fig. 1.

As everyone knows when the Poulsen arc was first evolved it was the first commercial generator of high frequency oscillations. The detector used with it was known as the "tikker." Now the "tikker" is still available to those who like to use it. Its efficiency is not high compared with modern receivers, but I should imagine that many

*A Paper read before the Wireless Society of London on Wednesday, December 28th, 1921.

THE RECEPTION OF C.W. WITHOUT VALVES

amateurs, if they could get hold of a suitable and inexpensive tikker, would use it, as one does not need highly efficient apparatus to receive high power C.W. stations in this country. In Europe the trouble is frequently to eliminate them. In Fig. 1 you see the original arrangement of the tikker. The tikker, of course, is nothing more than a vibrating interrupter. In the original tikker, contact was made between two gold wires which were vibrated against one another. These wires are shown in the Fig. at G.

Many amateurs think that the tikker was merely a device to interrupt the high frequency current after it had been rectified, but the original tikker circuit consisted of the oscillatory circuit without a rectifier and a large condenser (a condenser of a considerably higher value than the condenser in the tuning circuit) so that when the two wires came together the energy which happened to be in the tuning condenser discharged into the larger condenser.

Now here is another form of tikker (Fig. 2) having a rotating interrupter in place of the vibrating wires. The buzzer type of tikker does not give a musical note and there is, of course, a great advantage in having such a note.

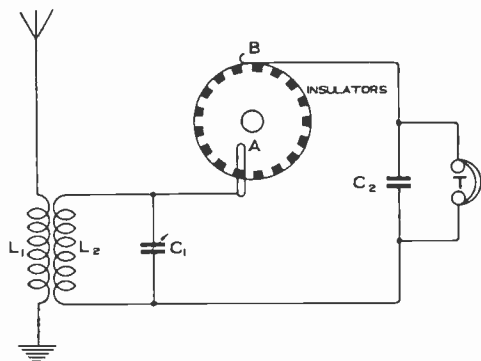

Fig. 2.

In this case the current is interrupted very rapidly but at a regular frequency, the results being a musical note, but whatever the form of interrupter the tikker circuit is usually the same.

There is no rectifier as in crystal sets, so that every time the contact is made, whatever the charge happens to be, either positive or negative, C_1 will first of all discharge into the condenser C_2 and then at the break C_2 will discharge through the telephones as a single pulse. The great disadvantage of all tikkers is that they give the same note (musical or non-musical) to signals and to atmospherics.

I had originally intended to show you this evening an experiment with a very simple form of tikker which gives quite good results. It requires a circuit either sharply tuned to the marking wave or less sharply to those stations which have no spacing wave. In any case where there is so little difference between marking and spacing waves that it is practically only separable with the heterodyne the tikker will give a continuous buzz

throughout. The principle of this tikker is shown in Fig. 3. In place of the vibrating wires or rotating break of Figs. 1 and 2 a form has been evolved consisting of a wire resting lightly upon the edge of a rotating wheel. It gives a kind of breathing note quite pleasant to read and has proved to be very sensitive as compared with many other

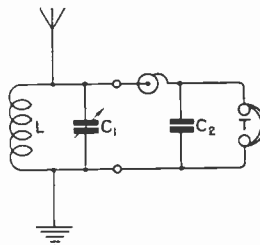

Fig. 3.

forms of tikker. It occurred to me while experimenting that it would be possible to dispense with an electric motor for rotating a wheel, or with a dry cell for buzzing, by using the edge of a gramophone turntable. Those who have gramophones can try the experiment for themselves. Unfortunately the gramophone has not arrived to-night for the paper, so that I cannot show the experiment.

To perform the experiment, connect a piece of electric lighting flex to condenser C_1 (Fig. 3) and connect another piece to condenser C_2 , the other connections being as shown. Now fray out one end of the first piece of flex and allow it to rub on the metal edge of the gramophone turntable. From the end of the second piece of flex separate out one or two strands, bending the others back. When this has been done, hold the end lightly and allow the tips of the strands to rub very lightly upon the metal edge, varying the pressure until the best results are obtained. Nauen, Carnarvon and Clifden—stations which do not radiate spacing waves—are among the best for experimenting with tikker devices, for with many C.W. stations, if tuning is not very carefully done, the tikker will give a continuous hiss from both marking and spacing waves.

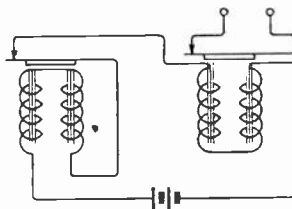

Fig. 4.

This is the simplest form of tikker I know, and those interested who try it will be surprised at the results. Another form of tikker, which is simple to make, uses two buzzers as shown in Fig. 4. To make it you take a pair of ordinary buzzers and alter the windings as shown.

The buzzer on the right has its windings connected up in series with the first buzzer, so that its make-and-break contacts have no current flowing through them. The interrupted current from the buzzer on the left will also pass through the coils on the right and will vibrate the armature. The two terminals on the right hand side are connected to the receiver as before. It is not advisable to use high note buzzers, as although it might appear that the very high note buzzers would give the best results it is difficult to get them to run together, and I find I do not get the musical note which I should expect in such a case. A further form of buzzer tikker which combines both a buzzer and a heterodyne method I shall mention later. All these early tikkers have the great disadvantage of resolving all the signals into one monotonous buzz. This is a serious objection.

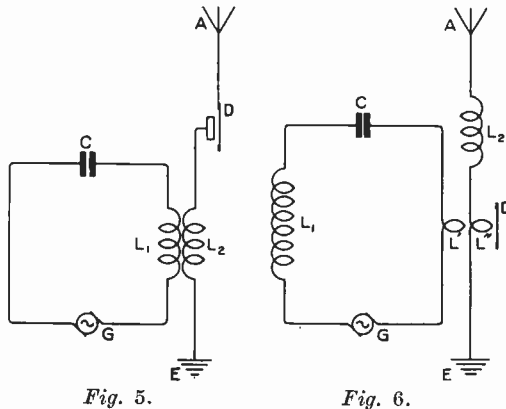

Fig. 5.

Fig. 6.

The next step in efficiency was the introduction of the heterodyne method of Fessenden. Fig. 5 shows one of the several heterodyne methods first described by Fessenden. The generator G was a small high frequency alternator (the three-electrode valve was not known at the time) and you will see at D an electrostatic telephone. I really cannot see how it worked well and it does not strike me as an efficient device. We will assume the aerial circuit including L_2 is tuned to a certain frequency. Then, by the well-known heterodyne method you tune the circuit on the left to a slightly different frequency. According to Fessenden's statement the difference of the electrostatic attraction between the diaphragm D and the other portion of the telephone set up by the beats will give you the necessary musical note. Fig. 6 shows another method in which you have a differentially wound telephone which would function in the same way. Fig. 7 shows a form with an iron core. I should not imagine the iron core one would be very efficient on radio frequencies. Fig. 8 shows what appears to be the most practical method of all, with a crystal to rectify the L.F. currents.

Owing to the great difficulty in obtaining a source of high frequency current which was perfectly constant in frequency the heterodyne

method was not much used in pre-valve days. Arcs could be used, of course, for this purpose, but they sent the received note up and down in a distressing fashion. For some time after this tikkers were still used particularly with the arc as

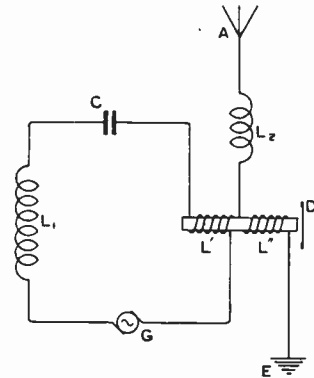

Fig. 7.

developed in the United States. I understand that for many years the Federal Company used the rubbing contact form, with a wire rubbing on the edge of a smooth wheel without any segments. It proved, I believe, one of the most efficient types of C.W. detector in its days.

The next device (Fig. 9) was the Goldschmidt tone wheel.* This was really a development of

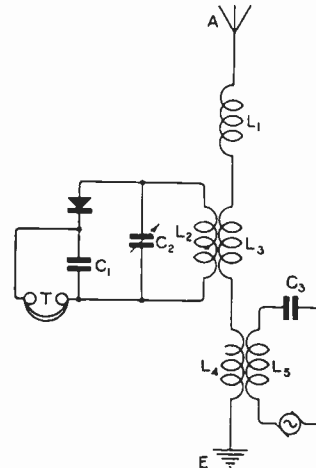

Fig. 8.

the tikker. If we run a rotating tikker at a speed high enough to make and break the circuit at the same frequency as the high frequency current we wish to detect, we can discharge the condenser in the receiving circuit every time it is charged

*AUTHOR'S NOTE.—There are two forms of tone-wheel. In one form a commutator is used which rectifies both halves of the waves received. This form is shown in Fig. 9, the two brushes B_1 and B_2 of which bear on different halves of the commutator. In the other form (that mentioned in the paper), the wheel is simply a high speed interrupter making and breaking the current at a speed approximating to that of the alternations.

THE RECEPTION OF C.W. WITHOUT VALVES

(say) positively. If then we run the tikker synchronously we shall get a perfectly rectified current or rather a series of pulses which will be in effect a steady current. If, however, we run our tikker at a slightly lower or higher speed the charge when "tapped" will first be positive at (say) the highest point of potential, then the next make will be at slightly lower potential, then after a few more "makes" the receiving condenser will be tapped at the "neutral" point.

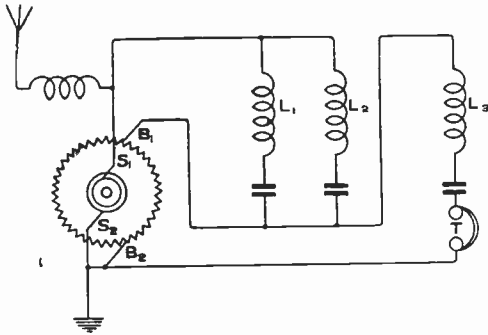

Fig. 9.

After this the condenser will be discharged when slightly negative and so on until it is discharged at the point of maximum negative potential. The result will be a "beat" similar to the note given by the heterodyne. The mechanical side of the Goldschmidt tone wheel wants a little attention if it is to run at a very high speed, but as we seem gradually to be increasing the wavelengths of our wireless stations—I do not suppose it will be very long before we go beyond the 30,000 metre point—and the frequencies will be correspondingly lower. It is not difficult to construct a tone wheel with a little motor running at 3,000 revs. per minute. If you take a frequency of 20,000 a second and a motor running at 3,000 revs. a minute you will need 400 segments on the wheel—not a very large number. It is rather a tricky device to run, but not unpractical, and a skilful amateur should be able to make one.

There is a further method of receiving C.W. which has been developed in this country and also in the United States. It consists of making the receiving condenser variable by rotation at a fair speed. The moving plates of the ordinary vane rotary condenser are attached to the shaft of the motor and run at (say) 300 or 400 revolutions a second. The capacity is thus varied at this frequency.

There is one more buzzer method of some interest giving a pleasing musical note.

The circuit is shown in Fig. 10. It consists of the well-known Marconi Balanced Crystal Receiver to which is connected a circuit consisting of L_3 , C_1 , C_2 , C_3 and C_4 energised by a circuit L_3' consisting of an inductance and condenser oscillated by a buzzer. The potentiometers of the two crystals

are adjusted so that only strong signals affect the receiver. Let us now operate the buzzer. Each interruption of the buzzer oscillates the circuit B, and each oscillation acting through J affects both

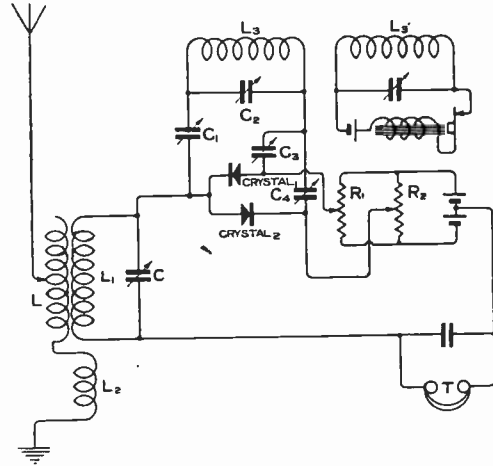

Fig. 10.

crystals and allows a pulse of current to pass from the condenser C to the telephones. If now the frequency of the circuit L_3' is adjusted to be slightly different from the incoming frequency of the signals, then the crystals will be "opened" progressively from one polarity to the other of the condenser C, giving an effect similar to the Goldschmidt tone wheel. If the oscillations in the buzzer circuit are of sufficient intensity to last from one interruption to the next, a practically continuous heterodyne note will be produced in the telephones, but if they do not persist long enough there will be a combination of a buzzer note and a heterodyne note.

So far we have considered only devices which do not amplify but the greatest possibilities in the reception of C.W. without valves seem to be those in which the dynamo principle is used. The American inventor Shoemaker has used the alternator principle for low frequency amplification and the production of a musical note at the same time. His device consists of a small alternator giving a note of say 500 per second suitable for aural reception, rectified current from a crystal detector being passed through the field of the alternator. You will see from Fig. 11 that when no rectified current comes from the crystal, there will be no field current, and you would hear nothing in the telephones connected to the armature. If, however, any currents pass from the crystal rectifier to the field coils you get a musical note depending on the frequency of the alternator. Not only do you get a musical note but the received signals are considerably amplified. This device would seem to suggest many experiments for the amateur. I stated early in this paper that the valve is a very

inefficient device as regards current consumption. When you have several valves in a receiving circuit you have a very large current consumption. The total consumption in, say, a four or five valve amplifier is more than enough to drive a small motor or a small alternator and the output of such a machine need only be very small. It seems to me that you could utilise, in the case of the provin-

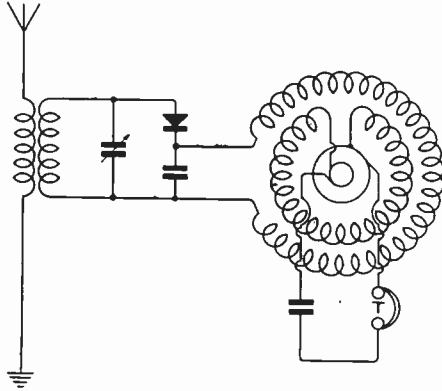

Fig. 11.

cial amateur, a clockwork device. You could use some form driven by a clockwork device such as was provided in the old magnetic detector and I have no reason to think that amplification by the dynamo principle may not reach a much higher state of perfection than has been reached by the valve. Although I have not been able to trace the number of the patent I know a certain amount of work has been done utilising the dynamo principle for high frequency amplification. There also appear to be possibilities in the use of a disc dynamo similar to the motor used in certain electric light meters.

The devices I have mentioned indicate there is a very wide field to be explored by the amateur in C.W. reception without valves. It would appear to be by no means impossible to get a much higher efficiency than we can at present obtain with valves. The best of valves have a short life and are expensive, while the accumulator and high tension battery often cost more than the rest of the apparatus. Some clockwork device such as I have suggested would be much cheaper to buy and offers a line of research open to all amateurs in country districts at small expense. I have at home carried out small experiments in this way, several being very promising, which I hope at a later date to show.

Unless, of course, you get some form of heterodyne or nearly synchronous interrupter you cannot possibly get the advantages of differentiating atmospheric from signals, but it would appear to be possible to make a low frequency dynamo amplifier on the same shaft as the Goldschmidt tone wheel the total power required to resolve this at high speed being very small. However, it is quite possible that some members have experimented in reception without valves, particularly in the early

days, and the main object of my paper is to raise a little discussion on this point.

With regard to valves and to show I have no bias against them, I think you will be interested in a three-valve amplifier I have constructed. Some months ago we all listened with great pleasure to a paper by Mr. Campbell Swinton on the construction of a six-valve amplifier. Immediately afterwards I decided to build such an amplifier but having no workshop facilities I was debarred from manufacturing the interchangeable transformers described. When later on I found you could purchase them I went into the matter again, but when I saw how high the prices were I changed my design and decided to see what could be done with the construction of a three-valve amplifier with one high frequency, one low frequency and a detector valve. An examination of various catalogues showed that the component parts were all available. Every part of the amplifier I have on the table was purchased new with the exception of a telephone transformer of the army type, a telephone condenser, and an empty Mark III case. The high frequency transformer is of Mr. Sullivan's design as advertised in the technical press, the low frequency transformer is of the Federal type, while the detector valve functions with a grid leak and condenser. I have several separate filament resistances for each valve, I am using different types of valve and can adjust each valve to the best point. The particular feature of the amplifier is not that it is better than the best commercial apparatus but that the cost is much lower. The whole amplifier costs less than £10 and those members who have any component parts by them can save that proportion of the cost. The whole of my receiving apparatus is on the table. It consists of a Mark III tuner, converted as described by Mr. Coursey in *The Wireless World* so that the A.T.C. can be placed either in series or in parallel, and with terminals fitted for extra inductances.

You will see I am using Duolaterally wound coils for tuning and reaction. They are mounted on the back of the Mark III tuner in a three-coil mounting. With these additional coils I can get wavelengths up to Bordeaux quite easily. On the top of the amplifier are ordinary American battery switches connected so that the high frequency valve and the detector valve, the detector valve and the note magnifier or all three valves together can be used. I shall be pleased to show the amplifier after the lecture to anyone who cares to see it, and to give you an idea of the strength of signals obtainable I will connect the instrument to a loud speaker. (*A Demonstration of the Amplifier was here given.*)

With this receiver with Duolateral coils and the three valves working I have no difficulty in hearing most of the American high power stations on the standard G.P.O. aerial. I have frequently heard New Brunswick, New York Central, Tuckerton, Annapolis and Marion stations. The advantages of the small aerial are, of course, that you do not get the atmospheric to the same extent as on the larger aerials. The Dutch concert is audible on two valves. That, gentlemen, completes my

THE RECEPTION OF C.W. WITHOUT VALVES

remarks and I shall be delighted to hear any other member's experiences in the reception of short waves without valves.

DISCUSSION.

Mr. A. A. Campbell Swinton.

We must thank Mr. Harris for drawing our attention to other matters besides valves. I think it is very likely true, as he says, that there is rather a tendency to neglect the other methods at the present time because the valve has produced such very wonderful results. I do not know if you are all aware that experiments are going on with valves which have no heated cathode at all, not *thermionic* valves, but *ionic* all the same: valves in which the electrodes are cold but in which a conducting atmosphere, I believe helium, is employed, and in which no grid is used. The modulation is effected electromagnetically by a coil outside the tube. I do not know if any experiments have been conducted with these valves in this country, but in America they are used, and if anybody present knows anything about the results obtained I am sure it would be of interest. There is no doubt at all that if we could have valves that did not require filaments they would last for ever and would want no filament batteries.

Helium is a very curious gas and at a suitable pressure conducts energy much better than any other gas, and I imagine that with high tension batteries of 500 or 1,000 volts, you might get an actual jump across the space through the helium which would not get across with any other kind of gas. I mention this because it is a subject of which we shall no doubt hear more before long.

Mr. Harris seemed to throw cold water and doubt on the electrostatic telephone receiver used by Fessenden. I personally made some experiments not so long ago on electrostatic telephones. These consisted of nothing but two sheets of metal which you have to charge up to a potential of some hundreds of volts. For best results I put in between the plates a piece of chamois leather. You glue the chamois leather to one of the two plates. You get quite good signals which are extraordinarily distinct. You cannot hear speech at a distance but if you hold the instrument to your ear you get quite good signals. It has one advantage in that you do not get the terrible noises from atmospheric and other causes which are sometimes enough to break one's ear drums.

Mr. C. F. Phillips.

With regard to the question of whether it be desirable to undertake research into the reception of C.W. signals without valves, it seems worth continuing that line of research only if there appears any likelihood of getting better results from things other than the present valve, or even perhaps of some new valve of completely different design. All thermionic valves possess two enormous points of advantage over any mechanical apparatus whatsoever, which I do not think the lecturer has touched upon. The first is the complete absence of inertia; every type of buzzer, tikker, tone wheel or alternator suffers from a large amount of inertia inherent to the apparatus itself and that inertia has to be compensated

for by extra power supplied to the apparatus to drive it; that extra power might just as well be put into a valve in the form of filament current. The second thing is that very valuable property possessed by all thermionic valves, which we term negative resistance; resistance, which occasions damping, is certainly not required and, in fact, it is much to be deprecated that any unnecessary resistance should be introduced in wireless receiving circuits: when you utilise a valve in a suitably arranged regenerative circuit you can neutralise practically the whole of the resistance (or damping) in that circuit, the energy for such neutralisation being supplied by the plate battery and being of the order of 1 milliampere or so.

The lecturer has assumed that most receiving valves need 2 or 3 watts heating current for the filament, but a series of valves has been manufactured which require from 0.09 to 0.3 watts to heat the filaments. These valves are known as "SR Valves" and are made by the Marconi-Osram Valve Company; I understand that if they are not actually on the market they will be very shortly. One pattern operates on $1\frac{1}{2}$ volts 0.06 amps. (0.09 watts), another on 3.2 volts 0.1 amps. (0.32 watts): currents of this order can be drawn comfortably from large dry cells, and if the voltage does drop a little one has only to turn up the filament rheostat! These valves are no worse than the standard R type of valve, they operate on normal plate battery voltages, say 30 to 70 volts, they are hard and very stable, and may be used as detectors, oscillators, and R.F. and L.F. amplifiers.

As regards the cold electrode valve mentioned by Mr. Campbell Swinton, this valve has been produced in the States and is known, I believe, as the "S Tube": it has not been found very good for reception, that seems to be merely a matter of further experiment, but it has been extraordinarily successful as a rectifier; it has some disadvantages when compared with the Kenotron type of rectifier, one of which is that there is drop of potential across the valve of the order of 200 volts, and also a critically adjusted external magnetic field has to be provided. As against those disadvantages it has no filament whatsoever, and a little valve about 7 ins. long and $1\frac{1}{2}$ ins. in diameter, with perfectly cold electrodes will deliver up to 1 kilowatt of rectified current.

The lecturer has referred to the probability of wavelengths going up in the future. Bordeaux, the longest wave station now operating, is 23,450 metres. I do not agree that the tendency is upwards: the frequency of Bordeaux is 12,800 per second which is getting very close to audibility, and once one arrives at audible frequency interference will make the high power working of a number of stations impossible. I think that the chief reason why extra long wavelengths were decided upon for these powerful stations was the expense or even impracticability of building powerful Goldschmidt or Bethenod alternators of a higher frequency than 15,000 or 20,000. Now that Marconi has shown us that it is quite possible to get very large powers, even of the order of 500 kW out of banks of valves, alternators may

be superseded, and as the higher frequencies do not trouble valves, there will no longer be any need for wavelengths to go up. It is surely preferable for them to come down, perhaps right down to the order of 100 to 300 metres, so that more wavelengths can be allotted without fear of interference.

However, I think we ought to thank Mr. Harris very much for directing our attention to subjects which, although they may not prove to be of importance to research, are of undoubted interest to amateurs.

Mr. R. E. H. Carpenter.

I do not think I have anything to add except to say I quite agree with Mr. Phillips with regard to the tendency to reduce rather than increase the wavelengths. There are two chief considerations, the first is with regard to the aerial efficiency and the second is with regard to reducing atmospherics. Captain Turner has shown in a very interesting paper in the *Radio Review* that as the wavelengths increase so the ratio of atmospheric to signal strength gets considerably worse and this seems a powerful argument for the reduction rather than the increase of wavelengths in the near future.

Capt. Donisthorpe.

I have nothing to add to what has already been said except to say that the rotating condenser arrangement mentioned by Mr. Harris gives quite satisfactory results. The note you get is rather a low one and makes a breathing sound.

Admiral Sir Henry Jackson.

I congratulate the lecturer on bringing certain points to our notice and there is no doubt that doing away with batteries may be of importance to explorers and those who if they want to use wireless have to employ a petrol motor or something of the kind. If they can have an arrangement like this dynamo that the author speaks about it might be very useful indeed for exploring parties, and I hope he continues researches in that direction and gives us his results. I think it is an interesting paper and I do not want to criticise the other parts.

Mr. G. G. Blake.

With regard to the dynamo tikker, the tikker where amplification was suggested on a dynamo principle, I think the greatest difficulty would be experienced in having to produce an electromagnetic field dependent entirely on the signals. The signal strength would be so weak that it would be difficult to get speech in any intensity at all. Adding an iron core to the field would absorb an appreciable current and probably damp out all the signals coming in.

Regarding the cold electrode valve, I wonder whether radium or radio active substance has ever been tried in place of the filament.

Mr. H. S. Walker.

I should be glad if the lecturer would give us a little more information on the reception of C.W. employing a gramophone. I did not quite follow how the incoming oscillations were rectified by the gramophone.

Mr. R. H. Klein.

I should like to know whether the dynamo

principle was used as a detector as well. I was not quite clear on that point. Also how the lecturer proposes to pass the signals received from one dynamo machine to another for the purpose of amplification or whether he considers sufficient amplification would be obtainable from one machine.

Mr. A. A. Campbell Swinton.

I can myself answer the gentleman with regard to radium. I believe it was suggested some years ago, but I do not think it is practical. As a matter of fact I myself read a paper before the Physical Society, something like 20 years ago, before valves were thought of, in which I showed that if you had two heated filaments, one of which was coated with radium and one of which was not, you could get an actual visible glow discharge from the one that was coated with radium with a lower voltage than the one that was not coated with radium. The number of electrons given out by radium are so small that I do not think its use practical from the point of view of making ionic valves.

If nobody else wishes to ask any questions I will ask Mr. Harris to reply to the discussion.

Mr. P. W. Harris.

On the point of the cold valve, I had myself heard that certain work was being done and if, as Mr. Campbell Swinton and Admiral Jackson said, we can do away with accumulators, we shall be taking a big step in advance.

My point regarding the electrostatic telephone was that in the particular circuit shown and at the point where it occurred in the circuit the arrangement was not such as would appear to give efficiency. I know excellent results have been obtained with other electrostatic telephones.

Mr. Phillips' point regarding the absence of inertia in the valve I apologise for not mentioning. It is an important point. As regards the negative resistance question I do not think we should be unable to obtain the equivalent from some other device, for if in an amplifier you feed back some of the energy you should obtain the equivalent by lessening the damping in the previous circuit. Mr. Phillips also mentioned the new Marconi-Osram valve. These valves are not yet on the market so far as I know or at least not in quantities. They also mark a step in advance. If you reduce the current consumption to a tenth of its present value the valve is still very inefficient and it does not exactly answer the point to say (I am not suggesting Mr. Phillips said so) that we can neglect other lines of research which are likely to be productive of good result in view of the fact that the valve is improving. In the past the coherers were by no means fully explored before crystal detectors came into use, and even to-day I am not sure that anyone knows exactly how the magnetic detector works—certainly Professor Wilson does not, judging from a conversation I had with him. I think we should always be looking for new lines of research, whether or not we have finished the particular line of research we are on. I must thank Mr. Phillips for his remarks on the point regarding long waves. What I meant to say was that since the first forms of tikker were used, particularly since Goldschmidt brought out his tone wheel,

THE RECEPTION OF C.W. WITHOUT VALVES

wavelengths have greatly increased. The excellent results given by the recent Transatlantic Tests show that you can get good results on short wavelengths and on these aerial efficiency is particularly high.

I was very interested to hear that Capt. Donisthorpe has used the rotating condenser. Shoemaker's U.S.A. patent is No. 1241565 of 1917.

Certainly there seems something in Mr. G. G. Blake's point regarding the residual field if you use the iron core.

One speaker asked a question regarding the use of gramophones. The gramophone merely serves as a convenient form of clockwork and you

have in the turntable a convenient metal disc, usually with a bare edge, to take the place of the rotating disc which I mentioned earlier in the paper. It is a simple means of trying a tikker where no current is available. The trouble with buzzing tikkers is not only induction but also the little difficulties of adjustment. They are also rather noisy, and if you want to do work on quiet signals you have to muffle the buzzer considerably.

The dynamo principle as described by Shoemaker utilised a crystal detector. The circuit is the ordinary form of crystal circuit and the field circuit of the alternator is connected in place of the telephones.

TRANSMISSION OF CALIBRATED WAVES FROM AIR MINISTRY WIRELESS STATION

The Air Ministry Wireless Station, London, will, from the 10th of January, 1922, transmit a series of calibrated waves daily at the times shown below:—

Time GMT	Wave-length (C. W.)	Call signs.	Signal.	Correction.
0745	1400	CQ v GFA	A series of figures 1 (● — — —) for 30 seconds followed by a single dash (—) lasting 5 seconds.	Immediately following the 5 second dash any necessary correction will be transmitted as follows:—
0750	1680	CQ v GFA	A series of figures 2 (● ● — —) for 30 seconds followed by a single dash (—) lasting 5 seconds.	<i>Indicating figure for the wave (i.e., "1" "2" BT followed by a 4-figure group indicating the actual wavelength transmitted.</i>
0753	900	CQ v GFA	A series of figures 3 (● ● ● —) for 30 seconds followed by a single dash (—) lasting 5 seconds.	If no correction is necessary \overline{VA} will be made after the 5 second dash.

Book Review

WIRELESS TELEGRAPHY, WITH SPECIAL REFERENCE TO THE QUENCHED-SPARK SYSTEM. By Bernard Leggett, A.M.I.E.E. (London: 1921, Chapman & Hall, Ltd., D.U. Technical Series, 11, Henrietta Street, W.C.2. pp. 485 + xv. 8½" x 5½". Price, 30s. net.)

This book, in fifteen chapters, was written, as its subtitle implies, to deal almost exclusively with the Quenched-Spark system of Wireless Telegraphy, but the author has, however, written an interesting though incomplete review of the progress and development, theoretical and practical, of wireless telegraphy generally. Literature on the Quenched-Spark system, as the author remarks in his preface, has been singularly lacking in this country, owing no doubt to a prejudice of its origin in Germany. A foreword in the shape of an extract from the *Electrician** throws rather a slur on British inventiveness in wireless. It is to be hoped, however, that the situation is not quite so bad as the writer would have us believe!

An interesting resumé of the birth and progress of wireless dating back to 1838, when K. A. Steinheil utilised the earth return in line telegraphy and predicted the possibility of telegraphy without the use of even a single wire. The beginning of the introductory chapter and the inclusion therein of a summary of the activities of the Berne International Bureau, is of considerable interest. The remainder of this chapter is taken up with a comparison of the relative merits of the Quenched-Spark over other systems, and the impression made on the reader is either that the author is strongly biased in his views or not very well informed on systems other

than the particular one in which he is personally interested.

A chapter is given up to the Theory of Quenched-Spark transmission, followed by a chapter each on the Transmitting and Receiving Apparatus and accessory apparatus, after which the author deals successively with the progress and application of both Wireless Telegraphy and Telephony in an able and interesting manner.

Of particular interest to those who had to deal with the application of Wireless Telegraphy and Telephony during the war are the chapters on wireless telegraphy in warfare and aeronautics. So little has been published on this subject that it is with considerable interest and pleasure that one gets a glimpse behind the veil of official secrecy and red tape.

Throughout, the author has consistently made out a good case for the Quenched-Spark system in comparison with other—perhaps from his point of view rival—systems, and the illustrations being for the most part of the former system, it must be borne in mind that this is the *raison d'être* of the book.

A useful feature of the book is an extensive and detailed reference bibliography appended to most of the chapters. From beginning to end the book is very fully illustrated. There is, however, as is general with wireless literature at the present time, a lack of standardisation in the symbols explaining the various circuit diagrams.

This book should prove a valuable edition to the D.U. Technical Series, and both the Author and Publisher are to be congratulated on its production.

**Electrician*, Editorial, p. 228, 21/12/19.

Transatlantic Tests

MR. PAUL F. GODLEY'S OWN ACCOUNT OF HIS EXPERIENCES

AT the time this is written there are some 30 or 40 American amateurs in an exceedingly pleasant frame of mind because of the fact that it has finally been possible for them to accomplish something about which they have been dreaming for years, viz., the "pushing" of their small power signals across the some 3,000 odd miles which separates them from their British cousins.

INAUGURATION OF THE TESTS.

The chain of events spreading over something like a year which led directly to the Transatlantic Transmission Tests just finished, are more or less familiar to all readers of *The Wireless World* and will not be reviewed here. But it would no doubt be of interest to recount briefly the following facts:— That the American Radio Relay League which represents American amateur thought with regard to long distance operation held their first National Convention in Chicago during September of this year; that delegates from all sections of the United States were present, some of them having travelled 2,000 miles; that there was a total attendance at [this Convention of something like 1,800 delegates and that the numbers who viewed the radio equipment on exhibition in one of Chicago's largest showplaces ran into thousands. This Convention covered a period of five days during which time business meetings, technical meetings and meetings open for general discussion had very full programmes. Needless to say there was a great deal of "rag chewing" regarding this, that and the other thing and the Transatlantic Tests of last February no doubt came up for their share of the discussion. Considerable speculation was rife at this time as to whether the failure of the previous Tests lay with British equipment, the British amateur's lack of knowledge concerning short wave operation, or whether the British amateurs were totally ineligible to the "order of the boiled owl," and finally in Executive Session the Board of Direction of the American Radio Relay League decided it would be a good plan to delegate some American amateur to proceed to Britain for the period of the Transatlantic Tests, which had already been arranged to take place during the latter part of this year. In making this decision they were firmly convinced that if the Tests failed the question would be settled once and for all, as to whether it was possible to get their small signals across

the Atlantic and that the sending of an amateur to England from America would create vastly more enthusiasm for the Tests on the part of the British amateurs than any other procedure possible.

SELECTION OF A U.S. AMATEUR FOR ENGLAND.

Although on the programme of events at the National Convention above-mentioned, it was impossible for me to attend owing to illness, and I was greatly surprised to receive a request from the Board of Direction of the Relay League asking me to act as their representative in England during these Tests. I was not in the least hesitant about accepting and immediately began to look forward to some very interesting and pleasant experiences and to make preparations in the way of getting out my old gear of one sort and another, in order that it might be well "tuned up" for the job. American amateurs with the better transmitters were also busily engaged getting their outfits into ship-shape condition and at this time a great many strange and amusing conversations reached my ears.

PRELIMINARY TESTS IN AMERICA.

The preliminary tests which were designed to eliminate those stations which lacked proper signalling range have been previously described, in brief at least, in various publications. Needless to say during these tests I did a great deal of listening and got my first thrill as I heard district after district from one end of the land to the other come in on their transmission schedules with clock-like precision, and realised the tremendous enthusiasm which was swaying the radio experimenter in the United States. During these initial Tests the star station upon which I worked was SZA located in Roswell, New Mexico, some 1,500 miles overland, which seemed to be working more or less consistently on 325 metres and who performed many rather interesting and encouraging "stunts" for me, among which was the operation of relays, telegraph sounders, etc. The interference at all times on most amateur wavelengths is such that it is rather difficult to get signals from extreme distances, so that even at the time of sailing there was no definite assurance at all that it would be possible to complete successfully the mission on which I was setting out. Plans were made to arrange test apparatus on board the *Aquitania* on which vessel I sailed, but were given up entirely after I had witnessed the volume of traffic which



Mr. Paul F. Godley.

TRANSATLANTIC TESTS

the *Aquitania's* men were called upon to handle.

ARRIVAL IN ENGLAND.

And so, after a six day voyage I landed in England in an alternately confident and panicky mental state. I began to meet the various notables in and around London. I consider it of extreme fortune that it was possible for me to attend the meeting of the Wireless Society of London and later to hear Dr. Fleming's remarkable lecture at the Royal Society of Arts on the evening of my first day and to meet and chat with such men as Senator Marconi, Admiral Sir Henry Jackson, President Elect of the Wireless Society of London, Mr. Campbell Swinton, Past President of the Wireless Society of London, Prof. G. W. O. Howe, and Mr. E. H. Shaughnessy of the Wireless Section, G.P.O., Mr. F. Hope-Jones, Chairman of the Wireless Society of London, and many others. At about this time it began to dawn on me that I was getting many times more attention than I had expected; as far as I could see British hospitality had been by no means sufficiently well advertised; and that I was not to have nearly enough time to talk with all the various men in and around London with whom I decided that I wished to talk. I also gathered from the sly glances here and there that the majority of the British amateurs had been unable to decide at that time whether I was a plain "nut," to use American parlance, or whether I really was confident of my ability to get signals, and I understand since that I was not far wrong.

PRELIMINARY TESTS AT WEMBLEY.

Preliminary arrangements for operation permit, etc., having been completed, initial tests with the equipment which I brought with me were instituted at the station of Mr. Frank Phillips at Wembley Park, and after four or five nights, ending usually about 4.30 in the morning I was greatly discouraged on account of the presence of vast numbers of harmonics from single circuit tube transmitters and the Poulsen arc, as well as by the strange actions of atmospherics—atmospheric conditions of a type which I had never before encountered. During the winter time in America atmospherics are at a minimum and quite uniform in their habits and, altogether, rather considerate. At Wembley Park I found them suddenly increasing during certain short periods of the night and suddenly decreasing to appear again in another quarter and in a new form. Five nights of this sort of thing was quite enough and I came to the firm conclusion that the vicinity of London, even Southern England for that matter, was no place for me, and immediately arranged to proceed to Scotland, having previously chosen Ardrossan as a location, providing conditions near London did not warrant location there.

DEPARTURE FOR SCOTLAND.

Immediately this decision became known wild tales of all sorts began to pour in as to the terrible Scotch climate—the rains, the mists, the chill temperatures, to say nothing of the resulting ill effects which I was assured one would most certainly be unable to dodge. Even taking all of this with a good bit of salt, I was not sure that I

looked forward to the trip into the Scotch "wilds" with any particular pleasure, particularly in view of the fact that even after having been in England a week I had been unable to find a sufficiently warm spot, and I understand that various honourable gentlemen who extended their hospitality are still complaining considerably as to the size of their gas bills. I can only say that I have no apologies to make.

The trip from London to Ardrossan was made *via* Aberdeen and Glasgow—Aberdeen having been included in order that I might get first hand information concerning the reception of radio telephone transmissions from America last year. On arriving in Glasgow I find myself in great fortune because there I meet Messrs. Sutherland and Carswell of the Marconi International Marine Communication Co., Ltd., who as far as results were concerned, seem to own and operate the better part of Scotland, for, everything which I seemed to require in the way of material and equipment, accessories and assistance were produced in a very magic fashion with a minimum of delay and I found myself transplanted to Ardrossan with Mr. Wood, Town Clerk, the Police Sergeant, and several other worthy citizens enlisted in my cause, the result being that only a few hours after reaching Ardrossan the tent in which the work was done was going up and the equipment for the antenna being distributed over the ground (of course one must admit that the unusual efforts on the part of these Scotch people were quite in order. It takes a great deal to offset the effects of Scotland's December weather.)

Mr. D. E. Pearson, Inspector of the Marconi International Marine Communication Co., Ltd., assisted me throughout the tests and I have a great respect for his ability as an operator, and for the courage—courage is the word—which he displayed in sitting up night after night in a leaky tent with high winds blowing and heavy rains falling—nothing but an occasional "wee drap" and a more or less unreliable three-ha-penny oil stove to keep him warm.

LOCATION OF A SITE AND SELECTION OF STATION.

After spending several hours in an attempt to locate a site on the beach which was fairly suitable to our purpose the attempt was finally given up and a site chosen in a grass covered field which had been freely treated with a sprinkling of seaweed. Darkness was approaching when the erection of the tent began. Heavy rain was falling and a decidedly disagreeable gusty wind blowing. About the time we thought our tent was well up a gust of wind came along, caught it, and wrecked the entire structure, boxes, gear and one man underneath. This was my first taste of Scotch weather and being wet to the skin the misfortune discouraged further attempt at work that night (December 6th.) Pearson took advantage of the decision, and went to Glasgow to get a supply of dry clothing, whereas I proceeded to the hotel and after having had what seemed to me to be a very scanty feed, not being used to Scotland's high teas, I rigged up a small low temperature Western electric tube, fed both filament and anode from small dry batteries,

threw a wire about 60 ft. in length into the top of a neighbouring tree, grounded to the gaspipe and with various odd pieces of apparatus which had still to be transferred to the scene of operations, I listened to ships signals and the very healthy static. The static was what worried me and I spent a rather restless night freely punctuated with dreams concerning the wonderful signals which I was *not* getting.

The following day, having enlisted additional labour, things were going in proper style, a line was laid out something under 1,300 ft. in length and 10 poles equally separated were planted, each pole being 12 ft. above ground and carrying a standard B.P.O. pattern insulator. A phosphor bronze wire was then run the entire length of the line and grounded through a variable non-inductive resistance, the ground plate itself taking the form of several short lengths of iron piping buried some 6 ft. in the earth at which depth we found the hole filled with water. In the meantime the tent had been erected, the side walls put on and a few floor boards spread underneath. A table was made from two trestles and four lengths of rough-sawed pine. The gear was unpacked carefully wiped free of water, of which all held plenty, and next given a general "once over" for broken or misplaced parts. A second bundle of iron piping was thrown into the "burn" which ran directly at the back of the tent and just over a stone wall. Again darkness had fallen it being nearly 6 p.m. and again we returned to Ardrossan about 1½ mile distant through the rain to get a bit of food and some rest before tackling the night's job, and this having been effected we found ourselves again in the 12 ft. by 18 ft. tent having brought with us sandwiches and coffee.

Without single exception all valves, accessories and gear were found to be in first-class condition, nothing broken, nothing out of order which was quite contrary to what I expected. By 11.30 p.m. the 3,000 metre amplifier was going and FL (Paris) was picked up with no antenna connections. In completing our setting up Paris time signals were missed but POZ (Nauen) served as a check on our timepieces at midnight. After time signals a short piece of wire was thrown into a tree for use in adjusting to short wavelengths and it was only a matter of moments before we were listening to a bedlam of 600 metre stations which were used for preliminary adjustment of all gearing for maximum sensitivity. By 1 a.m. we were feeling for short wave signals and picking up harmonics from what proved to be Poldhu spark as well as many other high power C.W. stations, although the harmonics were decidedly less severe than near London excepting that of Clifden (Ireland) which was very strong and later proved to be quite bothersome.

SOME PERSONAL IMPRESSIONS.

The things which have impressed me most as a result of my visit to the British Isles are chronologically, first, the unusual and totally unexpected efforts on the part of British radio men to assist me in every way. This not only applies to amateur wireless circles but to commercial and government circles as well. Messrs. Bradfield and Allen, joint managers of Marconi's

Wireless Telegraph Company, Ltd., have shown particular favour in smoothing the way for me everywhere, by the offer of assistance and equipment of every imaginable kind. Mr. Otto Rochs, traffic manager of the above-mentioned Company, has taken a particularly keen interest in the programme, and has been most untiring in his efforts to do all within his power to ensure a successful daily report reaching American amateurs, and it develops that these reports went gratis. Mr. H. J. Round and his staff extended every courtesy during a visit to Chelmsford, offering any information or equipment at their disposal, while Mr. W. K. Wissenden and other officials of the British Post Office, have been exceedingly kind in going considerably out of their way in order that these experiments may be carried out with true American freedom. Needless to say members of the amateur fraternity have given a great deal of their time and have gone to considerable expense in order that we might be successful, and nothing has pleased me more than to note the real interest taken in the project by all British amateurs whom I have met and I am keenly appreciative of the many courtesies extended to American amateurs through myself, such as the memorable little informal dinner to which I was invited on the evening of the day of my arrival.

Second; the most discouraging conditions under which (from the American point of view) British amateurs are forced to work. By this I mean their confinement to a power (input) of 10 watts and the illegality (as I understand it) of any exchange of communication relative to things which have no connection with any "tests" which are being carried out; and the great number of harmonics which fly around from various European stations. Of the 600 metre stations, FFU and FFH are particularly bothersome both in the vicinity of London and further north. Harmonics from the single circuit valve transmitter at Devizes are also numerous. The "hash" from Leafeild's arc renders many small bands of waves totally useless; Poldhu is also a serious offender by re-radiation on about 225 metres, while all of the ships which carry the valve sets have harmonics swinging in and out as they work on their 2,000 odd metre wave. Clifden, and Eiffel Tower and several other arc stations which I was unable to identify were also bothersome in all localities where I listened, but the worst offender of the lot was some C.W. station which transmits high speed and from which I counted up to the 39th harmonic.

Third; that although British amateurs seem to have been given the choice between a 180 metre wave and 1,000 metre wave, they have chosen the latter. To anyone who studies the matter it must be quite apparent that antenna efficiencies on this longer wavelength are far lower than those possible on the shorter; that where restrictions impose the use of small powers it should be desirable to get a very maximum of efficiency out of every single piece of gear which goes to make up the whole; an experienced man will also remember that short waves notoriously cover far greater distances under night-time conditions (that time when the average amateur is working with his gear) than do longer wave signals.

TRANSATLANTIC TESTS.

Fourth; the greatest hospitality was shown me on every occasion during my stay in Scotland, and unexpected and flattering interest was displayed in all that we were doing while offers of assistance were endless. A very enjoyable entertainment was provided on one occasion in Scotland as a break to the monotony.

And, finally, the terrible bundles of weather which the British Weather Bureau dispenses, to say nothing of the atmospherics of which there seems to be an abundant supply.

Upon my arrival in London from Scotland I have seen some of the reports which have reached British headquarters, and they show that many British amateurs have been successful in their reception. This is very pleasing to me because at the back of all the American plans for transatlantic transmission tests lurks the fond hope that before long it will be possible for British and American amateurs to communicate successfully at more or less frequent intervals. The part which British amateurs have played in these transmission tests has accomplished far more in the way of the creation of enthusiasm for this sort of thing than any other thing could have accomplished. American amateurs—all stations—are transmitting every night, day in and day out. What British amateurs heard during the week of the tests they may hear again and again throughout the coming season, providing they listen with sufficient patience, and, what is a most significant thing, one of the stations heard

from America is a station which I know very well and which was using an output of only 20 watts which means an input of about 40. Should British amateurs be allowed the use of 50 watts input the more or less frequent interchange of signals mentioned above would be looked forward to with a deal of anticipation on both sides of the Atlantic. We in America are getting much benefit both in a business way and in the way of pleasure as a result of the liberal radio policies there. It is quite a common thing to read in the daily paper of some unusual procedure in the way of radio telephony or telegraphy, such for example as the "evening hour story for children" as broadcasted by the stations of the Westinghouse Electric and Manufacturing Company, or such as the "Wireless Church" with its 20,000 or 30,000 auditors each Sunday morning. Is it hopeless to presume that sooner or later Europe may follow with similar programmes? Most certainly it is to be expected that within the next few months many British amateurs will have reported picking up the radio-phonc concerts now being broadcasted by various medium power stations in the States. One such report has already come to hand as I leave. At any rate, American amateurs will watch British amateur progress henceforth with an interest that is far more real than it has ever been in the past. British amateurs have proven their mettle and there are many who, at this moment, are being joyously welcomed into the glorious order of the "Hard Boiled Ham."

(IN THE NEXT ISSUE A DESCRIPTION OF MR. GODLEY'S STATION WILL BE PUBLISHED, WITH PHOTOGRAPHS AND DIAGRAMS.)

A Provincial Club Set.

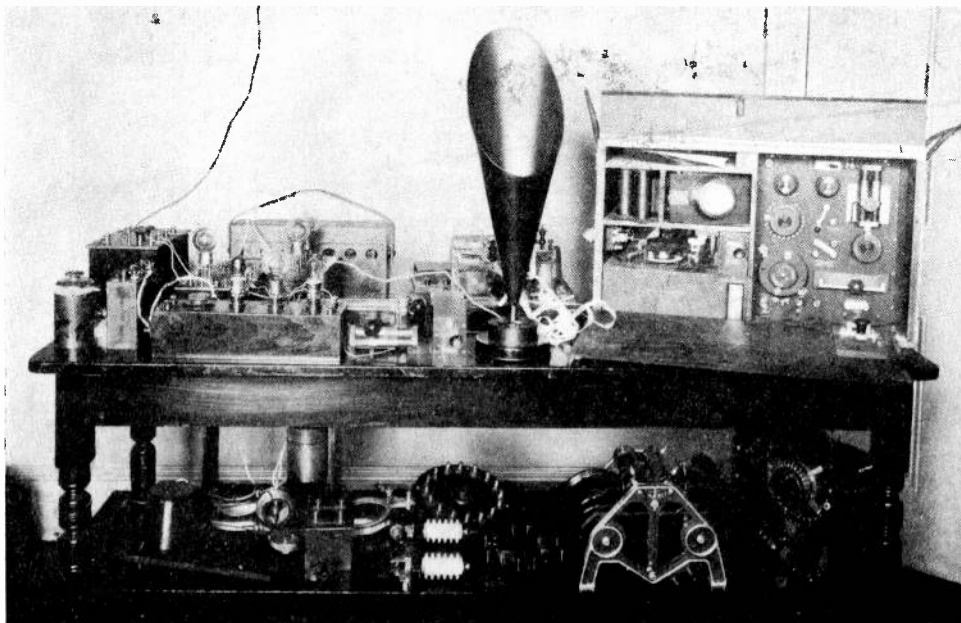

Apparatus of the Wireless Society of East Dorsetshire.

Mounting Slab Coils

A NOVEL METHOD FOR CONSTRUCTORS

THE accompanying photograph is contributed by Mr. E. T. Manley, Jr., and shows a novel and efficient method of mounting Slab Inductance Coils.

A brief note of the method of construction may be useful to those who wish to make up such

is fixed and the other hinged about $\frac{1}{2}$ in. away from the former. If desired a third holder may be mounted on the left hand side of the fixed one for coupled circuits, etc. The measurements of the frame are 4 in. by 4 in., and of the coil holders $3\frac{1}{2}$ in. by $1\frac{1}{2}$ in.

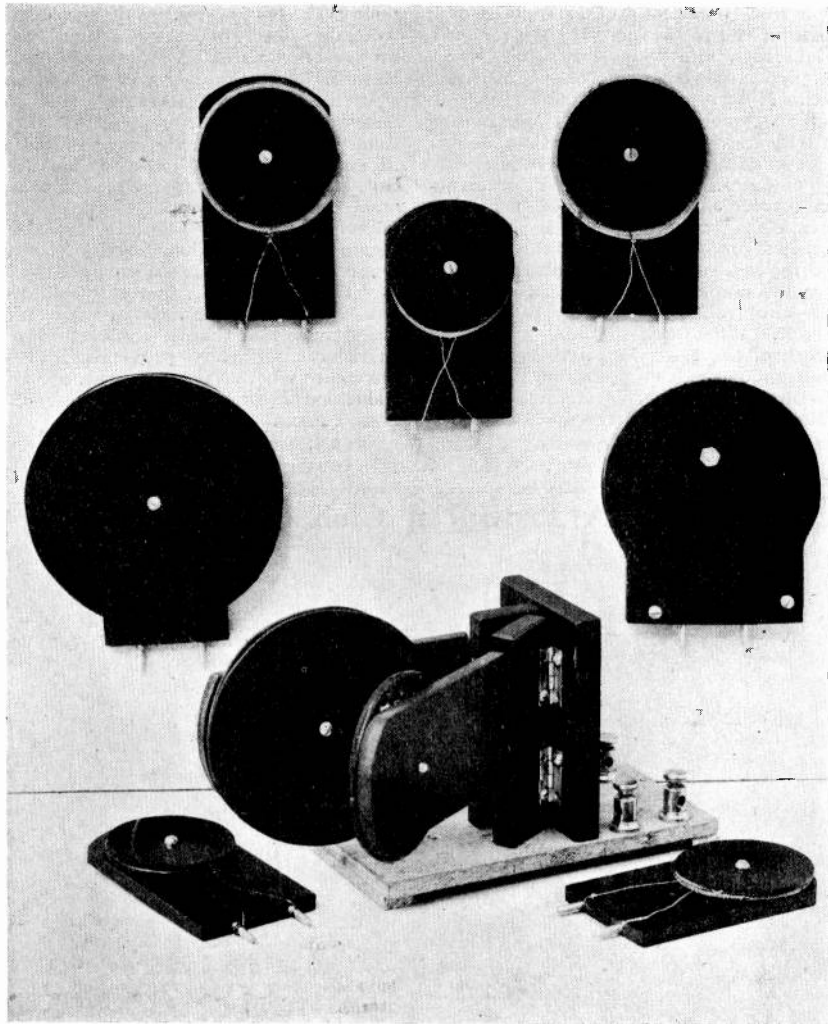

coil holders for themselves although the illustrations are sufficiently good to make the construction self-explanatory.

The frame is made from $\frac{3}{8}$ in. ebonite. The sockets are ordinary brass valve sockets let in and connections made from the back. One holder

For the coils of 2 in. diameter (or under) only one disc of ebonite was used, the ebonite holder acting as the other. In the larger coils a disc of ebonite was used on either side of the coils. The ebonite used for these discs was $\frac{1}{16}$ th in. thick.

Wireless Club Reports

NOTE.—Under this heading the Editor will be pleased to give publication to reports of the meetings of Wireless Clubs and Societies. Such reports should be submitted without covering letter in the exact form in which they are to appear and as concise as possible, the Editor reserving the right to edit and curtail the reports if necessary. The Editor will be pleased to consider for publication papers of unusual or special interest read before Societies. An Asterisk denotes affiliation with the Wireless Society of London.

Wireless Society of London.

The Annual General and 43rd Ordinary General Meeting of the Society was held on Wednesday, December 28th, 1921, at 6 p.m., at the Institution of Electrical Engineers, the President, Major J. Erskine-Murray, in the chair.

The President, opening the meeting, said :

The first business is with regard to the election of officers for the Committee next year. As there were no alternative names proposed to those put forward by the Committee I am to declare that the following are elected :—

President, Admiral of the Fleet Sir Henry B. Jackson, F.R.S. (*Applause*); *Vice-President*, Major J. Erskine-Murray, D.Sc.; *Acting Vice-Presidents*, Major Basil Binyon, and Mr. R. H. Klein; *Chairman*, Mr. Frank Hope-Jones; *Vice-Chairmen*, Mr. Maurice Child and Mr. G. P. Mair; *Committee*, Messrs. G. G. Blake, Philip R. Coursey, Joseph Josephs, J. Scott Taggart, W. H. Shortt, F. Phillips, R. E. H. Carpenter and Major H. Hamilton. Other officers remaining as for the past year.

These are in office for next year. There are no other proposals to make this evening.

The Annual Conference of Affiliated Wireless Societies will take place on Wednesday, January 25th, at 2.30 p.m., in this hall. Invitation tickets will be issued later. The Annual Dinner is on the same day at 6.45 p.m. Will all members and friends desirous of attending the Dinner kindly make application to the Secretary, Mr. L. McMichael, before January 15th. Tickets are 10s. 6d. each. Ladies are cordially invited.

The Presidential Address will also be given on January 25th at 8 p.m. January 25th will be a very busy day.

The next thing is to ask Mr. Hope-Jones to read you the Petition. Although on our own account we have been doing our best to increase facilities for wireless amateurs, we are very glad to have now, through this suggestion, amalgamated practically the whole of the Wireless Societies of this country, some three or four thousand people, in one joint Petition which it is proposed to send to the Postmaster-General. Beyond that I think I will leave it to Mr. Hope-Jones to give you full information.

Mr. F. Hope-Jones.

I think it is within your knowledge that our affiliated Societies, not merely in the north, but in the provinces generally, have felt very dissatisfied with the slow progress made by us in the matter of obtaining the necessary sanction for regular wireless transmissions. They naturally looked to us to carry on the negotiations on the basis of the request that originated at the Annual Conference of February this year. For some nine months we have been prosecuting these negotiations with the Post Office with a view to establishing weekly programmes of transmissions of high power calibration waves, wireless telegraphy and particularly

telephony, and those negotiations, of course, the Provincial Societies were unaware of. We cannot possibly keep them fully informed as to our methods of procedure in the endeavour to get what we want. It is not therefore to be surprised that they felt a little dissatisfied and wondered what we were doing. We understood their feelings when we organised this Petition which it is proposed to present to the Postmaster-General to-morrow. It is complete and I trust that most of you will be able to glance through it. The Petition is signed already by 65 Wireless Societies representing in all upwards of 3,300 radio-telegraphists in Great Britain. The wording of the document for signature is simply this "forwarded on behalf of" (in this case it is signed by the Halifax Wireless Society) so and so President, so and so Secretary. There are only 20 other Societies who are known to us or to the Editor of *The Wireless World*. It must not be assumed for one moment that these other 20 Societies would not associate themselves with us, but I think we may take it that they are mostly small Societies and Scholastic bodies, schools or colleges and are therefore in vacation at the present time and could not respond to the request for their signatures. I think you will remember that at our February Conference we were informed officially by St. Martin's-le-Grand that there were about 4,000 licence holders, so it is perfectly obvious that this Petition is signed by practically the whole body of the amateur radio-telegraphists in this country.

I will read you the Petition :—

To

THE RT. HON. F. G. KELLAWAY, M.P.,
Postmaster-General.

SIR,

We, the undersigned, on behalf of the Wireless Society of London and of most of the other Wireless Societies of the country, representing in the aggregate a large number of citizens interested in Wireless Telegraphy, ask you to be good enough to give consideration to our views as follows.

We wish to express our thanks for the courtesy and consideration which the authorities have always shown to the amateur radio-telegraphists of this country, and to state that we fully realise the difficulties that are inherent to the carrying on of wireless operations in a small and crowded country such as our own, where stringent regulations are obviously necessary to prevent undue interference.

We also wish to express our satisfaction at the permission recently given to the Marconi Company to send special calibration signals from Chelmsford for the benefit of our members for a period of half an hour every week.

We desire, however, to express our regret that Wireless Telephony has not been included in this arrangement, and to say that we hope that this

restriction may be reconsidered either with reduced power, or perhaps on a short wavelength of 200 or 300 metres, so as not to cause interference. We would point out that it is telephony in which the majority of our members are chiefly interested at the present time, this being the most recent achievement in wireless, and that in which, for moderate distances at all events, improvements such as avoidance of distortion, and the production of really articulate loud speakers and such like, are most required.

It is therefore primarily to serve the scientific purpose of improving the receiving arrangements that we desire to have telephony included.

We would, however, also call attention to the following general considerations which, in our opinion, should not be overlooked by the authorities in dealing with the question.

It should be remembered that Wireless Telegraphy was in the first instance originated, and has since been largely developed, by men, who at any rate to begin with, were not even electrical engineers or electricians, and still less qualified telegraphists. Many of these, when they began experimenting, were in this particular line pure amateurs, though no doubt some of them gradually attained to professional proficiency. New inventions and important improvements are still being made by this class of person, and the more numerous they are the more chance there is for good and useful work to be done. In this connection it is noteworthy that it is entirely due to amateurs that all records have quite recently been broken by the successful transmission and reception of signals across the Atlantic on 200-metre waves. To attract such workers in the first instance and to keep them interested, it is necessary to make the occupation interesting and even entertaining; hence the need for wireless telephonic speech and even music. Furthermore, the requirements of the large number of such amateur users have led to the establishment of numerous factories for the manufacture of wireless instruments and apparatus, where skilled designers and workmen are employed and many experiments are carried out, and where quite important improvements in instruments and methods are constantly being effected. Were it not for the demands of numerous amateurs, such manufacturing concerns would not exist, and advance in the art would be checked.

There is also the advantage, in the case of any future wars, of the existence of a number of persons skilled in wireless.

The educational value of wireless should also not be overlooked. Just as the advent of the motor car has undoubtedly done more to disseminate a knowledge of mechanics throughout the population than all the millions of money spent annually on technical education, so also the practice of wireless is teaching to thousands the principles of electrical science and of physics, and this without any expense to the State.

That the French authorities recognise the force of these considerations is evidenced by the transmissions of speech and music that have already commenced under Government auspices from the Eiffel Tower. It is understood that it is intended

to make these a regular feature like the time signals and meteorological reports, and it will be somewhat lamentable if England, where Wireless Telegraphy originated and whose Greenwich time is the time of the world, but who sends out no wireless time signals, should again fall behind other countries by reason of failure to move with events.

We are,
Your obedient servants.

I will be glad if you will take an opportunity of looking at the Petition.

The President.

There is one other matter. I received a telegram signed by Dr. Pierre Corret, Vice-President of the Société Française d'Etude de T.S.F. congratulating British Amateurs on receiving American signals. I replied to Dr. Corret, but the address was insufficient and the telegram has been returned. If anyone knows the correct address of the Société Française d'Etude de T.S.F. I shall be very glad if they can let me have it.† In the meantime I have handed it over to the Secretary asking him to have the telegram published and I believe it will go into *The Wireless World* so that if Dr. Corret reads *The Wireless World* he will be able to understand the reason for my not replying.

I call upon Mr. Harris to read his paper on "The Reception of C.W. without Valves." and if you will excuse me I will take the opportunity of going as I have another appointment. Mr. Campbell Swinton will kindly take my place.

Mr. A. A. Campbell Swinton.

Before calling upon Mr. Harris to read his paper, he has asked me to say that unfortunately he has been disappointed in that some of the apparatus has not arrived this evening for the experimental part of his lecture. He will give his paper, but some of the experiments cannot be performed, and to fill up the gap he proposes to tell us something about the three-valve amplifier which has been put together entirely from standard parts, such as can be obtained from stock from the various dealers. I will ask Mr. Harris to read his paper.

(For full Report of the Paper and Discussion thereon see pages 652 to 659 of this issue).

At the conclusion of the Discussion the Chairman said:

I am sure you wish to accord Mr. Harris a hearty vote of thanks for his paper which was certainly an interesting contribution.

The following gentlemen who were balloted for have all been duly elected: MEMBERS—Frederick Herbert Young, Norman Robinson, Thomas Ernest Smith, Joseph Arthur Woodhams, George T. Smith Clarke.

The next meeting has already been announced for January 25th.

The meeting adjourned at 7.20 p.m.

Wireless and Experimental Association.*

The members of the Society at the Central Hall, Peckham, on December 21st, had much to say about the reception of the American Amateur Signals.

†This address was subsequently supplied and the telegram despatched.

WIRELESS CLUB REPORTS

Mr. A. E. Greenslade, a member who received them, is going to tell us how he did it.

The Wireless World tells us that Mr. Godley, the American who came over specially to show the British amateur how to receive Americanese, was successful in receiving several complete messages and parts of a great many others.

He went to Ardrossan, near Glasgow, and there erected his station with an aerial 850 ft. long, absolutely directional with America.

We, who have to pick up signals and a living in London, have to be content by official regulation with 100 ft., pointing any old way the house faces, and yet we have done it.

If legend is to be relied upon, Scotland is not the sort of place to go to pick things up, wireless signals perhaps excepted. An unsympathetic London coroner's jury returned a verdict of death from natural causes on the Scotsman who stopped to pick up a sixpence in the roadway at the Mansion House.

We are not entitled yet to claim that our man is the only Londoner to pick up those American signals, but he is the only one we know, and we behave accordingly. We feel a little bit like the child who saw an Italian workman chip a piece of coloured tessera to make it fit into the design he was working out and charged him with not playing the rules of the game.

What would we not have done with 850 ft. of aerial and a kilowatt to chase up and down it?

Cambridge University Wireless Society.*

Proceedings for the Michaelmas term, 1921.

At the Second Annual General Meeting held on October 9th the following officers were elected for the year 1921-22:—

President, Mr. E. J. E. Hubbard (Jesus); *Hon. Secretary*, Mr. D. A. L. Wade (Clare); *Hon. Treasurer*, Mr. J. E. Gardner (Peterhouse).

The annual subscription was fixed at 5s. per annum, with an additional 2s. per term for the use of the Society's room and aerial.

On October 16th a meeting was held in Trinity College when Mr. A. S. Brereton described and demonstrated a five-valve receiver of his own manufacture.

On October 24th a meeting was held in the Engineering Laboratories when Mr. L. B. Turner, M.A., M.I.E.E., was unanimously elected a Vice-President of the Society.

The President then called upon Capt. H. de A. Donisthorpe to deliver a paper entitled "The Effect of a Magnetic Field on Thermionic Valves." The lecturer proceeded to describe the effect on the anode current of a triode when subjected to a magnetic field, and gave a demonstration showing how this effect could be used to increase the efficiency of a receiver. He then described experiments he had made in an endeavour to apply this effect to telephone transmission.

A general discussion ensued, and the meeting concluded with a hearty vote of thanks to Capt. Donisthorpe.

On November 6th, a meeting was held in St. John's College, when Mr. E. V. Appleton read a paper entitled "A Difficulty in Retro-active Reception."

The lecturer described some investigations he had carried out in conjunction with Dr. B. van der Pol into the phenomenon of backlash in starting and stopping oscillations in a triode.

He showed that this phenomenon was explained by taking proper account of the shape of the characteristic, and pointed out its bearing on how close one could approach to the oscillating condition when receiving spark or telephony.

A discussion ensued, and the meeting concluded with a hearty vote of thanks to Mr. Appleton for his interesting and instructive paper.

On November 20th, Capt. P. P. Eckersley, of the Marconi Company, delivered a paper before the Society entitled "Wireless on Aircraft."

The lecturer commenced by making some general remarks about telephony on aircraft, and then went on to describe the sets designed for civil aviation purposes by the Marconi Company, and also the ground station at Croydon. He concluded by briefly describing the earth screen invented by his brother in use at Carnarvon and Croydon, and a simple and ingenious method of measuring high frequency resistances.

Altogether a highly interesting and instructive discourse, which was much appreciated by the Society.

On December 4th, the President gave a description and demonstration of his recording apparatus. He started by recalling the principles of the Turner relay, described the different methods of quenching the oscillations, and several other minor points about the connections. He then explained the moving iron polarised relay which he had made, and proceeded to apply it to a printer and a 4 volt indicating lamp. A tape was printed during the demonstration and passed round for inspection. The meeting concluded with a discussion.

The membership of the Society now amounts to approximately seventy.

Hon. Secretary, Mr. D. Wade, Castle Lodge, Saffron Walden.

The Leeds and District Amateur Wireless Society.*

Hon. Secretary, Mr. D. E. Pettigrew, 37, Mexborough Avenue, Chapeltown Road, Leeds.

A General Meeting was held on December 23rd at the Leeds University, there being a good attendance. Mr. R. E. Timms (Hon. Treasurer) officiated at the buzzer owing to the absence of all Morse instructors. At 8 p.m. Mr. G. P. Kendall, B.Sc. (Vice-President), took the chair and called upon the Hon. Secretary to discharge certain business. This having been carried out, the Chairman called upon the Hon. Secretary again, this time to deliver a paper on "The Post Office Wireless Service." The lecturer commenced by briefly outlining P.O. wireless work from an historical standpoint and showed how the original "plain aerial" sets had been supplanted by rotary and quenched spark sets, continuous wave arc and valve transmitters. The coastal wireless service to ships was examined and "commercial procedure" briefly explained. A description of the Niton station followed, the working of the transmitter and receiver being explained both verbally and with the aid of blackboard diagrams. Devizes, Caister,

and Stonehaven stations were described, and the portion of the Central Telegraph Office assigned to radio work also touched upon. After mentioning the Northolt station now in course of erection, the Leafield and Cairo stations were described. The lecturer concluded his paper, after mentioning some actual results he had had on his receiver, from P.O. stations' transmissions. A short discussion ensued at the close of which the lecturer was accorded a very hearty vote of thanks.

The meeting closed about 10 p.m.

Brighton Radio Society.*

A well attended meeting was held on December 8th, when Capt. E. A. Hoghton, F.P.S.L., gave an interesting lecture on a new six-valve set of his own design. After lucidly explaining the apparatus, the lecturer proceeded to give a practical demonstration, and remarkably clear strong signals were received, the set being noticeably efficient when used with a small frame aerial. A hearty vote of thanks was accorded Capt. Hoghton at the conclusion of the lecture which was keenly appreciated by the members.

On December 10th a small party of the members visited Worthing to inspect the station owned by Mr. W. Rogers. Some surprising results were obtained by Mr. Rogers, who used only one valve. American stations were heard clearly, and the climax was reached when, still using but one valve, and a novel indoor aerial, American stations were read clearly and distinctly. The identity of these stations was confirmed by the Society's "experts," and Mr. Rogers was warmly congratulated on his excellent achievements.

The best thanks of the members are due to Mr. Fry and Mr. Rogers for a most interesting afternoon.

The Hon Secretary, Mr. D. F. Underwood, 68, Southdown Avenue, Brighton, will be pleased to furnish full particulars of the Society to any gentlemen interested.

Borough of Tynemouth Y.M.C.A. Amateur Wireless Society.*

On November 21st a representative gathering of members availed themselves of our President's kind offer to visit his residence for a practical demonstration upon his installation. After the demonstration a social gathering took place.

A hearty vote of thanks was proposed to Mr. and Mrs. J. E. Burnett for providing such an interesting and most enjoyable evening.

At a meeting of the Society held on November 28th, Dr. Jas. A. Hislop and Mr. Hilton Hutchinson gave a practical demonstration upon their own sets. The meeting was full of interest and very helpful to those members who were erecting their own installations.

Many questions were asked which were ably replied to by the respective gentlemen.

The second annual Exhibition of Wireless Telegraph Apparatus was held on November 30th and December 1st in the Y.M.C.A., North Shields. The Committee and members put a lot of work into the arrangements, and it was very gratifying that their labours were crowned with success, the Exhibition creating great interest in the town.

The thanks of the Committee are due, not only to the members, but to Messrs. North Eastern Instrument Co., of Gateshead-on-Tyne, Mr. H. W. Sullivan and Butler & Co., of London, and also Messrs. Marconi's Wireless Telegraph Co., Ltd., for the loan of lantern slides.

At the last meeting of the Society held on December 5th, a deviation from the usual course took place when Mr. J. C. Burnett, B.Sc., gave a lecture and demonstration upon the hydrophone.

The subject proved to be intensely interesting, and the members showed their appreciation in a very hearty manner.

Hon. Secretary, Mr. L. L. Sims, "Eynesbury," Cleveland Road, North Shields.

The Willesden Wireless Society.*

All communications to be addressed to the Hon. Secretary, Mr. F. A. Tuck, 87, Mayo Road, Willesden, N.W.10.

We have now reverted to our original arrangement of Tuesday evening meetings, which were replaced, as an experiment, by meetings on Thursdays and Saturdays.

We should like to congratulate our Chairman, Mr. W. Corsham, on successfully receiving some of the signals sent out in the recent Transatlantic Tests. No doubt by the time these lines appear in print the full result of the tests will have been published; but we are very pleased indeed to feel that a little of the glory belongs to Willesden, as a direct result of Mr. Corsham's endeavours in the small hours.

Informal meetings were held on December 6th and 13th, the latter evening being spent in compiling a syllabus of forthcoming lectures, extending to May, 1922.

A copy of the full syllabus will be sent to any gentlemen interested upon application to the Hon. Secretary.

At the meeting held on Tuesday, December 20th, the delegates who will represent the Society at the forthcoming Annual Conference were chosen. These are Mr. W. Mann, our Vice-Chairman, and Mr. F. A. Tuck, the Hon. Secretary. A resolution was also made and sent to the Wireless Society of London, in connection with this Conference. Mr. G. Wyatt then delivered his lecture on "Precision Gearcutting," and astonished the assembly by the marvellous accuracy embodied in modern laboratory timepieces. One instrument was mentioned whose error after a three months' run unattended, was but a fraction of a second!

The chronograph signals from FL are used to calibrate the instruments in which Mr. Wyatt is interested.

Edinburgh and District Radio Society.*

On December 14th, Mr. D. G. Watson gave his lecture on "Electric Motors," and gave a very full and comprehensive description of the means of achieving the maximum efficiency by the use of the various types of windings. He showed the advantage of using interpoles, and the manner in which they reduced power losses through distorted magnetic fields. Finally giving a diagram

WIRELESS CLUB REPORTS

and brief outline of a useful device for charging accumulators from a running motor of generator taking the supply leads for this from one of the main brushes and a "floating" brush, varying the E.M.F. on this line by altering the relative position of this extra brush relative to the main brush used in the circuit.

Hon. Secretary and Treasurer, Mr. W. Winkler.
9, Etrick Road, Edinburgh.

Redhill and District Y.M.C.A. Wireless Society.

A meeting of the above Society was held at the Y.M.C.A. on December 21st, with Mr. H. G. White in the chair. A set of rules drawn up by the Committee were submitted and passed with few amendments.

The object of the Society shall be the promotion of the science and the study of Wireless Telegraphy and Telephony and other kindred subjects.

Membership shall be limited to persons of either sex who are actively interested in the above subjects.

Subscriptions shall be 5s. per annum payable in advance from January 1st of each year.

Applications for membership shall be made to the Secretary who shall submit such applications to the Committee. The Committee reserve the right to refuse membership without assigning any reason for such action.

Meetings of the Society to take place at the Y.M.C.A. weekly on Wednesdays, commencing at 8 p.m.

Morse classes to be started for those who wish to learn telegraphy.

Hounslow and District Wireless Society.

The opening night of the above Society, at our new headquarters, Alexandra Schools, was held on Friday, December 2nd, 1921. Mr. Pike, the Chairman, addressed the meeting, and particularly welcomed the visitors. After stating our objects and aims as a Wireless Society, he gave a brief outline on our activities since we were formed on June 2nd, 1921. He then introduced to the meeting Lt. H. S. Walker, of Brentford, and Mr. F. O. Read of Burnhams. Lt. Walker then addressed the meeting, and gave a brief outline of the history of wireless telegraphy and telephony. He next described some of the apparatus kindly lent by Messrs. Burnham & Co., and the use of same. Lt. Walker was warmly applauded for his lecture, and the Chairman then called on Mr. F. O. Read to demonstrate the receiving set. Music was picked up from Lt. Walker's station at Brentford, also from 2FQ at Deptford. Later many time signals and weather reports were received, and altogether we had a very successful evening. Lt. Walker and Mr. F. O. Read were thanked by all present for the valuable assistance in making this night a success.

Intending members please communicate with the Hon. Secretary, Mr. A. J. Rolfe, 20, Standard Road, Hounslow.

Cambridge and District Wireless Society.

The first Annual General Meeting of the above Society took place on Wednesday, December 21st, at 7.30 p.m., in the Lecture Room of the Photo-

graphic Club, Ram Yard, Mr. W. S. Farren in the chair.

The Chairman in his opening remarks said that although the Society had only been in existence seven months it had shown remarkable progress inasmuch that the membership showed a total of 40 members and the balance sheet, after paying all expenses, also showed a good balance to be carried forward. It was proposed to raise the subscription from 8s. to 10s. for full members, and 4s. to 6s. for junior members, this being duly agreed to. The following members were elected as officers for the ensuing year:— Mr. W. S. Farren, *Chairman*; Mr. J. J. Butterfield, *Hon. Secretary*; Mr. Banjard, *Hon. Treasurer*; Messrs. H. W. Taylor and H. Culpan, *Members of the Committee*. Mr. H. W. Taylor was accorded a very hearty vote of thanks for his services as Hon. Secretary for the past seven months, the Chairman remarking that it was mainly through the efforts of Mr. Taylor that the Society came into existence. Messrs. Diver and Cross were asked to audit the balance sheet, and after the business of the evening was concluded the meeting was declared informal. A splendid array of apparatus belonging to members was shown, and various sets were put into action with very successful results. Special mention must be made of a three-valve set made by Mr. H. W. Taylor, this set working very successfully, signals being audible to all by placing the telephones on the table.

Another set that was much admired was the one-valve set made by Mr. Impey.

The New Year's Session commenced on Tuesday, January 10th, when a combined meeting of the Photographic Club and the Wireless Society was arranged.

All communications should now be addressed to the Hon. Secretary, Mr. J. J. Butterfield, 107, King Street, Cambridge.

Burton-on-Trent Wireless Club.*

Hon. Secretary, Mr. A. J. Selby, 66, Edward Street, Burton-on-Trent.

There was a large attendance at a meeting of the Club held on December 16th, when Mr. L. G. Simms presided. The proposal to hold an exhibition in the spring was discussed, and it was decided to leave it in the hands of the Committee.

The Chairman explained that only a few days before he had listened to a speech in Birmingham by Signor Marconi who foreshadowed that in the near future we should be speaking by wireless telephony to Australia and every British possession.

Mr. F. V. A. Smith then gave a lecture on wireless telephony, comparing it with line telephony.

In comparison with wireless telegraphy the advances in wireless telephony were extremely slow until about six years ago when the Three Electrode Thermionic Valve was introduced as a generator of wireless waves. Since then, however, such rapid progress has been made that its great future is already well assured.

At the conclusion of the lecture telephony was demonstrated to the audience, speech and music being received on a frame aerial erected in the room. Selections of music were heard from the Home Guards and Grenadier bands, and various vocalists.

The messages were heard most distinctly by all present with the aid of a large loud-sounding trumpet. A demonstration followed in the amplification of line telephony, when speech and music were transmitted from part of the *Mail* Office to the Lecture Room, and both were heard with the utmost distinction.

The discussion and the customary vote of thanks to the lecturer and Mr. Selby, who manipulated

the receiving set and for his trouble in getting the instruments together for the demonstrations, terminated a most instructive evening.

South Shields.

A Town's Wireless Club has been formed at the Y.M.C.A., Fowler Street, South Shields, and any desirous of joining the same should apply to Mr. E. Thompson, the General Secretary, at that institution.

10th Wimbledon Boy Scouts' Wireless Section

BY "SCOUTMASTER."

THE following is offered in the hope that it may prove interesting to the many Scouts and amateurs who peruse your magazine.

During the summer the Wireless Section of the 10th Wimbledon Troop of Boy Scouts, under the supervision of Mr. J. Ayres, worked hard to complete a wireless receiving set which we took to camp. The instrument has proved very efficient.

The accompanying photographs, Figs. 1 and 2, give an idea of the set, which is made to fit an ex-Government Mark III tuner box. On the left is a variable grid leak, and on the right a variable grid condenser. The centre switch controls a variable condenser, very useful for tuning telephony.

The set can be used as a coupled circuit as well as single circuit by manipulating a small two-way switch. Two variable condensers are fitted, one

Later we hope to be in a position to explain and give working diagrams in respect to a portable transmitter.

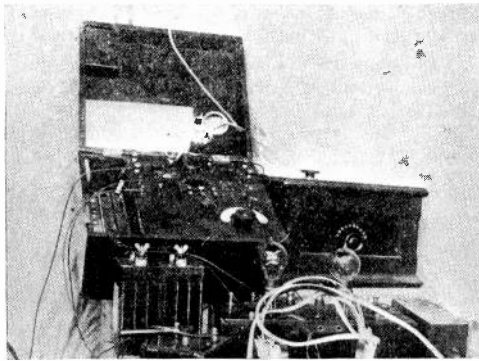

Fig. 1. Apparatus of the 10th Wimbledon Scouts.

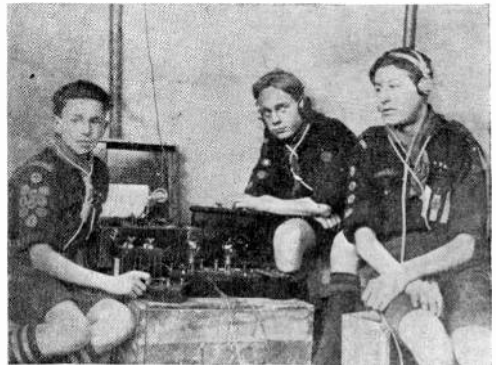

Fig. 2. Scout Operators at work.

Much material was supplied for the construction of this receiver by the Amateur Supplies Association, Tooting, and has given great satisfaction.

Correspondence

7th Engineer Officer,
P. & O. R.M.S. Kaiser-i-Hind,
Tilbury.

To the Editor of THE WIRELESS WORLD.

SIR,—Would you be so kind as to insert a notice in your columns to the effect that I would be glad to make the acquaintance of any wireless amateur so inclined in this part of the world. I am greatly desirous of keeping up-to-date my knowledge of radio, acquired whilst an amateur, before choosing the sea as a career, and would gladly avail myself of the opportunity for so doing when I am in port. Having no friends in London interested in wireless, I therefore write to you for help.

DONALD B. KNOCK.
Hon. Member:

Southport Wireless Experimental
Society.

December 12th, 1921.

primary and one secondary: when single circuit is used they are paralleled to each other, the secondary condenser being very small, three fixed vanes and two moving vanes make admirable possibilities for fine tuning on the shorter wavelengths. The inductances are external, and can be changed at will.

We should be very pleased to receive communication from any Scout Troops who are interested in this branch of signalling.

W. T. COMPONENTS

Transformers: H.F. & L.F.
 H.F. Couplings: Reactance Capacity.
 H.F. Couplings: Resistance Capacity.
 Amplifiers: H.F., L.F. & Combination.
 Condensers, Anode Resistances, Leaks, etc.

B. HESKETH,
Manufacturer of W.T. Apparatus,
HIGH ST., CHALVEY, SLOUGH.

SPECIAL OFFER OF POLE FINDERS

Suitable for H.T. and L.T. Circuits. When connected to leads **NEGATIVE END OF TUBE** will turn Red. When shaken solution will become clear again.

EVERY AMATEUR SHOULD POSSESS ONE

PRICE **4/3** post free.

Did you notice our **BARGAINS** in Dec. 24th issue?
LISTS FREE.

WIRELESS SUPPLIES 82 SWINBURNE RD.,
 ABINGDON, BERKS.

ACCUMULATORS

ENTIRELY NEW STOCK

Specially manufactured for us by "Peto & Radford"

Thoroughly well-made accumulators with wooden separators and non-corrosive terminals

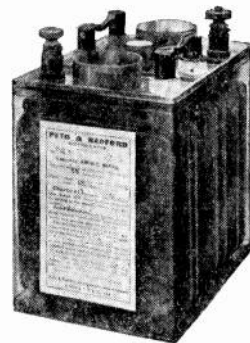

4 Volt,	44 Amp.	£1	7 0
4	.. 66	1	15 0
6	.. 44	2	0 0
6	.. 66	2	12 6

WATES BROS.

Retail Branch - 5, High Street, Bloomsbury, W.C.2
 Offices : 132, Charing Cross Rd., W.C.2 (Gerrard 576)

SIEMENS DRY BATTERIES FOR OPERATING WIRELESS VALVES.

THE illustration depicts a Siemens standard type of "15 volts" Dry Battery which is largely employed. If a battery of greater capacity is required size No. 789 "15 volts" 11 cells, should be specified. The latter battery measures approximately 14¼ in. × 1⅝ in. × 3⅝ in. high.



"15 volt" Siemens Dry Battery No. 643.
 Dimensions 9½ in. × 7⁄8 in. × 2¾ in. high.

The Company manufactures all types of Leclanché cells and batteries, fluid and dry, and can usually supply these to meet special requirements.

Manufactured by:

**SIEMENS BROTHERS
& CO., LTD.**

WOOLWICH, LONDON, S.E.18.

— Obtainable from all Dealers. —

ALL INTERESTED in Wireless Telegraphy

should if possible visit the **Hart Accumulator Company's**  **STAND No. 10** at the 2nd Annual Exhibition of the Birmingham Experimental Wireless Club at the Birmingham Technical School, from 18th to 21st January, 1922.

Special exhibits are being shown of the various types of 'Hart' Batteries largely used for Wireless Telegraphy all over the world.

Special quotations for High or Low Tension Batteries sent on receipt of particulars of requirements.

HART ACCUMULATOR CO., LTD. STRATFORD LONDON, E.15
BIRMINGHAM OFFICE 20, LINCOLN'S INN

" RADIO-CONSTRUCTA " Patents applied for

A series of highly-finished constructional parts made of ebonite throughout, by which the Wireless Experimenter and Amateur is enabled to easily build his own Apparatus, Receiving or Transmitting Sets, Experimental and Inventive Circuits. The parts are so designed that very little skill is required in assembling, and parts may be used any number of times, being assembled and dissembled at will. In addition to this each part is standardised and is interchangeable.

The educational value of the invention is very great, and the amateur will learn more in devising his own type of apparatus in this manner, than by purchasing highly polished and expensive sets, which are boxed in, and have always an appearance of mystery.

" RADIO-CONSTRUCTA " Makes Wireless Experiments easy and fascinating, and brings Wireless Telegraphy within the reach of all.

Realising the tremendous advance in Wireless, and especially Wireless Telephony, the Proprietors of "Radio-Constructa" have designed a number of complete sets of parts, by which anyone *without* previous knowledge of the principles of Wireless Telegraphy may build their own apparatus at the minimum of cost, with the maximum of interest and efficiency.

Below we give two illustrations of complete Wireless Receiving Sets, and the beginner will now be instructed to build these sets and others.

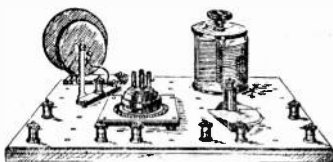

SINGLE VALVE SET

Comprising 13½in. by 10½in. Baseboard, drilled and the following articles for fixing into Baseboard, with long terminals and nuts for back wiring—Coil Stand and two plugs including two Basket Coils, 1,000 metres range, Combination Valve Holder, Filament Resistance and Condenser, Variable Condenser (.005), eight Terminals, Telephone Condenser, Wire and Insulating Sleeving.

£4 : 10 : 0 (Unassembled)

With Baseboard 6½in. by 10½in., 10/- less.

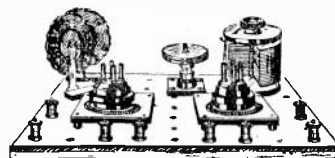

TWO-VALVE SET

Comprising the whole of the articles enumerated in Single Valve Set, substituting '001 Condenser, and adding additional Combination Valve Holder and Filament Resistance and Condenser, Mounted Valve Holder, Pin Transformer, H.F., 1,000 metres, and Vernier Condenser.

£6 : 10 : 0
(Unassembled)

FOR FURTHER PARTICULARS APPLY TO :—

RADIO-CONSTRUCTA (Dept. 2), 222 Great Dover Street, London, S.E.1
Telephone: HOP 3029. AGENCY APPOINTMENTS WILL BE CONSIDERED.

Questions and Answers

NOTE.—This section of the magazine is placed at the disposal of all readers who wish to receive advice and information on matters pertaining to both the technical and non-technical sides of wireless work. Readers should comply with the following rules.—(1) Each question should be numbered and written on a separate sheet on one side of the paper only. (2) Queries should be clear and concise. (3) Before sending in their questions readers are advised to search recent numbers to see whether the same queries have not been dealt with before. (4) The Editor cannot undertake to reply to queries by post. (5) All queries must be accompanied by the full name and address of the sender, which is for reference, not for publication. Queries will be answered under the initials and town of the correspondent, or, if so desired, under a "nom de plume." (6) Readers desirous of knowing the conditions of service, etc., for wireless operators will save time by writing direct to the various firms employing operators. (7) Four questions is the maximum which will be accepted at a time.

L.B. (Bath) asks (1) What is the station which calls QI on 4,000 metres. (2) For a good circuit for telephony reception. (3) If LP still sends telephony at 12.30 to 13.00. (4) For the simplest circuit for transmitting telephony.

- (1) Probably the P.O. station at Leafeld.
- (2) Any receiver with H.F. magnification will give good speech results.
- (3) Times irregular. See Supplement to Jan. 7th issue.
- (4) See diagram Fig. 1.

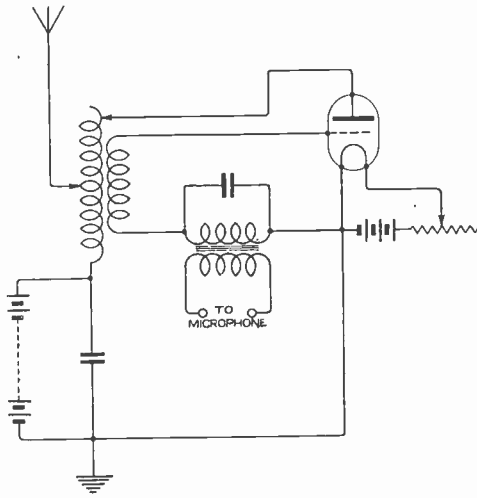

Fig. 1.

"RADIOPHILIST" (London).—We regret that we have not been able to obtain exact information on all points with regard to these valves. They are, however, examples of early types, nominally hard. We do not know the filament voltage for the A.E.G. valve; that for the Telefunken appears to be about 2.5. Plate volts are 200 for the A.E.G., and 100 for the Telefunken. Neither are likely to be of any use for transmission. They are not good rectifiers, and of most use as L.F. amplifiers.

R.O.C. (Leigh-on-Sea).—Calculation of these coils is almost impossible without some information as to the aerial and set with which they are to be used. Your smallest coil might have about 80

turns of No. 20 on a mean diameter of 5." For the largest wavelength you will possibly require about 1,500 turns, of preferably somewhat thinner wire, with about the same mean diameter.

R.C.P. (Guildford) asks (1) The reason why his single valve set gives stronger signals when he touches the earth lead. (2) For advice about an accumulator which is giving poor results.

(1) This is somewhat difficult to explain without actual test, but it appears possible that the result is due to the absence of a condenser across the primary of the telephone transformer.

(2) Symptoms point to nearly all the active material having been shaken off the plates. In order to make them of much use, it would be necessary to open up the cells and fit them with new positive plates, which could probably be obtained from the makers. The job is not a very easy one without previous experience, and we should advise you to get it done by a firm used to the work. It would probably pay you better to scrap the cells and get new ones.

L.S. (Braintree) asks various questions about a set which he proposes to use for telephony between 300 and 30,000 ms.

At present no telephony is being done above 4,000 ms. You would probably get much better telephony results if you confined the wavelength range of your set between 300 and 4,000 ms. An aerial of the size you mention will be very inefficient on very long waves. A capacity of 0.002 mfd. will be about right for an A.T.C. One valve will give you signals at all wavelengths, but the addition of further valves will of course improve results, especially at the longer wavelengths. Your telephones will be quite suitable. We regret that we have not space to answer others of your questions.

C.Mc.L. (Bearsden) asks (1) For a diagram of a set with two valves for slab inductances. (2) If E.S.2 valves could be used efficiently on the set. (3) What H.T. to use.

(1) The circuit of Fig. 3, page 526, November 12th, should be quite suitable. There are also many others in recent issues.

(2) Yes.

(3) About 100 volts should be about right on a set of this type.

J.A.S. (Stonehaven) asks (1) Whether an earth is improved by putting coke or cinders next to it when burying it. (2) Why an accumulator does not short circuit itself owing to the conductivity of the electrolyte. (3) For a diagram of the filament

wiring of a three-valve panel for experimental work.

- (1) Not much for wireless work.
- (2) Owing to the contact differences of potential between each plate and the electrolyte.
- (3) See diagram Fig. 2.

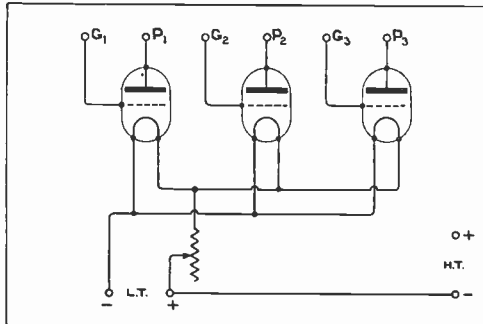

Fig. 2.

"NOVICE" (Abertridwr) asks (1) For the names of stations with certain call signs. (2) Why FL is much stronger than MPD with him. (3) Whether a variable condenser would be better for a secondary circuit than a fixed. (4) Why FL press is much fainter than time signals and weather reports.

(1) BUC, Bucharest; FFH, Le Havre; SXG, Athens; UFQ, not known.

(2) FL is radiating more power on a more efficient aerial, owing to the great height of the Eiffel Tower. You may be screened from MPD somewhat.

(3) Certainly, unless the inductance of the circuit is continuously variable, which is unlikely.

(4) When this is the case, it is due to a reduction in the power used. The desired range is probably less.

V.D.B. (Reading) asks (1) The wavelength of a small amateur aerial. (2) If it can be used for receiving PCGG. (3) How the wavelength can be increased. (4) For a three-valve circuit for the reception of PCGG.

(1) Approximately 50 metres.

(2) Somewhat small, but will give results with a good amplifier.

(3) By the addition of a loading coil or A.T.I.

(4) The circuit of Fig. 2, page 396, September 17th, should be about the best of the type you suggest. In this circuit the reaction coil should couple with the closed circuit inductance only, and not with the A.T.I. Coils should be wound single layer on cylindrical formers.

S.J.D. (Hockley) has a set which he says will only tune to 65 ms. He asks (1) For instructions for increasing the wavelength. (2) What instruments he will require for a two-valve amplifier.

(1) The diagram you send appears not to be of a receiver at all. It is of an amplifier. What you take to be the closed circuit is the grid condenser and leak. This amplifier will work quite well as it stands on long waves, but preferably omit the condenser between the grid and filament of the

first valve. Receiving circuits may be of ordinary two-circuit type. A.T.I. about 120,000 mhs. A.T.C. = 0.003 mfd.; closed circuit inductance 100,000 mhs; condenser, 0.004 mfd.

(2) Your own sketch is satisfactory. If you want further amplification additional valves may be added in the same way as those shown.

"JUNIOR" (Uppingham) asks (1) The range of the set given to "BEGINNER" (Highgate) on page 156, May 28th. (2) If he could get PCGG with it. (3) How to increase the wavelength to 30,000 metres. (4) If a reaction coil needs sliders or tappings.

(1) If you will read the reply you quote again you will notice that the set was designed for 5,000 ms.

(2) Very doubtful, without addition 1 H.F. amplification.

(3) This could be done by the substitution of much larger coils; but a set of this type would then be very inefficient, and we do not recommend it.

(4) A reaction coil need not have a slider, but if it is intended to serve for a very large range of wavelengths, a few tappings may be convenient.

"THE RAVEN" (Nunhead) asks (1) Whether he can use a Brown Loud Speaker with Weston relay on a single valve set. (2) If not, what additional apparatus is needed. (3) For a simple way of making a loud speaker. (4) What dangers are met with in experimenting with X-rays, and how to avoid them.

(1) and (2) You will not obtain enough power from a single valve set, except for extremely strong signals. You should use at least a three-valve amplifier.

(3) We know of nothing exactly on the lines you suggest, but various types are given in the issue for February 19th.

(4) The dangers attendant on a few experiments with lower power bulbs are negligible. With high power work, frequently done, they are serious. If you propose to undertake the latter, you should consult a good book on the subject.

"CRYSTAL" (West Croydon) asks (1) The wavelength range of his set. (2) Dimensions for a loose coupler to tune to 4,000 ms. (3) How to connect up the loose coupler. (4) The gauge of a sample of wire.

(1) About 1,600 ms.

(2) Primary 10" x 6", wound with No 24; secondary, 8" x 5", wound with No. 28.

(3) Connect as in Fig. 8, page 190, June 11th, and other crystal diagrams frequently given.

(4) No. 36.

2NN (Epping).—(1) The illustration you send gives us very little idea of the nature or use of the apparatus, of which you send no description. It does not appear as if it would be possible to use it for generation of H.T. for wireless purposes.

(2) Fairly large dry cells form the most satisfactory H.T. battery. The Siemens type "Q" cell is a very good specimen of the type. It is expensive, but well worth the price, as the life is many times that of the common flash lamp battery, and it stands up almost indefinitely on open circuit.

WIRELESS

Equipment of the very latest pattern for Passenger, Cargo and other vessels supplied installed and operated under Rental and Service Agreements, or Sold outright, with service if preferred.

Special equipment suitable for vessels of very small tonnage on advantageous terms

The MARCONI INTERNATIONAL MARINE COMMUNICATION COMPANY LIMITED.
MARCONI HOUSE, STRAND, LONDON. W.C.2:
Phone: CITY 8710. Cables: THULIUM, LONDON.
Telegrams: THULIUM, ESTRAND, LONDON.

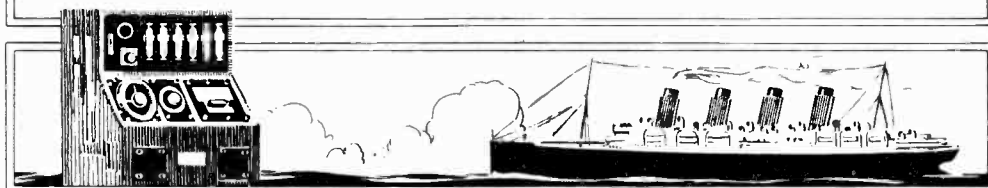

TELEPHONY TRANSMITTERS

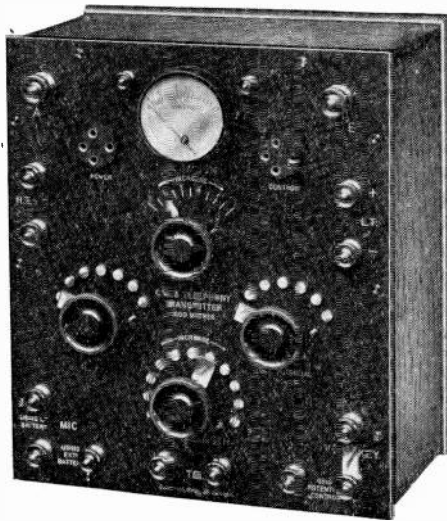

TYPE "F."

Constructed on the choke control principle and adjustable for highest efficiency on any plate voltage from 100 to 2000 volts. Gives 1 ampere in aerial with 150 volts dry cell.

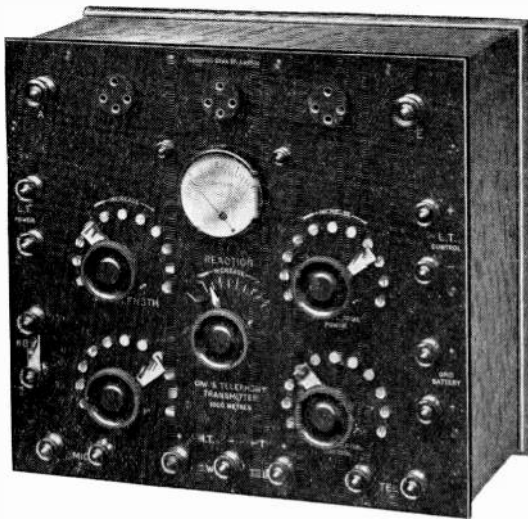

TYPE "H."

The ideal transmitter for duplex telephony. The aerial only radiates when the microphone is spoken into. Excellent modulation. Cool running valves and very low power consumption.

(Patent Pending.)

Particulars and Prices on Application.

Demonstrations given at our Works.

GAMBRELL BROS., LTD. MERTON ROAD,
SOUTHFIELDS,
S.W.18

QUESTIONS AND ANSWERS

H.G.D. (Didsbury) asks (1) *For suggestions for the improvement of a No. 1 aircraft tuner, adapted for use with a V24 valve.* (2) *Modifications to permit of its use as a wavemeter or separate heterodyne.*

(1) The set should work all right with a V24 valve. You may find it advisable to alter the volts applied to the grid. For satisfactory working it is essential that the reaction coupling should be variable.

(2) This set is not very convenient for this purpose, but might be used in this way if a variable condenser were placed across the aerial and earth terminals, in place of the aerial and the earth. It will be necessary to provide enough reactance for the set to oscillate, and it would have to be used at fixed values of the inductance.

"BEGINNER" (Nottingham).—(1) The introduction of two pairs of telephones of somewhat different resistance into a circuit will not seriously affect the signals. It is much more likely that the result is due to some fault which has developed in the circuit. Try each pair of telephones in the circuit separately. If results are bad with each, fault is in the circuit. If bad with only one pair, that pair is bad, probably from a break in a winding, or a break down of insulation to the case.

(2) We do not know of any suitable book.

L.T.P. (Kenley) asks (1) *Whether a circuit sketched will be satisfactory.* (2) and (3) *Windings for a loose coupler and reaction coil for 4,000 ms.*

(4) *The wavelengths used by certain stations.*

(1) Quite.

(2) and (3) See reply to **"CRYSTAL,"** above. For reaction coil try 4" x 3", wound with No. 28.

(4) FL, 2,800 ms.; POZ, about 2,900; GLD, 600 ms.; GNI, 600 ms.; BYC, about 4,500 ms.

R.W.B. (New Malden) asks (1) *If resistance amplifiers will function without grid leaks.* (2) *If 900 ms. is too low for efficient working with an amplifier of this type.* (3) *How to couple a separate heterodyne to such an amplifier.* (4) *Wavelength and power of Leafield.*

(1) No, they are necessary for maintaining the grid at a proper potential. Sets without them sometimes work fairly well if the insulation of the grid condenser is poor, but this is seldom efficient.

(2) Results may be fairly good, although this wavelength is about the limit for the type.

(3) Connect a small coil, coupling with the heterodyne, into the closed circuit.

(4) Wavelength about 8,500 metres; power, 250 kW. arc input.

"ARCH" (Copenhagen) asks various questions about an arc set which he proposes to make.

Your project appears fairly ambitious, having regard to the little information you appear to possess about the subject.

(1) It is difficult to predict values exactly, but they might be approximately as follows:— L_1 , 500 mhys; L_2 , 1,000 mhys; L_3 , 450 mhys.; L_4 , 50 mhys.; C, 0.0013 mfd.

(2) Owing to the extreme inefficiency of such a small aerial at such a long wavelength, the radiated power will be only about 5 watts, in spite of the fact that your input is to be about 2 kW.

(3) A microphone, if of heavy duty type, could be connected in the earth lead.

"EIKENHOF" (Cape Town) asks (1) *If flexible strain insulators are suitable for aeriels.* (2) *If a telephone transformer would increase the strength of signals with 2,000 ohm telephones.* (3) *If a 75' aerial, 20' high is suitable.* (4) *If a crystal set shown is useful.*

(1) Yes, provided they are mechanically strong enough.

(2) No.

(3) Yes.

(4) Yes, with the addition of a potentiometer and battery to the crystal.

J.B. (Weston-super-Mare) wishes to buy a cheap single valve set and asks advice.

Write to various advertisers in this magazine and ask for catalogues; or insert an advertisement in the magazine. In comparing prices, note whether the valve is included with the set. Get a set with magnetic reaction.

"AMPLIFIER" (Bristol) asks (1) *If circuit shown is suitable for L.F. amplification.* (2) *If it can be used with the same batteries as the H.F. set.* (3) *Dimensions for the telephone condenser.* (4) *If the set is suitable for all wavelengths.*

(1) Yes.

(2) Yes. The same filament resistance may be used.

(3) Area of overlap, 8 sq. cms. Total number of foils, 5, with mica 0.005" thick.

(4) Yes. Connect a two-megohm resistance from No. 2 grid to the negative filament.

L.K. (Dover) wishes to add a third valve—not resistance-coupled—to a two-valve set.

Add the valve as an L.F. amplifier. Connect a 1/1 transformer in the second anode circuit, in place of the telephone transformer, secondary to the grid of the third valve. Connect the filament of the third valve in parallel with the two first filaments. The same H.T. may also be used. You will find it advantageous to connect a 0.001 mfd. fixed condenser across the anode winding of the L.F. transformer.

"GRID LEAK" (Wimbledon) asks (1) *For criticism of a three-valve set.* (2) *If 8,000 ohm telephones may be used directly in the anode circuit.* (3) *If 1,000 mhys. is sufficient reaction with a 50,000 mhy. A.T.I.*

(1) You will find a series condenser in the aerial (0.0003 mfd.) very useful for C.W. Earth the negative side of the filament battery.

(2) The only reason for not using them is the possibility of the H.T. voltage breaking down the insulation of the very fine wire used. Connect 0.001 mfd. across the telephones.

(3) This will be sufficient if the reaction coil is included in the anode circuit of the rectifier, but probably not if it is placed in the anode of the first valve.

H.C.L. (Victoria) asks (1) *For the capacity of a condenser.* (2) *Size of foil for 0.02 mfd. condenser with waxed paper dielectric.* (3) *Basket coils for 3,000 ms.* (4) *Why no signals are received on a crystal set.*

(1) We cannot say without a knowledge of the distance between the plates.

(2) The overlap of the foils should be 50 sq. cms., and the thickness of the paper $5/1000''$. There should be 15 foils to each side of the condenser.

(3) To tune a P.M.G. aerial to this wavelength, three basket coils will be required, each 2 cms. inside diameter, and 16 cms. outside diameter, wound with No. 26 wire.

(4) Your present set is only suitable for ships on 600 ms., as its maximum wavelength is less than 1,000 ms. Connect a 0.002 mfd. condenser across the telephones. Otherwise it is quite O.K., and should give good results.

R.W. (Cambridge).—See reply to H.A. (Salford) below, which will give you all the information required.

A.U. (Whitby) has a L.F. amplifier which does not seem to magnify on short waves, and asks (1) If the wavelength of the transformers is wrong. (2) and (3) Information re making of intervalve transformers.

(1) The question of wavelength does not enter into the design of low frequency transformers, which should amplify as well on short waves as on long. We cannot state the most likely fault without a sketch of your circuits. Test the windings of the transformer for continuity with a galvanometer, or telephones and a cell.

(2) and (3) See articles in May 28th and June 25th issues on this subject.

F.C.A. (Hornsey) asks (1) for a three-valve circuit diagram. (2) If the set will receive concerts. (3) If 60 volts H.T. will be sufficient.

(1) See reply to H.A. (Salford) below for a suitable diagram.

(2) If the loose coupler (which is not described) is suitable for short waves.

(3) Yes, for most ordinary receiving valves.

H.A. (Salford) asks (1) For a diagram of a three-valve circuit—1 H.F., 1 rectifying, and 1 L.F. mag.

The required diagram is given in Fig. 3. It is not essential to use a transformer with 8,000 ohms telephones, but connecting them in the H.T. circuit renders insulation breakdowns likely.

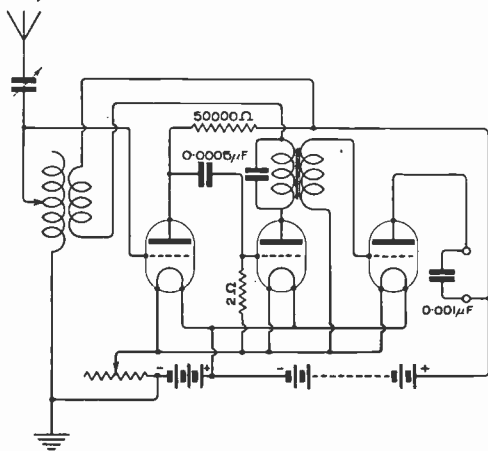

Fig. 3.

H.H.R. (Bristol) asks the following questions among others. (1) Where to find details for construction of a set suitable for all wavelengths. (2) The meaning of the term wavelength of say 2,500 ms. (3) Maximum range of reception for a set as in (1). (4) The life of a receiving valve.

(1) It is not desirable to obtain all possible wavelengths on a single set, as the methods which are best for very short waves are not those best for very long waves.

(2) We have not space to explain this. See Bangay's "Elementary Principles," particularly page 64.

(3) With skilful use transatlantic stations might be picked up under very favourable conditions.

(4) With careful use, and reasonably good luck, 1,500—2,000 hours for a good type valve.

W.B. (Malpas) asks the following questions re a proposed resistance amplifier. (1) Whether he will get P.C.G.G. with two valves. (2) If Brown's 8,000 ohm telephones are equally suitable for C.W. and telephony. (3) If separate H.T. and L.T. batteries are required for each valve. (4) If the tuner described on page 344 of September 3rd issue could be used for P.C.G.G. with a suitable amplifier.

(1) Difficult perhaps at such a distance, but not impossible.

(2) Quite.

(3) No; see many circuits in these columns.

(4) The circuit is quite good, and should give results with a 4 to 5 valve amplifier.

R.C. (Elderslie) asks (1) What windings to put on formers of a given size to get F.L. (2) Dimensions of pancakes to reach 2,000 ms. with a 0.001 mfd. condenser. (3) If a circuit sketched will be satisfactory.

(1) Primary $4\frac{1}{2}'' \times 6''$, wound with No. 28; secondary, $3\frac{3}{4}'' \times 6''$, wound with No. 30; but large coils wound with thicker wire would be preferable.

(2) Primary inside diameter 1'', outside 6'', wound with No. 24. Reaction coil, same size, wound with No. 26.

(3) Circuit will be O.K., but would be improved by a potentiometer to the second grid. You will also find 6 volts necessary for most receiving valves.

Correction to Advertisement.

Messrs. J. Lipowsky point out to us that an error appeared in their advertisement inserted in the last issue:—"Valves (Receiving) guaranteed, 1/-," should have appeared as "Valves (Receiving) guaranteed, 11/-." This error may perhaps have misled some of our readers.

SHARE MARKET REPORT.

Prices as we go to press. January 21st, are:—

Marconi Ordinary	£1	15	0
„ Preference	£1	15	0
„ Inter. Marine	£1	2	3

Radio Corporation of America:—

Ordinary	9	9
Preference	10	0

YOU COULD DO THIS

Messrs. Mullard Radio Valve Co., Ltd., Enfield, Middx.
Hammersmith.

Dear Sirs,

Regarding "ORA" Valves, using this valve alone I succeeded in receiving Panama on 9,300 m. and Java on 9,000 m. Panama is 7,000 miles west and Java is 9,000 miles east. For single valve reception these results must be approaching a record.

The "ORA" is undoubtedly a good valve which is offered at a reasonable price.

I am, &c., &c.

"ORA" VALVES

Price 15/- each.

Anode 30 volts. Filament 3.6 to 4.0 volts.

If your usual Wireless dealer cannot supply, forward the coupon and give his name.

Terms for quantities on application.

(The originals of the above letter, with similar testimonials can be seen at our offices on request.)

Oscillate-Rectify-Amplify



None genuine without this Mark

Mullard Radio Valve Co. Ltd

Claybrook Road,
Hammersmith, W.6.

Manchester Depot: 25 Market Street
Glasgow Depot: 206 Bath Street.

Contractors to
H.M. Admiralty, War Office
Royal Air Force & Post Office

Telephone: Hammersmith 312. Telegrams: Radiovalve, Hammers, London.

Codes:
ABC(9-2d)



9-10

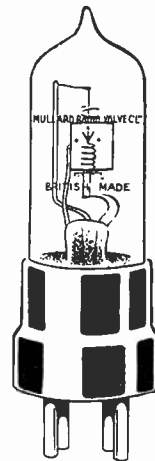

"ORA"
MULLARD VALVES
15/- Each



MULLARD PATENT
RESISTANCE
for Grid & Anode Circuits



MULLARD CONDENSERS



Mullard
4-pin Sockets

To the
MULLARD
RADIO VALVE
CO., LTD.

35, Claybrook Road,
Hammersmith,
London, W.6.

Please send me post free:

Quantity	Description and Price
.....	Mullard "ORA" valves ... each 15/-
.....	Mullard patent resistance combined with Mullard blocking condenser 12/6
.....	Mullard 4-pin Sockets Price 2/- each.

I enclose (cheque, money order, P.O.) for..... to cover the cost.

Name.....

Address.....

Name of usual Wireless Dealer.....

Address.....

Wires :
"EXONERATOR"
LONDON

ARNOLD, MACK & CO.
14 SUN STREET, FINSBURY SQUARE,
LONDON, E.C.2

'Phone :
LONDON WALL
7725

AMPLIFIERS

The desirability of obtaining these Amplifiers, while the opportunity lasts, cannot be too strongly emphasised, as apparatus of this calibre cannot again be obtained at such low prices.

A. Mark IV. - - - £5 10s. 0d.

C. Mark III. - - - £6 10s. 0d.

Note 1. The A. Mark IV. type used in conjunction with a simple tuning circuit constitutes a **complete Valve Receiver Amplifier**

Note 2, or again by a simple adjustment provided, this Amplifier may be used for Amplification **only** in conjunction with other apparatus.

Note 3. The C. Mark III. type is well-known for its high standard of efficiency as an **Amplifier.**

NOTICE.

TRANS-ATLANTIC SIGNALS RECEIVED.

Signals sent out by the American Amateurs were copied in LONDON during the recent tests and in one case read for a period of over two hours' duration.

The apparatus used in the accomplishment of this feat was of the well-known "OOJAH" make.

Not one, but every piece of apparatus used in the receiver was of "OOJAH" design and manufacture with the only exceptions of Valves, Telephones and Filament Accumulator Battery. This conclusively proves the superiority of "OOJAH" apparatus.

We beg to inform all wireless experimenters that we are the agents of "OOJAH" products in the S.E. district, and guarantee you first-class service.

Full particulars of the apparatus used in the tests with an illustration of same and diagram of circuits employed will be forwarded free of charge.

Have you tried OOJAH components ?

Set of 8 Slabs, 300 to 30,000 metres, complete with useful circuits, 15/- post 9d.

Set of 7 Baskets, 400 to 5,000 metres, complete with useful circuits, 10/- post 6d.

Vernier Condenser, Distant Control 6/3 post 6d.

Grid Leak and Condenser 6/- post 6d.

Look for Registered "TRADE MARK."

SCIENTIFIC SUPPLY STORES,

8, NEWINGTON CAUSEWAY, LONDON, S.E.1

'Phone: Hop 4177.

SLAB INDUCTANCES.

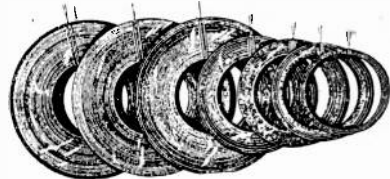

Per set of 8, range 300 to 30,000 metres, 15/-, postage 9d.

Per set of 7, range 300 to 25,000, 12/6, postage 9d.

These Inductances are useful as Aerial Tuning Inductances, Reaction Coils, Loose Couplers, Variometers, etc., and specially useful with "Radio Constructa" stand and holder, see page xiv.

Basket Inductances.—Specially wound for Dutch concert and general telephony, 3/6 per pair.

Vernier Condensers indispensable for fine tuning for telephony, 6/6, postage 6d.

36-Volt H.T. Battery, with Wander Plug. See illustration in previous number, 7/6, postage 9d.

15-Volt Unit, 3-terminal type, 3/6, postage 6d.

Pin Type Transformer to fit into R-Valve Socket in eight stages, from 6/- 300 metres, to 14/3 24,000 metres. Telephony range, 6/9 each. Postage 3d. in each case. The whole range of eight mounted on ebonite panel, with primary and secondary tapings, 52/6.

OUR NEW LIST (over 100 Illustrations), **POST FREE, 4d.**

H. D. BUTLER & Co.,

Showroom and Works : **61, Borough Road, Borough, S.E. 1**

3 minutes from Borough Tube Station.

Office : **BANK BUILDINGS, 222, GT. DOVER ST., S.E. 1**

Telephone : Hop 3029. Teleg. "Ingenuity," Phone, London."

All our goods obtainable at the
Army & Navy Co-Operative Society, Ltd.,
105, Victoria Street, S.W.

LESLIE McMICHAEL, M.I. Radio E.

PROVIDENCE PLACE

Telephone—
HAMPSTEAD 1281

KILBURN, N.W.6

WEST END LANE (Bus Services 1, 8, 16, 28, 31
all pass West End Lane.)

Nearest Tube Station: Kilburn Park (Bakerloo)

WESTERN LOUD SPEAKER

This instrument is capable of magnifying the production of signals to a remarkable extent, and the name of the maker is sufficient guarantee as to the workmanship. **Perfect for speech production. Complete on mahogany base, as illustrated** £3 (Low Resistance)

Only a limited quantity available.



I AM A BUYER

of every description of good,
up-to-date, and professionally made

WIRELESS APPARATUS

second-hand or new.

Send particulars of any goods suitable for resale, together with **lowest** cash price.

TOWNSHEND WAVEMETERS

STILL AVAILABLE

As supplied by me recently to the Royal Air Force **£3 15s.**

MARK III* TUNERS **£4 10s.**
Condition New

Send your wireless orders or enquiries.

Carriage paid on retail orders of £2 and upwards.

THE WIRELESS EQUIPMENT CO.

RADIO TELEPHONY

The very latest and most Efficient method of Transmitting Speech and Music is now placed on the Market, combining **ROBUST DESIGN, NEAT FINISH, and EXCELLENT WORKMANSHIP**, at an extremely moderate figure.

The design of this Radio Transmitter incorporates methods of Control by which the finest range of Adjustments can be easily and quickly obtained. The Grid Control, being scaled, permits of the best adjustments being obtained and permanently noted for future reliable use. Thus, the Experimenter can change the Wavelength Output and Degree of Modulation without fear of failure to obtain the best results. The Transmitting Set is constructed in two separate units, one comprising the Patent Control and Power Unit, and the other, the Tuning Coils. The price of the above units are as shown below.

Control and Power Unit - £8 Inductance Unit (for 1,000 metres) - £5
Complete Set, comprising both the units as above, also including Special Microphone & Key **£13**
Full Instructions are supplied with each set. **Valves Extra.** Power output of these sets from 1 to 50 Watts.
Inductances constructed to any W/L to order.

HIGH FREQUENCY AMPLIFIERS

The WIRELESS EQUIPMENT Co. are placing a new type of H.F. Amplifier on the market confident that it is the most efficient instrument possible to produce, containing specially designed transformers, the result of much experimenting. The Amplifiers are of the finest workmanship and contain potentiometer and filament control, the price at the same time being very moderate.

Wavelength range 600 to 3,000 metres. Other wavelengths to order at shortest notice.
Price (less valves) **3-Valve Amplifier - £4 : 17 : 6** **5-Valve Amplifier - £7 : 7 : 0**

Illustrated Price List sent upon receipt of stamp to

Works:
Wickford, ESSEX.

Experimental Station:
Brentford, MIDDLESEX

Offices & Test Department:
22, PARK ROAD
Colliers Wood, S.W.19

Agents for Holland: **RATABOS DAVENTER**

NOTICE to purchasers of "Polaris" Wireless Receiving Instruments.

Marconi's Wireless Telegraph Company Limited GIVE NOTICE that an Order was made by Mr. Justice Eve on the 12th July last restraining Messrs. A. W. Gamage, Ltd. from infringing their Letters Patent No. 13636 of 1913 and 28413 of 1913. Messrs. Gamage were further ordered upon oath to destroy all "Polaris" receiving apparatus, and to pay the Marconi Company £150 as the agreed damages and also to pay the costs.

The Marconi Company are in a position to take proceedings against any purchaser of "Polaris" receiving apparatus for infringement of their patents.

The Marconi Company are prepared, however, to allow purchasers to continue to use the apparatus on payment forthwith of a sum equal to 10 per cent. of the purchase price of the apparatus in respect of its past and future use.

Purchasers desiring to obtain permission to continue to use such apparatus should therefore communicate with the Marconi Company immediately.

Marconi House,
Strand, London, W.C.2.

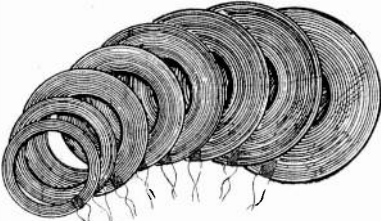

"OOJAH" Slab Inductances (set of 8) 300-30,000 metres 15/-
Set of blueprint curves (8) and circuits for above ... 4/-
"OOJAH" Basket Inductances (set of 7) 300-5,000 metres 9/6
Pair of Basket Inductances specially wound for Dutch Concert 3/6

Applications are invited for Agencies in all parts of the United Kingdom (London excepted). Write in the first instance to—
Box "OOJAH" c/o Messrs. BERTRAM DAY & Co., Ltd., 9-10, Charing Cross, S.W.1., enclosing business Card—

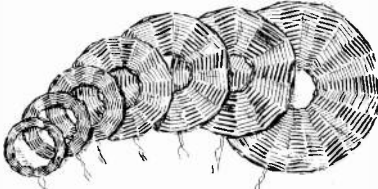

Actual Size
120 ohms

Terminals (plated), 4 BA, per doz.	2/6
Terminals, 2 BA single, per doz.	9d.
Contact Studs, per doz.	6d.
Marconi Balanced Crystal Receiver No. 16	45
Dutch Concert Tuner, post free (see last advertisement)	7/-
Valves (Receiving) guaranteed	11/-
Valve Holders, each	1/9

J. LIPOWSKY, 614, OLD FORD RD. Bow.
LONDON, E. Phone: East 3345.

SURPLUS

All the lines I have hitherto advertised, and which I shall advertise in future, are goods which I shall be able to repeat in years to come. This week I am giving a list of odd articles which have accumulated, and as they do not conform to my ideals, I am offering them at extremely low prices to clear, while they last, cash with order, postage extra.

2 only Wheatstone Bridges by R. W. Paul, direct reading 0'05 to 100 ohms	35/-
10 gross screws, 4 B.A. x 3/16"	3d.
8 gross screws, 6 B.A. x 5/32"	2d.
7 gross screws, 8 B.A. x 3/32"	2d.
23 Ader receivers	6/-
17 3-magnet generators, less handle	6/-

My standard lines are : Covered wires, see issue of 7th January. Sundry items, see previous issues. Ebonite, see next issue.

A. HINDERLICH, Central Hall, Southall.
Phone : Southall 121.

FOR SALE.

Wilson Transmitting Set, 130 Watt, complete with Interrupter	130/-
New Nickel Plated Microphones and Receivers ..	5/-
100 Volt Polished Mahogany Battery Boxes, with 6 Plug Sockets and 2 Plugs and leads (new) ..	5/-
60 Volt Battery Boxes with Plugs and leads ..	3/-
Triple Detectors in Ebonite Case (Crystal) ..	7/6
Microphones with replaceable insets, standard size Insets only, in tins	2/6
Silk Wire Basket Coils, set of four	1/6
New Mahogany Instrument Cases, with Brass Lock and Key, complete with Leather carrying straps (dovetailed)	2/6
Mk. III Change-over Switches	9/-
	5/-

All Carriage Paid. Apparatus of all kinds in Stock.

C. S. SWAN, 65 Windsor Rd., Leyton, E.10

URIAH BEATON'S BARGAINS.

Wireless Relays, Polarised, 10000 ohms, Siemen's .. each	150/-
Wireless Relays, Polarised, 10000 ohms, Roose's .. each	175/-
Strip of 10 Jacks, 2 Plugs and Cord, <i>Special Offer</i> .. each	5/-
Relays, Bright's double tongue each	12/6
Sullivan's Headphones, 120 ohms, with cord .. each	3/9
Watch Receivers in working order, <i>Special Offer</i> .. each	2/-
Double Headphones, 2000 ohms, in order, with cords each	6/6
Switch Contact Studs doz.	1/-

Packing and Postage Extra. Stamp for Reply.

ESTABLISHED 25 YEARS.

45, CHALK FARM ROAD, N.W.1

"R" TYPE VALVES

Price 11/6 post free

"ORA" V. Filament Valves ...	15/-
Valveholders 1/9, 2/- Screw Legs 2/6	
36 volt H.T. Batteries	8/-

All Items cheaper to callers. Registration 4d.

RUSSELL AND SHAW,
38, Great James St., Bedford Row, W.C.1

From Holborn through Brownlow Street, or Hand Court

Established 1900.

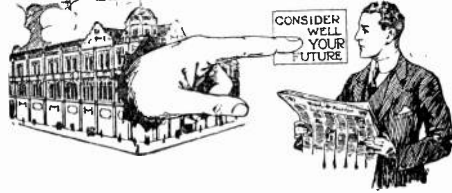

ARE YOU QUALIFIED? FOR THE JOB YOU SEEK? IF NOT—WHY NOT?

What Proof of Efficiency do YOU Carry? Your word to an employer is not proof that you are efficient, but a College Qualifying Diploma or Certificate signed by the Professional Staff, is a proof of efficiency, and a valuable asset in seeking a remunerative position.

If you are preparing for any exam. ask our adv. ce. We specialise in all exams. connected with technical subjects. All particulars FREE OF CHARGE. Parents should seek our advice for their sons.

CHALLENGE.

We are prepared to produce on demand 6,000 unsolicited testimonials from successful students or pay £100 to any charity you appoint. Having helped 6,000 to prosperity, surely we can help YOU. If you are interested in any of these subjects write, naming the subject, and we will send our FREE BOOKLET.

Please State Your Age.

ADVICE FREE.

WE TEACH BY POST

the following subjects:

- Architectural Drawing
- Building Construction
- Clerk of Works Duties
- Aviation
- Boiler Engineering
- Boiler Making
- Chemistry
- Civil Engineering
- Concrete and Steel
- Draughtsmanship
- Electricity
- Engineering
- Foundry Work
- Internal Comb. Engines
- Marine Engineering
- Mathematics
- Matriculation
- Metallurgy
- Mining
- Motor Engineering
- Naval Architecture
- Pattern Making
- Salesmanship
- Sanitation
- Shipbuilding
- Structural Engineering
- Surveying and Levelling
- Telegraphy & Telephony
- Wireless Telegraphy

Special Course for Apprentices



WIRELESS TRAINING COLLEGE LTD.

ST. MARY ST., CARDIFF, & NEPTUNE CHAMBERS, VICTORIA ST., BRISTOL.

The above Colleges are amongst the most successful in Great Britain for quickly qualifying Students for the Wireless Service. We have, since the outbreak of War, passed over 1,000 Students to Wireless Appointments. Two Systems are taught, the Marconi and Siemens Quench Spark System. We make a speciality in training ex-service men who have some knowledge of Wireless. Ex-service men can have a free test to ascertain the time it would take to qualify them if they will call at the College.

For Terms apply to—

LIEUT.-COMDR. J. R. SCHOFIELD, M.B.E., R.N.V.R. (C), Principal.

P.S. Every student who qualified at our Colleges was placed in a permanent situation.

P. ORMISTON & SONS
 (P. H. ORMISTON) :: ESTABLISHED 1793
 79 Clerkenwell Rd., London, E.C. 1
 "Ormiston, London." :: :: 13259 Central

Silk and Cotton Covered H.C. Copper Wire, Resistance Wires, Fuse Wire, Binding Wires, Charcoal Iron Core Wire, Asbestos Covered Wire, Braided and Twisted Wires, Bare Copper Strand and Flexibles of any Construction, Wire Ropes and Cords (fine sizes) in Galvanized Steel, Phosphor Bronze, &c.



READ'S for WIRELESS
 Sole Agents Wireless Trade for the
GIBSON PATENT TERMINAL COMPANY



Write for Illustrated Leaflet GW.
 New type of 2 and 3-valve amplifiers, low frequency, panel type.
 Price—
 £6 6 0 & £11 11 0
 Write for Illustrated Leaflet AW.
 We also manufacture to customers' own requirements, any small accessory, receiving or transmitting panels.

GIBSON'S TERMINALS TAC-END TYPE

F. O. READ & CO., LTD.
 Mechanical House, GREAT QUEEN ST., KINGSWAY, W.C.2 'Phone : Gerrard 442

SHEET, ROD AND TUBE stocked in qualities suitable for all Wireless work.
KNOBS (Moulded), various patterns stocked
CONDENSER SCALE BLANKS,
CONDENSER COVERS,
 ETC. ETC.

EBONITE
 (HARD RUBBER)

Enquiries Solicited.

WHOLESALE ONLY.

AMERICAN HARD RUBBER CO.
 (BRITAIN) LIMITED
 13a, FORE STREET, LONDON, E.C. 2.
 Telegrams : "Eboniseth, London." 'Phone: Central 12754



HINGED LID
 RECESS FOR PLUG LEADS

— Ex-"W.D." —
H.T. BATTERY BOX
 Fine polish mahog.
 6 plug sockets, 2 plugs
BRAND NEW
5/-
AERIAL INSULATORS
 Ebonite - Brass eye
 4/- Doz.



LESLIE DIXON & CO.
 (Dept. W.), 9, Colonial Avenue, Minories, E. 1

Tel. Address— Telephone—
 "Gardlocket, Fen, London." 1650 Avenue (3 lines).

GARDNER, LOCKET and HINTON, LTD.
 LONDON, CARDIFF, NEWCASTLE-ON-TYNE, GLASGOW, ETC.

Quotations and Specifications given for all descriptions of Welsh and other Steam and Manufacturing Coals.

Apply to Head Office:
13, FENCHURCH AVENUE, E.C.3

THE WIRELESS AGE THE AMERICAN MONTHLY JOURNAL OF WIRELESS TELEGRAPHY AND TELEPHONY
 A "Go-a-head" Magazine for Operators and Amateurs.

Sole European Agents : THE WIRELESS PRESS LTD., 12-13 Henrietta St., Strand, London, W.C.2

Get the most out of your valve
by using a—
**SUPER VII
RECEIVER**

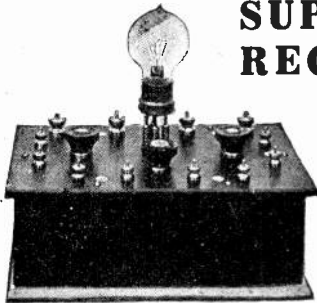

PRICE
£3 15 0
without valve

Single valve reception of telephony and music that cannot be bettered, will make your loose coupler work wonders on all wavelengths. Ask the man who owns one. He is satisfied. You could spend four or five times the price and not get better results.

WRITE FOR FULL PARTICULARS

Agents—

RUSSELL & SHAW, 38, St. James St., Bedford Row, W.C.1
G. H. PARKER, 10, St. James Parade, Muswell Hill
E. T. CHAPMAN, A.M.I.R.E., Abbotsford, Serpentine Rd.,
Poole, Dorset

GORDON CASTAGNOLI

MANUFACTURER OF WIRELESS APPARATUS
15, Rayne Road, Braintree, Essex

Sole Agent for Scotland: WILLIAM KERR DEWAR,
206, Bath Street, Glasgow.

MORSE MEMORIZING BY SOUND

The New Way of Learning the Code

The easiest, quickest and most thorough ever devised
for learning without instruments.

**DON'T TRY TO TEACH THE EARS
THROUGH THE EYES**

GET ONE OF THESE CARDS

This System teaches the signals as they come
through the Head 'Phones.

Printed on two celluloid cards
which fits your vest pocket.

Contains both Continental and American Morse.

PRICE **2/6** NETT.
(Postage 2d.)

THE WIRELESS PRESS, LIMITED

Dept. W.W.,

12/13, Henrietta St., London, W.C.2

DIARY & NOTEBOOK FOR 1922 FOR WIRELESS OPERATORS & AMATEURS

Price **3/6** Net. :: Post **3/9** free.

In best leather cases, with two
pockets, card and stamp divisions

**Complete with Special Sections to meet
requirements of Operators and Amateurs**

When ordering please specify
whether for Operator or Amateur

1922 REFILLS

FOR OPERATORS' & AMATEURS' DIARIES

Price **1/6** Net. Post **1/8** free.

THE WIRELESS PRESS, LTD.,
12-13, Henrietta St., Strand, London, W.C.2

A NEW BOOK FROM AMERICA.

Prepared Radio Measurements

with

SELF COMPUTING CHARTS.

By RALPH R. BATCHER, A.M.I.E.E.,

Price **10/6** Nett.

(Postage 5d.)

The Charts included in this book represent formulae
that are apt to occur in ordinary computations.

**THEY ARE DESIGNED TO ELIMINATE
ALL MATHEMATICAL WORK**

except in a few cases when it is necessary to
evaluate simple ratios, AND REQUIRE NO
SPECIAL EQUIPMENT.

The accuracy of these charts is above that with
which the various factors that enter into the
formulae can be measured with ordinary means.

The Wireless Press, Ltd.,

Dept. W.W.,

12-13, Henrietta Street, London, W.C.2

THE WIRELESS WORLD EXCHANGE AND MART

TARIFF. Advertisements are accepted for this Section at the rate of twopence per word, with a minimum charge of two shillings. The advertiser's name and address will be charged for, and single letters or single figures will be counted as two words. Compound words will be counted as two words.

DEPOSITS. All advertisements must be prepaid in the form of Postal Orders, the remittance being forwarded to Messrs. Bertram Day & Co., Ltd., 9 & 10, Charing Cross, S.W.1.

Intending purchasers may deposit the purchase money of any article advertised or sold by advertisers with Messrs. Bertram Day & Co., Ltd., who will acknowledge its receipt to the vendor and the depositor, the full addresses of whom should be given. Subject to special agreement between the parties, it is understood that all goods are sent on approval, each party paying carriage one way in the event of the goods being returned. The deposit will be retained until due advice of the completion of the purchase has been given or until the articles have been returned and accepted. In order to cover postage, etc., a fee of 6d. in respect of sums of £1 and under and 1s. for sums in excess of £1, must be paid at the same time as the deposit. For persons not resident in the United Kingdom these fees are doubled. We cannot undertake to receive any deposit less than 2s. 6d.

Deposits must be sent by either Postal Order or by Registered Letter; cheques will not be accepted. If the deposit is sent by Money Order it should be made payable to the advertiser of the goods, and the fee mentioned above should be sent in stamps or Postal Orders as a separate amount.

Startling Reduction IN THE PRICE OF WIRES

Double Cotton Covered, and Enamelled, all orders wound on reels. Nos. S.W.G.

Double Cotton Covered.—16, 2/2; 18, 2/3; 20, 2/7; 22, 3/-; 24, 3/8; 26, 4/3; 28, 5/1; 30, 6/2; per lb., plus postage.

Enamelled.—20, 2/8; 22, 2/10; 24, 3/2; 26, 3/6; 28, 4/-; 30, 4/5; 32, 4/7; 34, 4/10; 36, 5/4 per lb., postage.

INSTRUMENT CASES.

We make any type of small cabinets for wireless work. Send rough sketch and measurements. Large or small orders.

Trade supplied at special cut prices.

BOWER & CO., 15, Kingston Road, Wimbledon, S.W.19.

I Buy Wireless Gear of every description.

Send your particulars to:

WILKINSON,
Lonsdale Rd., Kilburn, N.W.6

Make your own Cigarette & see what you save.

ALWAYS USE A.G. CIGARETTE PAPER BEST & PUREST

TECHNICAL BOOKS.—Second-hand and New Books on every conceivable subject. Catalogue free. State wants. Books sent on approval. Books bought.—**FOYLE, 121-125, Charing Cross Road, London.**

WIRELESS AND ELECTRICAL LIST: 55 huge pages full of useful information, post free.—**THOMSONS, 5, Westboro, Scarborough.**

TO ALL USERS OF Terminals: We hold a stock of 150 varieties and can deliver by return. Illustrated list, two stamps.—**ELECTRICAL SUPPLY STORES, 5, Albert Terrace, King Cross, Halifax.**

ADVERTISER (25), seeks progressive position, any capacity, seven years in charge wireless stations. Siemens' Marconi and Radio Systems, seven months test room assistant, general mechanical knowledge.—Write P.G., c/o 54, New Oxford Street, W.C.

ADDITIONAL CAPITAL required for amateur Wireless Company, doing good business. Interest guaranteed.—Apply to Solicitors, **NASH, FIELD & CO., 12, Queen Street, Cheapside, E.C.**

FOR SALE.—Mark III Tuner Panels (less Buzzers, Condensers), but mounted with Loose Coupler, Potentiometer, Detector, 2 Changeover, 5 and 19-Way Stud Switches, Case, £1 5s. 6d. carriage paid. Ammeter, 0-300 amps, 30s. Series Parallel Switches, 2s. 6d. Carbonadium Detectors, 2s. 6d. Tapping Keys, 3s. Telephone Cords, 4-way, 2-way, valves, boxes, terminals, terminal lugs basket coils, 1 dozen 4s. Potentiometers, 5s. X-ray Switchboard (marble), £1 10s. Massive Copper Spark Gap, 10s. Stamp particulars.—**A. VALINS, 34, Pelham Street, Brick Lane, London.**

NEW "R" VALVES, Osram and Ediswan, ros. 6d. Postage and registration extra.—**WHALE & CO., 201, Powis Street, Woolwich.**

LEIGH WIRELESS AMATEURS and others please note that Wireless Accessories can now be obtained at 113, Leigh Road, Leigh-on-Sea. Compare prices. R Receiving Valves, ros. 6d. to callers, postage extra.

EFFICIENT RECEIVING SET.—Two-valve resistance amplifying panel, with capacity reaction and valves. Inductances, 300 to 30,000 in case with selector switch, .001 variable condenser, Brown's H.R. telephones, 4-40 accumulator, H.T. in case, Hesketh filament resistance, double slide tuning inductance, £15 or near offer.—61, Mortimer Road, N.W.10.

SOS EX MARCONI OPERATOR, with commercial education, First Class P.M.G. Certificate, experience with Valves, Bookkeeping, Type-writing, drive motor car and do all running repairs, wants work of any description with anyone, anywhere. Home or Abroad. Anything reasonable accepted.—**F. F. WARNER, High Lane, Stockport.**

REPAIRS.—Macedgould, Scientific Instrument Maker, 1, Devonshire Road, Hastings. Voltmeters, ammeters, galvos, recorders, repaired. Write for estimate.

SITUATION WANTED, Disabled ex-Air Force, Corporal, age 23, Telegraphist, Mechanic, anything wireless.—**TOVELL, 84, Camden Road, Ipswich.**

NEW VALVES FOR OLD!—Send dud Valve (any make) with 8/- for Filament Repair. Delivery by return, post free. Guaranteed equal to the most expensive. Also—Ebonite Valve Holder Boards, 3-valve, new, engraved, ready drilled, only 1/3, two for 2/3. Telephone Leads, new, per pair 2/-, two pairs 3/6. All post free. Stamp for lists.—**GENERAL RADIO, 24, Beaumont Avenue, Richmond, Surrey.**

New French "R" Type Valves
at 11/6 each, Reg. post free.

EBONITE, Sheet $\frac{3}{8}$ " thick,
per sq. foot .. 10/6
" Sheet $\frac{1}{2}$ " thick,
per sq. foot .. 6/-
" Sheet $\frac{5}{8}$ " thick,
per sq. foot .. 4/-
" Rod $\frac{1}{2}$ " thick,
per foot .. 6d.
" Rod $\frac{5}{8}$ " thick,
per foot .. 8d.

H.T. Units, 15 volt .. at 4/-

MORGAN & TAYLOR,
146, KING'S ROAD, CARDIFF.
Telephone 1239.

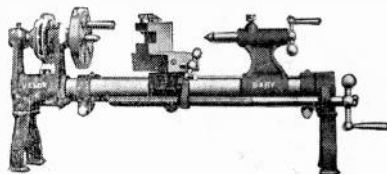

TOO CHEAP to be GOOD, yet the above is used in the manufacture of Electrical Instruments, Typewriter and Clock Parts. If good enough for these, **WHY not YOURS?**

Complete as illustrated - - £5 - 15 - 0
" without Slide-rest £2 - 15 - 6

Stamp for Leaflet:

VELOX TOOL CO.
255, Westgate Road, Newcastle-on-Tyne.

B Mark I, 2-Valve Receivers	6 s. 0	2 15 0
3-Valve French Amplifiers	3 s. 0	3 5 0
3-Valve Mark IV Amplifiers	5 s. 0	5 0 0
Marconi 20-Watt Spark Coil Condenser		
Morse Ke; and Spark Gap. In case	2 s. 0	2 0 0
Ditto, Smaller Set, no Gap	1 s. 15	1 15 0
(All above in Mahogany Cases and Strap.)		
H.T. Battery Boxes. Fine Polished Mahogany, Filled 6 Plug Socket, 2 Plugs and Cords. Detachable Lid, size 11 ins. by 7 ins. by 3 ins., each	0 s. 5	0 5 0
Light Ebonite Aerial Insulators, Brass Shackles	0 s. 0	0 0 6
Palmer Rubber R.A.F. Aerials 3ft., each	0 s. 2	0 2 6
Porcelain Pedestals, Ribbed Brass Stem, each	0 s. 2	0 2 6
Earth Mats, Copper Mesh, Brass Bound, each	0 s. 12	0 12 6
Ammeters and Voltmeters. Flush Switchboard	0 s. 10	0 10 6
6-Volt New P. & R. 40/80 amp. Accumulators	2 s. 10	2 10 0
Marconi Alternators, $\frac{1}{2}$ k.w. and 2 k.w.	10 s. 0	10 0 0
A.T.I. 8-Way Lever Switches. Ebonite Base	0 s. 7	0 7 6
H.P. 220 Volt A.C. Motors	10 s. 0	10 0 0
Shunt Dynamos, 12/16 Volts 10 amps.	6 s. 10	6 10 0
D.C. Motor Generator, Direct Coupled A.C. 220 Volt to 25 Volt 10 amps. for Battery Charging	33 s. 0	33 0 0
SLATE PANELS, CABLE AND WIRE MOTORS AND DYNAMOS.		

LESLIE DIXON & CO.,
9, Colonial Avenue, Minories, E.1.

THE WIRELESS WORLD EXCHANGE AND MART

SOMETHING NEW. POLE FINDERS

2 volt to 250 volt
Post **5/6** free

WILKINSON, Lonsdale Road, Kilburn, N.W.6
Every wireless experimenter should possess one

H.F. "Concerttransformers" 1,000 metre, "Plug-in," 8/6.
.0003 Variable Condenser for tuning above, 15/-. (Really fine results for telephony using these two.)
Set of Seven "Compactum" Tuning Coils, 300-25,000 metres, 12/6.
Complete Crystal Receiving Sets, 38/-, 42/-. Sets of parts to make amplifiers, 30/-, 40/-, 50/.
Fl. Resistance on ebonite hobbins, 3/3.
Fl. Resistance and Valve Holder on ebonite, 6/6.
Switch Arms, 1/6; Contacts, 1/6 doz.; Terminals, 2½d.

GET OUR LIST OF PARTS.
AMATEUR SUPPLIES, 134, Coteford Street, Tooting, London.

DONT READ THIS

if you are a millionaire.

Dutch Concert Tuners

7/- post free.

J. LIPOWSKY, see Terminal advert.,
614, Old Ford Road, Bow, E.

WANTED.—Tenders for the purchase of a wireless set, very powerful. Purchaser must dismantle.—Write W. & A. T. B. Eling Wharf, Totton, Southampton.

MARK III STAR TUNER (New), B Mark Star, 2-Valve Receiver (new), less transformers; 5-stud Solenoid Inductance, polished case, gins. by gins.; pair Brown's adjustable 8,000 telephones, perfect; Brown's Telephone Transformer—Lot £8 or offer.—HUGHES, 10, Friday Street, Henley, Oxon.

COMPLETE RECEIVING HEAD-PHONES, "Verity," 2,000 ohms. Never used, pre-war, 35s., offer.—LAURENCE, 62, Whitehall, Park, N.19.

ENGRAVED EBONITE CONDENSER DIALS, 4s. 6d. Engraved Ivorine Scales, 0 to 180° including brass pointer, 1s. 6d. Variable Condensers, .0003 mid., 15s.; .0005, 18s. Filament Rheostats, laminated, four-leaf switch arms, including bronze tension spring, bush, washers and nuts, 3/- Valve Holders, 1s. 6d. Rotary Vane Vernier Condensers (assembled), 5s. 6d.—M. FOSTER, 15, Western Street, Brighton.

EDISON RECORDS.—New Blue Amberols, list free.—ROBINSON, 333, Hainton Avenue, Grimsby.

EX-SERVICE MAN, First Class (P.M.G.), also experience with amateur wireless, requires situation. Anything connected with wireless.—COTTAM, Jews House, Strait, Lincoln.

TWO CROMPTON 24 H.P. Motor Generators, for wireless, and Two 40-ft. Sectional Masts. Low prices.—THE LONDON ELECTRIC FIRM, Croydon.

BRAND NEW MARK I Aircraft Valve Tuner, 60s., Transmitting Transformer, 185-200 volts to 5,000. Step-down Transformer, variable, 3-26 volts. Patent Crystal Detector, 5s. 43-Plate Variable Condenser, moving dial, 20s. Holtzer-Cabot 3,000 ohm head-gear, 30s. Pair wall telephones with transformers, 12s.—PELLY, 10, Cavendish Avenue, Eastbourne.

EFFICIENT CRYSTAL SET, 200-4,500, complete with potentiometer and aerial, £3.—JONES, Victoria Road, Gillingham, Dorset.

B.T.H. PORTABLE WIRELESS RECEIVER, as new, ready for operation, in original packing case, cost £35 accept highest offer. Semen's G.P.O. Polarised Relay 35/-. 2 Edison Phonographs suitable for recording. 15/- each—FITZHUGH, Pangbourne, Berks

More Bargains!

Single Valve Transmitter and Receiver Mk. 1 (two star) ex-Military 120/-
A. Mk. IV. Amplifiers 120/-
Two Valve 80 meter Receivers 45/-
Spark Coils in case with key 40/-
Wavemeters from 30/-
Variable Condensers '001 new 40/-
Mk. III: Tuner Cases 7/6
Ebonite, Mica, Copper Foil and all sundries

Send 2d. Stamp for PARTICULARS & ADVICE to
RADIO EXPERIMENTAL CO.
103, Gell Street, SHEFFIELD.



Solid Mahogany Instrument Cases,
new, 13x8x6

Hinged lid. Brass lock and key.
9/- post free. Trade supplied.
A. VALINS, 34, Pelham Street, Brick Lane, London, E.

FOR SALE WIRELESS SCHOOL IN SCOTLAND. Established - - 7 Years.

R.A.F. Telephone and C.W. Transmitter recently installed.
The present proprietor, owing to special circumstances, is desirous of disposing of this growing concern at a very moderate cost. A splendid opportunity for a young enthusiast with a small capital to obtain a bargain. Those interested should write to Box "15," c/o Bertram Day's Advertising Offices, 9-10, Charing Cross, S.W.1. when all particulars will be supplied to them.



Ship Design.
Boiler Making.
Aeroplane Design.
Aero Engines.
Structural Engineering.
Civil Engineering.
Municipal Engineering.

Surveying and Levelling.
Reinforced Concrete.
Building Construction.
Sanitary Science.
Plumbing.
Heating and Ventilating.

Tell us which subject mentioned below interests you, we will then immediately post you on a very interesting FREE BOOK pointing out your chances of success and explaining how we can give you just that knowledge to qualify you for a BETTER JOB. We also help to place you in a good position with high wages. *WE TEACH BY POST in your spare time and in your own home.* The Directors of the Institute highly recommend each of these Postal Courses, not only to the OLDER MEN, but also to APPRENTICES, and to Parents of lads leaving school.

Wireless Telegraphy.
Electrical Engineering.
Electrical Installations.
Electrical Control Gear.
Alternating Current.
Lighting (Electric, Gas, etc.)
Telegraphy.
Telephony.
Power House Operation.
Mechanical Engineering.
Internal Combustion Engines.
Draftsmanship.
Workshop Practice.

Machine Tools.
Electric Welding.
Mathematics.
Commercial Engineering.
Motor Engineering.
Electric Motor Car Ignition.
Starting and Lighting Systems.
Boiler Inspecting.
Engineers' Quantities and Estimating.
Marine Engineering
Naval Architecture.



EXAMINATIONS:—We specialise in the following Exams.:—A.M.I.E.Mech.E.; A.M.I.E.E.; A.M.Inst.C.E.; A.M.I.A.E.; Board of Trade Marine 2nd Class, 1st Class, Extra 1st Class; City and Guilds Examinations in Telegraphy, Telephony, etc.

Write for this Book to-day. It may mean the turning point of your career. Do not forget to mention the subject which interests you.

THE TECHNOLOGICAL INSTITUTE OF GREAT BRITAIN, LTD.
32, Thanet House, 231 and 232, Strand, London, W.C. 2.

RESOLUTIONS

Now that we have acquired larger works, we have resolved to offer the Amateur the benefits derived from up-to-date machinery and mass production methods. We have therefore made substantial **REDUCTIONS** in many cases as shown below.

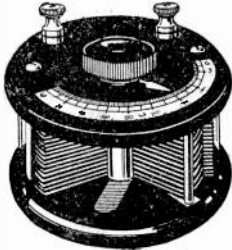

VARIABLE CONDENSERS
Die Cast Pattern
Enclosed in Celluloid Case, top and base of Bakelite.

'0006 ...	25/-
'0011 ...	32/6

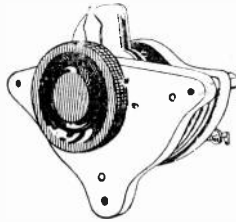

ANOTHER SNIP

DIE CAST CONDENSERS
Fitted with counter balance weight and engraved revolving dial, exactly as illustrated.

'00055 ...	25/-
'0011 ...	27/6

These are also specially designed for mounting on own panel.

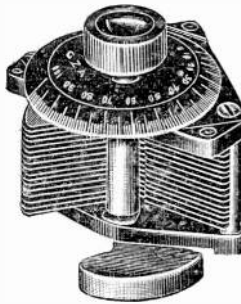

A MOST USEFUL CONDENSER
For Fine Tuning
Designed for panel mounting as illustrated.
Price 6/9



FILAMENT RESISTANCES
Resistance wound on Erinoid Former, knob fitted with brass bush and pointer ... Price 5/6 each



CONDENSER VANES
Stout Aluminium.

Per pair ...	3½d.
Washers, Rotary ... doz.	1/-
Fixed ...	3½d.



For Fine Adjustment.
EBONITE KNOB, fitted with brass bush and pointer, also 1/6" extended handle with knob as illustration 1/9

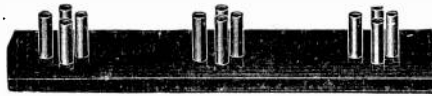

A series of 3 Valve Holders mounted on 1/2 in. ebonite base. All brass work lacquered...4/6



VALVE LEGS, with 2 nuts, lacquered ... 3d. each



INTERCHANGEABLE H.F. TRANSFORMERS
These have been fully described in previous issues of W.W.

300 ...	5/-	4000 ...	7/6
600 ...	8/-	6000 ...	8/6
1000 ...	6/6	12000 ...	9/6

Condensers to suit ... 15/-
Formers only ... 3/6



GRID LEAK Mounted on Condenser
Substantial : Reliable : Cheap
Leak between clips. Any value Complete ... 5/-
Leaks only (with clips) ... 2/6
Condensers ... 3/-

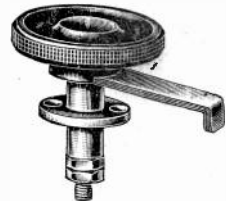

SWITCH ARMS
Undoubtedly the best value offered the amateur.
Ebonite knob, brass bush, 4 leaf contact, 2 nuts, all lacquered 2/9

To the TRADE

To Bona Fide Dealers, we are now able to quote keenest prices for instrument making of component parts.

MORSE READING CONTEST

- 1st Prize—Mr. Junks, Park Place, Lochee, Dundee.
2nd ,, A. J. Berman, Achterweg 24, Heemslede, Holland.
3rd ,, J. A. Gorton, 4, Arundel Rd., Weston-Super-Mare.

WORKS :
ELMORE STREET.
N. 1.

G. Z. AUCKLAND & SON

OFFICES & SHOWROOMS :
395 ST. JOHN ST.,
LONDON : E.C.

THESE GOODS CAN ALSO BE OBTAINED FROM :
CORELLI & RELLY, 48a, Grove Road, Eastbourne.
WESTCOMBE WIRELESS SUPPLY, 105, Eastcombe Avenue, Charlton, S.E.7.

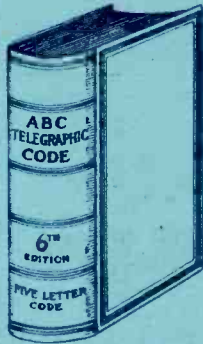

AN ENTIRELY NEW WORK.
The ABC Telegraphic CODE 6th Edition

FIVE-LETTER CODE.

An up-to-date Work, containing Five-letter Artificial Code Words with at least a TWO-letter difference and a **TERMINAL-INDEX** of the words at the end of the Book.

Cost of Cabling brought to a Minimum :: Simple to Use.

PRICE **£3 3s. 0d.** net (U.K. and Colonies.)

Inland Parcel Post 1/6 per copy. Continental Book Post 2/- per copy.

Publishers:—

EDEN FISHER & CO., LTD., 6, 7 & 8, Clements Lane, E.C.4
 And 95, 96 and 97 Fenchurch Street, London, E.C. 3.

ACCUMULATORS

SPECIAL OFFER—

ABSOLUTELY NEW — NOT EX-GOVVNT.

4 Volt.	40 amp.	18/6
4 ..	60	21/6
4 ..	80	24/6
4 ..	100	29/6
6 ..	40	24/6
6 ..	60	32 6
6 ..	80	35/6
6 ..	100	44/6

ALL OTHER SIZES QUOTED FOR.

Large Stock **DYNAMOS & ELECTRICAL ACCESSORIES**

Write for Lists. Good Discount to Trade.

F. YATES & SON,
 WHOLESALE ELECTRICIANS,

144 Church St., Kensington, London.
 Phone—Park 4276. W. 8

FOR RADIO PANELS
 USE

Condensite Celeron

This material is waterproof, immune to atmospheric and climatic conditions. will not warp, has high surface and volume restivity, high dielectric strength, low specific gravity.

Read this table of standard tests

WAVE LENGTHS	APPROX. FREQUENCY	PHASE DIFFERENCE	DI-ELECTRIC CONSTANT
Metres.	Cycles per second.	Degrees	K
373	804,000	2.0	4.7
1,295	231,500	1.8	4.8
3,067	97,800	1.8	4.9

We supply this material in standard size sheets. Rods, tubes or any special component parts.

Any further information will be sent you on enquiring from us.

THE DIAMOND FIBRE Co., Ltd.
 High Road, South Tottenham, London, N.15

Registered "NIPHAN" Trade Mark
WATER-TIGHT PLUGS AND CABLE COUPLINGS
 TO MEET HOME OFFICE REQUIREMENTS

As used by H. M. War Office, Electric Supply Companies, Railway Companies, Marconi's Wireless Telegraph Co.
SIMMONDS BROS., LTD.,
 4, 6 & 8, Newton St., HOLBORN, W.C.

Phones: 2600 Gerrard
 12061 Central.
 Telegrams: "Niphon, London."
 Patented in England and Abroad.

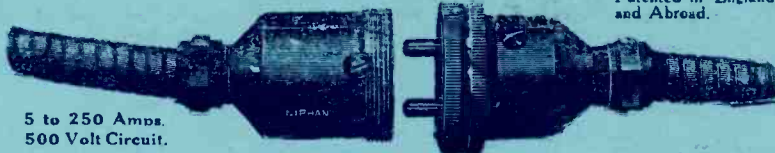

5 to 250 Amps.
 500 Volt Circuit.

COUPLING CONNECTING CABLES



3-WAY TEE.

THE NAME

SULLIVAN

ENSURES THE

HIGHEST EFFICIENCY and is A SOUND GUARANTEE

SULLIVAN WIRELESS INSTRUMENTS

have a world wide reputation for EFFICIENCY, RELIABILITY and CORRECT DESIGN. They are universally adopted by all serious Wireless experimenters, both amateurs and professionals.

THE NEW 1922 CATALOGUE W3

has been brought up-to-date, and contains details of Transmitting as well as Receiving Instruments. Owing to the decreased cost of materials and labour, prices have now been reduced to a level where many of the components are CHEAPER THAN SECOND-HAND DISPOSALS UNITS which are often obsolete and were not designed to meet the prevailing conditions of Wireless Science.

The new prices undoubtedly represent the BEST VALUE IN WIRELESS APPARATUS it is possible to obtain in ANY COUNTRY IN THE WORLD. Every instrument is made from new materials, fully guaranteed and the result of over TWENTY YEARS Wireless experience.

Typical Examples of Present Prices are the following:—

HIGH FREQUENCY INTERVAL TRANSFORMERS ...	£1 7 0 each.
Dimensions $3\frac{1}{2}'' \times 3'' \times 4\frac{1}{2}''$	
AUDIO FREQUENCY INTERVAL TRANSFORMERS ...	£1 14 0 ..
TELEPHONE TRANSFORMERS $3\frac{1}{4}'' \times 2\frac{1}{2}'' \times 3\frac{1}{2}''$...	£1 1 0 ..
PRECISION AIR CONDENSERS, improved design '0011 mfd.	£2 18 0 ..

The new catalogue is full of interest and contains over sixty pages and many clear illustrations including a number of excellent diagrams for Wireless Telephony Transmission and an Index. Every experimenter should secure a copy

Price 1/- post free.

MANUFACTURERS OF WIRELESS APPARATUS FOR OVER TWENTY YEARS.

H. W. SULLIVAN, WINCHESTER HOUSE,
LONDON, E.C.2, ENGLAND

Works:—“LIVERPOOL HOUSE,” MIDDLESEX STREET, LONDON, E.1

Telegrams: “Deadbeat, Stock, London.”

Telephone: Office—London Wall 3518

Works—Avenue 4871

Printed by Sanders Phillips & Co., Ltd., Chrysell Road, London, S.W.9, for the Proprietors and Publishers, The Wireless Press, Ltd., 12-13, Henrietta Street, London, W.C.2; Sydney, N.S.W., 97, Clarence Street; Melbourne, 422-24, Little Collins Street; New York, 326, Broadway.