

# THE WIRELESS WORLD

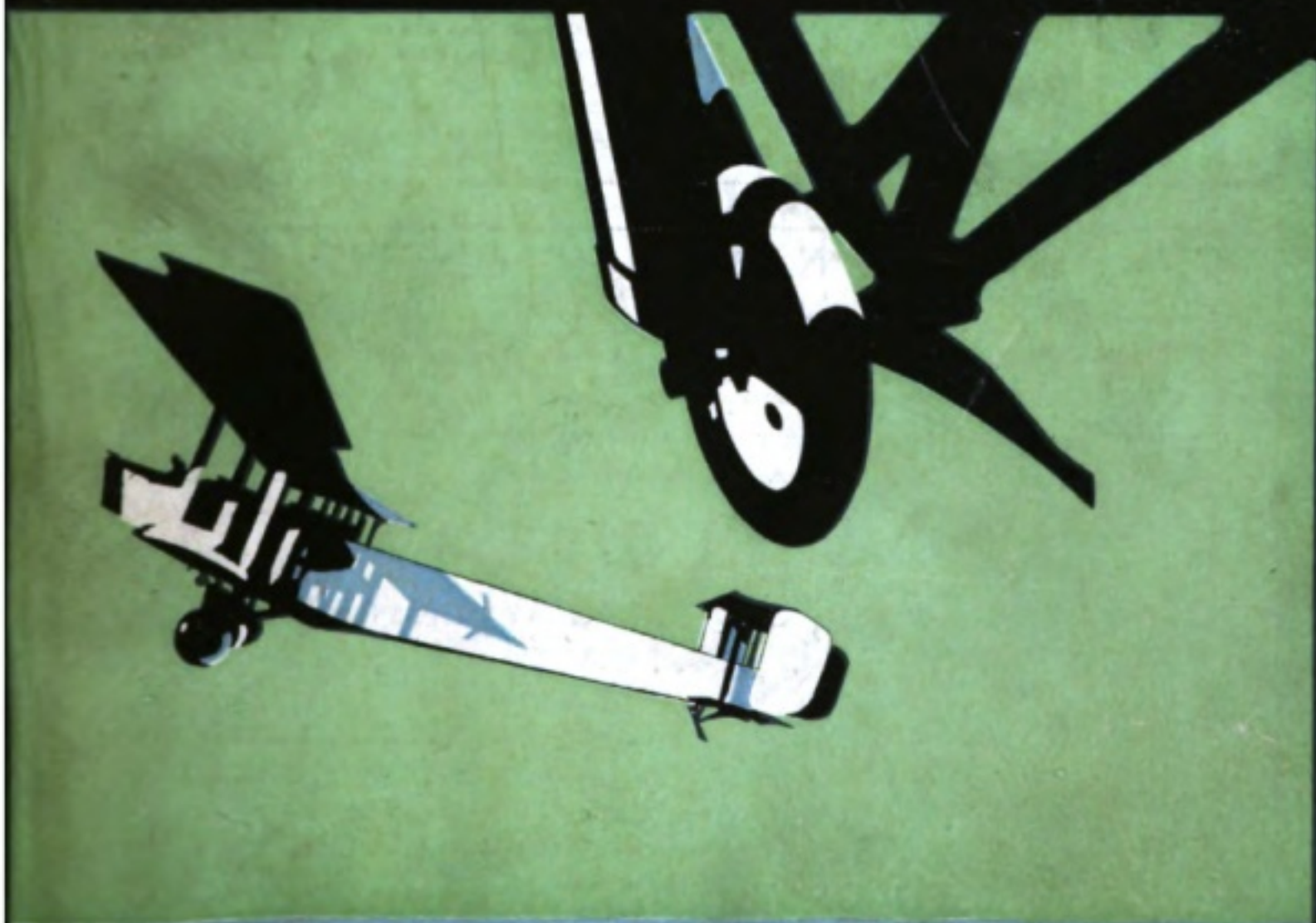

WIRELESS  
AND  
AVIATION

©

"ANTI-SULPHURIC" ENAMEL  
RESISTS ACID FUMES, Etc.

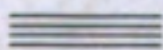

GRIFFITHS BROS. & Co. (London) Ltd.  
MACKS ROAD, BERMONDSEY, S.E. 16.

Digitized by Google

Original from  
UNIVERSITY OF MICHIGAN

# SULLIVAN INSTRUMENTS

Sullivan "Universal" Galvanometers and Shunts for Land and Sea use

## SULLIVAN TELEPHONE RECEIVERS

Fast Speed Wheatstone Automatic Transmitters and Receivers guaranteed at 400 words per minute, and Wheatstone Apparatus generally. Precision and Standard Measuring Equipments for D.C. and A.C. (high frequency) determinations, Condensers of Low Power Factor, etc

H. W. SULLIVAN, WINCHESTER HOUSE, LONDON, E.C., ENGLAND

Telegrams— "Deadbeat, London." Telephone: Office: 3518 London Wall. Works: 4871 Avenue.

WORKS: LIVERPOOL HOUSE, MIDDLESEX STREET LONDON, EC.

## P. ORMISTON & SONS

(P. H. ORMISTON) :: ESTABLISHED 1793

79 Clerkenwell Rd., London, E.C. 1

"Ormiston, London." :: :: 13259 Central

Silk and Cotton Covered H.C. Copper Wire, Resistance Wires, Fuse Wire, Binding Wires, Charcoal Iron Core Wire, Asbestos Covered Wire, Braided and Twisted Wires, Bare Copper Strand and Flexibles of any Construction, Wire Ropes and Cords (fine sizes) in Galvanized Steel, Phosphor Bronze, &c.

## COMMERCIAL UNION

ASSURANCE CO., LTD.

Head Office:

24, 25 & 26, CORNHILL, LONDON, E.C.

The following classes of Insurance effected: FIRE, LIFE AND ANNUITIES, MARINE, LEASEHOLD REDEMPTION AND SINKING FUND, ACCIDENT, including Personal Accident, Third Party, Burglary, Plate Glass, Fidelity Guarantee, Employers' Liability and Workmen's Compensation, including Domestic Servants' Insurance. The Company also act as TRUSTEES AND EXECUTORS.

### FIRE, LIFE, MARINE, ACCIDENT.

Capital fully Subscribed	...	...	£2,950,000
Capital Paid Up	...	...	£295,000
Total Assets (including Life Funds)	...	...	£24,902,252
31st December, 1913	...	...	£24,902,252
Total Annual Income exceeds	...	...	£2,500,000

## EXPERT TRAINING for Young Gentlemen (15-25) in Inland, Cable, and Wireless Telegraphy

**T**HIS old-established and up-to-date School is recognised by the War Office, Admiralty, Wireless Telegraph and Cable Companies as a training centre for Operators for their Services. **GOOD APPOINTMENTS** are open to our students as soon as qualified, the demand for Skilled Operators in all Services being greater than the supply. **SPECIAL COURSES** for men desirous of entering the Royal Flying Corps, Royal Engineers, Royal Naval Reserve and Royal Naval Volunteer Reserve (Telegraph Sections). **SPEED PRACTICE** for improvers daily and three nights weekly. **SPECIAL SHORT COURSE** suitable for men wishing to obtain Government Certificate and enter the service of the Marconi Co. At several recent Government Exams. **ALL CANDIDATES** obtained First Class Government Certificate. **NO BRANCHES OR POSTAL TUITION.** :: **FEES MODERATE.** :: **WRITE FOR PROSPFCTUS**

THE BRITISH SCHOOL OF TELEGRAPHY, LTD  
179, CLAPHAM ROAD, LONDON, S.W

PHONE—BRIXTON 215

A. W. WARD (MANAGER)

# THE WIRELESS WORLD

No. 73  
Vol. VII



APRIL  
1919

## Great Wireless Stations.

### POLDHU.

**T**O the ocean travelling public and to a large section of the stay-at-home community probably there is no better known high-power wireless station in these islands than that which is situated at Poldhu (sometimes spelt Poljew) in Cornwall, and it may be said with certainty that this station, or at any rate its immediate locality, is in a sense the Mecca of those workers who are interested, professionally or otherwise, in the practice and progress of radiotelegraphy. For it was here, appropriately at the beginning of the twentieth century, that Senatore Marconi erected the world's first high-power wireless plant and from here was sent the first wireless communication to be detected on the other side of the Atlantic.

Constructional work was begun in October, 1900, on a site which had been selected near the village of Mullion, after preliminary tests of transmission between the Isle of Wight and the Lizard had been performed with a view to finding out what effect the curvature

of the earth would have upon the emitted waves. By the autumn of 1901 the transmitting arrangements were well advanced, when a September gale played havoc with the masts—twenty 200-foot masts arranged in a circle 100 feet in radius—and occasioned a delay of some five weeks. However, at the end of this period Senatore Marconi was able to proceed to Newfoundland with his assistants and apparatus in order to make his final arrangements for the momentous experiment. Arriving at St. Johns early in December he succeeded, in spite of adverse weather, in elevating an aerial by means of a kite, and on December 12th, 1901, it was established beyond doubt that the pre-arranged signals, a series of the letter "S," were being received from Poldhu. The wavelength employed was about 2,000 metres, an interesting fact not generally known.

Thus with a transmitter of some 10 or 12 k.w. power, and an aerial composed of fifty bare stranded copper wires stretched between two masts 160 feet high and 200 feet apart, modern long dis-

## THE WIRELESS WORLD

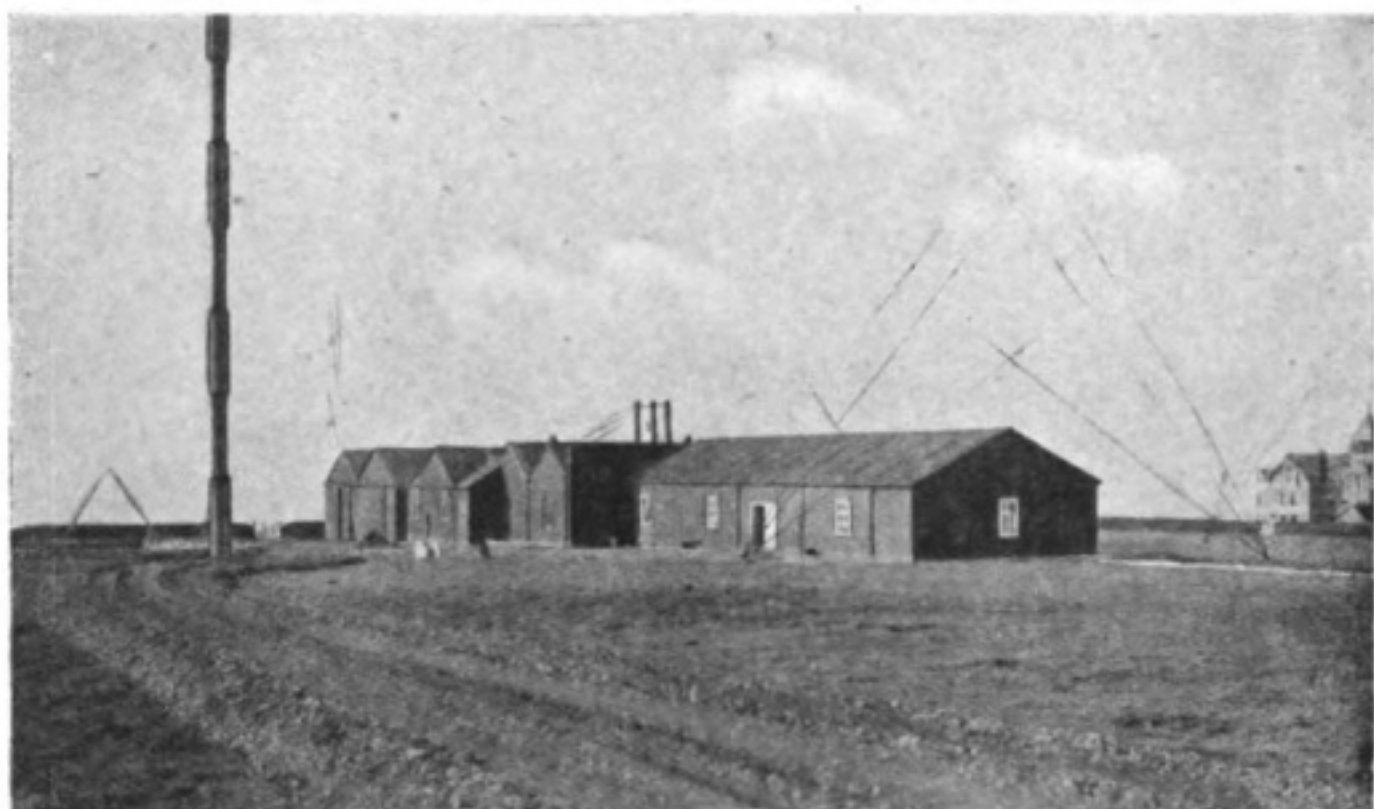

*A General View of the Main Station Buildings, Poldhu.*

tance wireless telegraphy' was foreshadowed. Steps were at once taken to erect a permanent station on the American side, and this would have been situated in Newfoundland, but owing to the fact that a cable company possessed the landing rights it was not possible to instal it there and eventually the Glace Bay (Nova Scotia) station was built. In the meantime alterations were made at Poldhu, wooden lattice-work towers replaced the original ring of masts, the aerial was enlarged, more plant was put in, and a transatlantic wireless service became at length an accomplished fact.

The present day plant which we shall presently describe is rated at 75 k.w. or more than six times the power originally used, and has been continuously employed during the war, not only in the delivery of war warnings and the usual nightly press service to ships but also in combating the Hun by means of transmitting official propaganda programmes.

The transmitting aerial, which is supported by four steel tubular and two wooden masts, is approximately 1,800 feet long and 200 feet high and consists

of 16 wires arranged in two sets of 8 parallel wires. The receiving aerial is composed of two wires each elevated by three masts.

The receiving house is situated on the edge of the cliff some 100 yards distant from the main station and comprises two rooms, one of which is devoted to the ordinary implements of landline telegraphy. The other room contains the receiving apparatus; this is of the most up-to-date type, and includes the super-sensitive three-electrode hard valve detector and amplifier which was described in a recent issue of this magazine. As an illustration of the value of these new receivers we may mention that on one occasion at Poldhu good signals were received from Nauen, a distance of about 800 miles, the aerial employed being a few turns of bell wire wound on a wooden box *inside* the receiving room. Arrangements for the reception and recording on wax cylinders of automatically transmitted high-speed signals are also installed, for during the war high-speed work was largely adopted by a number of foreign stations and it became

## POLDHU STATION

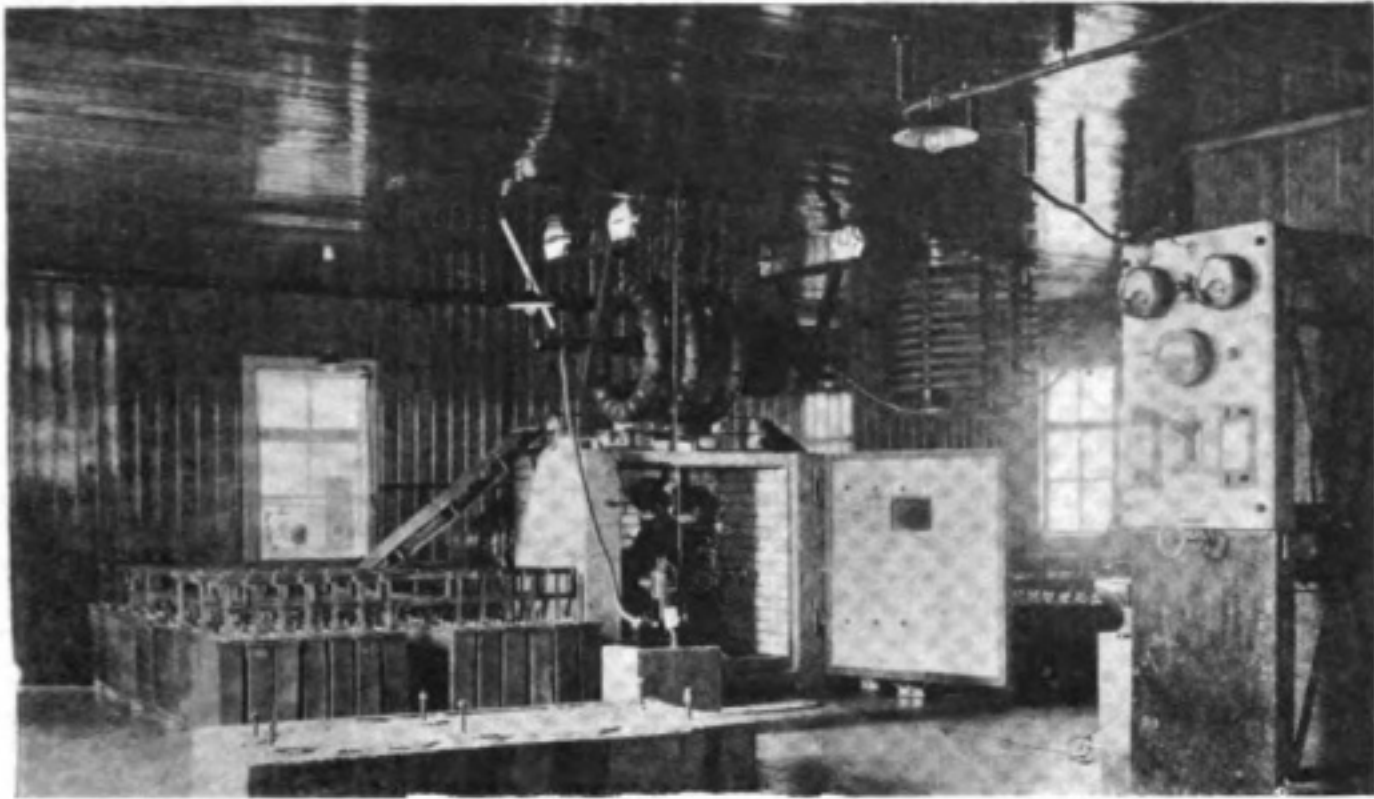

*The 75 k.w. Transmitting Apparatus.*

necessary to provide for reception at speeds ranging from thirty-five to sixty words per minute.

Auxiliary and emergency apparatus such as the Magnetic Detector and the balanced crystal tuner for the detection of long waves complete the equipment of the station as regards reception.

The buildings of the main station include the transmitting room, engine room and boiler house, workshop, carpenter's shop, stores and offices, constituting a model establishment for a modern radio station.

The transmitting room contains in addition to the newest installation the gear which was used until a short time before the outbreak of war. The new transmitting set is of the synchronous type, the disc, alternator and exciter being driven by a 110 H.P. De Laval turbine running at 2,100 r.p.m. The disc is of copper and is furnished with twelve 3-inch copper studs, the side discs being rotated by means of cycle chain and worm gear from the end of the alternator shaft.

The 75 k.w. alternator supplies

current at 2,000 v. (200 cycles), to three 25 k.w. oil-immersed transformers which are connected in parallel giving a secondary pressure of 13,000 v. which, in accordance with the newer practice, is placed directly across the spark-gaps. The H.T. mains are provided with protecting chokes consisting of No. 16 d.c.c. wire wound on wooden frames in four sections of 225 turns, two of these frames being connected in series with each main. The low frequency tuning inductance is air cooled and is supported on two ordinary earthen drainpipes.

The condenser system is composed of two banks of 91 "pots" all connected in parallel, with the exception of twenty-seven which are kept ready in position as spares. The "pots" which are of earthenware each contain two gallons of oil, in which are immersed seven zinc plates (13½-in. by 12¾-in.) and twenty glass plates 3 mm. in thickness; these are arranged in the order of 3 glass plates between two of zinc.

The jigger primary consists of two turns, 24½-in. in internal diameter, built up of a hundred strands of 7/20 S.W.G.

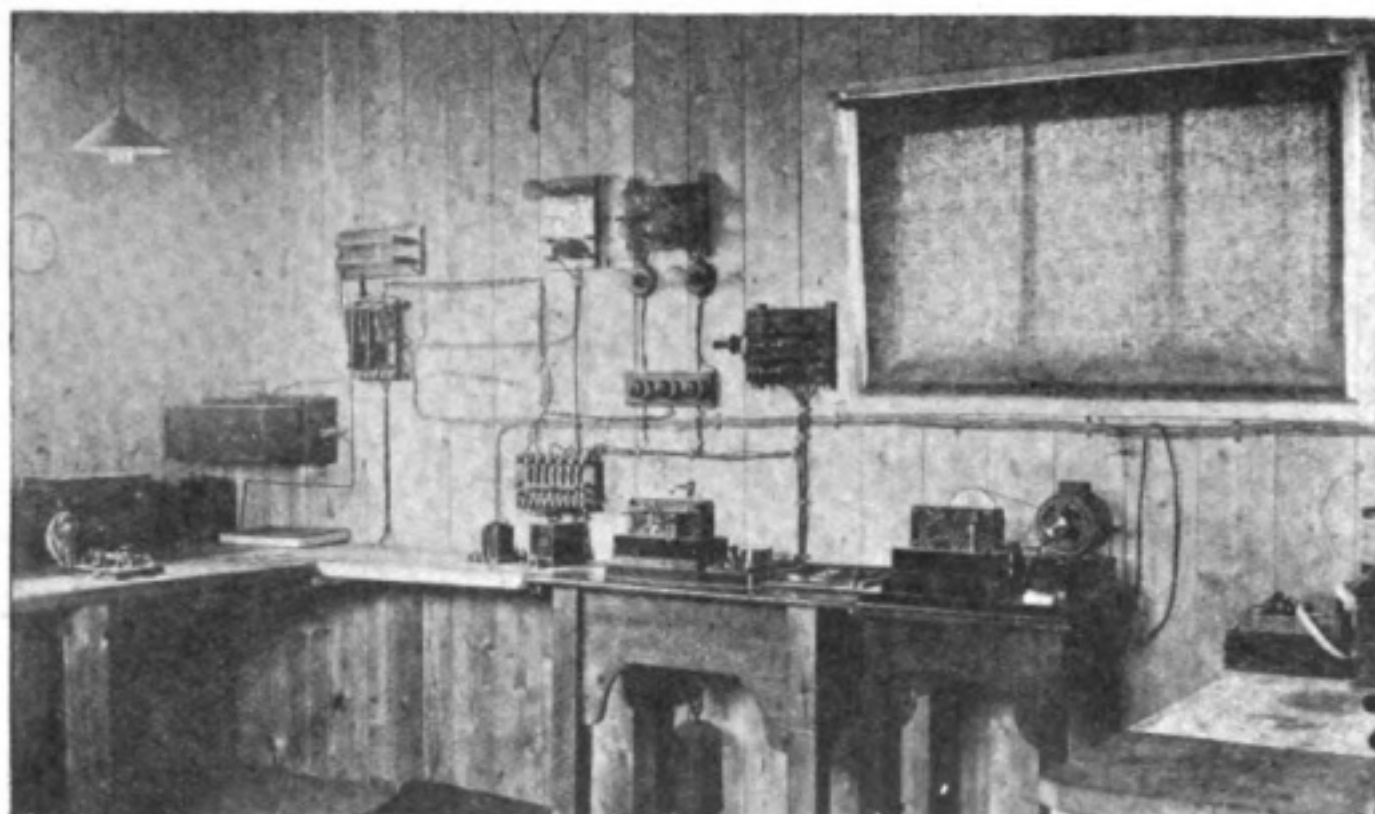

*The Land-line Room with Wheatstone Transmitter.*

wire, placed on a 5-in. wooden core. It is of interest to note that these two turns do not form a helix but are mounted in parallel planes and coupled by a 7-in. by 1/16-in. copper strip. The secondary winding of the jigger consists of seven turns of braided flex on a 17-diameter circular wooden frame; this and the primary winding can be seen in detail in our illustration, though of the three primary turns shown only two are in circuit. The aerial tuning inductance has ten turns of stranded wire, on a wooden frame of 38-in. diameter, supported from the ceiling with its longitudinal axis vertical. There is no separate H.F. tuning inductance as the circuit is permanently adjusted by means of the condensers and the jigger primary.

The boiler house which is separated from the adjacent rooms by a wall with fireproof doors, contains three "Robey" Loco type boilers (12-in. by 3-ft. 6-in. barrel) working at 150 lbs. per square inch and here also there are two duplex steam feed pumps of the Worthington type. Water is drawn from the cooling

pond through a Rankine filter and passes through a Ledward and Beckett tubular feed heater which utilises the exhaust from the pumps. This cooling pond is about 40 yards from the condenser and takes the form of an unlined pit, the dimensions of which are 22 yards by 22 yards and about 10 feet depth. In winter there are roughly 3 feet 6 inches of water standing in this, but in the summer an auxiliary supply is obtained from the steam pumping station in Poldhu Cove. A special filter pit, from which water is drawn for the ejector condenser, is connected to the cooling pond by a tunnel. The pumping station in the Cove has two horizontal duplex pumps, which take steam from a 6 H.P. vertical cross tube boiler and supply the cooling pond through a 2½-in. main.

The engine and turbine exhaust into an ejector jet condenser which is supplied by a Laval turbine-driven centrifugal pump, the normal vacuum being from 28-in. to 30-in.; the usual automatic vacuum breaker is fitted, and there is an alternative exhaust to atmosphere.

As a point of interest in connection

## POLDHU STATION

with constructional detail we may mention that the discs are housed in a brick chamber five feet high, provided with a wooden door in which are glazed windows, and ventilated by Sirocco type blowers which draw through 12-in. ducts.

Our readers are doubtless well aware of the great service rendered to navigators by the time signals which are sent out twice daily from the Eiffel Tower wire-

less station and will therefore be interested to learn that before the Gotha, as a dropper of bombs, disappeared from the air, complete preparations were made to carry on from Poldhu the invaluable work of time-signalling in the event of the destruction of Eiffel Tower station.

The normal transmitting wavelength employed by Poldhu is 2,800 metres and the daylight range is given as 1,800 miles.



*The Aerial System.*

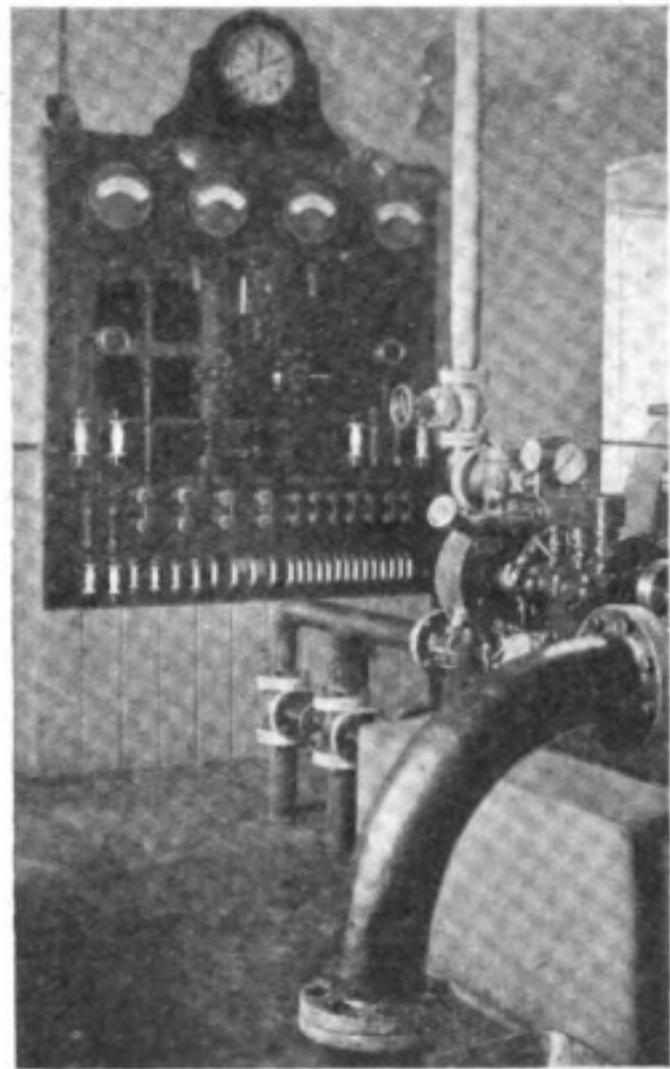

*A Switchboard in the Machine Room.*

# Transatlantic Wireless Telephony

ON March 19th it was announced by Marconi's Wireless Telegraph Company, Limited, that they had succeeded in establishing wireless telephone communication between Ballybunion, Ireland, and Louisburg, Cape Breton Is., Canada. Fuller particulars of this remarkable feat will be published in our next issue.



*CAPTAIN SLEE*



# Personalities in the Wireless World

**C**APTAIN SLEE, the Chairman of The Wireless Board, of which particulars are given on page 27, was born in May, 1878, at Wimbledon. Destined for the Navy, he entered the training ship "Britannia," and in 1894 made his first voyage to China, as midshipman on H.M.S. "Centurion." On this vessel he remained three years and then, according to the usual procedure, took his sailing course on board the brig "Nautilus." On completing this branch of instruction he qualified for his commission and already, early in his career, gave evidence of particular ability by obtaining four firsts out of the possible five in the examinations.

As Sub-Lieutenant the young officer then served on the destroyer "Decoy" and in the same capacity on the destroyer "Ernest" until 1899, when he was promoted Lieutenant. He then proceeded to the battleship "Anson," in the Mediterranean, and thence to the cruiser "Severn," after which he took the "long course" to qualify as torpedo Lieutenant. On obtaining this rank Captain Slee spent a year on the staff of the "Defiance," at Devonport, and here, in 1901, gained his first wireless experience.

Proceeding once more to the Mediterranean he spent two years on the battleship "Montagu," this experience being followed by six months on the battleship "Empress of India," stationed at Devonport. In May, 1906, he was attached to H.M.S. "Queen," but in August of that year, owing to eyesight trouble,—the after effects of an attack of typhoid,—he had to relinquish this position and has since held shore appointments.

For two years after leaving the "Queen" he served as Wireless Telegraph Experimental Officer on the "Vernon," at Portsmouth, and from 1908 until last year was in charge of all Naval wireless stations and War signal stations in Great Britain.

He was promoted to the rank of Acting Commander in 1913 and Acting Captain in 1918. On the formation of The Wireless Board Captain Slee was appointed head of the Board, in which capacity he has since served.

# The Poulsen Wireless System

Its Origin and Development

ONE of the interesting features of radiotelegraphic progress in the last four years has been the extension in the use of the arc as a generator of high frequency oscillations. From the letters we receive from time to time it is evident that many of our readers desire to obtain a general idea of the principles and working of the Poulsen system, and the following article has been penned with that end in view.

The arc method of generating continuous oscillations for radiotelegraphy

and telephony may be said to have had its origin in the pioneer work of the well-known scientist Mr. William Duddell, who in 1900 discovered the phenomenon known generally as the "singing arc." In the course of investigation he found that if a direct current arc be shunted by capacity and inductance in the manner shown in Fig. 1 the arc will commence to emit a musical note approximately equal in frequency to that of the circuit formed by the arc, capacity, and inductance.

By Duddell's arrangement, however,

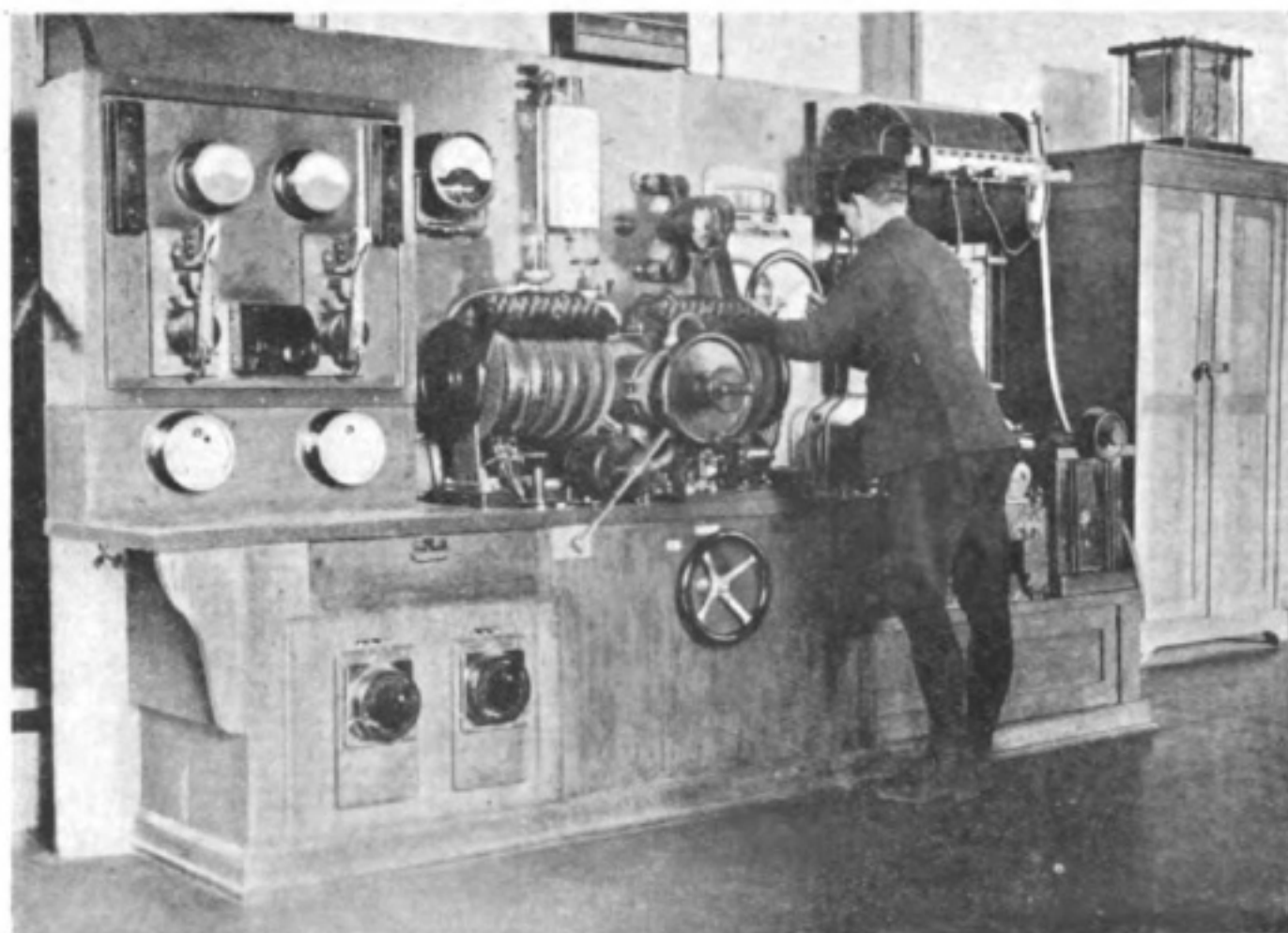

*The Poulsen Arc at Cologne with British Military Operator Adjusting.*

## THE POULSEN WIRELESS SYSTEM

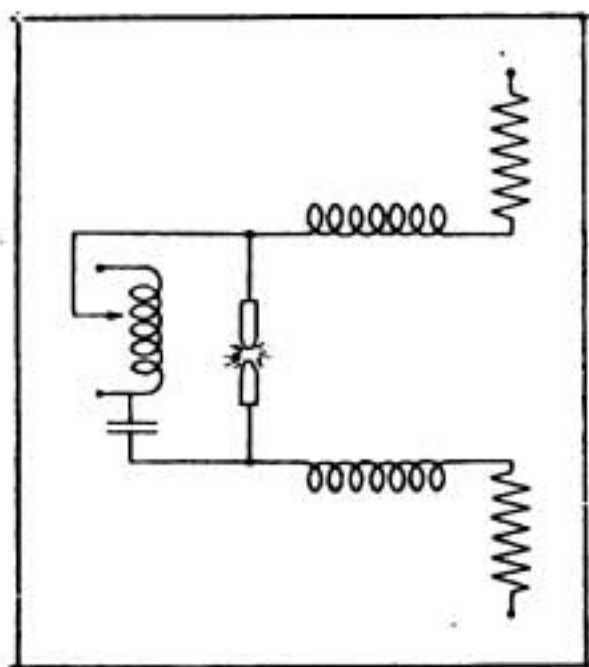

*Fig. 1. The Duddell Arc Circuit.*

it was not possible to obtain frequencies high enough for radiotelegraphy, as the value of the shunted condenser and inductance needed to be very large.

In the year 1903 a Danish scientist, Dr. Valdemar Poulsen, introduced two highly important modifications of the Duddell arc which immediately made this device a practical generator of high frequency oscillations of the order and power required for radiotelegraphy. The first of these consisted in striking the arc in a sealed chamber containing hydrogen or hydro-carbon gas and the second consisted in placing the arc itself in an intense transverse magnetic field. By these two modifications both the frequency and the power of the arc were considerably augmented. Other improvements of the apparatus introduced by Poulsen consisted in making the positive electrode of copper cooled by a constant flow of water and in rotating the carbon electrode to equalise the burning and consequently to increase the steadiness of the arc.

A general idea of the first Poulsen arrangement is given in Fig. 2. Fig. 3 shows how the arc itself being a current

bearing conductor is deflected by the magnetic field.

Professor Pedersen, the well-known Danish physicist, has collaborated with Dr. Poulsen in evolving the system. The Professor has been attached for a considerable number of years to the Royal College of Engineering in Copenhagen,—a college which has been established for more than a century.

In order to understand the principle upon which the Poulsen arc works and to grasp the importance of Poulsen's fundamental patents, we must now consider the Duddell arc and the peculiar property it possesses, by virtue of which it differs from an ordinary metallic conductor: it does not follow Ohms Law.

It is well known by all students that in a solid conductor the current flowing is dependent upon the voltage applied and as we increase the voltage so the current will increase until the material melts or evaporates. According to the electron theory now generally accepted conductors contain in their interatomic spaces free electrons or atoms of negative electricity. A current is said to flow

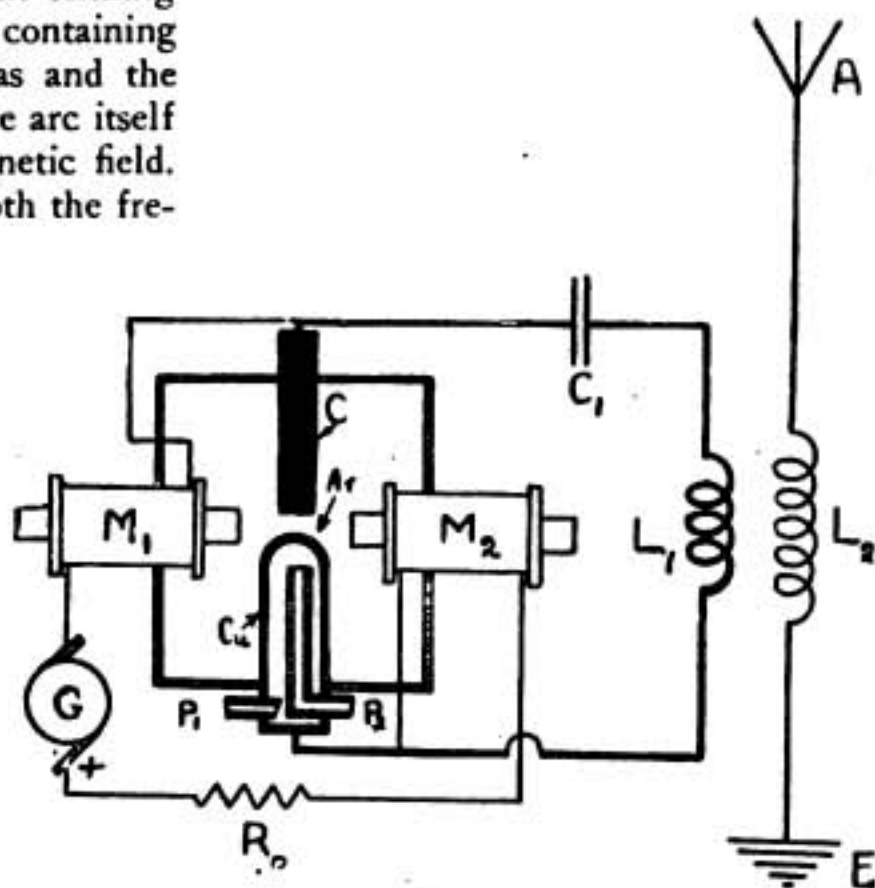

*Fig. 2.*

## THE WIRELESS WORLD

when a general drift of the free electrons takes place in one direction. In the case of a gas or vapour this body is not a conductor unless there exist free negative and positive charges called ions. Molecules of a gas can be ionised by the impact of electrons or ions thrown into them and, as a matter of fact, this is what happens in the case of an arc. When the arc is struck the incandescent negative electrode emits electrons which ionise the gas, the negative ions being pushed towards the positive electrode and the positive towards the negative electrode. Obviously if the ions are removed from the field as quickly as they are produced the current will be

We are now in a better position to understand what happens when the capacity and inductance of the Duddell arc are connected across the arc electrodes. The moment the condenser is joined to the two arc electrodes electricity flows into it and this momentarily reduces the current through the arc. This reduction as explained above is accompanied by an immediate increase in the potential difference of the carbons, and this again results in more current flowing into the condenser. Hence the condenser becomes charged to the full voltage or potential difference of the carbons. This condition is, however, unstable. The condenser begins at once

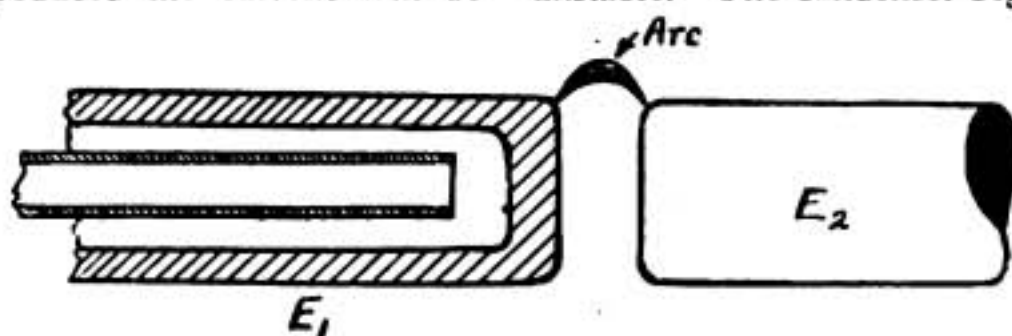

Fig. 3.

stationary and will not increase beyond a certain strength which is known as the saturation value. In this connection we cannot do better than quote Dr. J. A. Fleming who says: "Hence in a gaseous conductor the current does not increase steadily with the potential difference of the electrodes but tends towards a limiting value. Also it is clear that as the ions are moved towards the electrodes unless these latter remove them or absorb them sufficiently quickly the accumulation of negative ions near the positive electrodes and of positive ions near the negative electrodes will diminish the potential difference of the electrode and create that condition in which the increase of current—that is increase in migrations of ions—causes a decrease in the potential difference of the electrodes. In this case then we shall have a falling characteristic, or volt-ampere, curve."

to discharge back through the arc thus increasing the arc current. The result is that the potential difference of the carbons decreases and the discharge is still more facilitated. The condenser being in series with the inductance is over-discharged or given the equivalent of a reversed charge. The whole cycle of operations is then repeated and the condenser and inductance circuit charges and discharges with a frequency determined by the natural frequency of the whole circuit. It will be seen that the energy of oscillation is drawn from the battery or dynamo supplying the direct current to the arc.

In the case of the Duddell arc in air between two carbon electrodes the increase of current did not bring about a large decrease of voltage or, as we say, the falling characteristic was not very steep, and the associated condenser had to be large for the effect to be perceptible.

## THE POULSEN WIRELESS SYSTEM

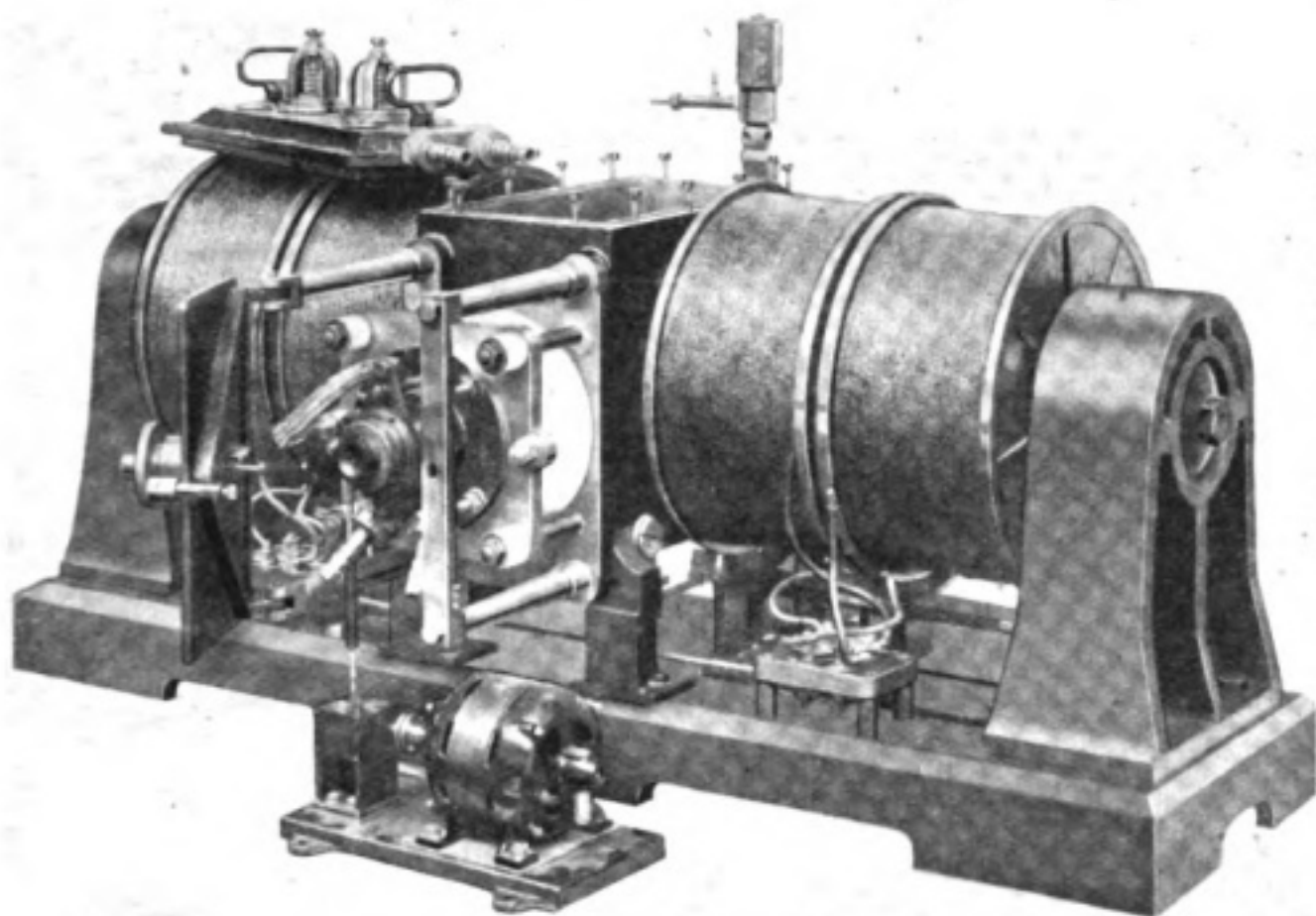

*A 200 kilowatt Poulsen Arc with lid of Arc Chamber removed.*

As the inductance had also to be large only low frequencies were attained. Further, owing to the presence of oxygen many of the positively charged carbon ions combine with the negatively charged oxygen ions form carbon dioxide and as a consequence many of the ions which would otherwise go to reduce the potential of the gap as previously explained were withdrawn. Poulsen by placing the arc in hydrogen prevented this wastage and thereby brought about a steepening of the curve, or an increase of voltage drop with rise of current. Smaller condensers could thus be used, with higher frequencies.

The introduction of the strong transverse magnetic field had very important effects. In the Duddell arrangement the arc itself is never extinguished but only diminished and increased in intensity. In many cases in the normal Poulsen arc the magnetic field blows out or de-ionises the arc once in every oscillation.

The advantage of blowing out the arc each time is that the full supply voltage is then available for charging the condenser, power being considerably increased thereby. The arc is re-struck as soon as the voltage of the condenser rises to a certain value. Another advantage of the magnetic field is that the arc can be lengthened or stretched out for a very short electrode separation, this latter facilitating the re-ignition. The hydrogen or hydro-carbon gas probably assists the de-ionisation in addition to its other functions. The cycle of events in the Poulsen arc where it is extinguished is thus, condenser charge, arc ignition, condenser discharge and reverse charge, reduction of arc current by opposed condenser current, extinction of arc, neutralisation of the reversed condenser charge by D.C. generator, new charge, re-ignition of arc, and so on indefinitely.

The early Poulsen transmitter, then,

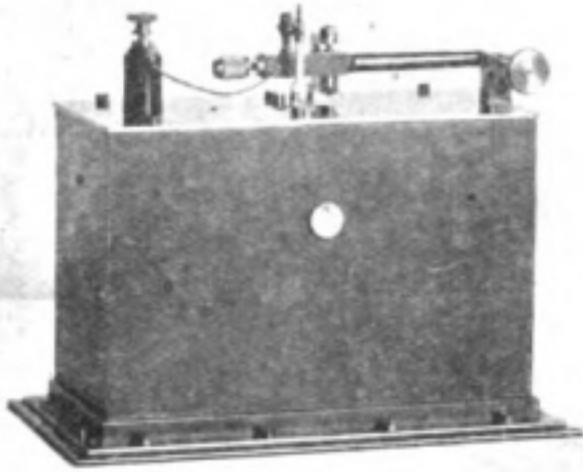

*Vibrating Gold Wire Ticker.*

consisted of a source of direct-current supply (usually a dynamo) the water cooled arc, the associated capacity and inductance and the usual aerial and earth inductively coupled to the closed oscillating circuit. As it was not practicable to start and stop the arc by means of a telegraph key for transmitting signals and as it was desirable from several points of view,—and particularly for steadiness,—to keep the arc in continual operation, an arrangement was made whereby signals were sent by slightly varying the wavelength. The normal radiation from the arc can be called the “spacing” or “compensating” wave while the shorter wavelength caused by the short circuiting of certain turns of aerial inductance is the “signalling” wave. If then the receiving operator tunes to the signalling waves he will hear only the Morse signals sent by the transmitting operator. Owing to the sharp tuning resulting from the use of continuous waves it is only necessary to alter the wavelength slightly when sending.

On the receiving side an inductively coupled tuner was fitted, tuning being very sharp owing to the fact that continuous and not damped waves were sent out from the transmitting station. In the case of spark signals the note heard in the receiving telephones is that of the spark frequency of the transmitter. In

the case of undamped waves, where radiation is continuous and not divided up into wave trains, it is necessary to provide some means of obtaining an audible note, such as by breaking up the stream of oscillations into groups of an audible frequency. In the early Poulsen stations the receiving device was known as the “ticker” and consisted merely of a form of interrupter by which a condenser in the receiving circuit was periodically discharged through the telephones at a convenient frequency. Several forms of ticker were made, some consisting merely of a vibrating contact between two gold wires, others of a rubbing contact between a wire and a metal disc and still others being similar in form to a rotary contact breaker.

In time it was found practicable to abandon the use of a closed oscillating circuit, and the arc is now connected directly to the aerial and earth, the capacity and inductance of which acts exactly in the same manner as in the closed circuit of Fig. 2. Several advantages arise out of this arrangement, among them being that no coupling of a closed to an open circuit is necessary, and the whole plant is considerably simplified. The general transmitting circuits for a station are well shown in the

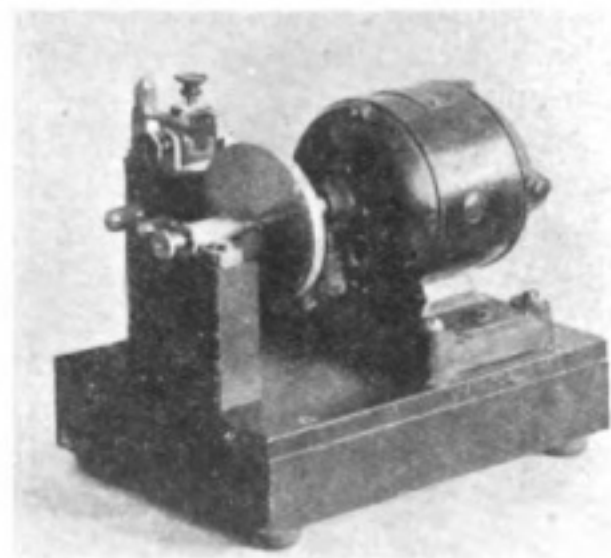

*Rotary Ticker.*

## THE POULSEN WIRELESS SYSTEM

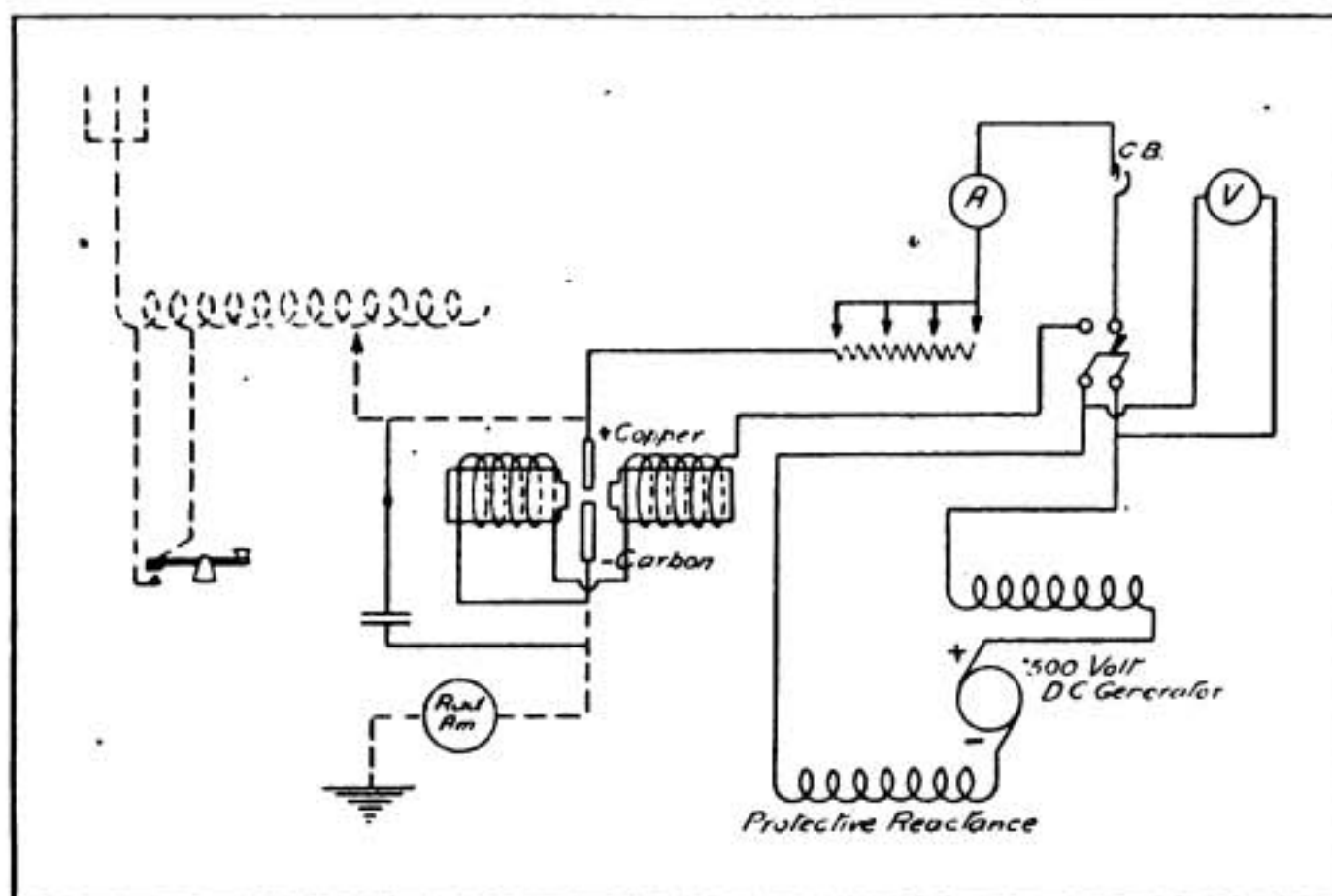

Fig. 4. The Transmitting Circuit at Washington (Arlington).

diagram on page 13 which indicates the arc circuits at Washington (Arlington). The purpose of the condenser across the arc will be explained later.

In the last few years the Poulsen arc has been considerably improved and has now become much more reliable in operation. It has now been proved that all parts of the apparatus must be designed to suit the power, wavelength and aerial used in each case. The most convenient means of providing the necessary hydro-carbon atmosphere has been found to be that of automatically dropping alcohol into the arc chamber where it is immediately vaporised. To equalise wear the carbon electrode is rotated automatically by means of a geared-down electric motor, and is automatically fed in, while the cooling arrangements for the positive pole and the arc chamber itself have reached a high degree of perfection. Without the cooling arrangements the copper pole would, of course, vaporise in a very few minutes. Single arcs are now frequently made to carry a

power as high as 100 kilowatts and in a few cases much more powerful installations have been erected. At the present time we understand that the construction of a one-thousand kilowatt arc is well under way in America and in this case practically the whole device is immersed in oil for cooling. Thus, although no fundamental change has been made in the apparatus since it was first invented by Dr. Poulsen, considerable progress in engineering details has removed the arc from the state of an interesting but an erratic laboratory instrument into the front rank of wireless transmitters. There are, however, still a number of difficulties to be overcome in connection with the steadiness of the arc on high powers, in signalling and in freeing the radiation from unwanted harmonics. Further, although the efficiency of conversion from direct current to high frequency current is fairly high (in the neighbourhood of 40 per cent.) the whole of the energy in the space wave is wasted and over-all efficiency is low.

## THE WIRELESS WORLD

In the United States the Federal Telegraph Company which works in conjunction with the Poulsen Wireless Corporation of San Francisco have introduced one or two modifications of circuits perhaps the most interesting being that shown in our diagram on page 13 wherein a large condenser is shunted across the arc. This has the effect of considerably increasing the arc current and has enabled the higher power installations to be erected.

The United States Naval Authorities have erected Poulsen Stations at San Diego in California, at Pearl Harbour in the Sandwich Islands, and at Cavité in the Phillipine Islands, the stations being respectively of 200, 500 and 500 kw. at the dynamo terminals.

The recent developments in the valve amplifier and receiver, and in continuous wave receivers generally have greatly increased the value of the arc transmitter, but as we have published articles on several occasions regarding continuous

wave reception we do not think it necessary to enter into details of receivers here. In the press some information has lately appeared with reference to later installations. Thus it is known that besides the powerful arc at the Eiffel Tower a still more important plant has been erected at Lyons, and a new wireless station on the Poulsen system has been in course of construction at a point near Bordeaux. This station was begun by the American Government but owing to the termination of hostilities it has been sold in an incomplete condition to the French Government for a large sum. This station has four masts 275 metres high and the power of the station on completion will be in the neighbourhood of 1100 kw. This station will, therefore, be in the front rank of high power installations and as the Lyons plant has been reported as communicating regularly with Shanghai some highly interesting long distance developments will probably ensue.

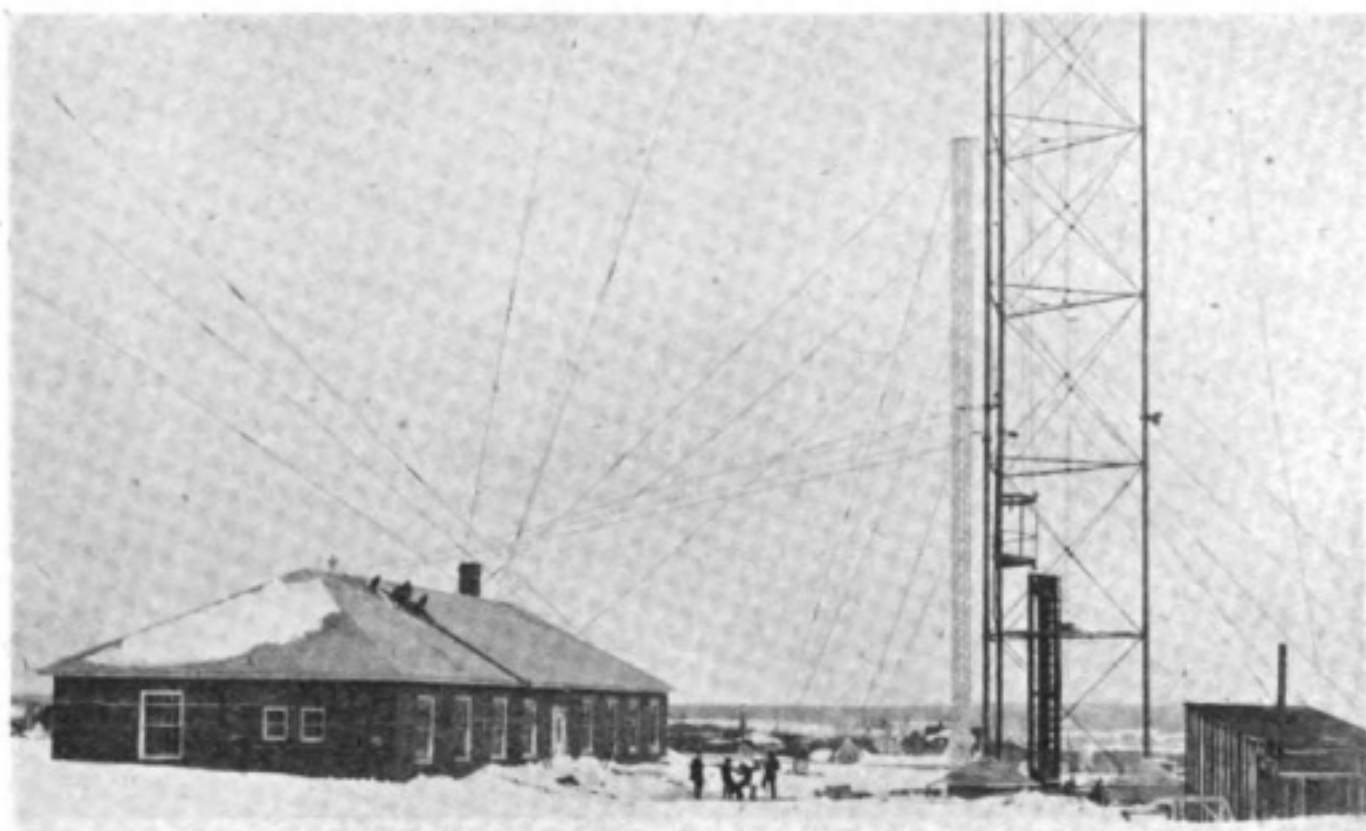

*The Poulsen Station at Newcastle, N.B., Canada.*



# Digest of Wireless Literature

HIGH FREQ. MACHINES OF THE INDUCTOR TYPE. *By M. Osnos. Jahrb. der dr. tel. Vol. 13, Part 4.*

THE H. F. machine has attracted a great deal of attention ever since the advent of Wireless Telegraphy. The most frequently proposed construction belongs to the so-called Inductor type (with the notable exception of the Goldschmidt machine), and it is a matter of not merely historical interest that all modern generators of this type can be derived from the machines described by Cail-Hermer and Guy in their patents taken out in 1892 (French patent No. 226,781) and 1901 (German patent No. 143,630) respectively.

The usual construction of such an alternator of the inductor type is shown on Fig. 1, where  $P_1$  denotes the stator and  $P_2$  the rotor. It will be seen that both the exciting and A.C. windings ( $W_e$  and  $W$ ) are arranged on the stator. The action of the machine depends on the periodical variation of the reluctance of the magnetic circuit, which is at its

minimum when the poles of the rotor and stator are in opposition and at its maximum—when the poles of the rotor are facing the intervals between the poles of the stator.

Since the relative position of rotor and stator at any moment  $t$  is exactly repeated next at the moment  $t + T$  where  $T$  is the time required for an angular displacement of the rotor as determined by the pitch, it is obvious that the frequency of such an alternator will be given by

$$p \times n,$$

where  $p$  is the number of poles, and  $n$  is the number of revs. per second.

It follows that in order to obtain a high frequency,  $p$  must be very large since  $n$  is limited by mechanical considerations. A high number of poles, however, involves a small space for winding. Cail-Hermer, therefore, proposed the construction shown on Fig. 2. It will be seen that each pole is sub-divided into a comparatively large number of teeth. Although the windings are arranged exactly in the same way as on Fig. 1, the interval between two consecutive identical positions of the rotor relatively

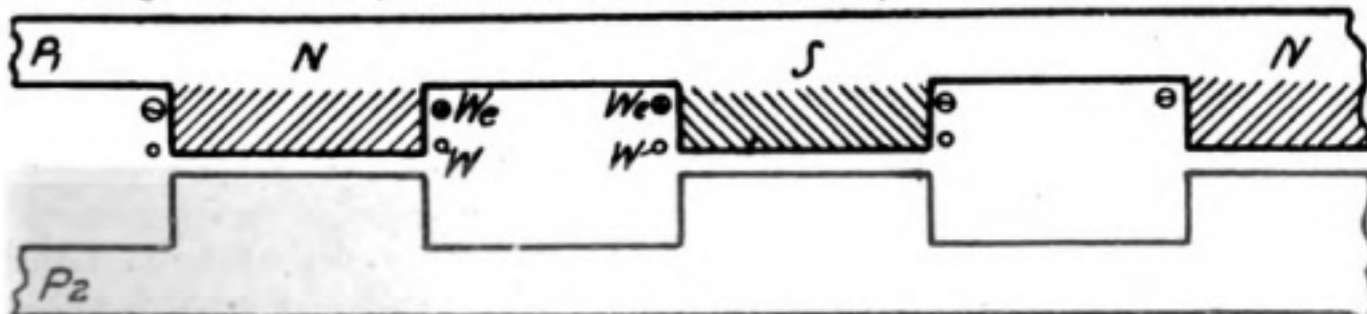

Fig. 1.

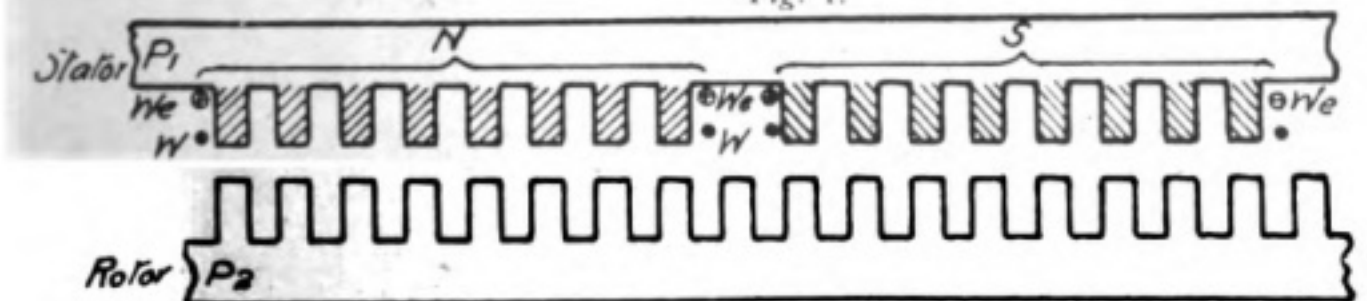

Fig. 2.

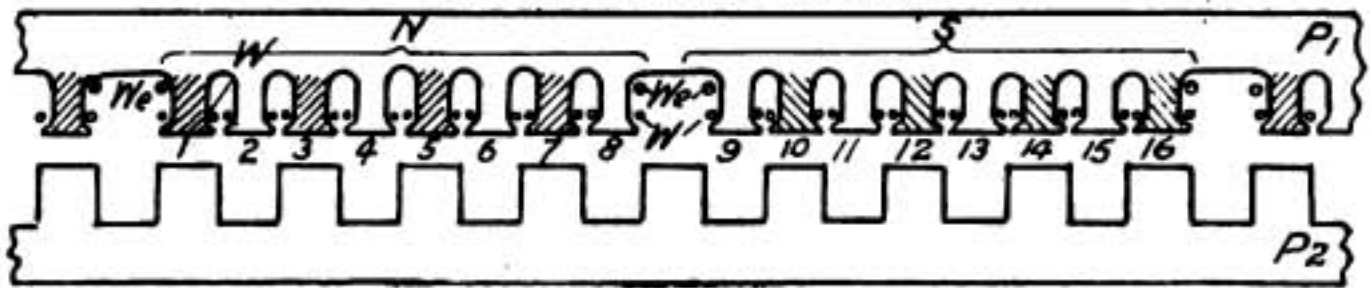

FIG. 3.

to the stator will be now determined by the pitch between the teeth, and the frequency will therefore be :

$$p_1 \times n$$

where  $p_1$  is the number of teeth on the rotor. It is obvious that at the same number of revolutions Cail-Hermer's machine will possess a frequency times larger than that obtainable with the ordinary construction.

The main drawback of this machine consists in the H.F. currents induced in the exciting winding. In order to suppress these currents, it is usual to introduce into the field circuit choking coils. The latter may, however, become very bulky, for the D.C. which necessarily flows through them tends to saturate the iron and thereby to diminish the inductance of these coils. Large masses of iron have therefore to be employed in order to keep the cores as far as possible from saturation, with the result that the choking coils may require more room than the machine itself.

It has been proposed to obviate this difficulty by employing two identical machines which are mechanically so coupled that when the teeth of the rotor face the teeth of the stator in one machine, the teeth of the rotor in the other machine face the intervals between the teeth of its stator. Since the currents induced in both machines will have a phase difference of  $180^\circ$ , the undesirable currents in the exciting windings can be eliminated by connecting them in opposition (the A.C. windings being, of course, connected to form a series arrangement). This method, however, has the inconveniency of entailing the use of two machines.

A far simpler solution is given by the construction shown in Fig. 3. The pitch between the teeth of the stator is here half of that on the rotor. Owing to this the total reluctance the magnetic circuit remains constant for all positions of the rotor and no currents will therefore be induced in the exciting windings which embrace the whole pole. But on the other hand, we cannot any more, arrange the A.C. windings coaxially with exciting coils (as in Fig. 2), for no currents will then be induced in them either. We shall have therefore to wind each tooth separately (as shown in Fig. 3), for the variations of flux are now limited to the teeth alone. The frequency obtainable from such a machine will still be determined as in the other cases, by the product of the number of teeth on the rotor and the number of revs. per second. It will also be seen that, since the currents induced in the coils embracing the shaded and unshaded teeth differ in phase by  $180^\circ$ , the connections between the consecutive coils will have to be made in such a manner that the E.M.Fs. should add.

The construction of this type of generator is sometimes modified as shown in Figs. 4 and 4A. By arranging the poles on both sides of the exciting coil, the machine is made homopolar, for all poles on one face of the stator will be of one sign. It is clear that the homopolar type differs from the machine shown on Fig. 3 only in so far as mechanical construction is concerned. Electrically, both machines are identical. The method given in Fig. 3 for the suppression of the H.F. currents in the exciting winding of the Cail-Hermer

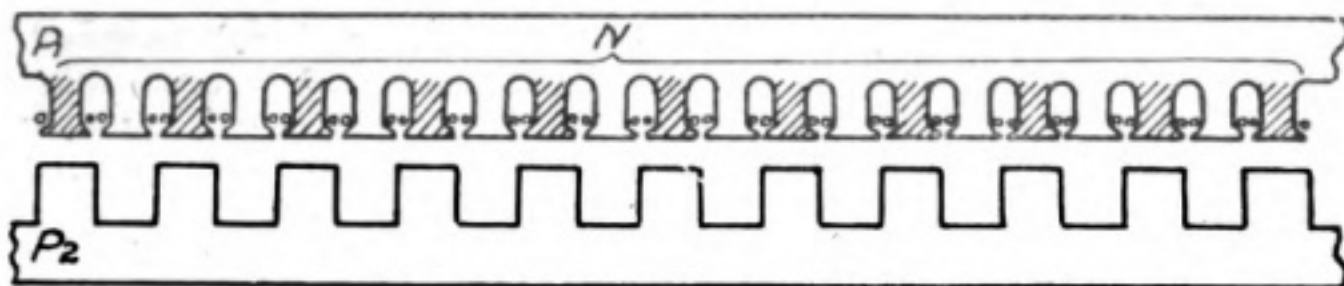

Fig. 4.

machine although very effective involves, however, a considerable increase in the number of the A.C. windings as compared with the original arrangement shown in Fig. 2.

A further improvement, which allows of having a small number of A.C. coils while obviating the generation of H.F. currents in the exciting winding, has been proposed by M. Guy in his patent mentioned above.

As shown in Fig. 5, by shading, the teeth on each pole of the stator are split up into two groups. At a moment when the teeth (shaded) belonging to one group face the teeth of the rotor, the teeth (unshaded) belonging to the other group face the intervals between the teeth of the rotor.

The total flux through a pole will therefore remain constant (as in Fig. 3), but periodical variations will take place in each group of teeth. It follows that the A.C. windings can be arranged now to embrace one half of a pole (as shown on Fig. 5 by  $a-b$ ;  $c-d$ ;  $e-f$ ;  $g-h$ ), and their number will be reduced to twice the number of poles.

A little consideration will, however, show that we can go still further and reduce the number of A.C. windings to the number of poles. Let us assume that in the position shown on Fig. 5, the E.M.F. induced in coil  $a-b$  is such that the current flows from  $a-c$ . We mark then  $a$  with  $+$  and  $b$  with  $-$ . The next group of shaded teeth, embraced by coil  $e-f$ , belong to a south pole, therefore we shall have to mark  $e$  with  $-$  and  $f$  with  $+$ ;

As to coils  $c-d$  and  $g-h$ , which embrace the groups of unshaded teeth, the E.M.F.s. induced in them will differ in phase by  $180^\circ$  from the E.M.F. induced in coils  $a-b$  and  $e-f$ . It follows that  $c$  and  $h$  will have to be marked with  $a-$  and  $d$  and  $g$  with  $a+$ . An inspection of the obtained results will show at once that conductors  $d, e$ , which lie in the same recess cancel each other and can therefore be omitted. On the other hand conductors  $f, g$ , and  $b, c$ , do not cancel each other. The result is that for each two coils such as  $c-d$  and  $e-f$  we can substitute one coil  $e-f$ . The number of A.C. windings can

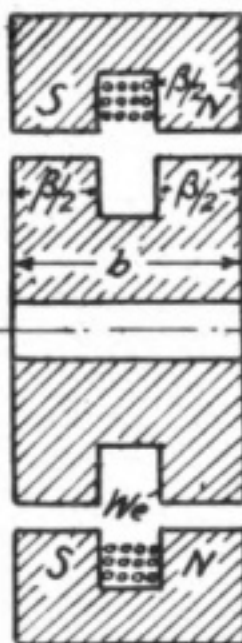

Fig. 4a.

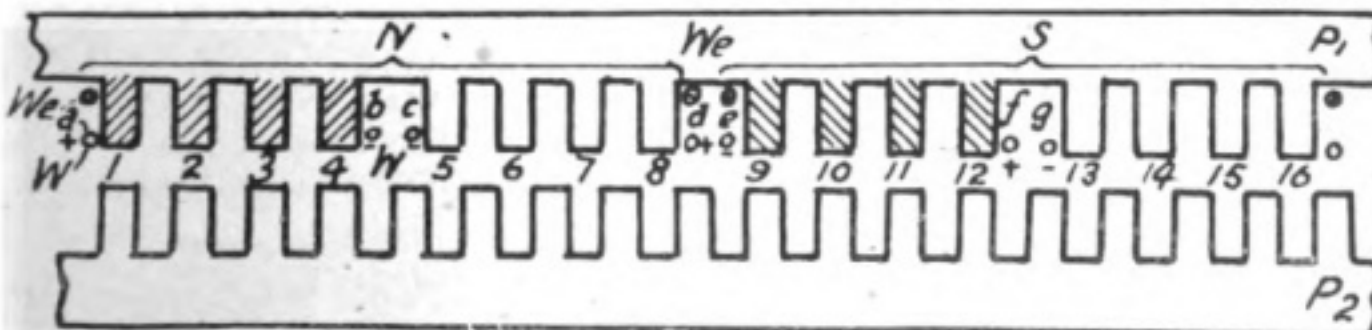

Fig. 5.

therefore be made equal to the number of poles. It will also be noticed that by this arrangement an increase in the space available for winding is obtained, for all the recesses between consecutive poles will contain conductors carrying D.C. only. We can express it in other words by saying that the D.C. and A.C. windings are displaced relatively to each other by  $90^\circ$ .

The action of M. Guy's machine can also be explained in the following more direct manner. Let us take a bi-polar machine (see Fig. 6) in which the exciting winding  $W_e$  is arranged at right angles to the A.C. winding  $W$ . The teeth on the poles which face at the given moment the teeth of the rotor (the shaded teeth in Fig. 5)

are represented by the thick lines *I* and *III*. It is obvious that almost the whole magnetic flux will follow the path of smallest reluctance, and can therefore be represented by  $N_{13}$  which on being resolved gives the component  $N'_{13}$  and  $N''_{13}$ . Half a period afterwards, the teeth *II* and *IV* will be just opposite the teeth of the rotor and the flux will have the direction  $N_{24}$ . Resolving again into two components we obtain  $N'_{13}$   $N''_{13}$ . We see then that the component  $N'_{13}$  remains constant and therefore can induce no currents either in  $W_e$  or  $W$ . As to the other component, it has changed in direction, and currents will be induced in  $W$ . The winding  $W_e$ , on the other hand, will be unaffected, for the variable component lies in its plane. For any intermediate position of the rotor, the *direction* of the component  $N$  remains the same, for the resultant  $N$  lies always on the same side of the vertical axis (*i.e.*,  $N$  will never fall in quadrants *II* and *III*). On the other hand the *magnitude*

of horizontal component may vary, but the variations will be comparatively small and a little consideration will show that the A.C. currents induced by them in  $W_e$  will possess a higher frequency than those induced by the vertical component in the winding  $W$ . Owing to this, the undesirable currents can be easily suppressed.

A limiting case of the Guy alternator is shown on Fig. 7. Each pole has only two teeth and their arrangement relatively to the rotor teeth is very similar to the one shown on Fig. 3. The method of winding shows, however, the characteristic feature of M. Guy's machines, for the exciting winding  $W_e$  is at right angles to the A.C. winding  $W$ .

The modification shown on Fig. 7 is due to the author and is protected by the German patent No. 267,798 belonging to the A.E.G.

In conclusion, the author points out that M. Guy's machine can easily be converted into the homopolar type in the same way as Figs. 4 and 4A have been obtained

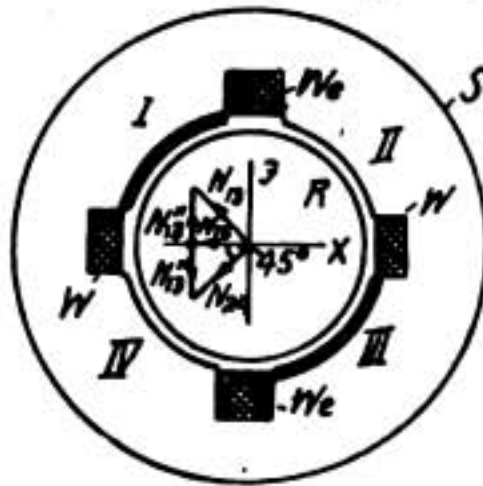

Fig. 6.

from Fig. 3.

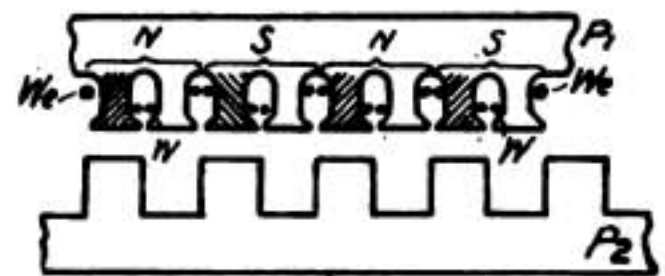

Fig. 7.

ON THE ELECTRICAL OPERATION AND MECHANICAL DESIGN OF AN IMPULSE EXCITATION MULTI-SPARK GROUP RADIO TRANSMITTER.

By B. Washington.

The article, which does not lend itself very well to abstracting, describes the

## DIGEST OF WIRELESS LITERATURE

wireless apparatus as manufactured by the firm of Cutting and Washington.

The discharger is of the quenched spark type, the electrodes being either aluminium - copper, copper - copper, or silver-silver. In all cases the discharger is placed in an airtight chamber, alcohol being fed through a wick. The distance between the electrodes varies between .02 and .36 mm.

It would appear that this spark-gap being carefully adjusted will give a unidirectional discharge. The number of oscillations in the antenna occurring between two successive discharges which is called by the author "inverse charge frequency" can be made very small and an oscillogram is shown where the inverse frequency is equal to one. By careful adjustment of the circuits, continuous oscillations may be generated.

The source of supply may be either a D.C. or A.C. generator (in the present article only sets with A.C. generators are described). In order to obtain a good note, it has been found that a homopolar machine, consisting of two stators and an unwound rotor between them is the most suitable. In order to further secure a pure and steady note, a circuit consisting of a capacity and inductance in series and having a period of approximately 1,500 cycles, is placed across the primary condenser.

Owing to the very thorough quenching, no sharp tuning is required; so, for instance, when the primary was tuned to a wave of 850 metres, the secondary could be varied between 490 and 670 metres without affecting the value of the antenna current.

The author gives in conclusion a description of some of the sets manufactured by his firm. The various apparatus are assembled on panels of "bakelite dilecto," and a  $\frac{1}{2}$  k.w. transmitter has an overall dimension of 14-in. by 28-in. by 18-in. In the receiver, a crystal, apparently of the type

requiring no auxiliary E.M.F., is employed and the secondary is of the aperiodic type.

### RESONANCE MEASUREMENTS IN RADIO-TELEGRAPHY.

*By L. W. Austin.*

(Washington Acad., Sc. 19.8.1918, p 498. "Science Abstracts," Section B, 31.10.1918, p. 388.)

The author draws the attention of Wireless Engineers to the utilization for the measuring purposes of the click, which is heard in the telephones of an oscillating valve circuit, when it is brought into resonance with another circuit at the proper coupling. The latter has to be varied until the click occurs at the same division of the variable condenser, independently of whether the resonance point is reached by increasing the capacity, or by decreasing it.

The author illustrates the method of application by describing the measurement (1) of the capacity of an antenna, and (2) of the wavelength of an incoming oscillation.

In the first case, a large inductance (about 25 times that of the antenna) is introduced into the aerial, and the oscillating audion circuit is properly coupled with the antenna and brought into resonance with the latter by the click test. The inductance is then disconnected from the antenna and ground, and connected to a variable condenser. The latter is so adjusted as to bring the circuit into resonance with the oscillating valve circuit. The reading of the condenser then gives the capacity of the antenna, subject to a small correction for the antenna inductance.

In the second case, the receiver is first accurately tuned to the incoming wave; the wavemeter is then coupled to the secondary circuit, and adjusted to resonance by the click method. The reading

## THE WIRELESS WORLD

of the wavemeter gives the wavelength of the sending station.

It will be seen that this method dispenses with all additional apparatus in

the wavemeter, and would make possible very accurate measurements even in places where sensitive galvanometers cannot be employed.

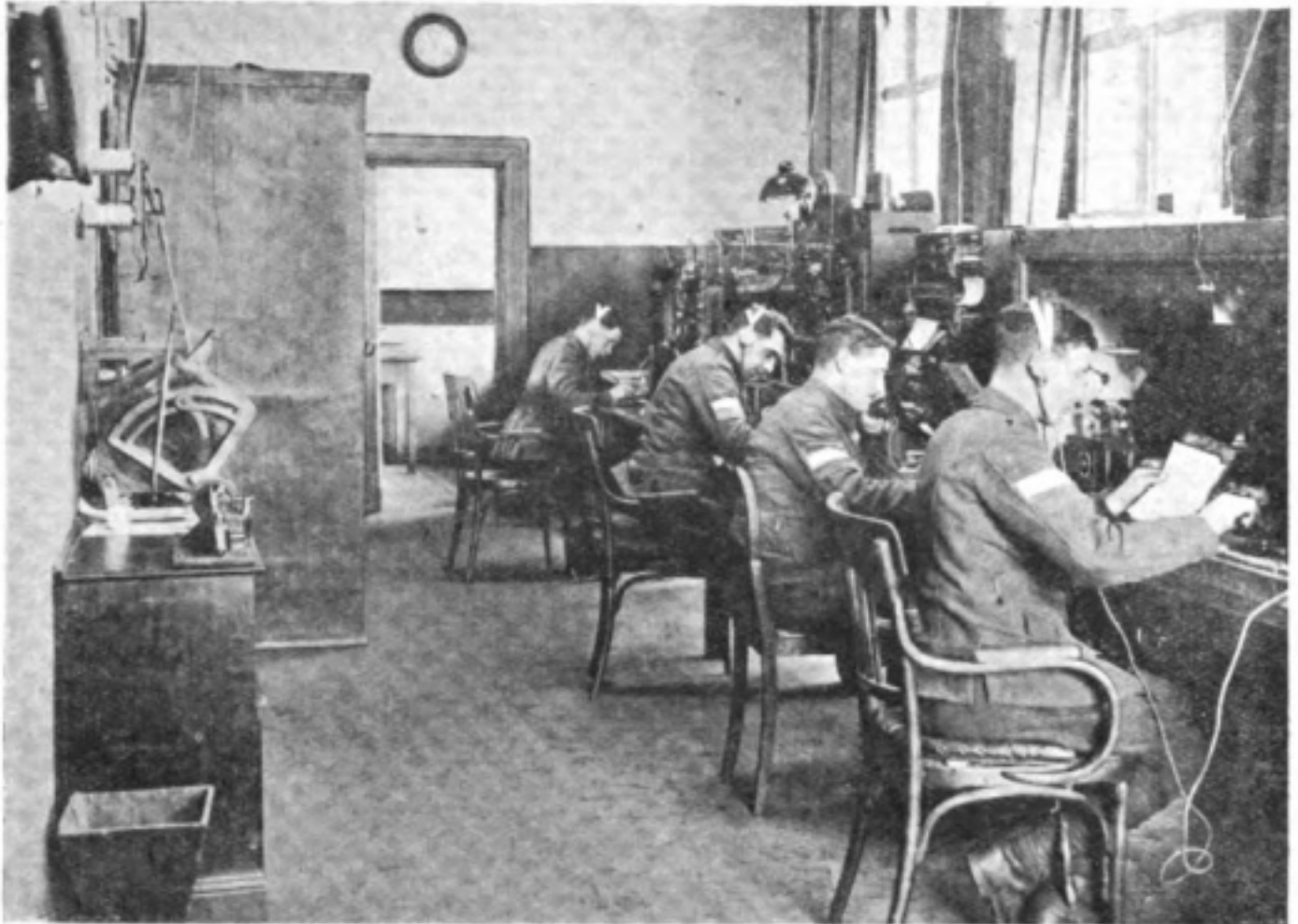

*British Operators at Work in the German Station at Cologne.*

### WIRELESS IN THE ARCTIC.

When the Crocker Land Expedition left New York for the Arctic in 1913 it carried with it what we think must be the most ambitious electrical outfit ever taken to within a few degrees of the Pole. In addition to a wireless installation the Expedition had the advantage of a complete 3-kw. generating plant charging an 80 ampere-hour accumulator battery of 125 volts pressure, an electric oven, electric stoves and lamps.

According to an article in the *General Electric Review* for January, "The attempt at radio-communication was disappointing." The cause of the trouble was, as usual, the difficulty of keeping the antenna aloft and an attempt to elevate it on kites was defeated because of the gustiness of the wind. In this con-

nection we reca'l that Scott suffered from the same cause when he tried to charge his accumulators with a windmill as a prime mover, and as in Scott's case the wind dissipated his hopes by taking the windmill some distance with it, so two puppies cut the communications of the Crocker Expedition by making a bed of the last unbroken kite. It is stated by the writer of the article that no "static" or other effect was noticed as a result of the Aurora, but as there is no indication that anything at all was received by wireless we are inclined to think that this observation is not reliable. The experience of operators on ships entering the Arctic circle shows that, as a rule, the "atmospherics" noticed during a display of the Aurora are very strong.

# "Forward Wireless" in Battle

## The Last Phase before the Armistice

By C. A. Oliver, Wireless Officer, 25th Division.

WHEN a Maritime Wireless man takes up Land Wireless he finds himself confronted with a number of difficulties which he seldom if ever experienced at sea. At sea, for instance, he had a heavy set which took up a comparatively large space, and he was able to obtain a large and efficient current from the ship's dynamo to either work his set from direct or to charge his accumulators with; on land, however, he finds that he must be able easily to transport his set from one place to another, and it must be compact and light in weight in consequence, he also finds that his source of energy must be small and compact.

This means that whereas at sea his set could be large and of great power, his portable land set must be small and of strictly limited power.

This in turn presents the difficulty of actual wireless communication over adequate distances so that the wireless may be of real practical value. In this respect the nature of the country is an important factor to be considered. The Wireless Officer must be able to sum up country by looking at it, and settle in his own mind how the means at his disposal can be set forth to the best advantage. A miscalculation in this respect may mean the temporary failure of his entire current system of wireless communication.

In the last great



C. A. Oliver.

Photo A. Spencer

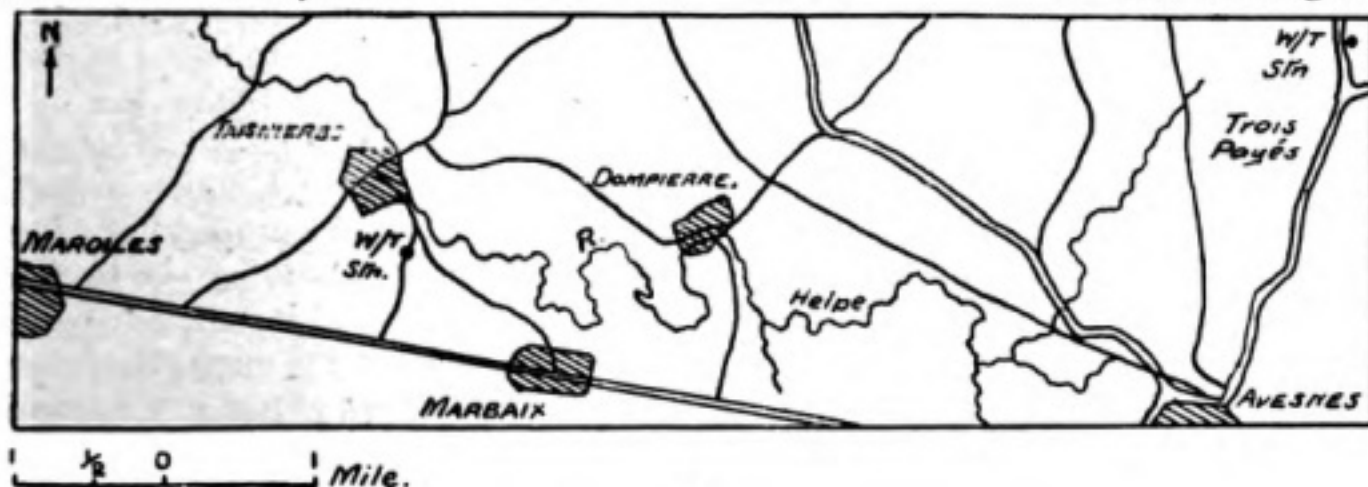



*Garde Mill Wireless Station.*

*No. 2*

battles before the Armistice on November 11th, two distinct types of country were encountered about the centre of the British Front. The first was rolling country interspersed with small villages and sunken roads—the second type was close country cut up by hedges and trees, and consisting very largely of wooded hills and valleys.

Another important factor to be considered by the Wireless Officer is that his entire system of communication may have to be altered and possibly carried forward at very short notice; he must therefore be prepared to move his stations rapidly to any selected spots and establish his new system of communication almost, if not quite, as soon as his old system has been abandoned.

The question of the supply of electrical power must naturally be given the greatest attention, and as accumulators to a large extent form the source of power, the collecting, charging and redistribution of these heavy articles needs careful forethought; the more rapidly the Army advances the closer must be

the attention given to this matter if stations are to be adequately supplied with electrical power.

It will therefore be clearly seen that the standard of efficiency of the Wireless Service on land must be of the highest degree in order that the Wireless communications may be of real value to a Unit or group of Units in the field. Not only must the general outline and details of the system be carefully thought out, but each man in the wireless system must be trained to the highest degree of efficiency in his own respective job. In order to review the forward wireless work during the great advance leading up to the culminating point of Armistice Day, it will be best to take a Sector of the battle front and follow out the wireless progress made in it. On the 22nd of October one Division found itself in the neighbourhood of Le Cateau, with its Units lying out in the direction of Pommereuil. Pommereuil—a small village on the outskirts of the Bois l'Évecque—was as yet in German hands. It had been decided that a Wire-



## "FORWARD WIRELESS" IN BATTLE

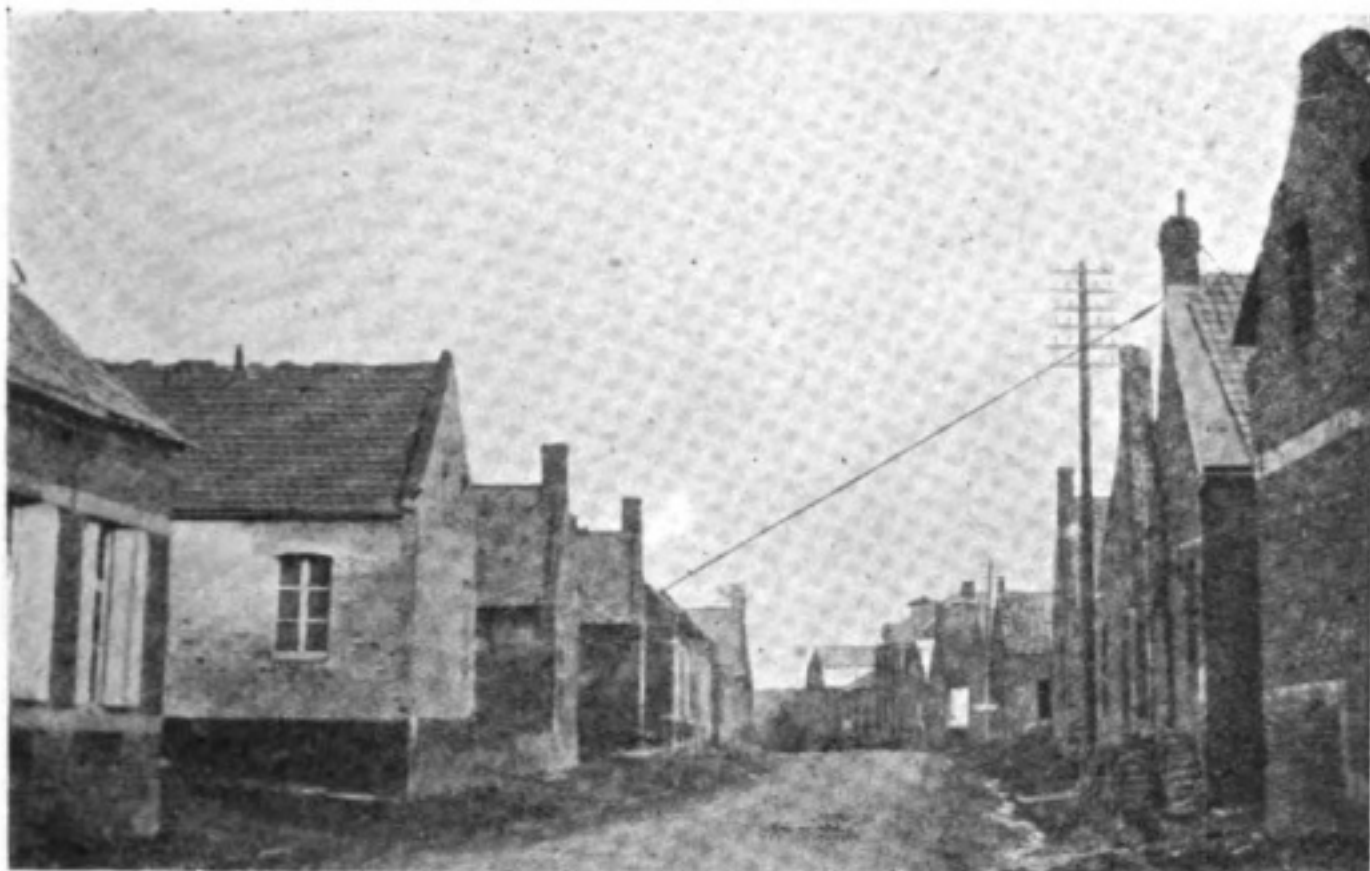

*Wireless Aerial, Pommereuil.*

No. 3

less Station should be established as soon as possible at Garde Mill, a cluster of farm houses in a small valley situated to the west and at the foot of Pommereuil. Later when the enemy had been driven from Pommereuil village two Wireless Stations were to be established in the neighbourhood of Pommereuil itself.

At dawn on the 23rd our troops attacked, and in face of fierce resistance from the Pommereuil slopes and the Bois l'Evêque carried the valley and the slopes beyond. The Wireless Station destined for Garde Mill pushed gallantly forward at the same time despite heavy machine gun and shell fire, and established itself early at Garde Mill.

The result of the prompt action of this resolute little party was that early reliable communication was established from a very forward area back to the rearmost Wireless Station, and information as to the progress of the battle could be got back without delay.

When a Station is wanted quickly it is not always possible to erect the very best of aerials until a little time has elapsed.

The Garde Mill aerial was at first run from a point half way up one of the farm buildings, but was later raised to the roof. The old general rule of "the higher the aerial the better the communication" holds good on land as well as at sea. The Garde Mill Station itself was in the cellar of a farm house.

Later, according to programme, two Wireless Stations were established in the Pommereuil area; one of these Stations is shown in the second photograph.

It may be noticed from the photographs that it was possible to utilise houses for supporting the wireless aerials. This indicates a distinct change from the phase of warfare such as was experienced in the Somme area. There it was the exception to find a building standing at all, and so the portable masts, which are carried by every Wireless Station, had to be erected. However, the addition in height usually afforded by a building is often preferable to the use of the portable wireless mast, and in the last phase of warfare before the Armistice the enemy was being pushed back for the

## THE WIRELESS WORLD



*Tilleul Farm W.T. Station.*

No. 4

most part so rapidly that in many cases buildings were not damaged at all by shot and shell, and it was possible to utilise them to a very large extent for supporting the aerials. This in addition to saving the erection of a mast, more often than not gave a considerable increase to the height of an aerial.

The Pommereuil Stations were able to work back direct to the rearmost station of the Unit near Le Cateau, and also to the station at Garde Mill. Later the Garde Mill Station was found to be unnecessary and was consequently closed down and withdrawn.

The front line by this time had reached the eastern outskirts of the Bois l'Évecque, and a Wireless Station was rapidly run out and established under some difficulties at Tilleul Farm. This station utilised the farm building for one aerial support and erected a 15-foot portable mast to support the distant end of the aerial. The station proved of the utmost value, especially during times when the telegraph and telephone lines had been cut up by shell fire. In such

cases the entire traffic of the lines in this area would be taken over and disposed of by the Wireless Station.

The great drawback where all cases of emergency of this sort arise is that all secret messages must be put into cypher, and naturally a small delay must occur while this is being done, and a similar delay at the other end while the message is being deciphered. This, of course, must always be a source of trouble with all wireless communications as we know them to-day, since anyone with a similarly tuned wireless set can pick up the messages. Hence, the enemy could if he wished pick up all our wireless work, but if it was in cypher it would be of little if any use to him. Unimportant messages were always transmitted in "clear," that is to say, in English.

Wooded country is always apt to offer resistance to wireless work, and a close scrutiny of the Bois l'Évecque was necessary before it could be decided what would be the most advantageous way of utilising the available wireless sets.

## "FORWARD WIRELESS" IN BATTLE



*W.T. Malgarni.*

N. 5

The Bois l'Évecque is for the most part now composed of shrubs and bushes a few feet high, tall trees only existing in parts; the Bosch had cut down most of the stouter timber, probably for making supports for his famous deep dug-outs, which still exist all over the country. In consequence the resistance offered to the wireless waves was not great between Tilleul Farm and the Pommereuil Station, and work was carried on without interruption.

Much more difficulty was experienced with the Malgarni Station which was sent forward and erected in that village in the early days of November. Whereas with the Tilleul Farm-Pommereuil communication only a corner of the wood had to be overcome, with the Malgarni - Pommereuil communication the whole of the wood had to be traversed, and in some parts of this route the trees of the Bois were full grown and tall, and therefore tended to break up the ether waves to a much greater extent. Also the country differed considerably from the Garde Mill area.

There the country was open, composed of rolling hills and valleys; round about the Bois l'Évecque the land began to change to "close country," and at Malgarni it was found to be entirely composed of small fields divided by tall thick hedges, of orchards and tall trees, and on the western side the Bois l'Évecque itself.

The first aerial erected at Malgarni was run out along the main street, the distant end being supported by the gable end of a house. At the home end a portable mast was erected on the upper part of a building, and sticking up through a hole in the roof which some obliging shell had torn open a short time before. This method afforded a good additional height for the aerial above the normal level of the roof. An insulated lead-in wire led from the aerial down into the cellar where the instruments were situated.

Malgarni was shelled at intervals by the enemy, but the aerial withstood all assaults and was never broken. The village was entirely deserted by civilians

*Landrecies Aerial.*

No. 6

with the exception of one bent old lady who kept a cow there and remained through all the strife of battle. She had been there during the German occupation, had passed as if by a miracle through the struggle of battle while the village was being wrested from German hands by the British, and now that the line rested but a short distance from her native village and her home was being bombarded by German shells she still remained, unhurt and unalarmed; and she was still there when the Germans were driven back for all time from the neighbourhood.

The position of the front line was at this time beginning to see some rapid changes, and whereas before the Bosch had taken the trouble to evacuate civilians before retiring himself in front of the advancing Allies, he now found all his work cut out for him in getting his own troops back, and had consequently no time to evacuate the civilians. He, however, found time to drive most of their live stock away with him! Our front line often consisted of

outposts at farms and houses occupied by civilians, in the next house but a few yards away might be one of the Bosch outposts. One little party of refugees coming down from the front line said that an English patrol had visited their farm in the morning, and the Bosch in the afternoon; when again the British returned that night the civilians left their farm and went back with the patrol into the British lines and safety.

Early in November the British line pushed forward again, wireless stations were established at points midway between Landrecies and Malgarni, the Malgarni Station then becoming a pivotal point for all the wireless traffic of that area. The day before this the aerial of this station was altered considerably, a 30-foot portable mast was erected in a field to the west of the station and the aerial swung round and fastened to it. Thus instead of the aerial running approximately north and south, its direction was east and west.

*(To be continued.)*

# The Wireless Telegraphy Board

Co-ordination in the Wireless Services

**W**ITH the widespread use of radiotelegraphy and telephony in the Army, Navy and Air Force, it has become necessary to form a Committee for the purpose of bringing together those who are directly responsible for radiotelegraphy and telephony in those forces. The Committee which bears the official name, the Wireless Telegraphy Board, has already been in existence for over a year, meetings being held at frequent intervals,—on the average once a week.

According to the Navy List for February, the following members represent the forces in question:—

*Head of Board*—Captain (Act.) J. A. Slee, R.N.

*Naval Members*—Commander B. Buxton, D.S.O., R.N.; Commander G. C. Candy, R.N.; Major S. C. Wace, R.M.A.

*Military Members*—Lieut.-Col. Ll. Evans, D.S.O., R.E.; Major A. Simpson C.M.G., R.E.

*Air Force Members*—Colonel L. F. Blandy, D.S.O., R.A.F.; Lieut.-Col. G. P. Grenfell, D.S.O., R.A.F.

The Military Member, Major (now Colonel) A. Simpson, has, however, resigned as it was necessary for him to leave the country in order to take up a post in H.M. Forces abroad. His place was taken for a time by Captain P. J. Edmunds, but this officer has now resigned for other duties, his seat being occupied by Captain Moorshead. Captain Slee, the head of the Board, is well known in wireless telegraph circles, and

his portrait together with biographical particulars appears on pages 6 and 7 of this issue.

Of the Naval Members Commander Buxton, D.S.O., R.N., represents the Department of Naval Intelligence at the Admiralty and Commander Candy the Department of Torpedoes and Mines. This latter Department is responsible for the whole of the wireless telegraph installations on board vessels of the Fleet as well as for the fitting of wireless telegraphy on the numerous trawlers, mine-sweepers and other Fleet auxiliaries.

Major (now Lieut.-Colonel) Wace was born in 1883, educated at Shrewsbury Schools and entered the Royal Marine Artillery in 1901. In 1908 he became assistant for wireless telegraphy duties on H.M.S. "Vernon," and in 1910 wireless telegraphy officer attached to the Mediterranean Cruiser squadron. In the following year he became Fleet Wireless Telegraph Officer in the Mediterranean and is the author of the Admiralty Wireless Telegraph Manual, Vol. I, published in 1911. In 1912 he was appointed in charge of the Malta Wireless Telegraph Stations and in 1917 was attached to the Naval Staff of the Admiralty.

Of the Military Members, Lieut.-Colonel Evans is responsible for the Military Wireless Working, and Captain Moorshead represents the Department of Military Intelligence.

Colonel F. L. Blandy, D.S.O., representing the Air Force, is Deputy Director of Communications in the R.A.F., and is responsible for the whole of wire-

## THE WIRELESS WORLD

less communications in that arm. Prior to taking up this appointment Colonel Blandy was in charge of the Biggin Hill Experimental Establishment.

Colonel C. P. Grenfell, D.S.O., representing the Air Force, has had a long experience in radiotelegraphy. Before the war he was associated successively with the Eastern Telegraph Company, The De Forest Radio Telegraph Company, The Amalgamated Radio Telegraph Company and The British Radio Telegraph Company. During the war he was in charge of the R.F.C. wireless in Egypt, 1915, was attached to the Senussi Expedition early in 1916, and in the same year served in both Salonica and France, where he remained in charge of wireless on Major-General Sir H. M. Trenchard's staff and later on Major-General Sir J. M. Salmond's staff until June, 1918. Colonel Grenfell was on the staff of the Chief of the Air Staff at the Air Ministry until December, 1918, when he was transferred to command the R.A.F.

Wireless Experimental Establishment at Biggin Hill, which command he still holds.

The Wireless Telegraphy Board has no executive power, but its recommendations represent the considered opinion of the Senior W/T Officers of the three services from the purely W/T point of view. The Board exists for the comparison of notes and ideas, the discussion of matters affecting any two or more of the three forces and the prevention of overlapping. In all such matters discussion between representatives of the three forces is of the greatest value, for without co-ordination considerable inconvenience might occur through, for example, stations of the Air Force using the same wavelengths as adjacent naval or military stations. Under the chairmanship of Captain Slee a great deal of highly valuable work has been carried out during the last twelve months and in making the arrangement for peace-time working the Board is still exceedingly active.



*The Cape Observatory, South Africa, where a Wireless Installation is fitted for Time Signal Purposes.*

# Sir Oliver Lodge's Retirement

## Plans for Future Research

**A**T the close of the present session Sir Oliver Lodge, D. Sc., F. R. S., will relinquish his position as Principal of Birmingham University, a post which he has held since that institution was established nineteen years ago. Luckily for science, however, he does not intend to step from the arena and content himself as a spectator of the wrestling between men and veiled nature: rather does he seek to come to closer grips, to hold on where the grasp of others seems to close upon nothingness, for he announces that the remainder of his life is to be devoted to the physical and psychical problems of the aether. It is pleasant to think that in making this decision at sixty-seven years of age Sir Oliver is instinctively following in the footsteps of the long line of eminent scientists who at sunset were too busy to confess themselves tired.

Born in 1851 at Penkull, near Stoke-on-Trent, Sir Oliver Lodge was in 1881 appointed as the first Professor of Physics at the Liverpool University and in 1900 went to Birmingham University as its first principal, receiving his knighthood in 1902 on the occasion of the coronation of King Edward VII. Great as have been his general contributions to physical science and his assistance to and

encouragement of scientific thought and education, it is his pioneer work in connection with wireless telegraphy which has won for him a high place amongst the successors of Maxwell and Hertz.

Following a considerable amount of fruitful research on Hertzian waves, in the course of which he improved upon Hertz's apparatus for the investigation



*Sir Oliver Lodge, D.Sc., F.R.S.*

of their optical properties, Sir Oliver Lodge was not long behind Senatore Marconi in patenting a system of wireless telegraphy; in this he had the co-operation of Dr. A. Muirhead. The Lodge-Muirhead system is chiefly characterised by the use of a balancing capacity instead of a direct earth connection such as is nowadays generally employed, the wires composing this being arranged in the form of a Maltese

cross, a replica of the characteristic flat-topped Lodge-Muirhead antenna. Another outstanding feature of the system is the multiple spark-discharger which, in the case of large power stations, has water-cooled electrodes. The receiving circuit is distinguished by being the first of its kind to be tuned, a natural result of its inventor's earlier work on syntony, whilst the detector, the Lodge-Muirhead wheel coherer, is probably the most efficient form of self-restoring coherer ever evolved. In 1911

## THE WIRELESS WORLD

the Lodge patents were acquired by the Marconi Company, one of whose scientific advisers Sir Oliver Lodge subsequently became. Sir Oliver's active interest in psychic research extends, we believe, over a space of thirty years. A significant fact; for when a thinker of his calibre interests himself during three decades in a branch of science which has had thrust upon it the rôle of the poor relation, and then emerges as one

of its public champions, there is good cause for those who airily dismiss it as a mere speciality of catchpenny conjurers, to take serious thought.

We venture to wish Sir Oliver Lodge the health and happiness to enjoy his freedom from official duties and a full measure of success in the investigations he is about to undertake—a wish which will be shared by his admirers all over the world.



*Birmingham University.*

## New Commercial Wireless Service

**O**N March 13th Marconi's Wireless Telegraph Co., Ltd., opened their commercial Spanish wireless service which would have been placed at the disposal of the public in 1914 had not the war made it necessary to use the stations for more important purposes. From this country wireless telegrams may now be sent to all parts of Spain, the Balearic Islands and the Canary Islands, and for this purpose may be handed in at the Company's offices at Marconi House, Strand, or 1A, Fenchurch Street, E.C., besides

at any Postal Telegraph Office in the London suburbs or the provinces. The Marconi Company states that on receipt of a telephone request to either of the above addresses, Marconigrams will be collected by their own messengers.

The rate per word to Spain and the Balearics is 2½d., and to the Canaries 4½d., with a minimum of 10d. per message; these rates, taking into consideration the speed and accuracy with which the traffic is handled and the facilities which are offered in respect to the collection of telegrams, should be very attractive to business men.



# Stray Waves

## SHOULD WIRELESS TELEGRAPHY BE CONTROLLED?

**U**NDER this heading the *Electrician* contributes a useful discussion of a subject which, with the cessation of hostilities and the consequent relaxation of certain tentacles of the Defence of the Realm Act, has again sprung into prominence. Unfortunately, however, the article to which we refer is marred by a lapse into what we had hoped was a habit of which the war had cured Britons, namely, that of depreciating our own scientific work and enterprise. For well-known reasons the major part of the work achieved by our countrymen in connection with the development of radiotelegraphic (and telephonic) appliances and methods during the past four years has been a sealed book to the general public and therefore we consider our contemporary's judgment to have been delivered somewhat hastily.

It was not to be expected that the matter could lightly be passed over by anyone representing wireless interests in this country and Mr. Godfrey Isaacs of the Marconi Company has accordingly written to the *Electrician*. We publish without further comment his letter, a copy of which he has handed to us for that purpose:—

The Editor, *The Electrician*.

“DEAR SIR,

“In your issue of the 21st ultimo you publish an interesting article entitled ‘Should Wireless Telegraphy be Controlled?’ With the views therein expressed most people I think will be inclined to agree. It contains statements however, which are scarcely accurate and

unless corrected would probably prejudice British industry at a time when everybody requires the fullest advantage of everything he possesses to keep his end up.

“For instance it is said ‘Our National record in Wireless Telegraphy apart from the financial side is a sorry one,’ and the writer then proceeds to cite a number of developments which he attributes to different foreign nations.

“The writer of your article loses sight of the following facts:—Wireless Telegraphy at sea was developed entirely from this country. Transatlantic communication was established between this country and the American continent years before anybody else could even attempt it; all the developments abroad of the three electrode valve have been merely developments of, and would not have been possible without, Dr. Fleming's great invention, and its first application to Wireless Telegraphy was by Senatore Marconi in England; and, the continuous wave system which has transmitted messages over the record distance of 12,000 to 13,000 miles is a Marconi machine, developed entirely in this country by Senatore Marconi himself with the assistance of British engineers.

“There have been a great many other developments during the war, but as you are aware they have not been published, and in the interests of the country we have not spoken of them. The writer of your article could therefore have had no knowledge of them.

“Your publication is to our knowledge much read by technicians and others in Foreign Government Departments, and I think you will therefore

## THE WIRELESS WORLD

agree that the article in question must be very damaging to us and to the industry of this country.

"I venture to believe that I need only draw your attention to these facts to ensure that in your next issue the credit which is due will be given to British enterprise.

"I am, etc.,

(Signed) "GODFREY C. ISAACS."

### FUTURE POSSIBILITIES OF WIRELESS.

No sooner had mankind discovered how to produce and control large electromagnetic waves when the utilitarian mind began to seek for a means of employing them in the everyday service of the community. In this quest the inventions of Senatore Marconi led the way and we have since seen the application of wireless to telephony, horology, photography, fog-signalling, and the steering of aircraft and seacraft. In his very interesting inaugural address on November 20th, 1918, as Chairman of the Council of the Royal Society of Arts, Mr. Allan A. Campbell Swinton dwelt at some length upon the achievements and possibilities of wireless telegraphy. Referring to the ever-increasing amount of news with which the Wireless Press is providing the newspapers he suggested that there is no reason why printing machines should not be so designed and constructed that they will themselves receive and also print news messages transmitted by special distributing stations. Hence arises a point, which, as Mr. Campbell Swinton indicates, bears directly upon the general aims of the League of Nations, for as it seems impossible to limit the transference of energy by aether-waves within international boundaries, such a news service would of necessity be more or less world-wide. From the point of view of costs, too, there is much in the idea to commend it,

since there would be scarcely any limit to the number of news receiving stations which could be served by a single transmitter of appropriate power, and thus the benefits accruing from such a scheme could be extended to private individuals as well as to the daily press.

But by far the most fascinating and important problem spoken of by Mr. Campbell Swinton was that of the wireless distribution of electrical energy in bulk. If, as is likely, electricity is to supersede coal not only in the mine and manufactory but in the home, then sooner or later we must have large power stations feeding much greater areas than those allocated to the present-day stations. From this there arises a problem which may eventually lead us direct to wireless distribution, namely, that of the conductors. This is a matter both of economy and practicability, and emphasizes our need of a material of much higher conductivity than copper and of a cheap insulator which will emerge successfully from the severe test it will be called upon to undergo.

The transmission of high electrical power by means of Hertzian waves is one of the dreams of wireless men and history proves that the dreams of scientists, provided they are the outcome of healthy scientific imaginations, have a way of coming true. The difficulties opposing the realization of this particular dream are numerous and formidable, yet the worst of them, the concentration of the waves upon a given limited area, has been already reconnoitred to some extent by Tesla and the men who are responsible for the systems of directive wireless telegraphy. In any case the idea cannot be dismissed as being outside the bounds of possibility and therefore it is to be hoped that it will not be allowed to drop. Many a promising thing has withered for lack of light and air and for that reason we shall be glad to accord free ventilation to the subject in our pages.

# Notes of the Month

## CANTOR LECTURES.

**O**N February 17th and 24th at the Royal Society of Arts, Dr. J. A. Fleming delivered the last two of a series of three lectures dealing with "The Scientific Problems of Electric Wave Telegraphy." In discussing long distance telegraphy he pointed out that although mathematicians had agreed upon the impossibility of communicating by wireless over half the earth's circumference this had actually been done by the Carnarvon station, as witness its recent feat of reaching Sydney, N.S.W., with good, readable signals. Dr. Fleming devoted considerable time to the problems of the effects upon electro-magnetic waves of the atmosphere and the crust of the earth, mentioning in connection with the latter that in selecting sites for wireless stations engineers would do well to make a geological survey and to determine the dielectric constant and conductivity of the earth in the proposed locality.

The final lecture was given over to a consideration of receiving devices, the history of the three-electrode valve being traced step by step from the first recorded observation of the electrical phenomena of hot filaments to the Fleming valve detector and from thence to the modern valve amplifier. These lectures attracted full audiences on each occasion—the usual tribute to Dr. Fleming's skill and charm as an expositor of science.

## OUR DESTINY IN THE AETHER.

From the *Toronto Daily News* comes a strong plea for an Imperial wireless

news service. At a time like the present when the units of the Empire are making contact with each other to a degree beyond any before achieved, such a service would be exceedingly valuable. The war has been the cause of a great increase in the production of wireless plant and it should be comparatively easy to find at once sufficient gear to enable a temporary system of news exchange within the Empire to be initiated without much delay. During the past month certain cable routes have been more or less unsatisfactory owing to breaks, and Mr. Godfrey Isaacs, the managing director of Marconi's Wireless Telegraph Co., Ltd., lost no time in pointing out that his Company could step into the breach with a wireless service to Holland within a few hours. The suggestion was eventually acted upon by the Post Office without reference to the Marconi Company. If this can be done in the case of short distances the like applies proportionately to great ones and plainly indicates the desirability of having an aether-line service which will be adequate to handle all the traffic on the occasion of an interruption of the cable service. An old theme, it is true, but although we have awakened to a sense of our destiny in the air, can the same be said of the nation in respect to the aether?

## THE BRITISH SCIENTIFIC PRODUCTS EXHIBITION.

One of the more encouraging signs of the times is the announcement that an exhibition illustrative of British scientific invention is to be held next July at the Central Hall, Westminster. The inten-

## THE WIRELESS WORLD

tion is to bring manufacturers into touch with inventors, a consummation which should not fail to make for the advancement of British industries. Incidentally there will be revealed many inventions hitherto kept from the public eye by the exigencies of war. As there is to be a section devoted to electrical engineering it is to be hoped that the wonderful developments of radiotelegraphic apparatus will receive fitting attention.



### AN UNEXPLAINED PHENOMENON.

From time to time we hear of instances of strong brush discharges taking place from the aerials on ship installations when the transmitter is not in operation. In a case recently brought to our notice the aerial plug was taken from the tuning inductance and laid on a wooden cabinet, when it was found to be emitting sparks, the discharge lasting for several minutes. We are also aware of operators having received severe shocks whilst handling the aerial plug

or approaching the hand towards the lower end of the aerial. Having investigated certain similar cases we find that whereas in some of them the discharge occurred whilst the fog-horn was in action and steam was striking the aerial, others cannot be accounted for in this way. Considering that the average ship's aerial is not large it seems that the effect to which we refer cannot be due to any ordinary electrical atmospheric condition of the atmosphere and may result from local super-storms of "strays," in which case it would be interesting to know from what causes such storms arise.



### COMMERCIAL WIRELESS SERVICE.

It is announced by Marconi's Wireless Telegraph Co., Ltd., that a resumption of its commercial service to Canada has been authorised by the Government.

The same Company is now accepting traffic for Bermuda, British West Indies and British Guiana.



*A Group of Wireless Men of the 7th Army Observation Group.*

# Aircraft Wireless Section

Edited by J. J. Honan (late Lieutenant and Instructor, R.A.F.)

*Editorial Note : Under this heading we propose month by month to deal with Wireless in Aviation by general articles of an instructional nature, and to give the latest news of progress.*

## SOME GENERALITIES

**D**ESPITE the enormous strides that have been made during the last few years in the development of aerial navigation, we still stand at the very edge of the new Kingdom.

From there, we peer forth into the future and conjure up prophetic visions of that time to come when the aerial stripling of to-day shall have grown into one huge Universal Transport Service. No longer cramped and distorted into a fearsome weapon of offence, but, instead, grown into its proper heritage of pride and place as perhaps the most powerful and beneficial agency that has yet been conceived of man's genius.

*The mastery of the air was consummated in the conquest of the Hun.*

In that, to some extent, lies the strength and the weakness of the present position.

During the last four years all progress in the newly-born science of Aviation has been subordinated to a particular purpose—War. Efforts that would normally have been directed and controlled by considerations of commercial efficiency, in tackling the unending difficulties that strew the path of progress, were diverted to the more restricted problem of evolving merely the most powerful weapon of offence.

But, after all, more has been gained than lost. The flow of invention may have been directed into narrower channels; but it has gained pace in the pro-

cess, and has made headway accordingly. How much, and how quickly, must be left to the judgment of a later period, when all that was done has been made known. Only then will a proper perspective be possible, and a due appreciation be paid to those responsible for the enormous forward strides taken during the period 1914-1918.

### *CARPE DIEM.*

Without the fierce stimulus of war, then, assuredly much ground that is now tilled and cultivated would still be lying fallow.

Now that the Armistice has been signed, and Peace is in sight, let us therefore seize firm hold of this one of the few good legacies of the God of War, and improve and remodel it on standards of general utility, and so give its future a new scope—one more appropriate to the era of peace and to the great part it will play in the good days to come.

## THE GENERAL VALUE OF WIRELESS TO THE AVIATOR.

Wireless is the *Fidus Achates* of Aviation. Without it the warrior pilot would have been sadly crippled in his late career. And in his new rôle—be it that of auxiliary to the Postmaster-General, or rival to the great Railway and Steamship Services, or even triple-express agent of Carter Paterson, or Pickford—he will find himself sorely handicapped without the kindly aid of the nimble ether wave.

## THE WIRELESS WORLD

Presently the world will be the richer (let us be optimistic!) by the creation of a Board of Aerial Control. It may start in rather a small way, but pilots and all those others (lesser lights, shall we say?) who look forward, one day, to earning their bread in the skies will come, in time, to treat it with that respect—quite untempered by affection—that is paid by the sailor-man to the Mercantile Marine Department of the Board of Trade. There will be many things about which it will frame ponderous and weird regulations, and "aircraft, wireless installations for the use of" will be one of them.

The Mercantile Marine has already set the fashion in wireless for the sailor. The necessity is even greater and more urgent in the case of the airman, so that it behoves such to take time by the forelock, and to mark, learn, and inwardly digest the signs of wireless progress as it is applied to the gentle art of aviation.

### DEVELOPMENT OF WIRELESS SETS DURING THE WAR.

Since 1914 many types of telegraphic and telephonic sets have been evolved by the R.N.A.S., the R.F.C., and the R.A.F. for specific use with aircraft. But the brand of war is not marked so deeply on them as upon the craft they serve; in fact most of the service sets are admirably adapted to commercial use.

Up to the present, however, it has not been possible to publish any account of their design or give particulars of their specific use. Indeed it is well known that the Enemy were most anxious to get hold of certain of our instruments, particularly the C.W. sets, and copies of German notices have been found in which big rewards were offered to their troops for the salvage of any portion of such instruments from wrecked planes. In turn we took special precautions to

ensure the destruction of such sets as were known to be the particular object of Hun envy—in the event of any of our craft unavoidably falling into their hands.

The time has now come, however, when there is every reason to expect that the curtain of secrecy will be raised and that it will be possible to publish a description of certain specified types. When this is permissible they will be dealt with in some detail in subsequent pages of this section of the *WIRELESS WORLD*.

### HOW WIRELESS GADGETS GENERALLY STRUCK THE AVERAGE PILOT—OR *VICE VERSA*.

In the days of not long ago, the flying man had, in the ordinary way, a somewhat excessive number of things to think about whilst plying his diversified trade amongst the clouds; and wireless gadgets in particular were wont to make him exceedingly tired and even peevish.

However, occasion arose from time to time which indicated that they had their good points. Very useful, for instance, in calling up the drome if Fritz should appear in large quantities whilst one was doing a lone "shoot" or patrol. It was better to make the affair into a pleasant conversazione, when the occasion offered, rather than to endure an unprofitable one-sided interview.

Again there was something to be said for the advantage of being able to go out solo—without observer or wireless operator—and conduct a little "shoot" alone. There was a certain zest added to the game when one could personally send an O.K. from time to time; or metaphorically "blind the gunners' eyes" when a "rank outsider" was recorded.

For this kind of work, a small short-range spark set was used, run from accumulators. There were practically

## AIRCRAFT WIRELESS SECTION

no adjustments to be made—just the aerial to be dropped, and a plug to be inserted.

Of course Morse was a bit troublesome, but not too bad, "and a bit of practice soon gave you speed and style" (ask the poor wireless operators in the batteries!). Moreover, once learnt, Morse had some useful applications apart from shop—into which it is not within the scope of this article to enquire.

However, in many cases, the quite understandable, if not wholly reasonable, initial prejudice of the average pilot against wireless was in one way or other broken down, and he became ready to investigate. Once having reached that stage he almost invariably "acquired grace," adopted the W/T instruments into his family of pukka gadgets, and thenceforward considered them as being worth their room in his bus instead of representing so much superfluous "clobber."

### WIRELESS MUST BE TAKEN INTO ACCOUNT BY THE AIRMAN.

The pilot who thus broke the ice and made friendly acquaintance with his useful ally is going to save himself trouble now should he decide to turn to the commercial side of flying.

For there is one thing just as certain as that the aeroplane has come to stay, and that is that it cannot do without wireless. Wireless telegraphy, wireless telephony, and last, and by no means least, the latest phase "direction finding" or navigation by wireless, will grow in scope of usefulness with the development of aerial traffic generally, until one becomes so much an inherent part of the other that they shall be well and truly married and no man shall put them asunder.

Consider the question from one or two aspects.

What other means will provide rapid and accurate communication with

Mother Earth, once it has been left. Signal lamps, flags, smoke bullets—what you will—all are old-fashioned and obsolete. They served their purpose in the early stages; but wireless is the one and only way now. It is the *goods*. And as such it becomes part of the pilot's educational outfit. Otherwise he will become a back number.

It is equally essential for solo flying, and for passenger work. As the flying controls of the aeroplane are steadily simplified, so the capacity of the pilot for auxiliary cares will be increased. And wireless should be the first to be adopted.

### SPARK SETS.

A simple spark set working on short wavelengths but with ample range for signalling to control stations and for similar kind of work already exists. It is run from accumulators; is simple to understand, and keep in efficient working order; weighs about 30 lbs. all told; and can be stowed away in an insignificant space. It is so useful within the stated limits that it may be regarded an indispensable part of the average bus equipment.

Then again, a longer range of transmission may be required; and the need has been met by the evolution of various types of continuous-wave valve generators, or small rotating-electrode sets. The former especially combine great efficiency with compactness and lightness. The latter type is heavier and more suitable for use in the bigger craft. Of course, the most suitable installation is entirely dependent upon the precise nature of the flying duties concerned.

The simple type of spark transmitter may be sufficient in the case of short point-to-point trips, whilst an entirely different outfit may be called for by the requirements of long-distance journeys, night flying, etc.

### TELEPHONY SETS.

Small telephony sets were developed

## THE WIRELESS WORLD

during the war that were practically perfect for the results required. Excellent and clear speech could be attained from plane to plane over a distance of from five to six miles. And this limit was self-imposed for obvious reasons. It was not wise to strive for a longer range in view of the fact that it was mainly evolved for formation-flying and manœuvring, at times in close contact with the enemy. But those limits can be easily passed now that different conditions prevail. From plane to ground the range with same set was much greater.

In these sets, too, simplicity of design was striven for and attained. For transmission, a small generator was employed, fitted on one of the struts and driven by screw blades mounted on the armature shaft and actuated by the slip stream from the main propeller. The armature windings of the generator were so designed as to secure a practically constant voltage throughout the inevitable variations of speed that might be anticipated during a normal flight. A small valve-set generated a continuous wave train, and by means of a microphone speech-frequency variations were imposed upon the steady C.W., so giving rise to audible speech in the receiver. The receiving-set comprised a wonderfully simple two-valve circuit.

Fitted with a double telephony set for reception and transmission, the pilot has full and adequate powers of communication, both with his brother Icarus, or with land. Moreover, with extra pairs of 'phones and a switch he can converse with one or more of his crew or passengers in complete independence of the pandemonium of engine noise that reduces attempts at speech in the higher realms to a mere pantomimic farce.

### ONE INSTANCE OF THE VALUE OF A TELEPHONY SET.

Most pilots at one time or other have

had the experience of losing a landing-wheel when taking off from bumpy or stony ground.

They retain probably a much clearer recollection of the nasty jar that accompanied the next landing.

In about ten cases to one this kind of mishap is not noticed by the pilot or passenger when it occurs, and that being so the loss generally remains unnoticed until such time as the missing wheel is badly wanted to perform its usual functions on landing. It is then too late, and the subsequent proceedings depend very largely upon the fickle Goddess.

If, however, the pilot *knows* he has lost the wheel, he "acts according," and in landing, manœuvres the joy stick so as to come to ground with a certain loss of grace, perhaps, but without damage to himself or the bus.

But *knowing* makes all the difference.

Should his bus be fitted with a phone set, he will be called up instanter from the drome and informed. The damage is bound to have been noticed there—and in fact is plainly seen by everybody who casts a glance aloft. So that either at the start of his trip or in passage he will be put wise from some land station or other. And to make assurance doubly sure some brother Jehu will inform him *en passant* that his port or starboard wheel is lonely, and will probably beg facetiously for the name and address of the next of kin.

In the old days, failing the phone, there was probably a flurry to get out ground strips—which were never ready in time.

Or a vain attempt to ring up the destination drome, if it was known; even then if the message got through there was sure to be some snag or misfire at the other end.

Or there was an outbreak of fervid and varied signals (not of the wireless variety), which—if noticed at all—only caused the pilot to think pensively of



## AIRCRAFT WIRELESS SECTION

the apparent abundance of good liquor that must have been wasted to produce such an unedifying exhibition.

In the last resort another man was given the job of chasing the sinner and attempting to convey the glad news by appropriate and graceful gestures. This was liable to produce many effects upon the unfortunate victim, varying from a contemptuous and complete ignoring of the unseemly performance, to the other extreme of creating a decided vertical draught and causing a sudden swoop to earth to get out of the way of an apparent madman.

If the resultant landing was not too disastrous the mystery was thereupon fully elucidated to the harassed one.

There is no need to embroider the subject. If a pilot has been through a similar experience—or through any of the *contretemps* incidental to his calling—where so much trouble and anxiety or annoyance could have been saved or avoided by the possession of some efficient means of communication with other people, on or off his own bus, he will, as a reasonable man already be a convert to the necessity for installing a telephony set in every type of aircraft.

### MORE CONCERNING THE WIRELESS TELEPHONE.

And, moreover, as a servant of science, he should be only too ready and anxious to investigate somewhat, not only the manner of working, but also the inner nature of this marvellous little instrument.

For in a sense it is even a more astounding manifestation of the mastery of mind over matter than even that intricate combination of machinery and structure that represents man's conquest of the air.

It is an interesting speculation as to which achievement would appear the more miraculous could it have been presented, say, to Archimedes—or even

for the matter of that to Newton.

At all events the annihilation of space encompassed by the harnessing of the universal ether through the medium of wireless apparatus generally, but more particularly the development of the wireless telephone, represents a feat undreamt of but a few decades ago, whereas the art of flying is an ambition that has burnt in the bosom of man since the mythical days of the ill-fated Icarus.

### APPEAL TO A CERTAIN TYPE OF MIND.

There must be an enormous fascination to the youth of scientific imagination in a career that is concerned with both achievements. It will be many a long year before the attraction of flying begins to pall. The world will be getting grey-whiskered in earnest then. And so long as man—of all ages—has not fallen into senility he will feel the call of the high, blue spaces. The old time life afloat will yield premier place, in the days to come, to the fascination of the "life aflight." Add to that the attraction that wireless undoubtedly has for the average scientifically-inclined youth, and the combination offers a future career full of stimulating possibilities.

### DIRECTION-FINDING APPARATUS.

It is more particularly in the development of the latest application of radio energy that the widest scope will be offered for a new career.

Direction-finding apparatus will in future form an absolutely essential part of the navigation outfit of all long-distance machines.

Directive transmission has long been a problem for the wireless engineer, but it is due to the inception of an efficient "radiogoniometer" or receiving-device that analyses the direction of the normal to the oncoming ether wave-front (and

therefore indicates its actual centre or point of origin) that the art of navigating by wireless has become possible.

Such a navigating set would have saved us the loss of that famous early Handley-Page machine that so sadly went astray one foggy day into the joyful hands of the Hun.

But, in revenge, D.F. sets *were* ready installed, perfected and indispensable, in those sleuth-hound craft that were on the point of being loosed to nose their deadly way to Berlin when the Armistice rang down the curtain. Sleuth-hounds, because like those animals they were provided with a faculty that would have guided them unerringly to their goal.

### ANOTHER TRIUMPH OF RADIO INGENUITY.

An arrangement of loop aerials hidden away in the fuselage and wing, a cascade set of receiving valves, and a simple differential indicator operated by a throw-over switch. Nothing very intricate or imposing to look at, occupying but little space, making but little demand as regards weight, easy to manipulate, and reliable.

It represents the triumph of the radio engineer, and the full extent of its application has, as yet, hardly been realised.

This set as fitted to the latest bombing machines has not long emerged from the experimental stage. There are still one or two inherent difficulties to be overcome before absolute precision is attained. One arises from the refraction effect or bending of the ether wave front as it encounters air strata of varying "ionic density"—particularly in the case where the transmitting station and receiver are on different sides of the dawn. The action of the sun causes the air to become comparatively more ionized and therefore slightly denser to the passage of the electro-magnetic waves; the wave-front is consequently slightly bent or distorted. But this

difficulty is being met and will be overcome and in any case the effect is relatively insignificant.

At present the results are wonderfully accurate—far beyond any alternative method, particularly for night flying, and certainly well within the limits of accuracy required for ordinary long-distance flying.

The set is, of course, being utilized for the transatlantic flight, and amongst the many objects to be served by that long-anticipated trip the successful application of this latest contribution of wireless to the onward progress of aviation will not be the least important.

### HOMING BY D.F.

In its simplest application, that of flying directly towards or away from a given transmitting station, only the wing coils are employed, the fusilage coil being cut out. The operation of the set in this manner is practically automatic, and can easily be managed by the pilot of a solo machine. No calculations are required, and no possible error can arise.

### NAVIGATING BY D.F.

In steering a definite course (as distinct from "Homing" on to a given station)—or in finding one's bearing in an unknown position, the process is slightly more involved, but it is by no means intricate.

In such cases, however, the presence of a navigating officer or operator is necessary. Bearings are taken from the plane, first on one transmitting station, whose location is identified by means of its code call, and next on a second known station. As the distance between the two transmitting stations is one of the known factors (or can be ascertained from the chart) and as the angle subtended by that base line at the point occupied by the plane has now been ascertained by the direction-finder, the exact determination of the plane's position is a matter of simple trigonometry.

# Aviation Notes

## WEATHER PROGNOSTICATION.

**T**HE coming boom in air traffic will mean a lot more work for the long-suffering Clerk of the Weather! The number of observation stations under the control of the Meteorological Office at the commencement of the war proved quite inadequate to give the detailed and reliable information as to weather conditions required for the guidance of pilots in the various theatres of war.

To fill this want the Royal Air Service created a new department of "weather prognostication," and erected a large number of additional wireless stations, scattered far and wide for the sole purpose of observing and recording data necessary to compile those weather forecasts which so often made the difference

between life and death to the flying man.

## MR. GRAHAME-WHITE'S LATEST AEROBUS PLANE.

In a recent address to the Royal Aeronautical Society, Mr. Grahame-White gave some interesting particulars of a machine he is designing for the London-Paris Service.

It is a biplane planned to carry 24 passengers exclusive of the crew and fitted with three 600 H.P. motors, two being tractors and the third a "pusher."

It is specially interesting to note that of the crew of five, one is a navigating officer and a second the *direction-finding wireless operator*. Verb, sap!

## OBIT.

Lieut. E. H. Dimmock, R.A.F., of the Wireless Telephony School, Winton, Bournemouth, died on February 3rd of pneumonia.



*A Group of Telephony Officers, R.A.F. Wireless School, Farnborough.*

# Practical Notes on the Use of Small-Power Continuous Wave Sets

BY J. SCOTT-TAGGART, M.S. BELGE E., A.M.I.RADIO E.

## I. TRANSMISSION.

**T**HE following notes are intended to show the value and possibilities of the continuous-wave set for communication purposes, and to deal with some of the practical points of interest to those whose experience in this direction is limited.

The simplicity with which undamped oscillations may be produced by means of the vacuum valve has opened up a new and extremely interesting field, which includes wireless telephony, to those whose opportunities were previously confined to the working of spark sets. It is of particular interest to the experimenter on account of the opportunities for investigation of a subject which is comparatively in an embryo stage.

Continuous-wave wireless, until recently, was often regarded as the privileged monopoly of those who had facilities for producing oscillating arcs by means of high-voltage currents. At the present time, however, the transmission of messages by means of undamped waves is of practical interest to all, and is no longer restricted to the fortunate few. Moreover, the expense of working continuous-wave wireless sets is, if anything, less than that of spark sets.

Let us first briefly review some of the peculiarities and advantages of this form of communication. The ionic valve can be made to generate persistent oscillations, of regular and almost pure sinoidal

wave-form, which set up continuous waves capable of travelling very considerable distances with small loss of energy, and with a small expenditure of primary current. A 10-watt set, for example, can be read at a distance of 50 miles on an ordinary single-valve heterodyning receiver. This fact alone will appeal to those who have no practical knowledge of these sets. On the other hand, this is liable to be considered a disadvantage in that mutual interference between sets is more probable. In spite of this, however, a greater number of stations are able to work within a given area without causing "jamming," partly on account of the sharper tuning of the waves, but chiefly on account of the very high selectivity of the heterodyning valve as a receiver of undamped waves. Let us suppose that such a receiving circuit is tuned to a wave-length of 800 metres, and is therefore oscillating at a frequency of 375,000. If the set now comes under the influence of a C.W. transmitting station sending on a wave-length of 750 metres, these oscillations of 400,000 frequency will interfere with the local oscillation producing beats of 25,000 frequency.

These beats, however, will be quite inaudible to the operator, the human ear being unaffected by frequencies higher than about 14,000. Only when the wave-length of an outside station is between 780 and 820 metres; will its signals be heard by an operator working on a set tuned to 800 metres. This alone

## PRACTICAL NOTES

explains the selectivity of continuous-wave working. Moreover, it explains why for practical purposes it is necessary to work on wave-lengths of the order of 1,000 metres. If a wave-length of 300 metres were used, and the receiving set were tuned to a wave-length more than three metres to either side of the correct one, no signals would be received. The arrangement, therefore, would be excessively sensitive and the swinging of the aerial or the slightest movement of the operator would cause the pitch of the note to vary, and would probably cut it out altogether at times.

Another point in connection with small-power C.W. sets is that the note-frequency can be varied at will on the receiving instrument by slightly altering the tuning of the local circuits. There is, therefore, no means of distinguishing a station by its peculiar note, as is the case in spark wireless. There is, however, the advantage that perfectly clear high notes may be obtained which can be easily read through atmospherics.

Distinctive notes *may* be given to stations by sacrificing the uniformity of the stream of waves, by making the voltage applied to the plate of the valve of an irregular or intermittent nature.

The waves emitted, however, cannot be strictly considered "continuous," and are capable of being received to a certain extent on ordinary circuits used for spark reception.

A further advantage of continuous-wave communication is that much looser couplings may be employed than in the case of undamped waves. The application of this fact is discussed later.

A commercial advantage of C.W. work is that a much higher speed of transmission is possible than in the case of damped waves where, if the speed of transmission were high, only one or two wave-trains would be sent to a dot or dash.

On account of the present desirability

of secrecy, it is impossible, just yet, to give details of the more recent developments of this branch of wireless telegraphy. The diagrams given here, however, are of circuits already well known, and which, while giving excellent results themselves, have been the basis for improvements in design.

Although a set may easily be designed having circuits which may be used for transmitting and receiving, it is preferable to have two sets, one a receiver and the other a transmitter. No alteration of adjustments need then be made, and each set may be adjusted to those values of reactance, filament current, high-tension voltage, etc., which give the best results. Owing to the very fine tuning required, it is highly undesirable that adjustments which affect wave-lengths should be altered when once they have been fixed.

Fig. 1 shows a typical circuit for the transmission of continuous waves. It consists of two oscillatory circuits, one forming the grid circuit and the other being included in the plate circuit of a valve. The plate oscillatory circuit also forms part of the open radiating circuit, auto-transformer effects being thus utilised. This direct type of coupling is perfectly efficient for continuous-wave work, and there is practically no advantage in having a separate open aerial circuit.

The grid oscillatory circuit may be made either variable or aperiodic. Slightly better results are obtained by tuning both plate and grid oscillatory circuits to the same wave-length. On the other hand, an aperiodic grid circuit lessens the number of adjustments necessary, and is perfectly efficient provided the discrepancy in wave-length between plate and grid circuit is not too great.

*R* is shown as an aperiodic reaction coil of such dimensions as will give a wave-length approximating to the one it is proposed to use. The coupling between

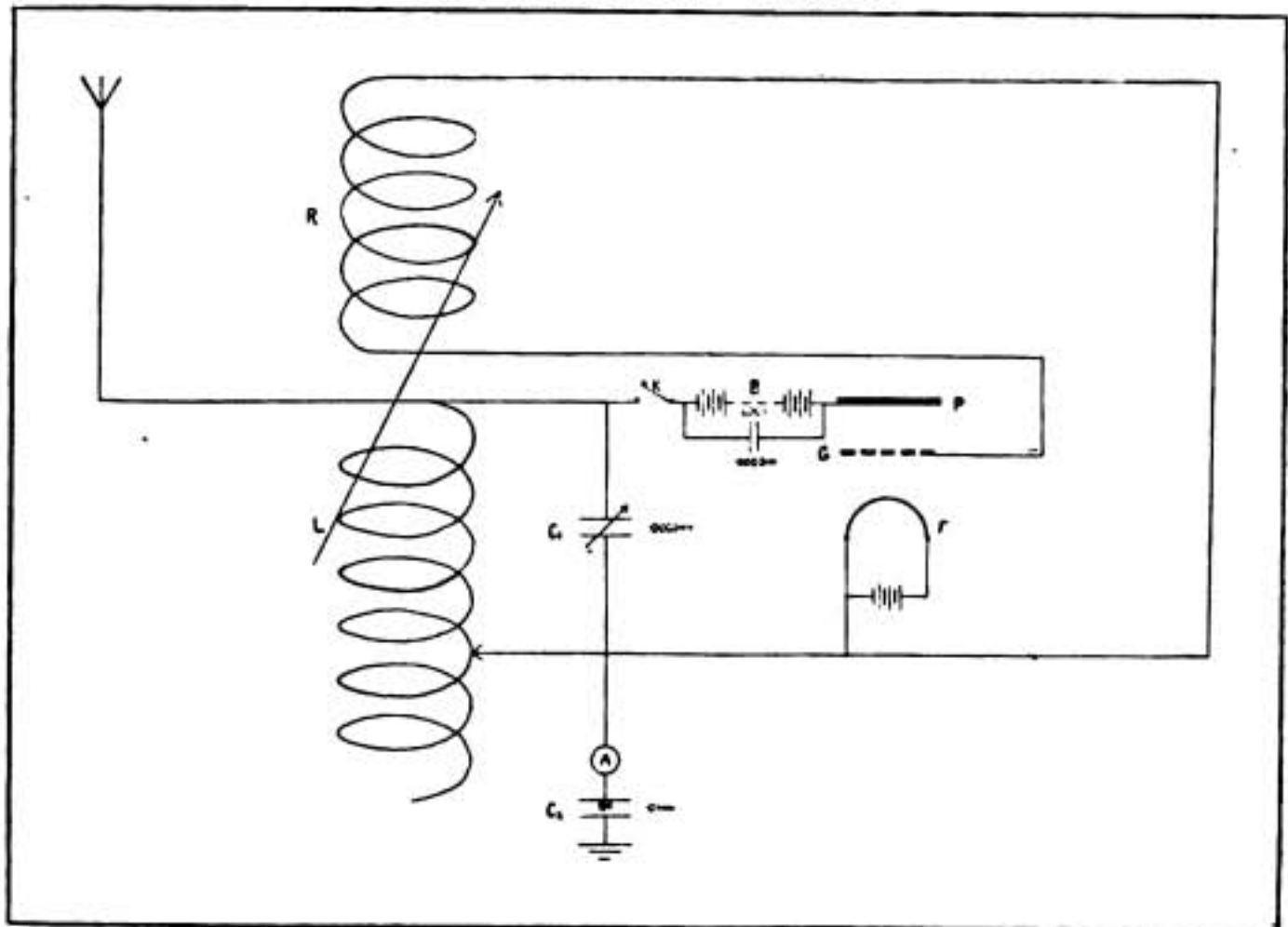

Fig. 1.

$R$  and  $L$  is variable.  $C_1$  is a small variable condenser of .005 mfd. for obtaining a fine adjustment of wave-length.  $A$  is a hot-wire ammeter for measuring the aerial current, and should read up to about 300 milliamperes.  $F$ , the filament of the valve, is heated by means of a six-volt accumulator.  $B$  is a high-tension battery of about 400 volts, consisting of a number of dry cells in series. It is shunted by a blocking condenser, which allows a more ready passage for the high-frequency oscillations taking place in the plate circuit.  $K$  is a tapping key.  $C_2$  is a blocking condenser in series with the earth, and is found to improve the results obtained. The best value for its capacity is determined by the capacity of the aerial. A value of .01 mfd. has been found suitable.

The above arrangement enables the reaction coil  $R$  to maintain the oscillations in  $L$  during the time that the key  $K$  is depressed. The frequency of the continuous waves emitted depends upon the

values of the inductance  $L$ , the condenser  $C_1$ , and to a smaller extent, on the value of the coupling between  $L$  and  $R$ . The value of the aerial current measured by  $A$  depends upon the coupling between  $R$  and  $L$ , the choice of values of  $L$  and  $C_1$ , the dimensions of the aerial, and chiefly the plate current (which is itself dependent on the plate voltage, the filament current and the nature of the valve).

Let us deal separately with the above facts.

In C.W. work, as in spark wireless, the longer and higher the aerial the greater will be the range of the set. The advantage of a long high aerial is, however, not nearly so marked in the case of C.W. sets. They are capable of transmitting, and more particularly receiving, long distances on short low aerals. Thus an aerial about ten yards long and three feet high will enable communication to be carried on over a distance of five or more

## PRACTICAL NOTES

miles. Moreover, it is fortunately an easy matter to make these small aeri-als radiate efficiently waves perhaps twenty times as long as the natural wave-length of the aerial. There is, however, for each aerial a wave-length on which maximum radiation is obtained, and this can be found by trying different combinations of  $L$  and  $C$ . For receiving continuous waves it is quite unnecessary to have the same height of aerial. If the aerial is too high, it is liable to give rise to excessive interference from spark stations, whose signals are improved to a greater extent than those from continuous-wave stations by increasing the height of the aerial. The best arrangement in some cases is therefore to have a high aerial for transmitting and a low one for receiving. It will be found that although the receiving circuit is made to oscillate very strongly when the other aerial is being used for transmission, this interferes in no way with the strength of signals obtained at the distant receiving station. When using very small aeri-als for transmission, their capacity should be made large. This may be done by having a large number of wires, or, more simply, by using a length of wire netting or gauze. Such aeri-als have been used by the writer with great success on motor-cars, railway wagons, etc., while moving, over ranges exceeding ten miles.

In addition to ordinary aeri-als, ground antennæ will be found to give excellent results, particularly when receiving signals. A suitable arrangement consists of two insulated wires, well insulated at the ends and about 80 yards each in length, raised a little from the ground, if possible, by grass or undergrowth. The lines should be run out from the aerial and earth terminals of the set, and should point in the direction of the station to which it is desired to work. Very decided directional effects will be noticed. Interesting results may be

obtained by earthing the ends of the antennæ direct or through condensers. When using such aeri-als, the condenser  $C_2$  should be small, and when receiving, greater values of high-tension voltage will be required to make the circuits oscillate.

On depressing the key  $K$  of Fig. 1 the system commences to oscillate, and a reading of perhaps 150 milliamperes will be registered by the ammeter  $A$ . The coupling between  $R$  and  $L$  is adjusted until the maximum reading is obtained in  $A$ . If the coupling is too loose, the alternating voltages on the grid of the valve are not sufficiently high to cause large changes in the plate current of the valve. This plate current is normally something like 40 milliamperes, an alternating voltage of about 50 volts being required to vary this current between zero and 80 milliamperes. If, on the other hand, the coupling is too tight, the voltage induced in the grid oscillatory circuit is greater than is necessary, and considerable energy is wasted in maintaining these undesirably strong oscillations. In addition, too tight a coupling impairs the wave-form of the oscillations, and harmonics are very liable to be produced.

Not only should the reading of the ammeter be high when the reaction coil coupling is correctly adjusted, but there should be no wavering of the needle when signals are being sent. This occasionally happens through the valve hesitating to oscillate. At the receiving station this results in broken signals. Another reason for the wavering of the ammeter needle, and a more likely one, is the unsuitability of the valve. Some valves give infinitely better results than other specimens of the same type. The vacuum requires to be of a very high order for transmission, and, if not good enough, will lead to irregularities in the movement of the ammeter needle. At the same time, excessive dimming of the

light from the valve is noticed when the key is pressed, and if the valve is genuinely "soft," a bluish glow will be seen. Valves should therefore be tested on the transmitting set, and those which fail to give a good ammeter reading, or which give an irregular one when the key is depressed, should be used on receiving circuits only, where they generally give better results than harder valves.

In place of the ammeter *A*, a small flash-lamp bulb may be included in the earth lead, the brightness of the light from the bulb indicating the relative strength of the aerial current. If the ammeter ever goes out of working order it may be shorted and the small lamp connected up as described.

A diminution of the filament current will cause a very appreciable difference in the aerial reading, and the accumulator should therefore be kept fully charged. The high-tension battery also should be seen to if the ammeter reading is below normal. Its voltage should be tested in sections when on load, and not after the battery has been standing for some time, as otherwise an excessively high value will be obtained which immediately drops after a few minutes' transmission. When the voltage of the 400-volt battery drops to about 350 volts, it should be replaced and tested through, and new cells substituted for the faulty ones.

In order to obtain the best radiation from the set the value of the condenser  $C_1$  should be as small as possible. It is quite probable that the same wave-length may be obtained by different combinations of inductance and capacity, and it will be found that the highest readings in *A* are obtained when an adjustment using a low value of  $C_1$  is made. The use of the variable condenser is therefore merely to give finer tuning.

It may be as well here to point out

the great importance which should be attached to the insulation of the aerial, the various windings and connections of the set, the high-tension battery, and even the six-volt accumulator. Everything as far as possible should be mounted on insulators and protected from moisture, which is often fatal to continuous-wave sets.

The lead-in from the aerial should not, if possible, be close to where people are likely to enter. The momentary extra capacity given to the aerial by a person moving about near to the aerial, the lead-in, or even the instrument, is liable to alter the wave-length emitted and to cause signals of varying pitch to be received at the far station. For a similar reason the earth lead should preferably be of insulated wire if it is liable to make contact anywhere. These precautions, though less necessary when dealing with damped waves, are obviously essential when it is remembered that the slightest alteration of the wave-length of transmitted signals results in an alternation of the note received at the other end. For a similar reason the same precautions should be taken at that station also.

It has already been stated that, for practical work, a wave-length in the neighbourhood of 1,000 metres should be used. It has also been shown that the slightest error in tuning at the receiving station will result in no signals being heard. It is, therefore, of the greatest importance that one should be able to tune the transmitter very exactly to the wave-length on which it is desired to send.

An ordinary wave-meter is useless for this purpose. Clicks only will be heard, and only very rough results may be obtained by tuning the wave-meter to the adjustment which gives the loudest clicks.

*(To be continued in May number.)*



# Correspondence

## THE AMATEUR POSITION.

DEAR SIR,

I was interested in "The Amateur Position," written for the March issue of the *WIRELESS WORLD*, and especially in the support given by such eminent scientists as Senatore Marconi, and Drs. Fleming and Eccles.

I imagine the greatest argument against the use of wireless by private experimenters will be that of interference and I would suggest membership of an accredited Society for Wireless Study should be insisted on before licenses are granted, to prevent, as far as possible, amateurs collecting loose and scattered units of apparatus, and fitting them up under varying conditions of efficiency, for the sole purpose of satisfying curiosity—that is, curiosity in reading commercial messages, for instance. I have known one or two amateurs whose interest in the Science seemed to go so far and no further.

This class, of amateur, of course, does more harm than good to the *bona fide* experimenter, who uses his apparatus for the research of radiotelegraphy as a science.

Undoubtedly, such a complex science can only be developed to its fullest extent if willing enthusiasts who voluntarily put their energy to its advancement are allowed to add their efforts to the inventions of others professionally engaged in diligent research.

Perhaps, through the *WIRELESS WORLD*, an appeal will be suggested for presentation to the Post Office, to inquire under what conditions and when the licenses for experimental work will be returned to former holders.

No doubt if an appeal, signed by, or supported by, some of the well-known experimenters, were to be sent forward this would have the desired effect of eliciting definite information, which at present, individuals, including myself, have been unable to obtain.

Yours, etc.,  
(Signed) J. KENNETH HELE.

The Editor, *WIRELESS WORLD*, Strand, W.C.2.

DEAR SIR,

RE AMATEUR WIRELESS.

As the oldest holder of an Experimental wireless license in this district, I was greatly interested in your article in your March number as to the position of the amateur.

As it seems "interference" is to be the platform on which the private experimenter is to be "suppressed" might I suggest the two following regulations which should stop all interference with commercial wireless.

1. The wavelength radiated not to exceed 200 metres.

2. That all transmitting sets are to work with an efficient break-in system.

No. 1 works very well in U.S.A. where in the past every encouragement has been given, and as 600 metres is the commercial wavelength, it would be a very poor operator who could not tune out 200 metres waves. No. 2, of course, enables the operator to at once hear if any other station is transmitting.

Thanking you for the keen interest you have always shown for the amateur,

Yours faithfully,  
(Signed) W. A. PELLV.

SIR,

Apropos to your articles on pp. 667 to 671 and your footnote in reference to a copy of a letter inserted in "The Portsmouth Evening News" which you display on page 683, I enclose herewith a letter received by the writer from the G.P.O. being a reply to the writer's enquiry regarding the question of amateur-owned W/T stations after peace is signed.

You will observe from the communication in question that the question is under official consideration, and the writer thinks that an announcement in your valuable magazine may do much to allay fears and suspicions cherished by many amateur enthusiasts, among whom the writer is proud to number himself.

I would further enquire whether you would be kind enough to insert a paragraph requesting amateurs in S.E. Essex to communicate with the writer with a view to the formation of a club when our aspirations in regard to the pre-war conditions of amateur W/T are likely to materialise.

Thanking you in anticipation of your courtesy and with every wish for the continued success of your welcome monthly.

Yours, etc.,

ALEXIS J. HALL,  
Ex Wireless Experimental Officer, R.A.F.  
General Post Office,  
London, E.C.1.

SIR,

16th December, 1918.

WIRELESS TELEGRAPH APPARATUS.

With reference to your letter of the 10th instant addressed to the Engineer-in-Chief of the Post Office, I am directed by the Postmaster-General to inform you that the conditions under which the use of wireless telegraph apparatus for private purposes can be permitted when the Defence of the Realm Regulations cease to be in force are under consideration, and a further letter on the subject shall be sent to you as early as possible.

I am, etc.,  
(Signed) M. D. WARD.

## THE WIRELESS WORLD

The Editor, WIRELESS WORLD.

DEAR SIR,

If the Government are contemplating a decision to grant no renewals of licences for the non-professional W/T enthusiast on the ground of possible interference with Government stations, I would venture to suggest that providing an amateur can show his capabilities to operate a station to conform with the existing Wireless Regulations, he should be granted a licence.

The fact that several enthusiasts in the field of wireless have spent considerable sums of money on their apparatus is sufficient testimony to the fact that they would not endanger the possibility of forfeiting their licences for the sake of annoying other stations.

The P.M.G. could at least grant a "probationary licence" and if any amateur was found to be contravening the regulations, let the licence be suspended for such periods according to the gravity of the offence committed.

Any further recurrence of the offence would warrant the complete forfeiture of the licence. I think this would meet with the approval of the majority of amateurs in the country who are keenly desirous of continuing their experiments in this highly interesting field of science.

I am, Sir,

Yours faithfully,

"STATICA."

# Patent Section

*Under this heading will be printed each month abridgements from the Illustrated Official Journal (Patents) of wireless patents recently published.*

121,500. Changing frequency of alternating-currents. British Thomson-Houston Co., 83, Cannon Street, London. (General Electric Co., Schenectady, New York, U.S.A.) November 14th, 1917. No. 16717. (Classes 38 (ii) and 40 (v).

An arrangement for increasing the frequency of an alternating-current consists of a source of alternating-current connected to a circuit provided with means for distorting the wave form of the current, thereby obtaining currents harmonic to the fundamental current, and a second circuit connected to the first circuit and resonant to the desired harmonic frequency. A third circuit similar to the second is provided if a further increase of frequency is desired. The first circuit is provided with means for stopping currents of the harmonic frequency, while the second circuit is provided with means for stopping currents of the fundamental

frequency. When applied to wireless telegraphy, the aerial connexion is such that the aerial currents have no action upon the frequency changing circuit. In the arrangement shown in Fig. 1 an alternator 1 is connected to a circuit containing a tuning condenser 9 and a wave-deformer consisting of an inductance 3 partly energized by a direct-current source 4. The terminals 5, 6 of this circuit are connected to a similar circuit containing a tuning condenser 23 and an inductance 11. The first circuit is provided with a circuit 7, 8 tuned to the frequency of the second circuit, thereby preventing the currents of the second circuit from passing into the first circuit. The second circuit is provided with a circuit 13, 14 tuned to the frequency of the first circuit and with a circuit 15, 16 tuned to the frequency of the succeeding circuit, whereby currents of the frequencies of these circuits cannot pass into the second circuit. In the arrangement shown in Fig. 2, the first circuit containing tuning capacities 30, 31 a wave-deformer consisting of an inductance 3, and an inductance 28, is coupled to the generator 1 through a transformer 24, 25; while the load circuit consisting of an aerial 26 is connected to an intermediate point 29 in the secondary winding 25. The inductance 28 and the capacity of the aerial operates as a device for preventing the higher frequency current from flowing in the circuit containing the capacities 30, 31 and the inductance 3, while the intermediate connexion 29 prevents the high frequency currents from flowing in the alternator circuit. In the modification shown in Fig. 3, a circuit 32, 33 is tuned to a lower harmonic frequency, say the third harmonic, and a circuit consisting of an inductance 34 and the aerial capacity to the ninth and desired harmonic.

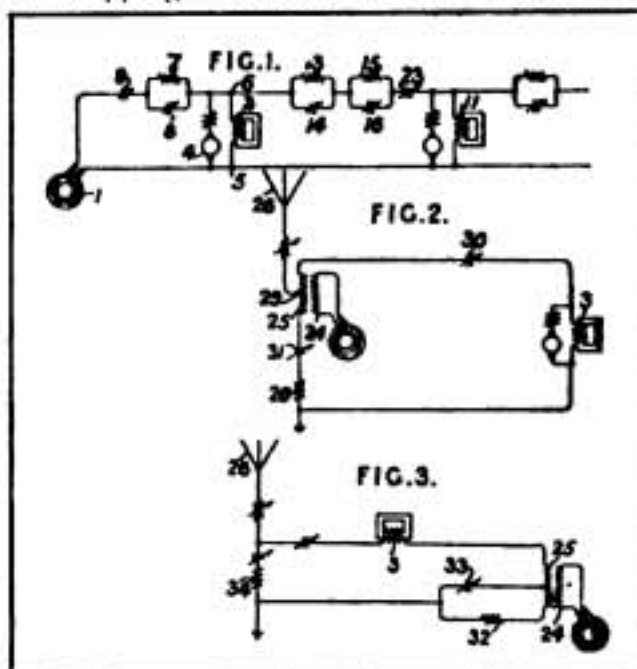

# The Construction of Amateur Wireless Apparatus

*In this, the first of a new series of Articles designed to give practical instruction in the manufacture of amateur installations and apparatus, the author deals with the main considerations in the design of a station. Subsequent Articles will explain in detail how each piece of apparatus may be constructed. The Wireless Press, Ltd., has arranged with Marconi's Wireless Telegraph Co., Ltd., to supply complete apparatus to the designs here given as soon as Amateur restrictions are released.*

## Article One : GENERAL CONSIDERATIONS.

THE wireless amateur who has taken up the study of his hobby, either by attending classes, or by reading some of the excellent books published on the theory of the subject, finds himself in a quandary when he commences to apply his theoretical knowledge to the actual construction and working of a station. Information as to the design of apparatus, on modern lines, is surprisingly scarce; and design, in wireless work, is the critical factor which will decide whether the apparatus shall operate with maximum efficiency or result in complete failure. For example, in a receiving circuit, an incorrect jigger ratio will render valueless all the amateur's endeavours to obtain the highest aerial he possibly can.

Recent developments in wireless telegraphy, more particularly in connection with the three-electrode valve, open up an entirely new field of work. The valve is peculiarly suited to the amateur's requirements. It may be used both for receiving and transmitting, and the man who possesses a good valve receiving circuit, even though he only has a very small aerial, will find himself far ahead of his friends using crystal receivers, though they may be favoured by being

able to erect high and costly aerials. The construction of the valve itself will not be dealt with, as it is beyond the reach of the average experimenter. Expert glass blowing is required and special exhausting pumps capable of producing very high vacua. The valves can be purchased, and the cost is not high. Every amateur is strongly recommended to take up the study of valve theory, the subject is a rapidly expanding one and as yet the field has only been partly explored. There is ample opportunity for the amateur to give valuable contributions to our knowledge of the three-electrode valve. The circuit arrangements and methods of application are legion, one has only to consult a file of patent specifications to realise this, and every wireless man has the opportunity of increasing the store of information. It will be quite impossible, in the scope of these articles, to deal with the subject exhaustively. We shall content ourselves with the design of apparatus employing the valve in two or three typical ways.

In regard to transmitting apparatus. The spark system will no doubt retain many adherents; but continuous wave transmission has so many advantages from the amateur's point of view, that

## THE WIRELESS WORLD

we propose to deal with transmitters of this type in some detail. This branch of the subject will doubtless be new to many, and can therefore be approached with added interest. For communication over long distances with small transmitting power it is the ideal method. Actual communication has been established between two stations five hundred miles apart, with quite small aerials, using a power of only *ten watts* in the transmitting aerial. This result may appear incredible to many and will serve to illustrate the possibilities of the system for the amateur. A continuous wave transmitter, more especially of the valve type, is very readily adaptable for wireless telephony, and we shall give designs for the construction of such apparatus. This latter development is of particular interest. There is always a mysterious fascination in conducting a conversation with a friend miles away, and hearing and identifying his voice, with no tangible connection between the two places.

At the outset, we wish the amateur to understand that these articles will *not* give instruction in the theory of wireless telegraphy. There are many books on the topic and it will be assumed that the reader has a thorough grasp of the essentials of the subject as set out in "The Elementary Principles of Wireless Telegraphy," by R. D. Bangay, in the last edition, both Parts I and II. It is absolutely necessary that the wireless man should understand the elements of alternating current theory and its extension to oscillatory circuits and high frequency currents. There is nothing to alarm the reader in this, once get rid of the idea that there is something mysterious and intangible about a high frequency current and difficulties vanish. There is no fundamental difference between the ordinary alternating currents used for lighting and power and those used for wireless, save that of frequency.

There is one other point to which we will refer before going on to practical considerations—namely, that of the amateur's licence. Every experimenter must obtain a licence before he commences work in wireless telegraphy. It is very necessary that the State should control the operations of wireless stations in order that public and commercial communications may proceed without interference. We urge upon every person who takes up wireless telegraphy either as a hobby or for serious experimental work, to take the greatest care to carry out their work so that the limitations set out in the licence granted to them are in no wise exceeded. The genuine amateur wireless telegraphist, will, of course do his best to observe the regulations in spirit and in letter, but it is very easy to make mistakes. Unless one is careful in checking the wavelength being used for transmitting, one may be unknowingly interfering with some other station engaged in important public work. It is the duty of the amateur, in return for facilities offered by the State, to take the greatest care in his work. Carelessness in this respect can only result in restrictions being placed upon amateur wireless. Another important point is secrecy, it is essential that private messages which may be overheard should not be divulged. Comment on this is unnecessary. It is, of course, not possible at this juncture to give any information as to what regulations the Government will apply to private wireless stations, but as soon as the rules are issued a full announcement will be made in these pages for the guidance of amateurs. Readers will understand that until this information is available we cannot go into the fullest details with regard to apparatus, as much depends upon the limitations of power, wavelength and system which may be ordered. We shall therefore, for the time being content ourselves with the indication of

## AMATEUR WIRELESS

the general broad principles which the constructor should follow when considering the erection of a station.

Amateur wireless telegraphists can, in the main, be divided into two classes: (a) the man with a natural inclination towards electrical engineering, whose hobby is his station; and (b) the man who wishes to experiment in wireless telegraphy from a purely scientific and academical standpoint. The first class form much the greater part of the body of wireless amateurs, and these articles will be therefore more particularly designed for the guidance of that class, but we hope to make them of such a character that the purely scientific student will find the practical assistance, and the designs given, of value to him in his work.

One of the first things to be considered is the site for the proposed station. The ideal transmitting or receiving aerial would be one erected upon a perfectly conducting surface. This ideal condition is, of course, not realisable in practice. The nearest approach to be made to it is that of an aerial on a steel ship at sea. In this case the "earth" is formed by a connection made to the hull of the ship; and since the hull is in contact with the surrounding sea water, which is a comparatively good conductor, we do arrive at a condition similar to the ideal. The opposite extreme is that of an aerial above a perfectly insulating surface, the "earth" in this case being formed by wires stretched out under the aerial. This condition is neared in the case of a station erected on dry desert sand. An aerial of given height operating under these conditions cannot be as good a radiator as a similar aerial erected under the first-mentioned condition, unless the earth wire system be very extensive. The site of the average station will lie somewhere between these two cases, and it is safest in practice to aim at getting as near to the first condition as is possible.

In a country site the main points to be observed are:—

- (1) Choose preferably high ground, and if near to the coast it will be better to choose land which slopes away towards the sea.
- (2) The space around the station should be as open as possible, trees, etc., do not matter as long as not too numerous and not too close to the station.
- (3) The ground should be such that it does not become very dry and scorched during the summer. Extensive earth systems are needed on land of this kind. It has been stated that a station should be erected over water-bearing strata which lead to the sea. Refinements of this kind in site choosing are generally impracticable.

The three points given above can only be observed in certain cases, a large number of wireless amateurs live in towns and are compelled to make the best of circumstances which exist.

In a town site the main points are:—

- (1) Try to get the aerial as high as possible. By "height" in this case is meant the distance of the aerial above the surrounding buildings and neighbouring conductors. An aerial supported ten feet above the leaded roofs of a building 50 feet in height cannot be taken as having a height of 60 feet. The presence of conductors under or near to the aerial effects a considerable reduction of effective height.
- (2) Avoid running the aerial close to and parallel with telephone and telegraph wires. This is particularly important in the case of a transmitting aerial. Currents will be induced in the neighbouring wires when transmitting, and if the aerial is within a foot or two of them damage may be done. In the case of a receiving aerial, nearby telegraph wires often cause troublesome "induction"

## THE WIRELESS WORLD

noises in the telephone receivers, which may be loud enough to jam out even strong signals.

- (3) It is bad practice to bring the aerial down lead close to rain water pipes, etc. Eddy currents are induced in masses of metal close to the down leads. These currents result in losses and reduce the radiation from the aerial.
- (4) *Never* under any circumstances use a connection to the gas pipes as an earth. If it is not practicable to sink a special earth plate for the station, connection should be made to the *water* pipe as near as possible to the point where it emerges from the ground.

It will be understood that the above remarks, both for town and country stations apply with much greater force to a station from which it is intended to transmit. Quite good receiving work can be carried out under conditions which appear to be most adverse, and the amateur should not be discouraged because he is not able to arrange his station as well as might be wished. Make the best of the facilities which offer themselves.

The construction of the aerial itself will be governed by whether it is intended to do receiving work only or not. For receiving only a single wire of not too small a gauge is all that is necessary. The increase in strength of signals which is obtained by the use of multiple wire aerials is so insignificant as to render unjustifiable the extra outlay on the aerial. A single wire aerial of No. 14 or No. 18 bare hard drawn copper wire is very suitable. The chief disadvantage being the low tensile strength of copper. This latter limitation makes it impossible to avoid a large sag in a long horizontal part of the aerial owing to the stretching, and ultimate breaking, of the wire as it is tightened up. The aerial is also easily carried away during a gale or blizzard.

For this reason it is generally customary to use a bronze alloy (such as silicon-bronze or phosphor-bronze) of high tensile strength for aerial construction. These wires are best stranded, and a very suitable size is 7/19 (*i.e.*, seven strands of No. 19 S.W.G. bronze wires laid together). This special aerial wire is now a commercial article, and the amateur is recommended to start right at the beginning and avail himself of it.

It is not always possible to arrange a transmitting aerial so that there are no joints in the wire, but this can be done in the case of a single wire receiving aerial. By adhering to the rule "no joints" a host of troubles are avoided. The aerial wire outside the wireless room should be one continuous length, and it should be led straight indoors, through a suitable leading-in insulator, right down to the bench or table where work is done. By this principle of avoiding joints anywhere one can at once say with certainty that there is no bad contact in the aerial itself in case of failure of signals, and the tracing of faults is thereby simplified. Joints may have quite a considerable resistance unless carefully made; they also weaken the wire at and near the junction, particularly if the wire is overheated when soldering. If joints *must* be made in the aerial wire, the simplest junction is made by the "Britannia" joint. This joint is particularly suited to stranded wire such as we recommend, and will be explained by diagrams when we give sample designs for masts and aerials. In any case all joints should be soldered up solid. The resistance of an unsoldered joint gradually increases as weathering and consequent oxidation of the surface of the conductor occurs.

It is sometimes stated that enamelled wire should be used for aerial work. The reason given being that uncovered wire oxidises on the surface; this oxidation increasing the skin resistance of the

conductor. Since the high frequency current in the aerial is at its greatest density on the surface of the wire, it is alleged that this oxidation increases the effective resistance of the aerial as a whole. If any such effect does occur its magnitude is so small as to be quite unappreciable under practical conditions.

Whilst on the subject of joints we would once again warn the amateur that the greatest care should be exercised in the soldering of phosphor- or silicon-bronze conductors. They should *not* be sweated. That is, soldered by coating with flux and then holding in the flame of a blowlamp whilst applying a stick of solder. This method is almost certain to lead to overheating with a consequent reduction in tensile strength of the wire at the point heated. The solder should be carefully applied by means of a copper soldering bit, with the minimum heat necessary. Of course, sufficient heat must be applied to cause the solder to flow properly and permeate right to the centre of the joint. It is not necessary to use resin as flux when soldering outside joints. The continual exposure of a joint to rain soon washes away all traces of any corrosive flux which may have been used. Any flux having zinc chloride as a base is quite suitable.

The earth connection is one of the factors in the usual amateur station which leaves much to be desired. For receiving work, particularly when using three-electrode valve circuits, the quality of the station earth is not important. The regenerative principle which is employed in the majority of circuits negatives any resistance which may be introduced into the aerial system by a poor earth. Therefore it is sufficient, in the case of a town station, to take a lead down to the water pipes. The connection to the pipe should be soldered, and it should be borne in mind that the remarks we have made regarding the necessity of ensuring good electrical

joints in the aerial apply with equal force to the earth lead and its connection to the grounding system. In the case of a country receiving station, it will generally be sufficient if a metal plate, about three feet by two feet in size, be buried so that its top edge (*i.e.*, one of the longer sides) is one foot below the surface of the ground. The earth lead, preferably of copper wire, should be soldered along the top edge of the plate, and to guard against the wire becoming detached by corrosion it is as well to insert two or three copper rivets along the edge, taking a turn around the head of each rivet before they are hammered up. It is best to bury the earth plate as near as possible to the receiving room, in order that the length of the earth lead may be kept short. If the lead *must* be long, say over ten feet, it is advisable to insulate it. This may be done either by supporting the bare conductor on small reel insulators fixed to the wall of the building, or by using insulated wire for the lead itself.

In a transmitting station every effort should be made to secure the best earth possible. By "best earth" is meant an earth connection with the lowest resistance possible. The resistance of an earth connection when used for purposes of wireless telegraphy is not necessarily the same as the ohmic resistance when measured by a method employing direct current. In this latter case the resistance measured is that of the earth plates, etc., to the surrounding soil (this quantity is generally known simply as the "ohmic resistance" of the earth connection), and is determined by the contact resistance between the earth plate or plates and the soil. When, however, high frequency currents are used for the measurement of the resistance quite a different value will be found (this value is generally known as the "high frequency resistance" of the earth). In the high frequency resistance of an earth capacity effects

## THE WIRELESS WORLD

play an important part; this fact is well illustrated in the use of "earth nets" for portable stations. An earth net consists of a length of copper netting laid on the surface of the ground underneath the aerial. Quite a practical earth can be secured in this manner. We shall return to the question of earth resistance later and indicate the method of measuring both the ohmic and the high frequency resistance of an earth and aerial system.

In a transmitting station it is our object to reduce the resistance of the earth to as low a value as possible. A high earth resistance means that most of the power which is delivered by the transmitter to the aerial is lost. The earth which the amateur will employ is chiefly dependent upon the depth of his pocket. The best arrangement is to lay down a circle of plates, about fifteen feet in diameter, either right round the transmitting room, or close to it. A lead should be attached to each plate and brought to the centre of the circle. All the leads are then soldered together and the earth lead proper jointed to them and led into the transmitting room. The leads from each individual plate is buried in a narrow trench about six inches below the surface of the ground. Each individual plate should be about three feet by two feet and should be buried in the manner indicated for a receiving station. The plates should be close together, edge to edge in fact. The earth may be still further improved by running four or five wires in separate trenches about six inches deep and three feet apart out underneath the aerial and a little beyond its end. It will be understood that in the foregoing description we have indicated the best arrangement for the amateur who has the necessary means and facilities at his disposal.

A great many readers will content themselves with something a little less complete and consequently not quite so efficient. Quite a workable earth for a

transmitting station can be made by burying two plates of the before-mentioned size (3 feet by 2 feet) face to face and about six or eight feet apart, the lead from each plate being brought to the midway line between the plates and there jointed to the station earth lead. In any case we recommend the amateur to run out at least one wire under the aerial to supplement the plates. Whatever arrangement of plates is decided upon it is necessary to arrange the connections to the plates so that the common earth lead is symmetrical with regard to them. By this we mean that the wires connecting each plate to the station earth lead should all be of the same length. If this rule is not adhered to, the current will not be evenly distributed over all the plates. Also it is obviously necessary that the earth lead should be of at least the same cross section as the wires forming the aerial. It is not consistent to use, say, two 7/19 wires in the aerial and then employ a single strand of No. 20 for the earth lead. We shall return to this point later when giving specimen drawings of aerials and earths.

As soon as the prohibition of amateur working is removed The Wireless Press, Ltd., will be in a position to supply working drawings of all parts of apparatus described in these articles. It must again be emphasised that until the restrictions are removed no practical work must be attempted by the amateur. It may be that by the time this magazine has passed through the press some indication may be given of the Government's future policy in this matter.

### SHARE MARKET REPORT.

Business in the various Marconi issues has been active during the past month. There has been considerable investment buying of both the Ordinary and Marconi Marine, both classes of shares showing a marked improvement in price since we last went to press.

Ordinary, £4. 15. 0; American, £1. 10. 0; Preference, £3. 17. 6; Canadian, 15s. od.; Spanish, 14s. 6d.; Marine, £3. 17. 6d.



# Library Table

"STATION X." By G. McLEOD WINSOR. London: Herbert Jenkins Limited, 6s. net.

**T**HE novelist who takes as his subject a wireless station is on dangerous ground and must walk very warily. The novelist who writes on communication with the stars is treading an equally difficult path. But the novelist who combines both of these subjects in one volume is attempting a truly formidable task and one towards which detailed criticism is certain to be directed. It is only fair to say at once that in "Station X" Mr. G. McLeod Winsor emerges very successfully from the ordeal, and has produced a book in which the greater part is equal to Wells at his best and challenges comparison with Jules Verne. The story deals with a secret Admiralty Wireless Telephone Station erected on a remote island in the Pacific and containing a plant of such high power that communication can be effected directly with Whitehall. To this Station is sent a party consisting of a naval lieutenant, a wireless operator and a Chinese servant, these three forming the crew of the Station. Early in the book we learn that the operator and the lieutenant in charge are temperamentally entirely dissimilar; on the one hand the operator, a Scotchman brought up in a lonely glen away from the bustle and hurry of town life, is moody and dreamy, and none too well educated, while the lieutenant is arbitrary in his manner, dogmatic in his views, and with no point of contact socially with his subordinate.

In this state of affairs the young

operator acquires the habit of taking long solitary walks around the island. One day, returning to the Station, he hears a cry and a revolver shot and finds both the lieutenant and Chinaman lying dead—the officer stabbed, with a revolver in his hand with which he shot his murderer. The shock of this terrible discovery almost unhinges the operator's mind, and after calling up Headquarters to advise them of the tragedy and request relief, he falls into a swoon. In this ecstatic state he speaks into the instrument, recording all he hears in shorthand, and on the arrival of the relieving party he is found rigid in his chair—to all appearances dead. It appears that the operator had been in communication with the planet Venus, the inhabitants of which disclosed a ghastly plot of the Martians to dominate the world and its inhabitants. Later a famous scientist, Professor Rudge, continues this communication and in the end after many exciting experiences the plot is defeated.

The author wisely avoids technicalities in his descriptions, but has thoroughly absorbed the "spirit" of wireless so that a technical reader is able to read the book with pleasure. The scenes upon the island and the descriptions of the communications with Venus and Mars are admirably done; the only fault we would find lies in the treatment given to those portions of the book which deal with adventures in England. Here the actors are badly depicted and the story tends to drag, but, in all, the volume is intensely interesting and will do much to stimulate thought in a direction which so far has been looked upon as purely the realm of romance.

# Personal Notes

## THE LATE LIEUT. R. H. HIRST.

**W**E regret to learn of the death of Lieutenant Harold Hugh Hirst, only son of Mr. Hirst, chairman and managing director of the General Electric Co., Ltd. Lieutenant Hirst, who belonged to the 21st Manchester Regiment and was attached to R.E. Signal Service, died at his home in Portland Place of pneumonia following influenza, on the 24th of February. On the outbreak of war he was in France and on returning to England fell seriously ill. Immediately on his recovery he joined the Inns of Court O.T.C. and became Divisional Signal Adviser to the 30th Division in England, in February, 1916, he proceeded to East Africa, but owing to malaria and dysentery he was invalided home towards the end of the year. After a long and protracted illness he recovered and in June, 1917, was transferred to the Wireless Service, in which he acted as Instructor. He proceeded to France in the summer of 1918 and took active part in the June advance preceding the armistice. The strain of the campaign, however, broke down his health and he was invalided home at the end of October. He had not fully recovered when he fell a victim to influenza followed by pneumonia. He leaves a wife and one child.

### A POSTHUMOUS HONOUR.

For services rendered to a Japanese destroyer which had been torpedoed in the Mediterranean Signalman Thomas William Woolcock, R.N., of Sefton Street, Southport, was awarded the Order of the Rising Sun (eighth class)

by the Japanese Naval Authorities. We understand that the H.M. destroyer "Ribble" received the S.O.S. from the torpedoed vessel and at once went to assist. Woolcock was one of the party to board the torpedoed vessel and rendered every assistance in getting the survivors and the injured aboard the British destroyer. It is regrettable that this gallant sailor did not live to receive the recognition bestowed upon him, for on transferring to one of the British cruisers Signalman Woolcock contracted influenza, and pneumonia supervening he died on the 30th of October last. We offer our deep sympathy to his relatives, who must be intensely proud of the decoration conferred upon him.

### AN AUSTRALIAN ECHO.

Mr. Jensen, who was relieved of his office of Australian Minister of Customs in consequence of the investigation by a Royal Commission concerning the Navy Department's purchase of wireless works at Randwick when he was Minister of the Navy, has gone to America. Reuter's Agency states that he sailed on January the 29th.

### DEATH OF MR. A. ALLAN.

We regret to learn of the death in Montreal of Mr. Andrew Allan, one of the founders of the Allan Steamship Line. Mr. Allan was President of the Canadian Marconi Company and Chairman of the Shipping Federation. He was deeply interested in wireless telegraphy from the earliest days and his influence and support at a time when Senatore Marconi's invention was looked upon as a scientific curiosity, was of the greatest assistance.

# Questions and Answers

*NOTE.—This section of the magazine is placed at the disposal of all readers who wish to receive advice and information on matters pertaining to both the technical and non-technical sides of wireless telegraphy. Readers should comply with the following rules: (1) Questions should be numbered and written on one side of the paper only, and should not exceed four in number. (2) Queries should be clear and concise. (3) Before sending in their questions readers are advised to search recent numbers to see whether the same queries have not been dealt with before. (4) The Editor cannot undertake to reply to queries by post. (5) All queries must be accompanied by the full name and address of the sender, which is for reference, not for publication. Queries will be answered under the initials and town of the correspondent, or, if so desired, under a "nom-de-plume."*

**O.O. (Aldershot).—**As the field covered by the general term "wireless telegraphy" is so wide and so rapidly expanding we cannot in these columns deal in detail with the opportunities of a career which the wireless service offers. However, it roughly divides into two branches, engineering and operating, and we think that in view of your experience as a telegraphist you should apply to one or other of the Marconi Companies for particulars of employment as an operator. We might add that positions as operators on commercial land wireless stations are generally filled either by men who are expert in land-line telegraphic work or by long service seagoing operators. Wireless engineers of the Marconi Company are required to have had a training in engineering at certain approved institutions.

**I.M. (Sunderland).—**We have not heard of any questions on the subject of Valve Receivers being asked in P.M.G. Examinations held up to the present time. When these Receivers are more widely used for commercial purposes the Post Office Examiners will no doubt ask the candidates to answer questions on the subject.

**M.O'N. (County Cork).—**Your enquiry should be addressed to:—The Traffic Manager, The Marconi International Marine Communication Co., Ltd., Marconi House, Strand, London, W.C.2.

**F.G.G. (Gillingham, Kent).—**The Marconi Free Training Scheme for operators has now ceased and we do not think there is any possibility of its re-establishment.

**A.H.S. (B.E.F.).—**The Engineers of Marconi's Wireless Telegraph Co., Ltd., are required to have studied at one of certain approved Institutions, a list of which can be

obtained from the aforesaid Company. From what you say of your previous experience we are not sure that you would at present qualify either as a draughtsman or as a general wireless engineer. We advise you to apply direct to the Company.

**S. G. L. (Bournemouth).—**(1) Undoubtedly direction finding will be a permanent feature in future commercial wireless work. (2) It is possible that you would find employment as a wireless operator engaged on direction finding work provided that you were able to pass the Postmaster-General's examination, the medical examination, etc. (3) You should apply to:—The Traffic Manager, The Marconi International Marine Communication Co., Ltd., Marconi House, Strand, London, W.C.2.

**W.D. (Beeston).—**(1) We are unable for several reasons to state the cost of a  $\frac{1}{4}$  k.w.,  $\frac{1}{2}$  k.w., and 1 k.w. Marconi sets. These sets are not as a rule sold outright, but are generally supplied at a yearly rental. Then, a bare description of an installation as being of a certain power is insufficient because no mention is made of the size of the aerial required or whether emergency gear is to be included. (2) We think the Marconi Company will be in a position to supply amateurs with portable wireless sets in the near future.

**A.E.W. (Catford).—**The information you require was published in the WIRELESS WORLD for May, 1918. Apart from the question of physical fitness and general education, we may say that the age of an applicant for a position as engineer in Marconi's Wireless Telegraph Co., Ltd., should be from 21 to 25 years, and he should have had two or three years college training in general engineering subjects and a further two years' mechanical engineering training in the workshops. A diploma in electrical engineering is necessary as evidence of competence. The following London institutions provide a suitable course of training:—City and Guilds (Engineering) College, City and Guilds of London Institute, Faraday House, Finsbury Technical College, King's College, Northampton Polytechnic Institute and University College.

**G.H. (Isle of Wight).—**(1) For permission to experiment with wireless telegraphy apparatus you should apply to the Secretary, G.P.O., giving full details of what you wish to do. (2) You will no doubt be able to obtain the apparatus you need from Marconi's Wireless Telegraph Co., Ltd., Marconi House, Strand, W.C.2., although this depends largely upon whether you obtain official permission to purchase.

## THE WIRELESS WORLD

J.A.V. (Ealing).—Asks if an Electrolytic detector in series with the aerial will work in practice. His telephones are connected in series with two dry batteries across the detector.

*Answer.*—In the first place an electrolytic detector is a high resistance detector, and therefore needs the application of a high voltage to render it efficient. A detector that can be used efficiently directly in the aerial circuit, must be of the low resistance type, such as a magnetic detector, as in the lower part of the aerial the current flowing is due to a low voltage.

It would therefore be much more efficient to connect the detector in series with the telephones and batteries across an inductance coil, possessing large inductance, in series with the aerial. If available a potentiometer of about 300 ohms should be connected across the battery and one of the telephone connections brought to the slider.

*Question 2.*—Asks if an A.T.I. and A.T.C. are required. As stated above an aerial inductance is almost an absolute necessity in any receiver. An aerial tuning condenser is not so, for the reason that a condenser in the aerial circuit has the effect of shortening the wavelength of the aerial circuit below the fundamental wavelength of the aerial. The lengths of aeriels generally used by amateurs usually give a fundamental wavelength low enough to dispense with an A.T.C.

*Question 3.*—Asks if it is possible to pick up anything with one, or more aerial wires in parallel, hung across a room. To this question we can only say no. If J.A.V. had several magnifying valves and the necessary apparatus it would be possible, but certainly not with the apparatus he seems to have at his disposal.

*Question 4.*—The object of an A.T.I. is to allow the aerial to be tuned to the wavelengths of incoming waves by either decreasing or increasing the amount of inductance in the aerial. Since the aerial forms one plate of a condenser and the earth the other plate, cutting down the length of the aerial has the effect of reducing the capacity, and therefore, less energy can be transferred to the detector circuit. Hence it is not practicable to cut down the length of an aerial too much and make up for the loss of both capacity and inductance by the addition of extra A.T.I. In determining the length of an aerial to be used for receiving work it is usual to reckon that the fundamental wavelength of the aerial shall be about double that of the lowest wavelength it is desired to receive, and then of course adding inductance to tune to the longer waves.

It seems to us that J.A.V. has not yet mastered the underlying principles of Wireless Telegraphy, or the proper working and value of the various pieces of apparatus used, and we would strongly recommend him to study thoroughly an elementary text book on the subject.

J.R.C.H. (Leeds).—Asks: Whether two-slide primary and secondary tuning coils have yet been wound to pay commercially. He has read that they are deemed practically and commercially impossible.

*Answer.*—If J.R.C.H. is thinking of the primary and secondary tuning coils such as are used in receivers, we are quite at a loss to understand why it has been deemed practically and commercially impossible. The Marconi Company have used for many years a two-slide inductance on some of their small transmitting and receiving sets and probably the majority of amateurs use them in their aerial circuit.

There are various disadvantages in them, however, which render their use in some receivers detrimental. The slide usually makes contact with several wires at once, especially if the wire be of small gauge, thus causing these turns to be short circuited. Another point against their use is that the narrow strips of wire along which the slide makes contact become oxidized on exposure to the air, thus sometimes causing a bad contact with the slide.

If J.R.C.H. has in mind the secondary and primary of tuning inductance of any transmitting set above about 250 watts he will find that these inductances usually consist of a few turns of heavy wire, or in the case of very large sets of copper tube, in which case tappings are made to the turns by means of a flexible connection fitted to a plug and socket.

W.F.B. (Fleetwood).—Wants a set of instructions for the working of Field Station sets "similar to my own set." He also sends us an "approximate" diagram of connections of his set. In the first place we should like to ask what an "approximate" diagram of connections is. Surely a diagram of connections is either right or wrong, and there can be nothing approximate about it. We have looked through this diagram and have only one fault to find with it, and that not a serious one. He connects his telephones across his crystal, whereas the usual method is to connect the telephones in series with the crystal, as for the average crystal this method gives better results.

We are somewhat at a loss to know why W.F.B. wants a set of working instructions of Marconi Field sets, as they would be of very little use to him in helping to work his own station. We think it would be much better for him to obtain R. D. Bangay's Principles of Wireless Telegraphy, published by the Marconi Press, and learn the function of each piece of apparatus used in a transmitter and receiver. Having done this he would then be in a much better position to use his own set efficiently, and to solve any little difficulty he came across.

We should like to draw W.F.B.'s attention to the point that we cannot undertake to return diagrams of connections, etc., and a copy of all diagrams should always be kept for future reference.