

WHAT TELEVISION MEANS TO YOU !

# Wireless Magazine

MARCH

AND MODERN TELEVISION

GEORGE  
NEWNES  
LTD. LONDON

Edited by PERCY W. HARRIS M.I.R.E.

**At Last!**  
**The Cold Valve—**  
Full Description, Circuits,  
and Drawings

**The "H.K." Four—**  
A New Straight Set with  
Automatic Volume Control

**All About**  
**Crystal Pick-ups**

**Re-conditioning**  
**Old Components**

**Short-wave**  
**Notes and News**

**Touring the**  
**European Ether**

**Set Buyers' Guide**



## SHORT WAVE SIMPLICITY

**A Loudspeaker Set  
for World Reception**

**FULL WORKING DRAWINGS  
& PICTURES**

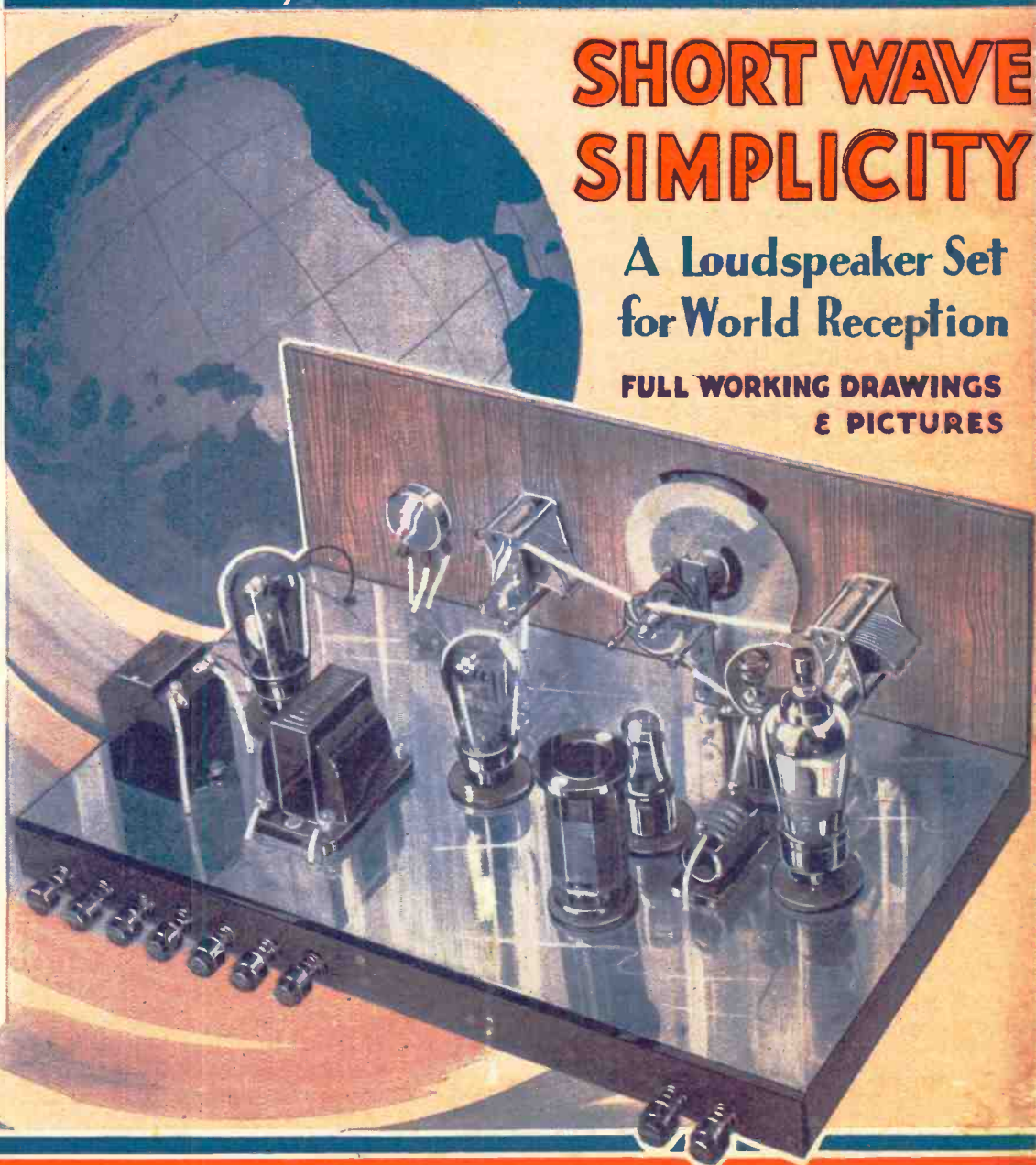

*The* **MAGAZINE FOR EVERY LISTENER**



# Give Your Set a Tonic!

## Get improved long range reception

A falling off in the sensitivity of a Set which makes reception of distant stations increasingly difficult probably indicates that the mutual conductance of the screen-grid valve has fallen below standard. In an H.F. Amplifier the overall magnification per stage is a function of the mutual conductance of the valve coupled with its interelectrode capacity.

The design of modern OSRAM Screen-Grid Valves maintains an exact balance between these characteristics and a type is available for every class of Receiver. You would not run your car with the brakes on — make sure that you are not operating your Set with a worn-out screen-grid valve, thus limiting its full capabilities with the risk of losing a foreign programme of particular interest.

Fit a new OSRAM Screen-Grid Valve for long range reception.



# Osram Valves

MADE IN ENGLAND

Sold By All Radio Dealers.

## A TONIC TO ANY SET

### OSRAM SCREEN-GRID VALVES

**S 23** For 2-volt Battery Kit Sets and Portables 12/6

**V S 24** For 2-volt Battery Sets with variable mu grid control 12/6

**MS 4 B** For all A.C. Mains Sets with single stage H.F. 17/6  
or **MS 4 B CATKIN**

**MS 4** For A.C. Mains Sets with two stages H.F. 17/6

**VMS 4** For A.C. Mains Sets with variable mu grid control 17/6  
or **VMS 4 CATKIN**

**DSB** For 0.25 amp. D.C. Sets 17/6

**VDS** For 0.25 amp. D.C. Sets 17/6  
(variable mu)

WRITE for the OSRAM VALVE GUIDE (1934 Edition). Sent post free.

Technical Editor:

G. P. KENDALL, B.Sc.

# Wireless Magazine

AND MODERN TELEVISION

Vol. XXI : MARCH, 1935 : No. 122

Assistant Editor:

T. F. HENN.

Edited by Percy W. Harris, M.I.R.E.

## FOR THE CONSTRUCTOR

THE "H.K." FOUR. Designed by Percy W. Harris, M.I.R.E., and G. P. Kendall, B.Sc. . . . . 93

THE STANDARD FOUR-VALVE SHORT-WAVER. By G. Howard Barry . . . . . 124

## TECHNICAL ARTICLES

A PRACTICAL COLD VALVE AT LAST! . . . . . 90

A PAGE FOR THE SERVICE ENGINEER. Conducted by G. P. Kendall, B.Sc. . . . . 108

RE-CONDITIONING OLD COMPONENTS. By G. P. Kendall, B.Sc. . . . . 109

NEW VALVE FOR SHORT-WAVE WORK . . . . . 112

STANDARD VALVE-HOLDER CONNECTIONS . . . . . 116

ALL ABOUT CRYSTAL PICK-UPS. By P. Wilson, M.A. . . . . 117

WHAT IS A GOOD SWITCH? . . . . . 120

EFFICIENT DETECTOR CIRCUITS FOR SHORT WAVES. By G. Howard Barry . . . . . 131

THE NEW POST OFFICE RADIO LINKS. By J. H. Reyner, B.Sc., A.M.I.E.E. . . . . 136

TESTS OF THE NEW SETS. By the "W.M." Set Selection Bureau . . . . . 139

## Contents

H.M.V. CONSOLE A.C. SUPER-HET . . . . . 140

FERRANTI GLORIA A.C. CONSOLETTA . . . . . 141

COSSOR 435A A.C. THREE-VALVER . . . . . 142

MARCONIPHONE 287 RADIOGRAM . . . . . 143

MCMICHAEL DUPLEX CLASS-B TRANS-PORTABLE . . . . . 144

TESTS OF NEW APPARATUS . . . . . 158

## TELEVISION SECTION

WHAT TELEVISION MEANS TO YOU. By the Editor . . . . . 85

## GENERAL ARTICLES

A PERSONAL MESSAGE TO YOU! By the Editor . . . . . 83

RADIO NEWS FROM ABROAD. By Jay Coote . . . . . 92

RADIO IS A SCIENCE! By Paul D. Tyers. . . . . 99

WIRELESS FOR THE BUSY MAN. By Percy W. Harris, M.I.R.E. . . . . 101

QUESTION TIME AT THE B.B.C. By T. F. Henn . . . . . 102

DR. FOLKEST'S PROPHECY . . . . . 112

TOUR EUROPE VIA ETHER! By J. Godchaux Abrahams . . . . . 113

HOW TO MAKE SET BUILDING EASY. By R. W. Hallows, M.A. . . . . 121

STATIONS THAT GET TIRED . . . . . 130

DO YOU KNOW WHAT A VERI IS? . . . . . 130

ROUND THE RADIO CINEMAS. By P. C. Conrad . . . . . 134

NEWS FROM THE RADIO SOCIETIES. By G6QB "W.M." SHORT-WAVE IDENTIFICATION PANELS. By Jay Coote . . . . . 150

RADIO AND THE LONE FLYER. By G6QB SPECIAL NOTES . . . . . 151

IN TUNE WITH THE TRADE. By Examiner . . . . . 152

WORLD'S BROADCAST WAVELENGTHS . . . . . 154

THE ELECTRIC HOUSE . . . . . 160

COUPONS : INDEX TO ADVERTISERS . . . . . 160

## GRAMO-RADIO FEATURES

RADIO FAVOURITES ON RECORDS . . . . . 146

Subscription Rates: Inland and Abroad, 15s. 6d. per annum; Canada, 13s. 6d. per annum.

Editorial and Advertisement Offices—"Wireless Magazine," George Newnes, Ltd., Southampton Street, Strand, London, W.C.2. Registered at the G.P.O. for transmission by Canadian Magazine Post.



# QUICKLY

# THE TRUTH

A sudden noise—or an equally aggravating silence . . . inefficiency somewhere in your set! Take your AvoMinor and find out at once. The AvoMinor is an investment in permanent security, for it is a precision instrument, accurate to a critical degree, and made to stand up to hard usage and even abuse. It is, in fact, a younger brother of the famous Avometer, the instrument used by all the leading manufacturers and their service engineers. With the AvoMinor you can test circuits, valves, components, batteries and power units with the dependable accuracy of the technical expert.

There is no substitute for the AvoMinor. It is a moving-coil combination testing meter—ten accurate instruments in one. Supplied in convenient case with leads and interchangeable testing prods and crocodile clips, and complete instruction booklet adequately illustrated.

Fully descriptive Folder post free from:—

THE AUTOMATIC COIL WINDER & ELECTRICAL EQUIPMENT CO., LTD  
Winder House, Douglas Street, London S.W.1. Telephone: Vic. 3404/7.

## TEN ACCURATE METERS IN ONE

CURRENT VOLTAGE

● 0-6 milliamps ● 0-6 volts

● 0-30 " ● 0-120 "

● 0-120 " ● 0-300 "

RESISTANCE

● 0-10,000 ohms ● 0-60,000 ohms

● 0-1,200,000 " ● 0-3 megohm

Size 4" x 3" x 1 1/2"

Total Resistance: 100,000 ohms.

Full scale deflection on 3 milliamps.

Deferred Terms if desired.

THE D.C.

# AVOMINOR

REGD. TRADE MARK

## TELLS THE WHOLE TRUTH

"RADIO SERVICING SIMPLIFIED"

Everyone should have this invaluable book. It explains every phase of fault-tracing step by step in non-technical language. The comprehensive diagrams make testing a matter of straightforward procedure.

2/6 post free 2/9

# SPECIFIED for BOTH THE H.K. FOUR and the STANDARD FOUR-VALVE SHORT-WAVER

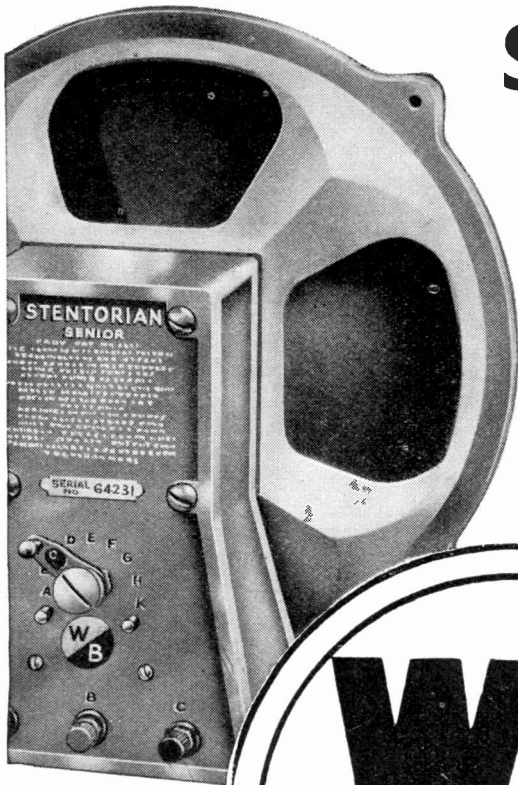

In this introductory issue of the new "Wireless Magazine" two well-known technicians are describing new receivers on which considerable time and care have been spent. It is significant that **each case the author's choice has fallen on a W.B. Stentorian Speaker.** Never before has a speaker design attained such an improvement over standard practice as to justify its choice in practically every "constructor" receiver published throughout the season.

You must hear the difference a Stentorian will bring to *your* set's performance. The *exclusive* new magnetic material, giving nearly double strength at similar cost, will bring a startling extra volume; and the new Whiteley speech coil will bring in a new vivid realism that will astound you.

Ask your dealer for a demonstration **to-day**, and realise why a Stentorian has been specified as first choice or exclusively for 95 per cent. of published constructor receivers this season.

## PRICES

Stentorian Senior (PMS1) ... 42/-

(100 per cent dust protection. Oversize cone.)

Stentorian Standard (PMS2) 32/6

Stentorian Baby (PMS6) ... 22/6

Write for the new W.B. Stentorian leaflet.



Ask your dealer about the newest "Stentorian" model, the "Baby," complete in walnut-veneered cabinet at the astounding price of .. .. **29/6**

# STENTORIAN

(PERMANENT MAGNET MOVING COIL SPEAKERS)

Whiteley Electrical Radio Co., Ltd., Radio Works, Mansfield, Notts  
Sole Agents in Scotland : Radivision Ltd., 233 St. Vincent Street, Glasgow, C.2.      Sole Agents in I.F.S. : Kelly and Shiel, Ltd., 47, Fleet Street, Dublin

Better service results from mentioning "Wireless Magazine" when writing to advertisers



# Wireless Magazine

—and Modern Television

The Editor's Page

March, 1935.

## A Personal Message to You!

WITH this issue, "Wireless Magazine" appears under a new ownership and with a new Editor. George Newnes, Ltd., the well-known publishers, have acquired the Magazine from Bernard Jones Publications, Ltd., and will not only continue to maintain the high standard which has been set in the past, but will endeavour still further to enhance its reputation by means of the latest authoritative information and up-to-date treatment of all wireless subjects. Fully alive to the new conditions in radio, we are planning a great future for "Wireless Magazine."

And here, if I may, I would like to introduce a little personal note. "Wireless Magazine" was founded by Mr. Bernard Jones during the time he was associated with Cassell & Co., Ltd., into whose offices I first wandered at the early age of five because my father was closely associated with the early history of this company.

MR. Bernard Jones has been a friend of mine for many years and when, at the end of 1931, I returned from a year's sojourn in the United States I gladly accepted his invitation to become a research consultant to "Wireless Magazine" and, as readers know, have contributed regularly since that time.

Now that Mr. Bernard Jones is occupying himself in other directions and Newnes have acquired "W.M.", they have entrusted me with the editorship, a task which I have felt an honour to accept and which I shall carry out all the more gladly from a realisation of the ideals which have animated it in the past, and with an experience which comes from a close contact with its readers over several years.

Other monthly magazines devoted to radio have come and gone (or have changed their names), but "Wireless Magazine" with its consistent policy of providing both entertainment and instruction in an attractive form has stood the test of time.

Associated with me in the conduct of "Wireless Magazine" I now have Mr. G. P. Kendall, B.Sc., also a personal friend for many years and an associate in radio journalism over a very long period. Mr. Kendall's books, technical articles and set designs have built up for him a sound reputation throughout the country, and as Technical Editor of "Wireless Magazine" he will, I am sure, give you of his best.

A number of other well-known technical writers including Mr. Paul D. Tyers, Mr. P. Wilson, M.A., Mr. J. H. Reyner, B.Sc., Mr. R. W. Hallows, M.A., Mr. J. Godchaux Abrahams, and many others, will regularly contribute and the customary features that you have come to appreciate, together with some new ones, will assure the continuance of interest. At the same time, "Wireless Magazine" has no intention of standing still. It is our intention to cater for the various new conditions which have arisen and to keep the journal in the forefront of progress.

You will be glad to hear, too, that Mr. T. F. Henn will retain his position of Assistant Editor and continue his much appreciated contributions.

WE have always valued the friendship of our readers, old and new. Please do not fail to write to us and tell us those features you like or do not like, the kind of articles you would like to see and the kind of sets you want to build. Remember that it is *your* magazine and that we are always glad to know what *you* think should appear on the menu!

Meanwhile, here is the March issue. What do you think of it?

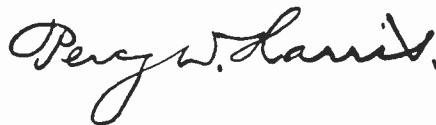

---

**The "H.K. Four"—the Straight Set of the Year—Page 93**

---

# OVER TWO MILLION RADIO SETS NOW OBSOLETE

## Marconi Jubilee Superhets For Few Shillings A Week

THE MARCONIPHONE COMPANY ARE NOW RELEASING AN ADVANCED NEW SUPERHET MODEL TO COMMEMORATE 'JUBILEE YEAR' AND TO PLACE WITHIN THE REACH OF THE AVERAGE HOME POWERFUL RADIO CAPABLE OF DOING FULL JUSTICE TO THE MANY BRILLIANT BROADCASTS THAT ARE PLANNED FOR 1935. THIS IS A 5-VALVE 7-STAGE RADIO WITH 25 TECHNICAL FEATURES OF PARTICULAR INTEREST. IT IS FOR A.C. MAINS ONLY AND IS AVAILABLE AS A RADIOGRAMOPHONE, A CONSOLE FLOOR MODEL, OR AS A TABLE GRAND.

The prices are unusually attractive. The radiogramophone costs only 22 guineas—the console, 17 guineas and the table grand, 12½ guineas. That is not all, however. So that every home shall have the opportunity of replacing its old radio with one of these new wonder sets, specially accommodating extended terms have been arranged which enable you to buy any of these models for as little as 5/- a week. As these irresistible terms apply to the radiogramophone as well, it is possible for almost every home to have this latest engineering masterpiece of the Marconi-men's genius which from a woman's point of view, is also a very beautiful piece of figured walnut furniture. This is indeed a great beginning to a great year. With this Jubilee radiogramophone you can choose freely between all the best radio programmes of Europe and the thousands of Columbia, Parlophone, and H.M.V. records.

### 1935—A Year of Brilliant Broadcasts

It was many months ago when the Marconi-men, learning that 1935 was to be full of all kinds of brilliant broadcasts, Jubilee celebrations, revelry and historical pageantry supported by vastly improved programmes at home and abroad, planned their own contribution to Jubilee year. The unique research and manufacturing resources of Marconiphone were concentrated upon designing and producing a new model of outstanding merits. The Marconi-men have given tests to this new chassis in



The imposing 'Radiogramophone' edition of the Marconi 'Jubilee' Superhet. Sells at only 22 gns. (Model 287).

all parts of Great Britain—from John o' Groats to Land's End—from Donegal to Dover. The result is that wherever there are A.C. electric mains, this wonderful piece of radio engineering will give first class performance. Countless experiments, checks and re-checks, a ruthless battle against the over-crowded ether, have led to interference, blasting, fading, and all the other bogeys of enjoyable radio reception being manacled and mastered. Thus for the flat in central London—or for the lonely highland mansion, the new Marconi 'Jubilee' model is equally efficient.

### A 'League of Stations'

It is no exaggeration to state that over two million receivers in use today are quite incapable of dealing satisfactorily with the existing crowded ether conditions, and the Marconi 'Jubilee' is designed to replace these obsolete sets with a high-power superhet at a cost within the means of all. It can end the radio chaos which exists in so many homes today. No longer need European stations be allowed to shriek at one another—here you have the effective selectivity of the powerful superhet. In the expressive words of one enthusiastic Marconi dealer this 'Jubilee' set is—"a veritable Geneva of the ether—a League of Stations."

### A Delight to the Technician

For the technician, the chassis is full of points of interest. Twenty-five of these features have been listed by the Marconi-men in their leaflets on the models. They include such intriguing things as:—Quiet tuning and adjustable Sensitivity, Time delayed A.V.C. over 1500 to 1 signal ratio, Tone compensated volume control, new Marconi Super Valves—the Triple purpose double-diode-triode, and high performance heptode detector oscillator, Positive 'Image' Suppression, Electron-coupled circuits, Electro-static inter-stage screening, and High-efficiency static suppression. These and many more interesting features are described in the 'Jubilee' model leaflets.

### What You Should Do.

A postcard to the Marconiphone Company Ltd., Radio House, Tottenham Court Road, London, brings this descriptive leaflet and also the name of the local Marconi-men who can let you see and hear the models in your locality.

You are urged to lose no time in getting to know this new Marconi 'Jubilee' wonder set. Already orders are eating up available supplies and amongst the first to possess the sets are many notable names.

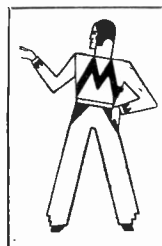

When replying to advertisements, please mention "Wireless Magazine"



## By the Editor

The publication of the report of the Royal Commission appointed to investigate the television position and to advise the Government on the best lines for its development has brought a flood of articles, opinions and partisan statements, most of which tend to confuse rather than enlighten the reader. Here is a plain statement of facts based on first-hand information

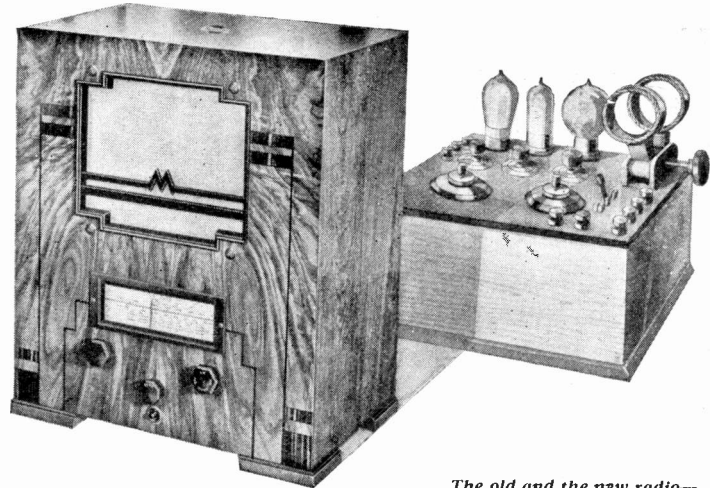

The old and the new radio—these are the improvements of just ten years. How will television progress now that it is well on the road?

# What Television Means to You!

The Facts Explained in Simple Language

“TELEVISION is here!” “Television is not here!” “Television will not be a practical service for several years to come!” “Television could start to-morrow!” Just what does it all mean? Unhappily throughout the whole of its history—short as it is—television has suffered from exaggeration by friend and foe alike, but most of all from premature promises based more on a cheery journalistic optimism than on any ascertainable fact.

Television is really no novelty in this country, but up to the present—in spite of much which has been said to the contrary—it has had a scientific rather than an entertainment value. This has been due to the fact that the service now available to the public produces, even on the most expensive apparatus, a picture of such coarse detail that in anything other than close-ups we have had to rely on guesswork rather than detail for identification.

### Broad Principles

The broad principles of television have been explained in this journal on a number of occasions, but perhaps it will be well to give a further brief and simple explanation.

Beginning at the receiving end, all television is based upon the fact that if a spot of light is made to traverse, say, a square area, line by line, until the whole surface is covered, and if this passage of the spot of light is fast

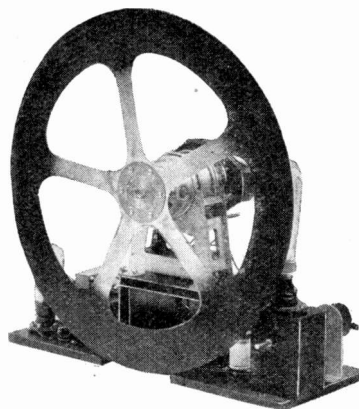
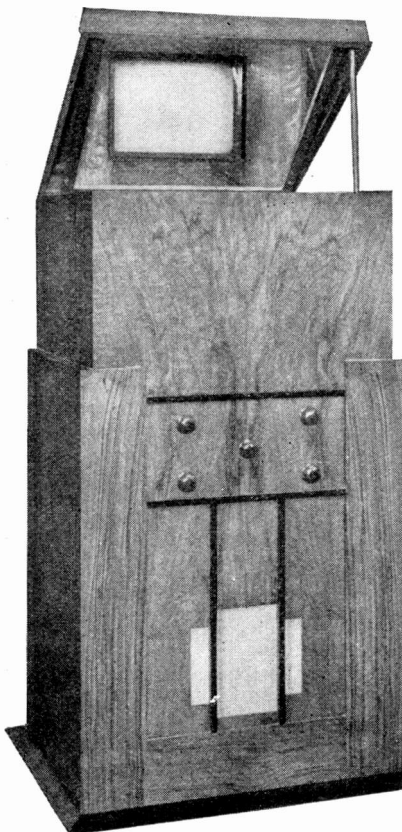

Another contrast between the old and the new. On the left you see a modern Baird cathode-ray television receiver giving a picture 9 in. by 12 in. The picture is so bright that it is unnecessary to extinguish the room lights in order to look-in. The set is designed for 180- to 240-line pictures

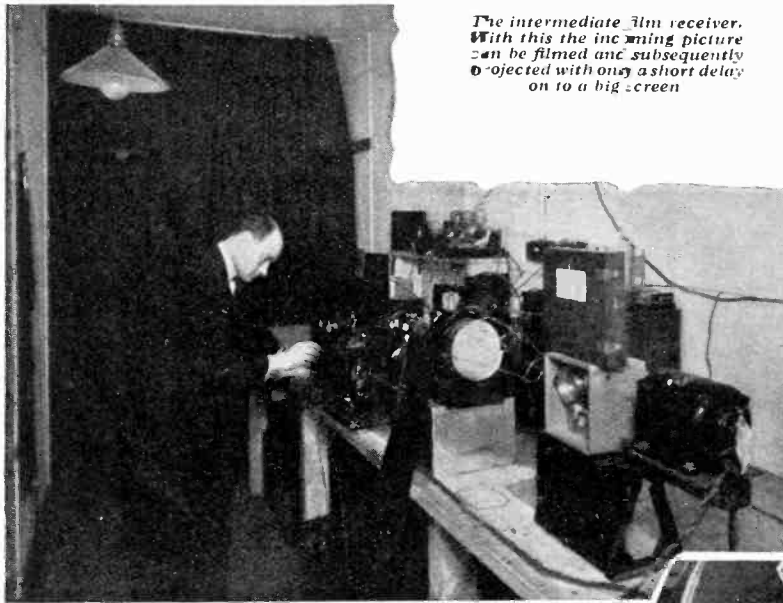

*The intermediate film receiver. With this the incoming picture can be filmed and subsequently projected with only a short delay on to a big screen.*

In sound broadcasting variations in strength of sound in the broadcast studio are converted into variations of strength of radiated energy, back again to varying currents of electricity, and finally into varying strength of sound. In television the varying strength of light reflected from surfaces to be televised is similarly changed into varying currents at the transmitting and receiving end and then, instead of into sound, into variations of light in our receiver.

**Point by Point**

By rapidly running over the subject to be televised, point by point, the light and shade of the subject can be changed into varying light strength in the trans-

enough, we get the impression that the whole area is evenly illuminated, just because the image of the bright spot of light persists in our eye long enough to cover the whole period of the "scanning" as it is called.

The simple analogy of a whirling electric lamp or a Catharine wheel is useful here. The firework called a Catharine wheel is really a spinning device which rotates so fast that it seems to produce a continuous circle of light, although actually the light is coming from only one point—the end of a paper tube. A rotating electric bulb is often used to produce the illusion of a circle of light.

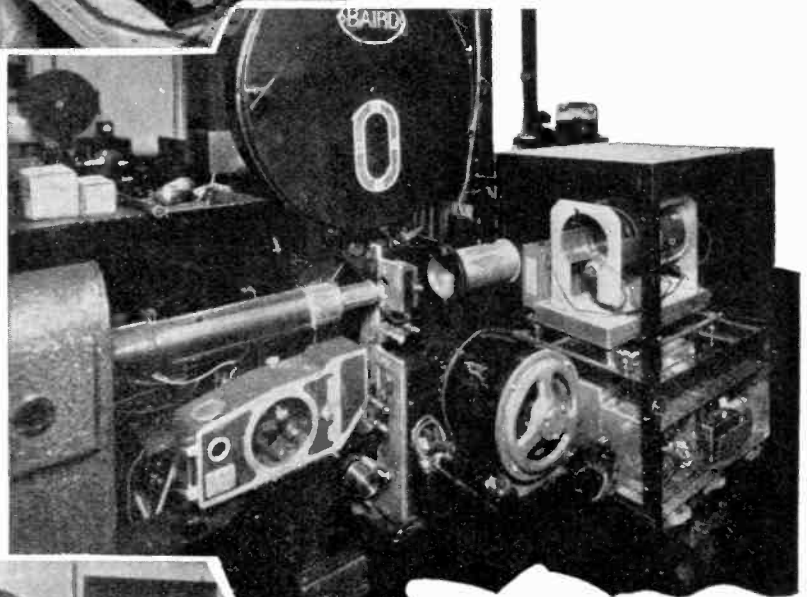

*Electron scanning of motion-picture film for television. In this apparatus there are no moving parts other than the film mechanism.*



*The older mechanical scanning of c.n. film for television transmission. Even by this method results showing considerable detail could be obtained.*

mitter and receiver so that, provided we use persistence of vision in one of the different ways available, the picture is reconstituted in the home.

Now whether this picture has entertainment value or not depends in the main on how much detail can be shown, whether or not the picture is steady and easily controlled, whether there is sufficient illumination for ordinary purposes, and whether more than one person at a time can see it. All kinds of practical difficulties have limited the development of television on the ordinary wavebands used for wireless reception. Difficulties in getting sufficiently rapid scanning to give the fine detail we

*Photographs by Courtesy of*



require for practical use led investigators to develop television on very short waves and to obtain what is now known as high-definition pictures.

The result of all this is that at the present time the following things can be done:—

(1) By means of a rapidly moving spot of light which falls on the subject to be televised and reflects itself on to a photo-electric cell, close-up of figures near to the transmitter can be very satisfactorily televised with a definition fully good enough for all close-up work.

(2) By means of what is known as the "electron camera" any studio scene or outdoor scene, even when the light is dull, can be picked up, scanned electrically, and

a minute the film can be passed on and scanned for transmission, being picked up in the normal way on a home receiver. This 30- or 35-seconds' delay is negligible for practical purposes, particularly as

The South tower at the Crystal Palace showing the vision transmitting aerial at the top and the sound aerial on the left

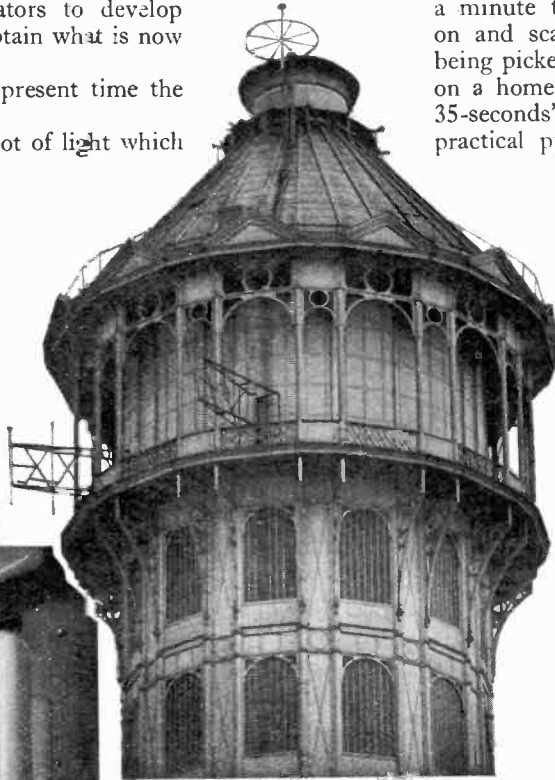

the sound is recorded and "delayed" in just the same manner. This method has the great advantage that not only can a scene be televised within half a minute of its occurring, but a permanent film record can be obtained for re-

broadcasting at a later and perhaps more suitable hour. The importance of this in a broadcast service cannot be over-estimated.

(4) Any standard motion-picture film or portion of it can be televised and received in the home with its sound just in the same way as subjects actually occurring can be sent out in a manner previously explained.

(5) By adopting a similar photographic technique to that



Miss Alma Taylor televising a new hat. The photo-electric cell's are enclosed in the white casing. Spotlight scanning is being used above the artist

transmitted in such a way as to be satisfactorily received in the home, provided the detail required is not too fine. The picture is not yet quite so sharp as the cinema, but the difference is only noticeable in scenes with a large number of small figures.

(3) Studio or outdoor scenes can be filmed with a special cinematograph camera, the film passed into a special machine which immediately develops and fixes it so rapidly that within half

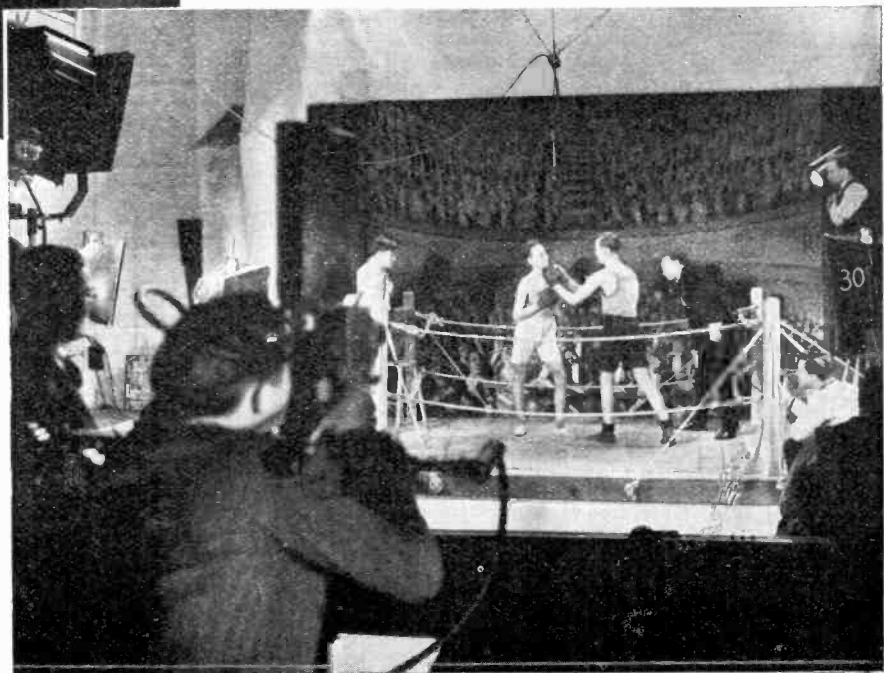

The electron camera televising a boxing match in the Baird studios at the Crystal Palace; only a moderate amount of artificial light is required for this method

Baird Television, Ltd.

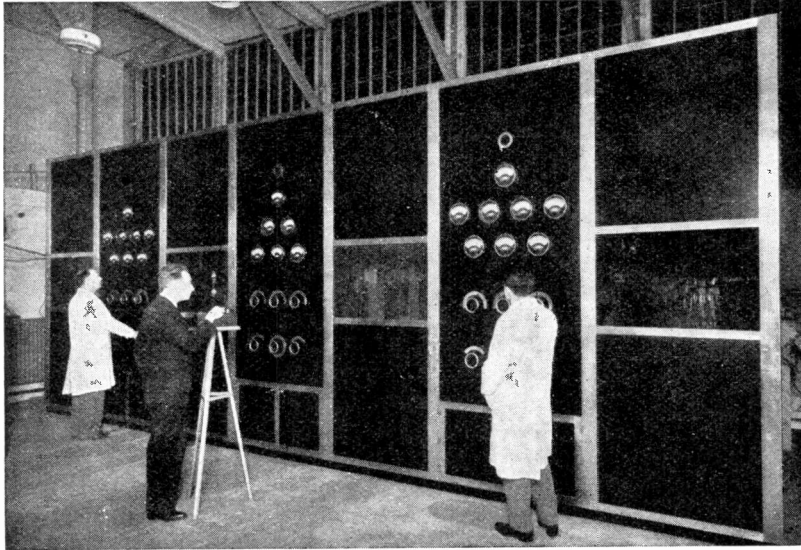

The transmitting panel at the Crystal Palace. This has 10-kilowatt input at 7 metres with 20-kilowatt peaks in the aerial. 1 kilowatt used for sound transmission gives an equivalent range

gone, its place being taken by the cathode-ray tube and an intensely bright little spot of light which is moved silently and electrically without any mechanical moving parts whatsoever.

#### Brilliant Illumination

The televisor illustrated on page 85 gives a picture 9 in. by 12 in. the light of which is so brilliant that one can view the picture in a normally illuminated living room, while if the artificial light is turned off the brilliance of the screen is such that it will throw a sharp shadow of the spectators on the wall behind.

The colour of the picture is a pleasant blue-black with pure white and good photographic gradation. A slightly smaller machine with a less luminous tube gives what may be termed a sepia-toned image which is quite pleasant to observe.

used in the delayed transmission of pictures referred to, an incoming television picture can be photographed on the film and within half a minute projected on the largest screen in a picture theatre. Other things can be done, too, but these described represent not theoretical but practical achievements which I have myself witnessed in each case.

So far as the definition is concerned apparatus is available to do all of the transmission and reception referred to on what is known as 180-line or 240-line picture. This means to say that the picture area on the receiver can resolve fine detail provided the unit of the detail is not smaller than 180th or 240th of the height of the picture. Actually when the subjects are moving a finer resolution than this is possible for certain optical reasons into which we cannot enter here.

#### Standards of Definition

As a matter of fact this is a surprisingly fine detail, although not quite so good as a well-focused home cinema so far as, shall we say, scenes in which a very large number of characters appear. In practice, however, this detail is fine enough to give any televised film or scene sufficient entertainment value to make the looker forget the definition is not so great as on the professional screen in at least 90 per cent. of the average films.

#### "Soft-focus" Effect

On close-ups and medium close-ups the definition is similar to that "soft-focus" effect which is so often used professionally in the films.

What is the receiver like? The old whirling disc or spinning mirror-drum operated by quite a powerful little electric motor has definitely

#### Simple controls of the Television Receiver

Is it difficult to manipulate? The instrument illustrated has in all six controls, three for the sound and three for the vision. Sound reception takes place just as on an ordinary broadcast receiver, and the three controls for the picture are: "tuning" the picture, or bringing the circuit into tune with the particular signal you want—this is done just as one tunes in a sound programme; "brightness" control, which explains itself; and "contrast" about which it may be said that if it is turned too much in one direction the picture becomes thin and washy and too much in the other too harsh. The happy medium is found in a moment, and the operation of the picture side is no more difficult than that of the sound.

What about cost? The type of receiver illustrated

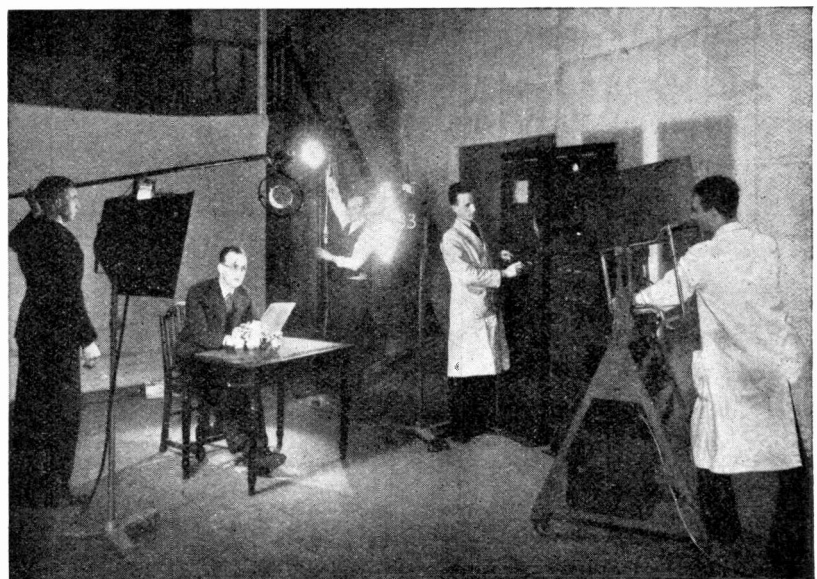

The electron camera (on the extreme right) in use. This picks up and electrically scans the scene in front of it



will probably cost from £50 to £75 at the beginning, but just as early wireless receivers were expensive and have gradually come down in cost as manufacturing methods have improved and the demand has increased, so there is every reason to think television receivers will come down in the same way.

### Baird Organisation

The photographs will give some idea of the activities of the Baird organisation which has at the Crystal Palace not only research laboratories, but complete television studios, dressing rooms, apparatus for both indoor and outdoor television transmissions, and the whole plant in a position to cover the London area with a service.

Electrical and Musical Industries, Ltd., have also done a good deal of experimental work in television, and they, too, have worked out schemes for high-definition transmission and reception.

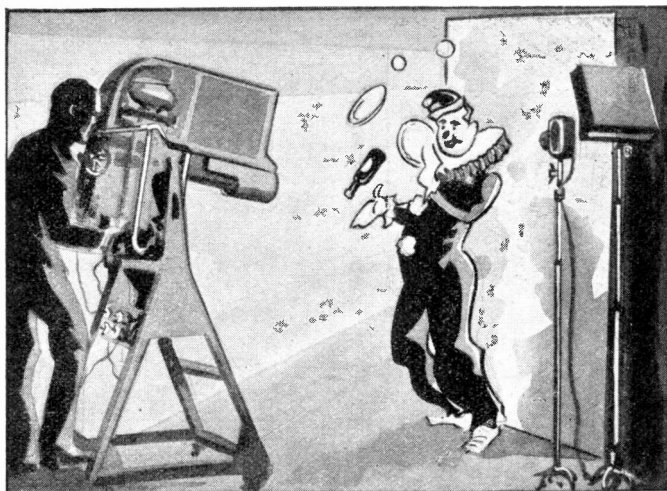

A glimpse into television's future—juggling clowns to amuse the children at tea-time!

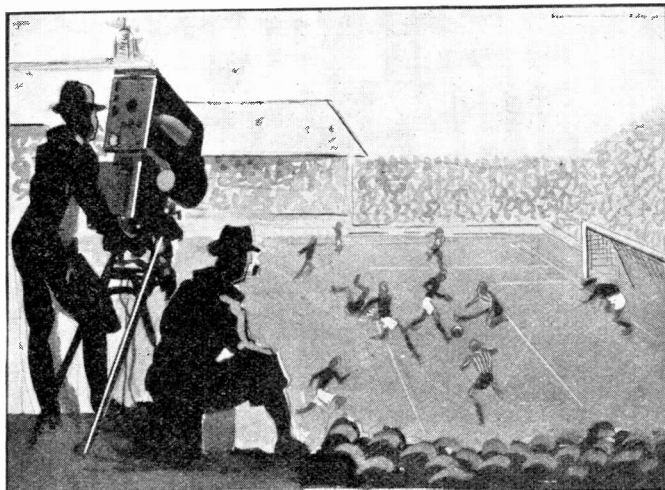

The television "camera" may soon be bringing news events into the home

A number of the other so-called systems, however, have little to show other than one or two specialised parts, and a good deal more information is required about them before they can be seriously considered.

On another page will be found a description of the Farnsworth Electron camera and the Farnsworth Multiplier, both of which are destined to play a very important part in the development of practical television, for they enable outdoor scenes to be immediately televised even though the lighting conditions are poor, such as is the case in this country on the average autumn and winter day.

Indeed, it is very probable that all mechanical scanning will be supplanted by electron scanning, just as the wireless valve and amplifier have gradually supplanted the older mechanical forms of relay with their delicate moving parts.

Mechanical scanning systems can, however, deal with high-definition television, although the high speeds of rotation of the discs and drums introduce a number of difficult mechanical problems.

It is sometimes asked what are the possibilities of high-definition television on the ordinary

broadcast band. The answer is that unless something entirely new and very revolutionary is introduced—there is no suggestion of it yet—such television is an impossibility.

The band of frequencies required is so large that unless the whole of the present medium waveband, *plus* some of the band used for shipping, were given over exclusively to *one* television transmission (not including sound!) the definition would be inferior to that now obtained on the ultra-short waves.

Another suggestion has been made that if short-wave adaptors were fitted to present broadcast receivers, the television signals could be received in this way with a corresponding saving of expense. This is a fallacy, however, for the tuning arrangements and circuits in a television receiver have to be worked out quite differently and there is little relation between them and those of a broadcast receiver made to receive sound only.

For example, the best broadcast receivers scarcely reproduce any frequencies above 5,000 or 6,000, whereas undistorted reproduction of frequencies up to 1,500,000 or more is required for television reception.

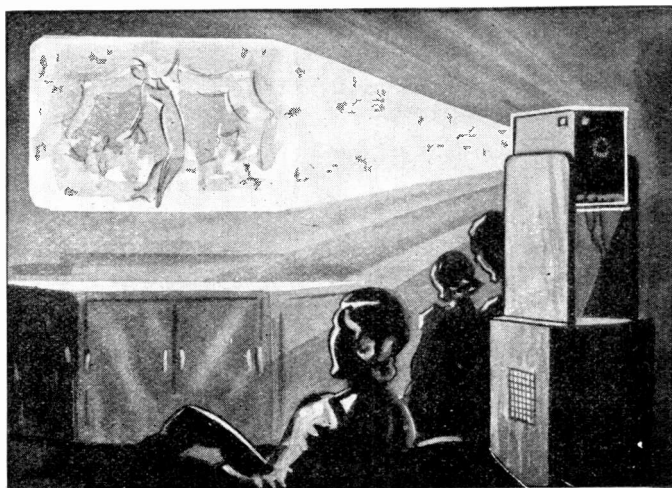

Another future possibility—pictures projected on to a large screen

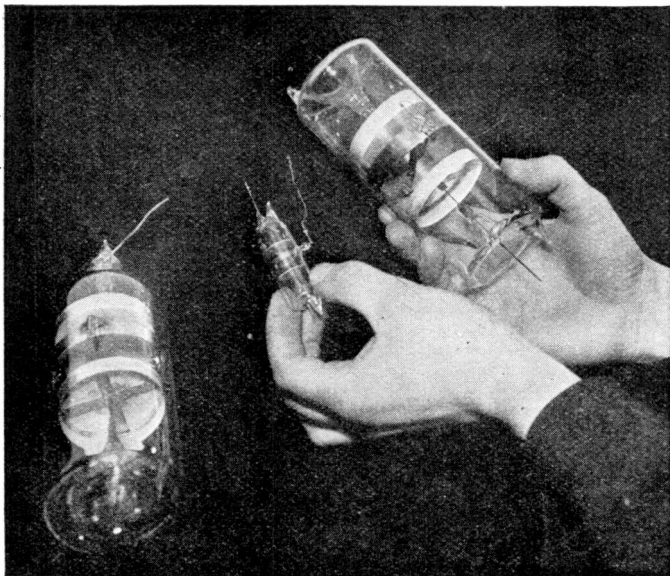

A special "W.M." photo showing three small Farnsworth multiplier tubes of the oscillating variety

# A Practical Cold Valve At Last!

First-hand details of the Farnsworth Electron Multiplier and how it is used in the Electron Camera

FOR some little time past stories have been reaching this country of an entirely new type of valve devoid of a filament or heater—the true *cold valve*, in fact—and with properties hitherto unheard of. The tube in question—known as the Farnsworth Electron Multiplier—has now reached this country, and "Wireless Magazine" has had an opportunity of handling these valves and of inspecting them under working conditions.

### Shock to the Radio Man

The Farnsworth tube comes as rather a shock to the experienced radio man who has come to realise that all valves are much the same so far as their general principles are concerned. With the conventional valve consisting of a directly or indirectly-heated cathode emitting electrons collected by the anode, the one or more grids with the anode or plate held at a higher potential than either grids or filament, the highly evacuated bulb and the standardised pin connections, our technique seemed fixed in these directions.

The Farnsworth tube, however, breaks right away from conventional practice and if we examine the drawing in Fig. 1 we can get some idea of how it works.

Various sizes of tubes are made according to the power-handling capabilities required. First of all we have a pair of disc cathodes sealed in an evacuated bulb, the discs being held parallel to one another. Between the discs is situated a metal ring, and when the valve is required to be used as an oscillator the circuit is arranged as shown in Fig. 2.

Here we see a conventional oscillatory circuit joined across the two cathodes with a lead taken from the centre tap on the inductance to a high-potential source which is in turn connected to the ring anode through a radio-frequency choke. The power is naturally

supplied by this high-tension source.

The surfaces of the two disc cathodes are so made that they emit electrons very freely, and we will imagine that two or three have been liberated by some means or other from, let us say, the left-hand cathode and are being attracted towards the ring anode. Surrounding the tube is placed a magnetic winding so as to give a magnetic flux which tends to keep the flow of electrons in a straight path towards the second cathode.

### Farnsworth Tube in Action

These electrons, instead of reaching the anode pass through the ring and would slowly lose their velocity and fail to reach the second cathode, but owing to the connection of the oscillatory circuit across the two cathodes they carry on. The emission of electrons from the left-hand cathode will bring about a change in relative potentials of the two discs and so the electrons will proceed from the first cathode to the second, hitting the second and releasing further electrons by secondary emission.

These in turn are attracted towards the ring anode, again under the influence of the magnetic field, pass through the ring, and once

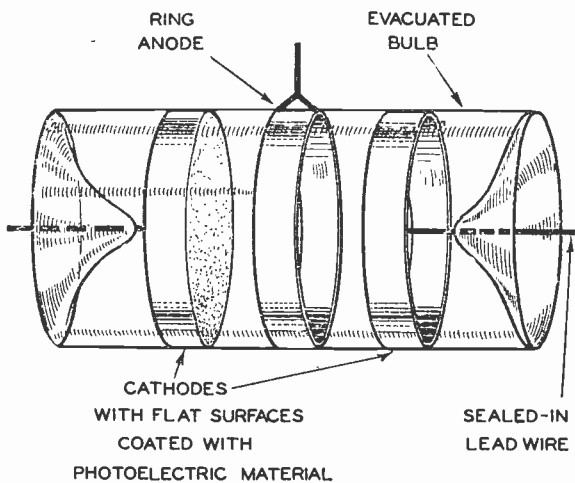

Fig. 1.—Showing the basic principle of the Farnsworth tube. There are two disc cathodes in a sealed evacuated tube with a ring anode between them

more there is a change of potential, this time in the opposite direction, and again still further electrons are emitted from the first cathode.

In this way a steadily increasing oscillatory current is built up which reaches saturation point when finally as many secondary electrons are absorbed by the anode as are emitted.

**Limiting Current**

The limiting current of such a tube is dependent upon the potential of the high-tension source and also the heat-dissipating powers of the tube, for if too high a potential is applied to a given tube the electrodes heat up and lose their essential properties. Naturally power can be withdrawn from the oscillatory circuit as indicated in the diagram.

The strength of the magnetic field plays a very important part in the operation of these tubes and if we reduce the strength of this field to some extent an interesting state of affairs arises. It can be shown that, with a certain strength of field, as the electrons pass backwards and forwards, steadily increasing in strength, their path gets more and more curved until finally they reach the ring anode.

**As an Amplifier**

If now we pierce a small hole in one of the cathodes and inject into this hole a stream of electrons from another source, the tube can be used as an amplifier, the amplified current varying in strength proportionately with the incoming current.

Another method of using the tube as an amplifier is to superimpose on the circuit a rapidly varying potential so that the tube is in effect

“quenched” at a super-audible frequency before each particular train of oscillations has had time to build up to saturation, the effect being very similar to that obtained in the earlier super-regenerative circuit.

This electron multiplier is also used in conjunction with another Farnsworth invention known as the Dissector Tube, which is used for television transmission. Here we have a large flat area at the end of a vacuum tube on which an image can be focussed by means of a camera lens, the disc surface to which we are referring here taking the place of the focussing screen in an ordinary camera.

When such a visual image is focussed electrons are emitted from the inner surface of this disc with an intensity depending upon the light falling upon them and therefore upon the image. A suitable magnetic field will compel the electron stream to focus itself at the opposite end of the tube where there is placed a very small aperture.

The surrounding field can now be varied with two sets of coils so that the whole of this “electron picture” can be moved bodily backwards and forwards across this small aperture, and thus electrically scan-

ned without any mechanically moving parts.

The number of lines to the inch would depend upon the size of this tiny aperture, and as a matter of fact it can be made small enough to give effective pictures even as high as 400-lines per inch.

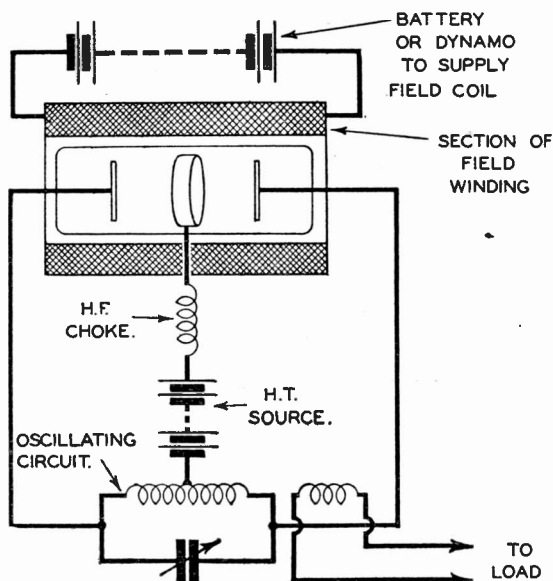

Fig. 2.—The circuit for using a Farnsworth tube as an oscillator. An explanation of this circuit is given in the accompanying article

This aperture being formed in one of the cathodes of the multiplier tube permits the electron stream to proceed through it where it is amplified thousands of times before being passed on to the transmitting apparatus.

In this way it is possible to televise ordinary street scenes with the Electron Camera even in winter time without sunlight. Such television has been regularly done recently with great success.

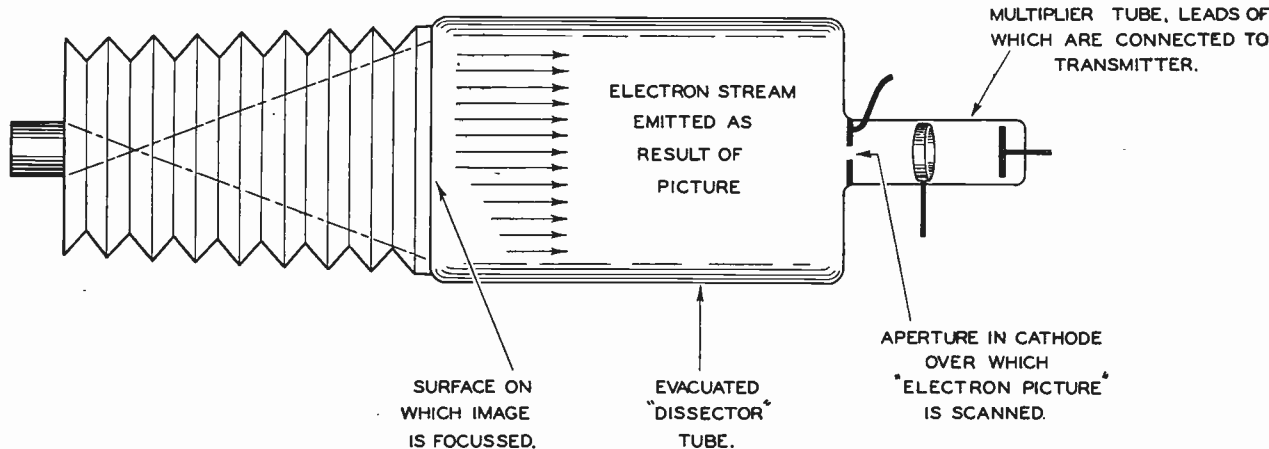

Fig. 3.—Showing the principle of the electron camera. This camera makes it possible to televise ordinary outside scenes in daylight, even though the light is not too good



# Radio News from Abroad

New Estonian 40-kilowatt : : Eiffel Tower's new wavelength : : Germany extends programme hours : : Radio in the Saar : : Marconi monopoly in Greece : : 25 kilowatts from Rabat

## ESTONIA

WITH the nationalisation of the broadcasting system, great developments may be expected in the Estonian radio services. For two years Tallinn has been satisfied with a 20-kilowatt transmitter, but the need for more powerful plant has become urgent. Plans are being drawn up for the construction of a 40-kilowatt station on a site near the capital.

## FRANCE

Paris listeners were requested recently to record their votes to find the best announcers in the Metropolis. Two women topped the poll, Lola Robert and Carmen Tessier, both popular officials at the Poste Parisien studio.

The decision to change the wavelength of Eiffel Tower, Paris, to 206 metres is causing some apprehension in French wireless circles. Although the alteration will benefit the long waveband it is thought that it will create chaos on channels between 200 and 225 metres.

With a power of .15 kilowatts it is anticipated that the FL broadcasts will swamp the Radio LL and Vitus (Ile de France) transmissions and, further, that it will clash with the harmonic of Radio Paris already present on 206 metres. French authorities consider that 209.9 metres would be a more favourable channel, although there is a risk of interference with Newcastle and possibly Beziers.

## GERMANY

Many of the studios have extended their daily transmissions, and Deutschlandsender is now on the air from G.M.T. 05.00 until 01.00 the following morning. Cologne—the old Langenberg transmitter which has been recently overhauled—seldom closes down before G.M.T. 01.00 or 01.30. The Germans are now, with the exception of European stations giving sponsored concerts, the latest on the air.

Although for some time the high-power Deutschlandsender has used as an interval signal the opening notes of a Dutch carillon as played by the bells of the Potsdam Garrison Church, in addition, between broadcasts, the studio now plays a new melody, *Die Saar is Deutsch* (The Saar is German). This has been

## By JAY COOTE

copied by some of the provincial stations and will no doubt be heard frequently until the Saar has been officially handed over to Germany.

By the middle of March it is hoped to open a new broadcasting studio at Saarbruecken; it has not yet been decided whether a new transmitter is to be built to feed the district or whether the local programmes are to be broadcast by the Stuttgart and Frankfurt-am-Main stations.

As against 6,780,570 licences in Great Britain at the end of 1934, Germany now boasts of 6,142,921 registered listeners. It should be borne in mind, however, that 427,464 represents free permits given to the unemployed, blind or otherwise disabled persons. In addition, although the tax is fixed generally at 24 marks per annum (payable in twelve instalments, if desired) schools and members of the Hitler Youth Organisation are only called upon to pay roughly 8 marks.

Some 75,000 listeners who, in the course of the year, had given up their membership, have been *tactfully* induced to renew their subscription.

## GREECE

The Marconi Company has been entrusted by the Hellenic Government with a broadcasting monopoly, and the right to install and operate transmitters for a period of twenty-five years. A site near Athens has been chosen for the 50-kilowatt station, which is to be built at Chelmsford.

## LITHUANIA

In view of the present political situation in the Baltic States, it is interesting to learn that the Lithuanian Government has decided to open as promptly as possible a 7-kilowatt transmitter at Heydekrug, near Memel (Klaipeda). It is to be used for broadcasts destined to combat Nazi propaganda from Koenigsberg.

Although the exact wavelength has not been fixed it is reported that it will be on or around 500 metres.

## MOROCCO

Work on the reconstruction of the Rabat transmitter has been hurried forward and by the time these lines are in print listeners should be receiving better and more powerful signals on 499.2 metres. Radio Maroc will be working on 25 k.w.

## POLAND

The retirement from the direction of the Katowice station of Papa Stefan (Dr. S. Tyminiecki), the founder of the famous Letter Box feature in that studio's programmes, would appear to confirm the rumour that the Katowice transmitter will be closed down in the near future.

The 24-kilowatt Torun station, which was officially opened on January 15, is temporarily working on 304.3 metres—a channel shared by Cracow.

As it is a difficult matter to synchronise the two transmitters there is a possibility that another wavelength may have to be sought, and this may necessitate the closing down of Katowice.

## PORTUGAL

The Lisbon-Barcarena National transmitter on 476 metres is still in its testing stage, although programmes are broadcast regularly every evening. It is for this reason that, so far, no details of the radio entertainments are published in advance. The call is: "Emissora Nacional Radio Lisboa,"—the studio possesses a woman announcer.

Many readers have deplored the absence of what is best termed "individual control" in modern wireless receivers. The conventional one-knob set is designed to give good reliable results under all conditions, even in the most unskilled hands, and to obtain this desirable state of affairs some efficiency and a good deal of interest have been sacrificed. In the "H.K." Four we have provided just that latitude for individual attention which enables the finest possible results to be obtained on any given station

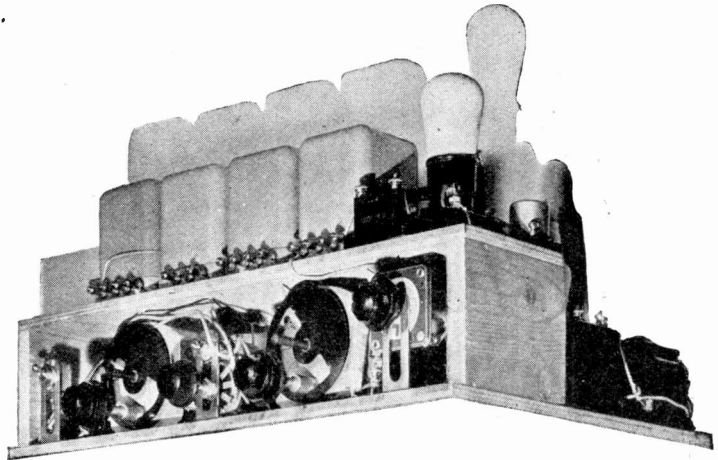

# The "H.K." Four

A NEW STRAIGHT SET  
FOR THE DISCRIMINATING USER

Designed by Percy W. Harris, M.I.R.E.  
and G. P. Kendall, B.Sc.

**L**ONG range, high selectivity and plenty of volume can be said to be the outstanding characteristics of this year's commercial receivers. Perhaps we should add a fourth—they represent remarkable value for money. The number of valves to a large extent determines the range and the number of tuned circuits the selectivity.

### Super-het Advantages

The super-het circuit offers a number of manufacturing advantages—some of the tuned circuits, for instance, are fixed and can be accurately set once and for all in the factory, while components have been so standardised that they can be turned out in immense quantities and therefore at very reasonable prices. For these and other reasons super-hets figure largely in all the makers' programmes for the current year.

But while the super-het circuit has advantages, particularly from the manu-

facturers' point of view, it is not free from disadvantages and drawbacks, some of which are difficult to overcome in low-priced sets.

There is, for example, the problem of second-channel interference and a certain general noisiness which is difficult to eliminate in sets where much magnification is done at relatively low radio frequencies. While in its simplest form the super-het has only two condensers, one to tune the first-detector grid circuit and the other to tune the oscillator. Such

a circuit is hopeless for modern conditions, and an additional tuned circuit usually precedes these two.

Furthermore, in order to make a one-knob receiver these three condensers must be ganged, and ganging an oscillator condenser with its specially shaped plates or padding capacity is a difficult problem to solve satisfactorily. It is, of course, solved frequently, but by the time we have modified the original super-het circuit to get satisfactory working in modern conditions, its elementary simplicity has vanished.

### Constructors' Advantage

The home constructor is in a very different position from the manufacturer. He has a wider choice of circuits, the conditions under which he works are different, he has not to consider the necessity of producing a large number of sets with relatively unskilled labour, nor must he work closely to a price. That he has not availed himself in the past of this wide latitude is partly due to the fact that some home-construction designs have been little more than copies of the commercial type of set without regard to conditions under which these commercial sets must be produced.

### Strong Appeal

Unhindered by conventions, we have worked out a receiver which will make a particularly strong appeal to "Wireless Magazine" readers for reasons which will now be explained.

First of all, a "straight" circuit has been chosen to give a very high radio-

### COMPONENTS—OUR POLICY

**C**OMPONENTS used in receiver designs published in "Wireless Magazine" are chosen for their suitability, efficiency and reliability. Their selection must not be taken to indicate any more than this, nor that other good-quality components are not equally suitable, save in a few cases clearly indicated where there are no suitable alternatives.

In a large number of cases there exist numerous good alternatives, as a study of the advertisement pages of this journal will show.





the central trimming knob on each condenser will be found useful (more about this next month). With regard to the automatic volume control, the extra valve used can be any odd specimen you have, and it uses no high-tension current whatever!

We claim no special novelty or mystery for the circuit. As pointed out elsewhere in this issue, wireless is a science and the merit of the circuit of this receiver can be assessed by any competent radio engineer who examines it. The application of it, however, has been very carefully worked out.

The "H.K." Four (you notice we call it a four and not a five because only four of the valves are working in the conventional manner) will out-perform many super-hets of much more elaborate construction as far as range and selectivity are concerned, while in tone quality we do believe the results are exceptional.

#### Silent Background

Being a "straight" set it has an unusually silent background, and its complete freedom from the squeals and whistles so often associated with long-range sets is one of its most pleasant characteristics.

Expressed simply, the circuit consists of an inductively-coupled aerial input to a band-pass circuit, applied to a variable- $\mu$  high-frequency valve. This is coupled, in turn, by a tuned-grid circuit to a second high-frequency valve of the variable- $\mu$  variety, a third tuned grid circuit being applied to a triode detector.

#### Tone Correction

The detector is coupled to a pentode output valve by means of a tone-correcting transformer, the curve of which is varied by means of a potentiometer to give the output results desired.

In the plate circuit of the pentode is a conventional output device with provision for an external loud-speaker. (In our experience, for the best quality reproduction in the average living room it is not always convenient or advisable to have the loud-speaker in the same place as the set. Furthermore, numerous readers already have separate loud-speakers of high quality to which the "H.K." Four can be connected as desired.) The receiver cabinet is left entirely to the discretion of the builder.

The valves used and their prices are indicated in the list of

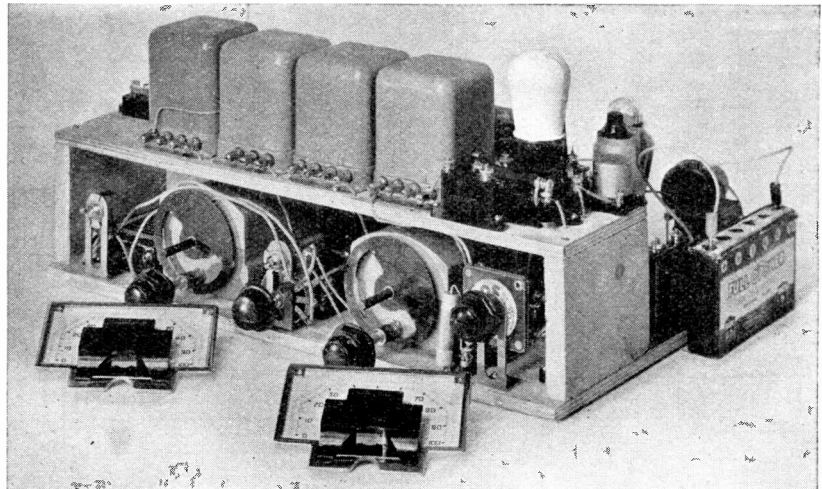

FULL-VISION TUNING SCALES FOR THE "H.K." FOUR

In front of the two condensers we have shown the two Formo dials supplied with the condensers. Next month we shall have more to say about a suitable cabinet for the "H.K." Four

parts, but thanks to the standardisation adopted by British valve manufacturers, any of the same general characteristics of other makes can be substituted if desired. The set being stable, and based on sound and well-tried principles, is not critical in such matters. The experienced constructor can use his own discretion in the choice of valves and, in fact, many of the components.

This statement, however, should not be interpreted to mean anything can be substituted for anything else without the most careful

consideration, and those who have not had experience sufficient to form sound judgment in these matters would be well advised to adhere in all respects to the published specification.

The first point which will strike the reader in examining the photographs and drawing of the receiver is the unusual arrangement of the coils above the variable condensers. This arrangement was adopted to make the wiring of all vital leads as short and direct as possible, thus contributing towards the stability of the receiver and its high efficiency.

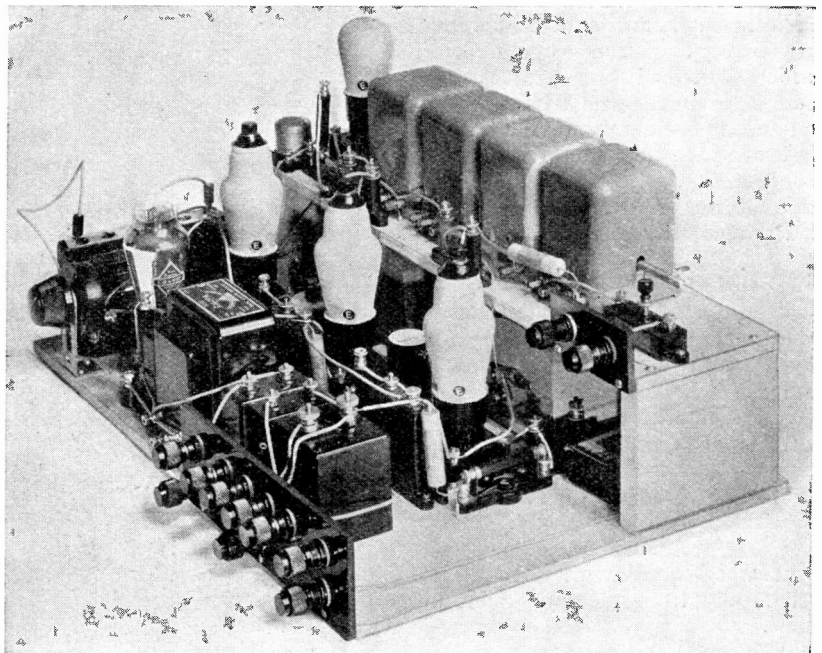

POSITION OF THE FIVE VALVES

On the extreme left next to the tone-control potentiometer is the pentode output valve; the valve on the top shelf next to the coil assembly is the detector. The three other valves are the automatic-volume-control valve on the left and the two high-frequency amplifiers. Note that the wave-change spindle projects to the left of the set, and will finally be linked to an extension piece passing through the side of the cabinet

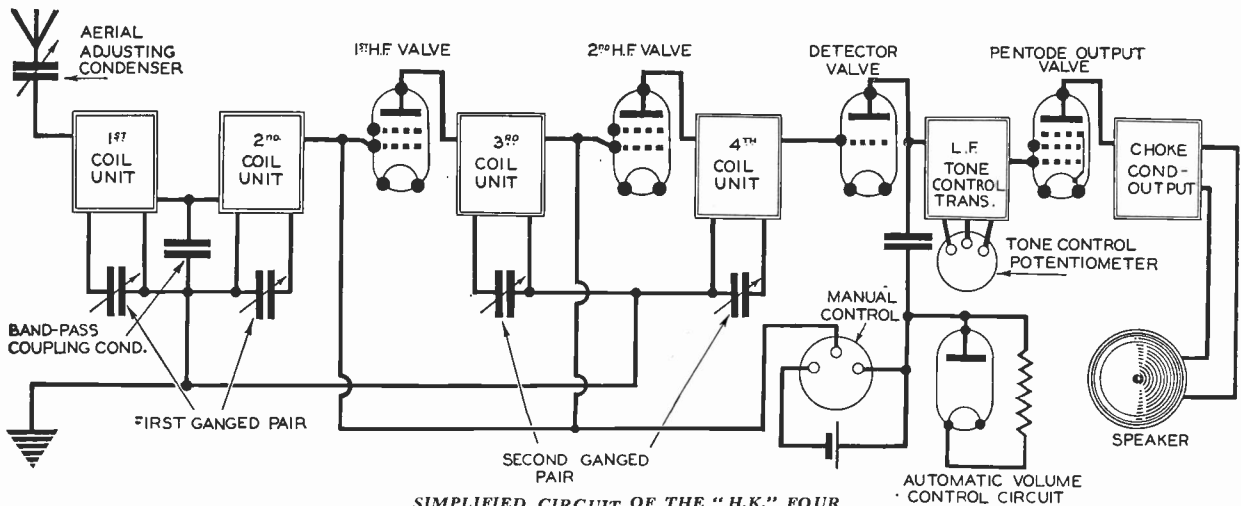

**SIMPLIFIED CIRCUIT OF THE "H.K." FOUR**  
*A simplified circuit in rather unusual form, intended to give the reader a general idea of the electrical layout of the receiver*

The scheme also enables us to place the detector valve not only as close as possible to its particular coil and condenser, but also immediately adjacent to the reaction condenser, thus keeping all of its leads as short as possible. The output of the detector valve can then be taken conveniently to its tone-correcting transformer and then to the output valve, while at the same time the special valve for the automatic volume control, the input to which comes from the plate circuit of the detector valve, can be placed just where we want it.

**Metallic Layer**

Both baseboard and bridge top are covered with a metallic layer which is earthed, but is *not* used to complete any actual circuits. The on-and-off switch is placed on the left of the panel, the two tuning condensers symmetrically on each side of the centre line, while the reaction condenser is on the right.

**About Volume Control**

The central knob is the hand-controlled volume adjuster, and immediately adjacent to this is a switch to cut out the automatic volume control if desired. Incidentally, unlike most sets having automatic volume control, the manual control *also* operates on the grids of the screen-grid valves, and *not* on the low-frequency stages. Our scheme is certainly the better one technically from the tone point of view.

The wave-change switch is arranged on the left of the cabinet in a convenient position, while the tone-control potentiometer, which varies

the proportion of bass and treble in the low-frequency reproduction, is placed at the back, for this is rarely used and is adjusted once and for all to suit the taste of the user, the damping of the set and the particular loud-speaker employed.

It is inadvisable to be constantly altering this adjustment, and its removal from the front of the panel to the back of the set not only improves the appearance of the receiver but also removes the temptation to "fiddle" to no particular advantage.

The layout shown should be rigidly adhered to because it has been most carefully worked out by the designers

to give the highest efficiency and at the same time the greatest ease of building. It has been found possible to dispense with nearly all sub-baseboard wiring in this set.

**Upright Fixed Condensers**

The vertical type of condenser has been used purposely in all cases for there are occasions when to screw a condenser flat on to a metal-coated baseboard may impair results. It also helps the simplicity of wiring which has been aimed at throughout.

At this juncture it will be well perhaps to explain in simple language

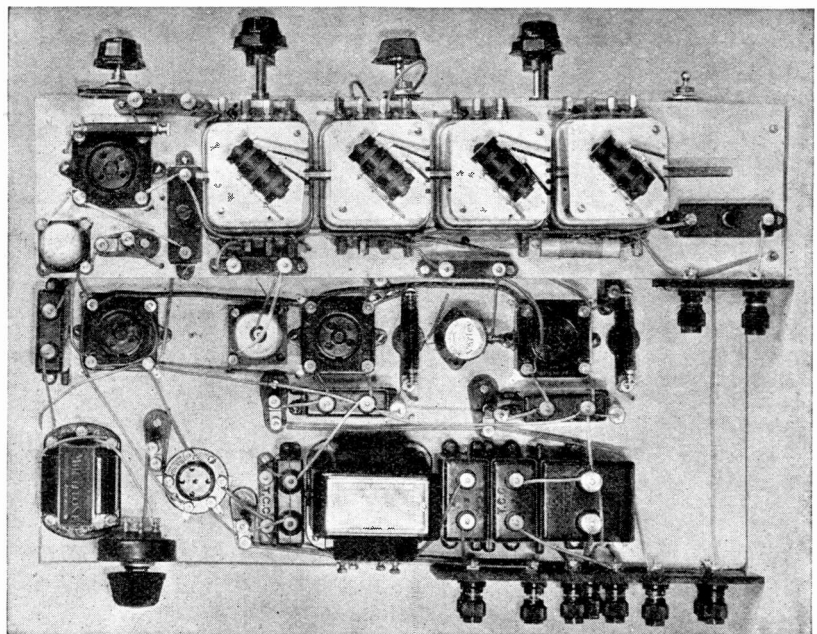

**PLAN VIEW OF THE "H.K." FOUR**  
*A plan view showing the really simple layout adopted for the set. This photograph should be studied carefully in conjunction with the wiring diagram on the opposite page*

just how automatic volume control works. Automatic volume control is obtained in modern sets in a number of different circuit arrangements, but they all depend upon the use of variable- $\mu$  valves, the voltages on the grids of which are controlled by the strength of the carrier wave reaching the detector.

In super-hets where there is a considerable gain before the second detector, the carrier is magnified

to such an extent that ample voltage for this volume control is obtained, but in a straight set such as this we have less to work with. The principle of action is the same, but as we have less control, the main value of the device is to prevent blasting and overloading on very strong signals.

The device is a very simple and economical one. We just use a further valve with grid and plate

(or in the case of a screen-grid valve control grid and screening grid) connected together and used as a simple diode without high-tension. This is connected via a blocking condenser to the plate of the detector valve, and is by-passed by a resistance. The amplified radio-frequency component in the plate circuit is thus rectified and a negative voltage depending upon the strength of the carrier is built up across this resistance.

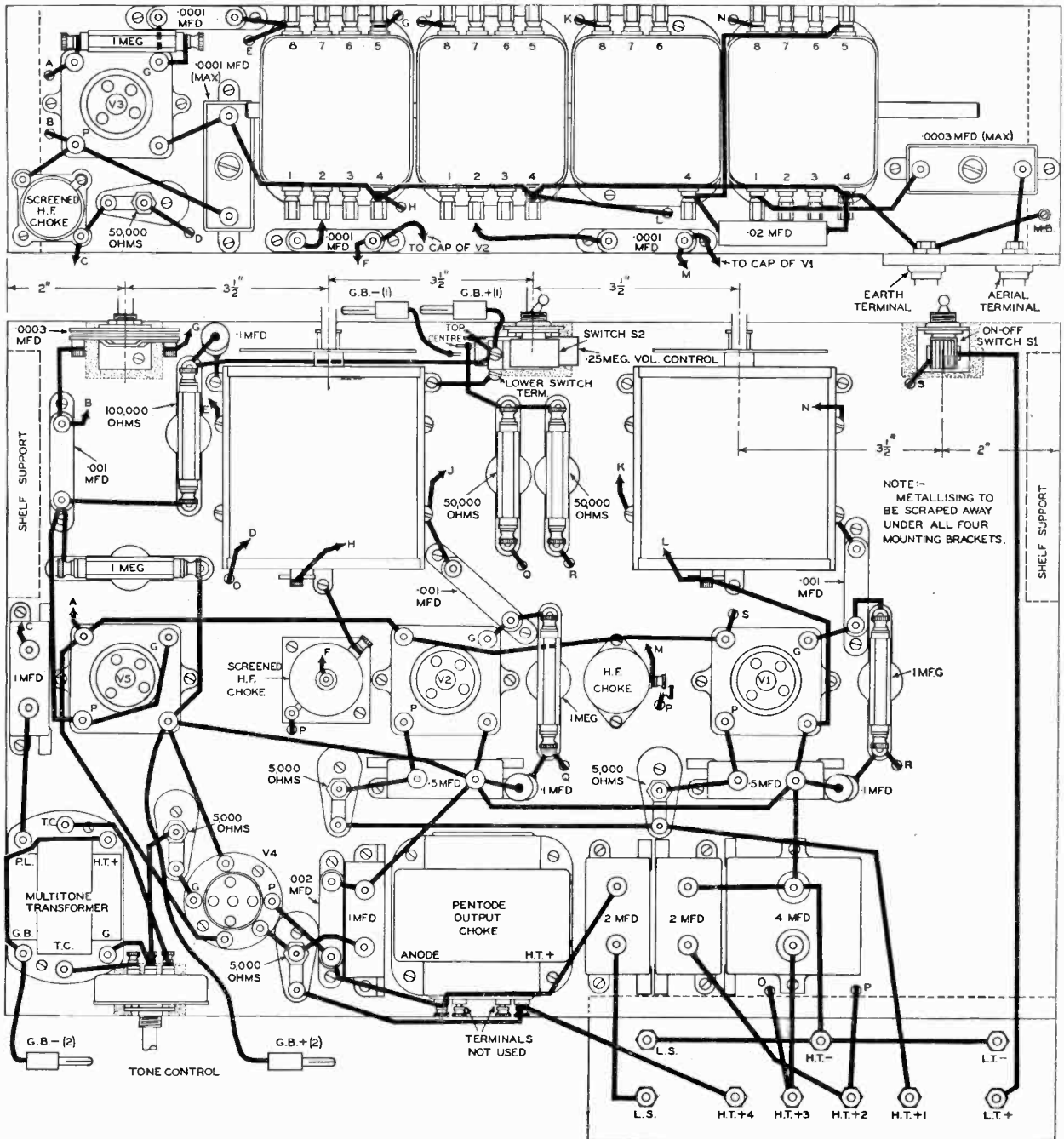

This is a scale layout of the full-size blueprint. Readers can obtain a full-size blueprint for half-price, that is 9d., post paid, if the coupon on the last page is used before March 30. Ask for No. WM384, and address your application to the "Wireless Magazine" Blueprint Department, 8-11 Southampton Street, Strand, W.C.2.



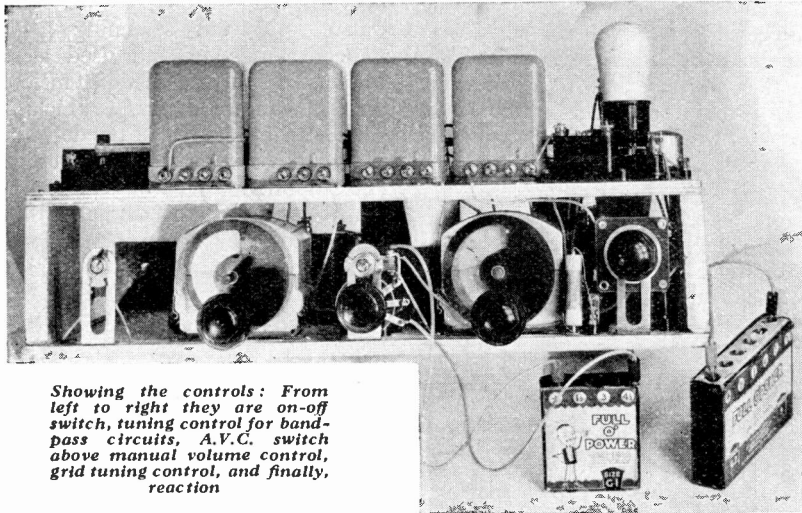

Showing the controls: From left to right they are on-off switch, tuning control for band-pass circuits, A.V.C. switch above manual volume control, grid tuning control, and finally, reaction

This voltage is then applied to the grids of the two variable-mu valves used for radio-frequency amplification via a pair of decoupling resistors, condensers being provided to prevent feed-back of radio-frequency energy.

**Overloading Avoided**

The stronger the carrier wave the more is the negative voltage applied to these grids and the lower the amplification and so overloading on strong signals is avoided.

An additional manual volume control is provided, as already explained, and a switch is fitted so that when so desired the automatic volume control can be cut out of action. The system used here is not

“full automatic volume control,” but it is nevertheless very useful and convenient.

You will notice that all three radio-frequency chokes are of different types. This is deliberately intended. It has been found that in adjacent circuits if both radio-frequency chokes have the same characteristics there is a tendency to oscillation, and so in the first radio-frequency plate circuit the type of choke is different from that in the second although both are of the same manufacture. In the plate circuit of the detector valve still another variety is fitted just because all three work satisfactorily together.

These are not the only three types by any means, and we do not wish

it to be thought that there is any special reason for choosing the particular models and makes for the particular places. They are just different, and no doubt many other combinations would work equally well.

**For Easy Wiring**

There are, you will see, a number of resistances of certain specified values. Those we have used are provided with terminals, which make wiring-up very convenient. Some are used in holders and some not. Provided the values of the resistances are the same as those given in the list of parts, other good quality makes can be substituted if desired, and the same remark applies to all of the fixed condensers provided they are of the vertical type.

**Instability and Quality**

If you care to dispense with the ability to vary the proportion of top and bottom, then any modern high-grade low-frequency transformer can be employed. It is not too well realised that the poor quality reproduction in many sets is not so much due to characteristics of the low-frequency transformer as to general instability.

A really stable set will give much better reproduction with the cheapest low-frequency transformer than an unstable set with the most

Continued on page 151

**COMPONENTS NEEDED FOR THE “H.K.” FOUR**

	£	s.	d.		s.	d.		s.	d.
<b>BASEBOARD ASSEMBLY</b>				<b>CONDENSERS, FIXED:</b>			<b>TERMINALS</b>		
1—Peto Scott metal-coated baseboard, 18 in. by 12 in., 3/8 in. thick	2	6		3—T.C.C. .0001-microfarad, edge-wise mounting, type 34	3	9	11—Belling-Lee, marked as follows: A., E., L.S., L.S., H.T.-, H.T.+1, H.T.+2, H.T.+3, H.T.+4, L.T.+1, L.T.-	5	6
<b>MISCELLANEOUS WOODWORK</b>				3—T.C.C. .001-microfarad, edge-wise mounting, type 34	4	6			
1—piece 18 in. by 4 1/4 in., 3/8 in. thick, also metal-coated.				1—T.C.C. .002-microfarad, edge-wise mounting, type 34	1	6	<b>SOUNDRIES</b>		
2—pieces 4 1/4 in. by 3 1/2 in., 3/8 in. or 3/4 in. thick. (These need not be metal coated, since they are merely the supports for the “bridge” piece.)				1—T.C.C. .02-microfarad, type 300	1	0	4—Peto Scott mounting brackets — for supporting switches, reaction condenser, volume control	1	4
<b>CHOKES, HIGH-FREQUENCY</b>				3—T.C.C. 1-microfarad, type 250 (Cartridge)	4	0	(Note. The slots in these may need enlarging to take the bushes of the switches. This is easily done with a file.)		
1—Varley Multicellular Junior (First high-frequency stage)	3	6		2—T.C.C. 5-microfarad, type 50	4	8	4—Wander plugs for grid-bias leads (two red and two black).		
1—Varley Nicore (Second high-frequency stage)	4	6		2—T.C.C. 1-microfarad, type 50	5	0	1—Terminal strip, 8 in. by 2 1/2 in.		
1—Wearite type HFPJ (Detector stage)	2	0		2—T.C.C. 2-microfarad, type 50	7	0	1—Terminal strip, 2 in. by 1 1/2 in.		
<b>CHOKES, LOW-FREQUENCY</b>				1—T.C.C. 4-microfarad, type 61	5	6	Wire, sleeving, flex, screws, etc.		
1—Varley Pentode output, type DP9	15	0		<b>HOLDERS, RESISTANCE</b>			<b>ACCESSORIES</b>		
<b>COILS</b>				6—Graham-Farish horizontal type	3	0	<b>BATTERIES</b>		
1—Set of Wearite Nucleon coils, comprising one BP1, one BP2, and two TG types, with special extension piece and coupler for wave-change switch	2	10	0	5—Graham-Farish vertical type...	2	6	1—Full o' Power 120-volt	17	6
<b>CONDENSERS, VARIABLE</b>				<b>HOLDERS, VALVE</b>			1—Full o' Power grid-bias unit, 9-volt	1	3
2—Formo double-gang type, with slow-motion drives and dust covers	1	5	0	4—Benjamin sprung 4-pin type	6	0	1—Full o' Power 4.5-volt	1	0
1—Graham-Farish .0003-microfarad reaction	2	0		1—Benjamin 5-pin	10		1—Smith's 2-volt accumulator, type 2RGN7	10	6
1—Formo compression type, .0001-microfarad	1	6		<b>RESISTANCES, FIXED</b>			<b>LOUD-SPEAKER</b>		
1—Formo .0003-microfarad compression	1	6		4—Graham-Farish 1-megohm Ohmites	6	0	1—W.B. Senior Stentorian (Or in cabinet at	2	2
				1—Graham-Farish 100,000-ohm	1	6		2	19
				3—Graham-Farish 50,000-ohm	4	6	<b>VALVES</b>		
				4—Graham-Farish 5,000-ohm	6	0	3—Cossor 220 VS (Note.—One of these is used for A.V.C. purposes, and any available type can be tried here.)	1	17
				<b>RESISTANCES, VARIABLE</b>			1—Cossor 210HF	5	6
				1—Multitone potentiometer for tone control	3	6	1—Cossor 220PT	13	6
				1—Erie .25-megohm volume control	3	6			
				<b>SWITCHES</b>					
				2—Bulgin on-off, type S80	3	0			
				<b>TRANSFORMER, LOW-FREQUENCY</b>					
				1—Multitone, ratio 1 to 4	17	6			

**A**FTER more than ten years of broadcasting it is perhaps a little strange to draw attention to the fact that radio is a science. Such an assertion may rob radio of its pseudo mysterious nature, but surely it is high time that many of us emerged from the realms of fantasy and regarded radio quite unemotionally as a cold, solid scientific fact.

#### Gamut of Phrases

I suppose there are many who talk glibly of volts and amperes and screen grids and the whole gamut of phrases which has grown around radio, and yet in so doing they more or less secretly believe that there is something very incomprehensible about it all.

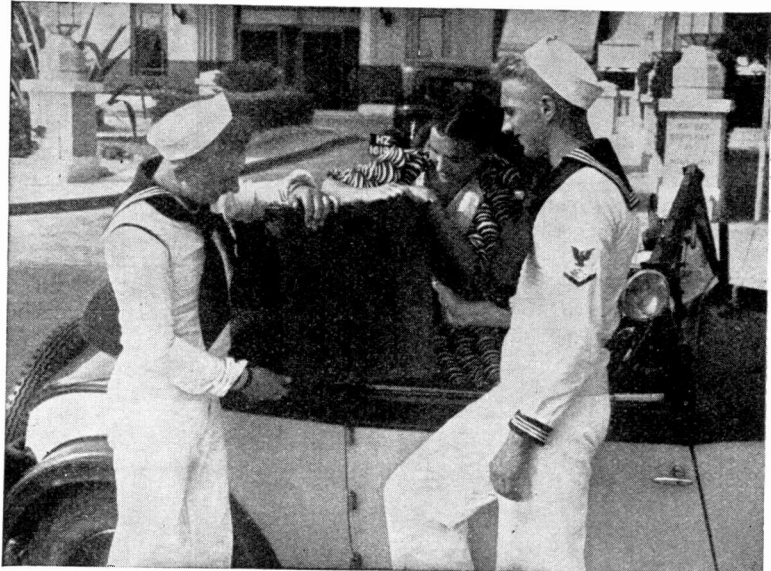

H. M. V. photo

Paul Tyers says that "there is nothing less mysterious, less romantic and more commonplace than a broadcast receiver." We wonder what these sailors think!

# Radio Is a Science!

Declares PAUL D. TYERS,

the designer of the well-known  
"W.M." Stenode Receivers

That such an idea should be prevalent amongst the general public is not surprising, but from time to time I am afraid quite a number of both writers and business men have encouraged and fostered such a belief.

It is difficult to recall how many times during the last decade one has met startling accounts of wonderful new developments. Special circuits have been produced to an accompaniment of much shouting from the house-tops, and in nearly all cases such outbursts have been accompanied by an atmosphere of mystery.

#### A Puzzled Technician

I can recall the case of a circuit being produced in which the normal conventions were abandoned and everything was so drawn that it took a skilled technician quite a little while to discover what it was really all about.

Then I believe there are many who still imagine that they will wake up one morning to find that some startling change has occurred and that the wireless set of to-morrow

will be in the form of a two-inch box which one can carry in the pocket without any form of power supply.

There are others who believe that their sons by reading a few books and paying a small premium can "go into wireless." Probably some of them do, but what happens I do not know.

This totally erroneous and mysterious idea of radio is probably unconsciously maintained by virtue of modern advertising methods in which some perfectly justifiable technical development is seized upon by advertising men as a salient feature. A firm may find, for example, that it is convenient to use material "X" in a valve or a loud-speaker. Before many months elapse national advertising tends to give one the impression that the use of material "X" has revolutionised radio and made everything else obsolete.

And so the whole partly-conscious and partly-unconscious teaching of erroneous doctrine goes on, and there are probably very few who are really blameless in this respect.

It is for this reason that it seems high time to undertake a really dispassionate investigation and try to realise exactly what radio is to-day and, more important, how the present state of technique has been reached.

Radio as we know it to-day is no happy accident; neither is there anything which is not understood or mysterious in any way whatever. Modern technique is definitely the outcome of nothing other than logical co-ordinated scientific development and investigation.

#### Commonplace

Because we have used electric lighting and heating in our homes for many years we regard it with little interest and accept it as one of the commonplace, everyday things of life, in exactly the same way as we do a motor-car, a chair or a table.

The principles underlying the design and operation of an electric lamp, radiator, or motor, are the same fundamental principles which we apply to the design of a radio receiver or transmitter. These fundamental principles have been known for years and they can be referred to in standard text books.

The progress made by radio is undoubtedly due to the pioneer work carried out by Fleming and De Forest in the development of the valve. These early experiments.

were carried out in the laboratory under an atmosphere which could not be termed anything other than highly scientific.

The same may be said of the pioneer work of Hertz and Marconi. In either case everything was logically reasoned, and all the results obtained were capable of being duplicated—a fact emphasising the

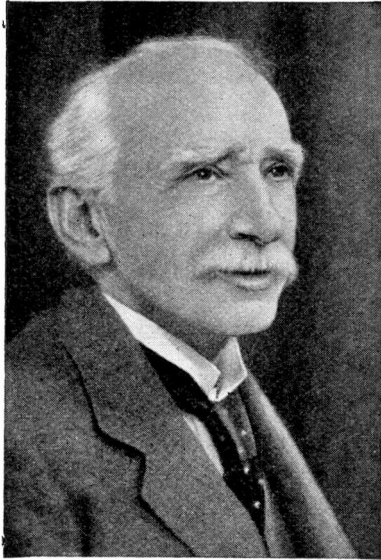

*Dr. Ambrose Fleming, the famous scientist, who has helped the progress of radio by his pioneer work with valves*

truly scientific nature of the work.

Very briefly, radio is best described as a branch of electrical engineering. Electrical engineering itself is purely the application of fundamental electrical principles, which is what radio engineering really is. Actually, however, the whole technique of radio embraces a far wider field because there is so much associated technique gathered from other sciences and branches of industry.

In this respect radic engineering is probably unique, and the associated technique is probably greater than that of any other application of electricity or almost any other branch of engineering, whether civil, mechanical or electrical. The fact that the field is so wide has already resulted in the existence of quite a number of specialists.

It is here interesting to consider exactly what constitutes a specialist. The popular idea of a specialist

is one who has a specialised knowledge of his subject. This, of course, is perfectly true, and is true almost by definition, but far more is really implied. A man cannot be a specialist unless he has a very extensive knowledge of the general principles of the whole subject, and also a useful working knowledge of any associated technique.

If one examines a modern wireless set step by step, one can find reflected the work of not one but a very large number of scientists and engineers. The valve alone is the outcome of the work of several different scientists. There is the expert in thermionics, a comparatively recent branch of electrical science. The chemist and physicist have each played their part in the production of the modern valve.

The valve as we know it to-day would not be possible but for the work of the chemist and the physicist, and in particular another specialist, the metallurgist.

Such things as the insulation in a set, the dust cores, or the high ohmic non-inductive resistances, we are apt to take for granted. All these, however, have been specially produced as a result of years of careful scientific laboratory work, and they have been produced essentially for radio.

If we turn our attention to such things as the loud-speaker or even the cabinet, we are again examining the result of the work of other specialists. A cabinet used for a wireless set is not comparable with the cabinet used to store sheet music, or a coal scuttle. These latter are simply pieces of furniture. The radio cabinet must have the necessary

acoustic properties and must also withstand temperature changes due to the heat from the set.

The loud-speaker has been produced as the result of the joint work of the electrical engineer and the physicist who had specialised in acoustics.

### The Radio Engineer

It is now easy to see that the radio engineer who is worthy of such a title is obviously a man who is first of all a thoroughly qualified electrical engineer with a specialised training in light current work as applied to audio and radio frequencies. At the same time, however, he possesses a thoroughly sound general scientific training as well as a very useful knowledge of every atom of associated technique which goes to produce the modern receiver.

This is a statement which I have often heard contradicted, but no better evidence for its justification can be found than examining the actual conditions under which an engineer has to work. I have been almost amazed myself from time to time at the tremendously diverse nature of apparatus and equipment that one requires in dealing with what appears to be a very simple problem.

### Diverse Apparatus

In my own laboratory I have found it absolutely impossible to carry out certain investigation or development work without the use of such widely diverse apparatus as a microscope and compressed air plant on one day, and on the next an electric furnace and a spray gun. That such should be necessary for the

development of radio technique is by no means obvious to the man in the street, but it gives abundant proof of the statement that radio is a science.

In conclusion, let me emphasise the fact that there is nothing less mysterious, less romantic, and more commonplace than a broadcast receiver. Only a set which is the outcome of continued logical scientific development by experienced workers can give a performance which is regarded today as satisfactory.

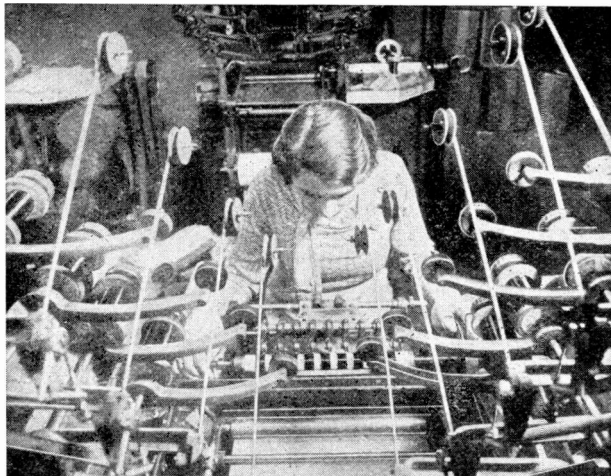

*Much thought and money has gone in the production of even the simplest radio component. Here is one of the intricate coil-winding machines at the Cossor works*



# Wireless for the Busy Man

By PERCY W. HARRIS, M.I.R.E.



H.M.V. photo

Gerardo, whom you all know as the conductor of his tango band, is a keen listener and wireless fan. He uses a 15-valve radiogram

The policy of "Wireless Magazine," as we have pointed out elsewhere, is to deal with the new conditions in radio and to get away from stereotyped methods of treatment. In the past it has been assumed, quite erroneously, that the radio public is divided into two classes—those who build their own sets and are interested in technicalities, and those—the majority—who buy their sets ready-made and have no interest in how they work. The hundreds of thousands—if not millions—of listeners who prefer to buy commercial sets and yet make radio their hobby have been practically ignored, for most of the technical articles have been written in a language they do not understand. We are remedying this omission in a series of articles of which this is the first. Technical readers are asked to recommend this special series to their set-using friends who have not had the chance of studying technique

**F**UNDAMENTALLY, there is a great resemblance between a telephone system and a wireless broadcasting system. In both cases sound energy is converted into electrical energy at the transmitter and re-converted into sound energy at the point where it is desired to listen. So closely are the two methods linked that frequently both are used in the same programme.

So far as this country is concerned the wired telephone *always* plays an important part in the broadcast service, for the simple reason that in not one single instance is the studio situated in the same place as the broadcast transmitter. All the programmes from, for example,

Broadcasting House in London are conveyed to the particular transmitter used by means of telephone wires.

Similarly the wire-telephone system can be interposed between two wireless links, as is the case when a British receiving station picks up a foreign broadcast and puts it on a telephone wire from which it is again passed to a wireless circuit and so to your ears at home.

Again, the numerous relay receiving systems now operating in this country each pick up the programmes on one large receiver and re-distribute them by means of wires. If these wires were connected to ordinary telephone receivers, such

as are used with the Post Office 'phone, you would hear the transmissions in one ear just as if you had lifted your ordinary 'phone off the hook.

## Not Radio Components

It is, of course, much more convenient to magnify the electric currents until they are sufficiently strong to operate a loud-speaker, but loud-speakers are not essentially "wireless" components, for similar magnification together with loud-speakers could be applied to the Post Office telephone if it were considered advisable, which, I may say in passing, is emphatically *not* the case.

However, on warships, in factories and in other places where there is a high "noise-level" the ordinary wire telephones are sometimes connected to loud-speakers.

## Clearing the Ground

You have probably guessed by now that I am endeavouring to clear the ground by pointing out just what is essentially wireless and what is merely an adaptation of existing telephone technique. Coming back to the studio from which the programme emanates, let us trace a talk from the studio reading desk to your fireside loud-speaker, avoiding technical terms as far as possible.

## Sound

It is not necessary to understand a great deal about the theories of sound, wave-forms, and the like, to appreciate the basic principles of wireless. If you tap a piece of wood sharply with another piece of wood you will hear a click just because at the point of contact between the two pieces of wood there has been a disturbance of the air which spread out in every direction as a wave.

### About Speed

That part of the air wave which enters your ear strikes the ear drum and thus a nerve sensation passes to your brain. At this juncture it is interesting to note a few points about speed. Sound seems to travel very fast, almost instantaneously, when you are near to the source, as is the case when you see the two pieces of wood struck together. Actually, the speed of sound travel in air is about 1,100 ft. a second. Light, however, travels very much faster—somewhere between 150,000 and 200,000 miles a second.

From these figures you will gather that while both sound and light waves are very fast in their travel as compared with, say, Sir Malcolm Campbell's Bluebird, the speed of sound waves is a dead crawl compared with that of light.

A little later we shall find that radio waves have the same speed as light waves and a number of other important similarities, as well as very big differences.

### Echo Effect

If sound reaches your ears from the same source but by two different paths you sometimes get the effect known as echo. Sound waves will bounce off a hard substance just as water waves will bounce off a rock, and so sometimes you are in a position where sound can reach you by a comparatively short path direct and by a much longer one from a reflecting surface some way off.

The direct-path sound will reach you practically immediately, but the long-path sound takes longer, and so you will get a repetition of sound, or a doubling, the time interval between the two components being dependent on the difference in the distance.

Another interesting sound phenomenon occurs in thunder and lightning. The thunder clap and the lightning flash occur at exactly the same moment, but as the lightning flash is generally a long distance away the sound waves take an appreciable time to reach the observer, so you see the lightning and only later hear the thunder roll.

Let us now return to the studio where our speaker is impatiently sitting with his manuscript in front of the reading desk, and the announcer is waiting. In the early days of broadcasting the speakers spoke directly into a mouthpiece almost identical with that used on the Post Office telephone, but later both the microphone, as it is called, and the apparatus connected with it were made much more sensitive so that it is no longer necessary to put one's lips up to a mouthpiece.

The microphone which serves to convert the sound waves into variations of electric current is enclosed in a suitable casing and concealed wires go from it to other apparatus.

There are dozens of different kinds of microphones, and we need not worry to consider them in detail. All operate by the pressure of the sound waves on some surface which moves with the waves and varies the strength of the electric current passing through the microphone, so that, in the currents emerging, variations of strength of electricity

exactly correspond to variations of pressure on the microphone surface.

It seems strange to speak about sound in terms of variation of pressure particularly when you consider the multitude and variety of sounds which can be successfully broadcast in all their delicate shades and variations. Careful analysis has shown that by combining various speeds of vibration, or frequencies we can get any kind of sound within the compass of the human ear, no matter how simple or complex.

### A Railing Experiment

Do you remember as a boy dragging a walking stick along the iron palings and finding that if you ran fast enough the separate blows gradually merged into a continuous sound? If you strike twenty-five or thirty blows regularly in one second it starts to produce a low musical note, and the shorter the intervals between the blows the higher the note.

### A Saw Noise!

If, again, you have some device, such as a circular saw, which gives a very large number of uniformly spaced blows in a second (the teeth of the saw do this on the piece of wood) then the sound will merge into a shriek or whistle.

High-pressure steam emerging from a small hole and impinging on the edge of a piece of metal so

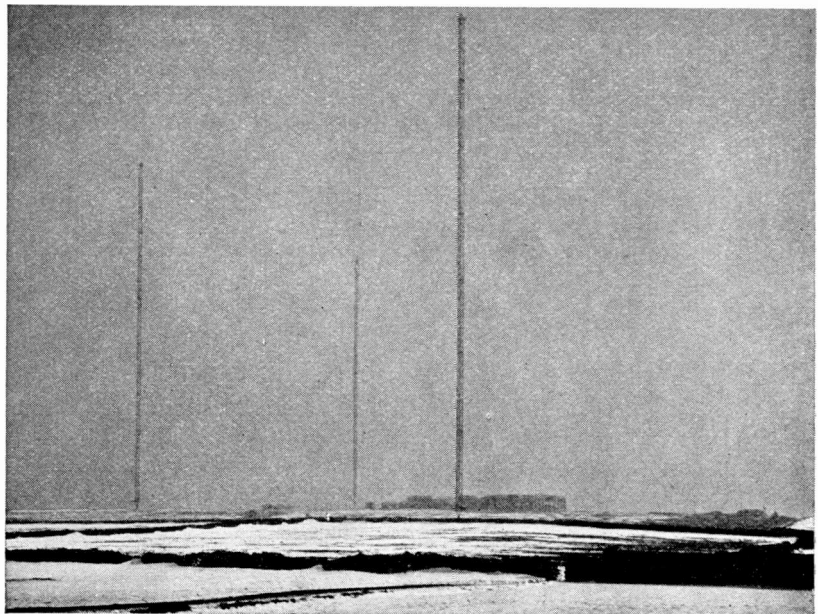

B.B.C. photo

The staunchness of the North Regional transmitter, high up on the Yorkshire moors, is fully tried out during the bleak winter weather. The masts are each 500 ft. high and were specially built to withstand Britain's Arctic spells!

as to make it vibrate very rapidly will give a shrill and piercing note, and this is exemplified in the steam whistle.

A jet of air similarly vibrating a reed at the bottom of a pipe gives a sound which is recognisable to you as that of a church organ note.

A short string when struck will vibrate more rapidly than a longer one, and this will suggest to you a whole range of musical instruments—violin, banjo, harp, piano, etc. In fact, something vibrating and disturbing the surrounding air is the basis of every musical instrument.

If the sounds follow one another regularly the note becomes a musical one; if irregularly, that is with no one predominant frequency, the sound is a rough, irritating or harsh noise.

### The Microphone

Our microphone, then, must be able to vibrate sympathetically for all of the various kinds of noises, whether they are produced by the vibrations of membranes in the human throat, by impact of a stick on a drum vellum, by the vibration of strings, air columns, or what not.

Excellent sound reproduction can be obtained with an instrument which will vibrate at all frequencies between 25 or 30 a second and 5,000 a second, but for really faithful reproduction the microphone must be able to respond up to at least 10,000 vibrations a second.

An ordinary Post Office microphone accepts very little below 200 vibrations per second or much above 2,000. Within this "frequency range," as we call it, most of the important voice frequencies are included sufficiently well to give intelligibility of speech but by no means sufficiently well to give the distinctive accents and tones of the speaker.

### Over the Telephone

If a person's main voice frequencies fall within this range then they will sound natural over the telephone, but if his general speech contains important frequencies outside of this range the voice will sound unnatural to you—this is the ex-

planation why some people sound good on the telephone and others do not!

Although there are many microphones which will produce considerable variations of electric current corresponding with voice-frequency vibrations, the actual amount and strength of current that can be varied in this way is comparatively small.

Fortunately there exists apparatus today enabling us to build practically perfect magnifiers which on their input side, will take the

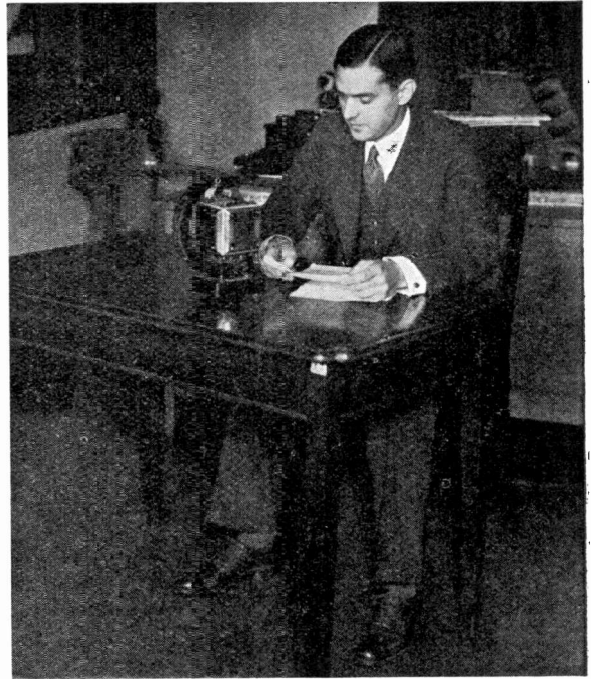

(Above) It is just a year ago that Mr. F. J. Philips, of Philips Lamps, Ltd., addressed the audience of an Australian radio exhibition by radio. Short-waves of 28 metres were used for this remarkable feat. (Left) Jack Payne is another keen radio fan. Here he is seen with an Ekco set at a Manchester cinema during a recent tour



comparatively feeble varying currents from our studio microphone and magnify them up to any degree we like without varying their *relative proportions*. The Post Office now use these magnifiers on long distance telephone lines, and is one of the reasons why it is now possible to speak from London to Paris or Berlin very much easier and quicker than it was possible a few years ago to speak from the City to the West End.

We could, if we so desired, take the current from the studio microphone into which our speaker is now declaiming and magnify it to such an extent that it could be

connected to some giant loud-speaker on the top of Broadcasting House and make enough sound to be heard for miles above the noise of the traffic.

As it is, all we do is to magnify it a fair amount and then connect it by a telephone line to Brookman's Park, Droitwich, or some other transmitter. There are, of course, sundry refine-

ments at Broadcasting House, very interesting in themselves, but having no particular bearing on the fundamentals of radio.

### B.B.C. Control Room

In passing it may be mentioned that in the B.B.C.'s control room the microphone sounds from various studios can be blended in varying strengths, gramophone or other sound records worked in with them, the proportional strength of different studios modified, echoes introduced and so forth, all in the cause of art.

But whether the speaker is comfortably ensconced in an armchair in a modernistic room at Broadcast-



Keystone View photo

This is one corner of the B.B.C.'s big junction at Broadcasting House where outgoing programmes are switched to the various British transmitters, such as Droitwich and Brookman's Park. Every switch is in duplicate to prevent any chances of breakdown—breakdowns do happen but the control room is not to blame!

ing House with a neat little box in front of him, or whether he has dashed into a telephone box in the nearest tube station and is speaking to a Post Office microphone there, provided both lines are connected to, say, Daventry, what reaches the transmitting station is very much the same in both cases, except that the studio transmission will be of better quality and probably of greater strength owing to the magnification given.

### Radio Begins

Within the last half century it has been discovered that just as waves of sound are set up in the air by the sharp impact of two objects against one another, so waves of free electricity (to use rather a loose term) can be set up in space by a sudden electric disturbance. But man was not the first to set up these waves of free electricity\* in space—Nature has done it since the world began by means of all kinds of natural electric discharges such as lightning and the Aurora Borealis.

Yet whatever peculiar phenomena are produced by nature or man

\* Strictly speaking, it is energy rather than electricity, which is radiated, but in order to make the explanations as simple as possible a few liberties are taken with the word "electricity."

we are not conscious of them unless they can be in some way made evident to our senses, so that although away back in the early part of last century a prediction was made that such disturbances could be produced, it was not until about fifty years ago that anyone devised an indicator to prove their presence at a distance from the source.

The first indicator took the form of a ring with a small gap in it, in which appeared a tiny electric spark as an indicator of the presence of the free electricity which had been picked up. This spark, produced at will a few feet away from the exciting cause, was the beginning of practical wireless, and it was not long before Marconi (then little more than a youth) decided to improve on the simple apparatus so as to extend the range over which this controlled electric spark could be produced.

By stopping and starting the producing apparatus according to the dots and dashes of the Morse Code and by greatly improving the sensitiveness to free electricity of his detecting instrument, he was able to get, through the medium of the senses of sight and sound, indication of this distant signalling.

Numerous other workers, both theoretical and practical, soon discovered a host of facts about the

waves of free electricity, notably that they were not stopped by ordinary obstacles but passed freely through most walls and objects opaque to light; that they travel with the speed of light and follow many of the laws deduced from the study of light phenomena. They could be reflected, bent about and even concentrated by means of large mirrors in certain circumstances.

### Powerful Electric Disturbances

We need not bother about the apparatus used once we have grasped the fact that by stopping and starting apparatus producing powerful electrical disturbances waves of free electricity could be sent off in space in all directions and their presence made manifest by some kind of receiving apparatus. It was found that by attaching a long wire to the disturbing source a bigger effect could be produced, and thus came the aerial or radiator of energy, the efficiency of which went up with size just as in a hot-water central heating system the larger the size of the radiating-pipe area the more heat we can distribute in the house. Similarly a long wire attached to the indicating instrument picked up more energy, and thus we have receiving as well as transmitting aerials.

### Early Gear was . . . .

The early apparatus, like most new things, was crude, elementary, inefficient and erratic. By forcing more and more power into the disturbing element or "transmitter" as we shall now call it, a greater and greater range was obtained, but for years nothing more than dots and dashes could be transmitted. In due time it was found that in the receiving apparatus not only were there generated minute electric currents caused by the impact of the electric disturbances on the aerial, but that these extremely minute currents were miniature reproductions of those in the transmitting apparatus.

### Fantastically Small

The actual amount picked up by any one aerial from a transmitting station was fantastically small because ninety-nine and ever-so-many-figures per cent of the energy sent out was wasted, only a small slice of the wave-front hitting the receiver aerial.



### The Coming of Telephony

With the realisation of this fact and the improvement of the disturbing source so that, so to speak, the degree of disturbance could be made to following the strength of the transmitting current, it became possible to link up the telephone wires with the disturbing machine or transmitter so that continuous streams of waves were sent out, rising and falling in strength ("modulated" is the correct word) according to the telephone line current.

Similarly great improvements at the receiving end so far as the detecting parts were concerned made the tiny current detectable over much greater distances, and when later we found how to magnify these tiny currents to make them follow faithfully the variations of electric waves it became possible to connect them to a telephone receiver. By further magnification and the substitution of a loud-speaker for an earpiece or pair of headphones we can make the sounds audible to the whole room, which is the case today.

#### Carefully Worded

This article is worded a little more carefully than perhaps might appear on the surface. You will notice earlier on I referred to sound waves *in the air* and later when we came to electric waves or waves of free electricity I designated them waves *in space*, not in the air. I have not yet

used that strange word "ether" which figures so largely in every wireless text book just because it is one of those "shelter words" which saves us thinking.

It is, however, necessary to point out that while sound waves will not occur in a vacuum, because the actual air is the medium through which they are transmitted, electric waves will occur in a vacuum and in the free space beyond the earth where there is no air, just because they are *not* air waves.

Certain things happen with electric waves in space where there is no air, and scientists have invented a mysterious invisible "something" which they call the "ether" and have ascribed to it properties which would enable them to account for certain phenomena connected with wireless waves and, for that matter, light waves.

It is, however, an abstraction and need not worry us in these articles except that it may occasionally be mentioned as the medium pervading all space in which these waves are produced.

Summarising our progress to date we can say that the speaker in the B.B.C. Talks Studio produces sound waves by means of his voice and the impact of these varying sound waves upon the microphone bring about corresponding variations of pressure, which in turn cause variations of strength in electric current which is taken by land lines to the transmitter.

This electric current, after being greatly magnified is made to operate

what may be termed a "space agitator" which radiates free waves of electricity into space, these waves flying off at a constant speed equal to that of light in all directions, just as if the transmitting station were the centre point of a successive series of giant half-bubbles of energy which grow and grow in circumference, sideways, forwards, backwards, upwards, everywhere at a constant speed of light—between 150,000 to 200,000 miles a *second*.

#### Another Article

*in this series will appear in the April "Wireless Magazine"*  
**ON SALE—MARCH 22**

Wherever a wireless aerial happens to come in the path of these invisible waves of electricity they set up in it minute electric currents which faithfully follow in proportionate intensity the variations of strength of the waves. So tiny are these currents that we have to magnify them to make them of any use for our loud-speaker.

#### Getting Rid of Interference

How we get rid of the mutual interference of large numbers of different transmitting stations on the same aerial, just how every kind of receiving set works, and what are the reasons for the various parts, will be explained in subsequent articles. The next article will deal particularly with tuning.

*Marchese Marconi has a special laboratory in the heart of London where he investigates the possibilities of radio communication on wavelengths below 1 metre. The laboratory houses a transmitter which works with a receiving station eleven miles down the Thames at Belvedere*

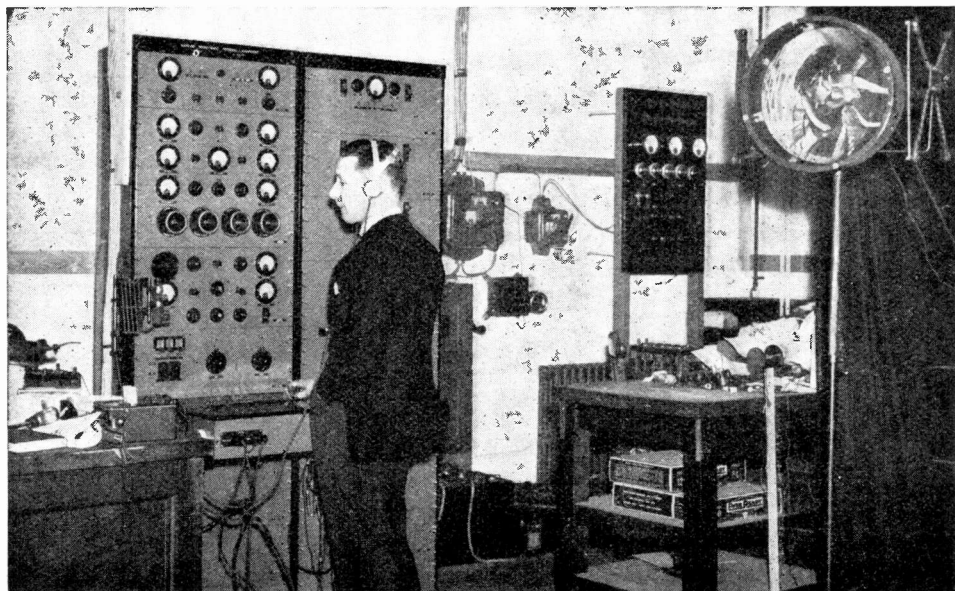

# Question Time at the B.B.C!

By T. F. HENN



Columbia photo

There is no need for us to introduce these two upholders of public-school tradition. The Western Brothers have, we hear, founded a club for brother "cuds," the annual sub. of which is five bob!

A LOT of nasty, awkward questions have been asked at Broadcasting House during the last few weeks. The trouble about them all, with one or two exceptions, is that there are two opinions to every debated topic.

The Clapham and Dwyer spot of bother is all over—it was purely an accident which upset a few listeners. I know for a fact that a few thousand letters were received at headquarters. But there is no reason why this one spot of trouble should result in absolute panic—for that is what appears to be happening.

For instance, one band broadcast a tune with words called *The Pig Got Up and Slowly Walked Away*. This caused a few stiff-necked grannies to get busy, with the result that the words of this number are taboo at Broadcasting House.

Incidentally I received a few days afterwards a record of this tune from a leading gramophone company. I have listened to this disc two or three times, and, believe me, there is nothing the matter with it at all.

Personally I consider it an insult by the B.B.C. to the band in question, though such B.B.C. actions as this are likely to do the band quite a deal of good. If you disagree—I am open to correction—let me know.

Apparently British broadcasting intends to be "on the level"—dance music must develop on His

*Majesty the Baby and Beautiful Moon* type of tunes.

I am waiting for the time when the B.B.C. and the television concerns have got looking-in well under way. Won't there be some nasty letters after first shows by the Dancing Daughters. Believe me, the B.B.C. are quite modern at St. George's Hall!

By the way, dance music reminds me of something I badly want to get off my chest. Jack Hylton, I hear, is getting simply amazing receptions on the Continent. In Berlin, where the proceeds went to German charities, he had an outstanding triumph.

Coming home! Do you all feel tremendously enthusiastic about our own broadcast dance music? I must be frank. The B.B.C. Dance Orchestra requires an overhaul. To my mind they lack most of the essentials of showmanship. Honestly, I listen to the B.B.C. Band on London Regional; then a slight turn of the dial upwards to Berlin, and what a difference. Ordinary straight German dance music has got B.B.C. dance music "licked to a frazzle."

It is the B.B.C.'s duty to provide us listeners with dance music worth having; and it is about time the Corporation woke up to the fact.

Jack Payne, I hear, is booked for the maiden voyage of the *Queen Mary* next year. He is broadcasting four times this month.

I have found a new radio attraction, though it is not good for one's health. I have been habitually listening to Stuttgart on 522.6 metres between the hours of midnight and 1 a.m. Almost every night the Germans broadcast a classical concert with announcements in four or five languages—including English.

Some nights they broadcast light orchestral music, other times we have songs or classical works. But the point is that I feel that ordinary British listeners should be given an opportunity of enjoying an alternative to dance music up to midnight. I have raised this point on more than one occasion. We get some sort of an alternative up till 11.10 p.m. Why should it not be extended until midnight?

One keen listener writes and says: "I do wish the B.B.C. would broadcast stirring martial music between seven and eight in the morning physical jerks."

The answer to this is that the B.B.C. have not experienced any demand for such early-morning broadcasts. And let me tell you this. They do *not* want to broadcast before 10.15 a.m., because such extra broadcasting would mean an increased staff, both in the studios and at the transmitters.

I suggest that my correspondent writes to the B.B.C.

Ice hockey enthusiasts should make a note that the B.B.C. is to relay commentaries on two matches from the Empire Stadium at Wembley. The first on March 2 will be at 9.10 p.m. on the occasion of a match between the Wembley Canadians and the Winnipeg Monarchs.

The second is March 9, when England is playing Canada. This relay is timed for 9.30 p.m.

Also for March I see that an Entertainment Hour programme is to be relayed direct from Vienna. It is far too early for details—the date is March 19. Dr. Adrian Boult and all the 119 members of the B.B.C. Symphony Orchestra are visiting Brussels for a concert on March 12. The concert will be relayed by landline to London and will be distributed to all National transmitters in the country for broadcast in the evening between 8.30 and 9.30, and 9.45 until 10.30.

Lines to the Continent must cost money, and a lot of money at that. I am sure that all British listeners would appreciate some unusual kind of Continental entertainment instead of a hardy annual!

I tuned-in to Whitaker-Wilson's re-construction of the trial of Dame Alice Lisle. This was ideal entertainment. A good radio play can



*We always get a good show when the Waters sisters take charge of the mike. Daisy and Gert can always be relied upon to provide an original turn*



*This is Reginald Kilbey, a 'cellist, who broadcasts with Albert Sandler's Orchestra*

produce a good illusion of historic events and, I think, there is room for more of this re-hashed history. But actors who cannot drop the modern English accent must not be given parts!

Ladies and gentlemen, let me present to you in bare form the B.B.C.'s idea of an evening's National entertainment. The time taken to perform this great show is six hours. I shall be very interested to receive postcards giving just the number of hours out of the six you would have your set switched on.

Here is the programme: 6.0, news; 6.25, gramophone interlude; 6.30, science talk; 6.45, cinema talk; 7.5, harpsichord recital of Handel's music; 7.30, a discussion; 8.0, a revue; 9.0, operatic gramophone records; 9.30, news; 10.0, wireless singers; 10.30, literary talk; 10.45, violin recital; 11.15, to midnight, dance music.

This is a brief outline of a National entertainment to be broadcast early in March.

SO we have a new attraction for Saturday afternoons. The B.B.C. are relaying between 4.45 and 5.15 p.m. excerpts from typical American programmes which, the B.B.C. states, are to give British listeners a chance "to dip into the morning programmes of America."

Whether this experiment is a success depends solely on the quality of reception from America. My experience shows that usually the entertainment is provided by Atlantic atmospheric and not by American artists!

No cables are being used, the whole of the entertainment being picked up in this country via short waves and re-broadcast.



*This scene, taken in the Columbia studios, shows Sir Thomas Beecham—the musician who is not frightened to tell the world what he thinks of the B.B.C.—conducting a violin concerto with Szegedi as soloist*

Conducted by G. P. Kendall, B.Sc.



The model 563 circuit tester made by the Weston Electrical Corp., Ltd. Its use is to enable the resistance in a circuit to be ascertained easily

### Testing Large Capacities

TESTING condensers of the larger capacities for leakage is not a very easy business for it is often found that the leak will only show up when a considerable voltage is applied. Many people attempt to test by means of a megger of the type used in ordinary electrical installation work, only to find that this method seems to show a leak in every condenser tested! That, of course, is due to the fact that the test voltage of this kind of megger varies with the speed at which the handle is turned, and since one cannot turn at a uniform rate by hand, current is continually flowing into and out of the condenser.

### Unsound Method

In theory, a satisfactory method is to be found in the use of a high-voltage source of some kind (D.C.) and a very low reading meter, but here again there is an objection; the meter is extremely liable to damage, first, by the considerable rush of current which flows into a condenser of large capacity, and secondly, by the short-circuit current which results from the test being inadvertently applied to a "punctured" condenser. By the time the needful safeguards have been provided the method is no longer simple or cheap.

Probably the best of the really inexpensive and simple methods of testing is with the aid of the neon

# A Page for the Service Engineer

lamp. Here all that one needs is a source of moderately high voltage, a pair of prods and an ordinary neon bulb.

The high voltage is best obtained from a small power transformer and rectifier; the latter can be any available triode valve of the low-frequency or power class, battery or mains, with plate and grid strapped.

Diagrams on this page show some suitable arrangements, wherein condenser *c* should be of some rather low capacity—of the order of 1 microfarad—while the power transformer should give about 200 to 250 volts.

Such a circuit will give quite clear

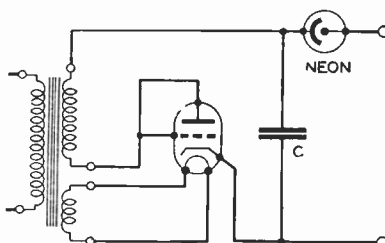

Fig. 1. Showing the circuit for using a neon lamp for testing condensers

indications of condenser faults, a good component showing only a single "blink" of the bulb when first connected to the tester; a leaky one produces a succession of flashes the rapidity of which gives some idea of the nature of the leak, while a complete puncture is denoted by a steady glow from the bulb.

### Output Comparisons

WHEN tests are being made upon a circuit with the aid of a modulated oscillator it is often desired to have some means of measuring, or at least comparing, outputs. Thus, in lining up a row of gang-tuned circuits it is not always easy to decide on the optimum adjustments by ear.

Sets with some form of visual tuning present no difficulty in this respect, but in other cases some kind

of output meter or indicator is a great help. Such meters are somewhat expensive, so it is useful to know that there is a very sensitive type of indicator which can be obtained for a few pence.

All that is needed is a flash-lamp bulb connected in series with the speech winding of the moving-coil loud-speaker; any fairly strong signal will cause this to light up, and the brightness of the glow will vary in sympathy with the strength of the output.

### Essential Precautions

Here, then, is a means of comparing outputs in the course of adjustment. It is necessary, however, to take certain precautions to avoid burning out the bulb, since this is easily done with a powerful set. The lamp should be shunted with a variable resistance of, say, 50 or 100 ohms maximum.

When adjustments are begun the resistance should be set so that the bulb lights up only dimly. As the output increases the resistance can be adjusted to keep pace with it.

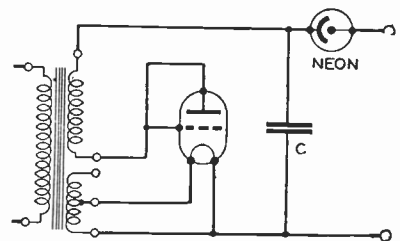
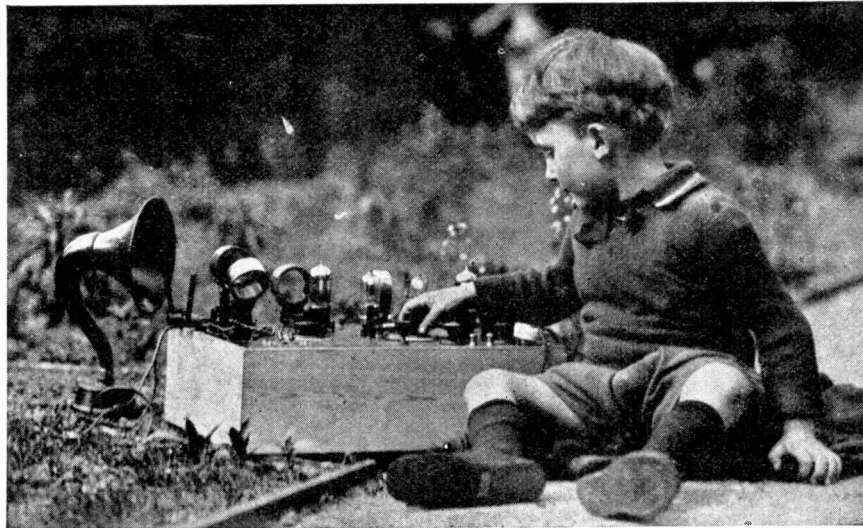

Fig. 2. A condenser-testing circuit using a 2-volt battery valve. Note that only half the 4-volt winding on the mains transformer is used

To be more specific, the resistance should at first be set to *minimum*, then gradually increased until the bulb begins to glow. Next, operations are commenced upon the receiver, whereupon it will be found that the lamp will brighten as more favourable adjustments are found. If it seems to be getting dangerously bright the shunt resistance should be reduced a little.



*This article, by our Technical Editor, stresses the extreme importance of good contacts. It is a vital question to the home constructor who uses up some of his existing stock of components when he builds a new receiver, as most of us do nowadays. Special precautions must be taken and here the right re-conditioning methods are fully explained.*



*Kitching & Clayton photo*

*Don't give your old radio gear to the children to play with—although they will enjoy themselves—for it often can be made particularly useful*

# Re-conditioning Old Components

By G. P. KENDALL, B.Sc.

**J**UST how this article came to be written is rather an involved story, but I'm afraid it must be told in order that the reader may understand what it is that I am trying to do.

It all began one day last autumn when I tried to read a somewhat rapid short-wave morse station and realised to my great disgust that I couldn't keep up. I have always believed that to get the full amount of interest out of radio one should be able to read morse at a fair pace, so it was evident that I had to do a little intensive practice to restore my lost words-per-minute.

## Interesting Experiment

The problem then was to decide how that practice might best be obtained.

I came to the conclusion that certain stations working on waves well away from ordinary broadcast bands would best serve the purpose.

That meant a special receiver, and it occurred to me that I could make its construction the oppor-

tunity to carry out an experiment which had long attracted me: I could build a real old-fashioned set, with none of the modern refinements, and see what it would do under present-day conditions. The plan was duly carried out; and a very interesting time I had with that old-style circuit, for its power and range when fitted with modern high-efficiency valves was truly astonishing.

That, however, is another story, and one which I may perhaps have an opportunity to tell upon another occasion. My present purpose is to relate certain experiences incidental to the actual building of the "old-timer" and go on to a discussion of some matters which I believe will prove interesting to all set constructors.

What actually happened was that I found myself involved in wholesale reconditioning operations upon a collection of components of considerable age. In the course of this work I made some simple-seeming discoveries which I fancy may be of

real help to many of my fellow practitioners in the gentle art of "using them over again."

Actually I believe the experience was a very salutary one, for it must be confessed that the majority of designers of sets for the home constructor nearly always use new or almost new components for their work, so failing to encounter one of the very real problems of the game as played by their readers.

## Vital Importance

Most home constructors, of course, find that if they do not make a point of using up their old components when a new set is built their hobby becomes prohibitively expensive, hence the process of refurbishing is to them of vital importance.

I certainly had a real taste of it when I built my old-fashioned set, because to produce the kind of receiver I wanted necessitated hunting through my stock cupboard for some of the treasured relics therein and getting them into working order once more.

## Instructive Experiences

It was no easy matter in certain cases, and it surely taught me some things I didn't know before about the effect of time on the average radio component! I got so interested in the question that I have since made quite a study of it, in which I have been considerably aided by the fact that I have some knowledge of the

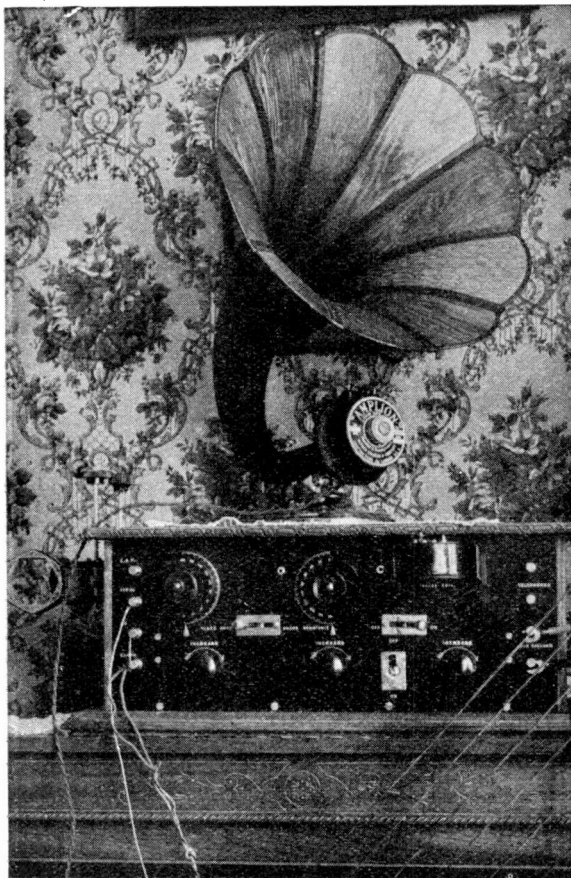

Kitching & Clayton photo

**A RELIC OF THE PAST!**

This picture of the All-Concert Three—designed by the Editor some twelve or so years ago—will revive memories of the old wireless days. Incidentally, this is the de-luxe version and the first set to be given a name

matter from the manufacturers' point of view. Some of my conclusions will, I think, prove helpful to the reader in less extreme cases than the one which started my investigations.

**Amazing Contrasts**

Before getting down to business, however, I am going to ask the reader to bear with me while I indulge in just one more digression: the collection of strange parts which I got together for my old-timer furnished such a remarkable contrast in price and quality with those available to-day that I really must mention one or two of them.

**Good Value?**

Perhaps the star piece of the collection was the very first low-frequency transformer which I ever bought, apart from certain war-surplus specimens. This remarkable component originally cost me £2, and it gives quality so bad that it must be heard to be believed: no bass at all, and high notes which crack up into a thousand pieces! It is now nearly

greenish-yellow colour.

For the grid leak I wanted to use another of my old friends, which appears to consist of a short section of clay pipe stem soaked in some highly secret composition, but investigation showed that its resistance is now well over 10 megohms. I reluctantly came to the conclusion that its days of usefulness are over: a pity, too, when one reflects that its price was nine and sixpence!

In its place I put a comparatively modern leak of the familiar tubular type with metal end-caps. Modern in appearance, perhaps, though not in cost, for I paid half a crown for it. Not very modern in construction, either, as I know

fourteen years or so old; to-day one could buy a better one for much less than five shillings.

I tried at first to use valve holders of roughly the same age, but here I came up against a rather illuminating difficulty: *most high-efficiency battery valves proved impossibly microphonic in rigid holders*, and so I had reluctantly to use some which were a mere five years old.

It seemed a pity, for the older ones were so highly characteristic of their period. They were turned from solid ebonite: cost me seven and six each, and are still in very fair condition, although they have turned a somewhat sickly

from previous post mortem investigations: the tube is no more than waxed cardboard, and the resistance element is a strip of paper dipped in Indian ink. Not a bad leak, though a trifle temperamental, and given to spitting and spluttering if made to handle a strong signal for any length of time!

**Still Good!**

For coils I used some of the first "plug-in" types—again anything up to ten years old—and here I was on safer ground. Although they required a great deal of attention before they could be persuaded to make good contact in their sockets their efficiency in terms of high-frequency resistance is superior to that of many of the ultra-compact screened units of the present day. (I am not referring here to iron-core coils, of course.)

Reminiscences of this sort are amusing to write, and I hope not uninteresting to read, but they will not help anyone with the particular problem which I have set out to discuss.

**Terminal Treatment**

What, then, is the first step in re-conditioning a component which has seen a fair amount of service? Experiments have convinced me that perhaps the most important general precaution, and one which is often neglected, is to see that proper electrical contact can be made to the terminals.

It looks a very simple business, but it calls for a little care. I find the best plan is first to take the terminal nuts right off and clean the

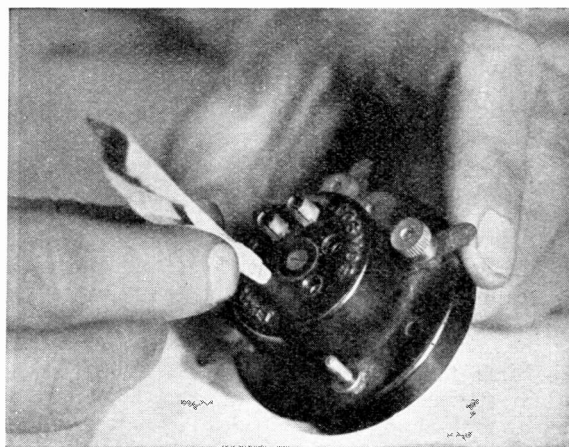

**CLEANING VALVE-HOLDER CONTACTS**

Although valve holders are tarnished and covered with dust, a small piece of glass-paper wrapped round a match stick will render them fit for active service

under sides by rubbing them on a piece of glass-paper or emery cloth. Then the threaded shanks should be examined and if the metal is much tarnished it should be rubbed lightly with the same cleaning material; this brightens only the "lands" of the thread, but since these engage with the grooves of the thread in the nuts, which are usually clean, it suffices to ensure good contact.

### Why Terminals Get Loose

Before the nuts are replaced it is advisable to make sure that the terminal assembly is really tightly secured in the case or body of the component. Terminals always tend to work loose in time, particularly when they are mounted in moulded bakelite cases: this material shrinks very slightly in course of time if it has not been very thoroughly "cooked" in the moulding process, and hence the loosening.

The shank of the terminal should therefore be gripped with a pair of pliers and held stationary while the lower nut is tightened up fully, assuming, of course, that it is not located in a little depression in the moulding, as is sometimes the case. To avoid damage to the thread, by the way, a small piece of card should be wrapped round the terminal shank before the pliers are brought into play.

### It Is Important!

I have a feeling that some of my readers will think all this too obvious to call for such elaborate explanation, but I would most earnestly assure them that the matter is one of real importance. I am convinced that if

every constructor were to go through the procedure which I have suggested every time he used a component which had already seen some service we should get a marked increase in those pleasing reports of excellent results at the first test.

After dirty terminals I believe that tarnished contacts at "plug-in" points are responsible for a substantial proportion of the troubles of the constructor. For example, valve holders: here the sockets are very prone to collect all sorts of dust and the metal itself is apt to acquire a tarnished surface.

It is true that the combination of socket and valve pin is to some extent self-cleaning, but when a holder has been out of use for some little time quite a number of insertions and withdrawals may be needed to produce really good contact.

Consequently, I always make a particular point of cleaning out the sockets with considerable thoroughness whenever I use a holder which is not brand new. This is how I do it: I take a small piece of glass-paper and roll it up into a little "spill" about the thickness of a match-stick, with the business side outwards; this I insert in each socket in turn. A turning motion then effects rapid cleaning of the interior of the socket.

In all such cases a little discretion is needed in dealing with nickel or chromium plated metal parts, such plating being the common practice nowadays. The cleaning should not be so vigorous that the plating is removed, lest the exposed brass surface should again tarnish very quickly.

Any interchangeable parts with clip-in fittings should also be regarded with a suspicious eye. The more modern

type is usually very thoroughly plated and does not tarnish at all easily, but this is not true of some of the older ones, which may need similar cleaning treatment. Particular attention should be paid to such interchangeable coil units as are used in certain types of all-wave sets and the majority of short-wave receivers.

Wave-change switches are, I find,

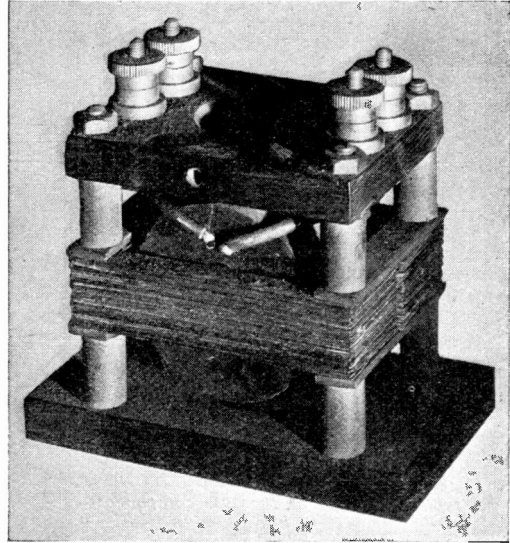

THE STAR PIECE OF THE COLLECTION  
"The first low-frequency transformer I ever bought  
... cost me £2... quality so bad that it must  
be heard to be believed... fourteen years or so old"

only prone to give trouble when they have been out of commission for some little time: the better modern types usually maintain their efficiency so long as they are kept in use, since they are almost always designed to produce a self-cleaning action when operated. When, therefore, a coil unit has been put away for a time it is wise to examine the switch-gear before building it into a new set.

### Clean Switch Contacts

Unless the switch parts appear to be perfectly bright and free from tarnish, it is advisable to clean the contacts, but care must be taken to avoid rubbing away the little button of special material which usually forms the contact surface proper. Only the *finest* grade of glass-paper should be used and precautions must be observed lest any spring members be bent out of shape.

Then there is a whole group of components in which contact must be made to some sort of spindle or other rotating part. Where the connection is made by means of a

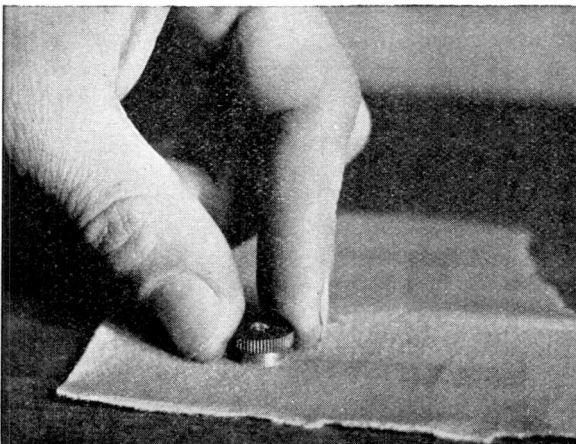

BRINGING OLD PIECES TO LIFE!

A simple job that needs care is the cleaning of terminal nuts. They should be rubbed on glass-paper or emery cloth till they regain their former brightness

pig-tail, careful inspection is all that is needed to satisfy oneself that the device is unbroken and properly secured at its ends, but in many cases some kind of rubbing contact is used and nothing can be taken for granted here.

The modern component with its parts enclosed in an almost air-tight case does not as a rule give trouble in this respect, so that such things as

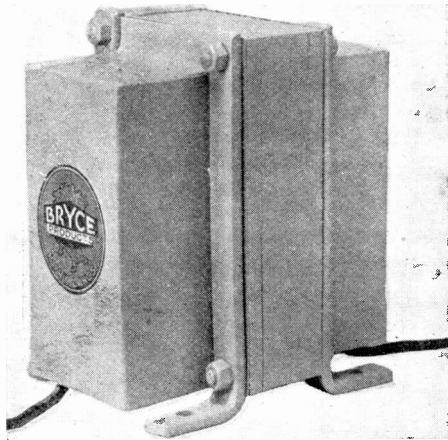

**THE MODERN DUST-PROOF COMPONENT**  
A typical example of the 1935 component—housed in a dustproof case with no terminals to get tarnished

volume controls can usually be put into service quite safely after the customary cleaning of terminals.

This is not true, however, of some of the earlier types, which often develop noisy and uncertain contact in the spindle connections. Cleaning is definitely to be advised as a routine precaution here, and it is necessary to separate the component parts of the spindle assembly to carry this out effectively. The rubbing surfaces should be cleaned up with glass-paper, and then given a *light* smear of vaseline before being reassembled.

#### A Weak Spot

Precisely the same treatment is to be recommended in the case of variable condensers which incorporate any kind of rubbing contact spring connection to the moving spindle; imperfect connection here will usually produce serious trouble. This applies most strongly to a large proportion of gang condensers, for few of even the most modern types are sufficiently well enclosed to protect them against corrosion effects of this sort.

It will have been noticed that I have not yet mentioned the more

obvious kind of general cleaning which a component usually needs after a spell in the store cupboard, or even of service in a receiver in more or less constant use; this, I think, is a matter which generally gets due attention, but I should perhaps point out that the removal of all surface dust and dirt is definitely essential. I find a cheap shaving brush an excellent weapon for the purpose, backed up with the compressed air blast with which Nature has provided us all.

Particular care should, of course, be taken to remove any smears of soldering flux left by previous use, for which operation a small paint brush dipped in methylated spirit is ideal.

Here I find myself at the end of my allotted space, and I must confess that I feel that I have no more than scratched the surface of my subject. I hope, however, that I have said enough to make readers take a serious interest in a matter which is of real importance to all constructors.

I keep coming back to the importance of the point, at the risk of boring the reader, simply because I want to make it very clear that I believe proper re-conditioning to be *essential* to success whenever a set is built to incorporate sundry components which have already seen service. I am so sure about this that I even do it myself!

#### NEW VALVE FOR SHORT-WAVE WORK

A NEW valve of great interest has just been placed on the market in America. Specially intended for ultra-short work, it is of such minute size that it has been christened the "Acorn Tube," although its official designation is "type 955." Less than 1 in. high and  $\frac{1}{2}$  in. wide, the valve is a triode of the indirectly-heated type, capable, so it is said, of working efficiently as detector, amplifier, or oscillator up to 600 megacycles (equivalent to a wave of half a metre).

#### General Characteristics

The general characteristics are: impedance, 12,500 ohms; amplification factor, 25; maximum plate voltage, 180; maximum plate current, 4.5 milliamperes; heater voltage, 6.25; heater current, .15 ampere.

The valve can be used for low-power transmission and has been found decidedly useful at the short distances commonly employed in tests with the so-called "optical" waves.

#### DE FOREST'S PROPHECY

"I AM very confident that 1935 will see actual *commercial* television in the home, giving a 200-line picture, black and white, 18 in. to 3 ft. square. And it will not be by cathode ray . . . The numerous long-foreseen problems of how to make television pay its way to popularity must be faced. These can all be successfully solved."

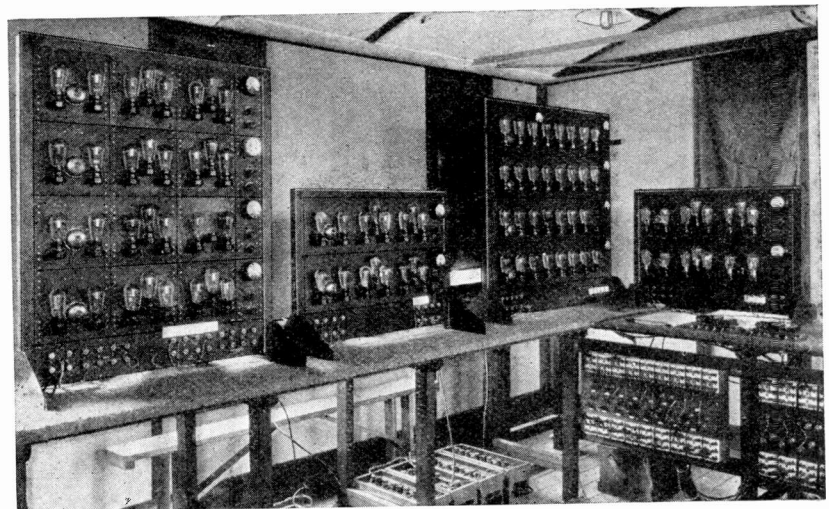

**SOME REAL RE-CONDITIONING WOULD BE NEEDED HERE!**  
This shows the first amplifier that was used for relaying a commentary to the crowd at the Hendon Air Pageant. Nowadays the relay amplifier consists of perhaps a dozen valves in all



Often you have tired of the B.B.C.'s fare—maybe you did not approve of the chamber music or vaudeville—and you fancied Viennese waltzes or military band music, perhaps opera. Here we present an article by a recognised authority on foreign radio who tells you from where certain types of entertainment are always available

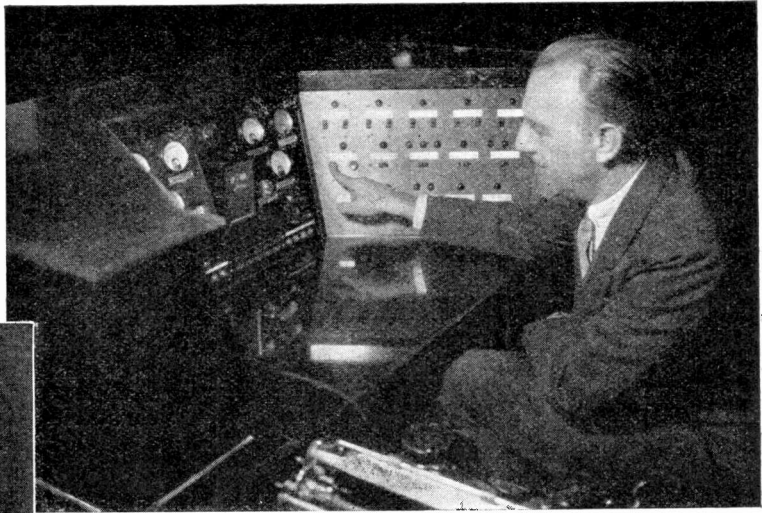

In the top corner is a photograph of the control desk at WLW—a 500-kilowatt station at Cincinnati, Ohio. It is not an infrequent occurrence for this giant to be picked up by British listeners. Above is Miss Edith Schob, one of Hamburg's lady announcers

# Tour Europe via Ether!

By J. GODCHAUX ABRAHAM

IF, as the owner of a multi-valve receiver, you limit your activities to the tuning in of broadcasts from the home stations, you are missing many of the advantages and benefits due to you in exchange for the ten shillings you must pay annually to the Postmaster General.

With the modern radio set you can roam across the Continent to your heart's content, calling a halt at numerous cities on the way. In the course of an evening you can sample, in as small or as large doses as you like, the best entertainments that Western nations have to offer.

The fact that you are not a linguist should not deter you from listening to the foreign broadcasters. Here I do not propose to deal with the various means by which stations can be identified; this was dealt with fully last month. On the other hand, it is my intention to show the kind of programmes obtainable from other than the home stations, and to give pointers to the various radio entertainments—to suit all tastes—that can be heard from abroad.

A few days ago an acquaintance told me that he had given up listening to programmes as he was tired of them. When I asked him what he particularly wanted, he replied: "Good brass-band concerts; we do not get enough of them." I pointed out that the B.B.C. had to

cater for every section of the community and, that in consequence, as everybody did not want brass bands they could devote only a percentage of the programme time to this class of music.

"But," I added, "why not go abroad for them? With some sixty high-power stations putting out tuneful music every night there is no difficulty in finding several with a brass band in their studio."

I picked up the day's programmes and scanned them; such an entertainment was available the same evening from three German stations, Prague, and Beromuenster. Incidentally the times could not have been more conveniently arranged.

I put this forward as an example. The listener with a modern receiver has every kind of programme at his disposal from one source or another, and he must indeed be exacting if, in addition to the B.B.C. stations, he cannot find some entertainment to interest him when roaming the Continent.

With the existing policy of main stations and relays we are not limited to the tuning-in of one channel, which may for some reason or other prove unsatisfactory. The same programme is usually taken by several stations, and it is always possible to find one wavelength to suit us.

The man who has laid out money on a modern receiver expects his set to supply every kind of entertainment when he turns to it in his leisure hours. The ether can and will supply many varieties of recreation, whether vocal or orchestral concerts, organ recitals, vaudeville, cabaret turns, operatic performances, relays of interesting sporting events, news bulletins, sundry talks on innumerable matters; in fact, the full contents of a twenty-four-page daily newspaper coupled to the world of amusement.



Gulliland photo  
This is Berlin's great radio centre. Here one can see the famous Witzleben tower and the huge buildings that house the capital's radio organisation

It is this infinite variety which permits us to compile our daily radio menu to suit our individual tastes, and the number of broadcasts at our disposal, in addition to those regularly furnished by the home stations, will demonstrate at one evening's sitting how simply, by careful selection, we can compile a timetable of transmissions to fill the hours we are able to devote to relaxation.

I might add here that every morning I scan the day's home and Continental programmes and jot down in my diary the times of the transmissions to which I feel I should like to listen. Invariably in this schedule there are intervals of which I avail myself to turn the condenser dial and take pot luck in the ether.

It is frequent at these odd moments to find eleventh-hour relays of topical events of which details could not be published in advance. It is the unexpected which pleases us most, and these impromptu captures are often of exceptional interest.

It must be borne in mind that even in the best regulated studios last moment hitches may occur; the relay of an outside broadcast, due to unforeseen

circumstances, may have to be cancelled. In my experience it happens often that the substituted entertainment—even if only an extempore makeshift—has proved of greater appeal to my ears than the original programme—possibly heard on a subsequent date.

There are topical events which crop up in every country which invariably upset programme arrangements; relays are carried out to bring the matter before the listening public, and I would have missed some of the most thrilling broadcasts from all parts of the earth had I not made it a rule to tour Europe nightly.

With the growing use of short-wave wireless links between Europe and other Continents, greater facilities are given to European radio stations to bring the world's happenings hot to the broadcast listener in a news-reel form. It is a policy which is being rapidly developed in all countries and which will find its complement in television. Music in every conceivable form throughout the ages has made an appeal to all peoples, and it is obvious that such transmissions must form the bulk of most radio entertainments.

In radio we are restricted, for the present, to music or the spoken word, but these fields are still so vast that there is very little likelihood of their showing any signs of exhaustion.

But just as our tastes vary in regard to entertainments, so do those of the different nations. It is this which gives us the opportunity of turning to certain countries for particular kinds of programmes.

We must if we enjoy opera seek the Italian wavelengths, for Italy is the land of the soprano, tenor and baritone. On most evenings if we turn our condensers round to the settings of Rome or Milan we shall pick up a relay of the best operatic performances Europe has to offer.

But, as already explained, we are not tied to these stations and can take the broadcast through such favourable channels as Trieste, Turin, and Florence, or, if necessary though less conveniently, through Bari or Naples.

Operatic works of a lighter character, such as comic operas or operettas, are frequently available through Vienna; it is the birthplace and home of the waltz, and from no other centre will you hear orchestras play this dance step with a brighter swing.

Tune in to Vienna on any evening and it is all Fleet Street to a heptode that you will strike a waltz.

Operas are frequently available also through German stations or from Copenhagen, Stockholm, Oslo, Warsaw, Beromuenster and occasionally through Radio Paris and other official French transmitters.

It would be difficult to pick out any particular foreign city to hear symphony concerts, as many of them possess subsidised state or municipal orchestras of which they are inordinately proud, and consequently make much use of their services in the radio programmes. For these try Berlin, Warsaw, Prague, Vienna, Budapest, Amsterdam (via Hilversum or Huizen), Beromuenster, Rome, Milan and most of the German provincial cities.

Brussels may be equally relied upon for good concerts. It would be foolish to ignore Moscow, as the U.S.S.R. capital prides itself on the possession of the largest studio orchestra in the world—over 160 musicians. Try the early evening hours.

If you want dance music, in addition to odd hours

during daylight, you can find it at almost every Continental studio on weekdays and on most Sundays from roughly 9.30 p.m. onwards.

What is advertised abroad as jazz is still in popular favour in nearly every country, and in some, such as Denmark, Norway, Switzerland, Belgium, you will discover first-class dance bands playing most of the popular hits with which our National and Regional transmitters have made us familiar.

For the older *steps* try Norway, Switzerland (at times), and the German stations, which, in their turn, although favouring foxtrots and tangos, invariably add to their programme waltzes and the older teutonic dances. With the exception of the Germans, who run their own studio bands, the others mostly relay their principal dance music from restaurants, hotels, cabarets and dance halls.

Gipsy music of the true *Zigeuner* type you will regularly receive from Budapest, and Prague on some evenings will also offer you a similar performance.

If there is anything lacking in radio broadcasts it is certainly not dance music, and the listener who cares for this style of entertainment above all others can tune in one station after another until he has reached saturation point.

Variety, vaudeville or music-hall, as we term the lighter form of radio broadcasts on this side of the channel, if presented on the Continent may fail to interest the British listener unless it comprises animal impersonators, players of quaint instruments, or similar turns, as to appreciate foreign humour it is essential one should be absolute master of the language.



Gulliland photo

20,000 listeners of Holland's A.V.R.O. listen regularly to broadcasts on dressmaking by Meerouw van der Rees van Leeuw

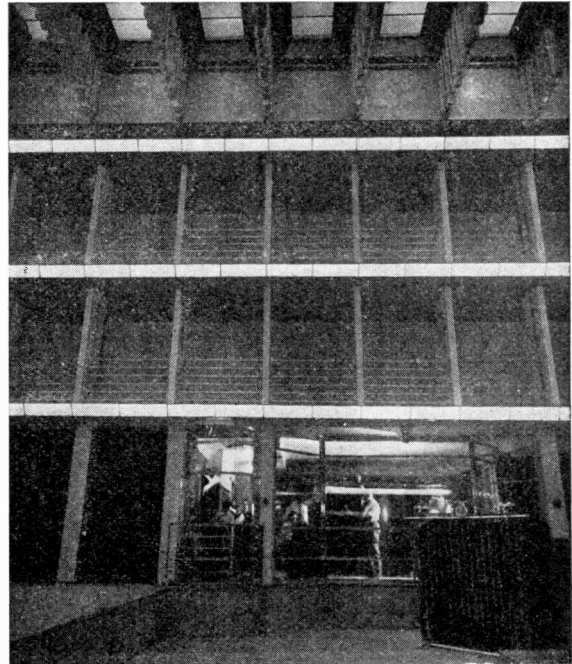

Gulliland photo

This is not the interior of a prison! It shows one of the control rooms leading off the main concert studio at the new Hamburg Broadcasting House

Fortunately most studios, and in particular the French, devote many hours weekly to the broadcast of gramophone records. You will notice that the bulk of them are of British or American origin.

Mention must be made of such stations as Luxembourg, Poste Parisien, Radio Normandie, and to a lesser degree Nice-Juan-les-Pins, who put out sponsored programmes entirely for the benefit of the British Isles, and in consequence possess English announcers.

Although this policy may not be viewed favourably in all quarters, it is one which must infallibly appeal to the Briton who understands none other than his native language.

Now for a few words regarding news bulletins. A number of foreign stations have adopted the idea of giving out topical talks or news bulletins in various tongues, which invariably include English.

Rome, for instance, nightly provides a summary. In addition many Continentals, and in particular the French studios, broadcast "final editions," and it does not require much more than a "school primer" knowledge to follow them. I have, on several occasions, picked up items of importance which in the ordinary course I should only have seen in the next morning's papers.

And finally, if my friend wants military brass bands, let him turn to German stations which, of all others, specialise in them.

Somewhere, somehow, "somewhen" (as H. G. Wells has it) throughout the twenty-four hours is an entertainment to be culled from the ether. At no time during the day or evening can the owner of a wireless receiver in working order draw a blank!

A New Feature for the Constructor

# Standard Valve-holder Connections

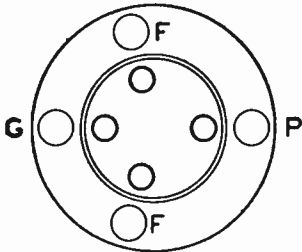

4-PIN TRIODE

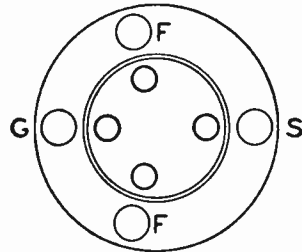

4-PIN SCREENED GRID OR H.F. PENTODE (DIRECTLY HEATED)

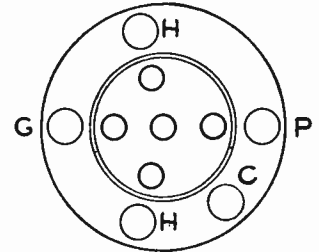

5-PIN TRIODE (INDIRECTLY HEATED)

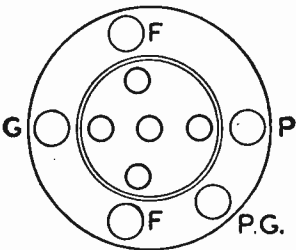

5-PIN L.F. PENTODE (DIRECTLY HEATED)

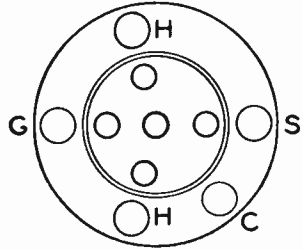

5-PIN SCREENED GRID (INDIRECTLY HEATED)

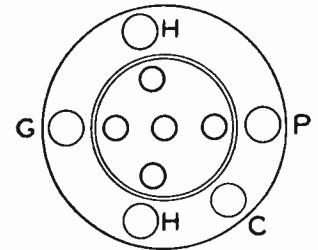

5-PIN L.F. PENTODE (INDIRECTLY HEATED)

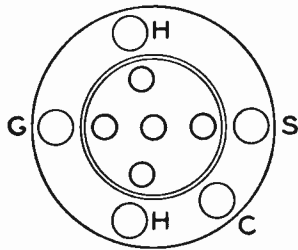

5-PIN H.F. PENTODE (INDIRECTLY HEATED)

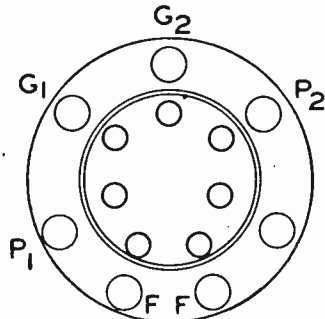

7-PIN CLASS B

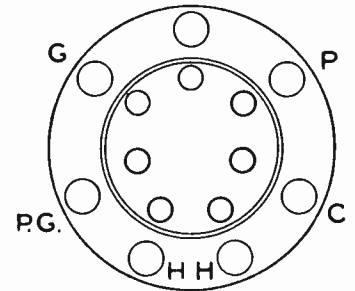

7-PIN L.F. PENTODE (INDIRECTLY HEATED)

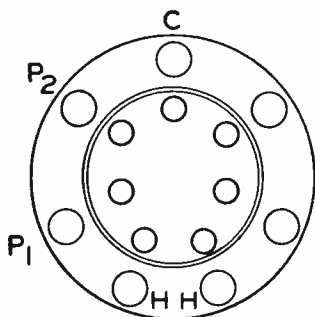

7-PIN DOUBLE DIODE (INDIRECTLY HEATED)

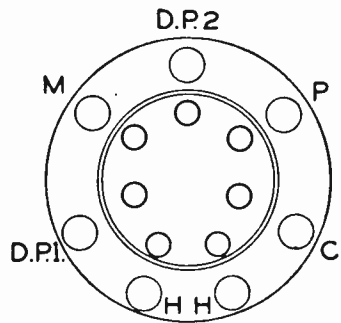

7-PIN DOUBLE-DIODE-TRIODE (INDIRECTLY HEATED)

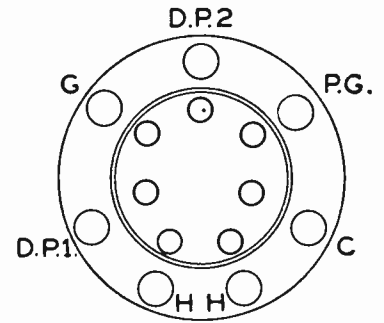

7-PIN DOUBLE-DIODE-PENTODE (INDIRECTLY HEATED)

There are now so many kinds of multi-pin valves that few constructors can memorise the connections of all the types with which they have to deal. We are, therefore, preparing a series of handy reference diagrams showing the connections of the more important types, the first selection appearing above. It is important to note that these diagrams show the connections of the valve holder, that is, the actual wiring. The following abbreviations are employed: G for grid, F for filament, P for plate, S for screening grid, H for heater, C for cathode, P.G. for priming grid, D.P. for diode plate, and M for metallising



# All About Crystal Pick-ups

By P. WILSON, M.A.



*Rochelle salt in the raw! An American engineer is holding a crystal of glass-like transparency. There is enough crystal here, when cut, to develop 1,500 volts*

The author is well known to "W.M." readers for his authoritative articles on pick-ups and pick-up curves. Here he describes the principles of the new piezo-electric types, upon which he has done a deal of experiment during the past few months. He shows that the new crystal pick-up is a definite advance upon the electro-magnetic types

**R**EAL thrills in this business of sound reproduction by radio and record do not come one's way very often. And when they do come they usually involve, myself, at any rate, in a good deal of experimenting and checking and rechecking.

The production of a successful piezo-electric pick-up and a captivating piezo tweeter loud-speaker, and at everyday prices, has given me both the thrills and the hard work during the past few months.

## Piezo-electricity

When the Rothermel Corporation, Ltd., sent me along samples last summer, I had but a hazy knowledge of what piezo-electricity really meant. I was aware that it had long been known that crystals of certain substances, such as quartz, tourmaline, and Rochelle salt (or Seidlitz powder, as we know it in another capacity) when subjected to stresses in certain ways would produce electric voltages on opposing surfaces.

I was also aware in a vague sort of way that piezo pick-ups had been

*This is the standard Rothermel crystal pick-up, the response curve of which is given on page 119*



produced about ten years ago. I remember reading something about an experimental pick-up by Rice, of Rice-Kellogg loud-speaker fame, but that was at the time when people were playing about with all sorts of schemes for making pick-ups.

I tried a few of the devices at the time, including condenser pick-ups and resistance pick-ups (of the carbon-granule and other types), but never found them comparable to the electromagnetic type.

I cannot say, then, that I was pre-disposed to favour piezo-electric devices. On the contrary, when I first read of them in the American press I was inclined to brush them aside as just another stunt. I was soon disillusioned.

My first tests of the piezo-electric pick-up showed at once that here was something worth following up. The fact that it has an unusually large output, of the order of 1.5-2

volts, did not specially commend it to me; in electro-magnetic pick-ups I had never found quality and quantity go hand in hand, and my amplifiers had all been designed to deal with low-voltage inputs.

But I did sit up and take notice when I found that on this occasion quality did accompany the quantity. It was evident that here was a method of interconversion of mechanical and electrical vibrations of rare sensitivity and it seemed likely that that fact alone would enable some of the disabilities under which an electro-magnetic device labours to be banished for ever.

## Well-founded Optimism

I began to experiment and at the same time to read up all the literature on piezo-electricity that I could lay my hands on. I soon discovered that my optimism was well founded. Two facts discovered by the Curies in 1880 excited my interest to start with.

The first was that for steady pressures the voltage produced was proportionate to the pressure, a linear relationship which is of the utmost importance in a sound-reproducing device since it means that harmonic distortion is absent.

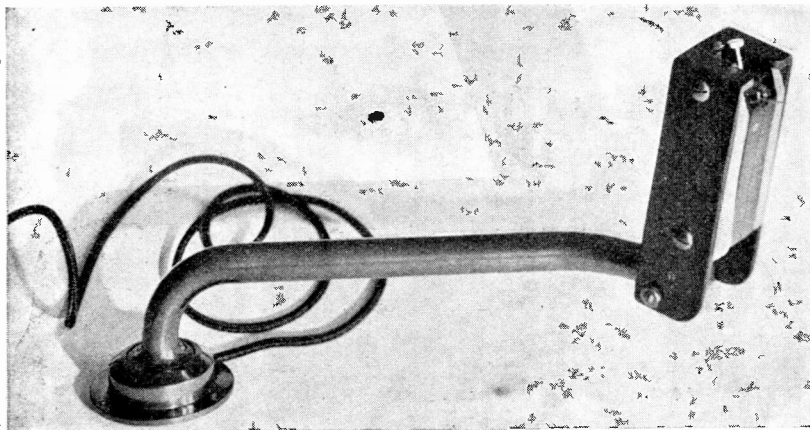

*This de-luxe model of the Rothermel crystal pick-up was designed by the author. It uses a special Rochelle salt cartridge capable of giving a response even better than that of the standard model*

The second was that Rochelle salt is much the most sensitive piezo-electric substance known. This is very fortunate since it can easily be grown into crystals artificially and therefore relatively cheap to produce. The story of these early researches left a number of doubts in my mind, however, and these doubts were not resolved until I came to understand the work that the Brush Development Company of America had carried out during the past ten years.

#### Rochelle Salt

Rochelle salt is brittle, is soluble in water, and is therefore subject in its raw state to atmospheric conditions. Moreover, early researches showed that the piezo-electric properties depended upon temperature and that they began to alter during a period of strain; there was a lag between pressure and voltage similar to the hysteresis effect in magnetism.

These were serious disabilities which made it clear why piezo-electricity had remained a laboratory curiosity instead of becoming a process of wide commercial application.

#### Waterproofed Crystal

The Brush Company removed them all, except perhaps the brittleness, when they devised efficient methods of waterproofing and discovered that by cementing together two plates of crystal with their strains in opposite directions the temperature and hysteresis effects disappeared.

Another doubt still remained. What were the resonance effects under oscillating stresses? Were they of very low or very high fre-

quency, or were they inextricably connected with the audible range of frequencies?

This was a crucial question for I had come to be very intolerant of marked resonances of audible frequency. In all mechanically vibrating devices resonance is unavoidable, I well knew. But I preferred to have them very high or very low in the scale. It was, therefore, a great relief to find that by suitable choice of dimensions for the crystal plates the resonance could comfortably be put quite high in the scale—in fact, anywhere from about 2,000 to 100,000 cycles.

I learned, however, that putting the resonance point higher in the scale meant a proportionate reduction in sensitivity, but this did not either surprise or perturb me. In any case, my early tests with the crystal pick-up showed that there was plenty of output to spare.

The next point that interested me was that so far as their effect on an electrical circuit was concerned these piezo-electric devices acted like small condensers. I measured the capacity of a few of the pick-ups and found it to be .0011 microfarads, and there was no measurable variation between them. This also was the electrical capacity of the little cone tweeters, which were produced just before Christmas.

This capacity characteristic has one or two important consequences. In the first place it should be noticed that one of our principal difficulties in sound reproduction work is to avoid the effects of stray capacities. Usually these capacities act in conjunction with our resistances, and the inductances of the coils in our

pick-ups, loud-speakers, etc., to reduce the high-note response of the apparatus.

With a piezo-electric device, however, a stray capacity may reduce sensitivity, but it will affect all frequencies equally. Thus with a crystal microphone or a crystal loud-speaker, provided the wires are sufficiently stout to make their resistance negligible, the connection of long leads, fully screened to avoid external interference, will have no effect on the frequency response of the device; it will reduce the output at all frequencies proportionately.

#### Two Important Points

So far as the pick-up was concerned, this did not matter so much because one rarely needs to use leads sufficiently long to have any appreciable effect. But here there are two other points of importance. It is convenient to have a volume control between a pick-up and the first stage of an amplifier.

At one time a variable shunt resistance was used, but it was soon appreciated that this meant a frequency response varying with the particular volume setting and unfortunately the variation was the wrong way; high notes were relatively more attenuated when the volume was low, exactly the opposite to what occurs with natural sounds.

#### American Solution

In America the difficulty was sometimes met by interposing a transformer between pick-up and amplifier—reducing the value of a resistance shunt across the primary of a transformer emphasizes the high-note peak of the transformer. But this arrangement leads to difficulties in other ways; for example, the very connection of a small inductance (the pick-up coil) in series with the primary of a transformer in itself causes the transformer to have a marked high note peak.

In this country it has been more usual to have a volume control in the form of a potentiometer shunted across the pick up. This is more satisfactory, though it means that the grid to cathode load of the first valve varies with the volume-control setting. This, however, is commonplace in most amplifiers and its effects as a rule are not very serious.

In the case of a pick-up, however, there is one very curious effect. If the potentiometer has a high value,

say .5 megohm or more, a queer parasitic hum is often built up in the amplifier when the slider of the potentiometer is near its middle setting; that is, at mid-volume setting. It disappears at low volume and it disappears at high volume.

**A Queer Hum**

This hum seems to have nothing to do with the electric mains supply for it is to be found in amplifiers operated entirely from batteries just as much as in mains-operated receivers. I have not yet seen a completely satisfactory explanation of it, though I can, and do, avoid it altogether in my amplifiers.

It is clear that the hum occurs when the grid of the valve is at its greatest impedence from the cathode, and in this respect it partakes of the characteristics of a free grid. I am also satisfied that the nature of the anode circuit of the valve has a bearing on the matter; if the anode load is high, the hum is usually more pronounced.

Further, it appears to be linked up with another curious effect which I can best illustrate by recounting an experience of my own some years ago.

I had built an amplifier in which the first low-frequency valve was a Marconi-Osram MHL/4, biased to -7.5 volts by means of a battery independent of the other bias batteries in the receiver. On radio everything was O.K. With a pick-up the kicking downwards of a milliammeter in the anode

circuit showed overloading and running into grid current with an input of less than .5 volt R.M.S. as measured on a Moullin voltmeter.

In that case the volume control was a variable resistance connected across the primary of a transformer in the anode circuit of the valve, and the curious thing was that the kicking of the milliammeter needle (which indicated grid overload) was a function of the setting of this volume control in the anode circuit! Evidently there was some feed-back between the anode and grid of the valve coming into play.

Now with that arrangement, and on other occasions when I have tried similar arrangements, I got a mighty mid-setting hum by connecting a potentiometer volume control across the pick-up, and I deduce, therefore, that inter-electrode feed-back (Miller effect), which to some extent determines the stability of a valve, is in some way connected with the hum.

I have made this digression from the main theme partly because of its own special interest, but principally because it serves to illustrate an important advantage of a capacitive

pick-up. When an electro-magnetic pick-up is being used, the instability can be reduced by using as volume control a shunt potentiometer of lower resistance value.

But this has the effect of attenuating the high-note response—which is unfortunate, since to attain a good high-note response in an electro-magnetic pick-up is a difficult matter unless one makes use of mechanical resonances, thereby creating a pronounced surface noise and undue record wear.

**Opposite Effect**

With a capacitive pick-up the opposite is the case. Reducing the value of the shunt resistance attenuates low frequencies, and in any case the valve is not seemingly unstable, even with a very high-resistance shunt; I have used 2 megohms without trouble.

The value of these features is more easily seen when the frequency response curve of the present model of a crystal pick-up is studied. I took many curves of various samples last autumn and found them as nearly identical as makes no matter.

The variations were unusually small and might even have been due to the fact that different needles were used, though from the same box, in each of the tests. I have never before found anything like the same degree of consistency between different samples of any make of pick-up.

The first point to notice is the relatively heavy bass when a .5-megohm potentiometer is used as volume control. This heavy bass is due to the fact that the armature, or what corresponds to the armature in an electro-magnetic pick-up, has a mechanical resonance very low in the scale.

**Less Record Wear**

The mechanical compliance of the pick-up at the needle point is much greater than one usually finds and this means that record wear should be much less.

As a check on this conclusion, one notes that the pick-up will track the large amplitude grooves of low-note constant-frequency records with ease, and that needle buzz on heavy passages of ordinary records is very small.

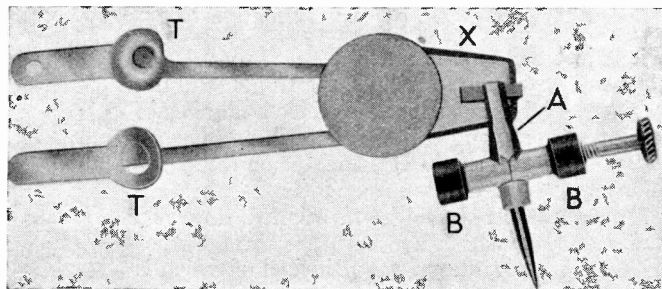

The piezo-electric pick-up is of unusually simple construction. It consists of a crystal element X, to which is cemented an armature, or needle-arm transformer A, rocking in sleeve bearings B. Voltages are set up between opposing crystal faces and are taken off by silver contacts T, T. There is no magnet or wire. The crystal element is sealed up in a bakelite cartridge

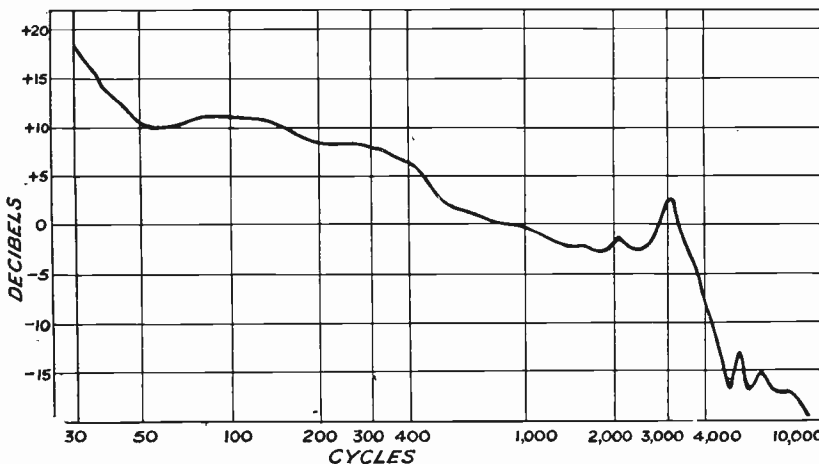

The response curve of the standard crystal pick-up with a .5-megohm shunt resistance. The output at 1,000 cycles is 1.7 volts

It should be remarked, too, that this bass is a *real* bass and not a fictitious one due to the fact that the amplitudes of low-note constant-frequency records are much greater than usual, and that owing to the large displacement of the needle point the magnetic poles have pulled the armature farther over than it ought strictly to have gone.

There are no magnets in a crystal pick-up and there is nothing corresponding to the negative compliance, or overbalancing pull, of the magnetic field.

### Strong Bass Response

I should not be surprised, therefore, if many people find the bass response with a .5-megohm volume control too strong. Their remedy is simple and happy. They need only use a potentiometer of lower value; .25 megohm, 100,000 ohms, or even less.

The performance of the pick-up to high notes, and the performance of the amplifier which follows, can only be improved by this substitution.

The next feature to notice is the the peak at about 3,000 cycles. This is the natural frequency of the particular size of crystal used in this model. It is lower in the scale than I should like to see it, and it is just a little too pronounced for one to be entirely happy about it.

It is not sufficiently strong, especially in view of the good bass response, to make the reproduction in any way shrill, but it is responsible for most of the surface noise one hears.

### Little Surface Noise

The consolation is that surface noise is less strong than that which one usually meets with in electromagnetic pick-ups.

I have heard an experimental crystal pick-up in which the natural frequency of the crystal is as high as 12,000 cycles and the surface noise with this was curiously like a heterodyne whistle, pronounced but not so objectionable as much of the surface noise one comes across.

I am looking forward to the time when production models of this type will be available, but I fear that for technical reasons that time is not yet.

The general slope of the response curve is the third feature of interest. If you measure it, you will find that it is not very much removed from the 3 decibels fall per octave, about which I wrote some time ago, with

the 3,000-cycle peak superimposed. The slope can be adjusted within limits by the value of the volume control potentiometer, as I have already explained.

There are, however, one or two small blemishes. These little peaks appear in the same places on all the samples of the standard pick-up I have measured.

What the reason for them is I do not quite know at the moment. I have not worried much about them up to now, for they are clearly so small as to be practically negligible. Certainly, I have not detected any aural evidence of their existence.

I have a notion that they are resonances due to transverse vibrations of the armature, or needle-holder or whatever one ought to call it.

They seem to be reduced somewhat when a non-metallic needle is used.

The rather flat trough at 50-70 cycles is probably due to a resonance in the carrying-arm, absorbing some of the vibration that should have gone via the armature. I found that I could fill it up by mounting the crystal cartridge on a different type of arm, similar to the one which Rothermels have now adopted for their *de-luxe* model.

In many cases, the trough will not be a disadvantage since a number of moving-coil loud-speakers have a surround resonance somewhere between those frequencies.

It should be mentioned, however, that this new arm has several other advantages, the principal of which is that needle buzz and record wear have been still further reduced.

The frequency-response curve has been plotted on a decibel basis, taking the 10 decibel distance on the vertical scale equal to that used for an octave on the horizontal scale. The output was measured, using H.M.V. constant-frequency records, Pyramid radiogram needles, and a Cambridge Moullin voltmeter.

The voltage output at 993 cycles was 1.7 which is at least double that given by the best electro-magnetic pick-ups. At 100 cycles the output was +12 decibels, which corresponds to a voltage of about  $4 \times 1.7$ , or nearly 7 volts. The peak voltage corresponding to this R.M.S. voltage would be  $7 \times 1.4$ , or nearly 10 volts, so that to take the full output the first valve in an amplifier would have to be such as to require a grid bias of not less than -10 volts.

Of course, this full voltage will rarely be encountered from an ordinary gramophone record; the amplitude of the 100-cycle constant-frequency record is greater than usual and the figures given above include a calibration correction for attenuation in recording.

### Ample Output

Still, a peak voltage of the order of 7 volts is by no means out of the question, even with an ordinary record.

It will be seen, therefore, that there is ample output to load a two-valve amplifier and it should be possible, though I have not made the experiment, to work a moving-coil loud-speaker at respectable volume with a single pentode valve of the high mutual-conductance type.

### Shunt Resistance Essential

To complete the picture, it must be added that the pick-up should never be used without a shunt resistance since otherwise the following valve will be robbed of its bias.

If a lower value than .5 megohm is used, the output in the 1,000-cycle region is unaffected; but below about 500 cycles there is a considerable reduction.

Thus with a 100,000-ohm shunt the output at 100 cycles and below falls by 6 decibels and the output voltage is only one-half that noted above. Increasing to 1 megohm, on the other hand, increases the bass output, but only by about 3 decibels at 100 cycles.

---

## What is a

## Good Switch?

JUST what it is that constitutes a good switch for radio purposes is very much a matter of argument, but it is interesting to note that actual figures concerning the vital factors are issued by one of the leading American specialist firms.

In introducing a new type of wave-change switch they give the following approximate characteristics:—

- Contact resistance: .0022 ohm.
- Resistance of metallic circuit: .001 ohm.
- Capacity between contacts: .04 micro-microfarad.
- Insulation resistance between contacts:  $1.2 \times 10^9$  ohms.



**Wireless Jobs Made Easy for  
Mr. Everyman**

**By R. W. HALLOWS,  
M.A.**



*The G.E.C. have a huge factory at Coventry devoted to the manufacture of high-tension batteries. Here workers are seen soldering the wander-plug sockets to the finished 1.5-volt cells*

# How to Make Set Building Easy

**T**HE other day I was thinking over just what jobs you have to be able to do nowadays when you build a wireless set at home. These are very different from what they were when broadcasting was an infant art. Components were then so expensive and sometimes so hard to obtain that many people, besides making their own coils, constructed also such things as valve holders, fixed resistances, small fixed condensers, and even more ambitious components like rheostats and variable condensers.

Nowadays most things are bought ready made and anyone who follows carefully a good design can make up an efficient wireless set in a short time and with very little trouble.

Still, though everything may be bought ready made, there are ways and ways of making wireless sets. Anyway, this month I am going to give you a few hints about construction. They are the fruits of many years' experience of set building. If you care to follow them you will find that they do ensure both easy and accurate building and the production of a set that is far less

likely to give trouble in the future than one which is put together more or less anyhow.

## Joints and Connections

I am not going to give you a disquisition on soldering, but I do just want to emphasise the big difference that ability and willingness to solder can make to the performances of a set and to its reliability.

The screw-down connection, in which the bared end of a wire is clamped beneath the milled nut of a terminal, is probably used by the vast majority of home constructors, but is satisfactory only up to a point. If you doubt this, here is an illuminating little test which you can apply to any set of your own make that is more than about a couple of months old.

## A Test for Contacts

Pull the set out of its cabinet and try each terminal nut with a pair of pliers (Fig. 1). If you don't find a large proportion of them so loose that you can give them a good half turn I shall be very much surprised.

One often hears it said that terminal nuts shake loose. They may in cases where the set is moved about a lot or subjected to a good deal of vibration, but in most instances I don't believe that they shake loose at all.

Then how is it that if you run over the screw-down connections of a set you so often find that many are in need of tightening? All metals possess in varying degree the quality of elasticity: stretch or compress a piece of metal slightly and as soon as the tension or the pressure is released it springs back to its original shape.

When a milled nut is first of all tightened down on to the bared end of a copper wire the wire is resilient and resists the pressure. But as time goes on it becomes fatigued and loses its spring. It then ceases to push back against the underside of the nut and a loose joint results.

## Contacts That Aren't

And there's another point! You may imagine that the wire and the nut have both nice smooth surfaces so that when the latter is tightened down there is contact between the two over a considerable area. If you have ever examined a screw-down connection under strong magnification you will see that nothing of the kind takes place. The surfaces are far from being smooth in reality.



why there is less home construction nowadays than there was a year or two ago is that people are frightened about undertaking the Clapham Junction type of wiring running to the valve holders and the coil assemblies.

It appears so easy to make a mistake; so difficult to locate the error when the finished set won't work.

### Wiring Made Easy

Now here's a way of making quite sure that you simply can't go wrong with your wiring connections. We will take the baseboard type of set first of all. Buy an extra copy of the full-sized blueprint—blueprints are not really expensive and the money will be well spent. Cut out the baseboard part of the print, lay it on the board and put a drawing-pin in each corner.

Now mount your components actually on the print, putting each exactly over its counterfeit presentment. When two or three components have been fixed in position the drawing pins can come out.

### You Can't Go Wrong

You see the idea, I think? The terminals of the actual components are exactly above those of the

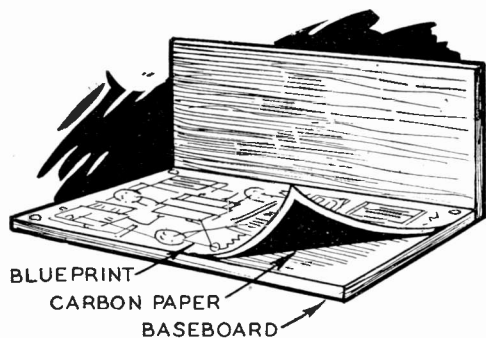

TRANSFERRING THE BLUEPRINT

Fig. 5.—Showing a method of transferring a blueprint drawing to the baseboard of a set. A bone knitting needle is the ideal tracing instrument

drawings that they cover—you must, of course, be careful to mount your components so that their terminals are just in the right positions.

The blueprint now shows you precisely what leads run from and to every terminal. Make your wires cover those on the blueprint below and you simply can't go wrong.

Next let us suppose that we have to deal with a chassis type of set with components mounted both

above and below the base and wires passing through from one side to the other.

Begin by drilling in the chassis any large holes that may be required for mounting valve holders, and so on. Cut corresponding holes in the blueprints for both the top and the underside of the base, then fix the prints in position.

You won't be able to use drawing pins, of course, in a metal chassis, but stamp edging will answer perfectly well. Mount sufficient components to fix the prints securely; then drill the smaller holes for the leads that pass through from top to underside.

All of these holes are marked on the print, and if you have been careful to make both the upper and the lower blueprints register you will find that when you pass the drill through from the top it emerges at the place marked on the under print for the hole.

Wiring now proceeds as already outlined, and once again instead of being difficult to get the connections right it becomes difficult to get them wrong.

Two possible objections to this scheme may occur at once to the reader. The first is that he doesn't want the blueprint to stay permanently on baseboard or upper side of chassis. The second is that if there is paper between the metal cases of components and a metal-covered baseboard or metal chassis there won't be a proper earthing contact between the two.

It is not difficult to remove the prints when the wiring has been done. Loosen off the fixing screws of the components and the paper can generally be removed without a great deal of trouble.

And now for the earthing problem. Let me say in the first place that I never trust any metal-cased component to earth itself just by being

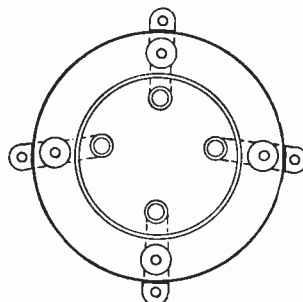

THIS TYPE OF VALVEHOLDER WAS EASY ENOUGH TO WIRE UP BUT WHAT ABOUT —

*This?*

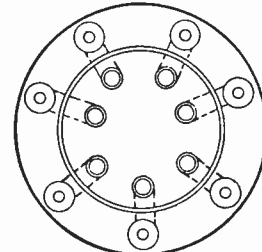

*or This?*

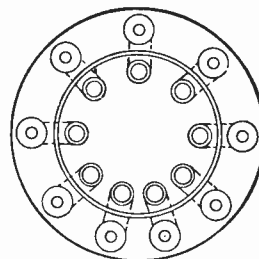

WIRING TODAY'S VALVE HOLDERS

Fig. 4.—This diagram is self explanatory. It shows that care must be taken when wiring up the fashionable valve holders of the day

screwed down hard on to a metal base or chassis. Many and many a time I have traced trouble in sets to the fact that this kind of thing produced no proper contact.

The only safe way is to attach a lead to the case and to solder or screw the other end of this to the metal.

If you don't like the idea of buying a second blueprint and *wasting* it in the way suggested, there is still another method of arriving at much the same end. This is illustrated in Fig. 5. Place a sheet of carbon paper—business side downwards—on the baseboard and the blueprint on top of it. Fix them with drawing pins if there is a wooden baseboard (drawing pins will do even if it is covered with metal foil) or with four small bolts and nuts (and washers, too, of course) if you are working on a metal chassis.

### Transfer Work

Now run over the whole of the blueprint drawing and every line of the wiring with the end of a bone knitting needle or something of the kind. This will transfer the whole thing to the place where you want it without in any way spoiling the blueprint.

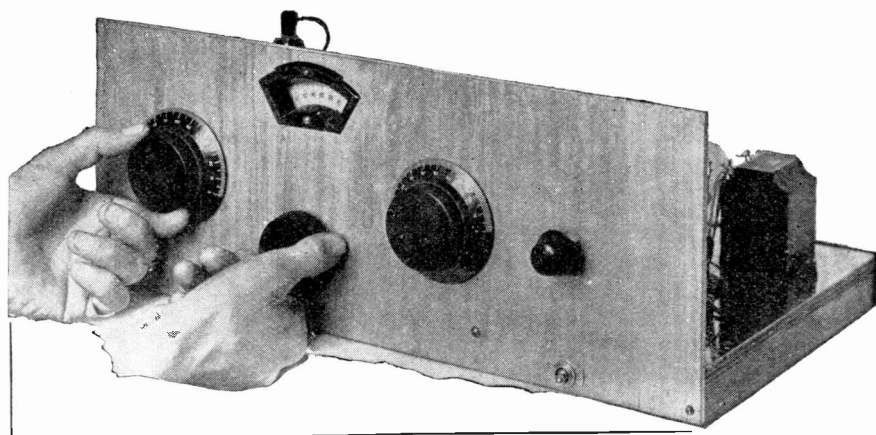

By  
G. HOWARD  
BARRY

Here we present details of a simple and reliable four-valve battery short-waver which can be built and used by anyone interested in radio. The design is not a complicated one, but we know it will give consistent results. We present this set with the knowledge that it will open up fresh fields for the radio listener to conquer.

# The Standard Four-valve Short-waver

**A** FEW years back the home constructor was accustomed to look upon short-wave work as the sacred prerogative of the amateur transmitter. One or two wizards, possibly, could design sets that the average man could handle—and sometimes he was fortunate enough to hear something on them! But short waves as a hobby or an amusement—no; they were too much like hard work.

## For the Keen Enthusiast

Just now there are signs that the self-imposed ban is being lifted. The keen radio enthusiast, finding that at least for the time being he has done all he wants to do on the broadcast bands, is looking for other worlds to conquer.

How *can* he overlook short waves? There they are, staring him in the face, and there they have been for

ten years. He has only himself to blame if he has neglected them.

Now there are signs of panic! Home-constructors are being rushed into short-wave work and told that it is the most wonderful thing ever thought of, as if it were a recent invention; marvellous tales of what can be done are circulating, just as if all this hadn't been done before.

I want to take a middle course. I want readers to understand that short waves are, and always have been, a most fascinating field for the radio experimenter. If you want armchair reception, leave them alone—for the present, at any rate: If you want to fill your house with floods of beautiful, undistorted music from the far corners of the earth, forget it—or wait a few years.

But if you are prepared to go back to the days of the kitchen table and the pair of pliers—to do a little

experimental work, to recapture the joys of making a set of which you can be proud, then short waves for you.

If you are just thinking of attacking them for the first time, then admittedly you're rather late in the field to style yourself a pioneer! Lots of good men have been steadily plodding away at short waves since 1924. Nevertheless, you will be able to feel rather as if you are back in the early days of radio once more, for the short-wave crowd is still quite select (compared, that is, with the tremendous army of broadcast listeners).

## Not an Epoch-maker

This standard four-valver has been designed with one idea only. It is not an epoch-making receiver that will bring in stations that no one has ever heard before (and never

---

## A Reliable Battery Short-waver That

---



wants to hear again). It won't even give you guaranteed reception from the U.S.A. on 365 days of the year. Neither, one might say in passing, will any other short-wave set although many proud owners and designers may *think* they will.

### Comfortable Operating

The set has been designed from the point of view of comfortable operating. It is a short-wave set that "handles" like an ordinary broadcast receiver, and one that has no special tricks or knacks about it whatever.

It may not make all the noise that is produced by what is called a hot four-valver. It isn't a hot set, but a carefully engineered design that will not let you down or cause a premature crop of grey hairs to appear.

Let us examine the set itself. The specification, reduced to its simplest terms, is "buffer stage, detector, and two L.F.'s." The buffer stage is an untuned screen-grid high-frequency stage; its merits will be discussed later on.

### Two Detector Refinements

The detector is a straightforward affair in every way, with two refinements that are very desirable in a short-wave receiver. First, it is equipped with a very small band-spreading condenser to ensure really easy tuning; and secondly the usual high-frequency choke in its anode circuit has been dispensed with, and

a resistance substituted. This improves what we may term the "handleability" of the set enormously.

At this juncture we had better analyse the desirable characteristics of a short-wave receiver, with particular reference to this particular example of the breed. What are the requirements for really easy operating? First, of course, there must not be the slightest trace of hand-capacity effects.

Everything on the front panel must be as dead as the controls of a commercial broadcast receiver

We used to put up with broadcast receivers on which the station carefully detuned itself as the operator removed his hands from the dials—but what should we say to one nowadays? The mere thought of such a thing is humorous.

Hand-capacity effects are the product of two things—an inherently unstable detector circuit, and a peculiar effect originating in the aerial circuit. An aerial-earth system cannot be designed to operate perfectly over the whole enormous range of short waves—not, at any rate, if it is simply slammed straight

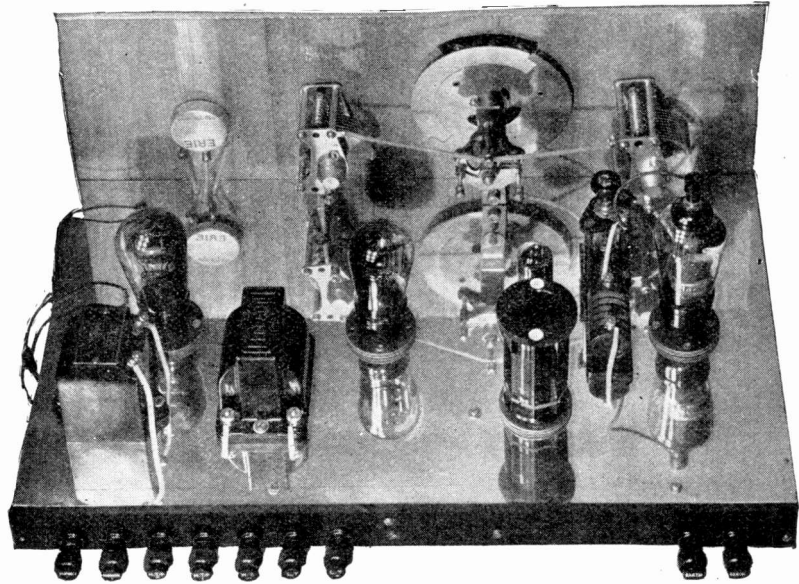

**EVERYTHING IS READY FOR THE FIRST TEST!**  
Here is the Standard Four-valve Short-waver complete with its valves and coil ready for test. Note the very clean layout

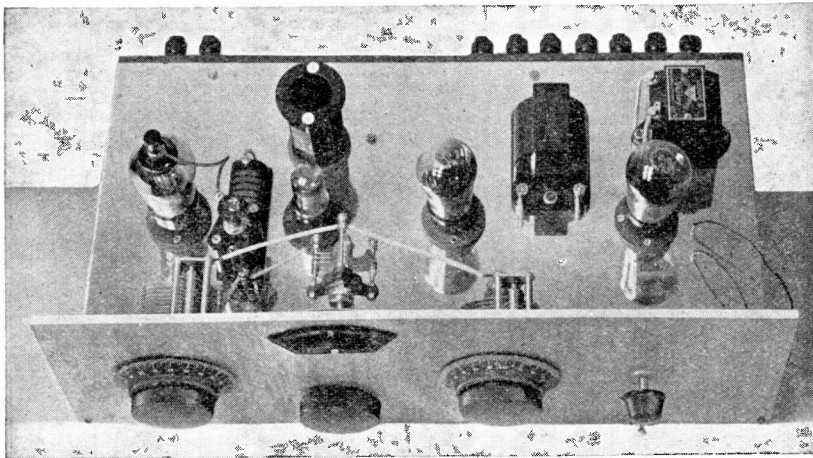

**SHOWING THE POSITION OF THE FOUR VALVES**  
From left to right the four valves are: screen-grid high-frequency amplifier, Catkin-type detector, first low-frequency amplifier and, finally, the power valve

on to the detector and left there.

An aerial 66 ft. long has a natural wavelength of about 42 metres, and will give good reception and freedom from hand-capacity on that wavelength and its harmonics. Every amateur transmitter knows this: most of them use an aerial of that length for transmission and find it excellent for reception on the 40- and 20-metre bands. On 30 metres, however, it is all upset, and even on 40 it can be all wrong if we add a long earth-lead to complicate matters.

The whole purpose of the untuned screen-grid stage is to act as a de-coupler for the aerial circuit. It turns out, in practice, to be a most amazing panacea for all the

# Can Be Used By Every Listener!

CHECKED BY  
G.P.K.  
BLUEPRINT N<sup>o</sup>.  
W.M.383

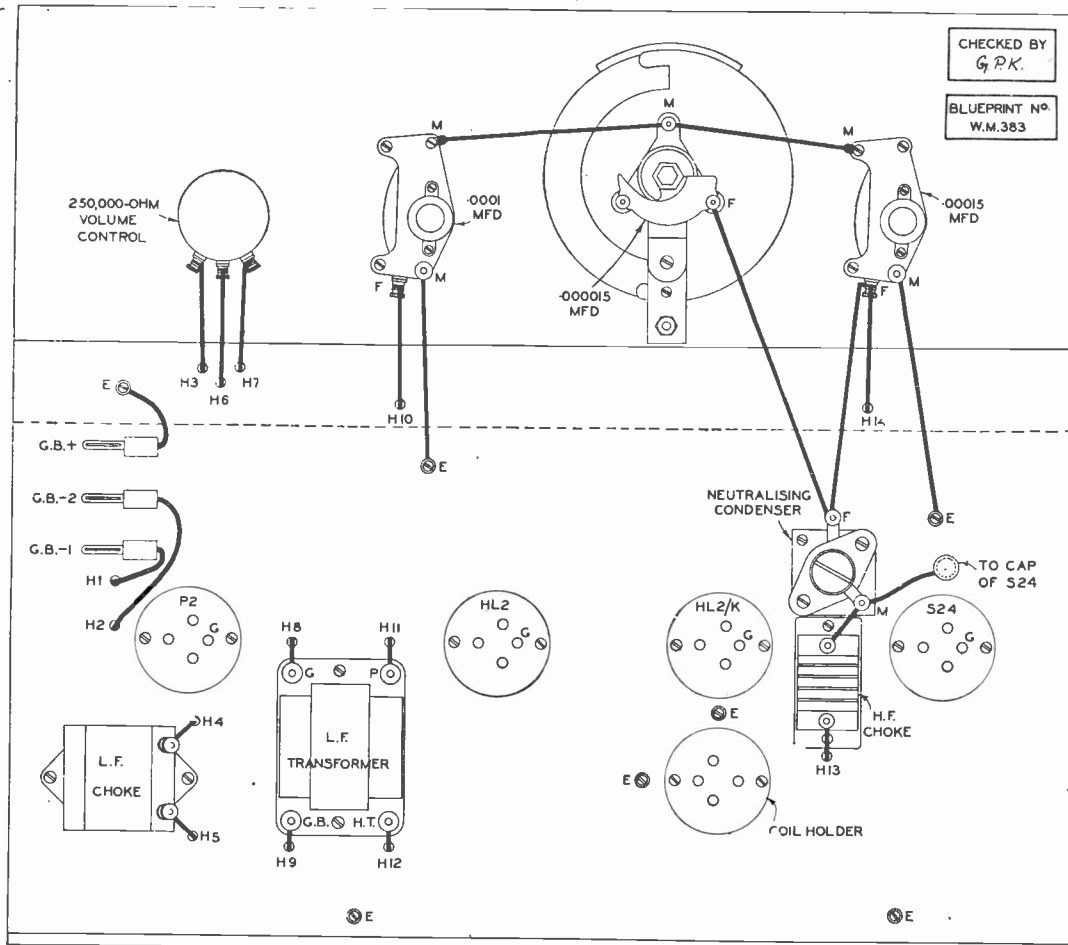

YOU CAN OBTAIN A FULL-SIZE BLUEPRINT  
A full-size blueprint of the Standard Four-valve Short-waver can be obtained from the "Wireless Magazine" Blueprint Department, 8-11 Southampton Street, Strand, London, W.C.2. Full details will be found on the last page of this issue.

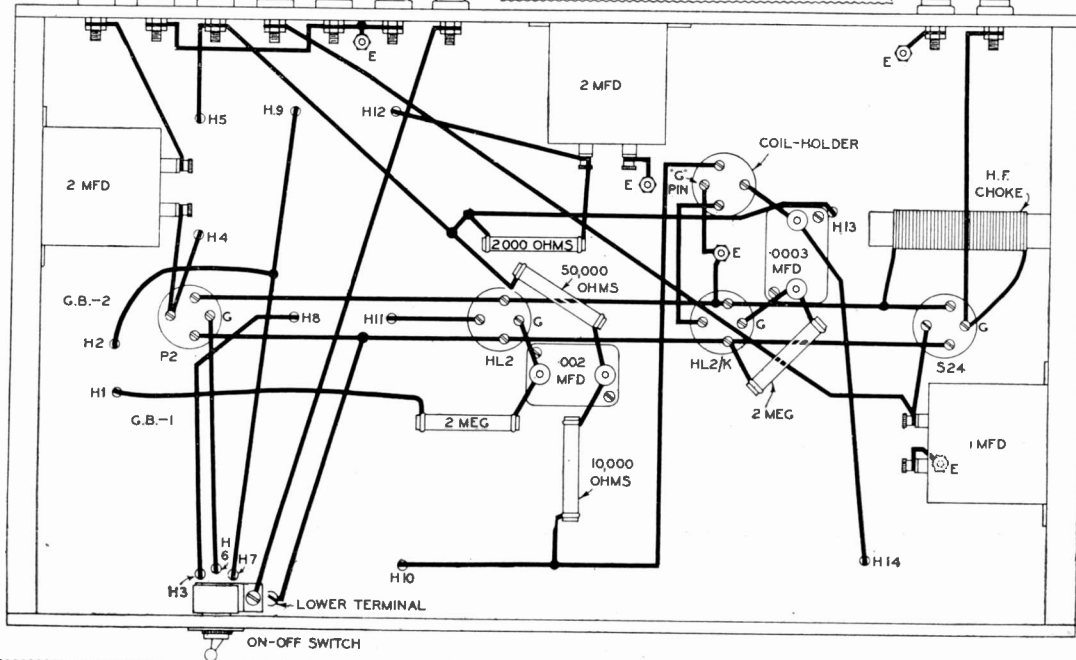

worst of the short-wave troubles. Hand-capacity is wiped right out, reaction-control is improved, and such troubles as threshold howl are often eliminated, simply by the addition of the extra valve. Surely it earns its keep, even if it does not give any amplification. (As a matter of fact it *does* give a small but useful amount when it is carefully designed.)

Threshold howl is a trouble that you will never have met, unless you have been previously acquainted with short waves. It is altogether a most noisome business. The symptoms are a beautifully smooth reaction control, completely ruined by a terrific hoot just on the point of oscillation. Theoreticians describe it as the "inverse of overlap," or the reverse of ploppy reaction control.

**Threshold Howl**

Some time back some R.S.G.B. members made an exhaustive study of this effect and its severity was found to be proportional to the total amount of inductance in the anode circuit of the detector valve. Thus it would be at its worst when the detector had a large reaction coil, a biggish high-frequency choke and a really good low-frequency transformer in its anode circuit, and certainly this was borne out in practice.

It could be lessened by using a poor high-frequency choke and a rank bad low-frequency transformer—together a charming method of getting rid of it! In this set its likelihood is obviated by the use of a

resistance of 10,000 ohms in place of the choke, and resistance-capacity coupling instead of a transformer. This, you must agree, is a logical method of killing it.

As a matter of fact, threshold howl has almost disappeared these days owing to the improved characteristics of the HL class of valve. There is still no difficulty in making it appear

main tuning control and equipped with a really good slow-motion drive.

In this receiver the main tuning condenser has a capacity of .00015 microfarad, and the band-spreader is one-tenth of this size. A capacity of .000015 microfarad, controlled by a silent dial, gives an ease of tuning that is really comparable with that of the average broadcast receiver.

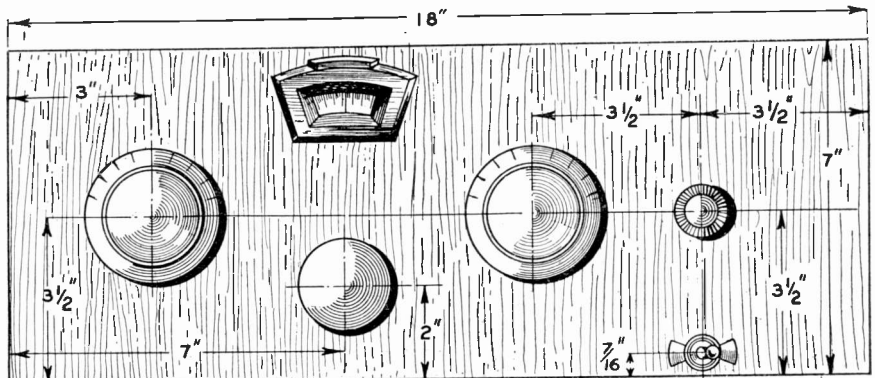

**FIVE CONTROLS ON A WOODEN PANEL**  
Reading from left to right the five controls are: approximate-tuning condenser, band-spreader tuner, reaction, and volume control—for use with 'phones—above the on-off switch

when some ancient valves are used. On this receiver the reaction control leaves nothing to be desired. The reaction windings on the coils used are of reasonable size; a .0001-microfarad air-dielectric reaction condenser with slow-motion drive is fitted, and this makes the control altogether *beautiful*.

With regard to the band-spreading business, there is no point in going back to the days of the old single-plate vernier. What we want is a really good condenser of very small capacity, wired in parallel with the

Short-wave broadcast stations work in groups, fairly close together in frequency, and one simply sets the .00015-microfarad condenser in the middle of one of these bands and carries out the real tuning on the other one.

After all, .00015 covers an enormous frequency-band, which may be as high as 9,000 or 10,000 kilocycles, and will make tuning ten times more difficult than it is on the medium waves. But the band-spreader is always available for final adjustments, and it really makes matters quite easy.

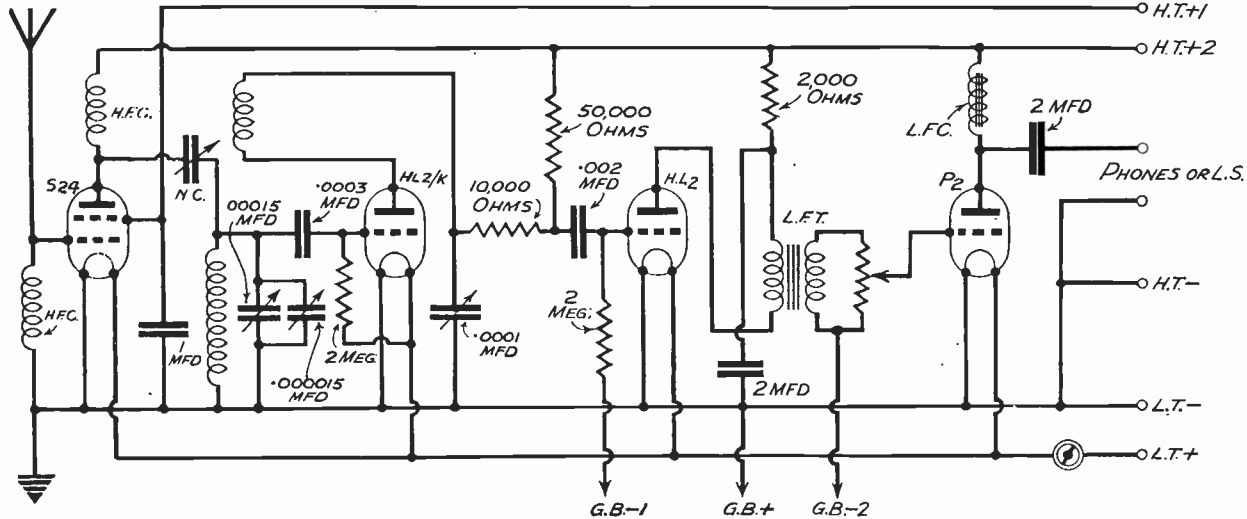

**CIRCUIT OF THE STANDARD FOUR-VALVE SHORT-WAVER**  
As can be seen there is little complication in this circuit to worry the amateur. There is a screen-grid amplifier, leaky-grid detector resistance-capacity coupled to the first low-frequency amplifier, which is transformer coupled to a triode output valve

So much, then, for the theoretical aspects of the first two valves. The low-frequency end of the set hardly needs discussion. The first low-frequency stage is a fairly high-magnification valve, resistance-coupled from the detector, and transformer-coupled to the output stage. Its high-tension feed is de-coupled, and it is intentionally equipped with a grid condenser that cuts off a little bass, which would otherwise tend to be excessive when much reaction is used.

### Not Super Quality

We are not out after super-quality—not yet, at all events—and the use of a .002-microfarad grid condenser has much to recommend it.

The last valve is provided with choke-filter output, which is always desirable in a short-wave set. It helps to overcome yet another trouble peculiar to the short waves—high-frequency in the output! How our elusive high-frequency can find its way right through to the 'phone cords and make them susceptible to hand-capacity effects has always been a bit of a mystery.

An even greater mystery is the reason why such a simple precaution as choke-filter output should cure it, but it does! But in this set there is not the slightest possibility of high-frequency getting right through as far as that, and the output circuit is included chiefly because we may want to use headphones occasionally.

### Volume Control

For this reason a volume control has been provided across the low-frequency transformer secondary. Many short-wave loud-speaker sets rely on the reaction as a control of volume, the designers overlooking the fact that there may be some people perverted enough to want to listen to C.W. signals!

This set, in practice, is equally suitable for the reception of broadcasts on the loud-speaker, and C.W. on 'phones. There are also many occasions on which one receives

signals that are not really sufficiently strong to give full intelligibility on the loud-speaker. Some listeners may wish to ignore it; others, knowing that the mere fact of its weakness probably means that it is interesting, will revel in following it with the 'phones until the station finally closes down without giving an announcement!

We seem to have got through a lot of talk without touching on the constructional side of the set at all. That, however, is probably a good policy, and certainly one that this writer intends to follow. The photographs and diagrams are there for the purpose of giving all the constructional data in compact form. What readers need is an explanation of *why* certain things have been incorporated in the set, and others left out.

On short waves, more than in any other branch of radio, it is essential that a common-sense outlook should be cultivated. One

with the idea that they will dispense with hand-capacity effects. In the old days, on longer wavelengths, this may have been all very well. The idea of introducing an earthed screen between the operator and the live controls was very fine. On short waves, however, it very often isn't an earthed screen at all. The earth terminal, at the back of the set, may be at earth potential, but it does not follow that the front panel will also be dead.

How could it be, when it is connected to the earth terminal by seven or eight inches of wire? (Yes, seven or eight inches is a considerable amount when we are handling a set on 15 metres.)

### The Earthed Screen

In this receiver it is the baseboard that is the earthed screen. All the earth-return leads are taken to the layer of metal on top of the baseboard by the shortest and most direct route. As a matter of fact, the moving vanes of the condensers on the front panel are all connected together by a length of wire, and earthed on to the baseboard at *both* ends.

Those who have read my article on short-wave detector circuits in this issue may criticise the length of the grid wiring in this set. True, it is a little on the long side; but it is done in a way that ensures freedom from trouble. The actual lead from the grid of the detector to the grid-condenser is almost non-existent. The other side of the grid condenser goes straight to the coil. The wire from the high-potential end of

the grid coil to the condenser which tunes that coil is *direct*, and the earth-return is very short indeed.

### Important Connections

The most important point to watch concerns the connections from the condenser to the coil. The condenser must be *literally across* the coil; the wires joining the two should not be run via other components, the earth return finding its way home, perhaps via the on-off switch and the battery leads. That

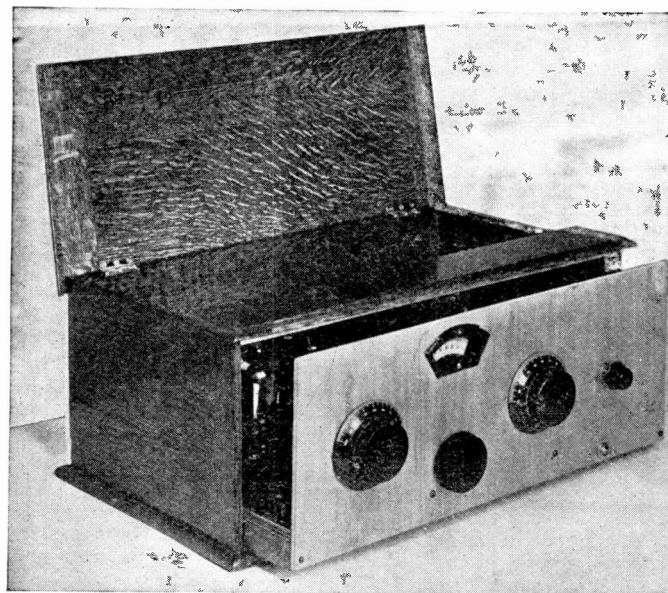

GABINET FOR THE SHORT-WAVER

The constructor can choose his own cabinet for his short-waver. Something after the style of this plain American type is ideal for the purpose

should know why tuning is sometimes difficult; how it can be made easier; what to do if it isn't made easier, and so on.

There are, however, one or two practical points that may be profitably discussed. The use of a wooden panel, for instance, may be the cause of some lifted eyebrows. Metal panels for short-wave sets have been all the rage in the past and are all very well in their way. But they do *not improve the handling of the set*.

They are presumably included



sort of thing is fatal in a short-wave receiver.

The input circuit of the high-frequency valve is looked after by a special high-frequency choke. A commercial choke was not used, as none seem to be of suitable inductance for this particular job.

#### Home-made Choke

The choke in question was wound on a length of  $\frac{1}{2}$ -in. ebonite tube with 60 turns of No. 28 d.c.c., "close-wound." A choke of unsuitable size might easily cause interaction between the grid and anode circuits of this valve, and a resistance, sometimes used, often gives rise to all sorts of queer effects.

One buffer stage that I met had the effect of bringing in London Regional and National at quite comfortable strength, whenever the set was in an oscillating state! There is quite enough to listen for on the short waves without superimposing the local programmes.

#### Wiring

Most of the wiring has been carried out underneath the baseboard, which is mounted on 1-in. runners to allow room for the smaller components to be accommodated underneath. The filaments are wired up "bus-bar" fashion, giving rise to the strange effect of tying the valves together. When the output valve is gently pushed with the finger, the other three move in unison. This has caused countless happy moments in the Editorial Department, and is confidently recommended for amusing the children!

This does not matter in the least, as the detector valve, of the Catkin type, is absolutely non-microphonic and the use of springy valve holders is not necessary at all. It simply

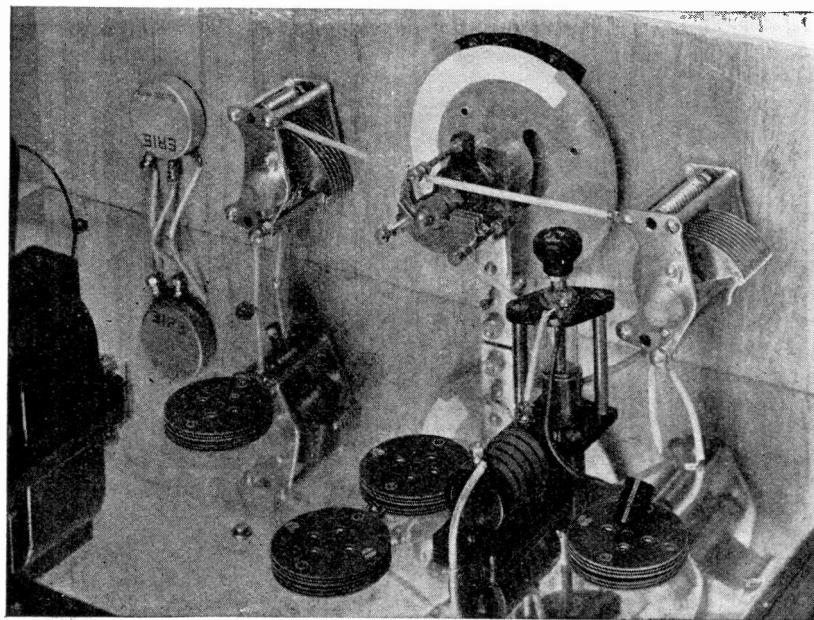

**CLOSE-UP OF THE TUNING COMPONENTS**

*This close-up view gives a striking idea of the set's simplicity. Note that although the two tuning condensers are connected together and earthed, the earth connection is made at both ends*

happened that the type chosen as the most suitable for the job happened to be of the "sprung" variety.

The photographs and wiring diagrams should make clear any small points of layout not mentioned. No reference has yet been made to the function of the neutralising condenser coupling the first valve to the detector. This, as a matter of fact, is purely a case for individual adjustment.

If the capacity used in this position is too great the detector will not oscillate over the whole tuning-range. If it is too small signals will be weak. A setting about half-in should be suitable for all purposes. A neutralising condenser has been used intentionally, rather than one of the pre-set variety, simply because its low maximum capacity will

thwart the desires of anyone with a bad attack of screw-down mania.

Even if it is operated all-in, selectivity will not suffer unduly and the performance of the receiver will not be affected. A pre-set type with a maximum of .0001-microfarad, if used in this position, can absolutely ruin the detector circuit if it is habitually operated near the maximum position.

#### 13 to 96 Metres

The three coils supplied cover wave-ranges of roughly 13 to 26, 24 to 52, and 46 to 96 metres with a .00015-microfarad tuning condenser. As the condenser in this set has a further .00015-microfarad in parallel with it these ranges may be extended a little.

The smallest coil therefore covers the 14-, 16-, 19- and 25-metre

### COMPONENTS NEEDED FOR THE STANDARD FOUR-VALVE SHORT-WAVER

#### CHASSIS

- 1—Peto-Scott chassis to specification.

#### CHOKE, HIGH-FREQUENCY

- 1—Home-made short-wave choke as described in text.

#### CHOKE, LOW-FREQUENCY

- 1—Varley, type DP 23 output choke.

#### COILS

- 1—set British Television Supplies short-wave coils.

#### CONDENSERS, FIXED

- 1—T.C.C. .002-microfarad.
- 1—T.C.C. .0003-microfarad.
- 2—T.M.C./Hydra 2-microfarad, 250-volt working.
- 1—T.M.C./Hydra 1-microfarad, 250-volt working.

#### CONDENSERS, VARIABLE

- 1—Polar short-wave .00015-microfarad slow-motion, type C.
- 1—Polar short-wave .0001-microfarad slow-motion, type C.
- 1—Eddystone .000015-microfarad short-wave condenser, type 900.
- 1—J.B. neutralising condenser.
- 1—Eddystone vernier slow-motion drive, type 9338.

#### HOLDERS, VALVE

- 5—Clix 4-pin.

#### RESISTANCES, FIXED

- 1—Erie 10,000-ohm, 1-watt type.
- 1—Erie 2,000-ohm, 1-watt type.
- 1—Erie 50,000-ohm, 1-watt type.
- 2—Erie 2-megohm, 1-watt type.

#### RESISTANCE, VARIABLE

- 1—Erie 250,000-ohm potentiometer.

#### SUNDRIES

- Tinned wire for connecting.
- Oiled cotton sleeving.
- 3-Clix wander plugs for grid-bias connections.

#### SWITCH

- 1—Bulgin on-off single-pole toggle.

#### TERMINALS

- 1—Peto-Scott terminal strip, complete with terminals to specification.

#### TRANSFORMER, LOW-FREQUENCY

- 1—Ferranti AF8.

#### VALVES

- 1—Marconi S24.
- 1—Marconi HL2/K.
- 1—Marconi HL2.
- 1—Marconi P2.

#### LOUD-SPEAKER

- 1—W.B. Stentorian, Standard model.

broadcast bands, and also the 20-metre amateur band. The next takes in the 25-, 31- and 49-metre broadcast bands and the 40-metre amateur band.

### Largest Coil

The largest starts off in the middle of the 49-metre broadcast band, which really spreads from 44 to 50 metres, and goes right up to the top of the range that the average short-wave man wants to cover.

time searching through them if it is more than an hour after sunset. During the late afternoon, however, they are quite lively.

The 25-metre band is not particularly interesting, and the 31-metre is noted chiefly for VK2ME, Sydney, and his famous Sunday morning transmissions; 49 metres, on the other hand, is always full of interest in the evenings. At 7 or 8 p.m. Johannesburg and Nairobi may usually be heard, and by 10.30

should be used. It should be possible to calibrate it fairly accurately, and this, of course, is an enormous help in the rapid identification of stations.

### Externals

Finally, a word or two about the "externals." The valves should be as specified in the list of components. The HL2/K makes an admirable detector on account of its non-microphonic qualities; the S24 is ideal for the buffer stage.

H.T.+2, which feeds all four valves, should be given between 120 and 135 volts; H.T.+1, the screen voltage for the first valve, between 70 and 80. The grid-bias voltages should be adjusted in accordance with the valve-makers' suggestions;  $1\frac{1}{2}$  volts for the first low-frequency amplifier and something between 12 and 16 for the second is required.

### Suitable Aerial

The aerial should preferably be as high and clear as possible, though not unduly long; 50 ft. is an ideal length for general-purpose short-wave work. If an indoor aerial must be used, let it be clear of walls, picture-rails and ceilings. A single wire across the middle of the room is worth more than all the Serpentine affairs that crawl round picture-rails.

The set will probably be found to work equally well with or without an earth. *If the provision of an earth improves matters—provide one! If not, don't bother.*

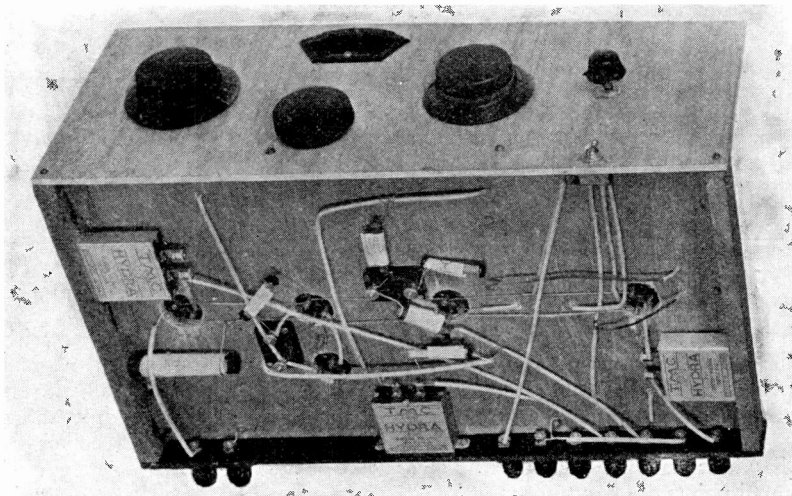

FEW COMPONENTS ON THE UNDERNEATH

All the fixed condensers and fixed resistances are on the underneath of the baseboard, which must be cut away for the fixing of the valve holders. The home-made short-wave choke is seen on the left

The 80-metre amateur band is fairly near the top of the tuning scale.

The three lowest broadcast bands and the 20-metre amateur band may be regarded (at this time of year, at all events) as daylight waves. There is no need to spend a lot of

the Americans are in full swing.

Next month more details about individual stations and their exact dial settings will be given. The object of this article is to enable you to construct the set, and to give some idea of how and when it

### STATIONS THAT GET TIRED

THOSE who remember the reception conditions of some seven or eight years ago will recollect that some of the strongest and most reliable foreign stations which we heard were the Spaniards. Most of those same stations are still working, yet they are not often heard at any great strength nowadays; in fact, many of them are definitely on the *difficult* list.

### Old Hands Will Know

This is but one example of a process quite familiar to those who have been listening for any length of time. It is continually being observed that new stations are heard at fine strength for a period which

may extend up to a few years, and then after that they retire into the background.

Fanciful people have declared that radio stations get tired, but measurements show that so far as actual aerial current is concerned they continue to deliver the accustomed power.

A more likely explanation seems to be that the continual passage of large quantities of radio-frequency current through the ground around the station results eventually in changes which increase the earth resistance and so reduce the amount of energy radiated. Even then, however, there are some awkward facts left unexplained, and it would appear that further research will be necessary to settle the matter convincingly.

### DO YOU KNOW WHAT A "VERI" IS?

THE short-wave enthusiasts of America have recently developed to an extraordinary degree of intensity the pastime of collecting verification cards from the short-wave broadcasting stations which they hear. Indeed, it would appear that it threatens to become more than a pastime, so seriously do some listeners take it. It is reported that quite elaborate schemes have been thought out by the less scrupulous for obtaining "veries" from stations which they have really never heard, and that in consequence many of the important broadcasters of North and South America are stiffening up the conditions which must be met before they will issue a "veri" confirming a certain reception.

What You Should Know About  
Short-wave Design No. 4.

This is the fourth article of a series by practical short-wave experts explaining simply the basic principles of short-wave working. Here G. Howard Barry thoroughly deals with the design of the short-wave detector stage and shows that it is the crucial point in the efficient operation of a short-wave receiver



N.P. photo

Short-wave experimenting and listening provide the greatest thrill that radio offers today. Construction and operation are both simple—and you will get endless fun out of this great hobby

# Efficient Detector Circuits for Short Waves

---

By G. HOWARD BARRY

---

ANY new development in radio must generally be allowed two or three years in which to establish itself in public opinion as an actual fact. There must be something highly abnormal about short-wave reception, which ceased to be a novelty in 1925 or 1926, but is still regarded as something rather fantastic and unreliable.

### More Interest

At last, however, there are distinct signs of an awakening of interest. Home constructors who find that it no longer gives them any great pleasure or thrill to build their own medium- and long-wave broadcast receivers are really beginning to get down to short-wave working—literally. Accordingly, the time would appear to be ripe for a not-too-technical survey of the basic prin-

ciples that one must observe, if one is to design a successful short-wave receiver.

It is an old cliché that must come first—the detector is the “focal point” of the whole receiver, and its operation must be above reproach in every way before a short-wave receiver is worth handling at all. Having reached the desirable state at which one really *can* say that the detector is hardly capable of improvement, then, and only then, can one start adding refinements.

The fact that one is up against all through is just this—that a detector circuit and layout that is altogether admirable in its performance on 300 metres may not be the slightest use to anyone when it is transferred to 30 metres.

One is dealing with a frequency ten times higher and one cannot

take the same liberties with it; the amounts of capacity and inductance with which one is dealing are so very much smaller that “strays” of either kind assume a really serious aspect.

Stray capacities, of course, show up most obviously in the use of an unnecessary amount of dielectric material—particularly when that material is of doubtful pedigree.

### Stray Inductance

Stray inductance (an unfamiliar term, this) generally exists in the wiring. When we deal with very short wavelengths, an excessively long lead in the high-frequency circuits may possess almost as much inductance as the coil itself.

The whole problem really settles down into the use of high-quality materials and common-sense layouts. In this, my first, article, I propose to deal chiefly with the detector circuit, and the application of commonsense thereto.

### Instability and Inability

An inefficient short-wave detector circuit makes its shortcomings known, generally in two ways—instability and inability. The “inability” part of it may be subdivided into inability to oscillate over the whole tuning range, inability to stop oscillating at certain points, and so on. One is rather tempted to add “debility,”

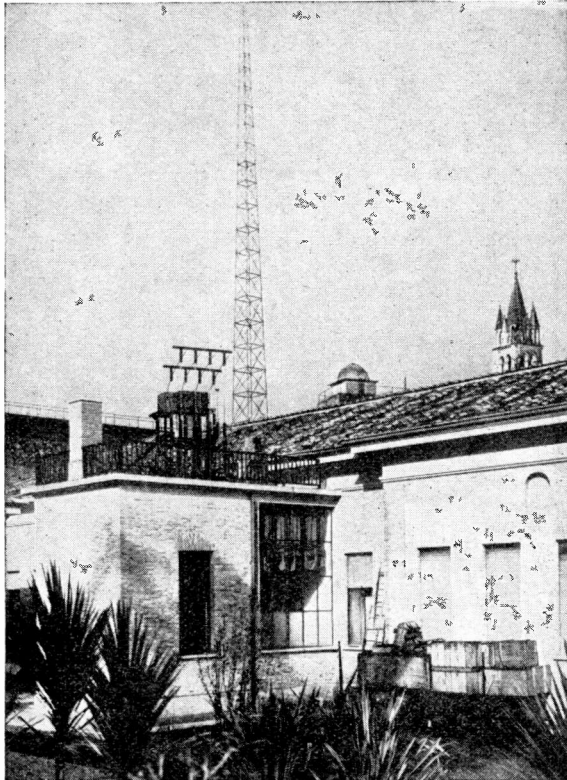

Gulliland photo.

The Pope has installed an up-to-date ultra-short and short-wave station at the Vatican. Here is the station building showing the new parabolic ultra-short-wave reflector

particularly where the reaction control is concerned.

Let us take Fig. 1 as the standard detector circuit. The circuit itself possesses no particular disadvantages; both tuning controls have one side at earth potential, and aerial-circuit damping is not excessive if reasonably loose coupling is employed.

### “Up-in-the-air” Reaction

It is not proposed to insult the intelligence of readers by giving the slightest consideration to circuits that involve a reaction control of the “up in the air” type—it is so very simple to move the condenser from the old “Reinartz” position to the other end of the coil, and the performance of the circuit is not altered in the slightest degree by doing so.

But even the circuit in Fig. 1 may be made thoroughly unsatisfactory, the most common fault being the use of too large a reaction coil. Too large a tuning condenser will merely make operation a more difficult matter—it will not necessarily upset the behaviour of the circuit.

In the reaction circuit the ideals at which to aim are: the reaction coil should be as small (physically and

wound with fairly heavy bare wire, and a reaction coil of much thinner insulated wire, close-wound and placed right inside the grid coil.

Many commercial coils which are entirely successful do *not* employ this arrangement, and there is no intention of belittling their performance. Home-made coils, however, may so easily be made to conform to this scheme, which is foolproof.

The once-fashionable two-pin coils have practically disappeared, and we have available quite a good selection of four and six-pin types; although their sizes and shapes show considerable variation, most of them lend themselves to a reasonably compact layout of the detector stage.

If we choose a four-pin type and do not intend to use high-frequency amplification before the detector, we are forced to resort to capacitive aerial coupling. This, in itself, is not a serious disadvantage. The weak spot lies in the operator who believes in draining the last decibel from his set and, in the course of so doing, tightens this coupling excessively

electrically) as possible, and its coupling to the grid coil should be *tight*. The chief reason for this is that loose coupling necessitates the use of a big coil, which may easily have a natural wavelength that falls within the tuning range of the grid coil in use. This will then cause a *dead spot* that will render part of that range almost useless.

With really tight coupling the reaction coil may be considerably smaller than the grid coil, and the possibility of this fault is completely avoided. My ideal arrangement consists of a grid coil space-

and ruins the selectivity of the receiver.

The average neutralising condenser at the “all-in” position provides an ample degree of coupling for the average outdoor aerial, and its use in preference to a pre-set type with a maximum of .0001 is specially recommended—unless the owner of the set is sensible enough to realise that the full .0001 is far too much!

### Reasonable Layout.

Fig. 2 shows an example of a reasonable layout for a detector stage using a well-known make of six-pin coil. Note the short grid-circuit wiring and—most important—never forget that the earth return is *part* of this wiring. How often do we see a beautifully short and direct grid lead, its effect completely spoilt by an earth-return that is left to look after itself.

One very strong recommendation that I wish to make is that the tuning condenser should never be of a

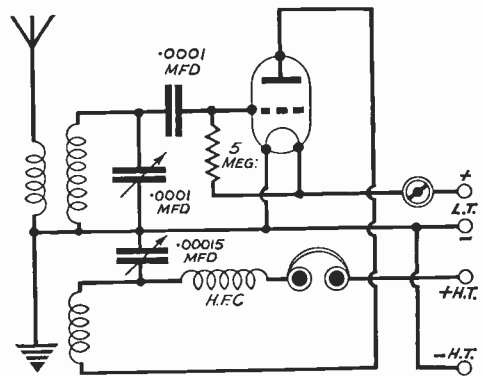

STANDARD SHORT-WAVE DETECTOR CIRCUIT.  
Fig. 1. A standard detector circuit in which both tuning controls have one side at earth potential

higher capacity than .00015 microfarad—and should preferably be of .0001 microfarad only. A .0001-microfarad condenser with the average commercial coil of seven turns gives a tuning range of something between 5,000 and 7,000 kilocycles which makes operation quite difficult enough, even with the best of slow-motion dials.

In passing, it seems an opportune moment to remark that the high selectivity so often attributed to short-wave receivers is often non-existent. What the enthusiast is really thinking of is *critical tuning*—not necessarily an advantage, and often the reverse.

This so-called *sharp tuning* is not



a fundamental property of short waves, as so many seem to imagine. It is merely what one would expect as the result of a large band-coverage!

So much, then, for the most elementary aspects of short-wave detector design. The time seems ripe for a discussion on the disadvantages of a detector—even one that conforms to all the foregoing recommendations.

**That Arch-bugbear !**

Hand-capacity—that arch-bugbear of the short-wave man—is being intentionally left out of the picture for the present. Good layout should obviate its very existence, but it will be dealt with in detail later on.

On short waves we have to deal with signals of all shapes, and we find that a really strong signal, instead of becoming merely *louder*, also spreads out over the dial. High-frequency amplification does not improve matters since it merely increases the number of strong signals that the detector is liable to have to deal with.

**Stopping Spreading**

We may reduce this particular trouble to a minimum by resisting the temptation to use too high an L/C ratio in the detector-grid circuit. A tremendous coil tuned by a very small condenser certainly gives admirable sensitivity, but it is less selective and, if we are concerned with C.W. reception, its frequency of oscillation is terribly susceptible to changes in plate voltage.

“High C”—a craze that attacked transmitting circuits in 1929—is the remedy. By “High C,” however, one still does not mean anything larger than .00015-microfarad condenser, but rather the ability to *place* the important wavebands so that they come near the top of the tuning range rather than at the lower end.

Incidentally, it should hardly be necessary to mention that a detector to be used for C.W. reception *must*

also be a stable oscillator and here, again, “High C” is valuable.

We are faced with rather a paradox when we come to add valves to our perfect regenerative detector. Short-wave “mush” is well known to those who have had any experience of the higher frequencies. Put very briefly, this is the situation: We shall never be faced, whatever the receiver, with a signal that is too weak to *hear*, but we may meet with quite a number that are too weak to come through the background noise.

This mush, by the way, is a highly complicated mixture of distant atmospherics, local “man-made static,” commercial stations’ harmonics, rays from outer space, and goodness knows what! Mush is definitely picked up by the aerial in most cases. No short-wave receiver worth anything at all has a high background level with the aerial disconnected. Selectivity has some effect upon the amount of outside mush picked up—the wider the acceptance-band of the receiver, the wider open is the door to the noise level.

But a certain amount of this mush is inevitable, and here is the paradox: We have probably a better signal-to-noise ratio with a detector working unaided than we shall ever get after we have started adding valves to it. It is a well-known

fact that a short-wave detector will receive, at a readable level, a signal which becomes unreadable when low-frequency amplification is added. The low-frequency stage is (or should be) no discriminator between frequencies, but the all-embracing mush usually *seems* to be amplified a little more than the wanted signal.

**“Worse as We Improve”**

On top of this, an infinitesimal amount of filament-hiss is probably introduced by each succeeding valve, so that our noise level gets progressively worse as we *improve* the receiver. This, doubtless, accounts for some of the phenomenal performances that are put up by single-valve receivers on the short waves.

The very best method of increasing the overall gain without ruining the signal-noise ratio is undoubtedly the addition of a tuned high-frequency stage, preferably employing a multi-mu valve. The very worst, for various reasons, is the introduction of a transformer-coupled low-frequency stage immediately after the detector.

**About the Super-het**

The super-het is in a class by itself, but for some reason everyone seems to overlook the fact that no super-het can be better than its first detector. Piling on amplification (of any kind) after an inefficient detector merely disguises the fact that the detector *is* inefficient. Beautifully strong signals are heard and everything appears to be all right. It is only by cutting out everything but the detector itself that the operator can be made to realise that that valve is not pulling its full weight.

In my next article I propose to deal with the various types of amplification—their relative advantages, and practical points of design concerning them.

If readers get stuck over any particular question, please drop me a line c/o “W.M.” It is useful when preparing future articles to have reader’s own experiences before one.

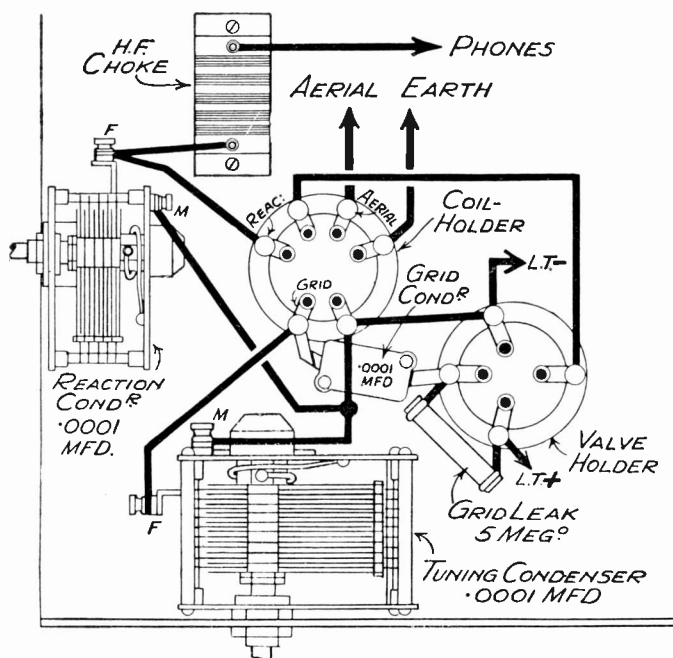

RECOMMENDED SHORT-WAVE DETECTOR LAYOUT  
 Fig. 2. A recommended layout for a short-wave detector arrangement in which a six-pin coil is used



Columbia photo

Quentin Maclean at the console of the huge Wurlitzer organ at the Trocadero Cinema. Radio listeners are admitted to the cinema on Wednesday mornings during broadcasts

fountain which plays immediately at the back of the organist, but as the B.B.C. microphone is up near the organ pipes the sound of running water is not relayed to listeners!

Tooting's Granada is popular with most cinema- and theatre-goers in the south-west of London, and Harold Ramsay (composer of *Her Name is Mary*) has made it famous to radio listeners all over the country.

Ramsay is musical director of a famous cinema circuit, of which the Tooting Granada is one of the biggest theatres.

The Tooting Granada's sister cinema is the Walthamstow Granada which, though not so spacious, is

# Round the Radio Cinemas

By P. C. CONRAD

DO you remember the early days of cinema organ broadcasting in this country . . . when, in 1926, Reginald Foort used to broadcast from the New Gallery in Regent Street?

Fred Kitchen had a fine orchestra there, and they broadcast regularly once a week. But one day when the B.B.C.'s O.B. gang was sent round to the New Gallery the engineers happened to hear the tail end of one of Reginald Foort's organ recitals.

The engineers sensed something new, and they decided to fit up a microphone to relay the organ. So right at the end of each Fred Kitchen orchestral broadcast a fifteen-minute relay was made of the New Gallery organ.

The cinema organ was then practically a novelty, and it was just a lucky stroke of fate that the microphone arrangements in that particular cinema were perfect. The B.B.C. received a huge number of letters from all over the country asking that the organist might be allowed to broadcast for more than a quarter of an hour, and after a few weeks Reginald Foort came on the air for the whole hour.

That was one of the first stepping-stones in relays from a cinema.

Relays are now made regularly from the Commodore Theatre at Hammersmith, the Granada Cinemas at Tooting and Walthamstow, the Gaumont Palace, Chester, the New

Victoria Cinemas at Bradford and Edinburgh, the Trocadero (Elephant and Castle), the Regal (Kingston-on-Thames) and many others.

In almost every cinema it is possible, at the cost of only a few pence, to secure a seat during the broadcast; in a few the public are not admitted during the broadcasting periods.

Let us take a trip round the radio cinemas from which the most frequent B.B.C. relays are made. Let's go first to the Regal at Kingston. Not only was this made famous when it first opened early in 1932 by Reginald Foort himself, but last July Reginald New (another favourite with radio listeners) took over the position of organist there.

Inside, the Regal is decorated in a futurist fashion, but the orchestra pit has a floral design as its keynote. In fact, when Reginald New broadcasts he sits in a bower of flowers.

The garden atmosphere at the Regal is heightened by a small

nevertheless claimed to be the largest cinema in Essex.

It was built a year before the Tooting Granada on the site of an old "blood-and-thunder" theatre. Harold Ramsay often plays on the organ at Walthamstow, but the B.B.C. only relays the Walthamstow Granada Orchestra of fourteen instrumentalists which is directed by Charles Manning.

There is a large balcony just above the vestibule of the Granada, and it is from here that the Manning orchestra broadcasts. There is no audience, but people passing from the vestibule on their way to their seats often stop and listen to a fragment of the Manning programme, generally unaware that the orchestra is broadcasting.

Charles Manning is known as the "Svengali of Music." He is a native of Barnstaple and is an amazing example of tremendous vitality and enthusiasm.

Body, arms, legs and head are all used while he is conducting, and patrons of the cinema have to be careful of the baton which sometimes comes flying into the auditorium.

He came to Walthamstow from Canada and America, where he held various conductorial posts in cinemas. "British audiences," he says, "are far more enthusiastic than those in America. They like good music."

And now let's make a trip up North to the Gaumont Palace at Chester where Sydney Gustard broadcasts.

Many cinemas have American Wurlitzer organs, but at the Chester Gaumont Palace they have a Compton organ made by the same firm that built the instrument in the Concert Hall at Broadcasting House.

Chester's Gaumont Palace is finished in the usual lavish fashion one associates with cinemas on the Gaumont circuit, but the interior does not look very bright when Gustard gives his recital. You see, he broadcasts at midday and no audience is needed, so the special lighting effects are not turned on; his only audience is an occasional cinema cleaner who stops for a minute in the middle of her work.

Our trip round the radio cinemas would not be complete without a visit to the famous Trocadero at the Elephant and Castle—the professional home of Quentin Maclean. The Trocadero is a vast cinema—it

can hold over 5,000 people: twice as many people as Drury Lane Theatre!

It was built in 1930, at the height of the super-cinema boom, and the management decided to give Quentin Maclean an instrument worthy of his genius, hence a four-manual organ of the very latest type which is the largest organ of its kind in Europe.

An audience is admitted during the broadcast. There is no need to be quiet, for applause is allowed in the cinema while Quentin is "on the air" . . . and there is plenty of it when the gilded organ console rises at the left-hand side and an illuminated notice announcing that the organist is broadcasting appears.

It is best to sit upstairs in the centre if you want to appreciate the organ during the broadcast for the pipes are placed on both sides of the screen.

The Trocadero Orchestra also

broadcasts, but as the time schedule is inconvenient for them at the Trocadero itself they broadcast from the Troxy Cinema in the Commercial Road, near Stepney.

This cinema is associated with the

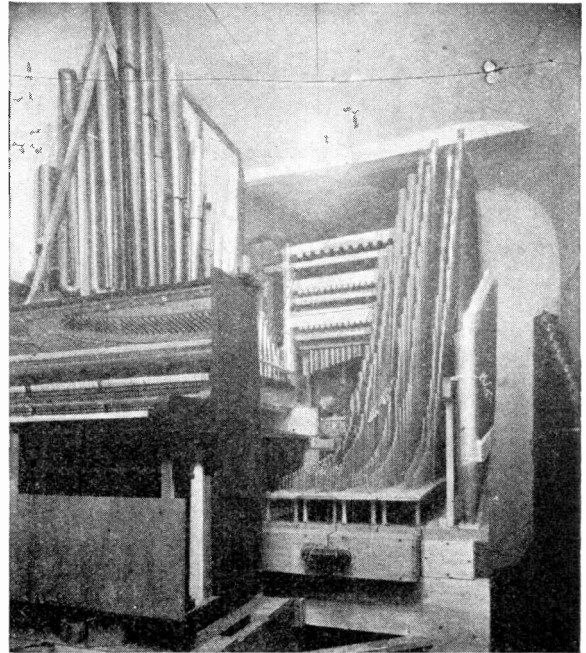

*This strange-looking contraption is actually an installed Compton cinema organ. Behind gilded pipes one can find a multitude of odd gadgets—even an electrically-controlled piano*

Trocadero, and every Wednesday afternoon the Trocadero Orchestra (directed by Alfred Van Dam) goes across in a special road coach to the Troxy. The broadcast from there is in a vestibule closed to the public while the Trocadero Orchestra is on the air.

One other London cinema comes to mind, the Regal at Edmonton. It is from here that Sidney Torch, a very clever organist who has recorded several "hot-hits" for Columbia in the Marble Arch Regal, broadcasts. Personally, I do not enjoy his radio recitals half as much as his records. He seems much more subdued when on the air. The Edmonton Regal is, however, worth a visit.

There are many other cinemas all over the country from which occasional relays, either of the organ or of the orchestra, are made, and it is the exception rather than the rule for the public to be refused admission. It is well worth taking a trip to a cinema when its music is on the air; the orchestras and organists always give of their best.



*A broadcaster who makes frequent appearances on the stages of super cinemas is Billy Cotton. Here he is seen with his band—one of the liveliest crowds that have yet broadcast*

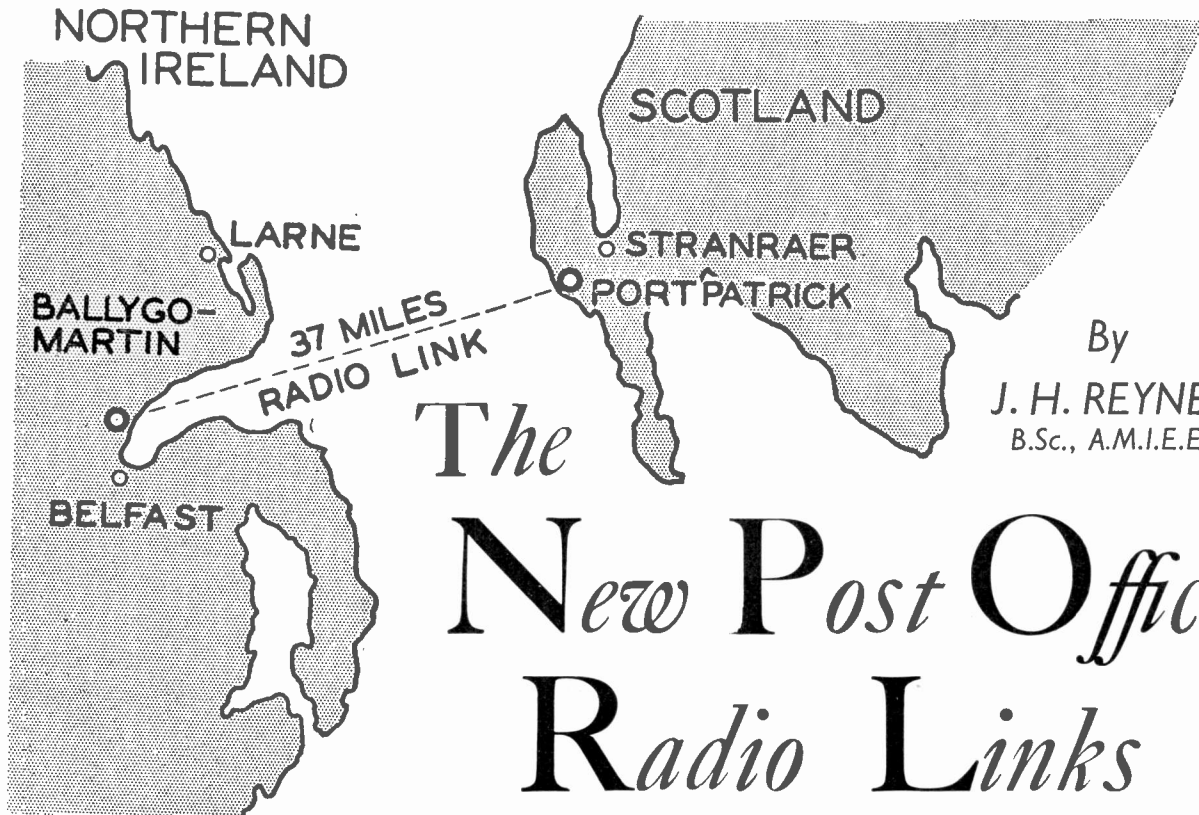

By  
J. H. REYNER  
B.Sc., A.M.I.E.E.

# The New Post Office Radio Links

SOME fifteen years ago there was a jaunt in the Post Office Engineering Department known as the Tíree Trip. A telegram would arrive one morning announcing that the cable between the mainland and the Western Isles had broken down and one of the engineers would proceed forthwith to the wilds of Scotland complete with emergency wireless station.

That was the beginning of Post Office radio links. It was very limited in its scope. Only telegraphy was handled and operators were required at both ends with the result that the service was only in use for a limited period each day.

The comparison between this and the latest radio link opened by the Post Office affords a striking commentary on the progress of radio in intervening years. The rapid increase in the long-distance telephone calls following on the recent reduction in charges has strained the existing resources to the limit in some instances. In particular the traffic to Ireland increased to such an extent that additional channels became urgently necessary.

### Expensive Cable Laying

Yet cable laying is an expensive and lengthy procedure, particularly where telephony circuits are concerned, and the Post Office radio department stepped into the breach with an experimental six-circuit ultra-short-wave radio link. The equipment was installed in a remarkably short time and has proved a striking

success from technical and commercial points of view.

I wonder how many people who have had occasion to telephone to Ireland within the last two months have had any idea that their conversation was not going over the ordinary cable?

The reason that the Post Office engineering people were able to supply the equipment at such short notice was that they had been accumulating data for some time on a similar but less ambitious experimental equipment across the Bristol Channel.

This service was an ideal one for such an experiment because alternative land-line routes were available in

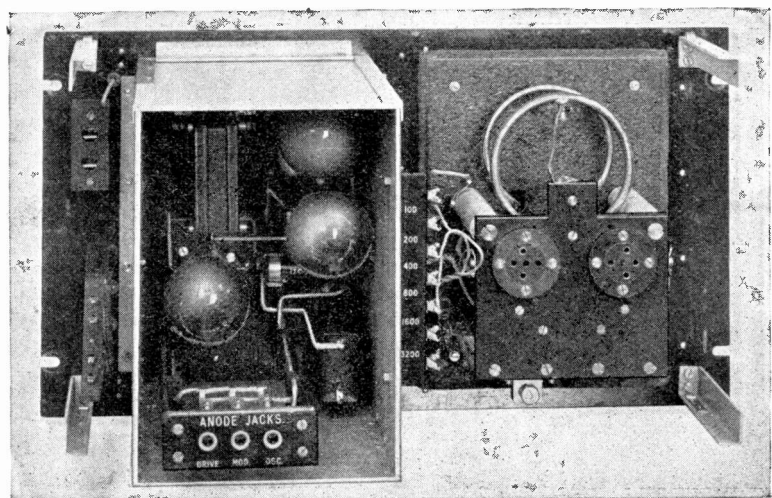

With the oscillator and modulator screens removed it is possible to see the arrangement of the six-circuit single transmitter used

the Severn Tunnel, and in point of fact this particular link is now little used and will probably shortly be discontinued.

It has, however, served its purpose of providing the necessary experience in the use of these exceedingly handy ultra-short waves around the 5-metre mark. Such wavelengths are, in fact, ideal for this type of work.

Since the direct ray is used all the time there is no question of fading. The short wavelength renders the construction of directive aeriels an easy matter and there is practically no interference from atmospheric disturbances. Those who have worked on these wavelengths will know the extraordinary quietness of the circuit, often leading one to suppose that some part of the equipment is not functioning.

### North Channel Link

Let us look at the North Channel link, as it is officially termed, a little more closely. In the first place it provides for six channels. The terminal points are at Portpatrick in Scotland and Ballygomartin in Northern Ireland.

The site at Portpatrick is some 250 ft. above sea level, while that on the Irish side is situated on Mount Gilbert 800 ft. up. We have therefore a direct optical path between the transmitter and the receiver. Both sites have also a slope of a few degrees in the direction of the transmission thereby ensuring the most favourable conditions.

### Wavelengths Between 4 and 6 Metres

Twelve frequencies are in use, six in each direction, the wavelengths used being between 4 and 6 metres. One of the advantages of these ultra-short waves is that the aerial system, or "array" as it is called, can easily be made long relative to the wavelength of the radiation itself.

In such circumstances the current at various parts of the aerial can be quite different, and in fact it is possible for the current in two sections of the aerial only a few feet apart to be flowing in opposite directions! This

being so it is possible to bend the wire in such a manner that the radiation is strongly directional in character. This procedure is adopted in the case of the equipment under consideration.

It is possible to increase these directive properties by fitting reflectors behind the aerial arrays, but in the present instance this is not found necessary and reflectors have been omitted accordingly.

As is usual with such systems the energy from the transmitter has to be fed into the aerial at the right point and in the correct phase, and for this purpose parallel wire transmission lines are used maintained at a

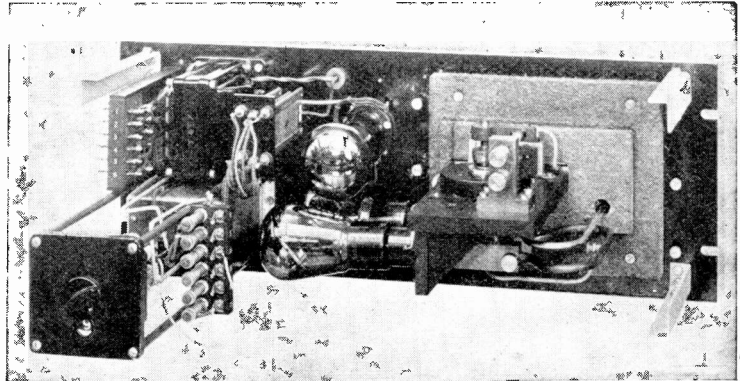

• A front view of the six-circuit short-wave single receiver used in the Post Office link between Ballygomartin and Portpatrick

constant spacing by Pyrex tubes. Similar transmission lines transfer the voltage picked up on the receiving aerial to the receiving equipment.

In order that this transmission of energy shall be carried out without appreciable loss or reflection, the transmission lines are coupled to the aeriels in the receivers by special matching transformers, which are, of course, air-cored and are actually provided with means of varying the coupling between primary and secondary so that the effective impedance of the termination at each end may be made equal to the characteristic impedance of the line.

This question of reflection on transmission lines is one on which we might with advantage say a few words.

Any pair of parallel wires will possess a certain inductance and a certain capacity between them. We can therefore consider a transmission line as made up of a large number of short sections each having its own inductance and capacity as shown in Fig. 1.

### Transmission Line

If we apply voltage at the beginning of the transmission line the first condenser will charge up and at the same time will begin to discharge through the second section into the second condenser. This in turn will begin to charge and also discharge into the third section, and in this way the voltage is transferred along the line until it reaches the far end.

Now all along the line the rate at which the voltage has been building up on each of the condensers in turn depends upon the inductance and capacity of line, and as each section of the

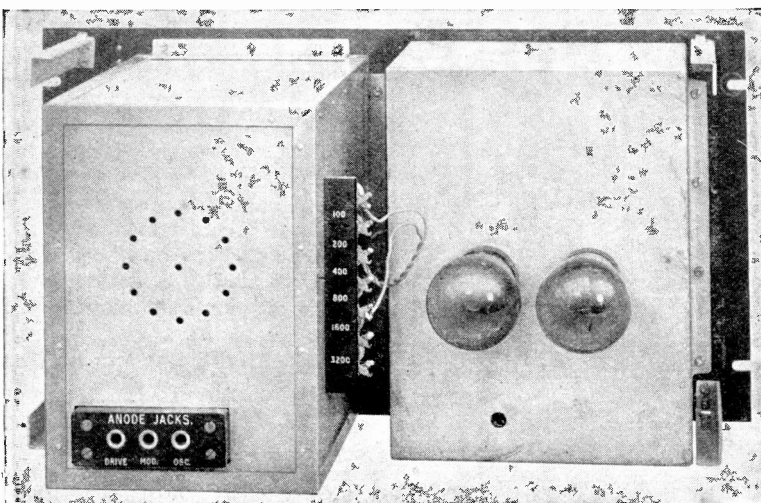

This shows the six-circuit ultra-short-wave single transmitter used in the radio link between Scotland and Northern Ireland



line has been building up in voltage it has also been paying out some energy into the next section.

At the far end of the line we have a sudden change in the conditions. We no longer have more transmission line, but we have some form of terminal equipment such as an aerial or a receiver.

If the impedance of this terminal equipment is such as to accept energy at the same rate as it is building up on the line then everything continues quite smoothly,

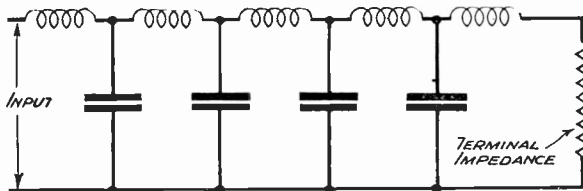

Fig. 1. A transmission line can be considered as made up of a large number of short sections each having its own inductance and capacity

but if this condition is not complied with then there is a surplus of energy which has nowhere to go and this commences to travel back along the line to the sending end.

This is known as reflection and is obviously wasteful, so that for correct operation it is necessary to match the terminal impedance to that of the line, which is known as the characteristic impedance and is determined by its inductance and capacity. It is for this reason that matching transformers are so necessary in transmission systems of this sort.

To revert to our discussion of the actual radio link the transmitters are each of the push-pull type comprising a pair of valves working as self-oscillators, reaction being applied between the grid of one valve and the anode of its partner through small condensers.

### High Frequencies

The anode circuit of the oscillators is tuned, the tuning condenser being compensated for variations in temperature because at these very high frequencies—nearly 100 million cycles per second—a change of a fraction of 1 per cent is more than the whole voice-frequency spectrum to be handled. Consequently, stability is a most important consideration.

As a further means of maintaining constancy secondary cells are used for all power supplies, these voltages being maintained constant by means of gas discharge relays which control the charging equipment.

Westinghouse rectifiers are used for the charging so that there is no rotary machinery at all.

The power output from each transmitter is of the order of

5 watts, and each is anode-modulated by a class-B amplifier fed from the repeaters connected to the normal trunk line. This again is an entirely automatic process and requires no attention.

The receivers are of the super-regenerative type, a form of circuit particularly suitable for these ultra-short waves as it is not only sensitive but not too sharp in its tuning properties while being sufficiently selective to discriminate between neighbouring channels.

A further advantage of this form of receiver is that it gives an inherent automatic control of gain, tending to give a constant output which thus dispenses with the need for voice-operated automatic level control.

### Common Quenching Oscillator

A further interesting feature is that a common quenching oscillator is used for all six receivers. The quenching voltage is fed through buffer amplifiers to the individual receivers in order to avoid cross-talk (that is, interaction between one receiver and another).

The illustrations with this article give some idea of the equipment in use. Although the Post Office authorities insist that the service is of a temporary nature, it will be seen that the equipment itself is of a highly finished character, and it has in fact been giving very satisfactory service in the short time since its installation.

A particularly satisfactory feature is the absence of any need for skilled attention. The frequencies of the transmissions are periodically checked by heterodyning with known harmonics of a crystal-controlled oscillator, but otherwise the equipment operates quite automatically and requires no more attention than a submarine cable.

### More Radio Links

There is every probability that further radio links will be brought into use from time to time as more and more experience is gained. There is in fact a short link already in use between two of the Shetland Islands.

Submarine cables are particularly difficult in localities such as this owing to the strong tides and heavy currents which result in frequent breakdowns. In fact the ultra-short-wave link may prove the solution to many of the problems of the telephone engineer.

Although we have only touched on the outline of these new Post Office developments it is obvious that this go-ahead department is a vital force in the field of radio engineering. The work of Post Office experts in the realm of short waves is obvious to everyone who has followed communication developments during the last year or two.

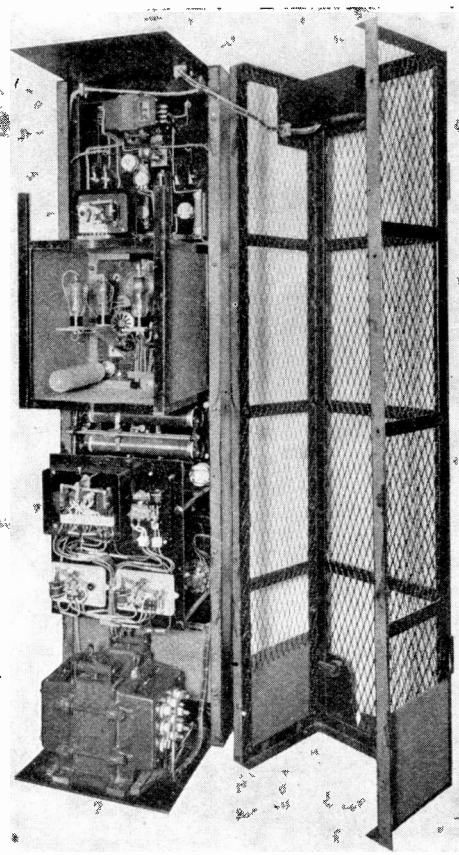

The neat power cubicle of the short-wave link transmitter, which the Post Office states is still in an experimental stage

# Tests of the New Sets

By the "W.M." Set  
Selection Bureau

WE have by now tested the cream of the sets introduced around last exhibition time, and we have learnt a deal from the investigations of the past few months.

That the standard of commercial sets has improved there is no doubt. Both technically and in appearance the improvement over previous years is most noticeable. We have also noted that the set maker to a large extent follows the wishes and desires of the valve maker.

Multi-grid valves of various types have been introduced during the past year and set makers have quickly—too quickly, perhaps—incorporated them in their sets, maybe without sufficient test work beforehand.

We cannot number quality of reproduction among the real improvements. Only a month or two ago Paul Tyers wrote in these pages that quality is, after all, an illusion of the real thing. The set that can produce the best illusion is naturally said to give the best quality.

Perhaps one of the main reasons is that prices have to be competitive with the result that a lot of gear is crammed into a small space and the loud-speaker is not giving of its best.

The home constructor has a definite advantage. He can at the cost of a few pounds build a carefully designed output stage and use a good loud-speaker to produce quality that has, to use a common expression, the commercial set knocked into a cocked hat.

There is tremendous room for improvement in commercial set quality as we know it to-day. We feel sure that the set-buying public would willingly spend a little extra if they knew that it would mean more realistic reproduction. This is the current problem for the set makers!

A number of new sets are making their appearance on the market and details of some will be found elsewhere in this issue. An interesting set is the new Philips Five-Eighty, an A.C. super-het selling at the low price of ten guineas.

Briefly, the circuit consists of an octode frequency-changer, a high-frequency pentode in the intermediate-



*This Cossor 536 A.C. radiogram is in perfectly charming surroundings! It is a radiogram version of the set tested this month and costs only sixteen guineas*

frequency stage, diode detector, and pentode output with an indirectly-heated valve rectifier.

In addition there is a modern horizontal cabinet with a square fret at one end, behind which is a fair-sized permanent-magnet moving-coil loud-speaker. A commendable point, and one that saves the non-technical user a lot of bother, is that the volume control is operative on both radio and on record reproduction when a pick-up is plugged into the sockets provided.

## FREE ADVICE TO PROSPECTIVE SET BUYERS

To make the most of this free advice service, we ask you to answer the following questions:—

- (1) The maximum price you wish to pay, and whether you are prepared to exceed this if there is no suitable set at your desired price.
- (2) The locality in which the set will be installed.
- (3) The stations required, that is, locals only or a selection of foreigners.
- (4) Whether you want an entirely self-contained set or one with external aerial and earth.
- (5) Whether battery or mains driven. If the latter, whether A.C. or D.C.

A stamped-addressed envelope for our reply is your only expense. Address your inquiry to Set Selection Bureau, "Wireless Magazine," 8-11 Southampton Street, W.C.2. Tell your friends about this useful service, exclusive to "W.M."

Chosen for test this month are sets representing a variety of tastes. The Cossor 435A is a fine three-valver; it won't get so many stations as a super-het, but it gives good quality. Ferranti's Gloria is, no doubt, one of the year's star sets. Both in appearance and in results it is almost the last word.

Marconiphone's model 287 radiogram is notable for its low price and for its exceptionally faithful record-reproduction capabilities. H.M.V.'s new console is a delightful piece of furniture, and its performance is well and truly up to H.M.V. standard.

The McMichael Duplex class-B transportable is recommended to those having no mains available and who want an entirely self-contained battery set giving a large output and pleasant quality.



"A neat little masterpiece . . . housed in a choice walnut cabinet of very convenient height."

ONCE again H.M.V. has turned out a neat little masterpiece. This model 444 under review is an A.C. super-het (four valves plus rectifier) housed in a choice walnut cabinet—inlaid with veneers—of a very convenient height. Convenient because the controls are in just the right position for operating from a cosy chair beside the traditional fireplace.

The dial, which is illuminated when the set is working, is let in across the top of the console and is

#### BRIEF SPECIFICATION

BRAND NAME: H.M.V.

MODEL: 444.

TECHNICAL SPECIFICATION: Five-valve (including rectifier) console super-het. The first valve is a heptode (Marconi MX40), which is coupled through a band-pass intermediate-frequency transformer to the intermediate-frequency amplifier (Marconi VMS4). The second detector and low-frequency circuit comprises a double-diode-triode (Marconi MHD4) and output pentode (Marconi MPT4). The indirectly-heated rectifier is a Marconi MU12.

POWER SUPPLY: A.C. mains, 200-250 volts, 50 cycles.

PRICE: £17 17s.

MAKERS: The Gramophone Co., Ltd., 98-108 Clerkenwell Road, London, E.C.1.

marked in wavelengths. Good clear markings that can be read at a fair distance!

The four control knobs are conveniently arranged on the front panel, half-way between the loud-speaker fret and the tuning scale. All knobs are clearly engraved with their functions: from the left they are the volume control and noise-suppressor control; tone; tuner, and combined wave-change, gramo-radio and on-off switch.

Valves used in the four-valve circuit are set out in the panel on this

page. The circuit makes use of a heptode frequency-changer preceded by a band-pass input arrangement to reduce second channel interference. This

is followed by an intermediate-frequency amplifier and, in turn, by a double-diode-triode second detector. One diode of the D.D.T. is for second detection, the other for providing the A.V.C. feedback voltage, while the triode portion is used as a low-frequency amplifier, which is resistance-capacity coupled to the output pentode. High tension is supplied by an indirectly-heated valve rectifier.

Inside, the cabinet is divided into two parts. The top part houses the set chassis and underneath is the loud-speaker. H.M.V. are pretty hot on acoustic problems, and in an attempt to produce life-like quality the loud-speaker compartment is specially shaped.

There is a board running from the bottom of the reproducer to the back of the cabinet. Incidentally H.M.V. tells us that special material is used for making the cone of the loud-speaker.

One noteworthy feature is the system of noise suppression. The noise-suppressor can be set so that only programmes of high entertainment value are received. The actual amount of Q action in use being controlled by a small knob on the back of the set.

We were more than satisfied with the performance of the 444 Console during extended tests carried out only a few miles from a B.B.C. Regional station. The bulk of

# H.M.V. Console A.C. Super-het

these tests were made on our standard 60 ft. outdoor aerial though, as we subsequently found, a small aerial of the indoor variety gave outstandingly good results.

We need say nothing more except that the quality was easily up to that high H.M.V. standard.

Tone can be controlled, that is to say, the amount of top-note response can be varied to suit individual requirements. With the control set for maximum brilliance, reproduction could be classed as a good illusion of the real thing.

With the set working to its full, that is with the noise-suppression system out of circuit, we logged forty-five stations of programme value between 200 and 550 metres.

With the noise-suppressor in circuit and carefully adjusted it was indeed a real pleasure to tour of Europe's best—just fifteen stations of choice entertainment value.

Our long-wave bag included about ten good stations: unlike Oliver Twist, we cannot expect more.

As a real radio entertainer this H.M.V. seventeen-guinea console is sincerely to be recommended.

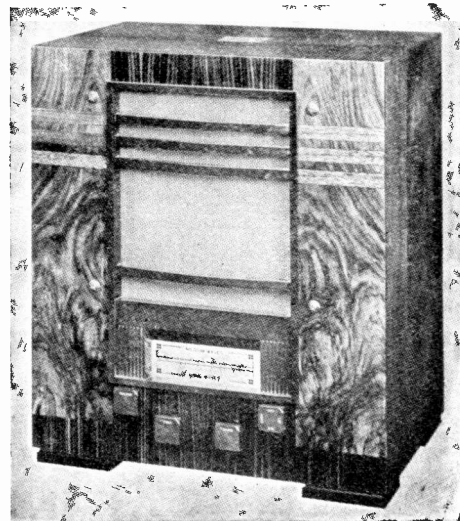

This is the table version of the model 444; it is known as the model 441 and costs £13 2s. 6d.

# Ferranti Gloria A.C. Consolette

**R**EAL ingenuity and brains have combined to produce this latest Ferranti Gloria table set. With no disrespect to other makes we can honestly say that this set is in a class of its own. Naturally one expects a super table set for an outlay of twenty-two guineas—the expecting ones will not be disappointed here.

There is not space to give a long description of the circuit. Let it be sufficient to say that it is a four-valve A.C. super-het with two other valves—making six in all—one being a noise suppressor valve and the other the mains rectifier.

Tradition of radio cabinet makers has been forgotten by the Ferranti

the clock is working.

Of the controls the tuner is in the centre, the on-off switch and volume control on the right, and the wave-change switch on the left. Above the scale is a small knob for adjusting the tone.

This tuning scale and “general factotum” is a triumph for the gadget hunter: every gadget is useful, though! In the centre are station markings—thirty-nine medium and twelve long, each with a small circle beside it. On the left is the visual tuner

and a pointer showing whether the set is tuned to medium or long waves.

On the other side is a scale showing the setting of the tone control—whether mellow or brilliant—and an indicator showing the position of the volume control.

The long pointer actuated by the tuner moves across the scale, and any station marked can be tuned in by setting the pointer so that it passes through the circle to the left of the station name. The adjustment is rather minute; the station is correctly tuned in when the tuning indicator—really a milliammeter needle—is at its maximum dip.

A glance at the “works” inside reveals the sturdy set chassis sprung on rubber at the bottom with the energised moving-coil loud-speaker just above. Ferranti’s have combined the mains voltage-adjustment panel on the same strip as the loud-speaker connections. The panel is accessible and easy to adjust, there being little chance of non-technicians making a mistake.

There is a long switch rod on

the back of the loud-speaker for cutting it out in favour of an external reproducer. On the back of the chassis are the aerial, earth, and pick-up terminals besides a small knob for bringing the noise-suppressor system into operation.

Our tests were carried out with only a small 20 ft. outdoor aerial, and on this we received every station marked on the dial.

### BRIEF SPECIFICATION

**BRAND NAME:** Ferranti.  
**MODEL:** Gloria Consolette.  
**TECHNICAL SPECIFICATION:** Four-valve A.C. super-het with noise-suppressor valve and full-wave rectifier, making six valves in all. Oscillator and first detector (Ferranti VHT4), intermediate-frequency amplifier (Ferranti VPT4), double-diode-triode second detector (Ferranti H4D), triode output (Ferranti LP4), full-wave rectifier (Ferranti R4) and noise-suppressor valve (Marconi Osram MHL4).  
**PRICE:** £23 2s.  
**POWER SUPPLY:** A.C. mains, 200-250 volts, 40-100 cycles.  
**MAKERS:** Ferranti, Ltd., Hollinwood, Lancs.

Selectivity can be summed up by saying that there is no noticeable station overlap except, perhaps, between minor foreign relays, the names of which are not marked on the dial. Quality—a subtle substance to define—must be heard to be believed. The mellow tone is not “woofy”; the brilliant setting is not shrill.

Without hesitation we can honestly say that this set is an achievement of which the makers have every right to be proud!

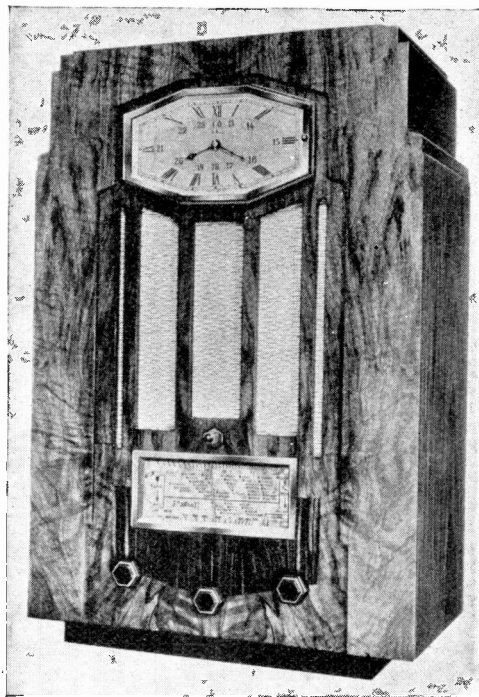

“This set is an achievement of which the makers have every right to be proud”

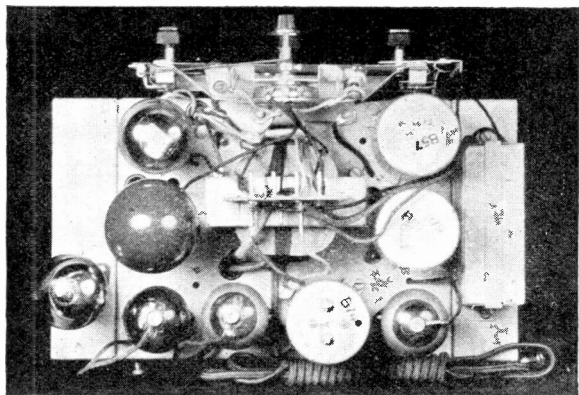

“A glance at the works inside reveals the sturdy set chassis sprung on rubber”

designers. The cabinet is of walnut—15 in. wide, 24 in. high, and 9 in. deep—with an electric clock at the top; the now famous Ferranti dial with the controls at the bottom.

Current is supplied to the clock immediately the set has been connected to the mains, no matter whether the set is switched on or off. This clock is of the synchronous type and must be started by twirling a small knob fitted on the back. There is a small knob by three o’clock, and when this is pulled the clock, which is hinged, slides out; it is then easy to get at the starting knob and the hands adjuster. There is a small second hand which shows whether

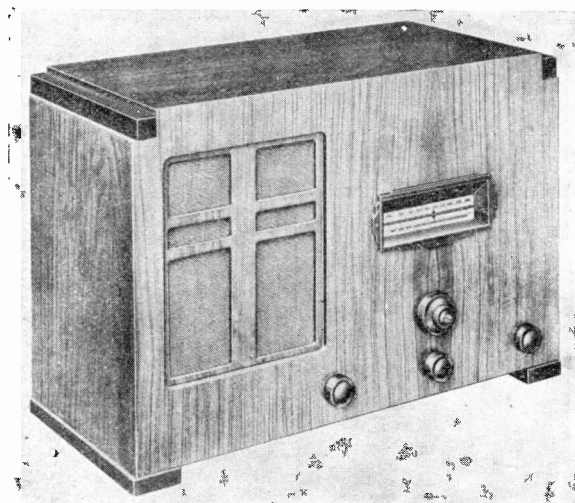

"An excellent proposition for the man who does not want to dip too far into his pocket"

**B**EFORE the vogue of mass-produced super-hets, three-valvers were the sets of the day. They went out of fashion mainly because their selectivity was hardly on a par with a pre-Lucerne congested ether. Three-valvers, like all other sets, have vastly improved during the past two or three years. This Cossor model 435A is a typical example of the up-to-date A.C. three-valver.

Admittedly they are not so selective and will not bring in so many stations as the super-het, but they have their uses—and important ones at that!

This Cossor set has been given stringent tests to find out exactly what it would do under modern ether conditions. In a nutshell, the set will bring between thirty and forty stations on a moderate length aerial with quality that is, on the whole, better than the average super-het.

In other words, the super-het gains on the score of selectivity and the straight set on quality.

The circuit used in this 435A is modern in every respect. There are three receiving valves; the high-frequency stage uses a variable- $\mu$  screen-grid valve. By varying the bias on this valve we have a practically distortionless method of volume control; this is important from the quality point of view.

A high-frequency pentode is used as a power-grid detector with sensitivity above the average. In the output a directly-heated pentode, which gives an output of about 2 watts, is used.

The set, built up on a metal chassis, fits at one end of the horizontal cabinet, the other end being occupied by an energised moving-coil loud-speaker fixed to a

## Cossor 435A A.C. Three-valver

substantial baffle. Of the cabinet itself we need say but little; it is finished in walnut and is, as can be seen from the illustration, of particularly neat design.

Every control necessary to get the most efficient results from the set will be found underneath a full-vision tuning scale—illuminated when the set is on—on the front of the cabinet.

The big knob—the main tuner—has a small knob superimposed; this operates a trimming condenser so that the user can get minute tuning adjustments when logging foreigners. Underneath from left to right are reaction, volume control, and a combined switch embodying long waves, medium waves, pick-up position, and off.

Dial calibrations are in wavelengths only; in steps of 40 metres for the medium waveband and in steps of 100 metres for the long waves. Each section is further sub-divided by means of ten small dots.

We have had the set in use for many days at our laboratories in South London, and have found by actual tests that the inexperienced listener can soon get the knack of bringing in even the weakest of Continental signals at entertainment strength and without interference.

The whole secret of successful tuning can be summed up in the advice that when tuning for distant foreigners the reaction should be advanced until the set is on the verge of oscillation and the volume control retarded as much as possible.

By doing this it is easy to log stations a couple of channels away from the main B.B.C. local station. On the

other hand, with just ordinary knob-tiddling any amount of stations can be brought in quite easily.

On the long waves Droitwich was inclined to spread, but with careful tuning it only occupied a very small section of the scale, leaving plenty of room to log eight or nine other signals.

Quality was definitely very good.

The set is reasonably priced. In fact, it is cheap; but do not let that deter you. It is an excellent proposition for the man who does not want to dip too far into his pocket!

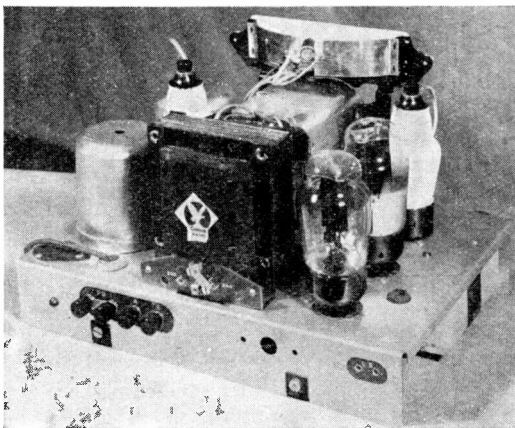

"The circuit used in this 435A is modern in every respect. There are three receiving valves"

### BRIEF SPECIFICATION

BRAND NAME: Cossor.  
MODEL: 435A.  
TECHNICAL SPECIFICATION: Straight A.C. three-valve circuit. Variable- $\mu$  screen-grid high-frequency amplifier (Cossor MV5G), high-frequency pentode detector (Cossor MS/Pen) with a directly-heated power pentode output (Cossor PT41). High-tension is provided by a full-wave rectifying valve (Cossor 442BU).  
POWER SUPPLY: A.C. mains, 200-250 volts, 40-100 cycles.  
PRICE: £9 15s.  
MAKERS: A. C. Cossor, Ltd., Kelvin Road, Highbury, London, N.5.



# Marconiphone 287 Radiogram

**T**HIS is a 1935 radiogram; it was released on February 1. That it is a handsome outfit will be appreciated by a glance at the illustrations on this page. The cabinet, of heavy walnut inlaid with Macassar ebony, is typical of Marconiphone's reputation for good craftsmanship. Quite reasonable is its size: 30 in. high, 27 in. wide, and 17 in. deep.

Inside, the layout of the set chassis and loud-speaker is rather unusual, though typical of the maker's practice. The set chassis is fixed on its side at one end, while the loud-speaker occupies a prominent place in the centre.

This Marconiphone radiogram was delivered to our laboratories with the mains transformer adjusted for 250-volt working—most sets are delivered with this voltage adjustment. We would strongly advise non-technical users to have the set installed by their local dealer, for the mains transformer adjustment panel is hidden away inside the cabinet.

The user will need some slight acrobatic skill to make the adjustment for his own supply, and this is a job that must be carefully carried out.

Other than this, the set is ready for use immediately it is taken out of its packing case; it is wise to make certain that the valves are secure in their sockets, though.

**T**he circuit comprises five valves (four plus a rectifier). First comes a heptode frequency-changer, and this is band-pass coupled to an intermediate-

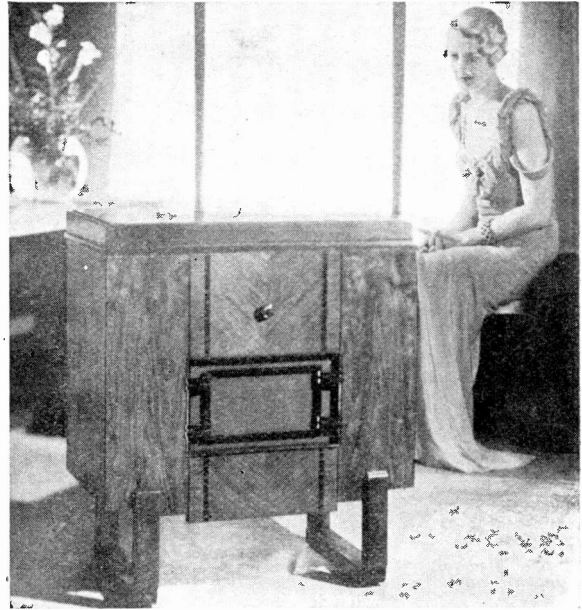

"The cabinet, of heavy walnut inlaid with Macassar ebony, is typical of Marconiphone's reputation for good craftsmanship. Quite reasonable is its size"

frequency amplifier. A double-diode-triode, which acts as second detector, first low-frequency amplifier and also provides the feed-back voltage for A.V.C., is resistance-capacity coupled to the output pentode.

This circuit is typical of modern-day practice and is one which will ensure satisfactory reception in most districts at night and in daylight.

A control on the back of the cabinet operates a variable noise suppressor. This can be adjusted so that *only* stations of good programme value are received—weak signals, mush and all noise being completely wiped out with the exception of a faint background.

A switch on the motor-board will cut out the noise-suppression system so that the user can get the last ounce from the four-valve circuit.

So much for the circuit. With the exception of the volume control on the front and the noise suppressor on the back, all the controls are grouped around the tuning scale—rectangular and marked in wavelengths only—on the motor-board.

**W**e thoroughly tested this radiogram under all manner of conditions. We found that in our locality—30 miles south of Brookmans Park—that a small indoor aerial would give good all-round results.

Selectivity under these conditions was ample; stations with a 9-kilocycle separation could be separated with ease. On the medium waves with the noise suppressor out of circuit we logged about forty medium-wave stations on our short indoor aerial.

Quality is typical Marconiphone. Perhaps there may be a little too much bass for some listeners, but on the whole reproduction was good without any trace of mains hum. We would like to pay a compliment to record-reproducing capabilities of the set—excellent!

## BRIEF SPECIFICATION

BRAND NAME: Marconiphone.

MODEL: 287.

TECHNICAL SPECIFICATION: Five-valve (including rectifier) A.C. super-het radiogram. Valves comprise heptode frequency-changer (Marconi MX40), intermediate-frequency amplifier (Marconi VMS4), double-diode-triode in the second-detector stage (Marconi MHD4), and output pentode (Marconi MPT4). The indirectly-heated rectifier is a Marconi MU12.

POWER SUPPLY: A.C., 200-250 volts, 50 cycles.

PRICE: £23 2s. (non-standard voltages, 5s. extra; non-standard frequencies, £1 1s. extra).

MAKERS: The Marconiphone Co., Ltd., Radio House, Tottenham Court Road, London, W.1.

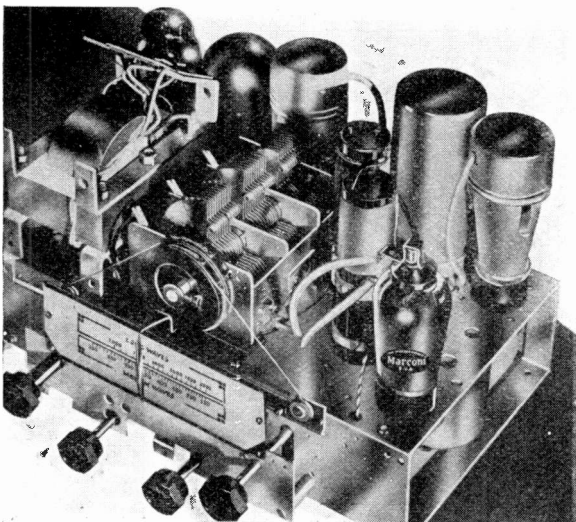

"Circuit is typical of modern-day practice and is one which will ensure satisfactory reception in most districts"

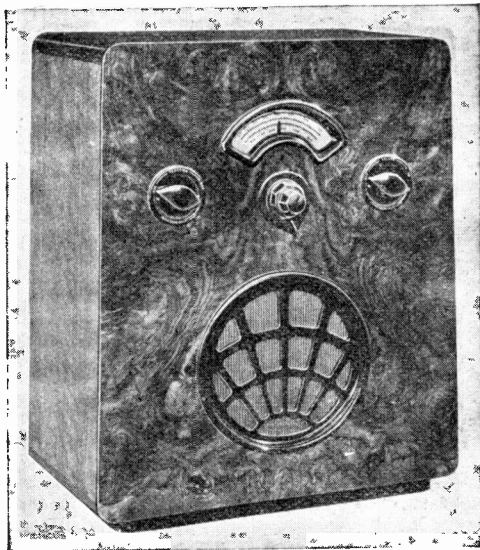

"The five-valve set chassis, batteries and moving-coil loud-speaker are housed in a really solid cabinet"

**T**HIS McMichael transportable under review is really a dual-purpose outfit.

It can serve the purpose of an ordinary domestic set attached to conventional aerial and earth, or it can be moved about like an ordinary portable, the one disadvantage being that it has no carrying handle. In these days of motoring such a set as this McMichael is a handy and economical proposition.

It is strongly made, the five-valve set chassis, batteries and moving-coil loud-speaker being housed in a really solid cabinet, which is fitted with a turntable on its base so that the set can be swung round to profit by the directional properties of the frame aerial.

The circuit used is one which will give eminently suitable results from a frame aerial, that is providing the set is used in civilised parts. We cannot speak of the results likely to be obtained in, say the Shetland Islands, though we have reason to believe that it would work satisfactorily with a fair outdoor aerial.

Five valves in all are used. The first is an ordinary screen-grid used as a high-frequency amplifier. A rheostat in the filament circuit of this valve acts as the set's main volume control; but more about this later.

The other valves are a detector, low-frequency amplifier, a small power valve as a

# McMichael Duplex Class-B Transportable

class-B driver, and a class-B valve. Arranged in the top half of the cabinet is the set chassis, while below all the available space is occupied by the accumulator, the combined high-tension and grid-bias battery, and a permanent-magnet moving-coil loud-speaker of reasonable proportions.

So that there is no chance of damage to the loud-speaker, a wooden partition separates it from the two batteries.

One has only to glance at the outfit to see that it comes from the house of McMichael; the good craftsmanship of the cabinet, with its well-known fret design being a striking point.

**T**here are only three controls on the front. On the extreme left is the reaction control; in the centre the main tuner and wave-change lever; and on the right the combined volume control and on-off switch.

As the tuning knob is turned a pointer moves across a full-vision scale—marked in wavelengths only—from 200-550 metres for the medium band and from below 900 to above 1,900 for the long. It is easy to see

to which waveband the set is tuned. Wave-changing is actuated by a lever at the bottom of the tuner, and this adjusts the length so that the pointer moves across the particular waveband in use.

**A** great advantage of class-B output is that when the set is switched on and no signals are being received, the high-tension current is

## BRIEF SPECIFICATION

MODEL: Duplex Transportable.

TECHNICAL SPECIFICATION: Five-valve battery-operated transportable with class-B output stage. The arrangement consists of a screen-grid high-frequency amplifier (Cossor 2155G), detector (Osram HL2), first low-frequency amplifier (Osram HL2), driver stage (Cossor 215P) and class-B output (Cossor 240B).

POWER SUPPLY: Self-contained combined high-tension and grid-bias battery, and 2-volt accumulator.

PRICE: £14 14s.

MAKERS: McMichael Radio, Ltd., Slough, Bucks.

quite low—in this set about 7 or 8 milliamperes. At normal room strength we found that the high-tension current varied between 9 and 15 milliamperes, the average being in the region of 10.

Operating is easy, though one needs to learn the knack of setting the volume control, for we found that there was a definite time lag between a change in volume-control setting and a noticeable change in volume from the loud-speaker.

With the frame aerial only we managed to log a good twenty signals on the medium band. We naturally moved the set around on its turntable to take advantage of the frame-aerial's directional properties. On the long waves we logged six or seven.

Quality would come under a classification of "decidedly good." McMichael's have a reputation for reliability coupled with a performance above the average. This reputation is clearly in evidence in the design and performance of this Duplex Transportable.



This shows the famous McMichael suit-case portable; another ideal set for use in and out of doors

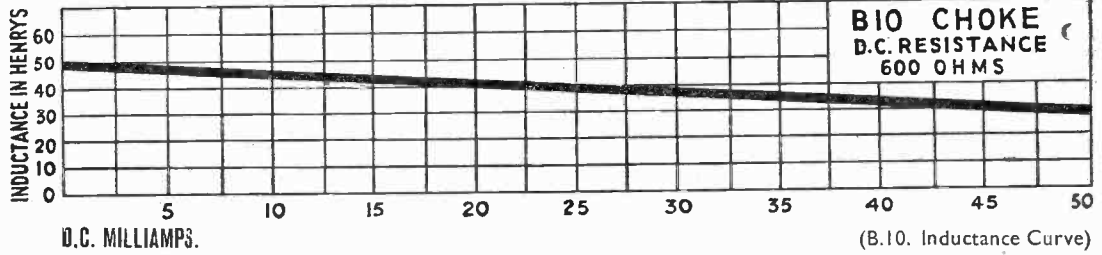

Inductance  
50/30 Henrys

Limiting Current  
50 mA

Approximate  
Resistance  
600 ohms

Dimensions  
3½" x 3½" x 2½"

Weight  
2 lbs. 2½ ozs.

Type  
B 10.

Price  
II/-

Ferranti Limited have been designers and builders of Transformers and other Mains apparatus since 1882; their experience in this branch of engineering, being unrivalled the world over, is a guarantee of the high efficiency, careful design, and good workmanship of every product bearing the Ferranti name.



Write for leaflet W522/1. FERRANTI LTD, HOLLINWOOD, LANCs.

# • USE EDDYSTONE COMPONENTS

—for your STANDARD SHORT WAYER



## Because:

Eddystones have the foremost short-wave components and lead short-wave design. **Ultra short-wave television on 7 metres will soon be here.** For these high frequencies only specialised design will be efficient. Ordinary insulation is inadequate, Eddystone components employ exclusively D.L.9 insulation, a high frequency dielectric pioneered by us and far superior to ordinary insulation. The Eddystone components you buy now will be suitable for the ultra short-wave reception of the future.

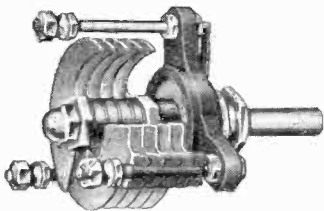

"EDDYSTONE" MICRODENSER  
No. 900  
DL-9 DIELECTRIC  
15 m.mfd. as specified for the Standard  
Short Waver—price 3/9.  
40 m.mfd.—4/3. 100m.mfd.—5/-.



"EDDYSTONE" Short  
Wave Valveholder No. 955  
DL-9 Dielectric  
Suitable for 7-metre work  
and for the Standard Short  
Waver. Price 1/2 each.

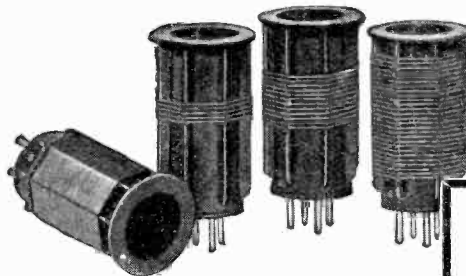

"EDDYSTONE" Short Wave-Coils  
DL-9 Dielectric.  
Set of 4 coils suitable for the Standard Short  
Waver, No. 932, L.B, Y, R and W. Price 16/6 the set.

933B Slow Motion Dial as specified for the  
Standard Short Waver. Price 7/6.

STRAITON & CO. LTD., Bromsgrove St., BIRMINGHAM  
London Service Depot.—  
WEBB'S RADIO STORES, 14 SOHO ST., OXFORD ST., W.1  
Glasgow Service: J. R. HUNTER, 138 West Nile Street

FULL LIST OF  
EDDYSTONE  
SHORT - WAVE  
COMPONENTS  
SENT FREE  
ON REQUEST

# EDDYSTONE

## SHORT WAVE COMPONENTS

**INSIST ON**  
**DL-9**  
(Trade Mark)  
**THE NEW**  
**HIGH**  
**FREQUENCY**  
**DIELECTRIC**

Mention of the "Wireless Magazine" will ensure prompt attention



Mark and Michal Hambourg recording in the H.M.V. studios. Their latest duet—a fine performance—is reviewed this month. (Right) A young tenor, John Hendrik, has taken many leading parts in recent B.B.C. musical productions. He records for Parlophone

**T**HIS month H.M.V. has released a record of the King's Christmas Day message. All the profits from the sale of this record will be devoted to the Industrial Welfare Society. The number is H.M.V. RCS2717.

Out of the bunch of records I have received this month, more than half of them are by artists we hear frequently over the air.

Pride of place is given to the B.B.C. Symphony Orchestra, with Arthur Schnabel as soloist, playing a Mozart piano concerto. That the work is splendidly done goes without saying. This concerto was the last written by Mozart; he died eleven months after its completion. In spite of the fact that Mozart was half-starved and practically penniless when he wrote the work, it is, nevertheless, full of that dainty style for which the composer is famed. The numbers are H.M.V. DB2249-2252, 6s. each.

Another splendid record by the same orchestra is Beethoven's *Fidelio* overture (H.M.V. DB2261). Beethoven wrote four complete overtures to *Fidelio*, and started on a fifth. This is the fourth and the one that is universally known as the *Fidelio* overture. The orchestra is conducted by Bruno Walter. For a massive orchestral rendering this will be hard to beat.

Albert Sandler is a delightful violinist and in company with thousands of other listeners, I always enjoy

his broadcasts. Columbia has produced a twelve-inch record called *Sandler Serenades*. There are only three tunes on each side, so there is hardly any medley effect. He plays the two Heykens Serenades, one being the famous *Standchen*; the others are by Toselli, Lehar's *Frasquita*, and finally *Les Millions d'Arlequin*, by Drigo. (Columbia DX667, 4s.)

**O**nly a Rose from *The Vagabond King* is a great tune! This and such favourites as *Song of the Vagabond*, *Love for Sale*, and *Someday* are included in a *Vagabond King* selection issued by Decca on K739, 3s. Bernice Clare and Carol Deis are the soloists.

For those who appreciate a spot of recorded opera I recommend Conchita Supervia and Manuritta singing *Air du Rosine et Duo* from Rossini's *Barber of Seville* (Parlophone R20267, 6s.). Supervia is a regular broadcaster over here, and on this record you have her at her best.

A growing craze is Silly Symphony tunes—from Walt Disney's film cartoons. Columbia has done a twelve-inch medley in style, with George Scott



# Radio

## A Review of the

Wood conducting the Silly Symphonic Orchestra (Columbia DX666, 4s.). The effects are cleverly done, and the record is one which will amuse the children—and us grown-ups. *Funny Little Bunnies*, *The Grasshopper* and *the Ants*, and *Wise*

*Little Hen* are the best of the tunes.

Ambrose and Band do a similar selection on one side of Decca K745 (3s.), the other side being a transcription of Ambrose's famous signature tune, *When Day is Done*. Ambrose may have dropped out of the limelight, but he still has that inimitable polish which no band can copy. This arrangement—by Munro—shows us polished Ambrose at his best. The varying styles throughout the four and a half minutes are truly amazing.

**A**mbrose has recorded *The Pig Got Up and Slowly Walked Away*—an absolutely harmless tune, the words of which are under the B.B.C. ban—on Decca F5377 (1s. 6d.). A really silly thing, this, and by no means questionable!

Now we come to what I consider are the four best light records of the month. The first is our old radio favourite Ronald Gourley playing a piano medley—with a little whistling—of popular hits such as *Smoke Gets in Your Eyes*, *Continental*, *Who Made Little Boy Blue*, and *Sweetmeat Joe*, *the Candy Man*. Gourley plays them



simply and the recording is outstandingly good. (H.M.V. B8265, 2s. 6d.)

Then there is a record by George Panton (guitar), accompanied by Edgar Jackson and his Sweet Harmony (Decca F5386, 1s. 6d.). He plays *Stay as Sweet as You Are* and *Dust on the Moon*. The next is Les Allen singing *My Kid's a Crooner* and *An Old Lullaby* on Columbia DB1496 (2s. 6d.). Les is assisted by an apparently small kiddie in the first tune, and who is, in all probability, the star of the record. I know I was far more interested in the kid's crooning than in Les.

Harry Roy, on an eighteenpenny Parlophone, records a Roy Medley. There are six of Harry's best "snorters"—*Tiger*, *Twelfth Street*, and *Bugle Call Rags* on one side, and *Chinatown*, *Somebody Stole My Gal*, and *Nobody's Sweetheart* on the other. Of course, this is phenomenal value for 1s. 6d. (Parlophone F100).

Another "smashing" Roy record is *His Majesty the Baby* and *My Kid's a Crooner* on F109. An unusual dance record which I thoroughly recommend is F108—also Parlophone. It is of Robert Renard and band playing *Crazy Fingers* and *Ghosts*, both foxtrots. This French band, with its light-hearted, simple style,

selection played by the Commodore Grand Orchestra (MR1530, 1s. 6d.); Billy Cotton playing *The Man on the Flying Trapeze* and *I Can't Dance* on MR1564, and *Roll Along Covered Wagon* with *We're Just Simple Folk* on MR1562; *Stay as Sweet as You Are* and *June in January* are played by Lew Stone on MR1558; and two songs by Gerry Fitz Gerald, *With Every Breath I Take* and *It's Home* on MR1553.

Best of the latest Brunswicks is Muriel Pollock and Vee Lawnhurst playing that fine tune *Nola*, and *Finesse* on 1911 (2s. 6d.). Two good Brunswick dance numbers are by Fletcher Henderson's Band and Duke Ellington on 1974 and 1973 respectively. Henderson plays *Hotter than Hell* and *Rug Cutter's Swing*, and Ellington gives us *I'm Satisfied* and *Sump'n 'Bout Rhythm*. The rhythm explanation by Ellington is really brilliant—even for him.

In the Columbia lists you will find some fine records by Carroll Gibbons both in the new 1s. 6d. dance music series and as half-crown piano solos.

H.M.V., of course, have their New Mayfair Dance Orchestra on the new 1s. 6d. series. This month's titles include well-known favourites.—T. F. H.

# Favourites on Records

## Latest Record Releases

is a pleasant change from our English bands.

You may remember that in January we heard a broadcast recital of South American records—mostly tangos—which could not be bought for love or money in this country. Now, from Parlophone comes a recording of *Clavelito* and *Amigaso*—both tangos—played by the Orquesta Tipica Francisco Canaro and recorded in Buenos Aires. The record in question is Odeon OT125 (1s. 6d.)—a couple of tangos really worth hearing. *Amigaso* is particularly brilliant. This is quite as good—maybe better—than those broadcast.

A record I would recommend to lovers of Bach's music is H.M.V. B8276 (2s. 6d.) with Mark Hambourg and his daughter Michal playing an arrangement by Mark Hambourg of a chorale from the *Cantata No. 147* on one side, and *Pastorale* from the *Christmas Oratorio* on the other. Perfectly played, this!

Regal-Zonophone's best discs for the month include a *Blossom Time*



The Allen family on parade before the Columbia microphone. Norman and Mrs. Allen have helped Les to make some really good records lately. Les Allen's "My Kid's a Crooner" is reviewed here



# News from the

Conducted by  
G6QB

TO introduce this new feature, here are a few details of the aims and objects of some of the better-known short-wave societies. There are, of course, many small local societies and clubs carrying out valuable work, but in the absence of definite information about their doings I am not mentioning more than one or two of them. I shall be glad to receive reports for inclusion in next month's issue.

# Radio Societies

*Under this heading we propose to publish reports every month of the activities of short-wave and transmitting societies. We shall be pleased to give publicity to any announcements of forthcoming events, etc., and secretaries of short-wave societies, whether national or local, are asked to make the fullest use of this space*

## The Radio Society of Great Britain

The R.S.G.B., the pioneer wireless society in the country and one of the oldest in the world, has gone through some considerable changes since it first saw life as the London Wireless Club. It now boasts the second title of British Empire Radio Union which sounds and is, fairly comprehensive!

For twenty-one years the R.S.G.B. has been fostering the amateur radio movement and it now has a home membership of well over 2,000.

Readers who have the idea that the R.S.G.B. is essentially a transmitters' society should get rid of it at once. One of the chief interests of its members, certainly, is amateur transmission, but one does not have to hold a transmitting licence to be interested in the subject!

More than 50 per cent of the home members are equipped for short-wave reception only and to them is issued a B.R.S. (British Receiving Station) number for identification purposes and for use on their report cards and correspondence.

The Society publishes its own monthly magazine, free to members; it operates a free QSL service for the interchange of reports on transmissions heard; and one of its most important branches is R.E.S.—the Research and Experimental section.

Regular meetings are held, except in the summer months, and the annual R.S.G.B. Convention is an outstanding event, generally held during Radio Exhibition time.

The B.E.R.U. is simply an extension of the R.S.G.B. for overseas members, and most of the radio societies of the Empire take an active part in B.E.R.U. work, and

certainly in world-wide tests, such as the B.E.R.U. contest which has just concluded.

Full particulars of the society may be obtained from the Secretary at R.S.G.B. headquarters, 53 Victoria Street, London, S.W.1.

## The Anglo-American Radio and Television Society

The A.A.R. & T.S., as its name implies, has television as one of its chief interests, but has also a strong short-wave membership for whom tests and meetings are arranged. A recent meeting took the form of a midnight DX party at which members' sets were compared under working conditions on real long-distance transmissions.

Full particulars may be obtained from Mr. Leslie W. Orton, Kingsthorpe, Willowbank, Uxbridge, Middlesex.

## The International Short-Wave Club

The International Short-wave Club, of East Liverpool, Ohio, U.S.A., is essentially a club for short-wave broadcast listeners. There are three chapters of the club in this country, and the London address is 10 St. Mary's Place, London, S.E.16, where Mr. Arthur Bear, the secretary

of the London Chapter, may be found.

Each chapter holds its own local meetings; London at the R.A.C.S. Hall, Wandsworth Road, S.W.8.

A monthly publication, *International Short-wave Radio*, is circulated to members. It is occupied chiefly with lists of short-wave broadcast stations and news of new stations heard by members. Various receiving competitions are organised.

## The International DX-ers' Alliance

The I.D.A. is another body with its main headquarters in the U.S.A., and its objects are rather similar to those of the I.S.W.C. with the exception that DX reception on the ordinary broadcast waves is an additional interest of the club. A monthly publication called *The British Globe-Circler* is forwarded to members. Prospective members in this country should get into touch with Mr. R. L. Rawles, Blackwater Corner, Newport, I.O.W.

## Local Societies

There are, all over the country, a number of local transmitting societies as well as clubs interested only in short-wave reception and television. Most of the transmitters' societies are affiliated to the R.S.G.B. and work in close co-operation with that body, their main object being to bring local members together at regular meetings and social functions.

I shall be specially glad to receive regular news from the secretaries of such societies, so that we may keep readers posted with dates of forthcoming tests, field days, and similar events.

### AN INVITATION

Secretaries of short-wave and transmitting societies are invited to make full use of this new feature in "W.M." Contributions and notices should be addressed to G6QB, c/o the Editor, "Wireless Magazine," George Newnes, Ltd., 8-11 Southampton Street, London, W.C.2



**PAY LESS FOR YOUR VALVES  
RECEIVE MORE FROM THEM**

**READ WHAT THE  
"WIRELESS MAGAZINE"  
SAYS ABOUT**

**TUNGSRAM  
BARIUM VALVES**

PRICES  
FROM  
**3/9**

Referring to the newest addition to the Tungfram range — a Battery Heptode — the "Wireless Magazine" technical staff say:— "It is a great achievement and is a definite step towards bringing down the total filament consumption with multi-valve sets."

Still further proof of Tungfram supremacy.

Expert preference for Tungfram valves is based on their efficiency. Yet they actually cost less than other valves.

Vast technical experience coupled with the advanced production methods employed in Tungfram's London factory have made this possible.

There are Tungfram valves to suit every set.

British made types are now on sale at your nearest Tungfram dealers. May we send you his name and address?

Tungfram Electric Lamp Works (Gt. Britain) Ltd.  
72 Oxford Street, London, W.1.

Factories in London, Austria, Czechoslovakia, Hungary, Italy & Poland

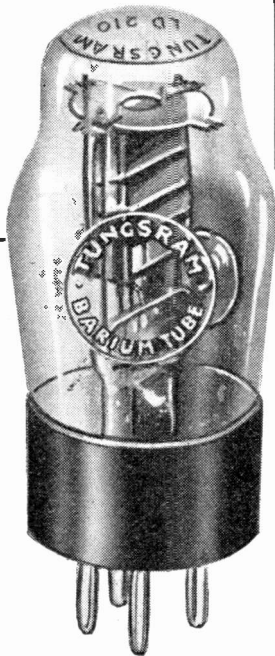

# FOR THE H.K. FOUR

This Varley Choke is wound on a sectionalised former and combines a high inductance with a low self capacity. Specified by the designer, it is extremely suitable for this particular circuit.

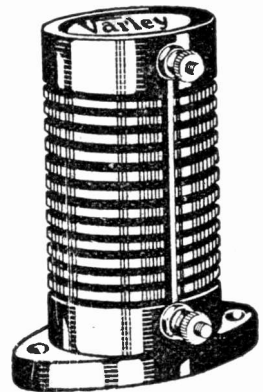

## JUNIOR MULTI-CELLULAR H.F. CHOKE

(List No. BP2)

**3/6**



One of the famous Varley L.F. Chokes. The Varley range of these components is comprehensive. It covers most requirements, including chokes for output filter circuits, smoothing in power circuits, and choke feeding power detectors. Use this Pentode Output choke for the H.K. Four — it's specified.

## PENTODE OUTPUT CHOKE

(List No. DP9)

**15/-**

This "Nicore" A.V.C. unit enables automatic volume control to be fitted to almost any type of receiver. It is specified for the H.K. Four — the set described fully in this issue of "Wireless Magazine."

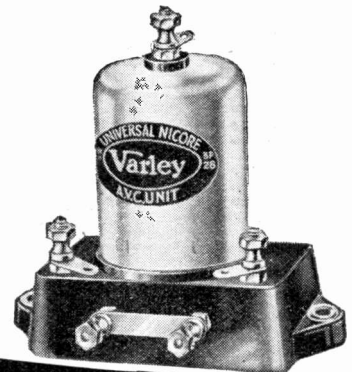

## "NICORE" A.V.C. UNIT

(List No. BP28)

**15/6**

# Varley

(Oliver Pell Control Ltd.)

Bloomfield Road, Woolwich, S.E.18. Phone: Woolwich 2345

Better service results from mentioning "Wireless Magazine" when writing to advertisers

# Radio and the Lone Flyer

John Grierson's Lecture to the R.S.G.B.

AT a meeting of the Radio Society of Great Britain held on January 25, Mr. John Grierson, the well-known pilot, gave an interesting talk on his experiences during his flights of 1933 and 1934.

Mr. Grierson, it will be remembered, flew from England to Canada via the North Atlantic route—Iceland, Greenland, and Hudson Bay.

Several R.S.G.B. members had had the privilege of co-operating with him on his second flight by keeping watch on his low-power short-wave signals, and the talk was of especial interest to them.

Mr. Grierson's plane was equipped with the Marconi-Robinson Homing device, operating on 600 metres, and also with a 5-watt transmitter working on 34 metres. He was not able to carry out two-way working on either wavelength,

but simply to "home" on fixed stations on 600 metres, and send out details of his position on 34 metres.

Actually the wonderful little 5-watt transmitter was heard well in this country during most of the flight.

The Homing device operates with a loop and a trailing aerial working together. A three-point switch is the only control about which the pilot has to worry, once he has adjusted the receiver to the station for which he is making. When he is on his true course, the centre position of the switch should give true zero, with a signal of equal intensity on each side position.

The operation is simplicity itself, and never once did it fail Mr. Grierson. On one occasion he was perilously near to being lost on the east coast of Greenland, but that was simply because the Angmagsalik station was transmitting for his

benefit at the precise times at which he was sending out his hourly short-wave calls.

One amusing incident (although it might easily have had a grim sequel) is worth mentioning. While flying over the ice-cap between the two coasts of Greenland, Mr. Grierson changed over to his rear petrol tank.

A few moments later the engine began to miss, and eventually petered out altogether.

Turning quickly, but without the slightest hope of reaching the sea, Mr. Grierson sent out the following: "Making forced landing on ice-cap. Please search. SOS. SOS." A few moments later he made the tremendous discovery that the front tank had been turned off, and the rear one was not turned on! Rectifying things without losing much time, he soon had the engine going again and was able to carry on.

At this he hurriedly grabbed the key and sent "OK OK OK OK . . ." A few moments after this he noticed that the transmitter had not been switched on! G6QB

Compiled for "W.M." by Jay Coote

## "W.M." Short-wave Identification Panels

**Metres: 31.25**    **LISBON (CT1AA)**    **Kilocycles: 9,600**  
**Power: 2 kw.**

(Portugal)

**Geographical position:** 9° 8' 00" W; 38° 42' 00" N.  
**Standard Time:** Greenwich Mean Time.  
**Announcer:** Man (occasionally a woman when relays are made of programmes from the Lisbon National station).  
Announcements are usually made in Portuguese, French, English and sometimes in Spanish and German.  
**Call:** "Aqui Estacao Radio Colonial Lisboa"; in English: "Radio, Colonial Lisbon CT1AA calling."  
**Interval Signal:** Cuckoo (2 notes: G, E) repeated three times.  
**Times of Transmission:** G.M.T. 21.30-24.00 (Tuesdays, Thursdays, Saturdays.) Studio concerts, gramophone records, talks, etc.  
Frequently relays broadcasts from the Lisbon-Barcarena National transmitter.  
Closes down with the playing of the Portuguese National Anthem: "A Portuguesa."

**Call:**                    **SZEKESFEHVAR**                    **Kilocycles:**  
**HAS3**                                       **15,370**  
**HAT**                                       **5,400**

**Metres: 19.52 (20 kw.) 55.56 (20 kw.)**

**Geographical position:** 18° 24' 00" E; 47° 03' 40" N.  
**Standard Time:** Central European (G.M.T. plus 1 hour).  
**Language:** Magyar; also frequent announcements in German and French.

**Announcers:** Man and woman.  
**Call:** "Hallo! Itt Radio Budapest" (followed by names of relays when programme is taken from capital studio).

**Interval Signal:** Musical box melody.  
When plays are transmitted a gong is struck at beginning and end of each act.

**Times of Transmission:** G.M.T. HAS3 13.00-14.00 (Sunday), HAT 01.00-02.00 (daily).

Closes down with goodnight greetings in several European languages; followed by the Hungarian National Anthem.

# POLAR

SPECIFIED-without alternative  
for the

## STANDARD 4 VALVE SHORT-WAVER

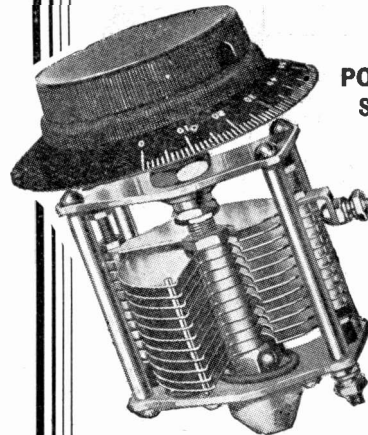

**POLAR TYPE "C"**  
**S.W. CONDENSER**

Fast and slow motion.  
All Brass. Double  
Spacing. Silent  
phosphor-bronze  
ball-bearings.

**One Required**  
**.00015 . . 8/6**

**One Required**  
**.0001 . . 8/3**

Also made in .00025, 9/6

## WINGROVE & ROGERS LTD.

188/189, STRAND, LONDON, W.C.2.

Phone: Temple Bar 2244.

Works: Old Swan, Liverpool

6392

## THE "H.K." FOUR

Continued from page 98

expensive. Only in a really stable set can one appreciate the advantages of tone control.

All of the baseboard components should be screwed down and wired up as far as possible before the bridge piece with its components is screwed into place. Also, all connections running between parts on the two different levels should be cut roughly to length and attached to the appropriate points on the main baseboard. Notice that the earth side of each pair of variable condensers is connected to a terminal at the back (this is for the moving plate assembly) while the fixed plates of each unit of each pair are taken out to two terminals, one on each side. This is a great convenience in wiring, and you will notice that this double terminal arrangement is made use of in our layout.

## About the Wiring Plan

Notes on wiring diagram: the shelf is shown moved away to expose parts below. Wires running from one level to another shown broken, with ends similarly lettered. Thus, from high-frequency choke on shelf runs a wire marked "C." This joins up with one marked "C" from 1-microfarad condenser beside V5.

Another example: a wire leaves terminal H.T.+2 and goes through hole "O." It emerges again through another hole "O" beside 1-megohm resistance near V5.

Note that connections are made to each of the holding-down screws of second gang condenser; these are merely earthing leads from various points. The connections from .0001-microfarad condensers on shelf may be taken to terminals No. 1, 2, or 3 on the associated coils. (Selectivity control.)

When the set is finished and the valves are in place, low-tension and high-tension supplies can be connected up and the set tried and operated complete without its cabinet.

The detector valve should be given 120 to 150 volts, the output 120 to 150, the screening grids 60 to 80, and the anodes of the high-frequency amplifiers 120 to 150.

## Critical Voltages

These voltages are very critical, and a little experimenting with screen-grid voltages is interesting. Next month the adjustment of the "H.K." Four for best results will be described and test reports published

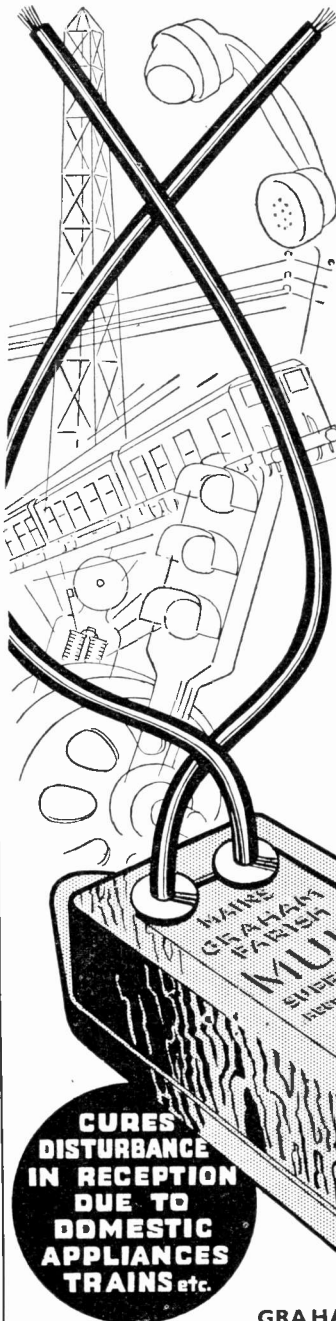

**Abolish those irritating disturbances!**

**fit a**

**MUM**  
**INTERFERENCE SUPPRESSOR**

Every listener knows, and hates, those irritating mains noises. They completely ruin radio reception. They are caused by trains, trams, telephones, bells, and all sorts of electrical devices, but can be cured by "Mum," the Interference Suppressor—and cured for good. To fit "Mum" is the work of a moment and the improvement is a revelation. Your programmes will come through with a purity you've never known before.

Simple fixing instructions are enclosed in every "Mum" carton, enabling the veriest novice to install "Mum" with the minimum of trouble. Ask your dealer for an introduction to "Mum" to-day.

GRAHAM FARISH LTD., BROMLEY, KENT.

## Special Notes

IN the test report of the Marconi-phone model 287 radiogram we omitted to point out that this model, in company with two others, comprise the new Jubilee range released by this firm on February 1.

Will readers note that to the list of parts required for the short-wave set, described in this issue, should be added one Bulgin short-wave high-frequency choke.

On page 139 the Set Selection Bureau states that details of new 1935 sets will be found elsewhere in this issue. We regret that through lack of space this feature has been held over until next month.

Two small mistakes occur on page 129 of this issue. The type number of the Eddystone dial should read 933B and not 9338. Incidentally, the last complete sentence on this page should read: "As the condenser in this set has a further .000015-microfarad . . ."

# In Tune with the Trade

## FERRANTI RADIO—1935

FOR a solid half-hour I have been drinking deeply of a new catalogue sent to me by the enthusiastic Sales Manager of Ferranti, Ltd. By the way, this firm has just finished building a huge new radio factory at Moston, Lancs; the floor area is 260,000 square ft., and Ferranti hope to employ about 3,000 people. That's the stuff to give 'em!

Now about this catalogue. In a nutshell it lists and illustrates every type of radio part made by Ferranti with the exception of complete sets. There is no need for me to mention efficiency and finish of these parts—that goes without saying. I will, however, mention price. The cry has always been: "Ferranti, marvellous stuff, but what prices!" This is all wrong nowadays.

Ferranti make the *best* for which one has to pay good prices, but they also make a range of reasonably priced parts within the reach of everyone.

### SEND TO US FOR THESE CATALOGUES!

Here we review the newest booklets and folders issued by four manufacturers. If you want copies of any or all of them, just cut out this coupon and send it to us. We will see that you get all the literature you desire. Please indicate the numbers (seen at the end of each paragraph) of the catalogues you want below:—

My name and address are:—

Send this coupon in an unsealed envelope, bearing 4d. stamp, to "Catalogue Service," WIRELESS MAGAZINE, 8-11 Southampton St., W.C.2. Valid till March 31.

I do suggest that you ask for this 32-page book. Transformers, chokes, condensers, wave-traps, potentiometers, loud-speakers and meters are just a few of the items—and valves, of course! **445**

## WEARITE'S LATEST

FROM Wright & Weaire I have received their latest catalogue, and it is typical of Wearite. I sincerely recommend this publication to all enthusiastic amateurs. It is not merely a catalogue of pictures, types and prices, but Wearite have gone to great pains to show constructors how to make the "bits" work in typical circuits.

Of special interest is the page devoted to mains interference. Wearite make the special chokes needed to stop—or at least reduce—mains noise and, besides a long discussion on the subject, they give circuit diagrams of a simple nature so that ordinary listeners can rig up the gear without trouble.

With Wearite one naturally associates coils. Here are pages devoted to dozens of different types and circuits are given showing how they should be used. **446**

## ALL-BAKELITE PICK-UP

DON'T take the title too seriously! This title means that the actual pick-up mechanism is housed in an all-bakelite case. Graham-Farish have sent me a leaflet describing their new pick-up which sells at the extraordinary low price of 14s. 6d.

On this leaflet they reproduce a curve showing the performance, and from this I gather that it must be

## EXAMINER Reviews the Latest Catalogues

remarkable value for money. The makers claim a good response down to 50 cycles and a sharp cut-off at the needle-scratch frequency.

I suggest that if you want a cheap pick-up with a fairly good performance you write for a copy of this leaflet. **447**

## THE WESTINGHOUSE ANNUAL

ONCE a year I get a copy of the All-metal Way from the Westinghouse Brake and Saxby Signal Co., Ltd. Every year this very valuable publication becomes more valuable and helpful. Let me remind you, first of all, that applications for this book must be accompanied by 3d. in stamps to cover the cost of postage.

You can learn a tremendous amount from the "All-metal Way." It describes the principles of automatic grid-bias, eliminator design, principles of rectification and the different types of metal rectifiers available for such work.

Then there is a special section devoted entirely to the little metal rectifiers known as Westectors. This section shows how they can and should be used in super-hets and as detectors in ordinary straightforward sets. In fact every use for every type of metal rectifier is described. Don't forget the stamps! **448**

## TUNE IN TO AUSTRALIA OR AMERICA with a HYVOLTSTAR

### UNIVERSAL Receiver

All Waves—ALL MAINS AC/DC

NOTE THE LOW PRICES! Universal All-Waves Super 5 (19 to 2,000 m.) Chassis and Valves, 14 gns. Complete Table Model, 18 gns. Table Radiogram, 24 gns. Universal All-Waves Super 7 (13 to 2,000 m.) Chassis and Valves 22 gns. Table Model 26 gns. Table Radiogram Model 30 gns. Console Radiogram with automatic Record changer, 40 gns. Have *Hylvoltstar* on Approval! Write for leaflet F.

UNIVERSAL HIGH VOLTAGE RADIO LTD., 28-29 Southampton Street, Strand, W.C.2. Phone TEMple Bar 4985.

## Universal all-wave KITS for Sets worth building

All Waves, All Mains AC/DC

The only up-to-date and really economical proposition for home constructors is a universal All wave Receiver Kit for A.C./D.C. Mains.

A comprehensive range is available, the finest Receivers at the lowest cost, including All-wave Superhets, Radiograms and Amplifiers.

Write for leaflet F giving particulars of all our models to

EUGEN J. FORBAT, SOLE AGENT, 28-29 SOUTHAMPTON STREET, STRAND, W.C.2. Telephone: TEMple Bar 8608.

## Let us MODERNISE your Receiver

We can convert any type into an up-to-date UNIVERSAL

Whatever its type or make we can convert your Set into a thoroughly up-to-date UNIVERSAL A.C./D.C. ALL-MAINS RECEIVER with Ostar-Ganz High Voltage Valves. The cost is not great and the improvement will astonish you. Send your Set Carriage Paid and we will quote you free. Or write for full particulars to the CONVERSION DEPT. (F)



# FREQUENCY CHANGERS

A very high efficiency, approaching 1.5mA/V., can be obtained with a Marconi MS4B as a frequency changer. If, however, A.V.C. control is required, this figure is reduced some 60% or more, as the rectifier efficiency drops very considerably. Thus we are led to employ the heptode, which also possesses important advantages as regards simplicity and even operation over a wide range of frequencies.

The Marconi range therefore includes these heptodes:—

- Marconi X21 for 2-volt batteries.
- Marconi MX40 for A.C. circuits.
- Marconi X30 for A.C., D.C. and Car Radio.

Send a card to The Marconiphone Company Ltd., Radio House, Tottenham Court Road, W.1, for the New Marconi Valve Catalogue and helpful information on Short Wave and broadcast reception.



# MARCONI

# VALVES

THE CHOICE OF THE EXPERTS



For the Connoisseur  
**ROTHERMEL-BRUSH**  
**DE LUXE HIGH FIDELITY**  
**PICK-UP**



Designed in collaboration with Mr. P. Wilson, Technical Editor of the "Gramophone."

The new Rothermel-Brush De Luxe Piezo-Electric high fidelity Pick-up provides an amazing performance of a character hitherto believed impossible. With an average output of 1.8 volts there are no pronounced peaks over the entire frequency range up to 10,000 c.p.s. The bronze finished arm has a swivel head to facilitate needle change and bearings are damped in order to eliminate resonances. The base has a ball race movement.

**PRICE £4.40**

Get to know more about this revolutionary high fidelity model, also our standard model crystal pick-up, tweeters, speakers and microphone by writing to-day for a copy of "PIEZO-ELECTRICITY"—a technical treatise on the application of Rochelle Salts to high fidelity reproducers. Price, 9d. post free.

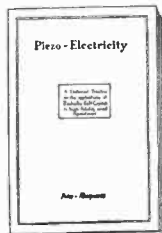

*R.A.R. Rothermel* LTD

Rothermel House,  
 Canterbury Rd., High Rd., Kilburn, N.W.6.  
 Phone: Maida Vale 6066.

# J.B. NEUTRALIZING CONDENSER

Catalogue No. 1050

PRICE **3/6**

This Jackson Bros. Neutralizing Condenser has been specified for Mr. Thomas' Short Wave Receiver. It is an instrument of most advanced design. Extremely simple, incorporating the best possible materials—the Knob and End Plates are of pure ebonite. The Knob is slotted so that an ordinary screwdriver may be used as an extension handle if necessary. Be sure of the best results from your set by using this fine Jackson Brothers' condenser.

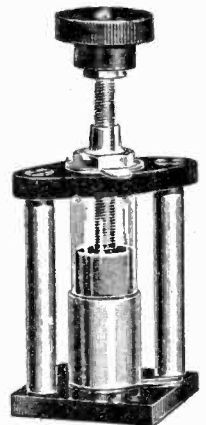

PRECISION INSTRUMENTS

Jackson Bros. (London) Ltd., 72 St. Thomas St., London, S.E.1.

Tel.: Hop 1837

Advertisers like to know you "saw it in the 'Wireless Magazine'"

# World's Broadcast Wavelengths

Stations best received in the British Isles are indicated in bold type. This list is corrected up to the time of going to press

Note: Names in brackets are those of the main stations from which the greater part of the programmes are relayed

Wave-length	Name of Station	Dial Readings	Country	Wave-length	Name of Station	Dial Readings	Country
13.93	Pittsburgh W8XK .. ..		United States	31.48	Schenectady W2XAF (WGY)		United States
14.00	Deal W2XDJ .. ..		United States	31.55	Daventry (Empire) GSB .. ..		Great Britain
14.49	Buenos Aires LSY .. ..		Argentina	31.55	Melbourne VK3ME .. ..		Victoria
14.58	Bandoeng PMB .. ..		Java	31.55	Caracas YV3BC .. ..		Venezuela
15.92	Bandoeng PLB .. ..		Java	31.58	Rio de Janeiro PSA .. ..		Brazil
16.36	Lawrenceville (N.J.) WLA .. ..		United States	31.6	Skamleback .. ..		Denmark
16.38	Rugby GAS .. ..		Great Britain	31.71	New Brunswick WKJ .. ..		United States
16.5	Drummondville (CFA8) .. ..		Canada	31.9	Bandoeng PLV .. ..		Java
16.56	Bandoeng PMC .. ..		Java	32.71	Lawrenceville WNA .. ..		United States
16.56	Buenos Aires LSY3 .. ..		Argentina	32.79	Maracay YVQ .. ..		Venezuela
16.81	Bandoeng PLF .. ..		Java	32.88	Szekesfehervar HAT4 .. ..		Hungary
16.85	Kootwijk PCV .. ..		Holland	33.26	Rugby GCS .. ..		Great Britain
16.86	Daventry Empire GSG .. ..		Great Britain	33.59	Rocky Point (N.J.) WEC .. ..		United States
16.878	Boundbrook W3XAL (WJZ) .. ..		United States	34.68	London VE9BY .. ..		Canada
16.88	Eindhoven PHX .. ..		Holland	36.65	Rio de Janeiro PSK (PRA3) .. ..		Brazil
19.47	Riobamba PRADO .. ..		Ecuador	37.04	Quito HCJB .. ..		Ecuador
19.52	Szekesfehervar .. ..		Hungary	37.33	Rabat (CNR) .. ..		Morocco
19.56	Schenectady W2XAD (WGY)		United States	37.41	Suva VPD .. ..		Fiji Isles
19.61	La Paz CP4 .. ..		Bolivia	38.07	Tokio JIAA .. ..		Japan
19.63	New York W2XE (WABC)		United States	38.47	Radio Nations HBP .. ..		Switzerland
19.67	Coytesville N.J. WIXAL (WEEI)		United States	38.65	Kootwijk PDM .. ..		Holland
19.67	Tashkent (Rim) .. ..		U.S.S.R.	39.34	Tashkent RIM .. ..		U.S.S.R.
19.68	Radio Colonial FYA .. ..		France	39.76	Moscow RK1 .. ..		U.S.S.R.
19.72	Saxonburg W8XK (KDKA)		United States	39.82	Riobamba PRADO .. ..		Ecuador
19.74	Zeeseen DJB .. ..		Germany	40.3	Radio Nations H8Q .. ..		Switzerland
19.82	Daventry (Empire) GSF .. ..		Great Britain	40.5	Bogota HJ3ABB .. ..		Colombia
19.84	Rome (Vatican) HVJ .. ..		Italy	40.54	Rocky Point WEN .. ..		U.S.A.
19.88	Moscow (RK1) .. ..		U.S.S.R.	41.55	Bogota HKE .. ..		Colombia
19.93	W8XK, Saxonburg (KDKA)		United States	41.6	Las Palmas EA8AB .. ..		Canary Isles
20.27	Rocky Point WQV .. ..		United States	41.67	Singapore VSIAB .. ..		Sis. Sett'l'mts.
20.31	Rocky Point N.Y. (WEB)		United States	41.84	Granada YN6RD .. ..		Nicaragua
21.43	Cairo SUV .. ..		Egypt	41.9	Manizales HJ4ABB .. ..		Colombia
21.53	Rocky Point WIK .. ..		United States	43	Madrid EA4AQ .. ..		Spain
21.58	Rocky Point WQP .. ..		United States	43.86	Budapest HAT2 .. ..		Hungary
21.605	Rocky Point WQT .. ..		United States	44.61	Rocky Point WQO .. ..		United States
21.83	Drummondville CJA8 .. ..		Canada	44.96	Maracay YVQ .. ..		Venezuela
22.26	Rocky Point WAJ .. ..		United States	45	Guatemala FM8KR .. ..		Tunis
22.48	Santa Rita YVQ .. ..		Venezuela	45	Guatemala City .. ..		S. America
22.684	Zeeseen (DHB) .. ..		Germany	45.02	Moscow RW72 .. ..		Ecuador
23.39	Radio Maroc (Rabat) CNR .. ..		Morocco	45.38	Barranquilla (HJ1ABB)		U.S.S.R.
24.41	Rugby GBU .. ..		Great Britain	46.53	Boundbrook W3XL (WJZ)		Colombia
24.9	Kootwijk PDV .. ..		Holland	46.69	Boston WIXAL (WJZ)		United States
25	Moscow RNE .. ..		U.S.S.R.	46.7	Calif HJ5ABB .. ..		United States
25.25	Radio Colonial, Paris (FYA)		France	47.5	S. Domingo HI2 .. ..		Colombia
25.25	Saxonburg (Pa.) W8XK (KDKA)		United States	47.8	Domingo HIAA .. ..		Dominican R.
25.28	Daventry (Empire) GSE .. ..		Great Britain	48.75	Winnipeg CJRO .. ..		Canada
25.34	Wayne W2XE (WABC)		United States	48.78	Caracas YV3BC .. ..		Venezuela
25.4	Rome ZRO .. ..		Italy	48.86	Saxonburg (Pa.) W8XK (KDKA)		United States
25.45	Boston WIXAL (WEEI)		United States	49	Moscow (RKK) .. ..		U.S.S.R.
25.49	Zeeseen DJD .. ..		Germany	49	Johannesburg ZTJ .. ..		South Africa
25.532	Daventry (Empire) GSD .. ..		Great Britain	49.02	Wayne W2XE (WABC)		United States
25.63	Radio Coloniale FYA .. ..		France	49.08	Caracas YVIBC .. ..		Venezuela
26.83	Funchal CT3AQ .. ..		Madeira	49.1	Halifax VE9HX (CHNS)		Canada
27.65	Nauen DFL .. ..		Germany	49.18	Boundbrook W3XAL (WJZ)		United States
27.86	Rugby GBP .. ..		Great Britain	49.18	Chicago W9XF (WENR)		United States
27.88	Marapicu PSG .. ..		Brazil	49.22	Bowmanville VE9GW (CRCT)		Canada
28.28	Rocky Point (N.J.) WEA .. ..		United States	49.26	St. John VE9BJ (CFBL)		N. Brunswick
28.5	Sydney VLK .. ..		N.S. Wales	49.3	La Paz CP5 .. ..		Bolivia
28.98	Buenos Aires LSX .. ..		Brazil	49.34	Chicago W9XAA (WCFL)		United States
29.03	Bermuda ZFD .. ..		West Indies	49.35	Zeeseen (D9M) .. ..		Germany
29.04	Ruysselede (ORK) .. ..		Belgium	49.39	Maracaibo V5BMO .. ..		Venezuela
29.35	Marapicu PSH .. ..		Brazil	49.4	Vienna OER2 .. ..		Austria
29.59	Leopoldville OPM .. ..		Belgian Congo	49.43	Vancouver VE9CS (CKFC)		Brit. Columbia
29.64	Marapicu PSI .. ..		Brazil	49.47	Nairobi VQ7LO .. ..		Kenya Colony
29.84	Abu Zabel, Cairo SUV .. ..		Egypt	49.5	Skamleback .. ..		Denmark
30	Radio Excelsior LR5 .. ..		Argentina	49.5	Philadelphia W4XAU (WCAU)		United States
30.1	Rome IRS .. ..		Italy	49.5	Cincinnati W8XAL (WLW)		United States
30.4	Lawrenceville WON .. ..		United States	49.586	Daventry (Empire) GSA .. ..		Great Britain
30.4	Tokio JIAA .. ..		Japan	49.6	Bogota HJ3ABI .. ..		Colombia
30.00	Madrid EAQ .. ..		Spain	49.67	Boston WIXAL (WEEI)		United States
30.77	Lawrenceville WOF .. ..		United States	49.83	Zeeseen DJC .. ..		Germany
30.9	Rugby GCA .. ..		Great Britain	49.9	Singapore ZHI .. ..		F.M. States
31.3	Daventry (Empire) GSC .. ..		Great Britain	49.92	Havana GOC .. ..		Cuba
31.23	Mexico City XETE .. ..		Mexico	49.96	Drummondville VE9DN (CFCF)		Canada
31.25	Lisbon CTIAA .. ..		Portugal	50	Moscow RNE .. ..		U.S.S.R.
31.26	Radio Nations HBL .. ..		Switzerland	50.8	Barcelona EA3AB .. ..		Spain
31.28	Philadelphia W3XAU (WCAU)		United States	50.26	Rome (Vatican) HVJ .. ..		Italy
31.28	Sydney VK2ME .. ..		N.S. Wales	50.42	Domingo HIX .. ..		Dominican R.
31.35	Millis WJXAZ (WBZ)		United States				
31.38	Zeeseen DJA .. ..		Germany				
31.41	Jeløy LCL .. ..		Norway				
31.45	Zeeseen (DJN) .. ..		Germany				

Continued on page 156

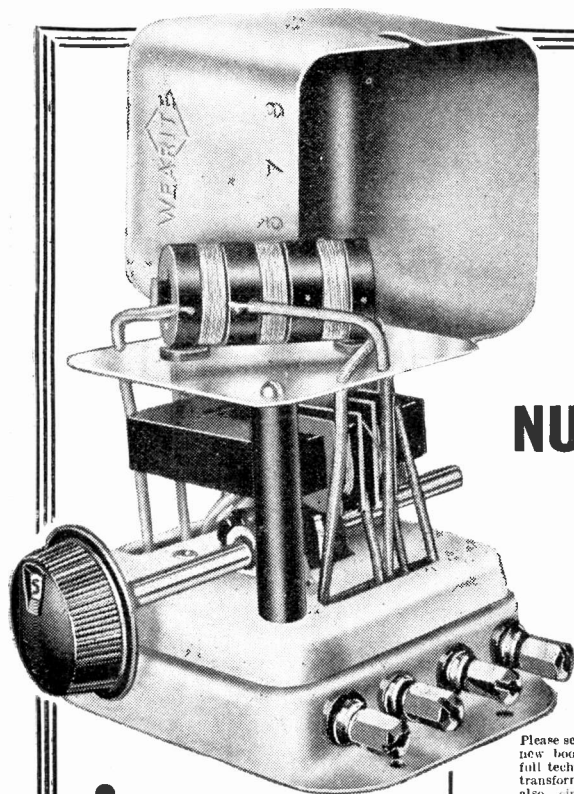

# Specified for the H. K. FOUR

The  
**WEARITE**  
Regd. Trade Mark

## NUCLEON IRON-CORED COILS

ONE TYPE B.P.1. ... .. Price 12s. 6d.  
ONE TYPE B.P.2. ... .. Price 12s. 6d.  
TWO TYPE T.G. ... .. Price each 12s. 6d.  
Extension Spindle ... .. Price 6d.

Also Specified  
ONE H. F. CHOKE TYPE H.F.P.J.... Price-2s. 0d.

**SEND THIS  
COUPON**

For the Wearite Book of Components, complete with operating data.

To MESSRS. WRIGHT & WEAIRE, LTD.,  
740 High Road, Tottenham, London N.17.

NAME .....

ADDRESS .....

W.M. 3:35 .....

Please send me a copy of your new booklet No. 834 giving full technical details of coils, transformers, chokes, etc., and also circuit diagrams and instructional details of the "Teaster" (L.P.) Series of Circuits.

6404

## First choice for "YOUR SECOND SET"

For this Short-wave receiver—and for every good set—the resistors specified are Eries. They are first essentials for stability. Every designer specifies them; every leading manufacturer relies on Eries. For reliability put Eries into your set.

The  
**ERIE VOLUME CONTROL**  
Specified for the "H.K." FOUR

Erie quality gives you the Volume Control that will never develop faults. Tested for life-time reliability. Price: **3/6**



**ERIE  
RESISTORS**

1/- Per Watt in all Values

Send for the free  
"Erie Resistor Servicing Booklet."  
THE RADIO RESISTOR CO., LTD.

1 Golden Square : : London, W.1

There was a young fellow  
named Jim

Complained that his Set  
had gone 'dim'

He found on inspection—

An unsoldered connection—

So FLUXITE put  
THAT right for HIM!



See that FLUXITE is always by you—in the house—garage—workshop—anywhere where simple speedy soldering is needed. Used for 30 years in government works and by the leading engineers and manufacturers. Of all Ironmongers—in tins, 4d., 8d., 1/4 and 2/8.

Ask to see the FLUXITE SMALL-SPACE SOLDERING SET—compact but substantial—complete with full instructions, 7/6. Ask also for Leaflet on CASE HARDENING STEEL and TEMPERING TOOLS with FLUXITE.

### THE FLUXITE GUN

Registered

is always ready to put "Fluxite" on the soldering job instantly. A little pressure places the right quantity on the right spot and one charging lasts for ages.

The Gun also projects grease into bearings, etc., and is used for grease like an oil can for oil.

Price 1/6.

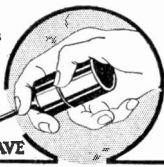

ALL MECHANICS WILL HAVE

# FLUXITE

IT SIMPLIFIES ALL SOLDERING

Fluxite Ltd., (Dept. 382), Dragon Works, Bermondsey Street, S.E.1

## SPECIFIED for the STANDARD 4-V. SHORT WAVE B.T.S.



SHORT  
WAVE  
COILS

SET of FOUR  
EXACTLY  
AS  
SPECIFIED **16/-**

FROM ALL DEALERS

### B.T.S. SHORT-WAVE ADAPTOR

AMERICA DIRECT ON YOUR PRESENT SET!

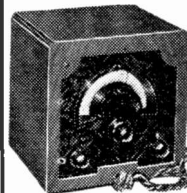

Simply plugs into your present battery or A.C. Mains Set and gives world-wide reception. The only Adaptor at the price incorporating 100-1 ratio aerial tuning and slow-motion reaction. With 2 plug-in coils, 13-26 and 24-52 metres, Extra coils, 46-96 and 90-130 metres, 4/8 each. Send **52/6** for fully descriptive leaflet.

FROM ALL DEALERS

If any difficulty, send direct. Write for lists of B.T.S. Short-wave and Television apparatus.

# B.T.S.



BRITISH TELEVISION SUPPLIES, LTD.,  
BUSH HOUSE, Dept. "W.M.3" LONDON, W.C.2

Better service results from mentioning "Wireless Magazine" when writing to advertisers

# WORLD'S BROADCAST WAVELENGTHS Continued from page 154

Note Specially the Re-arrangement of British Wavelengths

Wave-length	Name of Station	Dial Readings	Country	Wave-length	Name of Station	Dial Readings	Country
50.6	Medellin HJ4ABE		Colombia	304.3	Cracow		Poland
55.56	Szelesfehevar		Hungary	307.1	Belfast		N. Ireland
56.9	Königswusterhausen (DTG)		Germany	309.9	Grenoble PTT		France
57.03	Rocky Point WQN		United States	312.8	Poste Parisien, Paris		France
58.03	Bandoeng PMY		Java	315.8	Breslau		Germany
58.31	Prague		Czechoslovakia		Goteborg		Sweden
60.3	Rugby GBC		Great Britain	318.8	Algiers		North Africa
62.5	Long Island (N.J.) W2X		United States	321.9	Brussels (2)		Belgium
62.56	London		Ontario	325.4	Brno		Czechoslovakia
65.93	Rocky Point WAD		United States	328.6	Radio Toulouse		France
68.18	Moscow (RFCK)		U.S.S.R.	331.9	Hamburg		Germany
69.44	Rugby GDB		Great Britain	335.2	Limoges PTT		France
70.2	Khabarovsk RV15		U.S.S.R.	335.2	Helsinki		Finland
73	Quito (HCJB)		Ecuador	338.6	Graz		Austria
76	Maracay (YV11AM)		Venezuela	342.1	London Regional		Great Britain
80	Lisbon CTICT		Portugal	345.6	Poznan		Poland
84.5	Berlin D4AGE		Germany	349.2	Strasbourg		France
84.67	Mozambique CR7AA		East Africa		Bergen		Norway
85.9	Boston WIXAL		United States	352.9	Valencia		Spain
203.5	Plymouth		Great Britain	356.7	Berlin		Germany
204.8	Bournemouth		Great Britain	360.6	Moscow (4)		U.S.S.R.
206	Pecs		Hungary	362.8	Radio LL Paris		France
207.3	Fécamp		France	364.5	Bucharest		Roumania
207.3	Miskolcz		Hungary	368.6	Milan		Italy
209.9	Beziers		France	373.1	West Regional		Great Britain
211.3	Newcastle		Great Britain		Salonika		Greece
214	Tampere		Finland	377.4	Lvov		Poland
214	Soňa		Bulgaria		Barcelona (EAJ1)		Spain
215.4	Radio Lyon		France	382.2	Leipzig		Germany
216.8	Warsaw No. 2		Poland	386.6	Toulouse PTT		France
218.2	Basle, Berne		Switzerland	391.1	Scottish Regional		Great Britain
219.6	Lorun		Poland	395.8	Katowice		Poland
221.1	Turin (2)		Italy	400.5	Marseilles PTT		France
222.5	Milan		Italy	405.4	Munich		Germany
222.5	Dublin		Irish F. State		Seville		Spain
222.6	Bordeaux S.O.		France	410.4	Talinn		Estonia
	Königsberg		Germany		Madrid (España)		Spain
224	Montpellier		France	415.5	Kiev		U.S.S.R.
	Lodz		Poland	420.8	Rome		Italy
	Hanover		Germany	426.1	Stockholm		Sweden
	Bremen		Germany	431.7	Paris PTT		France
225.6	Flensburg		Germany	437.3	Belgrade		Yugoslavia
	Stettin		Germany	443.1	Sottens		Switzerland
	Magdeburg		Germany	449.1	North Regional		Great Britain
230.2	Danzig		Germany	455.9	Langenberg		Germany
	Linz		Austria	463	Lyons PTT		France
231.8	Salzburg		Austria	470.2	Prague (1)		Czechoslovakia
	Dornbirn		Austria	476.9	Trondheim		Norway
233.5	Aberdeen		Great Britain	483.9	Brussels (1)		Belgium
	Dresden		Germany	492.6	Florence		Italy
235.1	Stavanger		Norway		Sundsvall		Sweden
236.8	Nurnberg		Germany	499.2	Rabat		Morocco
238.5	San Sebastian		Spain	506.8	Vienna		Austria
240.2	Rome (3)		Italy	514.6	Agen		France
242	Juan-les-Pins		France		Riga		Latvia
242	Cork		Irish F. State	522.6	Mühlacker		Germany
243.7	Gleiwitz		Germany	531	Athlone		Irish F. State
245.5	Trieste		Italy	539.6	Beromünster		Switzerland
247.5	Lille PTT		France	549.5	Budapest		Hungary
249.2	Prague Stranice (2)		Czechoslovakia		Wilno		Poland
	Frankfurt-am-Main		Germany	559.7	Bolzano		Italy
	Trier		Germany		Vüperi		Finland
251	Freiburg-im-Breisgau		Germany	569.3	Ijubljana		Yugoslavia
	Cassel		Germany		Innsbruck		Austria
	Kaiserlautern		Germany	578	Hamar		Norway
253.2	Kharkov (2)		U.S.S.R.	696	Oulu		Finland
255.1	Copenhagen		Denmark		Moscow		U.S.S.R.
257.1	Monte Ceneri		Switzerland	748	Geneva		Switzerland
261.1	London National		Great Britain		Ostersund		Sweden
	North National		Great Britain	765	Boden		Sweden
263.2	Turin (1)		Italy	824	Smolensk		U.S.S.R.
265.3	Horby		Sweden	845	Fuinmark		Norway
267.4	Newcastle		Great Britain	1,107	Moscow (2)		U.S.S.R.
	Nyireghyaza		Hungary	1,144.2	Madona		Latvia
259.1	Kosice		Czechoslovakia	1,154	Oslo		Norway
269.5	Radio Vitus (Paris)		France	1,224	Leningrad		U.S.S.R.
270	Moravska-Ostrava		Czechoslovakia	1,261	Kalundborg		Denmark
271.7	Naples		Italy	1,304	Luxembourg		Luxembourg
274	Madrid EAJ7		Spain		Ankara		Turkey
276.2	Falun		Sweden	1,339	Warsaw		Poland
	Zagreb		Yugoslavia	1,354	Motala		Sweden
278.6	Bordeaux PTT		France	1,395	Eiffel Tower		France
280.9	Tiraspol		U.S.S.R.	1,442	Minsk		U.S.S.R.
283.3	Bari		Italy	1,500	Droitwich National		Great Britain
285.7	Scottish National		Great Britain	1,571	Deutschlandsender		Germany
288.5	Leningrad (2)		U.S.S.R.	1,600	Istanbul		Turkey
	Rennes PTT		France	1,648	Radio Paris		France
291	Königsberg		Germany	1,724	Moscow No. 1		U.S.S.R.
	Parade		Portugal	1,807	Lahti		Finland
293.5	Barcelona (EAJ)		Spain		Kootwijk		Holland
296.2	Midland Regional		Great Britain		Huizen		Holland
298.8	Bratislava		Czechoslovakia	1,875	Brasov		Roumania
301.5	Hilversum		Holland		Kaunas		Lithuania
304.3	Genoa		Italy	1,935			

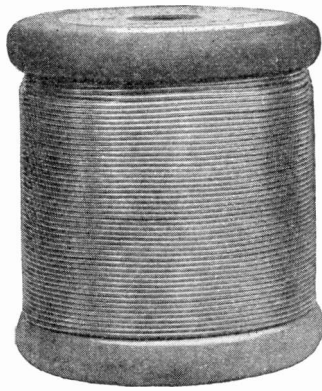

**B.I.**

**RESINKOR SOLDER  
AND  
CORALINE PASTE**

are two aids to efficient soldering. B.I. "Resinkor" Solder is a solder with just the right quantity of resin embedded in it. It is invaluable for the soldering of electrical connections, particularly on fine work. "Resinkor" can be supplied in coils, on reels, or in cut lengths as required, in all diameters down to 20 s.w.g. B.I. Coraline Soldering Paste is suitable for copper, brass, tin, iron and lead and for electrical connections except the jointing of paper insulated cables. It is quite easy to apply, even in the most awkward corners, and once having been applied it does not run off the work, nor does it dry. It gives off no spray and is very economical.



Supplied in 1-oz., 2-oz., ¼-lb., ½-lb., 1-lb. and 7-lb. tins.

**BRITISH INSULATED CABLES LTD.  
PRESCOT - LANCASHIRE**

Telephone No. PRESCOT 6571

London Office: Surrey House, Embankment, W.C.2. Tel. Nos.: Temple Bar 4793-4-5-6

**RELIABILITY**



Mountaineers do not trust their lives to a rope unless they are absolutely sure that it is free from flaws and has been subjected to searching tests.

Similarly you can be sure that T.M.C.-HYDRA condensers will never let you down. They are made from the best materials and are stringently tested to ensure that none but the finest condensers it is possible to produce, reach your hands.

T.M.C.-HYDRA condensers have built up a world-wide reputation for reliability and are accepted as the standard of excellence.

**T.M.C. BRITISH  
MADE  
HYDRA  
CONDENSERS**

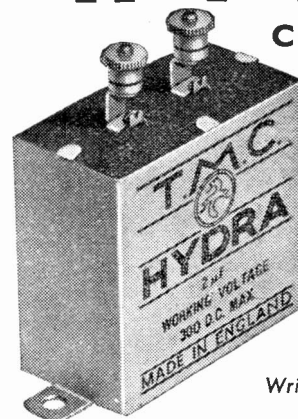

The special method of sealing T.M.C.-HYDRA condensers definitely prevents the penetration of moisture and so preserves the high electrical properties of the condensers.

Write for a copy of the new illustrated price list.

**T.M.C.-HARWELL (SALES) LTD**  
Britannia House, 233 Shaftesbury Avenue  
London, W.C.2. (A few doors from New Oxford Street)

Telephone: Temple Bar 0055 (3 lines)

Made by TELEPHONE MANUFACTURING Co., Ltd.

It helps us if you mention "Wireless Magazine"



# AN EPOCH FOR THE "H.K. FOUR"

Hear one at your Local Dealer or at our Demonstration Room at Aldwych House.

**FOR PERFECT QUALITY AND GREATEST VOLUME YOU MUST HAVE AN EPOCH**

**EPOCH TYPE A2 $\frac{1}{2}$  P.M.**

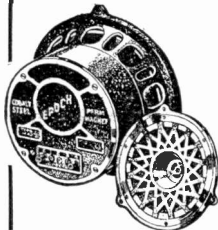

"Nial" magnet of high flux density. Interchangeable diaphragms (in all impedances to order.) Universal Multi-ratio Transformer. Handling capacity 5 watts. Fitted with 5 ratios matching transformer 63/- Fitted in handsome walnut cabinet 105/-

**FOR THE "STANDARD FOUR SHORT WAVE"**

THE IDEAL TYPE IS '20th CENTURY' P.M.M.C.



The Standard of Comparison in its class. High content "Nial" steel magnet with very high flux density. Aluminium frame (copper-plated), holding 8 $\frac{1}{2}$  in. diaphragm. Fitted with Universal Multi-ratio transformer. With universal transformer ready for use 35/- Fitted in handsome oak cabinet ... 47/6

**YOU MUST HEAR AN EPOCH**

Write Now for Full Illustrated List to—

**EPOCH REPRODUCERS**

**RADIO DEVELOPMENT Co.**  
Aldwych House, Aldwych, W.C.2  
Telephone: Holborn 9111

**WE SHALL BE PLEASED TO HELP YOU**

## TESTS OF NEW APPARATUS

### DUBILIER OIL-IMMERSED CONDENSERS

#### Description

FOR high-voltage working the Dubilier Condenser Co. is producing a series of oil-immersed condensers. We have had an opportunity of testing a 4-microfarad unit working at 1,000 volts D.C., and a 1-microfarad unit working at 1,500 volts.

The condensers utilise a multiple paper assembly mounted in a can which is completely oil-immersed. Connections are made by studs fitted with nuts and locking washers carried on insulating discs on the top of the cases. There are flanged feet for fixing purposes, and the mounting is vertical so that they occupy comparatively little space.

#### Observations

These condensers are very simply finished, no attempt having been made to render them particularly attractive. Mechanically, the mounting and fixing is quite sound and there is a useful leakage path between the lugs.

#### Measurements

Nominal capacity	4 mfd.	1 mfd.
Actual tolerance	+4.7%	-6%
Nominal tolerance	$\pm 15\%$	$\pm 15\%$
Power factor	.0071	.0047
Insulation	resistance 11,480	1,400
	meg/mfd.	meg/mfd.

The condensers are made by the Dubilier Condenser Co. (1925), Ltd. The 4-microfarad type 951 costs 17s. 6d. and the 1-microfarad type, 13s.

### AMPLION WIRE-WOUND RESISTANCES

#### Description

A SERIES of 1-watt wire-wound resistances manufactured by Amplion are constructed on quite conventional lines.

The resistance wire is in the form of a single layer spiral on an insulating tube. Connections are made by soft wires which project for about 1 $\frac{1}{2}$  in. at each end.

These resistances vary in length from about 1 in. for the 50-ohm unit to 1 $\frac{3}{4}$  in. for the 100,000-ohm unit.

The indication is by means of the standard colour code, but in addition each resistance has a small label.

## INSULATION

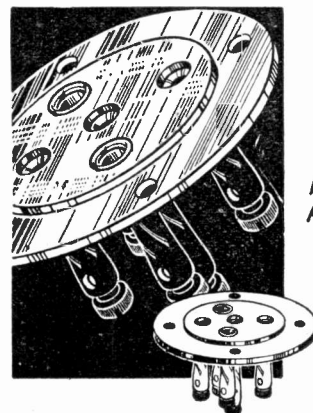

CLIX Points of Advantage

Clix obtain maximum insulation by mounting only the heads of valve sockets in thin paxolin, providing true low-loss construction, with resultant gain in efficiency. Although thin, the insulation is very strong, and will not chip or fracture with careless treatment.

C IX Specified for YOUR SECOND SET

**CLIX** Folder "W.M." Free  
**LECTRO LINX, LTD.**  
79a Rochester Row, London, S.W.1

**50 ohms to 100,000**

WIRE-WOUND RESISTORS

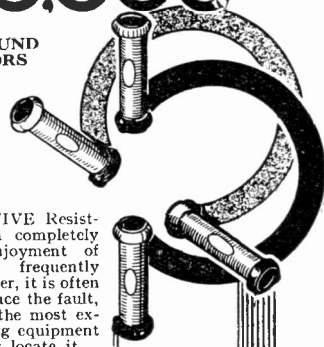

A DEFECTIVE Resistance can completely ruin the enjoyment of radio — and frequently does. Moreover, it is often difficult to trace the fault, as none but the most expensive testing equipment can definitely locate it.

When building your next set, or overhauling your present equipment, change over to Amplion resistors. They are colour coded, compact and sturdy, and all values are wire-wound, this method of construction giving the most reliable and constant form of resistance.

**1-WATT WIRE-WOUND RESISTORS**  
Price 1/- each; all values.

See test report on this page.

**AMPLION**

A. M. PLION (1932) LTD.

81-84 Rosoman Street, Rosebery Avenue, London, E.C.1

# PETO-SCOTT

IMMEDIATE DELIVERY CASH C.O.D.

## PILOT AUTHOR KITS

SEND US YOUR ENQUIRIES FOR EVERYTHING RADIO

Miscellaneous Components, Parts, Kits, Finished Receivers or Accessories for Cash or C.O.D. or H.P. on our own system of Easy Payments. Send us a list of your wants. We will quote you by return. C.O.D. orders value over 10/- sent carriage and post charges paid (GT. BRITAIN ONLY). H.P. Terms are NOT available to Irish and Overseas customers.

### H.K.4

**KIT "A"** Author's Kit of first specified parts, less Valves. **Cash or C.O.D. £10 10 0**  
Or 12 monthly payments of 19/3. Carriage Paid

**KIT "B"** As for Kit "A," but including set of 5 specified Valves, less Cabinet. Cash or C.O.D. Carriage Paid, £13/8/6. Or 12 monthly payments of 24/6.

**KIT "C"** As for Kit "A," but including set of specified Valves and Peto-Scott H.K.4 Cabinet. Cash or C.O.D. Carriage Paid, £15/8/6. Or 12 monthly payments of 27/6.

### KIT-BITS

You pay the Postman. We pay post charges on orders value over 10/- GREAT BRITAIN ONLY.

- 2 Peto-Scott ready-drilled ebonite terminal strips ... 1 6
- 2 Peto-Scott Metaplex baseboards and 2 wood supports ... 4 0
- 1 Set Wearite Nucleon coils ... 2 10 0

## STANDARD 4-VALVE

### SHORT-WAVER

**KIT "A"** Author's Kit of first specified parts, less Valves and Cabinet. **Cash or C.O.D. £5 15 0**  
Or 12 monthly payments of 10/6. Carriage Paid.

**KIT "B"** As for Kit "A," but including set of 4 specified Valves only. Cash or C.O.D. Carriage Paid, £7/10/6. Or 12 monthly payments of 13/6.

**KIT "C"** As for Kit "A," but including set of specified Valves and Peto-Scott American type Cabinet. Cash or C.O.D. Carriage Paid, £8/10/0. Or 12 monthly payments of 15/6.

**FINISHED INSTRUMENT**, Ready Assembled and Aerial Tested. Complete with Valves and Cabinet. Cash or C.O.D. Carriage Paid, £9/8/0. Or 12 monthly payments of 17/3.

### KIT-BITS

You pay the Postman. We pay post charges on orders value over 10/- GREAT BRITAIN ONLY.

- 1 Peto-Scott ebonite terminal strip with 9 marked terminals ... 3 6
- 1 Peto-Scott Plymax chassis, 18 in. by 10½ in. by 1½ in ... 9 6
- 1 B.T.S. S.W. choke ready wound and assembled to specification ... 2 6
- 1 Set B.T.S. short-wave coils, 13-190 metres ... 16 0

### FREE BLUEPRINT COUPON

PETO-SCOTT CO., LTD., 77 (Dept. W.M.3) City Road, London, E.C.1. Telephone: Clerkenwell 9406-7. West End Showrooms: 62 (Dept. W.M.3) High Holborn, London, W.C.1. Telephone: Holborn 3248.

Please send me descriptive literature of the Peto-Scott Short-wave New Discoverer H.F.P.3, together with FREE 1/- Full-size Blueprint, for which I enclose 3d. in stamps to cover postage.

NAME .....

ADDRESS .....

W.M.3

EST. 1919

### Observations

Little can be said of a resistance by mere inspection. It should be mentioned in passing, however, that the varnish appears to cover the wire adequately and no doubt protects it from the atmosphere. The colour coding is well carried out and there is no difficulty in differentiating between orange and yellow, or blue and purple—a point over which some resistances fail.

### Measurements

Rating	Tolerance per cent
50 .. .. .	+4.4
600 .. .. .	+0.6
5,000 .. .. .	-3.0
10,000 .. .. .	-2.6
15,000 .. .. .	-3.7
30,000 .. .. .	-3.7
75,000 .. .. .	-3.3
100,000 .. .. .	+5.0

Temperature co-efficient, +.0187 per cent per 1 degree Centigrade rise.

Temperature rise at rated load (1,000-ohm sample), 53 degrees Centigrade.

These resistances are made by Amplion (1932), Ltd., of 82-84 Rosoman Street, London, E.C.1, and cost 1s. each.

# DUBILIER

## oil-immersed paper dielectric condensers

### Type 951

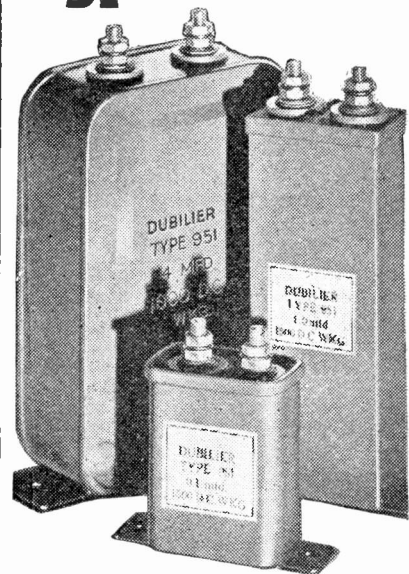

Dubilier's new departure in radio and amplifier design is a range of new Oil-Immersed Paper Dielectric Condensers, which will come as a boon to designers of apparatus for Television, Radio and Low Frequency Amplifiers, using the higher voltages.

Each condenser comprises a multiple paper dielectric element, impregnated and oil-immersed and hermetically sealed into a sheet metal container. Leakage of oil is impossible, but expansion is adequately accommodated. In capacity and working voltage these condensers are small and most compact. Their low price enables a capacity value hitherto prohibited to be used in resistance capacity coupled amplifiers.

Capacity $\mu$ f	D.C. Working Volts	D.C. Test Volts	Price Each
.02	1,500	3,000	10/-
.1	1,500	3,000	10/9
.5	1,500	3,000	11/-
1.0	1,000	2,000	11/6
1.0	1,500	3,000	13/-
1.0	2,000	4,000	15/-
2.0	1,000	2,000	13/-
2.0	2,000	4,000	17/6
4.0	1,000	2,000	17/6
4.0	2,000	4,000	21/-

Capacity tolerance plus or minus 15%

# DUBILIER

## CONDENSERS

DUBILIER CONDENSER CO. (1925) LTD., DUCON WORKS, VICTORIA ROAD, N. ACTON, W.3.

## 1935 EDITION... FREE!

A new and greatly enlarged edition of "ENGINEERING OPPORTUNITIES" is just off the Press. It describes the easy way in which you may become an A.M.I.C.E., A.M.I. Mech. E., A.M.I.E.E., A.M.I.A.E., A.M.I.W.T., etc., under one and contains the world's widest selection of courses in all branches of Civil, Mech., Elec., Motor, Aero., and Radio Engineering, Building, etc.

If you are earning less than £10 per week, you cannot afford to miss this unique guide to a first-class job.

"NO PASS—NO FEE" Guarantee.

DON'T DELAY—send for your FREE copy of the Handbook to-day. No cost or obligation of any kind.



THE BRITISH INSTITUTE OF ENGINEERING TECHNOLOGY, 283 Shakespeare House, 29-31 Oxford Street, London.

## SWIFT KITS & COMPONENTS ARE GUARANTEED

Send for our Price List for the H.K.4 and the Standard Four-Valve Short-Waver. All Standard Components and Accessories Supplied. THE SWIFT SERVICE & SUPPLY CO. (W.M.), 3 Featherstone Buildings, High Holborn, London, W.C.1. Phone: Holborn 1336.

## THE OUTLINE OF WIRELESS

By RALPH STRANGER

Fifth Edition - 8/6 net.

Covers the theory and practice of Wireless Reception from A to Z. FROM ALL BOOKSELLERS

GEORGE NEWNES, LTD., 8-11 Southampton St., Strand, London, W.C.2

## H.K.4 and STANDARD S.W. FOUR

FIRST SPECIFIED KITS

## MELFO-RAD QUEEN'S PLACE HOVE

CASH—C.O.D.—EASIWAY

# EASY TERMS

We specialise in the supply of all good quality Radio sets, components and accessories. Send list of requirements and keen quotation will be sent promptly. Cash and C.O.D. orders despatched by return of post. Price lists FREE.

## SEND 2/6 W.B. STENTORIAN

Revitalise your set with SENIOR PM 8.1 UNIT. Cash price £2 2s., or 2/6 with order and 11 monthly payments of 4/-.

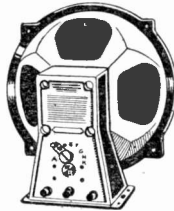

**STANDARD PM SPEAKER**  
Cash price £1 12s. 6d. or 2/6 with order and 11 monthly payments of 3/-.

## SEND 7/- GARRARD RADIO-GRAM UNIT

Model A.C.6, complete with volume control, ready for use. This unit converts any radio receiver into a high-class radio-gram for A.C. mains. Cash price £4 0 0 or 7/- with order and 11 monthly payments of 7/4. All other GARRARD motors supplied on similar terms. Illustrated list free.



Estd. 1925 **THE LONDON RADIO SUPPLY COMPANY** 'PHONE NATIONAL 1977  
11, OAT LANE, NOBLE STREET, LONDON, E.C.2

## INDEX TO ADVERTISERS

	Page
Amplion, Ltd. . . . .	158
Automatic Coil Winder Co. . . . .	81
British Inst. of Eng. Tech. . . . .	159
British Insulated Cables . . . . .	157
British Television Supplies, Ltd. . . . .	155
Dubilier Condenser Co., Ltd. . . . .	159
Exide and Drylex . . . . .	Back Cover
Ferranti, Ltd. . . . .	145
Fluxite, Ltd. . . . .	155
General Electric Co., Ltd. . . . .	Cover ii
Graham Farish, Ltd. . . . .	151
Jackson Bros. . . . .	153
Lectro Linx, Ltd. . . . .	158
London Radio Supply . . . . .	160
Matconiphone Co., Ltd. . . . .	84, 153
Ostar Ganz . . . . .	152
Peto-Scott Co., Ltd. . . . .	159
Picketts . . . . .	163
Radio Development Co. . . . .	158
Radio Resistor Co. . . . .	155
Rothermel, Ltd. . . . .	153
Stratton & Co. . . . .	145
Swift Service and Supply Co. . . . .	159
Technological Inst. of Great Britain . . . . .	160
Telephone Mfg. Co., Ltd. . . . .	150
Tungram Valves . . . . .	149
Varley (Oliver Pell Control, Ltd.) . . . . .	149
Whiteley Electrical Radio Co., Ltd. . . . .	82
Wingrove & Rogers, Ltd. . . . .	150
Wright & Weaire, Ltd. . . . .	155

## THE ELECTRIC HOUSE

MICHAEL EGAN, who is the author of "The Complete Wireless," and who has written on radio electrical subjects for many years, has turned playwright and is responsible for the comedy, *The Dominant Sex*, which is now running at the Shaftesbury Theatre, London.

*The Dominant Sex* has been hailed as the most brilliant comedy of recent years. The central character is a young farmer whose ambition it is to own a modern all-electric farm while his wife—like all modern wives—particularly wants an all-electric home.

Radio and electricity play a large part in the play, and particularly interesting is the all-electric house scene—one of the most outstanding electrical contrivances ever seen on the London stage.

THE NEXT ISSUE OF "W.M." will be on sale FRIDAY, MARCH 22, 1935 ORDER YOUR COPY IN ADVANCE

## Engineers' Guide

containing the widest choice of engineering courses in the world

Outlines The T.I.G.B.'s up-to-date home study Courses in Wireless, Electrical and Mechanical Engineering, etc. Shows how to become A.M.I.E.E., A.M.I.W.T., A.E.I.A., etc., and how to qualify for a well-paid post. Training until Successful Guaranteed. WRITE NOW for Free Guide.

THE TECHNOLOGICAL INSTITUTE OF GREAT BRITAIN, 105 Temple Bar House, London, E.C.4 (Founded 1917, 19,000 Successes.)



To Success

**Piano Tone RADIO GRAM CABINETS**  
As supplied to B.B.C.

65/- Polished Cabinet for 35/-  
No Middle Profits!

Famous maker offers finest Radio For Hire As Supplied to B.B.C. A Quality and Value impossible to better. Beautifully hand polished. GUARANTEED Piano Tone Acoustically.

Trial Will Delight You! (Cash or 10/- monthly.)  
LIST FREE! From Makers—

**PICKETT'S**  
Piano Tone  
Cabinet (W.M.) Works, Albion Road, Bexleyheath, Nr. London.

## BLUEPRINT COUPON

Valid only until March 30, 1935 (or until April 30, 1935, for overseas readers)

### FOR ONE BLUEPRINT ONLY

If you want a full-size blueprint of any ONE of the sets constructionally described in this issue for half price, cut out the above coupon and send it, together with a postal order, to Blueprint Department, WIRELESS MAGAZINE, 8-11 Southampton Street, Strand, London, W.C.2.

This coupon is valid for a blueprint of any ONE only of the following sets at the prices indicated:—

STANDARD FOUR-VALVER SHORT-WAVER (page 124), No. WM383, price 9d., post paid.

THE "H.K." FOUR (page 93) WM384, price 9d., post paid.

## INFORMATION COUPON

Valid only until March 30, 1935 (or until April 30, 1935, for overseas readers)

If you want to ask any questions, cut out the above coupon and send it, together with a postal order for 1s. and stamped, addressed envelope, to the Information Bureau, WIRELESS MAGAZINE, 8-11 Southampton Street, Strand, London, W.C.2.

Note that not more than two questions may be asked at a time and that queries should be written on one side of the paper only.

Under no circumstances can questions be answered personally or by telephone. All inquiries must be made by letter so that every reader gets exactly the same treatment.

Alterations to blueprints or special designs cannot be undertaken: nor can readers' sets or components be tested.

If you want advice on buying a set, a stamped, addressed envelope only (without coupon or fee) should be sent to the Set Selection Bureau, WIRELESS MAGAZINE, 8-11 Southampton Street, Strand, London, W.C.2.

# "Wireless Magazine" Blueprint Service

These blueprints are full-size. Copies of appropriate issues of "Practical Wireless," "Amateur Wireless," and of "Wireless Magazine" containing descriptions of most of these sets can be obtained at 4d. and 1s. 3d. each, respectively, post paid. Index letters "P.W." refer to "Practical Wireless" sets, "A.W." refer to "Amateur Wireless" sets, and "W.M." to "Wireless Magazine" sets. Send, preferably, a postal order (stamps over sixpence unacceptable) to "Wireless Magazine" Blueprint Dept., Geo. Newnes, Ltd., 8-11 Southampton Street, Strand, W.C.2.

## CRYSTAL SETS

### Blueprints, 6d. each.

Four-station Crystal Set	31.3.34	AW427
1934 Crystal Set	4.8.34	AW444
150-mile Crystal Set	27.10.34	AW450

## STRAIGHT SETS (Battery Operated)

### One-valvers: Blueprints, 1s. each.

B.B.C. One-valver	28.5.32	AW344
B.B.C. Special One-valver	6.5.33	AW387
Twenty-station Loud-speaker One-valver (Class B)	27.10.33	AW449

### Two-valvers: Blueprints, 1s. each.

Family Two (D, Trans)	Apr. '32	WM278
Melody Ranger Two (D, Trans)	13.5.33	AW388
Full-volume Two (SG, Det, Pen)	17.6.33	AW392
Iron-core Two (D, Trans)	29.7.33	AW395
Iron-core Two (D, QPP)	12.8.33	AW396
B.B.C. National Two with Lucerne Coil (D, Trans)	17.2.34	AW377A
Big-power Melody Two with Lucerne Coil (SG, Trans)	17.2.34	AW338A
Lucerne Minor (D, Pen)	24.3.34	AW426

### Three-valvers: Blueprints, 1s. each.

Transportable Three (SG, D, Pen)	Feb. '32	WM271
Multi-mag Three (D, 2 <sup>nd</sup> Trans)	June '32	WM288
Percy Harris Radiogram (HF, D, Trans)	Aug. '32	WM294
£6.6s. Radiogram (D, RC, Trans)	Apr. '33	WM318
Simple-tune Three (SG, D, Pen)	June '33	WM327
Tyers Iron-core Three (SG, D, Pen)	July '33	WM330
C.-B. Three (D, LF, Class B)	Sep. '33	WM333
Economy-pentode Three (SG, D, Pen)	Oct. '33	WM337
All-wave Three (D, 2LF)	Jan. '34	WM348
"W.M." 1934 Standard Three (SG, D, Pen)	Feb. '34	WM351
£3.3s. Three (SG, D, Trans)	Mar. '34	WM354
Iron-core Band-pass Three (SG, D, QP21)	June '34	WM362
1935 £6 6s. Battery Three (SG, D, Pen)	Oct. '34	WM371
£8 Radiogram (D, RC, Trans)	21.5.32	AW343
New Regional Three (D, RC, Trans)	25.6.32	AW349
Class-B Three (D, Trans, Class B)	22.4.33	AW386
New Britain's Favourite Three (D, Trans, Class B)	15.7.33	AW394
Home-built Coil Three (SG, D, Trans)	14.10.33	AW404
Fan and Family Three (D, Trans, Class B)	25.11.33	AW410
£5 5s. S.G.3 (SG, D, Trans)	2.12.33	AW412
1934 Ether Searcher: Baseboard Model (SG, D, Pen)	20.1.34	AW417
1934 Ether Searcher: Chassis Model (SG, D, Pen)	3.2.34	AW419
Lucerne Ranger (SG, D, Trans)	3.3.34	AW422
Cosser Melody Maker with Lucerne Coils	17.3.34	AW423
P.W.H. Mascot with Lucerne Coils (Det, R.C., Trans)	17.3.34	AW337A
Mullard Master Three with Lucerne Coils	24.3.34	AW424
Pentaquester (HF, Pen, D, Pen)	14.4.34	AW431
£5 5s. Three: De-luxe Version (SG, D, Trans)	19.5.34	AW435
Lucerne Straight Three (D, RC, Trans)	9.6.34	AW437
All-Britain Three (HF Pen, D, Pen)	6.10.34	AW448
"Wireless League" Three (HF Pen, D, Pen)	3.11.34	AW451

Graduating to a Low-frequency Stage (D, 2LF) ... Jan. '35 WM378

### Four-valvers: Blueprints, 1s. 6d. each.

Quadradyne (2 SG, D, Pen)	Feb. '32	WM273
Calibrator (SG, D, RC, Trans)	Oct. '32	WM300
Table Quad (SG, D, RC, Trans)	Nov. '32	WM303
Calibrator de Luxe (SG, D, RC, Trans)	Apr. '33	WM316
Self-contained Four (SG, D, LF, Class-B)	Aug. '33	WM331
Lucerne Straight Four (SG, D, LF, Trans)	Feb. '34	WM350
£5 5s. Battery Four (HF, D, 2LF)	Feb. '35	WM381
65/- Four (SG, D, RC, Trans)	17.12.32	AW370
"A.W." Ideal Four (2 SG, D, Pen)	16.9.33	AW202
2 H.F. Four (2 SG, D, Pen)	17.2.34	AW421
Crusaders' A.V.C. 4 (2 HF, D, QP21)	18.8.34	AW445
(Pentode and Class-B outputs for above; blueprints 6d. each)	25.8.34	AW445A

### Five-valvers: Blueprints, 1s. 6d. each.

Super-quality Five (2 HF, D, RC, Trans)	May '33	WM320
New Class-B Five (SG, D, LF, Class B)	Nov. '33	WM340
Class-B Quadradyne (2 SG, D, LF, Class B)	Dec. '33	WM344
1935 Super Five (Battery Super-het)	Jan. '35	WM379

## SPECIAL HALF-PRICE OFFER

Blueprints of the following "Wireless Magazine" sets described in this issue are obtainable at the special price, given below, if the coupon on last page is used before March 30, 1935.

Standard Four-valve Short-waver (SG, D, 2LF) WM383	9d.
The "HK4" (2HF, D, LF) WM384	9d.

## Mains Operated

### Two-valvers: Blueprints, 1s. each.

Economy A.C. Two (D, Trans)	June '32	WM286
A.C. Consolelectric Two (D, Pen) A.C.	23.9.33	AW403

### Three-valvers: Blueprints, 1s. each.

D.C. Calibrator (SG, D, Push-pull Pen) D.C.	July '33	WM328
Simplicity A.C. Radiogram (SG, D, Pen) A.C.	Oct. '33	WM338
Six-guinea AC/DC Three (HF Pen, D, Trans) A.C./D.C.	July '34	WM364
Mantovani A.C. Three (HF Pen, D, Pen) A.C.	Nov. '34	WM374
Home-lovers' New All-electric Three (SG, D, Trans) A.C.	25.3.33	AW383
S.G. Three (SG, D, Pen) A.C.	3.6.33	AW390
A.C. Triodyne (SG, D, Pen) A.C.	19.8.33	AW399
A.C. Pentaquester (HF Pen, D, Pen) A.C.	26.6.34	AW439

### Four-valvers: Blueprints, 1s. 6d. each.

A.C. Quadradyne (2 SG, D, Trans) A.C.	Apr. '32	WM279
All Metal Four (2 SG, D, Pen) A.C.	July '33	WM329
A.C. Melody Ranger (SG, DC, RC, Trans) A.C.	4.3.33	AW380
AC/DC Straight A.V.C. 4 (2 HF, D, Pen) A.C./D.C.	8.9.34	AW446
"W.M." A.C./D.C. Super Four	Feb. '35	WM382

## SUPER-HETS

### Battery Sets: Blueprints, 1s. 6d. each.

Super Senior	Oct. '31	WM256
1932 Super 60	Jan. '32	WM269
Q.P.P. Super 60	Apr. '33	WM319
"W.M." Stenode	Oct. '34	WM373
Modern Super Senior	Nov. '34	WM375
1934 Century Super	9.12.23	AW413

### Mains Sets: Blueprints, 1s. 6d. each.

1932 A.C. Super 60, A.C.	Feb. '32	WM272
Seventy-seven Super, A.C.	Dec. '32	WM305
"W.M." D.C. Super, D.C.	May, '33	WM321
Merrymaker Super, A.C.	Dec. '33	WM345
Heptode Super Three, A.C.	May '34	WM359
"W.M." Radiogram Super, A.C.	July '34	WM366
"W.M." Stenode, A.C.	Sep. '34	WM370
1934 A.C. Century Super, A.C.	10.3.34	AW425

## SHORT-WAVERS (Battery Operated)

### One-valvers: Blueprints, 1s. each.

S.W. One-valve	23.1.32	AW329
S.W. One-valver for America	31.3.34	AW427
Roma Short-waver	10.11.34	AW452

### Two-valvers: Blueprints, 1s. each.

Home-made Coil Two (D, Pen)	14.7.34	AW440
-----------------------------	---------	-------

### Three-valvers: Blueprints, 1s. each.

World-ranger Short-wave 3 (D, RC Trans)	20.8.32	AW355
Experimenter's 5-metre Set (D, Trans. Super-rega)	30.6.34	AW438
Experimenter's Short-waver	19.1.35	AW463

### Four-valvers: Blueprints, 1s. 6d. each.

"A.W." Short-wave World Beater (HF Pen, D, RC, Trans)	2.6.34	AW436
Empire Short-waver (SG, D, RC, Trans)	Mar. '33	WM318

### Super-hets: Blueprints, 1s. 6d. each.

Quartz-crystal Super	Oct. '34	WM372
----------------------	----------	-------

## Mains Operated

### Two-valvers: Blueprints, 1s. each.

Two-valve Mains Short-waver (D, Pen) A.C.	10.10.34	AW453
"W.M." Band-spread Short-waver (D, Pen) A.C./D.C.	Aug. '34	WM368

### Three-valvers: Blueprints, 1s. each.

Emigrator (SG, D, Pen), A.C.	Feb. '34	WM352
------------------------------	----------	-------

### Four-valvers: Blueprints, 1s. 6d. each.

Gold Coaster (SG, D, RC, Trans), A.C.	Aug. '32	WM292
---------------------------------------	----------	-------

## "PRACTICAL WIRELESS"

A.C.-D.C. Two	7.10.33	PW31
All-wave Unipen	14.10.33	PW31A
F.J.C. 3-valve A.V.C. (Transfer Print)	4.11.33	PW32
Luxus A.C. Superhet	14.10.33	PW33
A.C. Quadpak	2.12.33	PW34
Sixty-shilling Three	2.12.33	PW34A
Nucleon Class-B Four	6.1.34	PW34B
Fury Four Super	27.1.34	PW34C
A.C. Fury Four Super	10.2.34	PW34D
Leader Three	10.3.34	PW35
Pocket Portable	10.3.34	PW35A
D.C. Premier	31.3.34	PW35B
A.C. Leader	7.4.34	PW35C
Master Midget Two	12.5.34	PW35E
Atom Lightweight Portable	2.6.34	PW36
Ubique	28.7.34	PW36A
Four-range Super-mag. Two	11.6.34	PW36B
Summit Three	18.8.34	PW37
Armad Mains Three	18.8.34	PW38
Midget Short-wave Two	15.9.34	PW38A
All-pentode Three	29.9.34	PW39
£5 Superhet Three	27.01.34	PW40
A.C. £5 Superhet Three	24.11.34	PW41
D.C. £5 Superhet Three	1.12.34	PW42
Hall-mark Three	8.12.34	PW43
Universal £5 Superhet	15.12.34	PW44
A.C. Hall-mark	26.1.35	PW45

"Wireless Magazine" Blueprint Service George Newnes, Ltd., 8-11 Southampton Street, Strand, W.C.2



**“Yes, I’m fully charged  
Look at my indicator”**



I am the Exide “Indicator” Battery. When I say “Full” I am full—and that’s that. When my hand approaches “Empty” it is time to get me recharged—and that’s *that*. The point is that with me you always know where you stand. I put an end to uncertainty. I put an end to the risk of being let down by a run-down battery.

**PRICES WITH ‘INDICATORS’**

- Type DTG-C 2 volt 20 a.h. 5/-
- Type DFG-C 2 volt 45 a.h. 9/-
- Type DXG-C 2 volt 58 a.h. 10/-
- Type DMG-C 2 volt 70 a.h. 12/-
- Type DHG-C 2 volt 100 a.h. 15/6

★ These prices do not apply to the Irish Free State.

**Exide**

**“INDICATOR” BATTERY**

For wireless H.T. get **Drydex** the Exide dry battery

Exide Batteries are obtainable in sizes to suit every set from Exide Service Stations and all reputable dealers. Exide Service Stations give service on every make of battery. ● EXIDE BATTERIES, Exide Works, Clifton Junction, near Manchester. Branches : London, Manchester, Birmingham, Bristol, Glasgow, Dublin, Belfast. R70

**‘STILL KEEPS GOING WHEN THE REST HAVE STOPPED’**