

BATTERY STENODE FOR THE HOME CONSTRUCTOR!

Wireless Magazine

October
1934



AND NOW A BATTERY
STENODE

THE MOST SELECTIVE BATTERY SET YET!

PAUL TYERS
Designs A
Battery Stenode
for the
Amateur

G.E.C. H.T.

Thousands of listeners
have proved the
greater purity of
tone and the definitely
longer life

GUARANTEED
120 VOLT
144,000
MILLIWATT HOURS



PRICES:
60v: 5/6. 99v: 9/-.
120v: 12/9. 150v: 14/-.
108v: 10/-. 120v: 11/-.
Also Triple Capacity. 60v: 8/6. 124v: 11/6. 139v: 139v: 17/6.
Sold by all Radio Dealers

MADE IN ENGLAND

A TRIAL MEANS YOU'LL ALWAYS USE G.E.C. H.T.

Advt. of The General Electric Co. Ltd., Magnet House, Kingsway, London, W.C.2

Editor-in-Chief:
BERNARD E. JONES

Technical Editor:
J. H. REYNER
B.Sc. (Hons.), A.M.I.E.E.

Radiovision Editor:
H. CORBISHLEY

Wireless Magazine

The Best Shillingworth in Radio

Vol. XX : OCTOBER 1934 : No. 117

Editor:
D. SISSON RELPH

Research Consultants:
W. JAMES and
PERCY W. HARRIS

Assistant Editor:
T. F. HENN

Published by BERNARD JONES PUBLICATIONS, LTD., 58/61 Fetter Lane, London, E.C.4. Telephone: Central 4341 (four lines). Telegrams: "Beejapee, Fleet, London." Subscription: Great Britain and abroad, 15s. 6d. a year, post paid (Canada only, 13s. 6d.). Next issue published on Wednesday, October 31.

The Most Selective Battery Set

I AM just back from Droitwich and in my mind is a picture of the long, low house; of the two 700-ft. aerials apparently as thin as knitting needles and yet big enough to accommodate, each of them, a lift; at the foot of the aerial a house containing an aerial-tuning apparatus; and the whole of the equipment everywhere gleaming with spit and polish; the workmanship superb; everything efficient and costly; and the station representing the most up-to-date transmitting equipment in the world.

Our article on Droitwich points out, incidentally, that although the giant is putting 150 kilowatts into its aerial it can easily double this should need arise. They say that Droitwich has cost £200,000; only the B.B.C. knows the actual figure but it is safe to add another £50,000 or £100,000.

Our Stenode last month made people talk. It was undoubtedly the most arresting example for home constructors that has appeared in print within the last two years. In many places "W.M." sold out and we were quickly out of print owing to the tremendous interest the Stenode articles aroused.

We continue the story this month and give further information about some of the outstanding points of the A.C. model and pay particular attention to ganging and to the use of valves other than those specified.

But one of our two big features this month is the Battery Stenode. Again, it is the design of Paul D. Tyers. It really is a great set, so selective that at Watford, just a few miles from the London transmitter, on an adjacent wavelength to Turin, the London National transmitter can be received quite clear of interference.

And for what the set is, it is cheap, remarkably so, the complete outfit costing between £14 and £15; and for this money you are getting the most selective battery set yet offered to the home constructor.

Among its many "talking points," I may mention that the pentode output is so controlled that the amount of current taken from the high-tension battery varies according to the strength of the signal received. I do hope that you will make one of these two Stenode models; you won't regret it.

We have in the Quartz-crystal Super for short waves a luxurious battery short-waver designed by Kenneth Jowers and using seven valves in all, five of which are high-frequency pentodes. Our tests of the set indicate that the sensitivity is so great that it can be recommended for use in any part of the world. We hear from many overseas readers who are getting fine results with the old "W.M." Empire Short-waver and challenge us to give them a better set. Here it is.

Tone-correction devices for particular circuits, nearly a dozen in all, are given in Noel Bonavia-Hunt's contribution this month—one of the most comprehensive articles on tone control ever presented.

We have many other features in this issue and I cannot even mention them. But I must, at any rate, refer to the big extensions in B.B.C. programmes which begin quite shortly and to which we devote attention in this issue, and also to our tests of manufactured sets, these covering a wide variety of new receivers from a simple, cheap battery three-valver to a fifteen-valve all-wave set costing nearly £70.

This month Percy Harris ends his series of articles discussing the principles of set design. I hope you have benefited from them. They have gone into a difficult subject very thoroughly and I do not think Mr. Harris has left much out.

I set out this month to give a "Something for everybody" issue. As I contemplate it, I rather think I have achieved my object.
B. E. J.

FOR THE CONSTRUCTOR	
THE "W.M." BATTERY STENODE. Designed by Paul D. Tyers	201
THE 1935 66 Os. BATTERY THREE. Designed by the "W.M." Technical Staff	217
MAKING YOUR OWN MIKE. By K. Ian Goodman	235
MORE ABOUT THE "W.M." STENODE. By Paul D. Tyers	242
THE QUARTZ CRYSTAL SUPER. Designed by Kenneth Jowers	267
TECHNICAL FEATURES	
TONE CONTROL FOR THOSE HIGH NOTES! By Noel Bonavia-Hunt, M.A.	212
THE NEW SEASON IN GERMANY. By A. A. Gulliland	225
NEW USES FOR OLD VALVES	227
WHERE THE STENODE SCORES. By Paul D. Tyers	229
MEASURING THE UPS AND DOWNS IN SIGNAL STRENGTH. By E. H. Chapman, M.A., D.Sc.	239
LINKING THE OUTPUT VALVE TO THE LOUD-SPEAKER. By Percy W. Harris, M.Inst. Rad. E.	249

Contents	
GETTING THE BEST OUT OF CAR RADIO. By J. H. Reyner, A.M.I.E.E.	255
TESTS OF THE NEW SETS. By the "W.M." Set Selection Bureau	257
AMPLION FIVE-VALVE A.C. SUPER-HET	258
KOLSTER-BRANDEN NEW BATTERY PUP	259
SCOTT ALL-WAVE FIFTEEN	260
TELSEN SIX-VALVE A.C. SUPER-HET	261
G.E.C. RADIOGRAM. MODEL AVC5	262
TESTS OF NEW APPARATUS	265

GENERAL ARTICLES	
WORLD'S BROADCAST WAVELENGTHS	194
IN TUNE WITH THE TRADE. By Fetter Lane	198
DROITWICH OPENS A NEW LISTENING ERA! By T. F. Henn	208
STILL BETTER RADIO CABINETS. By Westerner	210
"THE STUFF OF RADIO"	216
BIG EXTENSION OF B.B.C. PROGRAMMES. By T. F. Henn	222

ON THE CREST OF THE WAVES. By Jay Coote	228
READERS REPORT ON "W.M." SETS	231
RADIO MEDLEY. By BM/PRESS	232
WIRELESS JOBS MADE EASY FOR MR. EVERY-MAN. By R. W. Hallows, M.A.	236
A UNIQUE SERVICE	241
WHAT LISTENERS GAIN FROM THE NEW RADIO. By Alan Hunter	246
BROADCASTING HOUSE, BERLIN	253
IS A RADIO CAREER WORTH WHILE? By J. J. Cleaver	254
NEWS OF THE SHORT WAVES. By Kenneth Jowers	263
WE MUST BE ENTERTAINED! By Whitaker-Wilson	278
NEWS FROM ALL QUARTERS	284
COUPONS: INDEX TO ADVERTISERS	288

GRAMO-RADIO SECTION	
CHOOSING YOUR RECORDS. By Whitaker-Wilson	272
ADDITIONAL RECORDS REVIEWED. By Chopstick	273

TELEVISION ARTICLE	
PROGRESS IN GERMANY	274

Next Month: TESTS AND OPERATING HINTS ON OUR STENODE SETS

Registered at the General Post Office for transmission by Canadian Magazine Post

Postage on this issue 3d. (inland and abroad)



BROADCAST WAVELENGTHS

Stations best received in the British Isles are indicated in bold type

Note: Names in brackets are those of stations relayed

Wave-length	Name of Station	Dial Readings	Country	Wave-length	Name of Station	Dial Readings	Country
13.92	East Pittsburgh		U.S.A.	31.41	Jeløy LCL		Norway
13.97	Daventry GSH		Great Britain	31.48	Schenectady W2XAF (WGY)		United States
14.00	Deal W2XDJ		United States	31.545	Daventry (Empire) GSB		Great Britain
14.49	Buenos Aires LSY		Argentina	31.55	Melbourne VK3ME		Victoria
14.58	Bandoeng PMB		Java	31.55	Caracas YV3BC		Venezuela
15.92	Bandoeng PLE		Java	31.58	Rio de Janeiro PSA		Brazil
16.36	Lawrenceville (N.J.) WLA		United States	31.60	Lisbon CT1AA		Portugal
16.38	Rugby GAS		Great Britain	31.71	New Brunswick WKJ		United States
16.5	Drummondville (CFA8)		Canada	31.9	Bandoeng PLV		Java
16.56	Bandoeng PMC		Java	32.71	Lawrenceville WNA		United States
16.56	Buenos Aires LSY3		Argentina	32.79	Maracay YVQ		Venezuela
16.81	Bandoeng PLF		Java	32.88	Szekesfehervar HAT4		Hungary
16.85	Kootwijk PCV		Holland	33.26	Rugby GCS		Great Britain
16.86	Daventry Empire GSG		Great Britain	33.59	Rocky Point (N.J.) WEC		United States
16.878	Boundbrook W3XAL (WJZ)		United States	34.68	London VE9BY		Canada
16.88	Eindhoven PHI		Holland	36.65	Rio de Janeiro PSK (PRA3)		Brazil
16.89	Königswusterhausen DJE		Germany	37.04	Quito HCJB		Ecuador
19.47	Riobamba PRADO		Ecuador	37.33	Rabat (CNR)		Morocco
19.55	Schenectady W2XAD (WGY)		United States	37.41	Suva VPD		Fiji Isles
19.61	La Paz CP4		Bolivia	38.07	Tokio J1AA		Japan
19.63	New York W2XE (WABC)		United States	38.47	Radio Nations HBP		Switzerland
19.67	Coytesville N.J. W1XAL (WEEI)		United States	38.65	Kootwijk PDM		Holland
19.67	Tashkent (Rim)		U.S.S.R.	39.34	Tashkent RIM		U.S.S.R.
19.68	Radio Colonial FYA		France	39.76	Moscow RKK		U.S.S.R.
19.72	Saxonburg W8XK (KDKA)		United States	39.82	Riobamba PRADO		Ecuador
19.93	W8XK, Saxonburg (KDKA)		United States	40.3	Radio Nations HBQ		Switzerland
19.737	Zeesen DJB		Germany	40.5	Bogota HJ3ABB		Colombia
19.815	Daventry (Empire) GSF		Great Britain	40.54	Rocky Point WEN		U.S.A.
19.84	Rome (Vatican) HVJ		Italy	41.55	Bogota HKE		Colombia
19.88	Moscow (RKK)		U.S.S.R.	41.55	Las Palmas EA8AB		Canary Isles
20.27	Rocky Point WQV		United States	41.67	Singapore VSIAB		Sts. Sett'lmts.
20.31	Rocky Point N.Y. (WEB)		United States	41.84	Grenada YN6RD		Nicaragua
21.43	Cairo SUV		Egypt	41.9	Manizales HJ4ABB		Colombia
21.53	Rocky Point WIK		United States	42.92	Jeløy		Norway
21.58	Rocky Point WOP		United States	43	Madrid EA4AQ		Spain
21.605	Rocky Point WQT		United States	43.86	Budapest HAT2		Hungary
21.83	Drummondville CJA8		Canada	44.61	Rocky Point WQO		United States
22.26	Rocky Point WAJ		United States	44.96	Maracay YVQ		Venezuela
22.48	Santa Rita YVQ		Venezuela	45	Constantine FM8KR		Tunis
22.684	Zeesen (DHB)		Germany	45	Guatemala City		S. America
23.39	Radio Maroc (Rabat) CNR		Morocco	45.02	Guayaquil HC2RL		Ecuador
24.41	Rugby GBU		Great Britain	45.38	Moscow RW72		U.S.S.R.
24.9	Kootwijk PDV		Holland	46.53	Barranquilla (HJ1ABB)		Colombia
25	Moscow RNE		U.S.S.R.	46.69	Boundbrook W3XL (WJZ)		United States
25.25	Radio Colonial, Paris (FYA)		France	46.7	Boston W1XAL		United States
25.25	Saxonburg (Pa.) W8XK (KDKA)		United States	47	Cali HJ5ABB		Colombia
25.28	Daventry (Empire) GSE		Great Britain	47.5	S. Domingo HIZ		Dominican R.
25.34	Wayne W2XE (WABC)		United States	47.8	Domingo H1AA		Dominican R.
25.4	Rome ZRO		Italy	48.75	Winnipeg CJRO		Canada
25.45	Boston W1XAL (WEEI)		United States	48.78	Caracas YV3BC		Venezuela
25.51	Zeesen DJD		Germany	48.86	Saxonburg (Pa.) W8XK (KDKA)		United States
25.532	Daventry (Empire) GSD		Great Britain	49	Moscow (RKK)		U.S.S.R.
25.58	Winnipeg (CJRX)		Canada	49	Johannesburg ZTJ		South Africa
25.63	Radio Coloniale FYA		France	49.02	Wayne W2XE (WABC)		United States
26.83	Funchal CT3AQ		Madeira	49.08	Caracas YV1BC		Venezuela
27.65	Nauen DFL		Germany	49.1	Halifax VE9HX (CHNS)		Canada
27.86	Rugby GBP		Great Britain	49.18	Boundbrook W3XAL (WJZ)		United States
27.88	Marapicu PSG		Brazil	49.18	Chicago W9XF (WENR)		United States
28.28	Rocky Point (N.J.) WEA		United States	49.22	Bowmanville VE9GW (CRCT)		Canada
28.5	Sydney VLK		N.S. Wales	49.26	St. John VE9BJ (CFBL)		N. Brunswick
28.98	Buenos Aires LSX		Brazil	49.3	La Paz CP5		Bolivia
29.03	Bermuda ZFD		West Indies	49.34	Chicago W9XAA (WCFL)		United States
29.04	Ruyssedele (ORK)		Belgium	49.39	Maracaibo V5BMO		Venezuela
29.16	Zeesen (DIQ)		Germany	49.4	Vienna OER2		Austria
29.35	Marapicu PSH		Brazil	49.43	Vancouver VE9CS (CKFC)		Brit. Columbia
29.59	Leopoldville OPM		Belgian Congo	49.47	Nairobi VQ7LO		Kenya Colony
29.64	Marapicu PSI		Brazil	49.5	Philadelphia W4XAU (WCAU)		United States
29.84	Abu Zabel, Cairo SUV		Egypt	49.5	Daventry (Empire) GSA		United States
30	Radio Excelsior LR5		Argentina	49.586	Daventry (Empire) GSA		Great Britain
30.1	Rome IRS		Italy	49.6	Bogota HJ3ABI		Colombia
30.4	Lawrenceville WON		United States	49.67	Boston W1XAL (WEED)		United States
30.43	Tokio J1AA		Japan	49.83	Zeesen DJC		Germany
30.43	Madrid EAQ		Spain	49.9	Singapore ZHI		F.M. States
30.77	Lawrenceville WOF		United States	49.92	Havana COC		Cuba
30.9	Rugby GCA		Great Britain	49.96	Drummondville VE9DN (CFCE)		Canada
31.23	Daventry (Empire) GSC		Great Britain	49.97	Caracas YV2BC		Venezuela
31.23	Mexico City XETE		Mexico	50.8	Barcelona EA3AB		Spain
31.26	Radio Nations HBL		Switzerland	50.8	Moscow RNE		U.S.S.R.
31.28	Philadelphia W3XAU (WCAU)		United States	50.26	Rome (Vatican) HVJ		Italy
31.28	Sydney VK2ME		N.S. Wales	50.26	Vatican		Rome
31.35	Millis W1XAZ (WBZ)		United States	50.42	Domingo HIX		Dominican R.
31.38	Zeesen DJA		Germany	50.6	Medellin HJ4ABE		Colombia

Continued on page 196

Why the price
is shown

SO BOLD

★
£5.15
OR 10/- A MONTH

KB

'NEW PUP'

3 VALVES WITH MOVING-COIL SPEAKER

When the price is low and the value great we are not afraid to beat the big drum. That's how it is with the KB 'New Pup.' We've simply got to tell you that you've never had the chance of such fully satisfying radio reception for so little money before. Look at the specification. 3 highly efficient valves, one a pentode. High grade moving coil speaker. Full-vision dial with station names. A really attractive and well-finished cabinet. And then look at the price—£5 15s. There's value for you! Real KB value. We christened it the 'New Pup' because it succeeds the original KB 'Pup'—the set that charmed more than 200,000 homes. To appreciate the value of the 'New Pup' you must hear it. KB authorised Dealers are waiting to demonstrate it to you—without obligation.

Over 200,000 of the original KB 'Pup' sets have been sold.

KB 'NEW PUP,' 3-valve Battery model. Handsome Oak Cabinet, **£5 15s.** or first payment of 12/- (including 2/- insurance) and 12 monthly payments of 10/-.

KB 'NEW PUP,' 3-valve A.C. model. Fine Walnut-finished Cabinet, **£6 17s. 6d.** or first payment of 14/- (including 2/- insurance) and 12 monthly payments of 12/-.

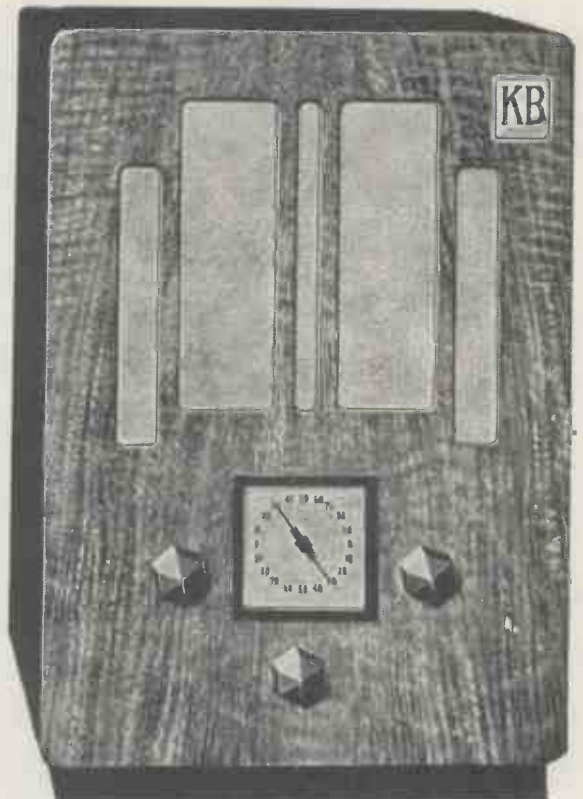

Send for new **KB CATALOGUE**

Post in unsealed envelope using ½d. stamp to
KOLSTER-BRANDES LTD., CRAY WORKS, SIDCUP, KENT
Please send me full particulars of the new KB receivers.

Name

Address

W.M.
Oct., 1934

KB RADIO

from £5 15s. to 65 guineas

WORLD'S BROADCAST WAVELENGTHS Continued from page 194

Wave-length	Name of Station	Dial Readings	Country	Wave-length	Name of Station	Dial Readings	Country
56.9	Königswusterhausen (DTG)		Germany	307.1	West Regional		Great Britain
57.03	Rocky Point WQN		United States	309.9	Grenoble PTT		France
58.03	Bandoeng PMY		Java	312.8	Poste Parisien, Paris		France
58.31	Prague		Czechoslovakia	315.8	Breslau		Germany
60.3	Rugby GBC		Great Britain		Goteborg		Sweden
62.5	Long Island (N.J.) W2X		United States	318.8	Algiers		North Africa
62.56	London		Ontario	321.9	Brussels (2)		Belgium
65.93	Rocky Point WAD		United States	325.4	Brno		Czechoslovakia
68.18	Moscow (RFCK)		U.S.S.R.	328.6	Radio Toulouse		France
69.44	Rugby GDB		Great Britain	331.9	Hamburg		Germany
70.2	Khabarovsk RV15		U.S.S.R.	335.2	Limoges PTT		France
73	Quito (HCJB)		Ecuador	335.2	Helsinki		Finland
76	Maracay (YV11AM)		Venezuela	338.6	Graz		Austria
80	Lisbon CTICT		Portugal	342.1	London Regional		Great Britain
84.5	Berlin D4AGE		Germany	345.6	Poznan		Poland
84.67	Mozambique CR7AA		East Africa	349.2	Strasbourg		France
85.9	Boston WIXAL		United States	352.9	Bergen		Norway
203.5	Plymouth		Great Britain	352.9	Valencia		Spain
204.7	Bournemouth		Great Britain	356.7	Berlin		Germany
206	Pecs		Hungary	360.6	Moscow (4)		U.S.S.R.
208.6	Fécamp		France	362.8	Radio LL Paris		France
209.9	Miskolcz		Hungary	364.5	Bucharest		Roumania
209.9	Beziers		France	368.6	Milan		Italy
211.3	Newcastle		Great Britain	373.1	Scottish Regional		Great Britain
214	Tampere		Finland		Salonika		Greece
214	Sofia		Bulgaria	377.4	Lvov		Poland
215.4	Radio Lyon		France	382.2	Barcelona (EAJ1)		Spain
216.8	Warsaw No. 2		Poland	382.2	Leipzig		Germany
218.2	Basle, Berne		Switzerland	386.6	Toulouse PTT		France
219.6	Lorun		Poland	391.1	Midland Regional		Great Britain
219.6	Turin (2)		Italy	395.8	Katowice		Poland
	Dublin		Irish F. State	400.5	Marseilles PTT		France
	Bordeaux S.O.		France	404.5	Munich		Germany
222.6	Königsberg		Germany		Seville		Spain
	Milan (2)		Italy	410.4	Tallinn		Estonia
224	Montpellier		France		Madrid (Espana)		Spain
	Lodz		Poland	415.5	Kiev		U.S.S.R.
	Hanover		Germany	420.8	Rome		Italy
	Bremen		Germany	426.1	Stockholm		Sweden
225.6	Flensburg		Germany	431.7	Paris PTT		France
	Stettin		Germany	437.3	Belgrade		Yugoslavia
	Magdeburg		Germany	443.1	Sottens		Switzerland
230.2	Danzig		Germany	449.1	North Regional		Great Britain
	Linz		Austria	455.9	Langenberg		Germany
231.8	Salzburg		Austria	463	Lyons PTT		France
	Dornbirn		Austria	470.2	Prague (1)		Czechoslovakia
	Aberdeen		Great Britain	476.9	Trondheim		Norway
233.5	Dresden		Germany	492.6	Brussels (1)		Belgium
235.1	Stavanger		Norway	491.8	Florence		Italy
236.8	Nurnberg		Germany	499.2	Sundsvall		Sweden
238.5	San Sebastian		Spain	506.8	Rabat		Morocco
238.5	Rome (3)		Italy	514.6	Vienna		Austria
240.2	Juan-les-Pins		France	514.6	Agen		France
241.9	Cork		Irish F. State	522.6	Riga		Latvia
243.7	Gleiwitz		Germany	522.6	Mühlacker		Germany
245.5	Trieste		Italy	531	Athlone		Irish F. State
247.3	Lille PTT		France	539.6	Beromünster		Switzerland
249.2	Prague Stranice (2)		Czechoslovakia	550.5	Budapest		Hungary
	Frankfurt-am-Main		Germany	559.7	Wilno		Poland
	Trier		Germany	559.7	Bolzano		Italy
251	Freiburg-im-Breisgau		Germany	569.3	Viiipuri		Finland
	Cassel		Germany	578	Ljubljana		Yugoslavia
	Kaiserlautern		Germany	578	Innsbruck		Austria
253.2	Kharkov (2)		U.S.S.R.	696	Hamar		Norway
255.1	Copenhagen		Denmark	725.5	Oulu		Finland
257.1	Monte Ceneri		Switzerland	748	Ostersund		Sweden
259.1	Moravska-Ostrava		Czechoslovakia	748	Moscow		U.S.S.R.
261.1	London National		Great Britain	765	Geneva		Switzerland
	West National		Great Britain	765	Boden		Switzerland
263.2	Turin (1)		Italy	824	Smolensk		U.S.S.R.
265.3	Horby		Sweden	845	Fuimark		Norway
267.4	Belfast		N. Ireland	1,107	Moscow (2)		U.S.S.R.
	Nyiregyhaza		Hungary	1,145	Mosdon		U.S.S.R.
	Kosice		Czechoslovakia	1,154	Oslo		Norway
269.5	Radio Vitus (Paris)		France	1,224	Leningrad		U.S.S.R.
271.7	Naples		Italy	1,263	Kalundborg		Denmark
274	Madrid EAJ7		Spain	1,304	Luxembourg		Luxembourg
276.2	Falun		Sweden	1,339	Warsaw		Poland
	Zagreb		Yugoslavia	1,389	Motala		Sweden
278.6	Bordeaux PTT		France	1,395	Eiffel Tower		France
280.9	Tiraspol		U.S.S.R.	1,442	Minsk		U.S.S.R.
283.3	Bari		Italy	1,500	Daventry National		Great Britain
285.7	Scottish National		Great Britain	1,310	Ankara		Turkey
	Leningrad (2)		U.S.S.R.	1,571	Deutschlandscoder		Germany
288.5	Rennes PTT		France	1,612.3	Istanbul		Turkey
	Konigsberg		Germany	1,648	Radio Paris		France
291	Parede		Portugal	1,724	Moscow No. 1		U.S.S.R.
	Barcelona (EAJ15)		Spain	1,807	Lahti		Finland
293.5	North National		Great Britain	1,807	Kootwijk		Holland
296.2	Bratislava		Czechoslovakia	1,875	Hilversum		Holland
298.8	Huizen		Holland	1,875	Brasov		Roumania
301.5	Genoa		Italy	1,935	Kaunas		Lithuania
304.3	Cracow		Poland	1,935			



ENERGY in every inch

You simply can't keep a good man down—nor a good battery!

Like the warrior shown above, the new "Anodex" have a remarkable reserve of energy. Packed with super-abundant power, they maintain a steady output for a very satisfying period



SMITH'S WIRELESS BATTERIES

S. SMITH & SONS (Motor Accessories) LTD.
CRICKLEWOOD LONDON, N.W.2



ARE YOU BUILDING THE STENODE RECEIVERS?



You cannot expect maximum results from your Stenode Receiver if you depart from specification. Grampian Reproducers are specified because they are built specially for the receiver... their brilliant reproduction matching the brilliant performance of the circuit.

You cannot improve on the expert technicians' choice. Be sure your speaker is a Grampian when building your Stenode.

GRAMPIAN IS THE SPECIFIED REPRODUCER

If you are building the Mains Model you will need Grampian Type E/1 Stenode. Complete with transformer.

The Battery Model calls for Grampian Type P.C.3/S. Complete with transformer.

29/6

35/-

For whatever purpose you need a reproducer, you cannot do better than buy a Grampian. Consistently specified by the leading set designers, you will find that a Grampian Reproducer gives you everything you ask of a loud-speaker.

GRAMPIAN REPRODUCERS LTD,
KEW GARDENS, SURREY.

Advertisers like to know you "saw it in the 'Wireless Magazine'"

In Tune with the Trade

FETTER LANE'S Review of the Latest Catalogues

SEND TO US FOR THESE CATALOGUES!

Here we review the newest booklets and folders issued by six manufacturers. If you want copies of any or all of them, just cut out this coupon and send it to us. We will see that you get all the literature you desire.

Just indicate the numbers (seen at the end of each paragraph) of the catalogues you want below :-

My name and address are :-

Send this coupon in an unsealed envelope, bearing a d. stamp, to "Catalogue Service," WIRELESS MAGAZINE, 58-61 Fetter Lane, E.C.4. Valid till Oct. 31.

Resistors by Erie

ALL you want to know about resistors, fixed and variable, together with useful technical data is contained in the latest little booklet issued by the Radio Resistor Co., Not only are all the products described in detail, but the key to the R.M.A. Colour Code is given besides the dimensions for all values of Erie resistors.

The technical data is really most useful. Several pages are devoted to design problems, characteristics, temperature rise with load, voltage, and temperature coefficients. While if one turns to pages 18 and 19 the "dope" and charts given there enable all calculations concerning Ohm's Law to be done in two ticks, without any headaches.

There's no doubt about the fact that every constructor should get hold of one of these fine booklets right away. **416**

Marconi Valves

I HAVE yet to find an amateur who does not delight in wading through a valve booklet. In view of this, I imagine that the Marconi-people will be swamped with requests for their latest issue as it certainly contains a whole heap of information. The full range of valves is described in detail and curves given for each.

Out of the sixty-four pages, which

forms the booklet, two are devoted to making the numerous valve bases quite clear, while seven pages contain circuit diagrams with component values, which are always valuable. To assist those who have to make replacements a comprehensive table of Marconi equivalents is given, making the matter quite easy. Why not join in the rush and secure one of the publications for your file? **417**

Utility Components

TWO leaflets just to hand contain details of two new lines now released by Wilkins & Wright, Ltd. They are the straight-line dial (illuminated) and the straight-line micro-dial. In both cases, full vision is obtainable while the scale is inclined at an angle which greatly assists in reading off the wavelength or degrees.

With the straight-line type a ratio of 12 : 1 is provided and the indicator moves across the scale in direct proportion to the angle of rotation of the knob.

An outstanding feature is that there is no trace of slip in the drive, even when used with the heaviest type of gang condenser. It is supplied with either two-colour scale marked in wavelengths and 0-100 degrees, or with plain black scale marked in 0-100 degrees only.

For coils having an inductance of 157 and 2,200 microhenries the two-colour scale is correct when used with the makers' condensers W.347 and W.349.

The micro-dial is fitted with a dual-ratio drive 12 : 1 and 150 : 1 and is therefore eminently suited for short-wave fans who require a smooth and reliable drive. **418**

Radiophone Reductions

HERE is some good news for the constructor. British Radiophone, Ltd., has sent us a list showing the reduced prices for many condensers. In some cases the reduction is as much as 10s. 6d. For example, the super-het three-gang,

type No. 467, is now 19s. 6d. against its old price of 30s.

Several new types are listed and it is interesting to note that the inductance of the coils suitable for operation with the gang condensers is specified. This step certainly enables one to match up the components quite closely. **419**

All About Amplion

RADIOGRAMS, sets, moving-coil loud-speakers, microphones and pick-ups are the features of Amplion's latest folder. The large Radiolux radiogram is described, together with the autogram model at fifty guineas. Both of these are for A.C. mains, while a smaller table model can be obtained for A.C. or D.C. mains.

Needless to say, all the sets employ a super-het circuit and all the latest devices to simplify their operation and secure a high degree of efficiency. All the loud-speakers listed are of the permanent-magnet type and vary in price from 55s. to 32s. 6d. Each model is fitted with a matching input transformer and magnets having generous proportions.

The cone housing is most rigid and the detailed improvements in the coil suspension add to the sensitivity and tonal balance. The two largest models with 10- and 7-in. diameter cones embody many refinements including a completely sealed magnetic gap. **420**

About W.B. Loud-speakers

ONCE a year, I make a regular habit of telling you about the latest W.B. loud-speakers. Unfortunately, I have not left myself much room this month, so I will have to be brief. I will mention them in full later.

I do want to draw your attention to the W.B. leaflet in which they describe a new Baby reproducer. It is so small, that it fits neatly in the palm of one's hand. And it gives results as good, and even better, than some full-grown makes. Write for this leaflet! **421**

UNRIVALLED!

EFFICIENCY

CONSISTENCY

ECONOMY

WITH

THESE NEW BATTERY VALVES



MARCONI
HL2/K, a
2-volt triode
employing
Catkin tech-
nique.

● Marconi 2-volt valves comprise the most complete range of up-to-date utility types—including the X21 heptode, the QP21 double output pentode and the new 'K' series, each particularly adapted to the requirements of modern circuit design. The more popular types are as follows: →

X21	Heptode	18/6
S23	Straight S.G.	12/6
S24	Straight S.G.	12/6
VS24	Vari-Mu S.G.	12/6
VP21	Vari-Mu H.F. Pen.	13/6
HD21	D.D. Triode	9/-
HL2	G.P. Triode	5/6
L21	L.F. Triode	5/6
LP2	Power	7/-
PT2	Pentode	13/6
B21	Class B	14/-
QP21	Q.P.P. Pentode	22/6

'K' series

VS24/K	Vari-Mu S.G.	12/6
HL2/K	G.P. Triode	5/6
PT2/K	Pentode	13/6

MARCONI VALVES



★ A card to The Marconiphone Co. Ltd., Radio House, Tottenham Court Road, W.1, will bring you a copy of the comprehensive new catalogue of Marconi valves.

THE CHOICE OF THE EXPERTS

Laboratory Built Radio

All our Receivers are hand Built by Experts

PUBLIC ADDRESS

We specialise in all types of Public Address equipment, microphones, amplifier and speaker installation designed for high fidelity reproduction. These have been supplied for use in hotels, garages, country houses, hospitals as well as carnivals, garden parties, etc. We install and maintain the above gear.

RECEIVERS

For those who require regular world-wide reception, together with a very high degree of fidelity in reproduction we supply a range of multi-valve receivers. These instruments have been designed to give the very finest performance possible, and are supplied as chassis, console receivers or radiograms.

SHORT WAVES

We have supplied high efficiency Short Wave Receivers for use in all parts of the world. All these receivers have single dial tuning and with a range from 13 metres. Five-metre receivers built to order. We also design and supply transmitters for Short and Ultra Short waves. Several pleasure yachts have been fitted with our equipment both for transmitting and receiving.

★ *Our consulting Engineer will be pleased to discuss details regarding particular installations. Write us your requirements and our estimates will be prepared free of charge. Our technical staff is at your disposal to advise on the selection of the most suitable receiver or apparatus.* ★

KEATES & CO.

91/93 BISHOPSGATE, E.C.2 Phone: London Wall 5750

Works:

HENDON, N.W.

Advertisers like to know you "saw it in the 'Wireless Magazine'"

The ear alone is not enough...



Science and sight combine to test "His Master's Voice" true-to-life tone • The Cathode Ray oscillograph is one of the wonders of science, for it turns sound into something you can see. It converts a musical composition into a graph This has been incorporated in apparatus specially designed by "His Master's Voice" Research engineers for checking the performance of the intermediate frequency stages of "His Master's Voice" super-hetrodyne instruments.

The Cathode Ray I.F. Visual Ganging Apparatus is one of the hundreds of testing fixtures used in the "His Master's Voice" factories at Hayes. This apparatus gives a visual indication of the shape of the response curve, and ensures the correct adjustment of the intermediate frequency stages in each superhetrodyne radio chassis. An unmodulated oscillator varying by approximately plus and minus 15 K.C. from 117 K.C. is fed into the receiver and the output from the second detector is viewed on the oscillograph. Any variation or inaccuracy in the response curve is clearly visible, and is corrected, if necessary, so that a uniform response is obtained throughout the audible range, in addition to the highest possible degree of selectivity.

"His Master's Voice"

THE GRAMOPHONE COMPANY LTD • 98-108 CLERKENWELL ROAD • LONDON • EC1
When replying to advertisements, please mention "Wireless Magazine"

PAUL TYERS

Last Month Gave
"W.M." Readers
Details of the Best-yet
A.C. Super-het.

Now He Describes the
Construction of a Bat-
tery STENODE, the
Most Important Set of
the Year!



The "W.M."

BATTERY STENODE

IF it were possible to produce a valve which would run equally well from A.C., D.C., or battery supply, the set-designer's problem would be greatly simplified. Of even greater importance, however, is the fact that there would be a tremendously increased stimulus to construction by the amateur.

The fact that one cannot always remain in the same district for life must act as a deterrent to spending a sum of money on a really first-class set.

Last month I designed for "Wireless Magazine" an A.C. mains version of a Stenode receiver. When I did this I had in mind the possibility of designing similar

Stenode sets for battery or D.C. mains operation. With this in view, I took as a nucleus of construction a form which I could apply with very little modification to other types of power supply.

On the face of it, it might appear that I did this simply to save work,

but this was not my consideration. I endeavoured to produce a form of construction which would be applicable to all types of sets so that should the home constructor find himself faced with moving into another district necessitating D.C. supply or even batteries, he would not have to rebuild the set completely and throw away half the components.

Like the A.C. Model

The battery set which I have now designed differs only from the mains model in the valves and some of the resistances and condensers, the power pack, of course, being dispensed with. This means that it is exceptionally easy at any time to convert either a mains model to a battery model or vice versa.

The battery chassis, in fact, is, in appearance, identical with the mains one and the same layout has been carefully followed. Use is made of the same brackets and strips for the resistances and condensers, the only difference being that quite a number of the clips are left blank because the battery set does not require quite so many resistances.



EVERYTHING FITS IN SNUGLY AND EFFICIENTLY

How the "W.M." Battery Stenode fits into its cabinet. As the set is a fair size the cabinet is also somewhat larger than usual, which limits any possibility of box resonance

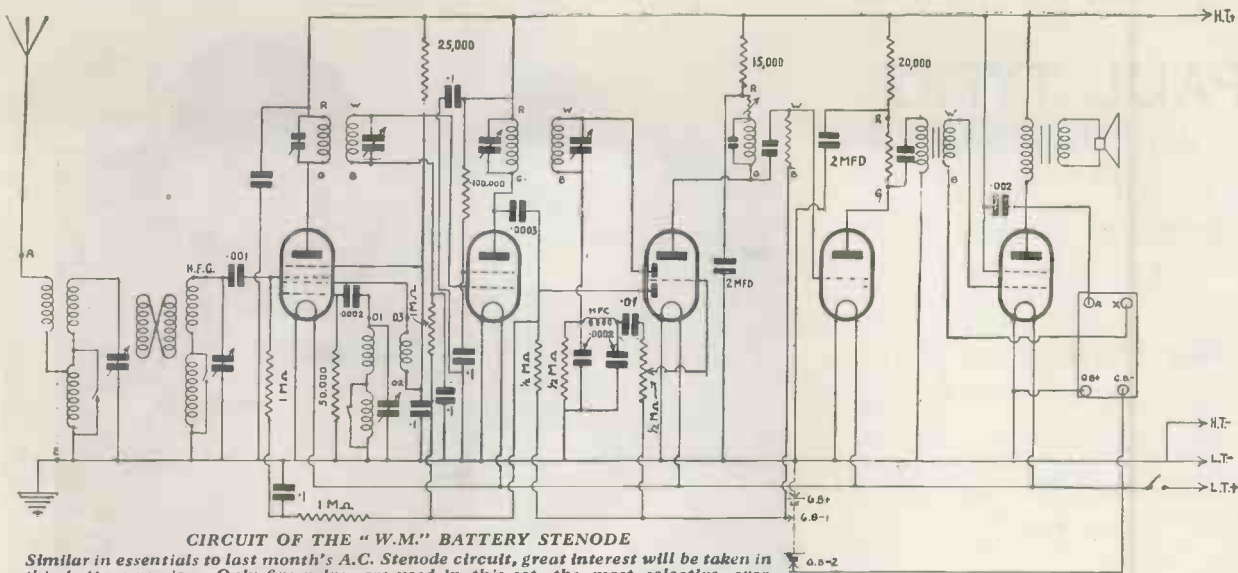

CIRCUIT OF THE "W.M." BATTERY STENODE

Similar in essentials to last month's A.C. Stenode circuit, great interest will be taken in this battery version. Only five valves are used in this set, the most selective ever presented to the constructor

There is one other difference, and this lies in the tuner. In the mains model I utilised a proprietary line known as the Radiopak, but this time I have employed a C.A.C. tuning pack. The two tuners are of somewhat similar type, employing band-pass pre-selection and circuits for an oscillator valve.

Tuning Unit

The present tuning pack, however, has been designed specifically for use with modern mixing valves and it is, therefore, very convenient to use. It occupies much the same space as the Radiopak, but constructors will find it necessary just to cut away one corner of the fixing flange so as to clear the mixing-valve socket.

I have pointed out on past occasions that the function of the Stenode receiver was to give selectivity between adjacent channels and that the use of the Stenode did not overcome any second-channel or heterodyne difficulties.

The C.A.C. tuning pack employs a special form of inductive link coupling which gives a fairly flat-topped resonance curve and a reasonably even gain over the entire waveband.

Oscillation Strength

I have mentioned that the circuits in the oscillator section have been specially designed for modern mixing valves. This is a matter of some importance, as it is essential to get the correct strength of oscillation. Oscillation strength is determined in part by the degree of coupling be-

tween the coils and the voltages at which the valve works.

Now, one cannot take liberties with the voltages in a mixing valve, and a modern mixing valve must be run very closely in accordance with the makers' rating. This means that the oscillator circuits must be designed to give the correct strength of oscillation with the specified oscillator anode voltage.

A very satisfactory degree of

NEXT MONTH

*Tests and
Operating Hints
on the "W.M."
Stenode Sets*

coupling appears to have been obtained in the unit in question and the practical performance of the set shows that the valve does not tend to generate a high percentage of harmonics, and the oscillator grid is definitely not overdriven. This means that the strength of heterodyne chirps is reduced to a minimum.

The dynamic resistance of the anode section of the mixing valve, which is the new Marconiphone X21, is quite high, and in conjunction with the Stenode couplers gives an excellent gain and a good resonance curve.

The first Stenode high-frequency coupler works into a Hivac variable-mu pentode, which again has an appropriate working impedance for the second Stenode coupler.

Double-diode-triode

This is followed by a double-diode-triode valve arranged in the same manner as that in the mains Stenode. One diode is used for rectification and the other is used for A.V.C. purposes, the potential being derived from the preceding anode through a small coupling condenser.

The A.V.C. voltage is applied to the grid of the mixing valve and the grid of the intermediate amplifier. The returns of both these valves are de-coupled.

It will be noticed that the grid return or the lower end of the pre-selector circuit is not available for bias control, and this bias has to be applied through a resistance-condenser network. This is clearly shown in the circuit.

Output Stage

Little need be said with regard to the first low-frequency valve, which is coupled through the variable tone corrector.

The output, which is provided by a pentode, differs from the mains model in that the battery economising scheme is used. For convenience I have utilised a proprietary network produced by Varley.

It is here advisable to explain how this works, in case any constructors are not acquainted with the method of operation. Normally, the

grid of the output pentode is biased right back so that the standing current is very small. Under these conditions the effective grid base is, of course, extremely limited as the valve is very near the cut-off point. The anode of the valve is coupled through a fixed condenser to a Westector rectifier.

Economiser Unit

Now it follows that whatever voltage is applied to the grid of the valve, there will be a corresponding magnified voltage at the anode. Alternating anode voltages are rectified by the rectifier, a mean voltage being obtained through the condenser-resistance network which is associated with it. The rectifier is so connected that this voltage is positive with respect to the filament.

It will be seen that the greater the magnitude of the A.C. components the greater will be the positive voltage. This positive voltage is used to overcome or oppose the high negative voltage supplied by the grid battery. As a result, as the magnitude of the grid voltage tends to rise so is the bias reduced until the full grid base of the valve is available for working.

High-tension Economy

This means that the standing current will only reach its maximum value on loud passages, and accordingly there is very considerable economy in high-tension current.

There are a number of various points which should be carefully noted, but these will be dealt with later. In building the set it is convenient to mount first of all the valve holders and Stenode couplers. The

various resistances and condensers which are carried on the strips are all soldered into position before they are actually fixed to the chassis.

Before this is done, however, the filament circuit should be wired up and it will then be found quite easy to connect the wires from the Stenode couplers to their respective positions and also take the very short leads to the various valve sockets direct from the condenser and resistance strips. The high-frequency choke and the two fixed condensers can be added when found most convenient.

It will be noted that a screened lead is used for the connection to the anode cap of the intermediate-frequency amplifier. It is important that this screen should be properly bonded and earthed, and the same applies to the screened leads which connect it to the volume control.

I have previously mentioned that it is essential not to take a long continuous earth lead in any chassis, and it will be seen that the earthing system forms quite a network, the earth wire going down to the chassis at quite a number of different points.

It will be noted that the wire that

goes to the grid cap of the mixing valve is unshielded. This is very necessary, as if a screened lead is used in this position the stray capacity across the first tuned circuit will be so great that the set will probably not trim properly.

Tight, Rigid Wires

The C.A.C. tuner has all the terminals on the far side. The wires from these terminals are taken underneath the chassis to their respective points, and it is essential to see that these are tight and rigidly anchored. Any variation here will tend to upset the ganging of the receiver because



SIMPLIFIED BY SUB-ASSEMBLIES

This view of the underside of the "W.M." Battery Stenode shows how the construction is simplified by the use of sub-assemblies for the mounting of tubular condensers and fixed resistances



YOU MUST KNOW ALL ABOUT THE MOST IMPORTANT SET OF THE YEAR

This "W.M." Battery Stenode is the first opportunity the constructor has had of building a battery set based on the principles evolved by Dr. James Robinson—it is undoubtedly the most important set of the year

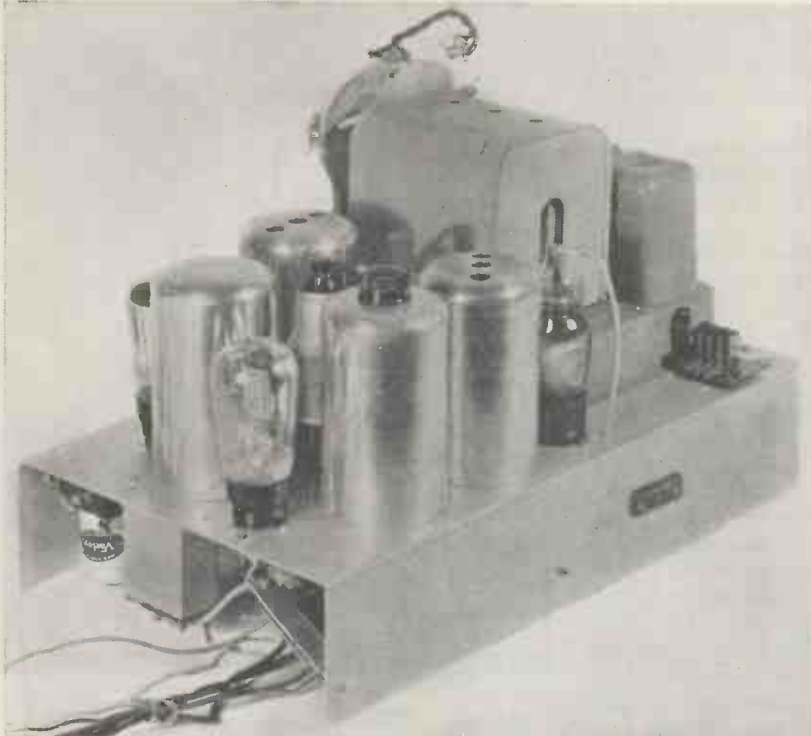

DESIGNED ON "COMMERCIAL" LINES FOR THE AMATEUR
Paul Tyers is one of our most experienced trade designers and in this "W.M." set he has adapted production methods for the benefit of the amateur. There is no doubt that thousands of constructors will build a "W.M." Stenode this coming winter

small capacity changes have a marked effect upon the Stenode system.

It will be seen that the high-tension supply is derived from one tapping only, a special 126-volt battery being used which fits nicely into the cabinet.

There are only two grid-bias connections, the first tapping being made at $1\frac{1}{2}$ volts. This provides the bias for the triode section of the double-diode-triode and the intermediate low-frequency amplifier, and

also provides the delay on the A.V.C. diode.

The bias used on the last valve will depend entirely upon the valve which is actually employed. Actually use has been made of a Hivac Z220.

The bias in an "economised" circuit is approximately twice the normal bias recommended by the valve manufacturer. Actually it is advisable to find the best tapping experimentally. The bias should be

made as large as possible so as to keep the steady current down to a minimum consistent, of course, with the absence of any distortion.

So as to give plenty of scope in varying the output valve and the bias required, an 18-volt grid-bias battery should be used.

Ganging the Set

The ganging of the set and initial adjustment is carried out in exactly the same manner as recommended for the mains version.

So far as the resistance-capacity network used in the set is concerned, there are only two resistances which are critical. The first is the resistance which supplies the screen and oscillator anode voltage for the mixing valve. This voltage should be kept as low as possible, for two reasons.

Critical Values

In the first place the anode current should be kept within reasonable limits and, secondly, if this is made too high the valve may not oscillate properly, the harmonic content may be bad, and the general conditions will be unsuitable. The set was tested with various mixing valves and it was found that most satisfactory results were obtained with a resistance of the order of 25,000 ohms, which gave a compromise between gain, purity of oscillation and anode current.

The next critical resistance is that which supplies the screen of the variable-mu pentode. A resistance of 100,000 ohms has been chosen as providing a good compromise. If this is reduced the gain will rise, but so will the anode current.

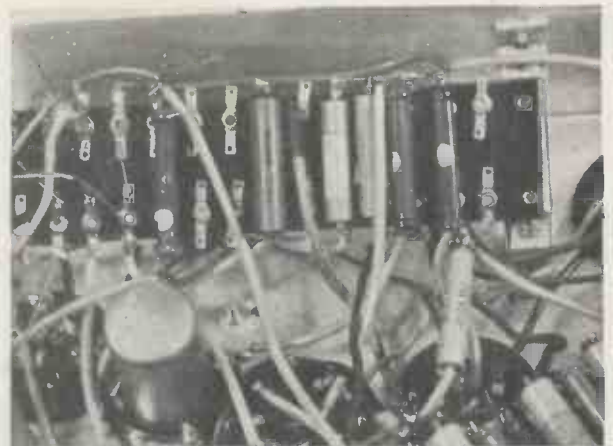
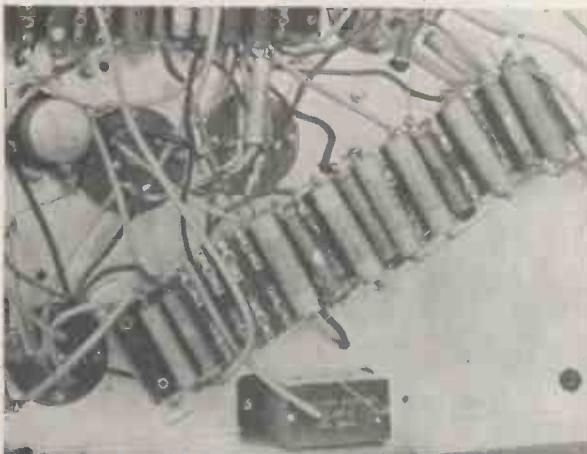

HOW COMMERCIAL PRACTICE HAS BEEN ADAPTED TO AMATEUR REQUIREMENTS
These photographs show the two sub-assemblies used for mounting the tubular condensers and fixed resistances. This method is commonly used in mass-production work and greatly facilitates construction

If a milliammeter is available, it will be found that with the resistances recommended and the valves suggested, the total feed will be of the order of 10 milliamperes under quiescent conditions, or even a little lower. The peak current, of course, rises above this value on loud passages owing to the economiser circuit which is employed.

First Tests

It will be remembered that the Stenode couplers are sent out tuned substantially to 110 kilocycles. In initially adjusting the receiver the trimmers on these should not be touched and the coupling should be set to about half way.

Tests should first be carried out with the local station and if everything is in order it should tune-in more or less at the correct position on the dial. The degree of coupling should then be slackened in both Stenode couplers and a careful note should be made of the position of the local station on the dial.

Dial Calibrations

It will be found that the calibration of the dial is reasonably accurate and if the station does not tune-in quite at the right place, a small adjustment should be made to the oscillator trimmer on the three-gang condenser. This is the one nearest to the dial.

A weak station should then be tuned-in and the strength should be brought to a maximum by varying the aerial and band-pass trimmers.

Under normal working conditions an extremely weak coupling is required in the first coupler, and slightly greater in the second one. These should be finally ganged on a weak station, but not until the calibration has been tested out on a number of points on the tuning scale. Fécamp is a very good station upon which to work.

Final Adjustments

The final adjustments are best carried out at night when the field strength of the various stations is at a maximum.

The best adjustment for maximum selectivity is obtained by tuning-in the adjacent channel to the local transmission, such as Turin when London National is working. This readily enables the correct ganging position to be obtained on the Stenode couplers and also shows the

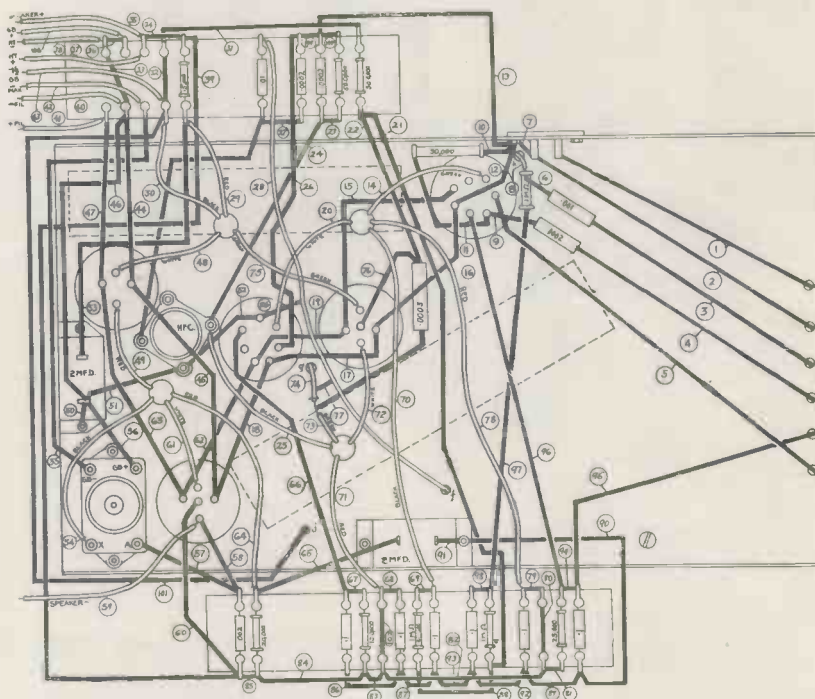
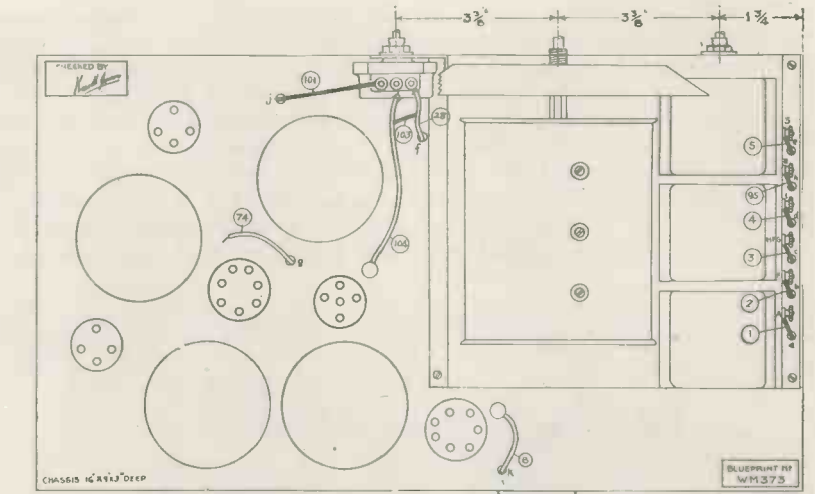

QUARTER-SCALE LAYOUT AND WIRING DIAGRAM
 If desired, a full-size blueprint can be obtained for half price, that is 9d., post paid, if the coupon on the last page of the issue is used by October 31. Ask for No. WM373 and address your application to "Wireless Magazine," Blueprint Dept., 58-61 Fetter Lane, London, E.C.4

best degree of coupling to employ. It will be remembered that with weak coupling more tone control will be required. The tone is adjusted, of course, by varying the knob on the first low-frequency coupler; clockwise rotation increases the bass, and anti-clockwise decreases the bass. The weaker the coupling the smaller is the bass response required. The tone correction in this receiver is spread over the two coupling units of the loud-speaker, a special rising characteristic loud-speaker in the form of a Gramplan being used. Once the degree of coupling and

the consequent selectivity which is required has been determined, no further adjustment should be made to the tone control in the set. All these ganging operations are best carried out before the set is put into the cabinet. This is essential because the padding condenser for the long-wave section has an adjustment which is only accessible from the bottom of the chassis. All the adjustments which have been described should be made on the medium-wave section, and not until everything is set in this position should the long-wave section be adjusted.

The only adjustment required for this is the rotation of the padding condenser knob just referred to, which is moved until a known station tunes in at the correct position on the main tuning dial. For example, the dial should be set to 1,500 metres and the padding condenser should then be adjusted until the station tunes dead in without any

on grounds of convenience and expense.

The primary function of the A.V.C. circuit is to overcome the defect of fading and at the same time provide sufficient bias to prevent overloading and distortion on strong local signals. The A.V.C., however, will not give the same output on field strengths of all intensities and

use must be made of the volume control when receiving very powerful local stations.

Use of Volume Control

Very considerable gain is obtained in the low-frequency section of the receiver and it is most important that very full use is made of the volume control when listening to the local station. In the case of nearly all other transmissions it should be possible to leave the volume control set to a suitable level and the majority of the Continental transmissions will come in at reasonably equal volume.

The actual performance obtained from the set, of course, depends entirely upon the valves used, and those recommended suit the circuit and network admirably.

Alternative Valves

Modification can be made to the valves without affecting the performance, and it is well to consider what the characteristics should be.

The first valve is a mixing valve and I do not recommend that this should be substituted by one of a radically different type, because if this is done it may be necessary to make very considerable modification.

The next valve is a Hivac VP215 variable-mu pentode and if valves of other types are used it may be necessary to alter the screen resistance to provide the necessary voltage. The valve makers' recommendation, however, can be taken

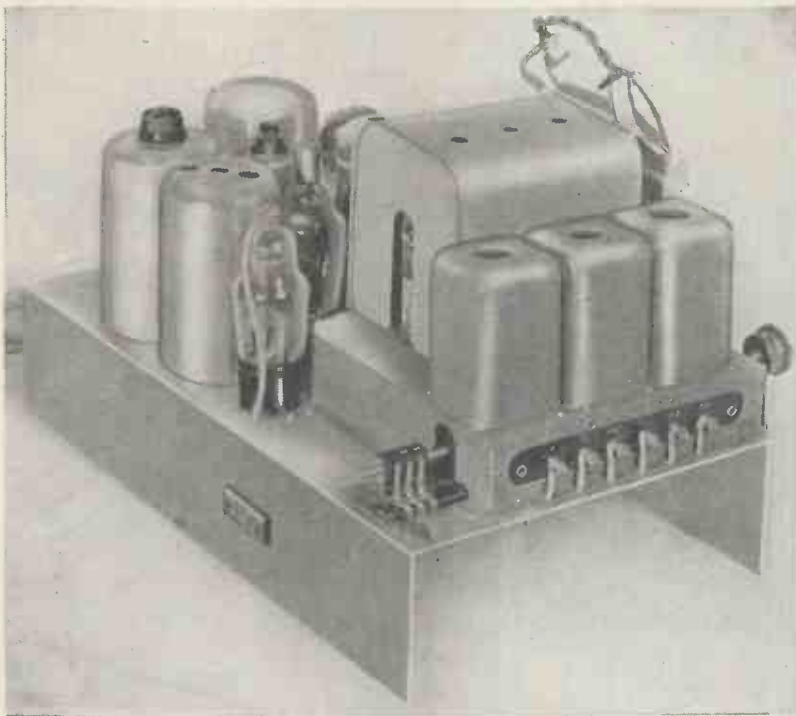

ALL THE STATIONS YOU WANT—WITHOUT ANY OVERLAP
All who build this "W.M." Battery Stenode will be amazed at its almost uncanny selectivity. You can get every station you want without the slightest trace of interference

further movement on the dial.

When this adjustment has been made the set can then be fitted into the cabinet and the various flexible leads re-connected to the high-tension, grid battery and accumulator.

The performance given by the set is very similar to that of the mains model, the difference, of course, being the fact that the overall gain is lower, and accordingly it may give just a few stations less than the mains receiver.

Selectivity Lost

No attempt should be made to push up the gain by making the coupling too tight in the Stenode couplers. If this is done the selectivity will be lost and only partial advantage will be taken of the Stenode principles.

It is perhaps necessary to refer to the matter of A.V.C. Only simple A.V.C. is used in the set, chiefly

COMPONENTS FOR THE "W.M." BATTERY STENODE

	£	s.	d.		
CHASSIS				SUNDRIES	
1—Peto Scott 16 in. by 9 in. by 3 in. with two resistance strips	12	6		Oiled sleeving (Peto Scott), say	1 0
CHOKE, HIGH-FREQUENCY				Round tinned copper wire, No. 25 gauge for connecting (Peto Scott), say	9
1—Wearite screened type H.F.P.	3	6		2 ft. screened sleeving (Peto Scott) say	3
CONDENSERS, FIXED				5 yds. thin flex (Peto Scott), say	5
13—T.C.C. tubular type, values: .0002 (3), .0003, .001, .002, .01, .1-microfarad (6)	10	9		2—Bulgin 2-volt pilot bulbs	1 0
2—T.C.C. type 65, values: 2-mfd.	5	4		2—Clix metal anode connectors	3
HOLDERS, VALVE				1—Varley Power Puncher	15 6
5—Clix type chassis mounting 5-pin (3), 7-pin (2)	3	0		TUNING UNIT	
PLUGS, TERMINALS, ETC.				1—C.A.C. type Super Tuning Pak	2 12 6
5—Clix wander plugs, marked HT+, HT-, GB-1, GB-2, GB+			7 1/2	ACCESSORIES	
2—Clix spade terminals marked LT+, LT-			4	BATTERIES	
1—Belling Lee socket strip, marked Aerial, Earth			9	1—Full o' Power 120-volt high-tension, type H4	19 0
RESISTANCES, FIXED				1—Full o' Power 16-volt grid bias	1 9
10—Claude Lyons, type 1-watt, values: 15,000-, 20,000-, 25,000-, 50,000-, 100,000-ohm 1/2- (2), 1-megohm (3)	5	0		1—Smiths 2-volt accumulator type 2RGN9	12 6
RESISTANCE, VARIABLE				CABINET	
1—Wearite 1/2-megohm type Q22	4	0		1—Peto Scott type Stenode B	1 2 6
STENODE COUPLING UNITS				LOUD-SPEAKER	
2—Belling-Lee high-frequency				1—Gramplan type GC3/FE	1 15 0
1—Belling-Lee 1st tone-correcting low-frequency.				VALVES	
1—Belling-Lee 2nd tone correcting low-frequency. Set of four	3	5	0	1—Osram X21	18 6
				1—Osram HD21	9 0
				1—Hivac VP215	10 6
				1—Hivac HL210	3 9
				1—Hivac Z220	10 6

as a guide. The double-diode-triode is not very critical, most battery valves of this class being very similar.

Low-frequency Bias

The intermediate low-frequency valve is actually a Hivac L210. If too high a gain valve is used in this position there will be blasting and overloading. It is also possible that the $1\frac{1}{2}$ -volts bias will be too high. If, however, the set is used in a locality where the signal strength is extremely weak, then an HL type of valve can be used.

The pentode valve output calls for no comment, except with respect to the Varley Power Puncher unit. This is fitted with terminals and links with the object of altering the load resistance to suit the valve impedance. The makers' leaflet recommends the most suitable link position for the valve used and these recommendations should be carefully followed.

Mixer Voltages

It is also necessary to refer to the mixer-valve network as it has a direct influence on the recommended screen and oscillator anode voltages.

In order to avoid complication, the mixing valve control grid has an initial negative bias equal to the A.V.C. delay voltage. All strong signals require quite a large bias on the control grid and accordingly this initial bias makes no difference.

The difference in the conversion conductance with zero bias and a small negative bias is quite small and therefore the presence of the bias is of no consequence. This means that the screen and oscillator voltages may be increased beyond the normal value.

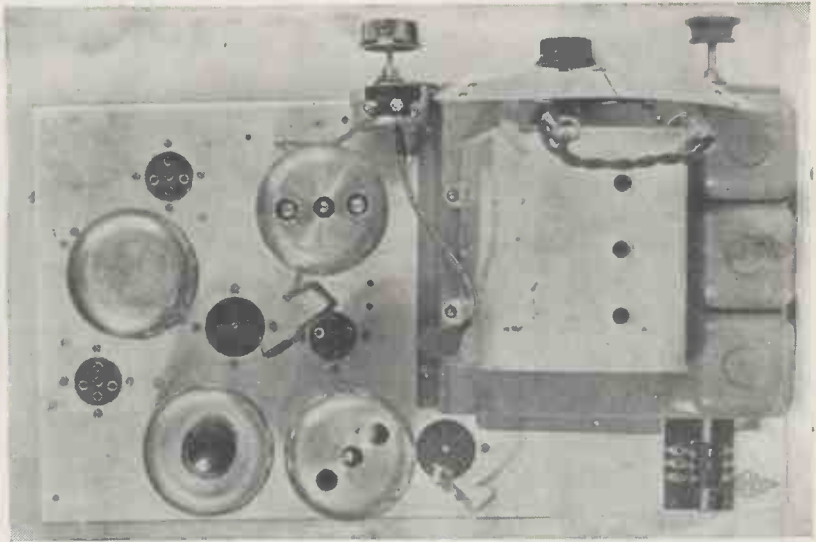

PLAN VIEW OF THE TOP OF THE STENODE CHASSIS

It will be seen that the "W.M." Battery Stenode is very similar in its arrangement to the A.C. model, full constructional details of which were published last month

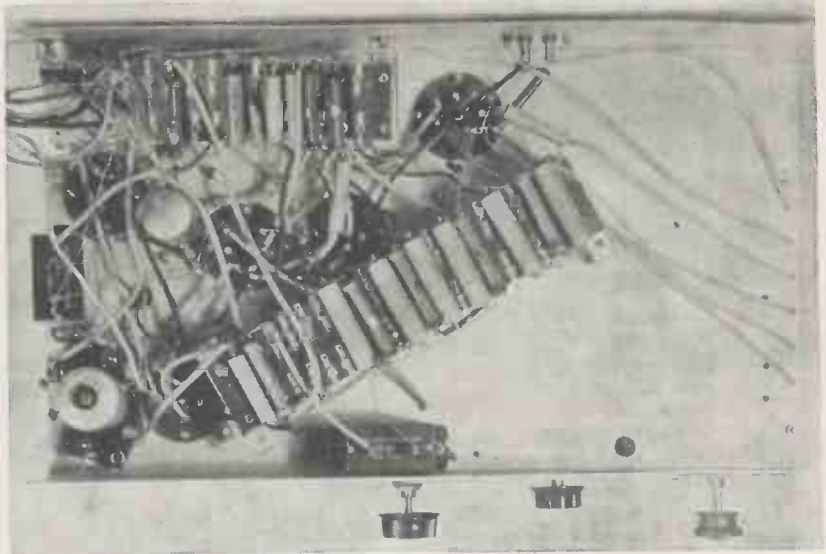

PLAN VIEW OF UNDERSIDE OF THE CHASSIS

This view of the underside of the chassis of the "W.M." Battery Stenode shows how the construction is simplified by the use of sub-assemblies for mounting the tubular condensers and fixed resistances

The MOST IMPORTANT SETS of the YEAR

are undoubtedly Paul Tyers' "W.M." designs—

The "W.M." A.C. STENODE (fully described last month) and

The "W.M." BATTERY STENODE (described in these pages)

EVERYBODY IS TALKING ABOUT THEM!

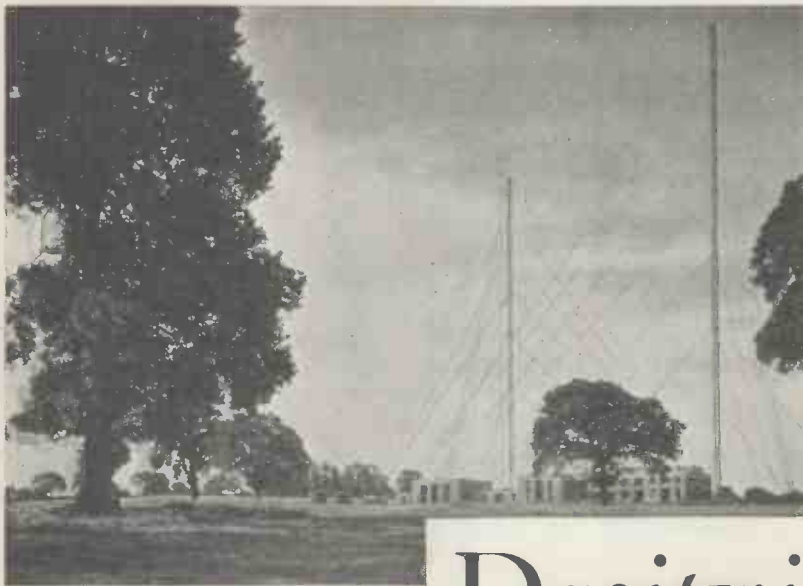

Photos by the B.B.C

Droitwich, Britain's highest powered power of 150 kilowatts. It will be October and will provide a reliable England and Wales. The new the quality long-waver. In this present at the opening ceremony, of the transmitter and shows how

This is the only B.B.C. transmitter with a power house generating A.C. current. All others generate D.C. which is smoothed before being used for driving other machines to give all the many currents needed for high and low tension and grid bias.

Droitwich Opens

FOR many moons we have been told of the wonders that would be installed at the B.B.C.'s first 150-kilowatt giant now built and working on the edge of that fine old county of Worcestershire. I was privileged to be present at the opening on September 6 and see for myself the "show" transmitter of British broadcasting.

One cannot help being impressed with the modern stone buildings dwarfed by two huge masts, each 700 ft. high—the highest masts of any B.B.C. transmitter. Inside the building is a maze of machinery finished in battle-ship grey and chromium, the sombreness of the gear being set off by the brilliant primrose-coloured walls.

Like all the new B.B.C. Regionals, Droitwich is an entirely self-contained unit—it does not rely on any outside distributing service for electricity supplies.

In many ways, Droitwich is different from other B.B.C. transmitters.

To the visitor, one of the most awe-inspiring halls is that where four 750 horse-power six-cylinder Diesel engines drive four alternators giving an A.C. output of 415 volts. This voltage is stepped up through a giant transformer to 16,000 volts and rectified through mercury-arc rectifiers, the output from which—about 18,500 volts—is used for the anodes of the four huge output valves. One of them is seen in the facing photograph.

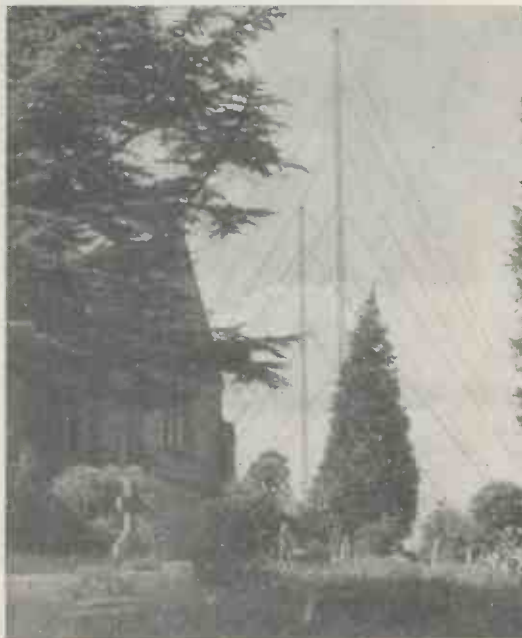

The huge 700 ft. masts of Droitwich can be seen for miles around the Worcestershire countryside. This delightful view was taken in the churchyard at Wychbold, a quarter of a mile away from the transmitter

At present only the new long-wave transmitting gear is installed. Before long, the transmitting apparatus for the new 50-kilowatt Midland Regional station will be put in position and, for the time being anyway, Droitwich will be finished.

But the B.B.C. are wise! They do not intend to let their new giant, which has cost them over £200,000, sink into obscurity by still greater power from Continental stations. There is plenty of room and plenty of power, even, for almost immediate development.

Normally, three Diesel-driven alternators will supply the power to both the long-wave and new Regional transmitters. The output from these three sets is 1,880 kilowatts and only 1,000 kilowatts are used under normal conditions for both trans-

mitters. So you see there is power enough already there to double the present 150-kilowatt long-wave giant. And there is no saying what the needs of the future may be.

You will notice one very great difference between signals from Daventry and Droitwich. At Droitwich very great care has been taken so that quality is as good as that from the medium-wave Regionals. Quality is not woofy like that of the old Daventry; it has its full share of the higher audible frequencies given to it by an important unit placed between

transmitter is on the air with a in full swing by the middle of programme service to the bulk of station can justly boast of being article, T. F. HENN, who was reveals some of the leading features it will open a new listening era.

the output of the transmitter and the aerial feeder lines.

This unit, called a Transducer, enables the transmitter to have a good response up to 9,000 cycles. It is for you to have a set that works efficiently on the long waves to reproduce the fine quality offered.

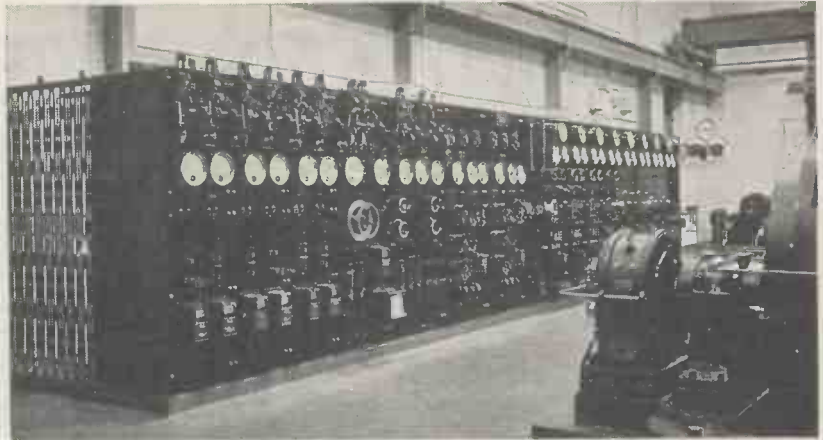

This shows the main switchboard between the power supply and the transmitting apparatus. Every precaution has been taken to ensure that an uninterrupted service is provided

a New Listening Era!

Droitwich is another great step forward in British broadcasting history. It will provide a regular service area over the bulk of these British islands. It has been said that when the station is well in its stride, the London, West and North National transmitters on the medium waveband will be closed down. That depends on Droitwich! Nothing will happen for some months yet.

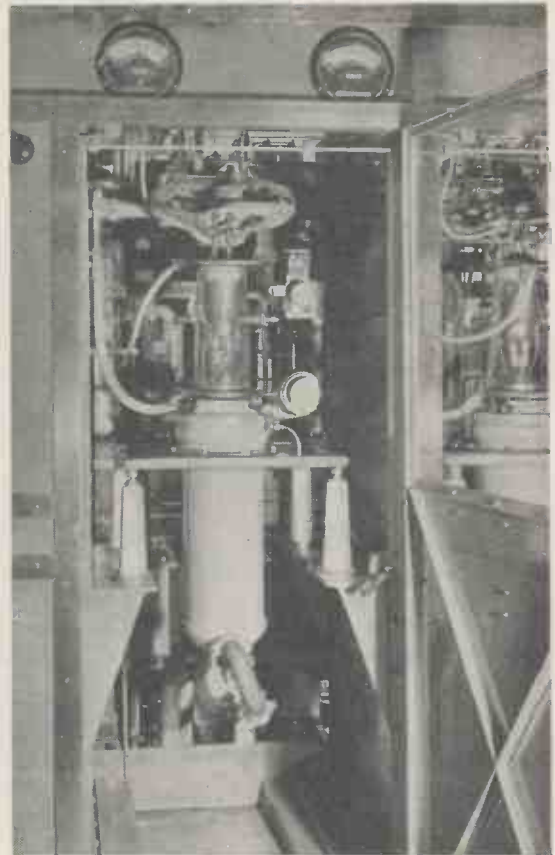
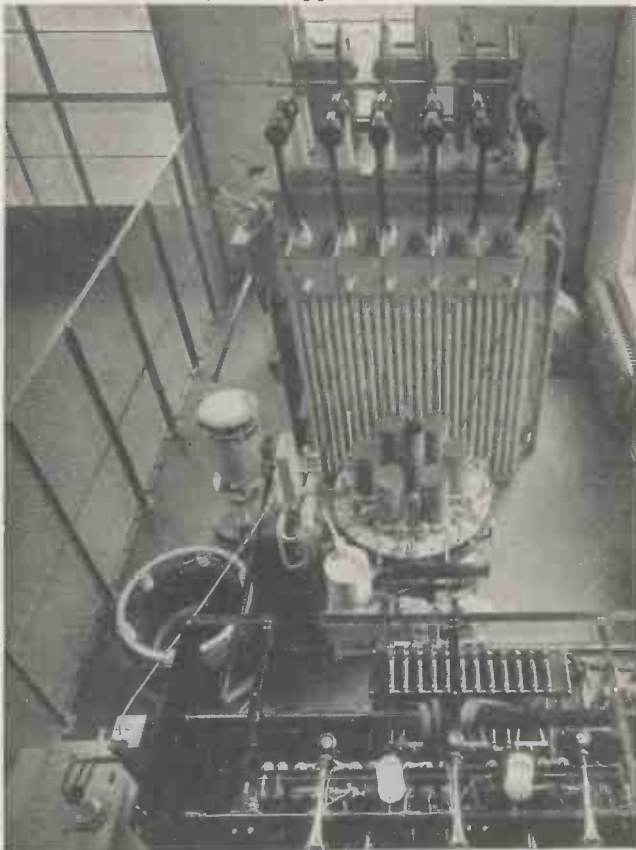

(Above) One of the huge output valves in the final stage of the transmitter. The anode is completely surrounded by a water jacket and the glass is kept cool by a constant flow of cold air. (Left) This is where the output of 415 volts A.C. from the alternators is stepped up by a huge transformer and rectified by a mercury arc rectifier to provide a voltage of 18,500 for the transmitting valves. The transformer is seen at the back and the mercury-arc rectifier in the centre

Still Better Radio Cabinets!

THAT appearance is a deciding factor in the selection of a radio set by the average listener was demonstrated to the writer very forcibly by an incident during Olympia week. A neighbour called late one evening—I had just returned from the show, weary of foot and speech. “Can you tell me what is the best set for us to buy; our old one is getting very bad and I’ve persuaded father to get a new one?” and so on, in that strain.

Had she been a man, I should have risen in wrath and said: “Go to—Olympia!” but she was young and, like most of the sets at the show, of quite attractive style. So I raked over a pile of new lists, endeavouring to play salesman, adviser and friend, when she interrupted my first words with: “Oh, but we don’t want a —; their new ones are very ugly, we think.”

That was to have been my first selection, but she was adamant; no eulogy of its quality, selectivity and certain special features had any effect; all because it was a little unorthodox, but to my way of thinking a really handsome outfit.

As may be expected, they did not follow my advice, but have ordered a refined piece of cabinet work, not caring what is inside it. It will produce a fairly good result and they are pleased with its looks—and so it is with most of us.

The sets exhibited at Olympia may be taken to represent British radio design for 1935. In general, there is no great advance in cabinet design over 1934 models, though an air of refinement is noticeable and there is a distinct tendency to tone down garish styles of decoration and to substitute sombre tones with much use of balanced grain designs done, of course, in veneers.

It is difficult to visualise any really new development in the outer appearance of radio sets; we seem to have arrived at much the same position as the bicycle, the car, and other mechanical marvels which now fit into our everyday lives in such a way that we do not give much thought to their technicalities, but accept them almost entirely at their face value. We know that—as with cars and cycles—any one of a dozen different makes of radio sets can be relied upon to give equal pleasure and service, therefore they must fall back on the two main points—quality and appearance—in the struggle for popularity.

Quality of reproduction is outside the scope of this article, but one thing is certain and that is that good looks are responsible for the sale of a very much larger number of sets than ever before.

High polish and gaudy finish may—at one time—have covered a multitude of radio sins, but that is not the case now. Rather is it that the excellence of work and design now offered to the listener is being balanced by equally worthy external appearance.

There is certainly a better quality in the cabinet work, particularly in the inside work to accommodate loud-speakers and chassis. Woods—walnut, oak, maple—

were in the majority and not much mahogany; but the use of bakelite was not so marked this year, the chief users being Ekco, G.E.C., and Philips.

There is room for improvement in avoiding sharp corners, some still employ picture-frame mouldings which produce ugly sharp points at the mitered corner joints. Ekco and Burndept score well with nicely rounded edges to their unusual-looking cabinets.

There is a decided move in the direction of building the set into a piece of furniture, such as the Bush Radio table set, the Austin “Grandfather,” and the bedside fitment of the same firm. In such

standard sets as Pye, Burndept, Halcyon and Ritz, subtle deviations from the usual rectangular cases give a “personality” to the sets.

A very laudible tendency is to make the loud-speaker panel quite plain—Marconi, Amplion, and Ferranti are good examples—and the absence of sinuous fretwork is a very good move.

The provision of a table to suit the set is a good line with several makers and Electrico offer matched tables for every set. The Radiogram, of course, lends itself to a real splash in cabinet work and some beautiful designs are made by Marconiphone, Amplion, Hartley Turner and British Radiophone.

In conclusion, just one small grumble. Tuning knobs are, as a rule, very poorly designed. On some of the best sets they are quite uncomfortable to handle; some are painfully small, but large knobs might spoil the looks altogether, so why not try a simple lever working in a slot?

Tuning scales and dials and escutcheon plates are still not very good, and there is a deal of room for improvement.

One point must be stressed upon cabinet makers. The modern tendency of using output valves that give huge volume calls for very stable construction upon the part of the cabinet makers. As a rule, little vibration is caused by the actual cabinets themselves; most of it is caused by badly fitting backs.

Still too many people are using three-ply wood for the cabinet backs. This is asking for trouble. The back should be given as much consideration as the front. Most 1935 cabinets are well made, back and front, but there are just a few isolated cases needing such small improvements.

TYPICAL 1935 CABINET DESIGNS

Our artist made a special journey round the stands at Olympia and sketched, what he considered, cabinets demonstrating the modern trend: (1) is a Bush table set finished in white oak, (2) Alba playing desk, (3) C.A.C.’s Austin radio divan—something new and unusual, (4) Amplion Radiolux automatic radiogram, (5) Marconiphone, model 292, autoradiogram, (6) Milnes five-valve table super-het on its neat stand, (7) a Halcyon table receiver in walnut, (8) Hartley-Turner radio gramophone in black and white oak, (9) Burndept’s model 203 radiogram with its two loud-speaker openings, (10) C.A.C. Austin grandfather clock radio gramophone in burr walnut, (11) a new Pye set on the Electrico matched table. Note that the back legs of the table are hollowed out to hide the set’s leads. (12) The All-wave radiogram in its neat oak cabinet

By Westerner

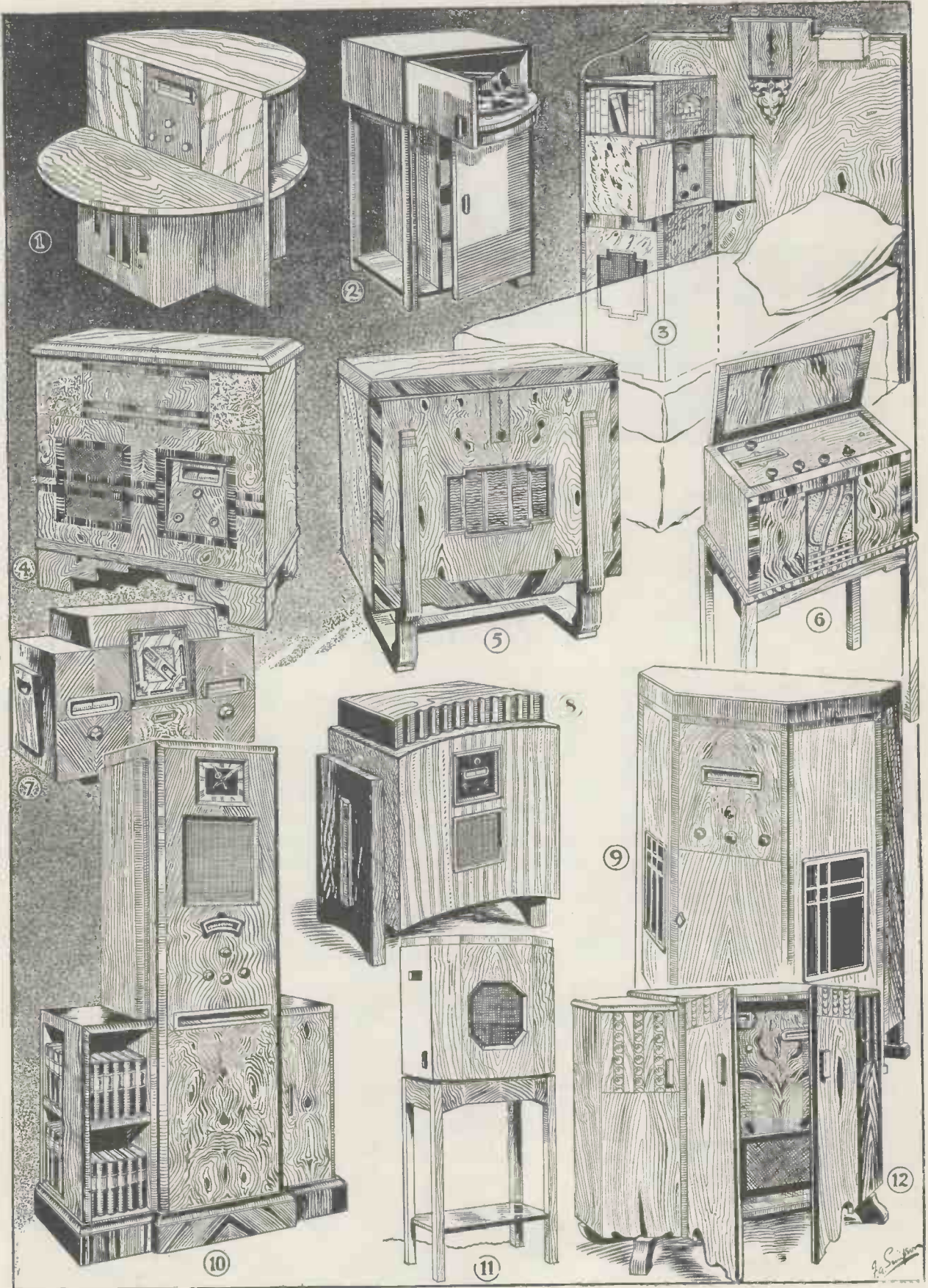



H.M.V. Photo

The whole response of a pick-up can be traced by a spot of light focused from a mirror galvanometer on to a transparent screen by means of this apparatus—one of the latest developments of H.M.V. laboratories

right enough; but the distortion is awful! We can only secure tolerable results by damping the upper register until the general quality becomes pleasing.

“Kind” of Reproduction

Again and again I have read letters and articles insisting on the design of amplifiers and loud-speakers capable of responding to the frequencies above 8,000 cycles. None of these writers seem to worry their heads about the kind of reproduction they are getting.

What on earth is the use or

IN the year 1921, and indeed later, it was impossible to reproduce the low notes either on radio or on the gramophone. It was even stated that nothing below 256 cycles could possibly come through. Then the moving-coil loud-speaker arrived, and with it the low notes. Today there is no difficulty in passing frequencies down to 50 cycles and lower.

Overlooked Top Notes

So much attention had been paid to this portion of the musical spectrum that the other end of it has been practically overlooked.

The moving-coil reproducer was regarded as a wonderful revealer of the high notes, and so it was when compared with the reed-driven cone loud-speaker, to say nothing of the average short-horn type.

Grave Shortcomings

We now realise the grave shortcomings of the moving-coil type in reproducing the upper register. When it does succeed in doing so, it does it badly.

Speaking for myself, I have never heard a moving-coil reproduce the higher notes free from objectionable resonances. Whatever claims may be made by designers for perfection of result, it simply is not there. There is little resemblance between the effect

Tone Control for Those High Notes!

Here we present another article by NOEL BONAVIA-HUNT, M.A., in which he deals with the problems of using suitable tone-correcting devices. This is one of the most comprehensive articles on tone control ever presented, and it will be read with interest by every reader

produced and the original.

The fact remains that the greatest problem confronting the quality seeker today is the reproduction of the high notes. We have got the low ones very respectably indeed; the high ones we most certainly have not got—yet.

There is no need to blink the fact. High notes come through all

advantage of getting these very high notes if they are not worth listening to when they arrive? Immediately on hearing them the connoisseur turns on the tone control. He naturally does not want to suffer the tortures of the damned.

A Farce!

We have at last come to the realisation of the fact that a straight-line frequency response up to 8,000 cycles or higher is a farce. No one with a discriminative ear will accept the result in its naked hideousness. I am not going into the science of the matter now, though I am prepared to prove my contention to the hilt if challenged.

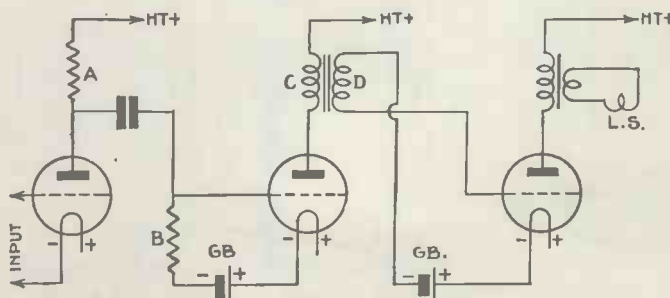

Fig. 1.—A skeleton circuit of a three-valve low-frequency amplifier indicating the places where the tone control can be incorporated

Even the veriest ignoramus, however, will agree that a vibrating diaphragm is not capable of distributing sound waves in the same manner as a voice or a musical instrument. The high notes are the first to be affected: they are easiest upset.

Too Expensive

The majority of listeners cannot afford in any case to resort to expensive apparatus for the purpose of eliminating high-note resonance or dissipating the head of the divergent beam emanating from the modern moving-coil loud-speaker. So far, the Voigt principle appears to be the best attempt to restore the purity of the upper register.

The electrostatic principle is also good, when properly handled. But most people want good quality reproduction from one loud-speaker system, and since a well-balanced low register is essential for music, it is not possible for this class of listener to indulge in the luxury of a pronounced upper register. Once they attempt to get it, they soon discover a wasp's nest.

Discretion

What is to be done? I fear we have got to play the coward, or perhaps that better part of valour which is discretion. In other words, the

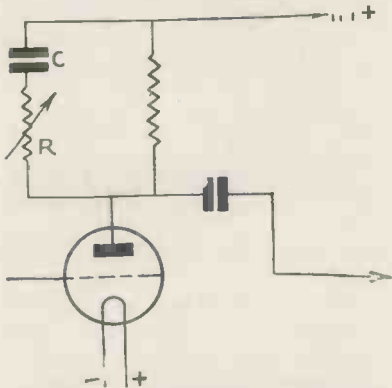

Fig. 2.—A common form of high-note bypass; the bigger the condenser capacity, the more high notes will be cut

treble must be placed under control. This is a very different matter from cutting it off completely above a certain frequency. A graduated droop is what is required.

So far, so good. Next we have to decide the limits of response. To cut off at 4,000 cycles is too low. There is an extraordinary difference in the resulting quality between a 4,000 and 5,000 cut off. Increase the compass to 6,000 and the quality

is better still. Most loud-speakers will respond to 6,000 cycles: it is after this that the struggle begins. Therefore we had best make this frequency our limit.

I am not for a moment suggesting that this is the ideal: it isn't.

The ideal is an infinite range; and the next best, I imagine, is a cut off at 10,000. Then at 9,000, 8,000, 7,000 and 6,000 respectively, according to the opportunities offered to the designer. But I set the limit of cut off definitely at 6,000. Below this datum line it is unsafe to go, if quality is aimed at. And within that limit it is possible to obtain excellent reproduction despite the assertions of pedants to the contrary.

In fact, as soon as we attempt to reach beyond it in an excess of enthusiasm, we are confronted with ever-increasing difficulties which are enough to daunt the boldest and bravest of adventurers.

Six thousand cycles let the limit be, then; and higher, if possible. But *not* a straight line response. Up to 4,000 the amplification curve may be straight: *after* this, a graduated droop is indicated. This means some form of control in the amplifier, and this control may be either fixed or variable.

There are various methods of introducing tone control, and there are various places in the amplifier where such controls may be put. First of all, let us see what these places are. In a radio receiver the upper register can, of course, be very easily cut out, let alone controlled, by introducing highly selective tuned circuits in the high-frequency side of the set.

We know all about this, and since the cut off thus introduced is serious and removes all hope of good quality, we do not propose to waste our time discussing it. The control of high notes must be confined to the low-frequency amplifier and, therefore, can be applied to any point between the first and the last amplifying valve.

Opinions vary a great deal as to the comparative merits of applying tone control early or late in the amplifying chain. I am personally convinced that it should be done at any rate before the last stage is reached, and this conviction holds good even in the case of a pentode output.

It is customary to muzzle down the pentode itself by applying a tone control to its anode circuit.

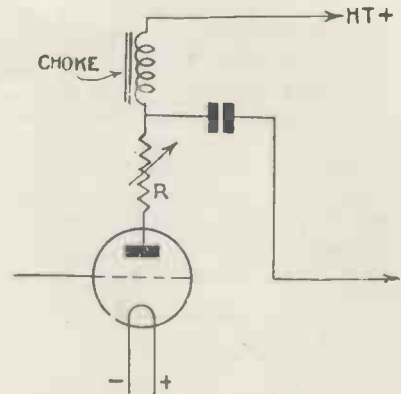

Fig. 4.—Another suggested method of tone control, but it is not recommended by the author

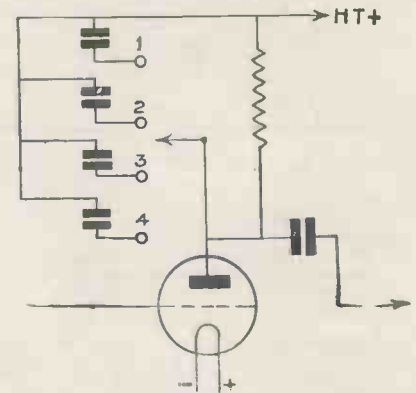

Fig. 3.—Showing the condenser-selector method of tone control. Capacities of the condensers used may vary from .0005 to .01 microfarad

The pentode valve is well known to favour high notes unduly, though this is not invariably the case, and not a few examples have been known to deteriorate and lose their high-note characteristics after two or three months' use.

Varying Pentodes

Moreover, pentodes vary considerably, and that is one, though by no means the only, reason why I am chary of recommending them wholesale. For the purpose of this article I prefer to assume that the output valve is a triode with a triode's characteristics and therefore requiring no tone-controlling device in its anode circuit.

A glance at Fig. 1 will show that there are four possible places where a controlling device can be connected apart from the output stage marked E. These four places are marked A, B, C, D, respectively. A is the anode resistance on the first valve: B is the grid leak of the second valve, while C and D are the primary and secondary windings of the low-frequency transformer which couples the second and third

valves. (The amplifier is not assumed to be an ideal one.)

Now it must be observed that these four circuits represent alternating-current zones in which the speech fluctuations of the microphone are amplified as far as possible without distortion. They can be divided, however, into two separate categories, in that A, and C have direct current also flowing

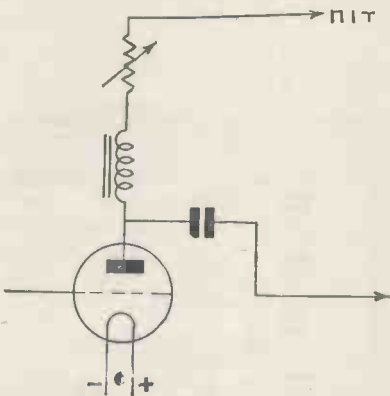

Fig. 5.—This method of tone control is distinctly better than that shown in Fig. 4, but it is not by any means ideal

through them, that is, from the source of high-tension supply, while B and D have not.

Tone-control Position

It is usual to connect tone controls to the former category, namely the circuits that have high-tension applied to them. In which case, if the earlier circuit is to be selected for preference, the control will be placed at A rather than at C. Alternatively, B rather than D would be selected for treatment.

The question to be determined is which circuit should we try to control, and this depends on the type of control employed. So we must pass quickly on to the various methods of controlling high-note response.

Commonest Form

The commonest form of high-note by-pass is that shown in Fig. 2. The bigger the capacity of the condenser C the more the high notes will be cut off, and therefore it is obvious that the capacity must not be too big. The earlier in the amplifier chain the by-pass is applied, the smaller the capacity of the condenser need be to produce the necessary high-note loss in the circuit.

For instance, a .001-microfarad condenser in the first stage would

produce much the same effect as a .01-microfarad in the last stage.

The capacity, therefore, depends on the position in the amplifier selected for it. The value of the resistance R can be infinite theoretically if it is required that the capacity of the condenser (in series with it) shall be neutralised. But as the resistance is reduced, so the condenser becomes more and more effective in damping out the high notes.

Thus it is possible to control the damping effect of the condenser in either direction by rotating the knob of the variable resistance. The value of this resistance need not be greater than .25 megohm. The snag in this particular arrangement lies in the control itself. It is not possible to find a value of condenser that does not cut off the top notes too much, unless one is chosen that exercises so negligible an effect as to be useless. Further, this method of damping high notes fails to produce that gradual droop in the characteristic response curve which is so important.

Another form of control is given in Fig. 3. Here a choice of a number of condensers of varying capacities is presented to the operator by means of a switch or else a stud and arm arrangement. The capacities may vary from .0005 to .01 microfarad. Of course, the objection to such an arrangement is that only one of the capacities chosen may be suitable, and the effect on top notes will be similar to that produced by the circuit in Fig. 2.

Fig. 4 illustrates a third method. The low-frequency choke can have an inductance of 100 to 250 henries and the variable resistance (R) can be of the order of a 100,000 ohms. The larger the resistance, the more the high notes will suffer, and vice

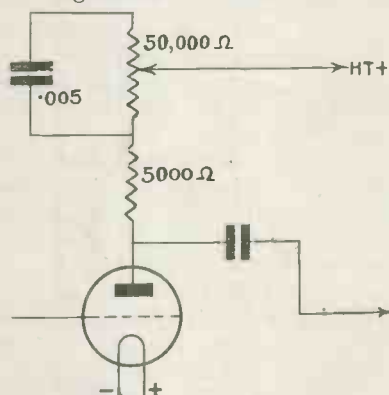

Fig. 6.—A form of tone control to give a drooping characteristic resulting in a slight loss of amplification

versa. Here, again, the device works badly because it is not possible to graduate the control sufficiently.

In Fig. 5 we see an inversion of the arrangement of Fig. 4. The choke must be of at least 250 henries inductance, while the variable resistance must be at least a .25 megohm. Reducing the value of the resistance ushers in the high notes, and vice versa.

Drooping Characteristic

Unfortunately, the device also affects the middle frequencies, so that it is not a genuine high-note controller.

The circuit shown in Fig. 6 does definitely produce a drooping characteristic when measured statically, and the high-tension positive can be applied to any portion of the resistance. When, however, the slider is moved down to the bottom of the resistance, there is only the 5,000-ohm resistance left in circuit,

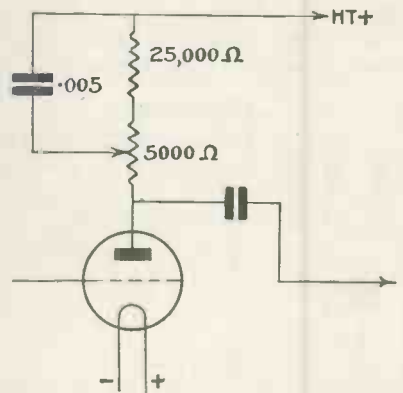

Fig. 7.—A method of tone control that provides a drooping characteristic as Fig. 6, but without loss of amplification

and this means a reduction in amplification.

One can avoid this latter fault by adopting the circuit of Fig. 7; but, on the other hand, the control of the upper register is restricted to the curve obtained from shunting all or a part of the 5,000-ohm resistance in addition to the 25,000-ohm resistance.

Just the Circuit!

Nevertheless, this circuit, apart from the question of control, takes a deal of beating, since it does provide just the characteristic that is wanted for good high-note reproduction.

All the diagrams given above illustrate various types of anode-circuit control. Some of the controls

could be transferred to the succeeding grid circuit: thus, the controlling devices of Figs. 2 and 3 could be applied instead to the grid leak B of Fig. 1, though the capacity of the condensers would have to be reduced in this position.

Satisfactory Filter

One last method of high-note control will now be mentioned, though the subject is by no means

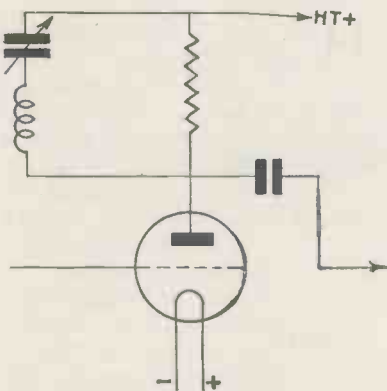

Fig. 8.—A circuit using a high-frequency choke and condenser shunted in parallel with either the anode or grid circuit

exhausted. This consists of a high-frequency choke and a condenser in series with it, the whole assembly being shunted in parallel with either the anode or the grid circuit.

Fig. 8 shows the control in its simplest form.

Fig. 9 gives an improved control. Now we have here a high-note filter and this is really the sort of thing we want, for this filter has the property of excluding high notes that get in our way—a situation we are so often placed in!

In Favour

This particular filter is capable of dealing with very small bands of frequencies without affecting those below or above—a very important point in its favour. Thus, should one be irritated by a heterodyne whistle occurring anywhere in the 4,000 to 9,000-cycle band, it can be suppressed. Similarly, a peak frequency band

causing surface noise on records due to needle tracking can be considerably modified to the great relief of the listener.

It is at this point in our discussion of tone control that the question of position arises for settlement, and for this reason. If the filter is placed in the anode circuit, as in Figs. 8 and 9, it will be necessary to employ a much larger choke winding as well as a wider range of condenser capacities to effect the same results as can be obtained if the filter is placed in the grid circuit as in Fig. 10.

Obviously, no one cares to wind thousands of turns for the sheer love of it, especially if the winding has to be done laboriously by hand! The actual difference between the requirements of the two alternative positions is a matter of some 2,000 turns of wire, which is not inconsiderable.

Or it may be put this way, that whereas an inductance of 1 henry is required for the anode position, little more than half this is needed in the grid circuit. Naturally, therefore, we select the grid position of Fig. 10 for our high-note filter.

The best position in the amplifier is as early as the first coupling stage and this is why the grid leak 2R of Fig. 10 has been chosen for

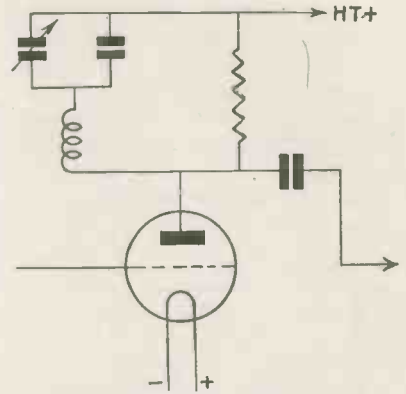

Fig. 9.—An improved circuit of Fig. 8, which merits the recommendation of the author

this purpose. The high-frequency choke used in this high-note filter is wound in two sections, consisting of 1,800 turns each of 32-gauge enamelled wire, making a total of 3,600 turns.

Making the Choke

A former of 1 in. in diameter will be found suitable for this purpose, and reference to Fig. 12 (a) and (b) will make it quite clear how this former may be devised so as to hold the windings in each of the slots.

It will be seen that if the wire is wound round the 1-in. former in Fig. 12 (a) it will completely fill the deep slot, which measures 1½ in. in depth and ¼ in. in width. This means that the diameter of the entire choke will be 3½ in., as shown.

Appearance

The appearance of the choke after winding is shown in Fig. 12 (b). The wire is wound round the former until the whole of the slot in each section is filled up to the outside edge. The last turn of the upper slot is taken through to the slot below and the winding is then continued till the lower section is completed, making a total number of 3,600 turns.

The capacity in series with the choke has to vary from .001- to .0015-microfarad, and this is best effected by using two condensers, one fixed with a value

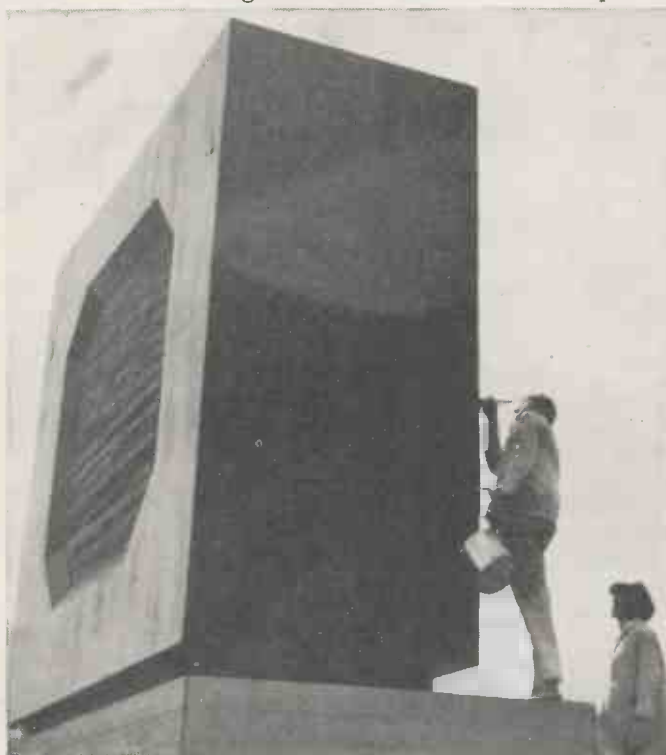

SOME LOUD-SPEAKER, THIS! World Wide photo
This giant loud-speaker was mounted on the top of a tunnel connecting two of the halls at the recent Berlin Radio Exhibition

of .001, and the other variable with a value of .0005 microfarad. A small midget tuning condenser will suffice for the latter purpose. These two condensers are connected as shown in Fig. 9 and also in Fig. 11 (where the correct position in the amplifier is given).

The variable condenser is, of

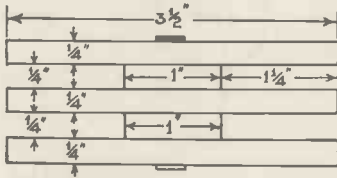

Fig. 12.—Details are given in these drawings for making the former for high-frequency choke referred to by the author

course, mounted on the panel. As this is rotated the frequency bands with peaks at 4,000, 5,000, 6,000, 7,000, 8,000, and 9,000 cycles respectively are altered so that each peak frequency is removed as required. Thus, a heterodyne whistle at any of these frequencies can easily be eliminated without the frequency characteristic of the amplifier being seriously affected: in fact, the quality of reproduction is not changed at all.

No Whistle Interference

If the amplifier or loud-speaker shows a cut-off at 6,000 cycles, obviously there will be no interference from whistles in the region above this limit, but the filter will be of service in eliminating whistles occurring up to 6,000 cycles. Since needle scratch from record tracking contains a peak frequency varying between 4,000 to 6,000 cycles which irritates the ear, the filter can be most usefully employed here and the clarity of reproduction is not in the least affected.

Three Types of Control

It will be realised that there are three types of high-note control which may be introduced in an amplifier.

The first is that which definitely cuts off the response curve at some selected frequency, with the result that no frequencies above this point can possibly be received from the loud-speaker.

The second type is that which produces a gradual cut off, starting at a given point in the curve and permitting the response to continue upwards till it reaches a point at

which it completely fails to be received.

The third is that which introduces an "inverted steeple" in the response curve at some particular point, thus eliminating a very narrow band of frequencies with one particular peak frequency, which is at all costs to be included in the by-pass process thus created.

Of these three, the second and third are the only really useful types, and the second type has already been introduced in Fig. 7, where the partially shunted anode resistance

noted, the complete arrangement is confined to one single stage of low-frequency coupling only, namely, that which couples the first and second valves of the low-frequency amplifier.

"The Stuff of Radio"

"Here, then, is something about radio drama by someone who, after nearly nine years, still finds it exciting." This is how Lance Sieveking introduces his latest book, "The Stuff of Radio," which has

just been published by Cassell and Co. (8s. 6d.).

The book is really a preface, plainly in the manner of Bernard Shaw, to the eight plays of the author which are printed in the other half of the book. In this preface he sets out to justify the Cinderella of Drama, as the broadcast play has been called.

Mr. Sieveking's contentions are as vitally new and interesting as his subject matter. In addition he writes of incidents that have occurred on the other side of the mike—always good reading.

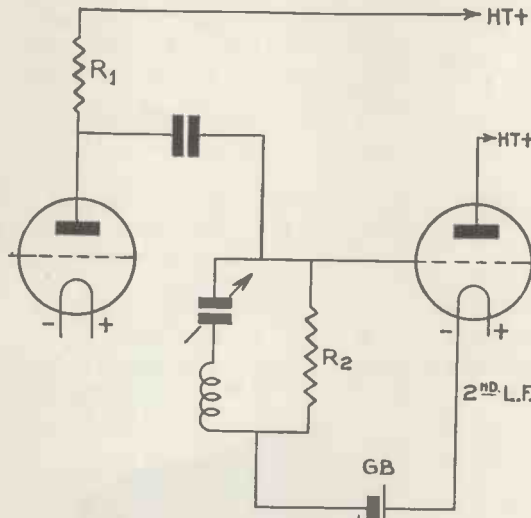

Fig. 10.—Showing the tone-correction filter placed in the grid lead of a second stage

ensures a graduated droop in the upper register up to at least 8,000 cycles.

The third type is the high note filter of Fig. 9, which, as has been pointed out, is a highly serviceable device in any receiver, whatever may be the conditions under which it is working.

In fact, the combination of both the second and third types of high-note control, which the reader will find given in Fig. 11, will provide all that is required for quality purposes and, be it

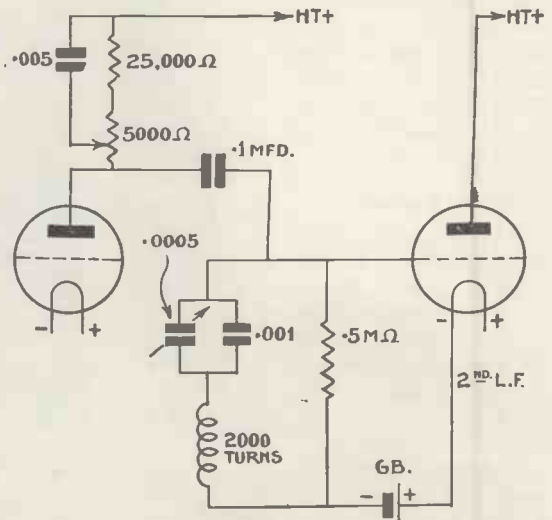

Fig. 11.—An excellent method embodying the circuits of Figs. 7 and 10. "It should commend itself to every reader," says the author



HEART OF THE SET
No doubt a deal of the set's efficiency is due to the iron-core coils, which are shown here with the screening cans removed

a screen-grid valve gives such a high step-up when correctly used.

The resistance in the anode circuit is more or less the correct value, or comparatively so, when you think of the low resistance of a low-frequency transformer primary. The effect of this is that we do actually get a fair percentage of the amplification of the screen-grid valve, which is in the region of 600.

More Volume!

With the triode and a low-frequency transformer, you cannot obtain more than a stage gain of 10 to 12 times, but even if we only obtain a fractional proportion of the amplification of a screen-grid valve it will be somewhere in the region of 100 times. So you need not worry about the resistance-capacity coupling. It will give you more volume and certainly better quality.

High-frequency Filter

Another reason for the reduction in cost is that instead of using a high-frequency choke in the detector anode circuit we have made our high-frequency filter consist of the anode resistance plus a .0002-microfarad bypass condenser.

We feel sure you will agree that the double-gang condenser with its tuning dial illuminated from the front is equal to any that you can buy.

Here, again, the whole unit only costs 11s., which is a very great saving over some of the condensers used last year. We have not, by the way, used a cover for this condenser, for it is not technically necessary and it would have cost an additional 1s. 6d.

So as to make the receiver as simple as possible, we have kept the number of controls down to the absolute minimum. There are only three controls on the panel. On the left-hand side is the wave-change switch which, when turned to the left, brings in medium waves and to the right, long waves.

In the centre is the tuning dial and concentric with the large tuning knob is a trimmer, which overcomes every ganging trouble. The third control is simply for volume.

Reaction has been omitted as a variable quantity, the receiver is sufficiently sensitive without it, and most of the Continental stations can be tuned in by simply adjusting the tuning and volume controls.

As there is an undoubted prejudice against a receiver without reaction, we have fitted inside the cabinet a small .0003-microfarad pre-set condenser which gives semi-adjustable reaction.

From time to time readers have asked if we could not have the on-off switch in various positions so as to suit their own particular types of cabinets. Some readers have even asked us to arrange it so that the on-off switch can be at a distance from the receiver. We hope in this set that we have catered for everyone.

Flexible Leads

The on-off switch is fitted with three flexible leads. If you make these leads long enough the switch can be fitted to any part of the cabinet, or by simply connecting triple flex it can work as a remote control.

About the Circuit

We can tell you all about the circuit in a few words, for we have left out every component that has no definite function, although we have left nothing out that might decrease efficiency.

The aerial is fed directly into the primary of an aerial coil and not through a pre-set condenser, for even

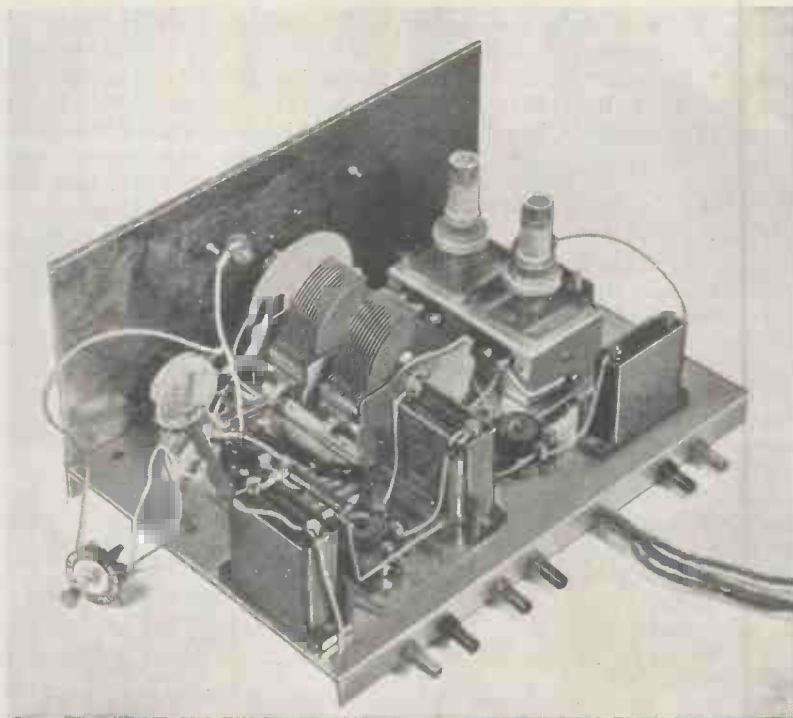

SIMPLE TO BUILD AND EFFICIENT IN OPERATION
A view of the 1935 £6 6s. Battery Three, minus valves and coil covers. Note that the cover for the gang condenser is not used and that the on-off switch is shown on the side so that it can be fitted anywhere on the side of the constructor's cabinet

with aerials up to 100 ft. in length the selectivity of the coils is ample without artificial means. The first screen-grid valve is of the variable-mu type and the bias applied to its grid is controlled by means of a 50,000-ohm potentiometer on the right-hand side of the panel.

When this control is turned in a clockwise direction you obtain maximum volume. For local station work, when signals are inclined to be overpoweringly loud, the volume can be adjusted down to normal room level, which is more that can be said for a receiver that relies upon the reaction control as a volume adjuster.

Maximum Amplification

The two screen-grid valves are coupled together by means of a high-frequency transformer. Most of you probably know that this is the only way to obtain maximum amplification from a screen-grid valve.

No matter how efficient it may be, the high-frequency choke—when you

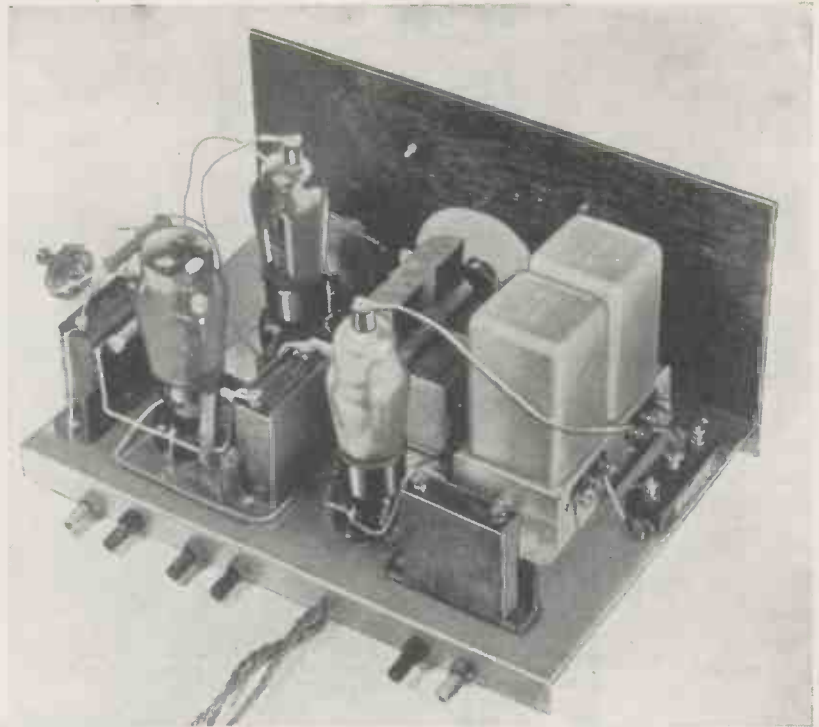

ALREADY FOR FITTING IN YOUR CABINET

A view of the finished set with the three valves in position. The screen-grid detector is at the back, and in the foreground are the pentode (left) and high-frequency amplifier (right)

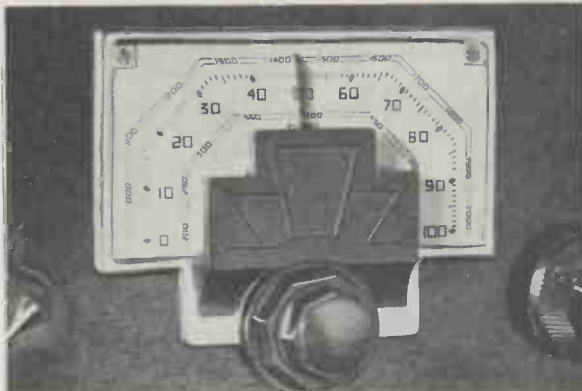

CLOSE-UP OF THE NEAT PANEL

Rather a fine-looking panel! The tuning control with trimmer is in the centre, wave-change switch on the left and volume control on the right

are using tuned-grid coupling—does not come up to a tuned transformer.

The detector valve is worked on the leaky-grid principle and there is nothing tricky about it except that you should vary the voltage applied to the screen through H.T.+1 to get maximum volume.

Adequate Decoupling

We need not say any more about the resistance-capacity coupling, for this is quite straightforward, although you will notice that the anode circuit is de-coupled. This was done to make quite sure that the receiver would be suitable for use with a mains unit.

We chose an output pentode which would give at least 500 milliwatts

output, but for those readers who have a good mains unit you will probably be glad to know that with 200 volts high tension the output is well over 1,000 milliwatts.

If the voltage on the auxiliary grid of a pentode is equal to that applied to the anode, which has to go to the loud-speaker, the voltage that actually reaches the anode will be lower than that which reaches the auxiliary grid. This causes an increase in anode current and a *very big* decrease in output.

To overcome this we have connected a 5,000-ohm resistance in series with the auxiliary grid to make sure that the auxiliary grid voltage is always lower than the anode voltage, even though the original applied voltages are the same.

You will notice that we have used a number of tubular condensers. We strongly advise you to adhere to this specification for, in addition to being much smaller than the Mansbridge type, they are cheaper and do not require any additional wiring.

We have, wherever possible, connected the tubular condensers between components by means of the wire ends, which are an integral part of the condenser. In this way the wiring has been very much simplified as you will see from the wiring plan and photographs.

Simple Construction

Although the construction is very simple, it is advisable for us to tell you of one or two little points which, perhaps, you cannot see from the illustrations.

You will find construction much easier if you use one of our full-size blueprints. With one of these in front of you it is just like looking at the original receiver, and then you will be quite certain not to make any mistakes in wiring.

Half-price Blueprint

A full-size blueprint of this receiver, No. WM371, can be obtained from the "Wireless Magazine" Blueprint Department, 58-61 Fetter Lane, London, E.C.4, for 6d., if the coupon on the last page is used before October 31.

You will see that instead of using a genuine chassis we have evolved a new shallow baseplate. An aluminium chassis, besides being difficult to

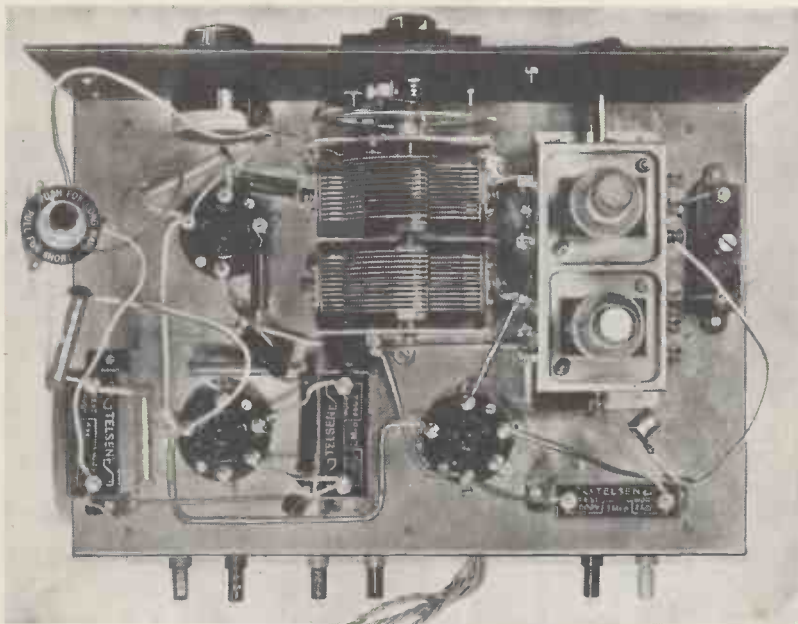

How every component is arranged on top of the shallow chassis is plainly seen from this photograph. It should be used in conjunction with the underside plan below and the half-scale wiring plan on the opposite page

make, is rather expensive to buy, but with our special baseplate all you have to do is to go into the nearest tinsmith and buy a sheet of aluminium, 12 in. by 8 in. and about 14 gauge, with two lengths of aluminium angle channelling.

Cheap Chassis

Bolt the channelling to the base-plate and you have a perfectly good chassis for about a quarter of the price you would have to pay for a proper aluminium chassis of similar size.

Many constructors of really simple sets do not like chassis construction,

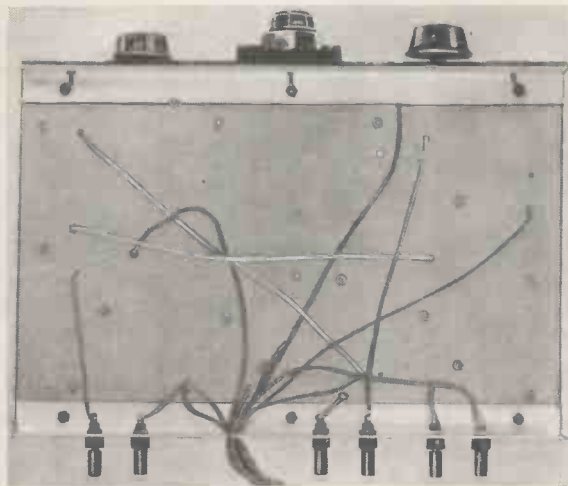

A view of the underside showing the positions of the few wires and connection sockets

therefore we have kept most of the wiring on top of the baseplate.

You will see by looking at the half-scale wiring plan that the only wires beneath the baseplate are one or two long ones which might cause trouble if they were on top. We have also fixed through the channelling at the back of the chassis the aerial and earth, pick-up and loud-speaker sockets.

Drilling the Chassis

You need not get worried about this chassis business. There are no large holes to drill. All you will need is a twist drill with a 4 or 5 B.A. drill. We have specified 6 B.A. nuts and bolts, and with these you can fix down all of the necessary components. There are no difficult fixing lugs to get at, and even though the receiver is very compact the average person will be able to get at all of the terminals quite easily.

Suitable Voltages

The receiver is even more simple to operate than it is to build. Voltages are not critical within certain limits. Connect G.B.+ into the positive of your grid-bias battery, G.B.—1 into 4.5 to 7.5 volts, and G.B.—2 into 9 volts.

Use a 120-volt high-tension battery, or a bigger one if you have one. Plug the negative socket into the negative of the battery, then plug H.T.+1 into a tapping between 60 and 80 and H.T.+2 into the maximum.

The three valves used are very efficient, although cheaper than usual makes.

COMPONENTS YOU WILL NEED TO BUILD THE 1935 £6 6s. BATTERY THREE

CHASSIS		£ s. d.	PLUGS AND TERMINALS		£ s. d.	3-doz. 6 B.A. nuts and bolts (Peto Scott), say		£ s. d.
1—Aluminium chassis 12 in. by 8 in. with 2 ft. of 3/4-in. angle channel, say	...	2 0	6—Clix plugs and sockets, marked: A, E, PU (2), L.S. + L.S.	...	2 0	5-yards thin flex (Peto Scott), say	6	
COILS			2—Clix spade terminals, marked: L.T. + L.T.	...	4	SWITCH	3	
1—Telsen two-gang assembly	...	19 6	6—Clix wander plugs, marked: H.T.+1, H.T.+2, H.T.—, G.B.+ , G.B.—1, G.B.—2	...	9	1—Bulgin 3-point on-off push-pull	1 0	
CONDENSERS, FIXED			RESISTANCES, FIXED			ACCESSORIES		
2—Telsen 2-microfarad 250-volt working	...	6 0	6—Erie, type 1-watt, values: 5,000-, 25,000 (2), 100,000-ohm, 1-megohm (2)	...	6 0	BATTERIES		
1—Telsen 1-microfarad 250-volt working	...	2 3	RESISTANCE, VARIABLE			1—Ever Ready 120-volt high-tension, type, Winner	11 0	
2—Franklin .01-microfarad tubular type	...	1 4	1—Erie 50,000-ohm	...	3 6	1—Ever Ready 9-volt grid-bias, type Winner	1 0	
1—Franklin .0003-microfarad tubular type	...	6	1—Formodenser .0003-microfarad max.	...	1 6	1—Exide 2-volt accumulator, type DTG	4 6	
1—Franklin .0002-microfarad tubular type	...	6	SUNDRIES			CABINET		
CONDENSERS, VARIABLE			Length of oiled sleeving (Peto Scott), say	...	6	1—Peto Scott, type Universal	15 0	
1—Formo two-gang .0005-microfarad with Mystic dial	...	11 0	Length of 20-gauge round tinned copper wire for connecting, (Peto Scott), say	...	6	LOUD-SPEAKER		
HOLDERS, VALVE						1—W.B., type Stentorian Baby	1 2 6	
3—W. B. 4-pin (2), 5-pin, base-board type	...	1 8				VALVES		
						1—362 VS2	7 6	
						1—362 SG2	7 6	
						1—362 ME2	10 0	

2'4'9

18'1

K.O. 11

Half-scale Wiring Plan

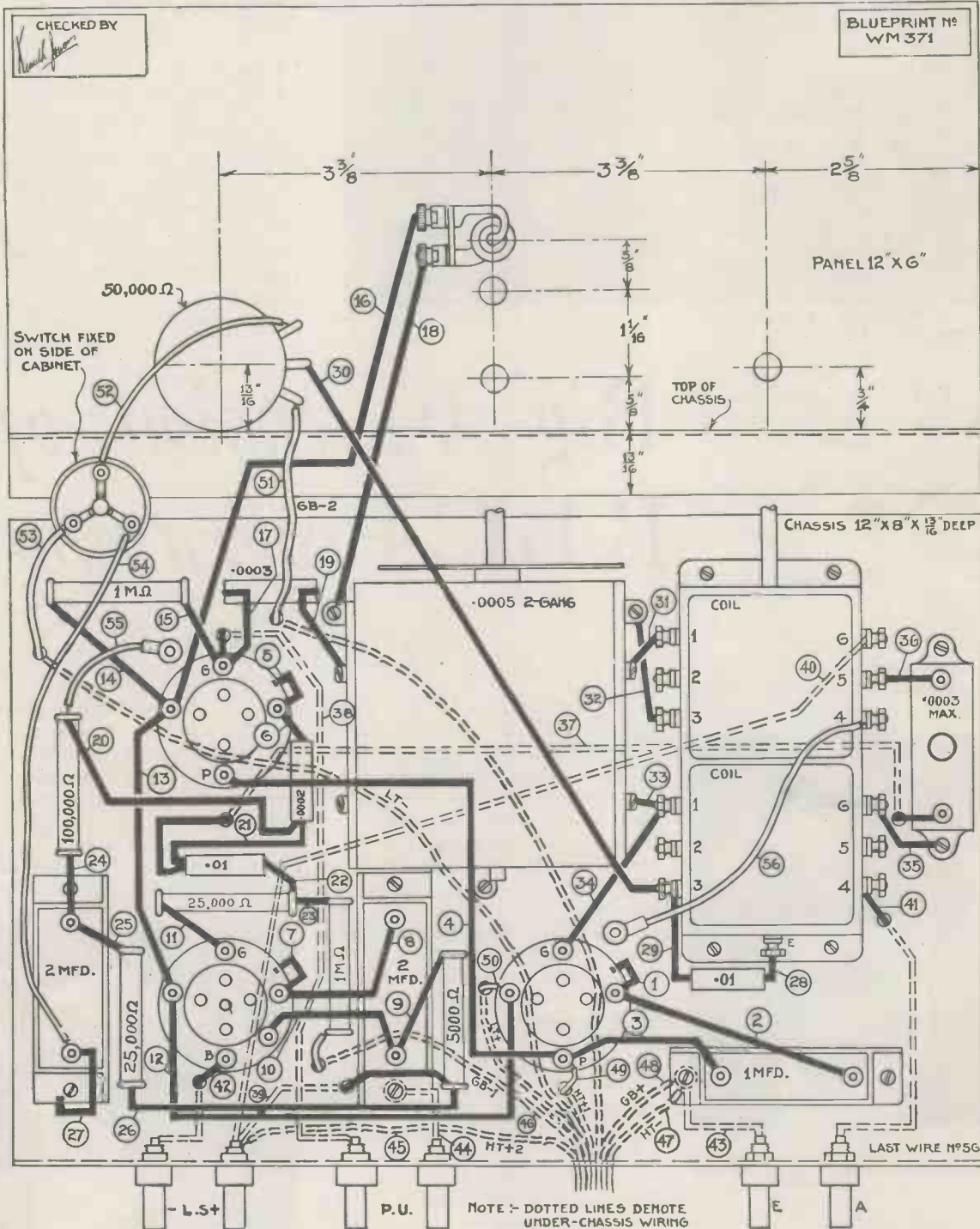

A FULL-SIZE BLUEPRINT FOR HALF-PRICE!
 If desired, a full-size blueprint can be obtained for half price, that is 6d., post paid, if the coupon to be found on the last page is used before October 31. Address your applications to the "Wireless Magazine" Blueprint Dept., 58-61 Fetter Lane, London, E.C.4. Ask for No. WM 371. An extension of time is made for overseas readers



This is Cleo Nordi, the wife of Walford Hyden of Cafe Collette fame

that it will be possible to give two concerts after the news instead of one. For instance, the Sunday-evening orchestral concerts—a popular feature of the winter—will start this year at 9.30, instead of 9.5 p.m.

The timing of the second news bulletins on weekdays in the National and Regional programmes has been altered to allow more flexibility in programme make-up. In the National programme the second news will be given at 9.30 p.m. and in the Regional at 10 p.m. The second news in the National programme will also be altered rather in form.

It is intended that this shall be

At last public opinion has made itself felt among the folk at Broadcasting House. For years, programmes have been made up at the B.B.C. with little regard of the tastes of the majority of listeners. Now the bomb has exploded!

No doubt the lesson learnt at Radiolympia is something to do with the changes that are to come into force on October 8.

I make no apologies for raking up my arguments in favour of an alter-

Big Extension of B.B.C. Programmes

By T. F. HENN

be an alternative to the late dance music until 11.15 every night. This, to my mind, is the greatest of all the changes that are to be made.

I have obtained the dance-music alternatives for the first week. Here they are: Monday, Julius Harrison is conducting the B.B.C. Orchestra from 10 to 11.15 p.m.; Tuesday, a talk by Sir James Jeans followed by the Gershom Parkington Quintet; Wednesday, chamber music by the International String Quartet; Thursday, St. Michael's mid-week service at 9.45 followed by an orchestral concert until 11.15 p.m.; Friday, recital of Poulenc's music; and Saturday, a popular orchestral concert conducted by Joseph Lewis.

So that is that. And certainly the material chosen is not too bad. There is only one danger—it must not be too highbrow. I know that the staff of Broadcasting House contains many musicians with a distinct leaning towards unmusical music! Watch them!

Now on Sundays the programme will be extended a quarter of an hour until 10.45 p.m. This will mean

more a news-reel with electrical recordings of important events and it will be followed by a topical talk.

Another important re-timing—not really a change—is that the main entertainment of an evening will not necessarily start at 8 p.m. or after. In the future, vaudeville programmes from St. George's Hall will frequently



A leader of a good dance band, Dare Lea has appeared many times with his band in recent programmes

native to the late dance music. When I suggested that thousands of listeners would like an orchestral or some other alternative, the B.B.C. replied that it could not see any demand for such an alternative on the part of listeners.

Anyway, from October 8 there will



A well-known tenor, John Armstrong—another broadcast artist who makes very regular appearances

be given at 7 p.m. So you see, the changes will have the effect of broadening the whole scope of broadcast entertainment.

Then, in addition to the main changes, there are a number of secondary ones. The season of public chamber-music concerts which were held in the Concert Hall last year will not be repeated this year. Attendances were not too good, and the B.B.C. has decided that in future chamber-music will be broadcast at odd times.

Those poor Bach cantatas have also been treated badly! They will only be performed when time can be found for them; there is no definite schedule. However, we are booked for more of them.



Here is a broadcaster you all know. It is Isolde Menges, who is known for her violin playing

Those rigid foundations of music, too, have been swept aside in the B.B.C.'s enthusiasm to make the programmes look brighter. On Mondays, Wednesdays and Fridays they will be heard at 7.5 p.m. and on Tuesdays and Thursdays at 6.30 p.m.

That is the main outline of the changes which come into force on Monday, October 8. You can take it from me that this is only the thin end of the wedge. The B.B.C. is really out to give better programmes at better times.

Now for an important reminder. Her Majesty the Queen will launch the new Cunarder 534 from the

yards on Clydebank at 2.30 p.m. on September 26. The commentary will be relayed from every National transmitter in the country. Listeners will hear the christening ceremony, the noise as the supports (which hold the giant vessel on the slipway) are knocked away, the swish as she slides down the slipway at a speed of twelve miles an hour into the water.

It will be a notable occasion in the history of British shipping. The B.B.C. is taking special care and



The Comic of the Keys who composes while you wait, Cliff Martell—a great turn in vaudeville shows



These artists have appeared in television and also at Radiolympia, Jass and Jessie with the animal

trouble to see that the relay is as perfect as possible.

Another important series of entertainments starts on September 27 when Regional listeners will hear the first of the new John Watt productions. It will be called *Songs from the Films* and is described as a chronological survey of film songs from the silent-picture theme song to the present-day talkie hit.

You know the quality of previous entertainments by John Watt. This, I firmly believe, will be even more interesting.

By the time you are reading these



Another fine pair of broadcasters, the Clayton sisters. They broadcast recently

notes, the B.B.C. Dance Orchestra will have returned from its annual holiday. Two changes will have been made in the personnel of the band.

Cyril Hellier, the leading violinist, and Arthur Williams, the second trumpet, will have left and their places will have been filled by Dan Donovan, who will sing besides playing the saxophone, and Charlie Price, a trumpeter, who also



Kitty Masters, the charming vocalist who is heard with Les Allen and the B.B.C. Dance Orchestra

has the knack of singing.

Dan Donovan, who used to broadcast frequently, comes to Henry Hall's band from Debroy Somers' band, and Charlie Price comes from Sid Lipton's



Boris Hambourg on holiday at Florence. He was heard and seen in a recent television broadcast

Grosvenor House band.

It is noticeable here that a violinist has been dropped and his place taken by another wind instrument. This, of course, has the effect of hardening the tonal effect of the band. Contrast this with its sweet style when it first started broadcasting eighteen months ago. Times do change!

Henry Hall is continuing his series of Saturday-night guest programmes during the autumn and the first will be on September 29.

You remember that last month I told you that the B.B.C. had cut down the number of Symphony Concerts at Queen's Hall for the coming season to twelve. In view of the new programme changes, these concerts will start at 8.30 and not at 8.15 p.m., as in previous years.

So far, details are very much in the air, except that Dr. Adrian Boult, the musical director of the B.B.C., is to conduct the majority of them. Among the guest conductors already engaged are Sir Thomas Beecham, Albert Coates, Felix Weingartner and Sir Henry Wood.

The B.B.C. are holding another London Music Festival next year. The concerts will be held at Queen's Hall in May and June. There

and that was when he conducted the New York Philharmonic Orchestra at Queen's Hall a few months ago, a short relay of which was arranged by the B.B.C.

There are just one or two other important events for next month to which I would like to draw your attention. The first is that Sir Thomas Beecham is to conduct Delius' famous *Mass of Life* on October 24. This concert will be in the nature of a memorial to Frederick Delius, who died at his French home earlier this year. It is a magnificent work and it will be heard at its best with Sir Thomas Beecham wielding the baton. Beecham is an acknowledged master of Delius' music.



Two great variety favourites, Claude Dampier and Miss Billy Cartisle. They had a rousing reception at the Olympia shows

Another interesting broadcast will be on October 7 when J. J. Taylor, of the Compton organ people, gives a recital of improvisations on the Concert Hall organ at Broadcasting House. Taylor was one of the big men behind the design of this B.B.C. organ and his recital at 7.35 p.m.—a Sunday—will demonstrate the beauty of tone that can be obtained from the B.B.C. instrument.

Ever since broadcasting began the name of Sir Dan Godfrey, conductor of the Bournemouth Municipal Orchestra, has had a prominent place in the programmes.

Sir Dan is retiring and is conducting his farewell concert at the Pavilion, Bournemouth, on Sunday, September 30. The concert, which will contain many old favourites, will be broadcast nationally.

will be eight altogether in the series.

The London Music Festival will be a great event next year, for it is announced that Arturo Toscanini, the most celebrated of living conductors, is coming to London to conduct four of the concerts.

Toscanini has only featured in one broadcast in this country before



This photograph of Roy Fox and his dance orchestra was taken at the British Lion Studios at Beaconsfield, where the film, "On the Air" which features this band, was "shot"

VISITORS to Radiolympia certainly enjoyed the G.P.O. exhibition in the small hall, and were no doubt awed by the demonstrations arranged by the National Physical Laboratories. But these two exhibits, however interesting and important, were only adjunct to the main business of the exhibition, that of showing the latest developments in the design of components and radio receivers.

At the Berlin Exhibition things were entirely different. Only three of the six halls surrounding the Berlin Funkturm were devoted to the radio industry. One of the remaining three had been booked by the Radio Manufacturers' Association as a whole to show the making of the "Volksempfänger" (People's set) and the other two by the German Post Office and the German Broadcasting Company.



Sport & General photo

A huge model of a Blaupunkt receiver with its novel tuning scale marked in stations, which was shown at the Berlin radio show

The New Season in Germany

Here A. A. GULLILAND, our German Correspondent, gives a special report on the Berlin Radio Exhibition recently held in six large halls on the famous Kaiserdamm in the German capital. For the first time, the opening of the show by Dr. Goebbels was televised and shown on a big screen in a theatre in the exhibition

The broadcasting concern thought it necessary to provide visitors to the show with impressive, symbolical displays where they could sit or stand and collect their thoughts.

The Post Office, on the other hand, was more practical. It, together with the engineering department of the Broadcasting Company, produced a highly interesting television theatre and showed listeners all about the suppression of man-made interference, and also gave them an idea of the working of a



Gulliland photo

MAKING THE "PEOPLE'S SET"

Three of the six halls at Berlin's radio show were devoted to the making of the "Volksempfänger," a set with a government specification that has to be made by all set makers and sold at a certain price

broadcast control room and radio transmitter.

The sensation of the exhibition, undoubtedly, was the so-called "television theatre;" not that the quality of the pictures had improved so very much from what was shown last year, but the wireless transmission and reception of the images has improved so very considerably that the German authorities now definitely intend to introduce an experi-

mental public service on ultra-short waves.

Synchronisation by means of wireless signals has also been attained and so makes television broadcasting independent of a mutual electric power supply.

The Fernseh A.G.'s intermediate film system has now reached the practical stage for the new German standard picture on 180 lines and 25 frames per second. It is now possible to televise all outdoor and indoor



Gulliland photo

SETS IN THE ENTRANCE HALL

One end of the big entrance hall was stacked to the ceiling with cases of the People's set in the form of a huge Swastika

scenes, which can be filmed with the help of this system. Reception is either on the screen of a cathode-ray tube for home use or by intermediate film (for projection) for large audiences.

Valve Holiday Year

Receiver design has been hampered by the imposition of the "Valve Holiday Year" and by the strict sub-division of all receivers into classes with minimum prices.

There are only really two new developments on the market. These are the two-valve reflex receiver and the three-valve reflex super-het. Unfortunately both these circuits do not tend to improve quality.

Practical Tuning Ideas

At Olympia quality of reproduction seemed to be the foremost achievement of the new season's sets, whereas in Germany, selectivity and ease of tuning were two of the most important considerations.

The Germans certainly have succeeded in producing really practical tuning devices based on new ideas. One firm, Seibt, fit their higher priced sets with a special blocking

device. Once the indicator has been turned to a given country, say Poland, only Polish stations can be received; all others are automatically blocked.

Naturally, if a Polish station suddenly exchanges its wavelength with an Italian station, the set will have to be readjusted. Another firm has introduced a ratio of 1:100 for

tuning and fits the tuning knob with a flywheel to improve ease of operation.

A third well-known firm of manufacturers provided a small ground glass screen on which the name of the station tuned in is projected in large letters.

"People's Set"

The "Volksempfänger" remains unchanged. It still is the cheapest set, and the price conventions already referred to prevent the prices of all other sets sinking below double the cost of the "Volksempfänger," that is below 150 marks.



World Wide photo

MODERN STANDS AT THE GERMAN RADIO SHOW

A scene in one of the halls in the Kaiserdamm buildings where the manufacturers' sets were on view. Very attractive stands, too!

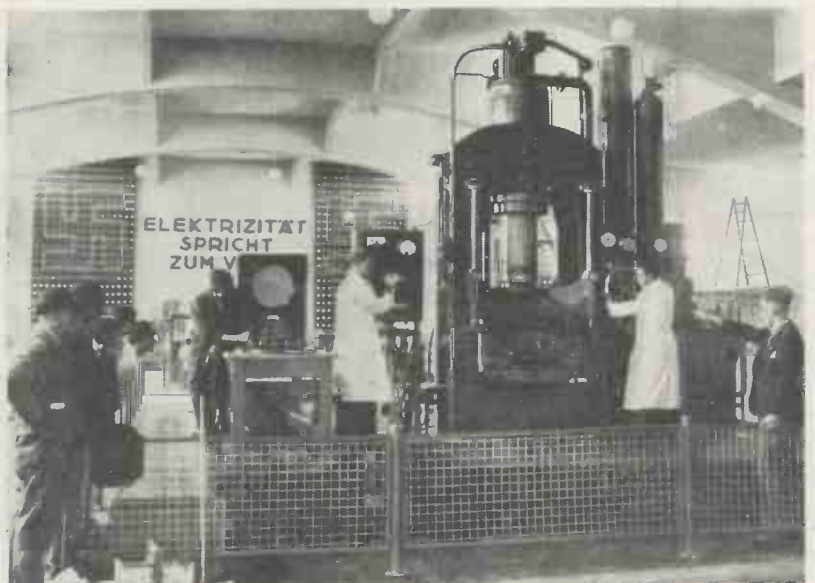

World Wide photo

MAKING CABINETS WITH A HYDRAULIC PRESS

A huge hydraulic press making bakelite cabinets for A.C. versions of the "Volksempfänger" receiver. The battery models of this set have wooden cabinets

Prices are up in Germany by about 10 per cent.

On the other hand, the manufacturers have a very large stock of last season's models, and these are available as long as they last at moderate reductions.

Multiple Valves

Only one firm, Loewe, have been allowed to include their multiple valve for universal mains sets, and these valves are only available to home constructors and in connection with that firm's receiving sets. The other German valve manufacturers only produce the new type of Universal and Midget valve for export.

The new German receivers have new cabinets, new tuning devices, but only slightly improved circuits.



World Wide photo

OPENING OF THE GREAT GERMAN RADIO SHOW

A view taken from the television box of the opening of the show by Dr. Goebbels. The opening ceremony was televised, and visitors inside the building saw it on a huge screen

New Uses for Old Valves

WHEN a valve has lost emission one looks upon it sadly and regretfully and then if one is wise casts it out and gets a new one.

Cast-out Valves

My junk box nowadays contains a dozen or more cast-out valves whose filaments are sound but whose emission has gone. I leave them there because from time to time I want a couple of multiple connecting plugs between one piece of apparatus and another—say an amplifier and a mains unit built on a separate chassis—and it is convenient to use old valve bases for this purpose.

With the modern sprung valve holders and sockets good contacts are assured and it is a joy to be able to make four or five (and soon even seven or nine) connections at once instead of having to fiddle about with independent terminals or plugs and sockets.

I usually have a few 4-way and 5-way connectors lying about ready for when they may be wanted. They are made quite easily and quickly, with an old valve base at each end of the 4- or 5-way cable, corresponding pins being connected together.

When the bulb has been broken the "innards" of a valve are easily

pulled out of the base with a pair of pliers, and it is then only necessary to unsolder the small wires from the pins, solder up the connecting cable, and fill the valve base with sealing wax.

Until recently this was the only use for old valves that I knew of. I have now discovered another, that of using a valve as a diode detector.

It is customary in these days to use a double-diode as the second detector in a super-het, one of the two diodes being used for the pur-

pose of providing delayed A.V.C. across R by the grid current is fed back from the point x to the grids of earlier valves through suitable filter circuits. The rectified signal is also taken off from x to the low-frequency amplifiers as shown.

Millimeter Readings

The voltage fed back biases the earlier valves and controls their amplification and also their anode current.

If therefore a millimeter is connected in the anode circuit of one of these earlier valves its reading will decrease as a station is tuned in, and the amount of decrease is a measure both of the signal strength applied to the diode v.

If, however, the signal strength is kept constant—as, for example, when one is tuned in to a local station—and the valve v is changed, then the decrease is a measure of the efficiency of the valve as a detector.

I happen to be using a double-diode as second detector, the anode socket of the valve holder and therefore the second diode, being left unconnected.

It occurred to me to ascertain what would happen if I substituted an ordinary valve, with the anode in the air, as it were.

Continued on the last page

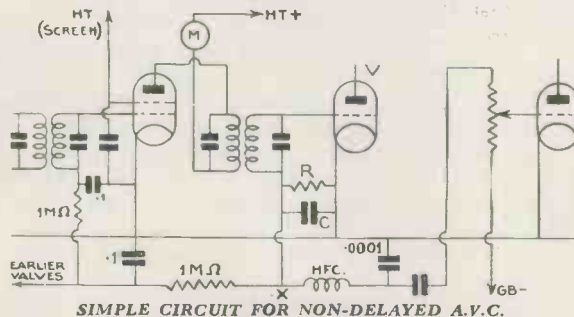
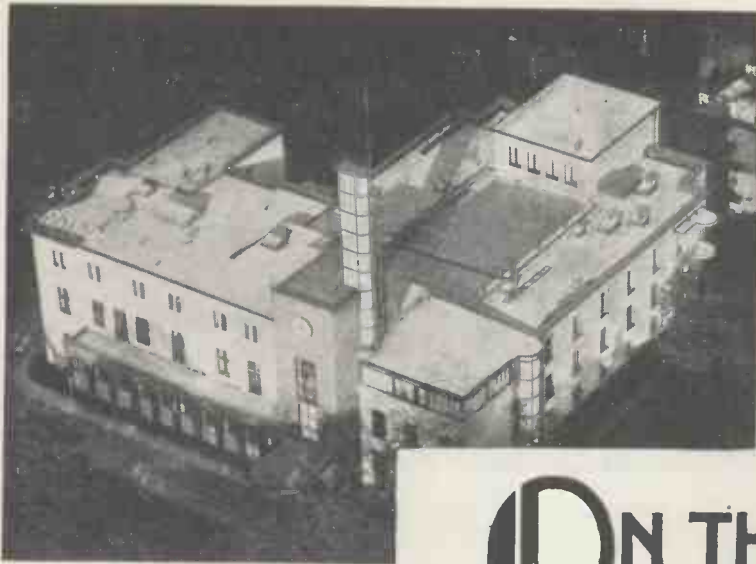

Fig. 1. A circuit recommended by the author for using an old valve for the purpose of providing non-delayed A.V.C.

pose of providing delayed A.V.C. But if one is content with simple, non-delayed A.V.C., which I mentioned in a note last month, then a single diode will serve both purposes quite well.

Fig. 1 is the fundamental circuit. The valve v is the diode, R and C being the associated grid leak and condenser of values, say, .1 to .5 megohms and .0001-microfarad respectively. The voltage built up



Gulliland Photo

HAMBURG BROADCASTING HOUSE
An aerial view of the new broadcasting headquarters at Hamburg. The flat roof of the main studio is seen behind the modern tower

DENMARK

FOR its winter radio season Copenhagen promises a series of concerts given by the State Symphony Orchestra to be directed amongst others by Egipto Tango of Buenos Aires and by Nicolai Malko, the Russian conductor. The instrumentalists and vocalists engaged for these special musical entertainments include such well-known names as Jascha Heifetz, violinist; Conchita Supervia, Vladimir Horowitz, Erna Berger, the famous German Singer, and many other stars of the concert platform.

It is probable that a number of these broadcasts will be relayed by transmitters in neighbouring countries. On such occasions, when the programmes are of international interest, announcements will be made in three or four European languages, including English.

FRANCE

Toulouse PTT, with a view to preventing any confusion with its "private" rival, Radio Toulouse, has adopted as an interval signal a musical box version of an old French folk song, *La Tyrolienne des Pyrénées*.

Work on the 120-kilowatt transmitter which will eventually take over the State programmes in this district is progressing well and it is hoped to launch it in 1935. In the meantime, Radio Toulouse has been authorised to use its high-power plant.

ON THE CREST OF THE WAVES

Radio News From All the World :: By JAY COOTE

GREENLAND

After considering various schemes the Danes have voted against the installation of a broadcasting station in Greenland, as it has been proved that the Kalundborg transmissions are well received in the Polar Circle.

During the winter, however, arrangements are to be made to relay programmes from Julianehaab (Greenland) and also to tap local talent in the Faroe Islands. Such a combination would provide entertainments of an interesting character.

GERMANY

At fixed periods during the day, all German stations are switched over to Berlin for official pronouncements or ministerial speeches. On these occasions, the call heard from Berlin is "Alle Deutsche Sender" (all German transmitters) and the broadcast is termed "Die Reichsendung" (State transmission).

Until roughly the end of September, the new Breslau high-power station will be resting to allow the engineers to make the necessary alterations for increasing its power

to a 100 kilowatts. During this period, the Breslau programmes will be broadcast by the old 17-kilowatt station.

HUNGARY

Listeners may have noticed that the good-night greetings which precede the closing down of the Budapest station appear to vary according to the announcer on duty. After the station has transmitted its final item, greetings are given in several European languages. You may hear a curt "good-night" in English, or "Bonne nuit, mesdames et messieurs." On other occasions

they are heard in Magyar with a French translation: "Radio Budapest Hongrie vous souhaite une bonne nuit."

JAPAN

The power of the Tokio station is to be raised to 150 kilowatts, an increase which may permit reception, now and again, of its programmes in the British Isles. During 1935-36 similar boosting of the Osaka, Niigata and Nagasaki transmitters is expected to take place.

SPAIN

It is to be hoped that the last plan put forward for the reorganisation of the Spanish broadcasting system will bear fruit. It calls for the construction of new transmitters over a period of three years. The first to be installed are two 50-kilowatt stations at Madrid and Barcelona—they will operate respectively on 293.5 and 274 metres and should be ready within twelve months.

A further six months should see the completion of Madrid National, to which, provisionally, the 1,639-metre channel (now used by Radio Paris) has been allotted.

Where the Stenode Scores

This is the second and final part of a simple article by PAUL TYERS explaining the principles of the Stenode system. The first part appeared in the September issue of "W.M." The manuscript has been approved by the inventor of the Stenode system, Dr. James Robinson, and is, we believe, the simplest authentic account of Stenode principles that has yet been propounded

INTERFERENCE can be divided into a number of different classes. It is not possible to go into the whole subject very fully or to consider all the conditions which are obtained in practice; to do so necessitates somewhat lengthy mathematical analysis which would be out of place in these columns.

The most important types of interference are the heterodyning of a desired carrier with an undesired carrier, the heterodyning of a desired carrier with an undesired sideband, and the heterodyning of an undesired carrier and undesired sideband.

No Direct Heterodyne

If stations have a definite separation of a given number of kilocycles and if, for example, our receiver definitely cuts off at 5,000 cycles, then there can be no direct heterodyning of an adjacent station unless the separation is smaller than the cut-off.

In other words, if the adjacent station is 10 kilocycles away and our receiver cuts off at 5,000 cycles, there can be no direct heterodyne note caused by the combination of the two carrier waves of the desired and undesired station.

Definite Note

Heterodyning could only occur when the interfering station was so near in frequency that it would give a beat note of perhaps 4,500 cycles, when we should hear a definite note.

It follows, however, that if our receiver accepts frequencies up to 10,000 cycles and if the adjacent station is 10 kilocycles away and if that station modulates up to 10,000 cycles, then there would be very appreciable interference.

It has previously been mentioned

that the Stenode achieves increased selectivity by virtue of some action quite apart from selectivity due to sharply tuned circuits.

Of paramount importance in interference problems is not the absolute value of received and interfering voltages, but relative values.

In order to obtain a clear picture of how the Stenode removes certain types of interference it is necessary to study very clearly the following reasoning, which is illustrated in Figs. 7, 8, and 9.

Fig. 7 shows the type of resonance curve which can be obtained with a Stenode receiver. Fig. 8 indicates desired waves $F_0 e_1 e_2$, and interfering waves are shown as $F_0 f_1 f_2$ before they reach the selective part of the receiver. Fig. 9 shows the effective voltages due to the various waves after they have passed through the selective portion of the receiver.

Here our desired carrier is shown as $E_0 e_1 e_2$, whilst the undesired carrier and sideband voltages are shown as $F_0 f_1 f_2$. It is these voltages that are now passed to the rectifier, and it is here that a very important action takes place.

It is well known that the output of any voltage applied to a rectifier is proportional to the product of the magnitude or amplitude of the high-frequency effects which have produced it. It follows, therefore, that the desired programme voltage has

an amplitude given by $E_0 e_1$, whilst the interfering programme voltage has an amplitude given by $F_0 f_1$.

It will also be seen that if the high-frequency voltages had been passed through a rectifier before going through a selectivity device the desired programme would have a voltage amplitude equal to $E_0 e_2$ and the undesired would have a voltage amplitude equal to $F_0 f_2$.

Now these voltages are of the same order of magnitude, and accordingly both programmes would have appeared together in the output. It will be seen, therefore, that the effect of the selectivity device is to cut down the intensity of both interfering carrier and interfering sidebands.

Beneficial Effect

It is also important, however, to consider another point, and that is why the subsequent tone correction does not destroy the beneficial effect which the selectivity device has introduced. It will probably be easy to understand by taking numerical examples of the conditions represented in Figs. 7, 8 and 9.

For the sake of example, the height of the resonance curve in Fig. 7 may be taken to represent 20 units, while the height of sideband voltage represents one unit. We are, therefore, justified in saying that the effect of the waves $e_1 e_2$ and F_0 are all cut down to substantially the same amount, that is, about 10 times.

Numerical Example

It should be clearly understood that this is not representative of actual practice and is a mere numerical example to make the principle clear.

The desired programme must, therefore, have a strength equivalent to $\frac{E_0 \times e_1}{10}$ and the interfering programme has a strength of $\frac{F_0 \times f_2}{10}$.

Now, it has been previously explained that the tone-correction factor for the desired programme is approximately the reciprocal of the resonance curve. Thus, in this simple case we multiply the desired effect by 10, but we cannot do so without multiplying the interfering programme by 10. The desired pro-

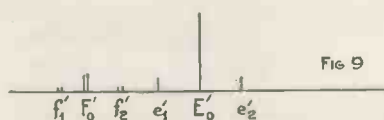
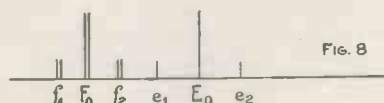
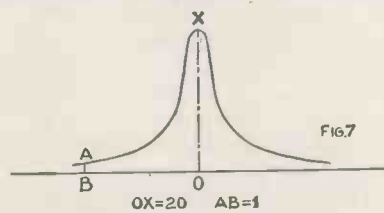

Fig. 7 shows the type of resonance curve obtained with a stenode. Fig. 8 indicates the desired waves, $F_0 e_1 e_2$, and interfering waves, $F_0 f_1 f_2$, before they reach the selective part of the set and Fig. 9 shows the effective voltages after they have passed through the selective stages

gramme has now become $E_0 e_1$, whilst the interfering programme becomes $F_0 f_1$.

This explanation should make perfectly clear why the selectivity system cuts down the interfering programme and why the tone correction subsequently applied does not restore it, although it does restore the desired programme to the correct proportion.

Still referring to Figs. 7, 8 and 9, it is obvious that there are various forms of interference to be considered. The first is the heterodyne

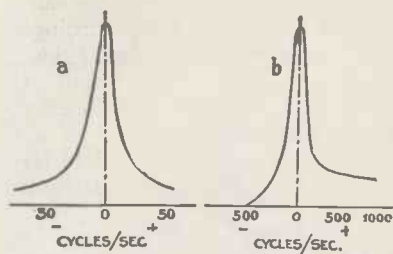

Fig. 10.—Typical curves obtained when a quartz crystal is used as a mechanical resonator

whistle between $E_0 F_0$ which has previously been referred to. The next is the effect produced by the interfering sidebands f_2 with the desired carrier.

Sideband Splash

This effect is what is known as sideband splash. If the sidebands were steady we should get a steady note similar to an ordinary heterodyne whistle between carriers.

It must be remembered that a programme consists of a series of notes which are continuously varying and, accordingly, such interference is not in the form of a steady whistle but the well-known splash effect. These effects, of course, do not give us anything intelligible and thus their disturbing effect is generally reduced.

Splash Effect

It is particularly interesting to note that with a highly selective circuit their effect appears to be lower than might have been expected, and under ordinary broadcasting conditions it is not appreciated with the Stenode unless the interfering station is at least five times as strong as the desired station.

It is of interest to mention the means which can be employed to obtain highly selective circuits.

There are really three main systems.

The first consists in applying very strong reaction to a tuned circuit and this, as is well known, has the effect of considerably increasing the effective selectivity as the retroaction tends to neutralise the effect of the inherent resistance in the circuit and so lowers the decrement.

In practice circuits with reaction are not too easy to handle and, although they have been used by the writer and also many other investigators, they do not appear to have found much favour and there are numerous practical difficulties.

The second method consists in using a circuit which has a natural or inherent low decrement, that is one in which the equivalent series high-frequency resistance is low.

This can be achieved by suitable design of an ordinary inductance, preferably by reducing the losses with the aid of a high-permeability dust core.

Whereas shapes of the approximate form, which have been shown in the illustrations, are actually obtained in practice by cascaded or loosely-coupled single-tuned circuits, all tuned to the same frequency, the writer has found that in practice Stenode receivers can be satisfactorily built simply by using four-tuned circuits of high efficiency with dust cores, the circuits being very loosely coupled.

The third method of obtaining radio-frequency selectivity is not by any form of tuned circuit, but by using what is in effect a mechanical resonator, such as a piezo-electric crystal. A number of materials exhibit this property, amongst which quartz may be mentioned. A piece of quartz when ground to certain accurate limits exhibits piezo-electric effects at a frequency which is a function of the physical dimensions of the material.

The quartz crystal, as is generally known, shows a tremendous change in effective impedance at a particular frequency. Actually the effective shape of the impedance plotted against frequency is slightly asymmetric and is on the lines indicated in Fig. 10. The curve is extremely steep and the crystal shows a very marked cut-off.

The subject of quartz crystals as selective devices is far too vast to be dealt with at the present instance. The use of crystal is a problem in itself, and as the shape of the crystal output is totally different from that

of cascaded tuned circuits it follows that the design of tone-correction circuits will be totally different in each case.

In practice sufficiently good quality can be obtained by using a tone-correction circuit that is in reality a compromise of the exact inverse of the radio-frequency response curve. If one uses sufficiently complicated filters and enough valves it is possible to obtain almost completely faithful reproduction over a very wide frequency range when using a Stenode circuit.

Good Tone Correction

Such complication, however, is quite unnecessary in ordinary practice, and the writer has found it possible to obtain good tone correction by splitting the circuits into two units.

It should be appreciated that the bulk of the modulation from a Stenode detector output is extremely low compared with carrier wave. This is obvious by examining the curve shown in Fig. 6. More low-frequency amplification is necessary than with an ordinary receiver and accordingly it is quite convenient to spread the tone correction over two valves.

It is well known that the amplification of a valve is a function of the impedance of the valve itself and the effective impedance of the load circuit.

Linear Amplification

In the case of pure resistance coupling the amplification is substantially linear over the frequency range because the load impedance does not vary with frequency. If the load, however, contains inductance the impedance of this varies with frequency.

It is obvious, therefore, that a simple network can be devised which offers a much lower impedance at

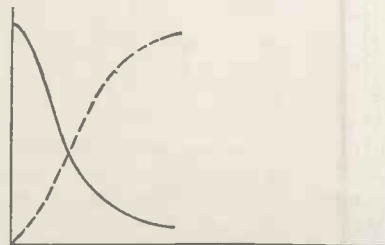

Fig. 6.—Full curve shows relation between detector output and audio-frequency; dotted line shows the necessary response for an audio-frequency amplifier

Continued on next page

Readers Report on "W.M." Sets

Here we present five enthusiastic reports from readers of different types of "W.M." sets, ranging from a de-luxe radiogram to a simple four-valve portable. All tell the same story of satisfactory results. Don't forget to send us a report on your "W.M." set: the reports are of great value to our Technical Staff

A.P.A. RADIOGRAM (May, 1932)

Clapton Park (London, E.5).—Perhaps I am rather late with my report on a fine "W.M." set, but I am enclosing two snaps of my homemade A.P.A. Radiogram designed by P. K. Turner in the "Wireless Magazine" for May, 1932. This is the second outfit I have built; the first one made was sold soon after it was built.

Needless to say, reproduction on both radio and records is absolutely realistic and I have never heard better.

Many thanks for such a fine set and also many thanks for the many other fine "W.M." sets that I have made.

Doncaster (Yorks).—I began building the A.P.A. Radiogram during my spare time

and as funds would allow. The set was finished some months afterwards and has since given every satisfaction. I have now fitted Ferrocart coils in the unit and would advise other constructors of this set to do the same. I must apologise to P. K. Turner for fitting a variable-mu screen-grid valve as detector in place of the MHL; the latter would not carry the load handed on by the high-frequency valve.

I can honestly say that every

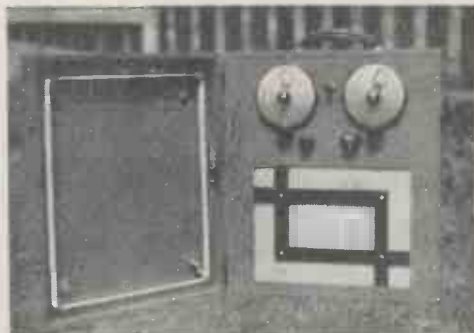

The Spectrum Portable of a Glasgow reader who is very proud of his outfit. His report is given at the bottom of this page

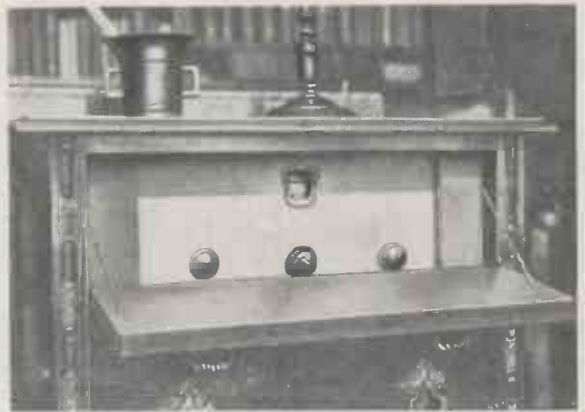

A Merry-maker Super built by a Chatham reader into a chest of drawers because he did not like the appearance of the ordinary wireless set

person who has heard the set has said, "By Jove, that's music—I've never heard a set like it for quality."

Many thanks to the staff of "Wireless Magazine" and last, but not least, the finest set on earth—the A.P.A. and Radio Unit, the perfect radio gramophone.

By the way, this is my fourteenth set since 1926 and my final!

SEVENTY-SEVEN SUPER (December, 1932)

Bellesley (Birmingham).—I should like to give a just word of praise to "Wireless Magazine." Many readers would, I am sure, like to know that for selectivity and volume there is no set to beat the Seventy-seven Super. I have one recommendation to make. That is that constructors should fix a 100,000-ohm volume control across the pick-up. I am enclosing a photograph of my outfit.

SPECTRUM PORTABLE (April, 1934)

Rutherglen (Glasgow, Scotland).—I have much pleasure in enclosing a photograph of the Spectrum Portable which I have built up exactly to specification. I must say that I am highly delighted with the set, its performance and quality, the latter being very fine indeed. I can get quite a number of Continental stations which, when one takes into account the size of the frame aerial and the time of the year, is very satisfactory indeed. With the very best wishes to "Wireless Magazine."

WHERE THE STENODE SCORES—(Continued from page 230)

the low frequencies than it does at the high frequencies.

The simplest example of this is a very small choke of low inductance together with a certain amount of resistance. At the higher frequencies the impedance of the choke will be quite high and, therefore, the amplification will be quite high. At the lower frequencies, however, the impedance of the choke falls away rapidly and accordingly the amplification of the low notes is reduced.

Ten Years Ago

An example of this is to be found in the early type of transformer used some ten years ago when bass response was unnecessary because loud-speakers of those times would not reproduce low notes. Transformer inductances were then of the

order of 5 to 10 henries instead of anything from 50 to 100 which are used to-day.

Modern valve design, which has given us more stable oscillators for frequency changing, greater stage gain, comparative freedom from microphony and the universal adoption of dust-core coils giving more efficient tuned circuits, has helped in making possible the simple production of a Stenode receiver.

Tests carried out during the last six months by the writer have shown that there are no real difficulties in building a Stenode receiver with a performance giving selectivity which will no doubt be surprising to those who have never had the opportunity of using anything more selective than a standard receiver.



Photopress photo

THE RIGHT PLACE FOR THE LOUD-SPEAKER

Many people are of the opinion that loud-speakers should be arranged above the level of the listeners' head for the best result. Here is a new reproducer that is hung from the ceiling

WE L L, Radiolympia is over and we can look back in comfort and consider all the new things we have seen. There is no doubt about the enthusiasm shown by the public over radio nowadays. The Show was held in perfect weather so it means a lot that even more people went to Olympia this year than last year.

I suppose that in common with myself most technical men would rather see the Radio Exhibition run as a technical show than as an enormous shop window. In this respect I think we could learn something from the Germans.

I have never been able to make time to go over to the Berlin Exhibition, but from pictures of it that I have seen and from conversations with people who have been over I gather that their effort is much more scientific than ours.

you will have seen the description of it in last month's issue. There certainly seemed to be a considerable amount of interest in this set, although the September issue of "Wireless Magazine" had not been published at that time.

Seeing this new set reminded me of a demonstration I went to in the early days of Dr. Robinson's original

Radio

They certainly hit on a good idea this year in having a complete model factory at work on the production of the standard German receiver, the Volksempfänger (or People's Set). I should like to see something of the kind over here.

◆ ◆
Stenode Possibilities

Whilst I was at the "Wireless Magazine" Stand at Olympia, I had a good look at the Tyers' Stenode, of which an unwired chassis was on view;

quartz-crystal receiver. I remember that the selectivity of that was so great that Rome, which in those days had a slight wavelength wobble, came and went as if it were suffering from high-speed fading. On an ordinary and comparatively flat-tuned set the transmission came in without any interruption whatever.

The new Tyers non-quartz design does not attain this very high degree of selectivity, of course, but those who have heard the new version are very much impressed with its performance. It certainly seems to be the most selective set that has yet been offered to the constructor.

◆ ◆ ◆
Future of A.C./D.C. Sets

I was interested in talking to an official of one of our greatest set-producing companies to hear him remark that next year all the cheap receivers, by which he meant all those selling at about 16 guineas and less, will be A.C./D.C. models.

The reason for this will not be because there will be an increased demand for A.C./D.C. sets as such, but because it is cheaper to manufacture a model of this type than it is to make a straight A.C. model; you save the cost of the mains transformer. Thus at last the D.C. man will be catered for in a very adequate way—and quite by accident!

It is rather ironical, isn't it, that as D.C. mains become

more and more scarce sets suitable for D.C. use come more and more into prominence?

◆ ◆ ◆
Short Waves in the Tropics

Although I personally have never been bitten by the short-wave bug I am always interested to meet people who do suffer that way. Recently I ran into a man who has



H.M.V. photo

HIS MASTER'S VOICE!

The prize bull mastiff of Mr. F. L. Heathorn, advertising manager of H.M.V. with a young friend, interested in the new High Fidelity Autoradiogram, the set with fifteen valves

Medley

Conducted
by BM/PRESS

spent ten years in tropical climes—in Porto Rico, to be exact. He would like to tell British short-wave manufacturers just what he thinks of them.

One most interesting point is that impregnating short-wave coils with beeswax is simply asking for trouble; tropical white ants plough through beeswax like one o'clock! And paraffin wax isn't much better because it always has some moisture in it and a thin line of corrosion gradually works its way all through until the wire goes phut.

In fact the best protection of all is air. Insects can't eat it and it is more or less unaffected by damp. My informant told me that at any time of the day you can collect quite a lot of moisture in his part of the world just by running your finger along the edge of a bench or table! What a life!

Real Portable at Last

Have you seen the latest portable? It is no larger than a box camera and weighs less than 3 lb. complete with headphones and batteries. And, what is more, it includes its own midget frame

aerial, which gives a range of over 100 miles for the reception of Regional stations.

I have heard this little set and predict a good market for it. It is

ideal to take about in a car and you can use it in your hotel whenever you want to. The low-tension current consumption is only .1 ampere, so recharging is not a great problem.



Osram photo

HUMPTY-DUMPTY OF THE RADIO SHOW!
These kiddies visited the Osram stand at Olympia and pulled one of the large model valves to pieces—but they could not put it together again!

The high-tension voltage is 45 volts only.

This set—known as the Portabout—is the first of its kind and has been developed from police-radio principles. I mentioned last month that Mr. C. L. P. Dean, who has developed portable radio for the Brighton police, was introducing a midget set to the public; the Portabout is the set I was referring to.

Where the Constructor Scores

Nowadays there is a lot of talk about the cost of building a set compared with the cost of buying an equivalent commercial model. The position is difficult, but component makers are in many cases doing what they can to meet it.

Some firms said that they would produce stripped components to help, but they are conspicuous by their absence from most of the new ranges. But there are a few firms who are reducing the cost of standard



Sport and General photo

AND NOW BEDSIDE RADIO DE-LUXE

Miss Angela Ward, the reigning Beauty Queen of England, tries out the latest in radio—de-luxe bedside receiver that created great interest at Radiolympia



RADIO OUT OF THE RUT
 Ekco have produced a most attractive range of sets this year. Here is the model A.C.85, available in walnut or black and chromium finish

parts quite considerably. I have in mind fixed resistances, which are now 6d. instead of 10½d. and 1s., and potentiometers, which are now around the 3s. 6d. mark instead of 5s. or 6s. each. And on top of that you have iron-core coils at 4s. 6d. a time.

There is no sign of any great drop in the prices of variable condensers, unless you go to the bakelite type, which are not very satisfactory for ordinary tuning.

Where the constructor scores is with big radio gramophones of the six- to eight-valve type with automatic record changers. That type of set costs anything up to £100 from a set maker, but most amateurs could make one up for about half that price—and be quite certain of getting results, too.

Guide to Amateur Radio

Beginners will be interested in an 82-page booklet just published at 6d. by the Radio Society of Great Britain. It is called "A Guide to Amateur Radio," and includes six technical articles and five practical features besides a lot of general information.

Titles of articles in the theoretical section are: "An Amateur Explains"; "Modern Valves and Their Appli-

cation"; "Aerial Systems"; "Power Supplies for Short-wave Transmitters"; "Artificial Aerials"; and "The Radio Spectrum."

Then in the practical section there are articles entitled: "A Two-valve Amateur Band Receiver"; "A Self-excited Tuned-plate Tuned-grid Transmitter for Use on 7 and 14 Megacycles"; "A 10-watt C.W. and Telephony Transmitter"; "A Dual-range Triode Frequency Meter" and "A 100-kilocycle Quartz Oscillator Calibration Unit."

Altogether a useful collec-

Overheard at Olympia

In the Exhibitor's Club at Olympia it was impossible to avoid overhearing many interesting tit-bits of conversation, most of which it would be most inadvisable to repeat here. But I cannot withhold the following illuminating comment regarding Broadcasting House:

"... a cross between a battleship and a lunatic asylum!"

Condenserless Tuning

One of the most interesting of the new components is the Varley permeability tuner, which is very much like a standard coil-and-condenser tuning pack in appearance. But there is no variable condenser, the

tuning being altered by sliding the cores in and out of the coils. The chief claim made for this tuner is that the selectivity is constant over both wavebands, which is, of course, an important point.

Another point about this tuner is that the coils are the same whether they are for use in a straight set (with or without band-pass) or in a super-het. In the latter case, though, a padding coil is used to convert one of the coils to a 110-kilocycle oscillator.

At present the cost of these units is on the high side, but there is no doubt that the price will come down as the demand increases. I think that there is a future for these tuners. London, W.C.1. *BM/PRESS.*



Marconiphone photo

THE FINISHING TOUCH TO A PERFECT HOLIDAY

These youngsters find that radio gives them a new kind of amusement when sand pies and castles begin to pall

tion of articles, particularly to the budding short-wave fan. Copies of the booklet can be obtained for 8d., post paid, on application to the Radio Society of Great Britain, 53 Victoria Street, London, S.W.1.



Wide World photo

SIX YEARS' USE IN FOUR DAYS

Christopher Stone inspects an ingenious mechanism that puts radio switches through the equivalent of six years' normal home use in four days

Making Your Own Mike

By K. IAN GOODMAN

A GOOD microphone giving really first-class quality is essential for those interested in public-address work, home talkies and home recording. Various types of microphones, their costs and applications have been dealt with in recent articles which have appeared in "Wireless Magazine," and we do not intend to touch on that subject here.

A simple moving-coil microphone costing less than £1 can be made at home with little trouble, and the following description will be sufficient for the merest novice.

Components for the Job

First of all the components. You will require an Epoch Dwarf 5 in. loud-speaker unit (23s. 6d.), a Sorbo rubber rectangular sponge (6d.), two Belling-Lee terminals marked "Output" (8d.), a piece of ebonite, 2 in. by 1 in., some $\frac{1}{8}$ in. and $\frac{3}{8}$ in. plywood, and some slag wool or cotton wool, small brass screws, headless brads and oiled sleeving.

The drawing on this page shows very clearly how the microphone is made. The first job, of course, is to mark out the $\frac{3}{8}$ in. plywood which forms the back and front of the case. This is simply done by drawing a circle having a diameter of $6\frac{1}{2}$ in. on the wood with a pair of pencil compasses. Draw four diameters on the wood, the angle between each being 45 degrees. Then join all the points where the diameters intersect the circle; the result is a perfect octagon.

Making the Wooden Case

Now with your fretsaw cut out the octagon. When you have done this, cut out a similar shape to the first one; you can use the octagon you have just made as a template for the second one.

The next job is to cut out eight pieces 4 in. by $2\frac{1}{2}$ in. each, using the $\frac{3}{8}$ in. plywood, for making the sides of the box. You can see how this is done from the drawing on this page. At this stage you can cut out from the centre of one of the octagon shaped pieces an aperture measuring $3\frac{1}{4}$ in. square; a fretsaw is the best tool for this job.

The side pieces are fixed with headless brads. All but three should be fitted; three sides being left off to enable the moving-coil loud-speaker to be fitted into position.

Having done that the transformer should be carefully removed from the loud-speaker, and a pair of

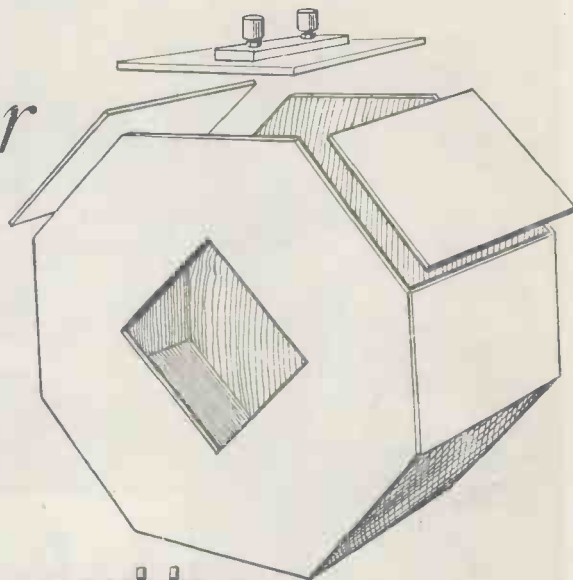

The top drawing shows clearly how the plywood is cut to make the case for housing the midget moving-coil loud-speaker. On the left you see how the loud-speaker is wedged into its case with a rubber sponge, the remaining space being filled with slag-wool or ordinary cotton wool

26-gauge wires soldered to the end of the speech coil wires. The wires should be covered with oiled sleeving and should be about 3 in. long.

Now put the Sorbo sponge over the magnet and slide the loud-speaker into its case, so that the diaphragm fits evenly over the square cut in the front. The fit will be fairly tight and screws should not be necessary. All that has to be done now is to fill the box with cotton or slag wool, but do not pack it too tightly.

Putting the Finishing Touches

Now screw on two of the remaining sides and then mount the terminals on the ebonite strip and connect up to the two wires on the speech coil and fix down.

Note that the last three sides *must* be fitted with screws and not brads so as to prevent any unnecessary hammering.

The transformer of the loud-speaker is hardly suitable as a microphone transformer, although the highest ratio can be tried. The best results will be obtained by using a properly designed microphone transformer, and Epoch make a model for this purpose.

The voltage output is not particularly high, and an extra stage of low-frequency amplification is usually necessary. However, that can be found by trial.

The finish of the microphone is a matter entirely for the constructor. He can paint, varnish or cover the case with rexine, according to his particular taste, and the opening can be covered with some form of silk. The writer is using this microphone with a three-stage 10-watt amplifier and is getting exceptionally good results. Quality is particularly good.



Electric soldering irons are used for efficiency and speed in the "W.M." Laboratories at Fetter Lane

By R. W. Hallows,
M.A.

Wireless Jobs Made Easy for Mr. Everyman

ONE of the handiest combination tools that I have seen for a long time has recently come my way. This is the Eclipse 4S tool which differs from the usual kind of combination arrangement in that it is a real engineering job.

Many jack-of-all-trades' tools are loathsome affairs since they do all kinds of jobs indifferently and none really well. Further, they are often fitted with a large variety of "business ends," badly shaped and made of poor material.

The Eclipse is not of this kind. The handle is well shaped; the blades are locked firmly in place by the binding screw; the various blades with which it is provided are really well shaped and are made of first-rate material.

Very Adaptable

Further, as will be seen by a glance at Figs. 1 and 2, the blades can be set into the handle either straight or at an angle—a most convenient arrangement. Generally speaking, for sawing or screwdriving the blade will be put in straight as in Fig. 1, whilst for slitting or using the edge of the file it will be inserted at an angle as illustrated in Fig. 2.

But any of the blades can be mounted in either position, which means that jobs on awkwardly shaped pieces of metal or work in awkward corners can be tackled easily.

Using the Tool

The handle is double-ended, one end being labelled "Sawing and Scraping," whilst the other is marked "Slitting and Slotting." The end marked "Sawing and Scraping" gives the straight-line

position of the blade seen in Fig. 1; that marked "Slitting and Slotting" gives the sloping position shown in Fig. 2. To insert a blade, simply slide it into the slot at the end and tighten down the binding screw.

The outfit consists of the holder, 5 double-edged slotting blades, 1 mica-cutter, 5 hacksaw blades, 2 scrapers, a slitting knife, a file and a screwdriver—sixteen tools in all. As it doesn't take more than a second or two to change over from one blade to another the whole outfit is always at your service.

The pointed hacksaw blades are just the things for most of the sawing jobs in wireless construction that will come Mr. Everyman's way, whilst the slotters are useful for a number of purposes,



TOOL FOR SAWING OR SCREWDRIVING
Fig. 1.—The Eclipse tool fixed up for sawing. The screwdriver blade fits into the other end

including the cleaning up of damaged nicks in screw heads.

The screwdriver blade is rather broad for wireless work, but if you have a grinder you can alter this in a few minutes—and if you haven't one any cycle repair shop or garage will trim up the blade for you for a few pence.

Component Changes

This year for the first time many components are available for the constructor in what is known as "stripped" form. This means that instead of being provided with elaborate cases furnished with rows of terminals they are plainly cased whilst soldering tags take the place of terminals.

If you wish, you can buy the same components—or most of them—in highly finished cases and complete

of tightening with the pliers.

Soldered connections, properly made, will last for years. They are better to begin with, owing to the superior electrical contact made, and they don't slacken off with the passage of time.

Soldering Made Easy

I know how averse many home constructors are from the use of the soldering iron, though frankly I could never understand why. If you will just spend half an hour in trying to make connections on the lines suggested in the following paragraphs you will find that they are the easiest of easy jobs and I am quite sure that you won't fight shy of soldering in the future.

The outfit costs very little. All that you need is a good quality soldering iron with a 2 oz. bit, a stick of tinman's solder and a small supply of flux such as Baker's Soldering Fluid or Fluxite. Total outlay is less than two shillings.

Tin the end of your bit in the way described in these notes in the June 1934, issue —if you have mislaid your copy you can get the back number—and you are ready to begin. Do the job slowly; you will find it easier.

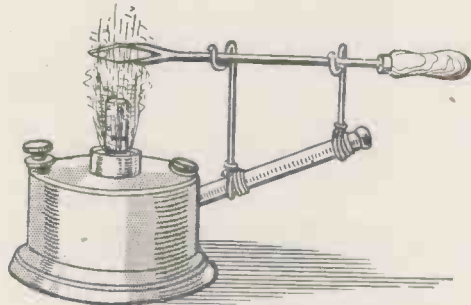

HEATING WITH A SPIRIT STOVE

Fig. 4.—Another reliable method of heating an iron is to rig it up on a spirit stove as shown in this drawing

with terminals. But if you are wise you will go in for the stripped or manufacturers' types. There are two big advantages for the home constructor in stripped components. The first (which will appeal to everyone) is that they are much cheaper; the second, that by using them you can eliminate all terminals inside your set.

Screw-down connections are not too good electrically and every one of them is a possible cause of trouble.

If you don't believe that last statement just take a pair of pliers and go over the screw-down connections of any set that has been made for three months or more. I am willing to wager that there are very few nuts that won't easily take another half turn and many of them will be found so slack that they will stand quite a bit

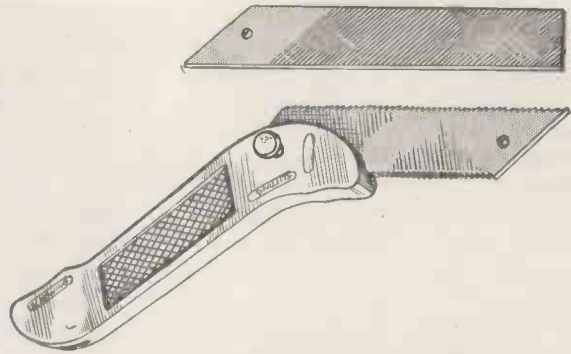

FOR SLITTING OR FILING

Fig. 2.—Another drawing of the Eclipse tool showing how it is used for slitting or filing

Heating the Iron

There is just one way by which you must never heat your soldering iron if you want to keep it in good condition and to find jobs easy, and that is by putting it straight into a coal fire. If you must make use of the fire because no other means of heating the iron is available, buy a short piece of copper tubing with an inside diameter of about 1 in.; put that into the fire (Fig. 3) and place your soldering iron inside it. The bit is thus protected from contact with the coals.

Remember that the whole secret of soldering is to use an iron that is not only hot but clean. You cannot possibly keep the bit clean if you put it straight into the fire.

An ordinary gas ring makes a perfectly good heater and this will be available in most homes. Myself, though, I prefer to use a spirit lamp for heating the small soldering irons that I employ for making connections in wireless sets.

Fig. 4 shows my own spirit lamp, which was made from an ordinary picnic stove by fixing two small brackets of stout wire to the handle. These brackets hold the bit in just the right position at the top of the flame.

They are made from No. 16-gauge tinned copper wire. The top end of each is shaped to hold the shaft of the iron and the lower end is twisted round the handle of the stove and soldered. You can leave out that piece of soldering if you like so long as you twist up the wire tightly with a pair of pliers. The secret of soldering is to do every job methodically and carefully.

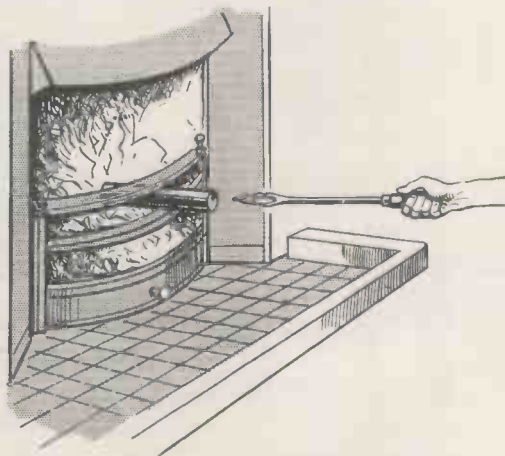

HEATING A SOLDERING IRON

Fig. 3.—If you must heat a soldering iron in a fire, place it inside a copper tube to protect the bit

Electric Soldering Irons

Unquestionably the best of all soldering irons is that heated by electricity. It can never become dirty in ordinary use and the correct temperature is easy to maintain. If, therefore, you have electric light in your house you will be well advised to go in for a soldering iron of this

Connecting Wires to Tags

We are now ready to tackle the job of soldering a lead to a tag. The various stages of the operation are shown in Fig. 5. Begin by seeing that your tag is bright and clean. You can make quite sure by giving it a scrape with an old knife. Next apply a *minute* quantity of flux—

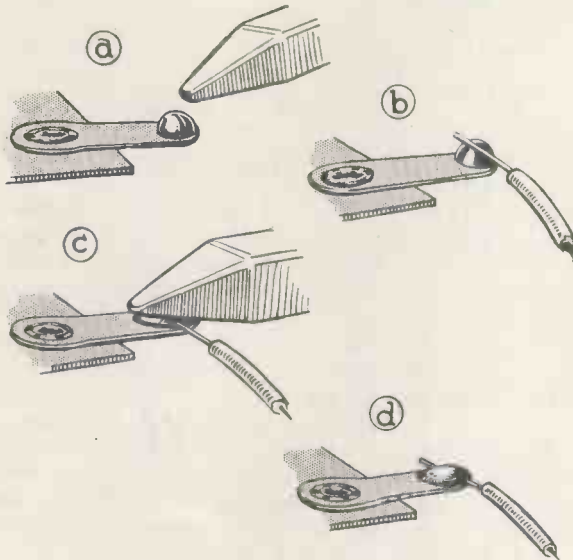

SOLDERING A LEAD TO A TAG

Fig. 5.—(a) Run a small blob of solder on to the tag, (b) lay the end of the lead on the tag, (c) press the lead into the tag with a hot soldering iron and (d) the job is finished

most beginners make the mistake of using far too much. Thirdly, having seen that your iron is hot and clean, take a little solder on to its point from the stick and make a small blob on the tip of the tag as shown at A in Fig. 5.

The solder should run on smoothly. If the blob stands up like a drop of water on a greasy surface then your tag is not clean and you won't make a sound job.

Fourth step: touch the end of the lead with flux—again a tiny amount should be used—and lay it on the blob. That lead is going to get hot so either

gently into the blob. It will sink in almost instantly—and there you are, a neat well-made joint about which you need have no fears.

Hints and Tips

If your iron is hot enough and the surface of the tag clean the blob should run *instantly* on to the tag. Just a touch with the iron; count *one, two, three* and there it is.

Similarly, if the temperature is right the lead will sink straight away into the blob when you press it in as shown in Fig. 5.

Always see that the leads are clean before soldering. Drawing the ends through a folded piece of fine emery cloth makes certain of this.

When soldering flex to tags unstrand the ends first of all to see that all are bright; clean up if necessary. Then twist tightly together, touch with flux and proceed as before.

Flex is sometimes made up of strands of plain untinned copper wire. In this case proceed as before, but tin the twisted-up end by applying a little solder before pressing into the blob.

Until he has got the knack, a beginner is liable to make "dry" joints. These *look* all right but the solder is not really adhering to the tag and a good hard pull will cause the joint to come adrift. Test your first few joints in this way.

The causes of dry joints are (1) iron not hot enough; (2) tag or wire dirty; (3) tag of unsuitable metal.

kind. They are not expensive and cost about six or seven shillings as a rule.

The Right Heat

Most beginners at soldering are frightened of getting the iron hot enough. They have been told—quite correctly—that if you get the iron too hot you will burn off the tinning on the point. Bearing this warning in mind they don't get it hot enough and the result is clumsy, messy and slow work.

When you are using a non-electric iron leave it in the flame of gas ring or spirit lamp until the flame takes on a bright green tinge in the neighbourhood of the bit. With an electric iron gauge the temperature by placing the bit for about half a second on a piece of paper. If it sings the paper brown the temperature is right.

Keep beside you a piece of rag and draw the hot bit across it for cleansing purposes before soldering.

hold it with pliers or wear an old glove on your left hand.

Last step: place the hot iron on the end of the lead and press it



INTERESTED IN THE "INNARDS"

Two American radio operators, on a visit to Cannes, keenly interested in the construction of the H.M.V. Superhet Portable Six

Here we present an interesting contribution from the pen of E. H. CHAPMAN, M.A., D.Sc., who opens up a new pastime in radio. Down at his home at Newton Abbott he has been making visual observations on fading conditions with the aid of a Moullin voltmeter connected in his radio receiver. The idea is simple and cheap, and can be tried successfully by all enthusiasts on their own sets

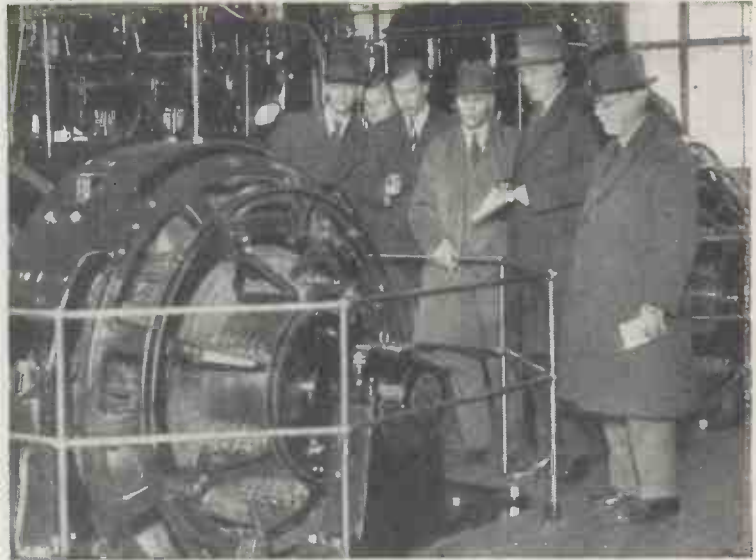

Watching the big generators at the No. 1 Regional transmitter at Moorside Edge

Measuring the Ups and Downs in Signal Strength

ONE of the most fascinating branches of wireless reception these days is that which may be briefly and quite correctly described as measuring the ups and downs in signal strength. In such work the transmission from a distant wireless station, received and amplified in the usual way, is finally shown by a reading on a sensitive galvanometer.

There is something very fascinating about this work of watching

wireless. Surprising results are often obtained and one has the comfortable feeling that the galvanometer cannot lie.

In the aural reception of wireless it is notorious how the ear deceives because of its natural powers of adaptability. There is no such power of adaptability in a galvanometer. The instrument records exactly what it receives and its readings can be trusted implicitly.

Have you ever thought how little we know of the way wireless waves travel? The engineer at a broadcasting station knows the function of each part of his transmitting apparatus. Every single function has its mathematical formula.

In reception it is the same. The purpose of each component part in a wireless receiver is known and its function can be expressed in mathematical terms. Yet, in direct contrast, we know very little of the link

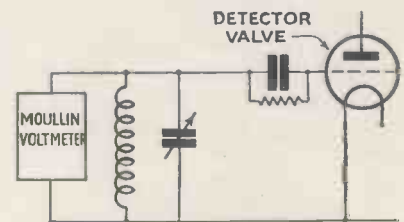

VOLTMETER IN CIRCUIT
Fig. 1.—Showing the position of the voltmeter in the grid circuit of the detector valve of the set

between transmitter and receiver, or of the manner in which the waves of wireless travel through that mysterious link we call the ether.

One realises this to the full when measuring the ups and downs in signal strength and it is this realisation, perhaps, which makes this branch of wireless so fascinating.

To anyone who possesses a Moullin voltmeter, it is an easy matter to carry out experiments in watching wireless. In its most usual form the Moullin voltmeter, which consists essentially of a sensitive galvanometer in the plate circuit of a valve, is worked from a 6-volt accumulator. The makers have, on request, produced an instrument which works

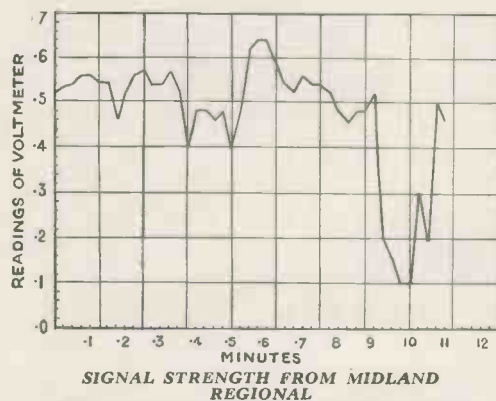
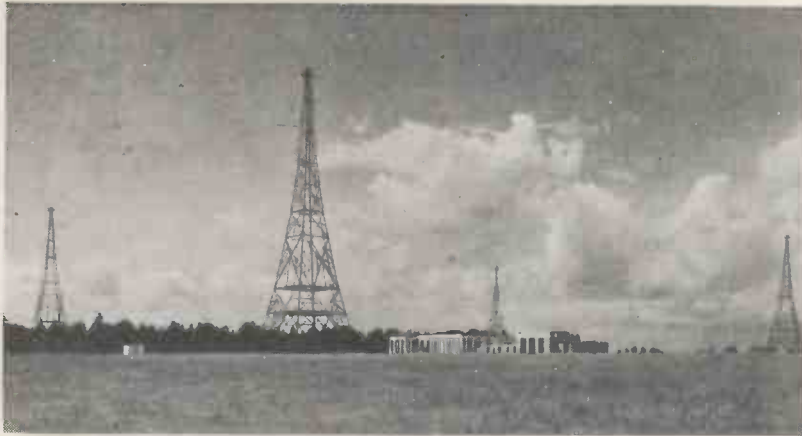

Fig. 3.—A curve showing the variations in received strength of Midland Regional on a summer evening after dark. Observations were made every fifteen seconds from a locality 170 miles away



REGIONAL AND NATIONAL AT BROOKMAN'S PARK

A view of the twin London transmitters. Variations in signal strength of London Regional—the masts are seen on the left—were measured by the author at Newton Abbott in Devon, 170 miles away

from a 2-volt accumulator. I happen to have one of these 2-volt Moullin voltmeters and I have found it a very simple matter to use it for the purpose of watching wireless signals from many British and long-wave foreigners.

Position of the Voltmeter

My receiving set has one screen-grid valve, a detector and two low-frequency amplifying valves. All I have to do when I want to watch wireless is to place the Moullin voltmeter across the grid-filament coil of the detector valve in my wireless set.

Fig. 1 shows the position of the voltmeter in circuit. This arrangement has the great advantage that I can use the wireless receiver at the same time. Thus, while I am watching wireless signals by keeping an eye on the pointer of the Moullin voltmeter, I can also listen to my loud-speaker and make comparisons between the voltmeter readings and the volume of sound coming from the loud-speaker.

Judging Volume

I might say here that, with the Moullin voltmeter connected to my receiving set in this fashion, it would take me very few minutes to convince you of the unreliability of the human ear in judging the volume of sound coming from a loud-speaker.

During the past three months I have devoted a considerable amount of time to watching wireless signals, and the observations I have made may be of interest to other enthusiastic listeners.

In Table 1 I have given a summary of my observations on six of the European long-wave broadcasting stations. Although the Moullin voltmeter is gradu-

ated accurately in volts from 0 to 1.5, readings taken with it, as I have used it, are on an arbitrary scale. The readings, however, are strictly comparable among themselves.

Long-wave Strength

The first point brought out by the figures in Table 1 is that there is very little difference between the daytime strength of these long-wave European stations and their strength after dark.

More important than this, however, is the fact that these readings taken after dark were steady readings. In other words not one of these

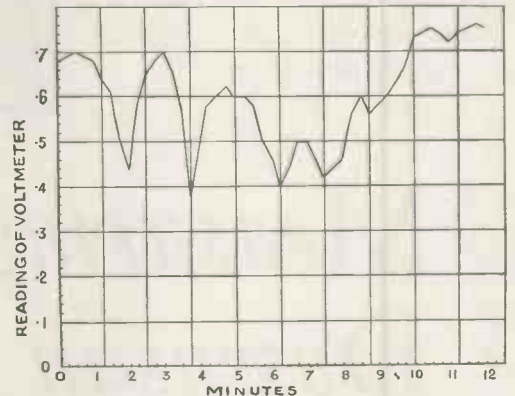

OBSERVATIONS ON SCOTTISH REGIONAL
Fig. 4.—Very good results were obtained from Scottish Regional, 380 miles away, during observations made every fifteen seconds after dark

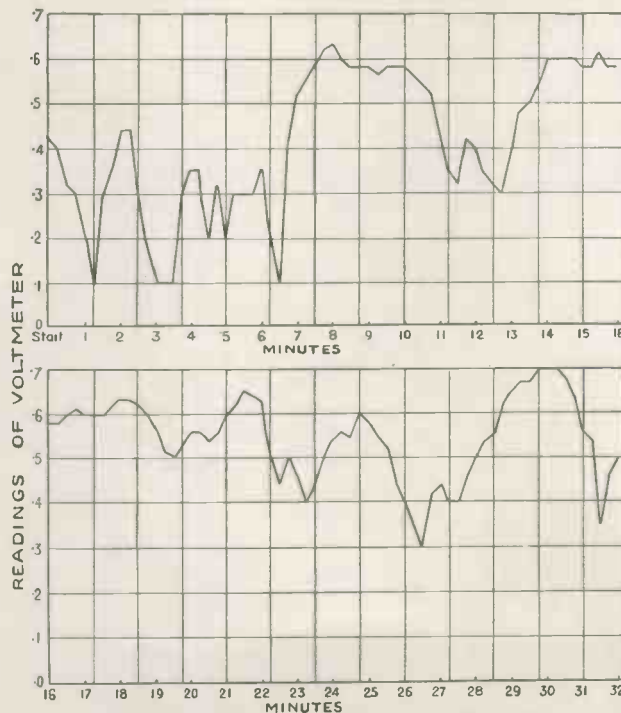

SEEING NORTH REGIONAL FOR 32 MINUTES

Fig. 2.—A curve taken with the aid of a Moullin voltmeter in Devon on the reception strength of North Regional, 220 miles away. Reception, as can be seen, is not as reliable as that of Scottish Regional, 380 miles away

long-wave stations showed any real tendency towards fading.

There would be no need, therefore, to fit automatic volume control to a wireless receiver built to receive the long-wave stations only.

Eiffel Tower

From the figures given in Table 1, there appears to be some discrepancy with regard to the Eiffel Tower transmission. The strength of this station is much higher than one would expect from the figure given for the power.

Turning now to the medium-wave broadcasting stations, Table 2 shows the results of observations made on our six British Regional and National stations on this waveband.

Here we have something very different from Table 1. A comparison of

these two tables shows most emphatically the superiority of long-wave transmission over medium-wave transmission, at any rate in summer.

Interesting Features

Examining Table 2 in detail we find some very interesting features. The distant stations to the north, namely, North Regional, Scottish Regional, North National and Scottish National give very poor reception during daylight. This is no doubt due, in part, to the screening effect of a hill to the north and quite near to my aerial.

After dark these four stations come in at varying strength. North Regional and North National actually fade over a range of 10 to 70. In other words, the strength of each of these two stations may, at one moment, be seven times as great as the strength at some other moment.

Now consider the two Scottish transmitters. These two transmitters are much further away than the two Northern transmitters, yet they both give more constant reception after dark. Indeed, the Scottish Regional transmission down here swings over

a range of strength represented by 35 to 76.

Putting it another way, the greatest strength of this Scottish Regional transmission is a little more than twice its least strength.

On the other hand, the greatest strength of the North Regional transmission in this district after dark is seven times its least strength.

It will be seen from Table 2 that, of the transmitters mentioned in the table, the only steady one in this district after dark is the West Regional transmitter. The companion transmitter, West National, uses the same wavelength as London National, hence the fading effect of the more distant London National transmitter spoils appreciably the joint reception of the two. The West National transmitter, only 48 miles away, ought to give steady reception after dark.

Figs. 2 to 5 are diagrams showing

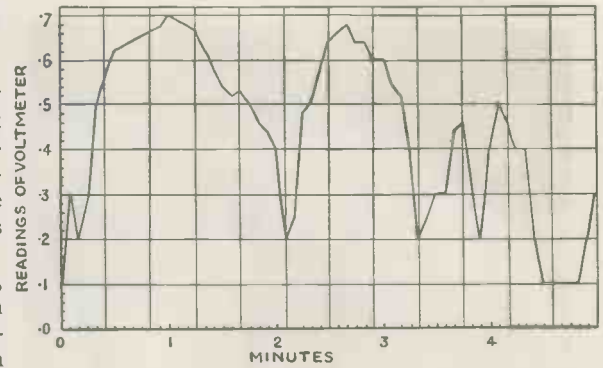

OBSERVATIONS ON LONDON REGIONAL
 Fig. 5.—Owing to rapid fading, the observations on London Regional, 170 miles from Newton Abbot, were made every five seconds

actual observations made when receiving North Regional, Midland Regional, Scottish Regional and London Regional transmissions.

These diagrams may serve to show how irregular is the phenomenon of fading.

I do believe that experiment in this field will prove enjoyable to many enthusiastic wireless fans. It is not an expensive hobby, and it will give hours of enjoyment.

Table 1—Long-wave Stations
 Observations During Summer Months, 1934

Station	Wave-length in metres	Power in Kilowatts	Distance in miles	Direction	Reading of Voltmeter	
					Day	Night
Huizen	1,875	50	400	E	.30	.35
Radio Paris	1,648	75	300	SE	.62	.62
Daventry National ..	1,500	30	170	NE	.66	.66
Eiffel Tower	1,395	13	300	SE	.40	.42
Luxembourg	1,304	150	450	ESE	.46	.46
Kalundborg	1,261	75	650	ENE	.20	.20

Table 2—Medium-wave Stations
 Observations during Summer Months, 1934

Station	Wave-length in metres	Power in kilowatts	Distance in miles	Direction	Reading of Voltmeter	
					Day	Night
North Regional ..	449	50	220	NNE	.10	.10-.70
Midland Regional ..	391	25	170	NE	.20	.10-.64
Scottish Regional ..	373	50	380	N	—	.35-.76
London Regional ..	342	50	170	ENE	.20	.10-.70
West Regional ..	307	50	48	NNE	.64	.60-.66
North National ..	296	50	220	NNE	.10	.10-.70
Scottish National ..	286	50	380	N	—	.30-.56
West National ..	261	50	48	NNE	.52	.30-.64
London National ..	261	50	170	ENE		

A Unique Service

AT this time of the year we make no apologies for devoting a few inches of our columns to remind you about our special blueprint service. Every "W.M." design when published has its own blueprint, which is priced according to the size of the set.

A great feature of these prints is that they can be used as templates. Every blueprint shows the position of every wire, numbered in the most logical order of assembly. They are drawn by skilled draughtsmen who know the art of set construction from A to Z.

You can always obtain a blueprint of one of the current sets for half its usual price if you send the coupon, which is always found on the last page of every issue, with your order. To extend this benefit to overseas readers we accept coupons from them up to two months after the publication date. In isolated cases even further time is allowed.

Another unique service is free advice to set buyers. Full details of this service will be found on the introductory page to the test of the new sets.



A member of the "W.M." Technical Staff building a model of the "W.M." Stenode in the Fetter Lane laboratories

More About the "W.M." STENODE

Last month we presented details for building the "W.M." Stenode, which we described as being the most selective and best station-getter ever presented to the home constructor. The set has created an amazing interest among readers and the radio trade generally. Here PAUL D. TYERS, the designer, goes into the question of ganging, the advisability of using valves other than those specified, and many other points of interest to the user

READERS who built the mains Stenode receiver described last month have no doubt by this time become familiar with its operation.

By comparison with ordinary super-hets there are several features in which it differs. The success of the operation of the Stenode depends entirely upon obtaining a highly peaked resonance curve from the output of the intermediate amplifier.

Critically Tuned

Now this peaked waveform will only be obtained so long as the four circuits in the two Stenode couplers are really critically tuned to the identical frequency. I explained last month how this tuning, or trimming operation as it is called, should be carried out.

When designing the trimming condensers used in the Stenode couplers I took great care to see that the mechanical features were such that there was no tendency for the condensers to vary in use. For this reason they are extremely rigidly built.

It is important to consider what will be the effect on the

receiver if the four circuits are not properly tuned.

Two things will happen. In the first place, the height of the resultant resonance curve will drop considerably. This will mean that the gain will be considerably reduced. The second trouble is far more disastrous as it means that the tonal balance will be wrong, because the tone correction circuits are designed for an accurately shaped output waveform from the intermediate section of the receiver.

There is even yet another trouble.

This is lack of selectivity, because supposing one circuit is actually tuned to 115 kilocycles there will be a strong resonance peak in the output curve somewhere in the region of 5,000 cycles off tune.

Top Notes Accentuated

This will do two things. It will tend to accentuate the top notes for which tone correction has already been made, and it will tremendously enhance sideband splash and interference from the edge of adjacent channels. It is vitally important,

therefore, to see that these four circuits are really accurately matched.

One of the contributory factors to the intermediate frequency wandering is change of electrical constants due to change in mechanical constants, and this is readily brought about by the heating of the various portions of the metal in the coils and condensers and so causing expansion.

This is one of the reasons why I specified a cabinet with no back, so as to assist in ventila-



SPECIAL STENODE COUPLERS

This photograph of part of the "W.M." Stenode shows the Stenode couplers—the heart of the set!

tion, and also arranged the power pack, where some amount of heat is likely to be generated, as a separate unit mounted near the loud-speaker.

Tests carried out in my own laboratory have shown that there does not appear to be any wandering of the intermediate-frequency trimming due to temperature variation.

Out of the Cabinet

Provided the set is rigidly built, trimming and all ganging operations are best carried out with the chassis removed from the cabinet. This gives greater freedom in movement and in the case of this particular receiver it is the only really satisfactory method of adjusting the long-wave ganging because the long-wave padding trimmer is only accessible from the front of the tuning pack.

Should you feel that the set is not giving quite the selectivity of which it is capable, it is an almost definite indication that something is wrong with the trimming and this should be very carefully checked.

Loss of Signal Strength

The trimming of the input circuits will have very little effect on the tonal quality of the reproduction. If these are badly out of gang then the chief trouble will be loss of signal strength.

It is, of course, vitally important that the oscillator section is trimmed so that it really does give a frequency difference of 110 kilocycles.

I believe that many home constructors tend to regard a valve merely as a valve. By this I mean there is a feeling that whereas one valve has been specified, surely a perfectly good valve of another make

will work just as well. I think it is very advisable to consider whether this view is really justified or not. Unfortunately, the only answer I can give is "It all depends."

Any good modern valve is capable of giving an extremely satisfactory performance, and a modern valve will work at a good efficiency. But for *maxi-*



VERY MODERN APPEARANCE

In its handsome horizontal-type cabinet, the "W.M." Stenode is really a fine looking outfit—and it works well! The main tuning dial is on the extreme left

um efficiency there are what are known as optimum conditions under which a valve must operate.

Valves of a class, as a rule, have somewhat similar characteristics, but valve designers have different opinions as to what forms the best constants of a valve, in exactly the same way as set designers vary their method of receiver design.

but it may definitely mean that whereas one valve has been specified in a set another valve will not work so well, because the associated networks do not give the valve the best operating conditions.

In designing the "W.M." Stenode I endeavoured to use values of resistances which would give a high standard of efficiency with a good



SEPARATE MAINS PACK
The mains unit is built separately and fits snugly in the cabinet between the set chassis and loud-speaker

Now it sometimes happens, for example, that a double-diode-triode valve made by one firm has really quite different characteristics in one or more respects from that of a valve made by another firm. This does not mean that one valve is better than another

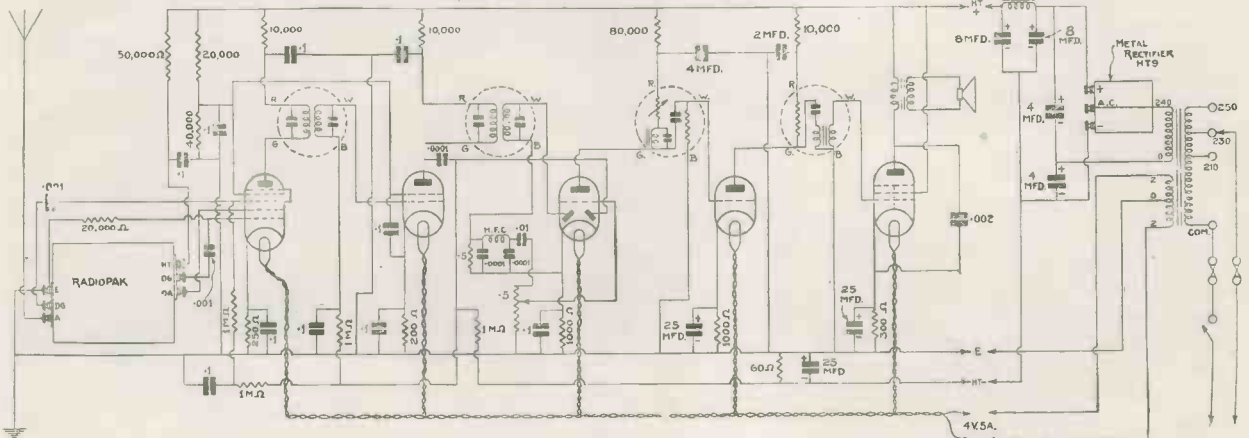

CIRCUIT OF THE "W.M." STENODE—THE FIRST HOME-CONSTRUCTORS' STENODE

As you can see, this circuit is really quite straightforward. It is a five-valve super-het and incorporates all the important features invented by Dr. James Robinson, the creator of the Stenode system

factor of safety and at the same time represent a compromise. If by any chance other types of valves are used in the Stenode than those for which the set is designed, it may be necessary to alter some of the resistances in order to obtain the most efficient results. This is a point which the constructor should watch very carefully.

Using Other Valves

Whether any harm results or not depends entirely upon the con-

stages does not show up nearly as badly as in the case of three valves all operating as low-frequency amplifiers. It is very important to see that with all the low-frequency amplification present none of the valves runs into grid current.

The bias is obtained automatically by resistances in the cathode leads, and the most important resistance is obviously that providing the bias for the output valve.

It will be remembered that I used an MPT Catkin pentode having an anode dissipation of 8 watts. This valve will give a really useful output, actually over 2 watts, without noticeable distortion. It is very important, however, that the average anode current under no signals should not exceed about 30 to 32 milliamperes.

I have used a resistance of 300 ohms for the automatic

bias for this valve, which is the nearest commercially produced resistor to satisfy the desired conditions. This provides a bias of the order of 12 volts, and working at this point the valve will give its full output.

In dealing with the adjustment of

the receiver I pointed out last month that readers who operated a Stenode receiver at a considerable distance from a strong transmitter would actually be able to obtain all the selectivity they required by slightly increasing the coupling in the high-frequency couplers, making the necessary adjustment to the tone by the tone control provided.

Coupling Adjustments

This increase in coupling will actually increase the voltage produced on the rectification diode, which means that larger peak voltages will be applied throughout the low-frequency amplifier. It is important to see, therefore, that the volume control is not turned up to maximum on very strong stations otherwise there will be definite distortion because I have designed the low-frequency amplification so that the grid bases of the valves will be fully loaded under very weak coupling conditions in the high-frequency section.

Overloading

If overloading actually results it is a sure indication that far too tight coupling is being used which, of course, will destroy the selectivity of the receiver.

The bias used for the low-frequency amplifier preceding the output valve is obtained from a 1,000-ohm resistance. It will be remembered, however, that this valve is not working at the maximum anode voltage as it is decoupled through 8,000 ohms.

Another point to remember is that

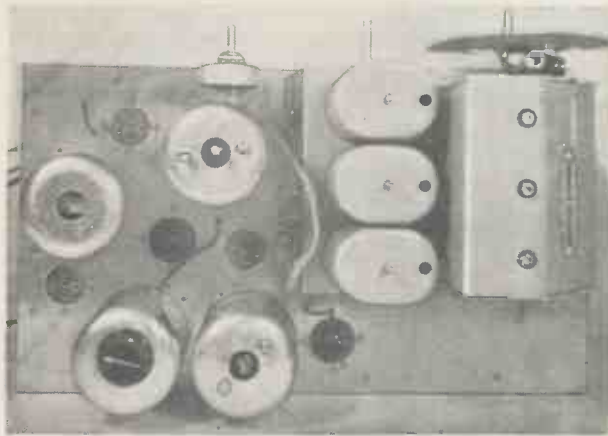

PLAN VIEW OF THE "W.M." STENODE

Although the set is the most ambitious design yet offered to the home constructor, the layout is so simple that anyone can build the set provided reasonable care is taken

ditions. Slightly increased anode voltages on the frequency changer, for example, are not likely to give much trouble; they may tend to increase the background noise, or even to give a tendency for forced oscillation on the medium wave-band owing to the first grid circuit being over-driven.

Most Important Valves

The most important valves, however, to watch are those in the low-frequency section, and particularly the output valve. It will be remembered that in a Stenode receiver there is a predominance of modulation frequencies in the region of the fundamental, and a diminution in the higher registers.

Accordingly, much greater low-frequency amplification is required because the high registers have to be amplified to the correct level. The extra low-frequency amplification necessitates very careful decoupling and screening so as to prevent any form of low-frequency instability.

A slight slip in the correct operating conditions of one or two

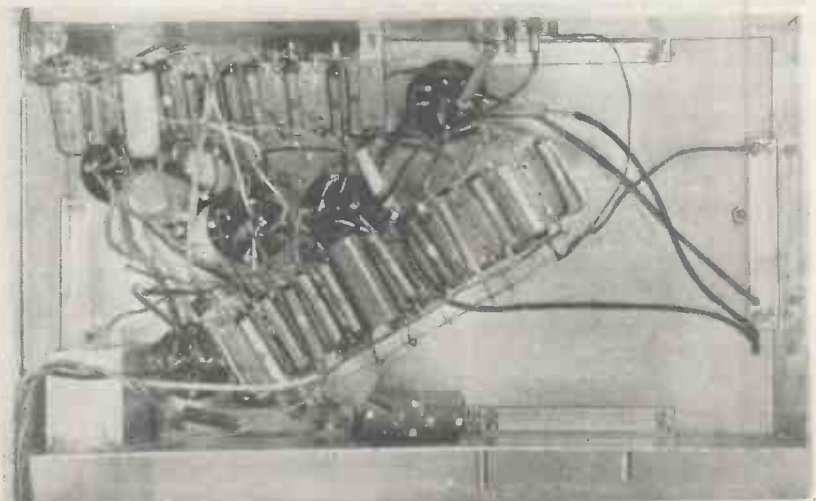

PLAN VIEW OF THE UNDERSIDE OF THE CHASSIS

For the sake of simplicity of construction and—mark you—efficiency, the resistances and condensers are mounted on two bakelite strips

this valve works at a comparatively small input because the anode circuit is only delivering speech voltages having a maximum peak value of about 12 volts. The actual bias on this valve is, therefore, not very critical because there is little possibility of distortion here owing to the extremely small grid swing.

About the Valves

I think I have made it very clear that it is important that all the valves work under their correct operating conditions and that any change in the valves may necessitate a corresponding change in the networks feeding them. It is, therefore, well to review the best conditions for all the valves which I have used in the set.

The frequency changer, which is a Cossor 41MPG, can be worked with 200 volts on the anode and up to 100 volts on the screen and oscillator anode. I have explained that if these voltages are increased trouble may be experienced.

Self-oscillation

The variable-mu pentode is another Cossor valve, an MSV/Pen. The screen voltage should not exceed 80 to 100 volts. If this value is increased there is definitely a tendency for self-oscillation. It is important to note that the screen of this valve and the screen of the frequency changer are actually fed from a common resistance, although a separate decoupling condenser is used on the variable-mu pentode.

The operating conditions of the double-diode-triode, which is a Cossor DDT, are not particularly

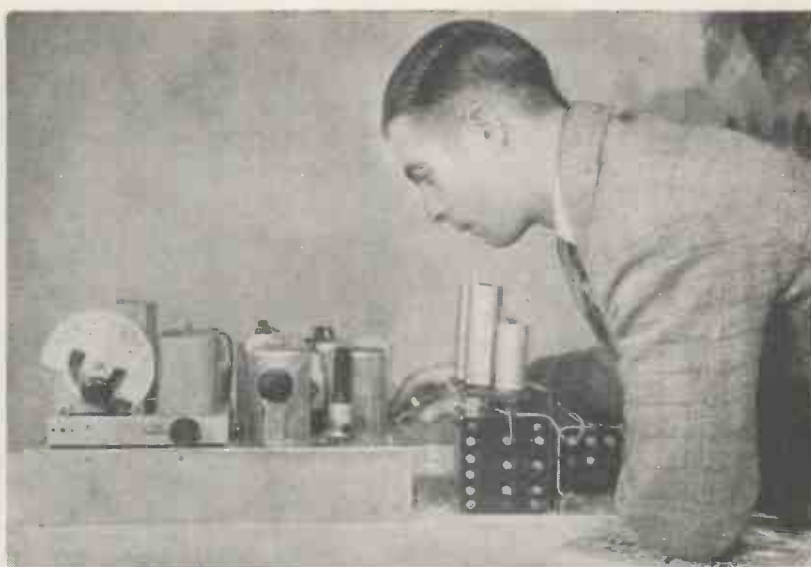

ADMIRING A GOOD DAY'S WORK!
The building of the "W.M." Stenode will present no difficulties to the merest novice in set building. Here is the set chassis and mains pack finished and ready for ganging and final tests before being put into its cabinet

critical. The automatic bias of the triode section of this valve is again obtained from a 1,000-ohm resistance.

The operating conditions of the first separate low-frequency valve, which is a Cossor 41MHL, I have already dealt with, and also those of the catkin output valve, which is a Marconi or Osram MPT4.

Intimately associated with the output valve is the question of loud-speaker matching. In this receiver a certain amount of tone correction is introduced by using a loud-speaker which has a rising top characteristic. Normally, correction is applied to a pentode with the object of reducing the upper-note response.

This usually takes the form of a shunt condenser and resistance. This circuit is also very necessary for protection purposes against high-voltage peaks. Actually, I have made use of only a single .002-microfarad condenser which is connected between the anode and the cathode.

About the Loud-speaker

While fairly satisfactory results may be obtained with ordinary types of loud-speakers and input transformers it is certainly preferable to adhere to the one specified as the whole network characteristics are arranged so that a correct working balance is obtained.

COMPONENTS NEEDED FOR THE "W.M." STENODE

	£	s.	d.		£	s.	d.		£	s.	d.
CHASSIS				STENODE COUPLING UNITS				CONDENSERS, FIXED			
1—Peto-Scott aluminium, 16 in. by 9 in. by 3 in., complete with two resistances holders	12	6		2—Belling-Lee high-frequency; 1 Belling-Lee 1st tone-correcting low-frequency; 1 Belling-Lee 2nd tone-correcting low-frequency; set of four	3	5	0	4—T.C.C. electrolytic, type S02, values: 4- (2), 8-microfarad (2)	1	2	0
CHOKE, HIGH-FREQUENCY				SUNDRIES				RECTIFIER			
1—Wearite, type HFP	3	6		1—Belling-Lee terminal strip, marked: Aerial, Earth	9			1—Westinghouse, type HT9	1	1	0
CONDENSERS, FIXED				1—1½-ft. aluminium strip, ½ in. wide, say	3			SUNDRIES			
17—T.M.C. Hydra, type tubular, values: .0001- (3), .001- (2), .002-, .01, 1-microfarad (10)	16	6		3 ft. screened sleeving, say	3			1—ebonite strip 6 in. by 2½ in., say	6		
3—Ferranti, type CE91, value 25-microfarad	9	0		Round-tinned copper wire, No. 20 gauge, for connecting, say	9			1—aluminium screen, 6 in. by 5½ in. to specification, say	9		
2—T.M.C. Hydra, type 30, values: 2-, 4-microfarad	8	9		Oiled-sleeving, say	1	6		6—aluminium brackets, say	6		
HOLDERS, FUSE				1—British Radiogram 3-in. metal mounting bracket	4			2—supporting wood blocks, 2½ in. by 1 in. by 1 in., say	2		
1—Bulgin twin, type F11 with 1-ampere fuses	2	0		5 doz. 6BA ½-in. bolts and nuts, say	1	6		TRANSFORMER, MAINS			
HOLDERS, VALVE				SWITCH				1—Sound Sales, type HT9, with following windings: 240 volts—200 milliamperes; 2-0-2 volts—5 amperes	1	17	6
5—Clix, type chassis-mounting, five-pin (3), seven-pin (2)	3	0		1—Bulgin on-off toggle, type S91LB	2	0		ACCESSORIES			
RESISTANCES, FIXED				TUNING UNIT				1—Peto-Scott, type Stenode	1	2	6
18—Claude Lyons, type 1-watt, values: 200-, 250-, 300-, 1,000- (2), 10,000- (3), 20,000- (2), 40,000-, 50,000-, 80,000-ohm, .5-, 1-megohm (4)	15	9		1—British Radiophone band-pass super-het Radiopak, type 110 kilocycles	3	15	0	LOUD-SPEAKER			
1—Claude Lyons, type FW60, value 60-ohm	1	6		BASEBOARD				1—Gramplan, type E1/Stenode	1	5	0
RESISTANCE, VARIABLE				1—three-ply, 9 in. by 7 in., say	4			VALVES			
1—Erie, .5-megohm	3	6						1—Cossor 41MPG	1	0	0
								1—Cossor MSV/Pen.	17	6	
								1—Cossor DDT	15	6	
								1—Cossor 41MHL	13	6	
								1—Marconi or Osram MPT4 Catkin	18	6	

What Listeners Gain from

Olympia with its story of new sets and new developments has gone for another year. The value of the new trend in set design and how it benefits the ordinary listener is dealt with thoroughly in this article by ALAN HUNTER

FROM a corner of the gallery at Radiolympia I gazed down upon radio's biggest shop window—upon a complete line-up of the new radio. A confusing sight.

From my vantage point I mused upon this and that development embodied in the sets below me. How many visitors, I wondered, realised just what they had gained from the new radio.

Favour for the New Cabinet Trend

And that is how this article came to be written. I shall start with the outward gains, ending up with some of the gains that are not quite so obvious.

Cabinets, then. Although slightly nauseated by all this talk of radio as furniture—as though radio had something to be ashamed of in being, well, just radio—I must admit I favour the general trend.

Towards simplification. Towards modernity, in other words. Gone are the fantastically ornate cabinets that had begun to house our radios. Mercifully, most firms are beginning to realise that if they really want their products to look like furniture they must call in furniture designers.

Some striking cabinets are the result. Such names as Gordon Russell and Betty Joel, synonymous with good furniture, are becoming more and more evident. Some of our vaster concerns still

think they know all there is to know about cabinets. Whereas in very truth, all they know is how to make exceedingly nice-looking boxes. In time they will see the light, no doubt.

It does not follow that because furniture folk design our cabinets they will necessarily seek to disguise the essential radio nature of our sets. Rather they may seek to capitalise the “knobiness” of radio—artistically merging radio's protuberances into an attractive *tout ensemble*.

More Variety in Cabinet Finish

What pleases me more than anything about these new radio cabinets is that a wider choice of woods is available. The deadly monotony of veneered walnut has given way to a just appreciation of the fact that there are other woods in the world—other woods used for the rest of the furniture in the house.

Well do I remember not long ago trying to find a cabinet that would merge with my weathered-oak

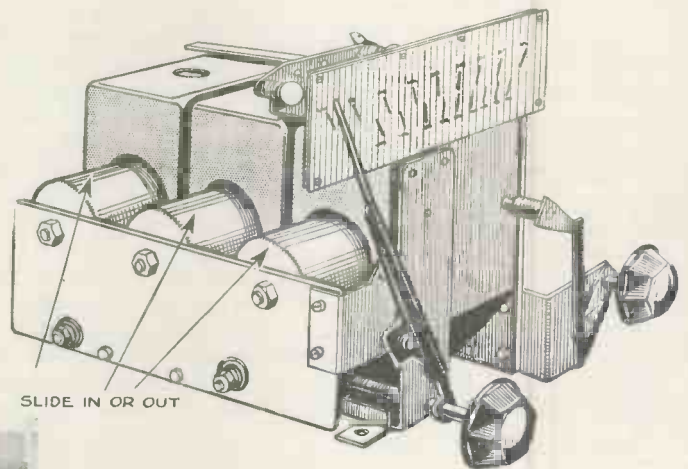

CONDENSERLESS TUNING UNIT

An artist's drawing of the new Varley three-gang permeability tuning unit which does away with multi-gang condensers

lounge. I tried in vain, and have fumed ever since while the walnut cabinet of my radio has struck the only jarring note in what is, I flatter myself, an otherwise coherently artistic whole.

Cabinets Are Better!

Cabinets, then, are better. Not exactly listener gains—but aesthetic gains, certainly. On second thoughts, too, I think these new cabinets *are* part of listener gains. The bigger cabinets must add to the true sonority of the reproduction—must help to some extent to reduce that ghastly “thomph” of yesteryear.

That the so-called table cabinet is not gaining any more in favour I gather from the number of stands being designed to support them. There has always been something of a mystery to me about table cabinets. Where are they supposed to stand? Very few occasional tables are strong enough to bear the bigger mains sets.

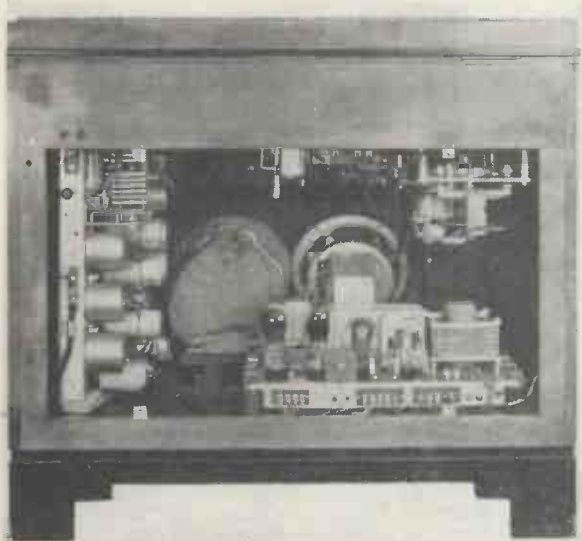

A SET FOR THE VERY BEST QUALITY!
Some set this! It is a back view of the H.M.V. high-fidelity radiogram. It uses fifteen valves, two loud-speakers, two chassis and costs over £100

the New Radio

Perhaps we are evolving towards a true pedestal type of cabinet, these stands and legs being a necessary stage in that evolution.

Looking at the new radio in its better cabinets, what is the very first thing that strikes you? Surely the extraordinary change in the face of dials.

Tuning Scales Have Improved

No longer does the tuning dial or scale hide itself behind a tiny aperture. It has blossomed out as a brave pretentious affair, sometimes taking up about a third of the whole of the front of the cabinet.

What are known as full-vision scales are now widely, if not yet universally, found in the latest sets. Full-



Keystone photo

SMALLEST SET AT OLYMPIA!

The honour of this season's smallest set goes to Portabout for their self-contained two-valver weighing 3 lb. As you can see, it is ideal for hiking

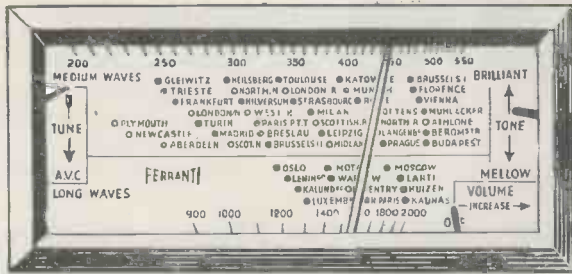

LIKE A CAR FACIA BOARD

You can almost watch the set work with the Ferranti dial. It is marked in stations and wavelengths and has visual indications for A.V.C., tone control and volume

vision meaning the all-the-time vision of the whole of the scale—in contrast to the transitory, fleeting glimpse we used to suffer from the old behind-the-miniature-aperture type of tuning arrangement.

We were always talking about that most horrid of words—the escutcheon. That word itself smacked of medievalism—as do such sets as still exist with anything but a full-vision scale, standing out boldly behind a revolving pointer, arrow or other moving device.

Dial Markings

These dials, or scales—I never know which it ought to be—are marked profusely in wavelengths. Often, too, in station names. For all-wave sets we have frequency calibrations, in kilocycles for the medium and long waves, in megacycles for the short waves.

We are assured that dials marked in these various ways are accurate beyond suspicion. Good enough for wavelengths, which of themselves do not change in relation to one another. For the station names

we can say less—offering up a silent prayer that the Lucerne Plan will stay put.

Quite apart from the profusion of calibrations, the modern tuning arrangements are still further made easy by all kinds of visual indicators of the correct point of tune.

Climbing lights, varying shadow widths, revolving neons, and so on all aim at giving the eye a sure indication when a station is exactly tuned-in—something the ear is less accurately able to determine, in any case. Now that so many sets have self-adjusting volume control, it is just impossible to detect the exact tuning point with the ear—because the action of the control valve tends to spread out the tuning location.

Luxury of Indication!

Scales help in more than just the tuning. They often enough these days give you a good idea of the tone—whether brilliant or mellow, as well as indicating which waveband you are tuning. Simple levers worked on cords do all this, making for a luxury of indications strongly reminiscent of the facia board of a car.

What a contrast it all is to a year or two ago! Then we had to put up with unmarked knobs, working entirely inconceivable internal circuits. Strange that it should have



STANDS FOR NEW SETS

The new Ekco five-valve super-het in its circular bakelite cabinet looks neat on a stand of this type



A REALLY "HOT" DIAL
The Dynatron dial—by Hacker of Maidenhead. A neon beam is the only movable part. The width of the beam varies according to the setting of the selectivity switch in the set

been thought easy to distinguish between a knob for volume and a knob for tone or waveband switching—just by looking at an identical group.

Controls Are Simple

Yes, decidedly, the listener has gained in genuine ease of control. The new radio offers no less imposing an array of control knobs than before—because, of course, the luxuries of tone control and suchlike subsidiaries more than counter-balance the elimination of the multiplicity of tuning controls. But today all controls are understandable controls—knobs and levers whose purpose is very clear if only the set user will take trouble to read.

Enough of this aspect of the new radio. Superficially, sets offer vast advantages—just by looking at their cabinets and twiddly bits you must be aware of that. Inside, though, still vaster changes have occurred.

Inside the Modern Set

Anyone hanging on to an old "breadboard" three-valver of, say, 1929, would be amazed at the extraordinary arrangement inside one of the latest sets. Steel chassis, screened coils and gang condensers . . . radio built more like a motor car than a wireless set.

In a circuit sense, too, modern radio has much to show the listener with an oldish set. Super-hets from those whistle-infested affairs we used to gloat over!

Today the super-het has been tamed. The coming of modern frequency-changer valves has helped tremendously to straighten out super-het design. With multiple valves, high-frequency

pentodes and other specialised valves, our designers have been able to take the hymn of hate out of super-hets. The whistles have been cut out, leaving sets that really do separate the stations—and without too bad a background.

Perhaps the most-discussed circuit development of the year is called, by the thoughtless, automatic volume control and by jargon-ridden amateurs, "A.V.C."

Those Magic Initials A.V.C.

In the cheaper super-hets vaunting these magic initials, the action is as often as not extremely perfunctory, and certainly does not have the effect of saving foreigners from fade-outs. Perhaps the more expensive supers, with their "quiet" control, more adequately live up to claims.

Certainly the elimination of inter-station "swishes" is a boon to be prized. Quiet self-adjusting volume control is supposed to give this. In one modish set a "Q" valve is claimed to differentiate quite definitely between signals and swish.

Closely connected with the levelling up of foreigners in volume and the elimination of background noises, is of course, quality of reproduction. High fidelity, which is American sales talk for good quality, is engineered into more than one set this year.

The Only Danger

Unless you are a plutocrat and can afford a hundred guineas or so I should advise you not to hear a high-fidelity instrument.

Slowly but surely we are advancing in this radio business.

It occurs to me the only danger is that set makers try to give all these new listener gains at an uneconomic price.



ALL-WAVERS FOR THE COLONIES
One of the neat and compact all-wave receivers designed for Colonial use by All-wave Radio and Television Ltd.



BEST FORM OF HOME ENTERTAINMENT
There is no doubt that the radio gramophone is the ideal home entertainer. This young lass from Scotland is admiring the quality of reproduction of the new G.E.C. model at Olympia

Linking the Output Valve to the Loud-speaker

By Percy W. Harris, M.Inst.Rad.E.

This is the eighth and final article in the series dealing with the principles of set design. Every attempt has been made to make these articles cover all the essential points. If any reader feels that some subject in which he is interested has been omitted, he is invited to write to the Editor. Any omissions can be repaired in a further article



A photograph of Percy W. Harris taken with one of his famous constructor sets in the "W.M." laboratories at Fetter Lane

IN last month's article we discussed the many problems connected with linking up the detector valve with the output valve. No mention was made of the three modifications of the output known respectively as push-pull, quiescent push-pull and class B. Although all three have been fully described from time to time in these pages a few notes regarding them are necessary in any series on set design.

One of the problems facing the designer, as we have already indicated in previous articles, is to avoid overload in any part of his circuit and deliver undistorted power to his loud-speaker. Detector overload is avoided in the main by suitable valves and sufficiently high voltages to enable the grid to swing on the loudest signal received without overloading.

Avoiding Overload

A modern detector valve in a suitably designed circuit can deliver so much undistorted power that the output valves of a few years ago are easily overloaded even if only one low-frequency stage is used. How, then, can we avoid output overload?

First of all we must choose a valve or valves which will handle without distortion a grid swing at least as big as the maximum delivered by the secondary of the transformer connected to the detector, or in the case of resistance coupling, across the output of this stage.

At first thought it might appear to be a simple matter to find exactly the correct valve, and we can examine the characteristics in the makers' catalogues and find one which has a straight characteristic over the voltage swing we desire to apply to it.

Unfortunately, there are two troubles here, the first being that the static characteristic (the characteristic of the valve taken with the constant plate voltage) is not a reliable guide, for the valve is not used in these conditions in any case.

As we have seen, we never work a valve without a load in the plate circuit. There is not space here to discuss the differences between static and dynamic characteristics of a valve and how the latter helps the designer and we must assume for the moment that the static characteristic is good enough guide for our immediate purpose.

The second point we have to bear in mind is that as big peak voltages are met with only occasionally, how much can we allow our signals to run on to the curved portion of the characteristic without serious distortion?

When Distortion Occurs

Distortion occurs whenever the input is not faithfully magnified and it can only be so treated when equal changes of grid voltage bring about equal changes of plate current. Directly the characteristic becomes curved at either end such faithful copying cannot occur. Most sets work in a slightly overloaded condition whenever there are loud passages in the music and this, incidentally, is one of the reasons why loud signals on the average set are trying to the ear.

It is not the actual loudness which worries us, but the distortion which inevitably accompanies this loudness. A signal of the same strength from a receiver giving an undistorted output will rarely sound unpleasant.

Let us now consider the case of an output valve which experience has shown us overloads badly when used in our experimental set. One

cure might seem to be to use two of these valves in parallel, but a moment's thought shows that the only effect of this will be to have a greater power handling capacity in the anode circuit without giving us the opportunity of using larger grid swings. See Figs. 1(a) and 1(b).

All we shall have done is to have cut down the total resistance of the

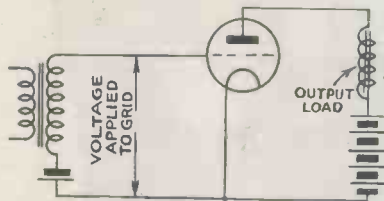

Fig. 1(a).—A typical arrangement of the output circuit

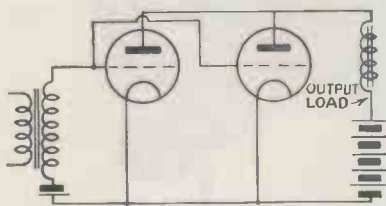

Fig. 1(b).—Here two valves are in parallel, but note that the same grid voltage as in Fig. 1(a) is applied to both valves

plate circuit. Fig. 1(b) shows this quite clearly and also indicates that the same grid voltage is applied to both valves.

Now consider Fig. 2 or the push-pull arrangement of the same two valves. Here we have a centre tap to the secondary transformer, the centre tap being connected through the grid-bias battery to the filament. The two extremes of the windings are joined to the two grids of the valves and thus the maximum voltage that either grid can get is exactly half of that applied to the valves when they are in parallel.

Important Difference

But notice this important difference. At any given moment when the top end of the secondary is positive, the bottom end is negative, so that the two valves are working simultaneously but in opposite phases.

If now we connect a centre tapped load in the plate or output circuit the two opposite phased outputs will combine and we can thus satisfactorily handle double the grid swing with this arrangement that we could in the arrangement of Fig. 1.

There is, however, a further advantage in this scheme and that is if the two push-pull valves are so used that the grid swing runs slightly

on to a curved portion of the characteristic, thereby creating harmonics, the other valve will do just the same and there will be a cancelling out in the output circuit enabling us to load these valves slightly more than normal without obvious distortion. In practice this ability to work on the curved portion of the characteristic has been used a great deal.

There are a number of practical points with regard to the design of push-pull stages. There is, for example, trouble sometimes found when, owing to the symmetrical halves of the transformer, parasitic oscillations at high frequency are set up and overload the valves with super-audible signals introducing a great deal of distortion.

"Stopping resistances," as they are called, are often introduced at the points x in Fig. 2 for the purpose of damping out these oscillations. Their value should be no higher than is necessary to stop the oscillations and resistances with a value of 5,000 ohms have often been used.

A good push-pull input transformer needs careful design and it is not merely a question of making a centre tap.

Considerations of space prevent me giving too much attention to any individual aspect of this work, interesting as it is, but I have dealt at some length with the principles of push-pull because an understanding is essential in proper design.

We have now seen that paralleling valves in the input does not help us in grid overloading but reduces the plate-circuit resistance and therefore enables us to handle a higher power with this particular valve. Parallel valves are very rarely used in ordinary wireless receivers because it is only necessary to choose a valve of lower impedance if the one we contemplated using is not suitable.

Push pull is much more satisfactory than the paralleling. Similarly the reader may well say that the push-pull method is rather a clumsy way of using two valves when a larger valve which will take a bigger grid swing can be substituted without all the complications.

This leads me to point out one advantage which, so far, I have not referred to in push-pull and that is the magnetic circuit of the output device.

Let us consider we have a simple centre-tap choke in the output (see Fig 2).

This must be designed with a suitable iron circuit to have the inductance we require and as there is the constant direct current flowing through this coil in an ordinary circuit saturation can easily occur if we have not plenty of iron. Here push-pull has a great advantage, for you will see that the two valves of the coil take their direct current from the plate circuit of the valve in opposite directions and the magnetic effects thereby cancel out.

Push-pull Advantage

This prevents magnetic overloading and enables the coil with its core to work with the alternating current just as if there were no direct current there.

This reduces the cost of the output device, whether transformer or choke, very considerably, and combined with the fact that the effects of harmonic distortion largely balance out, has given the push-pull method considerable popularity. A further advantage, also due to a balancing-out effect, is that if alternating current is used on the fila-

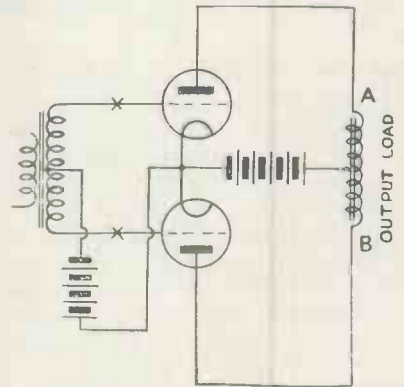

Fig. 2.—One of the most efficient of output circuits, the push-pull arrangement

ment, instead of getting the possibility of hum due to this cause in the output, the effect of any filament variations balance out.

Some of the grid-bias problems in mains sets also are avoided in this scheme.

Grid Bias Simplified

In a battery set the load on the high-tension battery is very considerable in push-pull because of the fact that both valves are supplied in parallel so far as the high-tension source is concerned. To reduce this two new modifications have been introduced known respectively as quiescent push-pull and class B.

In quiescent push-pull valves

with suitable characteristics are biased down till the quiescent plate current flowing is extremely small and the plate current therefore only rises when signals come in. This makes the average current supplied by the high-tension battery very low and enables loud signals to be handled with an average output very considerably less than with ordinary push-pull.

First of all two valves were used and more recently the necessary pairs of electrodes have been introduced into one bulb, making for compactness, cheapness and convenience.

Class-B Method

In the modification known as class B, already explained very thoroughly in these pages, the grids of valves with special characteristics are allowed to go positive, thereby drawing grid current whenever signals come in. Normally the plate current is very low. This gives a load on the secondary of the transformer which in other methods is absent because whenever the grids of a valve are kept negative the current flowing in the secondary is negligible and therefore it is a voltage rather than a power transformer.

In class B, however, when the transformer secondary has to deliver actual current or power, special transformers have to be designed and as these cannot give much of a step-up in themselves and have to draw power from a previous valve, the whole audio system has to be re-designed.

The only advantage of class B is that it enables loud signals to be given with *small average* currents from a high-tension battery, but it has its disadvantages and where ample current is available from a high-tension source it is by no means the best method.

Returning now to the question of valves in the output, the pentode is used both as a single valve, in ordinary push-pull, in Q.P.P. and, in fact, in every way, for the pentode valve is merely, as we have seen in previous articles, the means of getting higher amplification without the losses which previously were introduced when high-amplification output valves were used.

They do not call for any special

comment here and we can now proceed to the design of the output device and what has to be done to get the highest efficiency.

In Fig. 3(a) the plate of the valve is connected through an iron-core choke to the high-tension supply and therefore voltages will be set up across this choke which can be applied to the loud-speaker.

The design of this choke is very important for it must be able to handle the direct current and the super-imposed alternating current of the signal without producing magnetic saturation, otherwise serious distortion will be introduced. Its value, too, must be suited to the output valve, otherwise we shall not be able to deliver the requisite amount of power to our loud-speaker.

It must be free from bad resonances, otherwise we shall reintroduce the distortion we have so carefully got rid of in the previous stages. Furthermore, it cannot be considered without its load, which is the loud-speaker, and this is one of the reasons why so many sets which are otherwise good fall down badly when used in practical conditions.

How to connect the load is also a very important point. We can, if we like, introduce the loud-speaker itself as the load and providing the windings are suitable (which is rarely the case in home-assembled sets) there is no harm in so doing. In practice, however, it is advisable



RATHER LARGE VALVE!

A rather large valve made by the G.E.C., which was attractively shown on their stand at Radiolympia. The construction of the valve is clearly seen

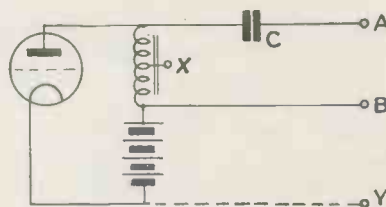

Fig. 3(a).—A choke output circuit in which the direct current is kept out of the loud-speaker windings

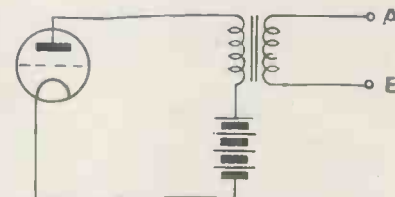

Fig. 3(b).—A circuit showing the use of an output transformer—a system that has many advantages

to keep the direct current out of the loud-speaker windings, using these windings only for the speech current, and this is easily done by using the choke as shown and the isolating condenser c.

Isolating Condenser

This condenser c, being in the path of the audio-frequency currents, must offer no serious opposition to them and certainly must not be selective. If the condenser is made small it will resist the flow of low-frequency currents while passing the high-frequency currents and reproduction will be tinny, quite apart from a general loss of power. A condenser of at least 2 microfarads should be used here and preferably more.

Transformer Output

In Fig. 3(b) we see the use of a transformer output. The transformer, of course, should be designed to suit the valve and it has several advantages.

First of all, we can dispense with the use of a condenser and the attendant troubles that it may give; the primary winding of the transformer being completely isolated from the secondary, of course. Secondly, we can design our secondary winding AB to suit the loud-speaker and we can also have a tapped secondary, if we desire, so as to match the transformer to several different loud-speakers.

This tapping idea is also applied to the choke in Fig. 3(a), converting it into an auto-transformer. For example—reverting now to Fig. 3(a)—if we make a tapping at x and connect the condenser c to this

point, we shall have a step-down effect in an auto-transformer.

Notice also that I have put an alternative connection at Y because the output can be taken from either A and B, or A and Y, the impedance of the battery being negligible. The advantage of taking the output from A and Y is that no part of the loud-speaker winding is above earth potential, whereas if we take it across A and B, the B lead is "hot."

Severe Shock

B is at the high-tension battery potential above the chassis and earth

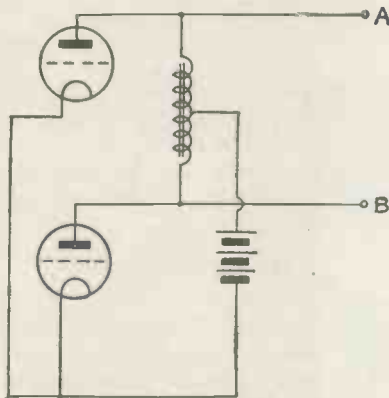

Fig. 3(c).—An adaptation of Fig. 3(a) for output valves arranged in push-pull

connection and touching it may give the user a severe shock. If we were to use a second isolating condenser, then this would be in series with the first, and to have the same capacity effect as the 2 microfarads in our drawing we should have to have two 4 microfarads, so that the cost would go up. It is therefore much easier to take the connection to Y.

Reverting now to the transformer connection. A good output transformer to work with a power valve cannot be cheap, for the plate current flowing is always high, therefore a good iron circuit is necessary as well as plenty of copper. A cheap output transformer is very poor economy and may entirely ruin the careful work one has put into a design in earlier stages.

If much experimental work is to be done one of the high-grade output transformers with tapped primary and secondary should be considered—in any case, do not stint money on your output.

In Fig. 3(c) we have a choke with centre tap as utilised in the push-pull system. In this diagram I have not inserted condensers because there is no direct-current difference in poten-

tial between the top and bottom of the choke, and therefore any load connected across the terminals A-B will take only the alternating current of the output. No direct current can flow because both ends of the choke are equally positive.

If, however, the loud-speaker is taken some distance from A and B, remember that both A and B are "hot" and you will get the full battery voltage between them and earth.

Fig. 3(d) shows a transformer push-pull output which is obviously free from the difficulties just referred to and has all the advantages of matching that I have already referred to in Fig. 3(b).

Moving-coil loud-speakers are usually supplied, in these days, complete with input transformer and generally with a centre-tapped transformer for use with push-pull. This transformer is the exact equivalent of the output transformer we have been discussing and is naturally substituted for it.

It is by no means certain, however, particularly in the cheaper loud-speakers, that the design of a transformer is good enough for the loud-speaker with which it is used, for prices have been cut to such an extent that the manufacturer naturally cuts down his manufacturing costs as low as he can.

For this reason I am sometimes asked whether there is any harm in using the loud-speaker transformer in conjunction with a good output transformer built into the set. If this latter is a 1:1 ratio then no harm whatever is done in connecting the output of the set transformer to the input terminals of the loud-speaker transformer. In this case only the audio-frequency output reaches the windings and there is therefore no question of saturation of the loud-speaker transformer by

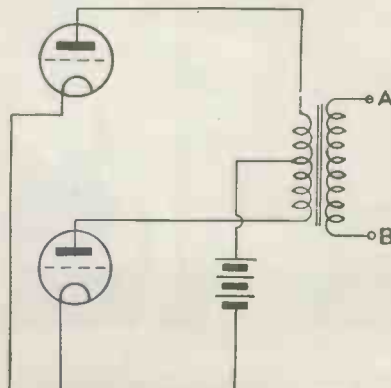

Fig. 3(d).—The conventional form of output arrangement for push-pull output valves is a centre-tapped transformer

the heavy direct current from the output valve or valves.

If the high-grade output transformer in the set is of the step-down variety then, provided the secondary is suitable for the particular speech coil (this can be found by consulting the makers), it is advisable to disconnect the loud-speaker transformer and to connect the set output transformer to the speech coil of the loud-speaker.

Well-designed Transformer

It is all a matter of the quality and type of loud-speaker you are using. High-grade moving-coil loud-speakers are provided with well-designed and adequate transformers.

If, however, you are connecting your set transformer to the speech coil of the loud-speaker, remember that both the secondary of your transformer and the windings of the speech coil will have very low resistance and therefore very high current. For this reason the lead from the transformer to the speech coil should be very short and also thick, for the current flowing in the speech coil with a loud signal is more in the nature of amperes than milliamperes and will easily burn out a flash-lamp on quite a moderate signal! In general experimental work, therefore, you will see that it is advisable to have the transformer actually on the loud-speaker.

A Final Word!

A final note. I originally planned this series to run over six articles and imagined I should cover fairly thoroughly the main considerations in set design. In order to get to the output stage and to deal even in a cursory manner with many of the important points I have run into eight articles and I am now painfully conscious of numerous omissions in the series.

If there are any aspects of set design which the reader thinks were insufficiently covered for his purpose and on which he would like articles, might I ask him to write to the Editor to this effect? For then out of the correspondence received we can see which omissions can be usefully repaired.

Every important aspect of the subject has been adequately covered but, maybe, there are one or two minor points about which readers are not quite clear. Do not hesitate to send a letter airing your opinion; they will be most welcome and helpful.

Broadcasting House Berlin



(1) Director Voss is the business manager for all German broadcasting

(2) This shows a corner of the staff restaurant on the roof of Berlin Broadcasting House. Members obtain their lunch at less than cost price, thanks to a handsome subsidy contributed by the broadcasting company

(3) A winner of a recent microphone contest to discover suitable personalities for training as radio reporters, Herr Krause



(4) The Berlin Wireless Orchestra in the huge concert hall at Berlin Broadcasting House. This studio is the largest in the world, the one at Radio City, New York, being one foot smaller

(5) Herr Hadamovsky, Director General of German broadcasting, is only 29 years old

(6) A very modern staircase at Berlin's radio headquarters

(7) Outside view of Berlin Broadcasting House

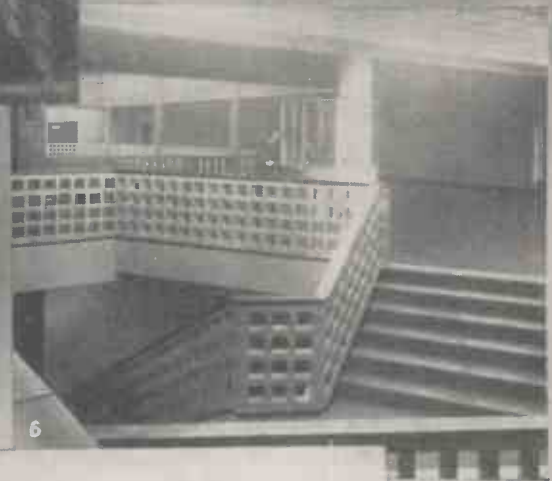

Photos by
Gulliland

Is a Radio Career Worth While?

WIRELESS, which we may take as including the allied professions of television, talking-picture reproduction, engineering and so forth, although one of the newest of the professions has undoubtedly now outgrown its infancy and is settling down to taking its place with other older professions.

Until comparatively recently—say, seven or eight years ago—it was but rarely that I received requests for advice from wireless enthusiasts, but today 10 per cent. of the students studying with the British Institute of Engineering Technology are engaged on courses in radio and allied groups.

This is a large percentage when it is realised that, wireless and electrical engineering quite apart, the courses available include mechanical, automobile, civil engineering and numerous other branches.

Intensive Development

Wireless today is in what I might term an "in-between" position. It is just entering on a period of intensive development and in the comparatively near future surprising extensions of its applications will undoubtedly take place. Now, therefore, is just the psychological time when a young man can step in and, so to speak, grow with the profession.

It follows that the man who qualifies in radio should have great opportunities ahead of him. A recognised qualification in wireless or one of the allied professions is as good as a gilt-edged security!

Few Qualified

In view of what I have said it is surprising how comparatively few men hold these recognised qualifications. Many men remain amateurs, dabbling, or stay in the rank-and-file brigade in commercial concerns. It is, however, helpful to these men to know that there is no reason at all why they should not attain the technical status to ensure remunerative executive employment for themselves.

The one point which must be emphasised is that of all the trades

wireless is probably the most technical and consequently the man without a qualification is fighting a losing battle from the start.

Without doubt, the most popular examination for wireless engineers is that held by the Institution of Electrical Engineers, leading to the A.M.I.E.E. qualification. This qualification is recognised all over the world and successful candidates are entitled to designate themselves "Chartered Electrical Engineers."

The examination is purely technical and is therefore most suitable for those desirous of obtaining the

invariably find they cannot turn their experience to good account, and consequently encounter great difficulty in obtaining worthwhile employment on shore.

Today, however, the position is quite different and there are so many other openings that no young man need trouble about the sea life with all its drawbacks. The chief opportunities nowadays are more in connection with broadcasting itself, research and the manufacturing side of wireless and the allied trades.

Typical Positions

The type of position I have in mind is, for instance, chief wireless service engineer, research engineer, works manager or production engineer in wireless manufacture, and so forth.

In view of the stage that the industry has reached, I can foresee that the man with a flair for wireless engineering who takes the trouble to equip himself with the necessary technical knowledge will have a flying start ahead of all others.

Opportunities Overseas

No doubt some men will ask themselves what possibilities wireless has to offer them overseas. Here again there are openings for the qualified man. Many wireless enthusiasts are particularly interested in short-wave work which, of course, is of most importance in countries a long way away.

In the colonies, for instance, short-wave wireless sets are almost entirely used to the exclusion of ordinary installations covering the broadcast and long wavebands. Prominent wireless manufacturers employ resident representatives abroad such as sales engineers, service engineers, and so on.

With regard to the actual financial prospects it is difficult for me to be definite as radio has not quite reached the stage where it has been divided into different grades with set rates of pay. On the whole the financial prospects are excellent and superior to those for any other profession.

One thing is certain. A qualified radio man can always demand a fair salary.

By J. J. CLEAVER

high positions in the manufacturing and research sides of the industry, or in broadcasting.

Again, there is the Institute of Wireless Technology, which caters for rather a different type of candidate. The two examinations held by this body are exceptionally suitable for those occupying, or desirous of occupying, positions in the more practical side of the trade.

The institute aims to certify all competent wireless engineers, including general technicians, service engineers, traders, etc., associates of the I.W.T. are entitled to designate themselves "Certified Wireless Engineers," and associate members "Incorporated Wireless Engineers."

Other well-known examinations are those held by the Radio Association, leading to the A.Rad.A. and F.Rad.A. qualifications, the Association of the British Radio Institution (A.B.R.I.), the City and Guilds Institute in radio communication, etc.

When wireless first came into being the chief openings of any account were for operators on ships. These openings certainly attracted young and adventurous men who wished to travel and see the world, but unfortunately the drawbacks were numerous. Although the immediate prospects are good, wireless operators have no very great future to look forward to and often tire of the life; then comes the real difficulty in that ex-wireless operators

The author of this article is Chief Careers Consultant of the British Institute of Engineering Technology.

THE most important part of a car-radio set is the fitting. However good the set itself may be, its performance can be spoiled by defective installation while, on the other hand, a relatively inferior set can be made to give good results if proper attention is paid when the set is first wired up.

The most important part of the whole set is the aerial and it is often assumed that this is quite an easy matter to fix up. Two types of aerial are commonly used, the roof aerial and the running-board aerial. The former is in the form of a wire net built into the roof of the car. If this is done by the car manufacturers, it can be quite a satisfactory proposition.

The aerial must be at least 3 in.



World Wide photo

A neat car-radio installation shown at the recent radio show. It is a seven-stage super-het outfit fitted with A.V.C. and made by Ekco

Getting the Best Out of Car Radio

By J. H. REYNER, B.Sc., A.M.I.E.E.

clear of any metal-work in the body, but even so it is not altogether suitable with the modern all-steel bodies which are now used to an increasing extent. The metal-work of the car is used as the earth for the receiver and if the aerial is situated entirely within a metal body it is very effectively screened and will, naturally, have a poor pick-up.

Danger of Short Circuit

Even when the aerial has been built in by the makers there is always a danger that it is short-circuiting to the metal framework at some point or another and, if this happens, the aerial is useless.

If the car has not already been fitted with such an aerial, it is a difficult matter to do so afterwards. The problem is to conceal the aerial from sight and this usually means removing some portion of the upholstery, which is difficult to get back again with the same finish as is obtained by the professional body-makers.

On the whole, therefore, many people prefer to use the second type of aerial consisting of a sheet of metal under one or both running boards. This is outside the earthed metal work of the car and, therefore, is capable of giving quite a good pick-up, although at first sight the use of an aerial underneath the car would seem a poor arrangement.

At least 8 or 9 sq. ft. of aerial should be used. It is rarely possible to obtain such an area under one running board alone, so that it is customary to fix an aerial under each running board.

The best aerial material is aluminium, although zinc may be used. Brass or copper are both expensive and heavy, while iron is definitely inferior in results.

Even with a running-board aerial, care has to be taken to see that no undue screening results. In one particular case a car was fitted with an aerial 2 in. under the running board and worked satisfactorily. A similar aerial on another car gave

only about one-third of the signal strength and it was found that the second car had an all-metal body and that the edges of the running-board were turned over to a depth of nearly 2 in.

Screening Effects

This produced sufficient screening to cut down signals very appreciably and it was not until the aerial had been dropped a further 2 in.—making it some 2 in. below the lowest metal-work on the car—that satisfactory results were obtained.

A good test for the aerial is to tune in a weak station and then, standing outside the car, to touch the aerial plate with one hand, making sure that the other hand is not touching the bodywork anywhere. If any appreciable increase in the signal strength is obtained the aerial is inadequate.

Fitting the Aerial

Either insufficient area has been provided or the aerial is not low enough to overcome the screening of the body and adjustment should be made to overcome these difficulties.

The two aerials, one under each running board, should be strapped together with a piece of stout wire or strip metal. It is important that this strip should be rigid enough not to vibrate when the car is running or it will give variable results. It may even produce an intermittent short-circuit which will cause crackling.

Having satisfactorily arranged the aerial, the next factor to be con-

sidered is that of the suppression of motor noises. The use of suppressor resistances in the leads to the sparking plugs is, of course, well known. A resistance of 20,000 ohms is adequate for any well-installed set and it is not necessary to use higher values than this.

Effect of Suppressors

Incidentally, it is often thought that the introduction of these suppressors affects the performance of the car. If the car is running satisfactorily in the first place, no trouble will result from the fitting of suppressors.

The purpose of the resistance is to cut out the oscillation which usually

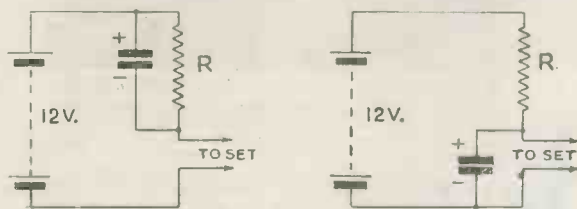

Fig. 1.—Alternative connections of the 250-microfarad condenser when running with a series resistance. See that polarity of the condenser is correct when fitted

follows the spark discharge, but the time and severity of the spark are not affected by the resistors. This has been proved by actual experiments on automobile engines.

A further source of interference is commutator ripple set up by the generator used for charging the battery. This can be completely cured by connecting a small condenser of about .5 microfarad across the generator terminals. Similar noise may be set up by any electric equipment, such as windscreen wipers and a similar cure is effective.

Curing Noise

When all these precautions have been taken the installation should be reasonably quiet. Incidentally, it is advisable to trim up the set before tackling the question of suppression. Most sets are provided with an adjustment which trims up the aerial circuit to allow for the particular aerial in use and until this has been done the set will not develop its full efficiency.

Motor noises are only really serious when the set is working full out so that the trimming should be carried out before suppression is started.

If trouble is still experienced, the interference will usually be found to arise from direct radiation from some of the "hot" parts in the battery

system. The low-tension leads to the coil, if such is fitted, will be found a fruitful source of trouble, and these may have to be run in shielded cable. This is sometimes rather a business, since it involves replacing the existing leads entirely with shielded leads, the outer casing being earthed at several points.

The lead from the aerial terminal of the set to the aerial itself must be run in shielded cable. This should be of a low-capacity type and should be as short as is practicable. The outer casing should be earthed at several points and not only at the set end.

On the other hand, it is sometimes found that if the lead from the aerial proper to the set is taken from the rear end of the car suppression becomes much more easy. The interference from the ignition system falls off in a most surprising manner as the aerial is moved farther and farther away. A distance of 3 or 4 ft. may reduce the noise level more than fifty times.

It may be necessary, therefore, to take the connection to the aerial at the back of the car, instead of the front. This involves using a longer length of lead-in cable, shielded all the way as already explained, but it is often very effective.

If a long length of lead-in cable has to be used, it is worth considering whether a step-down transformer should not be used similar to those employed with the shielded lead-in cables so commonly employed now on house sets. On the other hand, if a really low-capacity cable $\frac{3}{4}$ in. in diameter is used, the capacity losses in the lead-in (which at the most will not exceed 15 ft.) should not be serious.

Keep the set itself away from the ignition as much as possible to avoid direct radiation on to the set. The set itself must be enclosed completely in a metal case and any large gap in the containing case is almost bound to cause serious difficulties in suppression.

A final point concerns the actual connection to the battery. Many car-radio sets, particularly American models, run off a 6-volt supply. If your car is equipped with 12-volt lighting, there are two alternatives. One is to tap off 6 volts, but this discharges the bottom half of the battery more than the top and is undesirable.

Battery Connections

The other method is to insert a suitable resistance in the positive lead (between 1 and 1.5 ohms is usually correct) and run off the full 12 volts. The resistance required is easily calculated from the formula $R=6/\text{current}$ in amperes. Most car sets take 4 to 5 amperes.

**Look out for
another fine issue of
"Wireless Magazine"
on October 31
Order Your Copy Now!**

With sets having buzzer high-tension supply, this system may cause an increase in the hum. In such cases the resistance should be bypassed by a 250-microfarad electrolytic condenser, as shown in Fig. 1. Both methods should be tried and the best used. The special 250-microfarad condensers can be obtained from T.C.C.

These general hints should prove of value to those who are installing car radio. No hard and fast rule can be given, since every case has to be handled on its merits, but the information given will provide an indication of the general lines to be followed.

Above all, make certain that every connection is well and truly made.



AERIAL UNDERNEATH THE RUNNING BOARD
Showing an aerial fitted beneath the running board of a car. It should be mounted at least 2 in. beneath the board

AMONG the sets we have chosen this month for review are some typical of the trend of design and of present public taste. We do try to cater for the tastes of everyone and we feel that we have, in a measure, succeeded.

Many will be interested in the new Kolster-Brandes Pup, a three-valve battery set with loud-speaker and all power supply for only £5 15s. This little set is already popular; hundreds bought the original model when it was brought out some years ago. Owners of that set should make a special point of hearing the latest Pup, which has been so greatly improved and is now a straight three-valver.

Many readers place quality above everything else, so for those we have

Tests of the New Sets

By the "W.M." SET SELECTION BUREAU

tested and reported on the new Amplion Radiolux. This receiver uses an Amplion loud-speaker and the manufacturers have taken special precautions to see that the quality is of the highest possible standard.

Telsen's new set is a really good super-het for getting the stations. It has six valves including a pre-first detector high-frequency stage and it is fitted with Telsen's new tuning dial, of which they are very proud. It includes all the latest refinements, such as automatic volume control and a visual tuner. The tuning dial is calibrated in station names and wavelengths.

It appears from sales figures issued by the manufacturers that the inexpensive radio gramophones are one of the best sellers of the season. We have always known that the only reason for radio gramophones not selling last season was the ridiculous price.

The G.E.C. radiogram A.V.C.5—reviewed this month—costs only £23 2s., and we know that it will interest the majority of our readers.



THOROUGHLY TESTED BY CLAPHAM AND DWYER
Clapham and Dwyer are as keen listeners as broadcasters and find their Portadyne super-het ideal for the job. Clapham (left) is certainly impressed!

receiver, the fifteen-valve all-wave Scott. This is one of the finest sets that can be bought.

With this set there is no limit to the number of stations that can be heard, while on the short waves during our tests we received a programme from Japan, as well as others from many parts of the world.

Every year some misleading statements creep into the set manufacturers' advertisements. Last year it was the five-valve super-het, where they forgot to tell you that one of the valves was a rectifier and that there were only four receiving valves. This year they are a little more subtle.

Many of the so-called six-valve super-hets do not really give any better performance than last year's so-called fives. The super-hets last year consisted of a frequency changer, intermediate-frequency stage, double-diode-triode output, pentode, and rectifier.

This year they are using a separate diode and a separate triode, so using two valves instead of one and calling the set a six-valver. Very misleading, isn't it?

We are glad to see so many of the sets this year have embodied a pre-selector high-frequency stage. This makes quite certain that these super-hets will bring in plenty of stations during daylight and be reasonably free from background noise.

This represents about the lowest price that one can possibly pay for a high-grade instrument, for the G.E.C. have not skimmed the specification in any way.

Last of all, there is that amazing

FREE ADVICE TO PROSPECTIVE SET BUYERS

To make the most of this free advice service, we ask you to answer the following questions:—

(1) The maximum price you wish to pay, and whether you are prepared to exceed this if there is no suitable set at your desired price.

(2) The locality in which the set will be installed.

(3) The stations required, that is, locals only or a selection of foreigners.

(4) Whether you want an entirely self-contained set or one with external aerial and earth.

(5) Whether battery or mains driven. If the latter, whether A.C. or D.C.

A stamped-addressed envelope for our reply is your only expense. Address your inquiry to Set Selection Bureau, "Wireless Magazine," 58-61 Fetter Lane, E.C.4. Tell your friends about this useful service, exclusive to "W.M."



"This new Amplion receiver is supplied in a fine walnut cabinet of the conventional table type"

THIS new Amplion receiver is supplied in a fine walnut cabinet of the conventional table type, the loud-speaker—of Amplion manufacture—being above the receiver. There are only three controls, which combine the functions of on-off switch and volume; medium waves; long waves, and gramophone switching, with the tuner beneath the actual tuning dial. This tuning dial is calibrated in wavelengths between 850 and 2,000

BRIEF SPECIFICATION

MAKERS : Amplion (1932), Ltd.

MODEL : Radiolux A.C. Super-het.

PRICE : £12 12s.

VALVE SPECIFICATION : Octode combined oscillator-detector (Mullard FC4), high-frequency pentode intermediate-frequency stage (Mullard VP4A), band-pass coupled to a high frequency pentode detector (Mullard SP4) with power pentode output (Mullard Pen 4VA) and an indirectly-heated full-wave rectifying valve (Mullard IW4).

POWER SUPPLY : A.C. mains 190-265 volts, 40-100 cycles.

TYPE : Self-contained table model.

metres on long waves, and 200 and 550 metres on medium waves.

A special feature is the inclusion of a neon light tuning indicator, the glow from which varies according to the strength of the station received. The loud-speaker is an energised moving-coil type and really does give exceptionally good quality.

In addition the fine cabinet has been designed to prevent boom and box resonance.

Amplion Five-Valve A.C. Super-het

Although there are five valves used in this circuit, only four are receiving valves. The first is an octode frequency-changer, which is followed by a variable- μ high-frequency pentode as an intermediate-frequency amplifier. The second detector is a straight high-frequency pentode and is coupled to a power pentode, which gives over 3 watts undistorted output.

To obtain the maximum efficiency, a small pre-set condenser has been fitted to the intermediate-frequency transformer so that it can be carefully lined up to give optimum output. Fitted to the back of the chassis is a small trimming condenser, which enables the aerial to be adjusted to give the most efficient coupling.

The Amplion people have realised that to make a four-valve super-het stand out above others of a similar type every valve must pull its weight, and all components have to be chosen carefully so that they match perfectly with the valves in use.

This has been done here, consequently the Amplion super-het gives that little bit more which will make it so popular during the coming season.

One of the first points noticed was that the daylight range was distinctly better than the average super-het of its kind. Probably this was due not so much to the increased amplification, but to the very low background noise level.

We were able to turn the volume control to its maximum point without the background noise becoming high enough to overpower the weak signals.

Of course, after dark the DX properties of the receiver were even more pronounced.

DURING our tests we noticed there was a marked absence of second-channel whistles and, as selectivity was little over 8 kilocycles, we were able to receive almost every European station worth hearing. This was particularly noticeable on the long waves, and even the "private" station of Luxembourg was entirely free from interference.

The Sunday morning English programmes from Kalundborg were received at great strength, and even with the Luxembourg programme—less than 3 degrees away—there was no mutual interference.

We feel that readers should have no difficulty in tuning in less than forty to fifty stations. During the course of an evening's test, we heard over fifty without any difficulty at all, so there certainly should not be any trouble in increasing this log over a period test.



"The Amplion people have realised that to make a four-valve super-het stand out above all others, every valve must pull its weight and all components have to be chosen carefully"

Kolster Brandes New Battery Pup

THIS season, the demand being so great, the K.B. have had to introduce a new three-valve version of the Pup receiver, primarily for those users who still only want a simple straight battery to bring in two or three stations with maximum economy in battery costs.

Kolster Brandes have certainly achieved their object in the New Pup, a three-valve set with clock-face tuning, a large moving-coil loud-

speaker, and all power supply for only £5 15s. Even in view of its exceptionally low price, the receiver gives the best possible results for this type of set.

approximate positions marked on the tuning scale, in addition to the normal 0 to 90-degree calibration.

One of the most striking points about this very cheap receiver is the neat chassis and layout. All the small components are mounted out of sight, so all that can be seen on top of the chassis are the valves, variable condensers and tuning coil.

Tuning arrangements, by the way, are rather novel. So as to make quite sure that the receiver will be suitable for use in all parts of the country, there are four alternative aerial

tappings giving four totally different degrees of selectivity. A1 is for very long aerials, or when the receiver is used close to a local station. Actually the aerial is coupled on to the coil through a minute fixed condenser consisting of two pieces of twisted wire.

The second aerial tapping is for average conditions where selectivity is fairly important. The third tapping should be used when the receiver is operated from an indoor aerial or in a bad locality for reception, while the final tapping is only wanted when volume of the locals is of primary importance.

Although it is a straight three-valve set, K.B. have used a pentode in the output stage to give plenty of volume. There is no chance of this valve overloading as the low-frequency stages have been designed to prevent it. The detector valve is a metallised triode and is resistance-capacity coupled to a similar valve used as a low-frequency amplifier. A low-frequency transformer is used to couple this valve to the output pentode.

The minimum wavelength on the medium waveband is 196 metres, with a maximum of a little over 600 metres. This is a very wide range, particularly as the tuning condenser is of the mica-dielectric type.

The high-tension battery supplied has a voltage of 120, while the grid-



"The neat chassis and layout. All the small components are mounted out of sight"

speaker, and all power supply for only £5 15s. Even in view of its exceptionally low price, the receiver gives the best possible results for this type of set.

The cabinet is a standard oak upright model, quite clean, without any frills, but with a small clock-face type of tuning dial in the centre beneath the loud-speaker fret.

There are only three controls. On the left-hand side is a knob for volume and reaction control, on the right-hand side a tuning control which operates a hand on the clock face, and in the centre a combined wave-change and on-off switch.

Thirteen stations have their



"The cabinet is a standard oak upright model, quite clean, without any frills, but with a small clock-face type of tuning dial"

bias battery of 6 volts is also part of the main high-tension battery.

The low-tension accumulator has a capacity of 20 ampere hours and with normal running will last a fortnight with one charge. On an average the anode current is in the region of 8 milliamperes, a discharge well within the capacity of the battery.

You must not get the idea that this New Pup is intended to be a station-getter. The main idea is that it will

BRIEF SPECIFICATION

MAKERS: Kolster-Brandes, Ltd.

MODEL: K.B. 362.

PRICE: £5 15s. 0d.

VALVE SPECIFICATION: Triode detector (Cossor 210 HF), resistance-capacity coupled triode low-frequency amplifier (Cossor 210 HF metallised). This is transformer coupled to a steep-slope pentode with a high output (Cossor 220 HPT).

POWER SUPPLY: A combined high-tension and grid-bias battery with low tension accumulator, all self-contained.

TYPE: Upright table model with clock-face tuning.

REMARKS: This is the 1935 version of the K.B. Pup—a very reliable and cheap battery three.

bring in half a dozen stations at good listening strength without great expense. Of course, it is essential that a fairly good aerial is used.

During our tests we used one having a total length of 80 ft., including the lead-in. With this aerial we were able to receive the thirteen stations marked on the tuning dial, which include Fécamp, Luxembourg, and Radio Paris. This, we consider, is quite good going!

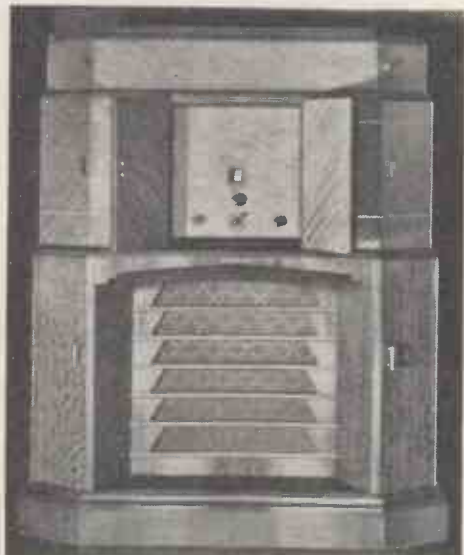

"The photographs do not show to advantage the workmanship or the fine way in which the receiver is finished"

ONLY on rare occasions do we review foreign-built receivers and only then when they are of exceptional interest and can be obtained easily in this country.

A receiver that comes in that category is the All-wave Fifteen, designed by the E. H. Scott Co., of Chicago, U.S.A., and is one of the largest sets on sale in England. It is impossible to do justice to this extraordinary set by means of a mere page report, so we will simply give you some idea of how the fifteen valves are used and tell you of some of the main features and of the results we obtained.

The agents in this country sell the chassis only, which is in two sections. The first section consists of the receiver circuit, which uses twelve valves, while the entire amplifier and power pack is on a second small chassis.

The photographs do not show to advantage the workmanship or the fine way in which the receiver is finished. Every component and screening can, as well as the chassis, are heavily chromium-plated, while not one wire of any description is visible. Both chassis are linked together by means of a multi-wave

and the fourth, 197 to 555 metres.

In front of the first detector is a high-frequency stage using a type 58 valve—a new triple grid valve. The mixer is a valve of a similar type, while the separate oscillator is a type 56. There are three stages of intermediate-frequency amplification, again using triple grid valves, while the second detector is the new Wunderlich valve which also provides A.V.C. to the three intermediate-frequency stages.

These valves are followed by three low-frequency amplifying stages, a most unusual arrangement, while the output stage consists of two valves in push-pull giving approximately 10 watts. In addition, there is also a full-wave valve rectifier and a beat-frequency oscillator.

In view of this most complicated

cable, which carries both power supply and receiver connections.

It would take far too long to give minute details as to the make-up of the circuit, so we must content ourselves with giving a bare outline.

First of all, the receiver tunes between 13 and 550 metres in four steps. The first waveband tunes between 13 and 30 metres, the second, 30 to 75 metres, the third, 75 to 197 metres

circuit, the receiver is most simple to tune. With the volume control set at a position which gives the required strength of signal, stations from all over the world can be tuned by simply rotating the single tuning knob.

Short-wave stations are receivable almost as easily as the local regionals, while four-waveband

BRIEF SPECIFICATION

MAKERS: E. H. Scott Laboratories, Inc., Chicago. English Agents: Keates & Co., 91-93 Bishopsgate, E.C.2.

MODEL: All-wave Fifteen.

PRICE: £68 5s. for complete chassis.

VALVE SPECIFICATION: Pre-selector stage (Arcturus triple grid, type 58), mixer stage (Arcturus type 58), separate oscillator (Arcturus 56), three intermediate-frequency stages (Arcturus 58), second detector (Arcturus Wunderlich), three low-frequency stages (Arcturus 56 valves), push-pull output (two Arcturus 2A3), full-wave rectifier (Arcturus 5Z3) and speech-frequency oscillator (Arcturus 56).

TYPE: Chassis, in two sections, or in radio gramophone form.

POWER SUPPLY: Self-contained mains equipment for A.C. supply.

REMARKS: One of the finest receivers it is possible to buy and, we believe, the largest obtainable in this country.

switching is accomplished by means of a single switch.

On test, we found that with any sort of aerial, every European station could be tuned in at full loud-speaker strength. During daylight the only difference in reception appeared to be a slight increase in background level. Short-wave reception was quite as easy as tuning in locals. During our tests we heard over 100 American stations, several South African, and Australians. We feel quite sure that we could have received stations from every country after prolonged test.

The receiver is available in many forms, varying in price from 65 guineas to 236 guineas, the latter model including an automatic record changer and a home recorder.



"Every component and screening can, as well as the chassis, are heavily chromium-plated while not one wire of any description is visible"

Telsen Six-valve A.C. Super-het

ALL the receivers in the Telsen range for this season are exceptionally interesting for they embody so many of the ideas for which we have so frequently asked during the past season. It has been the opinion of many that super-hets without a high-frequency stage were not really good enough when it came to long-distance daylight reception.

For this reason we were glad to have the opportunity of testing a receiver with five receiving valves and a valve rectifier. This Telsen six-valve super-het is available in

is in turn coupled to a double-diode valve, one diode used as a distortionless detector, the other providing automatic volume control.

To boost the low output from the diode, a steep-slope triode amplifier is used, which in turn is transformer coupled to a power pentode giving an output 3,400 milliwatts. In addition to this, the indirectly-heated

rectifying valve gives 350 volts high tension, which is adequate to ensure the finest quality.

The controls on the front of the cabinet are quite conventional, simply a combined on-off switch and volume control, master tuner and combined wave-change and a gramó-radio switch.

One of the high lights of the receiver is, however, the amazing tuning dial. On this dial are calibrated some fifty stations, while across the bottom, is the normal wavelength calibration. On the right-hand side, is a visual tuner of the needle type with which stations can be tuned in with the volume control set at zero.

The idea of this is that all noises and atmospherics, which are unavoidable on a long-range receiver, are missed by not turning the volume control up until the station is actually received at its correct tuning point.

An oblique line travels across the dial and the station is tuned in when this line crosses through the black or white square in front of the name of the station you wish to receive.

Most of the European stations that are worth hearing have been marked on the scale. In our opinion,

this receiver is one of the simplest to operate of the new season's sets.

The chassis will interest the technical buyer for it is unusually simple, clean and compact. Provision has been made for an external gramophone pick-up, additional loud-speakers and a mains aerial. Incidentally, we found that on the mains aerial we could receive almost as many stations as we could with a short external aerial.

Selectivity is about 9 kilocycles on



"The chassis will interest the technical buyer for it is unusually simple, clean and compact. Provision has been made for a gramophone pick-up"



"This Telsen six-valve super-het is available in both upright or horizontal cabinets . . . One of the high lights of the receiver is the amazing tuning dial"

both upright or horizontal cabinets, but in both cases the circuits are identical.

The first valve is a high-frequency amplifier with an iron-core coil in its grid circuit and followed by a triode-pentode frequency changer.

The tuning condensers in the preselector and oscillator circuits are coupled together to give single-dial control. The triode-pentode is band-pass coupled to a high-frequency pentode in the single intermediate-frequency stage, which

BRIEF SPECIFICATION

MAKERS : Telsen Electric Co., Ltd.
MODEL : 3435/MV.

PRICE : £14 14s.

VALVE SPECIFICATION : Pre-first detector high-frequency stage (Mazda A.C./V.P.1), combined detector-oscillator (Mazda A.C./T.P.), band-pass coupled to a single intermediate-frequency stage (Mazda A.C./V.P.1). Diode detection (Mazda V914), super-power output pentode (Mazda A.C.2/Pen), with full-wave rectifying valve (Micromesh R.3).

POWER SUPPLY : A.C. mains 200-250 volts, 40-100 cycles.

TYPE : Self-contained table cabinet receiver—a recommended new season's product.

medium waves and a little better than this on long waves, while with an aerial of about 50 ft., there was a marked absence of second-channel interference whistles.

Our tests were carried out 30 miles from the local station and in rather a poor position for long-distance reception, but even so, we were able to tune in a minimum of fifty stations. During daylight the long-wave stations always provided good entertainment, while Luxembourg was never interfered with by Kalundborg, on the adjacent channel.

G.E.C. Radiogram Model AVC5

WE are glad to see that the prophecy we made last year about the popularity of inexpensive radiograms is at last coming true.

This year, for the first time, there are several instruments of this type, all of which are really value for money. As we expected, this point is being appreciated by set buyers.

The General Electric Company has introduced what will be one of the most popular radiograms of its

All the controls are grouped on the motor-board and, in addition to the switch and tone control, there are three others on the right-hand side, including the master tuner, the wave-change and gramophone switch and sensitivity control.

This sensitivity control is very useful when receiving local stations.

The volume control for both radio and gramophone is on the front of the cabinet so that volume can be adjusted without opening the lid.

For the first time the new Osram universal valves are used in this receiver, but not in the conventional way. A mains transformer is also included to give the required 13 volts for the valve heaters.

The first valve is an Osram X30 heptode frequency-changer, followed by a W30 intermediate-frequency amplifier with a DH30 double-diode triode as a second detector and low-frequency amplifier. For an output valve G.E.C. use the new Osram N30 catkin pentode with a standard MU14 as a full-wave valve rectifier.

Approximately 3 watts are fed into the loud-speaker by the output pentode. This should be ample for all normal requirements. Quality is of the highest order and, even with the gramophone pick-up at full

volume, there is no chatter.

Most readers will be interested in the tuning dial. This is calibrated in station names and wavelengths with the medium-wave stations on one side in green and the long-wave stations in red. Station selection is by means of a white indicating line which passes through each of the station names as it is tuned in.

Fixed to the back of the cabinet is a short frame aerial, which is much more effective than a mains aerial, for it is considerably quieter in operation. With this aerial some eight or nine stations can be tuned in.

At a distance of twenty miles from the local stations and an aerial 50 ft.

BRIEF SPECIFICATION

MAKERS: General Electric Co., Ltd.

MODEL: A.V.C. 5 radio gramophone.

PRICE: £23 2s.

VALVE SPECIFICATION: Heptode combined detector-oscillator, (Osram X30), single variable- μ high-frequency pentode in the intermediate-frequency stage, (Osram W30), double-diode-triode second detector (Osram DH30), with a power pentode output (Osram N30). Full-wave valve rectifier (Osram MU14).

POWER SUPPLY: A.C. mains 200-250 volts, 40-100 cycles.

TYPE: Radio gramophone.

REMARKS: All valves with the exception of the rectifier are of the universal type.



"It is in a magnificent walnut cabinet and complete with a large moving-coil loud-speaker, induction gramophone motor . . . and pick-up"

kind during the coming season. It incorporates their already famous AVC5 chassis, but it is in a magnificent walnut cabinet and complete with a large moving-coil loud-speaker, induction gramophone motor and G.E.C. pick up.

Remembering that the price is only £23 2s., this instrument is very well finished, gives good quality, and includes many of the refinements associated with radio gramophones costing about forty to fifty guineas. The controls are rather unusual, inasmuch as the on-off switch is combined with the tone control and not combined with the volume control as is the usual practice.

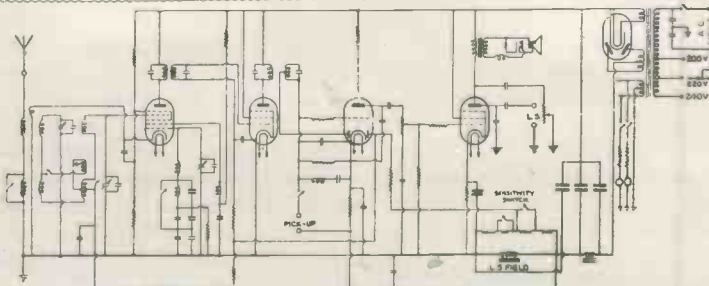

The circuit of the G.E.C. Radiogram AVC5 has many interesting refinements

News of the Short Waves

By **KENNETH JOWERS**



W8AFM, an American amateur station, on 20 metres, is easily picked up in this country after 11 p.m.

VERY often an enthusiastic listener will go to the expense of making a big receiver, using high-grade components, in an endeavour to get better and more consistent reception. The very things that would help are usually forgotten. How many listeners have any reliable means of telling to what frequency their receiver is tuned?

Difficult Conditions

Remember that on medium waves, with every other powerful station a guide as to what part of the band you are on, conditions are totally different. On short-waves, where all of the regular stations are bunched together on different wavebands, it is particularly difficult to tell your whereabouts between 12 and 80 metres.

As a general rule, I can tell what station is being tuned in by listening to the stations on either side, or by the time of day and the type of programme. With the Empire stations pushing out two or three programmes at a time and Zeesen having two or three stations on the

air at the same time, it is becoming increasingly difficult to be sure of the wavelengths and identities of the stations heard.

I have a very complete set of gadgets with which I can tell just what station is being tuned in and I find them invaluable, particularly if I am testing a new receiver. Wavemeters that are calibrated for all wavebands, and oscillators that will tell me the wavelength coverage of a set of coils are invaluable, but these instruments cost money.

If you intend seriously to go in for short waves then the expense would be worth while, but on the other hand the average listener requires simple and inexpensive apparatus. It is possible to make two or three meters which will be sufficiently accurate for your normal use at a cost of only a few shillings.

I am going to give you several circuits of such gear. Should you not want them at the moment, keep them by for when short waves really do come into their own such meters will be very helpful.

An absorption wavemeter is a unit that every short-wave listener should have. With it you can calibrate a receiver, while no exception can be taken to it on the score of cost. Fig. 1 shows a typical wavemeter consisting of a coil and tuning condenser, which is built on a small baseboard, and panel.

The coil should be similar to the one used in your short-

wave receiver, while the tuning condenser has a capacity of between .0001 and .0003 microfarad. Mount the condenser on the panel and connect across it the tuning coil. The coil can either be fixed to the baseboard by a holder or to the condenser itself. Do use a large dial on the condenser, for this will make

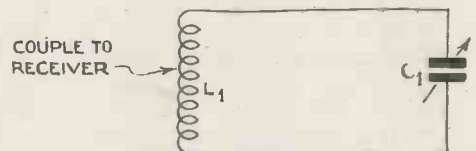

Fig. 1.—The circuit of a typical wavemeter consisting of a tuning coil and condenser

the unit much more simple to calibrate.

Calibration is quite an easy job if you go about it in the right way. There are always a number of stations that you can positively identify. The Empire stations are quite good in this respect. Tune in GSA on 49.59 metres, leave the receiver gently oscillating, then put the wavemeter close to the tuning coil of the set.

Calibrating

Adjust the condenser until you hear a pop in the loud-speaker or where you reach a well-defined point where the receiver goes out of oscillation. Repeat this for the other Empire stations on the 31, 25, 19, 16, and 13-metre bands, make a pencil note of the actual wavelengths

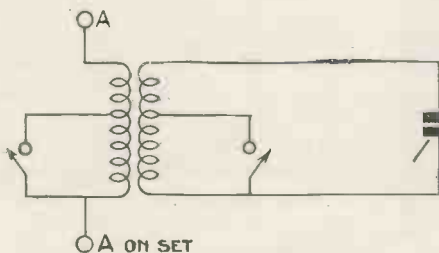

Fig. 2.—An alternative wavemeter circuit to Fig. 1. Here there is a primary winding to the coil



Fig. 3.—A circuit of a Dynatron oscillator that uses a screen-grid valve

and the reading from the wavemeter.

When you have done this you can plot a curve of wavemeter readings as against wavelengths on a piece of squared paper. Join all the points together, and you will be able to tell the dial readings of any intermediate station.

Alternative Method

This method of calibration holds good for all types of wavemeters. There is one little difficulty to this idea, and that is the calibration may vary unless the coil is always held at the same distance from the coil in the receiver.

This can be got over by fixing the meter to the baseboard or by using the circuit in Fig. 2. In this circuit there is a primary winding to the coil which is permanently connected to the receiver so that the amount of coupling remains constant.

Dynatron Oscillator

One of the best arrangements is the Dynatron oscillator, which produces a definite oscillation which can be picked up in the short-wave set. This type of wavemeter—shown in Fig. 3—uses a screen-grid valve, with a tuned coil in its anode circuit.

The connections are rather unusual, and you will notice that the anode voltage is between 0 and 20, while the screen voltage is between 60 and 100. The control grid is connected to either low-tension negative or positive. The best position can be found by experiment.

Provided that the anode current remains constant, then the

readings can always be reliable, so I advise you to connect a small milliammeter in circuit so that the voltages can be adjusted to keep the anode current steady.

One of the most useful gadgets to make up is a modulated oscillator, which can be run from the mains. This type of oscillator gives a steady low-pitched note that can be heard at a distance of about 20 or 30 yards from the actual oscillator. If this is calibrated in the usual way, it can be used as an oscillator or wavemeter, or as a means of giving a steady output so that the receiver can be adjusted to give the maximum results.

It is very similar to the simple Dynatron oscillator in Fig. 3, except that it has in its anode circuit a small low-frequency choke in parallel with a .01-microfarad fixed condenser.

Here again the constancy of the calibrations depends on the anode current of the valve. This should not vary with an A.C. valve, but you can always connect in circuit with the negative lead a small milliammeter if you have any doubt about it.

The pitch of the note can be varied by altering the value of the condenser in parallel with the low-frequency choke.

A .01-microfarad condenser is a good average value, but it can be varied to suit personal taste. The larger the condenser the lower the note, and vice versa.

Improving Conditions

Now is the time to get down to the making of these instruments, for short-wave conditions are improving steadily. During the past few weeks I have heard many DX stations which indicate that the 20-metre band is really worth considering. X1G, the Mexican station, has been

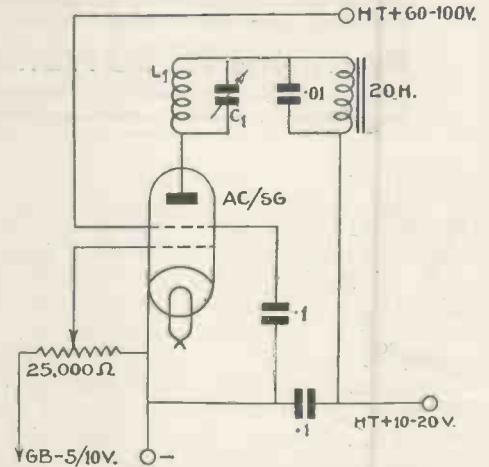

Fig. 4.—Circuit for a modulated Dynatron oscillator, which is for use on A.C. mains

heard quite frequently at good loud-speaker strength. Quite a number of the third and fourth district American stations have been coming over after 11 o'clock at night.

R. D. Everard, of Standon, tells me that although he has not been very fortunate lately he has logged such stations as CM6XS, W1CPD, W8GLY, VE2DX, ON4PA, PAOAO, PF8DL, and F4AA.

Most amateurs will have heard G2LZ talking to the Essex amateurs about his trip to Holland. It seems to me that G2LZ is a born entertainer, for his remarks were most amusing.

After he had shut down on Sunday morning, the 80-metre band was full of English amateurs calling him up. Fortunately conditions were bad and few of them got over.

That Sunday morning was rather interesting, for the local stations up to 50 or 60 miles away were coming in R3 to 4, whereas the North Country stations, over 200 miles away, were R8 to 9.

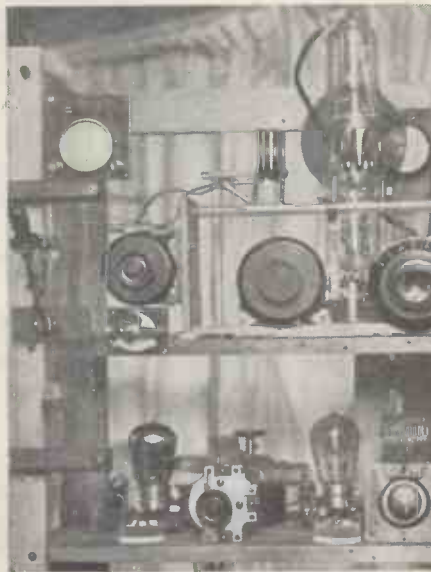

HOW THE GEAR IS ARRANGED
This photograph of part of a 10-metre transmitter is typical of that used by amateurs all over the country

TESTS OF NEW APPARATUS

Parmeko Microphone and Transformer :: Ekco A.C. Mains Unit :: W. B. Stentorian Loud-speaker
Marconiphone Pick-up :: Magnavox Model 66 A.C. Energised Loud-speaker

PARMEKO MICROPHONE

APPARATUS : Microphone and transformer.
MAKERS : Partridge & Mee, Ltd.
MODEL : Junior.
PRICE : £3 3s. (transformer 12s. 6d. extra).

THE name Parmeko has long been associated with high-grade power units and amplifiers. The entry of the firm into the microphone market will be regarded with interest. Certainly the sample submitted was both neat and workmanlike.

The microphone itself is housed in a diecast case with a plated cover over the front. It is carried by two springs in a simple framework mounted on a cast base, the whole making a simple but rigid fixing. A 15 to 1 transformer, matched to the microphone, is also supplied housed in a neat diecast shell.

Short of taking an actual response curve, which is a lengthy process, there is little that one can do to test a microphone except try it.

We were advised that the response only varied a few decibels from 80 to 8,000 cycles, and one can readily believe this. Tested on both speech and music, the response was noticeably good and we were unable to detect any resonances over the audible range.

The sensitivity was reasonable, depending almost directly on the D.C. across the instrument. About 12 volts appeared to be a good value, under which conditions it took 20 milliamperes.

With 12 volts D.C. and speaking a few inches away produced about $\frac{1}{4}$ volt. A sharp whistle gave 3 volts.

EKCO MAINS UNIT

APPARATUS : High-tension mains unit.
MAKERS : E. K. Cole, Ltd.
PRICE : £2 2s. 6d.

THIS is a simple high-tension unit suitable for sets taking between 15 and 20 milliamperes. It is housed in a brown bakelite case with a small panel in the middle on which the tapping points are placed.

Three taps are provided, a main output giving 120 to 150 volts, a variable tapping for 50 to 80 volts, and a screen-grid tapping supplying about 80 volts, both these last tapings being suitable for an output of 1 to 2 milliamperes.

A single-wave circuit is used and the transformer is of generous dimensions to allow for the D.C., which flows through the windings. The rectifier is of an unusual type, being very much smaller than usual. It measures only $1\frac{1}{4}$ in. long and has only twelve discs. For all

that, it delivers plenty of current.

On test we took various loads from the different tapings. It is unnecessary to enumerate these at length. Suffice to say that the unit lived up to its rating delivering 127 volts at 18 milliamperes on the full tap and voltages substantially as rated on the variable and screen-grid tapings with currents of 2 and 1 milliamperes respectively.

For an extra 10s. this unit will be supplied with a trickle charger which will charge a 2-volt accumulator at .5-ampere.

W.B. LOUD-SPEAKER

APPARATUS : W. B. Stentorian loud-speaker.
MAKERS : Whiteley Electrical Radio Co., Ltd.
PRICE : £2 2s.

THIS new addition to the W.B. range of loud-speakers contains several novel features. In the first place it uses a new alloy for the magnetic system, which gives an increased field strength in a small compass, an important factor in permanent-magnet loud-speakers.

A further feature is that the coil is completely

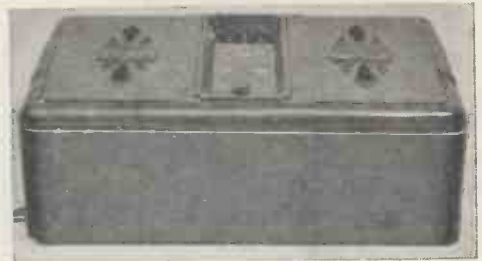

A new mains unit by Ekco is housed in a neat bakelite case

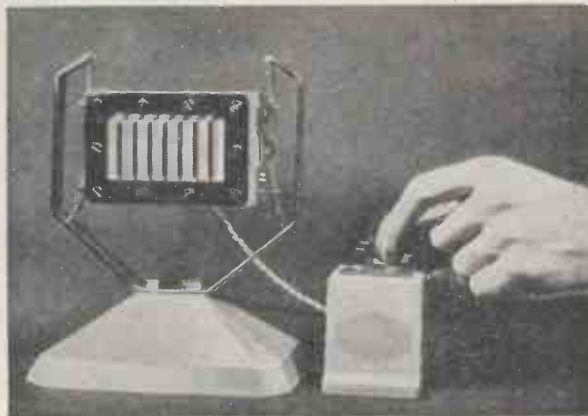

A Parmeko microphone and matching transformer which are ideal for amateur and professional use. They are moderately priced



Good frequency response is given by the new W. B. Stentorian permanent-magnet moving-coil instrument

enclosed both back and front, so that dust is excluded from the gap. This should preserve the freedom of movement, even when the instrument has been in use for some time.

The usual W.B. impedance-matching arrangements are provided in the form of a rotary switch covering nine positions, with a concentric knob which changes from a high to a low impedance. Thus a very wide range of coverage is obtained.

The response was good, particularly for a permanent-magnet loud-speaker. It went down to below 60 cycles without boominess and it would stand up to some 3 or 4 watts speech output without any signs of rattle.

Considering that the overall dimensions are only 10 in. high, 9½ in. wide by 5½ in. deep, this reproducer is certainly both neat and effective.

MARCONIPHONE PICK-UP

APPARATUS: Gramophone pick-up.
MAKERS: Marconiphone Co., Ltd.
MODEL: 25.
PRICE: £1 12s. 6d.

A NEW addition to the range of Marconiphone pick-ups is always a welcome event. The latest is a neat instrument in which there is evidence of simplicity of thought.

The pick-up is in one piece with a curved tone arm, both being finished in a brown moulding. The whole arm lifts up for inserting the needle.

A feature of the pick-up is the inclusion of a hum-bucking coil. As

a matter of interest we examined the effectiveness of this device and found that it certainly "did its stuff!" If the pick-up were placed near a mains transformer or motor with the hum-bucking coil out of circuit, a very pronounced hum could be detected. On connecting the coil in circuit again the hum vanished almost completely.

The response of the pick-up had a somewhat marked drop in the middle register, and this tends to throw the upper frequencies into prominence. This, however, is a good point because "top" can be lost

quickly enough. The sensitivity was above the average.

A feature of the pick-up is its small tracking error.

We can confidently recommend the pick-up to all grammo-radio fans in search of good quality.



The new 1934-5 Marconiphone pick-up—always a news event for the grammo-radio fan

MAGNAVOX MODEL 66 LOUD-SPEAKER

APPARATUS: Mains-energised moving-coil loud-speaker.
MAKERS: Magnavox (Gt. Britain), Ltd.
MODEL: 66, A.C. energised.
PRICE: £7 17s. 6d.

THIS new Magnavox model 66 is a remarkably fine piece of work. Following the practice popularised in their Magna series, a very massive magnet system is provided. This produces an unusually heavy magnetic field giving the loud-speaker a "bite" on transients which is pleasing in the extreme.

A 10½-in. diaphragm is employed with a coil of 2 in. diameter and a

particularly robust centring device is used, being some 4 in. across, mounted outside the coil.

The loud-speaker incorporates a power supply unit for the field embodying metal rectifier and the necessary (electrolytic) smoothing condensers. The hum is quite inaudible 2 ft. away.

A speech input transformer is supplied suitable for triode, pentode, or push-pull valves. The response, as

More About the Stenode Sets
in the November Issue of
"WIRELESS MAGAZINE"
Published on Wednesday,
October 31.

already mentioned, was excellent and the sensitivity high. The loud-speaker handled 10 watts during our test without any signs of distress.

The mains input leads are rather near the speech input leads and an inexperienced person might run some risk of shock in changing the connections with the field supply still live.

However, once the connections have been made there is no chance of trouble for a metal cover fits over the terminal connection strip. You can see this clearly in the photograph.

This, however, is a small criticism in a well-conceived production.

Magnavox make models of this type for use on D.C. mains.



A big A.C. energised moving-coil loud-speaker for the connoisseur of quality—the Magnavox model 66

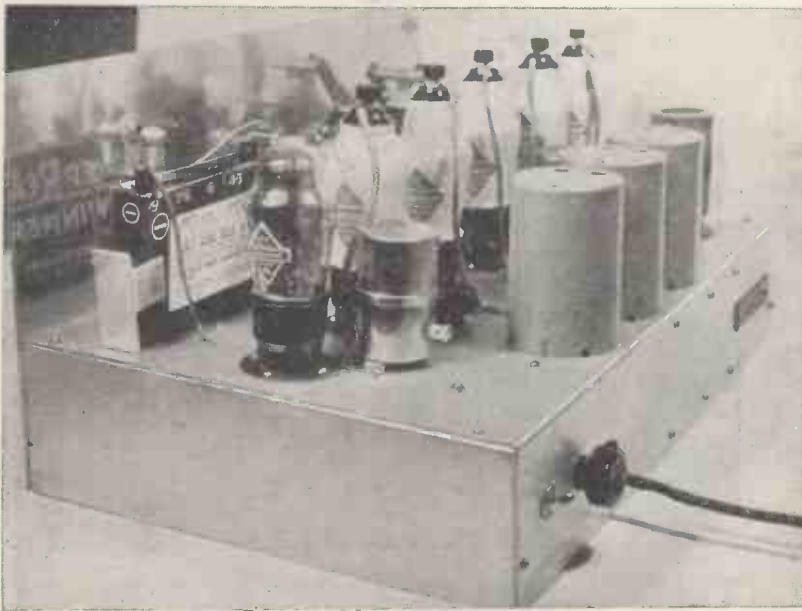

A HOT JOB FOR THE SHORT-WAVE ENTHUSIAST

A view of the top of the set showing the three 450-kilocycle intermediate-frequency coils, the long row of valves and the high-frequency choke

points about these commercial sets with which I did not agree, and I felt it would not be difficult to improve upon them.

Nine-kilocycle selectivity on short-waves is now useless with a really good long-distance receiver, but there is very little possibility of improving even the home constructors' sets as long as the best intermediate-frequency coils have a band width of 7 or 9 kilocycles.

Stenode Experiments

For a few years I have been experimenting with a medium-wave Stenode type of receiver, and, as most readers will probably know after reading about the Stenode receiver in this issue, the selectivity is so extraordinary that powerful stations can be tuned in even though they are only separated by the thickness of a pencil line on the tuning scale.

Six Months' Test

About six months ago, the final or seemingly final design was decided upon, and the Quartz-crystal Super was constructed. This set had overcome all of the snags which had previously troubled me with short-wave super-hets, but as new ideas came along I have steadily improved the original design. It now has a reaction control, a separate oscillator and several other points which were not part of the original design. So you see, it has been under practical tests long enough.

The receiver as it stands now is perfectly straightforward with the exception of one or two little points which must be considered. First of all, there are seven valves of which five are high-frequency pentodes. The first is in the high-frequency stage in front of the first detector. It is untuned and gives only a small stage gain below 20 metres. The idea is to stabilise the circuit so as to make it immune from any variations that might occur through differences in aerial capacity.

The first detector is a straight high-frequency pentode band-pass

coupled to a second variable- μ high-frequency pentode as the first intermediate-frequency amplifier.

The fourth valve is another intermediate-frequency amplifier with a quartz crystal resonating at 450 kilocycles in its grid circuit. As a second detector I have used another high-frequency pentode which gives a high stage gain and is very easy to handle.

One Watt Output

The power output of the low-frequency pentode is 1,000 milliwatts, more than enough for the average room. For the seventh valve we have used a triode as a separate oscillator.

In my original experiments I decided that this was not necessary. But as the background noise decreased considerably when the oscillator was independent of the first detector, it was obviously a great advantage and the seventh valve was really worth using.

Conventional Circuit

Actually the circuit is quite conventional. The first high-frequency valve is untuned, while the two tuning condensers, one of which tunes the grid circuit of the first detector and the other tunes the anode circuit of the oscillator valve, are both simple to handle.

The whole secret of the success of the receiver lies in the grid circuit of the second intermediate-frequency valve. Most readers will probably realise that by using a quartz crystal

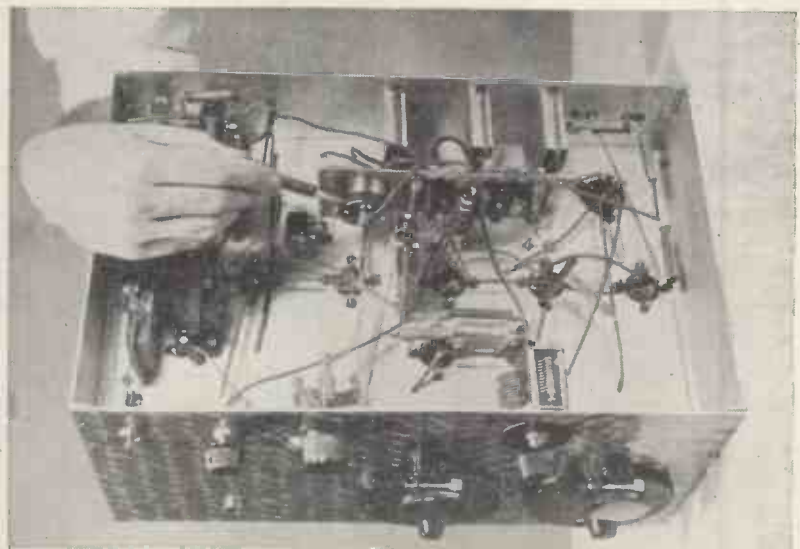

SECRET OF THE SET'S SELECTIVITY

Mounted on the resistance strip is the Brookes quartz crystal in an airtight mousing. It is the crystal that gives the extreme selectivity

in series with the grid input only one frequency, that of the crystal, can be accepted.

Optional Selectivity

This is rather too drastic for normal use except for the reception of Morse signals when a wide frequency band is not required. To flatten the tuning so as to receive telephony, I have used a circuit which enables the speech currents to be applied to the grid of the high-frequency pentode, associated with the crystal, either through the



MOUNTED QUARTZ CRYSTAL
This shows the Brookes quartz crystal. It has been specially designed for this set

crystal gate or through a variable condenser.

This condenser has a maximum capacity of 100 micro-microfarads, and the greater the capacity circuit, the less effective will be the crystal. In this way the selectivity can be varied up to 7 kilocycles, the maximum band width of the intermediate-frequency coils.

It will be appreciated from this that if you are listening to a station that is being interfered with, the selectivity can be increased to eliminate the unwanted station, or until the quality begins to suffer.

There are two sets of coils used in the receiver, both different.

Medium Waves as well

Although this set is called a short-waver it is rather misleading for the maximum wavelength is 510 metres. So in addition to the normal short wave-band the medium stations can be tuned in providing you are not too close to the local station, otherwise harmonics may be rather annoying.

Six coils tune between 12 and 510 metres in steps. The first wave range is 12 to 26 metres, followed by 22 to 47, 41 to 94, 76 to 170, 150 to 325, and 260 to 510.

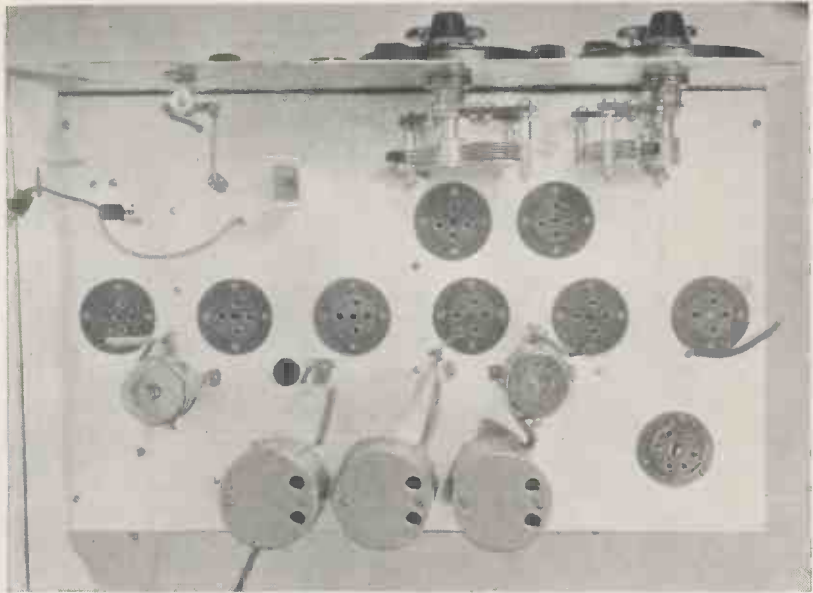

PLAN OF THE TOP SIDE OF THE SET

A plan view of the upper side of the Quartz-crystal Super, which should be used in conjunction with the wiring plan. Note how the screened anode leads are fixed to the chassis

For listeners abroad where selectivity is not so important, additional coils can be obtained to tune between 490 and 2,000 metres. The oscillator coil, which has only 4-pin connections, covers similar wave-ranges.

All the components that have been bolted to the chassis are fitted with shake-proof washers so there is no possibility of them becoming loose. This point will be appreciated by Colonial listeners.

The variable condensers, with the exception of the '0001-microfarad type across the crystal, are fixed directly to the chassis.

This '0001-type must be carefully bushed off the panel by means of ebonite spacing pieces, otherwise the grid circuit will be short-circuited to earth. Most of the anode and grid strip which is in turn bolted to the chassis. In this way I have overcome the snag of having untidy wires and floating resistances.

Provision for Pick-up.

You will notice that in the grid circuit of the second detector is a plug and jack. This is for the gramophone pick-up and you should remember that you will need

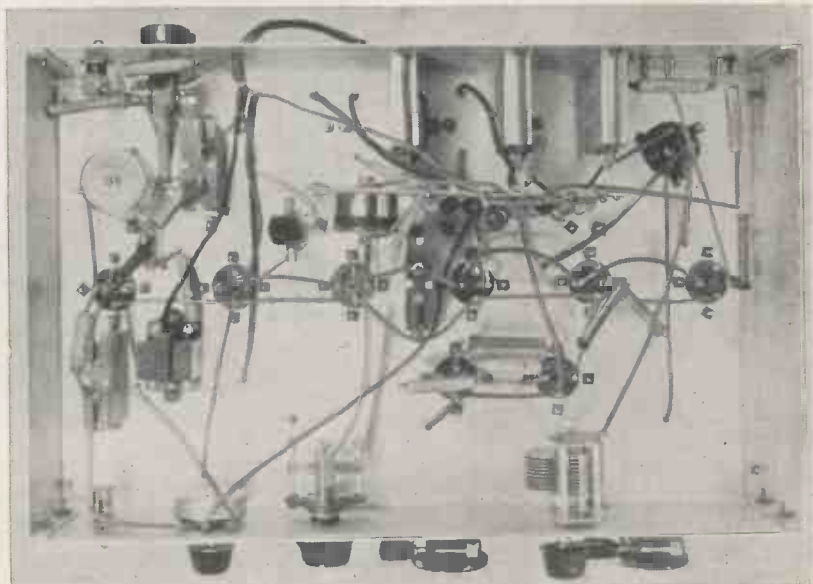

PLAN VIEW OF THE UNDERSIDE

A plan view of the underside of the chassis. It is, as you can see, a workmanlike layout that can be copied easily by all short-wave constructors

to the negative filament pin on each of the seven valve holders is taken direct to the nearest bolt on the chassis. This idea is used whenever possible to save wiring and make the whole chassis layout simple.

Anode Current

In normal circumstances, when the receiver is running at half strength the average anode current is about 18 milliamperes, but this will rise to 25 milliamperes at full volume.

This is perhaps rather large, but the current can be obtained from high-capacity dry batteries or from wet accumulators. You must not

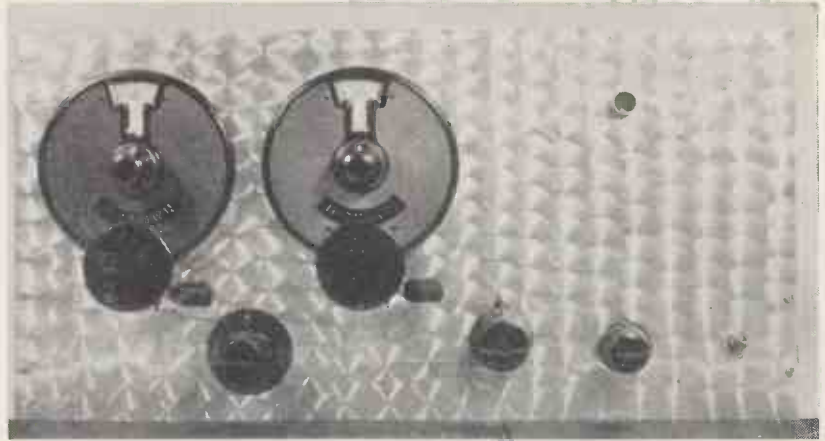

LAYOUT OF THE CONTROLS

The left-hand dial tunes the grid circuit of the first detector and the right-hand dial is the oscillator tuner. The small knobs, from left to right, are the optional reaction control, crystal cut-out, volume control, and on-off switch

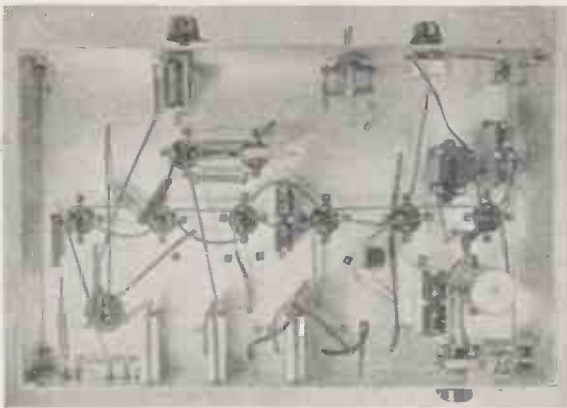

IN THE COURSE OF WIRING

To simplify the wiring of the underside, here you see a photograph of the set with only part of the wiring done

in any circumstances use a small dry battery, for it will last only a short time before the internal resistance begins to rise.

A word about the optional reaction

control. You will notice that the reaction winding on the high-frequency transformer has been connected to one side of the .0002 - microfarad reaction condenser, but the wire from the other side of the coil of the second detector has been omitted. This control is not absolutely necessary, though weak signals can be boosted up if it is carefully used. For your first tests, forget this control and do not worry about the crystal condenser providing it is set at maximum capacity.

Even with the tuning as flat as it is possible to make it, no station takes more than a quarter of a degree on the dial, so tuning will be really tricky unless you are prepared to tune very slowly.

I have made it as simple as I can by using Igranic dials that have two ratios, one of about 9 to 1 and the other about 500 to 1.

Next Month

In this short article I have not been able to give much help on tuning and other points of interest, but next month I will give many more details and a log of the stations that can be heard, with the approximate dial reading. This will enable all short-wave fans to get down to really long-distance reception without having to fiddle about finding the actual dial readings.

LIST OF PARTS NEEDED FOR THE QUARTZ-CRYSTAL SUPER

CHASSIS		HOLDERS, VALVE		BATTERIES	
	£ s. d.		£ s. d.		£ s. d.
1—Peto-Scott aluminium, 16 in. by 10 in. by 3 in., with 16 in. by 8 in. panel	14 0	8—Clix, type chassis-mounting, without terminals, four-pin (7), five-pin	3 5	2—Ever Ready 60-volt high-tension, type High-power 60	1 10 0
CHOKES, HIGH-FREQUENCY		RESISTANCES, FIXED		1—Ever Ready 9-volt grid-bias	1 0
3—Eddystone screened, type 983	11 3	14—Claude Lyons, type 1-watt, values: 5,000- (2), 10,000- (3), 25,000-, 50,000- (2), 100,000-ohm, 1- (4), 5-megohm	7 0	1—Evide 2-volt accumulator, type CZ96	16 6
1—Eddystone, type 948	2 9	RESISTANCES, VARIABLE		TRANSFORMERS, INTERMEDIATE-FREQUENCY	
COILS		1—Eric, 25,000-ohm	3 6	3—Eddystone 450-kilocycle, type 974	1 11 6
1—Set of five Eddystone six-pin, type 959 (12-510 metres)	1 10 6	SUNDRIES		TRANSFORMER, LOW-FREQUENCY	
1—Set of five B.T.S. four-pin oscillators (12-510 metres)	1 0 0	6 doz. 1/2-in. 6B.A. nuts and bolts say	2 0	1—Bulgin, type Senator	6 0
CONDENSERS, FIXED		6 doz. shake-proof washers, say	1 0	ACCESSORIES	
8—T.C.C. type tubular, values: .0001-, (2), .0005- (2), .005-, .006-, .01-microfarad (3)	10 0	1—Ohmic nine-way resistance strip, and crystal support	3 0	2—Ever Ready 60-volt high-tension, type High-power 60	1 10 0
6—T.M.C. Hydra, type 25, values: 1- (5), 2-microfarad	14 3	1—Clix terminal strip, marked: A1, A2, E	7	1—Ever Ready 9-volt grid-bias	1 0
CONDENSERS, VARIABLE		1—Goltone five-way battery cord	1 3	1—Evide 2-volt accumulator, type CZ96	16 6
2—Eddystone .00010-microfarad, type 922	17 0	1—Igranic loud-speaker jack	1 3	LOUD-SPEAKER	
1—Eddystone .0001-microfarad, type 900	5 0	1—Igranic pick-up jack, type P74	1 9	1—Ferranti, type MST, cabinet model	3 10 0
1—Eddystone .0002-microfarad, slow-motion reaction type	6 0	2—Bulgin plugs, type P15	3 0	HEADPHONES	
CRYSTAL, QUARTZ		1—Eddystone six-pin coil base, type chassis-mounting	1 6	1—Pair Brown A	2 10 0
1—Brookes 450-kilocycles with holder	1 10 0	3 ft. screened sleeving, say	9	VALVES	
DIALS, SLOW-MOTION		Oiled sleeving (Peto-Scott), say	1 6	3—Cossor 210VPT, metallised	2 0 6
2—Igranic, type micro-vernier	15 0	Round tinned copper wire, No. 20 gauge for connecting, say	1 0	2—Cossor 210SPT, metallised	1 7 6
		1—Bulgin signal lamp, type C19	1 3	1—Cossor 210Det, metallised	5 6
		1—Bulgin 2-volt pilot bulb	6	1—Cossor 220PT	13 6



Columbia photo

HENRY HALL AND IGOR STRAVINSKY
This photograph was taken in the Columbia studios during the recording of a new piano work by Stravinsky, the famous composer of modern music. Henry seems very interested

DEBROY SOMERS has had a happy time with the *Gondoliers*. That is to say he has given an excellent impression of the whole opera in a smart building-up of the tunes. A very good record, containing just what you want (Columbia DB1418, 4s.).

The Gaumont British Orchestra, conducted by Louis Levy, has done the same sort of office for *Chu Chin Chow*, which, as you know, has been recently filmed. In this selection you will get "The Cobbler's Song," "I'll Sing and Dance," and some of the entrances. Very well done! The orchestra is definitely good. Columbia DX592 (4s.).

Another light orchestral record has interested me. You had better get it as it may (or may not) be the last of its kind. Sir Dan Godfrey is about to retire from his position at Bournemouth, and I imagine this must be one of his last or latest records. It is of Offenbach's *Orpheus in the Underworld* overture, but it has nothing to do with gangsters, you understand. As it is of Orpheus it is sweet, which they are not. Very well done. Columbia DX593 (4s.).

The Berlin - Charlottenburg Opera Orchestra ought to make a big name for itself in this country. Get Decca LY6097 (3s. 6d.) and hear Schubert's *First Military March*, with the

Schubert-Liszt arrangement of the *Grand Hungarian March in C Minor* on the other side. Very fine and well worth having! I liked it immensely.

Johann Strauss' *Tales from the Vienna Woods*, played by Lilly Gyenes and her Twenty Hungarian Gypsy Girls. Rather out of the ordinary style and welcome on that account. The number is PO5101 of Decca (2s. 6d.).

Marek Weber has frozen on to the *Four Indian Love Lyrics*. I thought they had expired long ago. But he has very successfully revived them (H.M.V. B8205, 2s. 6d.).

Songs

By the way, I have heard several excerpts of light music from the very unusual film, *Evergreen*, featuring that great star, Jessie Matthews. Ask to hear some of them. I fancy you will be more than enthusiastic. I was!

Charles Kullman, tenor, sings Navine's *Serenade* and

CHOOSING

New Record Releases Reviewed

also *Come Back to Tomento* in a way I think should appeal to you. This is on Columbia DB1416 (2s. 6d.). On Columbia DB1417 you will find that admirable soprano, Ina Souez, singing *Love, I Give You My All* and *Always*. The first is from "Nirvana"; the second from "Puritan Lullaby." Sentimental, but good!

Parry's *Jerusalem* and *Christ is Risen* (Rachmaninoff) are sung, as you would expect Peter Dawson to sing them, on H.M.V. B8796 (2s. 6d.). A very good record indeed. The Rachmaninoff is a lovely song.

If you like *None but the Lonely Heart* of Tchaikovsky, do get H.M.V. DA1383 (4s.) because it is beautifully sung by Lawrence Tibbett, whose baritone voice records perfectly.

Perhaps the most effective vocal record before me is by Frank Titterton. It is an operatic selection, really and truly, but he is the chief figure in it. Decca K735 (3s.). Frank Titterton is one of our most characteristic tenors. His diction is always so good, which cannot be said for every recorded tenor, by a long way.

A Concerto

The London Philharmonic Orchestra, under John Barbirolli,



H.M.V. photo

MASTER OF LIGHT MUSIC
Marek Weber, a wizard of the violin and light-music presentation, records for H.M.V.



Columbia photos

(Top, left) A scene during the recording of a new dance number by Van Phillips and his all-star band. (Above) Jesse Matthews, the star of the new film, "Evergreen," records song hits for Columbia

Your Records

by WHITAKER - WILSON

plays the Mozart *Violin Concerto in A major* with Heifetz, the soloist. This is, of course, an important issue for the connoisseur. There are four discs.

It is a great triumph to have recorded a work of this kind so perfectly. H.M.V. DB2199-2202 (6s. each).

Columbia produces a little humour by Bobby Howes who appears in *Let's Dress for Dinner To-night* and *Yes, Sir! I Love Your Daughter*. You will get some amusement out of the latter.

I have a Sandler record for you on Columbia (DB1423, 2s. 6d.). *O Sole Mio* and a reverie by Zanne. Mr. Sandler is assisted by J. Samehtini (Cello) and S. Byfield (piano). A very pleasing combination.

Additional Records Reviewed

By CHOPSTICK

★(a) *Don't Let Your Love Go Wrong*, (b) *Why Don't You Practise What You Preach*, Boswell Sisters, 2s. 6d.

BRUNS 1832
A charming record of its kind. The Boswell Sisters are always worth hearing. I believe, really, that they are even surpassing their old standard nowadays. A real musical treat, this!

PIANO SOLO

★Billy Mayerl's *Savoy Havana Memories* (d.s.), Billy Mayerl at the piano, 2s. 6d.

COL DB1419
Billy Mayerl—master of syncopation—shows you how the piano should be played, and can be played. Very good, Billy—I wish I could play just half as well as you do on this disc. The medley is of very old favourites—but none the worse for that—and includes "Indian Love Call," "Kitten on the Keys," "Chilli Bom-Bom," and so on. Worth having by all!

Rhapsody in Blue (d.s.), Eight Piano Symphony, conducted by Harold Ramsay, 1s. 6d.

DECCA F5097

This disc of Gershwin's famous rhapsody was actually recorded on the stage of the Tooting Granada cinema, so accounting for the remarkable "live" acoustics of the recording. You have no doubt heard multi-piano orchestras before—this is a classic example of the magnificence of such a combination.

LIGHT ORCHESTRAL

★(a) *Evergreen*—Selection, (b) *Twenty Million Sweethearts*—Selection, New Mayfair Orch., 4s. **H.M.V. C2681**

"Evergreen" is the rage just now, and it well deserves it. "Over My Shoulder" and "When You've Got a Little Springtime" are in themselves sufficient to put the show right over. The New Mayfair Orchestra does more than justice to the cuteness of these tunes as well as all the others such as "Tinkle, Tinkle" and "Dancing on the Ceiling." On the reverse is a medley from the film (as title (b)). If you haven't heard "Evergreen" tunes you are missing the thrill of the day.

(a) *Hula Girl* (one-step), (b) *King's Serenade* (w.), Sol Hoopii and His Novelty

Quartet, 2s. 6d. **BRUNS 1822**

The novelty quartet consists of string bass, ukelele, guitar and steel guitar. The waltz is very attractive. Right speed to start with and it has a real Hawaiian flavour. One of the most brilliant works of its kind yet; (a) on the other hand is full to the brim with "hot pepper."

★(a) *Sweet Sorrow Blues*, (b) *Air in D Flat*, Spike Hughes and His Negro Orch., 1s. 6d. **DECCA F5101**

Truthfully this is the most brilliant "hot" record I have heard for a long time. Do not mistake (b) for a modern adaptation of a Bach Prom item—you would be disappointed. Those with a flare for the modern touch—get it at once.

DANCE MUSIC

(a) *At the Court of Old King Cole* (comedy f.), (b) *Dreamy Serenade* (tango), B.B.C. Dance Orch., directed by Henry Hall, 2s. 6d.

COL CB772

I do admire the tune (a)—composed by the late Raic da Costa—and I can sincerely recommend the B.B.C. band's version. I am paying this band a compliment when I say it is a kiddies' record. Every second of the three minutes will amuse youngsters from eighteen months to eighty. On the reverse is a tango

—but the B.B.C. band, as I have said elsewhere, has not got the happy knack.

(a) *Fair and Warmer* (f.), (b) *I'll String Along With You* (f.), Ray Noble and His Orch., 2s. 6d. **H.M.V. B6503**

Both these tunes are from the film, *Twenty Million Sweethearts* and have, as far as I can judge, a vocal by Al Bowlly. I am not keenly enthusiastic about them, but I am intrigued by Ray Noble's natty arrangements; (b) particularly has taken my fancy and makes the disc worth having. Ray has gone off to the States to seek new fields to conquer, but I do hope that we are not to lose him for long.

(a) *I'll String Along With You* (f.), *Little Valley in the Mountains* (tango), B.B.C. Dance Orch., 2s. 6d.

COL CB770

Very B.B.C.-ish this! (a) is a little too heavy for the type of tune, but whatever is wrong—if anything—is made up by the excellence of Les Allen.

(a) *It's All Forgotten Now* (slow f.), (b) *The Breeze* (slow f.), Van Phillips and His All-star Dance Orch., 2s. 6d.

COL CB774

You have heard this fine dance band in radio programmes—excellent, you will agree.

HOME TELEVISION SECTION

Progress in Germany

TELEVISION development in Germany is proceeding on different lines to what it is in this country. Under the guidance of the German postal

had their own ideas of what is required and what is immediately practicable and have worked accordingly.

No secret is made of progress in Germany and at the annual Radio Exhibition in recent years television has formed an important section. Demonstrations are given and all the apparatus is on view. It might be inferred that as all the firms have been grappling with the same problem results would have attained a fairly common standard.

This, however, has by no means been the case, as the recent demonstrations showed. All, however, showed a decided improvement on those of last year.

In recent years, cathode-ray and mechanical systems were about evenly divided; but it is significant that this year

only one concern showed a mechanical system of reception; all the rest were cathode-ray receivers. This single exception is the Tekade mirror screw with special mirrors, which are concave in both directions.

No doubt the general turn over to the cathode-ray tube is accounted for by the high standard necessary for 180-line scanning and a picture frequency of 25 per second.

The number of concerns which showed apparatus was less than last year, and it appears obvious that the reason is because mechanical systems could not attain the standard which has been set. It may be that this is indicative of the line which development will take in this country when the decision of the Postmaster General's Committee is known.

The concerns which are chiefly interested in television in Germany are three in number—Fernseh A. G., Telefunken, and Tekade. Manfred von Ardenne is also a well-known worker. The Fernseh A.G. are working on the intermediate film system, in which a film is taken of



Photo courtesy Telefunken
The Telefunken cathode-ray receiver for the home. It is expected that this type will shortly be available for the reception of the Berlin short-wave transmissions which are expected to commence in the autumn.

authorities all research workers are striving for a common end, and there is practically no secrecy being preserved regarding the progress that is being made.

The work is being pursued with a general standard as the object—180-line pictures and 25 pictures per second. The departures that have been made from this objective have been for the purpose of investigation and as easy stages towards ultimate development.

Conditions, therefore, are very different to what they are here, where individual workers have all

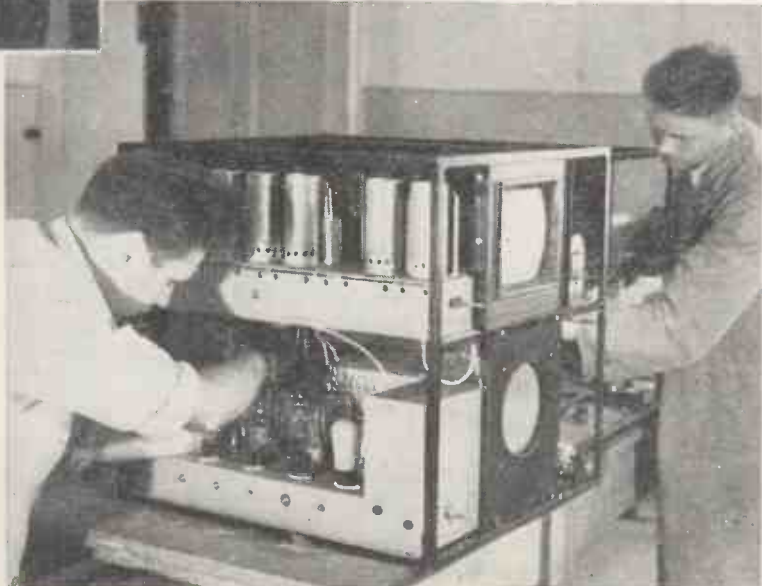

Photo courtesy Telefunken
The chassis of the Telefunken cathode-ray receiver in course of assembly

EVER-READY WIRELESS BATTERIES *chosen again*

This time, for the new

"W.M." QUARTZ CRYSTAL SUPER

Two Ever Ready High Power 60 volt
batteries priced at 15/- each and

one Ever Ready 9 volt Grid Bias
battery priced at 1/- have been

specified.



The best results from all the
best sets are assured when
Ever Ready batteries are used;
for there is an Ever Ready
battery made to power every

well-known set precisely and
with the greatest economy.
Write for the free list showing
the Ever Ready battery best
suited to your set.



WIRELESS BATTERIES

THE EVER READY CO. (GT. BRITAIN) LTD., HERCULES PLACE, HOLLOWAY, LONDON, N.7

When replying to advertisements, please mention "Wireless Magazine"

the scene it is wished to televise and this film is passed straight from the camera into developing and fixing tanks and is then scanned, after which the emulsion is removed and the film is resensitized for use over again. The time delay between the taking of the picture and the actual television transmission is exactly a minute and a quarter.

The system, although somewhat complicated, obviates many of the difficulties attendant upon the televising of outdoor scenes. Results so far obtained, though far from perfect, show considerable promise.

Whether the mirror screw as employed by the Tekade concern is the only practicable mechanical system for high-definition television it is difficult to say; but as remarked

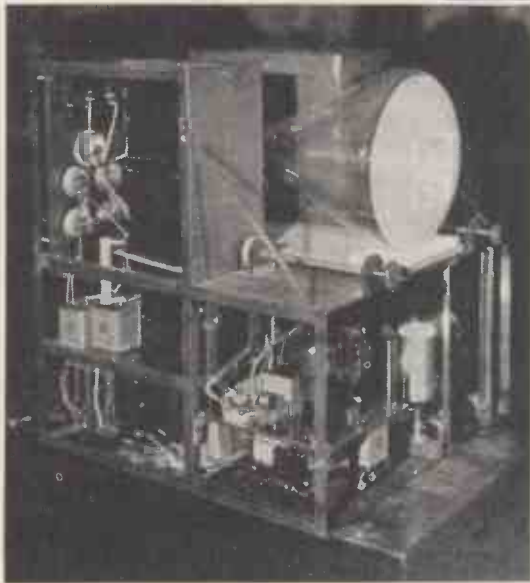

All transmissions at the exhibition were made by line, but concurrent with the development of television transmit-

upon the ultra-short waves, and it appears that most of the difficulties have now been surmounted. Excellent results have been obtained up to distances of about sixteen miles under ordinary conditions.

The only serious interference encountered is that from the ignition systems of motor-cars, and it has been possible to eliminate much of this. The opinion has now been formed that the Berlin Witzleben ultra-short wave transmitter which has a power of 4 kilowatts in the aerial is capable of providing the whole of the city with a television service.

It is now generally considered that the institution of a television service of high-definition pictures transmitted upon the ultra-short waves is imminent in Berlin.

*Photos courtesy
Tel funken*

(Above) The Berlin-Witzleben 15-kilowatt ultra-short wave transmitter

(Left) Another type of chassis of the Telefunken cathode-ray receiver

(Below) The scanning arrangements of the intermediate film transmitter

ting and receiving apparatus research has been proceeding with transmission

before, it is significant that it was the only apparatus of the mechanical type shown.

Neither do the results obtained warrant a great amount of optimism, for they were definitely inferior to those using cathode rays.

The Telefunken concern showed a cathode-ray receiver for the home which is the subject of one of the photographs on this page. This receiver proved that very fine results are possible and they easily come up to the standard of the home cinema. The picture was a sepia tone with dead black in the dark parts. From the point of view of all-round quality, the reproduction with this apparatus was easily the best of those demonstrated.

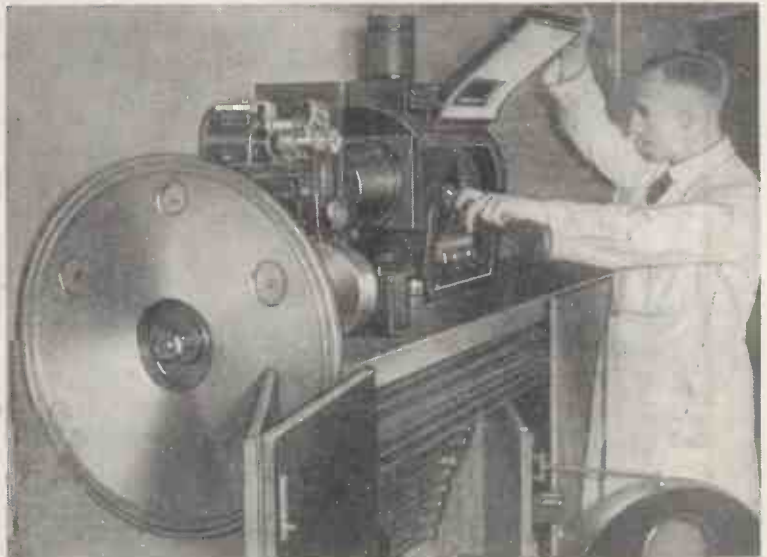

CONSTRUCTIONAL STRENGTH



The clean finish and quality of Hivac productions are strongly emphasised in the embossing of Hivac Anodes not only with the letter "H," but also with horizontal and vertical channels. These add to the strength of the structure and constitute a safeguard against buckling. This care in construction is responsible for the consistent characteristics of all Hivac valves.

HIVAC SPECIFIED FOR "THE BATTERY STENODE"

L210...	3/9
VP215	10/6
Z220...	13/6
DDT220	7/-

Hivac DDT220 also recommended for the combined det., A.V.C., and first L.F. stage.

Obtainable from all Curry's branches and high-class dealers.



BATTERY TYPES FROM 3/9

MAINS TYPES FROM 9/6

Hivac 1935 Valve Guide and Comparative Table "W.M." free on request.

CONSISTENT SERVICE

BRITISH MADE by High Vacuum Valve Co., Ltd., 113-117 Farringdon Rd., London, E.C.1

"CRYSTAL-GATES"

FOR SUPER-HET RECEIVERS

Frequency	Price
110 to 130 Kc/s.	16/6 ea.
*450 Kc/s.	20/- ea.
Holder (enclosed)	10/- ea.

* Specified for the "CRYSTAL-GATE SUPER"

BROOKES MEASURING TOOLS, 51-53 Church Street - Greenwich - London, S.E.10. Telephone: Greenwich 1828

Read about the 'stars' of the Mike and see what they look like in—

RADIO PICTORIAL

EVERY FRIDAY

PILOT AUTHOR KITS

Exact to Specification

SEND US YOUR ENQUIRIES FOR EVERYTHING RADIO

Miscellaneous Components, Parts, Kits, Finished Receivers or Accessories for Cash or C.O.D. or H.P. on our own system of Easy Payments. Send us a list of your wants. We will quote you by return. C.O.D. orders value over 10/- sent carriage and post charges paid (GREAT BRITAIN ONLY). Hire Purchase Terms are NOT available to Irish and Overseas customers.

BATTERY STENODE

Described in this month's issue.

KIT "A" Author's Kit of first specified parts, less valves and cabinet. £9/13/6
Cash or C.O.D. Carr. Paid Or 12 monthly payments of 17/9

KIT "B"—As for Kit "A," but including set of specified valves only. Cash or C.O.D. Carriage Paid, £12/6/8. Or 12 monthly payments of 22/6.

KIT "C"—As for Kit "A," but with set of specified valves and Peto-Scott Type Stenode "B" cabinet. Cash or C.O.D. Carriage Paid, £13/1/0. Or 12 monthly payments of 24/6.

KIT BITS You pay the Postman. We pay post charges on orders value over 10/- GREAT BRITAIN ONLY.

- 1 Peto-Scott aluminium chassis, as specified, 16 in. by 9 in. by 3 in., with 2 resistance strips, ready-£ s. d. drilled ... 12 6
- 1 Set of Balling Lee Stenode coupling units ... 3 5 0
- 1 Peto-Scott type Stenode B Cabinet ... 1 2 8

QUARTZ CRYSTAL SUPER

Described in this month's issue.

KIT "A" Author's Kit of first specified parts, less valves and cabinet. £12/11/6
Cash or C.O.D. Carr. Paid Or 12 monthly payments of 23/-

KIT "B"—As for Kit "A," but including set of specified valves only. Cash or C.O.D. Carriage Paid, £16/18/9. Or 48/- deposit and 11 monthly payments of 29/-.

KIT "C"—As for Kit "A," but with valves and Peto-Scott Cabinet. Cash or C.O.D. Carriage Paid £ 20/0/8. Or 50/8 deposit and 12 monthly payments of £2/-.

KIT-BITS You pay the postman. We pay post charges on orders value over 10/- GREAT BRITAIN ONLY.

- 1 Peto-Scott aluminium chassis and panel, as £ s. d. specified, ready-drilled ... 11 0
- 1 Ferranti type MST cabinet-model speaker ... 3 10 0

B.T.S. SET OF 5 SHORT-WAVE COILS £1

- (A) 12-29 metres ... 4/-
- (B) 26-52 metres ...
- (C) 47-96 metres ...
- (D) 80-260 metres ...
- (E) 210-510 metres ... each

NEW £6/6/0 BATTERY THREE

Described in this month's issue.

KIT A—Comprising Author's Kit of Specified Parts, less Valves and Cabinet. Cash or C.O.D., carr. paid. £3 or 12 monthly payments of 5/6.
A Peto-Scott Universal Console Cabinet, 21/-
1 set of Specified Valves £1/5/0.

PAUL D. TYER'S STENODE

Described in last month's issue.

RECEIVER KIT

Cash or C.O.D. Carriage Paid, £11/3/6. Or 12 monthly payments of 20/3.

MAINS UNIT KIT

Cash or C.O.D. Carriage Paid, £4/3/6. Or 12 monthly payments of 7/9.

COMPLETE KIT

Cash or C.O.D. Carriage Paid, £20/16/8. Or 76/3 deposit and 11 monthly payments of 34/-.

PETO-SCOTT CO. LTD.

77 (W.M.10) CITY ROAD, LONDON, E.C.1
Telephone: Clerkenwell 9406/7
West End Showrooms: 62 High Holborn, London, W.C.1
EST. 1919

Advertisers like to know you "saw it in the 'Wireless Magazine'"

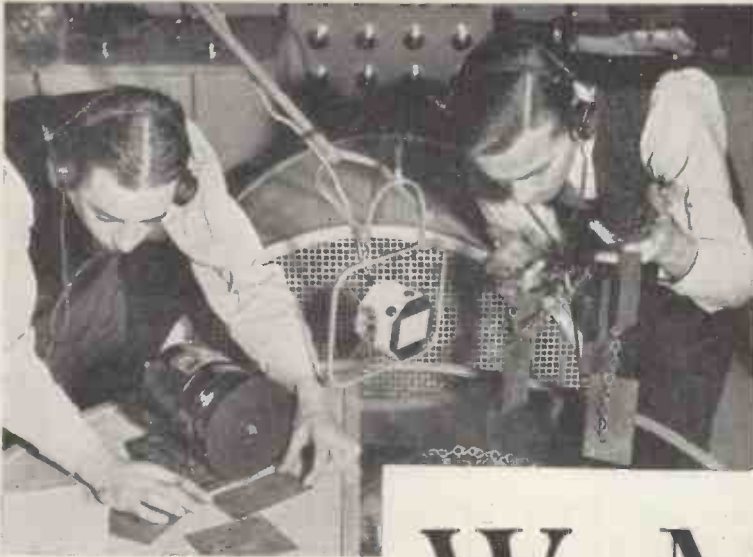

Keystone photo.

THERE is no getting away from entertainment. We live in that sort of age. We *must* be entertained.

Those of us who are old enough to remember when there was precious little entertainment to be had, are inclined to tell our young folk that they ought to be able to entertain themselves as their fathers did.

That is all very well, but it will hardly do in these days. There are still those happy souls who can go to see each of the Gilbert and Sullivan productions forty times and laugh more uproariously at the same old jokes each time, but they are gradually dying out. This generation responds to Gilbert and Sullivan, but not to that extent. There must always be something new.

The question as to what is and what is not entertainment in the radio sense requires going into occasionally.

The policy of the B.B.C. has always been to try everything once. A good policy, but one that is bound to lead them astray now and again. The trouble is that the slightest slip in the wrong direction and a broadcast becomes poor in the entertainment sense. Failures are made so easily—and who can forecast them?

On the other hand, it is possible to point to certain classes of broadcast which have either ceased to be good entertainment or else never were at any time.

Perhaps one of the most outstanding is the *impression* or *imita-*

We Must Be Entertained!

says WHITAKER-WILSON

tion. One well-known artist has threatened legal proceedings against anyone who imitates her on the air without her written permission. Not surprising in view of some of the imitations, which have been appallingly bad!

The whole thing came to a bad climax in the show relayed from the Midland Regional called *The Sincerest Form*. In this show, several Midland artists undertook to imitate well-known broadcasters. That was definitely one of the worst shows ever put on the wireless. Every comedian mimicked was pretty nearly libelled. The intention was all right, but the fact remained that people who are outstandingly good are not easily imitated.

The utter futility of this particular show came out in the stupidity of singing a song usually sung by Mr. A. B. C. and pretending it was an imitation of him. I could have sung the song, but it would not have been like either of them.

The whole policy of letting people, no matter how good, give

SO THIS IS ENTERTAINMENT!

We wonder what strange noises are being produced before the mike in the effects studio at Broadcasting House with these chains and other strange devices

imitations of other people on the air is wrong fundamentally. The people should do their own turns and nobody else's.

If the idea is to be extended, it is quite feasible for Harold Samuel to give a piano recital and say he is not playing as himself to-night, but is giving an imitation of Solomon or Myra Hess. Or getting Stanford Robinson to conduct the Theatre Orchestra and say he is imitating

Sir Henry Wood conducting a Prom is the same thing.

The idea, in any case, has been exploited out of all reason and has definitely no longer any entertainment value. It is time we had a rest from it.

Surely, if artists are not original enough to create turns of their own, they are not worth broadcasting. All they do is to cheapen the real artist and make them stale when they do appear. We can afford to pass by these radio imitators.

Animal or child impersonators are altogether different and to be commended in strict moderation. They are amongst our most original broadcasters. Wireless is quite obviously a good medium for them.

If we are to be entertained and not bored—how quickly we become bored!—there ought to be a committee of light-entertainment producers to consider humorous scripts. We have suffered from the silly comedian far too much lately. The backchatterer who just shrieks

Continued on page 280



BUY A

FULL O' POWER BATTERY

The Incomparable Radio Battery with exclusive features, which can be depended upon to provide the maximum of enjoyment from your wireless set, and the best possible service at the lowest cost consistent with dependability.

Buy one to-day. It proves its value by performance.

SIGNIFICANT
 FULL O'POWER Batteries have been specified for The Battery STENODE.

FULL O' POWER
 made by
SIEMENS
 Battery
 Specialists
 for over
 60 years



★BE SURE AND ASK YOUR DEALER FOR A SIEMENS FULL-O-POWER BATTERY

Advt. of Siemens Electric Lamps & Supplies Ltd. 38-39, Upper Thames Street, London, E.C.4

PACKED WITH INFORMATION

the latest Ferranti literature for home constructors



Full of interest and value, these latest Ferranti lists will prove to be of service to all constructors who desire to have the most up-to-date and efficient receivers.

- ✓ Booklet, Construction of Amplifiers.
- ✓ New complete Valve Catalogue.
- ✓ New list, Mains Components.
- ✓ New list, Audio Transformers.
- ✓ New list, Condensers.
- ✓ New list, Resistances and Potentiometers.
- ✓ New Speaker list.
- ✓ New Component Catalogue.
- ✓ New catalogue, Radio Meters.

Any of these publications will be sent on receipt of 1½d. stamp, or all of them on receipt of 3d. postage.



FERRANTI
 HOLLINWOOD
 LANCASHIRE
 SEASON
 1934 □ 1935

Dept. W.M.
 FERRANTI, LTD.,
 HOLLINWOOD, LANCASHIRE

Mention of the "Wireless Magazine" will ensure prompt attention

WE MUST BE ENTERTAINED I—

Continued from page 278

weak and feeble lines at his partner, trusting to luck that noise will do the trick, wants his script read out to him dispassionately and without the least intention to make anyone laugh.

Then if the rest of the committee laugh in the face of that sort of test, the backchatterer can be allowed to backchat. He is the most dangerous type of comedian in the humorous sense and we have had more than enough of him.

It all comes back to first principles. As we cannot see, we must depend on the quality of the lines.

There are several microphone characters whom we have come to regard as real people. In every case their popularity has been won on one thing alone—the actual humorous value of the lines. Inflection and quaint ways of saying those lines has always helped, but the value has been in the lines themselves.

Gert and Daisy (Elsie and Doris

Waters), Mrs. Feather (Jeanne de Casalis), Grandma Buggins (Mabel Constanduros)—to take three outstanding examples—stand up to the test every time. Gert and Daisy represent a type of Cockney well known to us. The fact that the Cockney inflexion is so perfectly done would stand the Misses Waters in very bad stead *unless the lines were there.*

Mrs. Feather, the most inconsequent personage of the wireless, would never have made herself famous had not the lines been there. She comes out with something original each time. The same with Grandma Buggins.

There are at least twenty comedians who can be relied upon for lines, but twenty—or forty—are not enough. If we are to be entertained, we must have more. The answer to that is not: "Well, you go and get them." Not at all.

The answer is, that several comedians who appear quite frequently are underrating the intelligence of their listening public. They want pulling up sharply. I am convinced if a humour committee sat and

dealt with scripts frankly, and told these people that merely silliness would not stand a chance of passing their standard, there would be a difference in no time.

I have often heard complaints of the number of orchestras broadcasting when there is nothing else on. Not everyone is entertained by orchestral music, light or otherwise. There was an outstanding instance of this, a month ago. There was a Brahms Prom on one wavelength and a relay of an orchestra from Vienna on the other. So that music lovers who wanted an orchestral concert were puzzled to know what to do for the best, and those who did not want orchestral music had a real grievance.

To be fair, I should say that sort of thing does not often occur and obviously both concerts were fixtures. Still, there is a tendency to overdo the orchestras in the general routine broadcasting.

The fact remains that we *must* be entertained. The fact also remains that we are entertained wonderfully well on the whole.

A New

PARMEKO

Product

The "PARMEKO" JUNIOR Microphone

Messrs. Partridge & Mee, Ltd., have now introduced a quality microphone at a reasonable price. Considerable research and special methods of construction have made this possible. The microphone has a good response and compares very favourably with the highest priced carbon microphone.

Finished in grey cellulose, with all bright parts heavily chromium plated.

Supplied complete with Table Stand.

PRICE £3 - 0 - 0

Suitable transformer 12s. 6d.

PARTRIDGE & MEE LTD.

"PARMEKO" WORKS,

Aylestone Park, Leicester

and at 74, New Oxford Street, London, W.C.

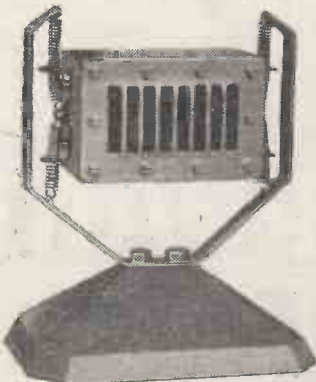

ALL SPECIFIED IN THE NEW 1935 £6-6-0 BATTERY 3

V.B.2. Variable Mutual Conductance. S.G. Valve. H.F. Amplifying Valve. Low H.T. Consumption. 7/6

S.Q.2. High Magnification S.G. Valve. High Mutual Conductance. With 362 Pentacular Perpendic. Anode. 7/6

M.E. Pentode Output Valve. No. "tetraode kink." Large undistorted output. 8-pin or 4-pin and side terminal. 10/-

Here are the three "362" valves specified by the actual designers of "The New 1935 £6.6/- Battery 3." Make certain of best results by following the specification of the experts. INSIST UPON THEM WHEN YOU BUY. They cost no more than similar makes. In most cases considerably less. If unobtainable locally—send P.O. direct to us. ALL CARRY THE "362" 6-MONTHS GUARANTEE.

362 VALVES

THE 362 RADIO VALVE CO. LTD.
STONEHAM RD, LONDON, E.5.

When replying to advertisements, please mention "Wireless Magazine"

AMPLION

“RADIOLUX”

RECEIVERS—RADIOGRAMS

These new models further enhance the Amplion reputation for quality reproduction, appearance, sustained service and entertainment value.



“RADIOLUX” SUPERHET

5-Valve Including Rectifier

For A.C. Mains 190/265 or 110 volts, 40/100 Cycles
AUTOMATIC VOLUME CONTROL. NEON LIGHT VISUAL TUNING. FULL VISION SCALE illuminated, and calibrated in metres and degrees. ENERGISED MOVING COIL SPEAKER, GRAMOPHONE PICK-UP CONNECTION. EXTERNAL SPEAKER CONNECTION.

TWO-TONE WALNUT CABINET with Gold Silk grille with ebonite black surround panel.

(D.C. MODEL)
190/265 Volts
H.P. Terms:
£1.8.0 Deposit
and 12 payments
of £1.2.9

13 GNS.

A.C. MODEL)
H.P. Terms:
£1.6.6 Deposit
and 12 payments
of £1.1.0

12 GNS.



“RADIOLUX” RADIOGRAM

A very remarkable instrument with all the outstanding features of the “Radiolux” Superhet Receiver mentioned above.

Collaro gramophone motor is electrically operated. Fitted with full automatic stop. Pick-up is the well-known Amplion unit. Beautiful cabinet veneered in two-tone walnut with burr walnut control panel.

H.P. Terms:
£2.17.9
Deposit and
12 payments
of £1.15.0

21 GNS.

(For Test Report on Amplion Super-het see Page 258)
Descriptive Literature “W.M.” Free on Request.

AMPLION (1932) LTD.

82-84, Rosoman St., Rosebery Ave., London, E.C.1

Telephone: Clerkenwell 5440/1.



Day in day out, year in year out, the lighthouse carries on with unfaltering reliability . . . guiding and safeguarding the ships that pass. And though their jobs are so vastly different, a condenser has perhaps one thing in common with a lighthouse . . . the need for absolute reliability. That is why so many set-builders are turning to T.M.C.-HYDRA condensers. By doing so they know not only that the condensers will be accurate to start with, but also that they will stay accurate in use. Equip your next set with T.M.C.-HYDRA condensers.

T.M.C. BRITISH MADE HYDRA CONDENSERS



Strict scientific control of every manufacturing process ensures the accurate rating of every T.M.C.-HYDRA condenser, while a special method of sealing prevents the penetration of moisture, so maintaining the high electrical properties of the condenser. T.M.C.-HYDRA condensers are sold by your radio dealer, but if you have any difficulty in obtaining supplies, write to the Sole Distributors:

T.M.C.-HARWELL (SALES) LTD
Britannia House, 233 Shaftesbury Avenue
London, W.C.2. (A few doors from New Oxford Street)
Telephone: Temple Bar 0055 (3 lines)

Made by TELEPHONE MANUFACTURING Co., Ltd.

It helps us if you mention “Wireless Magazine”

It comes out every Friday —the threepenny paper the family will enjoy too!

Every Friday RADIO PICTORIAL reveals in pictures and in words the home life of popular broadcasters. Scores of lifelike photographs of the favourites you listen to, thrilling fiction, clever humour, a corner for the children, a splendid feature for the wife, etc., etc. RADIO PICTORIAL puts you in intimate touch with the human side of broadcasting and adds greatly to your enjoyment of listening-in. A great threepennyworth!

★ Details of all the English Programmes from ten Continental Stations are given every week in RADIO PICTORIAL.

Special RADIO PICTORIAL Celebrity Concerts are also broadcast regularly from Poste Parisien and Radio Normandy. Tune in and listen to them.

GET YOUR NEWSAGENT TO DELIVER
"RADIO PICTORIAL" EVERY FRIDAY

RADIO PICTORIAL

ON SALE AT ALL
BOOKSTALLS and
NEWSAGENTS

Price 3^D.

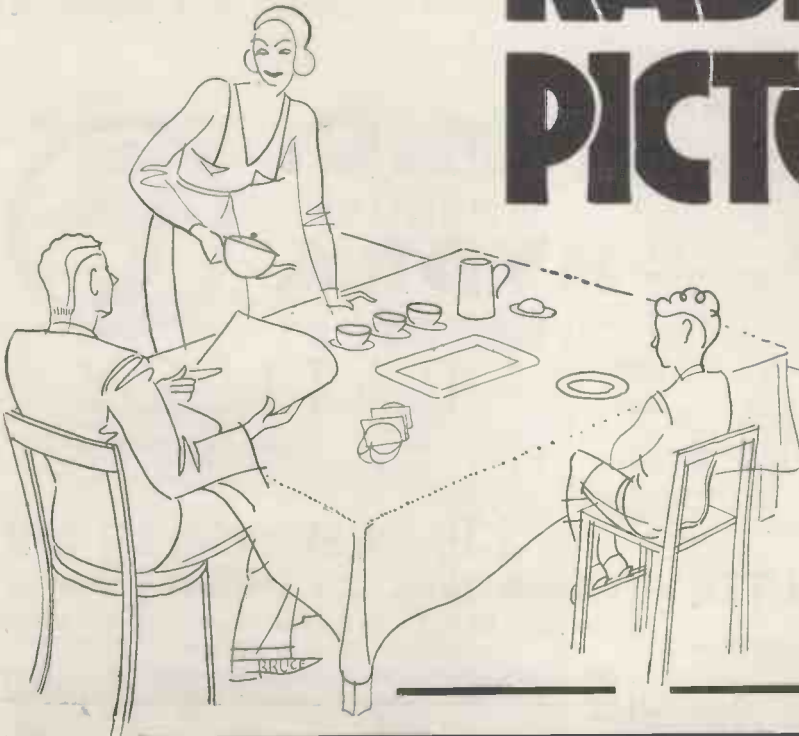

My 'Indicator'
tells you the
'Battery Time!'



I forewarn that you may be fore-armed. I tell you at a glance the *exact* state of my charge and there is nothing to memorise. You can depend on what I say. If I report "Full," then I *am* full. I am a sure safeguard against the nuisance of being caught unawares by a run-down battery. No need to run that risk. Have an Exide "Indicator" Battery.

Exide

PRICES WITH 'INDICATORS'

Type DTG-C 2 volt 20 a.h. 5/-
Type DFG-C 2 volt 45 a.h. 9/-
Type DXG-C 2 volt 58 a.h. 10/-
Type DMG-C 2 volt 70 a.h. 12/-
Type DHG-C 2 volt 100 a.h. 15/6

★ These prices do not apply to the Irish Free State.

"INDICATOR" BATTERY

For wireless H.T. get

Drydex

the Exide dry battery

From Exide Service Stations and all good dealers. EXIDE BATTERIES, Exide Works, Clifton Junction, near Manchester.
Branches: London, Manchester, Birmingham, Bristol, Glasgow, Dublin and Belfast.

R76

"STILL KEEP GOING WHEN THE REST HAVE STOPPED"

Better service results from mentioning "Wireless Magazine" when writing to advertisers



Enjoying programmes from the Ferranti battery portable—a six-valve super-het. A fine-looking set with an equally charming listener!

News from All Quarters

can be obtained from the Polytechnic.

Quantas Empire Airways, Ltd., and is expected to open in December.

The range of Pifco rotameters is described in a coloured brochure we have received from P.I.F. Co., Ltd., of Shudehill, Manchester. Constructors will find these high-grade instruments very useful in their experiments and the prices are within the reach of all. Copies will be sent free on request if "W.M." is mentioned in your application.

An efficient earthing device, made of copper, has just been introduced by British Insulated Cables, Ltd., of Prescott, Lancs. The price for an 18 in. rod is only 1s. 6d. and a 24 in. rod, 2s. 6d. There is no charge for delivery.

The B.B.C. has announced that there will be a further season of Promenade concerts at Queen's Hall from December 31 to January 12. They will be on the same lines as the present season and will be conducted by Sir Henry Wood.

COPIES of the tenth edition of the "I.E.E. Regulations for the Electrical Equipment of Buildings" has just been published by E. and F. N. Spon, Ltd., of 57 Haymarket, London, S.W.1. Copies can be obtained from the publishers or at the offices of the institution. The price is 1s. 6d. bound in cloth, and 1s. with a paper cover. Postage is 3d. and 2d. respectively on the two editions.

The five new DH86 four-engined aeroplanes for the Singapore-Brisbane branch of the England-Australia air route are being fitted with Marconi transmitting and receiving apparatus to enable them to maintain constant contact with the ground and with ship and coast stations. The service will be run by the

From Dubilier we have received a copy of their 1934-5 edition of the booklet dealing with condensers and resistances. Besides containing a full description of Dubilier products and prices, there is much technical information about condensers and resistances to interest the radio enthusiast. Copies can be obtained free from the Dubilier Condenser Co. (1925) Ltd., of Victoria Road, North Acton, London, W.3.

Interesting lectures on various aspects of radio are being given by many well-known authorities at the Polytechnic, Regent Street, London, W.1, during the coming winter. The wide range of subjects includes wireless and high-frequency engineering, electrical technology, radio-frequency measurements, design of wireless apparatus, wave propagation and reception, electro-acoustics, and there are courses for radio dealers, salesmen, and service engineers. A copy of the prospectus



PUZZLE—FIND THE LOUD-SPEAKER OPENING
Miss Evelyn Hayes, Joseph Griffin and Will Mahoney, all American radio stars, showing their interest in the new Pye radiogram. The main loud-speaker is underneath the cabinet, the small opening being for the special high-note reproducer

Are battery sets dying out? We think not! A director of Ever Ready, Ltd., the big battery manufacturers, said recently that "in 1930 there were produced and sold in this country 450,000 battery-operated sets, and by last year this number had increased by 200,000."

He attributes growing battery-set popularity to the fact that the battery set gives superior quality of tone, and it is not affected by breakdowns of the grid system.

WHEN BUYING
A PIPE YOU
LOOK AT THE
GRAIN

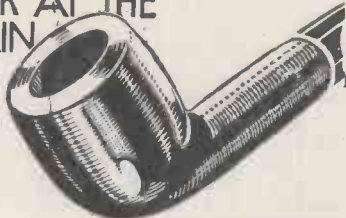

WHEN BUYING
A RECEIVER
LOOK AT THE
VALVEHOLDERS

To enjoy a smoke, a pipe must have a flawless bowl and correctly designed air channels. For continuous enjoyment of radio, you must fit well designed and reliable valveholders—"CLIX."

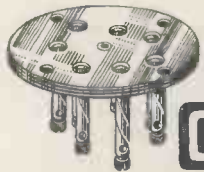

SPECIFIED FOR THE
"CRYSTAL-GATE SUPER"

Send for our New 1935
Folder "W.M." Free

CLIX

LECTRO LINX, LTD.,
79, ROCHESTER ROW, LONDON S.W.1



"We're Fluxite and Solder the reliable pair;
Famous for Soldering—known everywhere
For faulty connections—someone's to blame!
When fixing up YOUR Set—let THIS be YOUR
attm!"

See that Fluxite and Solder are
always by you—in the house—garage
—workshop—anywhere where
simple, speedy soldering is needed.

ALL MECHANICS WILL HAVE
FLUXITE
IT SIMPLIFIES ALL SOLDERING

All Ironmongers sell Fluxite in tins: 41., 8d.
1s. 41., and 2s. 8d. Ask to see the FLUXITE
POCKET SOLDERING SET—complete with full
instructions—7s. 6d. Ask also for our leaflet on
HARDENING STEEL with Fluxite.

FLUXITE LTD., Dept. 332,
Dragon Works, Bermondsey St., S.E.1

FOR ALL REPAIRS!



43940 Poiston
Southampton
Hants

Sirs
Received the
Anti-Interference Unit safe
and I must tell you
it is the thing I have been
hunting for ever since I
first had my all-mains
set. The interference was
awful in our district,
but thanks to your unit
it is a treat to listen to the
programmes now. Thank
you for the delivery

"
A TREAT
TO LISTEN
NOW" with the



PRICE
complete
with
instructions **10/6**

A nightmare of "crackles" and "buzzes" has
ended for this Southampton listener who
fitted a T.C.C. Anti-Interference Unit. Neon
signs, motors and generators do not exist for
him as far as his radio is concerned. Don't
let your listening be marred by such "man-
made static"—this T.C.C. Unit will cut it
out. Ask your Dealer to-day.

The Telegraph Condenser Co., Ltd.,
Wales Farm Road, N. Acton, W.3

T.C.C.
CONDENSER
ANTI-INTERFERENCE UNIT

YOU CANNOT GO WRONG IF YOU USE A

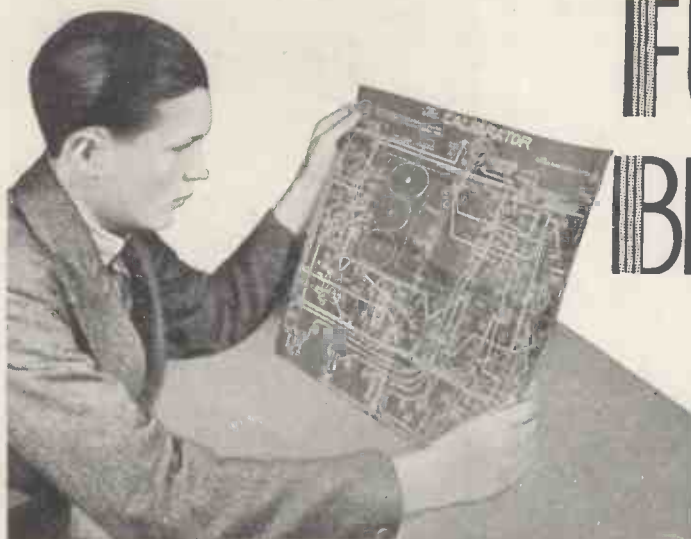

FULL-SIZE BLUEPRINT

Each blueprint shows the position of each component and every wire and makes construction a simple matter. Copies of "Wireless Magazine" and of "Amateur Wireless" containing descriptions of most of these sets can be obtained at 1s. 3d. and 4d., respectively, post paid. Index letters "A.W." refer to "Amateur Wireless" sets and "W.M." to "Wireless Magazine" sets. Send, preferably, a postal order (stamps over sixpence unacceptable) to "Wireless Magazine," Blueprint Dept., 58-61 Fetter Lane, London, E.C.4.

CRYSTAL SET (6d.)

- 1931 Crystal Set AW308
- 4 Station Crystal Set AW427

ONE-VALVE SETS (1s. each)

- Easy to Build One AW304
- Portable Short-wave One AW354
- B.B.C. One-valver AW387
- Short-wave One-valver AW429

TWO-VALVE SETS (1s. each)

- A Two for 7 Metres (D, Trans) WM295
- A.C. Quality Gem (D, Trans) WM312
- The Companionette (D, Pen-A.C./D.C.) WM358
- "W.M." Band-spread Short-waver (D, Pen) WM367

SPECIAL HALF-PRICE OFFER

Blueprints of the following "Wireless Magazine" sets described in this issue are obtainable at the special price, given below, if the coupon on last page is used before Oct. 31, 1934.

- 1935 £6 6s. Three, WM371 6d.
- Quartz-crystal Super, WM372 9d.
- Battery Stenode, WM373 9d.

- "A.W." Iron-core Two (D, Trans) AW395
- "A.W." Iron-core Two with Q.P.P. AW396
- Big Power Melody Two, with Lucerne Coils (SG, Trans) AW338A
- B.B.C. National Two, with Lucerne Coils (D, Trans) AW377A
- Lucerne Minor (Det, Pen) AW426
- Home Station A.C. 2 (D, Pen) AW374
- B.B.C. National Two (D, Trans) AW377
- Melody Ranger Two (D, Trans) AW388
- Consolecric Two (D, Pen) A.C. AW403
- Lucerne Minor (D, Pen) AW426

THREE-VALVE SETS (1s. each)

- C.B. Three (D, LF, Class-B) WM333
- Duo-tuned Three (SG, D, Pen) WM341
- A.C. Transportable (SG, D, Pen) WM347
- All-wave Three (D, 2LF) WM348
- "W.M." 1934 Standard Three (S.G., Det, Pen) WM351
- Emigrator (A.C. set: 14-500m.) (S.G., D, Pen) WM352
- £3 3s. Three (SG, D, Trans) WM354
- Heptode Super Three (A.C. Super-het) WM359
- Iron-core Band-pass Three (SG, D, QP 21) WM362
- £6 6s. A.C./D.C. Three (SG, D, Pen) WM364
- All-wave Battery Three (SG, D, Pen) WM365
- James Push-push Three (SG, D, Q.P.P.) (1/6) AW378
- Everybody's Home Radiogram (SG, D, Trans) AW381
- Home-lover's New All-electric 3 for A.C. mains (SG, D, Trans) AW383
- Our Up-to-the-Minute Three (SG, Westector, LF, Trans) AW384
- Class-B Three (D, Trans, class B) AW386
- A.C. Triodyne (SG, D, Pen) AW399
- Home-built Coil Three (SG, D, Trans) AW404

- Fan and Family Three (D, 2LF) AW410
- £5. 5s. S.G.3 (SG, D, Trans) AW412
- 39/- Lucerne Ranger (SG, D, Trans) AW422
- Penta-quester (S.G., D, Pen) AW431

FOUR-VALVE SETS (1s. 6d. each)

- Calibrator (SG, D, RC, Trans) WM300
- Table Quad (SG, D, RC, Trans) WM303
- "Words and Music" Radiogram (2 SG, D, Trans) WM307
- "Words and Music" Radiogram de Luxe (SG, D, RC, Q.P.P.) WM307a
- Home Short-waver (SG, D, RC, Trans) WM311
- Calibrator de Luxe (SG, D, RC, Trans) WM316
- All-metal Four (2 SG, D, Pen-A.C. Mains) WM329
- Self-contained Four (SG, D, LF, Class B) WM331
- All-progress Four (Battery Super-het) WM335
- Merrymaker Super (A.C. Super-het) WM345
- 1934 A.C. Quadrydyne (2SG, D, Pen) WM349
- Lucerne Straight Four (SG, D, LF, Trans) WM350
- Universal Merrymaker (A.C./D.C. Super-het) WM356
- "A.C. Melody Ranger" (SG, D, RC, Trans) AW380
- "A.W." Ideal Four (2SG, D, Pen) AW402
- 2 H.F. Four (2 SG, D, Trans) AW421
- Lucerne Major (256 SG, Trans) AW433
- Crusaders' A.V.C. Four (SG, D, LF) Class-B AW445

FIVE-VALVE SETS (1s. 6d. each)

- New Class-B Five (SG, D, LF, Class-B) WM340
- Class-B Quadrydyne (2 SG, D, LF, Class-B) WM344
- "W.M." A.C. Stenode WM370
- James Short-wave Super (Super-het) AW328
- Simple Super (Super-het) AW340
- The Etherdyne (Super-het) AW406
- 1934 Century Super (Battery super-het) AW413

SIX-VALVE SETS (1s. 6d. each)

- 1932 Super 60 (Super-het) WM269
- 1932 A.C. Super 60 (A.C. Super-het) WM272
- "W.M." D.C. (Super-het) WM321
- James Class-B Super (Super-het with iron-cored coils) WM326
- Welcome Portable with class-B output stage WM325
- Connoisseurs' Super (A.C. Super-het) WM334
- James Super Straight Six (2 SG, D, LF, Push-pull) WM339
- Lucerne Super (battery super-het) WM355

SEVEN-VALVE SETS (1s. 6d. each)

- Super Senior (Super-het) WM256
- Seventy-seven Super (A.C. Super-het) WM305
- Q.P.P. Super 60 (Super-het) WM319

EIGHT VALVE SET (1s. 6d.)

- "W.M." Radiogram Super (A.C. Super-het) WM356

PORTABLES (1s. 6d. each)

- Town and Country Four (SG, D, RC, Trans) WM282
- Everybody's Portable (five-valve Super-het) WM291
- Welcome Portable (six-valve Super-het) WM322
- Spectrum Portable (SG, D, QP21) WM357
- "Two H.F." Portable (2SG, D, QP21) WM363
- Tyers' Portable (SG, D, 2LF) WM367
- General-purpose Portable (SG, D, RC, Trans) AW351

AMPLIFIERS (1s. each)

- 10-watt A.C. Amplifier WM360
- "W.M." Electric Gramophone (1s. 6d.) WM369
- Universal Push-pull Amplifier AW300
- "A.W." Record Player (LF, Push-pull) AW319
- Battery-operated Amplifier AW362
- "A.W.'s" Push-push Amplifier AW376
- Class-B Gramophone Amplifier AW391
- Universal A.C. Amplifier (3-valve) AW411
- Five Q.P.P. Output Circuits AW315

MISCELLANEOUS (1s. each)

- A.C. Short-wave Converter WM353
- "A.W." Trickle Charger AW352
- Experimenters' D.C. Mains Unit AW430
- Experimenters' A.C. Mains Unit AW432
- Add-on Band-pass Unit AW359
- Plug-in Short-wave Adaptor AW382

You can always rest assured that if you build your set with a "W.M." full-size blueprint, it will work first time and work well!

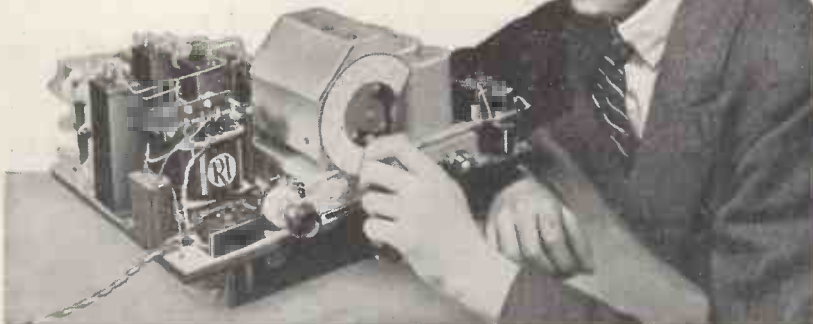



The
**Law for
Stability!**
**ERIE
RESISTORS**

Eries remain permanently silent—accurate and stable. Guaranteed against breakdown. Six Erie Resistors specified for this month's "The 1935 £6 6s. Battery Three."

**ERIE
POTENTIOMETER**

(New Erie Volume Control) also special for above set. Erie quality is a lifetime guaranteed variable resistance.

Erie Resistors, 1/- per watt in all values.
Erie Potentiometer, 3/6 or, with built-in mains switch, 5/-.

* Write for Erie Colour Code Chart with helpful data.

THE RADIO RESISTOR CO.,
1 Golden Square, Piccadilly, London, W.1.

YOUR FUTURE

Radio enjoyment will be assured by the use of a Pifco A.C. and D.C. Radiometer

The stars cannot foretell, nor can a crystal-gazer, that some time—perhaps to-night—your radio will become silent for no apparent reason. But . . . leave nothing to chance. In case of an unexpected breakdown in your set, be prepared to track down the fault immediately by getting now a Pifco A.C.-D.C. RADIOMETER. It is an amazing instrument which tests everything in radio—low tension, high tension, A.C. or D.C. Solidly constructed and supplied in a finely finished bakelite case, it is made, adjusted, and tested by highly skilled British instrument makers. As a safeguard against any possible damage being caused by accidental, wrong connections, there is a safety fuse included to protect all ranges.

You would doubtless regard such a fine instrument cheap at five times its amazing price of

12/6

Ask your dealer to show you one now or write for fuller details to PIFCO, LTD., SHUDEHILL, MANCHESTER, or 150 Charing Cross Road, London, W.C.2.

Adapters for testing 7 and 9-pin valves with a PIFCO Radiometer may be had for 3/- extra.



The "All-in-One" Radiometer for A.C. or D.C.

For testing electric or battery radio sets. Anybody, however inexperienced, can trace faults with this wonder instrument. Size of dial, 1 1/2 in. by 3/4 in. Complete with leads.



AVOID and REFUSE SUBSTITUTES

PIFCO
'All-in-One' RADIOMETER **A.C. AND D.C.**

PIFCO ON THE SPOT WILL TRACE YOUR TROUBLES LIKE A SHOT

ALL THE ENGLISH PROGRAMMES
from the CONTINENT each week in

RADIO PICTORIAL

Every Friday

Price 3d.

THE FIRST REAL PORTABLE



100
MILE
RANGE

WEIGHS
3 lbs.

EASY TO
CARRY

ALL
BRITISH

NO
AERIAL
RE-
QUIRED

TWO
VALVE
RE-
CEIVER

**4
GNS.**
All complete

THE PORTABOUT

THE SUCCESS OF RADIOLYMPIA

SOLE DISTRIBUTORS FOR BRITISH EMPIRE

MARLUKE, LTD., 2 GRAY'S INN RD., LONDON, W.C.

Better service results from mentioning "Wireless Magazine" when writing to advertisers

BLUEPRINT COUPON

Valid only until Oct. 31, 1934 (or until Nov. 30, 1934, for overseas readers)

FOR ONE BLUEPRINT ONLY

If you want a full-size blueprint of any ONE of the sets constructionally described in this issue for half price, cut out the above coupon and send it, together with a postal order, to Blueprint Department, WIRELESS MAGAZINE, 58-61 Fetter Lane, London, E.C.4.

This coupon is valid for a blueprint of any ONE only of the following sets at the prices indicated:—

- £6 6s. BATTERY THREE (page 247) No. WM371, price 6d., post paid.
- QUARTZ-CRYSTAL SUPER (page 267), No. WM372, price 9d., post paid.
- BATTERY STENODE (page 201), No. WM373, price 9d., post paid.

INFORMATION COUPON

Valid only until Oct. 31, 1934 (or until Nov. 30, 1934, for overseas readers)

If you want to ask any questions, cut out the above coupon and send it, together with a postal order for 1s. and stamped addressed envelope, to the Information Bureau, WIRELESS MAGAZINE, 58-61 Fetter Lane, London, E.C.4.

Note that not more than two questions may be asked at a time and that queries should be written on one side of the paper only.

Under no circumstances can questions be answered personally or by telephone. All inquiries must be made by letter so that every reader gets exactly the same treatment.

Alterations to blueprints or special designs cannot be undertaken: nor can readers' sets or components be tested.

If you want advice on buying a set, a stamped addressed envelope only (without coupon or fee) should be sent to the Set Selection Bureau, WIRELESS MAGAZINE, 58-61 Fetter Lane, London, E.C.4.

NEW USES FOR OLD VALVES

Continued from page 227

I started with a new H type valve, and got precisely the same deflection. I then went through all the valves in my junk box, all sorts of makes, all sorts of types, H, HL, P, super-power, screen-grid, varimu, full-wave rectifier. They all behaved satisfactorily and gave precisely the same deflection.

I put in a Westector (red to cathode, and black to grid) and got a deflection 5 per cent smaller, which is negligible.

Just think what this means. Any valve, if it has grid and filament intact, is as good as any other!

Distortion in Rectification

At least it is for signals of moderate and not abnormal strength, for the possibility of distortion in rectification should not be forgotten. But I checked this up and could detect no difference in quality from any of the valves I tried.

What You Need

All that you need to take advantage of this arrangement is a valve holder and the possibility of supplying the additional filament current.

With battery valves the thing is easy and even with mains valves a good mains transformer will easily stand the extra drain of filament current.

Of course, if the transformer regulation is poor one might get into difficulties. But such transformers should be taboo in any case.

P. Wilson.

LET ME PLAN YOUR RADIO CAREER

THE day of the wireless dabbler is over. Having evolved into a fully fledged profession, the wireless industry to-day demands as much study and preparation as any other established profession.

The possibilities in a wireless career are exceptionally bright for the young man with courage, foresight and, above all, sound technical preparation. I consider that in no other profession is technical training of so much importance.

For many years the B.I.E.T. has been predominant in the wireless training field, mainly because we insist upon our courses being kept abreast of modern developments. As an instance of this "up to the minute" ideal, it should be noted that we were the first college to offer tuition in Television and Talking-Picture Engineering.

As evidence of the authoritativeness of our training, I would mention that one of the world's leading film corporations have officially advised all their Sound Engineers to study under the guidance of the B.I.E.T.

The Institute offers the finest series of home-study Courses in Wireless and allied subjects it is possible to prepare. The Courses include General Wireless, Radio Servicing, High Frequency Engineering, Television, Talking-Picture Engineering, etc.

We also specialise in preparing candidates for all recognised Wireless Examinations, including A.M.I.E.E., A.M.I.W.T., A.Rad.A., A.B.R.A., and City and Guilds under "NO PASS—NO FEE" terms.

I offer my personal advice to any man who is interested in a Wireless career, whether he be novice or expert. My advice will be sent free and without any obligation whatsoever. On request I will also forward a free copy of our 256-page Handbook which outlines many ways in which a successful radio career will be planned and followed.

Address: **J. J. CLEAVER**
Chief Careers Consultant,

British Institute of Engineering Technology,
283 Shakespeare House, 29-31, Oxford Street, W.1.

INDEX TO ADVERTISERS

	Page
A	
Amplion (1932) Ltd.	281
Automatic Coil Winder Co., Ltd.	
B	
British Inst. of Eng. Tech.	288
Brookes Instrument Co., Ltd.	277
Bulgin, A. F., & Co., Ltd.	
C	
Clarke, H., & Co. (M/cr), Ltd.	Cover iv
D	
Drydex	283
E	
Ever Ready Co., Ltd.	275
Exide	
F	
Ferranti, Ltd.	279
Fluxite, Ltd.	285
G	
General Electric Co., Ltd.	Cover ii
Gramophone Co., Ltd., The	200
Gramphon Reproducers Ltd.	197
H	
High Vacuum Valve Co., Ltd.	277
J	
Jackson Bros.	
K	
Kolster Brandes, Ltd.	195
Keates & Co.	199
L	
Lectro Linx, Ltd.	285
Lyons, Claude, Ltd.	
M	
Marconiphone Co., Ltd.	199
McMichael Radio, Ltd.	
Melford Radio	
Marluke Ltd.	287
P	
Partridge & Mee, Ltd.	Cover iii, 280
Pertrix, Ltd.	
Peto Scott, Ltd.	277
Pifco	287
R	
Regent Fittings	
Radio Resistor, Co.	287
S	
Stratton & Co.	288
Siemens Bros.	279
Smith (M/A), Ltd.	197
T	
Telegraph Condenser Co., Ltd.	285
Telephone Mfg. Co., Ltd.	281
362 Valve Co. Ltd.	280
"Television"	
V	
Varley (Oliver Pell Control, Ltd.)	Cover iii
W	
Westinghouse Brake & Saxby Signal Co., Ltd.	Cover iii
Wright & Weaire, Ltd.	

1935 EDDYSTONE SHORT WAVE MANUAL



MANUAL

Fully illustrated with constructional details for building Battery and Mains S.W. Receivers—6v. S.W. Super-het with A.V.C.—All Wave Wave-meter—5-metre Receiver—Simple 5 metre Transmitter—Cross feed for Aerial System—Battery and Mains S.W. Converters—Amplitude Bands Receiver—100 watt Transmitter, Eliminators, etc.

COMPILED BY THE LEADING SHORT WAVE SPECIALISTS

PRICE
1/6

Obtainable from your radio dealer, W. H. Smith, or in case of difficulty, direct from STRATTON & CO., LTD. (Dept. 28), Bromsgrove Street, Birmingham. London Service Depot—Webb's, 14 Soho Street, W.1.



3^D

BRINGS TO YOU . . .

a copy of the 1935 edition of "The All Metal Way"—the modern treatise on A.C. Mains operation and the use of Westectors.

Send 3d. to-day to Dept. W.M.

THE WESTINGHOUSE BRAKE & SAXBY SIGNAL CO., LTD.,
82, YORK ROAD, KING'S CROSS, LONDON, N.1.



FOR EFFICIENT APPARATUS

SPECIALISTS IN

TRANSFORMERS :

Mains, Step-up and Step-down, Intervalve and Output.

CHOKES

Smoothing and Output

AMPLIFIERS

All types

MICROPHONES

Transverse current

LOUDSPEAKERS :

Moving Coil type, Semi-protection, Protection and Cinema.

RECORDING APPARATUS :

For Record recording.

TALKIE SOUND SYSTEMS :

Full size 35 mm, 16 mm, and 9 mm.

VOLUME CONTROLS :

Attenuators and Mixer Panels.

We shall be pleased to receive your enquiries.

PARTRIDGE & MEE, LTD.

PARMEKO WORKS

AYLESTONE PARK - LEICESTER

and at 74 NEW OXFORD ST., LONDON, W.C.1



NEW VARLEY UNIVERSAL POWER PUNCHER

Saves its cost in less than a Year!

A Varley Power Puncher Unit added to your existing three-valve receiver can save approximately 50 per cent. of your anode current. Thus the unit's cost is saved in less than a year. Unlike Q.P.P. and Class-B systems, it needs no special transformers or valves. The only possible addition is an inexpensive grid-bias battery. This Power Puncher Unit contains all resistances and condensers together with a small rectifier. Connections are easily made without extensive wiring alterations to your receiver. Write NOW for further information.

POWER PUNCHER

H.T. Economiser Unit

List No. DP45 . . . 15/6



Advertisement of Varley (Oliver Pell Control, Ltd.), Bloomfield Road, Woolwich, S.E.18. Telephone: Woolwich 2345

THIS IS THE ONLY RECEIVER

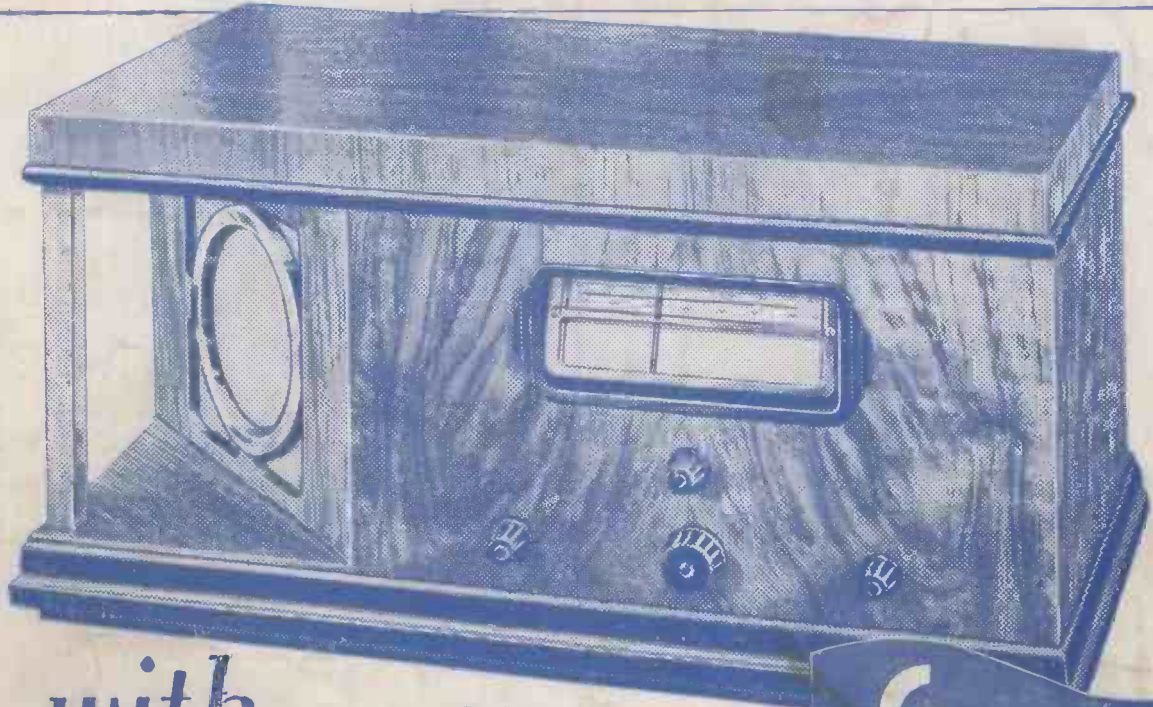

with

Pat. Pending

**SPECTRUM TUNING-
TILTING DIAL** and this

£14-14
CASH PRICE

Masterpiece of Cabinet Craftsmanship!

NO other receiver in the world gives such utterly perfect performance, such purity of tone PLUS . . . these 3 VITAL EXTRAS.

"SPECTRUM TUNING," the simplest and only certain station identification yet devised.

The TILTING DIAL is the only one in the world. It gives perfect readings at all angles from any tuning position. No peering and no stooping.

The "ATLAS" CABINET is the supreme triumph of the designer's and craftsman's—a perfect blend of richly grained walnut, ebony and chromium—and an asset to your home.

No wonder the "ATLAS 7-5-8" was the sensation of Olympia. Remember that these features are exclusive to "ATLAS." That is why you must INSIST on "ATLAS." Ask your dealer for a FREE demonstration today.

Exclusive to the **ATLAS**

POST THIS COUPON NOW

Messrs. H. Clarke & Co. (M/cr.) Ltd.
Patricroft, Manchester.

Please send me full details of the wonderful new
"ATLAS 7-5-8" Set—the Super Superhet.

Name

Address

83/10

"7-5-8"

SUPER-SUPERHET

H. Clarke & Co. (M/cr.) Ltd., Patricroft, Manchester. London: Bush House, W.C.2. Glasgow: G.E.S. Co. Ltd., 38 Oswald Street. I.F.S. Distributors: R. Marks Ltd., 27 Upper Liffey Street, Dublin.

SPECIFICATION 7 stages, 5 valves, 8 functions. For A.C. mains. Moving Coil Speaker, Band-Pass Tuning, Full Automatic Volume Control, Tone-Control, Noise Suppressor, Self-contained Aerial, Sockets for Pick-Up and Extra Speaker. Guaranteed for 12 months. H.P. Terms 30% deposit and 12 monthly payments of 25/- each. CASH £14. 14s. 6d. Prices do not apply to I.F.S.