

MORE ABOUT W. JAMES' 1929 CHUMMY

Wireless Magazine

VOL. IX.

NO. 5
JULY
1929

Double
Your Power
by Using
Up-to-date
Valves!

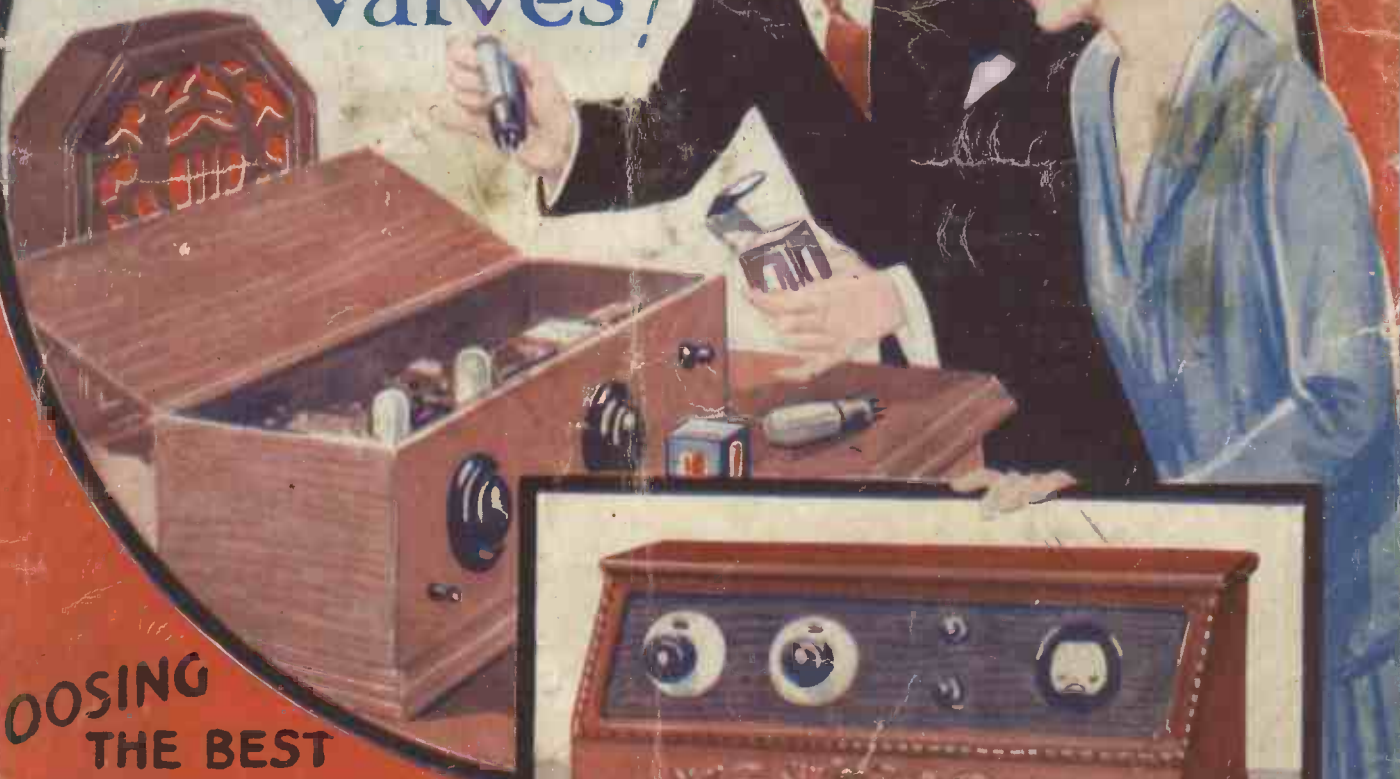

CHOOSING
THE BEST
VALVES FOR
EACH STAGE
OF YOUR SET



ONE OF THE SETS IN THIS ISSUE

These Are the COMPONENTS Specified by W. JAMES for the 1929 CHUMMY



will enhance the appearance of your "1929 Chummy"

ACCUMULATORS



JELLY ACID
NON-SPILLABLE

OBTAINABLE FROM DEALERS EVERYWHERE

LOUD-SPEAKER UNIT
BLUE SPOT
TYPE
66 K

SLOW MOTION DIALS



Model 6
Price 3/9
each

HARLIE BROS.
Balham Road, Edmonton, N.9

"CLIX"
SPADE TAGS
and
WANDER PLUGS

LECTRO LINX LTD.
254 Vauxhall Bridge Rd., S.W.1

Cossor
Screened Grid

The Valve that gives the "Chummy" its long range
—and the Cossor Transformer gives it its pure tone

READY RADIO PARTS
GUARANTEE
GOOD RESULTS

DUBILIER
CONDENSERS,
GRID LEAKS AND
RESISTANCES
are the BEST for any set.

H.F. CHOKE
SPRINGMORE WANDER PLUGS



VARIABLE CONDENSERS
VALVE HOLDERS

Supplied by
THE FORMO CO.
Cricklewood Lane, London, N.W.2

GLAZITE
BRITISH MADE REGD

COLOURED CONNECTING
WIRE IS USED IN ALL
"WIRELESS MAGAZINE"
SETS

BARREL SWITCH
and
ANODE COIL

Supplied by
WRIGHT & WEAIRE, LTD.
740 High Road, Tottenham,
London, N.17

Fixed Condensers:—

T.C.C.
OF COURSE!

For Satisfactory Results

BUY BRITISH
EVER READY
BRITAIN'S BEST BATTERIES

SECURITY, SERVICE & VALUE
—Last Longest

For further
Announcements
see
Inside Back Cover

THIS FAMOUS FOUR-VALVE PORTABLE WAS FULLY DESCRIBED LAST MONTH AND THERE ARE TWO FURTHER ARTICLES IN THIS ISSUE

Editor :

BERNARD E. JONES

Technical Editor :

J. H. REYNER,
B.Sc. (Hons.), A.M.I.E.E.

Wireless Magazine

The Best Shillingsworth in Radio

Vol. IX :: JULY, 1929 :: No. 54

Research Consultant :

W. JAMES

Assistant Editor :

D. SISSON RELPH

Changes at Savoy Hill

IS our friend, Captain P. P. Eckersley, who has just resigned his office as chief engineer of the B.B.C., yet one more of the B.B.C. officials who, in the language of our last month's article, are on the trek to the talkies? We shall see.

In the meantime, I am glad that he will retain an official connection with broadcasting, for his name and his personality are honoured and the technical course of broadcasting in this country is very much what he has made it. Our readers will extend their hearty good wishes to Captain Eckersley and thank him for his public work on their behalf.

Fortunately there remain good men on the B.B.C.'s engineering staff, and we need not fear diminution in interest, any falling away in technical achievement, or any lack of zeal on the part of the men who remain at the B.B.C. to carry on the work.

An article in our present number discusses whether the B.B.C. gets value for its money. We have never had the slightest doubt that, as far as its salaried servants of the first rank are concerned, it has always had its money's worth and more. Of course, a State organisation on B.B.C. lines can pay only on a standard set by Civil Service conditions.

Baynham Honri, himself an old B.B.C. servant, gives away more "talkie" secrets in a special article in this issue.

After the talkies—television. H. J. Barton Chapple, who, if I may give away a secret, is now officially connected with Baird television, starts in this issue a series of explanatory articles on television under the very happy title of "Around the Scanning Disc." Mr. Barton Chapple will take our readers figuratively by the hand and lead them on to a thorough understanding of the technique of television.

By the way, are you In Tune with the Trade? Turn over to page 504 and see what we mean. For some months now we have been rendering our readers a special catalogue service, and they appreciate that it saves their time and their precious postage stamps. Still more readers should take advantage of the benefits our scheme offers, and let us make contact between them and the manufacturer.

We give, this month, constructional details of a much less ambitious portable than the Reyner Wayfaver or the James Chummy. It is just a "picnic" portable—a cheap three-valver, quite suitable for listening to the local station and, within a hundred-mile radius, to Daventry. It is simple to build and will give, within the limits named, quite good results.

Other special constructional features in this month's issue include the All-wave Lodestone Five, certainly one of the most powerful sets described in these pages, designed to give perfect quality at great volume without reaction; a Two-ampere Low-tension Unit, by W. James, to be used for battery charging or for the direct operation from the mains of a set or of a moving-coil loud-speaker. J. H. Reyner's A.C. Mains Amplifier for radio or gramophone work, particularly adapted for use in sports clubs, dance rooms, etc.

Do Not Overlook the Half-price Blue-print Coupon on Page iii of the Cover

CONTENTS

	PAGE		PAGE
Valves to Use in Your Set	498	Trying Out a New Pick-up	534
Wavelengths of the European Stations ..	502		
In Tune with the Trade!	504	The All-wave Lodestone Five. Incorporates a push-pull Amplifier and Is Reactionless ..	535
Rejuvenate Your Set by using New Valves! By D. Sisson Relph ..	507	More "Talkie" Secrets. By Baynham Honri ..	542
Bergen's Broadcasting. By H. de A. Donisthorpe ..	511	How to Build a Two-ampere Low-tension Unit. By W. James ..	545
That Feminine Touch ..	512	What Reaction Really Is. Another Half-hour with Professor Megohm ..	549
Stopping Static ..	512	The A.C. Mains Amplifier. Requires No Batteries and is Suitable for Radio or Gramophone Work. By J. H. Reyner, B.Sc., A.M.I.E.E. ..	551
Those "Yankeeisms" ..	512	Broadcast Music of the Month. By Studius ..	554
Under My Aerial. Half-yard's Chat on the Month's Topics ..	513	New B.B.C. Manchester Headquarters ..	556
The Picnic Portable. A Cheap and Easily Constructed Three-valver ..	516	Further Notes on the Chummy. By W. James ..	557
Does the B.B.C. Get Value for Its Money? ..	521	"The Verdict Is —" ..	559
Around the Scanning Disc. By H. J. Barton Chapple, Wh.Sch., B.Sc. ..	523	Leaves from a Listener's Log. By Jay Coote ..	561
Are Portables Worth While to the Motorist? By Kenneth Ullyett ..	525	The Adventures of Alec Trode ..	562
Radio-equipped Cars in America ..	525	A New Gramo-Radio Outfit. Tested by J. H. Reyner, B.Sc., A.M.I.E.E. ..	564
My Impressions of the 1929 Chummy. By J. Godchaux Abrahams ..	527	How They Do It in the States ..	570
Irreverencies! A Radio Ventriloquial Sketch ..	529	Reference Sheets. Compiled by J. H. Reyner, B.Sc., A.M.I.E.E. ..	572
A Strange Error ..	530	Buyers' Guide and Classified Index to Advertisers ..	576
Studios in U.S.A. ..	530		
GRAMO-RADIO SECTION			
When Records Slip ..	531		
What's in A Name? ..	531		
Recent Record Successes. By H. T. Barnett, M.I.E.E. ..	532		
A New Double Horn ..	533		

Published by **BERNARD JONES PUBLICATIONS, LTD.**, publishers of "Wireless Magazine" and "Amateur Wireless." Editorial and Advertisement Offices: 58/61 Fetter Lane, London, E.C.4. Telephone: City 3733, 3734. Telegrams: "Beejapee, Fleet, London." Published about the 25th day of the month and bears the date of the month following. Subscription: Great Britain and Abroad, 15s. 6d. a year, post free (Canada only, 13s. 6d.) Contributions are invited and will be promptly considered.

Next Month: A Good Five-valve Portable with Three-electrode Valves

Registered at the General Post Office for Transmission by Canadian Magazine Post

Valves to Use in Your Set

TWO-VOLT VALVES: Three-electrode Types

Make.	Type.	Impedance.	Amp. Factor.	Fil. Volt.	Fil. Cur.
Ediswan	RC2	150,000	30	2	.1
Mazda	RC210	86,000	40	2	.1
Cosmos	SP16B	70,000	35	1.8	.09
Six-Sixty	210RC	68,000	35	2	.1
Ediswan	RC210	67,000	40	2	.1
Cossor	210RC	60,000	40	2	.1
Mullard	PM1A	51,000	36	2	.1
Marconi	DEH210	50,000	35	2	.1
Osram	DEH210		35	2	.1
Mazda	HF210	28,000	20	2	.1
Six-Sixty	210HF	27,000	13	2	.1
Ediswan	HF210	25,000	20	2	.1
Marconi	HL210	23,000	20	2	.1
Osram	HL210		20	2	.1
Mullard	PM1HF	22,500	18	2	.1
Cossor	210HF	20,000	15	2	.1
Six-Sixty	210LF	18,000	8.5	2	.1
Cosmos	SP16G	17,000	16	1.8	.09
Mazda	GP210	14,000	13	2	.1
Ediswan	LF210	13,000	13	2	.1
Cossor	210LF	12,000	10	2	.1
Marconi	DEL210		11	2	.1
Mullard	PM1LF	11	2	.1	
Osram	DEL210	11	2	.1	
Mullard	PM2DX	10,700	13.5	2	.25
Cosmos	SP16R	10,000	9	1.8	.09
Six-Sixty	215P	7,300	6.4	2	.15
Mazda	LF215	7,000	7	2	.15
Ediswan	PV215	6,600	8	2	.15
Cossor	220P	5,000	5	2	.2
Marconi	DEP215		7	2	.15
Osram	DEP215	7	2	.15	
Cosmos	SP18RR	4,500	6.5	2	.2
Mullard	PM2	4,400	7.5	2	.2
Cossor	220P	4,000	8	2	.3
Six-Sixty	230SP		3.9	2	.3
Mazda	P227	2,900	4	2	.27
Ediswan	PV225	2,700	3	2	.25
Mullard	PM252	2,600	5.4	2	.3
Marconi	DEP240	2,500	4	2	.4
Osram	DEP240		4	2	.4
Cossor	230XP	2,000	4	2	.3

FOUR-VOLT VALVES: Three-electrode Types

Make.	Type.	Impedance.	Amp. Factor.	Fil. Volt.	Fil. Cur.
Mazda	RC407	100,000	40	4	.075
Six-Sixty	4075RC	64,000	34	4	.075
Ediswan	RC410	61,000	40	4	.1
Cossor	410RC	60,000	40	4	.1
Marconi	DEH410		40	4	.1
Osram	DEH410	40	4	.1	
Mullard	PM3A	55,000	38	4	.075
Ediswan	HF410	22,000	25	4	.1
Mazda	HF407	21,000	18	4	.075
Cossor	410HF	20,000	20	4	.1
Six-Sixty	4075HF	16,500	13	4	.075
Mazda	GP407	14,000	14	4	.075
Mullard	PM3	13,000	14	4	.075
Ediswan	LF410	10,500	13	4	.1
Cossor	410LF	8,500	15	4	.1
Marconi	DEL410		15	4	.1
Osram	DEL410	15	4	.1	
Six-Sixty	410P	8,000	7.3	4	.1

FOUR-VOLT VALVES—Continued

Make.	Type.	Impedance.	Amp. Factor.	Fil. Volt.	Fil. Cur.
Mullard	PM4DX	7,500	15	4	.1
Mazda	LF407	5,700	8	4	.075
Ediswan	PV410	5,500	5.5	4	.1
Marconi	DEP410	5,000	7.5	4	.1
Osram	DEP410		7.5	4	.1
Ediswan	LF410a	4,500	9	4	.1
Mullard	PM4	4,450	8	4	.1
Cossor	410P	4,000	8	4	.1
Six-Sixty	425SP	3,600	3.2	4	.25
Mullard	PM254	3,500	3.15	4	.25
Mazda	P415	2,900	5.5	4	.15
Marconi	P425	2,250	4.5	4	.25
Osram	P425		4.5	4	.25
Cossor	415XP	2,000	4	4	1.5
Ediswan	PV425		3	4	.25

SIX-VOLT VALVES: Three-electrode Types

Make.	Type.	Impedance.	Amp. Factor.	Fil. Volt.	Fil. Cur.
Mazda	RC607	90,000	40	6	.075
Six-Sixty	6075RC	74,000	37	6	.075
Cossor	610RC		50	6	.1
Marconi	DEH610	60,000	40	6	.1
Osram	DEH610		40	6	.1
Mullard	PM5B	53,000	40	6	.075
Ediswan	RC610	50,000	40	6	.1
Marconi	HL610	30,000	30	6	.1
Osram	HL610		30	6	.1
Marconi	LS5B	25,000	20	5.25	.8
Osram	LS5B		20	5.25	.8
Ediswan	HF610	21,000	25	6	.1
Cosmos	DE50	20,000	9	6	.09
Cossor	610HF		20	6	.1
Mazda	HF607	20,000	20	6	.075
Six-Sixty	6075HF		20	6	.075
Mullard	PM5X	14,700	17.5	6	.075
Mazda	GP607	12,500	14	6	.075
Ediswan	LF610	10,000	15	6	.1
Mullard	PM6D	9,000	18	6	.1
Cossor	610LF	7,500	15	6	.1
Marconi	DEL610		15	6	.1
Osram	DEL610	15	6	.1	
Marconi	LS5	6,000	5	5.25	.8
Osram	LS5		5	5.25	.8
Six-Sixty	610P	5,300	7.2	6	.1
Mazda	LF607		9	6	.075
Mullard	PM6	5,200	7.1	6	.1
Cosmos	SP50R	4,500	6.5	5.5	.25
Ediswan	PV610	4,200	5	6	.1
Six-Sixty	625SP	3,600	3.2	6	.25
Cossor	610P	3,500	8	6	.1
Marconi	DEP610		8	6	.1
Mullard	PM256	3,500	3.15	6	.25
Osram	DEP610		8	6	.1
Ediswan	PV625	3,000	3	6	.25
Marconi	LS5A	2,750	2.5	5.25	.8
Osram	LS5A		2.5	5.25	.8
Mazda	P615	2,600	6	6	.15
Marconi	P625	2,400	6	6	.25
Osram	P625		6	6	.25
Cossor	610XP	2,000	5	6	.1
Mullard	DFA9		5	6	.6
Mazda	PX650	1,750	3.5	6	.5
Ediswan	PV625A	1,600	4	6	.25
Marconi	P625A		3.7	6	.25
Osram	P625A	3.7	6	.25	

(Continued on page 500)

BUILT LIKE A BRIDGE!

See how they're built!
Only Cossor Screened Grid Valves have Interlocked Electrodes

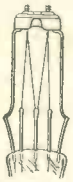

1. The double length Cossor filament famed for its colossal emission. Note the seonite bridge holding it rigidly in position.



2. Around the two stout grid supports is wound the first grid, electrically welded at twenty-five points.

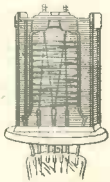

3. Note the enormous strength and rigidity of the screen. Built on four stout supports, capped by a metal bridge-piece anchored to seonite insulator.

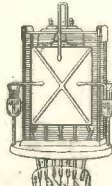

4. Finally, observe the construction of the anode. Actually two rectangular nickel plates are used and for greater rigidity each is diagonally ribbed.

**SHOCK - PROOF!
 NOISE - PROOF!
 BREAK - PROOF!**

In the Cossor Screened Grid Valve all the inherent weaknesses of valve design have been eliminated. By means of the wonderful new Cossor system of construction—illustrated here—each element is rigidly secured top and bottom. Even under the hardest blow individual movement is impossible. The Cossor Screened Grid Valve is rigid—built like a Bridge.

Noises in a valve are generally due to loose elements. In the Cossor Screened Grid Valve the elements *cannot* become loose because they are rigidly braced together and because every joint is scientifically welded.

Even the heaviest shock cannot disturb the perfect alignment of the electrodes in the Cossor Screened Grid Valve. It is the most robust and the most dependable Screened Grid Valve made in Great Britain.

For any Screened Grid Receiver choose Cossor. Accept no substitute—for there is no adequate substitute for the Cossor system of Interlocked Construction.

DEMAND



Technical Data.

Cossor 220 S.G. (2volts, .2 amps.) and 410 S.G. (4 volts, .1 amps.) Max Anode Volts 150, Impedance 200,000, Amplification Factor 200, Grid Bias 1.5 volts at max. anode Volts.

Price (each) **22/6**

A. C. Cossor Ltd., Highbury Grove, London, N.5.

COSSOR Screened Grid

THE ONLY SCREENED GRID VALVE WITH INTERLOCKED CONSTRUCTION

8678

Advertisers take more interest when you mention "Wireless Magazine"

VALVES TO USE IN YOUR SET—(Continued from page 498)

FOUR-ELECTRODE VALVES: Screened-grid						MAINS VALVES: Three- and Four-electrode					
Make.	Type.	Impedance.	Amp. Factor.	Fil. Volt.	Fil. Cur.	Make.	Type.	Impedance.	Amp. Factor.	Fil. Volt.	Fil. Cur.
Mullard...	PM12	230,000	200	2	.15	Marconi...	S Point 8	200,000	160	.8	.8
Six-Sixty	215SG	220,000	190	2	.15	Osram ...	S Point 8		160	.8	.8
Cossor ...	220SG	200,000	200	2	.2	Marconi...	H Point 8	55,000	40	.8	.8
Marconi...	S215		170	2	.15	Osram ...	H Point 8		40	.8	.8
Osram ...	S215		170	2	.15	Marconi...	HLPoint8	17,000	17	.8	.8
Ediswan	SG215	140,000	140	2	.15	Osram ...	HLPoint8		17	.8	.8
Mullard...	PM14	230,000	200	4	.075	Marconi...	P Point 8	6,000	6	.8	.8
Six-Sixty	4075SG	220,000	190	4	.075	Osram ...	P Point 8		6	.8	.8
Cossor ...	410SG	200,000	200	4	.1	Marconi...	KH1	30,000	40	3.5	2.0
Ediswan	SG410	115,000	140	4	.1	Osram ...			40	3.5	2.0
Marconi...	S625	175,000	110	6	.25	Marconi...	KL1	3,750	7.5	3.5	2.0
Osram ...	S625		110	6	.25	Osram ...	KL1		7.5	3.5	2.0
Ediswan	SG610	100,000	140	6	.1	Cosmos ...	AC/S	600,000	1,200	4	1.0
FIVE-ELECTRODE VALVES: Pentodes						Cossor ...	MSG410	200,000	400	4	1.0
Ediswan	5E225	65,000	80	2	.25	Ediswan	MI41RC	50,000	45	4	1.0
Six-Sixty	230PP	64,000	80	2	.3	Cossor ...	MRC415	25,000	35	4	1.5
Mullard...	PM22	62,500	82	2	.3	Cosmos ...	AC/G	17,500	35	4	1.5
Marconi...	PT235	55,000	90	2	.35	Cossor ...	MHF415	15,000	25	4	1.5
Osram ...	PT235		90	2	.35	Ediswan	MI41	9,000	16	4	1.0
Cossor ...	230QT	20,000	40	2	.3	Cossor ...	MLF410	8,000	15	4	1.0
Mullard...	PM24	28,600	62	4	.15	Cossor ...	MD415	5,500	10	4	1.5
Six Sixty	415PP	27,000	60	4	.15	Cosmos ...	AC/R	3,000	10	4	1.0
Cossor ...	415QT	20,000	40	4	.15	<i>A glance through the constructional articles in this issue will give the novice some hints regarding the best valves for the various types of circuits</i>					
Mullard...	PM26	25,000	50	6	.17						

LEWCOS QUALITY COMPONENTS

FIXED POTENTIOMETER



Price 5/6

Regd. Design No. 740579.

The LEWCOS FIXED POTENTIOMETER is designed to give smooth reaction control on all Radio Receivers.

Leaflets and chart showing performance will be sent on application.

H.F. CHOKE



Price 9/-

The finest quality materials and the high-class workmanship used in the manufacture of the LEWCOS H.F. CHOKE make it supreme. Its extraordinary efficiency may be gathered from the following figures taken from the "Wireless World" test report, 17/10/1928. Charts showing its performance and leaflets will be sent on application.

WAVELENGTH (metres)	IMPEDANCE (ohms)
200	12,500
300	21,800
500	45,500
1,600	214,000

"Self-resonance well above 3,500 metres and in circuit will probably approach 5,000 metres." These figures "definitely establish the Lewcos choke in the front rank of its class."

Reduction in price of **GLAZITE** (ROUHSI SLAID) REGD. OLD PRICE: 10d. per 10 ft. coil. NEW PRICE: 8d. per 10 ft. coil.

THE LONDON ELECTRIC WIRE COMPANY AND SMITHS LIMITED, CHURCH ROAD, LEYTON, LONDON, E.10. - - Trade Counter and Cable Sales: 7, Playhouse Yard, Golden Lane, E.C.1

Connoisseurs

choose



BLUE SPOT
99K
£5:5:0

Blue Spot

BLUE SPOT
49
£2:2:0



Those who can appreciate perfect reproduction make a point of choosing their speakers from the famous Blue Spot range.

Here are two of the most popular Blue Spot models—the 49 and its big brother the 99K.

The Blue Spot 49 is a marvellous little speaker finished in Trolite and embodies the well-known 66Z adjustable movement. It has all the purity of tone for which Blue Spot speakers are

renowned. There is no other speaker to touch it at the price—only 42/-.

Then there is the 99K—Blue Spot's greatest triumph. This speaker is driven by the 66K adjustable unit and can carry any amount of volume. It is housed in a Trolite faced cabinet of unique design, and is sold for the modest sum of £5.5.0.

Each speaker—in its own class—represents Blue Spot at its best and will satisfy the most exacting demands of the connoisseur.

F. A. HUGHES & CO., LIMITED, 204-6 Great Portland Street, London, W.1

Distributors for Northern England, Scotland and North Wales: H. C. RAWSON (SHEFFIELD & LONDON) LTD.,
100 LONDON ROAD, SHEFFIELD: 185 PRINCESS STREET, MANCHESTER.

WAVELENGTHS of the EUROPEAN STATIONS Under the Prague Plan



This is an unofficial list of wavelengths which will come into operation on June 30. A number of wavelengths have been allocated to each country, but at the time of going to press the particular stations have not been decided upon in some cases. Above is a photograph of Prague, reproduced by courtesy of the Czechoslovak Travel Bureau

Wave-length	Name of Town	Country	Kilo-cycles	Wave-length	Name of Town	Country	Kilo-cycles	
200	COMMON WAVELENGTHS	—	1,500	325	Breslau	Germany	922	
202		—	1,490	329	Montpellier	France	915	
203		—	1,480	332	Naples	Italy	906	
204		—	1,470	335	Posen	Poland	897	
206		—	1,460	339	—	Belgium	888	
207		—	1,450	342	Prague	Czecho-Slovakia	879	
208		—	Belgium	1,440	346	Strasburg	France	870
210		—	Hungary	1,430	349	Barcelona	Spain	861
211		—	Roumania	1,420	352	Graz	Austria	853
213		—	Italy	1,410	356	London (2LO)	Great Britain	844
214	—	Poland	1,400	360	Leipzig	Germany	834	
216	COMMON WAVELENGTHS	—	1,390	364	Bergen	Norway	825	
217		—	1,381	368	Seville	Spain	815	
218		—	1,375	372	Stuttgart	Germany	807	
220		—	France	1,360	377	Manchester	Great Britain	795
221		—	Finland	1,353	381	Radio Toulouse	France	787
223		—	Luxemburg	1,348	385	—	Poland and Italy	780
225		Cork	Ireland	1,335	390	Hamburg	Germany	769
226		—	Roumania	1,326	394	Bucharest	Roumania	762
227		Flensburg	Germany	1,320	399	Glasgow	Great Britain	750
229		—	Spain	1,312	403	Berne	Switzerland	743
231	—	Sweden	1,298	408	—	Poland	735	
232	—	Jugo-Slavia	1,291	413	Dublin	Ireland	726	
234	—	Poland	1,285	418	Berlin	Germany	717	
235	—	Norway	1,277	424	Madrid	Spain	707	
237	Juan les Pins	France	1,267	429	Belgrade	Jugo-Slavia	699	
239	—	Germany	1,255	436	Stockholm	Sweden	690	
240	—	Norway	1,250	441	Rome	Italy	680	
242	Newcastle	Great Britain	1,238	447	Paris (PTT)	France	671	
244	—	Poland	1,226	453	COMMON WAVELENGTH	—	660	
246	COMMON WAVELENGTH	—	1,219	459	Zurich	Switzerland	651	
248		—	Italy	1,209	466	Lyons	France	643
250		—	Czecho-Slovakia	1,200	473	Langenberg	Germany	636
251		—	Spain	1,194	479	Daventry (5GB)	Great Britain	627
253		—	Germany	1,186	487	—	Czecho-Slovakia	618
255		Toulouse (PTT)	France	1,175	493	Oslo	Norway	607
257		Hoerby	Sweden	1,167	501	Milan	Italy	600
259		Cologne	Germany	1,158	509	Brussels	Belgium	591
261		Leeds	Great Britain	1,150	517	Vienna	Austria	580
263		Kosice	Czecho-Slovakia	1,141	525	Riga	Lettland	573
265	Lille	France	1,131	533	Munich	Germany	564	
268	Barcelona (EAJ13)	Spain	1,118	542	Sundsvall	Sweden	555	
270	—	Greece	1,110	550	Budapest	Hungary	546	
272	Rennes	France	1,102	562	Augsburg	Germany	534	
274	Turin	Italy	1,096	562	Hanover	Germany	534	
276	Koenigsberg	Germany	1,087	572	Freiburg	Germany	523	
279	Bratislava	Czecho-Slovakia	1,077	572	Ljubljana	Jugo-Slavia	523	
281	Copenhagen	Denmark	1,069	680	Lausanne	Switzerland	441	
283	—	Portugal	1,060	760	Geneva	Switzerland	395	
286	Rheims	France	1,050	825	Moscow	Russia	364	
289	—	Great Britain	1,040	1,010	Basle	Switzerland	295	
291	—	Finland	1,030	1,072	Hilversum	Holland	279	
293	Limoges	France	1,022	1,153	Kalundborg	Denmark	259	
295	—	Holland	1,014	1,200	Stamboul	Turkey	250	
298	—	Esthonia	1,002	1,304	Kharkov	Russia	230	
301	Belfast	Ireland	997	1,348	Motala	Sweden	223	
304	—	France	988	1,411	Warsaw	Poland	212	
307	Zagreb	Jugo-Slavia	979	1,481	Moscow Komintern	Russia	203	
310	Aberdeen	Great Britain	969	1,553	Daventry (5XX)	Great Britain	194	
313	Cracow	Poland	960	1,635	Zeesen	Germany	184	
316	Marseilles	France	951	1,725	Radio Paris	France	173	
319	—	Bulgaria	941	1,800	Lahti	Finland	167	
322	—	Sweden	930	1,875	Huizen	Holland	161	

Amateur Wireless

The Best
Wireless
Weekly

BECAUSE you like the WIRELESS MAGAZINE for its expert detailed constructional articles and the many interesting phases of wireless which it so admirably presents, you cannot but like "AMATEUR WIRELESS."

The WIRELESS MAGAZINE, as you know, leads the monthlies: "AMATEUR WIRELESS" is foremost of the weeklies.

Every issue of "AMATEUR WIRELESS" contains remarkably useful constructional articles, helpful contributions on receiving and transmitting, novelties and new developments, and—finally and particularly—the best possible news service.

Take "Amateur Wireless"
each week and get the
best results from your set

3 D.
Every
Thursday

IN TUNE WITH THE TRADE!

FETTER LANE'S Review of Catalogues and Pamphlets

Pye Portrayed

THE Pye people, of Paris House, Oxford Circus, W.1, have charmed my artistic soul with a most attractively got-up catalogue dealing principally with the Pye portable, and also giving details of other Pye radio receivers.

The attractions of this book are such as it is impossible to describe in black and white print, for the colours make one long to grab the portable receiver out of the page and walk off with it into some of the summer scenes portrayed.

The only comment I have to make is that the attraction of the booklet is such as may detract from the receiver itself, and I know the Pye portable to be good. But if I were you, I should take the risk and be tempted to get the catalogue! **35**

A New Metal Rectifier

LET me be quite serious when talking about the new Igranick-Elkon metallic rectifier. This is quite a new type of rectifier for use with H.T. and L.T. supply units on A.C. mains, and also for miscellaneous jobs such as energising the field coils loud-speakers.

The Igranick-Elkon is different from other rectifiers in that cupric sulphide and magnesium discs are pressed together and the whole assembly provided with radiator plates.

All amateurs interested in metal rectifier units should get a folder which has just been issued by the Igranick Electric Co., Ltd., of 149 Queen Victoria Street, E.C.4. Herein are given the types of rectifier for all H.T. and L.T. purposes. **36**

For Cossor Users

HARDLY a catalogue, but nevertheless a most interesting publication; that is the way I should describe the new 64-page Cossor wireless book, which is issued gratis.

It deals primarily with the operation of both the new and the old type Cossor Melody Makers.

There are interesting articles on how to look after the mechanical details of the Melody Maker, how the Melody Maker works, and also about the various things one can do to the set to get the best from it. There are tips on tuning, hints on reading valve curves, instructions for converting the set for the ultra-short waves, and other useful hints.

There is a full list of Cossor valves with characteristic curves. Personally, I think all the information contained in the booklet is excellent.

Lewcos and "Q's"

SO many people nowadays are making use of Q coils to replace any single-range six-pin coil, and a good many others besides, that a folder which has just been issued by the Lewcos people—or, to give them their full title, the London Electric Wire Company & Smiths, Ltd., Church Road, Leyton, E.10—is very helpful.

I'll wager that to many people the term Q is rather indefinite and they may not be aware that there are QAA coils, QAR coils, QSP coils, QSG coils, and so on and so forth, but you will see the whole gamut for yourself if you get the folder.

It is very helpful, too, because it

A SPECIAL SERVICE FOR READERS

As a keen wireless enthusiast you naturally want to keep abreast of all the latest developments and this special feature will enable you to do so with the minimum of trouble.

Here we review the newest booklets and folders issued by eight well-known firms. If you want copies of any or all of them just cut out this coupon and send it to us. We will see that you get all the literature you desire.

Just indicate the numbers (seen at the end of each paragraph) of the catalogues you want below:—

My name and address are:—

Send this coupon in an unsealed envelope, bearing 1d. stamp, to "Catalogue Service," WIRELESS MAGAZINE, 58/61 Fetter Lane, E.C.4. Valid till July 31

shows the theoretical circuits of the coil connections, and also gives little diagrams showing the actual terminal connections. **38**

Cyldon's Cut

CYLDON prices have recently been reduced, and I have just had a catalogue sent me showing the new prices of the complete range of Synchrotune, log, mid-line, S.L.F. condensers, and so on. The prices were always competitive, but the new reduction has resulted in amazing value.

Of particular interest to the more technical fans are the dual and two-, three-, and four-gang condensers, and some very pretty little jobs in the way of transmitting and short-wave condensers.

I had almost forgotten the Cyldon Bébé condensers, which are most popular for reaction use, and which you will find included in many WIRELESS MAGAZINE sets. Cyldon components are made, of course, by Sydney S. Bird & Sons, Ltd., Cyldon Works, Sarnesfield Road, Enfield Town, Middlesex. **39**

A Spot of Latin—and Pandona

REMNANTS of my classical education (very meagre, it is true) were recalled by the reception of a folder dealing with the Pandona Portable Five Receiver. Pandona signifies the *Gifts of the God of Music* (derived from the Greek god Pan and donum, Lat. a gift). I take this from the folder, but it seems right to me.

Anyway, to return to our muttons, the Pandona is very compact, is said to weigh about 28 lb., and has provision for a gramophone pick-up. The "Pan" part of the name is symbolised by the familiar figure portrayed on the fret of the loud-speaker grille; altogether a very attractive receiver.

My poor humour is nothing like so helpful as the technical data given with this folder, which you can obtain from Pandona, Ltd. 87-89 Edmund Street, Birmingham. **40**

THE CHANNEL TUNNEL-

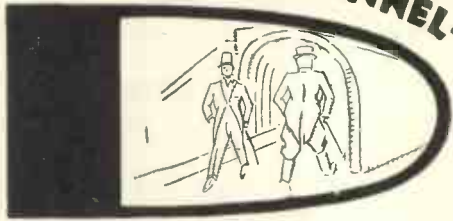

May TAKE YOU
TO THE CONTINENT
DARIO VALVES-

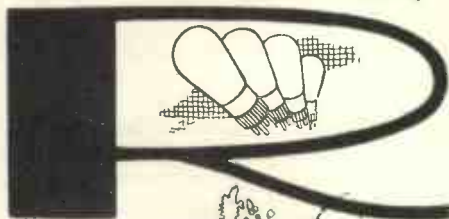

Will BRING THE CONTINENT
TO YOU

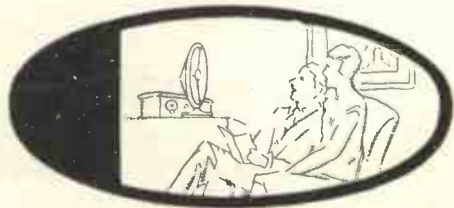

VALVES

A better Valve at a lower Price—Dario are the only valves at half-price which are GUARANTEED LONG LIFE.

Write for free Literature!

5/6	TWO VOLTS	7/6	FOUR VOLTS
	General Purpose, .05 amp.	5/6	General Purpose, .05 amp.
	R.C.C., .06 amp.	5/6	R.C.C., .07 amp.
	Super-Power, .18 amp.	7/6	Super-Power, .1 amp.
	Super H.F. & R.C.C., .18 amp.	7/6	Super H.F. & R.C.C., .1 amp.
	Pentodion, .3 amp.	21/-	Pentodion, .15 amp.

From your dealer or direct:

IMPEX ELECTRICAL LTD.,
(DEPT. K), 538, HIGH ROAD, LEYTONSTONE,
LONDON, E.11.

ESTABLISHED IN PUBLIC SERVICE

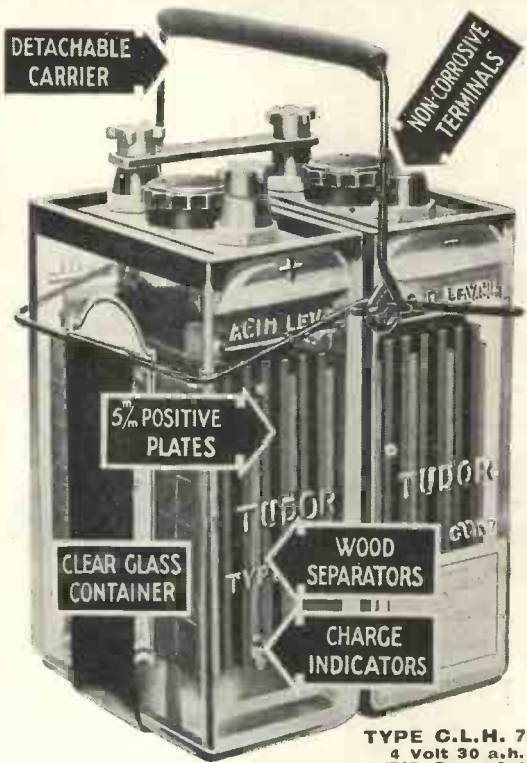

TYPE C.L.H. 7.
4 Volt 30 a.h.
27/9 Complete

WHAT MORE COULD YOU WANT IN A GOOD WIRELESS BATTERY?

The TUDOR Battery has everything a good wireless battery ought to have—charge indicators for convenience and safety—thick plates and wood separators, for long life and robustness—non-corrosive terminals with vaseline chambers—clear glass containers—big ebonite filling plugs—and now an all-metal carrier! Yet with all these advantages, TUDOR Batteries cost only slightly more.

Ask your local dealer to show you one and examine these detail refinements, including the ingenious indicators which tell you how much current you have left and when recharging becomes necessary.

The Monolt Unit is used with the Lodestone Five described in this issue—A 6V. 34 A.H. Battery with all the usual TUDOR features at only 40/-; Ask your local dealer for leaflets describing all types of TUDOR L.T. and H.T. accumulators or write us to-day



M.C. 51.

Tudor ACCUMULATORS

COUPON

Please send me full particulars of Tudor Wireless Accumulators.

Name.....

Address.....

TUDOR ACCUMULATOR CO., LTD., 2 NORFOLK STREET,
STRAND, W.C.2

Speedy replies result from mentioning "Wireless Magazine"

THE SECRET PROCESS

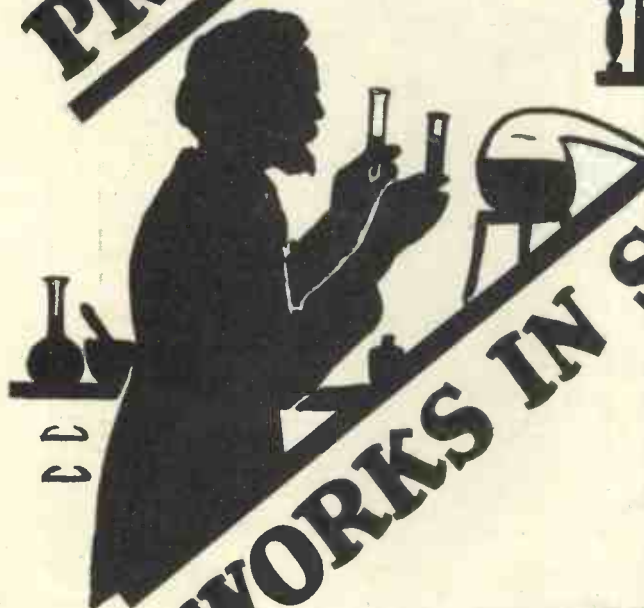

WORKS IN SILENCE

**generating
pure power
in big cells**

Steadily—sustainedly—noiselessly, the pure power flows from the big cells of the Lissen Battery. There is never a sign of ripple in it, never a trace of hum, because it is *chemically* generated by a secret process which Lissen alone know and use.

Right through the longest programme—through month after month of use—the fine quality and absolute purity of this current is maintained. It keeps loud-speaker utterance clear and true, gives natural reproduction of every note of music, every word of song.

Obtainable at every good radio dealer's—ask for Lissen New Process Battery and be sure to take no other.

LISSEN LIMITED, 500-520, Friars Lane, Richmond, Surrey.

Managing Director: THOS. N. COLE.

PRICES

60-volt (reads 66)	7/11
100-volt (reads 108)	12/11
36-volt	4/6
60-volt Super Power	13/6
9-volt Grid Bias	1/6
4½-volt Pocket Battery (4/6 a dozen) each	5d.
Single Cell Torch Battery	each 4½d.



Please mention "Wireless Magazine" when corresponding with advertisers

Rejuvenate Your Set by Using New Valves!

By D. SISSON RELPH

AN ARTICLE
FOR ALL
LISTENERS

CHOOSING THE
BEST TYPES

VALVE efficiency has increased by leaps and bounds during the past two years. Are you taking full advantage of the progress that has been made or are you putting up with mediocre results from an old set that would be improved almost out of all knowledge by the substitution of up-to-date valves—without any circuit alteration?

Useful and Actual Life

There is an impression amongst listeners that a valve is working at its full efficiency right up until the time when either its filament burns out or is broken.

But often the *useful* life of a valve is much shorter than its *actual* life, and it needs replacement long before becoming totally unusable if anything like good results are to be obtained from the receiver.

I have quite a collection of valves that have accumulated amongst my apparatus during the last nine years and, although many of them are in perfect condition—some are even brand new—I should not think of using them in a modern set, except as an amusing "stunt."

Almost Ludicrous Results!

And if I did use them, I know that the results would be almost ludicrous compared with what modern valves will accomplish, so great are the improvements that have been made even during the last nine months!

If your valves have been in use continuously for a year or more, you will get a very much better per-

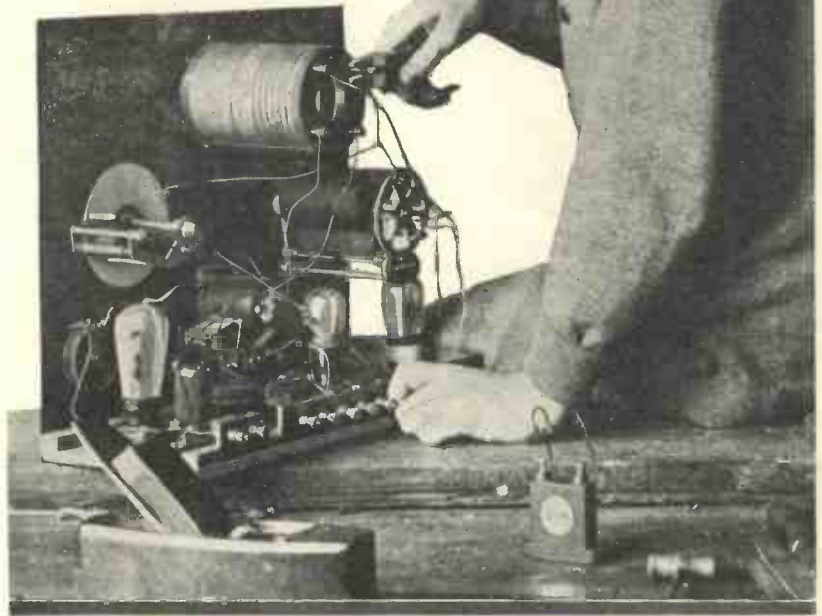

SEE HOW THEY TURN TO RADIO!

Even golfers have time for wireless. Here is Miss Enid Wilson, who recently won the English Women's Championship at Walton Heath, rebuilding one of her own sets

formance from the set—it is no exaggeration to say that you can double your power—if new types are provided.

It is well known that a valve amplifies; its power of magnifying is called *amplification factor* or *magnification factor*. Many valves of equivalent types now have double the amplification factor that they had two or three years ago, so you will easily see how you can improve the results obtained with your set by providing new valves:

Every valve also possesses another important property, its *resistance* to the electric currents that are generated in the set. This property is often incorrectly termed *impedance*, but it will be understood that in ordinary valve parlance the terms are interchangeable.

Maximum Valve Efficiency

It is important to realise that even a valve with a high amplification factor is not good if its impedance is too great. Put in another way, what

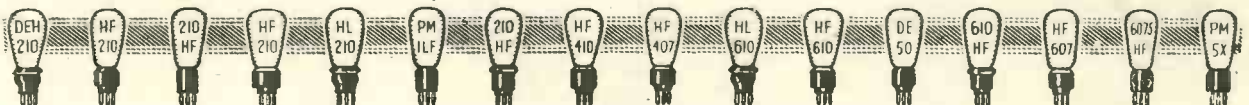

Sixteen representative valves suitable for high-frequency amplification

Rejuvenate Your Set by Using New Valves! (Continued)

we want for maximum efficiency is the greatest amplification factor for a given impedance.

Before we go any further, though, let us get some idea of relative amplification factors and impedances

have divided valves into six groups; this grouping depends on impedance and not on amplification factor.

You cannot take an old valve with an amplification factor of only 10, say, out of your set, replace it with a new

must be taken into consideration.

You know that every valve has an anode or plate, and any apparatus connected to this is said to be in the anode or plate circuit. There is a certain relationship between the impedance of the valve and the impedance of the apparatus in the anode circuit that will give the best results from any given circuit.

Something to Work On

Now we have something definite to work on and we shall see why the valves mentioned in the previous table are divided into six groups.

Every set has a detector valve, but not every detector valve has the same type of apparatus connected in its anode circuit. This is where, if you do not know how your set is arranged, you must do a little scouting round.

Pick out the detector-valve holder and trace the connection to the anode socket. (It will be seen that one socket is farther away from the other three, which are grouped close together; the "odd one out" is the anode socket.)

Recognising A Transformer

In most old sets it will lead to a low-frequency transformer (see the sketch on page 510), an instrument built up on an iron framework and usually marked with the letters IP, OP, IS, and OS. If this is the case, you will know that your detector valve is transformer coupled.

On the other hand, if the set is of fairly recent date, it may have a resistance-capacity coupling from the detector. The arrangement of this is illustrated by the sketches on this page. Both arrangements are identical electrically, but in the second the various parts have been boxed up.

Difference Between Couplings

The chief difference between the average resistance-capacity unit and a low-frequency transformer is that the latter is larger and is built up on a frame of iron laminations.

I do not think even beginners will

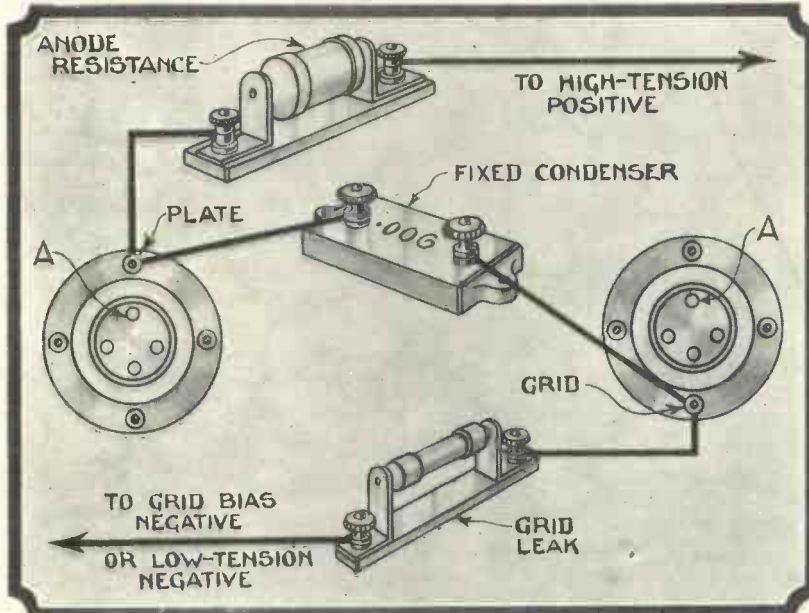

This sketch shows the component parts and connections of a resistance-capacity coupling with separate elements

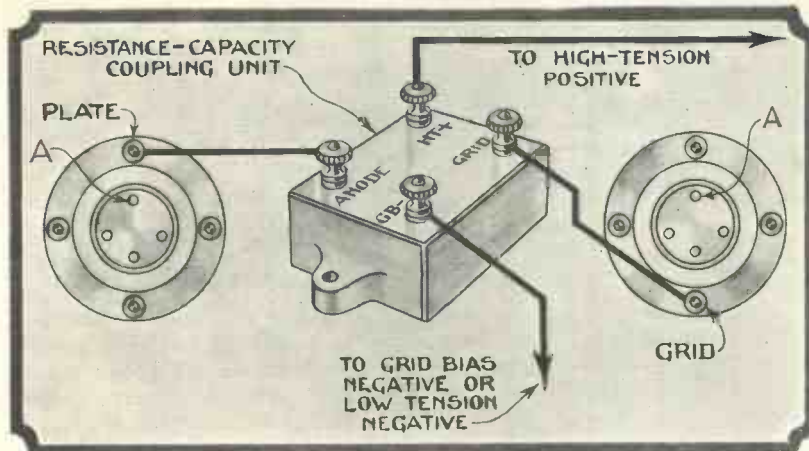

Here the anode resistance, fixed condenser and grid leak have been put inside a case, but the electrical properties are not changed

of modern valves. A glance at the lists of valves printed on pages 498 and 500 of this issue will show some comparative values, of which the table opposite is representative.

You will see from this table that I

type, giving an amplification of 30, and expect three times the power.

Although the valve plays such an important part in the receiver, it is not the only part that amplifies, and these other "amplifying components"

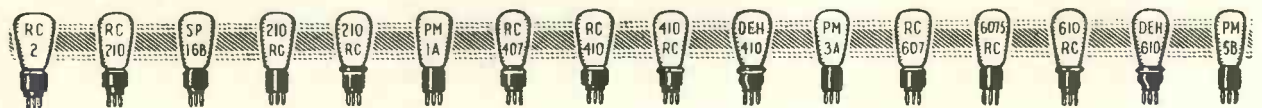

Valves used with resistance-capacity couplings should have high impedances

A Special Article by D. Sisson Relph

THE FIRST BROADCAST LESSON!

This photograph was taken on the occasion of the first B.B.C. broadcast to schools. Many such old-fashioned sets are in use all over the country, and the performance of most of them could be greatly improved by the use of up-to-date valves.

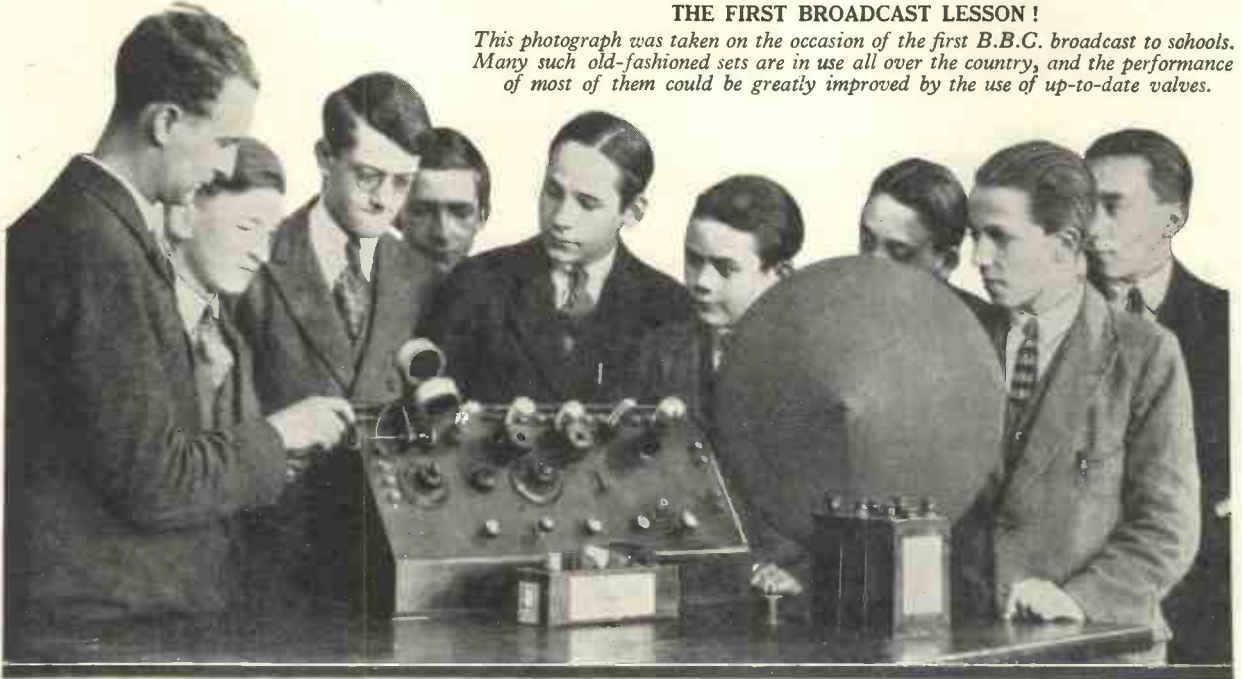

have any difficulty in differentiating between the two instruments.

Most listeners will know already if their set incorporates one or more stages of high-frequency amplification, so there will be no difficulty in the case of a high-frequency valve.

Detector and Two L.F. Stages

The majority of sets built and sold two or three years ago consisted of a detector stage with two transformer-coupled low-frequency amplifiers. In some cases two resistance-coupled amplifiers were used, in which case the second valve can be treated as a resistance-coupled detector.

The choice of new valves for a set will be considerably easier to the beginner if he realises that every set has one of the two types of detectors already discussed and a power valve in the last stage.

Moreover, these two valves are often the most important in the whole set, for whereas the use of wrong valves in the other stages may only result in lack of volume, the use of the wrong detector and power valves will inevitably produce bad quality, which is nowadays unforgetable.

Having gleaned some idea of how to sort out the various valves in a set we can now discuss more fully the choice of new types to give improved results.

First, the voltage of the filaments. Many listeners at present use two-volt valves just for the convenience of having a small accumulator. But more and more people are coming to the conclusion that this is false economy and are changing over to six-volt valves, which in almost all

cases have better characteristics.

For instance, a glance at the tables on page 498 will reveal that a two-volt valve with an impedance of 10,000 ohms has an amplification factor of 9 against 15 for a six-volt valve of the same impedance. Here, obviously, the six-volt valve is considerably better than the two-volter.

Deciding for Yourself

I shall not press the point of changing over from two- to six-volt valves. Having brought your attention to the advantages, I will leave you to decide whether it is worth getting a bigger accumulator. I will only say that I have not yet heard of anybody changing over from six-volt to two-volt valves for the sake of improved results.

If your set has a high-frequency amplifying stage you can safely get a valve with an impedance between 20,000 and 60,000 ohms, with an amplification factor between 20 and 40.

Moreover, most sets will be improved by providing the valve with 1½ volts negative grid bias. This is applied by breaking the grid return

Use of Valve	Amplification Factor	Impedance
1.—High-frequency amplifier ...	20	25,000
2.—Detector with resistance-capacity coupling ...	35	70,000
3.—Detector with transformer coupling ...	15	20,000
4.—Low-frequency valve with transformer coupling ...	10	10,000
5.—Small power valve ...	7	5,000
6.—Super power valve ...	4	2,500

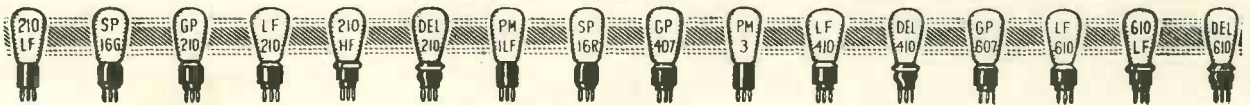

Medium-impedance valves can be used with most low-frequency transformers

Rejuvenate Your Set by Using New Valves! (Continued)

lead to low-tension, negative and inserting the $1\frac{1}{2}$ -volt cell so that the positive end is connected to low-tension negative and the negative end of the cell is led to grid of the high-frequency valve through the tuning circuit (or grid leak if there is more than one stage).

L.F. Transformer Coupling

We have already seen that there are two types of detector valve, depending upon the coupling that follows them. Let us first consider in detail the case of a low-frequency

transformer. A common value for the latter is 250,000 ohms; so a valve with an impedance of 80,000 to 120,000 ohms will be suitable.

If your set has a resistance-capacity coupling and you are not sure of the value of the anode resistance, it is worth while writing to the manufacturers before making your choice of a new valve.

Remember that the use of a lower impedance valve than those mentioned will not result in distortion; you will simply fail to get such good amplification as you would if the

when a dry-cell battery is used, unless a new one were obtained about once a fortnight!

Nearly all amateurs use batteries of too small a capacity to supply the valves they are using. The truth of the matter is that it is comparatively expensive to run super-power valves from dry high-tension batteries, and that is one of the reasons why the mains supply unit is becoming so popular.

For Large Receivers

For a two-valve set an ordinary standard-capacity battery (that is, with a maximum discharge of 7 milliamperes or so) can be used, but for a three- or four-valver a double- or triple-capacity battery is essential for economical operation of a set. It is always cheaper in the long run to buy super-capacity cells.

If you are still using a horn type of loud-speaker you will not gain very much by using a power valve of very low impedance. Anything between 3,000 and 5,000 ohms will give results good enough for most people.

With a cone loud-speaker, however, when it is possible to get better bass reproduction, an impedance between 2,000 and 3,500 ohms is likely to be more satisfactory.

In connection with power valves, it is most important to give one's full attention to grid bias. Negative bias is essential for all low-frequency amplifying valves, and in many cases it needs critical adjustment for the best results.

Details from Manufacturers

Before choosing new valves, I recommend every WIRELESS MAGAZINE reader to get from the valve manufacturers (free of charge) complete lists and characteristics of all the valves available.

A careful study of these particulars will enable you to choose a valve to give the best all-round service—as regards impedance, amplification factor, high-tension voltage, high-tension current, and grid bias.

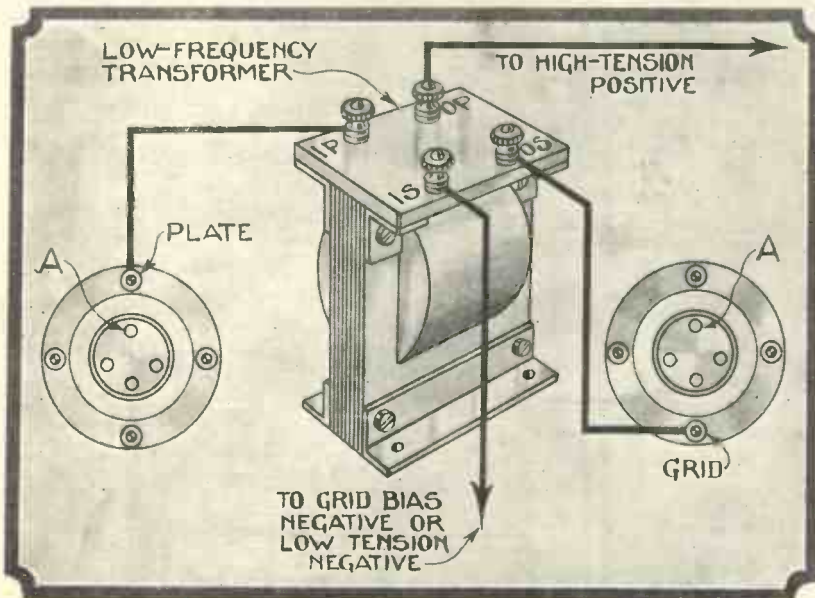

A low-frequency transformer is connected as shown, and can be recognised by its iron framework and usually the markings IP, OS, IS, and OS

transformer For use with most transformers it is safe to choose a valve with an impedance of about 20,000 ohms.

Some transformers will still give good quality with a valve impedance of 30,000 ohms or even higher, but unless you are sure of that, it is safer to get the lower value I have mentioned.

Resistance-capacity Couplings

In the case of a resistance-capacity-coupled detector, the valve impedance should be between one-half and one-third of the actual anode coup-

valve impedance and anode resistance had the proper relationship.

Indeed, when there are two resistance-capacity-coupled low-frequency stages in a set it is often advisable to use a low-impedance valve in the second stage to decrease the amplification deliberately so as to avoid overloading the last valve when receiving the local station.

The choice of the ideal last valve for a set would be very simple were it not for the question of high-tension supply. So many power (or super-power) valves that would give excellent results are out of the running

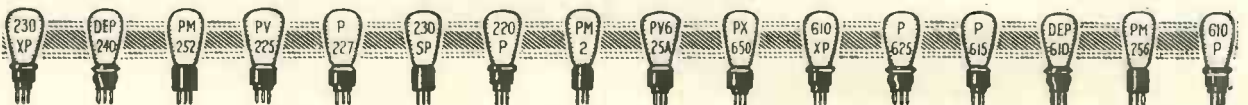

The use of any one of these sixteen power valves will ensure good quality from most ordinary sets

Bergen's Broadcasting

By H. de A.

DONISTHORPE

BROADCASTING has taught us in the British Isles to be less insular than we were in the past, and night after night there are thousands of listeners who tune in their radio receivers to European stations other than those belonging to the B.B.C. system.

Norway's Best Station

A few remarks relating to the broadcasting station of Bergen in Norway may, therefore, be of interest, since the offerings from this station can no doubt be often heard by many listeners in certain parts of these isles.

Bergen is the second largest city in Norway, with a population of only 100,000 inhabitants, and yet it boasts of its own broadcasting corporation.

British Relays

Bergen is a seafaring town of wondrous beauty located on one of the famous fjords, and because of the mountainous nature of the surrounding scenery its radio reception is somewhat restricted to the signals originating from the local Bergen station. Signals from the B.B.C. stations, however, are well heard in this town because of its locality on the extreme west coast of Norway with only sea intervening, and the programmes from the B.B.C. are often relayed for the benefit of the Bergen listeners.

As one approaches Bergen from

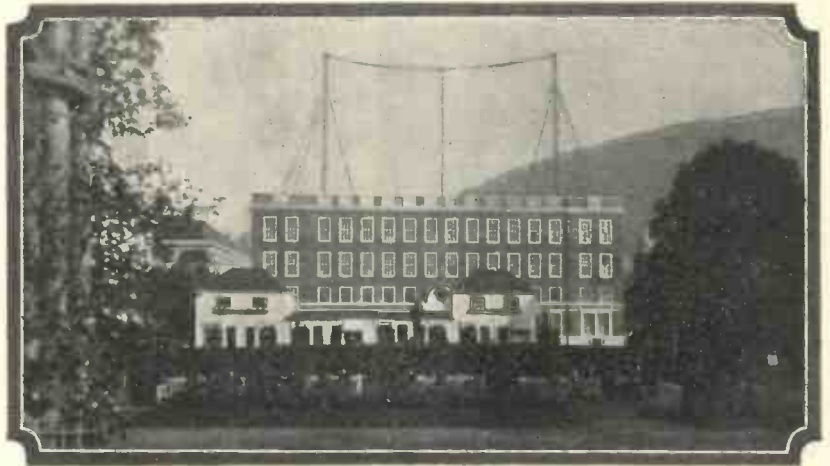

The Bergen transmitting station's aerial on the State Telegraph Office

the sea, it can well be appreciated that this city in the valley, whilst being sheltered from the winds and storms by the surrounding mountains, is also consequently screened from radio signals to a very large extent. Oslo, which is only 200 miles away, cannot be relied upon for regular reception, and when heard fading is very prevalent.

The Bergen Broadcasting Corporation is financed from the licences issued by the State of Norway. The receiving licence costs 20 kronnen per annum, or about twice as much as a licence costs here. The Government deducts 10 per cent. of the money collected for administrative purposes.

In addition to this revenue, a tax is levied on all radio receiving

apparatus sold, which is assessed according to the type of material sold. There is also a heavy import duty on all radio apparatus imported and there is very little material manufactured in Norway.

Radio Is Expensive

All these initial charges cause radio to be an expensive hobby, and the number of listeners is, therefore, limited. It is unfortunate that radio is so expensive, as broadcasting is a wonderful boon to the inhabitants of that country, where the listeners are so widely distributed and separated from the outside world.

It is reported that there are very few "pirate" listeners in Bergen, but there is a regular rounding up of these illicit receivers by the State authorities, and those who are discovered are fined a sum equivalent to double the licence fee. The Norwegians are, however, an honest race, and there are very few who seek this wonderful broadcasting entertainment without contributing their share towards its production and distribution.

1½-kilowatt Transmitter

The transmitting station of the Bergen Broadcasting Corporation is located in the building of the Telegraph Administration Department, situated in the heart of the town, and the actual apparatus is of the usual 1½-kilowatt type to be found in some of our stations here.

(Continued on next page)

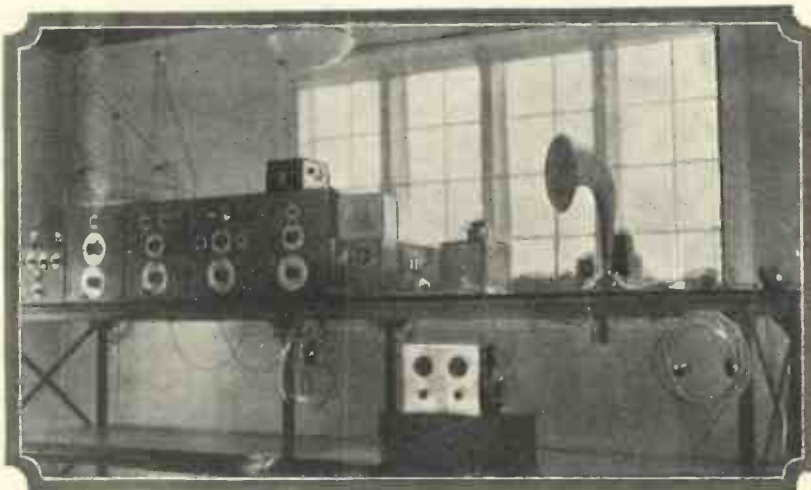

Apparatus inside the Fyllingen station

That Feminine Touch

THE other day I had the pleasure of talking to a man who happens to be the editor of the woman's section of a daily newspaper. I had always imagined that the articles therein on cookery, vacuum cleaners, unmentionables and other miscellaneous feminine whatnots were written by women, but I was told that it is not so and that men seem to know just as much about these things and can express themselves better—at which, of course, I said "Tut-tut."

Read by Men As Well

This is in parenthesis. What interested me more was the fact that the woman's page is read by men as well as women, and this editor said that no ordinary modern newspaper can get on without a woman's section or, at least, something with a feminine appeal.

How is it, then, that there is no feminine appeal in wireless? I suspect woman's interest of not being entirely tied down to cookery hints (as we may judge from the women's hours which were given formerly), but women do not seem to take much interest in the technical side of wireless.

They are satisfied so long as the set works, but immediately *paterfamilias* starts to tinker about he is greeted with a chorus of feminine complaints from mother and daughter.

Therefore, to attract women's interest in wireless, one must forget entirely the technical side.

Take my wife, for example, but perhaps I had better leave it at that!

HENPECK.

Stopping Static

TRAFFIC must be a bit of a bother in the States and there seem to be so many sources of artificial static that lucky is the Yank who can differentiate between electrical disturbances caused by the elements and those caused by other Yanks!

A strong source of static in this latter category is that set up by street cars (which means trams, if you don't speak American).

I have just been reading of a device made up by a Washington listener in order to cut out street-car static, and it consists of an 8-microfarad electrolytic condenser, and a 300-microhenry choke. The snag is, of

Bergen's Broadcasting (Continued from page 511)



Mast and aerial of the Fyllingen receiving station

The studio is in a separate building, belonging to the broadcasting corporation, about half a mile away from the transmitting station, to which it is connected by land-line system.

It is interesting to note that the transmitter itself is operated and maintained by, and at the expense of, the State Telegraph Department, whilst the programme department

and studio are financed by the private company.

In the control room of the studio land-lines come in from the Bergen Museum, where talks are given, and also from the National Theatre, whence frequent broadcasts emanate.

The local hotels and restaurants are also connected by land-line to the control room, and provide the dance music and tea-time programmes. Communication by wire is, of course, maintained with Oslo in case the "fading" is too bad to allow of direct radio relaying being obtained of any special programme that is being broadcast from Norway's capital city. Actually, some 1,500 hours of programmes are provided yearly by the corporation.

Special Listening Station

In these pages there are photographs of the listening station connected to the studio, which is located at a small village called Fyllingen, outside the valley of Bergen, and is employed for producing the outside relays from England and the Continent.

This little Bergen broadcasting corporation is quite an enterprising concern and produces its own local radio paper, and they deserve the success they are obtaining by reason of the fact that they are providing such excellent entertainment to the listeners of this shut-off little European city and at the same time keeping them in touch with the outside world.

Those "Yankeeisms"

SOME of the expressions which I discovered on turning over the pages of an American contemporary made me smile.

Here is a new expression.

It is "glass arm" and I puzzled for a long time to find out what it meant. Yankeeisms are invariably succinct and are not always explained. This one wasn't, but by dint of carefully reading the whole article (a labour in itself), I found that it denotes arm fatigue after a spell of morse-key manipulation—or as they call it in polite moments, telegrapher's paralysis.

C. WYNNE.

course, that this filter has to be fitted not to the receiver, but to the street car and there is at present no law compelling street car owners to fit static filters.

Trouble of this kind is very limited in this country and is experienced chiefly only by residents close to rather old-fashioned tramways or to electric trains which, on account of the greater current they consume, cause correspondingly greater static. In most cases it is found that using a counterpoise in place of a direct earth results in a minimisation of the crackling, while careful positioning of the aerial often has also a marked effect.

STATUS.

Halyard's Chat on the Month's Topics

Here you see an unusual view of the London transmitting aerial, taken from Marble Arch. This aerial will soon be replaced by that at Brookman's Park

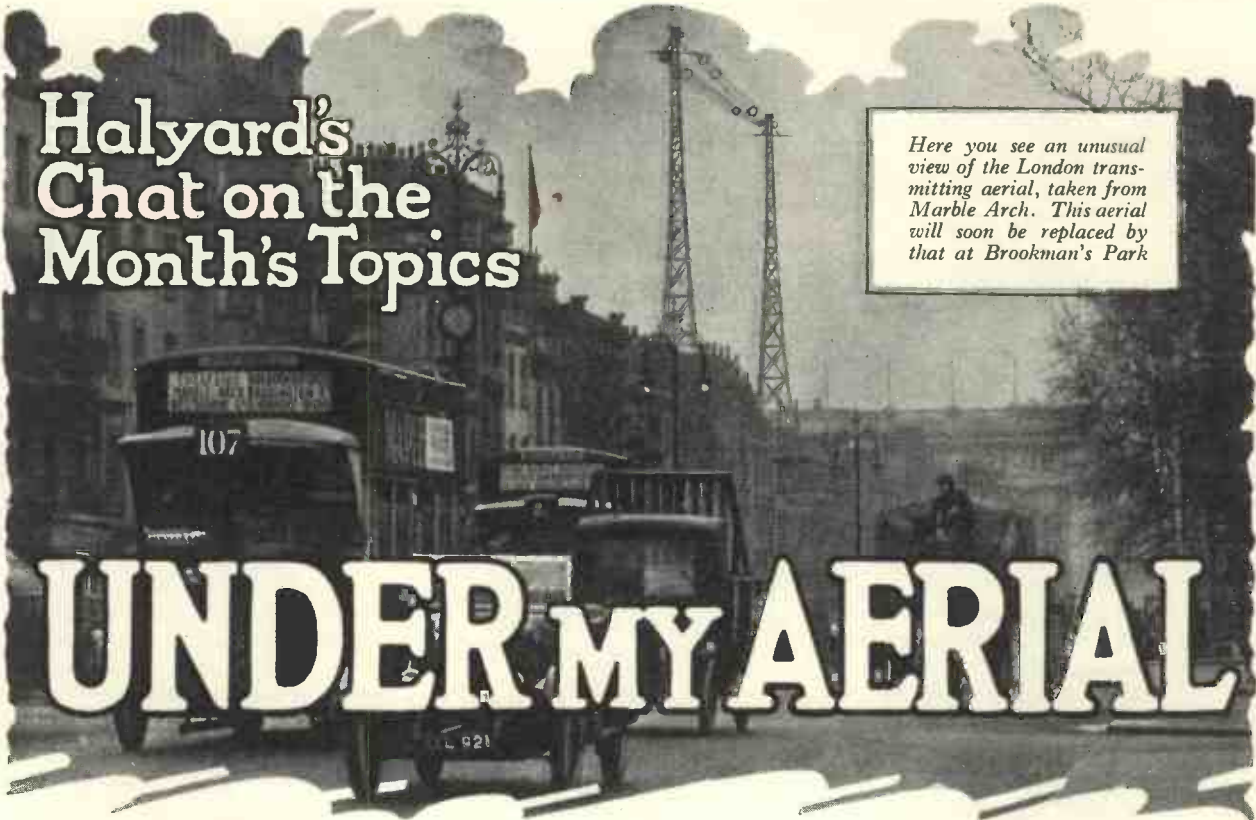

UNDER MY AERIAL

Portable Progress

DON'T you think that the progress wireless is making this summer is very largely due to the popularity of the portable set? Usually, at this time of the year, wireless falls off a little in popular favour because of the numerous counter attractions, outdoor sports for example.

This summer, however, wireless seems to be holding its own in marked fashion, and, judging from the steady increase which is taking place in the number of listeners, and the amount of business which is being done by makers of portable sets, wireless is actually progressing in a way which would be gratifying

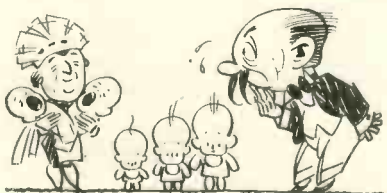

Steady increase

during the coldest and darkest of winters.

I am certain that the popularity of the portable set is having most to do with this summer progress. The proof of this popularity is to be found in my own house. I have a

portable set, a very simple affair to manage. There are only two controls, a tuning control and a volume control, and there is a simple push-pull switch to switch on or off.

So easy is this portable set of mine to work that several members of my household who have never dared to attempt the working of my bigger and more complicated sets have got into the way of using my portable just whenever they like. In consequence, we are having more wireless in my house than ever we have had.

Just now I have had to go out of one room into another away from the wireless so that I could compose my thoughts sufficiently to write these notes for you. Rather amusing, isn't it?

2L Over

If 2LO happens to be your local station or one of your favourite stations, you will be watching very anxiously for signs of the change-over which will soon be made from the Oxford Street transmitter to the new regional transmitter at Brookman's Park.

The first signs of the change will be test transmissions from the new station outside the usual broadcasting hours. I think a good many of us will turn an anxious dial towards

those first test transmissions. I know I shall, for one.

Our B.B.C. folk know how to engineer a change such as the pending one from the old 2LO to the new 2LO, and they deserve our thanks for the way in which they have



Your local station

planned out the change. I think they have given every consideration to our side of the matter.

After the preliminary tests have been completed, the new transmitter will be used for the broadcasting of dance music late at night. Then, for the benefit of those of us who go to bed before eleven (a pretty touch that, and one for which I am duly grateful), the new transmitter will come on the air at 9.15 p.m. Last of all, the Oxford Street transmitter will be switched off finally, and the Brookman's Park transmitter will be used for the whole of the London programme.

I consider these arrangements for the change-over to be admirable. We shall be able to accustom ourselves

Under My Aerial (Continued)

gradually to the new and more powerful transmitter, and we shall have ample opportunity for comparing the new transmitter with the old.

Reliability

I am having a great time with wireless out of doors this summer. On the average I have been out on some wireless stunt or other three times a week for the last month, and my knowledge of portable sets and how to use them in the open has increased accordingly.

One thing I am particularly struck with over my portable wireless work is the reliability of the portable set under very different conditions from day to day. I have hoicked my portable set about the countryside, climbed walls with it, slipped down grassy banks with it, dumped it here,



I am having a great time

there, anywhere, without plan or forethought, and the set has never failed me once.

To be able to say such a thing is, of course, as great a compliment to our broadcasting stations as it is to our modern sets and component parts.

Listening to a wireless set out in the country has a charm peculiarly its own. The better the setting, the better the set, so to speak. The more beautiful the view, the more entrancing is the music from the portable set—so it seems to me at any rate. You may be sure I am going to put in, or perhaps I ought to say put out, all the time I can in the open air with my portable set this summer.

By the way, have you noticed how very interested cows are in wireless? Fix your portable set in a field somewhere, get it working nicely, sit still and listen to the music and within a couple of minutes you'll have a ring of cows round you munching solemnly. Fact!

George is very anxious to try the effect of a prolonged oscillation howl on a ring of cows, but we have not yet found a suitable position with a safe retreat.

Signal Strength

Do you ever try your hand, or rather your ear, at making comparable estimates of the signal strength of your favourite broadcasting station from day to day? George and I rather pride ourselves on our ability in this direction, but I learnt the other day that my mathematical friend has got us both beaten easily. Where we work by ear, my mathematical friend uses a most ingenious instrument.

Really, it is most exciting to see the needle of this instrument moving to register the fraction of a—er—er—whatever it is my mathematical friend measures signal strength in.

Do you happen to know the unit in which signal strength is measured? I asked George and George said the unit was the gefusky, but I am not sure that George got the word right or, if he had, that my mathematical friend was not indulging in a little leg-pulling.

Let me tell you one most uncanny thing about this instrument, though. It records with unerring precision just when a broadcasting station breaks down or otherwise goes off the air. I know, because I saw it carry out this weird piece of wireless detective work. The station being received was one of our British broadcasting stations, and it suddenly went silent at five o'clock that afternoon, to come on again ten minutes later.

George is already saving up for one of these ingenious wireless watchdogs. He says there is satisfaction

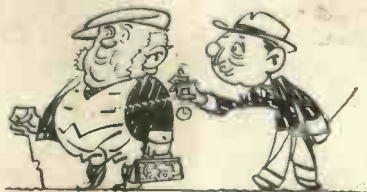

Do you ever try your hand?

to be gained out of writing to the B.B.C. to ask them why such and such a station broke down at five pip emma on the seventeenth inst.

Wet H.T.

During one of my recent tests with a portable set out in the open, I had a curious experience over the high-tension battery. The set I was using

was not the finished article. Instead of having everything assembled in final form in the portable cabinet, I had placed the valve section of the receiver, the batteries and the loud-speaker in a large flat box.

There was a leather handle at either end of the box for carrying the whole equipment, the handle at the

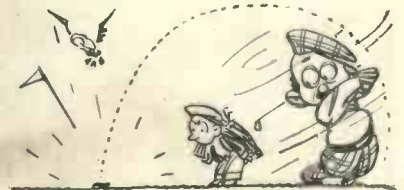

A curious experience

valve-section end of the box being for George, my engineer-in-chief, portable or unportable, and the handle at the other end, the battery, and heavier unfortunately, being for self—as we write on our cheques sometimes. To protect the equipment against rain, we had provided a mackintosh cover for the box.

Well! we were right out in a field enjoying ourselves with the apparatus when rain began to fall. Not wishing to bring our tests to an end we covered the box over with the mackintosh sheet, buttoned up our raincoats and carried on.

All went merrily for a time in spite of the rain. After a while, though, signal strength began to fail rather badly, so we took off the cover to investigate. We found that the rain had dripped off the cover right on to the top of the high-tension battery in the box and there was a nice pool of water short-circuiting half the battery.

I mopped up the water with my handkerchief, but we could not get signal strength back to its former good value, so we packed up and returned to drier conditions in the house.

Portable Licences

When you take your new portable set with you on your holidays this year, don't forget to put your wireless licence in your pocket.

According to the latest ruling of the P.M.G., your wireless licence covers the use of one portable set in addition to your fixed set in the house. There is, however, one condition

Halyard's Chat on the Month's Topics

attached to this very welcome concession and that is that, whenever you do take a portable set with you away from home, you must take your wireless licence with you and you must produce that wireless licence on demand. Hence the advice given above.

What I should like to know very much on this matter is the name, style or status of the official to whom has been delegated the duty of demanding to see our portable licences. Is it the policeman or the postman, the hotel proprietor or the rate collector? Possibly it may be an entirely new type of government official invented for the purpose, namely, the I.W.L., Inspector of Wireless Licences.

We cannot have anybody demanding to see our wireless licences, can we? Obviously not. I asked George for his views and he replied:

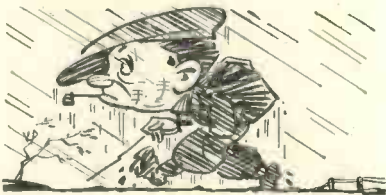

On your holidays this year

"The dignity of the listener demands a specially appointed inspector for the purpose, a well-paid and well-established official. If you can get the thing through, you might put me down for the South Devon area, will you?"

A Problem

This afternoon when I was carrying out some experimental work on high-frequency transformers there occurred one of those curious little wireless happenings which according to theory should be an impossibility. Very likely you have had a similar experience.

I was anxious to try a new type of high-frequency transformer that I had made, so in order to make sure that all the amplification I should obtain was from the high-frequency valve, I used a crystal rectifier after the valve.

The primary of my transformer was connected between the plate of the valve and the high-tension battery in the usual way and I had the crystal detector and phones in



A problem

series in the tuned secondary circuit of the transformer.

Not getting anything like the signal strength I expected, I began to twiddle the catswhisker about to find a better spot on the crystal. In the process of this search I lifted the catwhisker right off the crystal altogether, and to my great astonishment there was no diminution in signal strength.

Evidently the crystal was not functioning properly, but why should I hear anything through the phones when there was no rectifier in circuit? Can you give an explanation? If not I think we had better arm Young Amp with the problem and send him to Professor Megohm, don't you?

More Power

What is going to be the ultimate effect of all these increases in the power of the world's broadcasting stations? I know I have asked you this question before, but that was when things were far less alarming than they are at present. These proposed increases in power are going to affect you and me very considerably, and I wonder how we ought to prepare ourselves for them.

Starting at home, what is going to be the result to you of the increased power of the new regional station at Brookman's Park? According to present information, the power of this new station will be thirty kilowatts, as against the two kilowatts of our old friend, 2LO. Is this very great increase in the power of the London area station going to be to your advantage or disadvantage?

On the Continent the move towards



More power

higher power is very pronounced. Turin, the Italian station which has recently become such a great favourite with many of us, is to have its power increased from seven to fifty kilowatts. A new station at Bucharest, Roumania, is to have a power of twenty-four kilowatts.

Most startling of all, however, is the news that the Czecho-Slovakian government is to build the world's biggest broadcasting station, the power being one hundred and twenty kilowatts.

As far as I am concerned, these Continental stations can go on increasing their power until their aerial wires sizzle, but I am feeling just a little bit anxious about the increase in power of the London area station. It is all very well being able to pick up London on a pair of phones in series with a poker and a chunk of Derby Brights, but we do want to hear some other station occasionally.

The Wire Tamer

If there is one thing which catches my eye more readily than anything else it is new and highly burnished copper wire. This morning I happened to be motoring along a road a few miles from my home when my eye caught the familiar tint of copper some distance ahead. I looked at the

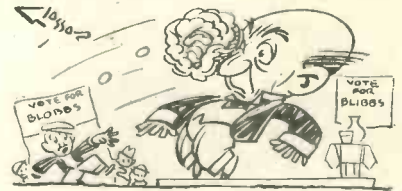

Catches my eye

brightly shining copper and, as I drew nearer to it, I saw that it was a couple of coils of wire held, one in each hand, by a telephone linesman.

Now I looked closely at that linesman as we passed him, and what do you think he was doing? He was walking backwards paying out wire from each of the two coils in his hands. More than that, he was doing this without the least trouble or concern, and he wasn't getting a single kink in either wire.

Could you do such a thing? I am certain I could not. Copper wire plays tricks on me just as easily as when I was a beginner. HALYARD.

THE PICNIC PORTABLE

A Cheap Three-valver for use near the Local Station. One Dial Tuning

Detector and Two Low-frequency Stages :: Utilises Standard Three-electrode Valves.



ALREADY this year we have described the construction of two good portable receivers in the WIRELESS MAGAZINE—J. H. Reynier's Wayfarer, and W. James' 1929 Chummy—and some readers will wonder why we are presenting details of another.

Meeting Every Need

The reason is one that has been advanced in these pages before. Every listener does not need the same type of set, and it is our aim to give the reader just what he wants in his particular case by publishing designs of a large number of good sets to conform with individual requirements.

The Picnic Portable, then, is intended only for use within close range of a local station—say 20 miles — and 100 or so miles from Daventry. It will therefore appeal particularly to those who want a completely self-contained receiver which can be built at comparatively low cost and which will be excellent for general use in the home or garden, as well as for taking out on picnics.

A great feature of the set is its ease of construction—a fact that will

be evident from a glance at the photographs.

Some readers will be sceptical regarding the utility of a three-valve portable set that uses only a small frame aerial, but their misgivings will be quite unfounded.

At the WIRELESS MAGAZINE offices in Fetter Lane—in the middle of London and in a building that contains a

and considerable amplification.

The fact that only standard three-electrode valves are utilised will appeal to many listeners, for they will be able to utilise components that they already have on hand and complete the set at low cost.

Both wavelengths are covered by the frame aerial and the change-over is made by operating a single push-pull switch. Beginners will be able to understand the working of a frame aerial much better if they realise that it is in effect only an enlarged tuning coil for the detector valve.

It has this difference from an ordinary tuning coil, however, in that it must be turned towards the transmitting station before any signals can be picked up. This directional feature is a most valuable

property, for it often enables an interfering station to be cut out.

Paralleled Windings

Two windings are provided for the long and short waves. For the long waves only, the long-wave winding is used, while for the short waves both windings are placed in parallel. Some technicians criticise this scheme on the grounds that it gives too loud

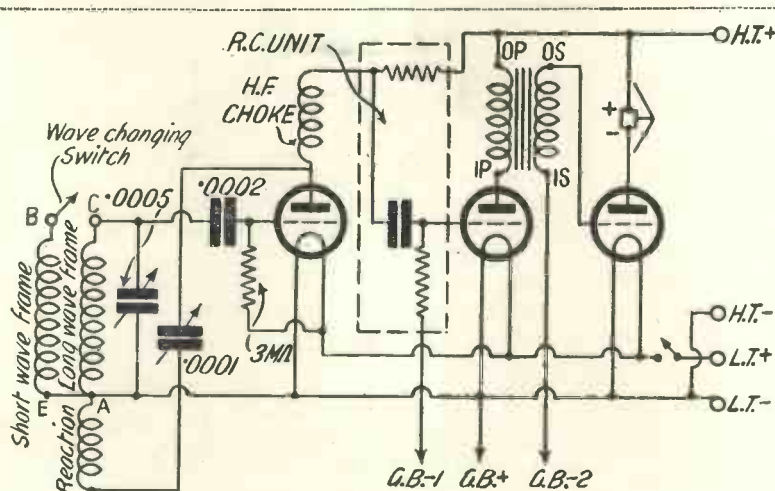

Here is the circuit of the Picnic Portable, which comprises a detector and two low-frequency stages

large number of steel girders that are detrimental to good results—the Picnic Portable picks up both 5GB and 5XX at good loud-speaker strength.

Actually the circuit combination used in the Picnic Portable is a leaky-grid detector, a stage of resistance-capacity coupled amplification and a transformer-coupled stage—a combination which gives excellent quality

tuning, but it does have certain advantages.

It is well known that if a piece of metal (or coil of wire) is placed in close proximity to a tuning coil damping is introduced, which cuts down signal strength and also broadens the tuning.

How Aerial Damping Occurs

If two separate windings are used in the frame aerial and these are used independently for long- and short-wave reception, then the long-wave winding will damp the short-wave winding when the latter is in use and results will suffer.

In the case of the parallel arrangement adopted in the Picnic Portable it will be appreciated that there is no damping on the short waves as both windings are in use together. The damping introduced by the unused short-wave winding when the long-wave winding is in use is not serious as there are few turns of wire.

Reaction is applied to the frame aerial and, besides increasing signal strength when desired, it also sharpens the tuning. The set is quite selective enough to separate without difficulty the stations it is intended to receive.

Straightforward Circuit

The circuit is quite straightforward and follows normal practice. The frame aerial is connected like an ordinary tuning coil across the grid and filament of the detector valve, and the wavelength is adjusted by means of a .0005-microfarad variable condenser. The grid condenser has a value of .0002 microfarad and the leak is 3 megohms, for maximum selectivity.

In the anode circuit of the detector

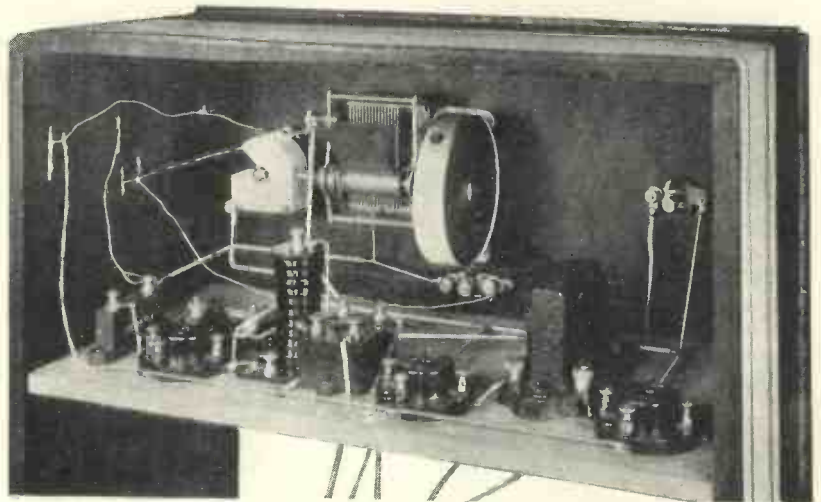

This view shows how the frame-aerial connections are taken to the receiver



How the frame aerial is wound

Reaction is obtained by taking a lead from the anode end of the choke to the reaction winding (actually on the frame-aerial former) and a .0001-microfarad variable condenser, which controls the amount of feedback.

Resistance-capacity Coupling

For the sake of cheapness and simplicity use is made of a combination resistance-capacity coupling unit, and for the best results it is essential that the type specified shall be used, otherwise the wrong values of anode resistance, coupling condenser, and grid leak may be obtained.

The first low-frequency amplifying valve is coupled to the power valve by means of a transformer in the ordinary way. This transformer is one of the new type with a special core of very high permeability. This means that although the core is small in area, it is just as efficient as an

is placed a high-frequency choke to keep high-frequency currents out of the subsequent low-frequency stages.

SEE HOW SIMPLE THE PICNIC PORTABLE IS TO BUILD!

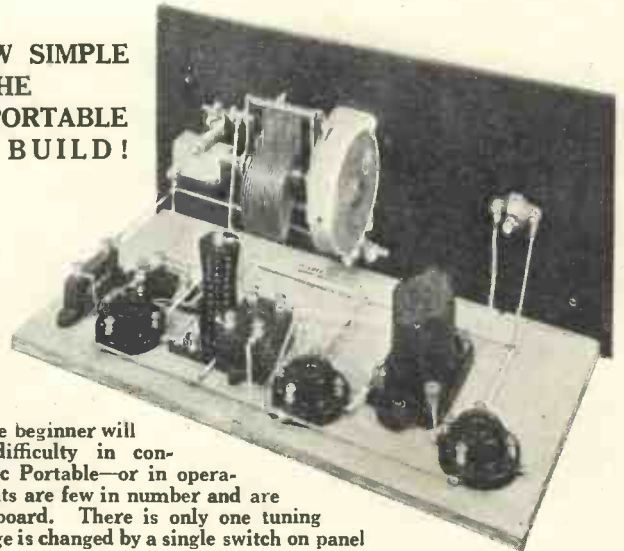
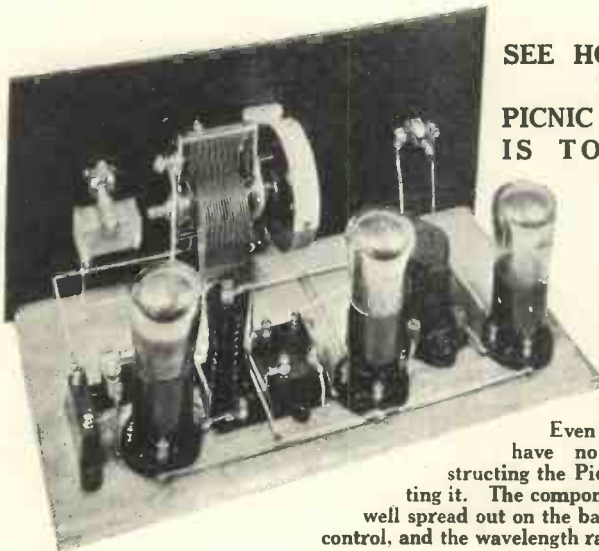

Even the beginner will have no difficulty in constructing the Picnic Portable—or in operating it. The components are few in number and are well spread out on the baseboard. There is only one tuning control, and the wavelength range is changed by a single switch on panel

The Picnic Portable Three (Continued)

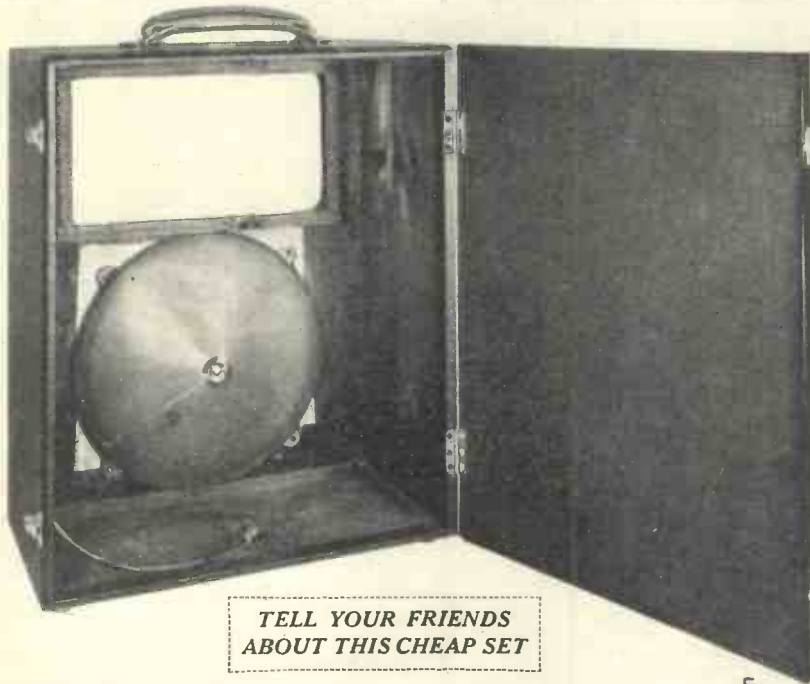

TELL YOUR FRIENDS
ABOUT THIS CHEAP SET

instrument of larger size with an ordinary iron core.

It is, of course, essential to apply grid bias to both the low-frequency amplifying valves.

There is little else to comment on as regards the actual circuit and we can now discuss the actual arrangement of the parts.

Use of Blueprint

Before discussing the construction, however, it will be as well to remind readers that, as is the case with all WIRELESS MAGAZINE receivers, a full-size blueprint is available. This can be obtained for half price, that is, 6d., post free, if the coupon on page iii of the cover is used by July 31. A reduced reproduction of this appears in these pages.

Where to Send

When applying for a blueprint send to Blueprint Dept, WIRELESS MAGAZINE, 58/61 Fetter Lane, E.C.4, and ask for No. WM148.

It will be seen from the photographs that the cabinet of the Picnic Portable is of the vertical type, that is, the operating position is the same as the carrying position. The case is comparatively light and, although

comparatively cheap, is well made and handsome in appearance.

Panel and Baseboard

The receiver itself is built up on the orthodox panel and baseboard, and is accommodated in the upper part of the cabinet, the controls protruding through a rectangular opening.

Underneath the receiver itself are accommodated the cone loud-speaker, low-tension accumulator and high-tension batteries. The fret in the cabinet for the loud-speaker is attractive in appearance and has a backing of tinsel cloth.

Simple Cone Loud-speaker

We particularly wish to point out that the actual cone and metal frame are obtained as an intergral unit—that is, there is no need for the constructor to cut a cone from paper and assemble it. All that has to be done

is to fix the reed driving unit to the cone by means of the conical washers supplied with it.

The first part of the construction to be undertaken is the winding of the frame aerial round the framework which fits inside the cabinet. The method of doing this will be clear from the diagrams and photographs.

On the left are dimensions and details of the frame aerial and reaction winding for the Picnic Portable

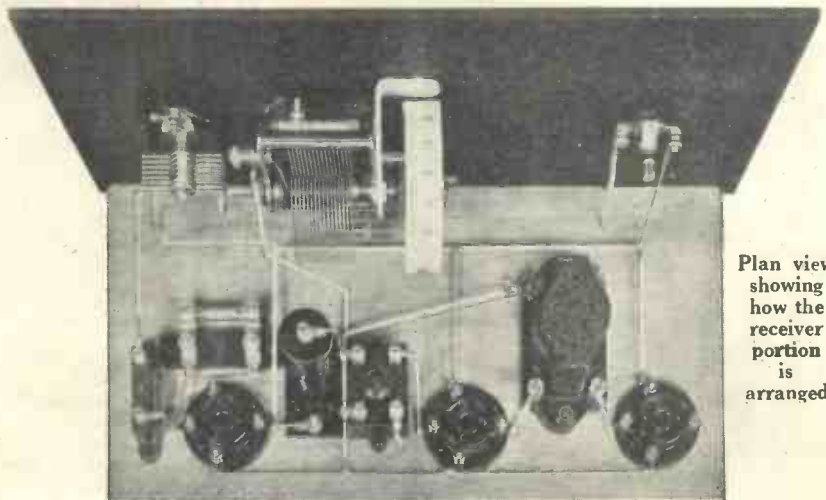
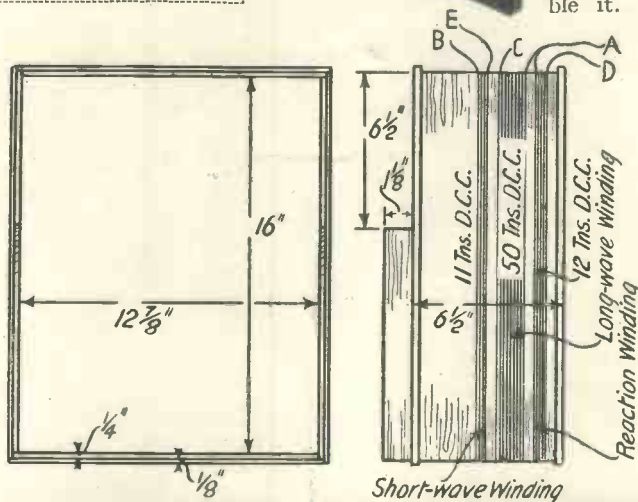

Plan view showing how the receiver portion is arranged

A Simple, Cheap and Efficient Receiver

Next, the set can be assembled in the ordinary way. As can be seen, it is extremely simple, and if the blueprint (or the reduced reproduction of the latter which appears in these pages) if carefully followed the constructor cannot possibly go wrong.

How to Wire Up Easily

When everything has been fixed firmly in position wiring up can be carried out with the set still outside the cabinet. On the wiring diagram every wire is numbered, and these numbers indicate the order in which the leads should be connected.

For instance, first connect up the lead No. 1 and cross the number through on the wiring diagram. Proceed with connection No. 2, and so on until the wiring is completed. Cut the flexible battery leads so that connections can be made to the batteries in the bottom of the case without difficulty and fix an indicating tag as soon as each wire is connected, otherwise there is a risk of the wrong connections being made.

Assembling the Loud-speaker

The assembly of the cone loud-speaker is quite simple. The metal framework with the cone already assembled has already been mentioned; it is only necessary to fix the driving unit in position and to attach the reed to the cone by means of the conical washers.

It will be noted that the unit used is of the non-adjustable type. This

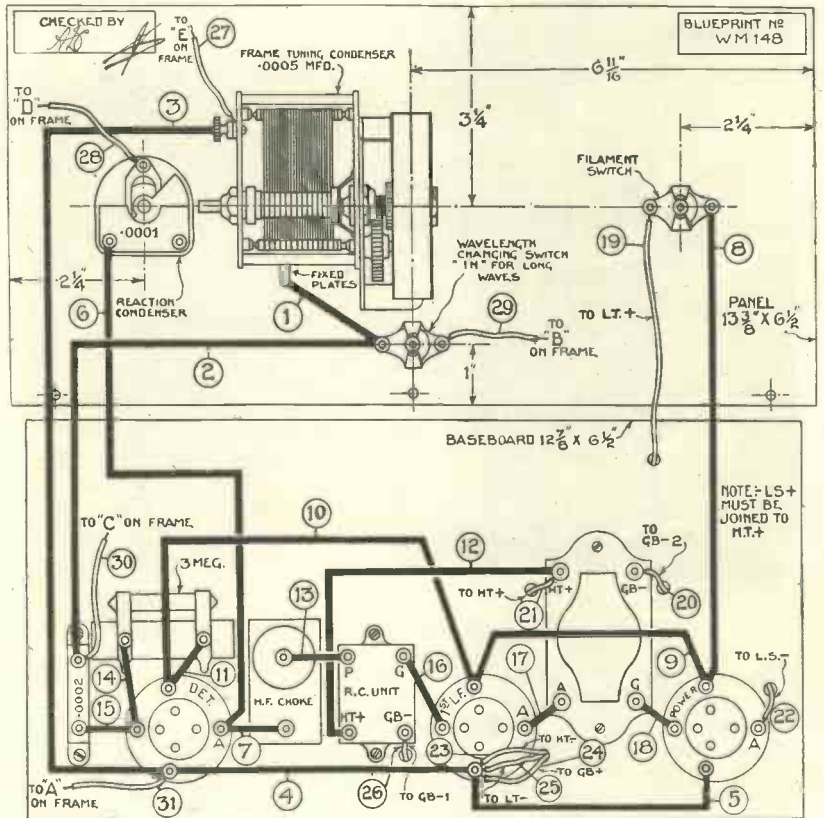

This layout and wiring diagram of the Picnic Portable can be obtained for half price, that is 6d., post free, if the coupon on page iii of cover is used by July 31. Ask for number WM148. Connect up in numerical order.

will be found quite satisfactory in use, but if desired a unit of the adjustable type can quite easily be substituted.

Before the set can be used, suitable valves must be chosen. This is not at all difficult, for the set is not critical as regards valves.

COMPONENTS REQUIRED FOR THE PICNIC PORTABLE THREE

Panel	1—13 3/8 in. by 6 1/2 in. (Potter, Raymond, or Will Day).	High-frequency Choke	1—Upright type (Ready Radio, Wearite, or Lewcos).
Cabinet	1—Portable type as illustrated (Will Day)	Dial Switches	1—Thumb-control type (Ormond).
Variable Condensers	1—.0005-microfarad (Ormond, Cyldon, or Jackson).		2—Push-pull on-off (Bulgin, Lotus, or Lissen).
	1—.0001-microfarad (Bulgin, Peto-Scott, or Lissen).	Sundries	1/2 lb. No. 26-gauge d.c.c. wire for aerial (Lewcos).
Fixed Condensers	1—.0002-microfarad (Trix, T.C.C., or Lissen).		Stiff wire for connecting (Glazite).
Valve Holders	3—Antimicrophonic (W.B., Lotus, or Formo).		Screws.
Grid Leak	1—3-megohm (Ediswan, Dubilier, or Lissen).	Loud-speaker	Flex for battery leads (Lewcos).
	1—Holder for above (Ediswan, Dubilier, or Lissen).		Indicating tags (Bulgin or Collett).
Low-frequency Transformer	1—Permalloy-core type (Philips, Mullard, or Cossor).	Batteries	2—Spade tags (Lectro-Linx).
Resistance-capacity Coupling	1—Combination unit (Trix type A).		5—Wander plugs, 2 red and 3 black (Igranic or Lectro-Linx).
			1—Reed-drive unit (Blue Spot).
			1—Metal frame with cone (White Spot).
			2—60-volt dry batteries (Lissen, Ever Ready, or Siemens).
			1—9-volt grid battery (Lissen, Ever Ready, or Siemens).
			1—2-volt accumulator (Exide WPC4, C.A.V., or Tudor).

The Picnic Portable Three (Continued)

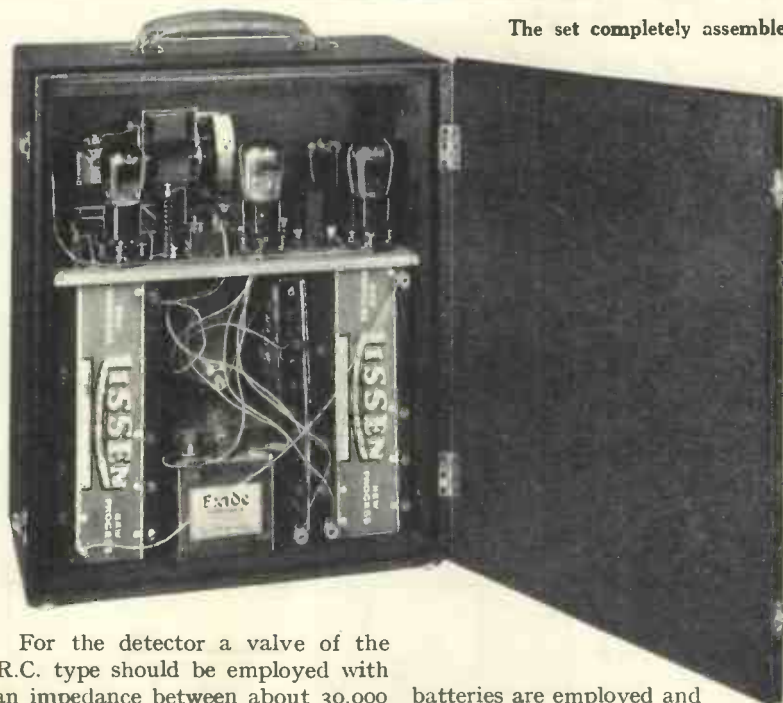

The set completely assembled

For the detector a valve of the R.C. type should be employed with an impedance between about 30,000 and 50,000 ohms, the higher value being preferable as it ensures the highest amplification factor—and also lower high-tension current consumption.

First Low-frequency Valve

The first low-frequency valve can—as a transformer with a permalloy core is used—have a fairly high impedance and a valve of the H.F. type can be successfully used in this position. For maximum strength use a valve with an impedance of about 20,000 to 30,000 ohms. This will also take only a small amount of high-tension current.

For the best quality the last valve should be of the small power type, with an impedance of 3,000 to 5,000 ohms. Actually a valve with an impedance as high as 7,500 ohms will give quite good results, but a lower impedance value will not so easily be overloaded by powerful signals from the local station. It should be borne in mind, however, that the lower the impedance of the valve, the higher will be its high-tension current consumption.

Question of Batteries

The valves will normally be of the two-volt type, unless a four-volt accumulator is accommodated in the cabinet. Two 60-volt high-tension

batteries are employed and the grid-bias battery will normally not need to be more than 9 volts.

Having obtained the necessary valves, it is a good plan to give the set a rough test before assembling it in the cabinet.

Place the valves in position and connect up the batteries. To one end of the loud-speaker apply the full voltage of both batteries (remember to connect the negative end of the second 60-volt block to the positive end of the first): this will supply anode current to all three valves.

To G.B.

—1 apply 3 to 4½ volts

and to G.B.

—2 apply 3 to 9 volts,

according to the maker's instructions.

The controls are arranged on the panel as follows: In the centre is the drum dial of the main tuning condenser, while underneath it is the wave-

change switch. On the left of the panel is the on-off switch, while on the right is the reaction condenser.

The wave-change switch is pulled out for the short waves and pushed in for the long waves, so first adjust this for the reception of the local station. Next, turn the front edge of the frame so that it is approximately in line with the direction of the station.

On Verge of Oscillation

Now pull out the knob of the on-off switch and turn the knob of the reaction condenser (note that no stop is provided on the model used in the original WIRELESS MAGAZINE receiver) until the slight rustling or hissing sound is heard from the loud-speaker which indicates that the set is on the verge of oscillation.

Turning the control of the main tuning condenser should now result in the local station being picked up without difficulty, but if it is not heard try rotating the frame aerial slowly, at the same time adjusting the main tuning condenser.

Readjusting Battery Voltages

Reaction should be adjusted for the best results, but if the reproduction is not loud and clear it is advisable to try readjusting the high-tension and grid-bias voltages.

It should be noted that, looking from the front of the set, the detector valve is on the extreme right, with the first L.F. amplifier in the centre and the power valve on the extreme left.

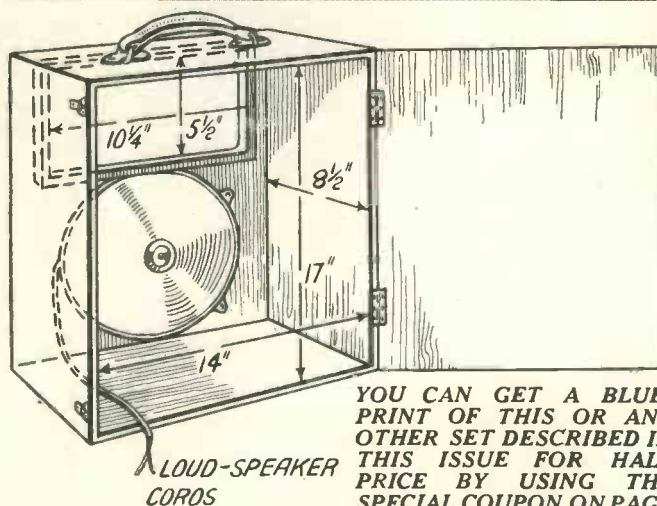

Details of the cabinet for the Picnic Portable

YOU CAN GET A BLUE-PRINT OF THIS OR ANY OTHER SET DESCRIBED IN THIS ISSUE FOR HALF PRICE BY USING THE SPECIAL COUPON ON PAGE III OF COVER

DOES THE B.B.C. GET VALUE FOR ITS MONEY?

THE issue of the B.B.C.'s report for 1928, showing a total income of £1,002,505 10s. 3d., was the usual occasion for resentful expressions of opinion among the hyper-critical. Vast sums of money, they said, were flowing into Savoy Hill, but the B.B.C. was not spending enough on programmes.

American Comparisons

In America, we were further told, artists like Van and Schenck, Paul Whiteman and others were drawing from £400 to £1,000 for a fifteen minutes' broadcast. The presentations from the studios of the National Broadcasting Company cost in 1928, just for the talent, £1,000,000, with a further £400,000 for the rental of wires to carry these programmes to the Company's associated stations.

What was the B.B.C. about that it was not displaying the same superb munificence? And why weren't the B.B.C.'s finances supervised by the Public Accounts Committee?

High Fees to Single Artists

Much more of the same sort of thing was ventilated; and it all showed a complete oversight of the facts associated with the conduct of broadcasting in Great Britain during last year. Take, for instance, the statement, quoted as revealing criminal neglect on the part of the B.B.C. in not following the same line of prodigality, that the American broadcasting concern paid fees of £1,000 to single artists.

Is the size of the fee paid necessarily a true criterion of talent? Not by any means. Big fees have sometimes been paid in this country for a name; but as regards the turn itself, this may have been scarcely worth a ten-pound note.

Some B.B.C. Bargains

Note this surprising fact. Incredibly large fees have been paid in America for exactly the same broadcasts as the B.B.C. has been able to secure at, to say the least, an economic



figure. This, the critics will no doubt say, is wrong, and should not be allowed, the B.B.C. drives too hard a bargain.

It is hardly likely that the average listener would agree, especially when he learns that not long ago a particular turn appeared in an American programme which cost the broadcasting authority £400. This same turn had been booked by the B.B.C. nearly a year previously for £8.

It seems absurd, with such a case on record, to attempt a comparison between the American and the British systems of programme buying. The B.B.C. does, however, invite the critic to name any reputable turn suitable for broadcasting that it has ignored, or of which it has failed to provide a practical equivalent. Members of the staff are daily scrutinizing not only all the available details of the world's entertainment talent, but also the details of national and international happenings; and it can be stated that the first question always brought up for settlement is whether the particular subject is suitable and available for broadcasting.

The second consideration, that of fee, is determined by market value and corporation policy. If, for example, the Football Association

had demanded an exorbitant sum for the privilege of broadcasting a running commentary on the Cup Final of 1929 (as a matter of fact, no fee at all was asked; the F.A. simply refused to allow the match to be broadcast), the B.B.C., in meeting the Association's demands, would have had to formulate a policy in respect of this and similar events; the size of the fee would not have been of paramount importance.

Further Misrepresentation

The Corporation has often been accused of giving the public what it thinks the public ought to have. This is a misrepresentation in many cases; for the B.B.C.'s purpose is more frequently to try and decide whether the fee asked is justifiable outlay in the public interest, be it £30 for a

Does the B.B.C. Get Value for Its Money? (Continued)



Bert Ambrose,
conductor at
the Mayfair
Hotel.

tip-top singer with talent, or £300 for a comedian with a certain degree of talent plus a vast amount of reputation.

Three Days' Radio for a Penny

While manifestly it is not germane to the quality of material, it is nevertheless well to bear in mind that the listener gets three days' programmes for a penny, and he is provided with 3,000 to 3,500 programme hours in a year. He may spend 120 hours a year in cinemas, by attending one performance a week; and he will pay approximately fifty-two shillings a year for this form of entertainment.

How often have the self-constituted champions of the so-called victims of B.B.C. high-handedness, not to say high-browism, declared with gusto that he who pays the piper has the right to call the tune. Much truth is in it; but if the quality of the tune were circumscribed by the individual's contribution to the piper's keep, then it would almost certainly be better to leave the B.B.C. to pipe unaided by its patrons' suggestions.

How the Money is Expended

If those self-same patrons are keen on knowing how their money is expended, let them study carefully the 1928 report. This shows that 2,628,392 licences were in force at the end of the year, representing the receipt by the Postmaster-General of a sum of £1,314,196.

Sir William Mitchell-Thomson took £164,274 of this total for his department's work in handing out licences

He also took £279,159 on behalf of his friend and colleague, the Chancellor of the Exchequer, and the latter added this little egg to his capacious financial nest. Thus listeners will note a sum of no less than £443,433 swallowed up by other things than broadcast programmes.

Now we come to broadcasting. Before anything at all can be transmitted, we must have the necessary plant and power, an engineering staff must be retained and, as part of their actual transmitting work, they must devote some attention to development and research. The cost, in 1928, was £160,455 for twenty-one stations, not an exorbitant amount for 68,000 hours' transmissions—about £2 10s. an hour.



Ivan
Tartakoff,
the Russian
baritone.

Then the inevitable overhead charges appear in the bill, such as rent, rates, taxes, insurance, heating and lighting, upkeep of premises, telephones, etc., accounting for a further £77,999. On top of this come salaries and expenses, £56,211, and Governors' fees, £6,100. Indeed, in spite of the most careful handling, £340,333, or thereabouts, is earmarked for the work of preparing the way for the programmes.

Like the telephone subscriber, who pays £8 a year installation rental, whether he makes 100 or 10,000 calls, so the B.B.C. would have found itself obliged to disburse this £340,000 odd, whether it had half a

million or a million pounds to spend on programmes.

What actually did it spend on programmes, and what proportion of each licence fee did the programme money represent?

Actually in 1928 the B.B.C. spent £538,990 on programmes, including the payment of artists, orchestras, news royalties, performing rights, simultaneous broadcast, telephone system and programme staff. This represented about 4s. 3d. of each licence fee.

Proportions of Expenditure

So we have the following proportions:—

	s. d.
Broadcast programmes (approximately) ...	4 3
B.B.C. work in making up programmes (approximately) ...	2 9
Treasury ...	1 9
Post Office ...	1 3

Little Extravagance Possible

If the B.B.C. were unable to resort to its revenue from publications, which amounted in 1928 to £120,635, for the necessary capital expenditure to enable the Corporation to develop and expand its programme services, broadcasting would find itself in a far less happy position than it enjoys to-day; for it is clear that very little waste or extravagance is possible out of the proportion of the listener's ten-shilling licence fee which actually finds its way into the B.B.C. coffers.



David
Openshaw,
light
comedy
songs.

READ THIS ARTICLE AND BE PREPARED FOR COMING DEVELOPMENTS

Around the Scanning Disc

TELEVISION SIMPLY EXPLAINED
FOR THE BEGINNER

By HJ. BARTON
CHAPPLE,
Wh.Sch., B.Sc.

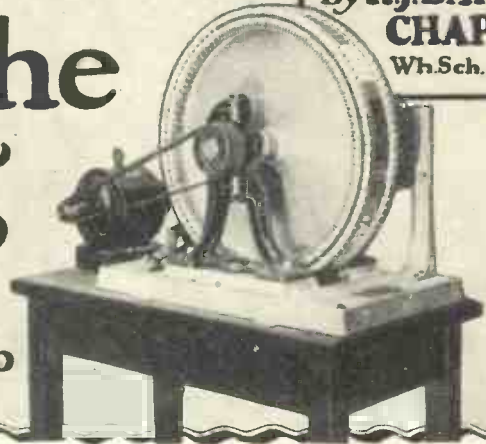

The photograph above shows part of the apparatus used in the Telefunken television system

THE "far-seeing" novitiate to the science of television has probably only some vague idea of what is actually meant by this subject, and unfortunately it is too frequently confused with other scientific achievements, so let us start this series by formulating what may be termed a definition of *true television*.

Put simply, it means "being able to see through the medium of electrical methods of transmission the reproduction on a screen of the image of moving, living, or stationary objects which are at some distance from the observer."

We can regard it as the reproduction of sight, for we can visually witness what is happening at a distance just as if we were eye-witnesses on the spot.

What a wonderful new field of investigation is opened up to the amateur by this subject! The rapidity with which wireless reception and transmission reached its present stage was attributable not only to the professional engineers engaged on the problems involved, but also to the unstinting efforts made by amateurs who were fascinated by the vast potentialities of wireless.

Assistance of the Home Experimenter

In an exactly similar manner the amateur and experimenter in his own home will be able to render untold assistance, for the collation and sifting of scattered results from wide areas will furnish data which cannot always be ascertained within the four walls of one laboratory.

No one would be foolish enough to say that television

as demonstrated by the various systems now undergoing investigation was perfect, but undoubtedly it has reached a sufficiently advanced stage to warrant the close attention of all wireless enthusiasts.

Preparing to "Look-in" to B.B.C. Stations

No doubt, readers will recall the Postmaster-General's recent pronouncement on the Baird system following the official tests between the B.B.C. and the Baird Television Development Co., Ltd. His summing up was "A wonderful scientific achievement," and with the promise of the use of a B.B.C. station for progressive

experiments we should be prepared to take advantage of "seeing in" when the opportunity occurs.

Anyone possessing a wireless receiver selective enough to receive a clear audible signal with little distortion and good volume can very easily add the necessary equipment for this new purpose. Since, however, it is never wise to try to run before we can walk, so it is always a bad practice to attempt to build a television

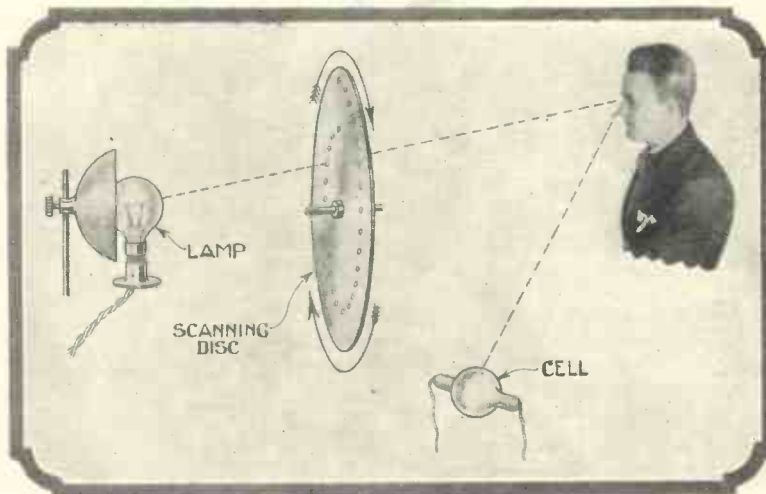

Sketch showing how scanning disc operates. This is the principle used in the Baird system

receiver or televisor before the elementary principles involved are understood with reasonable clarity.

In point of fact, seeing by wireless is only slightly more complicated than hearing by wireless. As the reader will have learnt for himself through the columns of this journal, when a voice is being broadcast from a transmitting station the person stands before a sensitive microphone, and in this instrument the sound waves are converted into varying electrical impulses. After amplification these are made to modulate a high-

Around the Scanning Disc (Continued)



TELEVISION ELECTRIC "EYE" AND REPRODUCER

Above is a G.E.C. photo-electric cell such as can be used for television transmissions. On the right is a simple type of neon lamp.

frequency carrier wave which is sent out into space.

When received on the home aerial the propagated electro-magnetic waves produce voltages in the aerial which are again amplified and rectified, and finally reconverted from electrical impulses into sound waves through the medium of the loud-speaker.

A "Light Microphone"

With television, naturally, certain of these processes are modified. The person being televised stands or sits in front of three or four light-sensitive or photo-electric cells. These cells are capable of responding to varying intensities of light and shadow and faithfully converting them into electrical impulses of corresponding strength; in effect, therefore, they act as an efficient "light microphone."

They are often referred to as the television eye, and one type is illustrated in an accompanying photograph.

A rapidly revolving metal disc perforated with a series of holes arranged in spiral form is located behind the light-sensitive cells, the actual speed of rotation depending upon the number of complete scans (hence the name "scanning disc") to be made per second, the usual minimum being ten per second.

Brilliant Light Focused on Subject

Situated behind the scanning disc is a high candle-power lamp, a beam of light being focused on the subject being televised through the holes of the revolving disc.

The sketch on page 523 gives a diagrammatic impression of what has just been described.

If a face is being scanned no discomfort will be experienced as the thin pencils of light play across or up and down the face, as the case may be. The narrow pencil of light will, in effect, sub-divide the features into a number of horizontal or vertical strips, the actual number of these being dependent upon the number of holes in the disc. This last-named factor, of course, has a direct bearing upon the desired quality of the picture.

Modulating the Carrier Wave

Whatever variation of light and shade is shown along these narrow strips of light is received by the light-sensitive cells and converted into electrical impulses of proportionate strength. In turn, these are amplified and made to modulate the high-frequency carrier, and thus be transmitted into space in a similar manner to speech waves.

Since the television signal thus sent out has a very distinctive note of its own, something like a high-pitched drone, it can be tuned in on a wireless receiving set and heard on the loud-speaker plainly and distinctly.

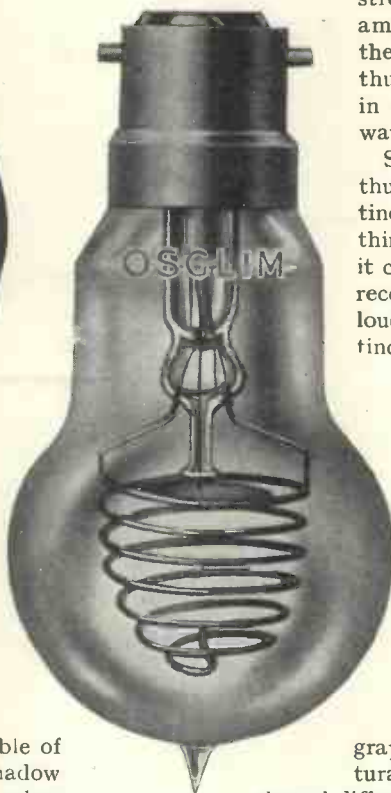

Lamp Instead of Speaker

When tuned-in to give the loudest volume, a change-over must be effected by substituting a neon lamp for the loud-speaker. The actual lamp employed is similar in principle to the ordinary beehive pattern which are popular as night-lights and shown in one of the photographic illustrations, but naturally the positive electrode is shaped differently.

This lamp has the peculiar property of responding instantly to the varying currents in the output circuit of the last valve of the receiving set, the variations, of course, being brought about by the varying intensity of the incoming television signal. It glows with a pinkish coloured light, brilliance being dependent upon signal strength.

You can verify this last fact for yourself by tuning-in a strong signal on your own wireless set and then substituting an Osglim lamp for the loud-speaker. It will flicker continuously and thus enable you to "see" speech or music, whichever is being broadcast from the station.

The next stage in our process is to mount in front of

(Continued on page 558)

Are Portables Worth While to the Motorist?



VERY interesting was what that popular pioneer, S. F. Edge, had to say in last month's WIRELESS MAGAZINE regarding radio and the road. He has played such a large part in the development of motoring (he risked his neck in racing Napiers when I was still practising broadsiding on the nursery floor!) that his views on the radio industry as a whole are valuable.

Wireless on the Road

But I wish he had said something about radio as it appeals to the average motorist. I am a motorist and I get about the country in quite useful chunks of mileage and, particularly in summertime, I frequently meet other motorists who likewise take an interest in wireless.

So often there seem to be wrong impressions of and doubts about portable radio that right here I want to correct them. But it is to be regretted that S. F. Edge did not take up the cudgels on behalf of those much-cussed instruments, "motorists' portables." Every wireless shop one looks into nowadays seems to have portables for sale, and I believe that the sales are soaring.

But it isn't often that one hears a portable working in a car, and the reason for this is that motorists' particular needs are largely overlooked by the average portable-set designer.

I can assure you that it is not due to prejudice on the part of road users. Some time back I had the opportunity of

By **KENNETH ULLYETT**

speaking to the general manager of a group of publications, including *The Motor* and *The Light Car and Cyclecar*, and he told me that he saw a great future for motorists' portable sets *when the kind of programmes that motorists want are broadcast!*

He was referring particularly to news, for as a great sportsman and the director of newspapers, he naturally attaches great importance to portable sets as news-getters.

Undoubtedly he is right, for even the speed of newspaper production is slow compared with the rapidity of the radio news service. This is of great value when touring away from populous areas.

But get away from opinions and come down to facts. Most motorists are radio listeners when at home, because the fact that a man is a motorist means (as the Treasury seems to think) that he can afford a receiver, and his interests will generally lie in the mechanical direction.

But when it comes to taking radio on the road . . . ah! That is a different proposition.

Take my own car, for example. It is a Continental two-seater with just sufficient "pep" to induce me to treat it *comme le sport*, and not to carry unnecessary weight. Moreover, space forbids.

Just the Problem . . .

When, say, a picnic is planned for the conclusion of a fast cross-country run, most of the available luggage space is taken up with picnic necessities and a spare two-gallon can of "essence." Is it worth while taking a portable set? Now, I think that is just the problem which faces many motorists. *Is it worth while?*

If it is an ordinary portable with a frame aerial then reception *en route* is an impossibility. Why? Well, considerable volume is required to drown the music of the road (not that the police often have to say "hush" to my exhaust note), interference from the engine is noticeable, and the

greatest snag is in keeping the set tuned in and with the frame in line with the transmitting station. So the utility is confined to the picnic itself.

Music is pleasant while eating, because it creates the atmosphere of an improvised, outdoor Simpson's, Holborn, or Frascati's. It is still more pleasant and something of a social necessity when the platters are cleared away (no paper strewn, if you please!) and we want to dance.

Snag One, the set may not work.

Radio-equipped Cars in America

A NEW industry, combining the automobile and radio, made its bow at New York Automobile Radio Corporation banquet recently. The new invention was demonstrated to 400 leaders of the automobile and radio world at the banquet.

Nine leading makes of cars—Stutz, Chrysler, Packard, Hupmobile, Graham-Paige, Reo, Pierce-Arrow, Cadillac, and Oakland—were unveiled, each equipped with broadcast receivers. The auto radio has been developed after four years of laboratory and research work, and has been tested for months on one hundred makes of cars throughout the world.

The set consists of a six-valve broadcast receiver, completely enclosed and properly shielded by a copper box installed behind the dash, with the radio dials placed in the centre of the instrument board. The six-volt valves used are mounted in cushion-based sockets, which so effectively absorb the vibration. To keep the balance of the dash board, the instruments are relocated and mounted in a bakelite panel.

The aerial for closed cars is copper wire netting concealed in the roof of the car, entirely out of sight. For open cars the aerial is made of heavy flexible copper cable, woven criss-cross into heavy canvas, which is made into the top of the car. The aerial will function whether the top is up or down.

The loud-speaker is mounted inconspicuously over the windshield on closed cars and under the instrument board on open models. A connection on the dash permits a loud-speaker to be plugged in and used at any distance from the car.

Ignition noises, which heretofore have been the obstacle of auto-radio, have been eliminated by a sound-filter system. Reception is perfect, regardless of the speed of the car. The wireless set is an integral part of the car. The turn of a lock switch—and all the entertainment on the air is brought to the motorist, whether he is cruising through city streets or streaking through the country at sixty miles an hour.

A million-dollar corporation, the Automobile Radio Corporation, has been formed for the manufacture of the invention. F. P.

Are Portables Worth While to the Motorist? (Continued)

In which case you will feel tempted to kick the thing back into the dickey rather than attempt to disembowel that cheap H.T. battery which has had its heart shaken by road vibration.

Snag Two, and the popular theme of humorous writers, 5XX may be the only station receivable, and the programme consist of a talk on bugs. I have known it happen so. Or it may be a running commentary on a Ruggier "semi," which will bore the girls, but cause the men-folk to assume expressions of satisfying thrilling reception.

A Gramophone?

Someone says: "Why didn't we bring a gramophone?" Which is rather tactless because it is a reminder to all that the last time a gramophone was brought you sat on a batch of borrowed records. You can't have it both ways.

The moral is a composite one. A motorists' portable should be capable of working *properly* when the car is travelling. It must be, at least, as reliable as a home set. It must be a gramo-radio outfit so that the right kind of music can always be "on tap."

In my opinion, the right place for a portable set is at the side of the scuttle-dash by the passenger's feet. There is generally quite a deal of space to spare here, and in this position the set is easy to operate and quite close to the fascia board and electric wiring.

It means that the receiver case will be somewhat triangular in shape to fit in with the floorboards, but this is no disadvantage, because I don't think that the loud-speaker should be an integral part of the set.

Assembly Considerations

The whole set should be strung on springs, as is done with Air Force receivers, and the whole of the wiring carried out with heavily-insulated leads stapled down (unless carrying H.F. currents) as is done in many mass-production American receivers. So far as the circuit is concerned, that has, I know, been dealt with by the technical folk.

All I feel qualified to say is that a screened-grid valve is essential, and that pentodes hold good promise because nobody minds a little tonal

imperfection if the volume is good—for outdoor portable work only, of course.

The aerial should be an integral part of the car, and as the craze nowadays is all for closed cars, and fabric-covered bodies at that, there should be no difficulty in building a giant frame in with the wooden body shell. This could be done, in construction, when the rooflight and fasci-board gadgets are fitted.

On the set itself there should also be provision for the addition of an outside aerial, which could consist of a reel of rubber-covered cable to be slung up wherever convenient.

Batteries need not be bothers. The low-tension supply is obvious—

YOU CAN'T SOLVE IT?

You don't know to where that connection should go or why your set works well one day and badly the next?

Well, why worry? We keep a staff specially to solve such problems as yours. Let them have your queries.

Every querist is answered direct by post.

Please observe the following conditions:

Ask not more than two questions at a time; write on one side of the paper only; attach to your query the coupon on cover iii; enclose a fee of 1s. (postal order); and send it with a stamped, addressed reply envelope to: Information Bureau, "Wireless Magazine," 58/61 Fetter Lane, E.C.4.

perhaps too obvious. I recommend that the L.T. never be obtained direct from the starter battery. In my own car, for example, it is disastrous to do so, if the set is used while the car is in motion, because the dynamo cannot be switched out of action, and as the charging rate is 12 amps at 15 volts, the battery voltage always increases appreciably during running.

I always "float charge" a small two-volt cell in the portable-set case, for this ensures a constant-voltage filament supply.

To revert to the set itself. The loud-speaker, as I have said, should not be an integral part of the case. Often on picnics it is not possi-

ble to take the car, and it is a good plan to leave the aerial and receiver in the car and to take the loud-speaker where required.

The receiver lid could be hinged to fall outwards, clear of the pedal controls and the gear and brake levers if central, and could carry a clockwork drive for the gramophone turntable. This would mean that only radio and not gramo-radio could be used while the car is in motion, but having tried to play a portable gramophone in a moving car, and having scratched valuable records as a result, I think that this would not be a disadvantage.

Question of Cost

In the foregoing I have not overlooked one obvious point lost by radio in favour of the gramophone. Quite a good portable gramophone can be purchased for a couple of pounds, whereas my ideal outfit, complete with H.T. converter, would probably cost ten or twenty times that amount.

If the matter were tackled by the car manufacturers themselves, in so far as incorporating an aerial and making provision in the electrical equipment for adding the set, and if proper mass-production methods were turned on the manufacture of the portable, it might all be done for an additional ten or fifteen pounds above the normal cost price of the car.

I know I carry the majority of motorist weight with me when I say that such a figure is inconsiderable.

Here I am doing what little I can to induce motor manufacturers to co-operate with portable-set manufacturers. It is, I think, significant that when Henry Ford was making his first experimental car he wrote (in very bad handwriting, incidentally) to a big firm of wheelwrights for four wheels. They refused to supply him because the order was not big enough! Now Ford turns out steel-spoke wheels at a few shillings a time, by co-operation with steel manufacturers.

In this country it is to Sir William Morris and Sir Herbert Austin that we must look for developments of this kind. I do not know about Sir Herbert, but Sir William is a keen listener. Perhaps his fancy may turn shortly in the commercial direction.

My Impressions of the 1929 Chummy

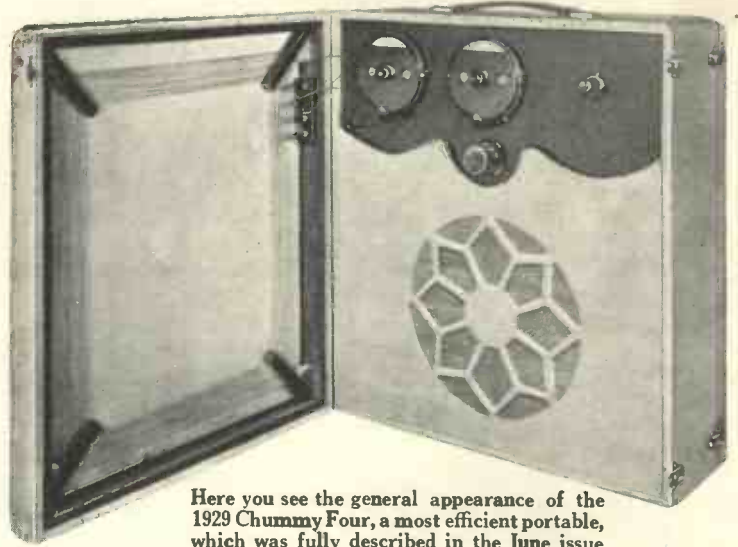

Here you see the general appearance of the 1929 Chummy Four, a most efficient portable, which was fully described in the June issue

J. Godchaux Abrahams Gives the Results of His Special Tests

WHEN, roughly a year ago, in these pages I reported on the excellent results I had obtained with the original Chummy Four, my only objection to the receiver—it was a minor one, I admit—was that its range was limited to the short-wave band (250 to 600 metres), and that no steps had been taken to allow a reception of the long-wave transmissions.

My Only Grouse Met

Now, if anything, the staff of the WIRELESS MAGAZINE is very conscientious—a fact you must have noticed on many occasions—and the inevitable result is found in the 1929 model of the Chummy Portable Four. It has been redesigned by W. James to bring it up to date and, whilst so doing, he has incorporated a long-wave aerial—thus at one fell swoop, as it were, sweeping away my only grouse.

100 Per Cent. More Useful

For over a week I have played with this new edition of an old and trusted friend, and have no hesitation in stating that *the double range it now possesses has added 100 per cent. to its utility as an everyday wireless receiver to be used both in the home and out of doors.*

It is a noted fact that during the summer months reception of foreign stations in the broadcasting band is more difficult than at other periods of the year; not only are the captured signals of smaller volume, but they

vary considerably from day to day.

On some evenings you may pull in a number of transmissions and offer them to the household at loud-speaker strength; on others the same stations will have modestly retired into oblivion, and curiously enough others, less easy, as a rule to tune in, will have acquired an unaccountable energy and suddenly, without any explanation, loom up big on your horizon.

It is for this reason that the amateur possessing a set capable of receiving but one range of stations, namely, those in the recognised broadcast band, is handicapped to a considerable degree. Transmissions on the long waves, generally speaking, are easier to receive during the sum-

mer months, during the daylight hours, than are their smaller brethren, and their addition to your tuning range will provide a greater number of alternative programmes.

Another advantage to be registered lies in the fact that with the exception of one or two European countries, all possess at least one high-power station on the long waves.

Long-wave Alternatives

Well, if you cannot get Stockholm, you can hear Motala; if Berlin is but a whisper, you can pick up its programmes via Koenigswusterhausen. The same applies to Kalundborg, which is fed by Copenhagen, to Eiffel Tower, relaying the Ecole Supérieure entertainments, and you must agree that it would be a great pity if you were not given an opportunity of hearing the excellent concerts offered to us by Hilversum.

And that, in a nutshell, is one of the great advantages shown by W. James' redesigned Chummy Portable, of which full details were given in the June issue of the WIRELESS MAGAZINE.

Razor-sharp Tuning

But a good set requires careful handling; your arrangements must not be slipshod. It will repay you to study the receiver and to give it all it requires to produce the best results. As it now stands, the tuning is razor-sharp and the selectivity of the circuit is everything that can be desired.

At less than one and a half miles

Full constructional details of the 1929 Chummy Four were given by W. James in the previous issue of the "Wireless Magazine," back copies of which can be obtained for 1s. 3d. each, post free, from the Publisher, "Wireless Magazine," 58/61, Fetter Lane, E.C. 4.

Full-size blueprints are also still available, but only at the full price of 1s. 6d. Ask for No. W.M. 145 and address your enquiry to the Blueprint Department.

Besides these comments by J. Godchaux Abrahams some further notes on the set by W. James himself appear on page 557.

My Impressions of the 1929 Chummy (Continued)

(where my house is situated) from the 2LO aerial, you may rest assured that the London transmissions are received at so deafening a volume that the frame aerial must be turned right away from the station and the H.T. considerably reduced if any listening on the loud-speaker is to be done in comfort, yet even at this distance it is possible to tune in to Daventry 5GB without a whisper coming through from the local transmitter.

As you are no doubt aware, it is not every receiver which will allow you to cut out such powerful signals at so close a proximity to the transmitting aerial.

Experimenting with Valves

To attain this selectivity, however, it is worth while experimenting with a few valves, in order to pick one which furnishes the best results as a detector. For the nearer stations I found that it suited me better to place the R.C. valve in the first L.F. stage and to use an H.F. valve of medium impedance in the detector position.

If you are the lucky possessor of a

your first valve, try either less or more than stated, as the variation may show a great improvement.

Personally, when using a valve of this description, I have always favoured a variable control on the voltage to the screening grid. In practice it would appear to add stability, and most certainly it enhances its selectivity. In any case, the high-tension voltage should be adjusted in such a manner to ensure the reaction being a smooth one; if you plop in and out of reaction you will find tuning difficult, and through this defect you may miss many transmissions or fail to bring them up to readable strength.

As regards the quality and tone of the music received, it was perfectly satisfactory, if the grid bias on the L.F. side was carefully adjusted. In the last stage I used a Cossor 210P as low-power valve, but rather more volume was obtained when it was exchanged for a "super" of that make. On the other hand, there was, of course, a greater drain on the accumulator and batteries.

In its present form, even with the

lator was brought into action.

If the Chummy is to be taken from room to room as required, or if, as I do, you include it as a "necessary" when a week-end jaunt is contemplated in the car, unspillable accumulators are essential. In my case, on two occasions the set inadvertently was placed on its back, and had ordinary accumulators been used, much gnashing of teeth would have resulted.

Shorting the Long-wave Winding

An important point to bear in mind also is that when the short-wave frame aerial is in use, the two sockets for the long-wave frame must be short-circuited, but there is no need to act in this way with the short aerial when long-wave stations are being tuned-in; in fact, better results will ensue if you do not do so.

Whilst twirling the condensers in the search of foreign transmissions I was pleasantly surprised to find that the coils had been so carefully calculated that the readings of both dials remained fairly uniform. On the long waves this was not the case in every instance, but, as a start, on a tour of the broadcasters, it was possible to begin by keeping the dials more or less in step with one another.

Generally speaking, the 1929 Chummy proved in every way as efficient as its forerunner, and to this was added the advantage of an extended range.

Some Stations Received

Such favourite entertainments as 2LO, 5GB, Langenberg, Nurnberg, Turin, Flensburg, Milan, Brussels, Vienna, Hilversum, Kalundborg, 5XX, Eiffel Tower, and Radio Paris were received at excellent strength, some of the more distant stations being heard quite well during daylight hours.

The set was only used with its own loud-speaker, but I have no doubt that if provision were made for headphones, a large number of weaker European transmissions could be successfully picked up.

In every point the 1929 Chummy upheld the reputation of its predecessor, and it should appeal to any amateur desirous of possessing an economical and efficient double-range portable.

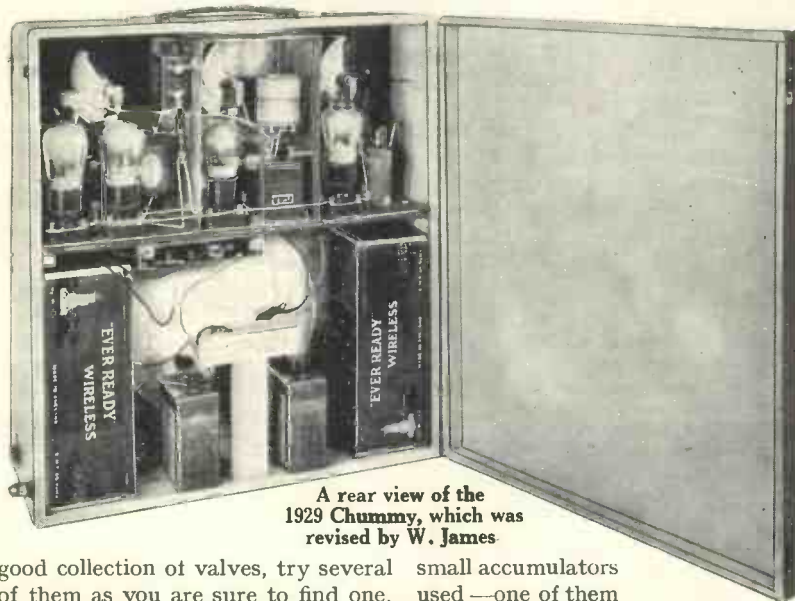

A rear view of the 1929 Chummy, which was revised by W. James

good collection of valves, try several of them as you are sure to find one, which, for that particular duty, will respond better than others. Valves of the same make, and nominally of the same impedance, etc., vary slightly, and chance may help you to select just the right one.

In the same way, although, as a rule, 60 volts high tension is recommended on the screen grid of

small accumulators used—one of them only being in circuit, the other being kept in reserve—the receiver proved very economical in its consumption of "juice." Roughly speaking, one charge allowed about twenty hours constant use, or, taking it on a basis of three hours daily—a very high figure!—a whole week's working before the second accumu-

Irreverencies!

A Radio Ventriloquial Sketch!

PHEW, lumme!

Hulla, what's up? You look hot.

So would you look hot if you'd shoved all the way here through the advertisements. Had a norful struggle to get past the crowd in the "answers to correspondents." Bit of all right this place, though. Where are we?

This, Sonny, is the Rest page.

The what page?

The Rest page. It's the modern wheeze in shops and other places. When you're tired of shopping or reading or what not, you just dodge in here for a breather and a rest. Who told you you might get on my knee?

Well, I like that! How d'you think I can squeeze in next to a hulking brute like you in a column this width? Rest page, eh? Anything to drink?

No.

No eats? Say, I was in a rest room once in a shop in Oxford Street, where you get yourself rich quick and I got chucked out for pinching. Nothing to pinch here though, is there? A bare 'ole, I call it.

You just behave yourself and talk to me. Hullo, hul-lo, what's that you've got in your hand?

What, this? I dunno. Found it lying about among the advertisements. Fellow who wanted to sell it said something about choking.

Choking? Let me see it. Say, it's a high-frequency choke. You mustn't keep that. Don't you know it's wicked to steal? Go and put it back at once.

Oh, all right, *all* right, I don't want it. High-frequency choke, my eye! That's what comes of getting blotto on all them skientific words! My auntie used to call that a "crumb down the prayer 'ole." How does this help you if you swaller a crumb down

Shut up! You don't understand.

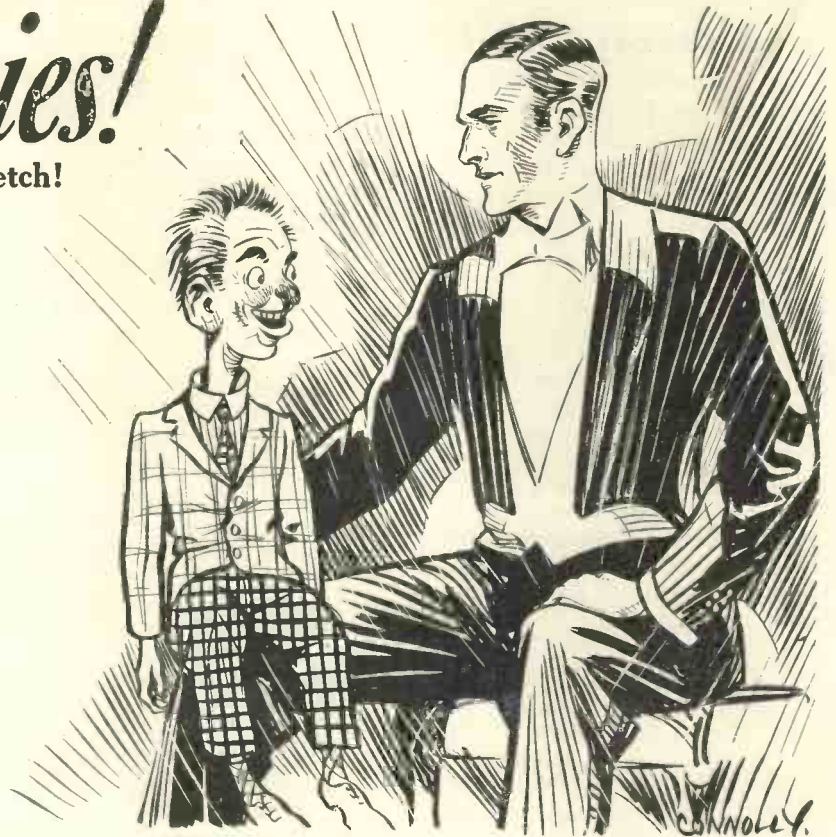

This isn't a nursery but a slap-up, first-rate, distinguished wireless magazine. That thing is a valuable component of a multidyne-hetero-screened grid-resistance-coupled-all-wave—

Caw, you don't shaysho! Anyhow, I don't hold with this wireless business. I didn't tell you that I'd made a set, did I?

No, did you really? That was very clever of you. How did you go about it?

Well, first of all I got hold of one of those picters of a dish of spaghetti, like what you see in this book—what they call dia- dia- diaphragms—, then I scrounged round a bit and what with bell wire from 'Olmwood Mansions where me and auntie live, and the giblets of the vacuum-cleaner and some stuff a pal of mine got for me, well—there you are, see?

Quite, and how does it work?

Eh?

How does it work; what do you receive?

Oh, what stations! Well, it's like this, how shall I put it . . . d'you mind if I tell you a bit of a yarn by way of illustration like?

Not at all; fire away.

Well, there was a man who was bragging as how he had a wonderful trained dog. Marvellous dog, that dog was. When he said to him "Will you lie down or *not*" . . . then the dog lied down . . . or not.

What has that got to do with your set?

Everythink. When I say to my set: "Will you get Motala or not, it just—

I see. But then, we are all in the same boat, more or less. That is just what they have these magazines for. The march of research is so rapid that something new and marvellous is being discovered every day. It is the function of a magazine like this to keep its finger on the throbbing pulse of the ether and to inform its readers . . .

Caw! You can't half pitch it, can't you? I suppose *you* got in like a perfect little gent, through the front cover?

Certainly, I am an honoured guest, I was paid to come in and give my opinion of the contents.

Paid! What, you!!!

Irreverencies!—A Radio Ventriloquial Sketch (Continued)

Why yes, I mean, I suppose so. The Assistant Editor has an honest face. Anyhow, I think it is pretty good and I must say it has improved my knowledge and . . .

What? His face?

No! The magazine!

Come off it! Really though, I never knew there was so much to it all. Wonderful how they find it out, isn't it? They fair take you by the hand and lead you. Tell you how to listen and what to listen to; tell you what you've heard when you've heard it, and why not, I shouldn't wonder. I say, if you get paid for sitting here with me, what do I get?

Hush! I'll see you outside afterwards.

Good egg! Where do they get all those girls from?

What girls?

Why the girls who sit in eight colours and in punts with portable sets in their laps, and the girls who show you with eighty teeth and the tips of two fingers how simple it all is,

and the girls who sit up in bed and bless the Blareophone Company because, though dying, they can listen to the jazz. D'you get one with a blueprint?

I should think it most unlikely. But seriously, don't you find that you know more about it all for having spent an afternoon here?

Raw-ther! What bothers me, though, is that they never seem satisfied. Consequence of the throbbing pulse, I suppose. They've no sooner got a set going right but they scrap it and tell you it was all a mistake and this next one is the real goods. Reminds me of one time I went with auntie to an 'at shop in 'igh Street, Balham. She went in very dignified and genteel and said to the lady she'd like an 'at. "Oh, yes," said the lady, sweet and gentle-like after auntie had told her all about the sort of 'at she wanted. "Would you mind sitting down for a moment, Mrs. 'Oskins," she said, "the fashion's just changing." Seems to me to be the same with this wireless business. Why, even the stations change their names and dodge about!

I haven't noticed it. What do you mean?

Well, when you hear a place you think is Munich call itself *munching* and play different tunes to what you expected from the official book-of-words, you have to write to a paper about it. If you say it was Munich, they answer, "Oh, yes, un-doubtedly it was Munich," and if you ask, "What was it?" they say they don't know because you seem to have sent them the gas-meter readings by mistake. So I ask you, where are you? As for hopping about . . . well hide and seek isn't in it with some of them. Why they even hide behind each other!

Ah, yes, the Brussels plan. But you seem to be in a grumbling mood to-day, laddie. Not my usual little ray of sunshine at all. In any case, we've been here long enough and we'd better get, unless we want the charwoman to sweep us out.

Make the ladies and gentlemen a nice bow.

GRIDDA.

A Strange Error

HOW many high-tension batteries have you bought and used since you first started wireless? Quite a considerable number, I daresay. Have you ever had one in which—but let me tell you the story as it actually occurred.

Fading Signals

A wireless neighbour of mine is the proud possessor of a five-valve portable set. As his signal strength had been falling off gradually for a few weeks, he decided to purchase a new high-tension battery. When he took the new battery home with him one Saturday afternoon, he did so in full expectancy of excellent signal strength over the week-end.

Nothing At All!

However, on placing the new battery in circuit in the receiver, he got absolutely nothing at all from the receiver. Putting back the old battery showed him that there was nothing wrong with the set. Very

puzzled, he took the new battery back to the shop from which he had purchased it.

A test with the voltmeter gave undeniable evidence that the battery was all right, and that, as with the majority of new batteries, it gave more than its listed voltage.

More Puzzled Than Ever

More puzzled than ever, my wireless neighbour returned home with the battery. After a good deal of pondering, he hit upon the solution to his puzzle. What do you think it was?

The cardboard container which held the battery had been put on the wrong way round so that the positive end of the battery was marked negative, and the negative end positive.

When the change round was made, the battery gave what was expected of it.

Have you ever had or heard of a high-tension battery in which the same error had been made by the makers?

K. M. T.

Studios in U.S.A.

THE Columbia Broadcasting System Building now being erected in New York City will occupy the top five floors in a 24-story building. There will be 15 individual studios on the five floors, each with its own control room. They will range in size from small chambers for individual entertainers to large auditoriums capable of holding more than 250 persons. Some of the larger ones will be two stories high.

Equipped for Sound Recording

All broadcasting, audition, and rehearsal halls are to be equipped for sound recording of records and films as well as for radio transmission. Plans are being made to take care of television transmission when that development becomes practical. Offices of the company are also in these upper five floors.

According to Mr. S. Paley, president of the system, the building should be ready in the early autumn.

F. P.

Wireless Magazine *Gramo-Radio Section*

A SPECIAL SUPPLEMENT FOR THOSE INTERESTED IN
THE ELECTRICAL REPRODUCTION OF GRAMOPHONE
RECORDS—THE FIRST OF ITS KIND TO BE PUBLISHED

When Records Slip

SOME of the modern electrically-recorded discs carry some very deeply-grooved passages and at least one of the advantages of gramophone is lost if such a deeply engraved record is rotated by a cheap motor with a weak spring.

What may happen is that the greater load entailed by the pick-up needle during these loud passages slows down the motor and causes a drop in tone. You may get this effect with a cheap motor when, of course, either the spring or governor control is at fault.

Root of the Trouble

Occasionally, record slip is experienced even with properly constructed drives, and sometimes even with electric drives. In such cases the root of the trouble is generally found to be slipping between the record and the turntable rather than actual slowing down of the driving mechanism.

Of course, the obvious way to obviate this is to renew the plush covering of the turntable or, alternatively (and this is perhaps a somewhat better way in very many cases) to cover the turntable with a rubber non-skid disc, this being interposed between the turntable and the record itself.

Cleaning the Disc

Another advantage of this is that the rubber disc can occasionally be cleaned so that dust does not cling to it. This is something which cannot readily be done with the normal plush covering of turntables, and the dust which adheres thereto is frequently transferred to the sound grooves of the underside of the record.

BIM.

What's in A Name ?

REALLY there should be a society for the protection of authors! I now have a very good idea of the immensity of the Editor's post bag, for it has been my unfortunate lot to have a small portion of the daily post bag diverted to me during the past few weeks.

In the March issue of the WIRELESS MAGAZINE, I penned a short

before readers for their votes. A northern correspondent suggests *radophone* which, I suppose, he intends to be pronounced with a flat "a" as though it were spelled *raddophone*, in order to give it the gramophone twang. Another suggestion from the same correspondent is *radograph*, but really I don't think this has very much bearing on the gramophone side.



Here you see the Edison Bell combined radio and gramophone machine which is operated direct from either A.C. or D.C. mains. A moving-coil loud-speaker is incorporated and the circuit uses five valves.

Two further suggestions are *electrone* and *electrophone*, both of which sound very "trady" to me and one, I think, is already in use in connection with a convertible electric gramophone.

"Gradiome"

Another suggestion is *gradiome* which, although it is a clever

note deploring the lack of a succinct name for "gramo-radio" receiver. As I said, one cannot talk about such an apparatus as a gramophone. The use of the expression "a radio" as a noun is an Americanism, and I loathe all such with an insufferable loathing.

Well, now, I received a healthy batch of correspondence on the subject and I put a few examples

combination of bits of words, conveys more the impression of a laboratory instrument, rather than a means of oral entertainment.

The Editor tells me that my request for a better name, which was prompted only by my own personal interest, can be repeated again. If you can think of a better name then write in and let me know. There is no prize!

Q.

Recent Record Successes

REVIEWED BY H.T. BARNETT, M.I.E.E.

IN the few months that have elapsed since last I wrote a general review of records there have been produced many masterpieces, but never before in so short a space of time have I known so many variations in the quality of recording; never before has such care been needed to steer clear of thin, reedy wiry and false recordings.

Examples of *blast* on records have been exceedingly few, but on all makes there has been a tendency on the part of the engineers to limit fullness of tone and to run to hardness.

Troubles with Hard Records

Now hard records are particularly unsuited for electrical reproduction; when using an ordinary gramophone they may be rendered quite passable by putting on a celluloid-diaphragmed sound-box (a sound-box that also possesses the good quality of minimising surface hiss and with it that peculiar hiss which frequently attends string tone in electrical recording), but when we are reproducing with a pick-up, a thing that has no diaphragm, of course no such low-down subterfuge is possible.

Therefore you may be sure that I have not included any really hard records in this list. In addition to being of full, sweet tone, they are all examples of correctly placed microphones (for instrumental and scale balance), of generally interesting music and of excellent performances.

Grand Organ Records

THE GRAND ORGAN. Important records for this instrument are (1) *Toccata and Fugue in D minor* (Bach), played by Alfred Sittard on the organ of St. Michael's, Hamburg (Polydor-Brunswick, 6s. 6d.) and (2) *Finale in B flat, Op. 21* (Franck), played by Guy Weitz on the organ of Westminster Cathedral (H.M.V., 4s. 6d.).

The first of these is the best all-round organ record I have. The second is nearly as good from the point of view of recording and is a

special show record for pedal-tone; it should be bought by everyone who may wish to show what a moving-coil speaker can do at the bottom of the scale whether they like Franck's music or not.

Minor works are *Sonata on 94th Psalm* (Reubke) played by Ball on the Temple Church organ (H.M.V., 3s.), and *War March of the Priests* played by Brown on the City Temple organ (Broadcast, 2s.).

THE PIANOFORTE. There are two specially good discs for this instrument, Chopin's *Nocturne in E flat* and *Waltz in A flat*, played by Brailowsky (Brunswick, a Polydor recording, 6s. 6d.), and Albeniz' *Tyriana* with Schuberts' *Military March*, played by Backhaus (H.M.V. 8s. 6d.). The former, more than any other record I have, most clearly shows the touch of the performer.

THE HARPSICHORD. An altogether precious thing is *The Italian Concerto* played by Alice Ehlers (Parlophone, 4s. 6d.).

THE HARP. The best record to date is *At the Spring* (Zabel) played by Mildred Dilling (H. M. V., 4s. 6d.)

THE PIANO AND ORCHESTRA. A magnificent concerto at popular price is the Columbia production *Concerto in A minor*, by Schumann, with Fanny Davies at the solo instrument, the orchestra being under Ansermet, four discs in album, 18s. Do not suppose the recording of this concerto is at all like the Columbia Greig; it is not, it is dulcet and full and true.

A one-disc work of splendid quality is Liszt's *2nd Hungarian Rhapsody*, played by Karol Szreter and the Berlin Opera Orchestra (Parlophone, 4s. 6d.).

On the lighter side, a magnificent record is *Funny Face* by Raie da Costa with her orchestra (Parlophone, 4s. 6d.).

THE GRAND ORCHESTRA. The other day a friend said: "If all your records were burnt, which would be the first you would replace?" I said: "The Philadelphia Orchestals." They certainly

comprise now some magnificent extracts from *Carmen*. For 6s. 6d. you can have *Soldiers Changing the Guard* and *March of the Smugglers*, and for 4s. *Preludes to Acts 1 and 4* (H.M.V.).

Berlin Opera Orchestra

The Berlin Opera Orchestals 1 like best are *Oberon Overture*, two discs at 4s. 6d., *Coppelia Fantasy*, 4s. 6d., and *Polonaise No. 1 in A* (Chopin) with *Hungarian Dances* (Brahms), 4s. 6d. (all Parlophones). The Margate Municipal Orchestra have made an excellent 3s. record of *Liszt's Rhapsody, No. 14* (Electron). A splendid recording of Mendelssohn's *Wedding March* is that of the San Francisco Orchestra (D1563, 6s. 6d., H.M.V.).

ENSEMBLE. Parlophone have a wonderful group of the music from Gounod's *Faust*; on one record we have the principal *Music from Act 4*, 4s. 6d., on another *Music from Act 5*, 4s. 6d., and last, and best of all, the *Closing Scene*, a stupendous production, 4s. 6d.

For 6s. 6d. Parlophone-Odeon have the *Drinking Song* and *The Storm* from *Othello* (R20075).

Salon Orchestals

SALON ORCHESTRALS. Ballet Music, *Le Cid*, two discs at 4s. 6d. (H.M.V.). *Mimnet* (Boccherini) with *Toreador* and *Andalouse* (Rubinstein), 4s. 6d. (Parlophone). *Overture Orpheus in the Underworld*, 4s. 6d. (Parlophone); *Waltzes, Winter Storms* (Finck) with *Ever or Never* (Waldteufel) 4s. 6d. (Parlophone).

CHAMBER MUSIC. For the wealthy there is the incomparable Casals Trio (violin, cello, and piano) in a perfect recording of *Beethoven's Op. 97, Trio No. 7 in B flat major, The Arch Duke*. Five 8s. 6d. discs in a free album (H.M.V.).

A most interesting issue by the National Gramophonic Society on three 6s. 6d. discs is *Mozart's Quintet in E flat major* for piano, oboe, clarinet, horn, and bassoon.

Magnificent recording is shown

by Brunswick in *Mozart's Clarinet Concerto*. Three discs at 6s. 6d. each. I tried first to play it with a fibre needle, as I like my clarinet tone slightly romanticised, but the point soon went and finally I got the best results with a Sympathetic needle sticking $\frac{3}{16}$ in. out from the grip.

Pure String Work

A pure string work is the *String Quartet in B flat major* (Schubert). Three discs at 6s. 6d. each, National Gramophonic Society. It is played by Boris Pecher, André Mangeot, Frank Howard, and Herbert Withers. The surface is noiseless and the recording super clean and nowhere heavy enough to cause the least roughness through needle friction, so that it should be a god-send to those who have very powerful sets and are able to turn on any desired amount of amplification.

MILITARY BANDS. Overtures: *La Forza del Destino*, played by Creators Band (4s. 6d., H.M.V.); *Light Cavalry*, Massed Bands (Parlophone, 2s. 6d.). Selection, *Finnish Suite* (Gilmer) by the City of London Civil Band (3s., H.M.V.). March, *Niebelungen* (Wagner) Massed Bands (2s. 6d., Parlophone).

All these records are such as we never had before. If you have a fine machine to show off, even if you do not care for band records yourself, by all means get the last mentioned of these to show your friends.

'Cello and Piano Records

'CELLO AND PIANO. A good double comprises that over-worked old chestnut *Le Cygne*, amply atoned for by the other side *Danse Espagnole* (Granados), 4s. 6d. (Parlophone).

CONCERT JAZZ. Following the lovely *Mississippi Suite*, I have a Paul Whiteman of Herbert's *Suite of Serenades* (4s. 6d., H.M.V.). Vincent Lopez in *Alexander's Ragtime Band* will be a classic (4s. 6d., Brunswick). Jack Hylton is very clever in *Early Ragtime Memories* (4s. 6d., H.M.V.).

VIOLIN AND PIANO. There is a big-tone recording of Peggy Cochran playing a dear old chestnut, *Simple Aveu* magnificently (2s. Broadcast, 12 in), and a 10 in. light recording of *Fauller D'Album* (Chabrier) with *Berceuse* (Grooley), two exquisite trifles played by

Rénee Chemet (4s. 6d., H.M.V.).

VOCAL RECORDS. Unless you are very rich, it is not policy to buy many of these. A good orchestral record you can bring out every week and never tire of it, but after you have heard a song two or three times it is not likely to come out again unless you have friends come in who have not yet heard it.

The following set of 12 in. discs are of particularly enduring character in my own estimation. The only one I have yet of the wonderful Czecho-Slovakian series on Electron is *Cavatina Figaro* (4s. 6d.), sung by Robert Primorzic. I have heard some of the others which are to follow and they are all very notable. Brunswick-Polydor have a glorious German drinking song *Epiphinas*, sung by Schlusnus, 6s. 6d.

The finest example of sheer

As a recognised authority on all matters relating to gramophone work, H. T. Barnett is well able to select the best records for electrical reproduction—a branch of radio that is of particular interest to all "Wireless Magazine" readers. This review will be found of considerable value by all who wish to add to their present collection of records.

vocalisation by a bass that I ever heard is given by Chaliapine, who sings Schubert's song, *Der Doppelgänger* (The Wraith), in Russian (8s. 6d., H.M.V.). Parlophone-Odeon are well represented by Lottie Lehmann, who sings two of Schubert's songs, *Du bist die Ruh* and *An die Musik*, in German. Morlais Morgan with a magnificently recorded orchestra (proportional even to the timpani) sings *Credo* from Othello in English (4s. 6d., Electron).

Of the 10 in. goods, the enduring ones are Lucrezia Bori in two selections from *Mignon* (4s. 6d., DA1017, H.M.V.); Lottie Lehmann in two of Schumann's songs, *Der Nussbaum* and *Aufträge* (4s., Parlophone-Odeon); and Richard

Tauber in *Die Lotusblume* by Schumann and *Ungeduld* by Schubert (4s., Parlophone-Odeon).

Negro Spirituals are perfectly represented by *My Lord, what a Mornin'*, sung by Paul Robeson (3s., H.M.V.) and *I'll be ready when de great day comes*, Jubilee choir (3s. Brunswick).

Some Popular Songs

Popular songs are well to the fore; the well-known Ronald Gourlay (drawing-room entertainer) sings *Half-a-dozen What-nots*, with a capital whistling solo on the reverse (3s., Electron); Gracie Fields is at her very best in a French song, *Reviens* (Fragson) (H.M.V., 3s.); Mabel Marks, who is certainly destined to use her remarkable recording voice on the "talkies," sings *She's a Great, Great Girl* and *There a'int no Sweet Man* dramatically (3s., Electron). At 1s. 3d. each, *The Song I Love* and another, and *A Dicky Bird Told Me So* and another are well worth mention (Radio).

DANCE MUSIC. Since I wrote my last article I have made up a small set all very first class and *different from one another in style*; H.M.V., numbers B5577 and B5622 (3s. each); Brunswick numbers 3867 and 3922 (3s. each); Electron, 0284 (3s.); Parlophone, R330, R335, R326, R276, R278, and R303, at 3s. each, with E6138 at 2s. 6d. At 1s. 3d. each, I have 907 and 913 (Radio) with 355 and 330 (Broadcast).

Special Piano Recordings

NOTE.—This morning by the same post I have two really perfect 12 in. pianoforte recordings at 4s. 6d.; certainly buy one of these before adding anything more expensive.

One is Chopin's *Fantasia Impromptu*, with one of the less known *impromptus* on the other side (Electron); my second record of the Czecho-Slovakian group, the other is *Fantasia Impromptu* again, with Liszt's *Gnomensweigen* on the reverse. You may take your choice, in piano tone and quality too; the first sounds like a Steinway and the second like a Blüthner.

A monument of ability is Jack Hylton's new dance pair, *House on the Hilltop* and *A Love Tale of Alsace-Lorraine* (3s., H.M.V.).

A New Double Horn

GRAMOPHONE enthusiasts will be interested in the new type of horn just produced by F. A. Boyd, The Gramo Depot, 142 Gray's Inn Road, W.C.1, which is illustrated here.

Perfect stereoscopic reproduction is claimed by virtue of the fact that one half of the horn reproduces the bass frequencies and the other half the treble frequencies.

Exponential

As can be seen, the left-hand part of the horn expands exponentially, while the right-hand side has no taper for approximately half its length, after which it expands on a smaller ratio to get the treble sharp and clear.

We were particularly pleased with the reproduction when we heard the horn demonstrated recently.



Trying Out a New Pick-up

ALTHOUGH it is a debatable point whether or not fibre needles only should be used with pick-ups, there can be no question about the value of fibres for experimental work.

A number of pick-ups, a notable example being the new *de luxe* Igranic, have been designed to use fibre needles exclusively; others, such as the R.I. model, are designed to give the most faithful reproduction with a loud-tone steel needle.

Semi-Permanent Needles

With pick-ups of this latter class, I have found that needles of the semi-permanent variety, such as Chromic, Chromic Electric, Dura-gold, American Petmecky, Trumpeter and Arrow—used once only, however—give the best reproduction of all.

Whatever type of pick-up you have, until all your experimental work in connection with, say, the original installation and fitting of the pick-up and its supporting arm has been carried out, it is best to

use fibre needles for the first trial runs.

Of course, you will select an old record to try out the pick-up first of all, and even assuming that satisfactory reproduction with this is secured, before trying next your favourite test record with a steel needle, it is as well to try it over first with a fibre one.

It is decidedly mortifying to see a neat spiral of the record material collecting on the end of the needle. In this instance I speak entirely from experience.

Fibres will never injure your records; the boot is on the other foot. At the first sign of trouble—of incorrect alignment, too heavy a weight on the point or too much damping of the pick-up—the fibre point goes on strike.

What happens is that the point breaks down entirely and the needle follows one groove of the record only, producing a sound rather original, but a trifle monotonous. In fact, at the best of times, fibre needles are erratic and inclined to give trouble, so if you

can eventually make a fibre needle last out the whole of one side of a 12-in. orchestral record in which the recording is robust in character you can be perfectly certain that your various adjustments are correct.

The ability to make one fibre point last out several records before a breakdown makes recutting of the point a necessity is a matter which keen gramophiles brag about.

Gramophiles and Radio Fans

In much the same way that radio fans in the early days of broadcasting have been known to publish abroad how many stations they have secured on their latest *Novo Nine*, so gramophiles of similar leanings have been known to announce that "last night I played through the whole album of *Tristan and Isolde* on one point—twenty double-sided 12-in. discs, my dear fellow!"

If you find that it is impossible to get a fibre needle to last out an average record you can be sure that something is radically wrong, and you should accordingly check over your adjustments.

A final point to remember in this connection is that the actual plane of vibration of the pick-up armature, normally the direction of the needle itself, should not be set at too steep an angle to the face of the record.

Individual Peculiarities

I recently measured the needle angle of one of the latest and most expensive proprietary gramophones of the sound-box type and found it to be 63 degrees. This is in agreement with the angle I have arrived at by experiment and is a figure very suitable for setting a pick-up, but, of course, individual makes have their own peculiarities, and the best position for minimum wear and most faithful reproduction can only be found by experiment.

Practical Compromise

As the needle angle is made more steep, so reproduction becomes better, but at the same time wear of the record rapidly increases. The angle used in practice is a compromise, and you should try to set your pick-up so that the needle angle is the least possible without reproduction being spoilt.

NEEDLE-POINT.

The ALL-WAVE LODESTONE FIVE

A POWERFUL YET REACTION-LESS RECEIVER GIVING SUPERLATIVE QUALITY OF REPRODUCTION :: DESIGNED BY THE "WIRELESS MAGAZINE" TECHNICAL STAFF

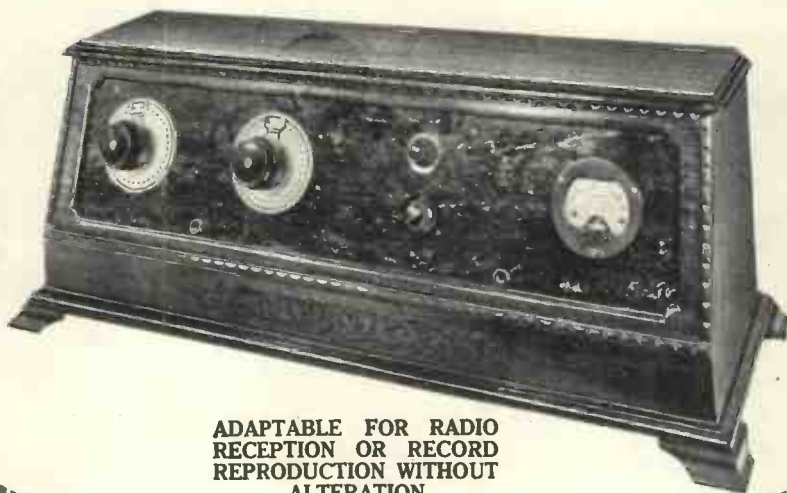

PUSH-PULL AMPLIFIER CAN BE OPERATED DIRECT FROM A.C. MAINS WITHOUT BATTERIES AS WILL BE EXPLAINED NEXT MONTH

ADAPTABLE FOR RADIO RECEPTION OR RECORD REPRODUCTION WITHOUT ALTERATION

Uses Standard Three-electrode Valves

Full-size Blueprint available for 9d., post free

THERE is a growing demand amongst listeners — especially those who are gramophone enthusiasts and music-lovers—for sets that will give really high-class reproduction, even if the range is limited to only a few stations.

In producing the All-wave Lodestone Five, we have tried to combine absolute purity of reproduction with adequate range for all normal purposes. The set has no reaction.

Satisfies Exacting Tastes

We believe that we have succeeded and that the receiver described and illustrated in the following pages will meet the needs of hundreds of discriminating amateurs who can afford to satisfy their exacting radio tastes.

The outstanding feature of the set is the use of dual-range Litz coils based on those used by W. James in his Touchstone Four—the most popular receiver ever described in the WIRELESS MAGAZINE. It should be understood that the special coils used in this set were not actually designed by W. James; they are proprietary products, and therefore constructional details cannot be given.

Better Than Normal Coils

Moreover, it is only fair to W. James to state that he is not wholly in favour of plugging in his particularly efficient type of coil, a practice

which he has found to result in some inevitable losses. This does not mean that the plug-in coils are useless; although not quite so efficient as coils of the fixed type, they are nevertheless considerably better in performance than the normal commercial tuner.

With these coils reaction is not required, and therefore one control is immediately obviated.

Actually the circuit utilised in the All-wave Lodestone Five is a neutralised high-frequency stage with an ordinary three-electrode valve, an anode-bend detector, a resistance-capacity coupled low-frequency stage (the set is similar up to this point to the original Touchstone, except that the tuning condensers are not ganged)

For those who demand superlative quality of reproduction with adequate range we confidently recommend the All-wave Lodestone Five.

The special Litz coils used in this receiver are based on those designed by W. James, which were used with such success in the Touchstone Four and in the Lodestone Three.

The set described in this article utilises highly efficient components and represents all that is best in modern design.

By the mere insertion of a single plug the set can be changed from an efficient radio receiver to a powerful amplifier for the electrical reproduction of gramophone records.

and a final push-pull amplifying stage using two valves.

As in the case of the Music Player, described last month, a jack switching system is used with a great increase in the general utility of the receiver. The first jack is for inserting a pick-up in the grid circuit of the detector valve.

Changing the Grid Bias

The insertion of the pick-up jack automatically switches off the high-frequency valve and changes the grid-bias so that the "detector" valve actually amplifies instead of "anode-bends."

Two loud-speaker jacks are provided. When the loud-speaker plug is inserted in the first of these, only three valves are switched on, while the primary of the push-pull input transformer is utilised as an output choke, the loud-speaker being connected to high-tension negative through a 2-microfarad fixed condenser in the ordinary way.

Connecting the Amplifier

When the loud-speaker plug is inserted in the last jack the push-pull amplifier is put into commission.

In this way the All-wave Lodestone Five can be adapted to the following circuits:—

- (i) Five-valve radio receiver,
- (ii) Three-valve radio receiver,

The All-wave Lodestone Five (Continued)

THE ALL-WAVE LODESTONE FIVE IS THE BEST
OF ITS CLASS AND CANNOT BE BEATEN

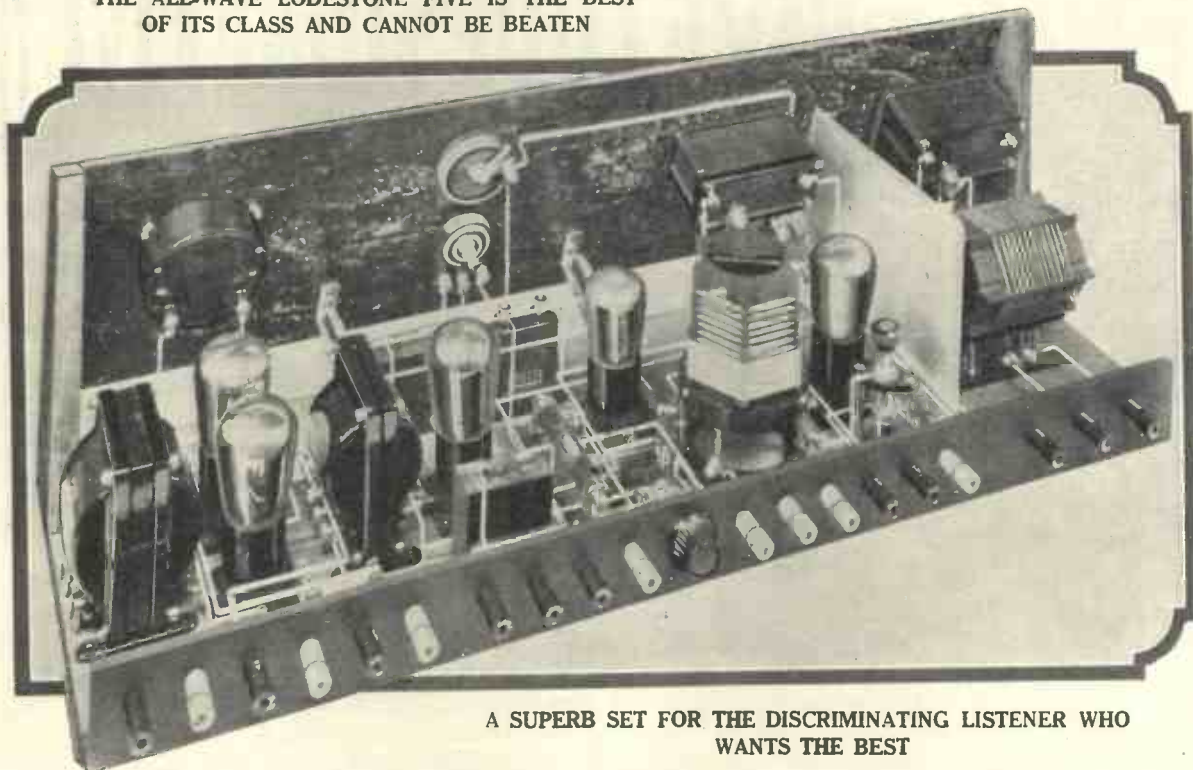

A SUPERB SET FOR THE DISCRIMINATING LISTENER WHO
WANTS THE BEST

This rear view of the All-wave Lodestone Five shows the valves and long-wave coils in position. Special safety plugs and sockets are used for the battery connections

- (iii) Two-valve gramophone amplifier, and
- (iv) Four-valve gramophone amplifier.

Separate Amplifier Connections

Before discussing the circuit in detail, however, there is another feature about the set that we desire to emphasise. All the power supply leads for the push-pull amplifier are provided with separate terminals. That is, there are two low-tension, two high-tension, and two grid-bias terminals for the push-pull valves only.

The reason for this is that so many listeners want to use their alternating current (A.C.) mains for supplying all the current to their receivers. While this is a costly proposition for the average set, it is simple in the case of a push-pull amplifier. No elaborate smoothing system is necessary, for any hum is automatically cancelled out by the push-pull arrangement. Therefore the filaments of the push-pull valves can be fed straight from the A.C. mains through a transformer.

Next month we shall describe the construction of an A.C. mains unit that will supply the high-tension (up to 350 volts), low-tension, and grid-bias for the push-pull amplifier direct from the mains without the use of batteries—which will, however, still be needed for the first three valves (unless an ordinary high-tension unit with adequate smoothing arrangements is employed).

It should be clearly understood, however, that the whole receiver can be supplied from dry batteries if desired, although the high-tension voltage available for the last valves will then be considerably less than if a mains-supply unit were employed.

Operation from Batteries

This month, therefore, we shall confine ourselves to discussing the operation of the set entirely from batteries.

Now as regards details of the actual circuit employed. The actual aerial "transformer" and high-frequency transformer are the most efficient that have yet been designed,

and their advantages were fully dealt with by W. James^o in his article on the Touchstone Four (WIRELESS MAGAZINE, November, 1928).

The aerial transformer consists of a fine-wire primary interleaved with a secondary of Litz (stranded and insulated) wire, which has a very low resistance, and therefore gives extraordinarily sharp tuning and a high degree of amplification.

Aerial Adaptability

Two tappings are provided on the primary to suit different aerial conditions and the secondary is tuned with a .00033-microfarad variable condenser. It should be noted that the use of .0005-microfarad condensers is not advised; the recommended value will enable the whole of the broadcast waveband to be covered.

The aerial transformer and condenser are shielded from the remainder of the components by a small vertical screen, which can be of aluminium or copper. On the aerial side of the screen is accommodated a 1½-volt dry cell to supply

Use W. James' Special Litz-wound Coils

bias for the more efficient operation of the high-frequency valve.

The principle of construction of the high-frequency transformer is the same as that of the aerial transformer. The secondary is wound with Litz wire, while the primary and neutralising windings are of fine-gauge wire wound over one end of the secondary, which is again tuned by a .00033-microfarad variable condenser. Fine wire is used for these windings to keep the capacity effects as low as possible; for this reason the pins on the bottom of the coils are also spaced well apart.

Ease of Neutralisation

For ease in neutralisation a special rheostat is provided for the high-frequency valve, which can thus be easily switched off. Moreover, in order to prevent overloading of the detector valve (for even an anode-bend detector can be overloaded)

this rheostat is mounted on the panel, in which position it can easily be used as a volume control.

It has already been mentioned that two grid-bias points are provided for altering the bias on the "detector" for radio detection or pick-up amplification. Another refinement for the critical control of the "anode-bend" point is the inclusion in the anode circuit of a variable high resistance, by means of which the anode voltage can be varied within wide limits.

This variable resistance is in series with the normal fixed anode resistance (of 100,000 ohms) used as part of the resistance-capacity coupling. From the junction of these two resistances a 2-microfarad condenser is led to earth; the arrangement therefore acts as a motor-boat stopper and ensures the greatest stability of operation.

So that an adequate proportion of

the bass frequencies are amplified a large coupling condenser (.01 microfarad) is used between the detector and the first low-frequency amplifier, which is provided with a variable 1-megohm grid leak (actually a wire-wound potentiometer).

This variable grid leak acts as the main volume control, particularly for gramophone reproduction. By turning it, the volume of sound can be reduced from a roar to a whisper.

Push-pull Arrangement

In the anode circuit of the first low-frequency amplifier is connected the push-pull input transformer. This has an ordinary primary winding, but the secondary is centretapped. The two ends of the secondary winding are connected to the grids of the two push-pull valves, grid-bias for both of which is supplied to the centre tap.

The primary, it has already been

COMPONENTS REQUIRED FOR THE ALL-WAVE LODESTONE FIVE

Panel	1—27½ in. by 7 in., mahogany finish (Becol, Raymond, or Ready Radio).	Slow-motion Dials	2—Hairline cursor type (Utility type W181, or Ormond).
	✓ 1—27 in. by 2 in. terminal strip (Raymond, Ready Radio, or Omnora).	Meter	✓ 1—0 to 150 panel type milliammeter (Ferranti or Sifam).
Variable Condensers	✓ 2—.00033-microfarad (Burndept, Cyldon, or Polar).	Screen	✓ 1—Aluminium or copper (Ready Radio, Parex, or Raymond).
Fixed Condensers	✓ 1—.0003-microfarad (Dubilier, T.C.C., or Trix).	Terminals	19—Safety plugs and sockets, marked:— Aerial 1, Aerial 2, Earth, L.T.+(2), L.T.-(2), H.T.-(2), H.T.+, H.T.+1, H.T.+2, H.T.3, Grid+(2), Grid-, Grid-1, Grid-2, Grid-3 (Belling-Lee).
	✓ 1—.01-microfarad, mica dielectric (Dubilier).	Batteries	1—1½-volt grid cell (Siemens or Ever-Ready).
	✓ 2—2-microfarad (Mullard, T.C.C., or Lissen).	Sundries	15—2 ft. lengths insulated wire (Glazite) Screws.
Coils	2—Aerial coils with holder (Berclif).	Cabinet	1—Sloping-front type with baseboard. (W & T. Lock, Pickett, or Camco)
	2—High-frequency transformers with holder (Berclif).	RECOMMENDED ACCESSORIES	
Valve Holders	✓ 5—Antimicrophonic (Marconiphone, W.B. or Lotus).	Batteries	1—22-volt grid-bias battery, tapped every 1½ volts for 9 volts (Ever-Ready or Siemens).
Grid Leaks	2—100,000-ohm (Ediswan or Lissen).		1—120-volt super-capacity high-tension battery (Ever-Ready, Siemens, or Columbia).
	2—Porcelain holders for above (Bulgin).		1—6-volt accumulator (Tudor type CLH7, Exide, or C.A.V.).
Anode Resistances	1—100,000-ohm with holder (Edison Bell, Dubilier, or Mullard).	Valves	1—High-frequency valve (Marconi HL610 or Osram HL610).
	1—Variable resistance (Clarostat Universal or Regentstat).		✓ 1—Detector valve (Marconi HL610, Osram HL610, or Mullard PM5B).
Transformers	1—Push-pull input (Ferranti, type AF3 (c)).		✓ 1—Low-frequency valve (Mazda LF607, Mullard PM6, or Ediswan PV610).
	✓ 1—Push-pull output (Ferranti, type OPM 1(c)), for high-resistance loud-speaker		2—Push-pull valves (Ediswan PV625A, Marconi 625A, or Osram 625A).
Jacks and Plugs	3—Jacks (Igranic types P65 and P66 (two)).	Loud-speaker	✓ 1—Cone model (Celestion, Blue Spot or B.T.H.).
	2—Plugs (Igranic).		
Rheostat	✓ 1—15-ohm (Lissen, Peerless, or Igranic).		
Neutralising Condenser	1—Baseboard type (Jackson or Gambrell)		
Potentiometer	1—1-megohm panel type (Igranic).		

The All-wave Lodestone Five (Continued)

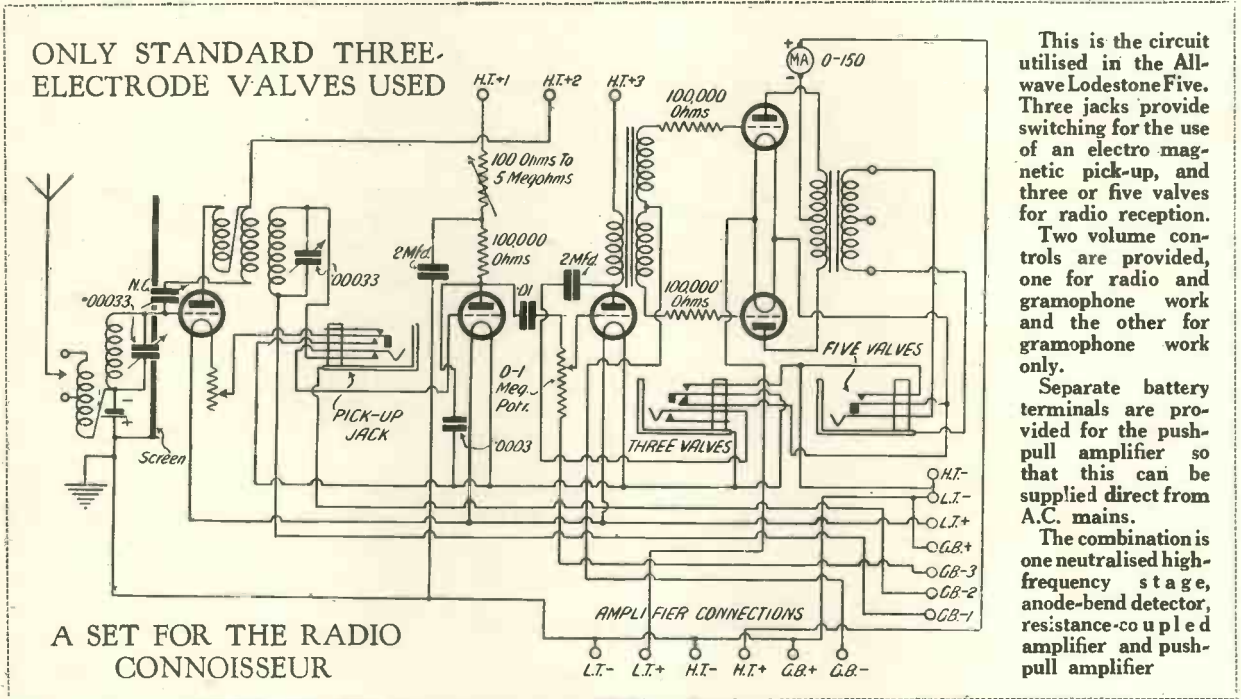

This is the circuit utilised in the All-wave Lodestone Five. Three jacks provide switching for the use of an electro magnetic pick-up, and three or five valves for radio reception.

Two volume controls are provided, one for radio and gramophone work and the other for gramophone work only.

Separate battery terminals are provided for the push-pull amplifier so that this can be supplied direct from A.C. mains.

The combination is one neutralised high-frequency stage, anode-bend detector, resistance-coupled amplifier and push-pull amplifier

pointed out, is used as an output choke for the loud-speaker when only the first two or three valves are being used.

Doubling the Grid Swing

The effect of arranging valves in "push-pull" (in distinction to a "paralleling" arrangement) is that the effective grid swing available is twice that of either of the valves used separately (they must be of identical types, by the way, and their characteristics should be matched as far as possible). This means that there is less likelihood of overloading, and therefore even when only "small" power valves are used with comparatively low values of high-tension voltage the quality of reproduction is amazingly good.

Push-pull Output Transformer

It will be obvious that there are now two different anode currents that must be passed to the loud-speaker, and these are brought together by means of a push-pull output transformer. In this case the primary is centre-tapped, the outer ends being connected to the anode of the push-pull valves and the centre tap being taken to the high-tension supply.

Normally the secondary would be

untapped, but actually we have used a tapped-secondary transformer so that it can be matched up with the loud-speaker to give the best possible results.

The tapings available with the particular model specified are 1 to 1, 1.6 to 1, and 2.7 to 1. These values are suitable for the average "high-

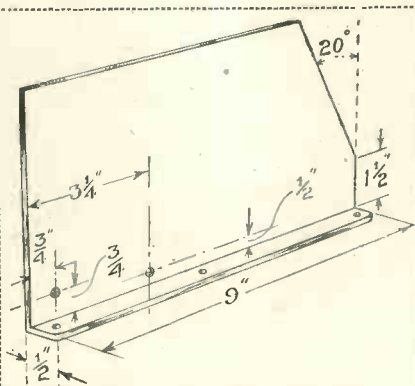

Dimensions of aluminium or copper screen for the All-wave Lodestone Five

resistance" cone loud-speaker. (The choice of a different output transformer for use with a moving-coil loud-speaker will be discussed next month.)

It will be noticed that the use of an output transformer effectively insulates the loud-speaker windings

from the steady direct currents in the anode circuits of the push-pull valves.

Indicating Distortion

For the sake of stability a 100,000-ohm resistance (grid leaks are suitable) is included in the grid circuit of each push-pull valve, while a milliammeter is provided in the anode circuit to indicate distortion if it occurs owing to the incorrect adjustment of the valves or overloading.

The reason for separate terminals for the push-pull amplifier has already been discussed, but there is a secondary advantage to this scheme which has not yet been mentioned. This is the possibility of using valves of different filament voltages for the first three positions and in the push-pull stage.

An Economical Scheme

For instance, any listener already owning a set using two-volt valves (six-volt valves are recommended if they can be used without great trouble or expense) could utilise these for the first three stages and get only two new six-volt valves for the push-pull stages.

Alternatively, four- or six-volt valves can be used in the first stages

The All-wave Lodestone Five (Continued)

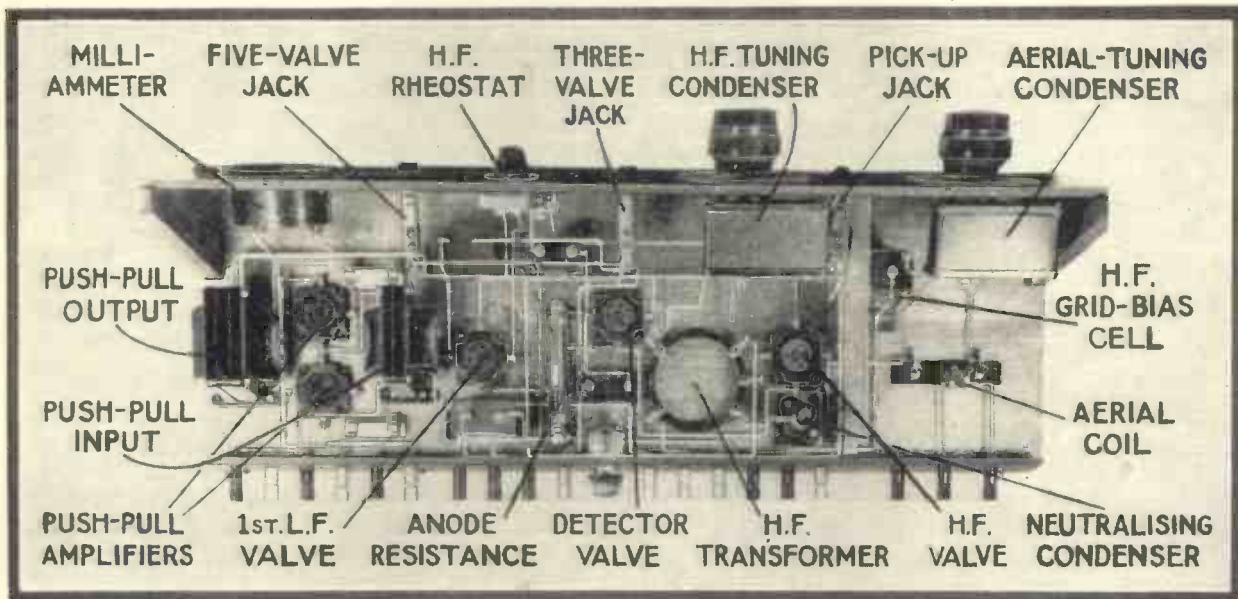

This plan view of the All-wave Lodestone Five clearly shows the arrangement of all the parts. Remember that a full-size blueprint can be obtained for 9d., post free

said. With the exception of the connections to the three jack switches and the neutralising condenser, no soldering is necessary, the remainder of the components being provided with screw-down terminals.

However, whatever little difficulty may arise will be immediately overcome by a glance at the full-size blueprint, which is available for half-price (that is, 9d., post free) if the coupon on page iii of the cover is used by July 31. An extension of time will be made in the case of overseas readers.

Address your inquiry to Blueprint Dept., WIRELESS MAGAZINE, 58-61 Fetter Lane, London, E.C.4, and ask for No. WM 146.

Constructors are specially advised to keep to the specification of components recommended by the WIRELESS MAGAZINE. The substitution of parts other than those recommended may materially affect the performance.

Automatic Wiring-up

Wiring-up becomes automatic if the blueprint (or the reduced reproduction of it which appears in these pages) is carefully followed. It will be noticed that every connection bears a number, these numbers indicate the order of assembly.

For instance, first complete connection No. 1 and cross that figure

through on the blueprint. Then proceed until the wiring is completed, crossing through each number on the blueprint as the corresponding connection is made.

In this way it is impossible to go wrong, and the wiring is built up in the most efficient way from the base-board upwards. With the aid of the photographs it can be made to follow almost exactly that of the original receiver.

Choice of Suitable Valves

Before the set can be used, however, suitable valves must be inserted in the holders. A number of suitable six-volt valves are mentioned in the list of components, and these will be found particularly satisfactory.

The best high-frequency valve is the Marconi or Osram HL610, as no equivalent valve of other make has such a good characteristic (a magnification of 30 and an impedance of 30,000). With one of these valves and his own special type of Litz coil (on which those used in this set are based) W. James claims that he obtains greater amplification than is possible from a screened-grid high-frequency amplifier.

For the detector stage a valve of approximately the same impedance is suitable. For the best results its impedance should be between one-

half and one-third of that of the anode resistance associated with it (in this case 100,000 ohms).

The first low-frequency amplifier should have a relatively low impedance for the sake of quality. A valve with an impedance between 5,000 and 10,000 ohms will be satisfactory. (These "impedance" remarks, of course, apply whatever the voltage of the valve filaments.)

As regards the push-pull amplifier, it must be remembered that the total impedance is the sum of the impedances of the two valves used. For this reason it is desirable to use two valves of lower impedance than would normally be used for a "parallel" arrangement. Any valves with impedances between 1,500 and 2,500 ohms will do, but they must be of identical types.

Adequate Batteries Essential

We assume that the constructor will be using an accumulator and dry batteries for his high-tension supply. (We shall discuss the use of different valves for mains operation next month.) It is desirable that an accumulator at least as large as that mentioned in the list of components (30 ampere-hours capacity) be used, and it is even more important that an adequate size of cell should be incorporated in the high-tension battery.

A Powerful Receiver for Radio or Gramophone Work

The best voltages to apply to the grids and anodes of the valves used will be clear from a glance at the details supplied by each manufacturer. The "detector" valve will normally need 3 volts bias for radio and only $1\frac{1}{2}$ volts bias for pick-up work.

Convenient Bias Battery

It will be found convenient to use a 22-volt battery tapped at every $1\frac{1}{2}$ volts for the first 9 volts, as this will supply bias for the whole set—unless some very large power valves are used in the push-pull stage.

The actual operation of the set is

Here are details of the cabinet for the All-wave Lodestone Five. It is identical with that used for the famous 1927 Five, with the exception that the back is cut away to accommodate the terminal strip, which extends the whole length of the baseboard.

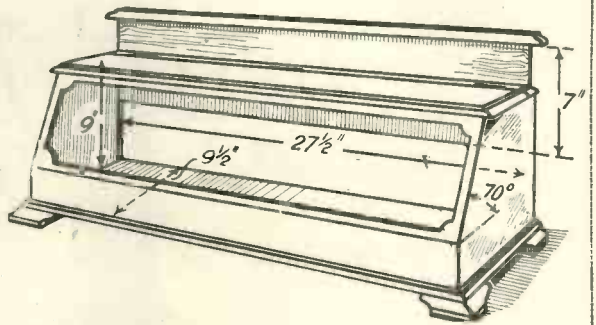

valve set should be neutralised.

To neutralise the set tune in the local station as loudly as possible,

reostat on the front panel. Now turn the knob of the neutralising condenser on the baseboard until the local station just becomes inaudible; at this point the valve is neutralised and it can then be switched on again.

When a change is made from short-wave coils to long-wave coils, or *vice versa*, the high-frequency valve must be re-neutralised.

Gramophone Reproduction

Inserting the loud-speaker plug in the right-hand jack will switch on all five valves and turns the set into a real "he-man" receiver. To use the set for gramophone reproduction simply connect a pick-up to another plug and insert it in the left-hand jack. There is no other adjustment to be made.

Further points about the All-wave Lodestone Five, together with an A.C. mains supply unit for the push-pull stage will be discussed next month.

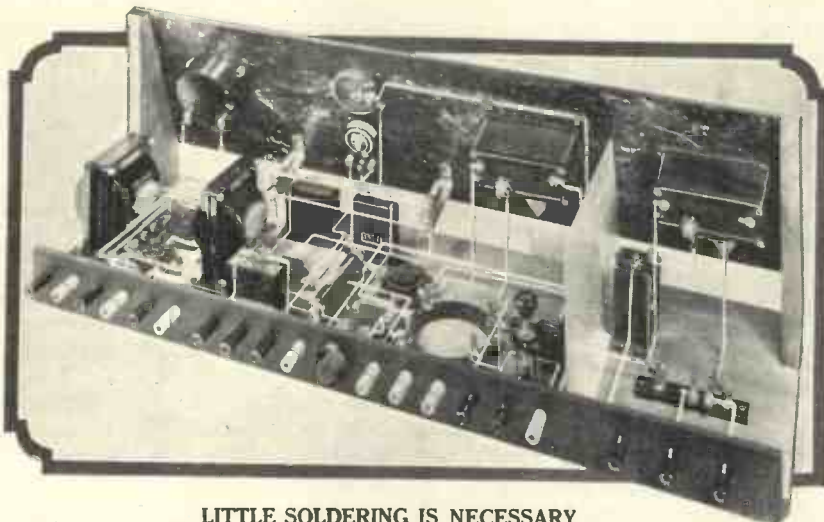

LITTLE SOLDERING IS NECESSARY

A view of the All-wave Lodestone Five without valves or coils in position

simplicity itself once all the external connections have been made.

First plug in the two short-wave coils and the valves. Then place the loud-speaker plug in the centre jack, which puts the first three valves in operation. Turn the knob of the high-frequency valve rheostat as far as possible to the right (for maximum volume) and the knob of the variable grid-leak to the left (also for maximum volume).

How to Neutralise the Set

Now rotate the dials of the two main tuning dials in unison, remembering that for any particular station their readings will be practically the same. As soon as the local station is picked up adjust the variable anode resistance on the terminal strip until the best signals are obtained, when the high-frequency

and then switch off the high-frequency valve by means of the



THERE IS NO REACTION CONTROL

Another view of the All-wave Lodestone Five complete with valves and short-wave coils



THE first five years of broadcasting have shown as much technical progress as did the first fifteen years of motoring. And the first year of "talkies" has seen about as much progress in their development as there was in those five years of broadcasting.

Sighing Like a Furnace

The talking picture, offspring of "Pop" Kinema and "Ma" Radio, has passed through its muling, puking, and whining stages and is now sighing like a furnace for the patronage of the cinema-going public.

Since I burst into print in the March number of the WIRELESS MAGAZINE, over two hundred talking picture installations have been put into various cinemas all over Great Britain, and this number is now increasing at the rate of about six each week. The "talkies" have come to stay, whether we like them or not.

As a matter of fact, the Hollywood-cum-Western Electric magnates have already decided for us that we shall like 'em, for have they not sunk millions of dollars in plant and patents? It's no use worrying; we must put cotton wool in our ears and hope for the best.

Open Development

I had always had faint hopes that the development of the talking picture would be carried out on "open" lines, in the same way as other modern vices. Quality and perfection, not yet attained, would naturally be expected to win through on their own merits. Unfortunately, technical progress is fast becoming a secondary matter, a

mere pawn in a game of commercial chess.

The Western Electric Company, whose excellent Vitaphone and Movietone systems I have already described, are trying by various ways and means to prevent other systems' sound films being shown on Western Electric apparatus, and they are also forbidding the projection of Vitaphone and Movietone films on other makers' sound projectors.

There is, undoubtedly, a great deal to be said for Western Electric's claim that their reputation would be

Every reader will be interested in this authoritative contribution by Baynham Honri, a late member of the B.B.C. engineering research staff, who is now in charge of the sound side of Gainsborough Pictures, a branch of the Gaumont-British Picture Corporation. Gainsborough Pictures produced *The Rat*, *The Constant Nymph*, *The Lodger* and *Woman to Woman*.

ruined if their films were reproduced on inferior apparatus, judging by some of the poor "demonstrations" of "world shattering" talking film inventions of the last few months.

But, on the other hand, there are one or two systems which are equal to, if not better than, those developed by Western Electric. All the time this "cornering" game has been going on, the Radio Corporation of America and British Talking Pictures had been getting ahead quietly and steadily with their developments: which brings me to a consideration of the latter company's system.

British Talking Pictures used to be known as Phonofilms, and were shown publicly for the first time at the Holborn Empire about three years ago. Based on the patents of Dr. de Forest, the invention was largely developed in this country by Mr. C. F. Elwell, the well-known radio engineer.

Perfect Synchronisation

The first demonstrations were exceedingly crude, the sounds and voices appearing to come from anywhere but the figures on the screen. Synchronisation was perfect, however, for the Phonofilm system had the sound photographed on the edge of the cinema film.

Quality of sound was poor, reproduction being reminiscent of a tiny gramophone of twenty years ago. Indeed, it seemed to be little better than the Hepworth, Edison and Clarendon talking pictures of 1909, which were simple combinations of the cinematograph and the crude gramophone of that year.

Technical Snags Overcome

Efforts were made by the Phonofilm people to improve the quality of the sound by the use of different types of loud-speakers, and the demonstrations about six months after the Holborn Empire show at the Capitol Cinema, London, indicated that a little progress had been made. It was not until about six months ago, however, that the greatest technical snags were overcome and the system could be compared with its American rival, Movietone.

A technical brick wall in the shape

of difficulties in recording and reproduction of the low notes had hitherto prevented all possibility of the creation of the illusion of "talking pictures." The chief fault was in the "lamp" which impressed the sound frequencies on the film, which was found to be insensitive and uneven in its response to various musical frequencies. Let us examine the system in detail.

Light Variations

The sounds are picked up by a condenser microphone, amplified and passed on to a special glow-discharge tube on the cinematograph camera. The brilliancy of the "glow" varies in accordance with the sounds picked up by the microphone, and a lens focuses the beam through a small slot on to the edge of the "movie."

When the negative film is developed, the sound impression appears by the side of the movie in the form of a series of horizontal lines of various densities. A print is made from this negative in the ordinary way and placed upon a cinema projector.

Square Picture

The projector lens shows only the moving picture on the screen, slightly more square than normal owing to the section taken up by the sound record.

A separate light is projected through the sound section on to a photo-electric cell, and according to the variation in density of this record,

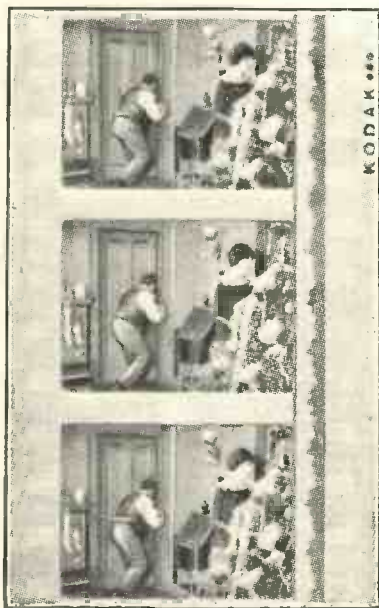

Section of R.C.A. Photophone film with sound record on right

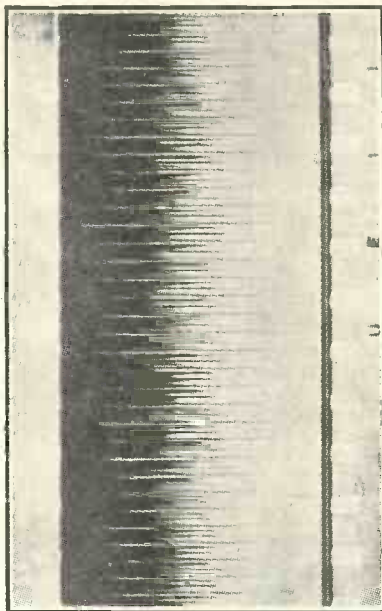

British Acoustic sound record

the illumination and consequent electrical resistance of the cell will vary. The variations in current passed by the cell are magnified up to loud-speaker strength—and there you are!

With first-class amplifying gear and specially designed moving-coil loud-speakers, the Phonofilm has improved out of all recognition—so much so that the very name of Phonofilm has been discarded in favour of the "higher sounding" title of British Talking Picture!

Bass notes come from the picture with a roundness only equalled by another sound-on-edge-of-film system—the R.C.A. Photophone. It now remains for the B.T.P. producers and engineers to improve the acoustics and working technique for this system to stand comparison with any other in the world.

Different Method of Recording

The general technical description of the Radio Corporation of America's Photophone is much the same as for the British Talking Picture, or the Movietone—it records the sound on the edge of the film. The chief difference—and possible superiority—lies in the method of recording the sound on the film.

Instead of having a light or discharge tube varying at audio frequencies, the microphone currents are made to drive a special kind of oscillograph which makes a wavy line of constant density on the edge of the movie.

Naturally, such a sound record is

far easier to handle in the processes of development and printing than the varying density methods of Movietone and British Talking Pictures. This disadvantage of the variable density systems has been largely overcome by the photographing of the sound on a separate negative and combining it later with the movie during the process of printing, a complicated and difficult operation.

British Acoustic Process

The British Acoustic process, a system rather on the lines of the R.C.A. Photophone in that the sound is photographed on the "constant density" system, gave promise of a great future, but the system was handicapped at the outset by certain shortcomings of the reproducing gear and by the fact that a separate film was used for recording and reproducing the sound.

This has now been abandoned, and it is possible that the system may reappear with the sound impressed on the edge of the film.

German Co-operation

The British Phototone Company originally used a gramophone method of synchronisation with moderately good results, but a "tie up" has been made with a German company, whereby Phototone will be able to use a sound-on-film method.

I understand that amazing improvements have been made in the design of the valve amplifiers and

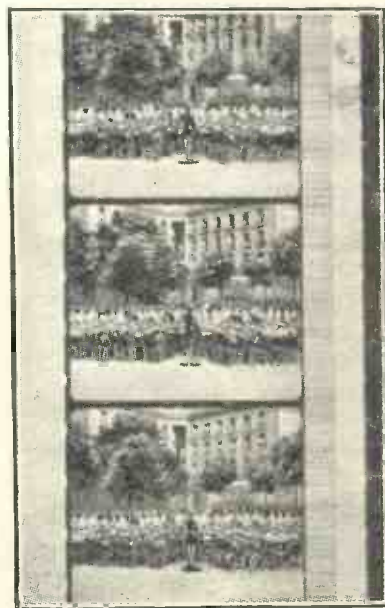

Section of Movietone film, with sound record at the side

More "Talkie" Secrets (Continued)

loud-speaker gear since this system was first demonstrated.

The Blattner Sound Film is not a sound film at all: it is a synchronised sound wire. Little has been heard of this system since its London demonstration, but I understand that



Western Electric exponential horn used for Vitaphone and Movietone films

surprising developments have been made in the use of the sound wire as an original studio recording medium, the recorded impressions being transferred to the edge of the movie for projection.

Great Stumbling Block

On the whole, the past six months may be said to have seen the "peak" of the synchronised gramophone record method of making talking films. The great stumbling block of the gramophone record is its inflexibility. The whole "length" of a record has to be "shot" at one time, severely limiting the continual change of scene, which is possible with silent films and talkies of the "sound-on-edge" type.

Unavoidable Distortion

It is, of course, possible to re-record a number of separate recordings on to one disc, carefully timing the synchronisation and changing over from one record to another, or of re-recording sound-on-film scenes on a disc. But the result is rather like a poor carbon copy of typewriting. The unavoidable distortions and background noises of both recordings are

added together, with consequent injury to the final reproduction.

Interference, a Paramount talking film, was originally recorded with Movietone, but with the sound occupying the whole width of a separate film. No cinemas in England were equipped for the projection of this type of talkie, and so the whole of the sound was re-recorded on discs. The result was typical of what may be expected if attempts are made to make the gramophone talkie "flexible."

At this point, a brief survey of the big sound films presented up to now may be of interest. *The Jazz Singer*, *The Terror*, *The Singing Fool*, *The Hometowners*, and several silent pictures with synchronised music have been seen and heard by thousands of cinemagoers.

These were all made on the Western Electric Vitaphone system, which undoubtedly gets the utmost out of the gramophone record method. The average quality of the sound was good, but the sibilants of speech and high musical notes were missing, as were the extreme bass notes. The double-bass could be seen fiddling away without making a sound!

There have not been many Movietone or Photophone full-length pictures, but *The Melody of Love* and *In Old Arizona* give some indication of the possibilities of sound-on-film drama. The average quality at present is not so good as Vitaphone, but "in spots" both systems surpass the Vitaphone's best efforts. The Photophone reproduction of the bass notes of music is remarkably good.

An American newspaper recently invited cinemagoers to answer a few questions on the subject of talkies with rather interesting results. Here they are:—

Question	Votes	
	Yes	No
1. Do you prefer talking pictures? ...	50%	50%
2. Do you want silent films eliminated? ...	7%	93%
3. Do you prefer orchestra to synchronised musical score? (Recorded musical accompaniment) ...	54%	46%

4. Do you prefer organ music to synchronised score? ...	23%	77%
5. Would you limit sound in pictures to effects and music? ...	38%	62%
6. Do you object to part-"Talkies"? ...	31%	69%
7. Is your interest increasing in "Talkies"? ...	69%	31%
8. Is your interest waning as the novelty wears off? ...	23%	77%
9. Do you think that the "Talkies" are a substitute for the legitimate stage? ...	—	100%

Unaware of the "Wheels"

Judging by the success of the better talking films in Great Britain, the opinion of the British public would not be very different from that of their American cousins, as indicated in the questionnaire. If the commercial side of the "talkies" does not kill open competition and improvement, the talking picture will soon be in a state when it will be possible to see and hear without being subconsciously aware of the "wheels going round" and the presence of loud-speakers.

And I don't think that even the most ignorant Hollywood magnate wants to kill the goose that lays the golden eggs.

DO YOU WANT TO BUY A SET?

We shall be glad to advise you as to which types of sets are the best for your personal use.

Tell us how much, roughly, you wish to spend; where you are situated; what stations you wish to receive; whether you intend to use a cone or moving-coil loud-speaker, and we will advise you as to the general lines of sets that will answer your purpose.

Send your inquiry with coupon (p. iii cover), a stamped addressed envelope, and a fee of 1s. to:

Buyer's Advice Bureau,
WIRELESS MAGAZINE
58/61 Fetter Lane, E.C.4.

How to Build A TWO-AMPERE LOW-TENSION UNIT

For
Charging Accumulators,
Direct Operation
of a Set, or
Supplying Field Current
for a Moving-coil
Loud-speaker

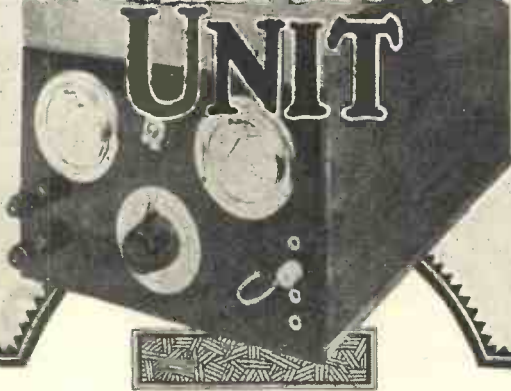

Specially Designed by
W. James for the
"Wireless Magazine" ..
A Device of Great
Utility to the
Experimenter with
A.C. Mains

VALVES of the low-voltage type taking currents for heating of the order of .1 ampere are so widely employed by all classes of listeners that current requirements are more or less satisfactorily met by a relatively small accumulator.

This battery, it is true, has to be charged at intervals of perhaps a fortnight and is, therefore, not entirely a trouble-free component. But such a battery, being inexpensive to buy and maintain, is accepted by the majority of listeners as a suitable means for supplying a set fitted with valves of the economical type.

More Powerful Equipment

A time generally arrives, however, when the amateur decides to make use of a more powerful receiving equipment. Perhaps one or two super-power valves are fitted in the amplifier; a moving-coil type loud-speaker may make its appearance or the better characteristics of six-volt valves as compared with those having two-volt filaments may be recognised and a change made.

The amateur is then compelled also to arrange for a larger supply of current, as the battery that has been used in the past is no longer able to provide the heavier current taken by the new apparatus.

Reviewing the Whole Problem

A larger accumulator may be obtained, but no doubt the opportunity which presents itself at this stage would be taken of reviewing the various sources of filament current.

First, there is the filament power unit, which comprises an accumu-

lator and charger suitably connected by a switch in order that when the battery is not discharging through the valves it is being charged from the mains. This type of unit may appeal to a number of amateurs because of its simplicity and the knowledge that this combination is relatively trouble free. The only attention needed is the addition of a little distilled water from time to time, as the charging rate can so be arranged that the battery never runs down.

But there will be others anxious to dispense with accumulators altogether if they can build a power unit for supplying all low-tension circuits. The advantages of such a unit are obvious. Liquids are dispensed with and the current from the mains supply is only flowing through the unit whilst the receiver is being used.

This power unit must, of course, supply a steady direct current whose voltage is either practically constant or readily controllable. A unit for

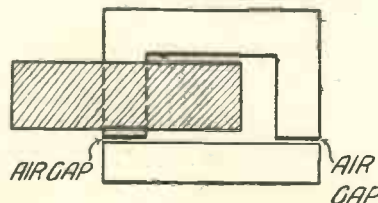

Illustrating air gap in core of
low-tension choke

delivering a suitable output from an alternating current supply of electricity will, therefore, comprise a suitable transformer and rectifier for converting the alternating into a

direct current, a smoothing circuit for levelling the output current and making it continuous, and a means for controlling the voltage.

The essential parts are indicated

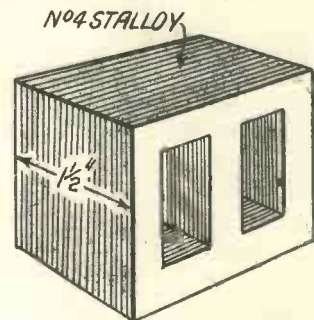

How the core of the power
transformer is built up

in the diagram on page 546, where A is the mains transformer, B the rectifier, C the smoothing circuit, and D the voltage-regulating apparatus. This equipment is in effect a charger, such as described last month, to which is connected the smoothing and regulating circuits.

Accumulator Charging

A different type of rectifier is naturally used, as there is a change in voltage across the smoothing circuit, but the apparatus may be employed without modification for accumulator charging. The power unit illustrated here has, in fact, been arranged in order that accumulators may conveniently be charged at different rates, as will be described presently.

In order that the unit shall be

How to Build A Two-ampere L.T. Unit (Continued)

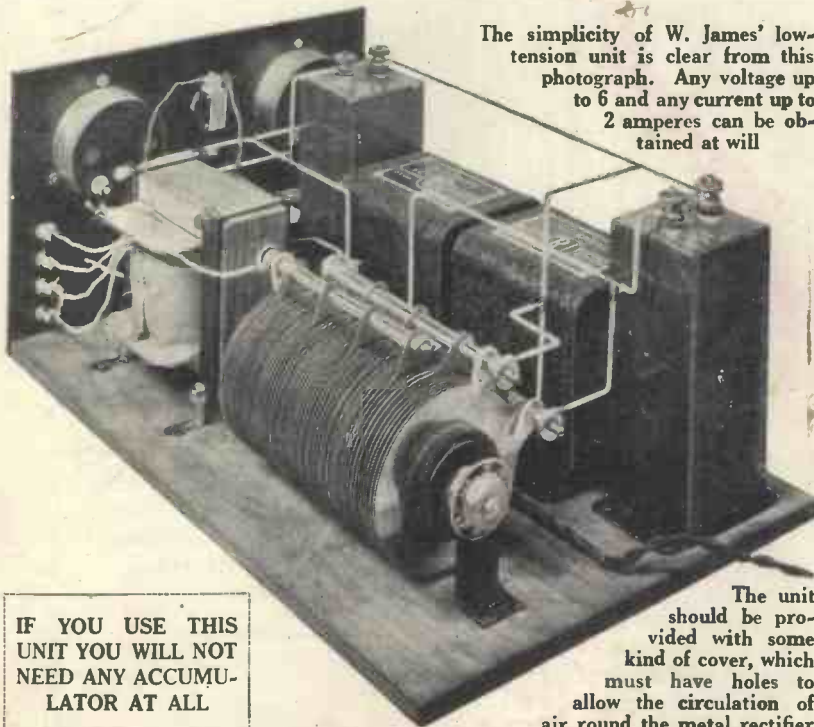

The simplicity of W. James' low-tension unit is clear from this photograph. Any voltage up to 6 and any current up to 2 amperes can be obtained at will

IF YOU USE THIS UNIT YOU WILL NOT NEED ANY ACCUMULATOR AT ALL

The unit should be provided with some kind of cover, which must have holes to allow the circulation of air round the metal rectifier

suitable for the largest of receivers or moving-coil loud-speakers, or for charging a battery of large capacity, a two-ampere metal rectifier is employed. This rectifier is constructed to pass two amperes at nine volts when it is supplied with an alternating current having a voltage of approximately 12.

Small Power Transformer

The first essential part of the equipment is, therefore, a transformer having a primary winding suitable for the voltage and frequency of the mains supply and a secondary winding giving 12 volts. The transformer described last month will not be suitable, because it was arranged to work with a one-ampere unit (type R4-2-2), and calculation shows that it is hardly possible to use an iron core of that size.

Larger Winding or Larger Core

This is because heavier windings must be employed in order to carry the current without overheating, and it is therefore necessary either to provide a larger winding space or a larger core, when the number of turns in the primary winding will be proportionately reduced.

The cheapest and easiest way out

of the difficulty is to use a larger number of core stampings for then, even though the wires are thicker, there will be room for them. A core built up of No. 4 Stalloy transformer laminations to a total thickness of 1.5 inches is suitable and for a 200-volt 50-cycle mains supply the

Mains Voltages	Primary Turns
250	1,250
240	1,200
230	1,150
220	1,100
210	1,050
200	1,000
110	550

It will be noticed there are five turns per volt, and do not forget the core is composed of No. 4 Stalloy stampings built to a thickness of 1.5 inches measured when the laminations are clamped together.

Four Secondary Tappings

The maximum secondary voltage required is 12, which is obtained by providing 60 turns. This winding is tapped at 30, 40 and 50 turns, giving A.C. voltages of 6, 8 and 10 respectively.

No. 26-gauge enamelled wire is used for the primary for all voltages (excepting 110, when the gauge should be No. 24) and No. 18 double cotton-covered wire is used for the secondary in all types.

Little Voltage Variation

The wire is rather thicker than is necessary from the point of view of heating, and the transformer remains cool at all times. There is an advantage in using relatively thick wire, however, as the voltage drop in the windings is minimised, with the result the voltage measured across the terminals of the secondary does not vary very much from no load to full load.

Enamel-covered wire for the primary is recommended because it is cheap to purchase and takes up less space than wire of the same gauge, but having a

double-cotton covering. When using enamel-covered wire the precaution of laying a sheet of thin paper over every few layers of wire should be taken.

Making a Simple Former

It is an easy matter to construct a former having either a circular or

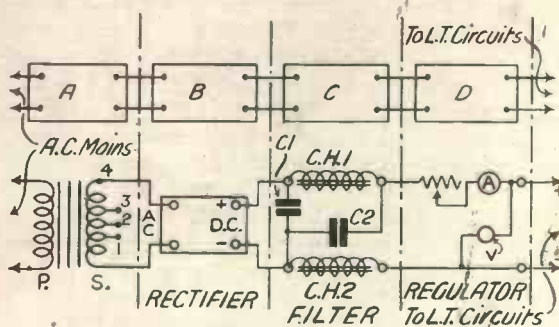

Here is the circuit of the two-ampere low-tension unit for A.C. mains working

primary winding will have 1,000 turns.

These figures may be checked approximately by writing down the different values in the formula given last month on page 456. For mains of other voltages the number of turns included in the primary winding will be as follows.—

A Special "Wireless Magazine" Design by W. James

rectangular central portion or a wooden winding former may be used and the coils covered with tape when they are taken from the former.

Winding the Wire

The sketches will make matters clearer. When winding, it is as well to pull the wire fairly tightly, in order that the finished coils shall not be too loose and bulky. The number of turns in the secondary winding remain constant at 60, regardless of the primary, but tapings are made at turns number 30, 40 and 50, in order that lower voltages, as described, may be obtained with ease.

Do not forget to insulate one winding from the other with several

This view clearly shows the two electrolytic condensers and the smoothing chokes

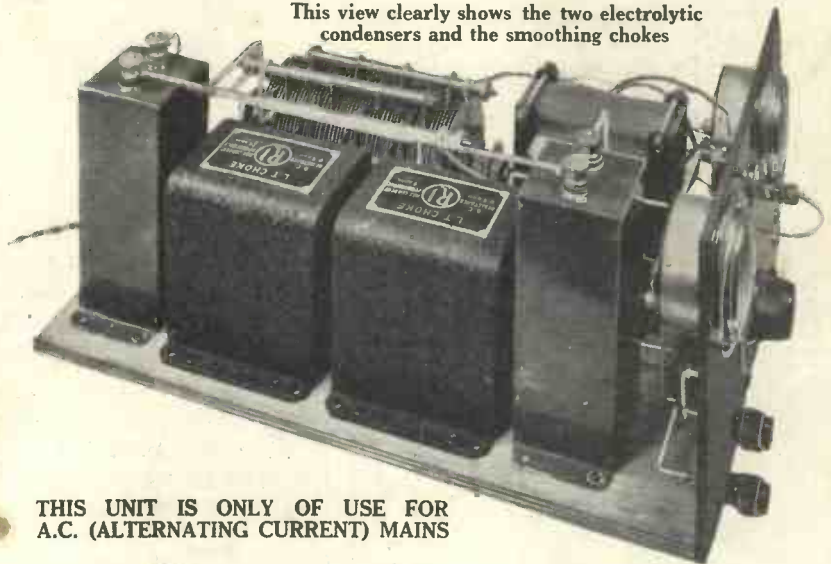

THIS UNIT IS ONLY OF USE FOR A.C. (ALTERNATING CURRENT) MAINS

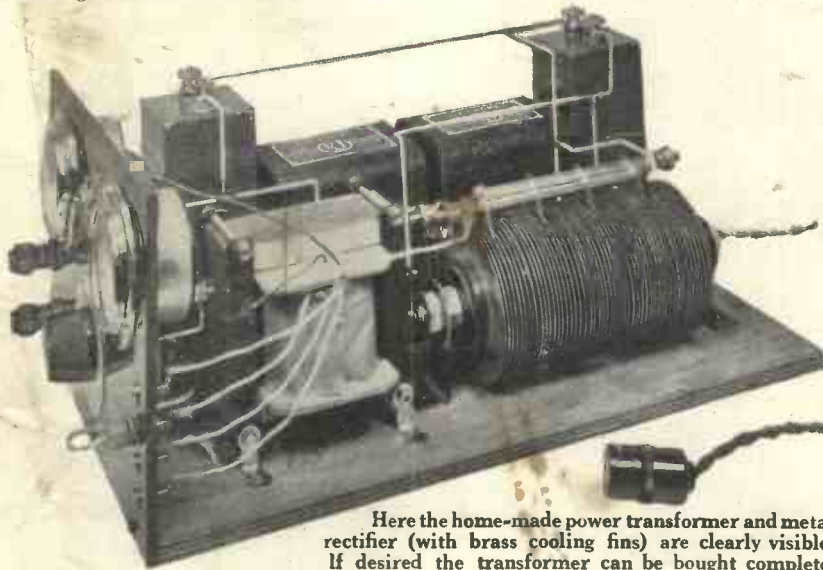

Here the home-made power transformer and metal rectifier (with brass cooling fins) are clearly visible. If desired the transformer can be bought complete

layers of tape and so to arrange the coils, either by employing an insulating former or by wrapping them with Empire cloth or tape, that there is no chance of their making contact with the core.

Finally, pack the laminations together to avoid air gaps and grip them tightly with brackets to hold them in position and prevent buzzing.

Smoothing the Supply

The current obtained from the output of a rectifier is direct but pulsating, and if it were passed through the filaments of the valves in a receiver a hum would be heard. It is therefore essential to smooth or level the current, and for this

COMPONENTS REQUIRED FOR THE TWO-AMPERE LOW-TENSION UNIT

Panel	1—9 in. by 6 in. (Resiston, Potter, or Raymond).	Meter	1—0.3 ammeter, panel type (Sifam or Ferranti)
Fixed Condensers	2—2,000-microfarad electrolytic condensers (T.C.C.).	Switch	1—Quick-break (Claude Lyons).
Transformers	1—Power transformer as per specification (Regent Radio or Parmeko).	Terminals	2—Marked: L.T.+, L.T.— (Belling-Lee or Ealex).
Plugs and Sockets	1—Wander plug (Belling-Lee, Lectro-Linx, or Igranic). 4—Sockets (Lectro-Linx).	Sundries	Length of twin lighting flex (Lewcos). 1—Lamp connector. Stiff insulated wire (Glazite).
Rheostat	1—Power type, carrying 2 amperes (Burndept)	Chokes	2—Low-tension type, carrying 3 amperes (Radio Instruments type EY9).
Meter	1—0.10 voltmeter, panel type (Sifam or Ferranti).	Rectifier	1—Metal type (Westinghouse type A9).
		Cabinet	1—Wood cover with baseboard, 9 in. by 14 in. (Pickett, Caxton, or Edwards).

Note:—Instructions for building the small power transformer are given in the article.

How to Build A Two-ampere L.T. Charger (Continued)

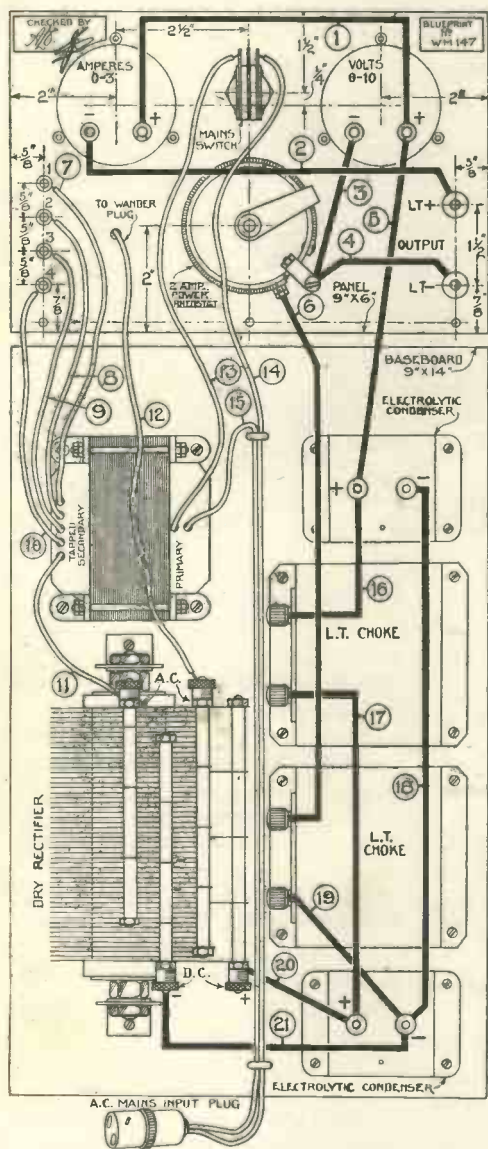

This layout and wiring diagram of the two-ampere low-tension unit can be obtained as a full-size blueprint for half-price (that is, 6d., post free) if the coupon on page iii of the cover is used by July 31. Ask for No. WM147. Wire up in numerical order

purpose choking coils and condensers are used.

The choking coils are composed of iron and wire, as ordinary choking coils, but because they have to carry a relatively heavy current, thick wire must be used and an air gap must be left in the magnetic circuit of the iron as indicated in one of the diagrams. Naturally, the inductance of a choking coil that will carry two amperes is comparatively small when the component is compactly arranged.

necessary to employ condensers in addition. Ordinary condensers would be of no value because the resistance of the load (that is, the filaments of the valve and perhaps a loud-speaker field winding) is so small. If there are four valves passing a total current of one ampere at 6 volts, for example, the resistance is 6 ohms.

Condensers having a very

large capacity must therefore be used and the electrolytic type designed for low-voltage circuits are suitable. Two are needed. They have one terminal coloured red or marked positive and a second one

marked negative, and it is essential they be properly connected in the circuit. These condensers have a capacity of from 1,000 to 2,000 microfarads, but they are no more bulky than an ordinary paper condenser of 4 microfarads.

The complete smoothing circuit, therefore, comprises two special choking coils and two electrolytic condensers. They are usually completely effective in smoothing the current. The reason for including an adjustable resistance in the circuit will now be clear, for the actual voltage across the output terminals of the unit is dependent upon the current flowing. There is the voltage lost in the choking coils, the rectifier, and the transformer; an adjustable resistance and a voltmeter and ammeter are therefore included in order that the voltage may be set according to the number of valves (and their type) used in the receiver. The ammeter is for indicating the amount of the current passing, more particularly when charging an accumulator.

As the choking coils will not by themselves smooth the current it is necessary to employ condensers in addition. Ordinary condensers would be of no value because the resistance of the load (that is, the filaments of the valve and perhaps a loud-speaker field winding) is so small. If there are four valves passing a total current of one ampere at 6 volts, for example, the resistance is 6 ohms.

Condensers having a very large capacity must therefore be used and the electrolytic type designed for low-voltage circuits are suitable. Two are needed. They have one terminal coloured red or marked positive and a second one

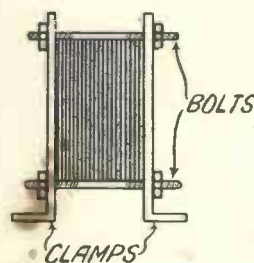

How the core laminations are bolted together

marked negative, and it is essential they be properly connected in the circuit. These condensers have a capacity of from 1,000 to 2,000 microfarads, but they are no more bulky than an ordinary paper condenser of 4 microfarads.

The complete smoothing circuit, therefore, comprises two special choking coils and two electrolytic condensers. They are usually completely effective in smoothing the current.

(Continued on page 566)

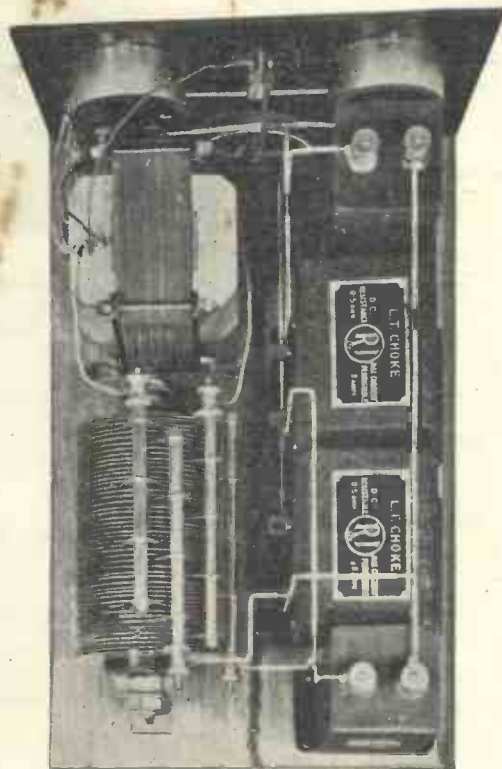

This plan view clearly shows how the two-ampere low-tension unit is arranged. Its construction is very simple and can be undertaken by any beginner

Half-hours with the Professor

What REACTION Really Is

"HERE, Amp," said Mr. Plarz one day, "what is this reaction you're so fond of talking about?"

"Oh," said Amp, airily, "it's a gadget you shove on to a set in order to boost up the signals."

"Yes," agreed Mr. Plarz, "I know that. I've got one on my own set, but I don't know how it works. I've got some idea of tuning, but this doesn't seem to me to be a tune at all."

"No, it isn't."

"But, it's got a condenser and a coil in it, so what is the difference?"

Amp Gets Going

"Oh," said Amp in a superior manner, "that's only one particular form of reaction. You can have quite a lot of other forms as well. S'matter o' fac', it's like this," he said. "You know a valve amplifies, don't you?"

Plarz nodded.

"Well," resumed Amp, "you take some of the energy you get out of the valve and shove it back into the input so that it boosts up the signals already there."

Plarz scratched his head. "But doesn't that rather muddle things up?" he objected. "I mean, I've got into my head the idea that you put into a detector valve high-frequency currents and you get low-frequency currents out. If you go and pump some of the low-frequency currents back, I should have thought you would have got an awful mix-up."

No Mix-up in Practice

It was Amp's turn to look perplexed. "Well, Plarz," he said, "you do get some funny ideas, don't you? I don't know quite where you picked up that point of view and I don't quite see how to answer you. All I know is that you are wrong somewhere, because you don't get a nasty mix-up when you actually try it."

"No," agreed the other. "That's why I want to know more about it."

Both boys were silent for a short time. Finally, Amp said: "Look here, I believe if I thought it out carefully enough, I could tell you where you were wrong and probably explain your difficulty. But I might tell you something that

wasn't correct and what's more you would probably find some more nasty snags before we got very much further. I vote we go and ask old Megohm to have a little pow-wow about it."

"Won't he mind?" said Plarz, a little doubtfully.

"Not a bit," said Amp, "he's quite used to my blowing in at all sorts of odd moments."

"To my sorrow, I am," said a voice behind them. They both spun round and found Megohm himself regarding them with a smile.

"Talk of the devil—" grinned Amp to his friend's horror. Megohm, however, only laughed. "Well," he said, "what is it you want to worry me about?"

"A little problem on reaction," replied the boy. "Plarz here was wondering just how reaction worked and why you didn't get a mix-up. You tell him, Plarz," he broke off, turning to his friend.

Plarz took up the tale.

"Well, as I explained to Amp, you put H.F. into the detector and take L.F. out, so that if you couple back from the output to the input, you would get the two mixed up."

"I see," said the Professor. "Well, you are getting mixed up because your statements are not definite enough. In the first place, you don't simply take the output from the detector and put it back in the input and secondly the action of the detector valve is not as you put it, namely, that you put H.F. in and take L.F. out. It is because of these two loose ideas that you are experiencing difficulty in understanding what is happening."

Amp avoided the Professor's eye. Looseness of expression was, according to Megohm, one of his weaknesses. Perhaps if he said nothing, the matter would blow over.

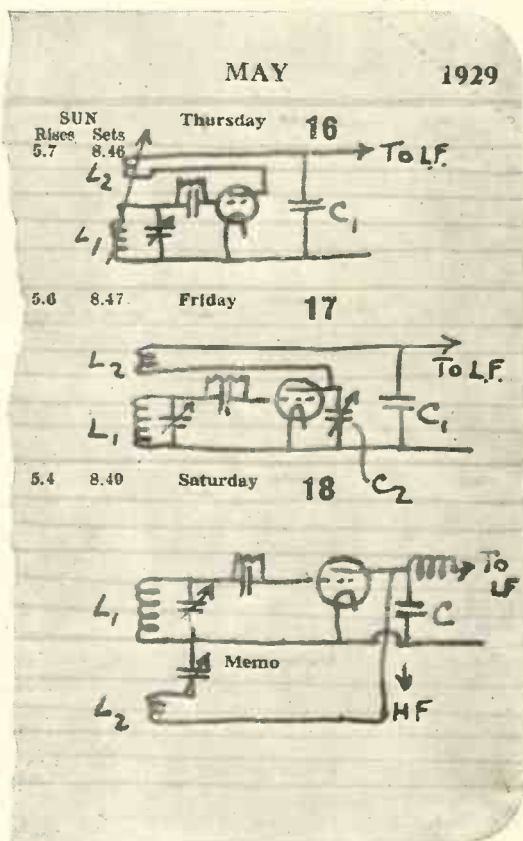

Some reaction circuits taken straight from Prof. Megohm's note book

This proved to be the case, for Megohm continued: "I think first of all, we had better obtain a clear idea of the action of the detector, so that we can explode one of these fallacies. What we put into the detector is modulated high-frequency. It is a high-frequency carrier wave the strength of which is varied from moment to moment in accordance with the modulations in the transmitter."

Detector As Current Separator

"The action of the detector is to separate the two components so that in the output circuit we have both a high-frequency component and a low-frequency component. For the purpose of producing loud-speaker reproduction or even telephone reception, we only utilise the low-frequency portion, but the high-frequency current is still there and must be provided

What Reaction Really Is (Continued)

with a suitable path to lead it away."

"Is that what they call keeping the H.F. out of the L.F. stages, Professor?" broke in Amp.

"Exactly. Perhaps I will tell you more about that another time. The fact remains that for ordinary purposes, we do not require the H.F. after the detector valve and we must provide an easy means for the H.F. to run away, as it were."

Mr. Plarz Sees Light

Megohm paused, as he often did, in order to see whether his remarks had started any train of thought in the minds of his listeners. He always preferred his hearers to follow up ideas for themselves and in this case he was not disappointed. Plarz suddenly said:

"Well, if that is so, it seems to clear up my difficulty, because I can understand how you can get a strengthening effect if you add the H.F. after the detector to the H.F. before."

"That is what you are doing," agreed Megohm. "We take some of the high-frequency currents in the output from the detector and we introduce it back into the input circuit. If we arrange matters correctly, this will strengthen the currents already present so that we can obtain an increased amplification effect."

"I say, Professor," broke in Amp. "Why do some reaction circuits work better than others?"

"That is a matter of the phase of the current," was the reply. "It is obvious that any coupling from the anode to the grid circuit must be in such a direction that it will help the currents already existing if we are to obtain a proper reaction effect. If the coupling is in the wrong direction we shall obtain a decrease instead of an increase in the signal strength which would be the reverse of what we require. That is obvious, isn't it?" he asked.

The boys nodded.

Greatest Possible Reaction Effect

"But," continued the Professor, "if you think about it you will see that it is possible to obtain either of these two states of affairs to varying extents. The best possible condition is such that the maximum voltage is

introduced into the grid circuit at the instant when the voltage in the grid circuit itself is a maximum.

"Then the reaction effect which, of course, is varying the whole time, goes through its various changes at exactly the same instants as the grid circuit itself and the two effects add up to give the greatest possible reaction effect.

"As you know, if you increase the reaction effect too much, the circuit will tend to oscillate continuously and we desire our arrangement to be such that we can work up to the oscillation point with a smooth control so that the circuit slides in and out of oscillation instead of going in suddenly."

"Yes," agreed Amp, "that makes an awful difference when you are trying to receive distant stations. That's why I asked you, as a matter of fact."

Megohm nodded. "You will find that the circuit in which the reaction is exactly in phase with the grid circuit is a very comfortable one to handle. What is more, the reaction effect is better than a normal circuit."

Useless Oscillation

"But," he continued, "we are still able to obtain a reaction effect even if the two voltages do not coincide. The reaction voltage may reach its maximum a little before or a little after the grid voltage, in which case we shall still obtain an additive effect, but not the maximum effect. The greater the deviation we obtain from the 'in phase' condition, the poorer does the reaction effect become until we reach a condition where it is possible to make the circuit oscillate at one setting of the reaction condenser without obtaining any real increase in the signal strength, up to the oscillation point.

"This is a distressing state of affairs which is quite often obtained, the reaction effect being of little value although the circuits can be made to oscillate comparatively easily."

"Gee!" exclaimed Amp. "I never knew that before. I have once or twice come across circuits like that, but I never realised what the explanation was."

"Well," said Megohm, "there you have it. Of course, as you get more

and more out of phase, you reach a point where the reaction is in the reverse direction and causes a decrease instead of an increase in the signal strength. The thing to aim at is to obtain the reaction effect in phase as near as possible and this is largely a matter of the arrangement of the anode circuit."

"Could you sketch out a few good circuits?" asked Plarz.

Professor Megohm's Circuits

"I can give you one or two skeleton arrangements from which you can build. Here you are." So saying, Megohm tore a leaf out of his pocket-book and drew the three circuits shown.

"The first circuit has magnetically-controlled reaction, where we use the high-frequency in the anode circuit before it has been separated from the L.F. We must take care, however, to provide a ready path for the high-frequency immediately after it has done its work and this is what the condenser C1 is placed in circuit for.

"The second circuit is a variation of this. Instead of making the coupling between the two coils L1 and L2 variable, we make them fixed and we shunt the high-frequency before it has time to go through the reaction coil. The larger we make this shunting condenser C2, the less the reaction effect and *vice versa*. C1 is still in place to shunt the H.F. which does flow in the reaction coil and prevent it from reaching the L.F. stages.

"Thirdly, there is a simple Reinartz reaction arrangement in which we separate the high and low-frequency currents at once. The low-frequency currents go through the H.F. choke and the L.F. stages. The high-frequency currents cannot go this way so they go through the reaction coil L2 and the reaction condenser to L.T.

Additional By-pass Condenser

"With this circuit, it is often advisable to connect an additional condenser C from the anode of the detector to L.T. in order to provide adequate by-passing of the H.F. And there you are."

"Well, Professor," said Amp. "Thanks very much. I think we've got quite a lot to think about."

The A.C. Mains Amplifier

A 50-watt Three-stage Amplifier Supplied with All Current Direct from the Mains for Gramophone or Radio Reproduction at Great Volume and Absolute Purity

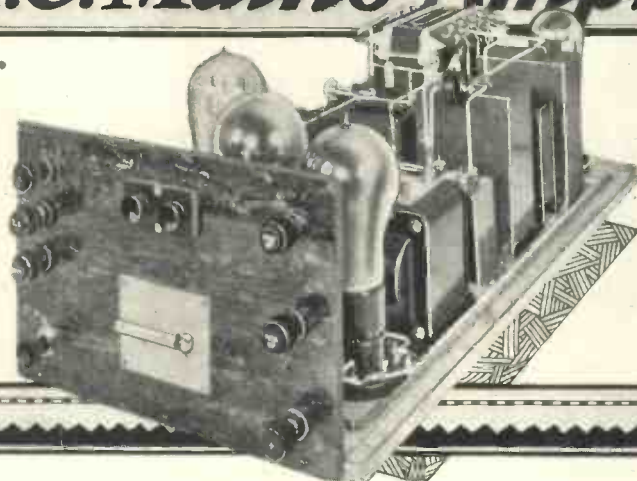

Specially Developed by J. H. REYNER, B.Sc., A.M.I.E.E., at the Furzehill Laboratories After Several Months of Extended Research :: For Use in Sports Clubs, Dance Halls and Schools

THE amplifier described herewith is based on research work occupying several months during which time an experimental amplifier at the Furzehill Laboratories has been undergoing slow and gradual changes for the better.

The final equipment has now reached a high pitch of efficiency and the present amplifier is a simplified version, utilising somewhat less power and made up as a complete unit in which the amplifier and the equipment for supplying the high- and low-tension voltages are combined.

Four Secondaries

The circuit of the arrangement is shown below. In the first place the mains are connected through a double-pole switch and a pair of fuses to the primary of the transformer. This complies with the I.E.E. regulations. There are four secondary windings on the transformer as follows :

- (1) 350 volts centre-tapped for the high-tension supply.
- (2) 5 volts centre-tapped for the filament of the U5 rectifying valve.
- (3) 4 volts centre-tapped for supply-

last valve, which is an LS5A heated directly by raw AC.

The remainder of the eliminator circuit is more or less straightforward, the principal feature being that each

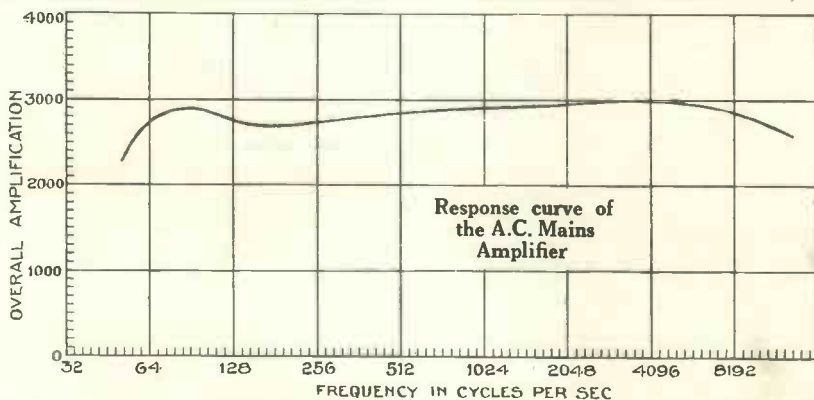

ing the heaters of the first two amplifying valves which are of the indirectly-heated type.

- (4) 5.5 volts centre-tapped for the

circuit is independently filtered with its own choke, while in the case of the first two anode circuits, a breaking-down resistance is inserted to reduce the voltage to what is required. The voltages actually are as follows, 100 volts on the first valve, 180 volts on the second valve and 320 volts on the LS5A.

Grid Bias for Power Valve

Grid bias is obtained by the insertion of a resistance in the negative lead, the voltage drop on which is utilised for supplying the bias to the various valves. This resistance is arranged to give a maximum of 85 volts drop at the full-load current of 40 milliamperes. This bias is adequate for an LS5A with 300 volts on the anode.

The various tappings enable suitably smaller voltages to be utilised

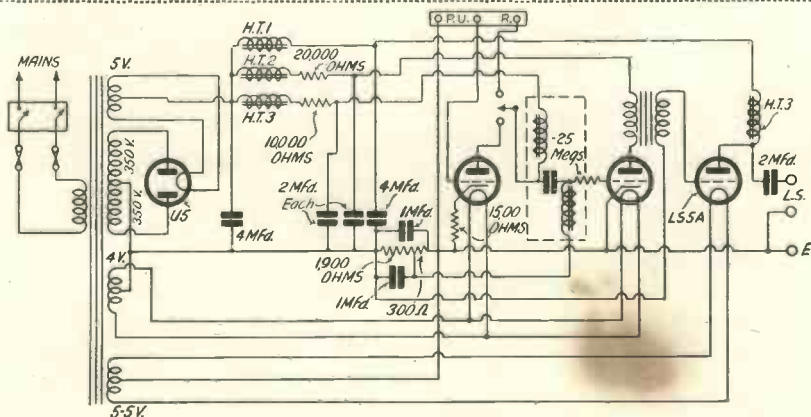

Circuit diagram of the A.C. Mains Amplifier

The A.C. Mains Amplifier (Continued)

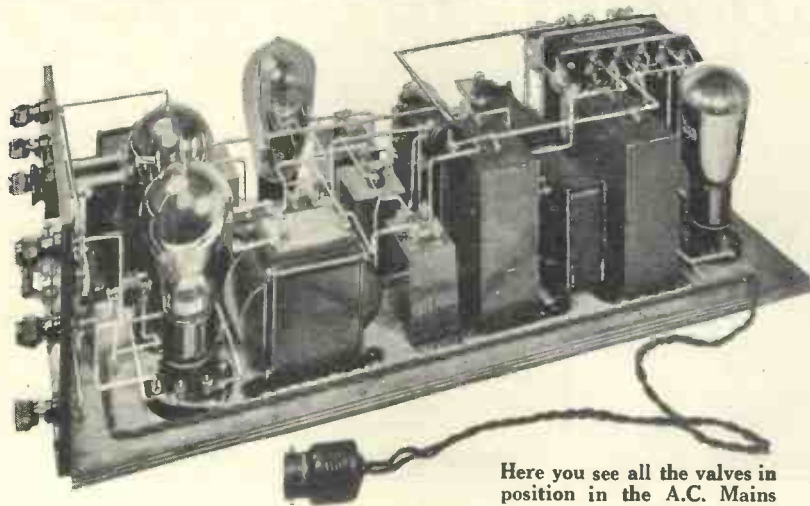

Here you see all the valves in position in the A.C. Mains Amplifier

on the first two valves in the amplifier, the actual values being 3 and 12 volts respectively.

The right-hand portion shows the amplifier itself. Here we have, first of all, a Cosmos Green-spot valve, indirectly heated as has already been described, which is followed by a dual-impedance coupler. This valve supplies a Cosmos Red-spot valve followed by a Pye

4 : 1 transformer, the output of which is applied to the LS5A valve.

A choke-output arrangement is used to isolate the loud-speaker from the amplifier, the second loud-speaker terminal being connected to the negative H.T. point, which is also connected to the earth end terminal. The I.E.E. regulations require that an earthing terminal of this character shall be provided and it is advisable to make use thereof in ordinary practice, although it is not absolutely essential to the satisfactory operation of the amplifier.

A Happy Combination

The dual-impedance coupler followed by the transformer has been found to be a particularly happy combination. Dual-impedance by virtue of the resonant effect produced between the coupling condenser and

the grid choke has a characteristic which rises slightly in the bass. High-

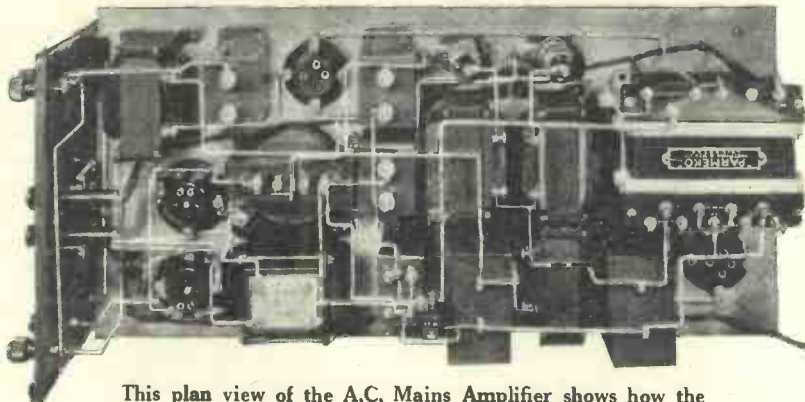

This plan view of the A.C. Mains Amplifier shows how the parts are arranged

frequencies are maintained with this form of coupler up to limits well above what is required, the cut-off being hardly appreciable at 10,000 cycles.

The 4 : 1 transformer, on the other hand, produces a definite cut-off in the upper registers which is desirable in that it avoids unwanted interference from frequencies outside the audible range.

Bass Fall-off Arrested

The bass registers tend to fall away on the transformer, even when it is of good quality and this fall off is arrested to some extent by the bass resonance in the dual-impedance coupler.

The nett result is a substantially uniform response over a range of frequencies from below 50 cycles up to 8,000. The actual response curve is

shown on page 551 where the effect of the bass resonance can be clearly seen and it will be appreciated that the amplification is well maintained at both ends of the scale.

The method adopted has distinct advantages over resistance-coupling for the overall amplification is

By J. H. REYNER, B.Sc., A.M.I.E.E.

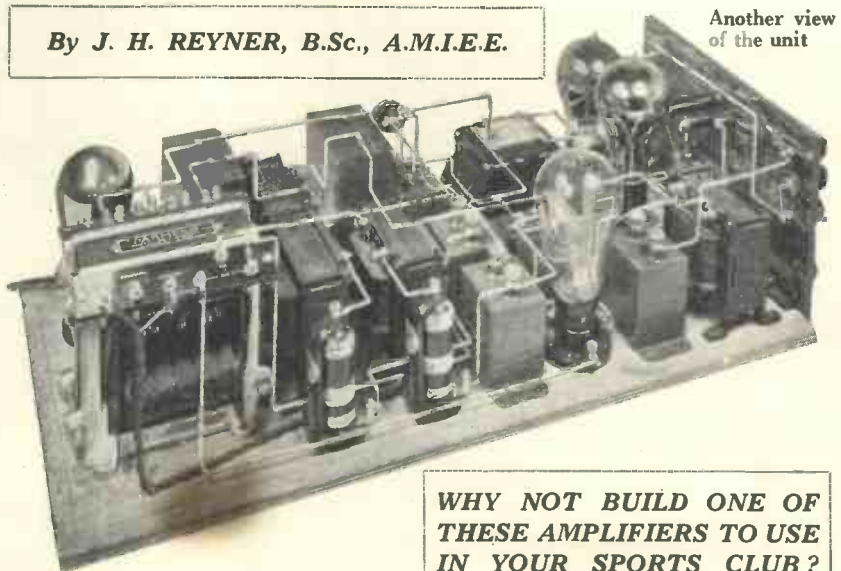

Another view of the unit

WHY NOT BUILD ONE OF THESE AMPLIFIERS TO USE IN YOUR SPORTS CLUB?

Specially Designed by J. H. Reyner, B.Sc., A.M.I.E.E.

five or six times as great as could be obtained with a two-stage resistance amplifier, while resistance-coupling tends to lose the high notes as is well known unless low values of resistance are employed, in which case the discrepancy between the present system and the resistance-coupled arrangement would be even greater.

Overall Amplification

The overall amplification will be seen to be of the order of 3,000, which is more than is required for most purposes. In fact, in actual use, the volume control across a pick-up must be kept well towards the bottom of the scale or the last valve will be overloaded.

In view of this excess of amplification over normal requirements it may seem curious that a 4 to 1 ratio transformer is employed in the second stage. This is essential, however, in order to carry the relatively heavy anode current.

The Red-spot valve is actually over-biased in order to reduce the anode current to a value in the neighbourhood of 10 or 12 milliamperes. Even this current is enough to saturate a low-ratio transformer, having a correspondingly high primary inductance, and it is more from this point of view than that of obtaining amplification that a 4 to 1 transformer is employed.

It is particularly important to use a transformer which will handle the necessary anode current, for the average 4 to 1 transformer to-day will not carry currents of this order.

No Bass Loss

The fact that the primary has a lower inductance does not trouble us because of the very low resistance of the Red-spot valve, and it will be seen from the characteristic there is no loss in the lower register. The over-biasing does not cause any difficulty because in any case we are well within the limits of the Red-spot valve.

The grid swing on the last valve may be of the order of 80 volts, which means that the grid swing on the Red-spot valve is only in the neighbourhood of 3 volts so that even with the valve biased to 12 or 13 volts negative, there is ample characteristic to handle this grid swing.

The grid swing on the first valve is, of course, very small. Three volts bias is put on, however, in order to avoid any possible flow of grid current which usually begins to flow about 1½ volts negative with the Green-spot valve. If anything, therefore, this valve is also slightly over-biased, but the grid swing is well within the limits and no distortion will result.

It is the last valve, therefore, which is limiting the amplifier throughout, there being an ample factor of safety in the other stages. The output from one LS5A with 300 volts on the anode is, however, amply sufficient to give good volume in an ordinary room, and for this reason a more elaborate output stage has not been provided.

For Pick-up or Radio Work

Three input terminals are provided to the amplifier. Two of these are for the connection of gramophone pick-up or for any other form of pick-up which is desired. The third terminal, which operates in conjunction with the push-pull switch on the panel, is for the connection of the apparatus to radio equipment. In this latter case, the first valve of the amplifier is not required and the anode terminal of the dual-impedance coupler is connected direct to this third terminal instead of to the anode of the first valve.

This terminal, therefore, is taken direct to the anode of the detector valve in the radio set, which is then coupled up to the amplifier in the desired manner. In addition the H.T.— on the radio set must be connected to the earth terminal on the power amplifier. This is important.

Any H.F. choke or similar arrangement in the anode circuit of the detector valve

(Continued on page 568)

LAYOUT AND WIRING DIAGRAM

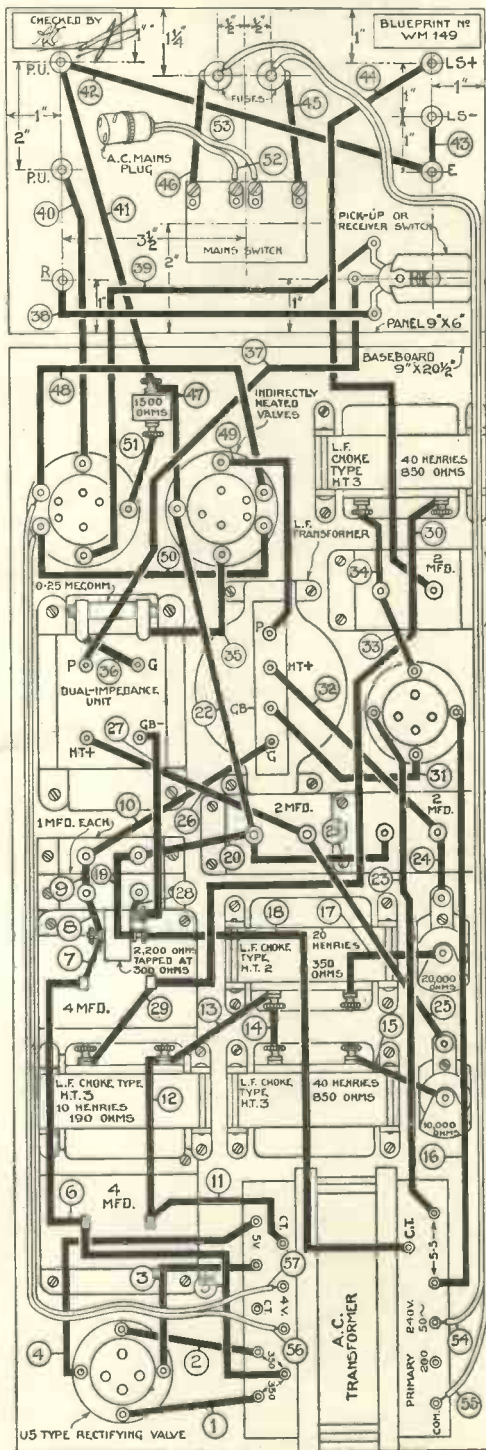

This layout and wiring diagram can be obtained as a full-size blueprint for half price, that is 9d., post free, if the coupon on page iii of the cover is used by July 31. Ask for No. W.M.149. Connect up in numerical order as indicated

BROADCAST MUSIC



Amy Samuel,
dramatic
soprano

war work he was specially presented to the Prince of Wales, as conductor he has established his orchestra amongst the finest in the country, while as composer, amongst many perhaps bigger works, none will be more popular than that famous patrol "The Wee MacGregor." I doubt whether any band, trio, or orchestra is without this in its repertoire.



Susanne Rée and—

note is that of Buxton Spa Pavilion, frequently broadcast, and of which Mr. Horace Fellowes, a well-known musician, is musical director. He was heard again from Manchester on July 6 and July 13.

Missed by Londoners

One orchestra which will be missed by Londoners is that of Frank Westfield at the Prince of Wales Playhouse, Lewisham. But as this cinema has gone over to talkies it is no longer possible to relay.

The weekly Symphony Concerts also from 5GB have proved interesting; the last

Horace Fellowes,
musical director of
the Buxton Pavilion
Gardens Augmented
Orchestra

WITH the advent of summer, lighter programmes should be expected, and for the most part June has seen considerable improvement. Several interesting concerts from the provinces have been heard, chief amongst them the relays, which are to continue throughout the summer to 5GB and Birmingham from the Jephson Gardens, Leamington Spa. Commencing on July 16 the Band of the 17/21st Lancers, conducted by F. J. Allsebrook, will carry out the series.

Devonshire Park Orchestra

The great municipal orchestras have probably done as much to spread the cult of high-class music throughout the country as wireless music itself, and amongst the big orchestras one of the first which jumps to one's mind is the great Devonshire Park Orchestra of Eastbourne, and which was specially chosen for the Newcastle Exhibition,



T. Russell Goddard



Angus Ross, violinist

Captain Amers' Orchestra has broadcast on other occasions, and will probably be heard again when the new season opens. His work has been complimented by many, amongst them Sir Thomas Beecham, for he has the supreme knack of maintaining perfect balance of tone without the slightest loss of tone or quality.

Another fine orchestra, the National Orchestra of Wales, gave its last concert of the present series on July 6, when Ben Davies was announced as the vocalist.

Amongst the provincial orchestras of



DO NOT OVERLOOK H T. BARNETT'S SPECIAL REVIEW OF GRAMOPHONE RECORDS WHICH APPEARS ON PAGE 532—IN THE GRAMO-RADIO SECTION

the opening of which by the Prince of Wales was also broadcast.

It is conducted by Captain H. G. Amers, of the Territorial Division, and he is one of the few who has turned from war honours won overseas to the winning of fame both as a composer and conductor. For his

OF THE MONTH



—Professor Louis Rée

one, on July 22nd, included a first performance of Frederic d'Erlanger's overture, "Romantic Prelude." He will be remembered as the composer of "Tess," which was broadcast last month from Birmingham.

Some Great Soloists

Amongst the soloists, these same symphony concerts have had many great names. Adila Fachiri and Kathleen Long, the famous violinist and pianist respectively, need no comment, while from the provinces also have been heard several well-known and capable artists, amongst them Philip Whiteway, who has broadcast many times, notably from Belfast recently; Angus



Grace H. Angus, vocalist



John Rorke, vocalist

Ross, another clever violinist; Norris Stanley. Frank Cantell; and Alec Sim, the brilliant violinist who has made such fine Scottish records for Beltona lists.

Apart from the Midland Piano-forte Sextet, general music has been in the hands of violinists, 'cellists such as Cedric Sharpe and Edith Lake; but two clever French pianists gave a special recital, namely, M. and Mme. Louis and Suzanne Rée, proving themselves artistic interpre-



Captain Amers, leader of the Devonshire Park Orchestra, who is broadcasting from the Newcastle Exhibition

Lesley Duff, soprano



and operatic singers on the stage, has made exceptionally artistic Vocalion records out of many of his successes.

"Where 'Ere You Walk" (Handel) is an excellent example. As to his broadcasting work, he has been heard from London, Birmingham, Cardiff, and Manchester many times during the last two years.

More Familiar Names

The familiar names of Elsie Sud-daby, John Rorke, Gertrude Johnson, and Sydney Northcote have all figured prominently; while artistes from the provinces include Lesley Duff, a charming concert vocalist; Gwladys Naish, the famous oratorio

ters of their native composers, as well as Mozart's Sonata in D.

Naturally, the vocal side of most programmes predominates, and opera has, of course, had its

innings. It was unfortunate that a hitch should have occurred with the announced broadcasting of *The Valkyrie* late in May, and something more appropriate than gramophone records might have been substituted; but, apart from that, some fine voices have been heard.

Mr. Leonard Gowings is one of our finest tenors; Mr. Frank Titterton, who took the name part in Massenet's opera *The Jester of our Lady*, besides being one of the finest of our concert

"MORE 'TALKIE' SECRETS!" IS THE TITLE OF A SPECIAL ARTICLE ON PAGE 542 OF THIS ISSUE WHICH WILL BE READ WITH INTEREST

singer, and well named indeed "The Welsh Nightingale"; Amy Samuel, a Scottish dramatic soprano, Grace Angus; and Doris Gambell—all familiar names to listeners.

Vaudeville is gradually being given a more important place in the B.B.C. scheme of things, and if only they



Gwladys
Nash,
singer

Broadcast Music of the Month (Continued)

fame), Melville Gideon, Tommy Handley, and Hector Gordon. All have given us the welcome "spot of humour."

Apart from German opera—and this might well have been omitted—the best choice of the B.B.C.'s list of operas this month are: *The Swallows*, a lesser known work of Puccini, on June 24, and Delibes *Le Roi l'a Dit*, which will be given on July 24 and 26.

The last night of the German opera season will be transmitted on Friday night, June 28, though up to going to press the opera has not yet been announced. Let us hope that we are not given another disappointment; and, if so, let the B.B.C. give us something more satisfying than gramophone records.



Philip
Whiteaway,
solo violinist

would not confuse syncopation with entertainment all would be well.

We have had rather too much of the Buggins Family lately; so that the announcement of the sketch *Mrs. Hamlet Insures Herself*, written by Herbert C. Sargent, and broadcast by Mabel Constanduros and Michael Hogan, proved a welcome relief.

Some Good Revues

Some of the smaller revues have been good, amongst them another dose entitled *More Djinn and Bitters*, written by Clifford Seyler; *Micro-Phun*, by Edmund Wynschenk; *Wallah-Wallah*, by Gordon McConnell, author of *A May Time Medley* and *Airy Nothings*; and the announced excerpts of six episodes from the Grossmith book, *The Diary of a Nobody*, with George Grossmith, the son and nephew of the author as compères.

Many talented newcomers have also appeared before the microphone, as well as Deslys and Clark, the two first cabaret entertainers to open up their own night club in this country. They have broadcast here for nearly two years, and are about to leave for America to broadcast.

Another Radio "Find"

Another new wireless "find" is Eddie Robinson, a wireless comedian who hails from Lancashire and promises to make good over the ether. Keith Wilbur, the New Zealand mimic; an Italian operatic singer named Lordain, who is attributed with a command of four voices—soprano, tenor, baritone, and bass; and Frederick Chester, who specialises in West Country dialect, are amongst the best.

Familiar radio artists whose work is well known are Clapham and Dwyer, Billy Mayerl (of syncopated

The New B.B.C. Manchester Headquarters

RECENTLY the northern regional headquarters of the B.B.C. made its début to listeners of that area with a performance of Coleridge Taylor's *Hiawatha*. Of course, until the other regional transmitters have been completed, such as the one at present being undertaken at Brookman's Park, the new northern headquarters cannot really operate at full speed.

Conveniently Situated

The new headquarters are actually over a bank in Piccadilly, which is in the heart of Manchester and "conveniently situated," as the auctioneers say, for the convenience of artists and the B.B.C.'s clerical staff.

Apart from the office block associated with the regional headquarters, there are a number of studios, the arrangements of which, and the multitudinous things possible on the engineering side, are superior to anything at present in existence, even at Savoy Hill.

The largest studio is a double-decker, similar in design to "No. 7" at London. It has a gallery for spectators and for choral performers

in operas and so on. No previous B.B.C. studio has had a gallery of this kind.

Non-resonant Linings

There is a smaller studio which will be used for small orchestral combinations, and, no less important, the Children's Hour. Both these studios have the walls lined with non-resonant material. In this new venture the B.B.C. is not departing from previous accepted ideas.

The third studio is quite a small one, and has a colour scheme different from and darker than the others, in fact it might almost be called sombre. This will be used chiefly for talks.

Northern Regional Director

Mr. E. Liveing is the northern regional director, and as the talent from the surrounding districts is transferred to the Manchester headquarters, he will find that he has some very hard work in front of him. But the incentive adequately to supply the needs of so large a body of listeners should give—as the psychologists say—a distinct "urge."

MANCURIAN.

Further Notes on the Chummy

THE efficiency of a receiver fitted with coils that may be switched from the long to the medium wavelengths is rarely so great as when interchangeable coils or separate fixed coils are used.

This is particularly true when compactness is an important consideration. For every size of former there is a gauge of wire which will result in the minimum of losses, but even though care is taken to employ this particular size of wire, the coil may not be as good as one having a greater diameter or a better ratio of length to diameter.

Dual-wave Limitations

When a shielded valve is employed for high-frequency amplification the efficiency of the coils used is not in itself of first importance, because oscillation will begin when the losses are below a certain value. At the same time, one does not expect to receive so many stations with a receiver of the compact type and fitted with a dual-wave range coil in comparison with a similar set but having a single tuning range.

There must be a little give and take in order that average results may be obtained on the two wavelength ranges. This is true of the 1929 Chummy Four. It was designed for providing good quality of reproduction from a few stations rather than fair quality from a large number, and I think that in building a self-contained set that would give, first and foremost, a quality of reproduction that would be acceptable to those accustomed to listening to good receivers of the ordinary type I have produced a set that will suit the readers of this magazine.

A Mistake

Too many portable receivers howl and squeal, and have to be used practically oscillating. This seems to me a mistake.

When the frame aerial and the anode-tuning coil are fixed, as they are in the Chummy, the only variable factors are the valves and the batteries. It is the shielded valve and that used for detection which have the greatest effect.

The shielded valve, for instance,

By W. JAMES the Designer of the 1929 Model.

helps to decide not only the magnification and stability of the receiver, but also the amount of the reaction that must be used in order to produce oscillation in the anode circuit. This valve is, in effect, connected across the anode tuning coil, and as its anode impedance is lowered more reaction must be used.

So far as the "goodness" of the valve is concerned, it will be clear that the aerial circuit may be set oscillating if the valve characteristics are favourable. Thus, for example, with a valve having an impedance of 200,000 ohms and a magnification factor of 150 the circuit may be stable, but it may oscillate when the valve has a magnification factor of 200 for the same impedance.

The oscillation could be stopped by altering the shield or anode voltages, but this implies a certain amount of oscillation on the part of the user to discover the reason for the trouble.

Reaction and the Detector

Detector valves, being of the ordinary type, are probably more uniform than shielded valves, but, even so, one may tend to be more noisy than another or more microphonic. The quality of the reaction and also the sensitivity are liable to vary according to the valve used.

When these various factors are taken into account it is clear that one cannot design for the most favourable condition, which would be when the aerial circuit oscillates at about the same time as the anode circuit. It would not be safe to arrange for this, as one is not able to guarantee that all valves will be alike.

But one is able so to arrange the circuit that it is reasonably sensitive without the use of too much reaction; and, indeed, a portable receiver—or, for that matter, any set having only a single high-frequency stage and a frame aerial—would be a very poor affair were reaction effects cut out.

The chief difficulties are always the arrangement of the frame aeri-

How shall they be arranged with respect to the receiver and what connections shall be employed?

When they are fitted round the set itself there is the damping effect of the batteries and other parts which tend to weaken the signals and broaden the tuning. An alternative method would be to fit one of them in the front cover of the set and the other in the back cover, but this introduces tuning difficulties. The two aeri-als were therefore fitted in the front cover of the Chummy, as this arrangement is the most convenient. Naturally, one aerial influences the other to some extent—which, however, can be allowed for by the arrangement of the high-frequency circuits as a whole.

Minimising Interaction

The maximum efficiency is obtained when the aeri-als are separate, but as it is more convenient to have them fitted together with a simple means for switching I have adopted this arrangement. It will have been observed, however, that there is a fair space between the two aeri-als as arranged in the cover of the set, and this helps to minimise interaction.

There may be a tendency for the aerial to oscillate when a particularly good shielded valve is employed, but, as I have explained, it is necessary to design with average valves. The set is then quite stable over the whole of its tuning range, and there is no tendency for squealing to occur.

Those who employ valves they may have by them of different types will, of course, have to try different grid-bias values in order to obtain the best results with the minimum of anode current. The batteries used are of reasonable size and capacity, but one cannot too greatly stress the importance of employing the correct grid bias when good quality of reproduction combined with the minimum replacement costs is the object.

Setting up the Loud-speaker

It is necessary to set up the loud-speaker with care. Particulars of the cone and the mounting for the unit have been given, but I expect a number of readers will have a unit

Further Notes on the Chummy (Continued)

by them that they would like to use. They will probably have to employ a cone having different dimensions from that illustrated, but there will be no difficulty in arranging for this, as there is a fair amount of room.

Loud-speaker Unit

Some may have a unit which would be better mounted on the front panel of the set instead of on a bracket at the back. A little re-arrangement of the batteries will then be found necessary in order that a cone of suitable size may be fitted.

When a different unit is employed a fixed condenser of about .001 microfarad may have to be joined between the anode of the last valve and its filament. This connection is nearly always to be preferred from joining the condenser across the loud-speaker wires.

Third Anode Circuit

It will have been observed from the diagrams of the receiver that no condenser is employed in the anode circuit of the third valve. One is not needed, for the reasons that a reaction condenser of large capacity is employed and the transformer has suitable characteristics.

The transformer used has, as a matter of fact, a very low self-

capacity, with the result little high-frequency current can reach the grid of the first low-frequency valve. There is no need to employ either a stopping resistance or an additional by-pass condenser, which is a great advantage.

By-pass condensers that have occasionally to be used for the purpose of stabilising a set usually materially lower the tone of the reproduction which, therefore, sounds unnaturally low pitched. As this is a fault of certain cone type loud-speakers, there is a definite disadvantage in including parts which would still further lower the tone.

Extended Frequency Range

The transformer amplifies the higher frequencies very well in addition to the low ones. It therefore tends to compensate for the effect of the detector valve and the high-frequency circuits in reducing the strength of the higher frequencies. Although this transformer is not very large, its performance is good because of the amount of special steel employed in its core. This steel is many times as expensive as the iron ordinarily used, and one of the benefits derived from its use is an extension of the frequency range over which it magnifies.

It is unusual to include an anode-

circuit filter in the detector circuit of a portable receiver, but here again the principle consideration was stability and good quality of reproduction.

Guarding Against Distortion

A saving in the cost could have been effected by omitting to include this unit, but the quality will remain acceptable for longer periods during the life of the high-tension dry battery than it would have had the unit not been fitted. The detector-valve circuit is undoubtedly the most sensitive as regards feed-back from other circuits through battery couplings, and when there are two low-frequency stages it is essential to guard against distortion from this source.

Tuning will be found quite sharp, but not critical, and the set is therefore quite suitable for use near a powerful station. The centre-tapped frames help the tuning and stability, as does also the shield circuit filter.

Best Shield Voltage

It is important to determine by experiment the best voltage for the shield. This will be a little more than usual, owing to the fall in voltage across the filter resistance, which is of 10,000 ohms. The H.T. wire is marked H.T. + 1 in the diagrams.

Around the Scanning Disc (Continued from page 524)

this lamp another scanning disc similar to the one used at the transmitting station. This must run in synchronism—that is, at the same speed and in the same phase relationship to the one at the broadcasting studio—and this will permit the light from the neon lamp to pass through the holes in the disc and reach the eye of the observer.

Owing to what is known as the persistence of vision, our televised subject which was previously disintegrated by the transmitter scanning disc is now re-integrated and built up as a whole, being plainly visible.

We can regard the revolving disc and the neon lamp which recreate the image as serving the eye in a similar

manner as the loud-speaker serves the ear, and anyone who has been privileged to witness an actual demonstration of television cannot fail to be struck with the quality of reproduction.

When carried out at the proper speeds, the eye does not dwell on the mechanics of the process; the light flashes reveal themselves as a surface spread, and not as a sequence, and this is just what is required.

Later we shall pursue our subject a stage farther with greater detail, but it was necessary first of all to be in a position to conjure up a mental picture of the *modus operandi* of the whole scheme as outlined and illustrated in this article.

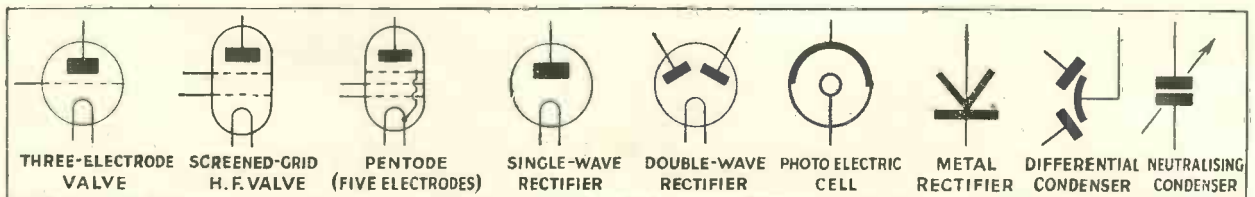

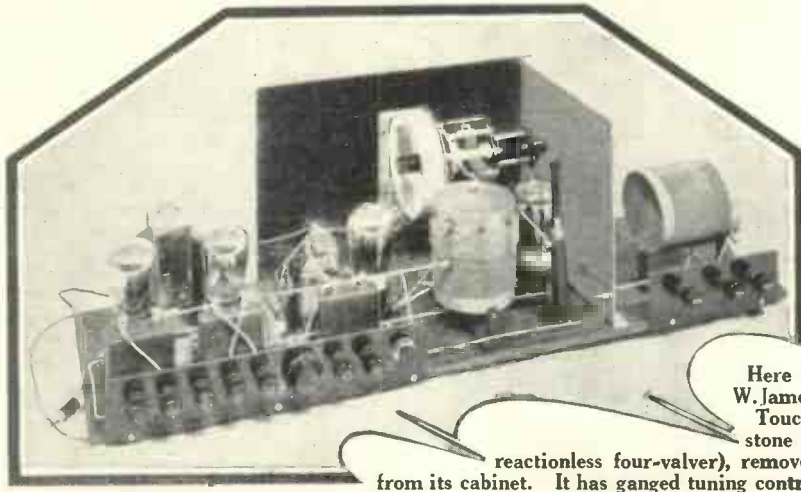

Here is W. James' Touchstone (a reactionless four-valver), removed from its cabinet. It has ganged tuning control

"THE VERDICT IS—"

Ten Satisfied Readers Give Their Opinions of "W.M." Sets

TOUCHSTONE FOUR

ALTHOUGH it is suitable only for reception on the medium waveband and has no reaction control, W. James' Touchstone Four (WIRELESS MAGAZINE, November, 1928) is the most popular receiver ever described in these pages. A Tufnell Park reader says:

Having built the Touchstone for my brother, I must say this is a fine set. I tuned-in eighteen stations at Tufnell Park and twenty-five at Tooting (my brother's house). For ease of tuning it is the best set I have made. My own sets have been all five-valvers during the last two years, but the Touchstone beats a lot of them.

I only found one thing: that was, the last valve was overloaded on near stations. Thanking Mr. James for such a fine set.

ANOTHER reader at Liverpool, who wanted to convert the Touchstone for long-wave reception, says:

I have constructed the Touchstone Four. You are to be congratulated for designing such a splendid set for reception on the medium waves.

EMPIRE FIVE

A READER who lives only about one mile from 2LO has been able to get more than forty stations at loud-speaker strength with the Empire Five (WIRELESS MAGAZINE, October, 1928). Can any reader beat this record?

I feel that I must write to you to let you know that I have built the Empire Five. I have had to wait a long time for the Burndept condensers, but it was worth the wait. Speaking bluntly, it is "some set." It is child's play to tune-in foreign stations now, and all at loud-speaker strength; in fact, too loud for a small room.

I think it's wonderful, considering I am only about a mile from 2LO, to be able to cut out London so easily.

I kept to the components stated, with the exception that I am using a Ferranti B1 choke instead of a Parmeko output filter choke, as I was unable to get one at the time.

I am working off 120 volts accumulator H.T. and using 4-volt Mullard valves, namely, two screened grids, PM3, PM4, and PM254, which, in my opinion, seems to be a good combination.

I find if I have the valves on full it is much too loud, and to make it comfortable I have to cut the filament current down. But anyway I am convinced that I have "The Set" for 1929.

Below is a list of stations that I have logged up to the present. Thanking you for publishing such a set:

	LONG WAVES.	
Kovis	5 XX	Motala
Huizen	Lahti	Kalundborg
Radio Paris	Eiffel Tower	Hilversum
Königswusterhausen	Warsaw	Imperial Airways
	SHORT WAVES.	
Budapest	Rome	Barcelona
Munich	Madrid	Goteborg
Vienna	Frankfurt	Prague
Brussels	Kattowice	Huizen
Milan	Hamburg	Gleiwitz
5GB	Bremen	Breslau
Lyons	Toulouse	Kaiserlautern
Berlin	Stuttart	Cologne
Langenberg	Leipzig	Bourne-
Ecole	2LO	mouth
Superieure		

ECONOMY SCREENED-GRID FOUR

A GUERNSEY reader describes the Economy Screened-grid Four (WIRELESS MAGAZINE, December, 1928) as "the S.G. set at the price." Here are his comments:

I have just finished constructing the Economy Screened-grid Four and am delighted with the result.

I "tried it out" on Sunday morning, and after a few minutes' searching, picked up a Continental station, on the broadcast band, at a fairly good volume on loud-speaker.

I experienced a certain amount of "mushiness" on the local station, but after changing the 100,000-ohm resistance on Mullard S.G. valve to 50,000, had clearer reception.

Bournemouth is our local station, distance about eighty miles, and I have to turn volume control about half way, the volume is so great. Even 2LO is received at a good loud-speaker volume, at a distance of about 175 miles.

I haven't tried it on the long waves yet.

I can fully recommend the Economy Screened-grid Four as the S.G. set at the price.

INCEPTOR 3

WE are always particularly pleased to hear good reports about WIRELESS MAGAZINE sets from overseas readers, because it shows that British designs can more than hold their own against American competitors. Here is a letter about the popular Inceptor 3 (WIRELESS MAGAZINE, October, 1928), from a reader in St. Helens (Tasmania):

I have been a subscriber out here to your magazine for over two years.

Requiring a set to take away with me on a six weeks' camping holiday, I built the Inceptor 3. I am now writing to say how pleased I am with it.

I have no difficulty in bringing in all the A class stations at full loud-speaker strength, the furthest being Brisbane, distance 800 to 900 air miles. The daylight reception is splendid; in addition to 3LO Melbourne at full loud-speaker strength, 300 air miles, 2FC Sydney, 450 to 500 air miles, is received at excellent strength on the loud-speaker.

There were a few minor alterations to the set as follows: An aerial coupler, as used in the Solodyne (being shielded in a can), but only the secondary was used, the aerial being joined to the centre tap.

Then for the screened-grid valve anode coil an astatic coil was used, one of the Parex brand which I had got from England for the receiver published, I think, October, 1927. On the end of the former I wound twenty-three turns of d.s.c. wire as a reaction coil.

As I had a 222 Radiotron S.G. valve, I used it; this valve has the control grid on the top of the valve and has the VX base, the screening grid connection being to the usual grid terminal. I put in a variable grid leak (a Bradley leak),

"The Verdict Is——" (Continued)

and found the careful adjustment of this made all the difference.

I used a Ferranti AF5 transformer between the detector and Philips pentode valve, and used the set with an A.J.S. horn loud-speaker. For tone I have never heard a better combination.

The Philips pentode valve has 130 volts on the plate and also on the auxiliary grid, and from 16 to 20 volts negative grid bias.

ANOTHER reader nearer home, at Cheadle Hulme (Cheshire), finds the tone and volume of the Inceptor everything that he desires, as do three of his friends:

I would like to join in the chorus of praise that is being bestowed on the Inceptor 3. My enthusiasm has spread to three others, who have built the set, and I suppose are again spreading this enthusiasm.

I found the tone, which to my mind is the first consideration, to be excellent, and the volume all that could be desired, even on the most distant stations.

I made one addition which might appeal to the gramophone fan; I placed a jack by the side of the screen, in between the two tuning condensers, and joined up to the grid and L.T. positive of the detector valve, and I find it makes an excellent amplifier, although a volume control is desirable if using the pentode valve.

I get my high tension from an eliminator, and found when making the set up in its original form that I had motor-boating, so I put in a 20,000-ohm resistance in the H.T. lead No.2, with a 2-microfarad condenser to earth, and this completely cured the trouble.

In making the set so small, due allowance for changing the aerial coil has not been made, and if your experimenters just fitted their set into a cabinet, I think they would agree with me; the danger from this is, if the aerial coil is slightly tight, there is a possibility of knocking the screened-grid valve when taking the coil out; in fact I had a practical experience of this and had to buy a new valve.

Anyhow, many thanks for introducing me to a very fine set.

ANOTHER reader at Southall gets motor-boating when he uses his Inceptor 3 with a mains H.T. supply unit. He should incorporate a "stopper," as described in the preceding letter:

I feel that I must write you re the Inceptor 3. To say that I am satisfied with its performance is putting it mildly. Tonal quality is perfect, range all that you could desire, and volume ample, especially for distant reception.

Selectivity on low waveband, right on top of 2LO, can be improved upon, and I am about to incorporate a first-class wave-trap to give greater selectivity when bringing in stations such as Toulouse, etc.

High tension used (4-volt valves) is of accumulator type, with Exide trickle charger in use when reception is not required. I gave an eliminator a trial,

WHERE "WIRELESS MAGAZINE" SETS ARE IN USE

INDIA TASMANIA GUERNSEY

Something more than just praise for the WIRELESS MAGAZINE are the letters from readers reproduced in these pages—they are a definite help to the amateur who wants to build a new set. Remember that back copies describing any of these sets can be obtained for 1s. 3d. each, post free, and that full-size blueprints are available as indicated on another page of this issue. Readers are invited to send us photographs of WIRELESS MAGAZINE receivers they have built; for each one printed we shall pay half a guinea.

but I could not manage to cut out motor-boating.

The cost of upkeep, H.T. and L.T., does not cost more than sixpence per week, and this with the set in use upon an average of eight hours daily.

I have had many fine sets, but never one that I liked better, and several friends have stated that the reception from the Inceptor 3 is the most melodious they have heard.

I am most particular to keep the H.T. in first-class order, for I do not think any set has a fair chance if this is not done.

◆ ◆ ◆
1928 FIVE

IT is only when one reads such letters as the following, about the 1928 Five (WIRELESS MAGAZINE, January, 1928), from a Jodhpur (India) reader that one realises what long-distance reception really is:

I have hesitated to send you my results with the 1928 Five because I hardly hoped that they would be believed. Having worked the set for over a year, I feel I must tell my experiences.

The only Indian station I am able to

receive is Bombay, distant about 500 miles. Calcutta, 1,500 miles, is a complete blank. I have therefore been unable to calibrate my set.

Any evening after 22.30 hours (I.S.T.) I am able to log at least six European stations at quite good loud-speaker strength.

To take last night as a typical evening: At about 23 hours I got a church service with particularly good choral singing. I believe the language to be Italian, but I am quite possibly wrong. I followed the service at good loud-speaker strength for about half an hour. Following this I picked up several German talks, a French station, and several others, the language of which I was ignorant.

In all I received eight European stations in the space of an hour and a half, all on the loud-speaker at quite good strength. The only station I could identify was Breslau, which always comes through very well here after 22 hours.

I particularly wish to emphasise that I am not "pulling the long bow." I have not included stations heard on the phones or stations which could not be held for any length of time.

As I have duplicated my results in two different places distant 300 miles apart, it cannot be put down to local freak reception. My outfit consists of the 1928 Five, A.C. eliminator, filter unit, and permanent-magnet moving-coil loud-speaker, all built from descriptions in the WIRELESS MAGAZINE.

◆ ◆ ◆
REVELATION FOUR

THOUGH details of it were published long ago as July, 1927, the Revelation Four is still giving good service. A reader at Inverness has logged over sixty stations on the loud-speaker:

I have been a regular and conscientious reader of the WIRELESS MAGAZINE ever since July, 1927, when I built the Alpha One (which, unfortunately, did not work!), and the Revelation Four, which does work—and then some!

I have studied the WIRELESS MAGAZINE Reference Sheets and found them an invaluable aid in my ordinary studies.

I hope to send you a complete report of my Revelation Four soon, but meanwhile let me say that in Inverness, where the set is installed, I have logged over sixty stations—on the ordinary broadcast band, without preliminary tuning-in on phones—on a B.T.H. loud-speaker.

Thanking you for such a fine set and for all the benefits I have derived from "W.M." and "A.W."

ANOTHER reader at Birmingham also pays tribute to the good service given by the Revelation Four:

As I am writing for catalogues by your new service, I might just as well write and tell you how satisfied I am with your magazine and your sets—especially your Revelation Four, from which I am getting very good service. Wishing your magazine the best of luck.

Leaves from A Listener's Log.

By JAY COOTE

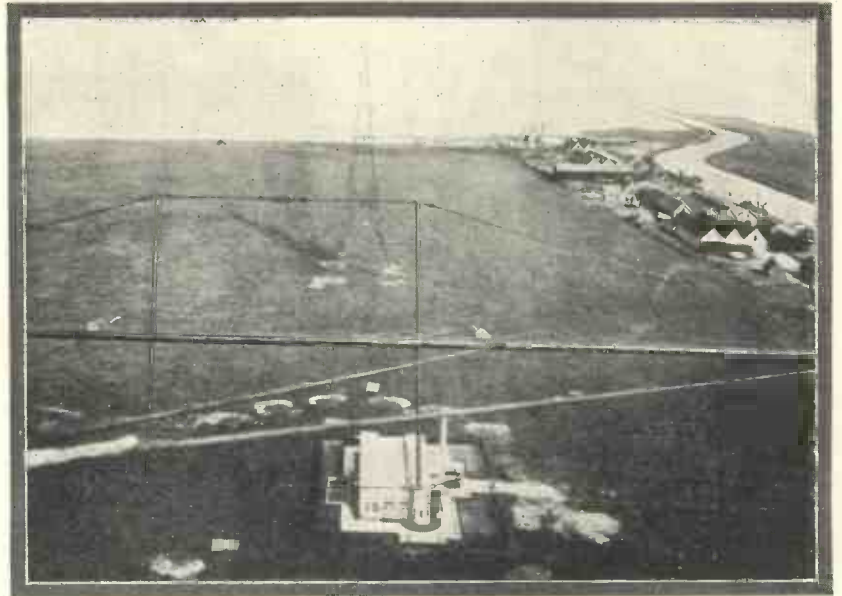

An unusual view of the famous Dutch broadcasting station at Huizen

BOTH Radio Barcelona (EAJ1) and Radio Catalana (EAJ13), in commemoration of the International Exhibition which is being held this summer in their city, have invested in new transmitters, and are now broadcasting on higher power. No doubt, at least, in the case of the former, you must have noticed how much stronger are the signals received.

It will be worth your while to turn to both of these stations from time to time, as although regular programmes are advertised, with entertainments at the exhibition to fall back upon, we may expect relays of very interesting outside broadcasts.

The 1929 fair has been built on a large scale, and includes, besides other attractions, a model Spanish village surrounding an arena in which gala bull fights are to take place on fixed dates. There is no doubt that some time or other you will be given a peep, via ether, at one of these cruel displays, and if you understand Spanish the running commentary should provide you with the maximum of thrills.

Cross-talk Comedians

On more than one evening when listening to Radio Barcelona I was given the impression that a great part of the programme was contributed by two cross-talk comedians, one of whom appeared to be peculiarly hard in the up-take, and required from his companion tediously long explanations of the most simple matters.

Apparently, all this back-chat is provided by one man, Senor Toreski, the principal studio announcer, a retired stage comedian, who also possesses ventriloquial gifts. What we actually hear is a conversation with his doll, El Miliou, for whom he has created a reputation equal only to that of the Spanish Dictator!

Broadcast Publicity

This humorous cross-talk before the mike has enabled the announcer to introduce the bulk of the broadcast publicity carried out by the station, and in this form it has proved more acceptable to listeners.

For some little time past the regular lunch-hour concert given by Radio Paris has been limited to a broadcast of gramophone records, an item which is daily becoming a more prominent feature in the French programmes.

If the B.B.C. does not give to the public the names of the interpreters of its plays, neither does Radio Paris, for some unknown reason, make it clear to its unseen audience that canned music is being served up for their entertainment during the mid-day meal; but in view of the fact that by so doing no publicity is given to the actual records, I find that the stock is a limited one—they are repeated frequently at somewhat short intervals.

P.T.T. Paris also seems to have cut out of its programmes the broadcast of studio bands, for you will hear almost daily from the Eiffel

Tower a series of rather antiquated dance tunes.

Although a new radio law has been again submitted to the French Chamber for discussion, in the meantime most of the studios sadly lack funds, and have considerable difficulty in making ends meet. It is a simple explanation of the reason for which most of the French broadcast entertainments are so poor in comparison with those put over the ether by soundly organised concerns in other countries.

Not to be outdone by London, Berlin is also to possess a super-broadcasting house. I have seen a preliminary sketch of the plan as conceived by a leading German architect and the appearance of the building-to-be reminds me of nothing less than a vast modern cigarette factory or the possible premises of a world-wide motor-car corporation.

More for Utility Than Show

It is in the new style of the familiar flat-fronted barrack-like tenements designed more for utility than show, and could never be taken for an artistic centre or as headquarters of the Broadcasting Association.

It will, however, contain all the multitudinous offices necessitated for the organisation of the German system, including spacious studios and concert-halls, as well as the radio museum being built up by the Reichs Posts and Telegraphs.

Leaves from a Listener's Log (Continued)

Its site is within a short distance of the present Witzleben transmitter, in that new portion of Berlin which already possesses the permanent radio exhibition buildings, automobile palace, and racing track. Work on the Berlin Broadcasting House is to be begun during the coming summer, and it is to be completed by 1930.

Perhaps late at night or during the morning hours you may have

in a gruff and typically Teutonic voice, runs as follows: "Achtung! Achtung! Hier der Nordseerundfunk Norddeich," followed by a more pleasant "Guten Morgen," twice repeated.

The bulletin usually consists of information regarding direction and strength of prevailing wind, a weather report and forecast, and, when necessary, gale warnings.

The speaker may also transmit items of news useful to skippers of

nationalities who may receive the transmission.

In the matter of weather forecasts—although, no doubt, most British ships secure their information from 5XX—any craft within the radius of the Hamburg transmitter may pick up nightly at the end of the news a somewhat similar bulletin in the English language. The announcer—a German—gives it out very clearly and should be understandable to most listeners.

The Adventures of Alec Trode

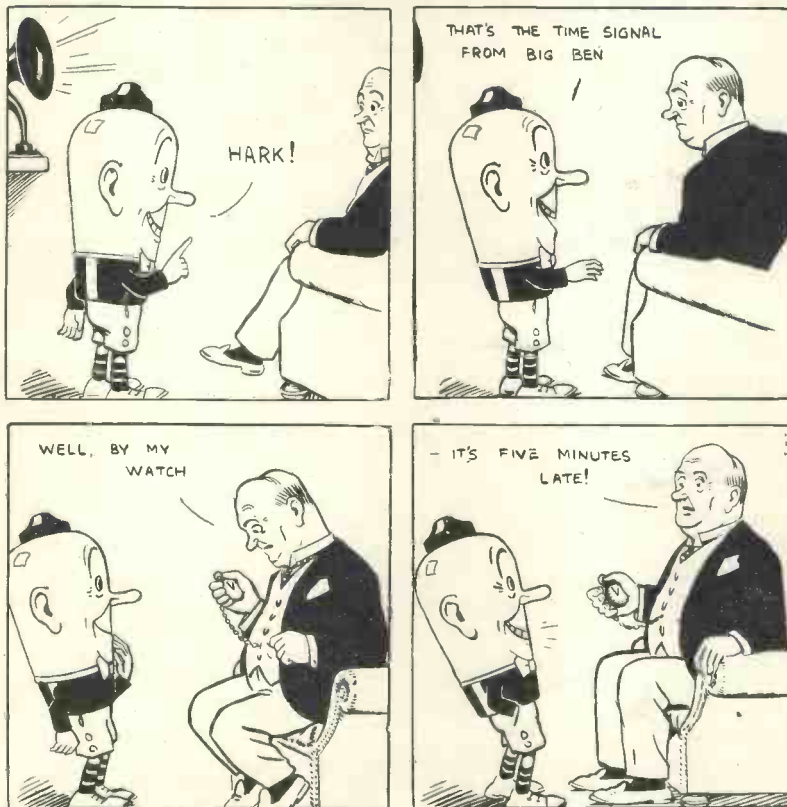

picked up a speech transmission on a wavelength which in your log you had allotted to Zeesen (Königswusterhausen); it is another German station, that of Norddeich, which assures, amongst other duties, a non-musical broadcast service to the fishing fleets in the North Sea and the Baltic.

As its power is in the neighbourhood of 10 kilowatts, you should be able to hear it at even so early as 11 a.m. B.S.T. The announcement,

trawlers and other fishing craft, giving details concerning the catches, as well as the market prices realised in the different ports. You will hear the names of such places as Altona, Cuxhaven, Bremerhaven, and others mentioned. As a rule, his delivery is slow, in order that the price quotations may be taken down by the interested parties.

It is a service which has proved invaluable to the German fishing fleets, as well as to those of other

Drift Ice Warnings

The transmission includes valuable data, and in winter great stress is laid on the accessibility of German ports in the North Sea and Baltic or warnings in the event of drift ice or of any obstacles in the fairway.

Unless some drastic alteration is made to the Prague wave plan, on June 30 we may have to register the loss of our very old friend Hilversum, for to Holland only one long wavelength has been allotted, and for some unaccountable reason it is to be taken by Huizen. In the lower waveband, 298 metres has also been reserved to the Dutch, and so far as I can see, if the authorities insist upon the plan being carried out *in toto*, this would be the only alternative left to Holland's oldest and best transmitter.

Kalundborg's Position

It is difficult to understand the reason for which such a decision should have been taken, in view of the fact that Kalundborg, a very much newer arrival on the air, has been allowed to retain, within a fraction or so, the position it has occupied for some little time.

Believe me, the Dutch listeners are very sore over the matter, and I think you will agree that their grievance is justified. Hilversum was one of the very first studios to provide good musical entertainments, and I think I am not making an exaggerated statement if I say that it is to-day, of the nearer Continental stations, the one which makes the greatest appeal to British listeners.

For some months now, through the initiative of a British wireless concern, it has broadcast on alternate Sundays a special concert.

WEARITE COMPONENTS

FOR THE
"A.C. MAINS AMPLIFIER"
described in this issue

Constant Inductance L.F. Chokes.
H.T.1, H.T.2, H.T.3, H.T.4. 21/-
EACH

1,500 ohm Resistance .. 3/6

2,200 ohm Resistance, to pass
40 milliamps and tapped at
300 ohms 4/6

WRIGHT & WEIRE, LTD.
740 High Rd., Tottenham, N.17
Telephones: Tottenham 3847/8

Do not miss this Opportunity!
PORTABLE CABINETS
30/-

Finished in blue, black, brown, maroon, leatherette. Complete with frame. Carriage rail 3/- extra. Packing free.

**WE CAN SUPPLY
ALL LEADING
PORTABLE SETS
from STOCK**

including :-

FARADEx 5-valve Portable in leather suit case 16 gns.

BEAR 5-valve Portable in leather suit case 16 gns.

McMICHAEL Super Range Four in leather suit case .. £23 2s.

SELECTOR 5-valve Portable in leather suit case £31 10s

ALL PORTABLE SETS SUPPLIED ON EASY TERMS.

Send your enquiries for prompt attention to :-

WILL-DAY LTD.

(THE BEST IN THE WEST)

19 LISLE STREET, LEICESTER SQUARE, LONDON, W.C.2.
Telephone: (2lines) Regent 0921 and 0922 Telegrams: Willday, London

FOR THE PICNIC PORTABLE THREE



EXIDE UNSPILLABLE BATTERY
Type WPC4
2 volts, 24 amp. hrs. Price 16/6.

Exide Unspillable Batteries are supplied as standard on practically all the leading portable sets on the market. And so the designers of the Picnic Portable Three have followed this great lead. They specify the Exide Unspillable Battery, Type WPC4 and you would do well, if you would have absolute cleanliness and long trouble-free service, to follow this good advice to the letter.

Exide

THE LONG LIFE BATTERY FOR WIRELESS

When at home save your dry H. T. Batteries and have crystal clear reception by running your set off Exide H. T. Batteries.

Obtainable from Exide Service Agents or any reputable dealer.

EXIDE BATTERIES, CLIFTON JUNCTION, NR. MANCHESTER
London Sales & Service Depot: 215-229 Shaftesbury Avenue, W.C.2

Advertisers take more interest when you mention "Wireless Magazine"

A Gramo-Radio Outfit

Tested by J. H. REYNER, B.Sc., A.M.I.E.E.



The Lecodyne G3 Table Grand

DESIGNERS of portable gramophones have always been faced with the difficulty of containing a satisfactory sound-producing chamber in a reasonably sized cabinet together with other essential equipment for gramophone reproduction. This difficulty had also to be met by the designer of portable radio apparatus, but in this case the solution was found by utilising a vibrating diaphragm in place of the horn loud-speaker

Pleasant Results

The diaphragm or cone loud-speaker has become highly developed as the result of recent research work and is now generally accepted as one of the most pleasant, if not most powerful, means of reproducing speech and music.

Thus it is simpler to design an efficient sound producer for a portable radio set than for a portable gramophone. It follows that if the two can be combined, radio and gramophone, into a single portable cabinet, we should obtain the advantages of either and also be able to switch over from one to the other.

Such a set is the Lecodyne radio and gramophone equipment, manufactured by the London Electrical Co., of 1 Sherborne Lane, E.C.4. The complete assembly is housed in a cabinet measuring 15 in. by 8 in. by 12 in.

Volume-control Regulation

On raising the lid of the equipment a large diameter turn-table is disclosed, complete with speed control, "stop," and "start." At the back of the turntable a pick-up arm and tone arm rests on a metal support, whilst a knob close by regulates the volume from gramophone records.

The sound is reproduced by an 11-in. cone loud-speaker mounted in the lid of the cabinet; this has a number of ventilating holes cut in it for the

purpose of reducing box resonance. A gramophone handle projecting from the right-hand side of the cabinet screws into a spring motor, which is capable of playing three 10-in. records without reducing speed. The motor is mechanically silent in operation and is not noticeable whilst a record is being played.

The switches and wireless controls are placed on a panel situated at the front of the cabinet. A single multi-contact switch in the centre of the panel performs the operation of changing over from radio to gramophone and in its mid-position disconnects the valve filaments. The left- and right-hand dials

This set is now supplied as standard with a Celestion loud-speaker and a Blue Spot pick-up

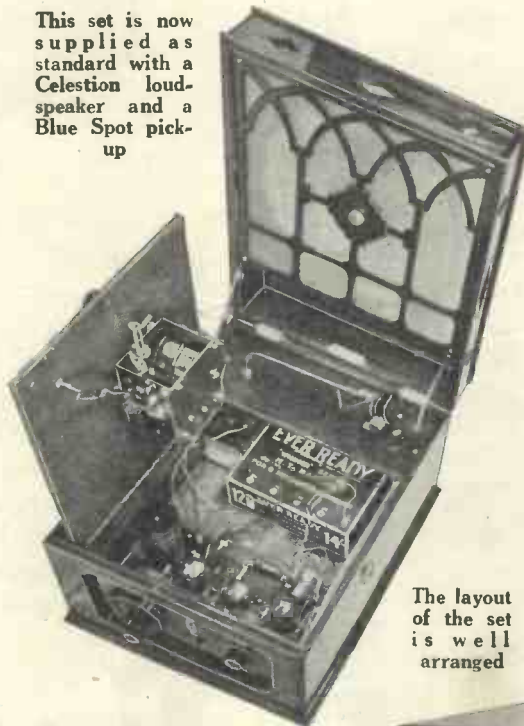

The layout of the set is well arranged

are the tuning and reaction controls respectively. The change over from high to low wavelengths is performed by operating a push-pull switch.

Three valves in all are used, a detector and two low-frequency valves on the radio set, which become three amplifying valves on the gramophone side. The coupling between the detector and first L.F. valve is of the resistance-capacity type, with a 3:1 L.F. transformer in the final stage.

The overall H.T. consumption

from the 120-volt H.T. battery proved to be 11 milliamperes; since there is ample battery space, we expected to see a double-capacity battery in place of the single-capacity battery fitted in the model which we tested. A single-capacity cell will only give 6 or 7 milliamperes economically. The low-tension supply is obtained from a two-volt accumulator and the current consumption here is only .4 ampere.

Actual Results on Test

The actual test of this set was carried out at a distance of 12 miles from the London broadcasting station and approximately 70 from Daventry. Readers will therefore be able to gauge approximately the performance of the set in various localities. Having connected an external aerial and earth, it is only necessary to push the switch up to "Radio," adjust the left-hand dial until the broadcasting is received, and then alter the reaction control until the required volume is obtained.

During daytime very strong results were obtained from the local station without loud-speaker distortion, whilst reception from Daventry 5XX and 5GB was also obtainable at good loud-speaker strength. When tuned to 5GB during an interval in broadcasting it was possible to hear 2LO faintly in the background; this interference was, however, drowned as soon as 5GB began to modulate.

With an indoor aerial the results were surprisingly good, the local station being received at excellent strength; the two Daventrys could be brought up, by manipulation of the reaction control, to a pleasing volume. When

(Continued on page 570)



The Lecodyne set closed

CAN YOU TAKE YOUR LOUD-SPEAKER INTO THE GARDEN ?

Long extension leads can cause many troubles and serious distortion unless you use an output circuit of correct design



IGRANIC ELECTRIC CO LTD
149, Queen Victoria Street, E.C.4.
Works: BEDFORD.

THE IGRANIC TAPPED "C.C." OUTPUT UNIT

enables you to use your loud-speaker at any desired distance from the receiver. It prevents the leakage of H.T., improves reproduction and enables only one wire to be used instead of two extension leads. It will give step-down or step-up as required. **21/6**

When the volume from the receiver is not sufficient for outdoor listening, a Pentode valve will often give the extra amplification necessary. To prevent distortion owing to the impedance of the valve being so high in comparison with that of the speaker use an IGRANIC PENTOFORMER at your output stage. Two tapings provide necessary step-down ratio. **30/-**

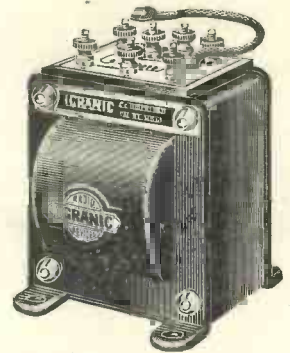

Apply to your dealer or write direct to Dept. J. 877.



essential for best results

MODEL W.1B.
for **A. C. MAINS**
£4 19s. 6d.

There is no more satisfactory source of power for your set than a Mains Unit. There is no Mains Unit on the market more satisfactory than a REGENTONE.

A.C. Models incorporate Westinghouse Metal Rectifier.

All models are guaranteed one year, and our guarantee covers the rectifier. Write for illustrated lists.

Regen. Radio Supply Co.
21 Bartlett's Buildings, E.C.4



ON July 1st, all Wireless Dealers will be showing entirely new Brown instruments including the wonderful new Brown "Vee" Unit. Look out for them !

Advt. S. G. Brown, Ltd., Western Avenue, N. Acton, W.3

Ⓒ 8684

Mention of the "Wireless Magazine" will ensure prompt attention

A Two-ampere Low-tension Unit (Continued from page 548)

but it is sometimes necessary to add a further electrolytic condenser in order that the last trace of hum may be removed.

It is the filament of the detector valve which is the most sensitive, and when the low-frequency amplifier is a rather more than usually powerful one the slight variations in the filament current may be sufficient to produce a little disturbance neces-

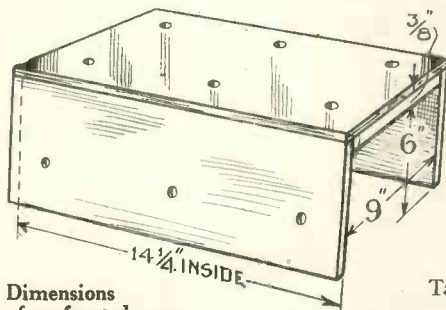

Dimensions of perforated cover

sitating the use of an additional condenser.

In the regulating circuit is a resistance which is of the power type, as it may have to carry for lengthy periods a current of 2 amperes. There is also a moving-coil ammeter having the maximum scale reading of 3 amperes and a voltmeter reading to 10 volts.

Arranging the Apparatus

The illustrations show how the apparatus may be arranged. A small ebonite front panel is used to carry the two instruments, the regulating resistance, the mains switch, two D.C. output terminals, and four sockets. The sockets are connected to the tapping on the low-voltage winding of the transformer and should be employed in conjunction with the adjustable resistance in order that the output may be correct.

Simple Wiring

Wiring is a simple matter, as there are so few parts and the only high-voltage wires are the pair which connect with the mains and the primary winding of the transformer.

When the instrument is complete the lowest voltage from the secondary winding (that is, tap 1) should be connected by means of the plug and an accumulator, or the valve filaments, be joined to the output terminals.

It is *never* advisable to connect the mains unless a suitable load is across the output terminals, as the voltage may rise to over 10 volts and injure the voltmeter.

The tappings have been so arranged that accumulators of 2, 4 or 6 volts may be charged. I have made a series of measurements in order to find the charging currents under various conditions with the following results:—

ACCUMULATOR CHARGING.

2-VOLT CELL.

	Res. all in.	Res. all out.
Tap 1	.7 amp.	1.1 amps.
" 2	1.25 amps.	2.2 amps.
" 3	1.9 amps.	Over 3 amps.
" 4	Too great.	—

4-VOLT CELL.

	Res. all in.	Res. all out.
Tap 1	.4 amp.	.5 amp.
" 2	.8 amp.	1.2 amps.
" 3	1.3 amps.	2.2 amps.
" 4	1.9 amps.	3 amps.

6-VOLT CELL.

	Res. all in.	Res. all out.
Tap 1	Too small.	
" 2	.5 amp.	.7 amp.
" 3	1 amp.	1.4 amps.
" 4	1.5 amps.	2.4 amps.

The cells used in the test were of the 40-ampere-hour type, reading two volts each. The test figures show currents in excess of 2 amperes, but one should remember not to charge at more than 2 amperes. Incidentally, the voltage of the cells is indicated by the voltmeter when the mains switch is in its off position.

I expect the power unit will be used mainly for heating filaments and for supplying current to the field winding of a loud-speaker. For this reason I have measured the output under various conditions in order that the reader may see the range of

outputs obtained from the various tappings.

Readings on Load

In these tests various fixed resistances were connected to the output terminals and the regulating resistance on the panel set at its middle position. Readings were then taken and also when the adjustable resistance was put "all in" and "all out." The results are given in the table, and it will be noticed that I have made adjustments to provide 2-, 4- and 6-volt outputs.

	RESISTANCE LOAD.					
	Res. Central.		All in.		All out.	
	volts.	amps.	volts.	amps.	volts.	amps.
Tap 1	2	.9	1.8	.75	2.2	1
	4	.5	3.8	.4	4.2	.5
Tap 2	2	1.8	1.7	1.5	2.5	2.2
	4	1.2	3.6	1.1	4.6	1.4
Tap 3	6	.7	5.6	.6	6.3	.7
	4	1.9	3.5	1.6	4.6	2.2
Tap 4	6	1.2	5.5	1.1	6.6	1.4
	6	2.0	5.3	1.75	6.6	2.3

These figures clearly show the controlling range of the adjustable resistance and the usefulness of the tappings.

Use of Additional Resistance

A wider range could, of course, be covered by employing an additional adjustable resistance or, alternatively, a larger one in the power unit. There is sufficient control, however, for most purposes. The unit does not generate much heat, and may therefore be covered in, but it is advisable to provide a few holes in order that the cooling of the rectifier may be assisted. I have had the apparatus running for twenty-four hours continuously and the parts were barely warm.

Good Things in the Next Issue!

Q A new three-valve set by W. James, which makes use of his special Binowave Coils.

Q "Should Railway Wireless Be Compulsory?" An arresting article which explains how radio could prevent railway accidents.

Q The Enchanter, a simple five-valve Portable that gives really good results with ordinary three-electrode valves.

Q A Special A.C. Mains Unit for supplying high tension, low tension and grid bias for the push-pull valves in the All-wave Lodestone Five.

On Sale Everywhere July 25

SAY 'T.C.C.'



WHEN you think of Condensers, think of T.C.C. — and you won't go wrong For, because T.C.C. have made nothing but Condensers for over 22 years, the letters T.C.C. on a Condenser are recognised throughout the World as the undisputed hall-mark of accuracy and dependability.

WHENEVER

Remember, there is a T.C.C. Condenser for every purpose. Here is an enlarged illustration of the Flat Mica Type. All Wireless Dealers stock it—in capacities from .0001 mfd., 1/10 to .01 mfd., 3/6.

YOU WANT

CONDENSERS!

Adv. Telegraph Condenser Co., Ltd.,
Wales Farm Rd., N. Acton, London, W.3.

8717

ALL-WAVE LODESTONE 5

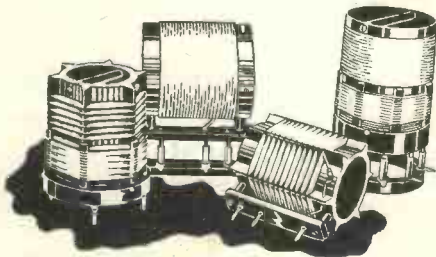

BERCLIF COILS SPECIFIED
76/6 the Set. From Stock.

BERCLIF DUAL COILS
(200 to 2,000 Metres)

For MULLARD
S.G.P.
30/- pair.

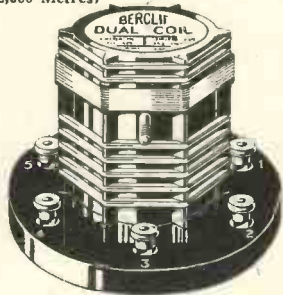

Also wound for many other circuits at 15/- each, complete with extension arms and knob. The most efficient dual coils yet made. Full list of coils and components post free. Trade supplied.

SIMMONDS BROS. SHIRELAND RD. SMETHWICK

As Specified for "1929 CHUMMY FOUR" and other outstanding Circuits



"DE LUXE" LOG CONDENSER
The SMALLEST, LIGHTEST and most EFFICIENT CONDENSERS obtainable.

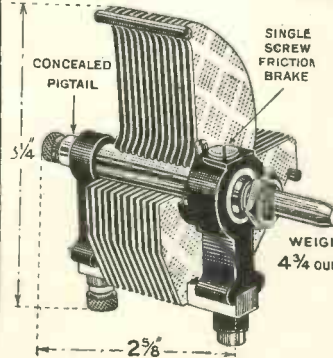

PRICE
6/-
each

The "CHUMMY FOUR" Specifies:
WEIGHT TWO0005
ONE00035



VALVE-HOLDER—
Anti-microphonic, as specified BAKELITE throughout, including BASEPLATE. Practically DUST-PROOF.

As will be seen from illustration, Terminals are provided as well as soldering tags.

Price
1/3

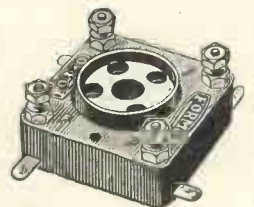

THE FORMO CO.
CROWN WORKS, CRICKLEWOOD LANE, LONDON, N.W.2

The A.C. Mains Amplifier (Continued from page 553)

must be left in circuit, as for example the arrangement shown on page 551. The dual-impedance coupler merely replaces the ordinary L.F. coupling device whatever it may be.

Incidentally, it should be remembered that until this third terminal is

the LS5A burns out that any strain will be placed on the condensers.

So much for the general arrangement. The input to the amplifier is 50 watts. At 240 volts, it will take 200 milliamperes, a little less than a 60-watt lamp. The output in D.C.

ment which is not necessary and the system shown will be quite satisfactory.

It may be noted that throughout the equipment constant-inductance chokes have been used. These are a new type of choke, the inductance

COMPONENTS REQUIRED FOR THE A.C. MAINS AMPLIFIER

Panel Transformers	5 in. by 6 in (Raymond, Becol, or Potter). 1—Mains transformer (Parmeko). 1—Low-frequency transformer, 4 to 1 (Pye).	Valve Holders	2—Special holders for Cosmos mains valves (Cosmos). 2—Ordinary holders (Cosmos, W.B., or Lotus).
Fixed Condensers	2—4-microfarad, 1,000-volt test (T.C.C. or Dubilier). 3—2-microfarad, 1,000-volt test (T.C.C. or Dubilier). 2—1-microfarad, 500-volt test (T.C.C. or Dubilier).	Grid Leak	1—.25-megohm (Dubilier, Mullard, or Ediswan).
Chokes	4—Constant-inductance low-frequency chokes (Wearite types H.T.1, H.T.2, H.T.3 and H.T.4).	Switches	1—Two-pole (Marconiphone). 1—Change-over, jack type (Lotus).
Dual-impedance Units	2—Dual-impedance couplers (Igranic).	Sundries	1—Twin fuse (Gambrell). 1—Electric-light adaptor, with flex.
Resistances	1—20,000-ohm, power type (Varley). 1—100,000-ohm, power type (Varley). 1—1,500-ohm, to carry 40 milliamperes (Wearite). 1—2,200-ohm, tapped at 300 ohms, to carry 40 milliamperes (Wearite).	Terminals.	6—Marked: Pick-up (2), +, L.S.+, L.S.—, Earth (Belling-Lee).
		Valves	1—U5 rectifying valve (Marconi or Osram). 1—AC/G (Cosmos). 1—AC/R (Cosmos). 1—LS5A (Marconi or Osram).
		Baseboard	1—21 in. by 10 in., and cover (Raymond, Pickett, or Camco).

connected to the radio set and the radio set is switched on, the full 300 volts is between this terminal and earth. As soon as any current is taken from the detector, the breaking-down resistance comes into play and cuts the resistance down.

On this question of high voltage, it may be pointed out that all the condensers in the set are of the 500-volt type, tested on 1,000 volts. This is a fair factor of safety, although at first sight it may not seem to be quite enough.

Lag in Filament Heating

Actually, however, since the eliminator supplies both L.T. and H.T. voltages, it is impossible for the H.T. to be applied before the L.T. The filament of the U5 valve takes a short time to build up and deliver its emission (a mere fraction of a second), during which time the LS5A filament has also come up to temperature and will immediately drain the current away from the smoothing condensers.

Thus, no condenser in the system will, under normal circumstances, have any chance of a high voltage developing across it and it is only if

is 40 milliamperes at 350 volts, This, of course, is only 14 watts, but it must be remembered that there are four filaments also being supplied by the transformer, the combined wattage of which is just over 20 watts, so that the actual efficiency of the equipment is 70 per cent.

The output arrangement is suitable for the average high-resistance loud-

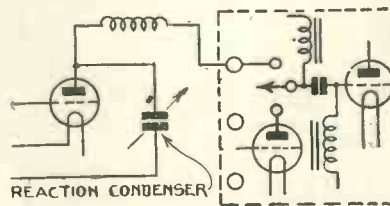

Connection of amplifier to radio set. The H.T.— on the set must also be connected to the earth terminal on the amplifier.

speaker, whether coil or cone. For the greatest possible efficiency, more particularly where a coil-driven loudspeaker is employed, the choke output arrangement shown should be replaced by an output transformer giving the correct ratio of valve to external impedance. For all ordinary purposes, however, this is a refine-

of which does not vary appreciably with the amount of D.C. flowing. The chokes therefore maintain their rated inductance more or less irrespective of the conditions under which they are used, which is a very important property and renders the amplifier inherently stable and not liable to change as load conditions vary.

The construction of the amplifier is straightforward and requires no comment whatever. It is desirable to follow the layout given, as this has been very carefully thought out to avoid trouble from direct induction and, if this is done, no hum should be experienced.

How to Use the Unit

When the amplifier has been completely constructed according to the instructions given, all that is necessary is to connect it up to the mains, insert the valves in their respective positions and switch on.

It may finally be pointed out that the various values and components in this amplifier have been carefully thought out and that the best results cannot be obtained unless the specified components are used.

Make your Portable Live!



EVER READY Batteries provide clear, strong power that make wireless reception a delight. They were the first batteries made for wireless, and are still unapproached for consistent quality and guaranteed service.

- PORTABLE 1. 63 volts 8/6. Size 6" x 5" x 3"
- PORTABLE 2. 99 volts 13/6. Size 9" x 5" x 3"
- PORTABLE 3. 108 volts 15/-. Size 10" x 5" x 3"



EVER READY BRITAINS BEST BATTERIES

Advt. of The Ever Ready Co. (G.B.), Ltd., Hercules Place, London, N.7.



FLUXITE

**conquers solder
— anyway, it
makes it run!**

FLUXITE is sold in tins, price 8d., 1/4 and 2/8.
Another use for Fluxite: Hardening Tools and Case Hardening.
Ask for leaflet on improved methods

FLUXITE LTD.,
(Dept. 332)
Rotherhithe, S.E.16

SOLDERING SET Complete 7/6
or LAMP only 2/6



SIMPLIFIES ALL SOLDERING

WEARITE COMPONENTS

FOR "ARCADIAN PORTABLE"

Coils	10/6
Screen	9/6
H.F. Choke	6/6
Battery Switch	1/-
Valve Holders, Sprung	Each	2/6
Grid Leak Clips	Pair	-/6
Coil Formers	7/6

FOR "SHORT-WAVE LINK"

Valve Holders, Sprung	Each	2/6
H.F. Choke	6/6

FOR "1929 'CHUMMY 4'"

Rotary Switch, 2-way...	3/9
Anode Coll	10/6

DUAL RANGE TUNER

Wavelengths: Low 190—500	}	15/-
Long 950—1900		

As used in Ferranti Circuits.

DECOUPLING RESISTANCES

500 ohm	Each	}	1/6
600 ohm		

WRIGHT & WEAIRE LTD.
740 High Road, Tottenham. N.17
Telephones: Tottenham 3847/8

THERE MUST BE A REASON

Why Celestion has come to mean "The Very Soul of Music"

REALISM

Celestion possesses the most exclusive feature that it is possible for any reproducing instrument to possess: **REALISM.**

CELESTION

LOUD-SPEAKERS

The Very Soul of Music

The only sure proof of our Statement is to hear Celestion yourself. You can do so without obligation at any good Wireless Dealers, or at our Showrooms. Models range from £5.10.0 in oak or mahogany. British throughout. Made under licence.

The new Celestion Booklet is free and gives you briefly and interestingly all particulars. Mail the coupon below for your copy now!

CELESTION LTD. (DEPT. K),
KINGSTON-ON-THAMES.

Showrooms:
106 VICTORIA STREET,
LONDON, S.W.1



Model C12

WHEN A BETTER LOUD-SPEAKER IS MADE CELESTION WILL MAKE IT.

FREE! Please send me a copy of the New Celestion Booklet! Post to Celestion, Ltd., Dept. K, Kingston-on-Thames

NAME.....

ADDRESS.....

How They Do It in the States

President of the N.B.C. Visits Europe

MERLIN H. AYLESWORTH, president of the National Broadcasting Company in America is on a visit to Europe. Slender, of nervous type, quick in thought and action, always physically and mentally on hair-trigger, almost instant in his decision, he is alert for new and novel ideas that may advance the art of broadcasting.

Aylesworth believes that service to the public is the one foundation on which the company should base its hopes for permanent support and ultimate prosperity. As a result he measures the things N.B.C. should do or not do by the test of whether they will benefit the public.

Most folks probably in Aylesworth's position would think they had to know a lot about the technical and engineering side of radio. But the N.B.C. president troubles himself with that not at all. He will tell you he doesn't know the difference between a kilocycle and a motor-cycle, or a short-wave and a permanent wave.

He has a technical staff to deal with those things. But he does try to envision the vast possibilities of radio as an educational and cultural force, as a purveyor of entertainment, information and instruction. His enthusiasm and sense of the dramatic and his refusal to accept as final "it can't be done" often enables him to accomplish the seemingly impossible.

Briefly, Aylesworth is the man of

vision. He seeks idealistic results with little consideration of their cost in "filthy lucre."

With some sixty-three broadcasting stations to feed, the N.B.C. mainly relies for its upkeep on the income accruing from microphone publicity given to a large group of industrial and commercial concerns who sponsor the programmes.

No direct advertising is permitted as it is considered that bald "puffs" would raise the antagonism of listeners and would defeat its own ends.

Of the sixty-three transmitters dotted all over the North American continent, from New York on the East coast, to San Francisco in the west, and from Chicago to Miami in Florida, only three broadcasting stations are actually owned by the company.

Daily transmissions are almost continuous from 7 a.m. until midnight and simultaneously, where necessary, three different entertainments can be relayed to three separate groups of stations included in this system.

A rule has been made that no educational or instructional talks shall last more than 15 minutes and statistics show that of the total transmissions only 33 per cent of the time is devoted to speech.

In his opinion, Mr. Aylesworth states that the tastes of the listeners had undergone considerable change in the space of two years.

A Gramo-Radio Outfit

(Continued from page 564)

using a large outside aerial it might be advantageous to place a small series capacity in the aerial circuit.

The reproduction and clarity of music and speech on both radio and gramophone records was commendably good. A large volume output could be obtained from the loud-speaker without tendency to rattle or distort in an unpleasant manner. When receiving gramophone records the volume control functioned satisfactorily, although it was rather stiff to operate when attempting to weaken the output.

It is always possible to differentiate between those sets designed merely to receive a number of stations at sufficient volume and those others in which quality of reproduction is studied and in which the loud-speaker has been chosen to match the set. Although of quite simple design, the loud-speaker and amplifier appeared to suit each

other well in the Lecodyne set, and although the reproduction could not be described as brilliant, the tone was pleasing to the ear and free from all undesirable harshness.

Anyone who can operate a normal gramophone will be able to work the Lecodyne equipment equally well on both gramophone and radio. This is partly due to the ease of tuning on the radio side and to the provision of simple switches for altering the wavelength range and changing over from radio to gramophone.

Those who live in towns will be interested in the performance of the set on a small aerial which, although not so convenient as a self-contained frame aerial, can be erected without difficulty when both indoors and out in the open.

To say that a set is simple to operate and will give adequate strength of reproduction and pleasing quality is sufficient indication of its merit. At its price we feel justified in recommending the Lecodyne equipment to readers.



CHOKES : TRANSFORMERS : UNITS SPEAK FOR THEMSELVES

Parmeko transformers and chokes are used in the latest "TALKIE AMPLIFIERS" and by the leading makers of Radio Gramophones. Parmeko products are made by specialists who will design and supply the most efficient Output transformers or chokes for any amplifier or loud-speaker.

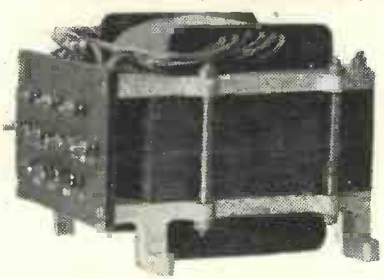

All Parmeko instruments are guaranteed accurate to specification. Their robust construction and fine workmanship make them instruments fit for the laboratory. The Power Amplifier described in this issue specifies a Parmeko Transformer. - - Price £3 : 10 : 0

Send your Amplifier problems to us : we are specialists.

12, BELVOIR STREET,
LEICESTER.
Cent. 22276

174 NEW OXFORD ST.
LONDON, W.C.1
Museum 5070

PARTRIDGE & MEE, LTD.

AT LAST!
A really good Portable
at a reasonable price.
Only £10 : 10 : 0 Complete

This set comprises screened-grid valve, detector and two transformer coupled stages, and is complete with Valves, Batteries, Loud-speaker and handsome solid oak cabinet with protecting lid. One dial control only.

Components for all sets described in this issue in stock.
WRITE FOR PRICE LISTS,
FREE ON APPLICATION.

CASH, C.O.D. or EASY TERMS

EVISON & PAYNE,
83, Borough High St., London Bridge, S.E.1
Phone : Hop 1221.

USE
EELEX
TREBLE DUTY
TERMINALS
AND OTHER WIRELESS ACCESSORIES
J.J. EASTICK & SONS.
EELEX HOUSE, BUNHILL ROW, LONDON, E.C.1

A Bureau for Your Wireless!

ADAPTABLE TO ALL SETS!
Nothing to touch! The snug way those untidy, dusty parts, trailing wires and batteries are compactly enclosed will delight you. As a beautiful piece of furniture, the "RADIOLA" will add pride to the home because it is modern and stylish.

Already over 3,000 delighted users. Highly recommended by the Radio Press and leading experts.

"Radiola" de luxe, from £5 5 0 to £11 11 0
"Popular" Oak Model, from £3 15 0
Cash or Easy Payments.

A stately British-made Cabinet, trade-marked and guaranteed, sent on APPROVAL. (If you wish to part with it we will willingly refund FULL MONEY and pay return carriage 500 l)

Full particulars, Booklet and Photographs FREE (they will interest you!) from the actual makers:

PICKETT'S, WIRELESS FURNITURE MAKERS
"M.G." WORKS, BEXLEY HEATH, KENT
Established since the beginning of Broadcasting.

THE "PICNIC THREE"

The H. & B. Kit contains only highest-class components, Panel drilled. Best quality oak Cabinet, £6 10s. Od. Blue spot unit included. Blueprint free with all orders. Any parts sold separately. Send for detailed list. EVERY PART IN STOCK.

CHUMMY FOUR. H. & B. kit of specified Parts including Oak Cabinet, Blue Spot speaker unit. Panel drilled and Frame aerial wound. £9 8s. 6d. Valves, Accumulator, and H. T. Batteries extra. Immediate delivery of all parts.

CABINETS IN OAK, £2. SPECIAL ANODE COIL, 10/6.
Carriage Paid on all orders.

Gradual Payments if desired.

H. & B. RADIO CO.
34 BEAK STREET, REGENT ST., LONDON
Gerrard 2834

PARFAIT
THE PERFECT
EBONITE PANEL
ONE QUALITY ONLY
THE BEST

SUPPLIED IN SIX FINISHES

Matt	Semi-Polished Mahogany	Highly Polished Black
Cube Surface	Highly Polished Mahogany	Semi-Polished-Black

Stocked by most Wireless dealers. If any difficulty in obtaining locally, write for name of nearest stockist to:

H. B. POTTER & Co, Ltd., Station Buildings, ROCHDALE

The New W.B. 5-PIN VALVE HOLDER
For A.C. Valves

The most scientifically designed 5-Pin Valve Holder on the market. Fitted with patent expanding leg sockets suitable either for resilient or solid valve legs. Already this new W.B. Valve Holder is in use in the laboratories of the leading Valve Manufacturers in this country.

Ask your Dealer to show you one to-day.

Price **1/6**

WHITELEY BONEHAM & CO., LTD.,
Nottingham Rd., Mansfield, Notts.

WHY WORRY!
to make your Wireless Set when we will build and test any Receiver

FREE OF CHARGE
The Customer pays for Components and Marconi Royalty only.

EASY TERMS
QUOTED BY RETURN. WE HAVE EVERYTHING WIRELESS

ALL SETS made, Master 3 S.G.P., Titan 3, Lissen S.G., Osram Music Magnet, all "W.M." Circuits, etc.

Complete Sets, Components, Loud-speakers, H.T. Units, Portables, etc.
Call or send a list of your requirements
BEST MONTHLY TERMS BY RETURN
THE P.D.P. CO., LTD.
(Dept. W.M.) 121 CHEAPSIDE, London, E.C.2
Phone: National 9846

The new Lotus Transformer gives you an unexcelled performance—

and costs only 12/6



Your set will leap into life when you fit the new Lotus Transformer. For purity, tone and good amplification this transformer is absolutely unequalled at the price and gives as good a performance as you will get from a transformer at a higher figure.

Made with all the care, accuracy and handsome finish typical of every Lotus component, this is the transformer you must get for your next set.

★ OTHER LOTUS COMPONENTS

NEW Lotus Drum Dials from 29/6; Lotus Flat Vernier Dials, 4/9; Lotus Valve Holders, 1/3; Lotus Variable Condensers, from 5/-; Lotus Remote Controls, Jacks, Switches, Plugs, etc.

Write for free literature.

From all Radio Dealers.

LOTUS
COMPONENTS

Garnett, Whiteley & Co. Ltd., Liverpool.

Coaston

"Wireless Magazine" REFERENCE SHEETS

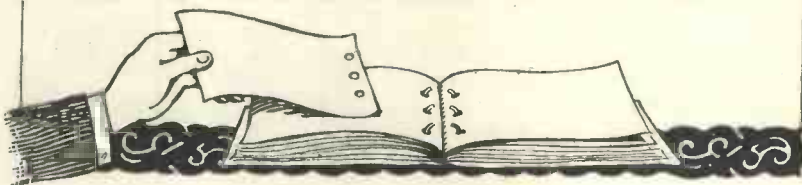

Compiled by J. H. REYNER, B.Sc., A.M.I.E.E.

Month by month these sheets can be cut out and filed—either in a loose-leaf folder or on cards—for reference. The sequence of filing is

a matter for personal choice. In a short time the amateur will be able to compile for himself a valuable reference book.

WIRELESS MAGAZINE Reference Sheet

No. 131

Using D.C. Meters on A.C.

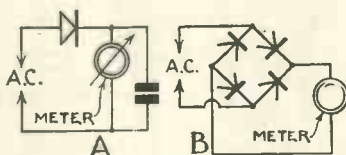

Using D.C. meters for measuring A.C. currents

THE introduction of the metal rectifier has rendered it possible to utilise direct-current instruments for measuring alternating current. There are many instances when this is convenient.

In some cases a particular D.C. meter is available but not the corresponding A.C. type, while in other cases it is possible to obtain a more sensitive reading by utilising a moving-coil D.C. meter rather than a relatively less sensitive A.C. meter.

The simplest possible arrangement is shown at A. Here a single section of a rectifier is placed in series with the meter and a large condenser (such as an electrolytic condenser) is connected

across the meter. Care must be taken to connect the electrolytic condenser correctly and to make sure that it is rated to stand the maximum peak voltage of the alternating current, which is approximately 1½ times the rated (R.M.S.) value. The rectifier also must be capable of withstanding this voltage and more than one section in series must be used if necessary.

This arrangement will give a good steady reading on the D.C. meter, but the calibration of the meter will not necessarily be good and it will be necessary to check the calibration at various points and possibly to re-calibrate.

A better but more elaborate method is to use a bridge rectifier, as shown at B. Here both halves of the wave are rectified and the D.C. meter, if of a suitable type, will read the mean or average value of the rectified current. The movement of the meter must not be too light as otherwise it will tend to flicker slightly owing to the unsteady voltage applied to it, but for all ordinary instruments, the reading is quite steady. This method incidentally is independent of frequency, whereas the first method, utilising an electrolytic condenser, is not.

The advantage of both these methods is that the reading is proportional to the current and not to the square thereof as in the case of ordinary A.C. instruments.

WIRELESS MAGAZINE Reference Sheet

No. 132

Permalloy

MANY of the low-frequency transformers in use to-day are built up on a special form of electrical steel, which has a higher permeability than the ordinary silicon-steel, such as Stalloy. The advantage of this is that a smaller quantity of iron and a much smaller winding is necessary in order to produce the required results.

The material is much more expensive than ordinary electrical steel, but owing to the smaller quantities of both iron and copper required in a particular instrument, the ultimate cost is not prohibitive and the characteristics are usually considerably improved.

There is no definite specification for this type of steel as various manufacturers use different materials to their own specification. In general, the material employed consists of an alloy of iron and nickel. The addition of nickel in small quantities causes the permeability to fall, but after this, it rises rapidly.

It remains at a good value over a relatively large variation of the percentage, after which it rises rapidly to a peak value at which a very high permeability is exhibited. Beyond this point, the permeability falls right away and if pure nickel is used, the permeability is distinctly less than that of iron.

The variation is as shown in the curve.

Some manufacturers prefer to work with 40 per cent to 60 per cent. nickel content as small variations in the amount of nickel present do not seriously affect the performance of the alloy, and it is possible to obtain efficient results with care. The improvement in the permeability is sufficiently good to warrant the use of the

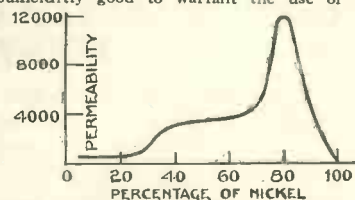

Permeability of Permalloy

material, although it is not the best that can be obtained.

Permalloy is an alloy consisting of 80 per cent. nickel, at which point it will be seen that the permeability is at its maximum. In order to obtain the required results, these alloys have to be carefully treated.

IMPOSSIBLE TO BURN OUT VALVES



This new Belling-Lee product is the first on the market which has both plug and socket completely insulated. SAFETY—high and low voltage plugs are not interchangeable, so that valves cannot be burnt out. CONVENIENCE—no tools required, unique loading device by which both tray and copper are gripped, plug and socket both engraved. FINISH—a feature of every BELLING-LEE product all over the world.

PRICE 9d.

Prov. Pat. (Pans: portion 3d. each, box portion 6d. each)

BELLING-LEE

Advertisement of Belling & Lee Ltd., Queensway Works, Ponders End, Middx.

FREE LIST OF CABINETS



FOR ALL THE POPULAR CIRCUITS, MOVING-COIL AND CONE SPEAKERS

Send this coupon for free copy

To **CARRINGTON MFG. CO., LTD.**
Camco Works, Sanderstead Road, South Croydon.
Telephone: Croydon 0623 (2 lines)

Please send me full details of the "Moving Coil" and other Camco Cabinets.

NAME

ADDRESS

W.M.



The CHOICE of CRITICS

BULGIN RADIO PRODUCTS

600 OHM DE-COUPLING RESISTANCES



Non-inductively wound and fitted with terminal connections.

for use with all S.G. Valves. See "Amateur Wireless" test report, May 4, 1929.

0001 Condensers variable for "Picnic" Portable **5/6**

PRICE **1/6** each

as illustrated, or for Baseboard mounting

Send for our 56-page Catalogue and Manual.

A. F. BULGIN & CO., 9-10-11 Cursitor Street, Chancery Lane, London, E.C.4

The Easy Way TO PERFECT RADIO

In addition to their own extensive range Peto Scott offer you every known Radio Receiver or Component—all on

EASY TERMS

The following list is merely representative and we ask you to fill in the coupon below or send us a list of your requirements.

THE ALL-WAVE LODESTONE FIVE. Kit of parts (See this issue). Send only 21/- balance in easy instalments.

1929 CHUMMY FOUR. Kit of parts (See last issue). Send only 21/- balance in easy instalments.

THE WAYFARER PORTABLE. Kit of parts. Send only 20/11, balance in easy instalments.

PORTABLES. All the leading makes from 21/- down. Balance in easy instalments.

THE NEW MULLARD S.G.P. MASTER THREE. Complete kit of components. Send only 15/-, balance by easy instalments.

LEADING MAKES OF H.T. ELIMINATORS AND ACCUMULATORS from 4/7 down. Balance in 11 monthly instalments of 4/7.

CELESTION. C.12 SPEAKER. Send only 13/4, balance in 11 monthly instalments of 13/4.

BUILD YOUR OWN SET THE EASY WAY NOW! OUR CATALOGUE CONTAINS ALL THE LEADING MAKES OF RECEIVERS, ACCESSORIES, KITS OF COMPONENTS FOR THE HOME CONSTRUCTOR.

Mail Coupon in unsealed envelope under 4d. stamp

PETO SCOTT CO., LTD.

Please send me your big Illustrated Lists.

NAME

ADDRESS

WM 1/6

Call in for free demonstration or advice by our qualified engineers at any of these addresses.

77 CITY ROAD, LONDON, E.C.1.
62, HIGH HOLBORN, LONDON, W.C.1.
4, MANCHESTER STREET, LIVERPOOL.
33, WHITELOW ROAD, CHORLTON-GUM HARDY, MANCHESTER.

OMNORA LTD.

THE SET BUILDERS SUPPLY STORES

Build the PICNIC PORTABLE THREE

	£ s. d.
1 Panel, 13½ in. by 6½ in.	4 6
1 Portable type cabinet	1 10 0
1 Ormond .0005 variable condenser	8 0
1 Bulgin .0001 reaction condenser	5 6
1 Lissen .0002 fixed condenser	1 0
3 Antiphonic valve holders	4 6
1 Lissen grid leak and holder	1 0
1 Cossor L.F. transformer	1 1 0
1 Trix R.C.G. unit, type A	5 6
1 Omnora H.F. choke	7 0
1 Ormond thumb-control dial	5 0
2 Push-pull on-off switches	3 0
Sundry wire, screws, flex, tags, etc., as specified	6 0
1 Blue Spot reed-drive unit	1 1 0
1 White Spot metal frame, with cone	10 6
2 66-volt Lissen batteries	15 10
1 9-volt grid battery	1 6
1 Exide accumulator, type WPC.4	16 6
	£8 8 4

1 Set of 3 valves for above, as specified

Ready wired and tested, including valves and Royalty

We specialise in the All-wave Lodestone Five, Two-ampere L.T. Unit, and all apparatus described in "Wireless Magazine" and other journals.

Send for latest lists, including Portable and Radio Gramophone Instruments. Overseas readers are advised to write for particulars of the **Magnum Universal Three**, a S.G. Det. Pentode receiver operating on the ultra short waves of 15 metres up to 2,000 metres.

OMNORA LTD. Home Construction Specialists.
258 NEW CROSS ROAD, LONDON, S.E.14
Phone: New Cross 1273.



CLAROSTAT

VARIABLE RESISTANCES FOR VOLUME, TONE, DISTANT CONTROL, ELIMINATORS ETC.,

As frequently specified by "The Experts".

• HIGH QUALITY • LOW PRICE •

New 20 Page Brochure free on request. Many unique circuits.

CLAUDE LYONS LTD.

76, OLDHALL ST., LIVERPOOL

AGENCY WANTED. Good cheap portable set Factoring Agency required. New showrooms or shed. Apply—A. H. Shirley, 130 The Broadway, Cowley Road, Oxford.

DIRECTORY OF ENQUIRY AGENTS covering British Isles. Price 6/6 Post Free. Also Debts required (all parts). Bird's, 43 Bridge Street, Northampton.

PAREX

SCREENS COILS

1929 CHUMMY FOUR SCREENING BOX 7½ x 5 x 4 in.

Aluminium, 5/6. Copper, 9/6.
Dual Coil as specified, 10/6.

All-Wave Lodestone 5

Aluminium Screens 2/- Copper 3/6

E. PAROSSI 10, FEATHERSTONE BUILDINGS, LONDON, W.C.1 Phone Chancery 7010

LOOK OUT FOR THE ENCHANTER FIVE-VALVE PORTABLE IN NEXT MONTH'S WIRELESS MAGAZINE

Advertisers like to know you "saw it in the 'Wireless Magazine'"



ENGINEERING PRECISION.

Bestriding the Tyne like a Colossus, this inspiring new bridge leaps the great waterway in one span, a perfect example to Newcastle—and, indeed, the world—of the skill and precision to be found in twentieth-century engineering.

No less worthy examples of craftsmanship are to be found in the products of J.B. Infinite care and accuracy, and a flair for turning a good design into a perfect one, have raised J.B. precision instruments to an unassailable position of good repute.

Here is their neutralising condenser—an example of J.B. Engineering Precision. So far ahead of all other models that it cannot go wrong. Extremely simple, and incorporating the best possible materials.

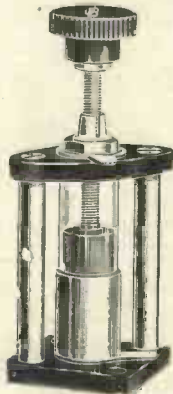

As used in the "ALL-WAVE LODESTONE FIVE," described in this issue.

PRICE
3/6



PRECISION INSTRUMENTS

At Jackson Bros., 72, St. Thomas' Street, London, S.E.1. Telephone: Hop 1837

Pentode Output Circuits

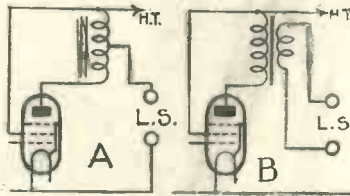

Two pentode output circuits

IT is becoming recognised that in order to obtain reasonably good quality from a pentode valve, it is necessary to use some form of step-down output arrangement in order that the impedances of the output circuit and the valve may be more nearly matched.

The current is carried by the primary winding of a transformer, by a choke, both of which can be wound with heavier gauge wire and will, therefore, stand up to the potentials applied by the action of switching on and off.

Practical experience indicates that a ratio of between 2-1 and 4-1 is usually most satisfactory

with the average high-resistance loud-speaker. With a step-down ratio of this order, no loss in signal strength results, but the quality is considerably improved and the use of such an arrangement is to be recommended.

A choke output arrangement is shown at A. The choke in question, of course, must be capable of carrying currents up to about 30 milliamperes without saturation and should have an inductance at this current of at least 60 to 80 henries, owing to the high impedance of the pentode valve.

Tappings are taken on this choke so that an auto-transformer arrangement is obtained, the loud-speaker being connected across the tapped portion which has been arranged to occur between quarter and half of the way from the H.T. end of the choke. As usual with a choke-output circuit, the other end of the loud-speaker should be connected to L.T.—

A transformer arrangement achieving the same result is shown at B. The primary winding of this transformer must comply with the same conditions as those of the choke, that is to say when carrying a current of between 20 and 30 milliamperes, the inductance must be at least 60 to 80 henries, and preferably more.

The secondary winding is arranged to give a step-down effect of the required order.

Output Transformers

THE arguments in favour of the use of an output transformer are similar to those for a choke-output circuit. The output transformer is perhaps more usual in cases where an unequal ratio is required, as for example where it is required to step down the output to suit a relatively low-resistance loud-speaker, although a tapped auto-transformer choke may be used.

Where good quality is desired, it is important to arrange that the effective impedance of the anode circuit bears a suitable relation to the internal resistance of the last valve or system of valves. It is not always convenient to alter the actual impedance of the anode circuit or to choose valves of the appropriate impedance.

For example, with a low-resistance moving-coil loud-speaker the resistance of the valve would have to be a few hundred ohms only to obtain the correct matching. This is impracticable for ordinary purposes.

It is possible to obtain the desired effect by the use of an unequal ratio of transformation. If the load and valve impedances are already correct, a 1:1 ratio is sufficient. If the load impedance is less than the valve impedance, then a step-down arrangement is employed.

The connection of a load across the secondary

of a transformer introduces an equivalent load into the primary circuit proportional to the square of the transformation ratio. Thus a load of 1,000 ohms connected across a 2:1 step-down transformer would be equivalent to a load of 4,000 ohms in the primary circuit. Based on this theory, it is possible to arrange to match up valve and speaker impedances by the choice of a suitable ratio of transformation.

The next question is the most suitable ratio of external effective anode impedance to internal valve resistance. If the impedance of the load circuit is substantially constant, then the maximum undistorted output is obtained when the load impedance is twice the valve impedance. With moving-coil loud-speakers, this condition is more or less complied with and we can utilise this factor in working out our transformation ratio (see Sheet No. 135).

With the horn or cone type of speaker, however, the impedance increases somewhat rapidly with the frequency and it is not possible to make the same assumption. Some form of average figure must be taken and this can be worked out to accentuate either the lower or the upper frequencies, depending upon the particular type of loud-speaker.

Output Transformer Ratios

AS discussed in Sheet No. 134, the appropriate ratio of transformation in an output transformer depends upon circumstances. For a horn or cone loud-speaker, the impedance of which varies with frequency, an estimate may be obtained by making the effective anode impedance at 200 cycles equal to the valve resistance.

The required ratio of transformation is then given by

$$\text{Ratio} = \sqrt{\frac{\text{Valve impedance}}{\text{Speaker impedance}}}$$

For moving-coil speakers, on the other hand, the effective impedance is practically constant over the audio frequency range and here maximum undistorted output is obtained by making the effective anode impedance twice that of the valve. The ratio is then

$$\text{Ratio} = \sqrt{\frac{2 \times \text{Valve impedance}}{\text{Speaker impedance}}}$$

The impedance of the moving coil in a coil-drive speaker may be taken as approximately twice its D.C. resistance.

Where valves are used in parallel, it is necessary to divide the impedance of each individual valve by the total number of valves used in parallel in order to obtain the effective valve impedance for use in the above formulae.

It should be pointed out that since the expression depends upon the square root, the placing of two valves in parallel does not mean that the transformation ratio will be halved. If, for example, a 25:1 transformer is used with a single valve, then with two valves in parallel the appropriate ratio would not be 12½:1, but 17½:1.

Where valves are used in push-pull, the effective valve impedance across the primary of the transformer is twice that of each valve and this must be allowed for in the above formulae. Here again, the question of the root sign must be taken into account. If the 25:1 transformer is suitable for one valve, then two such valves in push-pull will require not a 50:1 transformer, but a 35:1 transformer.

The above expressions apply equally to tapped auto-transformer output chokes.

FULL-SIZE BLUEPRINTS FOR EVERY REQUIREMENT

Each blueprint shows the position of each component and every wire and makes construction a simple matter. Copies of "Wireless Magazine" and of "Amateur Wireless" containing descriptions of all these sets can be obtained at 1s. 3d. and 4d. respectively, post free. Index letters "A.W." refer to "Amateur Wireless" sets and "W.M." to "Wireless Magazine" sets.

CRYSTAL SETS

- All these 6d. each, post free.
- Two-programme Set .. WM25
 - Centre-tap Set .. WM50
 - Super Set .. AW64
 - 1020 Crystal Receiver .. AW165
 - A Daventry-Local Crystal Set .. AW185

ONE-VALVE SETS

- All these 1s. each, post free.
- Long-range Hartley .. WM54
 - Reflexed One for the Loud-speaker .. WM66
 - Special One .. WM116
 - Reinartz One .. WM127
 - All-wave Reinartz .. AW2
 - Hartley DX .. AW27
 - Economy One .. AW71
 - Loud-speaker Special .. AW78
 - Ultra-sensitive Hartley One .. AW103
 - Fan's Short-wave One .. AW119
 - Super Reinartz One .. AW127
 - Beginner's One-valver .. AW140

TWO-VALVE SETS

- All these 1s. each, post free.
- Two-programme 2 (D, Trans) .. WM56
 - Q-coil 2 (D, Trans) .. WM62
 - Crusader (D, Trans) .. WM69
 - Flat-dweller's 2 (HF, D) .. WM76
 - Two-Daventry Two (D, Trans) .. WM77
 - Tetrode Short-wave Two (SG, D) .. WM79
 - Key-to-the-Ether Two (D, Pentode) .. WM107
 - Meteor Two (D, Trans) .. WM114
 - Clipper Two (D, Trans) .. WM135
 - Twinflex (Reflex) .. WM138
 - Continental Two (D, Trans) .. WM143
 - 30/- 2 (D, Trans) .. AW61
 - Economical 2 (D, RC) .. AW66
 - Two-wave (D, Trans) .. AW83
 - Ultra-selective Hartley (D, Trans) .. AW90
 - Oceanic Short-wave (D, Trans) .. AW91
 - Trapped Reinartz (D, Trans) .. AW92
 - "Q" 2 (D, Trans) .. AW99
 - Long Distance Two (HF, D) .. AW110
 - Three-waveband Two (D, Trans) .. AW112
 - DX Headphone Two (HF, D) .. AW134
 - Ace of Twos (D, Pentode) .. AW143
 - Home Two (D, Trans) .. AW146
 - Chapman-Reinartz Two (D, Trans—4d. with copy of "A.W.") .. AW148
 - Globe DX Two (SG, D) .. AW157
 - East to West Short-wave Two (D, Trans) .. AW159
 - Beginner's Two (D, Trans) .. AW171
 - Auto Two (D, Trans) .. AW174
 - All-Main Two (D, Trans) .. AW180
 - 1929 Favourite Two (D, Trans) .. AW186

THREE-VALVE SETS

- All these 1s. each, post free.
- Five-guinea 3 (HF, D, Trans) .. WM20
 - Metropolitan (D, 2LF) .. WM48
 - Britannia (D, 2 Trans) .. WM52
 - W.M.67 .. WM67
 - Pole-to-Pole Short-wave (D, RC, Trans) .. WM89
 - Glee-singer Three (D, 2RC) .. WM92
 - Aladdin Three (HF, D, LF) .. WM95
 - Inceptor Three (SG, D, Pentode) Price 1s. 3d. with copy of "W.M." .. WM105
 - All-wave Screened-grid Three (HF, D, Pentode) .. WM110
 - Gramophone Three (D, 2RC) .. WM115
 - Standard Coil Three (HF, D, Trans) .. WM117
 - Festival Three (D, 2 LF-Dual Imp) .. WM118
 - Wide-world Short-waver (SG, D, Trans) .. WM120
 - New Year Three (SG, D, Pentode) .. WM123
 - The Q3 (D, RC, Trans) .. WM124
 - Lodestone Three (HF, D, Trans) .. WM129
 - Simple Screen Three (HF, D, Trans) .. WM131
 - Dynamic Three (SG, D, Trans) .. WM136

- At Home Three (D, 2RC) .. WM141
- Short Wave Link (D, RC, Trans) .. WM142
- Split-primary (HF, D, Trans) .. AW24
- Modern Tuned-anode (HF, D, Trans) .. AW35
- Tetrode 3 (HF, D, Trans) .. AW36
- Special (D, 2LF) .. AW44
- Economy 3 (D, 2RC) .. AW48
- Short-wave (D, RC, Trans) .. AW50
- Ether-searcher (D, RC, Trans) .. AW52
- Standard (D, 2 Trans) .. AW56
- Hartley DX (D, RC, Trans) .. AW63
- Broadcast 3 (D, RC, Trans) .. AW76
- Q-coil 3 (D, RC, Trans) .. AW84
- British Station Three (HF, D, Trans) .. AW122
- Optional Two-three (D, 2LF) .. AW124
- "Simpler Wireless" Mains Three (D, 2LF) .. AW126
- Simplicity Screen-grid Three (HF, D, Trans) .. AW132
- "Proms" Three (D, 2RC) .. AW137
- Adaptable Three (D, 2 Trans) .. AW139
- All-purpose Short-wave Three (D, RC, Trans) .. AW147
- Screen-grid Q-Coil Three (HF, D, Trans) .. AW150
- New-style Mains Three (HF, D, Trans—Price 1/6) .. AW151
- All-Round Three (D, RC, Trans) .. AW155
- James Special Three (HF, D, Trans) .. AW156
- All Britain Three (HF, D, Trans) .. AW158
- Bantam Three (D, RC, Trans) .. AW160
- Hartley Dual-range Three (D, RC, Trans) .. AW166
- Listener's Three (HF, D, Trans) Price 4d. free with copy of "A.W." .. AW169
- Ind-wave Three (D, RC, Trans) .. AW172
- Clarion Three (SG, D, Trans) .. AW175
- 1929 Favourite Three (D, RC, Trans) .. AW179

FOUR-VALVE SETS

- All these 1s. 6d. each, post free.
- Simplicity (HF, D, 2 Trans) .. WM49
 - Gramo-Radio 4 (D, RC, 2 Trans Push-pull) .. WM70
 - Screened grid 4 (HF, D, 2RC) .. WM77
 - Five-pounder Four (HF, D, RC, Trans) .. WM91
 - Frame-aerial Four (HF, D, 2RC) .. WM85
 - Touchstone (HF, D, RC, Trans) .. WM100
 - Reynier's Furzehill Four (SG, D, 2 Trans) .. WM112
 - Economy Screen-grid Four (SG, D, RC, Trans) .. WM113
 - Binowave Four (SG, D, RC, Trans) .. WM119
 - Standard-coil Four (HF, D, 2RC) .. WM122
 - Dominions Four (2SG, D, Trans) .. WM134
 - The Drum Major (HF, D, RC, Trans) .. WM137
 - Music Player (HF, D, RC, Trans) .. WM144
 - All-purpose 4 (HF, D, RC, Trans) .. AW43
 - Special 4 (HF, D, 2LF) .. AW70
 - "Q" 4 (HF, D, RC) .. AW98
 - Explorer Four (HF, D, RC, Trans) .. AW120
 - Sumertime Searcher (2HF, D, Trans) .. AW128
 - Overseas Shortwaver (HF, D, 2 Trans) .. AW133
 - Ranger Four (SG, D, RC, Trans) .. AW145
 - Facility Four (HF, D, 2RC-Q-coil) .. AW154
 - Broadcast Picture Four (HF, D, 2RC) .. AW163
 - The Orchestra Four (D, RC, Push-pull) .. AW167
 - All Europe Four (2HF, D, Trans) .. AW174
 - Stability Four (HF, D, RC, Trans) .. AW182

FIVE-VALVE SETS

- All these 1s. 6d. each, post free.
- Exhibition 5 (2HF, D, RC, Trans) .. WM33
 - 1928 Five (2HF, D, 2 Trans) .. WM46
 - All-the-world 5 (2HF, D, 2RC) .. WM63
 - Cataract 5 (HF, D, RC, Push-pull) .. WM79
 - Empire Five (2SG, D, RC, Trans) .. WM96
 - Fidelity Five (HF, D, RC-parallel) .. WM130
 - *All-wave Lodestone Five (HF, D, Push-Pull) .. WM146
 - Individual 5 (2HF, D, 2 Trans) .. AW25
 - School 5 (HF, D, 2RC) .. AW85
 - "Q" Gang-control Five (2HF, D, 2Trans) .. AW161

SIX-VALVE SETS

- 1s. 6d. each, post free.
- Nomad (2HF, D, RC, Push-pull, Trans) .. WM31
 - Connoisseur's Six (2HF, D, RC, Push-pull) .. WM88
 - Eagle Six (3HF, D, RC, Trans) .. WM106
 - Short-wave Super-6 (Super-het, Trans) .. AW67
 - Adapter for above (see miscellaneous list) .. AW67A

SEVEN-VALVE SETS

- 1s. 6d., post free.
- Simpladyne (Super-het) .. WM22

PORTABLE SETS

- Price Post Free
- Springtime 2 (D, Trans) .. WM12 1/-
 - Chummy 4 (HF, D, RC, Trans) .. WM80 1/6
 - Chummy 4 (with modification for L.S. and H.F.) .. WM80a 1/6
 - Pigmy Portable (D, Trans) .. WM04 1/-
 - Wayfarer Portable (Super-het) .. WM139 1/6
 - 1929 Chummy (SG, D, Trans, RC) .. WM145 1/6
 - *Picnic Portable (D, RC, Trans) .. WM149 1/-
 - Table Grand 4 (HF, D, 2RC) .. AW03 1/6
 - Attache Portable 2 (HF, D) .. AW06 1/-
 - Daventry Portable (D, Trans) .. AW105 1/-
 - Daventry Loud-speaker Portable (2HF, D, RC, Trans) .. AW107 1/6
 - Town and Country (HF, D, RC, Trans) .. AW111 1/6
 - House and Garden (SG, HF, D, RC, Trans) .. AW116 1/6
 - "Best-yet" Portable (SG, D, 2 Trans) .. AW136 1/6
 - House Portable (SG, D, RC, Trans) .. AW168 1/6
 - Arcadian Portable (SG, D, 2 Trans) with Linen-diaphragm Loud-speaker (half-scale) .. AW177 1/6
 - 45 5 0 Portable (D, Trans) .. AW181 1/-
 - Talisman Portable (SG, D, 2 Trans) .. AW184 1/6
 - Holiday Portable Three (D, 2 Trans) .. AW188 1/-

AMPLIFIERS

- All these 1s. each, post free
- Super-power Unit (2 v.) .. WM103
 - Signal Booster (HF Unit) .. WM128
 - Audiotrol Amplifier .. WM132
 - Screened-grid HF Unit .. AW75
 - One-valve LF Unit .. AW79
 - Super-power Push-pull .. AW86
 - Hook-on Short-waver .. AW104
 - Purity Amplifier .. AW108
 - Add-on Distance-getter .. AW117
 - Screened-grid HF Amplifier .. AW138
 - "A.W." Gramophone Amplifier (3RC) .. AW162
 - Searcher Unit (H.F.) .. AW176
 - Gramophone Amplifier (3 v.) .. AW187

MISCELLANEOUS

- Price Post Free
- A.C. Mains Eliminator .. WM41 1/-
 - Portable Cone Loud-speaker .. WM73 1/-
 - "Junior" Moving-coil Loud-speaker .. WM81 1/-
 - Universal Short-wave Adapter .. WM82 1/-
 - Linen-diaphragm Loud-speaker .. WM90 1/-
 - Valveless A.C. Power Unit for L.T. .. WM100 -/6
 - Valveless A.C. Power Unit for H.T. .. WM101 -/6
 - Simple Cone .. WM111 1/-
 - Buzzer Wavemeter .. WM121 -/6
 - James H.T. Unit for A.C. Mains .. WM125 1/-
 - Lodestone Loud-speaker .. WM126 1/-
 - James H. T. Unit for D.C. Mains .. WM133 1/-
 - Short-Wave Adaptor for Dominions Five .. WM140 1/-
 - *Two Ampere Low-tension Unit .. WM147 1/-
 - *A.C. Mains Amplifier .. WM148 1/-
 - Heterodyne Wavemeter .. AW7 1 -
 - Rectifying Unit for "Simpler Wireless" Sets .. AW62 1/-
 - Adapter for Short-wave Super 6 H.T. from A.C. Mains .. AW67a -/6
 - H.T. Eliminator for A.C. (200 v. output) .. AW102 1/-
 - L.T. and H.T. Mains Unit (DC) .. AW123 1/-
 - Knife-edge Wavetrap .. AW131 -/6
 - All-metal Eliminator for H.T. .. AW135 1/-
 - Duplex-diaphragm Loud-speaker .. AW142 1/-
 - Power-plus Loud-speaker .. AW149 1/-
 - Linen-diaphragm Loud-speaker with Baffle .. AW152 1/-
 - Pedestal Cone Loud-speaker .. AW164 1/-
 - Listener's Speaker, price 4d. with copy of "A.W." .. AW170 -/1
 - Arcadian Linen-diaphragm Loud-speaker (full-size) .. AW177 1/-
 - D.C. Unit (H.T.) .. AW178 1/-
 - Short-wave Adaptor (IV.) .. AW183 1/-

Send, preferably, a postal order (stamps over sixpence in value unacceptable) to

Wireless Magazine

Blueprint Dept., 58/61
Fetter Lane - E.C.4

A blueprint of any one set described in the current issue of the "Wireless Magazine" can be obtained for half-price up to the date indicated on the coupon (which is always to be found on page iii of the cover) if this is sent when application is made. These blueprints are marked with an asterisk (*) in the above list and are printed in bold type. An extension of time will be made in the case of overseas readers

"Wireless Magazine" Buyers' Guide and Classified Index to Advertisers

<u>BATTERIES</u>		<i>Month Page</i>
Chloride Electrical Storage Co., Ltd. ...	July	563
Edwards, Rowland, & Co., Ltd. ...	May	397
Ever Ready Co. (G.B.), Ltd. ...	July	569
Lesingham, F. L. ...	May	369
Lissen, Ltd. ...	July	506
Siemens Bros. & Co., Ltd. ...	May	310
Tudor Accumulator Co., Ltd. ...	July	503
Vandervell, C. A., & Co., Ltd. ...	July	Cover ii

<u>CABINETS</u>		<i>Month Page</i>
Carrington Manufacturing Co., Ltd. ...	July	573
Day, Will, Ltd. ...	July	563
Edwards, F. W. ...	May	381
Hobbies, Ltd. ...	May	397
Pickett Bros. ...	July	571
Igranic Electric Co., Ltd. ...	July	Cover ii

<u>CHOKES</u>		<i>Month Page</i>
Partridge & Mee, Ltd. ...	June	481

<u>COILS</u>		<i>Month Page</i>
British General Manufacturing Co. ...	June	493
London Electric Wire Co. and Smiths, Ltd. ...	July	500
Rothermel Corporation, Ltd. ...	May	397
Simmonds Bros. ...	July	567
Turner & Co. ...	May	394
Wright & Weaire, Ltd. ...	July	Cover ii

<u>CONDENSERS (Fixed)</u>		<i>Month Page</i>
Dubilier Condenser Co. (1925), Ltd. ...	July	Cover ii
Telegraph Condenser Co., Ltd. ...	July	567
		Cover ii

<u>CONDENSERS (Variable)</u>		<i>Month Page</i>
Bird, Sydney S., & Sons	June	407
Dubilier Condenser Co. (1925), Ltd. ...	June	405
Formo Co. ...	May	394
Jackson Bros. ...	July	574
Lissen, Ltd. ...	May	316

<u>COMPONENTS</u>		<i>Month Page</i>
Bulgin, A. F., & Co. ...	June	487
Day, Will, Ltd. ...	June	485
Formo Co. ...	July	567
		Cover ii
Garnett, Whiteley & Co., Ltd. ...	June	492
Wright & Weaire, Ltd. ...	July	569

<u>DIALS</u>		<i>Month Page</i>
Harlie Brothers ...	July	Cover ii

<u>EBONITE</u>		<i>Month Page</i>
American Hard Rubber Co., Ltd. ...	July	Cover ii
British Ebonite Co., Ltd. ...	May	397
Potter, H. B., & Co., Ltd. ...	July	571

<u>GRAMOPHONE EQUIPMENT</u>		<i>Month Page</i>
Alestrian Gramophone Co. ...	May	375
British Thomson-Houston Co., Ltd. ...	June	403
London Electrical Co. ...	May	307
Peto-Scott Co., Ltd. ...	May	Cover ii

<u>KITS</u>		<i>Month Page</i>
Evison & Payne ...	July	571
H. & B. Radio Co. ...	July	571
Northern Radio Co. ...	June	487
Omnora, Ltd. ...	July	573
P.D.P. Co., Ltd. ...	July	571
Peto-Scott Co., Ltd. ...	July	573
Raymond, K. ...	June	409
Ready Radio Supply Co. ...	July	Cover ii, Cover iii

<u>LOUD-SPEAKERS</u>		<i>Month Page</i>
British Thomson-Houston Co., Ltd. ...	May	315
Brown, S. G., Ltd. ...	July	565
Celestion, Ltd. ...	July	570
Hughes, F. A., & Co., Ltd. ...	July	501
		Cover ii
Whiteley, Boneham & Co., Ltd. ...	May	523

<u>MAINS-SUPPLY EQUIPMENT</u>		<i>Month Page</i>
Clarke, H., & Co. (M/CR), Ltd. ...	May	399
Philips Lamps, Ltd. ...	May	389
Regent Radio Supply Co. ...	July	565

<u>PORTABLES</u>		<i>Month Page</i>
Westinghouse Brake and Saxby Signal Co., Ltd. ...	June	485
Wright & Weaire, Ltd. ...	July	563

<u>RESISTANCES</u>		<i>Month Page</i>
Bulgin, A. F. & Co. ...	July	573
Igranic Electric Co., Ltd. ...	May	369
Lyons, Claude, Ltd. ...	July	573

<u>SCREENS</u>		<i>Month Page</i>
Paroussi, E. ...	July	573

<u>SOLDERING FLUX</u>		<i>Month Page</i>
Fluxite, Ltd. ...	July	569

<u>SWITCHES</u>		<i>Month Page</i>
Bulgin, A. F., & Co. ...	May	383

<u>TERMINALS</u>		<i>Month Page</i>
Belling & Lee, Ltd. ...	July	573
Eastick, J. J., & Sons ...	July	571
Lectro Linx, Ltd. ...	July	Cover ii

<u>TRANSFORMERS</u>		<i>Month Page</i>
Brown, S. G., Ltd. ...	June	477
Garnett, Whiteley & Co., Ltd. ...	July	572
Igranic Electric Co., Ltd. ...	July	565
Lewis, S., & Co., Ltd. ...	May	381
Marconiphone Co., Ltd. ...	May	Cover iv
Partridge & Mee, Ltd. ...	July	571

<u>VALVES</u>		<i>Month Page</i>
Cossor, A. C., Ltd. ...	July	499
Edison Swan Co., Ltd. ...	May	307
Impex Electrical, Ltd. ...	July	505

<u>VALVE HOLDERS</u>		<i>Month Page</i>
Whiteley, Boneham and Co., Ltd. ...	July	571

THE 1929 CHUMMY

EQUAL TO ANY 20 GUINEA MODEL

2,000 ORIGINAL CHUMMY OWNERS

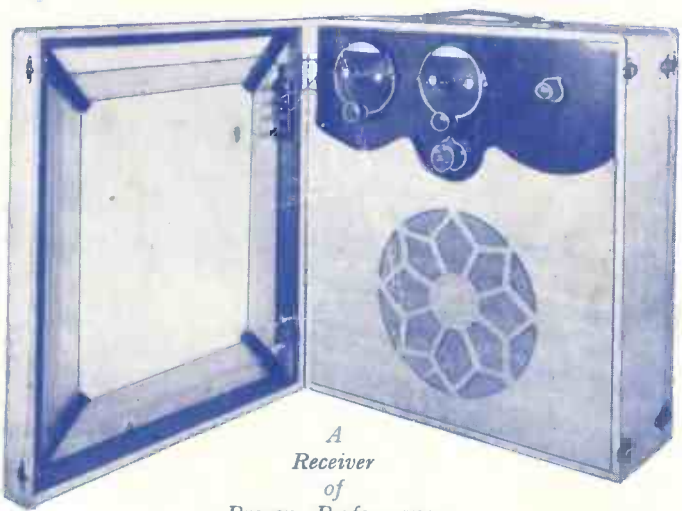

USED THE READY RADIO SERVICE

A Receiver of Proven Performance

KIT OF PARTS
with Valves and Accessories

£14:6:0
(Complete to the last screw)

Ready Radio

SET COMPLETE
carefully built to specification
(Test Report Supplied)

£16:16:0
(including royalties)

IMMEDIATE DESPATCH SERVICE

READY RADIO SPECIFIED PARTS

- | | |
|--|-------|
| Dual range coil .. | 10 6 |
| Copper Screening Box .. | 6 6 |
| Polished Oak Cabinet, with loud-speaker and aerial fittings, and silk-covered grille | 2-0-0 |
| Aerial frame and fittings (excluding wire) .. | 5 0 |
| Wire for frame aerial .. | 2 6 |
| Aerial, complete .. | 1 0 0 |
| Assembling & mounting loud-speaker | 5 0 |
| Winding aerial (excluding wire) .. | 2 6 |

† All drilling free

IMPORTANT

IT IS WISE TO USE CORRECT PARTS

(Trade enquiries)

PRICE LIST OF ORIGINAL PARTS.

	£ s. d.		£ s. d.
1 Resistor ebonite panel, 16 in. by 8 in.	8 0	1 Marconiphone, type A, R.C.C. unit ..	8 0
2 Formo de Luxe .0005 mfd. variable condensers ..	12 0	2 Panel brackets ..	2 0
2 Earle slow-motion dials ..	7 6	1 Blue Spot 66K adjustable loud-speaker unit ..	1 5 0
1 Formo de Luxe .00035 mfd. variable condenser ..	3 0	2 Lissen 66-volt high-tension batteries ..	15 10
1 Small Knob with pointer ..	6 6	1 Lissen 9-volt grid-bias battery ..	1 6
2 Dubilier 1 mfd. fixed condensers ..	5 0	1 1½-volt dry cell, type U.W.1	1 0
1 T.C.C. 2 mfd. fixed condenser ..	3 10	2 C.A.V., type 2 N.S.9., 2-volt accumulators ..	1 4 0
4 Anti-microphonic valve holders ..	5 0	1 Piece of special cone paper, 8 in. square ..	9
1 Igranic high-frequency choke ..	5 0	1 Set of Igranic spring wander plugs ..	4 0
1 Wearrel two-pole two-way barrel switch with knob ..	3 9	4 Lectro Linx spade tags, 2 black and 2 red ..	8
1 Graham Farish 2-megohm grid leak ..	1 0	1 Ready Radio copper screening box ..	6 6
1 Graham Farish .0002 mfd. fixed condenser ..	1 0	1 Set of Indicating tabs ..	9
1 Ready Radio coil, with support ..	10 6	1 Ready Radio cabinet, with baseboard, loud-speaker, and frame aerial fittings ..	2 0 0
1 Graham Farish 20,000 ohm resistance ..	2 3	Wire for frame aerial (4 oz. 28 g.s.c.) ..	2 6
1 Graham Farish 10,000 ohm resistance ..	2 3	20 ft. Glasite, quantity of flex, screws, etc. ..	2 7
1 Graham Farish .002 Fixed Condenser ..	1 0	Complete set of valves, S.G., detector, L.F. and power ..	2 16 0
1 Cosor low-frequency transformer ..	1 1 0		

Inclusive Total - £14:6:0

Any part can be supplied separately
† Free blueprint with all orders over £2.

READY RADIO DISPATCH SERVICE

HOME AND ABROAD

INLAND

ALL orders despatched post free in sealed cartons, or by rail, carriage paid. Packing cases 2/6, credited on return.

OVERSEAS

ALL orders carefully packed and insured; all charges forward.
Cash with order or C.O.D.

STOP PRESS

In response to numerous requests from our old "Chummy" customers we are supplying a special conversion kit of essential parts, as shewn in red in the price list.

CONVERSION KIT £1-12-6

TEL. NO.
HOP 5555
(Private Ex.)

READY RADIO SUPPLY CO.
159, BOROUGH HIGH STREET, LONDON BRIDGE, S.E.1
Three minutes from London Bridge Stations

'GRAMS:
READY HOP 5555
LONDON.

Half-price **BLUEPRINT** Coupon Valid until July 31, 1929
FOR ANY ONE SET CONSTRUCTIONALLY DESCRIBED IN THIS ISSUE.

Send Free of **INFORMATION** Coupon Valid until July 31, 1929
IS NOT MORE THAN TWO QUESTIONS TO BE ASKED AT A TIME



Be sure of the trouble-free radio which every one is enjoying these days. Even if your set is getting on in years Philips Trickle Charger and H.T. Unit will bring it up to date.

Put the Trickle Charger in circuit and when you switch off the set for the night you automatically switch on the charger, which restores your L.T. Battery for the next programme. Very simple—only one movement of the switch. Very economical—no recharging bills, and Philips Trickle Charger is almost negligible in running costs. Very easy—no more journeys to and from the recharging station.

Save yourself time, money and trouble—fit Philips Trickle Charger to-day. Price 55/-

Philips H.T. Supply Unit for A.C. Mains, incorporating grid bias. Type 3003 £8-15-0

Modernise your radio set

PHILIPS
for Radio

PHILIPS, LAMPS LTD., RADIO DEPT., PHILIPS HOUSE, 145, CHARING CROSS ROAD, LONDON, W.C.2