

HOW RADIO HAS MADE "TALKIES" POSSIBLE

# Wireless Magazine

VOL. 9. No 50.

MARCH, 1929

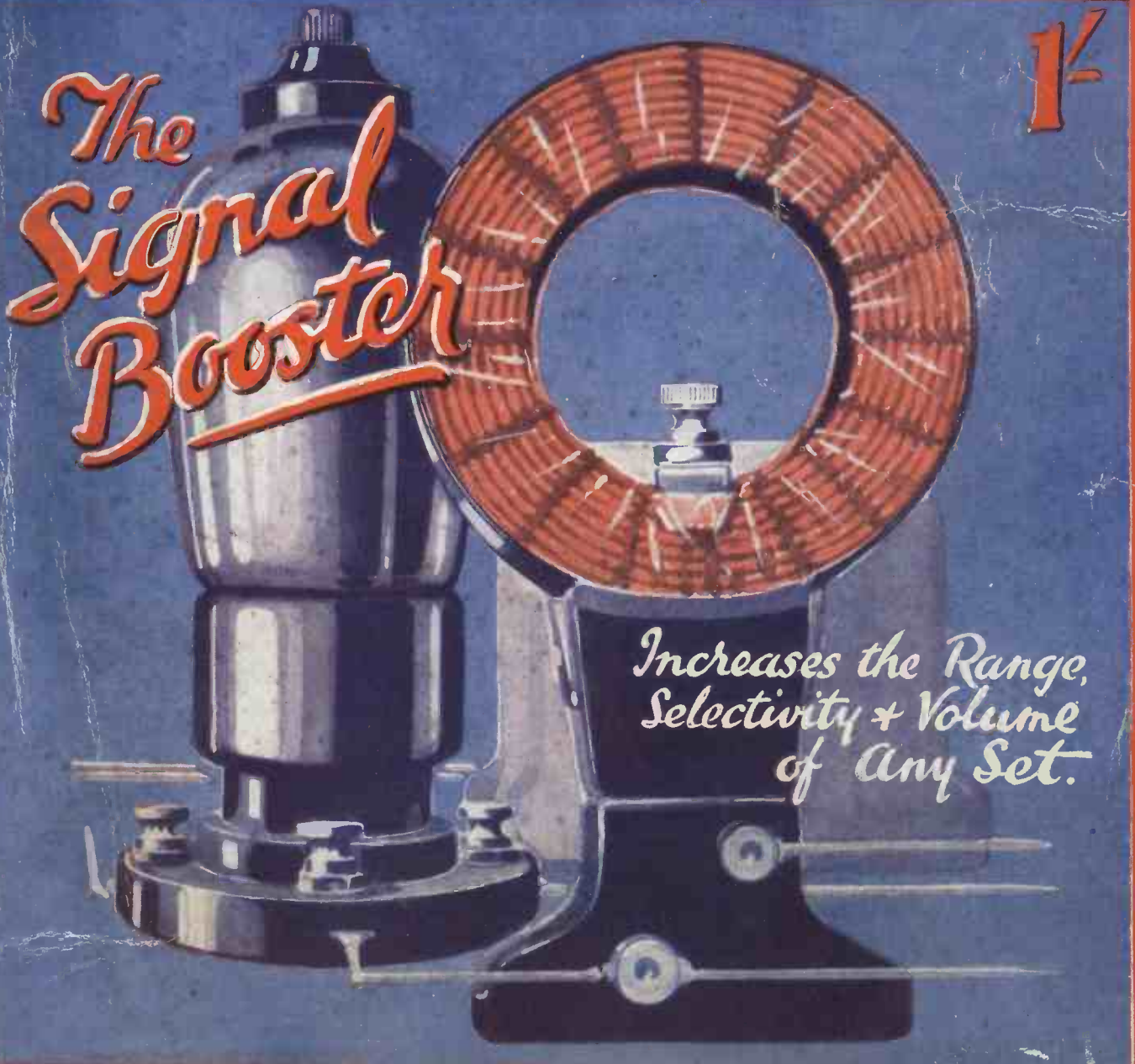

*The  
Signal  
Booster*

*Increases the Range,  
Selectivity + Volume  
of Any Set.*

14

FULL-SIZE BLUE-PRINTS FOR SIXPENCE OR NINEPENCE



# EVERY LEWCOS COIL IS DESIGNED SPECIALLY TO GIVE IMPROVED RECEPTION



**CENTRE TAPPED COIL**  
Pat. No. 271,384

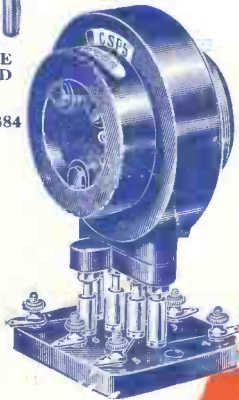

**SUPER COIL**  
Pat. No. 285,723

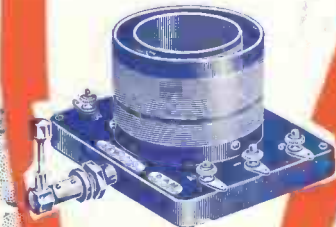

"Q" COIL

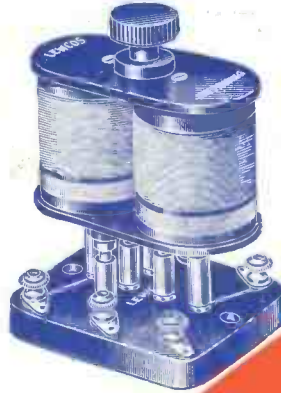

**BINOCULAR COIL**  
Pat. No. 277,876



H.F. CHOKE

LEWCOS engineers are occupied year in and year out on problems connected with the improvement of radio reception—inductive coupling, minimum self-capacity and low H.F. resistance—these are factors demanding continuous experiment and research, the result of which is shown in the remarkable superiority of LEWCOS Coils.

Many of the most successful receivers last year depended in a large measure on the high efficiency of LEWCOS Coils, therefore take the advice of the Technical experts of the "Wireless Magazine" and use LEWCOS Coils when you build the "Lodestone" and "Simple Screen Three" receivers described in this issue.

## LEWCOS

REGD.  
**RADIO PRODUCTS**  
THE LONDON ELECTRIC WIRE  
COMPANY AND SMITHS LIMITED  
Church Road, Leyton, London, E.10

Telephone: Walthamstow 253r.      Telegrams: Lewcos,  
Phone, London.  
Trade Counter and Cable Sales:  
7 Playhouse Yard, Golden Lane, London, E.C.1



H.F. TRANSFORMER  
FOR "TOUCH-  
STONE" RECEIVER



Editor :

BERNARD E. JONES

Technical Editor :

J. H. REYNER,  
B.Sc. (Hons.), A.M.I.E.E.

# Wireless Magazine

The Best Shillingsworth in Radio

Vol. IX :: MARCH, 1929 :: No. 50

Research Consultant :

W. JAMES

Assistant Editor :

D. SISSON RELPH

## Something for Everybody

**A**S I refresh my mind by glancing through the page proofs, I cannot help thinking that there is something for everybody in this issue—for the constructor, for the grammo-radio enthusiast, for the reader who wishes to increase his understanding of wireless phenomena and technicalities, and for those who enjoy general informative articles.

I find it difficult to put any one feature in the first place, but there is a very practical interest to be found in Captain Round's article, "A Trick with Your Portable."

"Those Talkies!" by Baynham Honri, is an excellent account of the production of talking films, the newest scientific amusement made possible by the use of the thermionic valve.

**GRAMO-RADIO** Grammo-radio people will carefully consider J. H. Reyner's answer to **HINTS** the question "Are Scratch Filters Worth While?" He shows that the reduction of scratch when using the pick-up is not so much due to any merit of the system of electrical reproduction as to the fact that both amplifier and loud-speaker cannot operate at the scratch frequencies.

Another grammo-radio article in this issue—that by Captain H. T. Barnett—is a guide to those who want the very best reproduction.

"Professor Megohm" this month is imparting much sound information to our Young Amp on the subject of the grid leak, which everybody knows all about until they are asked a few pointed questions.

**LODESTONE** On the constructional side, first **LOUD-SPEAKER** mention must be given to the Lodestone Loud-speaker, the operation and response of which are dealt with by the designer, W. James. I am particularly pleased with the results given by this loud-speaker, and there can be no question that the design marks a definite advance.

It is not the only Lodestone in this issue—there is the Lodestone Three, which uses the same coils as this designer's Touchstone Four, and either of these sets will be found to give very fine quality, especially if used in conjunction with the new loud-speaker.

There is a good "five"—the Fidelity Five—in this issue. I have had it in use myself for two or three months, and can answer for its purity of tone. It is a real music-lover's set. J. H. Reyner is responsible for the Simple Screen Three, a neat little set which achieves the fashionable note.

**A SIGNAL BOOSTER** Our cover is devoted to a most useful little addition which can be placed in front of any set. We call it the Signal Booster, and if any reader offers the criticism that we could have found a more English name we would like to reply that the word "boost" is believed to be an old English word borrowed by our American cousins.

This screened-grid H.F. device does exactly what its title suggests—it boosts the incoming signal, and with its help many an otherwise feeble set will be found of ample range and volume, while the selectivity will also be improved.

Do Not Overlook the Half-price Blue-print Coupon on Page III of the Cover

## CONTENTS

	PAGE		PAGE
Valves to Use in Your Set	108	What is Permeability?	141
Dangers of Political Broadcasting. Cartoon	111	The Fable of the "Goggetah"	142
Radio Dancing. By Fred Elizalde	112	Mains Matters	143
Scm R d o Epitaphs Verse	113	What Others Have Done with "W.M." Sets	144
Improving Broadcast Pictures. By D. Sisson Relph	114	<b>The Signal Booster.</b> Increases Range, Volume, and Selectivity	146
<b>The Fidelity Five.</b> A Powerful Set with Paralleled Output Valves	116	A Trick with Your Portable. By Capt. H. J. Round	151
Voice in the Ether	120	Women are Becoming Wireless Enthusiasts	153
		He Knew What's Watt!	153
		Those Talkies! By Baynham Honri	154
<b>GRAMO-RADIO SECTION</b>		Variety Was Ready. By Gracie Fields	159
<b>Damping and Record Damage</b>	121	The Letters of Priscilla Payne-Smythe	160
What's in a Name?	121	<b>The Lodestone Three.</b> W. James' Successor to the Famous Touchstone	161
Getting the Best Reproduction. By H. T. Barnett	122	Thinking Out a New Type of Aerial	166
The Plano-reflex Principle	123	Half Hours with the Professor: A Chat About Grid Leaks and Condensers	167
Keeping Records Clean Are Scratch Filters Worth While? By J. H. Reyner, B.Sc.	124	In Tune with the Trade! Broadcast Music of the Month	171
Indexing Records	125	Making Your Own Binowave Coils. By W. James	174
The Best Organ Records By H. T. Barnett	126	Continental Notes	178
		It Pays to Test Your Valves! By D. Sisson Relph	182
Problems for the B.B.C.'s Financial Wizards	127	<b>The Auditrol Unit.</b> A Two-valve Amplifier	186
New Wavelengths of Broadcasting Stations	128	Plays by Television	192
<b>The Simple Screen Three.</b> A New Receiver by J. H. Reyner, B.Sc.	129	Novelties and New Apparatus Tested	194
The Lazy Lover Verse	133	Reference Sheets	198
The Lodestone Loud-speaker. By W. James	134	Helping the Inventor	202
Under My Aerial	137	English as She Is Spoke	204
The Inceptor 3. Verse	139	Index to Advertisers	204
Results with the New-year Three. By J. Godchaux Abrahams	140		

Published by BERNARD JONES PUBLICATIONS, LTD., publishers of "Wireless Magazine" and "Amateur Wireless." Editorial and Advertisement Offices: 58/61 Fetter Lane, London, E.C.4. Telephone: City 3733, 3734. Telegrams: "Bejapee, Fleet, London." Published about the 25th day of the month and bears the date of the month following. Subscription: Great Britain and Abroad, 15s. 6d. a year, post free (Canada only, 15s. 6d.). Contributions are invited and will be promptly considered.



# mind the high notes!

**T**here's no need to worry about high-note loss if you use Ohmite Anode Resistances—they're non-inductive, and as the self-capacity is absolutely negligible the high-note loss usually attributable to Anode Resistances is nil. They'll carry the current too! Ohmites are built and guaranteed to carry 10 milliamps within their rated voltage and their values are accurate and constant. Megites also contribute to the efficiency of your set. Use them in place of your ordinary grid leaks and, in addition to preserving the top stuff, you'll get that much coveted silent background.

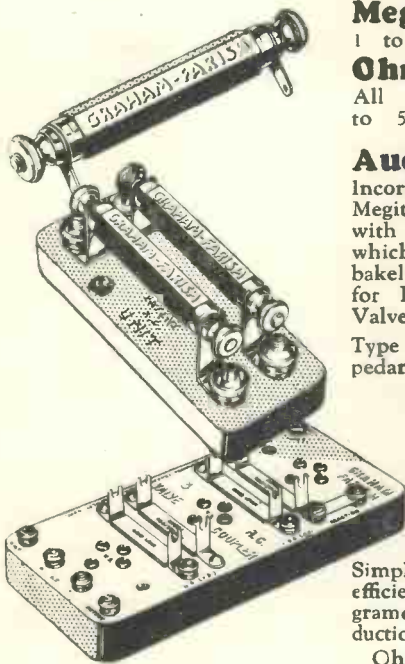

**Megites**  
1 to 5 megohms. **2/-**

**Ohmites**  
All values, 5,000 to 500,000 Ohms. **2/3**

**Audion R.C. Unit**  
Incorporates Ohmite and Megite Resistances together with a coupling condenser which is sealed into a bakelite moulding. Type 1 for High Impedance Valves. **5/-**

Type 2 for Medium Impedance Valves **5/6**

**3-Valve R.C. Coupler**

The R.C. Coupler is, in effect, a 3-valve resistance coupled amplifier and is designed to use Ohmites and Megites. Simple and remarkably efficient. The ideal unit for gramophone reproduction. **12/6**

Ohmites and Megites to suit your valves extra.

## GRAHAM FARISH

Advt. of Graham Farish Ltd., Bromley, Kent



### KNOW your VALVE VALUES

With the Ferranti Valve Tester you can test valves under actual working conditions whilst the Set valves in operation. Valve characteristics change with age, and you can keep in touch with these variations and trace the slightest distortion. The need for replacement may be ascertained beyond doubt, and the actual working voltages checked and adjusted.

Fitted in a neat Bakelite case, this handy Instrument gives the following readings at the mere turn of a switch: Plate volts, Plate current, L.T. volts, Grid-bias volts, and continuity of Grid circuits.

Price £5 : 15 : 0

## FERRANTI

FERRANTI LTD. HOLLINWOOD LANCASHIRE



### NORMA H.F. CHOKE

Especially wound to suit all B.B.C. stations. High-class job. The choke is protected from dust as the windings are glass enclosed.

**GUARANTEED PRICE 3/6**

**NORMAN HUNTLY**  
35, CLERKENWELL GREEN, E.C.1.

*Now on Sale.*

## Charles Letts's 1929 "AMATEUR WIRELESS" NOTEBOOK DIARY

88-page Reference Section. Full of Useful Information.

Prices : 1/6 and 2/6

Order from :  
"AMATEUR WIRELESS" OFFICE  
58 Fetter Lane, London, E.C.

# NOW! YOU CAN HEAR THE ROLLING OF THE D-r-r-r-u-m-m-s



**A wonderful new Transformer with a marvellous performance on the lower tones . . . .**

The Cossor L.F. Transformer gives new realism to the reproduction of any Receiver. It gives even amplification of all tones—from the roll of the drums to the piping of the piccolo. The wonderful reproduction of the famous Cossor Melody Maker is largely due to its Cossor L.F. Transformer. The Cossor L.F. Transformer will give better results in your Receiver—see it at your Dealer's.



**Price 21/-**

**The wonderful  
NEW**

*Made and guaranteed  
by the makers of the  
famous Cossor Valves*

# COSSOR L.F. TRANSFORMER

# Valves to Use in Your Set

## TWO-VOLT VALVES: Three-electrode Types

Make.	Type.	Impedance.	Amp. Factor.	Fil. Volt.	Fil. Cur.
Ediswan	RC2	150,000	30	2	.1
Mazda ...	RC210	86,000	40	2	.1
Cosmos ...	SP16B	70,000	35	1.8	.09
Six-Sixty	210RC	68,000	35	2	.1
Ediswan	RC210	67,000	40	2	.1
Cossor ...	210RC	60,000	40	2	.1
Mullard...	PM1A	51,000	36	2	.1
Marconi...	DEH210	50,000	35	2	.1
Osram ...	DEH210		35	2	.1
Mazda ...	HF210	28,000	20	2	.1
Six-Sixty	210HF	27,000	13	2	.1
Ediswan	HF210	25,000	20	2	.1
Marconi...	HL210	23,000	20	2	.1
Osram ...	HL210		20	2	.1
Mullard...	PM1HF	22,500	18	2	.1
Cossor ...	210HF	20,000	15	2	.1
Six-Sixty	210LF	18,000	8.5	2	.1
Cosmos ...	SP16G	17,000	16	1.8	.09
Mazda ...	GP210	14,000	13	2	.1
Ediswan	LF210	13,000	13	2	.1
Cossor ...	210LF	12,000	10	2	.1
Marconi...	DEL210		11	2	.1
Mullard...	PM1LF	11	2	.1	
Osram ...	DEL210	11	2	.1	
Mullard...	PM2DX	10,700	13.5	2	.25
Cosmos ...	SP16R	10,000	9	1.8	.09
Six-Sixty	215P	7,300	6.4	2	.15
Mazda ...	LF215	7,000	7	2	.15
Ediswan	PV215	6,600	8	2	.15
Cossor ...	220P	5,000	5	2	.2
Marconi...	DEP215		7	2	.15
Osram ...	DEP215	7	2	.15	
Cosmos ...	SP18RR	4,500	6.5	2	.2
Mullard...	PM2	4,400	7.5	2	.2
Cossor ...	220P	4,000	8	2	.3
Six-Sixty	230SP		3.9	2	.3
Mazda ...	P227	2,900	4	2	.27
Ediswan	PV225	2,700	3	2	.25
Mullard...	PM252	2,600	5.4	2	.3
Marconi...	DEP240	2,500	4	2	.4
Osram ...	DEP240		4	2	.4
Cossor ...	230XP	2,000	4	2	.3

## FOUR-VOLT VALVES: Three-electrode Types

Make.	Type.	Impedance.	Amp. Factor.	Fil. Volt.	Fil. Cur.
Mazda ...	RC407	100,000	40	4	.075
Six-Sixty	4075RC	64,000	34	4	.075
Ediswan	RC410	61,000	40	4	.1
Cossor ...	410RC	60,000	40	4	.1
Marconi...	DEH410		40	4	.1
Osram ...	DEH410	40	4	.1	
Mullard...	PM3A	55,000	38	4	.075
Ediswan	HF410	22,000	25	4	.1
Mazda ...	HF407	21,000	18	4	.075
Cossor ...	410HF	20,000	20	4	.1
Six-Sixty	4075HF	16,500	13	4	.075
Mazda ...	GP407	14,000	14	4	.075
Mullard...	PM3	13,000	14	4	.075
Ediswan	LF410	10,500	13	4	.1
Cossor ...	410LF	8,500	15	4	.1
Marconi...	DEL410		15	4	.1
Osram ...	DEL410	15	4	.1	
Six-Sixty	410P	8,000	7.3	4	.1

## FOUR-VOLT VALVES—Continued

Make.	Type.	Impedance.	Amp. Factor.	Fil. Volt.	Fil. Cur.
Mullard...	PM4DX	7,500	15	4	.1
Mazda ...	LF407	5,700	8	4	.075
Ediswan	PV410	5,500	5.5	4	.1
Marconi...	DEP410	5,000	7.5	4	.1
Osram ...	DEP410		7.5	4	.1
Ediswan	LF410a	4,500	9	4	.1
Mullard...	PM4	4,450	8	4	.1
Cossor ...	410P	4,000	8	4	.1
Six-Sixty	425SP	3,600	3.2	4	.25
Mullard...	PM254	3,500	3.15	4	.25
Mazda ...	P415	2,900	5.5	4	.15
Marconi...	P425	2,250	4.5	4	.25
Osram ...	P425		4.5	4	.25
Cossor ...	415XP	2,000	4	4	1.5
Ediswan	PV425		3	4	.25

## SIX-VOLT VALVES: Three-electrode Types

Make.	Type.	Impedance.	Amp. Factor.	Fil. Volt.	Fil. Cur.
Mazda ...	RC607	90,000	40	6	.075
Six-Sixty	6075RC	74,000	37	6	.075
Cossor ...	610RC	60,000	50	6	.1
Marconi...	DEH610		40	6	.1
Osram ...	DEH610	40	6	.1	
Mullard...	PM5B	53,000	40	6	.075
Ediswan	RC610	50,000	40	6	.1
Marconi...	HL610	30,000	30	6	.1
Osram ...	HL610		30	6	.1
Marconi...	LS5B	25,000	20	5.25	.8
Osram ...	LS5B		20	5.25	.8
Ediswan	HF610	21,000	25	6	.1
Cosmos ...	DE50	20,000	9	6	.09
Cossor ...	610HF		20	6	.1
Mazda ...	HF607	20,000	20	6	.075
Six-Sixty	6075HF	14,700	20	6	.075
Mullard...	PM5X		17.5	6	.075
Mazda ...	GP607	12,500	14	6	.075
Ediswan	LF610	10,000	15	6	.1
Mullard...	PM6D	9,000	18	6	.1
Cossor ...	610LF	7,500	15	6	.1
Marconi...	DEL610		15	6	.1
Osram ...	DEL610	15	6	.1	
Marconi...	LS5	6,000	5	5.25	.8
Osram ...	LS5		5	5.25	.8
Six-Sixty	610P	5,300	7.2	6	.1
Mazda ...	LF607		9	6	.075
Mullard...	PM6	5,200	7.1	6	.1
Ediswan	PV610	4,200	5	6	.1
Six-Sixty	625SP	3,600	3.2	6	.25
Cossor ...	610P	3,500	8	6	.1
Marconi...	DEP610		8	6	.1
Mullard...	PM256	3,500	3.15	6	.25
Osram ...	DEP610		8	6	.1
Ediswan	PV625	3,000	3	6	.25
Marconi...	LS5A	2,750	2.5	5.25	.8
Osram ...	LS5A		2.5	5.25	.8
Mazda ...	P615	2,600	6	6	.15
Marconi...	P625	2,400	6	6	.25
Osram ...	P625		6	6	.25
Cossor ...	610XP	2,000	5	6	.1
Mullard...	DFA9		5	6	.6
Mazda ...	PX650	1,750	3.5	6	.5
Ediswan	PV625A	1,600	4	6	.25
Marconi...	P625A		3.7	6	.25
Osram ...	P625A		3.7	6	.25



**FOUR-ELECTRODE VALVES: Screened-grid**

Make.	Type.	Impedance.	Amp. Factor.	Fil. Volt.	Fil. Cur.
Mullard...	PM12	230,000	200	2	.15
Six-Sixty	215SG	220,000	190	2	.15
Cossor ...	220SG		200	2	.2
Marconi...	S215	200,000	170	2	.15
Osram ...	S215		170	2	.15
Ediswan	SG215	140,000	140	2	.15
Mullard ...	PM14	230,000	200	4	.075
Six-Sixty	4075SG	220,000	190	4	.075
Cossor ...	410SG	200,000	200	4	.1
Ediswan	SG410	115,000	140	4	.1
Marconi...	S625	175,000	110	6	.25
Osram ...	S625		110	6	.25
Ediswan	SG610	100,000	140	6	.1

**FIVE-ELECTRODE VALVES: Pentodes**

Make.	Type.	Impedance.	Amp. Factor.	Fil. Volt.	Fil. Cur.
Ediswan	5E225	65,000	80	2	.25
Six-Sixty	230PP	64,000	80	2	.3
Mullard...	PM22	62,500	82	2	.3
Marconi...	PT235	55,000	90	2	.35
Osram ...	PT235		90	2	.35
Cossor ...	230QT	20,000	40	2	.3
Mullard...	PM24	28,600	62	4	.15
Six Sixty	415PP	27,000	60	4	.15
Cosror ...	415 QT	20,000	40	4	.15
Mullard...	PM26	25,000	50	6	.17

**MAINS VALVES: Three- and Four-electrode**

Make.	Type.	Impedance.	Amp. Factor.	Fil. Volt.	Fil. Cur.
Marconi...	S Point 8	200,000	160	.8	.8
Osram ...	S Point 8		160	.8	.8
Marconi...	H Point 8	55,000	40	.8	.8
Osram ...	H Point 8		40	.8	.8
Marconi...	HLPoint8	17,000	17	.8	.8
Osram ...	HLPoint8		17	.8	.8
Marconi...	P Point 8	6,000	6	.8	.8
Osram ...	P Point 8		6	.8	.8
Marconi...	KH1	30,000	40	3.5	2.0
Osram ...	KH1		40	3.5	2.0
Marconi...	KL1	3,750	7.5	3.5	2.0
Osram ...	KL1		7.5	3.5	2.0
Cossor ...	MRC	80,000	50	4	1.0
Ediswan	MI4IRC	50,000	45	4	1.0
Cossor ...	MHF	20,000	20	4	1.0
Cosmos ...	AC/G	17,500	35	4	1.0
Ediswan	MI4I	9,000	16	4	1.0
Cossor ...	MLF	8,000	8	4	1.0
Cossor ...	MP	6,500	5.5	4	1.0
Cosmos ...	AC/R	3,000	10	4	1.0
Cossor ...	MXP		3.5	4	1.0

*A glance through the constructional articles in this issue will give the novice some hints regarding the best valves for the various types of circuits*

*Fit a*  
**BRITISH GENERAL**  
**AERIAL TUNING UNIT and be sure of every wave-length**



Alterations do not affect the set which has a British General Tuning Unit, which covers ALL Wave-lengths between 250-2,000 metres. Plug-in-coils are designed for a very small range and with the new B.B.C. and Foreign wave-lengths you may find reception difficult. Fit a British General Tuning Unit and *make certain*. **18/6**  
 Easy fixing, simple tuning. Price **18/6**

From all good dealers or direct from—

**BRITISH GENERAL**

**MANUFACTURING CO., LTD.**  
**BROCKLEY WORKS, - LONDON, S.E.4**

DUBILIER  
for  
Durability

PRICE  
3/6



DUBILIER NEUTRALISING  
CONDENSER

This component is designed for baseboard mounting, and occupies very little space either vertically or horizontally. It has a maximum capacity of approximately 50 micro-microfarads and a very low minimum. At such an unusually low price it is proving a popular component.

*If unobtainable from your dealer write direct to us giving his name and address.*

DUBILIER  
CONDENSERS

Advt. of Dubilier Condenser Co. (1925) Ltd., Ducon Works, Victoria Road, N. Acton, London, W 3

**LISSEN  
VARIABLE  
CONDENSER**

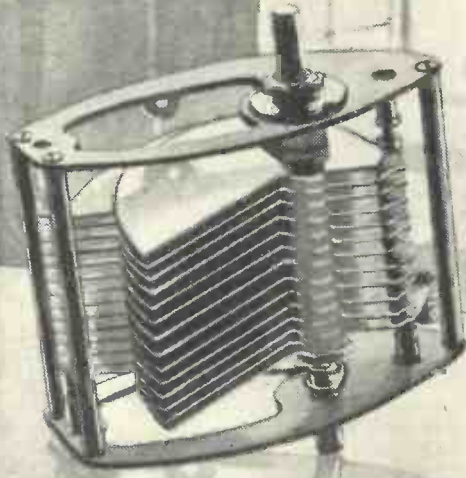

**FREE AND FACILE  
TUNING**  
*full strength  
tuning*  
**BECAUSE OF  
NO-CONDENSER-LOSS**

—a new and definite improvement in tuning, a new ease in separating stations close together, a new standard of low-loss efficiency, and a new standard of value for money—that is what the Lissen Variable Condenser offers you.

See the rigid, unshakable construction, yet note the entire absence of pressure on the end plates or vanes. See the long bearing, and extended spindle for ganging, the feet for base-board mounting, the new and convenient position of the fixed vanes terminal.

Compare it with any condenser at any price whatever—remember it can be used in any circuit and is practically everlasting—remember it is a low-loss condenser such as you have never before been able to buy at these prices:—

**LISSEN**  
**LOW-LOSS  
VARIABLE  
CONDENSER**

.0001-mfd. capacity	...	...	5/9
.0002-mfd.	"	...	6/-
.0003-mfd.	"	...	6/-
.00035-mfd.	"	...	6/3
.0005-mfd.	"	...	6/6

Obtainable from all Radio Dealers.

**LISSEN LTD.**

16-20, Friars Lane,  
Richmond, Surrey

(Managing Director,  
THOS. N. COLE)

**LISSEN**  
**REACTION  
CONDENSER**

Embodies many of the exclusive features of the big Lissen Condenser, including no end pressure on any end plate to distort frame or vanes.

"A" TYPE 4/-

"B" TYPE, with insulated bushes for mounting on panel.  
Price 4/6

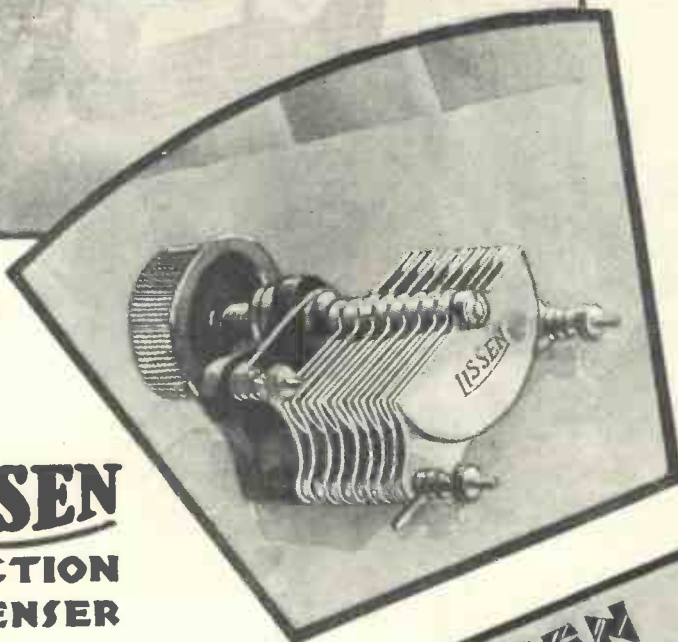



## DANGERS OF POLITICAL BROADCASTING



WIFE : ' What on earth is the matter, John?'

HUBBY : ' It's all right, my dear, only a difference of opinion on the de-rating question!''



Introducing Fred Elizalde of "Savoy Music" fame

# Radio Dancing

FRED ELIZALDE, of "Savoy Music" Fame Tells "W.M." Readers How to Get the Best Out of It

**D**ANCING to radio syncopations? Well, there seem to me to be at least four aspects. They all apply particularly to radio dancing, which is very different from dancing to a real orchestra, or even to a gramophone.

### Four Important Points

Firstly, learning to dance, which you can do very comfortably by radio. Secondly, *what* to dance: this is important with the younger set, who already are tired of the haunting languor of tango and waltz, and want some new fashionable steps. Thirdly, how to use a receiver to the best advantage for dance purposes. Fourthly and finally, there is dance music from the point of view of the unseen orchestra—unseen, of course, to perhaps a million listeners, though "in the flesh," to a much smaller number in a cabaret.

I suppose I did learn to dance! But that was years ago before the banjo-playing and Mah Jong crazes cropped up, so I can't profess to be expert on this side of radio education. Personally, I think that without treading on the toes of dancing instructors, the B.B.C. could do even more helpful work than it does in

step, and waltz is being varied by the Charleston, tango and so on, not forgetting the Yale.

You dancers don't take kindly to new-fangled ideas, and for my part I am content to introduce variation by novel orchestration: the dance orchestra plays such a large part in making a success of a dance.

I don't think you should place too much stress on this question, for you'll find every dance party finding its own familiar steps, when you switch on the loud-speaker, despite prevailing fashion. In the privacy of your own room you can *enjoy* dancing without having to worry what the Joneses across the way think of your wife's fox-trotting or dance frock

### Suitable Receivers

I have seen many a nateur receivers and I know that the WIRELESS MAGAZINE plays a most important part in advising its readers of technical developments able to improve a large-output set for dance work. Plenty of volume is essential, for it's hard to believe the "mush" created by even a dozen couples dancing, and the music must always be clearly audible!

inducing people to dance. The loud-speaker is a good dancing master, because you can take his counsel in private.

What to dance is a problem settled for you by fashion, which wireless is helping to form. The eternal round of fox-trot, one-

Speaking as a non-technical enthusiast, but as one able to appreciate the average dance-enthusiast's needs, I should say that a three-valve set (with two stages of L.F. amplification) is satisfactory within a range of ten miles or so from a main station. This combination, with a large loud-speaker, will comfortably fill a medium-size room.

### No Technical Authority

An extra amplification stage with a "super"-power valve or a push-pull arrangement will be needed for giving ample volume at a greater range, or for filling a small hall; but please don't quote me as a technical authority. I find many suitable sets on glancing quickly through a few of the past issues of this journal.

Here is one technical point, though, which does give me the opportunity to put in a spoke. Every set for dance purposes should have provision for electric reproduction of a gramophone. It is so easy to do this, with a pick-up, that I wonder it is not almost a standard arrangement, and not only for dance music.

With some receivers I have heard it has taken perhaps two or three minutes to change from radio to gramo, and *vice versa*. This is a trouble which I know need not exist, and a plug and jack, or a simple switching arrangement, will make the change over almost instantaneous.

### Announcing the Items

One other point, which does not come directly within my sphere. There should be provision for bringing into use a simple microphone in order to announce the names of items *via* the loud speaker when records are being reproduced electrically.

Perhaps one day the B.B.C. will be



able to provide an alternative programme of almost continuous dance music, though who could carry on such a never-ceasing babbling brook, I don't know!

Until then gramophone is the easiest way out of the difficulty, for the B.B.C. obviously is limited in the dance-music time it can allot. With a gramophone as a stand-by (and with electric reproduction, of course) one has an almost unlimited source of syncopation.

### Plenty of Good Dance Records

There are plenty of good dance-band gramophone recordings, and if you can work the instrument in conjunction with the radio amplifier (so that the volume is sufficient for dance purposes) you will find it more of a temptation to put on a record or two for a "hesitation," "glide," or "drag," particularly if the B.B.C. is dumb at that time, or is putting over a housewifery talk.

Now for dance music, so far as the orchestra is concerned; and spare me a little sympathy, for I don't think

It is my opinion that old-fashioned "hot" methods of playing have given way to more melodious, but still highly rhythmic presentation. This is just what the wireless listeners and dancers want, for "stunt" playing does not go down well unless one can see the performers.

*Per contra*, scantily-varied jazzing becomes monotonous after a time, and after an hour or so of straightforward and perhaps dull playing the dancer unconsciously looks to the motionless loud-speaker for inspiration!

It really is difficult to convey to the radio dancer a happy medium of style. So many dancers do not appreciate the manner in which a typical orchestra is composed. A saxophone, a piano and a kettledrum is a combination which is the comprehension by some people of an ideal orchestra!

### Scientific Balance

A scientific balance has to be obtained between alto and tenor "saxes," piano, violins, trumpets, banjos, drums, and all the gamut of instruments in a high-class orchestra.

Our cartoonist's impression of Fred Elizalde



arrange in advance some difficult matters of instrument balance and performer-position (in conjunction with an unusual orchestration) going only by guess-work, and with previous broadcast experience as a guide.

### Complaints

If even a slight mistake is made, so many hundreds of thousands of dancing belles will turn to their swains and complain in this wise: "Elizalde's rotten; that saxophone man must have been sitting on top of the microphone." Or, perhaps: "That band sounds all bass drum."

Well, too much of that kind of thing is bad for an orchestra's reputation, and frays dancers' tempers. So to avoid such errors, you see, the dance orchestras have much hard work to do before those few golden hours (or mayhap only a golden twenty minutes) in the presence of the almighty Mike.

### Enthusiasm

But I'm enthusiastic about radio dancing, and have no hesitation in advising all listeners to make the utmost use of their receivers to this end. See that the L.F. amplifying side of your set is in order, and that the loud-speaker is capable of delivering a sufficient flow of pure music.

Don't spoil my hard work in orchestration by low-frequency distortion!

*Fred Elizalde*

## SOME RADIO EPITAPHS

*Suggested by J. W. Pape*

*Here lies the sad remains of a low-class engineer,  
Who didn't know the difference 'twixt a volt and an ampere.  
We buried him darkly at dead of night.  
He got too much high tension and blew out his light.*

*Here lies buried the body of Pogston,  
A radio "ham" from Little Hogston.  
He turned quite thirsty and drank some acid,  
Now here he lies so calm and placid.*

*Here lies the body of Archie Kidd,  
Who thought himself an electron on the grid.  
They put him in a home for lunatic chaps,  
And now he is crying, "Clixie Snaps."*

*And here we have interred the body, stiff and stark,  
Of Claude Herbert Samuel Benjamin Anthony Darke.  
He tried to charge his battery from electric mains I'm told,  
But he mixed the charge up somewhat and we found him stiff and cold.*

you appreciate all the difficulties. The chief trouble is that we leaders have to please the tastes of so many. If you play "straight" you are termed uninteresting, while, if your orchestration is elaborate or curious, you are dubbed a creator of cacophony.

"Cheap," "cacophonous," "puerile," "barbarous," these are some of the terms we get from our almost unknown contributors and correspondents who class all syncopated music as "jazz."

This is hard to achieve in the ordinary way, and still more difficult for gramophone recording.

For gramophone work, with electrical recording, one has to consider the tricky points about studio and "mike," but there is always the consolation that a repeat recording can be made if there is any error of orchestration or balance.

Radio can't allow this! Things must be right first time, and often I have had to

# Improving Broadcast Pictures

By D. SISSON RELPH



A "Dot and Carrie" cartoon from the "Star," transmitted by the Fultograph system on January 15. The lettering would have been better if the paper had been drier

CONSTANT experiments are being made to improve the quality of pictures broadcast by the B.B.C. from Daventry 5XX by the Fultograph system, which I have already fully described in the WIRELESS MAGAZINE (December, 1928, and January, 1929).

### Fruitful Results

These experiments are concerned both with transmission and reception; moreover, they are proving fruitful and already the pictures that can be received daily are very much better than those sent out two months ago.

At this stage, I must point out

that the reproductions which appear in these pages are examples of wireless pictures at their worst—in receiving them I have broken nearly all the rules. For instance, one is told to leave the paper to dry for five minutes (after it has been soaked in the potassium iodide—starch solution) before using it. In most cases I have simply dried the paper between sheets of blotting paper and then put it directly on the cylinder.

Having received the pictures, it is necessary to take certain precautions to prevent them from fading. They should be dried in front of an electric fire for about two minutes and stored in the dark.

In each case I have dried my pictures by means of a coal or gas fire and consequently they have been affected by the fumes and are not as good as they might otherwise be.

Nevertheless, it will be seen that the pictures are of reasonably good quality and anybody with a Fultograph machine can reasonably expect to get better reproductions than those shown here.

### Photo-electric Transmitter

The improvement at the transmitting end is of considerable importance. It will be recalled that at first the picture to be transmitted was transferred on to a copper plate treated with insulating varnish. As a needle point traversed the copper a current flowed when it came in contact with untreated portions, and no current could pass when a film of varnish came between the needle and the cylinder.

In the new system a photo-electric cell is used. This means that the copper foil is dispensed with. Not only is the photo-electric method cheaper (the copper foils were quite expensive and two were made of each picture, in case of accidents), but it also gives greatly improved results.

### Photographic Negative Used

Instead of using a copper foil, the actual photographic negative is wrapped round the cylinder, which is traversed by a point of light. The



How the Fultograph machine is connected up

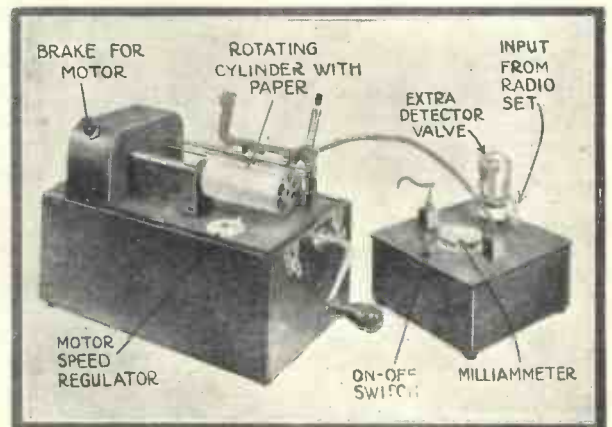

Another view of the complete Fultograph gear



intensity of the light passing through the negative depends, of course, on the density at that particular point, and so more or less light falls on the photo-electric cell—a device that converts changes in light intensity into varying electric currents.

### Remarkable Quality

Some weeks before a public demonstration was given, I was privileged to see this photo-electric transmitter in operation. It is capable of producing pictures of remarkably good quality and is undoubtedly the greatest advance that has yet been made. By the time this issue is published, it is probable that it will be in general use.

So much for the transmitter. What improvements are being made at the receiving end? It will be evident that to a great extent the quality of the picture depends upon the surface of the paper on which they are reproduced.

Many different kinds of paper are being tried and it is possible that a more suitable kind will be found than that at present supplied. Different ways of applying the solution are also receiving attention, and important developments can be expected in this connection. It is possible, for example, that it may be found possible to supply the paper already "doped" in a dry condition, in which case it would only need damping with water.

### Times of Transmission

One of the greatest drawbacks about wireless pictures is the inconvenient time (to most people) at which they are transmitted. Very few people can spare time from 2 to 2.30 p.m. on a week-day to operate a receiver, and it would be a great step towards making the scheme more

popular if the transmissions could be sent out from Daventry 5XX every night from, say, 9 to 9.30 p.m.

This problem is, I learn, also receiving attention. The object of sending the pictures out in the afternoon is that it is a convenient time for public demonstrations to be made.

A scheme is now announced for the supply of complete kits of parts for

his own rod, and buy the remainder.

It is possible that a clever mechanic could make everything for himself except the magnetic clutch. The work is, however, beyond the resources and capabilities of the average wireless enthusiast.

Apart from these purely technical developments, there is also an interesting possibility regarding administration. So-called "secrets" to the



This picture has faded slightly and the reproduction hardly does the original justice. It was received from Daventry 5XX on January 19

the amateur who desires to construct his own picture machine. The parts are identical with those employed in the standard Fultograph receiver, and it is understood that the complete kit will be priced at about £16.

Any amateur who has a flair for the use of simple workshop gear will be able to make such of his own parts as he desires. He could turn up his own cylinder, for instance, and thred

effect that there will be an amalgamation between the Fultograph and Baird television interests are circulating freely (at the time of going to press); a director of Wireless Pictures (1928), Ltd., has admitted that negotiations are taking place.

Should the "still" picture and "moving" picture interests combine, interesting developments can be expected in a few months.

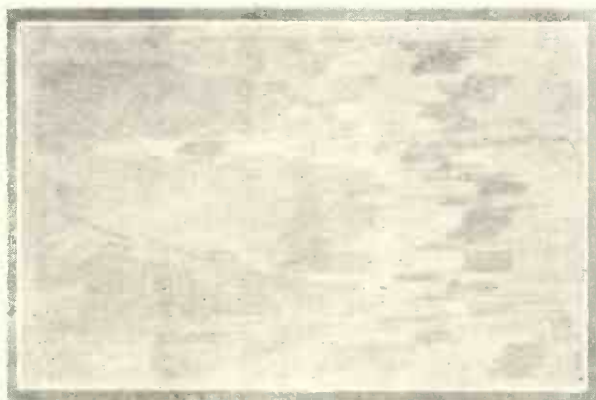

An example of what happens when the machine is put out of synchronism by interference—in this case, morse jamming Vienna (which transmits every day)

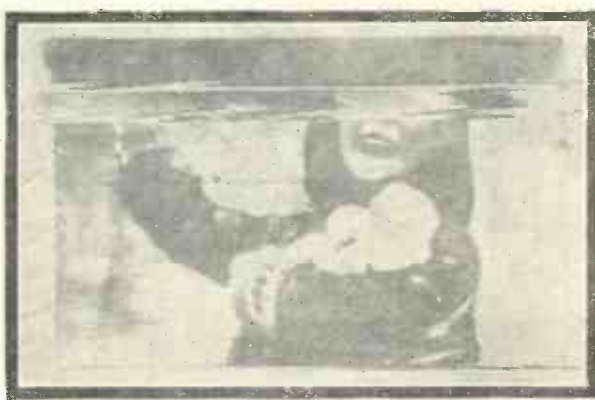

The top part of this picture—sent from Daventry on January 16—was lost because a valve in the radio receiver burnt out! It was quickly replaced

# The FIDELITY FIVE

A RECEIVER WITH SUFFICIENT POWER TO OPERATE EVEN THE LARGEST OF LOUD-SPEAKERS WITH ABSOLUTE PURITY, AND GIVING THE ADVANTAGE OF ELECTRICAL REPRODUCTION OF GRAMOPHONE RECORDS AS WELL AS THE CHOICE OF MANY BRITISH AND CONTINENTAL BROADCAST PROGRAMMES

COMPRISES NEUTRALISED H.F., DETECTOR, AND TWO R.C. COUPLED L.F. STAGES (LAST TWO VALVES IN PARALLEL)

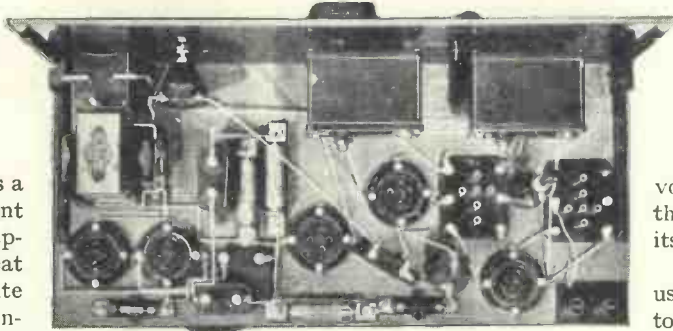

Plan view of baseboard of the Fidelity Five

A SPECIAL DESIGN FOR THE RADIO CONNOISSEUR, PRODUCED BY THE "W.M." TECHNICAL STAFF AFTER PROLONGED EXPERIMENT

ANYBODY who wants a powerful and efficient "four-five" valve set, capable of achieving great ranges, yet giving absolute purity of reproduction, cannot do better than build the Fidelity Five. This set has been used for a period of months by the Editor of the WIRELESS MAGAZINE in his Surrey home, where it has given complete satisfaction.

### Secret of Its Success

Everything about the Fidelity Five is straightforward—and therein lies its success. Components of the very best makes have been used throughout, and everything possible has been done to ensure purity of reproduction whether the station received is ten miles or 1,000 miles distant.

Not only can the receiver be relied upon to pick up numerous alternative programmes from all parts of the Continent, at almost any hour of the day or night, but it is also specially intended for the electrical reproduction of gramophone records.

In fact, the Fidelity Five is a set of which anyone might be proud—it brings the world's best musical and dramatic talent straight into the home, where it can be enjoyed in comfort whenever desired.

### Four or Five Valves

It has been mentioned that the set is a "four-five." In other words, either four or five valves can be used at will. The last two power valves are in parallel, and in cases where great

volume is not required, one of them can be removed from its holder.

When all five valves are in use, the volume is sufficient to operate any moving-coil loud-speaker and, by choosing valves with appropriate impedances, the set can be adjusted to "match" any kind of reproducer.

### THE EDITOR'S OPINION OF THE SET

*THE Fidelity Five has been in use by me for two or three months—frankly not so much as a "five" as a "four", in connection with a moving-coil loud-speaker.*

*It is a reasonably selective set of considerable range,*

### High-frequency Coupling

Range—not the greatest possible, but enough for all normal purposes—is assured by a single stage of high-frequency amplification. This is carried out with an ordinary three-electrode valve which is coupled to the detector by means of a split-primary transformer (see circuit reproduced on page 118).

It will be seen from the circuit diagram that the primary winding is tapped at 4, a connection from this point being taken to high-tension positive. This arrangement enables neutralisation to be carried out so that the receiver is quite stable in operation. Between point 3 and the grid of the valve is the neutralising condenser, the adjustment of which is explained later.

### What Neutralising Does

Because of the small capacity which exists between the grid and plate of the valve, a small portion of the amplified energy in the plate circuit leaks back to the grid circuit. The object of the neutralising condenser is to feed an equivalent amount of energy back to the grid, but in the reverse direction.

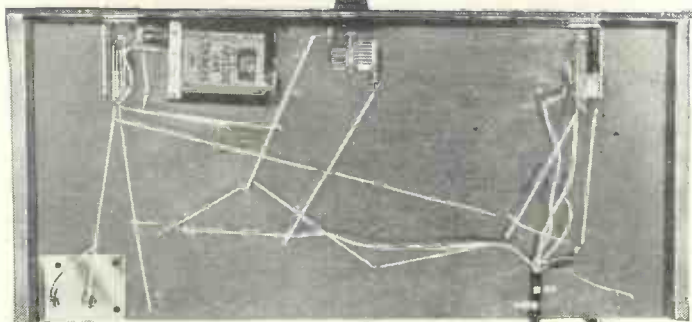

Under baseboard view of the Fidelity Five

*and while I won't occupy space with a list of the stations heard on it, I may say that the list includes many of the British stations and a large number of the Continentals.*

*As a music-lover's set I recommend it, the quality of reproduction being remarkably pure and "lifelike".*

THE EDITOR.



The energy flowing back through the valve and through the condenser being equal and opposite, the effect is that no energy leaks back through the valve. When this condition is obtained (by fine adjustment of the condenser), the valve capacity is said to be neutralised or balanced.

The aerial circuit consists of a single tapped winding, tuned by a .0005-microfarad variable condenser. The object of tapping the coil is to increase the selectivity, the tuning being much sharper when the aerial is connected to point 3 than when it is connected to point 4.

**How Reaction is Obtained and Utilised**

But to revert to the high-frequency anode circuit again. It will be seen that the secondary is tuned by another .0005-microfarad fixed condenser. The part of the winding tapped off between points 2 and 6, in conjunction with a .0001-microfarad variable condenser, gives a reaction effect, enabling the operator by adjustment of the condenser to regulate the amount of energy fed back from the anode circuit of the detector valve to the grid circuit and thus to control regeneration or reaction.

Reaction in a receiver, when properly used, is a most valuable quality. Not only does it enable great ranges to be covered with otherwise simple apparatus, but it can also be brought into play in order to sharpen tuning and thus separate stations which would otherwise be difficult to get at all.

**Combination**

It will be observed that the combination employed is a stage of neutralised high-frequency amplification, a detector and one resistance-capacity coupled low-frequency amplifier in turn coupled to two power valves in parallel, also by the resistance-capacity method.

There are two reasons for using an anode-bend detector, as is done in this case. In the first place, it introduces little damping across the tuning circuit and, therefore, tuning is kept sharp. The second reason is that an anode-bend detector is not so easily overloaded as one working on the leaky-grid principle, and thus perfect quality is assured.

A battery cord is used instead of terminals

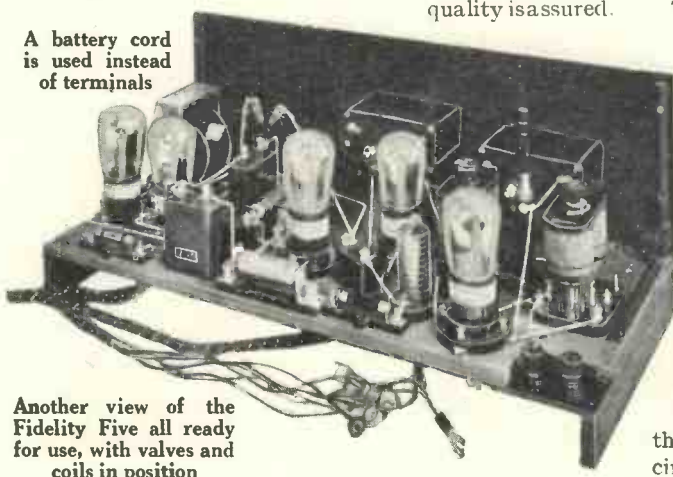

Another view of the Fidelity Five all ready for use, with valves and coils in position

Note the neat appearance of the Fidelity Five

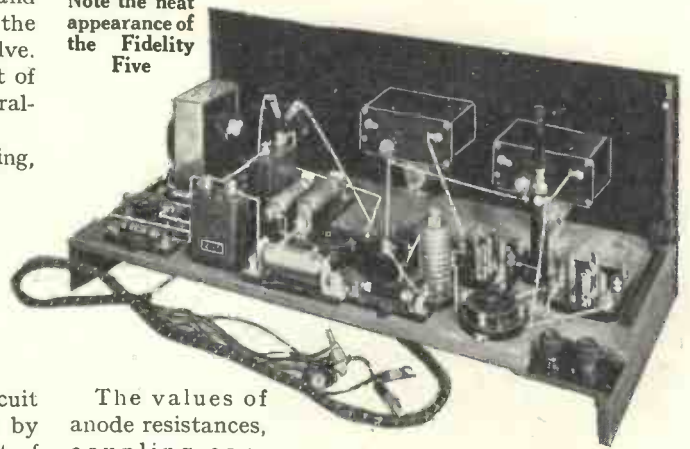

The values of anode resistances, coupling condensers and grid leaks for the two low-frequency stages have been chosen so that the bass frequencies are reproduced in adequate proportion. Each stage is also provided with a "motor-boat" stopper, which takes the form of an extra 50,000-ohm resistance in series with the anode resistance and a 2-microfarad fixed condenser.

"Motor-boating" is a term applied to unwanted low-frequency oscillations which arise in the low-frequency circuits; the effect is exactly as if one were receiving a relay of a motor-boat race. "Motor-boating" occurs only with high-tension battery supply when the cells begin to run down and develop a high resistance; it commonly occurs when the high-tension is obtained from a mains supply unit.

**For Mains Working**

The inclusion of "stoppers" in the Fidelity Five means that high-tension batteries can be used much

longer than would otherwise be the case without "motor-boating" developing and, if desired, the anode supply can be taken from a mains unit without any trouble occurring.

Volume is controlled by varying the value of the grid leak associated with the first low-frequency amplifier. The further the tapping is taken towards the grid end of the high-resistance potentiometer used as a grid leak the greater is the volume.

The advantage of using two valves in parallel is well known to most amateurs. It enables one to get the greatest possible power for operating a loud-speaker. It must be remembered, though, that when two valves are in parallel the effective impedance of the combination (assuming both to have identical characteristics—as, indeed, is essential) is half that of either of the valves on its own.

**Effect with 3,000-ohm Power Valves**

In other words, if the valves used have an impedance of 3,000 ohms each, the impedance of the two in parallel will be only 1,500 ohms. (In push-pull amplification the total impedance is double that of either valve used.)

With valves in parallel, it will be appreciated that the anode current flowing in the loud-speaker circuit will be heavy, and is, therefore, liable to

## The Fidelity Five (Continued)

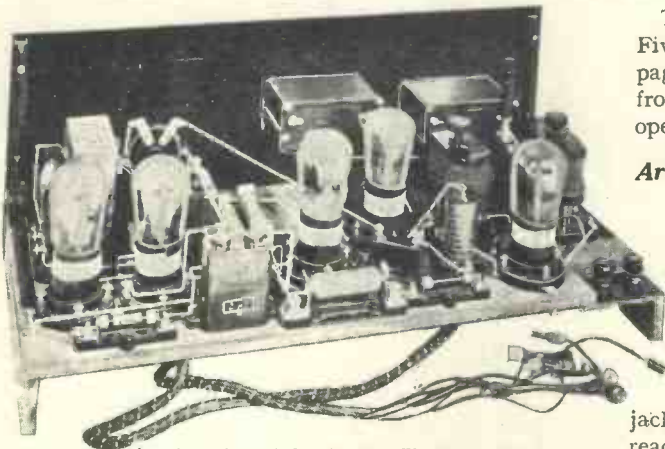

Another view of the Fidelity Five all ready for use

cause damage to the loud-speaker windings.

For this reason a choke-output circuit is employed. The direct current from the high-tension supply flows unimpeded through the comparatively low resistance of the choke, but the loud-speaker is insulated from the direct current by a fixed condenser of 4 microfarads capacity. Fluctuating signal currents, however, are able to pass through the condenser and thus actuate the loud-speaker.

### Special Switching

Note should be made of the methods of switching the Fidelity Five. In the anode circuit of the parallel valves is a jack. Insertion of a plug connected to the loud-speaker into this jack (a P65) automatically completes the filament circuits and the set is switched on. Conversely, withdrawal of the loud-speaker plug switches off the receiver.

In the grid circuit of the detector valve, another jack is included. This enables a gramophone pick-up to be put in circuit when it is desired to reproduce gramophone records through the medium of the low-frequency amplifying portion of the set and the loud-speaker. The pick-up is connected to a plug, and when this is inserted in the jack (a P63), the filament of the high-frequency valve is switched off.

### No Metal Screening Necessary

Constructors will observe that no metal screening is provided between the tuning circuits. This is unnecessary, as astatically wound coils (having practically no external field) are utilised.

The photographs show how handsome the Fidelity Five is; a view of the complete receiver is reproduced on page 117. In spite of its apparent complexity, as judged from the circuit, the set is by no means difficult to operate, as a glance at the front panel will show.

### Arrangement of the Operating Controls

Across the middle of the panel will be seen two knobs. The first (small one) controls the aerial-tuning condenser; the centre dial (a large one of the slow-motion type, because this circuit needs much more critical adjustment), tunes the anode circuit; while the last knob is that of the potentiometer, used as a volume control.

Along the bottom of the panel are arranged the jack for plugging in the gramophone pick-up; the reaction condenser (immediately underneath the slow-motion dial); and the jack for plugging in the loud-speaker and switching on the set.

Not only is the set easy to operate; but its construction is not beyond the capabilities of the average home-

constructor. In fact, with the aid of a full-size blueprint, even the novice can undertake the building of the Fidelity Five.

### What the Blueprint Shows

The blueprint shows the positions and sizes of all the holes to be drilled in the panel (it can be used as a template) and the positions of every component. Moreover, it indicates the best sequence of wiring.

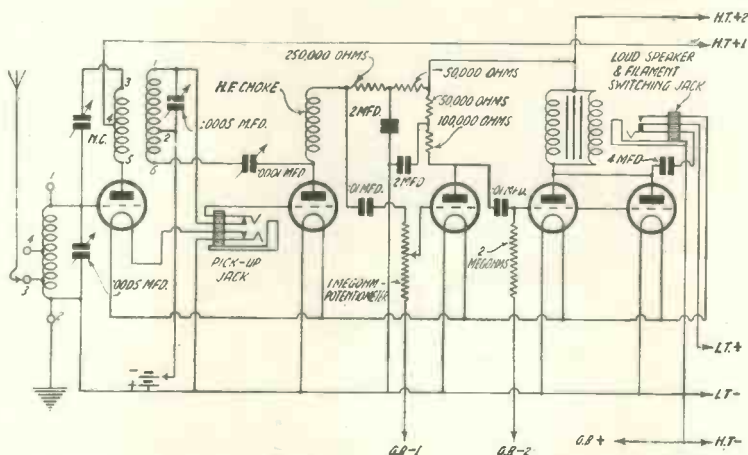

This is the circuit employed in the Fidelity Five. Note that the last two valves are in parallel

All the points to be connected together first are lettered *a*. When these points have been wired, all the points

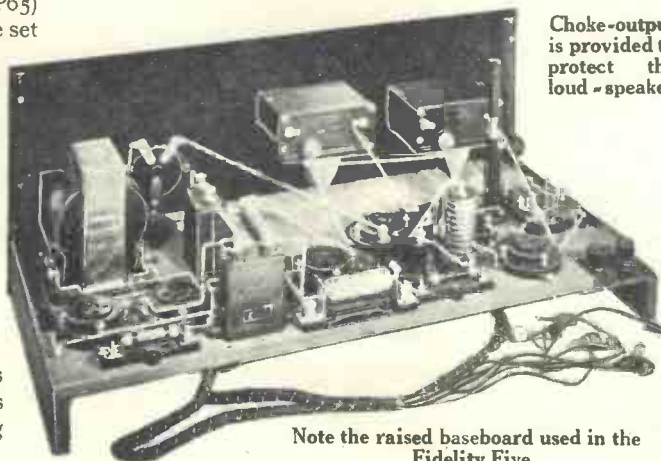

Note the raised baseboard used in the Fidelity Five





## The Fidelity Five (Continued)

## VOICE IN THE ETHER

*Voice in the ether, song in the night,  
Bringing me pleasure and real delight,  
Where do you come from? Nobody knows—  
Out of the Continent, I suppose.  
Are you from Langenberg, Berne, or Bordeaux,  
Madrid or Motala, Milan or Malmo?  
But now you are speaking; there's a twang in your talk—  
Oh, can it be true—are you really New York?  
"Schenectady calling!" Oh, marvellous thing!  
Across the Atlantic you're going to sing;  
It's long after midnight, the world is in bed,  
But here I am sitting with phones on my head,  
And as the old clock in the corner strikes two,  
I sit at my wireless and listen to you.  
Ah, dear little maiden at WGY,  
I list to your song with a whimsical sigh;  
To some one, no doubt, you appear very real,  
A lovely and beautiful creature, I feel,  
But there! I don't worry; I list and rejoice,  
For to me you are just a Divine Little Voice!*

P. C. P.

the Lewcos BAC5 and BSP5; for the long waves, BAC20 and BSP20.

An eight-way battery cord has been used, instead of terminals, and the connections are as follows: L.T. + and L.T. - to accumulator of the same voltage as the valves to be used; H.T. +1 to 120 volts; H.T. +2 to 150 to 180 volts; G.B. -1 to 1½ to 4½ volts negative; G.B. -2 to 9 to 36 volts, as recommended by the manufacturers. Connections to G.B. + and H.T. - are obvious.

**Special Bias Battery for Detector Valve**

Normally 1½ volts negative should be applied to the grid of the detector valve.

The aerial and earth must be taken to the two terminals provided on the baseboard, two holes being drilled in the side of the cabinet for their insertion. The loud-speaker is connected to one plug and the gramophone pick-up to another.

To operate the set, insert the appropriate valves and coils in their holders (the BAC coils are for the aerial, and the BSP coils for the high-frequency circuit).

**Switching the Set On**

Turn the volume control as far to the right as possible (for maximum volume), and turn the reaction condenser to the minimum position. Now put the loud-speaker plug into the right-hand jack to switch the set on.

Adjust the centre (slow-motion) dial to about the middle of the scale and then adjust the reaction condenser until a very slight rustling or hissing is heard from the loud-

speaker. If no sound is heard however the aerial condenser is adjusted, turn the reaction control a little and again, adjust the aerial condenser.

As soon as a point is found where the set sounds "live," turn both aerial- and anode-tuning controls in unison and in the same direction until a station is picked up. When a signal is heard, readjust both tuning circuits and the reaction control for the best results. The volume control can be used if the station is too loud.

**How to Neutralise**

To neutralise the set (a procedure that will be necessary when changing from one waveband to another), first tune in a station as loudly as possible; next remove one of the filament connections from the holder of the high-frequency valve, and turn the

neutralising condenser until the signal becomes inaudible. The set is then neutralised and the filament connection can be replaced. Note that while this adjustment is being made the valve must not be removed from its holder.

To use the set for gramo-radio simply push the pick-up plug into the left-hand jack. Regulate the volume by means of the volume control. There is no need to adjust the tuning or reaction controls.

There is no doubt that the Fidelity Five will meet the needs of many WIRELESS MAGAZINE readers and we shall look forward with interest to their reports. Let us know what you think of it when you have built it!

**COMPONENTS REQUIRED FOR THE FIDELITY FIVE**

- |  |   |
|--|---|
| 1—Ebonite panel, 20 in. by 8 in. (Becol, Parfait, or Raymond).         | 1—4-microfarad fixed condenser (Dubilier, T.C.C., or Mullard).                  |
| 2—.0005-microfarad variable condensers (Burndept, Utility, or Cyldon). | 1—.25-megohm grid leak with holder (Mullard, Graham-Farish, or Ediswan).        |
| 1—Slow-motion dial (Burndept, Igranic, or Formo).                      | 1—2-megohm grid leak with holder (Mullard, Graham-Farish, or Ediswan).          |
| 1—Small slow-motion dial (R.I. and Varley).                            | 2—50,000-ohm resistances with holders (Dubilier, Ferranti, or R.I. and Varley). |
| 1—.0001-microfarad reaction condenser (Bulgin, Cyldon, or Ormond).     | 1—100,000-ohm resistance with holder (Dubilier, Ferranti, or R.I. and Varley).  |
| 1—1-megohm potentiometer (Igranic)                                     | 1—Output choke (Igranic type G, Ferranti, or Parmeko).                          |
| 2—Plugs and jacks (Igranic, types P63 and P65).                        | 1—Terminal strip, 3 in. by 2 in.  |
| 2—Six-pin coil bases (Lewcos).   | 2—Terminals, marked: Aerial, Earth (Belling-Lee or Ealex).                      |
| 5—Anti-microphonic valve holders (Lotus, Formo, or Marconiphone).      | 1—4½-volt tapped grid-bias battery (Siemens type G1 or Ever-Ready).             |
| 1—Neutralising condenser (Gambrell or Jackson Bros.).                  | 1—8-way battery cord (Lewcos).  |
| 1—High-frequency choke (Wearite, Lewcos, or Igranic).                  | 1—Cabinet with 9 in. baseboard (Edwards or Caxton).                             |
| 2—.01-microfarad fixed condensers (Dubilier, T.C.C., or Mullard).      | 2—Binocular aerial coils (Lewcos).  |
| 2—2-microfarad fixed condensers (Dubilier, T.C.C., or Mullard).        | 2—Binocular BSP coils (Lewcos).   |



# Wireless Magazine *Gramo-Radio Section*

A SPECIAL SUPPLEMENT FOR THOSE INTERESTED IN  
THE ELECTRICAL REPRODUCTION OF GRAMOPHONE  
RECORDS—THE FIRST OF ITS KIND TO BE PUBLISHED

## CONTENTS

<i>Damping and Record Damage</i>	-	121
<i>What's In a Name?</i>	-	121
<i>Getting the Best Reproduction.</i> By H. T. Barnett, M.I.E.E.	-	122
<i>The Plano-reflex Principle</i>	-	123
<i>Keeping Records Clean</i>	-	123
<i>Are Scratch Filters Worth While?</i> By J. H. Reyner, B.Sc.	-	124
<i>Indexing Records</i>	-	125
<i>The Best Organ Records.</i> By H. T. Barnett, M.I.E.E.	-	126

### DAMPING AND RECORD DAMAGE

YOU know, of course, that if a pick-up with a heavily damped reed is used, record wear will be increased tremendously, and may be as much, or even greater, than when a normal sound-box is in use.

#### A Necessary Evil

Reed damping is, with normal types of pick-up, a necessary evil, because too much play in the reed and needle carrier results in "tinniness" and loss of strength on the low notes. This does not hold true, of course, with pick-ups of the dual mass-suspension type, but only in cases where the reed is supported in rubber, and so on.

In certain instances cheap pick-ups may be too heavily damped, however, and it is impossible to tell the amount of damping simply by moving the needle-holder with the fingers. A practical test is the only safe way of knowing.

#### Piano Records Useful

A record of a pianoforte solo is very useful for such a test, for with musical items like these it is easier for a non-musical listener to pick out any faults. The piano is an instrument to which nearly everyone is accustomed, whereas flaws in orchestral or choral intricacies might pass unnoticed.

In general, too much damping



CANTOPHONE  
GRAMO-RADIO  
EQUIPMENT

Illustrated here is a combined all-electric (for A.C. or D.C. mains) gramophone and five-valve all-wave receiver. A volume control is provided and provision is made for plugging in two extra loud-speakers if desired.

There is space for storing 42 records and an automatic repeating device.

No external aerial or earth are needed for the radio set, although provision is made for their use. All the current is taken from the mains.

This instrument is made by the Cantophone Wireless Co., of 310 Regent Street, W.1.

will cut down the volume seriously (though up to a point this does not matter, because an extra stage of L.F. can always be used if additional purity justifies it) and undue prominence will be given to the bass notes. The general tone, too, may sound "woolly."

Insufficient damping, on the other hand, will most probably accentuate the higher notes at the expense of the bass. MAC.

### WHAT'S IN A NAME?

A GRAMOPHONE is just a gramophone, and no more; but a gram-radio outfit is—well, it must stay at gram-radio outfit. There is no one name which can be given, despite a tendency to talk of

such apparatus as a gram-radio. This is impossible grammatically, for "gramo" is an adjective and the use of the expression "a radio," as a noun, is an Americanism.

Even "gramophone" was not always the name given to what we now recognise as such. A gramophone is, of course, different from a phonograph, and the first records were called phonograms. Edison always used to call the recorder the phonet and the reproducer the phonograph. Bell's graphophone was invented about ten years later.

Does any of this mixture of names suggest to radio enthusiasts a substitute for the clumsy combination of words "gramo-radio receiver"?  
QUEUE.



Records are stored flat in the Sesame cabinet, a model of which is seen here

ASSUMING that your records are all of true centre, that they cannot slip on the turn-table, that your needle-track alignment is good, that your needle angle is  $50^\circ$ , that the needle is not canted or tilted sideways or carrying too much weight, and that the needles themselves are well chosen, then there is only one point needing attention, so far as mechanical matters are concerned, and that is to use in combination such a pick-up and such a tone-arm that chatter is not produced when a record is being played.

### Objectionable Chatter

I know from experience that the distribution of weight and consequent leverage under needle action is in many pick-ups very different from that obtaining in gramophone sound-boxes, and that this may cause a most objectionable and destructive chatter.

If you are tied to a particular tone-arm or pick-up carrier you may find it necessary to try various pick-ups before you get one with which the reproduction is perfectly smooth.

Conversely, if you are tied to a particular pick-up you may find that one tone-arm or carrier will permit chatter and that another will not.

Be quite sure you do not mistake

# Getting the Best Reproduction

In this article H. T. BARNETT, M.I.E.E., explains how to choose the best combination of pick-up and tone-arm to avoid chatter when records are being reproduced. He also reviews some cabinets for storing records

blasting of the loud-speaker for chatter; if the latter is present it may usually be heard by placing the ear quite near to the pick-up when the record is rotating and the wireless set is entirely disconnected.

### Flexible Coupling

Sometimes a more or less elastic or flexible coupling to the pick-up—such, for example, as a piece of rubber tubing or a sound-box adaptor or two—may reduce chatter; but any capacity for vibratory oscillation in the sound-box or pick-up is to be deprecated, because, although it may increase the tone volume obtainable, particularly in the bass, it always causes a lot of record wear.

The more rigid the connection of the sound-box or pick-up to its tone-arm or carrier, the better it will be for your records, so long as chatter is not produced.

A particularly good tone-arm—the best I know for the long acoustic system type of gramophone—is the Crescent, made by Vernon Lockwood, Ltd., of City Road, E.C.1. Its price is 21s.

It makes an excellent pick-up carrier because it gives good alignment with about 8 in. length between base centre and needle. It is H.M.V fitting.

An inexpensive but rather short carrier arm for pick-ups, priced at 3s. and made by Edison Bell, Ltd., of Glengall Road, S.E.15, is now obtainable. It is Continental fitting at the neck.

The long arm may readily be bent when setting the track align-

ment, and this is sometimes a great convenience.

When you have a gramophone, instead of removing the sound-box every time you wish to use the pick-up, it is better policy to fit a special carrier arm for the pick-up, and then either electrical or mechanical reproduction can be used as desired without a moment's delay.

The Continental fitting pick-up suitable for this carrier arm is also an Edison Bell product, and priced at 27s. 6d.

### Permanent Adaptor

The plug is put into the detector valve socket, and then the valve is put into the socket on the top of the plug. It may be left there permanently, because it does not interfere with ordinary wireless reception; the double plug connector is to be joined up when one wishes to play a record—that is all.

The materials used in the manufacture of records are very hygroscopic. When records are made of glass (tough Jena glass), as, no doubt, some day they will be, this is a trouble we shall not have to bother us.

At present, however, it is essential, if records are to retain a smooth, glassy surface, that they should be stored in such a way that air cannot circulate over them or over *even the edges* of envelopes in which they are kept.

If they are in albums, the albums *must* be kept in close, dry cabinets, cupboards, or drawers, or else, when we get a spell of wet

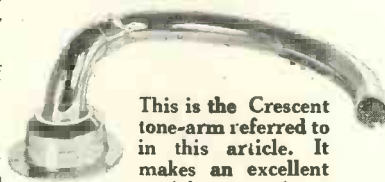

This is the Crescent tone-arm referred to in this article. It makes an excellent pick-up carrier



weather, the paper of the album will absorb moisture from the air and rapidly transfer it to the surface of the record, which will then rapidly roughen.

### Proper Storage Cabinet

Far better than keeping one's records in albums is to deal boldly with the question directly the first record is purchased and to obtain a storage cabinet or a filing system that can be fitted into some cabinet or cupboard of one's own.

The Sesame storage cabinet is now well known and is made in many models, both plain and ornamented. The records are stored

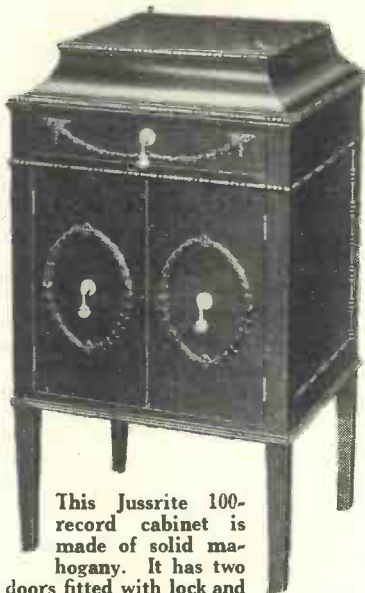

This Jussrite 100-record cabinet is made of solid mahogany. It has two doors fitted with lock and key and a drawer for accessories

flat, and therefore do not tend to warp, and even if warped when received soon flatten out again.

Although stored flat, they are presented on edge when the cabinet is opened, the actual record box swinging over outwardly (on trunnions) as soon as the releasing key is turned.

Boumpfrey, Arundel & Co., Ltd., of 1 Whitcombe Street, Pall Mall East, W.C.2, are the makers.

### For One or Two Hundred Records

For one or two hundred records of 12-in. size this will be found a very useful container, although it is a little difficult to get records out from the back.

I store all my own best records, when reviewed, in cabinets or in a cupboard fitted with the very in-

expensive (cheaper than albums) Jussrite filing system.

Records of all sizes can be grouped together indiscriminately. Each record container bears a number tab, and any record can be got out in a moment directly it has been selected from the catalogue sheet.

The records are hung vertically in bag containers, close enough together to prevent records from warping; normally the fronts of all the bags are flush, but when one desires a certain record the number tag on the bottom of the bag is pulled forward, the bag with it, and then it is easy to catch hold of the record and withdraw it.

The bag remains forward until, in returning the record, one restores it to its normally flush position.

The manufacturers of the system, both in cabinets and in sectional models for fitting into one's own cabinets, are the Murdock Trading Co., of 59 Clerkenwell Road, E.C.

The acid grease from one's fingers will attack record material and damage it as quickly as water will do. *Never touch a record except at the extreme edge.*

### Removing Moisture

Every time you take a record out to use it lay it on a flat surface, and give it a good firm wiping round and round the grooves with a velvet polishing pad (I use a threepenny one from Woolworth's); this will remove any dust, and also possibly any film of moisture that may have become deposited upon the record on bringing it out into the air.

## The Plano-reflex Principle

A GRAMOPHONE enthusiast friend recently raved to me about the advantages of the new plano-reflex principle as applied to tone arms. It supersedes swannecks and similar devices, the idea being that by flattening the curved portions of the tone-arm positive reflection of the sound waves is obtained.

Possibly the idea could be adapted for loud-speaker horns, and it rather convinces one that the last has not yet been heard of developments in horn-type loud-speakers. The gramophone manufacturers still use sound chambers based on old loud-

speaker practice, and it is common knowledge that the better makes are putting up a hard fight against electrical-reproduction machines.

In other words, horn-type reproducers are vying with moving-coil reproducers, and the moral seems obvious. For really loud public-address work, engineers often put the sound output of a moving-coil loud-speaker through a type of logarithmic horn to obtain the maximum volume. Similar instruments, with horns based on plano-reflex principles, may yet see the light of day for ordinary amateur use. QUEUE.

## Keeping Records Clean

A BSENCE of surface scratch and longevity of a record depend very largely on whether or not the record surface has been kept clean. Dust, grit, and particles of the record composition itself act as abrasives if allowed to accumulate, and it is not always an easy job to make sure that all harmful dirt is removed.

Brushing over the record surface with rag is worse than useless, for, instead of being removed, the gritty particles are frequently forced deep into the sound grooves, which in time may break down the track and result in excessive background hiss.

The correct method takes time. Smear a few drops of fine oil over the record and rub it well into the sound channels with a soft silk duster.

### Shifting Dust with Needle

Play the record over, using a very fine "pianissimo" needle, which will shift dust from the bottoms of the grooves. Wipe over the surface with a dry portion of the duster, play it over again with a normal-volume needle, and finally polish with a pad of velvet.

A lengthy process, but one which will cut down the record expenses.

B. MARSHALL.

J. H. REYNER, B.Sc., A.M.I.E.E., Answers the Question—

# Are SCRATCH FILTERS Worth While?

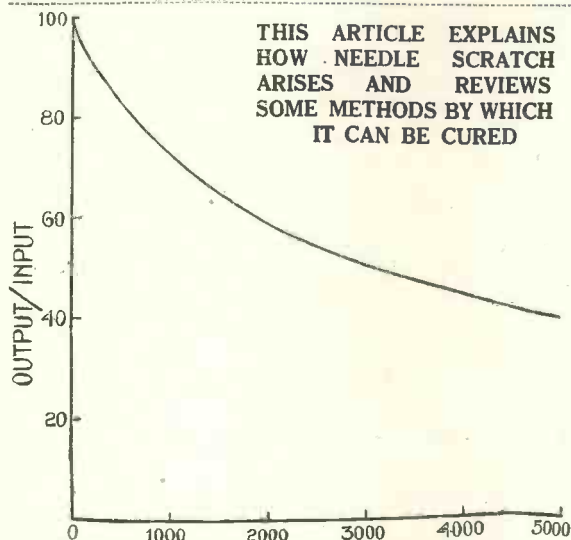

Fig. 1.—Effect of shunt condenser of '015-microfarad capacity

ONE encounters varying opinions on the subject of electrical gramophone reproduction. One of the features claimed for the system is the decrease in the scratch which it is said accompanies the reproduction of a gramophone record.

On the other hand, you will meet people who claim that the scratch is, if anything, worse than with mechanical reproduction. It is significant that the original claims for absence of scratch are not made with such freedom nowadays, whereas, on the other hand, one hears comments on all sides as to the desirability of utilising some method for eliminating the scratch.

## Real Truth of the Matter

The truth of the matter is that in many cases scratch is noticeably reduced when electrical reproduction is adopted. This, however, is not so much due to any inherent merit of the electrical pick-up itself or due to any abhorrence on the part of the electrons to scratch *per se*, but because the amplifier, and even more the loud-speaker, are incapable of achieving the frequencies in which the scratch predominates. To some extent the pick-up response curve is a factor in determining

the amount of scratch which is reproduced.

Any analysis of scratch on a record is a very difficult matter. The scratch is principally caused by friction between the needle and the walls of the groove in the record, while the point of the record bearing upon the bottom of the track is also responsible. Which of the two exercises the preponderating effect

depends upon the type of sound-box or pick-up used.

Theoretically, unevennesses in the bottom of the record groove, which imparts a vertical motion to the needle, should have no effect upon the sound-box or pick-up. This is not achieved in practice, but it is clear that the relative effect of this type of motion upon the scratch

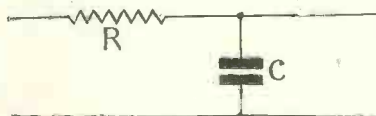

Fig. 2.—Resistance in series with condenser

depends essentially upon how close the particular reproducer is to the ideal.

Scratch, therefore, cannot be considered as taking place at any given frequency. It is found, however, that a great deal of the more noticeable scratch occurs in the upper registers, somewhere in the neighbourhood of 4,000 cycles per second and upwards.

If we cut off the higher frequencies the scratch becomes less noticeable and this is what takes place in a large number of amplifiers and

loud-speakers. We talk glibly of the necessity for reproducing frequencies of 6,000, 7,000, and 8,000 cycles per second. There are, however, a limited number of loud-speakers which will reproduce such high frequencies at all satisfactorily.

## Top Frequencies Lost

Many loud-speakers cut off, to all intents and purposes, even before 4,000 cycles per second is reached, while even if the loud-speaker is tolerably efficient at this point, the amplifier usually assists in losing the top frequencies.

The result, therefore, is that scratch appears to be less noticeable while the tone has a fictitious mellowness which sounds rather pleasant at first, but soon begins to pall owing to the lack of brilliance. It is becoming increasingly recognised that the upper frequencies are necessary for naturalness, and that the mellow tone so often considered desirable is a snare and a delusion!

We are, therefore, faced with two incompatible requirements. In order to minimise the noticeable scratch from a record we must cut off the frequencies above 4,000 or so. In order to retain brilliance and crispness of reproduction with true fidelity, so that, for example, a violin does not sound like a flute, then we must retain as much of the higher frequencies as we can, even up to, and including, 8,000 cycles per second.

## Striking a Compromise

Obviously we must strike a compromise between these two and this is determined entirely by the conditions under which reproduction is taking place.

If the loud-speaker and amplifier combined do not reproduce efficiently above 4,000 cycles, then the scratch will be fairly small, and we can reduce it to a vanishing point by including a scratch filter, cutting off all frequencies above this point. This will eliminate the remaining trace of scratch without



upsetting the quality since the reproducing system as a whole cannot do any better.

### When We Can Afford to Cut Off

As we increase the effectiveness of the reproducing system, including the amplifier and the pick-up, so that the upper registers are more satisfactorily reproduced, then it is clear that we can afford to cut off less and less of the high tones and when we reach the state of the nearly perfect equipment which can be evolved to-day, we must then definitely decide to lose a certain amount of the upper registers in order to combat scratch.

Tests made at the Furzehill laboratories indicate, as far as can be judged, aurally, that with a good loud-speaker and reproducing equipment, naturalness can be retained if a scratch filter is inserted which begins to cut off at 5,000 to 6,000 cycles per second and this may be taken as a fair average value under most practical conditions.

### A Simple Method

We have then to consider the manner in which we can cut off the upper frequencies above a certain limit without affecting the frequencies below this point. One of the ways of reducing the effect of the high frequencies is to shunt a condenser of suitable value across the source of supply.

This is clearly not a satisfactory method, however, because it will exercise a gradual effect, cutting down the frequencies to an increasing extent somewhat in the manner shown in Fig. 1.

### Losing Brilliance

From this curve, it will be seen that the input has been reduced considerably in the frequencies above 5,000, but that the frequencies in the immediate vicinity, that is, from 3,000 to 5,000 have also suffered serious curtailment and we should undoubtedly lose much of the brilliance we desire to retain.

We can, however, improve the performance by inserting a resistance in series with the condenser, as in Fig. 2. The initial voltage is applied across the two in series, while the output voltage is connected across the condenser. The impedance of the resistance remains constant irrespective of frequency,

whereas the voltage developed across the condenser falls off as the frequency is increased.

The proportion of voltage, therefore, applied across the output terminals is dependent upon the relative impedance of the condenser and the resistance. This is a simple type of "low-pass" filter.

Still better filters can be obtained by inserting a choke in series with the condenser, instead of a resistance. This is another form of low-pass filter and by using a sufficient number of sections, it is possible to make the cut-off almost as sharp as one desires, so that the curve

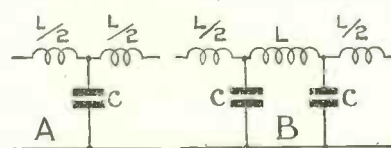

Fig. 3(a).—Single section of low-pass filter

Fig. 3(b).—Two low-pass filter sections in series

becomes almost square-topped.

Fig. 3(a) shows a single section of a low-pass filter and Fig. 3(b) shows two of these sections in series giving a two-section arrangement. It will be noted that the complete section not only includes an inductance before the condenser, but also after it, this being to avoid reflection, an effect which I shall discuss in a further article. In a multi-section filter, therefore, the middle inductances are all twice the value of the terminal inductances, this being a feature of a properly-designed arrangement.

Fig. 4 shows the type of curve obtained with a two-section filter, as shown in Fig. 3(b), with appropriate values for the different components. It will be seen that the frequencies below the cut-off point are quite well maintained, and that a fairly sharp cut-off results at the actual critical frequency.

Next month I propose to give

data showing how the cut-off can be made to vary in accordance with the constants of the filter, so that it will be possible for those readers who are interested to design their own scratch filters, and to try them on their own equipment.

### INDEXING RECORDS

NO matter how efficient are the record-storing arrangements (and they *should* be efficient if the records are worth keeping), it is often difficult to know just which record is which.

The discs should be stored horizontally, and this may render it no easy matter to affix name tags to the record covers so that they are clearly visible. A good plan is to gum to one corner of each record cover a small numbered or lettered tag. These numbers or letters can correspond with an index kept on a separate shelf.

### Use of Pocket Note-book

A pocket note-book with cut-out marginal alphabetical index is very useful for this, for in most books of this kind quite a number of entries can usually be made on one page, and the records can be numbered A1, A2, A3, and so on, until one alphabetical section is complete, and then B1, B2, B3, etc.

If desired, a second book may be kept in which the record titles are given in alphabetical order, and obviously for this a marginal-index book is just the thing. "MAC."

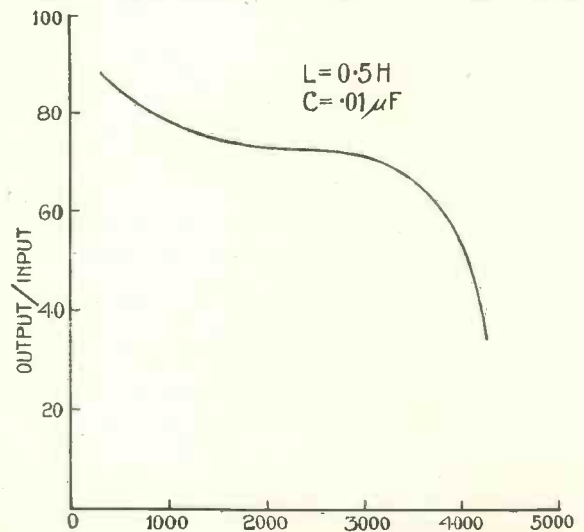

Fig. 4.—Curve obtained with two-section filter as shown in Fig. 3(b)

# The Best Organ Records

TO me there are two kinds of satisfaction derivable from music: the mental pleasure (including the emotional) arising from following the invention of the composer and performers in melody, harmony, and rhythm with those variations of time and volume that may be called expression, and another, a purely physical content, that I feel when my body is *bathed in musical vibrations*.

## Physical Joy of the Organ

I love to sit right beside a concert grand piano when a vigorous performer is at work, and I love better still to sit in some roof concentration of grand organ-tone when some majestic composition is being played; if the composition is a good one, then so much the better; but even if there is not much invention in the music, so long as the glorious instrument is saturating me with musical tone the physical joy remains.

No doubt the same feeling, unexpressed and therefore subconscious, is at the root of the affection so many feel for the grand organ, notwithstanding its marked inferiority to the grand orchestra in the complexity of musical ideas it is able to portray.

## Where Radio Comes In

Only valve amplification and a modern loud-speaker (or two) can put enough energy into the air to give a grand organ record the *physical* superiority to an orchestra justifying its rendition to a musical audience in these days of unlimited magnificent orchestral recordings.

Many hundreds of organ records have passed through my hands

By H. T. BARNETT, M.I.E.E.

since electrical recording began, but only a few of them render music of a kind that is much more interesting on an orchestra, and with such volume and solidity as to make one feel enthusiasm for the intrinsic grandeur and magnificence of the organ used.

Of course, with 100 tracks to the inch it is impossible to record the fundamental of 32 ft. tone proportionally, the success of recording deep pedal tone so that it shall be convincing lying in the generation and recording of the friendly groups of harmonics when we hear them recreate in our brains (and perhaps in our floors and ceilings) the *impression* of the fundamentals (or the actual frequencies) from which they were derived.

In my opinion the best of the whole group, be it remembered strictly from the physical point of view, is *Easter Hymns* (3s., B2274, H.M.V.). It is played by Herbert Dawson on the organ of Kingsway Hall. An organist friend tells me the 32-ft. tone on this organ is 'synthetic.' If that is the case I wish all organs used for recording had a synthetic 32-ft. stop. Certainly the trumpet stop is the best I ever heard.

Next to this there are three, the two new Columbia discs made on the Lyons Cathedral organ by Edouard Commette, *Toccata*, Gigout (9497, 4s. 6d.), and *Fantasia in G Minor*, Bach (9552, 4s. 6d.), with *Epilogue on the "Old 100th,"* played by Stanley Roper at St. Margarets, Westminster (C1682, H.M.V., 4s. 6d.).

A record fully as brilliant as these, but a little less full in the deep bass, is *Fantasia and Fugue on B.A.C.H.*, Liszt, played by Guy Weitz on the organ of the Romish Cathedral at Westminster (C1351, H.M.V., 4s. 6d.).

## Full-blooded Examples

Full-blooded examples of other organs that particularly appeal to me are as follows:

The Albert Hall: *Land of Hope and Glory*, played by Reginald Foort (C1529, H.M.V., 4s. 6d.).

Temple Church: *Sonata on 94th Psalm* (presumably an extract), Reubke, played by G. Thalbin Ball (B2788, H.M.V., 3s.).

Central Hall, Westminster: *Storm*, Meale, played by Arthur Meale (B2347, H.M.V., 3s.).

Whitefields Tabernacle: *The Tempest*, Shaw, played by Spencer Shaw (Winner, 2s.), and *Merchant of Venice Marches* (Winner, 2s.). The numbers are 4587 and 4767.

Canterbury Cathedral: *Scipio* (march), Handel, played by Dr. Palmer (B2542, H.M.V., 3s.).

## Magnificent Tone

Now, in addition to these organ-only records, there are two records in which there is magnificent organ tone in combination with that of other instruments. The first is *Hallelujah Chorus*, Handel, played by Paul Mania, with some assistance by a trumpet (E10760, Parlophone, 4s. 6d.), and *Trumpet Voluntary*, Purcell, with *Solemn Melody*, Davies, played by the Hallé Orchestra, with the organ of the Free Trade Hall, Manchester (L1986, Columbia, 6s. 6d.).

## Is There Anything You Want To Know?

Whatever you want to know about grammo-radio, consult the "Wireless Magazine" Technical Staff. For many months they have kept abreast of this latest development and can reply to any query that may be raised in connection with it.

If your pick-up does not give the results you think it should—if your amplifier is not quite distortionless—in fact, if you are in trouble of any sort, the Technical Staff can put you on the right track.

So that the Staff is not absolutely overwhelmed with

queries (and to avoid the trouble of answering any of a frivolous nature, which results from a free service) a nominal fee of 1s. is charged for every two questions asked.

Write your query or queries (not more than two can be answered for each reader) on one side of a sheet of paper and send it, together with a stamped addressed envelope, a postal order for 1s. and the coupon from page iii of the cover, to Grammo-Radio Queries, "Wireless Magazine," 58/61 Fetter Lane, E.C.4.



# Problems for the B.B.C.'s Financial Wizards

LIFE has been rather eventful at Savoy Hill recently. The appropriation of the critics respecting the transference of Mr. R. E. Jeffrey from the post of Dramatic Producer to that of head of the new Ideas Department was taken very seriously and urgent representations were made on behalf of Mr. Val Gielgud, his successor in the Dramatic Department, in order that the latter's aims and ideas might receive equal consideration from the Press to that accorded Mr. Jeffrey.

And Val, with a little prompting,

**Ronald Colman  
listens on the  
short waves**



"stumped up" handsomely. He announced that he intended, as soon as he was comfortably settled in the saddle, to commission plays from well-known dramatists, which has left O.C. Finance wondering where the new Dramatic Producer reckons the money is to come from.

However, we are already promised a radio play by Mr. Ashley Dukes, who wrote *The Man with a Load of Mischief*; and that makes a capital start for young Mr. Gielgud, who should do well in his new job when he has conquered his initial nervousness

and adapted himself to certain financial limitations, about which his predecessor, R. E. J., with six years' experience behind him, can say a good deal.

Other commitments of the B.B.C. for 1929 will be regarded as requiring first consideration from the financial wizards of Savoy Hill; Sir Thomas Beecham's national orchestra scheme, for example, definitely ranks higher than dramatic commissions, even as the latter take precedence of variety.

Listeners will hear something soon about an extension of activity in the last-named field. Mr. Black, of the London Palladium, did yeoman service to broadcasting in breaking down

adamant over the question of liaison with broadcasting are beginning to be impressed by the Palladium experiment and a chain of relays from all over the West End is well within the bounds of probability. The Coliseum and Alhambra are only a beginning.

## Target of the Sharpshooters

The B.B.C. was the target of the sharpshooters of the Press for some weeks at the opening of 1929; but Savoy Hill did not concern itself greatly over the general attack on its finances. The balance sheets, which are properly available for the Postmaster General, show that the criticisms levelled against the B.B.C. as regards extravagance in its plans for the erection of Broadcasting House and in the salaries paid to the Board of Governors had no genuine foundation.

It seemed to be assumed that the Board's meetings should be heralded by a fanfare of trumpets and that communiques should be issued respecting all of the Board's activities. Because this has never been done since the Corporation came into being in 1927, the conclusion was reached that the five members of the Board did very little for their keep.

## What Are the Facts?

What are the facts? The Board meets on an average at fortnightly intervals to deal with matters which require collective decisions. In the intervals between these meetings, each Governor regularly handles the more pressing problems affecting different branches of the B.B.C., by and with the advice of the Director-General, Sir John Reith.

The publicity officials at Savoy Hill exercise all their ingenuity in keeping the Big Six out of the limelight; but it should be remembered that every announcement that emanates from the B.B.C. and every programme item reflects in some degree the activities and policies of those at the top.

the outer ramparts of the variety managers' defences against the incursions of Savoy Hill.

The inner defences are weakening and very soon nothing will be left of the ban which for four years has kept the broadcasting studio and the variety stage in a state of polite hostility. Once the managers have adopted a permissive attitude towards broadcasting from the stage of the several leading halls, some arrangement will follow for the use of individual artists on a co-operative basis.

It is significant that some of the managers who have hitherto proved

# New Wavelengths of the European Stations

Wavelength	Station and Call Sign	Kilocycles	Wavelength	Station and Call Sign	Kilocycles
211.3	Beziere	1,420	387.1	Dresden	776
222.2	Cork (5CK)	1,350		Bremen	766
236.2	Montpellier	1,270	391.6	Hamburg	757
240	Nurnberg	1,250	396	Plymouth (5PY)	757
243.9	Newcastle (5NO)	1,230	396.3	Bucharest	750
245.9	Posen	1,120	400	San Sebastian (EAJ8)	748
250	Kiel	1,200	401	Glasgow (5SC)	744
	Cassel	1,190	404	Radio Espana	703
252.1	Juan-les-Pins	1,190	405	Madrid (EAJ7)	739
260.1	Hoerby	1,153	406	Berne	735
260.9	Leeds (2LS)	1,150	408	Reval (Tallin)	724
	Laibach	1,140	411	Dublin (2RN)	721
263.2	Cologne	1,136	414	Radio Maroc (Rabat)	720
264	Lille (PTT)	1,130	416.1	Kattowitz	712
265.5	Muenster	1,130	416.6	Grenoble (PTT)	694
265	Trollhattan	1,130	421.3	Frankfurt	655
	Kosice	1,100	432.3	Brunn (Brno)	676
272.7	Danzig	1,100	438	Stockholm	668
	Kaiserslautern	1,100	443.8	Rome (Roma)	654
273	Limoges (PTT)	1,090	449.8	Paris (Ecole Sup., PTT)	658
	Sheffield (6LF)	1,080		Bordeaux (Radio Sud Ouest)	649
275	Turin	1,074	455.9	Aachen	631
	Ghent	1,070		Porsgrund	630
277.8	Bratislava	1,070		Innsbruck	622
279	Bordeaux (PTT)	1,070	456	Bolzano	613
280	Rennes	1,070		Aalesund	604
280.4	Koenigsberg	1,070		Klagenfurt	600
	Berlin (E)	1,061	462.2	Langenberg	595
283	Stettin	1,050	475.3	Berlin	586
	Magdeburg	1,050	467	Lyons (PTT)	577
285	Barcelona (EAJ13)	1,040	482	Daventry (5GB)	568
288.5	Bournemouth (6BM)	1,030	489.4	Zurich	559
	Edinburgh (2EH)	1,030	496.7	Oslo	550
291.3	Radio Lyons	1,020	500	Tromso	541
	Dundee (2DE)	1,010	504.2	Milan	530
	Liverpool (6LV)	1,000	511.9	Brussels	520
294.1	Stoke-on-Trent (5ST)	991	519.2	Vienna	441
	Swansea (5SX)	982	528.2	Riga	395
	Hull (6KH)	973	536.7	Munich	390
297	Notodden	970	545.5	Sundsvall	363.5
300	Huizen	964	554.5	Budapest	323
303	Belfast (2BE)	955		Augsburg	300
305	Agen	951	566	Hanover	297
308	Zagreb (Agram)	950		Cracow	280
309	Oviedo (EAJ19)	937	577	Hamar	277.6
311	Aberdeen (2BD)	931	577	Freiburg	262
314	Wilno	928	680	Lausanne	250
315	Marseilles (PTT)	919	760	Geneva	222
315.7	Falun	910	770	Ostersund	212
321.2	Breslau	901	825	Moscow	202
322.6	Vitus (Paris)	892	925	Homei	202
323	Cardiff (5WA)	883	1,000	Leningrad	199
326.4	Gleitwitz	874	1,010	Basle	192
329.7	Brussels	863	1,071	Hilversum	182
333	Naples	856	1,080	Strasbourg	178
333.3	Reykjavik	846.7	1,153.8	Kalundborg	172
336.3	Paris—Petit Parisien	847	1,200	Stamboul	165
339.8	Copenhagen	838		Boden	161
343.2	Prague (Praha)	829	1,351.2	Motala	154
346.8	Goteborg	820	1,415.1	Warsaw	150
350.5	Barcelona (EAJ1)	811	1,485.1	Moscow	142
354	Algiers (PTT)	800	1,488.15	Paris—Eiffel Tower	199
354.2	Graz	802	1,504	Lahti	192
358	London (2LO)	793	1,562.5	Daventry (5XX)	182
361.9	Leipzig	784		Norddeich	178
365.9	Bergen	775	1,648.3	Zeesen	172
369.9	Seville (EAJ5)	775	1,680	Kharkov	165
370	Paris (Radio LL)	775	1,744	Radio Paris	161
374	Helsingfors (Helsinki)	775	1,818	Angora	154
374.1	Stuttgart	775	1,852	Huizen	150
378	Manchester (2ZY)	775	1,950	Scheveningenhaven	142
382.7	Toulouse	775	2,000	Kovno	142
387	Fredriksstad	775	2,041	Bergen	142



# J. H. REYNER'S Simple Screen Three

COMPRISES SCREENED-GRID H.F., DETECTOR AND TRANSFORMER - COUPLED L.F. STAGE



The Q coils cover both wavelength ranges

THERE is a certain controversy concerning screened-grid valve sets as to the amount of screening which is necessary. In general, a screened-grid set is much more carefully screened than a receiver employing triode valves. One is sometimes tempted to ask whether elaborate screening is really necessary and the present receiver is an attempt to answer this question.

### Extremely Simple Layout

A short time ago I constructed a very simple three-valve receiver having one H.F. detector and one L.F., ordinary three-electrode valves being used throughout. I found that by paying particular regard to the question of stray coupling between the

circuits and by using Q coils, which assisted me owing to their astatic properties, I was able to obtain an extremely simple layout which nevertheless gave results distinctly above the average.

It occurred to me that with proper precautions, similar results should be obtainable utilising a screened-grid valve and that the amplification should be enhanced owing to the greater mutual conductance of the four-electrode valve.

One of the principal features of this type of circuit, however, is the absence of any neutralising adjustment, the capacity feedback in the valve being absolutely negligible owing to the screening. It is clearly necessary to avoid stray couplings

external to the valve or the effectiveness will be nullified.

Now magnetic coupling we can avoid by using astatic coils or by suitably arranging the connections to the coils, or both. Capacity coupling, however, is more difficult to avoid unless some sort of screening is adopted, but I felt that, at the most, a simple partition screen in between the anode and grid circuits would meet the case.

### Confirmed by Experiment

This was soon confirmed experimentally, for I found that by using Q coils, separated by a suitable distance and with a simple partition screen between them, I was able to obtain perfect stability with a high degree of amplification.

This, therefore, made it possible to design a simple receiver which could be constructed with the minimum of difficulty and yet which would make use of the undoubted advantages arising from the employment of the screened-grid valve. The circuit adopted is simple in character, being illustrated on the next page.

### Leaky-grid Detector

It should be observed that there is a tuned-grid circuit followed by a transformer-coupled arrangement, feeding a cumulative grid detector. In order to minimise damping and also to give a smooth reaction control, the grid leak has been connected to the potentiometer across the L.T. supply.

This is a fixed potentiometer having a resistance of 2,000 ohms

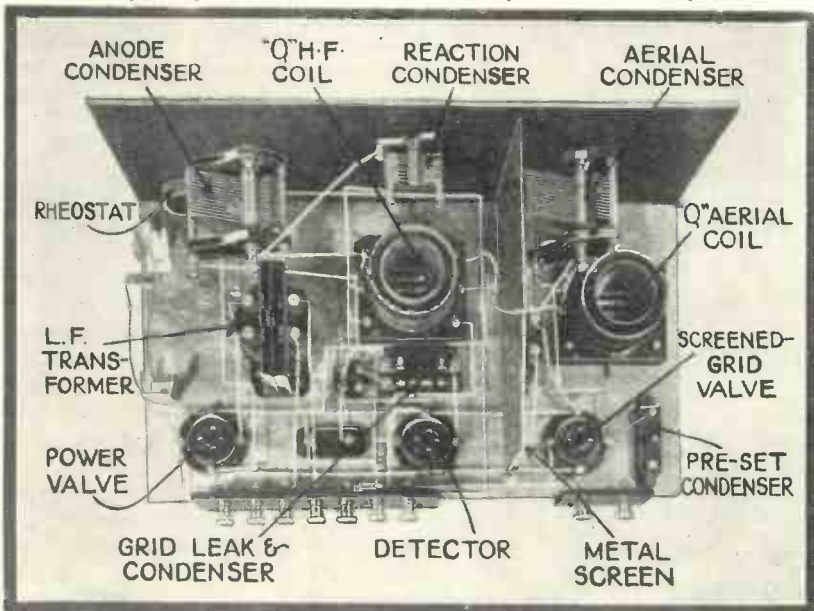

This plan view clearly shows the layout of all the parts in the Simple Screen Three





## A Screened-grid Valve Set by J. H. Reyner

step-up ratio of approximately 1:2 with a tight coupling on both wavebands so that the circuit is to all intents and purposes equivalent to a centre-tapped coil.

It will be noted that no high-frequency choke has been included in the detector circuit and that, in addition, a .0001-microfarad condenser has been connected from the anode of the detector valve down to L.T.—. This will appear to many to be against the usual principles of design, but, in point of fact, it is an arrangement which gives excellent results in practice.

### Insufficient By-passing

The H.F. choke is usually employed to keep high-frequency currents out of the L.F. stages, the H.F. itself being by-passed through the reaction condenser. In the present instance we are only using a very small reaction condenser and the by-pass condenser is not sufficient.

I have, therefore, connected an additional .0001-microfarad condenser from the anode of the detector to L.T.—, thereby providing adequate by-pass for the H.F. currents. With this precaution it was not found necessary to include a high-frequency choke, as neither the quality nor the reaction effect was at all impaired by omitting it.

### Master Rheostat

A master rheostat has been provided to control all the valves, this also serving as a volume control. The screened-grid valve is sufficiently critical on filament temperature to lose a great deal of its efficiency if the filament voltage is only slightly reduced, while the detector and L.F. valves retain their characteristics practically unimpaired. The arrangement, therefore, works as a satisfactory volume control without causing distortion.

### Simple to Construct

Coming now to the construction of the set, this has been laid out with a view to simplicity. The screen in particular has been carefully thought out. It consists of a simple partition screen and there are only three wires which have to pass from one side of the screen to the other.

Two of these are the filament wires

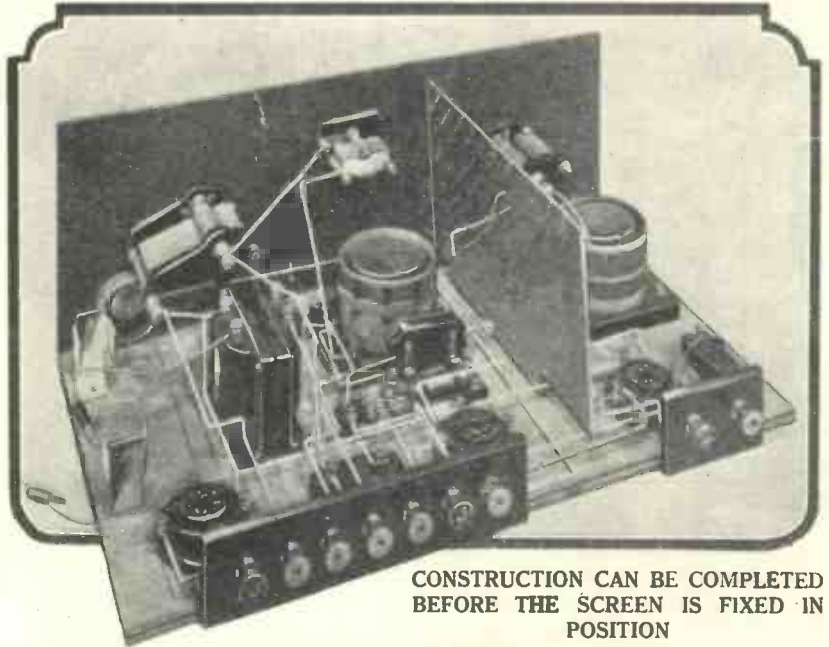

CONSTRUCTION CAN BE COMPLETED BEFORE THE SCREEN IS FIXED IN POSITION

The grid-bias battery is mounted in the clips on the left of the baseboard in the Simple Screen Three

from the screened-grid valve, and to allow these to have ready access, a portion of the screen has been cut away at the bottom. The third lead is that from the anode of the H.F. valve to the primary of the Q-coil transformer. This is a simple flex lead which passes through the screen itself. There is finally a connection

which has to be made from L.T.— to the screen itself.

The object of arranging matters in this way is that the whole of the set can be constructed entirely *without the screen in position*, which allows full access to all the components. The screen may then be placed in its appropriate position, when it will

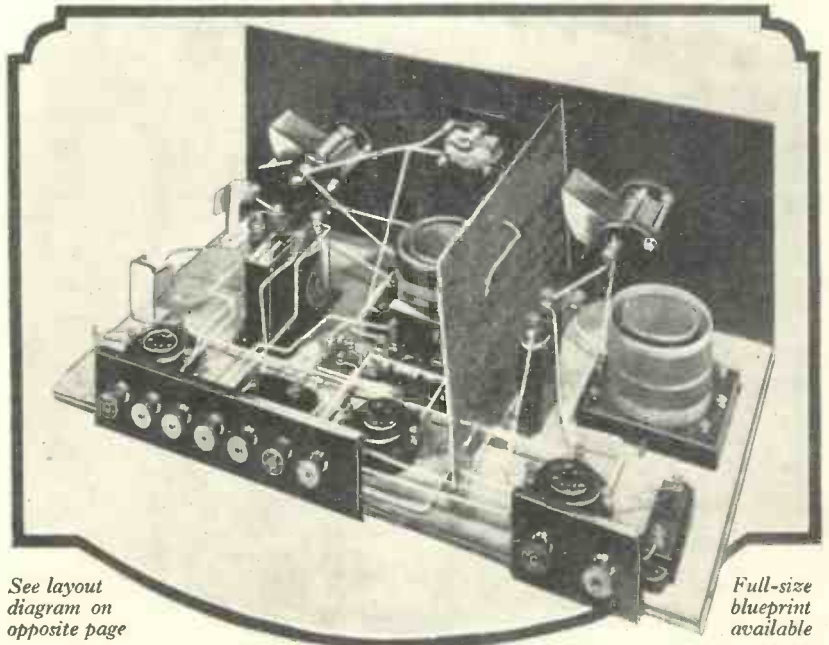

See layout diagram on opposite page

Full-size blueprint available

Another view of the Simple Screen Three, which incorporates special all-wave coils

## The Simple Screen Three (Continued)

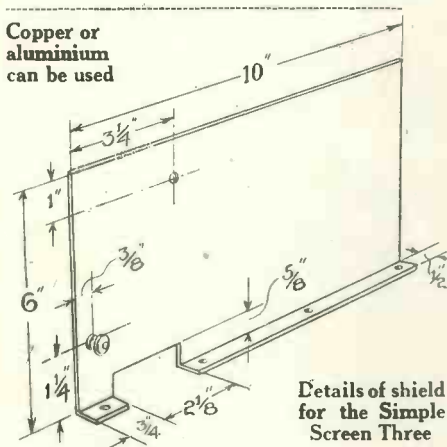

automatically clear the filament wires owing to the slot already referred to.

Two connections are then necessary from earth and L.T.— on to the screen and finally the flex lead is poked through the hole in the appropriate position. The construction is thus simplified to the greatest possible extent.

The first operation is the mounting on the panel of the two tuning condensers, the reaction condenser and the master rheostat. Two holes must also be drilled in the positions shown for the spindles of the Q-coil switches.

### Baseboard Components

Attention should then be turned to the baseboard components. First of all mount the two Q coils, the QA coil on the left and the QSG coil in the middle. The QA coil has been mounted a little more to the rear of the baseboard to clear the tuning condenser and allow easy access to the terminals.

The three valve holders are distributed along the back of the baseboard, the L.F. transformer towards the right-hand side, the extreme right-hand position being occupied by the grid-bias battery. The grid condenser and leak, H.F. by-pass condenser and fixed potentiometer are mounted in the positions shown. The sole remaining component is the pre-set condenser in the aerial lead.

### Advantage of Variability

In early Q-coil circuits, this condenser was usually made a fixed condenser of .0001-microfarad capa-

city. It has been found subsequently that a very flexible adjustment of the selectivity to suit one's own local conditions can be obtained if this is made variable.

The present condenser is variable from .0003 to .00025-microfarad, between which extremes positions can readily be found which give suitable results. The larger this capacity is made, the less the selectivity and the greater the signal strength. If this capacity is made too large, however, there is a tendency for the aerial dial to fall out of step with the H.F. dial towards the bottom of the scale.

Having assembled the components, excepting the screen, which is not yet put in position, the wiring may be carried out. This will present no

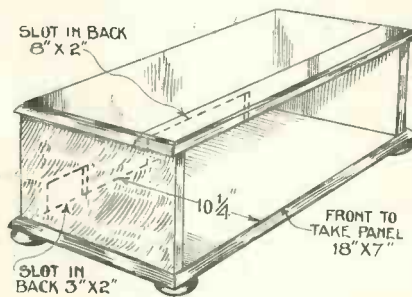

Dimensions of Cabinet

difficulty. For the sake of further simplicity no soldered joints have been made anywhere in the wiring, all the connections being taken from terminal to terminal so that the receiver may be constructed by the

most non-technical reader without difficulty.

Full-size blueprints can be obtained on application to the office of the WIRELESS MAGAZINE. These show the wiring in such unmistakable terms that there is no possibility of error.

Having completed the wiring, with the exception of the two wires from L.T.— to screen and earth to screen, the screen should be placed in position. If the wiring has been followed out in accordance with the diagram given, the screen will fit in position without fouling anything.

### One Small Terminal

There is a small terminal towards the bottom of the rear portion of the screen and to this two further wires should be connected, one to one terminal of the first valve holder and the other to the earth terminal. The flexible lead from terminal No. 3 of the QSG coil should be pushed through the hole in the screen provided therefor and this completes the wiring.

The testing out of the receiver may then be proceeded with. Connect up batteries to the several terminals as follows: 2, 4, or 6 volts to L.T., according to the valves to be used. H.T.— is connected to the L.T.— terminal. The H.T.+1 terminal is taken to 80 volts or thereabouts; H.T.+2 is taken to 60 volts, while H.T.+3 is taken to 120 volts.

### Lower Voltage if Desired

Slightly less voltage may be used on H.T.+3 if desired, quite good results being obtainable with only 100 volts.

### COMPONENTS REQUIRED FOR THE SIMPLE SCREEN THREE

- |  |  |
|--|--|
| 1—Ebonite panel, 7 in. by 18 in. (Parfait, Becol, or Trolite).         | 1—.0003-microfarad fixed condenser and 2-megohm grid leak (Mullard).   |
| 2—.0005-microfarad variable condensers (Ormond, Utility, or Formo)     | 1—.0001-microfarad fixed condenser (Dubilier, Mullard, or Lissen).   |
| 1—.0001-microfarad reaction condenser (Peto-Scott, Bulgin, or Lissen). | 1—Low-frequency transformer (Ediswan, B.T.H., or R.I. and Varley)  |
| 1—15-ohm filament rheostat (Peerless, Lissen, or Gecophone).           | 1—Pair grid-bias battery clips (Bulgin).   |
| 3—Antimicrophonic valve holders (W.B., Benjamin, or Formo).            | 9—Terminals, marked: Aerial, Earth, L.T.+1, L.T.—, H.T.+1, H.T.+2, H.T.+3, L.S.+1, L.S.— (Eelex or Belling-Lee). |
| 1—QA coil (Wearite, Lewcos, or Finston).                               | 2—Terminal strips, 3 in. by 2 in. and 8 in. by 2 in. (Parfait, Becol, or Trolite).                               |
| 1—QSG coil (Wearite, Lewcos, or Finston).                              | 1—Copper screen (Parex, Wilburn, or Ready-Radio).  |
| 1—1-microfarad fixed condenser (Dubilier, Lissen, or Mullard).         | 1—Cabinet with 10 in. baseboard (Carrington).  |
| 1—.0003—.00025-microfarad pre-set condenser (Formo type J).            |  |
| 1—Fixed potentiometer (Polar).   |  |



## J. H. Reyner's Latest All-wave Receiver

In such circumstances, it will probably be found advisable to reduce the voltage on H.T. +1 to 70.

The loud-speaker may be connected up in circuit, the aerial and earth connected to the appropriate terminals and a grid-bias battery inserted in the clips on the right-hand side of the baseboard.

The red plug (from the valve holder) should be connected to the positive socket on this battery, while the lead from the transformer terminating in the black plug should be connected to 6 to 9 volts, according to the valve in use. The makers' instructions issued with each valve give clear indication of the correct grid bias to use with any given H.T.

### Suitable Valves to Use

The valves to be used in the receiver are of the ordinary variety. A straightforward screened-grid valve such as the Osram S215 or corresponding type may be used in the first stage, and the flexible lead coming through the screen is connected to the terminal on the top of the valve.

The next stage should carry a simple detector valve having a medium impedance. A Mullard PM1HF or a Marconi HL210 serve excellently in this position.

The last stage should carry a super-power valve such as an Osram DEP240 or the Cosmos SP18RR. An ordinary power valve may be used here, but there will be a tendency to overload owing to the strong signals provided by the detector.

Switch on the set by rotating the master rheostat in a clockwise direction to its maximum position. Place both the Q-coil switches either to the left or to the right. Both switches must be in the same direction as no satisfactory results will be obtained if one is in one position and the other in the other.

### Switch Positions

The particular position of the switch for long and short waves is indicated by the makers themselves. Rotate the two tuning dials approximately together with the reaction condenser at the minimum position.

No difficulty will be experienced in hearing a number of stations which can be brought up to full

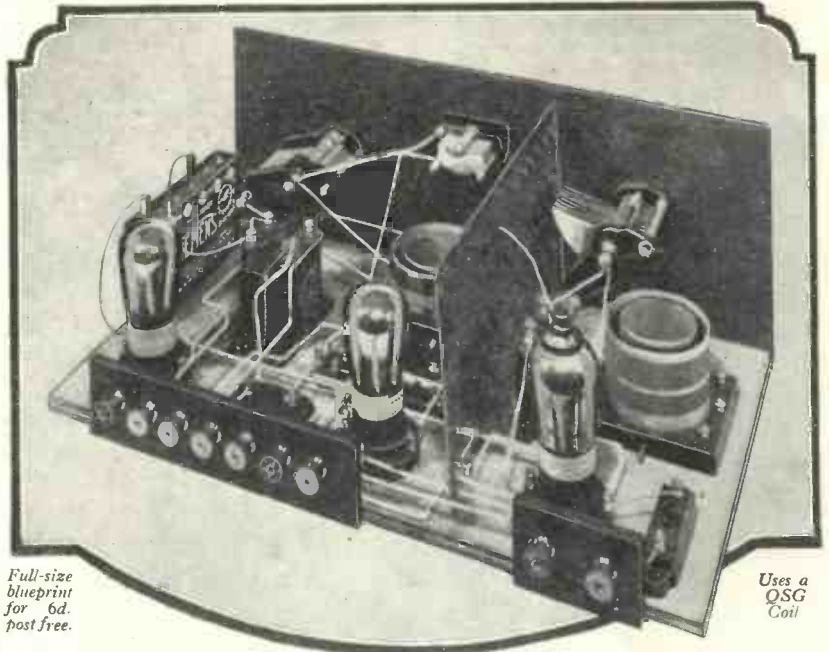

Full-size  
blueprint  
for 6d.  
post free.

Uses a  
QSG  
Coil

Another view showing the Simple Screen Three all ready for use with valves in position

strength with the reaction control. No reaction, of course, is required on powerful stations such as the local station or 5GB, while many of the foreign stations are received at excellent strength without any reaction control.

a peculiar tuning note. I thought at first that it was Radio Paris and was somewhat disappointed with the weak signal obtained, for although the station was at good loud-speaker strength, it had not the punch behind it which I expected from Radio Paris.

A few minutes later, a clock proceeded to chime the four quarters and then to strike the hour. This indicated a station sufficiently far away to have a different time from ours.

After this, the station proceeded to give announcements of some character in a language with which I was not familiar, each announcement being repeated twice over.

### Result of Wavemeter Test

A wavemeter test which showed the station to be operating on 1,873 metres, coupled with the fact that Kosice in Czecho-Slovakia is rated to work on 1,870 metres and should, moreover be working at this particular time in the morning, practically established the identity of the station. As the station is only operating on 5 kilowatts and is distant 800 miles, this will give readers a fair indication of the capabilities of the receiver.

### The Lazy Lover

(Tune : "To Anthea.")

*Bid me to give, and I will give  
Instructions unto thee,  
Although thy head is like a sieve  
For science, I can see.*

*Bid me explain, and I'll explain  
The cathode, grid and choke,  
And strive to make my meaning plain,  
Your interest to evoke.*

*Bid me to name, and I will name  
Transformers, volts, and "therms,"  
Although to thee they are but names,  
A mass of jumbled terms.*

*Thou art my Love, my heart of hearts,  
But do not beg of me  
To gather up those wireless parts  
And make a set for thee!*

LESLIE M. OYLER.

An interesting point arose when I was testing the receiver. I happened to be tuning-in at half-past ten in the morning and found a station giving

# The LODESTONE LOUD-SPEAKER

## Its Operation and Response

*Further Notes on the New Moving-coil Loud-speaker by W. JAMES*

AS this loud-speaker has what is commonly known as a low-resistance moving coil, a transformer must be employed to couple it with the last valve of the receiver. This transformer introduces three effects and is, therefore, a most important component, which must be considered in conjunction with the characteristics of the last valve and of the loud-speaker.

### Adequate Inductance

In the first place, it prevents a direct current passing through the moving coil; it does this because the secondary winding, to which the coil is connected, is insulated from the primary. As usually connected, the whole of the anode current passes through the primary winding, from which it follows that the number of turns of wire in this winding and the size and arrangement of the core must be correctly proportioned in order that the transformer shall have adequate inductance under working conditions.

### Current Strength and Load

The second and third effects to which I shall refer are to some extent related and will, therefore, be discussed together. One is concerned more specifically with the relative strengths of the currents passing through the secondary circuit at the lower and higher frequencies, whilst the other has to do with the effective load in the anode circuit of the power valve and its relationship to the amount of the power that can be obtained from the use of a given out-

put valve and high-tension voltage.

It is well known that the maximum amount of power is to be obtained when the load connected to the valve has approximately twice the impedance of the valve. For this reason when the load itself has a low

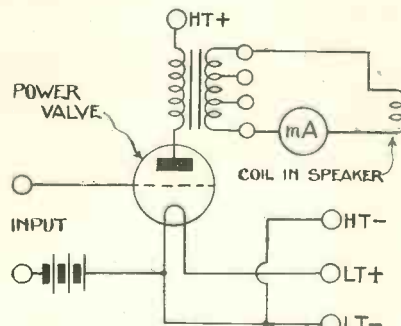

Fig. 1.—Circuit used for taking response curves

impedance, a transformer is generally employed in order that the effective impedance connected to the anode may more nearly approach the optimum condition.

The term "matching impedances" may be familiar in this connection

*Full Constructional Details Were Given in the February Issue of "W.M."*

and there is a simple formula which, when properly used, is helpful in practice:

$$\text{TRANSFORMER RATIO} = \sqrt{\frac{2 \times \text{valve impedance}}{\text{Impedance of load}}}$$

As an example, with a 15-ohm loud-speaker and a 3,000-ohm valve, the first ratio to try would be 20 to 1.

It therefore follows that the effect of the transformer connected to the coil is equivalent to a load of 6,000 ohms joined to the anode of the 3,000-ohm valve, which is a condition for maximum output. This, incidentally, is only true at the particular frequency for which the impedance of the load is 15 ohms.

### Overloading the Valve

When the equivalent load is smaller than this amount the valve cannot be used to provide so much power without distortion and, when the load is much smaller, the valve will show signs of being overloaded (also by the milliammeter test), provided, of course, the input is maintained at the same value as under the condition for maximum power.

### Frequency Proportionality

But a point of great importance has to be considered along with the power conditions. I refer to the relative proportions of the higher and lower frequencies as indicated by the current passing through the moving coil for equal input voltages to the grid of the power valve, and my tests have brought out several most interesting results.

I connected a low-frequency oscillator to the input of a power valve having a tapped transformer and the



loud-speaker connected to it (Fig. 1). The low-frequency current passing through the moving coil was measured at various frequencies and it was found that, with a given valve, the amount of the low-frequency current did not vary greatly when the ratio was made 9, 15, or 22.5 to 1, but the amount of the current flowing at frequencies above about 1,000 varied considerably.

**Aluminium and Paper Formers**

The curves of Fig. 2 show the results for a 3,000-ohm valve; the moving-coil in this experiment had an aluminium former. When a coil wound on an ordinary paper tube was employed, the results were as indicated in Fig. 3.

From these curves one would judge the best results to be obtained when the transformer had a ratio of 9 to 1, but the fact should not be lost sight of that bass overloading may be experienced. My experiments seem to indicate the best results are obtained when the ratio is 9 to 1 for the coil

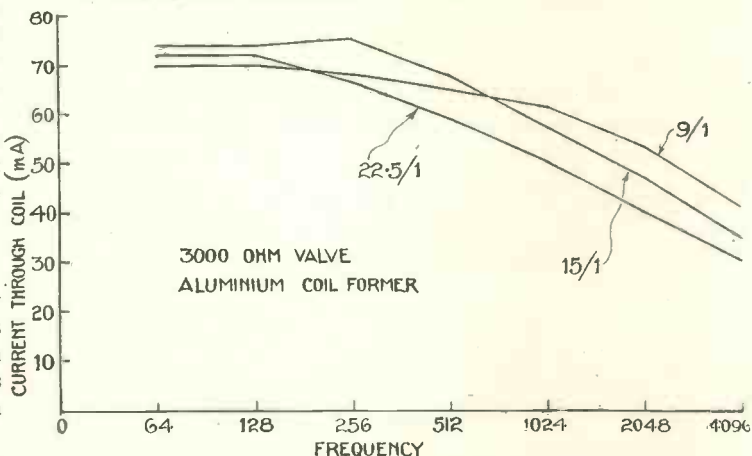

Fig. 2.—Response curve of Lodestone with aluminium former

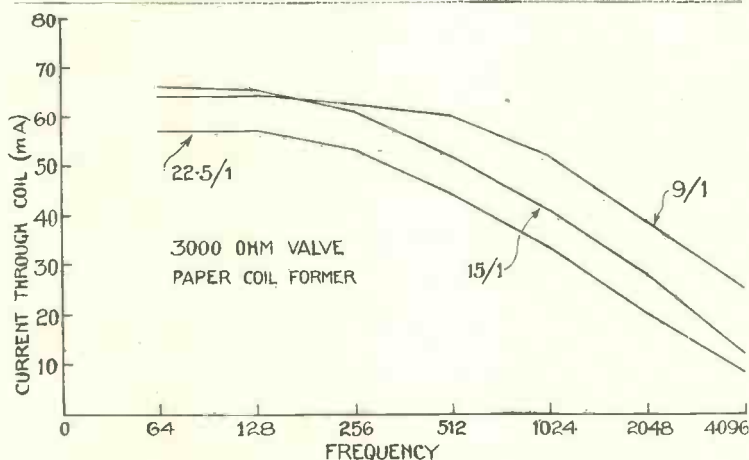

Fig. 3.—Response curve of Lodestone with paper former

the correct ratio, although the actual strength of the bass notes is not varied.

These points will be understood from the curves. Thus, in Fig. 3, at 64 cycles the current was about 70 milliamperes, and at a little over 4,000 cycles 41 milliamperes when the ratio was 9 to 1, and 30 milliamperes when the ratio was 22.5 to 1.

**No Indication of Relative Volume**

It must not be thought that the curves indicate the relative strengths of the sounds actually produced because they do not; the currents flowing are a guide, but other factors help determine the output of sound. These are the material of which the cone is made, its size, the method of supporting it and the nature of the centring device. But the curves illustrate the importance of the ratio of the transformer and a user of the loud-speaker will be able to choose intelligently the best ratio for his own circumstances.

Certain receivers magnify treble notes rather more than the bass, whilst others may provide practically uniform magnification, from which it is evident that were the same transformer ratio used, the reproduction would sound different in the two instances. By altering the ratio, however, the relative strength of the higher notes may be varied to suit the circumstances.

having a paper former and 15 to 1 for the coil with the aluminium former.

The 9 to 1 ratio should be used when output valves are connected in parallel or when the impedance of the output valve is about 2,000 ohms.

In these experiments I employed a Ferranti tapped output transformer and a Cossor super-power valve.

**Use of Tapped Transformer**

A standard 25 to 1 output transformer is satisfactory for a valve of about 4,000 ohms (3,000 to 5,000 ohms in last month's article). I would suggest that a tapped transformer be employed, however, for then the listener will be able to alter the relative strengths of the treble and bass notes.

As the volume is so largely determined by the strength of the notes of from about 200 to 2,000 cycles, the sound output is increased by employing

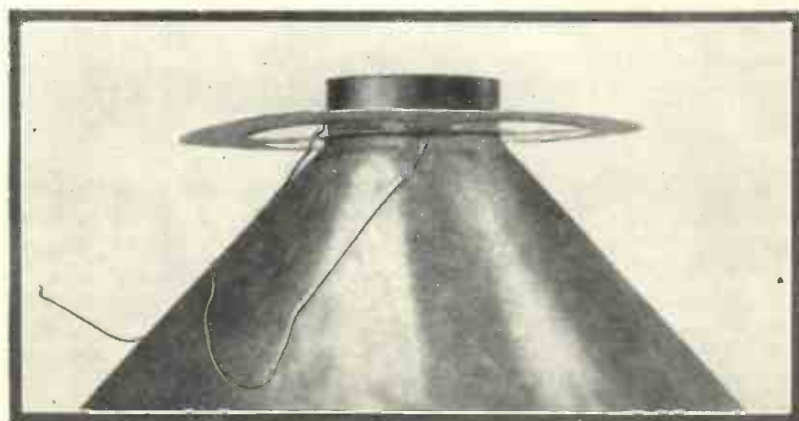

This view shows how the coil and centring device are fixed to the cone

## The Lodestone Loud-speaker (Continued)

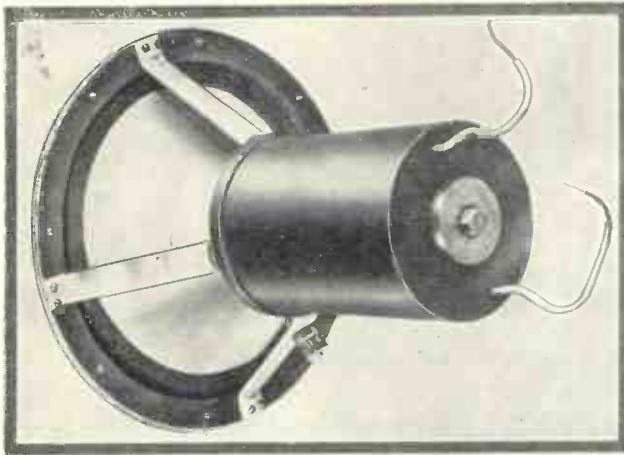

Another view of the Lodestone loud-speaker. A full-size blueprint (No. WM 126) is available for 1s., post free

There are one or two points in the construction to which attention is drawn. The first is the fixing of the centring device. A cork washer should first be placed in position in the recessed portion provided in the aluminium cone support and then the paper centring ring should be laid in position on the surface of the cork. The second cork washer should then be fitted and a trace of Seccotine may be employed to hold it lightly in position.

### Automatic

As the cork washers and the paper centring ring are accurately cut to fit, the central hole in the paper ring will automatically be in its correct position.

The moving coil should be fastened to the paper ring by sticking it with Seccotine and it must be truly positioned and allowed to remain until the joint is quite firm. The centring ring is secured  $\frac{1}{10}$  in. from the edge of the moving coil in order that there may be free movement.

### Cutting the Paper Cone

Finally, the paper cone is cut as described in the February issue of this magazine. Notice, however, that it is necessary to leave a portion in order that the two edges may overlap by  $\frac{3}{16}$  in.; a little Seccotine should

be applied and the edges firmly secured. The leather surround comprises four pieces which are cut to the shape indicated and then stuck to the inner surface of the cone with an overlap of  $\frac{3}{16}$  in. It is necessary to cut a cardboard ring to fit the metal framework. The leather surround may be Seccotined to

this ring and then the cone assembled in position. When it has been properly located it should be fastened with Seccotine to the coil former and the bottom of the centring ring. Some hours must pass before the joints are firm and then the complete

It is, of course, very necessary to employ a baffle, and, as previously described, a sheet of cardboard may be used when experimenting.

### Details of Field Windings

Details of the 6-volt winding for the field have been given. For a 100-volt supply the winding may be of No. 32-gauge enamelled wire with every second or third layer covered with a sheet of thin paper. No. 34-gauge wire may be used for a 200- to 250-volt winding, and here again, when enamelled wire is used it is essential to provide the paper insulation and, of course, to carefully bring out the ends.

### A SUCCESSFUL SET

*THE All-wave Screened-grid Three is giving excellent results in the North, as this letter from a Manchester reader discloses:*

I have now wired up my All-wave Screened-grid Three as per diagram in the magazine, and the results obtained yesterday were very satisfactory. As

### MOUNTING THE LODESTONE

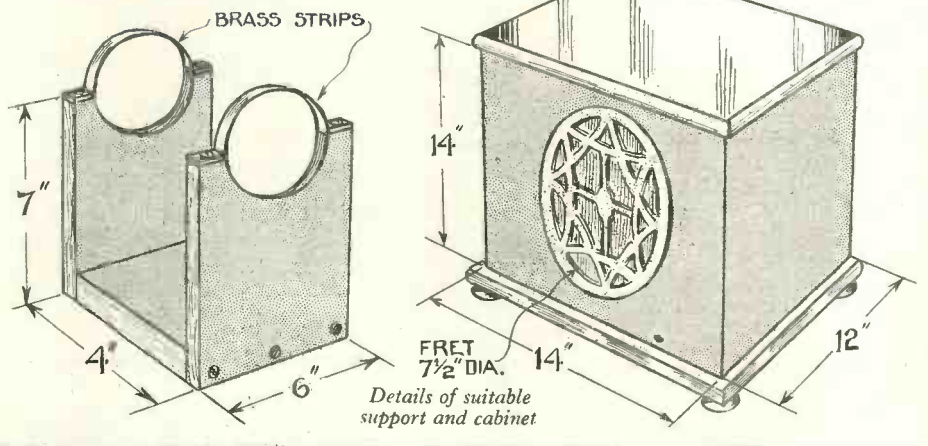

cone may be fitted to the electromagnet and bolted down. Do not forget to secure the leads from the moving coil to the surface of the cone. Two strips of thin paper may be employed and they should be placed over the fine wires and stuck to the cone. An amount of wire should be left between the cone and the terminals in order to allow free movement without fear of the wires being broken.

yet, I have no pentode, but I am using a Mullard power valve.

The stations definitely identified were Manchester, the two Daventry stations, Frankfurt, Stuttgart, Stockholm, Hilversum, Voxhaus, Radio Paris, Hamburg, Koenigswusterhausen, and Copenhagen, through Kalundborg, Denmark, very strong. There were dozens of other stations which I could not identify at the moment.

*This receiver was described in the November issue of "WIRELESS MAGAZINE" and full-size blueprints can be obtained for 1/- each, post free*



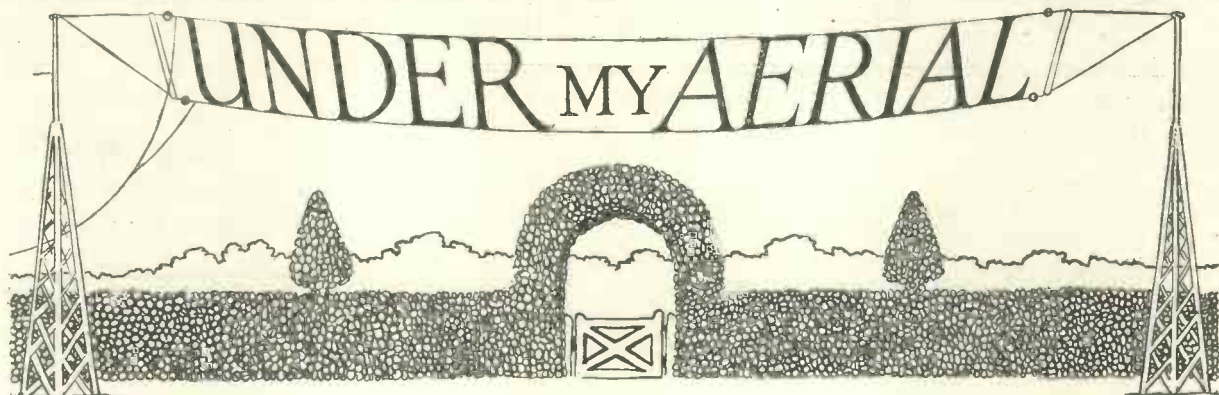

### Spring Noises

ISN'T this just about the time of the year when the B.B.C. programme builders should be planning out their programmes for the delightful days of early spring? How would it be, then, if we passed on a few suggestions to our programme builders as to the typical springtime noises we should like to have broadcast to us this year?

My first suggestion is the broadcasting of the songs of several birds which sing so beautifully to us even before the leaf buds have begun to burst on the trees. The blackbird would be my first choice, and the thrush my second. If further songsters were required, I would name the chaffinch and the hedge-sparrow.

Then I would like to suggest the broadcasting of the calls of the less musical birds, the sawing noise of the great tit, for example, and the sucking noise of the starling on the chimney pot.

Other delightful springtime noises I should like to hear from my loud-speaker are the humming noise of the bees in the white alyssum and the

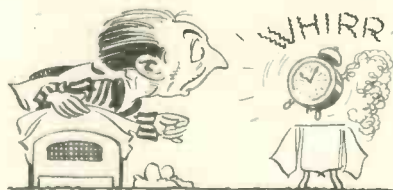

Spring Noises

cheeping of a brood of newly-hatched chicks.

What typical springtime noises can you suggest we might have broadcast to us this spring?

### Variable Conditions

Have you been worried at all by the big changes which have taken

place in reception conditions on certain nights this winter? Some really remarkable changes have occurred, sometimes within the space of a few hours.

I have not been unduly bothered by these changes when using my outside aerial, but I have found these changes very troublesome indeed when using my new frame aerial in conjunction with my new portable set.

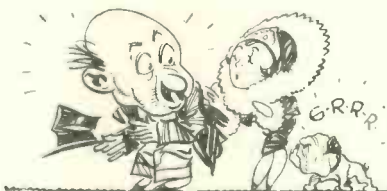

Have You Been Worried

If you have had experience of reception with a frame aerial, I think you will agree with me when I say that such reception is very susceptible to changes in reception conditions.

When I first tried my new portable set and frame aerial at six o'clock one evening, I obtained such poor results that I thought I must have made a mistake in the wiring of the set. I went over the wiring and found it correct and then I thought I would reverse one pair of leads to the transformers. Fortunately I had to leave the set for a while.

At ten o'clock I returned to the set. Stations came in all round the tuning dial and I was really elated with my success. A remarkable change had taken place in reception conditions during the few hours I had left the set.

One interesting thing I particularly noticed that evening was that the change to better conditions had caused the directional setting of the frame aerial to become much more critical.

### Ideas

"Now then, George, old man, here is a golden opportunity for you at last," I said to my technical adviser on his last visit to my main reception room.

"I am all attention," said George.

"The new Research Department, B.B.C. Programmes, asks listeners to send along any bright ideas they may have for the betterment of our wireless programmes."

"Well?"

"The idea must be bright, constructive, and original. For a really good idea the B.B.C. is willing to pay. Now then, George, here's your chance to earn an honest penny from the B.B.C. A good idea might mean getting your licence money back."

"I shall have to give the matter my serious attention. Most of my ideas, though, are either too bright, too constructive, or too original."

"How about this for a first idea, George—a weekly talk to wireless constructors?"

"Excellent. We should all like that."

"Suppose you gave the first talk



An Honest Penny

of the series, George, what would be your star piece of information?"

"How to tell bad ebonite from good. Recent research has caused me to evolve a simple test. You drop the ebonite and tread on it. If it is good ebonite, nothing happens. If it is bad ebonite, you need a brush and a dustpan to clear up the mess."

## Under My Aerial (Continued)

"What about non-wireless subjects, George? Have you any ideas at all?"

"Just one. I should put on a mystery speaker once each week. Neither the name nor the subject of the speaker would be announced. You would arouse any amount of interest in attempts to identify the speakers. Uncle Arthur from Geneva might go on for the first mystery speaker. We have very pleasant personal recollections of Uncle Arthur, you know. We should recognise him all right."

### Three Only

What is going to be the outcome of all these developments which are taking place in valve design these days? It looks to me as if the day is not far distant when nobody will ever dream of making a valve set with more than three valves.



Three Only

The screened-grid valve, with its high magnification factor, is rapidly superseding the two-valve high-frequency amplifier used on the high-frequency side of a multi-valve receiver.

Further developments are being made with this screened-grid type of valve, so successfully popularised by the Chummy Four set, and it is confidently expected that a screened-grid valve equivalent in performance to a three-valve high-frequency amplifier will soon be forthcoming.

On the low-frequency side of our sets, the pentode is the most interesting thing at the moment. This new five-electrode valve gives a remarkable degree of amplification, but it possesses several disadvantages, chief of which is the big demand it makes on the high-tension battery. These disadvantages are, however, being overcome.

We ought to keep a very close watch on these developments in valve design. At present it may be all right for us to look upon the man with the multi-valve set as the chief

amongst us. Soon, however, a man's rank in our world of wireless will not be determined by the number of his valves, but rather by the number of electrodes in his three valves.

### Foreign Goods

One day last week I happened to call on a wireless friend of mine who is a wireless manufacturer in a pretty big way of business. I found him in his office carefully going through a design for a new three-valve set. Naturally, I was very interested, and we had a fine old crack together over the work he had in hand.

Amongst a good number of things which came up for discussion was the question of a slow-motion dial for the set. Now, I have my own ideas on slow-motion dials. I have tried all the well-known types and I have my own favourite type. Rather to my satisfaction, I found that my manufacturer friend had a decided leaning towards my favourite.

He showed me, however, a smaller type of dial of attractive design. I asked the price of this smaller type, and I could not help remarking on that price when I realised that it was only a little more than half the price of my own favourite slow-motion dial.

"I suppose you will use this cheaper dial in your set," I remarked to my manufacturer friend.

"No, I shall do no such thing," was his reply.

"Why?" I asked, rather puzzled.

"Because it is of foreign make."

I think my manufacturer friend's attitude towards wireless components



One Day Last Week

of foreign origin is one which ought to commend itself to us all, don't you?

### Not Wanted

I wonder if any of you who live on the slopes of the southern Pennines have seen the B.B.C. mobile transmitter recently, either at work or on



Not Wanted

the move. According to reports at the time of writing this mobile transmitter is still roaming the Pennines in search of a suitable site for the northern twin-wave regional station.

A couple of weeks ago, I was exploring a picturesque part of the southern Pennines myself. Although I tramped a good many miles amongst the hills, I did not catch a glimpse of the B.B.C. motor transmitter. Some of you will have been more fortunate than I was.

The interesting thing about this roaming transmitter is that, wherever it goes, it receives a poor sort of a welcome. The good folk of the Pennine towns seem to have got the idea that a regional station on a town's doorstep is not likely to prove a blessing to listeners in that town.

Still, a site for the northern regional station must be found somewhere near a town of reasonable size. You cannot put a regional station right out in the wilds, miles away from electricity and water supplies, and telephone land-lines. Besides, as George says, the poor engineers must be able to go to the pictures occasionally.

### Wireless Mysteries

Do you happen to know which particular London lamp-post it was which suddenly began to give out music and speech from 2LO some time back? I should very much like to know where that lamp-post is so that I could go and have a good look at it.

Perhaps you have never heard of this mysterious lamp-post. Neither had I until I read about it in an article on wireless mysteries in an American wireless magazine the other day.

Do you know of any mysterious wireless happenings? Have you ever heard a wireless receiver with neither loud-speaker nor telephones attached to it give out sweet music? Such a



## Halyard's Chat on the Month's Topics

thing has been known to occur, the explanation being that the laminations of the core of the low-frequency transformer have acted as diaphragms.

A most intriguing wireless mystery referred to in the article mentioned above was that of a water faucet at Boston, U.S.A., which suddenly started to give out music from a wireless station a mile and a half away.

Now I was as interested in this Boston mystery faucet as in the



Wireless Mysteries

London mystery lamp post. Not knowing quite what a faucet was, I looked up the word in my dictionary and I found: Faucet—a pipe inserted in a cask for drawing liquor. Funny, isn't it? The Boston faucet, however, was described as a water faucet.

George says that, with a faucet, you draw liquor, but with a water faucet you draw your own conclusions.

### A Frame Aerial

Have you begun to think about portable sets and frame aerials for the coming outdoor season? I like plenty of time to think about such things, and I like plenty of time in



Have You Begun

which to do my experimental work indoors before I venture out into the open.

Already I have made a new three-valve portable set and a new frame aerial, and I want to give you the recipe for this new frame aerial. Here it is: One cabinet maker with tools and wood, fifteen minutes of his

time, and one shilling with which to pay.

My first idea was to make the frame aerial myself and I went to my cabinet maker with the intention of purchasing four thin wooden rods and then coming away. When I got in his workshop, however, I realised that, with his band saw and drills, he would do in a few minutes work which would take me an hour or two to do. Hence I gave him my idea of the frame aerial I wanted and then stood by while he knocked the thing into shape.

First of all, he cut a piece of wood 18 in. long, 6 in. wide and  $\frac{1}{2}$  in. thick, for the base. Then he cut a piece of wood 18 in. long, 4 in. wide and a  $\frac{1}{4}$  in. thick, for the top. The wooden rods I bought were circular rods of  $\frac{1}{2}$  in. diameter and they were 3 ft. long. In the wooden base, and in the wooden top, my man drilled holes for the rods.

He then hammered the four rods into the holes in the base. Then he hammered the top piece on to the four vertical rods, and there was the frame for the frame aerial complete. Fifteen minutes; cost, one shilling.

It took me just four minutes to wind the wire on the frame, and I had the frame aerial in use for reception within half an hour of my decision to make it. Quick work—can you beat it?

### Dismantling a Set

Have you ever noticed how much can be learnt from the work of dismantling a wireless set? I have just undone a two-valve set in order to provide myself with several component parts I needed for another set, and, instead of looking upon the



Dismantling a Set

task as a tedious one to be hurried through as quickly as possible, I did the work slowly and tried to learn all I could from it.

This two-valve set I dismantled had been made by an experienced mechanic in the research department of a well-known wireless firm. The set had been made for show purposes and it had fulfilled its mission in life. I was very sorry to have to carry out the work of demolition, but I had a similar set of my own construction and needs must where the—er—a shortage of funds drives.

In my work of unsoldering, I found that the constructor of the set had used a solder which required a hotter soldering bit than the solder I use. I also found that a resin flux had been used, and not the soldering fluid with which I am familiar.

Apart from a number of other points of wireless interest, I learnt one or two things about the constructor of the set. Judging from the time it took me to unscrew the nuts which held the variable condenser shafts to the front of the panel that constructor must have had extraordinarily strong wrists.

George was with me when I was working on this two-valve, and he fired off a proverb, or epigram, or whatever it was, which I must pass on to you. It was this: *One man's set is another man's undoing.*

HALYARD.

## THE INCEPTOR 3

*I must confess to having felt a little my position,  
As one of those unfortunates who missed the Exhibition.  
I've heard and read of wonder sets, requiring no ability  
To tune the world, on just three valves, with guaranteed stability.  
I cursed my own ineptitude and want of foresight clear,  
And bought the WIRELESS MAGAZINE my troubled heart to cheer,  
Describing the Inceptor 3; said I, "Why that's the set for me!  
It does what all the multi's claim, and costs not much for parts;  
And the blueprint and instructions clear will please all builders' hearts."  
So now at last I have a set, the very latest three,  
And I thank you, Mr. Editor, for what you've done for me.*

H. L. P.

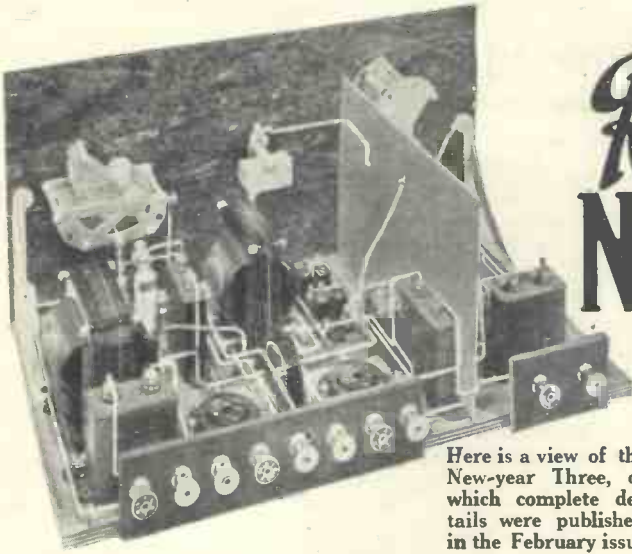

Here is a view of the New-year Three, of which complete details were published in the February issue

# Results with the NEW-YEAR THREE

Results of a Test by  
J. GODCHAUX ABRAHAMS

Build This Set—A Standard  
Three-valver for 1929

**A**FTER having made a thorough test over a period of four days of the New-year Three, I have not yet been able to make up my mind whether I like it less, as well, or better than the Inceptor 3, with which I obtained such very good results.

### Advantages of the New Set

I must take it that the receiver under review is a development, in a slightly altered form, of the Inceptor circuit and, most certainly, in one or two points, it possesses advantages over its October predecessor.

Although from the actual log published on page 141, I do not appear to have captured as many stations as with the Inceptor 3, this is not due to any fault or failing on the part of the new set.

Seldom in my experience have I found, as in the evenings chosen for the test, such adverse atmospheric conditions.

### Ether Peculiarly "Dead"

On these nights the ether was peculiarly "dead," and most transmissions which in ordinary circumstances should have rattled the

loud-speaker, furnished but very comfortable signals. For this reason to my mind,

The New-year Three possesses, one great advantage—that of being equipped with slow-motion dials, on which a steady grip may be secured for fine tuning; in addition it has been furnished with an efficient "stopper," which allowed me to feed it from the mains through a D.C. eliminator without suffering from the "popping" discomforts of motor-boating.

the weaker or more distant transmissions were far below standard.

Moreover, during the past month or so, interference among stations has largely increased, and in one or two instances on the test evenings some transmissions were badly jammed.

### COMPONENTS REQUIRED FOR THE NEW-YEAR THREE

- |  |   |
|--|---|
| <ul style="list-style-type: none"> <li>1—Ebonite panel, 16 in. by 8 in. (Trolite, Becol, or Parfait).</li> <li>2—.0005-microfarad variable condensers (Lotus, Lewcos, or Polar).</li> <li>2—Slow-motion dials (Lotus, Igranic, or Formo).</li> <li>1—12-ohm panel rheostat (Gecophone, Lissen, or Peerless).</li> <li>1—.0001-microfarad reaction condenser (Bulgin, Ormond, or Cydon).</li> <li>1—On-off switch (Lissen, Benjamin, or Wearite).</li> <li>3—Single coil holders (Magnum, Lotus, or Will Day).</li> <li>3—Antimicrophonic valve holders (W.B., Igranic, or Trix).</li> <li>3—1-microfarad fixed condensers (T.C.C., Mullard, or Lissen).</li> <li>2—500-ohm resistances (Ready Radio or Wearite).</li> <li>1—Copper or aluminium screen (Parex, Omnora, or Wilburn).</li> <li>1—.0002-microfarad fixed condenser (T.C.C. type SP).</li> </ul> | <ul style="list-style-type: none"> <li>1—3-megohm grid leak (Dubilier, Ediswan, or Mullard).</li> <li>1—High-frequency choke (Burndept, Igranic, or Ormond).</li> <li>1—Low-frequency transformer (Ferranti AF3, B.T.H., or British General).</li> <li>1—10,000-ohm resistance with holder (Lissen, R.I. and Varley, or Mullard).</li> <li>1—2-microfarad fixed condenser (T.C.C., Mullard, or Lissen).</li> <li>1—Output choke (Ferranti B1, Parmeko or Gecophone).</li> <li>2—Terminal strips, 8 in. by 2 in. and 3 in. by 2 in. (Trolite, Becol, or Parfait).</li> <li>10—Terminals, marked:—Aerial, Earth, L.T.+ , L.T.—, H.T.+1, H.T.+2, G.B.—, G.B.+ , L.S.+ , L.S.— (Ealex or Belling-Lee).</li> <li>1—Pair panel brackets (Magnum, Camco, or Raymond).</li> <li>1—Cabinet with 9-in. baseboard (Pickett).</li> <li>1—Set tapped two-pin plug-in coils (Atlas).</li> </ul> |
|--|---|

Circuit of the New-year Three

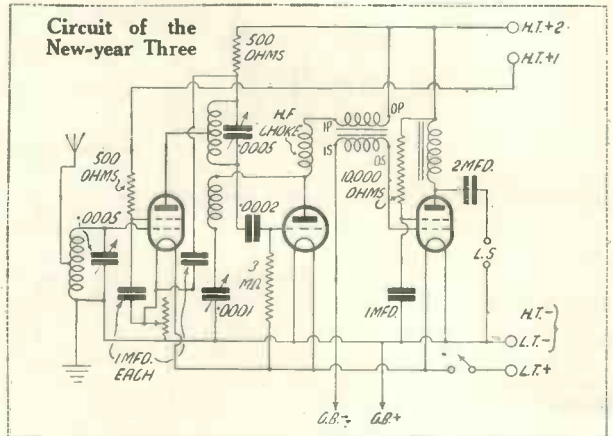



unwanted stations and bring in others. Such a receiver deserves its proper equipment of valves, namely, a screened-grid H.F., a high-impedance detector, and a pentode in the L.F. position with, as an alternative, a good super-power valve, for which it can be exchanged when the signals are too loud.

**Too Loud to be Comfortable**

In the case of the local station—in this instance 2LO—a pentode could not be used, and even when an ordinary low-power L.F. valve was inserted the rheostat governing the screened-grid valve had to be adjusted. With Daventry 5GB, also, reception was too loud to be comfortable in a small room.

The quality of reproduction was, where signals were adequate, everything one could desire, providing correct grid bias was given to the last valve. It will be found that grid bias must be adjusted according to whether a super-power or pentode valve is used in the third stage.

I might add that to test the quality of the L.F. circuit, I switched out the screened-grid valve, inserted an adaptor in the detector-valve socket, and using an R.C. valve followed by a pentode, obtained excellent reproduction of gramophone records from a moderately-priced pick-up.

**Little to Choose**

Generally speaking, I consider there is little to choose between the Inceptor 3 and the New-year Three, although, as pointed out, the later model includes certain improvements which, although slightly increasing the cost, will be found of considerable utility.

On second thoughts, I don't mind which of these two models is given to me; they are both excellent types of efficient household receivers. The Editor may take the hint. (Or he may not!—Ed.)



Full-size blueprints of the New-year Three can be obtained for 1/6 each, post free. Ask for No. W.M.123

**TEST REPORT OF THE NEW-YEAR THREE**

January 4, 6, 7, 1929.

**MEDIUM WAVES**

Coils used : No. 60 (centre-tapped) ; reaction, No. 40.

Wavelength. (metres).	Station.	Condenser Readings.	
		Aerial.	Anode.
242	Nurnberg (loud) .. .. .	30	32
250	Muenster (loud) .. .. .	32	34.5
*264	PTT Lille (heterodyned) .. .. .	36	40
*278	Kaiserslautern (heterodyned) .. .. .	40	44.5
283	Cologne (loud) .. .. .	42	48
319	Dublin (loud) .. .. .	54	60.5
*337	Copenhagen (faint) .. .. .	56	63.5
*349	Prague (heterodyned) .. .. .	59	65
361	2LO London (very loud) .. .. .	68	74
388 (?)	Radio Toulouse (loud) .. .. .	75	82
*396	Hamburg (badly jammed on all three nights) .. .. .	80 (?)	86 (?)
*414	Radio Maroc (?). Not identified, but French language clearly heard. Possibly PTT Grenoble .. .. .	84	90
416	Goeteborg (heterodyned by Radio Maroc) .. .. .	85	92
422	Kattowitz (loud) .. .. .	89	95
429	Frankfurt (poor on two nights and badly heterodyned) .. .. .	92	98
434.8	Madrid EA77 (very good in later hours) .. .. .	96	102
450	Rome (faint). Was identified by its national anthem when closing down .. .. .	100	108
470	Langenberg (loud) .. .. .	106	118
484	Berlin (clear when 5GB off the air) .. .. .	120	134
491	5GB Daventry (loud) .. .. .	126	142
508	Brussels (loud) .. .. .	132	148
517 (a)	Vienna (loud) .. .. .	140	155
*547	Milan (poor) .. .. .	150	167
555	Buda-Pest (strong) .. .. .	160	176

NOTE.—(a) Vienna on these three nights was received at such strength that the picture transmissions could easily have been captured.

**LONG WAVES**

Coils used : No. 200 (centre-tapped) ; reaction, No. 75 or 100.

Wavelength. (metres).	Station.	Condenser Readings.	
		Aerial.	Anode.
1,071	Hilversum (loud) .. .. .	55	60
1,153	Kalundborg (loud) .. .. .	62	68
1,485	Eiffel Tower (strong) .. .. .	114	122
1,562	Daventry 5XX (very loud) .. .. .	120	134
1,649	Zeesen (loud) .. .. .	134	145
1,764	Radio Paris (loud) .. .. .	145	150
1,852	Huizen (strong) .. .. .	158	165

Stations marked \* were only heard on headphones ; others ranged from medium to full loud-speaker strength, with pentode valve in L.F. stage. Where headphones were used an ordinary low-power L.F. valve was used. On the occasions where very strong signals were received on loud-speaker, the pentode was replaced by a super-power L.F. valve.

J. GODCHAUX ABRAHAMS.

**What Is Permeability ?**

ADVENT of L.F. transformers having cores of various new alloys which are more compact but vastly more efficient than bulky old-type cores has set some "know-all" talking about permeability. What is permeability? Well, it is well known that the magnetic field set up by, say, the winding of a transformer depends on the number of turns and the strength of the

current. If we now push the iron core of the transformer through the centre of the winding the magnetic field will become instantly stronger, this being due to what is known as the greater "permeability" of the iron.

**Strength of the Field**

The permeability of air is considered to be unity, and that of iron may be so much as a hundred times greater. As a matter of fact, the permeability depends on the initial strength of the field, and an iron core in a weak field may have little more permeability than air.

MACB.

Another Fable (A Long Way) After Aesop :: Chronicled by Hugh R. Seeley

# The Fable "Gō-Gettah"

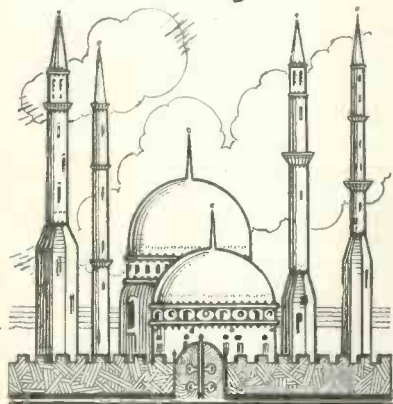

ONCE upon a Time, there dwelt in the Capital of a Kingdom many days distant by Sea and by Land to the Eastward of Jeb-el-Tarik or Pillars of Hercules (1), a Youth named Nō-Zijim.

Being of a vagrant Disposition and little disposed to Toil, it came to pass that he resorted with low Associates and was led by them into Misdemeanours, wherefore his Reward was a Bastinado at the hands of the *Khōps*. By the local Kadi he was banished from the Land; for many Moons was his Face no longer seen in the Bazaars, and the Places which he had been wont to frequent knew him not.

And behold, after the passing of many Years, there landed upon the Coast, from a Vessel, one who was garbed in strange Habits. Upon his Feet were glistening black Coverings, upon either Leg a soft Cylinder of Cloth, and from his Mouth he blew Clouds of Smoke or Vapour.

Hailing him a Chariot, he caused himself to be conveyed with his Baggage to the Capital, where, being arrived, he took up his Abode in a Khan and proceeded to visit the Bazaars and Souks.

Anon, gathered he Acquaintances around him and to these, all marveling at the Strangeness of his Words, did he reveal that he was none other than Nō-Zijim, the Banished One, that he had wandered in strange Lands and distant Places, gaining thereby Knowledge, Wealth, and Cunning, and that he had brought back a Magic Casket containing a

mighty Djinn, by whose Devotion he was able to overhear strange Voices and Songs from places beyond the Seven Seas, yea, even the vile Plottings of his Enemies.

This did he forthwith display, to the exceeding Mystification of his Audience, drawing from his Box much curious Talk and weird Musical Sounds.

The Fame of his Attainments soon spread itself throughout the City, and reached the ears of the Khalif, who quickly dispatched a Sure Messenger, bidding the Stranger repair to the Palace, there to give Evidence of his wonderful Gifts. In Obedience to the Royal Summons, did the Youth proceed thither, finding the Court assembled and the Khalif upon his Throne, surrounded by his Viziers, Men-at-Arms, Dancing Maidens, scented Fountains, Bul-Buls, Jesters and chained Tigers.

No Whit abashed, did he stand forth and offer, for the Delectation of the Ruler of the Land, to bid the Spirit imprisoned in the Casket to discourse wise Words and Music gathered from all Corners of the Earth. Whereat, the Sultan, having nodded his Leave, he did flood the Throne-Room with strange Words and with Curious Noises.

The Brow of the Ruler darkened as the Entertainment proceeded. Anon did he bid the Youth desist and addressed him thus:

"For Thy so-called Melody give I not the fourth part of a Sequin, for it is of an Uncouthness offensive to mine Ear. Yet, that would I let pass, for not to all and sundry is it given to discourse sweet Music. But that thou shouldst have dared to foist upon Me, as wise Words from Foreign Lands, empty Sounds like unto the Cackling of Hens and the Rustling of Dry Leaves, therefore must thy Presumption not remain unpunished."

And, turning to the Chief *Khōp* of the Palace, he bade him lead the Youth hence and cut off his *Nap-pa*.

And it came to pass that, as the Youth was about to be seized, there sprang forward a beauteous Maiden from amongst the Throng of Dancing-

Girls who, making deep Obeisance to the Khalif, spake thus:

"Stay thy Hand, O Mighty One, I entreat thee, lest thou doest that which it will ever grieve thee to recall. Long before it became my blissful Lot to number myself amongst the Palace Follies did I, even I, Flatula, travel the strange and distant Land of Jazz, whence cometh this Youth; and there did I learn to understand the Words which he hath conjured from his Box. These are weighty in Sooth and of Import to Thee. I would fain translate them to thee for thine everlasting Benefit."

And being given Leave, she did proceed: "The Voice from the Box saith that from the North advanceth a deep Depression, also that in Pursuance of the increased Lust for Pork, the Price of the Hog hath risen by many Shekels in the Market Place, and, further, that one named *Chinston* hath averred that he did not speak the Words imputed to him, but quite otherwise and to a different Effect."

Whereat, stroked the Khalif his Beard, pondered long and did make answer:—

"For thy Words, O Flatula, am I grateful to thee. The Parable which thou hast given me is easy to unravel and of deep Moment to myself. It can mean but this: that my treacherous Neighbour in the North, that Dog from a cross-bred Mother, is preparing to attack me and that he hath so far drifted from the Faith as to lust for the Flesh of the Hog. The Sheik of strange Name can but be one of his Viziers, for they were ever a per-

WHAT VALVES SHALL I GET FOR MY SET? READERS WHO ARE ASKING THEMSELVES THAT QUESTION SHOULD TURN TO PAGES 108 & 109, WHERE THEY WILL FIND DETAILS OF ALL THE NEW TYPES AVAILABLE FOR THE AMATEUR

(1) Now known as the Straits of Gibraltar.



# Mains Matters

fidious Breed, apt to eat and twist their Words. Let then Mine Army be prepared and marched forthwith to the Northern Frontier, there to withstand and hurl back the coming Assault.

"And as for you," quoth he, addressing Nō-zijim, "almost *did* I wrong thee. Thou art a *great* Man and of my Counsel. Accept, thou, these priceless Gems as part of thy Reward; likewise, these rare Unguents, Carpets, Ivories, Camels, and Concubines. Further *will* I prove my Favour unto thee by entrusting thee *with* my Confidence. Proceed thou to mine Enemies *in* the North, where dissembling thy Plans and ingratiating thyself with them, thou mayst overhear *their* Councils and frustrate their knavish Tricks."

Hereupon gathered the Youth all that which had been bestowed upon him and wended his Way northward in a Caravan of many Camels, accompanied by *the* beauteous Flatula, of whom he *had* become Enamoured.

After many Days of Hardship and of Adventures, they arrived at the Capital of the North, where the Magnificence of their Equipage and the Magic of the Box failed not to gain for *them* Audience at the Palace.

Here repeated Nō-zijim before the King *all* those Sorceries and Enchantments of which the *Djinn* rendered him capable.

At the Hour of Eve, before a Great Company, was the Throne Room filled by a strange Voice and alien Words, whereto the King listened in Awe, but without Comprehension. *But* the Maiden Flatula was at Hand to interpret the Message, which she *did* as shall appear:

"From the South advanceth a cyclonic Disturbance. An Alliance hath been concluded, in view of the forthcoming Struggle, between N.U.R. and T.U.C. The Conference on Disarmament hath again broken asunder without Avail."

Then arose the King in his Wrath and cried:—

"For thy Message and Parable, O Stranger, can I never grant thee adequate Reward. Meanwhile accept *thou* these Jewels of rare Worth, these Spices, Perfumes, and cunning Works of Gold.

"The Parable is clear indeed, and hath but one Meaning. The proud-stomached Upstart who misruleth the Land to the South is about to attack me and my People and to

despoil the Land. To this criminal End hath *he* found himself Allies among the Barbarians of *Nur* and of *Tuc*, and the Efforts of mine own Ambassador to divert him from his dastardly Purpose have proved of no Profit. But we shall not await this Pleasure. Nay, verily we shall mobilise our Legions forthwith, and march South to his Encounter and Discomfiture, smiting him *Hip* and *Thigh*, and causing him to bite the Dust.

"For thee, Nō-Zijim, have I a further mission of high Honour and Importance. Proceed thou to the Country of mine Enemy where, scattering the Largesse with which *I* shall entrust thee, *thou* mayst win over his Captains and frustrate his designs."

And behold, in the Dawn of the Day following thereupon, did Nō-

**B**EFORE adding any kind of mains H.T. or L.T. eliminator to a set it is first necessary to find out if the mains supply is A.C. or D.C., the periodicity if the supply is A.C., the voltage, and if one wire is earthed. Examination of the markings on the meter will usually show if the supply is alternating or direct, and the periodicity in the case of A.C., but a polite note to the electricity suppliers or the local showrooms will usually gain this information.

Failing this, take two leads from a mains point, and insert a lamp in

## INTRODUCING THE DUDS CONCERT PARTY



A group of entertainers who give enjoyment to listeners

Zijim and Flatula set out with a richly-comparisond Caravan of Camels in order to fulfil *their* Mission. But, after having journeyed some Leagues upon their Way, they changed their direction privily to the Coast with all the Speed they might encompass, thence taking Ship for the distant Land beyond Jeb-el-Tarik or Pillars of Hercules, and the Chronicle hath it that their Baggage did occupy the full Burthen of the Vessel.

The Moral whereof is that *no* Man need let his *left* Hand know whom his *right* Hand doeth.

one of them. Then place the two free ends in water to which a little salt is added. The lamp will glow dully and bubbles will form at the wire ends, the negative wire collecting most of them. An A.C. supply will give an equal electrolysis.

Then take the end of the lead in which the lamp is connected out of the water, and touch it to some earthed body such as a water pipe. If the lamp glows, then this lead is above earth. As its polarity has already been detected, the *ded* action is obvious.

M.L.B.



Three-valve Touchstone Set made by a Chalfont St. Giles reader (see bottom of column)

**THE TOUCHSTONE**

PERHAPS the most popular set ever described in these pages, W. James's Touchstone (WIRELESS MAGAZINE, November, 1928) has been built by thousands of readers all over the world. A Leeds reader has received thirty-five stations at full loud-speaker strength:

I feel I must write to you personally and thank you for designing such a wonderful set as the Touchstone. It does all you claim for it and more, as I have been able to obtain some thirty-five stations at full loud-speaker strength on quite a small aerial.

The aerial is 20 ft. high at one end and 12 ft. at the other, so you will see that the set is not working under the best conditions.

The set is built exactly to your specification and the valves used are three Osram HL 610's and one P625A, but I am thinking of altering these as sometimes the volume is too loud for the filament resistance to control and perhaps I should do better with a valve of lower amplification factor in the detector stage.

The local station is only a mile away and roars in, but I have no difficulty in cutting him out. As for 5GB, this station is magnificent and the volume control has to be cut right down, otherwise strength is unbearable.

The set is used with the linen-dia-phragm loud-speaker, described in *Amateur Wireless*, and for purity is equal to many M.C. speakers I have heard.

I hope you will give us further notes on this remarkable receiver in the near future.

A CHALFONT ST. GILES reader writes again about the Touchstone and also about the Music Chарmer (WIRELESS MAGAZINE, March, 1928):

I wrote to you some weeks ago concerning the Touchstone but have received no reply—no doubt you have mislaid the letter. [This letter was published on page 63 of the February issue.—Ed.]

However, you will probably be inter-

# WHAT OTHERS HAVE DONE WITH "WM." SETS YOU CAN DO, TOO!

ested in the enclosed photos. One is of a three-valve receiver with the Touchstone H.F. amplifier, followed by a PM4D and a Pentone for output to an M.C. speaker.

As I informed you in my previous letter, this set has given ample volume for dancing in a fair-sized hall and brings in almost any European station worth listening to.

The other photograph is of a pedestal cabinet containing the Music Chарmer with a special all-wave coil and an arrangement of jacks and Formodensors so that no tuning is required for 2LO., 5GB or 5XX, although a variable condenser is incorporated for foreign stations.

I enclose the circuit arrangement of the detector and also particulars of the all-wave coil. You will notice that if the plug is not in any of the four sockets the L.T. supply is cut off. The jacks used are of the telephone and L.T. type—the plug being shorted, giving the equivalent of a double-pole single-throw switch.

With best wishes for the success of WIRELESS MAGAZINE in the coming year.

centres when other than local programmes are wanted.

I only quote dial readings partly for brevity and partly because the identity of some of the continental stations is not yet known. All the stations mentioned below were received on A1 terminal and about 50 per cent. required only half available volume in a room 14 ft. 6 in. by 18 ft. with a cone speaker constructed with a Blue Spot unit.

The dial readings are:—2, 6, 10.5, 13, 18.5, 21, 23.5, 28, 32.5, 39 (local station), 41.5, 43, 53, 55.5, 56.25, 59.5, 60.5, 61, 62.25, 63.5, 66, 70.5, 76.25, 79.5, 80, 82, 83.75, 84.25, and 92.75.

Three of these stations often have had hetrodyne whistles, and two or three others suffer sometimes from slight background.

I use 2-volt valves with a super power in last stage, 120 volts H.T. accumulator. The aerial is indifferent, being somewhat shielded, while the earth is good, being 3 ft. of 2 in. copper tube. The coils I wound myself according to instructions and the speaker is actuated through a

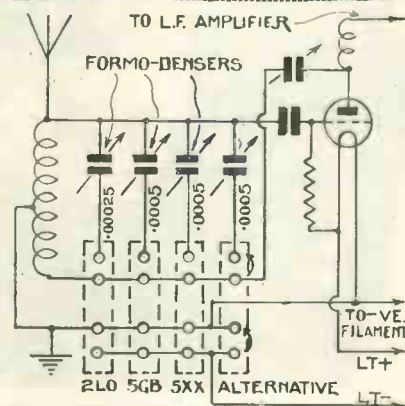

**MODIFICATIONS TO THE MUSIC CHARMER**

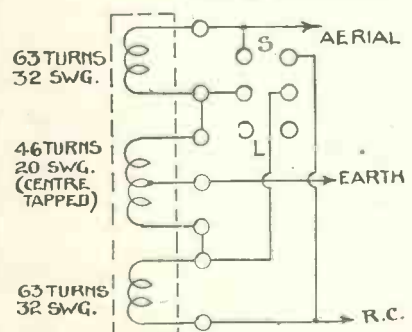

Modified tuning arrangement used for the Music Chарmer by a Chalfont St. Giles reader (see reference in centre column above). The all-wave coil is wound on a 4-in. Paxolin former with d.s.c. wire, and there is a 1/2-in. space between the sections

THE Irish are notoriously difficult to please, but this certainly does not apply as far as the Touchstone is concerned, as this appreciative letter from a Belfast reader proves:

I herewith write my appreciation of Mr. James's Touchstone and give an idea of its performance three miles from 2BE.

In considering the results obtained the fact should be taken into account that Belfast is roughly, as the crow flies, 335 miles from London and that the same distance beyond London would be over 100 miles beyond Paris. In fact, Northern Ireland is, geographically, one of the worst situated broadcasting

filter circuit incorporated in the set. I find that slightly better results are to be obtained by supplying a separate G.B. tapping of about 4 1/2 volts to the R.C. coupling. In my case this improves both quality and volume a little, but it is quite noticeable.

I must say that for simplicity of operation, stability over entire range, economy in upkeep and astonishing results the Touchstone is easily the best four-valve receiver I have yet tried out. I only hope that the Lodestone speaker will be worthy of its predecessor, the Touchstone receiver. With best wishes and many thanks to the WIRELESS MAGAZINE staff.



**S**OUTH Wales is represented by a letter from a Llanelly reader, who enthusiastically guessed the windings for long-wave coils. Anyhow, he seems to have been successful:—

With your permission I would like to write my experiences of this fine set for the benefit of other builders.

I wanted to use it mostly on the long waves as being best and most free from interferences. So I had to copy the coil winding data and guess the correct number of turns as only the short-wave coils were given.

To use the high-class condensers and Colvern coil formers out of my previous two-valver (I am not very rich), I had to alter the layout a little (I warn others against this latter proceeding).

Well to cut a long story short, the set would not work! And three weeks of trying only got Daventry 5XX on the headphones. So sadly I rearranged the layout more in accordance with the author's specification. (Some different valves were used and other alterations made.—ED.)

The set was an instant success, Radio Paris was heard at very great volume, far too loud, and Daventry 5XX was simply titanic power and also pure. Everything in the room vibrates with Daventry. Turning the little reaction knob has an astounding effect on long-wave distant stations.

I am making the linen-diaphragm loud-speaker and after my previous experience the wood is all oak and as thick as utility and appearance will permit. My present 5ft. wood horn (exponential type) booms like some monster drum on account of thin wood walls.

**FURZEHILL FOUR**

**M**ANY amateurs found J. H. Reynier's Furzehill Four (WIRELESS MAGAZINE, December, 1928), just the kind of set they needed. Here is a letter about it from Fife:

You may be interested to know that I have completed the Furzehill Four yesterday, and have already succeeded in improving on your test report.

I have used identical components with yours in every case, and with four-volt Mullard valves throughout and a poorish aerial the results are magnificent.

Curiously enough I have found that the tuning scale published with your description of the set is quite useless—my own tuning is totally different from yours, particularly on the long waves.

In addition to the stations shown in the enclosed list, I have also found about half a dozen stations so badly heterodyned as to be unidentifiable.

**SHORT WAVES:—**

7	Malmö	46½	Posen
7½	Lille	49	Barcelona
14	Cologne	51½	Prague
18½	Bordeaux	53	Cardiff
23	Edinburgh	56	London
28	Hanover	57½	Leipzig
30½	Koenigsberg	61½	Stuttgart
32	Belfast	63½	Manchester
34	Toulouse	65	Toulouse
36	Newcastle	66	Hamburg
40	Breslau	69½	Glasgow
42	Bournemouth	72	Goeteborg
43½	Gleiwitz	76	Frankfurt
46	Huizen	85	Langenberg

**Something More Than Just Praise—**

for the WIRELESS MAGAZINE are the letters from readers reproduced in these pages—they are a definite help to the amateur who wants to build a new set, for they do give an unbiased view of what each set will accomplish in different localities.

Remember that back copies describing any of these sets can be obtained for 1s. 3d. each, post free, and that full-size blueprints are available

as indicated on another page of this issue.

Readers are invited to send us photographs of WIRELESS MAGAZINE receivers they have built; for each one printed we shall pay a fee of half a guinea.

If you have recently built a WIRELESS MAGAZINE set let us hear what results you are getting and so give to your fellow amateurs—

**Proof That "W.M." Sets Are Really Good!**

<b>SHORT WAVES (continued)</b>	
87	Lyons
90	5GB
91½	Aberdeen
<b>LONG WAVES:—</b>	
0	Hilversum
19	Warsaw
48	Motala
54	Moscow
59	Lahti
64	5XX

<b>LONG WAVES (continued)</b>	
Warsaw	Hilversum
<i>*Daylight reception</i>	
<b>MEDIUM WAVES:—</b>	
Budapest	Toulouse
Milan	Manchester
Munich	Stuttgart
Vienna	Liepzig (when 2LO silent)
Brussels	London
Daventry 5GB	Huizen
Lyons	Copenhagen
Langenberg	Breslau
Rome	Frankfurt
Frankfurt	Dublin
Kattowitz	Cologne
Hamburg	Nürnberg

**FIVE-POUNDER FOUR**

**G**REAT popularity has been enjoyed by the Five-pounder Four (WIRELESS MAGAZINE, August, 1928). One reader at Leyton has built an additional high-frequency unit for use with it and gets a large number of stations:—

Shortly after the issue of your August number I put together your Five-pounder Four set. As I can never let well enough alone, however, I also made an extra H.F. unit for occasional use.

Using the two together I have compiled the following list of stations received, many of which came through on the original set:—

<b>LONG WAVES:—</b>	
Huizen	*Moscow
*Radio Paris	*Motala
*Berlin	Berlin (when on 1250)
*Daventry 5XX	*Kalundborg
Lahti	

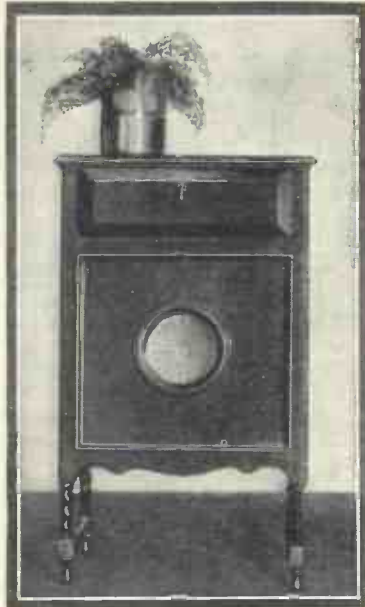

Pedestal Cabinet containing the Music Charmer, as made by a Chalfont St. Giles reader (see letter at bottom of first column on opposite page)

When Stuttgart has closed down I have also heard Schenectady, U.S.A.

The above list is of "loud-speaker" stations only, as I very rarely use phones.

I might also add that on the occasion of the Armistice broadcast I used the original set to provide reception at the church I attend; with two loud-speakers in parallel it provided ample volume for the congregation to join in (and keep time with) the singing of "O God our help."

Altogether I am exceedingly satisfied with the set.

**KEY-TO-THE-ETHER TWO**

**I**T is no exaggerated claim to say that amateurs all over the world are guided by WIRELESS MAGAZINE technical designs. This letter from an Amsterdam reader about the Key-to-the-ether Two (WIRELESS MAGAZINE, November, 1928), proves that:

As a regular reader of your very interesting magazine, I have the pleasure of informing you that I have constructed the Key-to-the-ether Two, which appeared in November last.

I was never so much surprised at the results I got with this set on both wavelengths. The first station I got was very loud, and the music excellent. At first I thought it was Huizen on the short wave, but after the announcement I heard it was Budapest.

That evening I got eighteen stations on the short waves, and seven stations on the long wave-band, all stations at full loud-speaker strength.

I have made a new centre-tapped coil. The coil with a parallel condenser gives the stations between 900 and 2,000 metres, and the same coil with the same condenser in series gives the stations between 250 and 600 metres.

In concluding let me say I have made and heard lots of three-valve receivers, but the Key-to-the-ether Two is better. I hope many of your readers have made this receiver, and I am sure they have the same excellent results.

# The Signal Booster

*Will add  
Punch to  
your set!*



INCREASES **RANGE  
VOLUME  
SELECTIVITY**

As a keen radio listener you must have already asked yourself the following questions:—

Is your set sufficiently selective—can you, for instance, cut out Daventry 5XX on 1,562 metres and receive without interference the Fultograph transmissions from Königswusterhausen on 1,649 metres? Is your range big enough—can you get really distant stations with ease? Is the volume of distant stations enough?

### If You Answer "No"

If your answers to these questions are *No* then you will want to build the Signal Booster described in these pages. On the other hand, if you already own a four- or five-valver that has been described in the WIRELESS MAGAZINE during recent months, it is probable that your answers will be in the affirmative.

What, then, is this Signal Booster? It is a simple high-frequency amplifying unit with a screened-grid valve which will add tremendously to the selectivity, range, and volume of any set which is lacking in these respects.

The cost of constructing the Signal Booster is approximately (including a screened-grid valve and coils to cover

both upper and lower wavelength bands) £5, and it is quite economical in use—it will not take more than another three or four milliamperes from your source of high-tension, while most screened-grid valve filaments consume only .15 ampere from the accumulator.

You will see then that at a comparatively small cost you can increase

practice. A member of the WIRELESS MAGAZINE Staff has for some weeks been using the Standard-coil Three (described in the January issue). This set comprises a high-frequency amplifier, a detector, and one stage of transformer-coupled low-frequency amplification.

For a set of its type, it is selective, but the volume it gives is not very great on account of its single stage of low-frequency magnification. Nevertheless on a *short indoor aerial* in Kensington it will receive both the Daventrys at really good loud-speaker strength—and, of course, a number of other stations as well.

### Limitations

However, in spite of its relatively good performance (for the aerial and earth conditions were really quite bad) it would not receive the Fultograph transmissions from Berlin, because of interference from Daventry 5XX and the volume from Radio Paris was not good enough to operate a loud-speaker (a large cone model) well.

All this was changed as soon as the Signal Booster was coupled up. Berlin could be picked up at any time without interference from

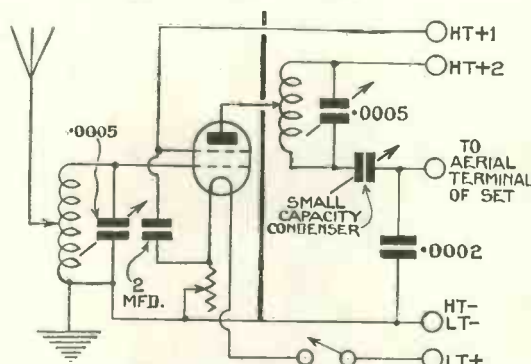

See how simple is the circuit of the Signal Booster

the utility of your present receiver tenfold—the additional selectivity alone will enable you to hear many interesting foreign transmissions that have hitherto been out of your reach, because they were cloaked by nearer and more powerful stations.

Let us give an example of what the Signal Booster will actually do in



Daventry 5XX—the difference in their wavelengths is only 87 metres or 10.8 kilocycles—and Radio Paris could also be received without difficulty at really good strength and without distortion.

Moreover, no reaction was necessary as it had been when the Standard-coil Three was in use on its own.

**For Any Existing Set**

We are certain that every reader of the WIRELESS MAGAZINE who builds the Signal Booster will be glad he did so. Remember that it can be used with any existing set, no matter whether it uses high-frequency amplification or not.

If you have been thinking of building a wavetrapp, build the Signal Booster instead. It will give you all the selectivity the average wavetrapp will—and it will give you punch as well!

We have said that the Signal Booster is simple—this fact is evidenced by the photographs and diagrams reproduced in these pages. Nobody can go wrong if use is made of a full-size blueprint, which acts as template, layout and wiring diagram.

**Every Wire Numbered**

The sizes of all holes in the panel are indicated and every wire is numbered in order of assembly. There are twenty in all and if these are made in order it is certain that the Signal Booster will work directly it is coupled to the main receiver and switched on.

Of course, a blueprint is not essential, all the necessary details being reproduced in these pages on a smaller scale.

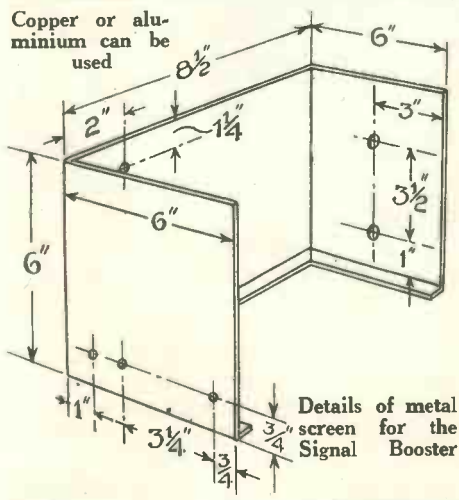

If you do want a blueprint, however, (and there is no doubt that many readers do appreciate working from one) you can get one for half price, that is, 6d., post free, up till March 31, by using the special coupon on page iii of the cover.

Send this, together with your name and address and a postal order for 6d., to Blueprint Dept., WIRELESS

is to obtain increased selectivity; for instance, a double-tapped coil can be used, in which case the unit will be even more selective than with the centre-tapped type.

The best advice that can be given the prospective constructor in this respect is to make use of what coils he has on hand, if any, or, if he has to buy coils, to get centre-tapped

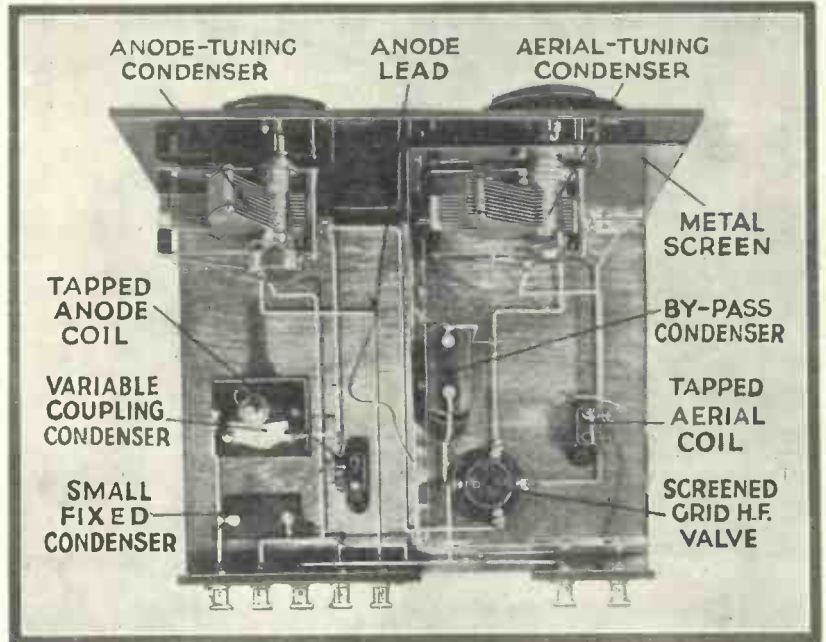

This photograph shows clearly how all the parts are arranged in the Signal Booster, the construction of which can be undertaken even by the most inexperienced amateur

MAGAZINE, 58/61 Fetter Lane, E.C.4. Ask for No. W.M. 128.

Readers who can understand a theoretical circuit will be interested in that reproduced on page 146; this shows how the Signal Booster is arranged electrically.

In the first place, note that two-pin plug-in coils are used; these have the merit of being cheap and are quite efficient enough for the circuit in view. Moreover, many listeners who will want to build the unit will already have a set of suitable coils in their possession.

The aerial coil, which is tuned by a .0005-microfarad variable condenser, is shown with the aerial tapped on at the centre. Now this is not essential and, if desired, an untapped coil can be used with the aerial connected directly to the grid end in the ordinary way. The object of tapping down on the coil

aerial coils for preference.

On the other hand it is essential for the anode coil to be centre-tapped in order to get the best results from the valve. A centre-tapped coil in the anode circuit not only gives the greatest amplification from the valve without oscillation, but it also, of course, gives better selectivity. A double-tapped coil should not, however, be used in this position.

**Two High-tension Voltages**

Two high-tension (positive) terminals are provided—one for applying 60 to 75 volts to the screening grid of the high-frequency valve and the other for applying 120 volts to the anode.

It is essential to use a rheostat in the filament circuit of the valve and so that this need not be disturbed when it has been set, a push-pull switch has also been provided for making and breaking the circuit. Indeed, this rheostat is a most valuable control, for as the filament current is decreased, so is the

## The Signal Booster (Continued)

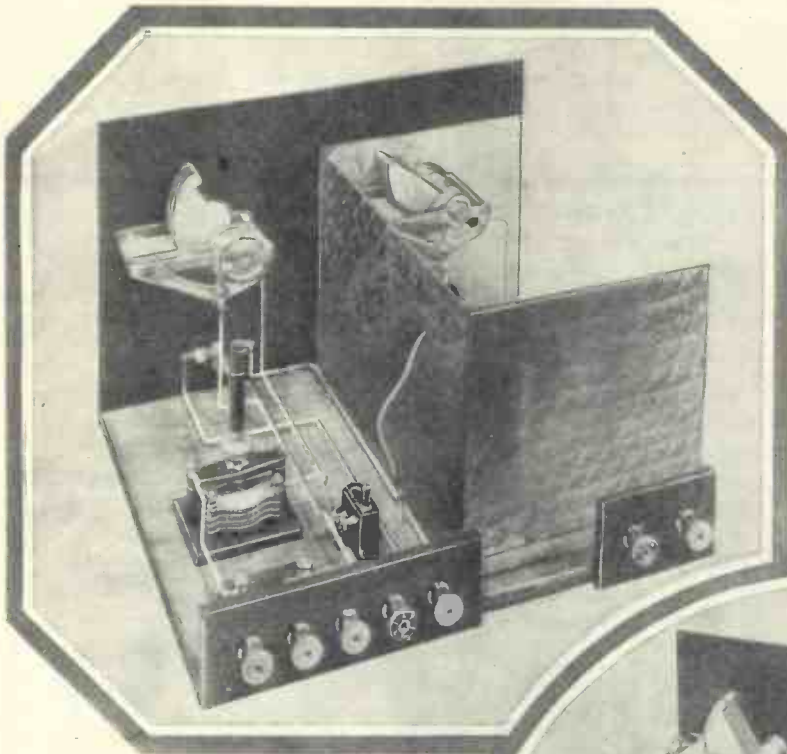

The lead from the anode of the screened-grid valve can be seen projecting through the screen

impedance of the valve increased and a better degree of selectivity obtained.

By the way, in the original unit the .0005-microfarad variable condenser tuning the anode coil was one provided with a slow-motion control. This type of condenser is especially recommended, as it simplifies tuning considerably and allows very fine adjustments to be made without difficulty.

### Variable Coupling Condenser

It will be seen that between the bottom end of the anode coil and the output terminal marked "aerial" (to be connected to the aerial terminal of the main receiver) there is a variable condenser. This serves two purposes.

Its main object is to insulate the high-tension current supplied to the anode of the screened-grid valve from the main receiver, but to allow alternating (high-frequency) signal impulses to pass.

The value of this condenser need only be very small and, in practice, it is most convenient to use a condenser of the "neutralising" type, which has a capacity of 50 micro-microfarads or so (.00005 microfarad).

The purpose of the .0002-microfarad fixed condenser across the output "aerial" terminal and low-tension negative (which it will be seen is earthed) is to compen-

sate for the aerial-earth capacity across the tuner in the main receiver, for, of course, when the Signal Booster is in use, the aerial and earth are disconnected from the main set and connected to the aerial and earth terminals of the unit itself.

### Obtaining the Components

So much for the theoretical consideration of the Signal Booster. Let us once again turn to the practical side. We will assume that the prospective constructor has already obtained all the necessary parts as indicated in the list of components, to be found on page 150. No doubt many readers will already have a number of the parts in their possession.

The first operation is the

Note the gap between the metal screen and the small terminal strip

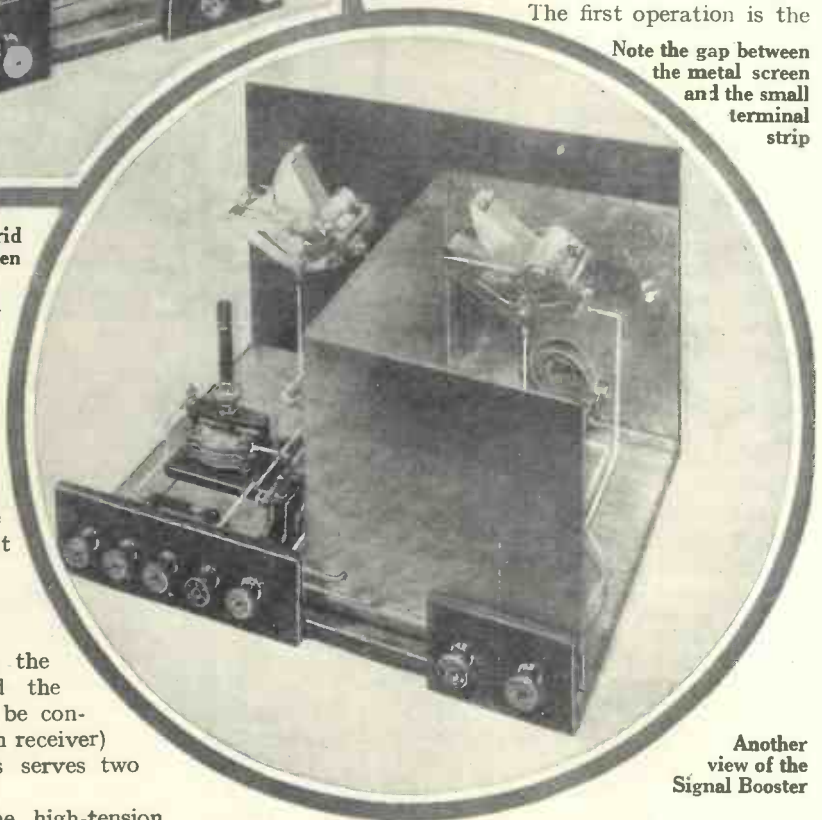

Another view of the Signal Booster

drilling of the front panel. This will present no difficulty if the full-size blueprint is used as a template—just lay the top part of the blueprint over the panel and drill holes as indicated.

Next, the copper or aluminium screen must be assembled. The dimensions of this are indicated on page 147, or, alternatively, it can be obtained already drilled from one of the firms indicated in the list of components.

When the screen has been obtained and the panel



## Will Increase the Range and Selectivity of Any Set

drilled, screw them both to the baseboard so that the holes for the variable condenser spindle coincide. When this has been done the remainder of the components can be fixed in the positions indicated.

### Wiring-up the Unit is a Simple Job

Everything is now ready for wiring up—perhaps the simplest part of the whole construction. In the first place remember that it is essential to use *insulated wire* for the connections which go through the metal screen, or short-circuits will occur. Indeed, it is desirable to use insulated wire throughout.

broadcast wavelengths—two for the long waves and two for the short waves.

The long-wave coils should be two No. 200's and the short-wave coils two No. 60's.

### Many Screened-grid Valves Available

As regards the screened-grid high-frequency valve, there is a choice of many makes, as can be gathered by referring to the table on page 109 of this issue. Actually a Six-Sixty 215SG was used during the tests already referred to, but the equivalent Cossor or Mullard valve would be quite satisfactory. These valves are, of course, 2-volters.

If the main set uses 4- or 6-volt valves, there are two courses open to the operator. Either he can use a 2-volt valve and tap off 2 volts from his accumulator or he can obtain a 4- or 6-volt screened-grid valve.

With regard to 6-volt screened-grid valves, there is only one make of the upright type at present available and that is the Ediswan SG610. Both the Marconi and Osram S625 are the horizontal type and not suitable for use with the Signal Booster.

Now for connecting up the unit to the main receiver. There is no need to make any alterations to the connections to the main set except to remove the aerial and earth leads and screw them to

Another view of the Signal Booster ready for use

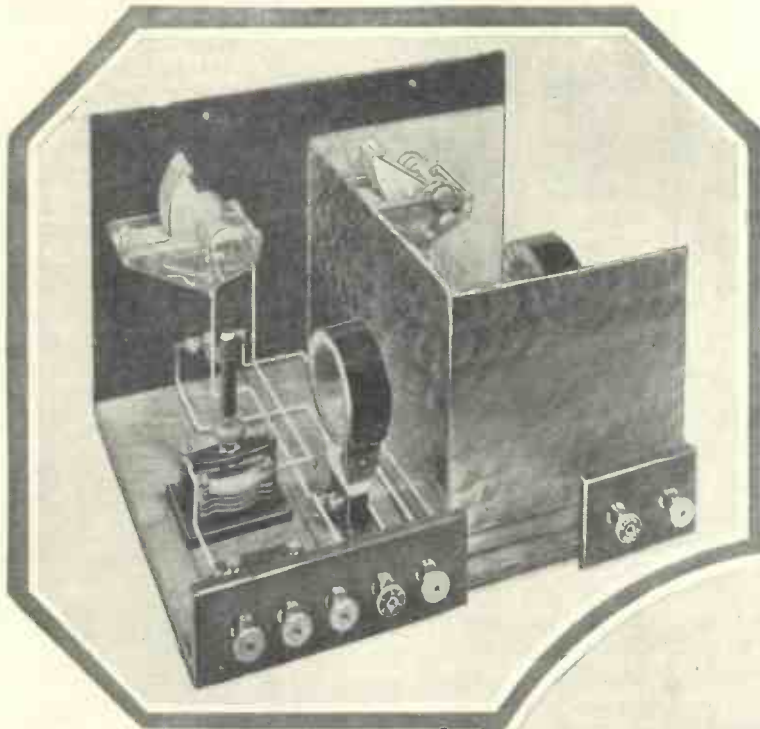

This photograph shows the anode coil in position

Refer to the blueprint or the reduced wiring diagram reproduced on page 150 and pick out connection No. 1. Cut a piece of wire of suitable length and screw it in position; then cross through No. 1 on the diagram. Proceed with wire No. 2 and, when this has been connected, put a mark through that number on the diagram.

### Twenty Connections in all

Carry on in this way to the leads numbered 20 when the Signal Booster will have been finished and be ready for use, when it has been coupled to the main set.

Before the unit is used, however, the operator should make sure that he has the proper coils and valve. Any standard two-pin plug-in coils can be used, provided that the anode coil is centre-tapped. Four coils will be needed to cover the upper and lower

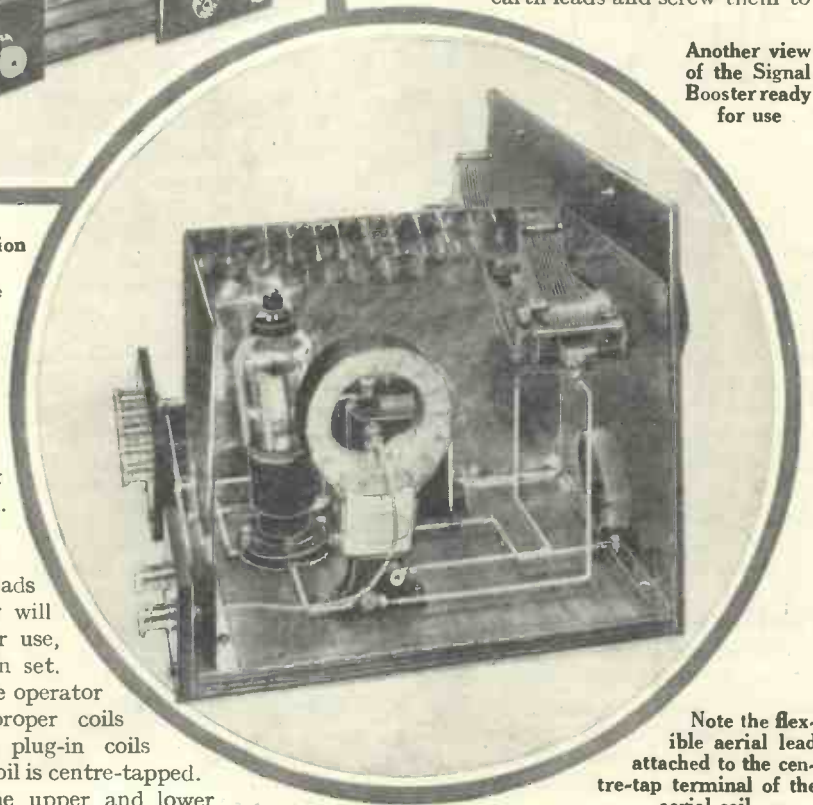

Note the flexible aerial lead attached to the centre-tap terminal of the aerial coil

## The Signal Booster (Continued)

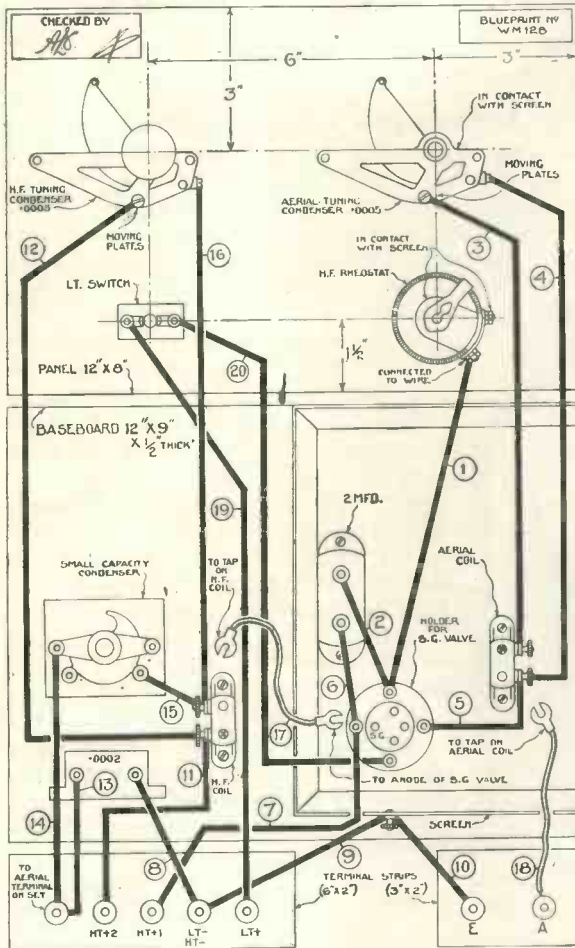

This wiring diagram and layout can be obtained as a full-size blueprint for half price, that is, 6d., post free, if the coupon on page iii of the cover is used by March 31. Ask for No. W.M. 128. Connect up the wires in numerical order

the main set, connect the lead from the unit to the grid side of this, instead of to the main aerial terminal.

If a separate accumulator is used for providing filament current for the valve in the Signal Booster, connect the negative terminal of this to the earth terminal of the main receiver.

### Operation

Now for the operation of the unit. Put the appropriate coils and valve in the holders and connect up the flexible leads. Take care in connecting the flexible lead from the anode terminal

screen towards the anode coil, so that the length of lead between the anode terminal of the valve and the metal screen is as short as possible.

When using the Signal Booster for the first time it is convenient to tune in a station on the main receiver alone first and then put the extra unit in operation.

### Temporary Aerial Lead

To do this, disconnect the aerial lead from the unit and apply it to the aerial terminal of the main set in the ordinary way. Now tune in a station on the main set in the ordinary way.

Without switching off the main set, remove the aerial lead and fix it to the aerial terminal on the unit. Now pull out the on-off switch and turn the rheostat full on. If the whole receiver should oscillate, reduce the filament current by means of the rheostat (turn the knob a little back to the left).

Place the vanes of the "neutralising" condenser so that they are right in mesh and turn the knob of the variable anode condenser until the station already tuned-in on the main set is heard again.

If the station picked up was weak in the first place, it may not be heard until the aerial condensers of the Signal Booster and of the main set are adjusted. When the signal is heard, reduce reaction on the main set and retune all the dials until the loudest signal is obtained.

The effect of varying the coupling condenser on the baseboard can also be tried, but normally this can be

(Continued on page 158)

the aerial and aerial terminals on the right-hand terminal strip (looking from the back) of the Signal Booster.

Also connect up the L.T.+ and L.T.- terminals of the Signal Booster to the accumulator to be used (not forgetting to tap off the proper voltage if a 2-volt screened-grid valve is to be operated from a 6-volt battery). To H.T.+1 apply the screening grid voltage recommended by the makers (it varies from 60 to 80 volts) and to H.T.+2 apply 120 volts. Before making these connections, of course, see that the push-pull switch on the panel of the Signal Booster is "in."

### Final Connection

The connections are completed by taking a lead from the output "aerial" terminal of the unit to the aerial terminal of the main set (no connection is made to the earth terminal of the main receiver). If a series aerial condenser is provided in

valve (on top) of the screened-grid valve to the centre-tap of the anode coil that the end does not touch the metal screen or the high-tension supply will be short-circuited.

When the connection has been made, pull the lead through the

### COMPONENTS REQUIRED FOR THE SIGNAL BOOSTER

- 1—Ebonite panel, 12 in. by 8 in. (Becol, Parfait, or Trolite).
- 1—.0005-microfarad variable condenser (Jackson Bros., Ormond, or Gecophone).
- 1—.0005-microfarad variable condenser with slow-motion device (Jackson Bros., Ormond, or Gecophone).
- 1—15-ohm panel rheostat (Peerless, Lissen, or Ormond).
- 1—On-off switch (Trix, Bulgin, or Lotus).
- 2—Dial indicators (Bulgin).
- 2—Single-coil holders (Lissen, Lotus, or Peto-Scott).
- 1—Antimicrophonic valve holder (Trix, Lotus, or Benjamin).
- 1—2-microfarad fixed condenser

- (Lissen, T.C.C., or Dubilier).
- 1—.0002-microfarad fixed condenser (Lissen, Dubilier, or T.C.C.).
- 1—Neutralising condenser (Peto-Scott, Gambrell, or Igranic).
- 2—Terminal strips, 3 in. by 2 in. and 6 in. by 2 in. (Becol, Parfait, or Trolite).
- 7—Terminals, marked: Aerial (2), Earth., H.T.+1, H.T.+2, L.T.+1, L.T.- (Ealex or Belling-Lee).
- 3—Spade tags (Lectro-Linx). Short length flex.
- Stiff wire for connecting (Glazite).
- 1—Copper screen (Parex, Ready-Radio, or Wilburn).
- 1—Cabinet with 9 in. baseboard (Pickett).



# A Trick with Your Portable

*Tuning Circuits Discussed by Capt. H. J. ROUND, M.I.E.E.*

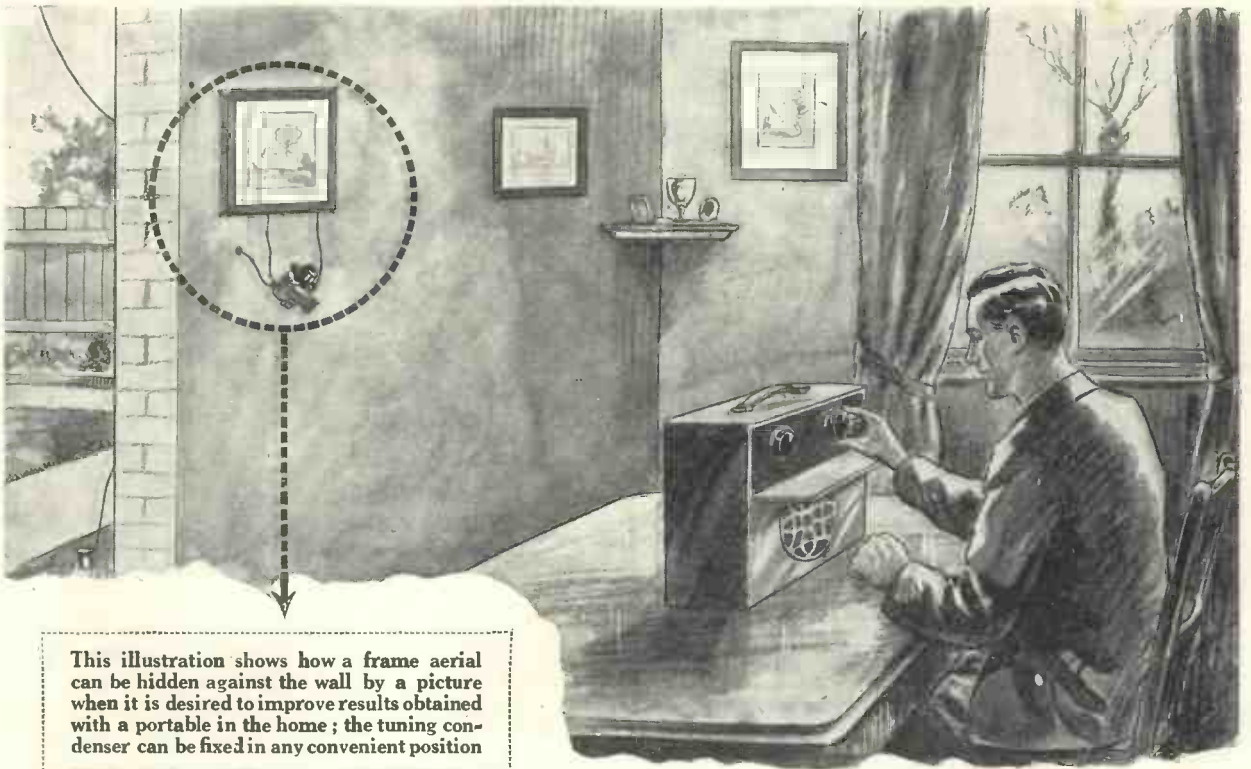

This illustration shows how a frame aerial can be hidden against the wall by a picture when it is desired to improve results obtained with a portable in the home; the tuning condenser can be fixed in any convenient position

**I** ALWAYS consider that in the design of a receiver the three factors—quality, sensitivity and selectivity—should be considered primarily but, of course, the order in which we put these three requirements very much depends upon circumstances.

Sensitivity and selectivity go together to a very great extent, for it is no use increasing our sensitiveness unless we also increase selectivity and, of course, it is positively wasteful to give an insensitive receiver a high selectivity.

## **Rules Hard to Formulate**

Quantitative rules on this subject of sensitivity and selectivity are very hard to formulate and usually in designing a receiver we give a selectivity which by experience we know will be right under most conditions.

The ideal that we really would like to get would only be obtainable by a design too expensive to sell.

A typical example which a designer has to handle is to make a receiver which will bring all European stations of importance up to full loud-speaker

strength and at the same time cut out the local station and 5GB.

If the listener requires such a receiver and he lives only quarter of a mile from 2LO, then, assuming a wavetrap is not permissible, the receiver will be very expensive.

If he lives a mile away from 2LO the receiver will be very much cheaper, and ten miles away the apparatus becomes quite cheap and simple.

What basis should the designer take—the quarter mile, the mile, or the ten miles?

Actually he takes the price it is required to sell at, works backwards and gives the listener the best he knows. With such a receiver—while the local station is transmitting—the listener is blind for a certain wavelength range round that local station and round 5GB.

It is high time that our manufacturers gave data on what their receivers will do—more data, I mean, than the perfectly meaningless "30 to 40 station" statement, which reception may be merely weak loud-

speaker strength, and may be when the local is not working.

I am attempting now to collect real data upon the subject of foreign stations; that is, the strengths to which their signals rise and fall—and with these used in connection with the contour charts given by the B.B.C. for the locals I intend to find out what tuning we really need under various circumstances, for, at present, I only have the qualitative knowledge that every one else has.

## **How We Accomplish Tuning**

Our tuning is given us by a combination of condensers and inductances, the simplest case being one condenser and one inductance. It is well known that the sharpness of tuning of such an arrangement depends upon the resistance which sometimes gets into the circuit.

If a circuit with inductance and capacity had no resistance, and we induced current at a certain frequency into it, the current would theoretically steadily rise to an infinite value.

But ever so slight a change in

## A Trick with Your Portable (Continued)

frequency would result in a big decrease of current. As any one transmission of speech or music is made up of a band of frequencies such, very good resonance would result in only certain frequencies being received—and we should get distortion.

In practice there is a limit to the lowness of resistance we can use in a circuit, although there is no limit to the lowness of resistance we can make a circuit by using the well-known reaction principles, and this limit is decided by the quality.

### A Concrete Example

To give a concrete example, with one tuning circuit only: If our local station is on 385 metres and we wish to receive with fair quality a station on 400 metres, the foreign station should be at least  $\frac{1}{20}$ th as strong as the local or  $\frac{1}{40}$ th at 420 metres and  $\frac{1}{80}$ th at 440 metres.

This would not be a bad sort of condition at, say, 20 miles from 2LO, but would be more or less hopeless at one mile, and to get better effects we have to resort to either more distortion of the foreign station by using more reaction, or, what is a much better thing to do, to use another tuned circuit actuated by the first tuned circuit and then the results are improved by the square of the above figures.

Whereas at 400 metres we previously had to have a foreigner  $\frac{1}{20}$ th of the strength of the local station now we can be content with one  $\frac{1}{400}$ th of the strength of the local.

Of course, we must be able to magnify this  $\frac{1}{400}$ th signal up to loud-speaker strength—showing how tuning and magnification or sensitivity go together.

### Simple Experiment

I have quite recently carried out a little test at my home which illustrates the principles of multiple circuit tuning so well that I will describe it here—and anyone who has a portable receiver can repeat the experiment with ease.

The experiment is not only interesting, but is worth while, in certain cases, putting into common use in the house.

My portable consists in the main of

a tuned frame with reaction—all the other tunings are so flat that they may be considered as not there at all.

Now this portable gets Langenberg in daylight at weak to medium loud-speaker strength without interference

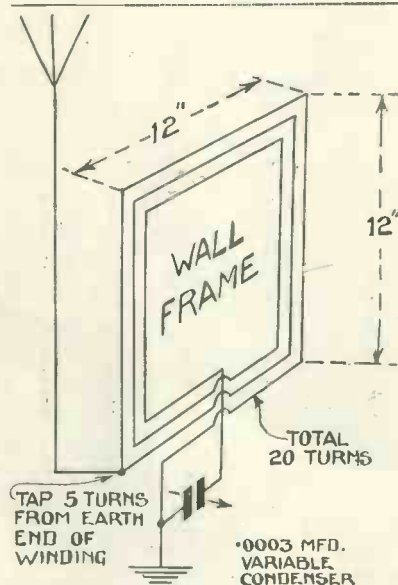

Theoretical diagram of the arrangement explained by Capt. Round

from Daventry and, wanting louder signals, I decided to hitch my aerial on to the set.

Any method I adopted at first certainly brought up Langenberg to fairly good strength, but it brought in 5GB as well, and the extra sensitivity was not of much use to me.

### 2LO Spreading Itself

Near London's wave the effect was still worse—in fact, with the aerial on 2LO nearly spread itself across the map.

Having available a frame aerial about 1 ft. square, I stuck this against the wall, put a condenser across it and then tapped on to the frame with aerial and earth.

For those who wish to do the experiment, the frame had about twenty turns of spaced winding and the tuning condenser was of .0003-microfarad capacity.

I tapped my earth connection at one end and the aerial about five turns from the earth end.

Now, setting the .0003-microfarad condenser to zero so that the aerial system was far away from Langenberg

(any other station would have done), I first of all tuned up the portable to the station, keeping it far away from the aerial while doing so.

On bringing the portable nearer and nearer the frame, at about 1 ft. distance, with a slight increase in the reaction, Langenberg's signals were very strong, but so also was Daventry 5GB and no amount of adjustment on the receiver would separate them. So far I only had a single-circuit receiver.

### Daventry Quite Absent

Next I removed the portable (keeping it parallel to the wall frame) to a distance of 3 ft. and then turned the .0003-microfarad aerial condenser. At Langenberg's tuning point his signals suddenly increased up to the same strength I could get in the previous untuned aerial position, but this time Daventry was quite absent.

One could go to distances of 6 ft. between frame and portable and by careful adjustment get full strength signals.

I then proceeded to try stations between London's wave and 400 metres, and found it quite easy to separate 2LO down to 20 metres away and closer still with looser couplings and more reaction.

After tuning up to any one station the receiver can be shifted over a wide area without seriously altering signals, and I suggest to those who are keen on getting one particular station that the arrangement is ideal.

Of course, all other stations come in on the portable just as though the aerial was not there, at these longer coupling distances, but if the condenser attached to the frame is calibrated searching can quite easily be done.

### Question of Larger Frame

A larger frame will enable reception to take place at greater distances from the frame, but I hardly think there will be much advantage in general practice, except possibly the advantage that one can choose the spot for the receiver in a more convenient place.

A second frame of four times the number of turns will be necessary for the long waves and for your own sake



## Women are Becoming Wireless Enthusiasts

keep the two frames well separated, because whenever a long-wave frame gets near a short-wave frame when the latter is being used, a serious reduction in signals is likely to take place.

Of course a good aerial is essential—an indoor aerial or another frame will give no appreciable gain in strength and you will be mixed up between the direct reception of the receiver and the indirect reception through the aerial system.

### Minimum Position

When using the trick to receive near the local station's wavelength, the receiver should be set at the minimum position of the local and the aerial frame.

Those who wish to do tricks may remember that such an arrangement can work quite well with a wall or even a floor in between, so that if necessary the aerial can be quite camouflaged.

I expect if I were to take curves of such an arrangement I have been transgressing all the rules, that is, not to increase tuning and reaction beyond the distortion point, but you must take it that I merely wanted to illustrate to you a principle.

### Four Circuits Better Than Two

Just as two tuning circuits are much better than one—so four circuits are better than two, and four circuits with a certain resistance each are always better than two circuits even of a lower resistance if we bear in mind what we are aiming at—quality as well as selectivity.

The general tendency, I think, is going to be towards four and six circuits—coupled with or without valves—but until a ganged condenser is produced which is both accurate and cheap we shall not reach the goal aimed at.

### SPECIAL NOTE

[Since writing the above article I have received the February number of WIRELESS MAGAZINE and in it I find a description in a letter from a reader of the experiment I have described with a portable.

As, however, I have introduced the experiment to illustrate the principles of tuning, I have left my text as originally written, but at the same time I wish to acknowledge the co-invention and pre-publication of the scheme by the reader (see page 64 of the February issue).]

NOTHING came as a greater surprise to me at the recent wireless exhibition than the number of women that were seen thronging the huge hall at Olympia.

They were not there in company of their husbands or sweethearts merely to pass through, they were interested in the various latest improvements; they asked questions; they wanted information; they wanted to test for themselves; they were as keen and enthusiastic as their men companions.

One stallholder informed me that he had sold twenty sets to women that day and that as far as his rivals were concerned they were doing the same thing.

### A Great Change

This reveals a great change. Not long ago the women folk regarded us radio fans as more or less nuisances with our miles of wires, numerous coils, ugly aeriels, batteries and accumulators. We must admit that we kept the principal room of the home in a regular state of topsy-turvydom and after many cross words we took our whole outfit to some room far away from the wife.

Not only that, the time is not long since the wife would not dare touch the set in case she burst the valves. She was under orders not to touch

anything unless we men were home. Her curiosity, however, would not leave the set alone. There was the afternoon programme she wanted and she insisted on a set she could switch on and off at her will.

### Sets Fit to be Seen

Thus early, women insisted that we should have sets fit to be seen in the best room of the house along with the other pieces of furniture and matching them in colour and design. Sets that would not obtrude with their clumsiness even when heard. They further are mainly responsible for the simplicity of the modern set. It is they who have demanded them mostly and the supply is to satisfy them.

But women will not be satisfied there. Already a large number of them are becoming radio fans and as keen as the rabid man enthusiast. They were seen buying parts and new sections at the exhibition. Indeed, a college which trains girls for certain careers has this session a course of training for girls in wireless engineering. A well-known radio engineer is in charge and already fifteen girls have enrolled as students.

The women are coming into their own and they are discovering that radio is part of their inheritance. They mean to possess it. E. B. R.

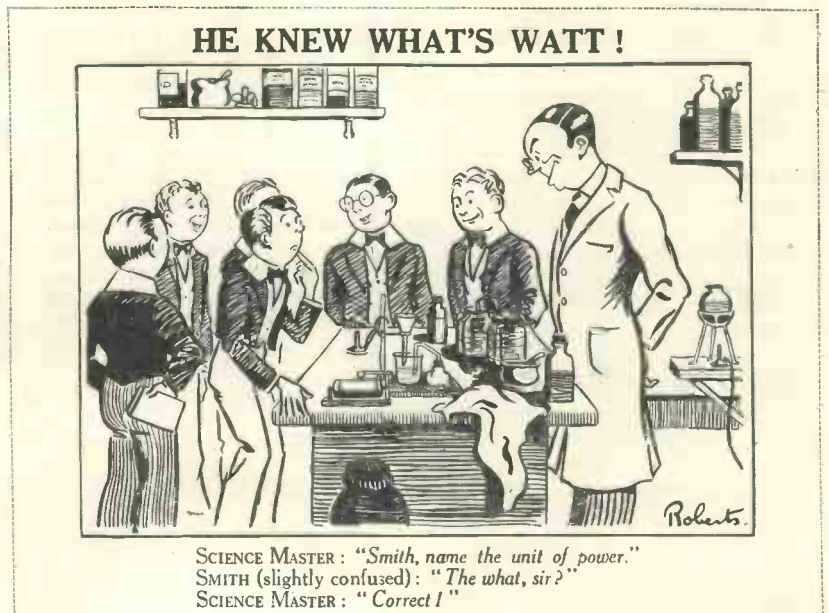



This sound-proof cabinet, used as an operating box for filming talking pictures, prevents the noise of the camera getting into the microphones

"CURSE YOU!" snarled the movie villain as he throttled the harassed heroine. "Good!" said the film producer, "we'll move the camera up for a close-up of the girl showin' full-blooded terror." Meanwhile, the villain relaxed his murderous grip and conversed quietly with his late victim until the camera was ready for the next "take."

#### Old Method of Procedure

That, my friends, was the old method of procedure followed out exactly to formula during the making of any "super-thrilling-cinemelodrama" of the silver screen. That the formula was a good one is proved by the way these pictures were (and still are) consumed by a ravenous cinema public, who revelled in close-ups of scorching passions and bristling moustaches.

#### We Cannot Resist Them!

Yes, most of us cannot resist the fascination of these shadows which usually represent life as it isn't, full of laughter, and tears, "mother," custard-pies and the Stars-and-stripes-God-bless-it!

But the old order changeth, giving way to a new one which opens up

that originally accompanied this somewhat direct remark, may have been suppressed in deference to the film censor.

The villain now has to learn his lines and oaths by heart in the same way as his colleague of the stage, and

Every radio enthusiast must be interested in the possibilities of "talkies"—if not from the entertainment point of view then from the technical standpoint. This article shows clearly how far wireless amplifiers are essential to the successful production and reproduction of synchronised films and explains the differences between the systems in general use

he has to sound as villainous as he looks.

The great sound-film craze is raging in America and sweeping all before it. Five or six hundred cinemas in the United States are already equipped for showing sound films and before

vast new fields for the harrowing of our souls and the straining of our credulity.

The "talkies" have arrived! By the "talkies" I mean, of course, the synchronisation of mechanical sound reproduction with the moving images on the screen so that an illusion of actual living and talking pictures is obtained. The villain's hearty "Curse you!" is now audible as well as visible—though the embroideries,

another twelve months have passed this number will have increased to over two thousand. The fever has spread to the British Isles and nearly a hundred cinemas are already equipped with sound-film apparatus.

The chief aim of the sound film is to convey the impression that the images on the screen are talking or making some sort of sound. In order to get this effect, sound and movie have to be recorded simultaneously, and re-synchronised during "projection."

#### Twenty-five Different Systems

Very complicated apparatus is required for keeping the speeds constant at both recording and reproducing ends, and the quality, strength and synchronisation correct at the reproducing end. At the moment, there are no less than about twenty-five different systems which claim to achieve this, and a few of them carry out the claims in quite a satisfactory manner.

All the systems have one thing in common—a multi-stage valve amplifier and loud-speaker (or speakers) for the reproduction of the sound in the cinema.

#### Two Main Classes

Otherwise, they may be roughly divided into two classes: (1) Systems which use a photographic method for recording sounds. (2) Systems which use a phonographic method for recording sounds. There are one or two odd systems which use methods of recording which do not come into these two categories and these will be mentioned later.

The first class, that of the photographic sound on film, includes such systems as the Western Electric Movietone, the British Phonofilm, the R.C.A. Photophone, the Cinephone, and the British Acoustic. The last-named system uses a separate length of standard-size film for the sound record; the others all have the sound record on one edge of the actual movie, between the picture and the perforations.

#### Most Popular Method

The second class is at present the most popular among the leading film manufacturers. The synchronised gramophone disc is used in many sound film processes, the chief being the Vitaphone (developed by Western Electric), the British Phototone, the Vocafilm and the Bristolphone.

Other similar devices (of which



little has yet been seen or heard in this country) include the Dramaphone, the Duplex Orchestrola Electrograph, Kuegraph, Projectophone, Orchestraphone and so on, almost *ad infinitum*.

**How the Film is Made**

The Vitaphone has had a most successful *première* in London, and as this system is being used by the three leading American film corporations, it will perhaps be the best system to describe in detail. Let me first of all describe the production of a sound film scene in a cinema studio.

The film actors and actresses have all learned their parts for the scene in the same way as their colleagues of the stage. The producer carefully rehearses his players before any record, sound or movie, is taken, and special note is made of the movements of the players about the "set" so that microphones may be suspended, placed or hidden (inside book-cases, flower vases, etc.) to pick up the voices from the various "nearest positions."

**Moving "Mikes"**

In certain cases it is necessary to mount a microphone on a long counter-balanced arm so that it may be moved about during the taking of a scene—the microphone, of course, being above the heads of the actors and just out of the view of the movie camera lens.

Everything being ready for the recording of the scene, a preliminary test is made with the sound record only. An engineer in a special

control room listens to the speech on a loud-speaker and manipulates various knobs which control the outputs of the many microphones on the "set" in order to get the best effect.

The recording is made on the usual soft wax "master" and is afterwards played back to the artists and producer on a loud-speaker. This soft wax record is useless after it has been reproduced two or three times.

When the producer is satisfied that the sound part of the scene is in order, everything is prepared for the final "take," when both movie cameras and gramophone-microphone pickups will be recorded. The cameras (for there are at least two or three) are located in a sound-proof cabin on wheels and are driven by special synchronous motors, all working off the same supply and perfectly "in step" with one another and with the gramophone record drive.

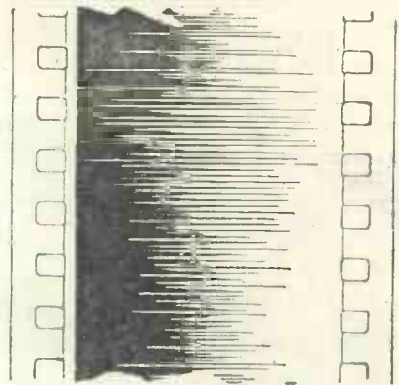

Section of the separate sound film used in the British Acoustic process

any special points of view have to be "shot" concurrently with the recording—hence the two or more cameras.

The cameras are set up in sound-proof cabins rather larger than telephone cabinets, and heavily padded with felt and sound insulating material. The outsides of the cabins are also padded with felt in order to minimise the particular reflection of sound, known as the "standing wave" effect.

**Tuning Note**

We all noticed the variation in strength of the old tuning note as we walked about the room with the loud-speaker blaring it out. Sometimes it would be deafening—but there were "blind spots" where it could hardly

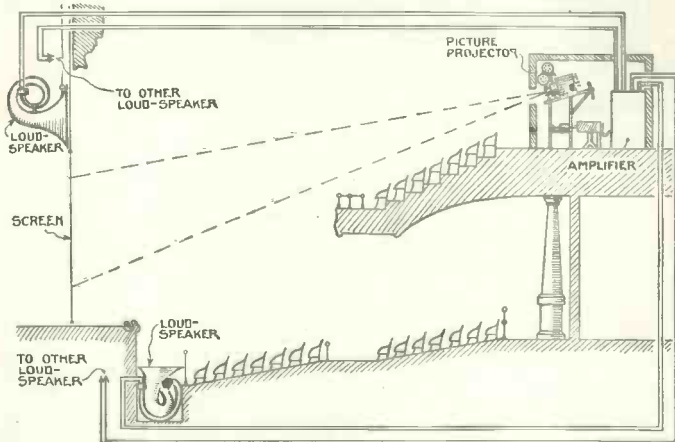

Cross-section of typical cinema showing apparatus necessary for Movietone reproduction

be heard at all.

This is a simple example of the "standing wave" effect, a problem which has worried the designers of studios at the B.B.C. for many years. Bad standing-wave effects introduce all kinds of blasting and distortion. Particular care has to be taken with the placing of all the studio lighting gear for this reason.

**Sound-proof Cameras**

The cameras "shoot" through plate glass, or have their lenses fitted to the end of sound-proof cones so that no sound of the camera or driving mechanism reaches the recording microphones. "Close-ups" are obtained with cameras side-by-side by the simple expedient of fitting one of the instruments with a long focus or telescopic lens.

Each camera is fitted with large film magazines which will hold 1,000 feet, instead of the usual 400 feet (1,000 feet is the average length of a film "reel" or "part").

The speeds of the film and record turntable must be absolutely constant and the same each time a recording is made and certain standard speeds have been fixed for the operation of the Vitaphone. The film runs through the cameras at the rate of 90 feet per minute and the recording is always made at  $33\frac{1}{3}$  revolutions of the turntable per minute.

Once a record is started and a scene is being photographed, the action has to be continued through to the bitter end! There is no stopping or taking little sections of the scene at a time, as with the ordinary silent movies. Long shots, close-ups, and



Horizontal lines on the left margin of the film are the actual photographic impressions of the sound (British Phonofilm system)

## Baynham Honri Discusses Those Talkies! (Continued)

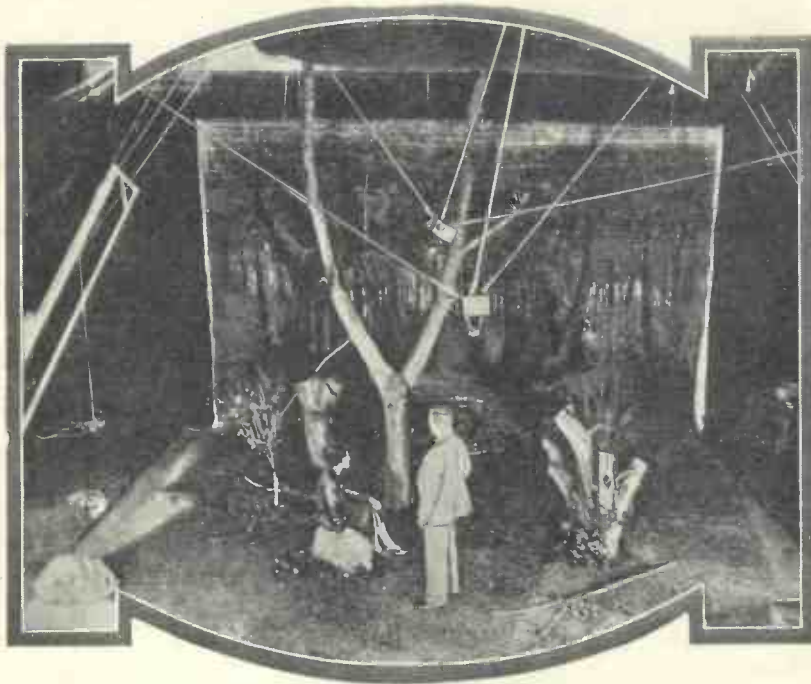

*A cinema studio "set" ready for the production of a talking picture. Note the two microphones suspended above the heads of the artists and the curtains draped for the elimination of echo*

Usually, if there are two cameras in action on an average "talkie" scene, the lenses used are respectively two-inch and three-inch in focal length for the long-shots and close-ups.

The producer is, of course, unable to shout instructions to players during the actual "shooting" of a scene. Any special cues or signals have to be given by gestures or the flashing of signal lamps.

### **Signal Lights Out of View of Camera**

Previously the producer shouted: "Butler!" at the precise moment he wanted that individual to open the door and announce the arrival of Mr. Sherlock Holmes. Now, he has to give the butler his cue by means of a signal light which is out of view of the camera.

Another departure from the usual method of procedure is in the type of lighting which has to be used for the taking of "talkies." The usual electric-arc lights and "spots" are replaced by incandescent electric lamps. These are much more silent than the old arc lights and in addition give (when used in connection with panchromatic cinema negative film) a much better reproduction of the colour values in monochrome.

### **Correct Tone of Light Grey Instead of Black**

The red uniforms of the North-west Mounted Police, for instance, are reproduced in the correct tone of light grey, not black, as was the result with old methods of cinematography.

It is interesting to note that this improvement in the technique of cinema film photography, now also being

used for "silent" movies, was almost wholly due to the necessity of "incandescents" for talkies.

The microphones used in the Vitaphone talking film system are usually of the standard Western Electric electrostatic type, though I understand that very good results have also been obtained with a carefully-designed non-resonant carbon microphone, rather similar to the Marconi-Reisz which is used by the B.B.C.

### **Microphone Amplifiers**

Each microphone has its own one or two-stage amplifier which magnifies impulses before they are selected and mixed on a control board. From the control board the impulses go through more amplifiers (including a power stage) to the electric recording cutter.

This cutter is similar to the standard type of electric gramophone recording apparatus, except that the recording is started at the centre of the record instead of the outside, and the wax "master" is of such a size that

18-inch records may be made. The photograph on page 158 shows the parts of this interesting instrument.

The pipe going up from the cutting needle to the top of the picture is part of a built-in vacuum cleaner! It draws the wax cuttings and other extraneous matter



*Getting ready for making a Phonofilm talking picture in one of the new studios at Wembley*

from the record during the actual cutting process.

The path of the needle may be watched through the microscope for the detection of "blasting" during the recording of loud sounds.

Blasting is also kept well "under" by the controlling engineer, who keeps a close watch on the amplifier



## How They Are Produced and Reproduced

volume meters, as seen in the photograph below.

Though this does not strictly come under the heading of "sound films," it may interest some readers to know how the final records, as used for Vitaphone reproduction, or, for that matter, records for home use, are produced from the original soft wax "master" record. Before

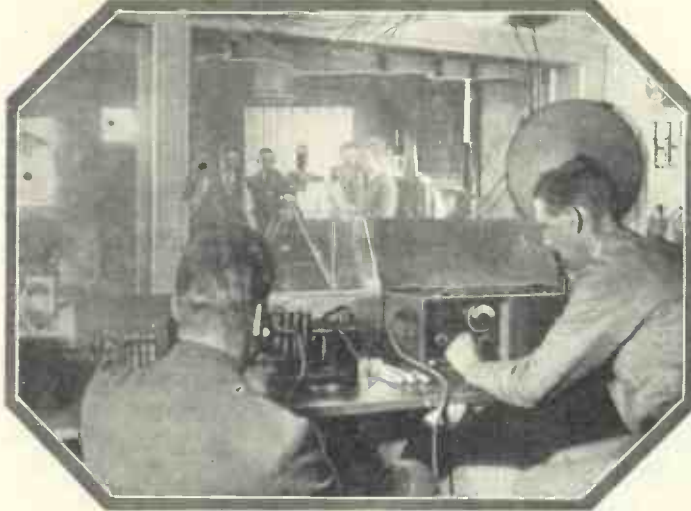

*In the Phonofilm system, the controlling engineers work behind plate glass and have a full view of the scene being taken in the studio*

recording is begun the wax "masters" have to be warmed in order to soften the wax.

When the recording is completed and the wax has hardened, the record is coated with a carbon preparation of very fine grain, which is a conductor of electricity. It is then suspended in a copper-plating bath (copper sulphate) and a small voltage applied for twelve or more hours until it has acquired quite a thick deposit of copper.

The copper impression is then stripped from the wax and carefully soldered on to a circular piece of metal alloy of sufficient strength as to make the metal "master" record suitable for stamping out copies of the original.

### More Copper Plating

In most cases, however, the first metal "master" record is not actually used for stamping out the final copies of the record. It goes through another copper-plating process which results in a metal impression exactly similar to the original wax recording.

This impression is called the "mother" record and is used for the reproduction (by another copper-plating process) of any number of "sub-master" records of the same subject, all of which may be used for stamping out the final black composition copies of the records.

The indentations on the wax, the "mother" and the final composition records are exactly alike, but opposite in impression to the indentations on the "master" and "sub-master," the latter being the equivalent of photographic negatives.

At last we arrive at the cinema. I've taken a long time to get you here—but here we are!

### Layout of Vitaphone Reproducing System

The diagram on page 155 shows the layout of a cinema theatre wired-up for Vitaphone presentation. A gramophone turntable is geared on to the cinema projector and specially heavy fly-wheels and motor drive attached to ensure constancy of speed. An electrical gramophone pick-up is connected through a fade and switchboard to two multi-stage amplifiers, the last one being a high-power stage of four 50-watt valves operated with a plate potential of 750 volts.

Switches are included which enable a selection of the loud-speaker to be made—there are usually four of the exponential horn type.

### Synchronised Until a Break Occurs

The operator threads his film up so that a special frame marked "start" is in the gate. He then places the electrical pick-up needle at the correct starting place on the record, which is indicated with an arrow. The movie and record are now set for synchronisation, and will remain so unless the film happens to break, an infrequent happening nowadays.

When the cue for starting is given, the motor-drive is switched on and the film and record start up together, the starting up period being covered by a section

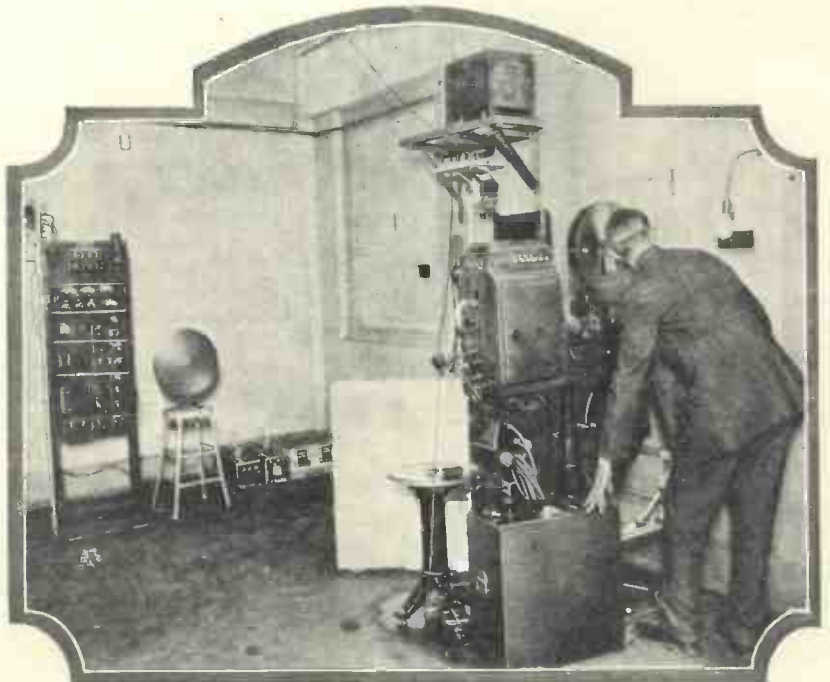

*A typical operating box fitted up for the reproduction of Vitaphone talking pictures  
Note the gramophone turntable with pick-up and control loud-speaker*

## Baynham Honri Discusses Those Talkies ! (Continued)

of blank on both film and record.

The Movietone, the Phonofilm, and other systems in which the sound is photographed on the edge of the film are similar to the extent that their films are inter-changeable. The microphone impulses are amplified in the usual way until they are of sufficient strength to vary the illumination of a discharge tube or "aeo" light at audio frequencies, the variations of the light being recorded on the photographic emulsion of the film. Several systems have variations of this method.

### Less Complicated

The technique of this kind of sound film recording is much less complicated than the disc systems, and the various "shots" may be started and stopped as desired.

Synchronisation is always perfect, the sound impression being on the edge of the movie, and the editing and arrangement of scenes may be carried out in the same way as with ordinary "silent" pictures. The recording outfit is comparatively compact and is eminently suitable for the sound film recording of topical events, when the more cumbersome and slow synchronised gramophone record system would be out of the question.

Other methods include the British

Acoustic process, in which the sound record is photographed on a separate standard size film; the Blattner system, in which the recording is made on iron wire, and a German method in which the gramophone needle groove is actually on the edge of the movie film. With the exception of the first, these systems have yet to be heard to be believed! A section of British Acoustic sound

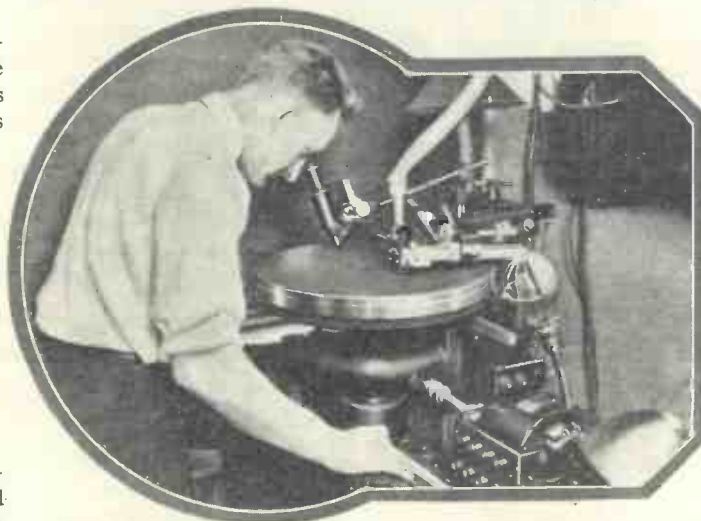

A close-up of the recording apparatus used in the Vitaphone system

film is illustrated on page 155.

All of the photographed-sound systems use some form of selenium or photo-electric cell for re-converting the light waves into electrical impulses. A point of light shines through the photographic impressions of sound on to the photo-electric cell, the variations in the light producing similar variations in the resistance of the photo-electric cell.

The fluctuations in current are amplified in the usual way (as with the Vitaphone) and fed to loud-speakers.

It must be admitted that the photo-electric cell is still not altogether a satisfactory and reliable component part of the talking-film gear, and it is largely owing to the weakness of this link that the disc system of talking films gives the finest reproduction.

### Rapid Development

The progress of the development of this invention is being carried out so rapidly, however, that it may not be very long before the photographic-sound systems regain their supremacy. The ease of handling and commercial advantages of the sound-on-edge-of-film method are so marked that it is highly probable that it will become standard.

Some absent-minded inventor may make a lucky mistake and discover the key to the problems of the present defects of the photographic-sound film and—poof!—the cinema exhibitor who has bought the other kind of equipment will curse him as roundly as the villain in my first paragraph!

But that absent-minded inventor may also absent-mindedly forget to make that mistake!

## The Signal Booster (Continued from page 150)

left almost completely in mesh.

A few minutes listening will soon enable the operator to get the hang of things.

### Searching for Stations

When the positions of a few stations are once known, it is best when searching for other stations to adjust the anode condenser critically and swing round with the two "aerial" condensers (that is, the aerial condensers on the unit and on the main receiver).

If ordinary tuning will not give

sufficient selectivity for an unwanted station to be cut out there are two "tricks" that will almost certainly give the desired result.

The first is to reduce the filament current of the screened-grid valve. This has the effect of increasing the impedance and makes tuning sharper.

The same effect can be obtained by reducing the anode voltage of the screened-grid valve (that is, the voltage applied to H.T.+2) from its normal 120 volts to a value of approximately 36. This results in a great increase of selectivity and only

a negligible decrease of signal strength. It is a trick, however, that is only recommended as a last resort.

One final word. When switching off, do not forget to turn off both Signal Booster and main receiver!

### Tell Your Friends!

Remember that the addition of the Signal Booster will bring an old set right up-to-date in punch and selectivity—so if you know of any fellow amateurs using old receivers with limited capabilities bring this article to their notice.





# Variety Was Ready When Radio Came!

By **GRACIE FIELDS**, the Famous Comedienne

In the light of these facts, what chance has variety as we know it of securing a permanent place in the radio programmes?

That it is extremely popular with all classes of listener was evident from the voting of those hundreds of thousands of people when asked to put the various items of radio fare in order of popularity. It is possible, however, that this gesture of approval was shown only in the absence of something better.

Suppose we could suddenly be enabled to listen to a wireless programme of twenty-five years hence? Would there be anything resembling the stage and radio variety we know to-day? Or would it be changed out of recognition?

I am inclined to think that of the various forms of entertainment broadcast to-day, variety will change least of all—this after a careful consideration of the requirements and limitations of the wireless medium.

Just think of the obvious drawbacks in transferring an ordinary stage play from the stage to the broadcasting studio! It is true that the announcer may give some description of the setting so that listeners can form a mental picture of what is going on. But how long does that mental impression last? Five minutes after the characters in a radio play have started to talk, the listener's mental picture of the scene has dimmed.

In the theatre this is impossible. The scenery is there in front of you. You cannot forget it even if you want to, and its presence inevitably affects your interpretation of the play. From this angle, variety scores, because in the really great variety turns scenery was never very important. Its absence in broadcast variety matters little.

Again, variety turns are short. Concentration is at a minimum, and

while it is not difficult to concentrate through an act of a stage play, it is infinitely harder to do so in a radio play. In length — because they are short and snappy — variety turns are particularly suitable for broadcasting.

And there's another thing. There are rarely more than one or two artists on the stage in a variety turn, and consequently when it is broadcast it is a simple matter for the listener to identify individuals.

## Traces of Guilt?

But in a stage play with seven, eight or more players, all on the stage at once, it is another matter. While the hero holds the centre of the stage and delivers his impassioned protestations of innocence, you may have your eye on the other character you suspect of committing the murder in order to see if he shows any traces of guilt.

You cannot do that when the same play is being broadcast. Either the play must be altered or some of the enjoyment lost. A variety turn can be broadcast without nearly the same need for adaptation, for the reason that the attention is focused only on one or two people.

## Individuality and Personality

But perhaps the main reason why broadcast variety is not likely to suffer great change is that a reputation in variety depends above all else on the individuality and personality of the performer. It is a rule to which there are no exceptions. Your great figures in variety—Dan Leno, Marie Lloyd, Harry Lauder—are those who, without any aid from scenery or effects can reduce a great audience to laughter or tears, simply because they are what they are!

The successful variety artist is, in a way, his own scenery. He becomes familiar to his audience. There is no need for the announcer to describe  
(Continued in third col. of next page)

SO far, of course, the entertainment side of broadcasting has been made up largely of already existing forms of amusement.

Variety, revue, the drama—all these existed before radio was anything but a dream which might some day come true; and when it did, they were all very naturally swept in to assist this new and rather bewildering art.

## A Breathing Space

Obviously no one had ever written a revue sketch, a play, or a variety turn specially for broadcasting purposes, so at first material originally intended for the stage or music hall was pressed into service. Later came a breathing space, and time for reflection.

It gradually became evident that this new medium demanded a new mode of approach. And so everywhere at the moment there is discussion of this new technique which broadcasting has made imperative—the technique of entertaining people by ear only, unassisted by any visual effect.

## No Substitute for the Theatre

Acceptance has gradually been granted to the idea that radio is no substitute for the theatre or music hall; that it must stand on its own feet; and that it has many natural advantages and disadvantages which must be considered in preparing suitable broadcast material.

# THE LETTERS OF Priscilla Playne-Smythe

Stewcombe Manor,  
Little Bodley,  
Nr. Hurdham.  
18-1-1929.

DEAR MR. EDITOR,

I do hope that I am not trespassing upon your good nature in writing you again so soon for information, but you gave me the impression of positively enjoying my letters, by publishing them in your *delightful* magazine.\*

I feel that you have conferred upon me the freedom of the letter-box, so to speak, and that I have come to represent the average *thoughtful* reader for whom you cater; that my little perplexities are typical of those of all who take wireless *at all seriously*.

Although I continue to get most edifying results from my set I cannot blind myself to the *possibility* that the science of radio is progressing and I should simply hate not to be abreast of the times.

Now, in your magazine, I find some devices advertised which are guaranteed to improve reception. Even after allowing for a possible deficiency in *modesty* on the part of the makers, there must be something in them—the devices I mean. My trouble is that I cannot *quite* make out what purpose they are intended to serve.

I find, for instance, that many merchants advocate "pick-ups"—a most mysterious sounding article. I was speaking of these at table only yesterday, when, to my surprise, I suddenly found that my housemaid was blushing quite *furiously*.

Upon making enquiries of her later, she told me—rather defiantly, I thought—that outside the house her time was her *own*, that the barman at the Crown was a perfect gent and that, anyhow, she didn't see what a girl was to do in a place where there is no cinema or dancing!

I assure you that I was *amazed* and we were quite hopelessly at cross-purposes. What *can* she imagine me to have been speaking about?

Now, Mr. Editor, what *are* these "pick-ups" and is it perfectly safe and "nice" to use one?

There is also a thing called an "eliminator" which figures promi-

ently in your advertisements. I have looked most carefully over my set, but I really cannot find anything I should care to do without, though I have tried every *imaginable* part, in turn.

Besides, these eliminators would appear to be something which one *adds* to it. I find a foreign station called "Achtung-Achtung" (which I take to be in Poland, like Baden-Baden) jabbering and *squeaking* at me on most evenings behind several English stations and this I should *certainly* like to eliminate, if I could. Do you think one of these "gadgets" (I hate *slang* but this word seems so *very apt*) would help me to do so?

At the same time, I would not care to add to the state of tension in which I usually find myself whilst listening and to do this would seem to be their main feature, from the text of the advertisements.

In my opinion, one should seek to *relax* to wireless programmes, sit quietly in the soft glow of a lamp (we have no electricity in Little Bodley)—and cultivate that condition of empty *beatitude* which makes one receptive of beautiful impressions. Only thus can one *really* appreciate the voice of the starched and *expensive-sounding* young man who gave us the Australian Test Match scores.

Considerations such as these have led me to an idea which I really *do* believe you will hail warmly. It is so *fatally* easy to buy expensive paraphernalia, but would not a little practical economy be equally desirable especially if it makes for efficiency?

To put it shortly, I find that whilst I am listening, there are no less than 60 whole volts flowing through my set from the cardboard box and six more from the glass jar, making 66 volts in all.

This *huge* quantity of electricity does nothing whatever but to cause my lamps to glow very faintly and to produce sounds from my loud-speaker. All that is left over—and it must be by far the greater part—goes to waste down the earth wire whilst still perfectly fresh and hardly used at all.

It has occurred to me that it must be possible to bring all this energy

*back* into the set and make it do further work, after the musical admixture has been filtered out of it by some means. I put it badly, I know, but think of the water circulation in a motor-car radiator and you will see exactly what I mean.

I do *not* profess to know how this is to be done but doubtless one of your *smart* young engineers could devise something in a *flash*, now that the inspiration is forthcoming. I make you a present of the idea, knowing that if anything really *revolutionary* comes of it, you will be the first to give me a share of the credit.

With my very best wishes for the prosperity of your fascinating publication, believe me

Yours very sincerely,  
PRISCILLA PLAYNE-SMYTHE.

P.S.—I now find that my housemaid has, without the very least technical training, successively "picked-up" the station porter, the postman and the local policeman, and that she has "eliminated" them one by one as and when they became inconvenient.

I am perfectly *certain* that she did not make any use of the devices advertised in your magazine. Probably she has never even heard of them!

## Variety Was Ready

(Continued from preceding page)

Harry Lauder. Everyone knows him. His atmosphere is created in advance.

It may be objected that the newcomer to radio variety is rather at a loss here. If the announcer introduces a name which means nothing to the listener, what can the poor artist do? The answer is simple. By his mannerisms in speech, by a hundred little devices, he can create a personality for himself. It has already been done.

If, as I imagine, broadcast variety continues to change very little fundamentally, it will be because it was, as it were, ready to hand for radio purposes, with a need for only small adjustments.

In the main variety was the readiest of all forms of entertainment for the coming of broadcasting.

\* See WIRELESS MAGAZINE No. 42 (July, 1928), No. 47 (December, 1928).





## The Lodestone Three (Continued)

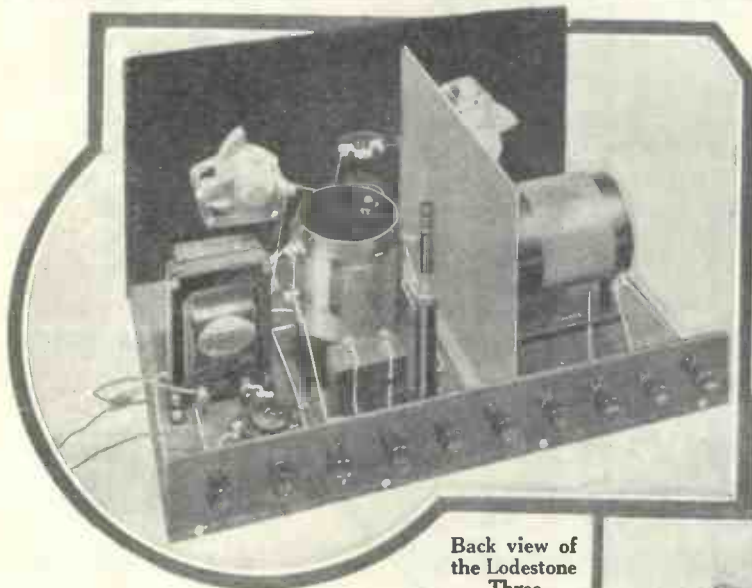

Back view of the Lodestone Three

valve holder which accommodates the first amplifying valve was carefully chosen. Further, a negative bias is provided for the amplifying valve by the simple expedient of connecting a filament rheostat in the negative lead to the valve.

### When Maximum Amplification Is Obtained

This rheostat also serves as the volume control. Maximum high-frequency amplification is obtained when the rheostat is nearly short-circuited. There is then only a small negative bias and the anode impedance of the valve is the minimum. Consequently, the high-frequency amplification is the maximum.

It is reduced by increasing the amount of the filament resistance in circuit. This has the effect of raising the anode impedance, which reduces the high-frequency magnification.

In the anode circuit of the high-frequency amplifying valve is the primary winding of a high-frequency transformer.

This is of fine wire (No. 40-gauge, silk-covered) and interwound with it is a similar winding which is connected between positive high-tension and a balancing condenser. These two windings, the primary and the balancing, have a tight magnetic coupling, but the capacity of one

winding to the other is the minimum. This follows from the method of arranging the windings.

They are interwound and, therefore, tightly coupled magnetically, and they are of fine wire which minimises their capacity.

These two windings are fitted over one end of a secondary coil of No. 27/42 Litzen-draht, and it should be noted that this end is the end joined to the filament circuit through a grid battery. The amplification and selectivity would be impaired were the two fine-wire windings placed over the end



Note the special Lodestone coils (as used in the Touchstone)

of the secondary connected to the grid of the detector and it is, therefore, of great importance that the connections be properly effected.

The primary and balancing windings actually cover rather more than one third of the filament end of the secondary, but as they are of such fine wire and separated by ebonite spacing strips from the secondary, the capacity with the secondary is very small.

With this circuit a balance is easily effected. The balancing condenser is adjusted with the filament rheostat turned off, and once set it holds good over the whole tuning range. This balancing condenser is mounted on the baseboard of the receiver and once it has been set it should be left.

### Reaction Not Intended—and Not Needed

I am aware that by turning it a little from the point of balance a reaction effect is produced and the signals are strengthened. But, had I intended to provide adjustable reaction, I would have placed a suitable condenser upon the front panel.

So great is the high-frequency amplification provided by the single stage that reaction is not necessary and therefore no provision has been made for it.

An anode-bend detector is employed, as we desire good

Copper or aluminium can be used

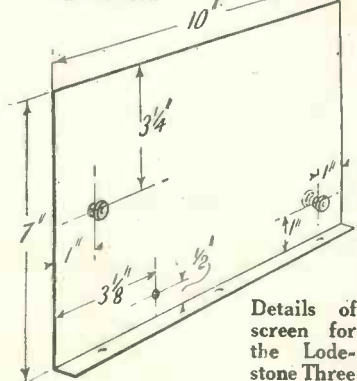

Details of screen for the Lodestone Three



# A Simple Reactionless Three-valver by W. James

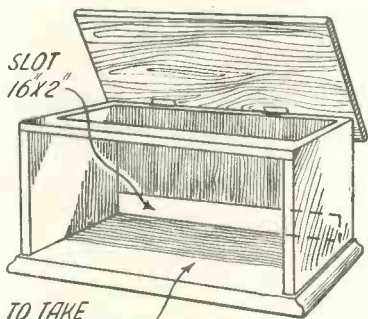

TO TAKE  
PANEL 16x8"

Dimensions of cabinet for the Lodestone  
Three

included with the valve in its container. For anode-bend rectification, the grid bias would be adjusted to approximately point A, for then rectification occurs.

Now the manufacturers quote the impedance and amplification figures for an anode voltage of 100 and a grid bias of zero, and we are employing the valve with a relatively large grid bias. In fact, the impedance of the valve measured about the working point which we have selected is some two or three times greater.

### How Detector Impedance Affects Quality

How does this affect the quality when a transformer is employed between the detector and the power valve? Obviously the effective impedance when a signal is being received must not be greater than that for which the transformer will function satisfactorily and, at the same time, the detector valve itself must be so operated that it does not introduce more than a negligible amount of distortion.

We must, therefore, consider what happens

selectivity as well as acceptable quality of reproduction. This method of detection is fairly easily explained. Let us refer to Fig. 1 for a moment (p. 166).

This shows a single characteristic curve of a valve such as the makers provide on instruction slips which are

when a signal is being received. Our grid bias and high tension are so adjusted that when no signal is being received we are at point A on the curve of Fig. 1. We now tune a signal, which may be represented by the curves B of Fig. 2.

These curves are intended to represent the high-frequency current modulated by a sine wave of audible frequency; but it is, of course, quite impossible to draw them correctly, because, whilst the high-frequency current may be of 1,000,000 cycles per second, the low-frequency may be of 1,000 cycles.

### Effective Impedance Greatly Reduced

But the important point is the fact that the modulated portion is producing an anode current not about point A, but about point c. From this it follows that the effective anode impedance of the valve is much less than when it was measured about point A.

It will naturally vary according to the strength of the high-frequency input to the detector. For a weak input the impedance is greater than for a strong input, but if, by means of the volume control, the input is varied so as always to practically fully load the detector, the impedance will not vary to any extent.

Grid current should *not* be permitted. Therefore, a signal such as in Fig. 3 is too strong as this would

Two more views of the Lodestone Three all ready for use

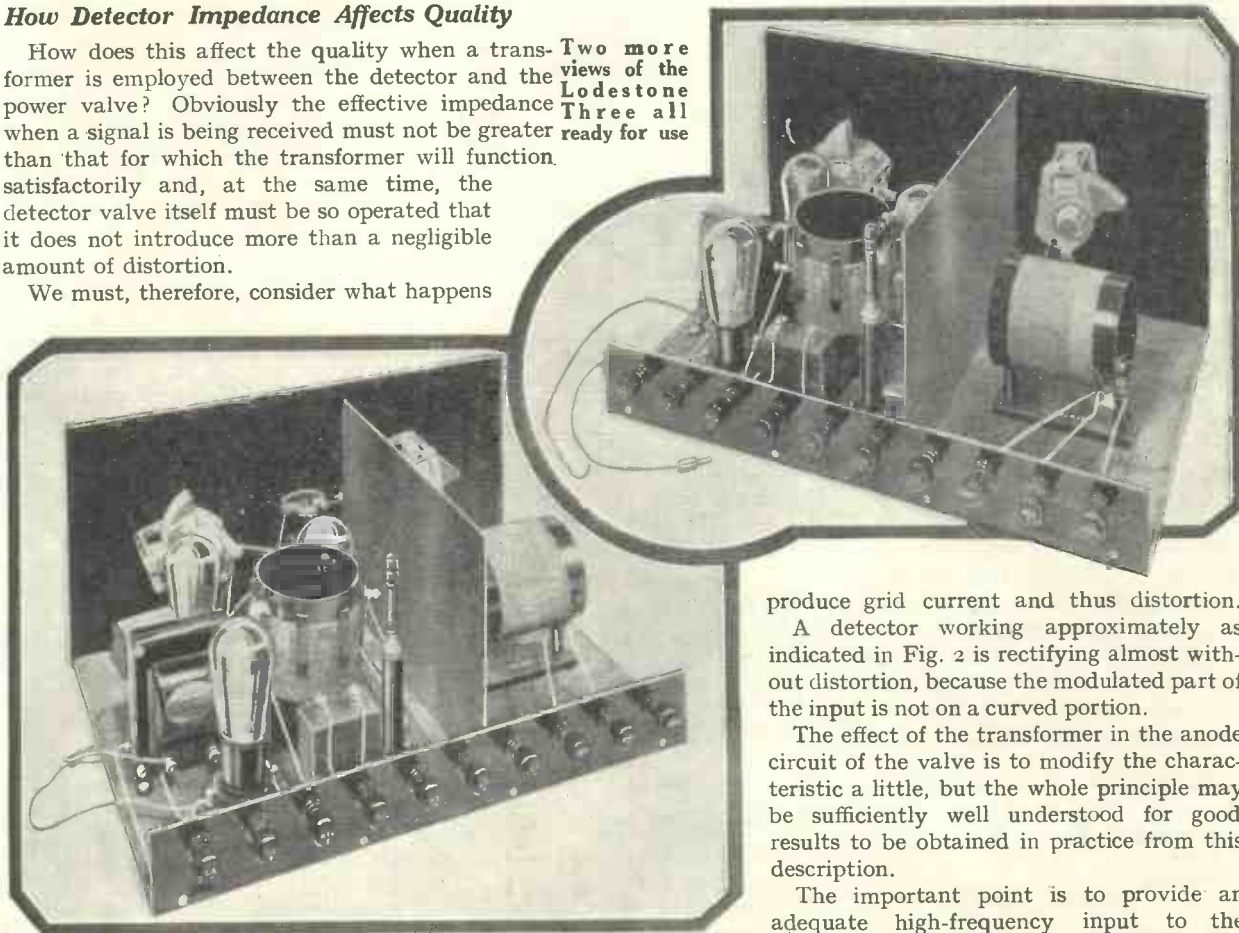

produce grid current and thus distortion.

A detector working approximately as indicated in Fig. 2 is rectifying almost without distortion, because the modulated part of the input is not on a curved portion.

The effect of the transformer in the anode circuit of the valve is to modify the characteristic a little, but the whole principle may be sufficiently well understood for good results to be obtained in practice from this description.

The important point is to provide an adequate high-frequency input to the

# W. James' Lodestone Three (Continued)

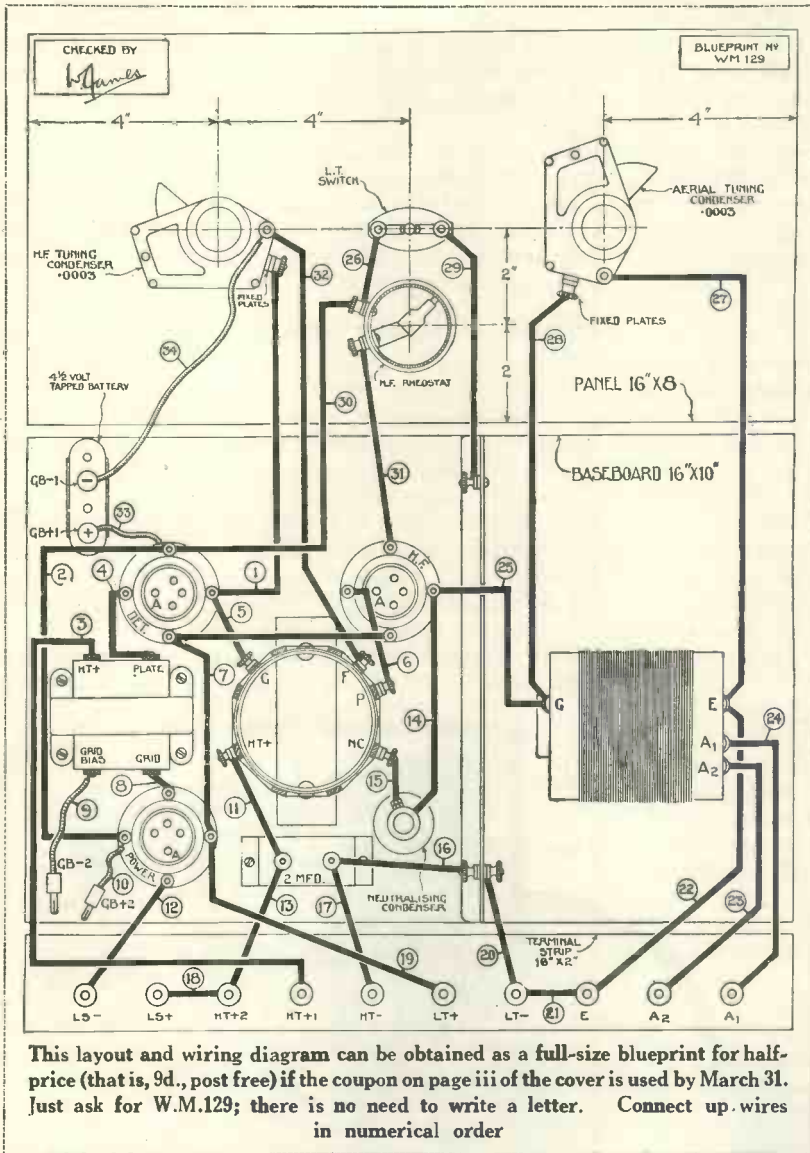

a valve is generally of the resistance-capacity type and must be used with this form of coupling.

In this receiver we employ a transformer, and we have, therefore, to make certain that the impedance of the detector, whilst receiving a normal signal, is suited to the characteristics of the particular transformer employed.

Little can be written concerning the third or output valve. It must, of course, be of the power type, and whether an ordinary power valve, or one known as a super-power valve, be employed here is a matter for the reader to decide.

### Question of H.T. Source

When small high-tension batteries are used, the ordinary power valve will probably be most satisfactory, but the user who employs large dry batteries or a mains unit and wishes to operate a reasonably good loud-speaker should fit a super-power valve, and put as much high tension on it as possible with the appropriate grid bias.

From the illustrations and drawings it will be seen that the receiver is an easy one to construct. On the front panel there are two tuning condensers, the volume-control rheostat and filament-circuit switch. A single metal screen is employed between the aerial coil and its tuning condenser and the remainder of the circuit.

This screen is to minimise capacitive couplings; magnetic couplings are minimised by mounting the coils at right angles in the manner shown. Notice that the inter-valve high-frequency transformer is mounted upright and the aerial coil horizontally.

### Making Your Own Coils

These coils may be purchased from two or three manufacturers or they may be constructed at home from the description that I gave in the January issue of the WIRELESS MAGAZINE.

detector, which must, of course, be of a suitable type.

Any reader who has a low-reading milliammeter may check the behaviour of an anode-bend detector by including it in the circuit and noting the current which is passing when no signal is being received, and also, when a signal of the correct strength is being applied to the detector.

The effect of overloading may be

noted, and for that matter, of under loading as well. It may seem strange to refer to underloading an anode-bend rectifier, but from the description the reader will understand what is meant.

Naturally the type of valve plays an important part. A valve with a sharp bend at the bottom of its characteristic may be employed to rectify relatively weak signals. Such





## Especially Intended for Household Use

When winding the coils at home, be very careful to solder every strand of the high-frequency cable and also properly connect the two fine-wire windings of the inter-valve transformer.

### Small By-pass Condenser

A by-pass condenser must be connected across the anode circuit of the detector. The Ferranti transformer shown in the illustrations has this condenser included in its container and an additional one is therefore not required. But should an alternative transformer be employed, a fixed condenser of .0003 microfarad must be connected either across the primary winding by joining it to the two terminals on the transformer, or preferably, one side of the fixed condenser should be connected to the anode of the valve, and the other side to the negative filament terminal on the valve holder.

### H.F. Transformer Connections

There are no special points in the wiring, although care must be taken that the high-frequency transformer be joined as indicated in the wiring diagram.

The best valves to use in this receiver will depend upon the amount of high tension available. Thus,

### COMPONENTS REQUIRED FOR THE LODESTONE THREE

- |   |  |
|---|--|
| 1—Ebonite panel, 16 in. by 8 in. (Ripault, Radion, or Will Day).                                | 1—Low-frequency transformer (Ferranti AF <sub>3</sub> , Marconiphone Ideal or Cossor).                                       |
| 2—.0003-microfarad variable condensers with slow-motion control (Polar, Utility, or Gecophone). | 1—Terminal strip, 16 in. by 2 in. (Ripault, Radion, or Will Day).  |
| 1—Lodestone aerial coil (Lewcos, Wearite or Berclif).   | 10—Terminals, marked: Aerial 1, Aerial 2, Earth, L.T.+ , L.T.—, H.T.+1, H.T.+2, H.T.—, L.S.+ , L.S.— (Belling-Lee or Ealex). |
| 1—Lodestone high-frequency transformer (Lewcos, Wearite, or Berclif).                           | 4—4½-volt tapped dry cell (Siemens).   |
| 1—12-ohm panel rheostat (Gecophone, Marconiphone, or R.I. and Varley).                          | 1—Cabinet with 8 in. baseboard (Pickett).  |
| 3—Antimicrophonic valve holders (Lotus, W.B., or Igranic).                                      | 4—Wander plugs (Lectro-Linx). Short length of flex.  |
| 1—Neutralising condenser (Gambrell Neutrovernia).   | Stiff wire for connecting (Glazite).   |
| 2—Dial indicators (Bulgin).   | 1—Metal screen (Parex, Wilburn, or Ready-Radio).   |
| 1—2-microfarad fixed condenser (T.C.C., Dubilier, or Mullard).                                  |  |

when a high tension of approximately 150 is applied to terminal H.T.+2 the valve used for high-frequency amplification may be of the R.C. type in certain series and in others of the HL type. (See lists on pages 108-109.)

The higher the impedance of this valve, the greater will be the selectivity, but at the same time, the amplification will fall off a little in comparison with the results obtained when a valve of from 20,000 to 30,000 ohms is employed.

For lower voltages, such as 120, a valve of 20,000 to 30,000 ohms impedance should preferably be used, but the point it is desired to emphasize is that the impedance of the valve affects both selectivity and magnification. The amplification factor of the valve is also a most important quantity, as it directly affects the magnification.

### Increased Magnification

Thus, if we employed a valve having an impedance of 20,000 ohms with a magnification factor of 10, the magnification provided by the stage might be 25; yet, by using a valve of the same impedance, but having a magnification factor of 20, the magnification of the stage would be twice as much, that is 50.

For the detector position a valve of from 10,000 to 20,000 ohms may be used with a grid-bias of 4.5 volts negative. If this is a Cossor 210HF, for example, the anode voltage will have to be approximately 90. This should be connected to the terminal H.T.+.

### Correct Grid Bias

In the third position fit a power valve and supply it with the correct grid bias.

(A grid-bias battery can be conveniently fixed inside the cabinet by means of brackets supplied by certain manufacturers.)

When a large outdoor aerial is used, connection should be made with terminal "Aerial 1" for the best

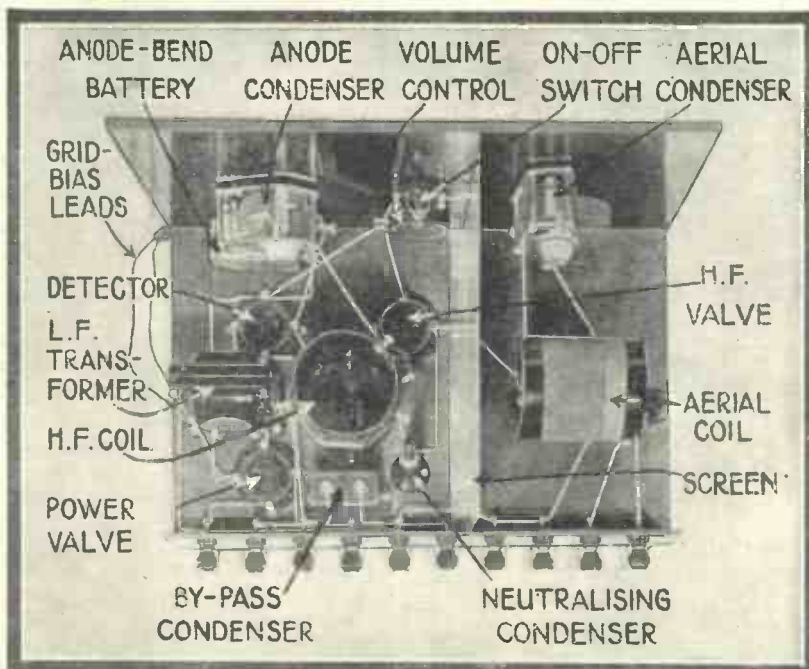

The arrangement of all the parts in the Lodestone Three is clear from this plan view

## W. James' Lodestone Three (Continued)

selectivity, but better all-round results will be secured from a relatively small aerial when the aerial is joined to terminal "Aerial 2."

Tune to the local station and adjust the high tension applied to the detector valve and also when neces-

stabilised by setting the balancing condenser. Slowly rotate this condenser until there is no self-oscillation and, in order to provide a good balance, switch off the first valve and so adjust this balancing condenser that the local station is not heard.

of the reproduction leaves little to be desired and the amount of the volume to be obtained, without distortion, is dependent upon the type of output valve, and the amount of the high tension applied to it.

### ANODE-BEND DETECTION EXPLAINED

These diagrams should be studied in conjunction with the explanation included in the description of the Lodestone Three on Page 163

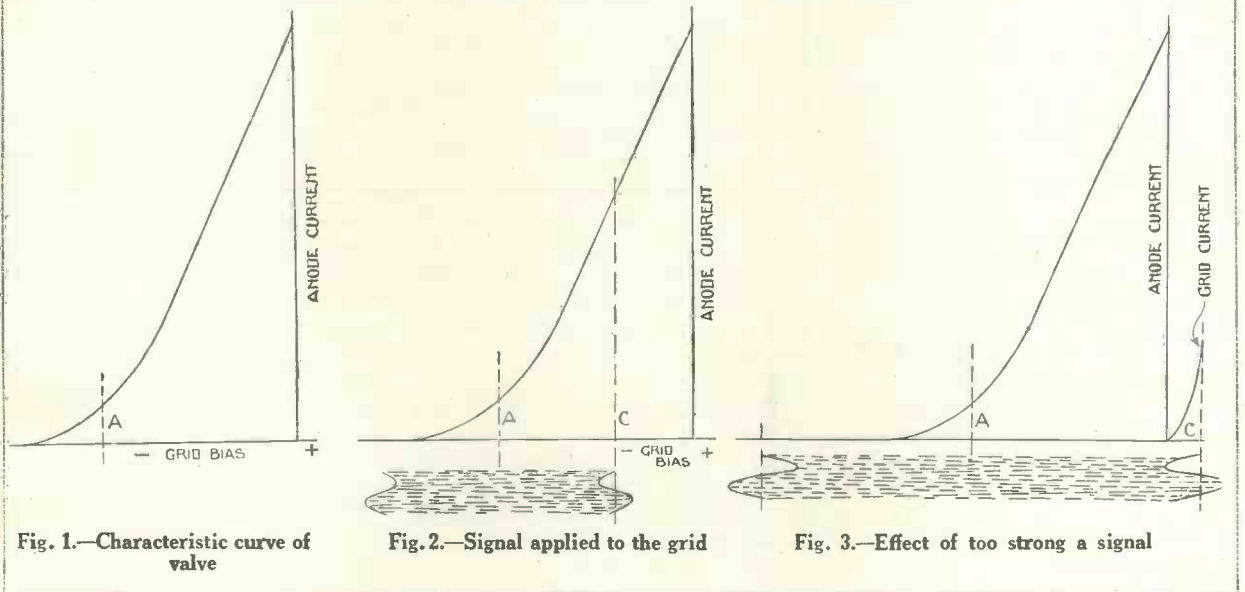

sary the grid bias to this valve. To do this properly, it is advisable to turn down the volume control in order that changes in the signal strength as the result of varying the high tension or grid bias may be noted.

Then the receiver will have to be

The receiver will then be quite stable, and will remain so until the valve in the high-frequency stage is changed.

This receiver is not intended for the reception of distant stations, but several may be heard on the loud-speaker at good strength. The quality

A well-constructed moving-coil loud-speaker may be used with this receiver (such as the Lodestone I described last month), or one of the cone type. There will be ample volume from the more powerful of stations.

## Thinking Out a New Type of Aerial

HAVE you ever tried to think out an entirely new type of aerial? Rather a proposition, isn't it? Still, some people seem to be able to get hold of novel ideas in the way of aerials and to turn those ideas to profitable use.

### Two Classifications

I suppose in this country we should classify our aerials as outdoor aerials and indoor aerials. The same classification no doubt held in America until someone came along with an

entirely new idea, the underground aerial.

We never hear of underground aerials in this country, yet American manufacturers seem to advertise underground aerials almost as much as any other part of a wireless installation, and I daresay more money is made in America over the sale of underground aerials than over the sale of all other types of aerial put together.

It doesn't seem to me to be an absolute impossibility to invent a new

and efficient type of aerial. There is a big demand for an outdoor aerial which would take up very little room, and yet give results comparable with the widely-used single-wire aerial. Have you any bright ideas for a new and compact form of outdoor aerial?

### A Profitable Idea

I really do think this question of aerials is worth looking into. One of us might strike a very profitable idea. What is your opinion? AERIAL.



# Half Hours with the Professor

## Professor Megohm and Young Amp Discuss Grid Leaks and Condensers

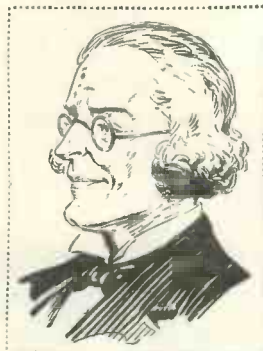

**Y**OUNG AMP, with a cheerful grin on his face and an enormous bulge in one cheek due to the presence of a large lump of toffee, was watching the Professor experimenting with a hook-up. Suddenly a terrific squeal emanated from the loud-speaker. Amp started violently, but the Pro-

He had been reading only the other day about the importance of time constants in detector circuits.

"I'm glad to hear it," sighed Megohm wearily. "Would you mind telling me what your precious time-constant is?"

"Now, now, now," broke in Amp, "don't get shirty. You ought to know I haven't the faintest idea what it is. Anyhow, I was right, wasn't I?"

The Professor grunted. "You were right in so far as I am going to change the grid leak and therefore change the time-constant, but why you should choose to look at it from that point of view, I don't know. The time-constant of a circuit is a factor involving the rate at which the current will rise to its full value on switching on or con-

versely will die away on switching off. dies away according to an exponential law, the rate of rise or fall being proportional to CRT where C and R are the capacity and resistance and t is the time which has elapsed since switching on or off. When CRT = 1, so that

$$t = \frac{1}{CR}$$

the current will have risen to 63 per cent. of its full value or conversely have fallen to 37 per cent. of the initial value."

"I don't altogether follow that, Professor," exclaimed the boy.

### Not Very Much Help

"No," answered Megohm, "nor do I particularly see why you should bother your head with it. It does not help you very much in understanding what is happening with the modern receiver. You know how a cumulative grid detector works, don't you?"

"Yes, I think so."

"Good, let's hear all about it."

"Oh, er——" Amp took a deep breath and collected his thoughts.

"Well, Professor," he said at length, "the signals coming in cause the voltage on the grid condenser to build up to a negative potential.

Then the anode current of the valve, which depends on the grid potential, will drop and so we get a change of anode current."

"That is more or less correct. How long do we stay like that?"

"Oh, that is what the grid leak is for! When the signal has finished, the charge leaks away off the condenser through the grid leak—and so we start again. You know—round and round the mul——" Here, seeing the Professor's eyebrows beetling

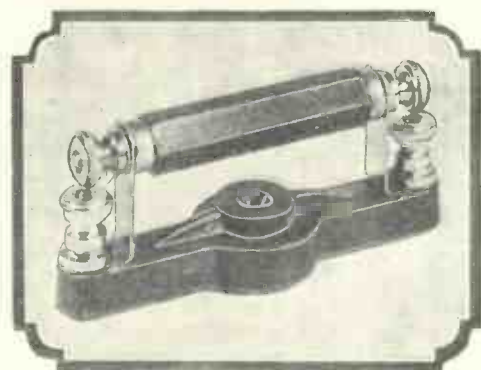

Graham-Farish grid leak with holder

fessor seemed to take no notice, merely murmuring in an abstracted manner, "Yes—grid leaks."

"Oh, undoubtedly," exclaimed the boy.

"Yes, I think so."

"Yes."

"Yes—what are you talking about, anyhow?" broke in Megohm irritably, coming down to earth.

"I don't know. What are you?"

"Grid leaks," was the reply.

"The grid leak here is too high—that is why I am getting this squeal."

### Time-Constant

"Oh, ah," burred Amp cheerfully. "I know. You've got the time-constant wrong."

Megohm looked at the boy in astonishment while Amp put his hands in his pockets and tried to look unperturbed.

"Are you likely to get any worse?" queried Megohm at length.

"No, I don't think so," replied Amp, with a little less assurance. Surely he had not dropped a brick?

versely will die away on switching off.

"If you have a condenser and you connect a battery across it the condenser will almost instantaneously take up a voltage corresponding to that of the battery. If, on the other hand, you charge the condenser through a high resistance, the voltage will not instantaneously reach its maximum value, but will take a certain time to do so.

"The actual time taken for the current to reach a certain predetermined proportion of the full value depends upon the relative values of resistance and capacity and may be evaluated in terms of the product of these two, which is the time constant of the circuit. The current in a condenser circuit grows or



New Dubilier upright holder for grid leak, which takes up little space

## Half Hours with the Professor (Continued)

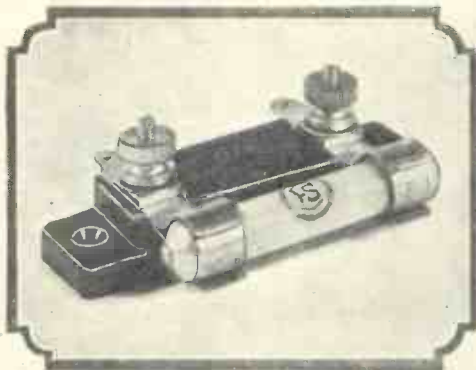

Ediswan vacuum-type grid leak and holder

into an enormous frown, Amp desisted.

"Your explanation is all right as far as it goes. You must remember, however, that in a telephony signal we do not obtain a series of isolated impulses followed by a series of rests. We have a continuous impulse due to the carrier wave, the strength of which is being varied the whole time.

### Following Signal Variations

"Consequently, the value of the condenser and leak must be such that the charge on the condenser can follow these variations with a reasonable fidelity.

"Now for this to apply all we need to ensure is that the impedance of the whole network shall be approximately constant over the full range of audio frequencies which have to be received.

"That is a much simpler way of looking at it than by considering any time-constant, for it is quite a simple matter to calculate the impedance of a condenser with a resistance in parallel at, say 50 cycles and 5,000 cycles, and to see if they are reasonably the same. If so, then you know that the values which you have chosen for your condenser and leak are correct from the point of view of quality."

"What about the case where the leak is connected straight across grid and filament?" interrupted the boy.

"That gives exactly the same state of affairs for it is virtually in parallel with the condenser. We can neglect

the inductance of the coil entirely, when dealing with the low frequencies. A point, however, which does arise is that we must take into account the resistance of the grid-to-filament path of the valve.

"For modern work, we use the valve with a small positive potential on the grid obtained by connecting the grid leak either to L.T.+ or to some slightly positive point by means of a potentiometer. In

Amp scratched his head. "Well, Professor," he said, "I never knew that. I always thought the grid leak was most important."

### Not of Great Importance

"No," was the reply, "as you see, in almost every practical case it is not. The only place where it would be of importance would be if we connected the grid leak to L.T.—. Except with certain types of valve, this means that no grid current is flowing and here it is usually found that we must use a very low value of grid leak in order to comply with our conditions for good quality.

"This brings me to the point which we haven't yet discussed—that of signal strength. It does not follow that because the combination is correct for quality that it is right for signal strength.

"For example, if we make the grid leak much too small we cut down the signal strength very considerably, besides adding materially to the damping imposed upon the tuned circuit and detector. On the other hand, if we make the grid leak too high, we get the nasty hooting which you heard just now."

"Why should that be then, Professor?"

"To explain that, your initial crude explanation is helpful. It simply means that the charge on the condenser has not had sufficient time to leak away. This gives rise to continual building-up and discharging occurring at a rapid rate such as you have just heard."

"I should rather like to  
(Continued on page 170)

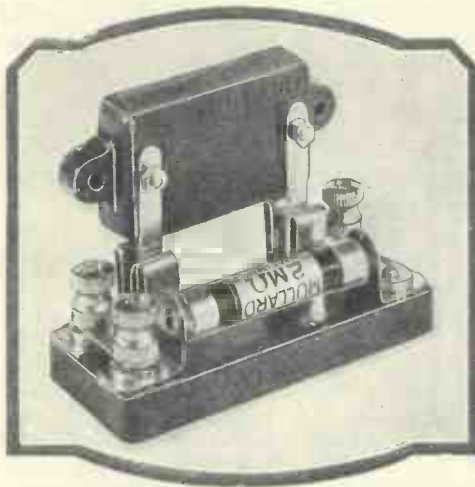

Mullard holder for grid leak and grid condenser



Three well-known makes of grid leaks—Igranic, Carborundum and Loewe

such circumstances, the grid-to-filament resistance of the valve becomes quite appreciable and we must allow for this resistance in parallel with the grid leak and condenser.

"In most cases, indeed, it is smaller than that of the grid leak itself and the sole function of the grid leak is to bias the valves correctly, the quality being determined purely and simply by the resistance of the grid-to-filament path of the valve itself."

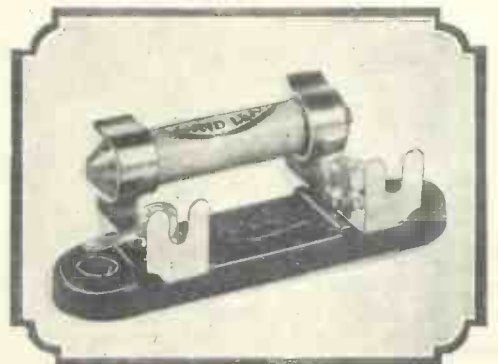

Lissen grid leak with holder





# In Tune With the Trade!

By "FETTER LANE"

## The A.C. Problem

THE new Ediswan gas-filled rectifying valves provide a ready solution to those who are getting to hate the "alternatingness" of their mains supply and are wishing it were steady D.C. suitable for the various needs of wireless sets.

Those who want to know something about the best arrangements for A.C. rectifiers, and the kind of components to buy, should get a very handy booklet called "Radio Power Supply Units," which has just been issued by the Edison Swan Electric Co., Ltd., 123-5 Queen Victoria Street, E.C.4. **7**

## "Juice" From the Mains

RAYTHEON, G. R., Clarostat, and T.C.C. combine to produce something better, supplied by Claude Lyons, Ltd., 76 Oldhall Street, Liverpool. That is the introduction to a folder describing mains eliminators for A.C. and D.C. supplies. Lists of parts, and prices, are given, and you can't go wrong. **8**

## Wet H.T.

ARE you interested in wet H.T. batteries? It isn't for me to present a brief on behalf of any particular make or type of battery, but I must confess to seeing much excellent sense in two booklets just sent me by the Standard Wet Battery Co., 184-8 Shaftesbury Avenue, London, W.C.2. These are the Standard booklet and instruction booklet, and both are interesting.

The Standard people make sac Leclanché batteries for every H.T. purpose, and also for L.T. if you want it. Sets of batteries and sets of parts

can be obtained, and they are all described in the booklets I have mentioned. **9**

## From-the-mains Sets

I DON'T profess to rank among the upper ten so far as technicalities are concerned, but it does seem to me that in producing at a reasonable price an all-from-the-mains (A.C.) receiver, with a screened-grid H.F. stage and a pentode, Philips are starting a new era.

The tuner covers wavebands from 200 up to 2,000 metres without coil changing, and the final output is stated to be sufficient to operate a moving-coil loud-speaker. A somewhat similar two-valver is also available, and both are described in a folder to be had from Philips Lamps, Ltd., 145 Charing Cross Road, W.C.2. **10**

## A NEW SERVICE FOR READERS

As a keen wireless enthusiast you naturally want to keep abreast of all the latest developments and this new feature will enable you to do so with the minimum of trouble.

Here we review the newest booklets and folders issued by nine well-known firms. If you want copies of any or all of them just cut out this coupon and send it to us. We will see that you get all the literature you desire.

Just indicate the numbers (seen at the end of each paragraph) of the catalogues you want below:—

My name and address are:—

Send this coupon in an unsealed envelope, bearing 1d. stamp, to "Catalogue Service," WIRELESS MAGAZINE, 58/61 Fetter Lane, E.C.4.

## Clix Catalogued

"CLIX For Contact" is the animated slogan of Lectro Linx, Ltd., 254 Vauxhall Bridge Road, Westminster, S.W.1. Under this bright heading they have just issued a catalogue of all Clix radio specialities.

What I am particularly interested in are the new Clix accumulator knobs and lead-coated spade terminals, both of which are ideal gadgets for owners of accumulators the "juice" of which is apt to creep.

The accumulator knobs strike me as being particularly cunning, as they are provided with a groove or trap for filling with vaseline, and this, of course, prevents acid creeping to the terminal stem. Anyway, read about them for yourselves in "Clix For Contact." **11**

## For Varying H.T.

MULLARD'S intend to keep my Mullard catalogue up-to-date, for they have just sent me a number of leaflets for insertion in my file. The first carries their number WA18, and is all about the Mullard P.M. potential divider.

This is a gadget which will appeal to those making up their own mains eliminators or who wish to increase the voltage variation range of existing units. The divider has ten tappings, and allows for a comprehensive range of voltage variations, the total resistance between tappings 1 and 10 being 9,000 ohms.

A table showing the voltages obtainable on each tapping is given in this leaflet, which can be obtained from the Mullard people at Nightingale Works, Nightingale Lane, Balham, S.W.12. **12**

**Lewcos' Latest**

AS the whole range of Lewcos components is so well known to wireless amateurs, I confess I skipped quickly through the catalogue portion of the latest booklet issued by the London Electric Wire Co. and Smiths, Ltd., Church Road, Leyton, E.10.

Towards the end of this I discovered some very handy tables of wire data, for which I am offering many mental thanks to the Lewcos people, and which I am cutting out and pasting on a card and intend to keep for reference.

Another feature which will be found very handy by possessors and intending possessors of Lewcos coils is a number of typical circuits showing the exact wiring connections for these. **13**

**"For Every User . . ."**

A BOOK for Every User of a Radio Receiver" is Colvern's own title for their own booklet; and on the back is the slogan, "There is a Colvern coil for every radio need." Well, that sounds embracing enough, and a short glance through the pages showed the slogan to be correct.

Some of the things dealt with are (first and most important) the dual-range coil, standard six-pin coils, formers, screens, short-wave gadgets, vernier condensers, and so on; but this is not a catalogue in the ordinary sense of the word.

There are quite a number of helpful circuits and set specifications. These will be of use both to those who are looking out for some new "hook-ups" to try out, and also for those who want to know how to use Colvern components in existing sets. Colvern, Ltd.'s address is Mawneys Road, Romford, Essex. **14**

**To Take With You**

AS the evenings get longer I am ready to sing with spring poets the best lyrics on music, and portable music in particular; and, most particularly, Lissen portable radio sets and gramophones.

The Friars Lane folk have sent me two folders, one of which deals with an ultra-neat portable "five," and the other with a couple of most striking and convincing portable gramophones. See the descriptions for yourselves by getting the folders from Lissen Ltd., Friars Lane, Richmond, Surrey. **15**

**Half Hours with the Professor** (Continued from page 168)

work out the values for myself, Professor, and see how they turn out."

"You can do that quite easily if you wish," was the reply. "As it happens there is a reference sheet in this month's WIRELESS MAGAZINE which gives you all the particulars you require."

So saying Megohm turned up Reference Sheet No. 113 (page 199).

Amp scanned it with interest. "Gee, Professor," he exclaimed at length, "can I borrow this? And, I say," he hurried on without waiting for a reply, "does the same thing apply to the grid leak on an R.C. valve?"

"No, the conditions there are somewhat different, but just as easy to understand. Let's hear your ideas about the working of an R.C. stage."

"Oh, I know that one," exclaimed Amp readily. "You have fluctuating currents in the anode circuit of the valve and these set up voltages across the resistance—like this," he added maliciously, drawing from his pocket an old envelope and scribbling a sketch in the Professor's best style.

"These voltages are transferred to the next valve through the coupling condenser and we put a leak in to polarise the grid to its correct voltage."

**Voltage Split Up**

"Yes," agreed Megohm, "that is quite correct. Now the voltage which is developed across the resistance is split up into two portions. One portion is developed across the coupling condenser, while the other portion is produced across the grid leak, where it is applied across the valve itself. It is only the second portion which is useful to us and the first portion is wasted.

"Fortunately, the voltage drop on the coupling condenser is normally quite small. The question is, what controls the voltage developed across any condenser?"

Amp looked at the Professor, thinking this was just a rhetorical question; suddenly realising, however, that Megohm expected him to answer it, he puzzled his brain and then said, "Oh, the current."

"Yes, anything else?"

Amp once again thought hard and, after a moment's reflection said, "Oh yes, of course, it depends upon the frequency."

"Quite correct; and if we reduce the the frequency what happens to the voltage?"

"It goes down," exclaimed Amp cheerfully.

Megohm stared at this sorrowfully.

**Inductance and Capacity**

"Oh, no, Professor," broke in Amp, quickly. "I'm sorry. The voltage increases with the frequency on an inductance and it goes down if you increase the frequency with a condenser. That's right, isn't it?"

Megohm nodded. "That's better," he said. "So that as we reduce the frequency, the voltage developed on the coupling condenser will increase. Obviously if we make the frequency low enough we can develop most of the voltage across the coupling condenser and very little across the valve itself."

"Oh, yes, I suppose you can," broke in Amp thoughtfully.

"Well, we arrange the relative values of coupling condenser and grid leak so that at 50 cycles we shall still obtain 90 per cent. of the full voltage across the second valve. That is a thing which you can easily work out for yourself, although, as a matter of fact, it is all worked out for you in Reference Sheet No. 34."

So saying, Megohm turned up the sheet and pointed it out to Amp.

"You should make your grid leak four or five times the value of the anode resistance," he resumed. "If you make it any higher than this, you are liable to get grid choking. You can then determine the correct value of coupling condenser from the chart. It does not matter of course, if you make the coupling condenser greater than the value given, but this is the minimum."

"Why, then, are there three values shown for one, two, and three stages?"

"If you have two stages and you want the overall amplification at 50 cycles to be 90 per cent. of the maximum, then the amplification of each stage must be the square root of .9 or 95 per cent. This will involve a slightly higher value of coupling condenser and so on for three stages or any other number.

"And there you are," concluded Megohm looking at his watch, "I think we have had quite enough talky-talky for one afternoon."



# BROADCAST MUSIC *of the* MONTH

Reviewed by **STUDIUS**

WITH the raising of the ban by the highest of the music-hall managers, Sir Oswald Stoll, a different atmosphere has crept into the vaudeville or variety texture of the programmes. True, a superabundance of syncopated and jazz turns still mars the ear, but there is obviously an endeavour to give listeners a little more of what they want, and not what the B.B.C. thinks they ought to want.

## News Heartily Welcomed

Consequently, the news that arrangements are in hand for broadcasts from the Alhambra, and Coliseum, with the continuance of the Palladium relays, was heartily welcomed.

Variety artists have been strongly to the front throughout this month, and many well-known names are found. Dorothy Monkman, now as familiar to listeners as her sister Phyllis, has given many appearances before the microphone, and 5GB had two excellent programmes arranged for February 13 and February 16, respectively, when additional artists were "Stainless Stephen," Grace Ivell, and Vivian Worth, two of the earliest feminine entertainers, who have remained together since their first contract very

early in the days of broadcasting.

Mischa Motte, whose vocal imitations seem to be well liked, had as fellow-artists Ivan Firth and Phyllis Scott, Brian Victor, and a well-known provincial comedienne, Kitty Woodford.

Many artists in the provinces have proved their ability to entertain large audiences, amongst them being Gladys Ross, who calls her turns "Philosophy at the Piano."

Another star vaudeville programme from 2LO con-

Gracie  
Fields



Archie  
Camden



auspices of the B.B.C., the latest being Sir Thomas Beecham, and Albert Coates, heard again on February 15. Mr. Coates was born in Russia, but received his general education at Liverpool, afterwards studying music in the city of music, Leipzig.

During the war he remained in Petrograd, being put in entire charge of the Opera after the 1917 revolution, the appointment being subsequently confirmed by the Bolsheviks.

Another well-known conductor is John Ansell, who is a composer too, and it was fitting that a special programme of his own compositions should be announced for February 21.

## Popular Sir Henry Wood

One is glad to note that Sir Henry Wood will continue to conduct the B.B.C. promenade concerts at Queens Hall, the thirty-fifth season, as usual. A rumour seems to have got about that the National Symphony Orchestra, under Sir Thomas Beecham, would replace this popular series, but one ventures to believe that the Proms and Sir Henry

tained the names of well-known artists, including Douglas Byng and Lance Lister from C. B. Cochran's revue, Tommy Handley and Jean Allistone in *Hilarious Limits*, Leslie Weston, and Harry Pepper, one of the new

"Follies." *Old Tivoli Nights*, an entertainment announced from the Belfast studio, would have come better from 2LO; the old music hall still remains enshrined in London hearts.

Some of the "old stagers," too, might well have been engaged, but the artists—Thornley Dodge, Ivan

Barbara Austen,  
the Welsh-American  
prima donna



Firth, Phyllis Scott, Fred Masters, and the Braniffs, known as "The Wonder Kids"—obviously know their work.

Many well-known, one might now say world-known, conductors have held sway under the



Franklyn  
Kelsey



Louis  
Martin

**Broadcast  
Music  
of the  
Month  
(Continued)**



John  
Armstrong



Harry  
Sennett

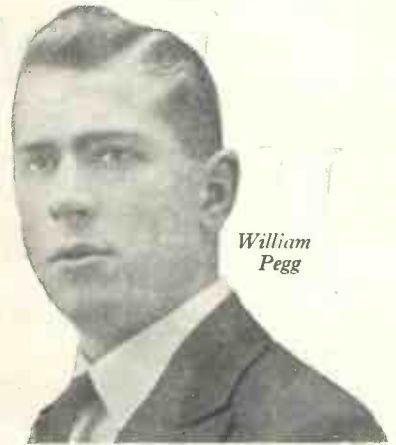

William  
Pegg



Gladys  
Ross

Wood are synonymous terms. The relay of municipal orchestras is also to be commended. Some of the finest concerts of the year were those given by the Bournemouth Symphony Orchestra, under Sir Dan Godfrey, and a newcomer to the public was found in the orchestra of Folkestone relayed from the Leas Cliff Hall on February 21, under Eldridge Newman.

Concerts, too, that are found of interest come from the Buxton Pavilion Gardens, where Horace Fellows is the conductor.

The piano, of course, has had its full share of honours this month, and amongst the famous artists who have been heard are Egon Petri, Paul Wittgenstein, Stanislaus Niedzielski, and Arthur Rubinstein. From Birmingham concerts have been given by the Midland Pianoforte Sextet, a very clever and unique combination.

**Many Quartet Broadcasts**

The violin usually broadcasts well, but comparatively few actual recitals have been heard, string music being confined to quartets, such as The Budapest, Gershom Parkington Quintet, J. H. Squire Celeste Octet, Virtuoso String Quartet, and the fine hotel orchestras of Signor Colombo and Rene Tapponnier.

Outstanding soloists, however, have been Melsa, Isolde Menges, who joined forces with Dale Smith (returning to the microphone after a serious operation), Frank Cantell, the leader of 5IT orchestra, and Norris Stanley, the last heard from 5GB, and Peggy Cochrane, the noted Vocalion violinist. Her rendering of the Andante of Mendelssohn's concerto is artistic.

**Some Unusual Instruments**

Amongst the more unusual instruments heard may be mentioned the bassoon, played by Archie Camden from Manchester; the harpsichord, by Wanda Landowska, who was announced to make her first concert appearance in England on Feb. 15, when Handel's Concerto for that instrument was conducted at Queens Hall under Albert Coates. For the 'cello we have had three early broadcasters in Beatrice Eveline, Seth Lancaster and Cedric Sharpe.

Although many people continue to complain of the "unknowns and unwanted," who give talks, ample opportunities of hearing the masters of their particular subject have occurred. Few will contest the supremacy of Sir Oliver Lodge, or Professor Mottram.

(Continued on page 200)



Christopher Mayson

THERE IS A PHOTOGRAPH OF THE DUDS CONCERT PARTY ON PAGE 143

READ THE ARTICLE BY GRACIE FIELDS ON PAGE 159



Bernard  
Ross



Dorothy  
Daniels

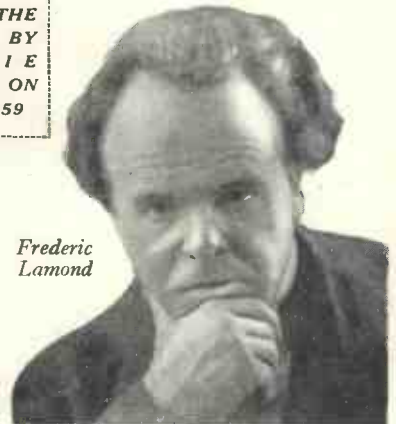

Frederic  
Lamond



# Make the Melody LOUDER and CLEARER

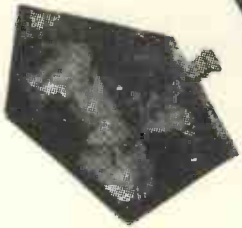

Get the best out of your Receiver—  
enormous volume—tremendous  
range—perfect tone—you get them  
all with Cossor Valves. Cossor  
Valves made possible the wonder-  
ful Cossor Melody Maker—the  
greatest achievement in the history  
of Radio. Cossor Valves improve  
any Receiver—use them in yours.  
Your Dealer will tell you which  
types you need.

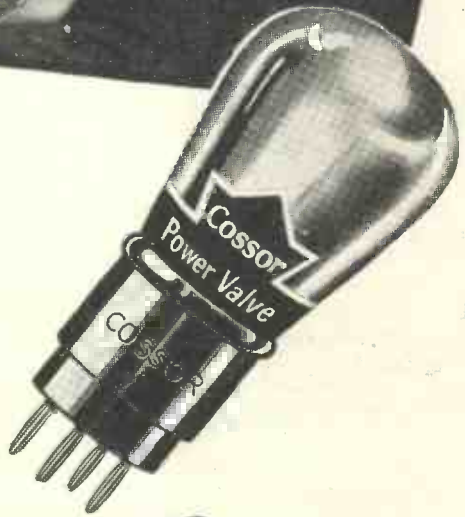

with  
**COSSOR**  
VALVES

# Making Your Own - BINOWAVE Coils

By W. JAMES

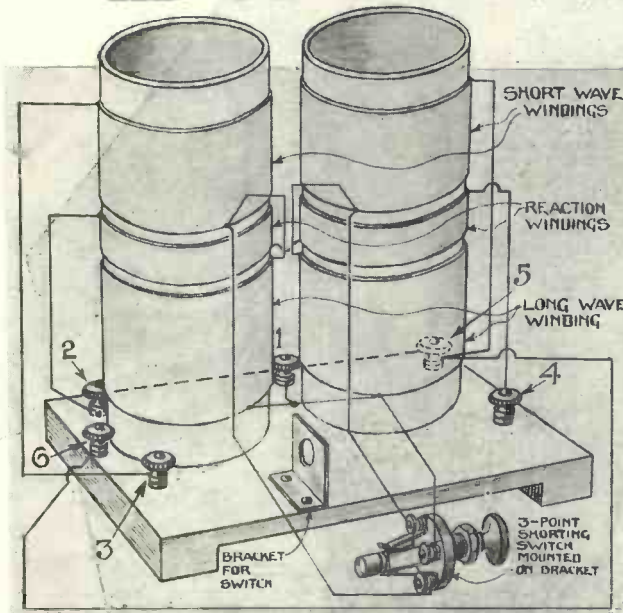

Diagrammatic sketch of Binowave coil

**T**HE coils used in the Binowave may be very easily constructed at home at small cost. The aerial and anode coils each comprise a base of ebonite and two tubes of Paxolin, 4 in. long and 2 in. in diameter. A three-pole push-pull short-circuiting switch is mounted on each base and is used in order that the wavelength ranges of the coils may be changed.

### Similarity Between Coils

The aerial coil is constructed in precisely the same manner as the anode coil, excepting that the anode coil is provided with a reaction winding. But otherwise the coils have equal numbers of turns and are connected to the switches in the same manner.

The drawings show the relative positions of the windings and the numbers of turns. Thus, the aerial coil comprises two tubes each of which has a winding of 45 turns of No. 26-gauge double silk-covered wire and 150 turns of No. 38-gauge d.s.c. wire put on in the same direction. Therefore, on each tube is a

short winding of thick and another of thinner wire. There is a space of  $\frac{5}{8}$  in. between the two windings, which have their inner ends connected together. Referring to Fig. 1, the short-wave winding of 45 turns is marked S.W., whilst the long-wave winding of 150 turns is marked L.W. Notice that it is the two inner ends which are connected together.

The two tubes are mounted side by side, with a space of  $\frac{1}{4}$  in. between them and the wave-change switch is mounted on one side of the base in order to be convenient for wiring. It is not difficult to fasten the two tubes to the base. A method which may be recommended consists in fitting a piece of wood about  $\frac{1}{4}$  in. thick and  $\frac{1}{2}$  in. wide to the lower ends of the two tubes. Wood screws may then be passed through the ebonite base into these fixing pieces. It is necessary to drill small holes for the connecting wires, which pass from the windings to the terminals and the switch contacts, and then the windings are joined as indicated in Fig. 1.

First the two ends of the fine-wire windings are connected together and connected to terminal No. 1 and to one of the switch contacts.

The end of one of the short-wave windings is then taken to terminal No. 3, whilst the other short-wave winding is joined to terminal No. 5.

There are still two switch contacts to be joined to the windings, and a wire must therefore be taken from one of the junctions of the long- and short-wave windings to one of the switch contacts, whilst the third contact is joined to the other junction as indicated in the diagram.

**How Connections Are Made**

This coil is connected to an aerial circuit as indicated in Fig. 2. It will be observed that the aerial is connected to the centre point of the tuning coil when receiving on the medium or the longer wavelengths. Experiments have proved that increased signal strength and selectivity are obtained by this method of connecting as compared with when the full coil is included in the aerial circuit.

### How Connections Are Made

A further advantage is that the aerial-tuning condenser remains more nearly in step with the anode-tuning condenser because the effect of the capacity of the aerial is greatly minimised. Tuning is therefore sharp without being critical and the circuit feeds large signal voltages to

(Continued on page 176)

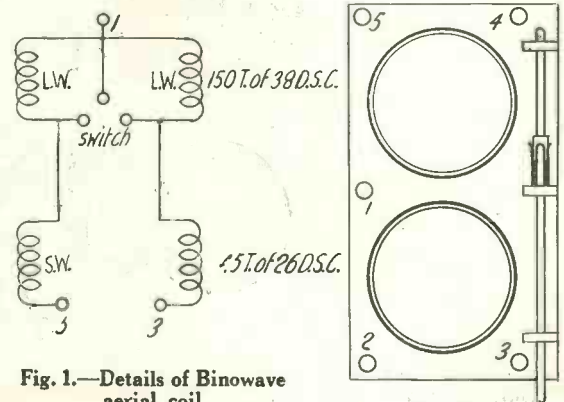

Fig. 1.—Details of Binowave aerial coil



**IN EVERY  
SET YOU  
BUILD OR  
BUY  
INSIST ON**

# **LOTUS COMPONENTS**

**FOR YOUR SET  
CHOOSE—**

*Lotus Dual Wave Coil, 15/-, 16/6, 21/-;  
Lotus Vernier Dial, 4/9;  
Lotus Variable Condensers, from 5/-; Lotus  
Buoyancy Valve Holders, 1/3 to 1/9; Lotus  
Jacks, Switches and  
Plugs; Coil Holders,  
Single Coil Holders,  
Lotus Remote Control  
for reception in every  
room from any type of  
set.*

**FROM ALL RADIO  
DEALERS.**

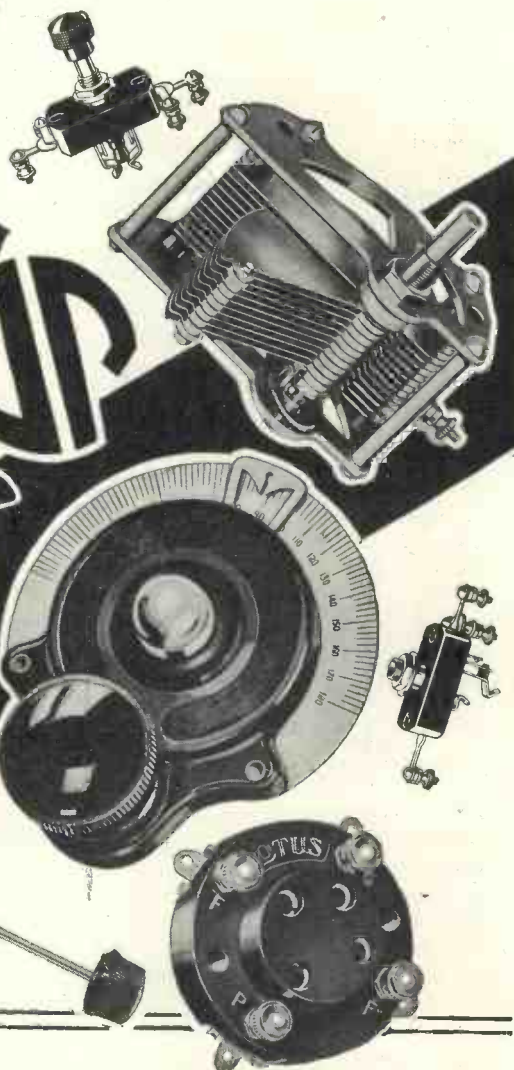

**Garnett Whiteley & Co., Ltd., Broadgreen Road, Liverpool**

## Making Your Own Binowave Coils (Continued)

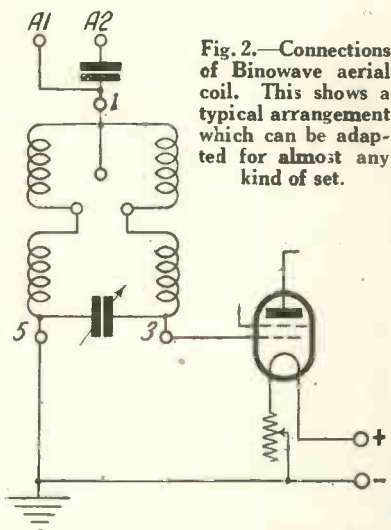

Fig. 2.—Connections of Binowave aerial coil. This shows a typical arrangement which can be adapted for almost any kind of set.

the grid of the valve connected to the coil.

The anode coil has long- and short-wave coils, which are wound on a pair of tubes in exactly the same manner as an aerial coil. But there is a reaction winding, and this comprises 65 turns of No. 40-gauge d.s.c. on each tube.

All windings are laid on in the same direction and connected as indicated in Fig. 3, where S.W. is one of the short-wave windings, R a reaction winding, and L.W. a long-wave winding.

Notice that the short- and long-wave windings are connected together, as in the aerial coil, but that the reaction winding is quite separate.

### Six-terminal Coil

There are six terminals. No. 1 is connected to the junction of the two long-wave coils and one of the switch contacts and Nos. 5 and 6 are connected together and to one end of the short-wave winding. The opposite end of the short-wave winding is connected to terminal No. 3, whilst the reaction winding is connected to terminals Nos. 2 and 4.

It is important that all the connections be taken from the coils to the terminals exactly as indicated, for then the reaction coil will be in the correct direction with regard to the anode coil and the convenient wiring

of the Binowave Four will not need to be changed.

Reference to the theoretical circuit of Fig. 4 will make clear how this coil is joined to a shielded valve. The anode of the shielded valve is connected to the centre point of the coil upon both wavelength ranges, whilst the high tension is joined to one end and the grid condenser to the other.

With this circuit arrangement not only is complete stability assured, but the selectivity is very good, and because of the step-up effect which is obtained the voltage amplification for the stage will be considerable.

I prefer not to give actual figures for the high-frequency amplification of such an arrangement because, as I have explained before, the amount of the high-frequency amplification to

The wavelength range of the coils is from 200 to 580 metres and from 900 to 2,000 metres when tuning condensers of .0005-microfarad capacity are employed. They enable the fullest advantage to be taken of modern shielded valves of the type having, for example, an amplification factor of 200 for an anode impedance of 200,000.

### No Interference with Neighbours

Full reaction may be used on the anode circuit when necessary without fear that the aerial circuit will oscillate, and these coils are the best I have tried for employment in shielded-valve circuits. As they have extremely small stray fields, a minimum of shielding will suffice, and a further point of interest to the purchasing public is their low price.

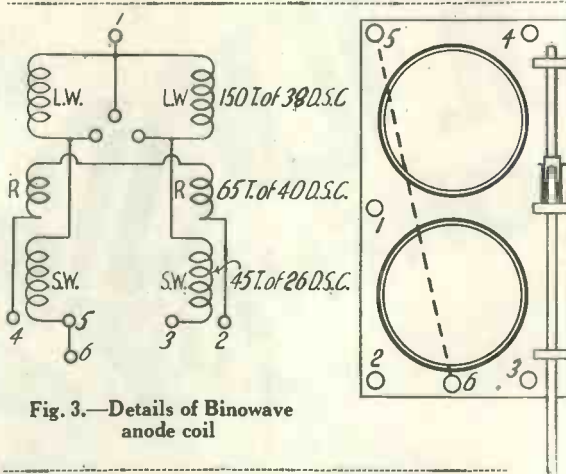

Fig. 3.—Details of Binowave anode coil

be obtained with stability depends entirely upon the construction of the aerial circuit. Thus, when the aerial circuit is a poor one, much more high-frequency amplification may be used without oscillation occurring.

At the same time, the selectivity of such an arrangement would be poor in comparison with a circuit including a well-made aerial coil. It cannot be too strongly emphasised that because all shielded valves have a small grid-to-anode capacity, a current passes from the anode to the grid circuit, producing a regenerative effect. This effectually limits the amount of the high-frequency amplification and prevents one from giving a figure that will prove of the slightest value.

FULL DETAILS OF THE BINOWAVE FOUR WERE GIVEN IN THE JANUARY ISSUE OF THE "WIRELESS MAGAZINE," COPIES OF WHICH CAN BE OBTAINED FROM THE PUBLISHER AT 1s. 3d. EACH, POST FREE. THE SET COMPRISES ONE SCREENED-GRID H.F. STAGE, LEAKY-GRID DETECTOR, ONE RESISTANCE-COUPLED L.F. STAGE AND A TRANSFORMER-COUPLED L.F. STAGE

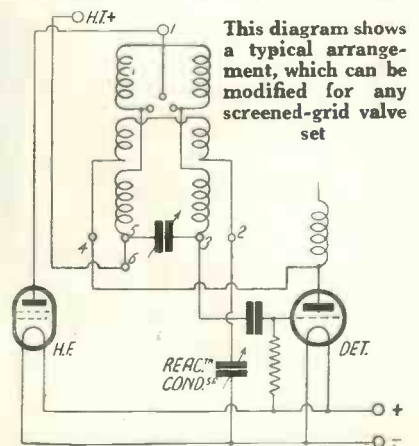

Fig. 4.—Connections for Binowave anode coil



# MR. STRADIVARIUS DID NOT MAKE KETTLE DRUMS!



ANTONIUS STRADIVARIUS was a specialist. He devoted his entire life to one thing—the making of violins. For three-score years he laboured lovingly at his craft, so that, to this day, his violins are cherished treasures and their maker acclaimed the first in his art for all time. Like the violin-maker of Cremona, we are specialists. For nearly a quarter of a century we have made nothing but condensers. And because we have never deviated from our task—never expended our energy in the making of other components—the name T.C.C. on a condenser is accepted throughout the world as the undisputed hall-mark of accuracy and dependability. Take no risks: use T.C.C. Condensers in your next Set.

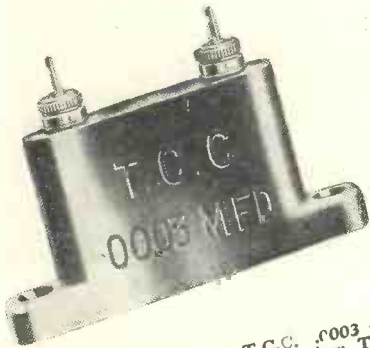

Illustrated above is T.C.C. .0003 mfd. Mica Condensers, price 1/10; below, T.C.C. .0003 mfd. Condenser, price 1/10.

SEND 1D. STAMP FOR FREE BOOK

A penny stamp will bring you a book which will show you how anyone can build an L.T. or H.T. eliminator. Send for it to-day and save money, time and trouble.

FOR OVER 22 YEARS WE HAVE MADE NOTHING BUT

# T.C.C. CONDENSERS

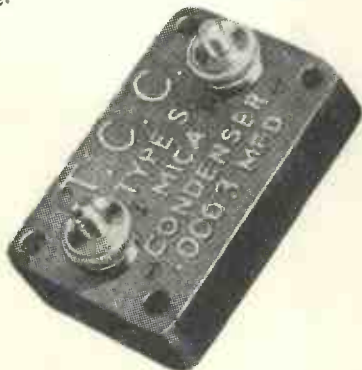

# CONTINENTAL NOTES

Special authoritative notes on broadcasting developments in all parts of the world garnered by JAY COOTE specially for the "Wireless Magazine"

IT is to be hoped that by the time you read these lines, some re-adjustment of the Plan de Bruxelles, in the allocation of wavelengths to the European transmitters may have suggested itself to the Geneva Bureau, and that we shall not have to wait until its next conference at Prague to alleviate the present chaos in the ether.

## Good Friends Lost to Me

Sad to relate, in common with many other radio fans, I lost many good friends on the night of January 13; most of them lie buried in mush, and the new-comers have not compensated me in any shape or form.

On paper, I take it, there is no difficulty in working out positions in the broadcasting band for the numerous stations which have cropped upon the Continent during the past few years, and in theory the frequency separation on which the Plan de Bruxelles is based may be correct, but in practice, believe me, the result is not a happy one.

Such stations as Hoerby and Cologne, Kattowitz and Frankfurt, Langenberg and Daventry 5GB, to name only a few amongst them, should not be adjacent neighbours; their individual powers are such that they must necessarily, at least for the distant listener, mar each other's transmissions.

## Disregarding the Plan

Moreover, although the majority of broadcasters are in agreement with the Union, there remains a minority which constitutes a factor liable to upset the entire scheme. Both France and Spain paid no attention to the Geneva plan of wavelengths, and from observations made at the time of writing, they are still disregarding the Plan de Bruxelles to-day.

Note that although in most instances in their published programmes they may advertise the wavelength allotted to them, you will find a search most difficult and when on a peculiarly lucky night you have identified one of these culprits, on

another evening you may discover him many metres astray!

I cannot visualise anything more happy-go-lucky than a French or Spanish broadcasting studio or station. My reference to Spain reminds me that Cadiz, although still appearing in many lists, has been closed for the past four months or more; with but two exceptions, only the Union Radio studios have survived in that country.

## Two Stations at Madrid

On the other hand, Madrid still possesses two stations, EAJ7, the main broadcaster and Radio Espana, which has now limited its programmes to one weekly transmission, namely, Mondays at 10 p.m. G.M.T.; it operates on or about 404 metres.

Lately, trouble has again cropped up in the city of Toulouse and the antagonism existing between the

official and private stations is likely to reach breaking point.

## Cause of the Friction

The cause of the friction, as in the past, is two fold, firstly the increase in power of Radio Toulouse—I am assured that it may shortly blossom forth as a 20-kilowatt—and secondly the relays of operatic performances from the Théâtre de la Capitale, which the Radiophonie du Midi transmitter still takes by wireless link, for the benefit of its subscribers.

For some considerable time, the French P.T.T. refused to grant this studio the use of the telephone land-lines for this purpose; later, as a result of official representations made by the local authorities the Post Office relented and reluctantly placed a cable at the disposal of Radio Toulouse.

Experience proved, however, that when relays of performances were to be made, the Post Office suffered a series of unaccountable accidents in which this unfortunate cable was always involved. Hence the return to the wireless relay, carried out by means of a small short-wave transmitter in the Théâtre de la Capitale. And it is due to a number of these official pin pricks that the two competitors are on the verge of war.

Official programmes published by some of the smaller Continental stations do not necessarily indicate the items which will be broadcast on the date mentioned; in many instances they include what the studio thinks it may transmit if all goes well!

## Departing from Schedule

During the last month or so, I jotted down in my log a few notes regarding stations which departed from their advertised schedule, and of these I find the French transmitters head the list.

Radio Paris on one occasion announced a broadcast of an opera to start at 8.30 p.m. I heard the overture at 8 p.m. and the show was over

(Continued on page 180)

## VERSATILITY



Our cartoonist's impression of Dion Clayton Calthrop—author, artist and designer





Run in -  
before you  
run out -  
Get an

WINNER SERIES for 6 m.a. emission. 60 volt	7/-
POPULAR SERIES for 6 m.a. emission. 66 volt	9/6
STANDARD SERIES for 6 m.a. emission. 66 volt	12/6
POPULAR POWER SERIES for 10-16 m.a. emis- sion. 60 volt	13/6
STANDARD SERIES for 10-16 m.a. emis- sion. 66 volt	22/-
EVER READY Co. (G.B.) Ltd., HOLLOWAY, N.7.	

**EVER READY** Regd.

**Britain's Best Battery**

## Jay Coote's Continental Notes (Continued)



George Padbury, conductor of the Cosmo Club Dance Band

forty minutes later or ten minutes after its advertised time.

Another concert, by Radio LL, Paris, opened up fifty-five minutes late, and on another night Ecole Supérieure, after giving the précis of a play which constituted the main feature of the programme, enjoyed an interval of ten minutes and put over a series of gramophone records!

### No Proper System

Bear in mind that in France there exists no proper broadcasting system and consequently the French listener can only rely on individual effort—strangely hampered in most cases—made by the various private and official studios. As you are no doubt aware, many of the concerts broadcast by French stations are offered to them by outside clubs and associations.

### A Good Story

A good story to this effect has gone the rounds of Paris wireless circles. In a programme submitted to the authorities, one of the items included a musical composition followed by the words: "First performance of the Mozart Cycle." The secretary of the organising committee received a letter from the studio station that this sentence would have to be omitted, for "no free advertisement could be granted for bicycles!"

Apart from Berne, one hears but little of the Swiss stations; generally speaking, they are of too low a power to be picked up at satisfactory strength in the British Isles. Lausanne has taken a leaf out of the 2LO book and recently organised a "My Programme" series, asking their subscribers whether they would care to be station director for one evening.

It was not left, however, to the general public to decide whether the show was a good one, but the decision was in the hands of a jury composed of the editors of local newspapers, and members of the Société Romande, the company responsible for the broadcasting organisation of the studio.

The main difficulty would appear to have been the question of cost, for



Alphonse du Clos, conductor at the Hotel Cecil

although at first sight it was easy to sketch out an evening's entertainment, naming band, actors, instrumentalist and vocalists to be engaged, the stumbling block was the £10 limit, or the 250 Swiss francs, given as the utmost amount to be expended on the programme.

From what I gather, Lausanne has not yet discovered an ideal form of entertainment at that price.

Up to the present, the Stockholm entertainments have been available to us, if not always through the capital transmitter, at least through Motala, the reinvigorated Goeteborg and the new 10-kilowatt, Hoerby. Oslo programmes, on the other hand, have been more difficult to capture for its

relays are even weaker than the main station which is a 1-kilowatt.

Towards the end of the spring, however, there should be little doubt of your hearing all the Norwegian you want and even more, for Norway will then possess a super-power transmitter sixty times stronger than the present one.

### Location of the New Station

It is being erected on the Eastern side of the Oslo Fjord, at no great distance from the capital itself, and when it stands up, I take it that although many may benefit by its energy, there will be an outcry in Norway that the giant blots out all possibility of hearing the foreigners! Whether it will work on 496 metres, the wavelength now allotted to the present station by the Plan de Bruxelles is a moot point, for, if so, I fear there will be trouble for its neighbours.

### Not an Easy Proposition

Admittedly, a 60-kilowatt station is not an easy proposition to handle in the broadcasting band and it will prove a thankless task to find a suitable place for it. Generally speaking, the Oslo programmes, to which I have frequently listened via Porsgrund or Frederiksstad, are good although somewhat meagre as compared with those broadcast by Copenhagen, Stockholm and Berlin.



Al Starita, conductor at the Piccadilly Hotel



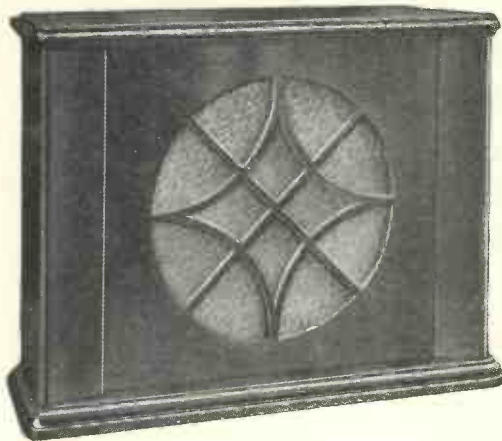

## BLUE SPOT 59 Speaker—£4 4s.

To listen to the Blue Spot 59 model is a revelation in loudspeaker reproduction. Its secret lies in the Blue Spot 66K adjustable 4-pole armature unit—the finest unit obtainable. The Unit can be supplied separately with full directions for the home-constructor, price 25/- from any leading wireless retailer. It will give results that will astound you.

**F. A. HUGHES & CO., LIMITED**  
204-6 Great Portland Street, London, W.1

DISTRIBUTORS FOR NORTHERN ENGLAND, SCOTLAND AND NORTH WALES: H. C. Rawson (Sheffield and London) Ltd., 100 London Road, Sheffield; 185 Princess Street, Manchester.

*"Ideal Blue Spot Cone Speakers are sold under full protection of the patents owned by Standard Telephones and Cables and the Hopkins and Lektophone Corporations."*

**Blue Spot  
66K Unit  
25/-**



# USE IGRANIC

Build only with Igranic Radio Devices and be sure of maximum efficiency throughout your set.

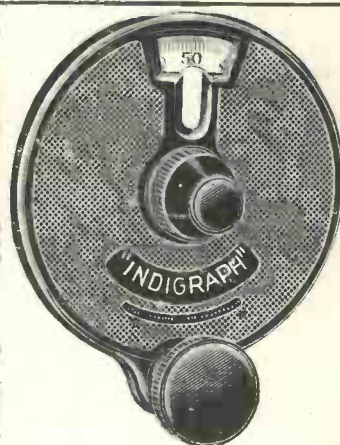

## Igranic "INDIGRAPH" Vernier Knob and Dial

Smooth as silk in movement, entirely free from backlash and particularly handsome in appearance, the "Indigraph" is a firm favourite. Reduction ratio 8 : 1.

Price 6/-

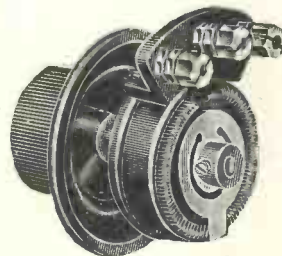

## Igranic "MEGOSTAT"

A potentiometer type of variable high resistance in which constancy of variation is assured. Resistance values of 50,000, 500,000 ohms, 1 and 5 megohms.

Price 6/- each



## Igranic TAPPED "C.C." OUTPUT UNIT

A complete output filter circuit with tapings by which a step-up or step-down auto-transformer effect may be obtained to suit every type of loudspeaker.

Price 21/6



## Igranic "SPRINGMORE" PLUG

The popular self-adjusting wander plug which also acts as a socket. In various colours.

Price 3d. each

*Apply to your dealer. If he cannot supply you, please write at once to DEPT. J799.*

**IGRANIC ELECTRIC CO. LTD.**

**149 Queen Victoria Street,  
LONDON, E.C.4**

**Works : BEDFORD**

# It Pays to Test Your Valves!

A New Instrument Reviewed by D. SISSON RELPH

OF all the parts in a wireless receiver, the valves are the most intriguing items to most listeners. With good valves properly adjusted, even a poorly-constructed set will give passably good results, but the best set ever made would be useless if the wrong valves were employed.

Not only do valves make or mar a set, but they need more critical adjustment than any other components if they are to work to the very best advantage.

his valves are operating by means of appropriate meters.

During the past few weeks I have used quite extensively (so often, in fact, that my wife has spoken of going into mourning as a "wireless widow"!) one of the new Ferranti valve testers. This instrument is particularly neat and, although it is relatively expensive, there is no doubt that WIRELESS MAGAZINE readers will be glad to know something about it.

- (1) Off position.
- (2) Anode current in two ranges: (a) 0-10 milliamperes and (b) 0-100 milliamperes.
- (3) Anode voltage in two ranges: (a) 0-100 volts and (b) 0-300 volts.
- (4) Grid-bias voltage in two ranges: (a) 0-10 volts and (b) 0-100 volts.
- (5) Grid circuit: this position gives no quantitative reading, the movement of the needle indicating only that the grid circuit is complete—for instance, it will show if the secondary of an inter valve transformer has broken down.
- (6) Filament voltage: two positions are provided, so that a reading can be obtained irrespective of which way round the filament connections are wired.

## A First-grade Meter

The meter itself is a first-grade instrument and has a resistance, when in use as a voltmeter, of 1,000 ohms per volt. The total resistance is 300,000 ohms and a current of 1 milli-ampere gives a full-scale deflection.

A particularly pleasing feature about this Ferranti tester is that it is quite fool-proof and even a child could not damage it—although, of course, one does not deliberately give valve testers to kiddies as playthings!

It will be observed from the photographs that a fuse of Lilliputian dimensions is provided; a spare fuse is provided (in an envelope) in the case in which each instrument is sent out. This case, by the way, measures only 7 in. long by 4 in. wide by 2½ in. deep and can be easily carried about.

To use the tester one removes the valve from its holder, inserts the adaptor, and then places the valve in position on top of the adaptor (see photograph). Movement of the dial then enables one to take any of the readings referred to already.

—When I first used the instrument

(Continued on page 184)

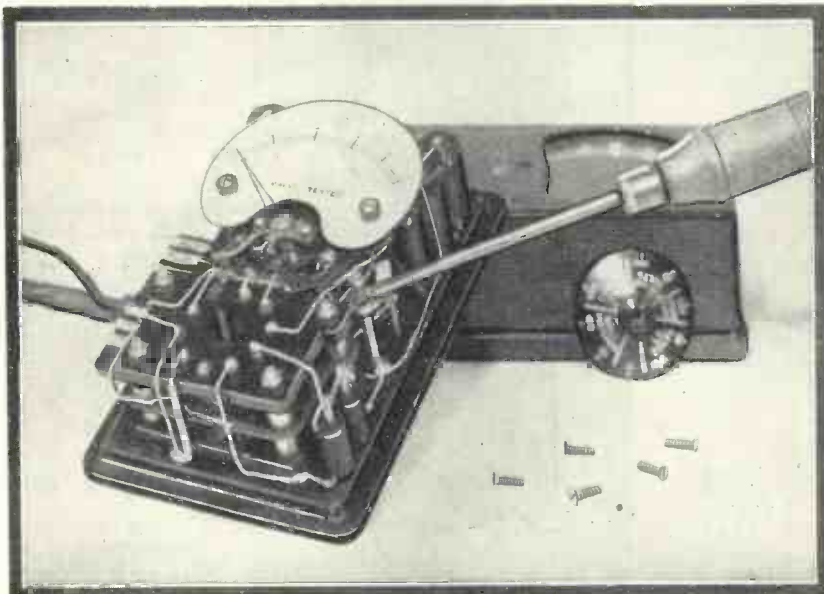

Here is the Ferranti valve tester removed from its case. At the top can be seen the various shunting resistances. The screwdriver shows the position of the fuse

To get the best out of any valve, it is essential that it should be operated under the proper conditions, which are specified by the manufacturers. Nowadays, when really high voltage batteries and mains supply units are in general use, it is especially necessary to take precautions to see that valves are not being overrun.

A filament will rapidly disintegrate if more current is passed through the valve than the makers intended, and every listener who is at all particular about his receiver takes care to check up the conditions under which

The appearance of the tester can be seen from the photographs reproduced in these pages. It consists essentially of a multi-range combination voltmeter and milliammeter contained in a moulded case, which is provided with a lead terminating in an adaptor for insertion in a standard valve holder, and an extra lead for connection to the grid-bias battery where one is used.

On top of the case is a dial divided into six sections and the rotation of this enables one to get any of the following readings:—



# THIS CURVE TELLS THE TRUTH ABOUT THE TRANSFORMER THAT TELLS THE TRUTH.

THIS National Physical Laboratory Curve tells the truth about the Brown L.F. Transformer. It proves beyond all words, that the Brown evenly amplifies every note throughout the whole harmonic scale. Treble and bass—the delicate strains of the violin and the deep notes of the bassoon—the Brown gives you them all distinct and clear, yet each in its proper place and at its correct strength. In short the Brown Transformer tells the truth about the broadcast. The secret is in its special alloy core and its unique method of winding. Ratio 3.5 to 1. Ask your dealer for further particulars.

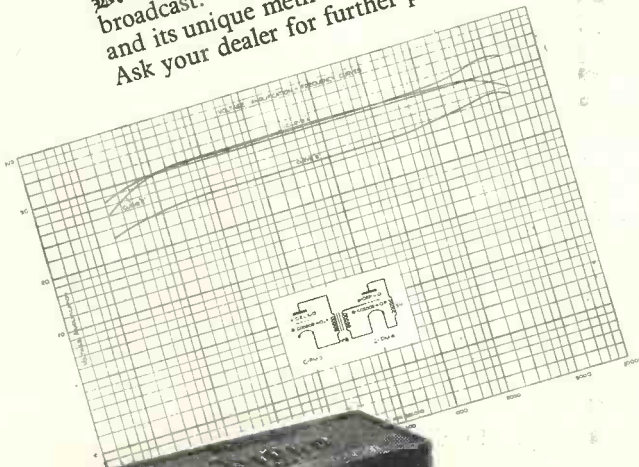

PRICE  
**30/-**

Made by  
**Brown**  
of Loud Speaker  
Fame

S. G. BROWN, LTD., Western Avenue, North Acton, London, W.3.

7254

For  
**THE BINOWAVE**

**AERIAL COIL**      **ANODE COIL**

**25/-**  
the pair

The R.I. & Varley Binowave Coils—for "The Binowave 4," described in the January issue of *Wireless Magazine*—are made exactly to Mr. James' specification.

Out of our wide range of radio components there are none in which we have specialised to the same extent as in our winding department. The experience gained in perfecting our famous Bi-duplex winding—which dates back as far as 1896—is reflected in any and every R.I. & Varley wire-wound job marketed to-day.

The efficiency, reliability, and finish of our "Binowave 4" Coils are another tribute to R.I. & Varley craftsmanship and engineering skill.

THE MARK OF  AND **Varley** BETTER RADIO

LTD

Kingsway House, 103 Kingsway, London, W.C.2. Telephone: Holborn 5803.

## It Pays to Test Your Valves ! (Continued)

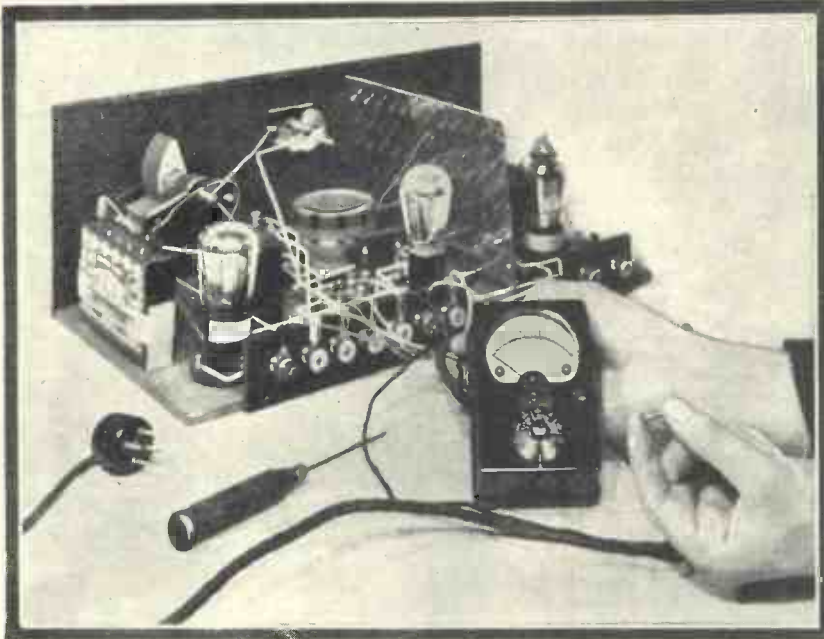

This photograph shows how the fuse is changed—if it ever burns out. Note the small size of the complete instrument

I was rather perturbed by the violence with which the needle shot over against the stop while passing from one range to the other. For instance, in turning the dial from "Grid-bias Volts" to "H.T. Volts" the switch is momentarily connected to the 0-100 volt range and if one has 180 volts on the anode the needle gives a most alarming kick.

(b) 0-100 volts and (c) 0-300 volts.

Two special points should be noted when using the instrument for testing valves in a set under working conditions.

Depending upon which way round the filament connections are wired, the grid-bias reading will be either correct, or increased by the voltage of the low-tension supply. In the

instruments which will be supplied shortly the grid-bias reading is correct when the filament voltage is obtained with the dial set to "10." When the dial is opposite "10R" on the filament range the grid-bias is increased by the amount of the filament voltage, and this must be subtracted.

### High Anode Resistances

The other point concerns readings taken when there is a very high resistance in the anode circuit, such as occurs in resistance-capacity amplifiers. The proper procedure in this case is to take the total voltage across both the valve and resistance (using the tester as an ordinary voltmeter without inserting the adaptor in the valve holder) and also measure the anode current.

From these readings calculate the voltage drop across the resistance (resistance in ohms multiplied by current in amperes): subtracting this result from the total voltage will give the actual potential on the valve anode.

These notes are not all that could be written about this interesting instrument, but they will be sufficient, I think, to show readers of the WIRELESS MAGAZINE the utility of the Ferranti valve tester for general radio work.

### Special Zero Adjuster

However, the special type of pointer used in Ferranti meters is exceptionally robust and even if it were to become slightly bent after long use no harm would result—a screw is provided for setting the needle exactly to the zero mark should it get upset.

Quite apart from its use for testing valves under working conditions, however, the meter can be used in the ordinary way if connections are made direct to the adaptor instead of plugging the latter into a valve holder.

Used like this (the various connections are indicated on a slip of paper pasted on to the bottom of the container) the following ranges are available :

- (1) Milliammeter : (a) 0-10 milliamperes and (b) 0-100 milliamperes.
- (2) Voltmeter : (a) 0-10 volts.



How the Ferranti valve tester is connected in a set. The extra lead is for taking grid-bias voltages



# YOU CAN USE YOUR SET TO REPRODUCE PICTURES

## by the addition of a **Fultograph**

### THE FULTOGRAPH KIT INCLUDES:—

C/1. Aluminium mounting plate, drilled and tapped ..	£ s. d.
C/2. Two ball-bearing pedestals, complete with ball bearings ..	12 6
C/3. Two square pedestals, with rails and fixing screws ..	18 6
C/4. Special double-spring clock-work motor, driving spindle projection, 2½ in. ..	7 6
C/5. Steel threaded main spindle ..	2 2 0
C/8. Electro-magnetic clutch (see separate pamphlet) ..	14 6
C/9. Brass N.P. cylinder, with hinged paper clip and set screw ..	4 4 0
C/10. "Stop-start" mechanism assembled, complete with all switches and adjusting screws ..	10 6
C/11. Stylus carriage with two runner wheels, hard steel traversing wheel and platinum pointed stylus in N.P. holder and frame ..	1 11
C/12. Insulating platform, with slip ring contacts for clutch and cover ..	1 6 6
C/13. Metal protecting cover for clutch mechanism, with brake ..	2 6
C/14. Moving-coil milliammeter, 0/5, flush mounting, N.P. ..	10 6
C/15. Magnetic relay, best quality instrument finish, 4,000 ohms ..	1 0 0
C/16. Transformer, 1:6 ..	16 0
C/17. Non-inductive 60-ohms resistance ..	8 6
C/18. Quick make and break "on-and off" switch ..	9
C/19. Six-way connecting cord, with two six-way plugs ..	2 0
C/20. Five-way Multicolour battery cord with five-way plug, three battery plugs, and two spade terminals ..	8 6
C/21. Six-point moulded socket and ebonite socket board with cables ..	9 6
C/22. Paxolin panel, 7½ by 6½, for relay box, with valve holder, drilled and bored where necessary ..	7 6
C/23. Five-way moulded socket for relay panel and screws ..	5 0
C/24. Six-way moulded socket for relay panel ..	2 9
C/25. Two N.P. terminal sockets with nuts ..	3 0
C/26. Condenser, .011 mfd. ..	1 0
	2 6

### NOT INCLUDED IN THE KIT:—

C/51. Best quality dark oak cabinet and cover for picture receiver, with N.P. locking clips and carrying handle ..	£ s. d.
C/52. Dark oak cabinet for relay panel ..	1 2 6
C/29. Fultopaper, per packet of 100 sheets ..	4 2
C/30. Fultograph solution, per pint bottle ..	9
	4 0

If your set works a loud-speaker it will work a Fultograph, by means of which you can receive the pictures broadcast daily from this country and the Continent.

You can construct your own Fultograph if you wish, but to ensure the best wireless picture reception you should buy the genuine components as used in the standard Fultograph. Complete kits are also available, and contain every component necessary for the construction of the Fultograph Wireless Picture Receiver, with the exception of valve, paper, and solution. Included are full directions for assembly and adjustment, together with illustrations and wiring diagrams.

**WIRELESS PICTURES (1928) LTD.**  
DORLAND HOUSE, 14-16 REGENT STREET, S.W.1

## COMPLETE KIT £16

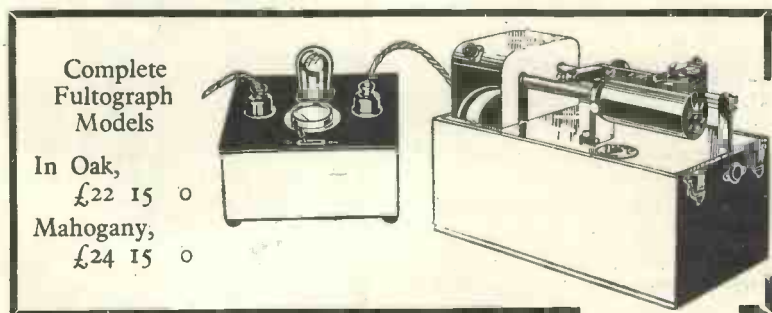

Complete  
Fultograph  
Models

In Oak,  
£22 15 0  
Mahogany,  
£24 15 0

PICTURE BROADCASTING IS INTERNATIONAL



It will be seen that there are four terminals on the top panel of the unit. Two of these are for the input and are connected to the electrical pick-up for gramophone work. The other terminals are for the loud-speaker.

**Position of Volume Control**

The dial in the centre of the panel is the volume control, and enables the reproduction to be so regulated that the best results are obtained from any type of record and pick-up that may be used in combination. The small knob is the on-off switch.

Adequate volume for all ordinary purposes can be obtained from two valves, and in this particular instance use is made of one resistance-capacity coupled stage with a pentode output valve. It is common knowledge that the pentode valve gives considerably greater amplification than the usual type of three-electrode valve. (the pentode is a five-electrode valve).

It has already been emphasised that the provision of an adequate volume control is of foremost importance; it is also a matter of concern where the control is introduced. The best practice is obviously to control the input to the amplifier—then there is no chance of anything being overloaded.

**Pick-up Voltages**

So great is the voltage developed by some pick-ups on a loud record that there is even a likelihood of the first valve of an amplifier being overloaded unless this precaution is taken.

In the Auditrol Unit, therefore, the voltages applied to the grid of the first valve are controlled by a potentiometer placed between grid and filament. British manufacturers

*(Continued on page 188)*

ONE of the greatest assets in any amplifier is the provision of a volume control. The proper use of it ensures that whatever the conditions under which the amplifier is working, the magnification will be kept within permissible limits and that no part of the gear—either valves or loud-speaker—will be overloaded.

**Excessive Power**

Indeed, only now is adequate attention being given to this question of controlling volume. Many cases of so-called distortion are merely due to excessive and unnecessary power, a state of affairs that the sensible use of a volume control would speedily put right.

The Auditrol Unit is, as its name implies, something that enables the volume of sound to be controlled. It is more than that—it is a two-stage amplifier specially designed for obtaining the best results from a pentode power valve.

Primarily the Auditrol Unit is intended as a gramophone amplifier, but it can, with a slight alteration, also be used in conjunction with a radio receiver if necessary.

**Batteries Out of Sight**

To meet the needs of the gramophone enthusiast who wants to reproduce records electrically, however, the unit has been built in such a form that it can easily be placed alongside the gramophone without taking up a lot of room. Instead of terminals, a battery cord is provided, so that the necessary sources of power can be hidden on the floor or on a shelf under the table.

AN AMPLIFIER FOR  
GRAMOPHONE OR RADIO  
WORK

INCLUDES AN EFFICIENT  
FORM OF VOLUME CON-  
TROL

ONE RESISTANCE-CAPA-  
CITY COUPLED STAGE AND  
PENTODE OUTPUT VALVE

CAN BE PLACED ALONG-  
SIDE GRAMOPHONE WITH  
BATTERIES ON FLOOR OR  
SHELF UNDER TABLE

SPECIAL OUTPUT TRANS-  
FORMER TO MATCH UP  
LOUD-SPEAKER WITH  
PENTODE

STABILISING RESISTANCE  
FOR PENTODE AUXILIARY  
GRID

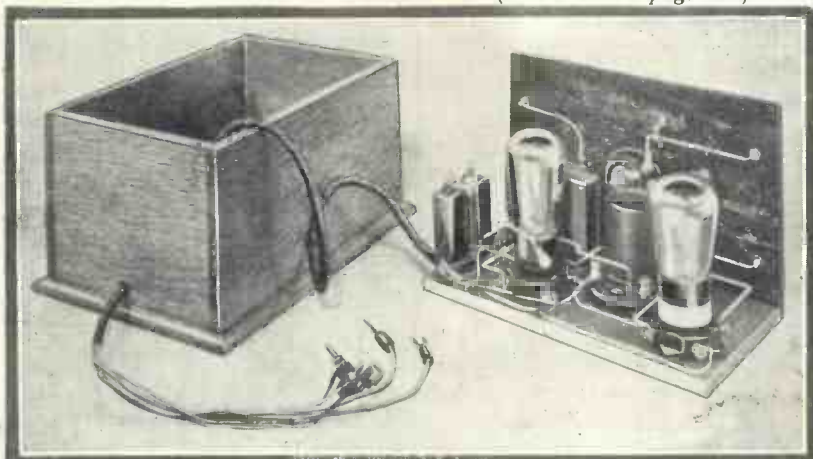

This photograph shows the actual two-stage amplifier removed from the cabinet



# We make it



*exactly to*  
**Mr. W. James'**  
*specification*

Whiteley Boneham & Co., Ltd., are the sole makers of Mr. James' remarkable new Moving Coil Loudspeaker, specially designed for "Wireless Magazine." The aluminium moving coil incorporated in "The Lodestone" is a novel feature in Loudspeaker design that needs wonderfully careful manufacture. Another notable feature is the very low current consumption of 0.5 Amp. The Lodestone is sold as a kit of parts for £4:4:0, and can be assembled with perfect ease by anyone.

Demonstrations given daily at 21, Bartlett's Buildings, Holborn Circus, E.C.1. Literature from here or Nottingham Road, Mansfield, Notts.

**WHITELEY BONEHAM & Co. Ltd.,**  
Nottingham Road, Mansfield, Notts.



## **The Wandering Minstrel**

brightened a Dark Age which burnt scientists as wizards. Now is the Wandering Minstrel wizard too—tuning his lays from the ether, calling living voices from across a continent. Yet honoured in that his magic minstrelsy is part of the homeliness of modern homes.

# **Burndept** screened ethophone

Five valve results from a three valve receiver at a modest price.

20 to 25 stations. Utilizes Screened Grid and Pentode valves.

£12.7.0 complete with valves and royalty from your local dealer

*Write for catalogues and hire purchase terms to—*  
**BURNDEPT WIRELESS (1928) LTD., BLACKHEATH, S.E.3**

## The Auditrol Unit *(Continued from page 186)*

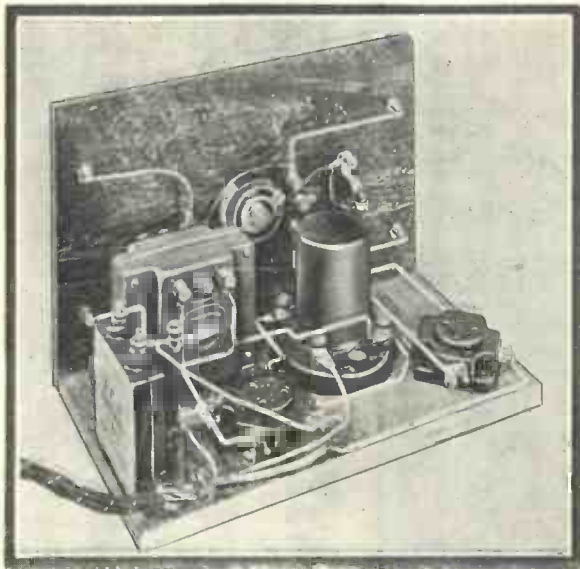

Notice how compact is the arrangement of the Auditrol Unit

make such potentiometers only in limited ranges of resistances, and we have therefore used a 500,000-ohm instrument in this case.

### Better Value

This is satisfactory for ordinary use, but we prefer a value in the neighbourhood of 100,000 ohms.

As will be seen from the circuit diagram on this page, provision is made for applying grid bias to the first valve, one end of the potentiometer being connected to the grid-bias battery.

The first valve is coupled to the second by means of a resistance-capacity coupling, a method which gives adequate amplification of the bass frequencies. The actual coupler used is the Mullard unit, which is contained in a neat metal case provided with a base carrying only four terminals.

### Special Stabilising Device Incorporated

This unit incorporates a special device for preventing high-frequency currents from flowing through the low-frequency circuits, which in this case help to stabilise the amplifier. Only one model of this coupler is manufactured, and the anode resistance has a value of 200,000 ohms.

Some attention may now be given to the pentode power valve—a new form of amplifier that has come in for a good deal of criticism. Three points cited in the case against pentodes are: (1) their comparatively heavy anode-current consumption; (2) their tendency to reproduce too much high-frequency (that is, not enough bass); and (3) their mechanical fragility.

Let us consider each point separately. First, as regards high-tension current consumption; this is higher than that needed by a number of ordinary power valves—but then the pentode gives much greater amplification. Actually some pentodes now on the market consume as little as 7 milliamperes with appropriate grid bias.

### Matching Up the Loud-speaker with the Valve

It is true that the reproduction from a set including a pentode is high-pitched compared with that obtained with a normal super-power valve, but this is a matter that can be corrected, either by means of a condenser or by means of a special output transformer to match up the impedance of the loud-speaker with the valve, which has a very much higher impedance than a three-electrode valve.

In the Auditrol Unit, the latter method is employed, a step-down of 3 to 1 being utilised. In this way the greatest amplification is obtained from the valve and the quality is better than if the loud-speaker were connected directly in the anode circuit.

It will be observed that the anode circuit is connected between P1 and P3 on the transformer; this is correct for the normal pentode. For a 2,000-ohm loud-speaker, the secondary terminals S1 and S3 should be used. The terminal S2 is a one-third tap on the secondary and by connecting to S1 and S2 or S2 and S3, the best results can be obtained for any loud-speaker resistance.

Another point about the output transformer which

*(Continued on page 190)*

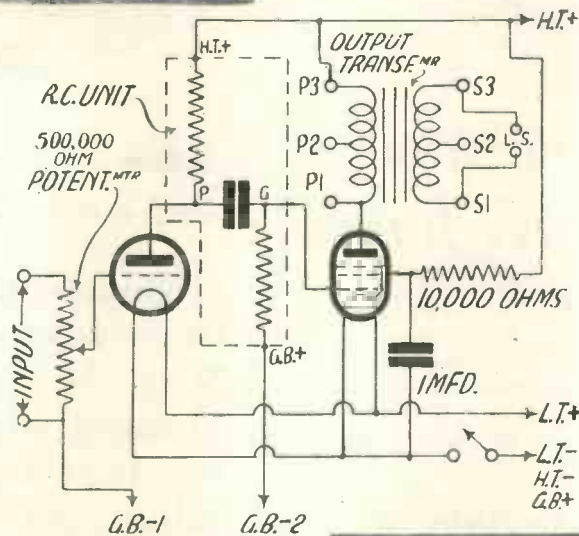

Here is the circuit used for the Auditrol Unit

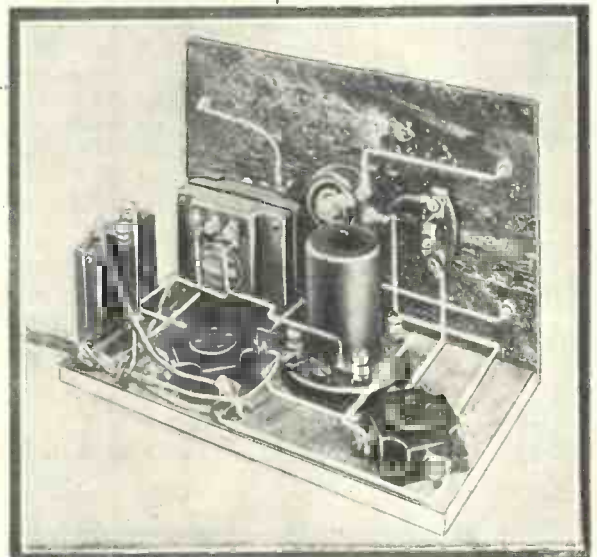

Another view of the Auditrol Unit



**UNRESERVEDLY  
SPECIFIED**

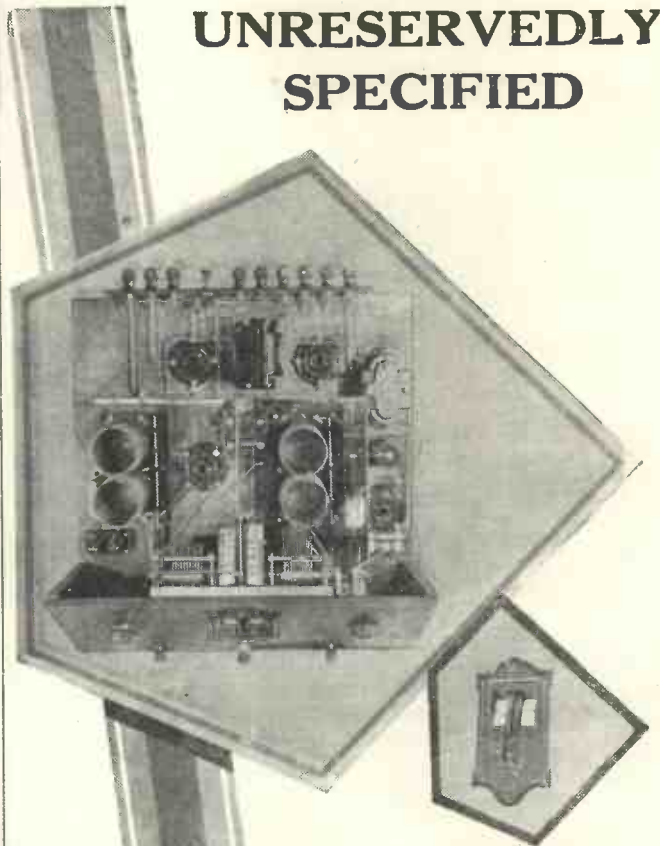

Mr. W. James unreservedly specifies Cyldon Synchronatune Condensers for his first screened-grid circuit—the Binowave 4.

The Cyldon Synchronatune System incorporates gang control—with individual adjustment of each stage—dignified panel layout—and precision condenser units electrically matched.

Cyldon Synchronatune Twin '0005 mfd. assembly, complete with drum and escutcheon plate in standard black finish, as specified for Binowave 4. **Price 47/-**

Cyldon '0003 Bebe Condenser, as specified, for reaction control.

**Price 11/-**

Cyldon condensers are also specified for the latest short wave circuit—the "New Empire Receiver"—a '00015 model being used.

**CYLDON  
CONDENSERS  
FIVE YEARS GUARANTEE**

Sydney S. Bird & Sons, Ltd.,  
Cyldon Works, Enfield Town,  
MIDDLESEX.

**BEST WAY TO ALL STATIONS**

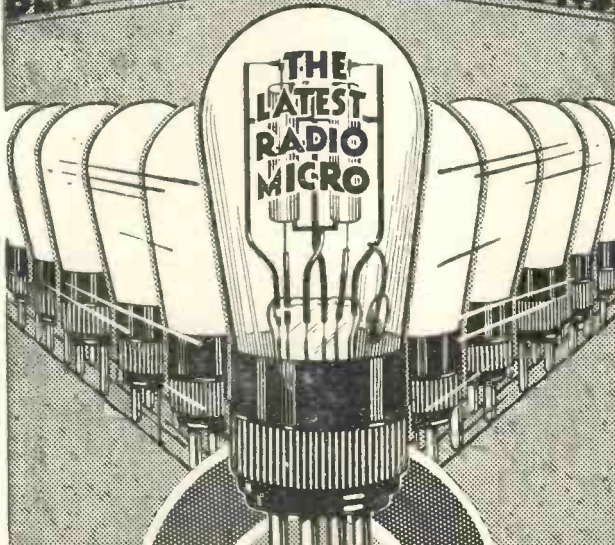

**DARIO**

**VALVES**

**—AND THE CHEAPEST  
WAY, TOO,**

guaranteeing utmost satisfaction. Just look at the prices below—made possible by reason of the biggest valve output in the world. Radio without Dario can never be radio at its best.

**SUPERLATIVE FINISH—LOWEST CONSUMPTION**

TWO VOLTS	
General Purpose, .05 amp. . . . .	5/6
R.C.C., .06 amp. . . . .	5/6
Super-Power, .16 amp. . . . .	7/6
Super H.F. & R.C.C. .16 amp. . . . .	7/6
Pentodion, .15 amp. . . . .	21/-

FOUR VOLTS	
General Purpose, .05 amp. . . . .	5/6
R.C.C., .07 amp. . . . .	5/6
Super-Power, .1 amp. . . . .	7/6
Super H.F. & R.C.C. .1 amp. . . . .	7/6
Pentodion, .15 amp. . . . .	21/-

From your dealer or direct:

**IMPEX ELECTRICAL, LTD.**

Dept. B.  
**5/6** 538, High Road, **7/6**  
Leytonstone, E.11.

## The Auditrol Unit *(Continued from page 188)*

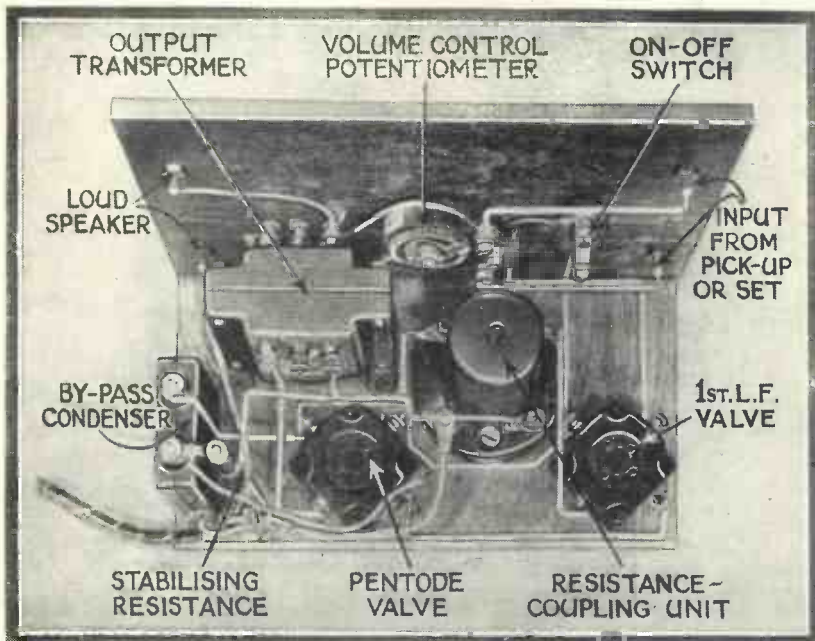

This plan view shows clearly how all the parts are arranged in the Auditrol Unit

should not be overlooked is that it effectively insulates the loud-speaker windings from the direct anode current and, therefore, affords them protection.

### Mechanical Strength

The last point under consideration—namely the mechanical strength of the five closely-packed electrodes—is one that is receiving the closest attention from the valve manufacturers themselves. It is unquestionable that great improvements

have been made in this respect during the past few months.

Indeed, one member of the WIRELESS MAGAZINE Staff has two Mullard pentodes that were accidentally knocked off a table by a cat and fell a distance of nearly 3 ft. to the floor (in their boxes) without suffering any apparent damage!

Reviewing these facts, and bearing in mind the great amplifying qualities of the pentode, the reader will be able to form his own opinion of its worth.

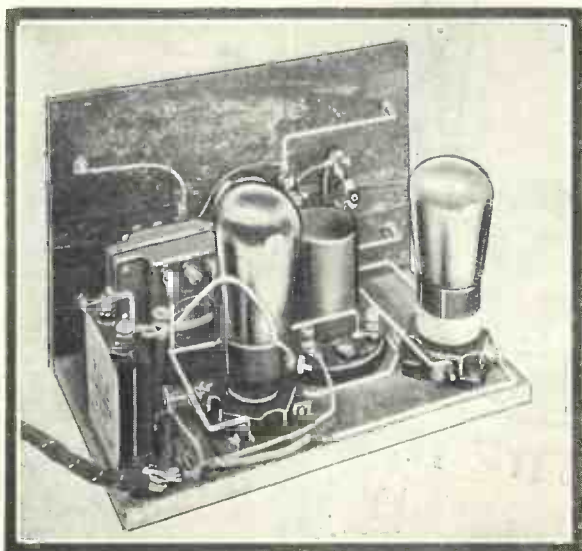

Another view of the Auditrol Unit

To proceed with our description of the Auditrol Unit.

### Stabilising Resistance

In the auxiliary grid circuit of the pentode there is a 10,000-ohm resistance, and a by-pass condenser of 1 microfarad capacity. This arrangement prevents low-frequency oscillation occurring, and stabilises the whole amplifier.

There is nothing difficult about the actual construction,

which is clear from the photographs and diagrams reproduced in these pages.

However, those who desire one can obtain a full-size blueprint for half price (that is, 6d., post free), by using

**DO NOT OVERLOOK  
THE GRAMO-RADIO  
SECTION on PAGES  
121—126**

the coupon on page iii of the cover by March 31.

Address your inquiry to Blueprint Dept., WIRELESS MAGAZINE, 58/61 Fetter Lane, E.C.4, and ask for No. WM132.

For ease of assembly, the usual panel and baseboard method of construction has been adopted, the valves being horizontal when in use.

### Drilling the Panel

The first part of the construction is, of course, the drilling of the panel. For this operation, the blueprint can be used, or, alternatively, the positions and sizes of all the drilling holes will be found on the reduced reproduction on page 192.

The panel is held to the baseboard by means of ordinary wood screws, and it can be thus fixed in position

*(Continued on page 192)*

### COMPONENTS REQUIRED FOR THE AUDITROL UNIT

- 1—Ebonite panel, 9 in. by 6 in. (Raymond, Becol, or Ripault).
- 1—500,000-ohm potentiometer (Igranitic).
- 1—On-off switch (Lotus, Bulgin, or Lissen).
- 4—Terminals, marked: Input (2), L.S.+, L.S.— (Belling-Lee or Ealex).
- 2—Anti-microphonic valve holders (Marconiphone, Lotus, or Formo).
- 1—Resistance-capacity coupling unit (Mullard).
- 1—Output transformer (Marconiphone Universal).
- 1—10,000-ohm resistance (Graham-Farish).
- 1—1-microfarad fixed condenser (T.C.C., Lissen, or Mullard).
- 1—5-way battery cord (Lewcos).
- 1—Cabinet with 4 $\frac{3}{4}$  in. baseboard (Pickett).



# CONSTANT H.T.

## MODEL W.1.B. FOR A.C. MAINS.

Output 120 v. at 18 m/a.  
1 variable and 1 fixed  
tapping.

£4.19.6

Incorporating  
Westinghouse  
Metal Rectifier.

Specially designed for  
such popular sets as the  
Mullard Master 3\*,  
Cosor Melody Maker,  
Lamplugh Popular, etc.



*Special H. T. Model for the Megavox Three incorporat-  
ing Westinghouse Metal Rectifier, special tapping for  
screen and complying throughout with the I.E.E.  
recommendations.*

£7.12.6 complete



*Advt. of Regent Radio Supply Co., 21 Bartlett's Buildings, E.C.4.*

**SOMETHING NEW for the  
HOME CONSTRUCTOR—**

## The "ALESTRIAN" GRAMOPHONE

*A magnificent instrument. Can  
be assembled in one evening*

Complete kit with blueprint  
and full instructions, price

£6 6 0

Write for Leaflet No. 1 :

**THE ALESTRIAN  
GRAMOPHONE COMPANY**  
Stour Road, Old Ford, London, E.3

Telephone: East 6266

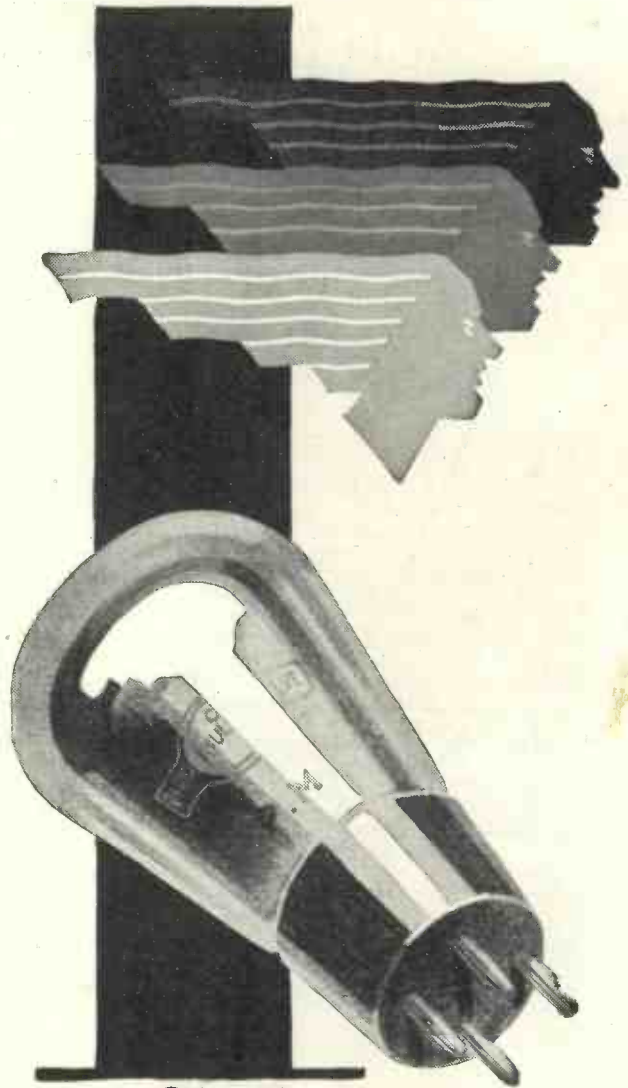

**— TONE  
— VOLUME  
— DISTANCE**

Tone—the character of a  
sound ... quality ... har-  
mony ... light and shade ...

You realise how true a  
description that is as soon  
as you put Mullard 1929  
P.M. Radio Valves in your  
Receiver. Then it is that  
your radio takes on  
character—and tone—  
only equalled by the ori-  
ginal performance itself.

Ask your radio dealer to-  
day for a set of Mullard  
P.M. Valves for your  
receiver.

# Mullard

**THE MASTER VALVE**

# The Auditrol Unit *(Continued from page 190)*

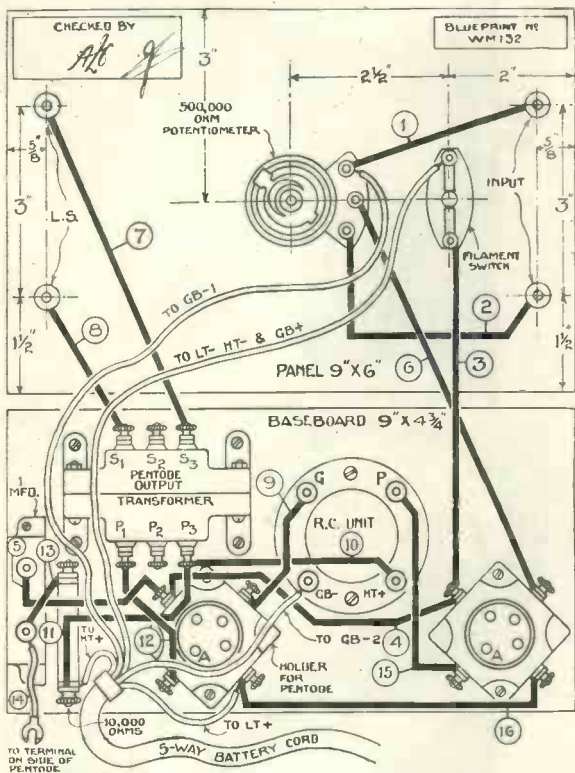

This layout and wiring diagram can be obtained as a full-size blueprint for half price (that is, 6d., post free), if the coupon on page iii of the cover is used by March 31. Ask for No. WM132

when the necessary components have been fixed to it.

As soon as the remainder of the components have been placed and fixed in position on the baseboard, wiring up can be started. There will be no difficulty about this if a full-size blueprint is used.

### Wiring Up the Unit

Both on the blueprint and the wiring diagram, reproduced above, all the wires are numbered in order of connection. First connect wire No. 1; then wire No. 2; and so on to No. 16. Leads to the battery cord are not numbered, but the external connections are clearly indicated. Note that L.T.—, H.T.—, and G.B.+ are common to one lead.

As soon as wiring up has been completed satisfactorily, the free end of the battery cord can be slipped through the hole provided for it at one end of the cabinet, and the whole unit slipped into position.

Before this is done, however, the

unit should be given a preliminary test. To do this, suitable valves must be chosen.

### Choice of Valves

Reference to the lists on pages 108 and 109 will show that there is a large number of valves from which a choice can be made. As the anode resistance in the coupling unit has a value of 200,000 ohms, the first valve should have an impedance between 50,000 and 80,000 ohms. The value is not critical and a valve with a high amplification factor can be chosen.

As regards the choice of a pentode, there are a number of different makes available. At present Mullard's choice of a pentode, there are a number of different makes available. At present Mullard's choice of a pentode, there are a number of different makes available. At present Mullard's choice of a pentode, there are a number of different makes available.

Several manufacturers make 2-volt and 4-volt pentodes, and of the former we can specially recommend the Ediswan 5E225, which is com-

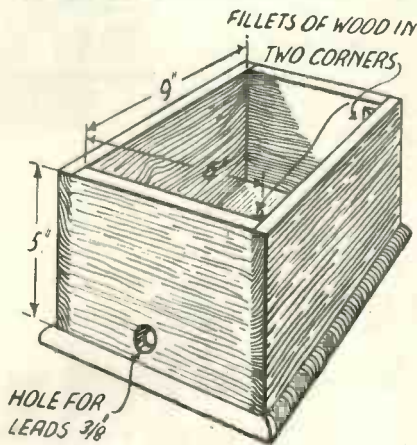

Details of cabinet for the Auditrol Unit

paratively economical in the way of anode current.

Normally 120 volts should be applied to the anodes of both valves, and also to the auxiliary grid of the pentode. This is accomplished by connecting the single H.T.+ lead from the unit to a 120-volt battery.

From 1½ to 4½ volts grid bias will be needed for the first valve, while most pentodes will want from 6 to 9 volts negative bias.

## Plays by Television

IT is not an easy matter to obtain a correct idea of the present position of television. There are still tremendous difficulties in the way of sight broadcasting, but what a glorious future television will open for us once those preliminary difficulties are overcome!

### First Television Play

According to accounts from America, what might be called the first television play was broadcast as long ago as last September. The most interesting feature of this transmission, perhaps, was that three wavelengths were used, one for the voice and two for the images.

Crude as this attempt to televise a play may have been, it does mark a definite beginning of an entirely new form of broadcast. Improvements will undoubtedly follow, and one can just begin to imagine the television play of the future.

With television successfully established, broadcast drama will become the greatest feature of our broadcast programmes, instead of the somewhat doubtful feature it is at present.

Then, again, what will television do to our news service? Think of what it will be like to see the boat-race as well as hear a description of it. A television news service will be nothing less than a topical news cinematograph film served up at the actual moment of happening instead of days later.

### Worth the Candle

Sometimes I wonder how the television experimenter can go on working so patiently with so little reward, but when I think of the tremendous possibilities in television, I begin to see that, after all, the game may be worth the candle.

AERIAL.



# AN APOLOGY

TELEGRAPH CONDENSER COMPANY LIMITED  
DOUBLE MOUNTING CONDENSERS

ADVERTISEMENTs have recently been issued featuring the Telegraph Condenser Company's Condensers with the special feature of the double mounting bracket as an innovation first evolved by us, but we find to our regret that this is incorrect.

This feature, for which originality was claimed by us, had already been previously registered by Mr. T. Graham Farish, of Graham-Farish Ltd., on the 16th day of

August, 1926, No. 723271, Class 3, and incorporated in their condensers since that date.

We wish to take this the first opportunity of publicly acknowledging the error, but are happy to announce that arrangements have been made which will enable this special double mounting feature to be continued in T.C.C. Condensers under licence from Mr. T. Graham Farish, the registered proprietor of the design.

**TELEGRAPH CONDENSER COMPANY LTD.**

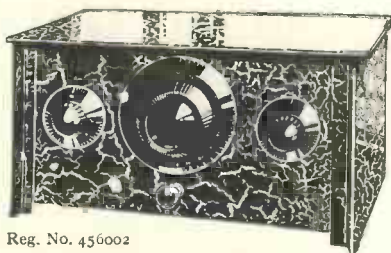

Reg. No. 456002

Anyone can build this set in 60 minutes. Circuit allows use of standard valves (1 H.F. and 1 Power). Blueprint and easily followed Diagram of Connections included with every set. Cabinet and full kit supplied in carton.

Obtainable from all Dealers, or

**THE BEDFORD ELECTRICAL & RADIO CO., LTD.**  
22 CAMPBELL ROAD, BEDFORD

**TO HOME  
CONSTRUCTORS!  
BUILD THE  
PEERLESS  
"RESONIC 2"**

*No drilling.  
No soldering.  
All wires  
cut and bent.  
Just assemble.*

**COST  
£3.15.0**

**ONLY**

## The CANTOPHONE Radio-Gramophone



*The New Wonder  
Instrument.*

**From 85 Guineas.**

*No Gramophone Winding. No Accumulator Charging.*

A wireless set and an electrically reproducing gramophone combined. It works from the electric light main. The volume of sound is variable without the slightest distortion from a whisper to the full power of a large dance band.

**THE CANTOPHONE WIRELESS CO.**  
REMO HOUSE, 310, REGENT ST., LONDON, W 1 Telephone: Mayfair 2532

## FINSTON "Q" COILS

are a very efficient type of coil with a dual wavelength covering 250/2,000 metres. Made to J. H. Reyners' specification and officially approved. With Finston coils you are guaranteed the best possible results.

## BINOWAVE COILS

Made to specification and specially designed for circuits employing Screened Grid Valves. A change-over switch is embodied which gives you immediately either Short- or Long-wave reception. The coils are mounted on a base and have terminals at side for connections.

Price complete 25/- per set.

**COILS FOR THE  
ALL BRITAIN THREE Q.A. 15/-  
Q.S.P. 21/-**

SEND FOR ILLUSTRATED LEAFLET (B/A)

**STONE MFG. Co.,** 108, GREAT SAFFRON HILL  
LONDON, E.C.1 Tel.: Hol. 4844

# Novelties & New Apparatus Tested

Personally Tested in the Furzehill Laboratories  
by J. H. REYNER, B.Sc., A.M.I.E.E.



N.S.F. Variable Condenser

### N.S.F. CONDENSER

WE have recently tested an N.S.F. condenser submitted by S. W. Lewis & Co., of 39 Victoria Street, S.W. 1. This component is designed to obey a logarithmic law and can, therefore, be used with success in gang-controlled circuits.

The rotating spindle carrying the moving vanes is held in position by two long bushes fixed to a suitably shaped metal plate whilst the fixed vanes are clamped to a pair of insulated supports attached to the plate. This gives a

fairly robust assembly with a particularly low minimum capacity.

Although no pigtail contact is employed between the rotating spindle and its corresponding terminal, the contact is electrically good and the motion is commendably smooth.

Our test showed the condenser to have a maximum capacity of approximately .00054-microfarad and a minimum of .000012-microfarad. The component can be recommended.

### JUNIT MULTIPLE SWITCH

IN portable receivers it is desirable to be able to change the connections of the frame aerial from long to short waves and *vice versa* quickly and easily. In obtaining the most satisfactory results, it is found desirable to sectionalise the frame and to series-parallel the connections. The sections are used in series for the long waves and in parallel for the short waves.

This, however, involves somewhat complicated arrangements and is consequently not as extensively used as more

simple methods. The Junit Manufacturing Co., of 2 Ravenscourt Square, W., have produced a multi-point switch having eight contacts. Two of these contacts are operated by a push-pull motion of the switch, whereby the filaments of the set may be switched on and off, while the combination of the remaining contacts is altered by rotating the switch through a half-circle.

The construction of the switch is (Continued on page 196)

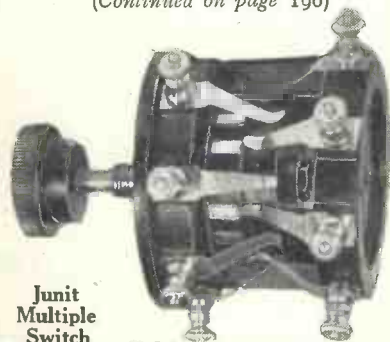

Junit Multiple Switch

*"Where did that one come from"*



Type "B"

Even when their heads are engraved, terminals are apt to be very muddling—if the tops come off.

The tops of Belling-Lee terminals cannot possibly come off—one of the many advantages to be gained by using these excellent little products.

Made in Three types, Type "B" 6d  
Type "M" 4½d. Type "R" 3d.

Belling & Lee, Ltd., Queensway Works  
Ponders End, Middlesex

**BELLING-LEE**  
TERMINALS



BUY

AMATEUR

WIRELESS

3D.

WEEKLY



THE BEST  
COMPANION  
TO WIRELESS  
MAGAZINE



## "PAREX" Screens Again

Are used in and recommended for ALL SCREEN CIRCUITS IN THIS PAPER

- "THE LODESTONE 3," Screen - 4/6  
H.F. Transformer, 15/- Aerial Coil, 10/-
- "THE SIMPLE SCREEN 3" Screen - 4/6
- "THE SIGNAL BOOSTER" Screen - 7/6

Screens for all Circuits from your dealer or direct from:—

**E. Paroussi,** 10 Featherstone Blgs.  
London :: W.C.1.

Phone: Chancery 7010

**CAMCO**  
**FOR**

**PORTABLE**  
**TRANSPORTABLE**  
**LOUD-SPEAKER**  
**CABINETS, etc.**

Send Coupon for latest list

To Carrington Mfg. Co., Ltd., Camco Works,  
Sanderstead Road, South Croydon. Telephone—  
Croydon 0623 (3 lines).

Please send me your latest list

Name .....

Address .....

W.M.



# READY RADIO SUPPLY CO.

Three minutes from London Bridge Underground and Southern Stations.

Telephone: Hop 5555 (Private Exchange) **159 BOROUGH HIGH ST., LONDON BRIDGE, S.E.1** Telegrams: Ready, Hop 5555, London

THE HOUSE FOR SERVICE AND QUALITY

ALL THE CORRECT PARTS FOR THE

**"LODESTONE THREE"**

	£	s.	d.
One ebonite panel, 16 in. by 8 in. (Resiston) .....	8	0	
Two .0003-microfarad variable condensers with slow-motion control (Polar) .....	1	4	0
One set Lodestone coils (Lewcos, Wearite) .....	1	10	0
One 12-ohm panel rheostat (Gecophone) .....	2	9	
Three anti-microphonic valve holders (W.B., Lotus, Igranic) .....	3	9	
One neutralising condenser (Gambrell neutrovernier) .....	5	6	
Two dial indicators (Bulgin) .....	5	4	
One 2-microfarad fixed condenser (T.C.C.) .....	3	10	
One L. F. transformer (Ferranti, A.F.3) .....	1	15	0
One terminal strip, 16 in. by 2 in. (Ready Radio) .....	1	10	
Ten terminals (Belling-Lee) .....	3	9	
One 1½-volt dry cell (Siemens type T) .....	3	9	
One cabinet (Pickett) .....	1	5	0
Two wander plugs .....	4		
Flex .....	6		
20 ft. of Glazite .....	1	8	
One on-off switch (Lotus) .....	1	6	
Three Valves .....	2	4	0
<b>Total, including valves</b> .....	<b>29</b>	<b>12</b>	<b>6</b>

INLAND: All orders post free. OVERSEAS: Consignments carefully packed and insured. Charges Forward.

ALL THE CORRECT PARTS FOR THE

**"FIDELITY FIVE"**

	£	s.	d.
One ebonite panel, 20 in. by 8 in. ....	10	0	
Two .0005-microfarad variable condensers (Burdept) .....	1	11	0
Two slow-motion dials (Burdept) .....	9	0	
One .0001-microfarad reaction condenser (Bulgin) .....	5	0	
One 1-megohm potentiometer (Igranic) .....	5	6	
Two plugs and jacks (Igranic) .....	7	9	
Two six-pin coil bases (Lewcos) .....	5	6	
Five anti-microphonic valve holders (Lotus) .....	6	3	
One neutralising condenser (Gambrell or Jackson Bros.) .....	5	6	
One high-frequency choke (Wearite) .....	6	6	
Two .01-microfarad fixed condensers (Dubilier) .....	4	0	
Two 2-microfarad fixed condensers (Dubilier) .....	7	0	
One 4-microfarad fixed condenser (Dubilier) .....	7	6	
One 25-megohm grid leak with holder (Mullard) .....	3	6	
One 2-megohm grid leak with holder (Mullard) .....	3	6	
Two 50,000-ohm resistances with holders (Dubilier) .....	13	0	
One 100,000-ohm resistance with holder (Dubilier) .....	6	6	
One output choke (Parmeko) .....	1	7	6
One terminal strip, 3 in. by 2 in. (Ready Radio) .....	6		
Two terminals, marked: Aerial, Earth (Belling-Lee) .....	9		
One 4½-volt tapped grid-bias battery (Siemens type 61) .....	1	3	
One 8-way battery cord (Lewcos) .....	9	6	
One Ready Radio cabinet with 9 in. baseboard, oak or mahogany .....	1	12	6
One complete set coils (Lewcos) .....	2	17	0
Five valves .....	2	19	0
<b>Total, including valves</b> .....	<b>216</b>	<b>5</b>	<b>0</b>

ALL THE CORRECT PARTS FOR THE

**"SIGNAL BOOSTER"**

(H.F. Unit)

	£	s.	d.
Ebonite panel, 12 in. by 8 in. ....	5	8	
One .0005-microfarad variable condenser (Jackson Bros.) .....	11	6	
One .0005-microfarad slow-motion variable condenser (Jackson, Bros.) .....	5	9	
One 15-ohm panel rheostat (Peerless) .....	2	3	
One on-off switch (Lotus) .....	1	6	
Two dial indicators (Bulgin) .....	2	4	
Two single-coil holders (Lotus) .....	1	4	
One anti-microphonic valve holder (Lotus) .....	1	3	
One 2-microfarad grid condenser (Lissen) .....	3	6	
One .0002-microfarad fixed condenser (Lissen) .....	1	0	
One neutralising condenser (Peto-Scott) .....	5	0	
Two terminal strips, 6 in. by 2 in. (Ready Radio) .....	1	4	
Seven terminals (Belling-Lee) .....	2	7	
One copper screen (Ready Radio) .....	2	6	
Cabinet, oak or mahogany, 12 in. by 8 in. by 9 in., with baseboard (Ready Radio) .....	1	2	6
Flex and Glazite .....	2	6	
One screened-grid valve .....	1	2	6
<b>Total, including valve</b> .....	<b>24</b>	<b>13</b>	<b>0</b>

FREE BLUEPRINT with all orders over £2. ALL COMMISSIONS RECEIVE IMMEDIATE PERSONAL ATTENTION.

Send for our 144-page Illustrated General Catalogue, price One Shilling. Sent free with all orders if requested.

INDISPENSABLE WITH MOVING COIL LOUD-SPEAKERS

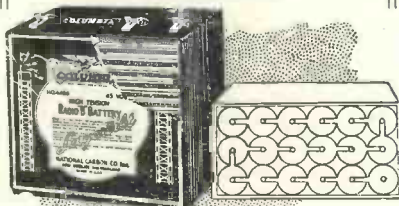

An adequate supply of H.T. Current is more necessary than anything else with a Moving-coil Loud-speaker. High-capacity H.T. Batteries are essential, otherwise the best results cannot be obtained.

Your mind is automatically directed to the COLUMBIA LAYERBILT Heavy Duty H.T. Battery. This new patented COLUMBIA LAYERBILT is the latest development in the radio battery art. It provides more hours of H.T. service per cost than any other H.T. battery on the market. The amount of extra service it renders is by far in excess of its increased cost over ordinary batteries. Its electrical capacity is 35-52% greater than any other battery of the same size.

The COLUMBIA 4780 60-volt Heavy Duty Battery was used by Mr. W. James for the "Touchstone"—even better results can be obtained by using our LAYERBILT Battery.

Price 25/-

Write to-day for our new 27-page brochure entitled "Why Radio is better with Battery Power." It is packed with interesting information.

J. R. MORRIS,

Imperial House, 15 Kingsway, London, W.C.2  
Scotland: J. T. Cartwright, 3 Cadogan Street, Glasgow.

SEE PAGE 169

FOR

REVIEW OF CATALOGUES

Keep in touch with Latest Developments

MAKE USE OF OUR INFORMATION SERVICE

SEE

PAGE 169

Keep on Saying DARIO for Radio See page 189

TRIX COMPONENTS

are used in the SIGNAL BOOSTER & REFLEX 2 valver

These three TRIX Components are used in the above named sets. The TRIX "Pull and Push" Switch-clean "make" and "break" terminals and soldering tags, nickel-silver springs and attractive bushed knob. Fits all panels up to ¼ in. thickness. Nickel plated. ... 1/3 each  
The TRIX Anti-Microphonic Valve Holder with guiding groove and red anode indicator. Price 1/3 each. And the TRIX Fixed Condenser—real ruby mica insulation. Fully guaranteed for capacity, insulation and voltage tests. Full particulars from

ERIC J. LEVER (TRIX) LTD.,  
8/9 Clerkenwell Green, London, E.C.1  
Phone: Clerkenwell 3014/5

TRIX Fixed Condenser



PRICES from 1/- EACH





**Try this Approval**

**The "RADIOLA"**

Just imagine how striking your Wireless Set will look housed in one of these handsome Bureaux. How your friends will admire it, what pride of possession you will experience! The RADIOLA is a Wireless Cabinet, Writing Bureau, Gramophone Record Storage Cabinet and a beautiful article of furniture, too. Over 3,000 delighted users have bought RADIOLAS through the post at makers' prices, the lowest you can pay. Why not you? Write for one on 7 days free trial (money back if unsatisfied) delivered carriage paid to your home.

As used by Radio Press for "2 DA," "Big Ben," by Percy Harris, "Binowave 4" by W. James, etc. See Jan. "W.M." p. 528.

'Phone: Bexleyheath 194

from **75/-**

Do this NOW! Write for illustrated price lists of all models in oak and mahogany to the makers:

**PICKETT'S**  
Wireless Cabinets  
W1 MAG WORKS BEXLEY HEATH N. LONDON



**NEVER SAY DIE!**

**UP MAN AND TRY**

**FLUXITE**  
- IT SIMPLIFIES ALL SOLDERING

FLUXITE is sold in tins, price 8d., 1/4 and 2/8. Another use for Fluxite: Hardening Tools and Case Hardening.

**SOLDERING SET Complete** 7/6  
or LAMP only 2/6

Ask for leaflet on improved methods.

**FLUXITE LTD.,**  
(Dept. 332)  
Rotherhithe, S.E.16.



**EFFICIENCY — RECOGNISED**

**BECOL**

**EBONITE PANELS**  
for

MULLARD MASTER PORTABLE FIVE SIX-SIXTY MYSTERY RECEIVER  
INCEPTOR THREE ("Wireless Magazine")  
THE TOUCHSTONE ("Wireless Magazine")  
BINOWAVE FOUR ("Wireless Magazine")

**GUARANTEED. READY FOR USE. LOOK FOR TRADE-MARK.**

Write for BECOL handbook on Wireless Circuits giving general data and illustrations of windings. Price 4d. Post Free.

**SOLE MAKERS:**  
**THE BRITISH EBONITE CO. LTD.**  
HANWELL, LONDON, W.7

**GRADUAL PAYMENT**  
on all Wireless & Gramophone Goods

Why wait—take advantage of our scheme of gradual payments. You can have gramophone or wireless goods to the value of £5 or over without financial worry or embarrassment.

**AN EXAMPLE**

£5 worth of goods supplied on DEPOSIT OF **20/-** and 9/- per month for 10 months.

**COSSOR MELODY KITS.**  
£7 : 15 : 0 Cash, or 31/- deposit and 12/5 per month for 10 months.

**MAGNAVOX MOVING-COIL SPEAKER.**  
£8 : 5 : 0 Cash, or 33/- deposit and 13/3 per month for 10 months.

ANY GRAMOPHONE, WIRELESS SET, SPEAKER, RECORDS OR COMPONENTS SUPPLIED ON THE SAME TERMS.

Please write for full details.

**For the Best in Radio**

**WILL DAY LTD.**  
(THE BEST IN THE WEST)  
19 LISLE STREET, LEICESTER SQUARE, LONDON, W.C.2.  
Telephone: (2 lines) Regent 0921 and 0922 Telegams: Will Day, London

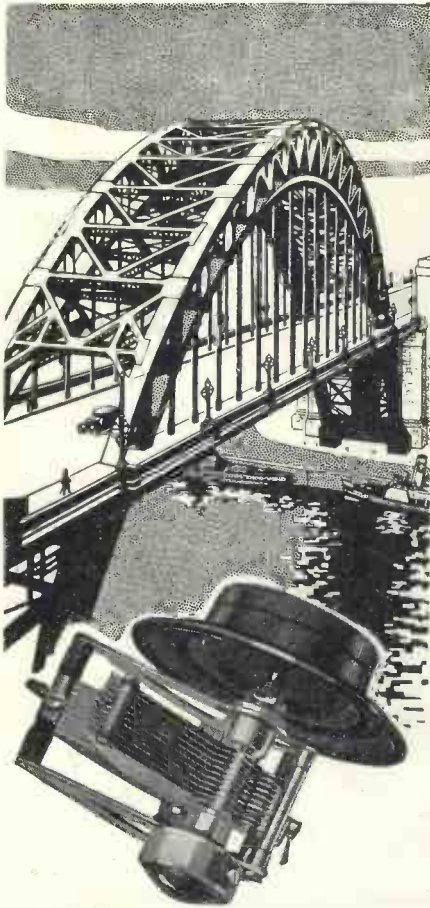

## ENGINEERING PRECISION

Bestriding the Tyne like a Colossus, this inspiring new bridge leaps the great waterway in one span, a perfect example to Newcastle—and indeed the world—of the skill and precision to be found in twentieth-century engineering.

No less worthy examples of craftsmanship are to be found in the products of J.B. Infinite care and accuracy, and a flair for turning a good design into a perfect one have raised J.B. precision instruments to an unassailable position of good repute.

The J.B. New Type Slow Motion Condenser (Ratio 40-1) is really a wonderful job. The height of the Vernier Knob and Dial is less than that of last year's model, but the new arrangement provides remarkably convenient control, and is vastly improved in appearance. Completely enclosed in dustproof mechanism—a real protection from accidental damage. Tension of friction mechanism adjustable. Absolutely silent on short waves. Every possible precaution has been taken to prevent wear.

Prices :  
S.L.F.  
.0005 14/6  
.00035 13/6  
.00025 13/-  
.00015 13/-



Prices :  
LOG.  
.0005 14/6  
.0003 13/6  
.00025 13/-  
.00015 13/-

## PRECISION INSTRUMENTS

Advt. of Jackson Brothers, 72, St. Thomas' Street London, S.E.1. Telephone : Hob 1837.

# "Wireless Magazine" REFERENCE SHEETS



Compiled by J. H. REYNER, B.Sc., A.M.I.E.E.

Month by month these sheets can be cut out and filed—either in a loose-leaf folder or on cards—for reference. The sequence of filing is

a matter for personal choice. In a short time the amateur will be able to compile for himself a valuable reference book.

### WIRELESS MAGAZINE Reference Sheet

No. 111

## Inductance, Variation with A.C.

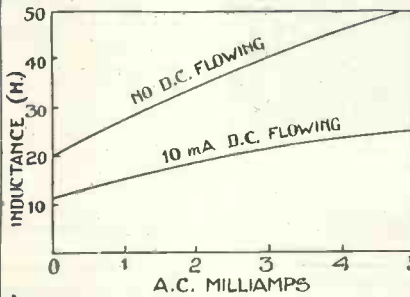

Variation of inductance with various values of A.C.

IRON-CORED inductances may often appear to have widely differing values of inductance according to the conditions under which they are measured. The ordinary saturation effect due to the passage of direct current through the winding, or an associated winding on the same core, is well known. It is not always appreciated that the inductance is dependent

to some extent upon the alternating current flowing through the winding.

This, however, must obviously be the case. The reason for the variation of inductance with D.C. is that the permeability of the iron varies in accordance with the state of magnetisation of the iron. Given any steady state of magnetisation, the super position of alternating currents through the winding will produce a variation in the steady condition unless the current used is negligibly small.

Where bridge methods of measurement are employed this condition is complied with, but if measurement is made by passing current through the choke and measuring the voltage drop or by some similar method, usually carried out at power frequencies (40 to 100 cycles per second), then the A.C. is not negligible and exercises considerable effect upon the magnetisation of the iron. This results in a change in the inductance depending upon the strength of the alternating current.

The value of inductance with 1 milliampere A.C. may be as much as 20 or 30 per cent. higher than with a negligible alternating component and further values of A.C. cause corresponding increase. An actual curve showing the variation of inductance in a particular instance is shown in the diagram.

### WIRELESS MAGAZINE Reference Sheet

No. 112

## Condensers, Testing Voltage of

THE choice of a condenser in an eliminator circuit is often a somewhat arbitrary matter. The normal working voltage on the eliminator is no real guide to the voltage which the condenser may be called upon to withstand. It is necessary to allow a large factor of safety to take account of certain peak values of voltage which may result in a break-down on the condenser.

Such break-down, if serious and prolonged, will result in a heavy current passing through portions of the apparatus which were not designed for such current and serious damage may result.

A condenser is always tested at a much higher voltage than the working value. In general, a condenser should be tested at a maximum voltage equal to twice the estimated maximum working voltage. Thus, a condenser in a circuit which will not have to stand more than 300 volts under maximum conditions should be tested on 600 volts D.C.

In some cases, condensers are tested on A.C. and in the case just considered a test on 500 volts A.C. would be satisfactory. This is because the value of 500 is the root-mean-square voltage which is an average value and the maximum value of the voltage rises considerably above this. With a pure sine wave, the maximum or

peak voltage is 1.4 times the R.M.S. or nominal value. Thus, a condenser rated at 500 volts A.C. test has actually withstood 700 volts peak voltage.

Even the precaution of doubling the voltage to allow a factor of safety is not always satisfactory. When the current is suddenly switched off, we have a closed circuit formed by the smoothing choke, the smoothing condenser and the reservoir condenser in series. The sudden breaking of the current through the choke sets up a very large voltage which is applied across the two condensers in series.

With a 50-henry choke carrying, say, 20 milliamperes, the instantaneous voltage developed may be as much as 1,000 volts, so that each of the two condensers has to stand 500 volts. If the eliminator is still connected to the mains, the reservoir condenser has, in addition, its normal working voltage at no-load (this in itself being considerably higher than the normal).

It is thus quite possible to have a voltage of 700 to 800 volts across the reservoir condenser in quite a small eliminator and to allow for this a condenser tested at 1,000 volts D.C. at least should be employed.



WIRELESS MAGAZINE Reference Sheet

No. 113

Grid Condenser Values

THE grid rectifier is not satisfactory for strong signals, but provided the values of condenser and resistance are correctly chosen, the method is satisfactory for weak signals and has the advantage of being efficient and simple. The principal cause of distortion lies in the fact that the impedance of the condenser and leak combination is not constant, but varies with frequency.

For distortionless reception one condition, therefore, is obviously that the impedance of the grid network shall be as constant as possible over the working range, which under normal circumstances is, say, 50 cycles to 5,000 cycles.

The grid network consists of the condenser in parallel with a resistance, this resistance being made up of the grid leak and the resistance of the grid-to-filament path of the valve in parallel.

The impedance of this combination to audio-frequency currents falls off rapidly above a critical frequency given by  $f = 0.71 \frac{R+r}{CkR}$ , where

C=grid condenser capacity (microfarads), R=

grid-leak resistance (megohms), r=resistance of grid-filament path of valve (megohms), and f=frequency of current.

In this expression C and R are under the control of the designer, while r depends upon the working point adopted on the grid of the detector valve, and this is again to some extent under the control of the designer. The more positive the grid is made the less becomes the resistance of the grid to filament path. Some representative values will be found in Sheet No. 114.

It is interesting to note that if the grid return is connected to L.T.—, the resistance of the grid to filament path becomes practically infinite. In this case, it will be found that the critical frequency occurs at about 250 cycles with ordinary values, indicating that heavy distortion will result with considerable loss of the high notes.

This is found to be the case in practice, it being well known that the connection of the grid return to L.T.— gives rise to distortion.

(For further information on this subject see Sheets Nos. 1 and 44.)

THERE MUST BE A REASON—

WHY CELESTION IS THE MOST POPULAR LOUD-SPEAKER AMONG THE MANY THOUSANDS OF LISTENERS - IN.

IT IS RECOGNISED

as the one Loud-speaker which shows you just how good Broadcasting really is.

BRITISH THROUGHOUT Models from £5 10 0. Made under Licence. Insist on your Dealer demonstrating, or call at our Showrooms, one minute from Victoria Station, where you can also hear the finest sets. Write for new illustrated Booklet "K".

CELESTION, LTD., KINGSTON-ON-THAMES

SHOWROOMS: 106, VICTORIA STREET, LONDON S.W.1:

CELESTION

THE VERY SOUL OF MUSIC



WHEN A BETTER LOUD-SPEAKER IS MADE—CELESTION WILL MAKE IT.

WIRELESS MAGAZINE Reference Sheet

No. 114

Grid Current in Detector Valves

IT is well known that with the customary cumulative grid rectifier used in the majority of simple receiving sets, appreciable current flows between the grid and filament of the valve. This current is, indeed, essential for the rectifying action, and in consequence thereof the resistance of the path between the grid and filament is not very high, as in the case of a normal valve, but is comparatively low.

It is useful to have an idea of the approximate order of this resistance under different practical conditions, this knowledge being necessary in estimating the correct proportion of capacity and resistance to use in the rectifying circuits, as explained in Sheet No. 113.

It is also of use in estimating the damping introduced into the tuned circuit associated with the detector valve. From the knowledge of this resistance the best proportions of detector circuit can often be arranged.

The figures given in the table following give the approximate resistances of representative 2-volt valves in use to-day under actual working conditions. The grid of the valve was connected through a 2-megohm leak to the potentials quoted in the table and the grid current noted.

The resistance of the valve between grid and filament was estimated from these figures by reference to the grid-current characteristic.

The figures given refer to the average of several characteristics taken on a number of corresponding types of different makes. It will be observed that the resistance is less for R.C. valves than for H.F. valves. This means better quality (other things being equal), but heavier damping.

Type of Valve.	Potential of grid, connected through 2-megohm leak.	Resistance of grid-filament path (ohms)
H.F. (2 volt)	2.0	250,000
	1.5	290,000
	1.0	400,000
	0.5	800,000
R.C. (2 volt)	2.0	125,000
	1.5	180,000
	1.0	280,000
	0.5	450,000

WIRELESS MAGAZINE Reference Sheet

No. 115

Inductance, Approximate Formula for

IT is often useful to be able to estimate the approximate inductance of a coil without recourse to particularly accurate methods. Moreover, it often happens that the facilities for the accurate methods are not present, since such formulae involve the use of correction factors depending upon the shape of the coil.

In such circumstances, a simple formula which will give the inductance to a fair degree of accuracy within, say, 10 per cent., and which contains all the terms necessary, is of distinct value.

Such a formula must, of necessity, be empirical, being based upon the results of practical tests, assisted by theoretical considerations. Such a formula is the one given herewith, which is of considerable use in obtaining rough-and-ready estimates of the inductance of any coil which is actually in being or is to be designed. The formula, which gives the inductance directly in microhenries, is as follows. All dimensions are in inches.

$$L = \frac{0.2n^2D^2}{3.5D+8l} \times \frac{D-2.25d}{D}$$

where D=outside diameter of coil.  
l=length of coil.  
d=depth of winding (in a multilayer coil).  
n=number of turns.

Where a single-layer coil is being considered, the first portion of the formula only is used. The second term of the formula is a correcting factor, allowing for the depth of winding where a multilayer coil is being considered.

The significance of the various dimensions quoted in the formula will easily be seen by reference to the diagram accompanying this sheet.

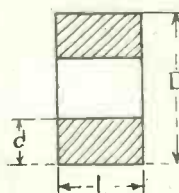

### KIT'S OF PARTS FOR ALL CIRCUITS

Send Detailed List for Keen Quotations  
HANDSOME OAK POLISHED SPEAKER CABINETS



13 x 13 x 6  
**12/11**  
Post 1/8  
**BLUE SPOT UNIT 66K (101)**  
**25/-**  
BALANCED ARMATURE OR THE LOT WITH BUCKRAM CONE. 12"  
**35/-**  
Carriage Paid

Similar to above but cannot guarantee exact pattern of front panel but all good designs

**SQUIRE CONE KIT** comprising KRAFT Diaphragm, CARD Ring and Segments Aluminium Cradle Frame; ready to use (post free) Complete Lot 15/- (Plywod Clamping Washer Free)

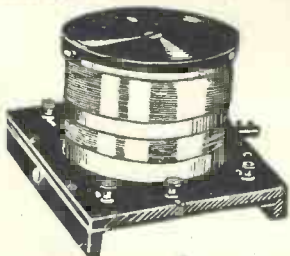

### Q COILS

QA 15/- QSP 21/- QAM 21/- QSG 21/- QAR 21/- BINOWAVE (W. James) 25/- pr. LEWCOS OR FINSTON

### SIMPLE SCREEN 3

W. Mag., March, 1929. COMPONENTS: 2 Ormond .0005, 12/-; .0001 Reaction, 4/-; 15-ohm Rheostat, 2/6; 3 Spring V. Holders, 3/9; QA Coil, 15/-; QSG Coil, 21/-; Dubilier 1-mfd., 2/6; Formo Type "J", 2/-; Fixed Potentiometer, 2/-; .0003 and 2-meg., 5/-; .0001 Fixed, 1/6; L.F. (R.L. & Varley), 15/-.  
**TOTAL £4 6 3 (Post Free).**  
For 2/6 extra with parts 1 will include: G.B. Clips, 9 Engraved Terminals, 2 Strips, 3 x 2 and 8 x 2, Copper Screen, Ebonite Panel 18 x 7, Screws, Wire, etc.

**COSSOR NEW MELODY** Special Offer 250/600 B.B.C. 8/6 per pair Long Wave 9/6 per pair. POST 1/- pair.  
**PLUG-IN COILS ACCURATELY WOUND HIGHEST QUALITY D.S.C. WIRE TESTED**

**COUPON No. 60**  
ONLY ONE COUPON ON ANY ONE ORDER

If you spend 25/- or more you can buy for 3d. extra any one (only) of the following: S.M. Dial, 100 ft. 7/22 Copper Aerial, 12 yds. Lead-in, Fuse and Holder, 12 Nickel Terminals, 60X Coil, H.F. Choke, Permanent Detector, Battery Switch, .0003 and 2-meg. Leak, 9-volt Grid Bias, Panel Brackets, 6-pin Coil Base, 100 ft. Insulated Aerial, Loud Speaker Silk Cord, 30 ft. Covered Connecting Wire, Ebonite panel, 9 x 8. 12 yds. Twin Flex. 100 ft. indoor Aerial, Cycle Rear Reflector.  
See Advt. in all Wireless Journals.

## K. RAYMOND

27 & 28a, LISLE ST., LONDON, W.C.2  
Come to LEICESTER SQUARE TUBE.

This address is at the back of Daly's Theatre Phones: Gerrard 4637 and 2821

**HOURS OF BUSINESS**  
EVERY DAY 9 to 4  
SATURDAY 9 to 9  
SUN. MORN. 11 to 1

**C.O.D.** Orders sent by return where possible. Send order, PAY POSTMAN.

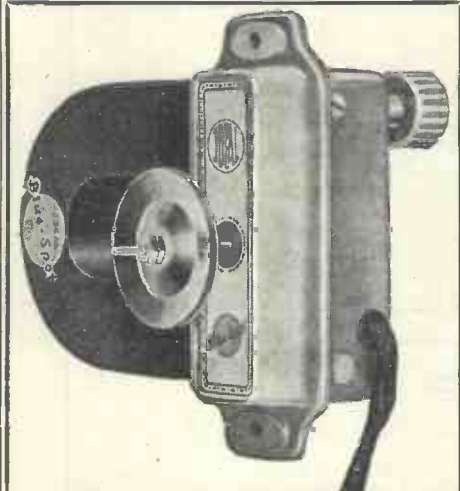

**BLUE SPOT 66K (101)**  
Adjustable Power Model 4 Pole Bal. Armature  
THE WORLD'S BEST UNIT.  
POST FREE **25/-**

**LISSEN**  
Valve Holders, 1/-; Fixed Condensers, 1/-; 1/6; Leaks, 1/-; Switches 1/6, 2/6; Latest 2-way Cam. Vernier, 4/6; Rheostats, 2/6; B.B., 1/6; Lissenola, 13/6; L.F. Transformers, 8/6; Coils, 60X, 6/4; 250X, 9/9; 60-v. H.T., 7/11; 100-v., 12/11; Super 60-v., 13/6; Grid Bias, 1/6; 4.5, 5d.; Super L.F., 19/-; Variable .0003, 6/-; .0005, 6/6.

A.W., P.W., M.W. **STANDARD LOADING COILS, 7/6**  
C.O.D. extra.  
MAGNUM, LEWCOS.

**TRITRON VALVES**  
always in stock

140-pp. Catalogue illustrated all latest Components **3d.**

**LOUD SPEAKERS**  
Amplion, B.T.H., Celestion, M.F.A., and all good makes.

Wates' Combined Volt, Amp. & Milliamperemeter **8/6**

**IF IT'S WIRELESS**  
We have it!

Copper and Aluminium Screens (all sizes) made to order.  
P.W. Screening Boxes .. 12/6 Scott's All-Wave Tuner .. 13/6  
P.W. Loading Coils .. 7/6 DX Set 4 Short Wave .. 7/6  
Harlie Wave Selector .. 12/6 DX L.F. Standard Ratio .. 8/-  
Tunewell Dual 3 Star .. 7/9 Wello L.F. Power .. 11/6  
Combined Wave Q 3 Star.. 12/6 Wello Standard .. 8/6

**ORMOND**  
S.M. Drum Dial, 5/-; Rheostats, 6, 15, 30 ohm, 2/-; Midget .0001 max., 4/-; Log. .0005 and 4in. Dial, 6/-; Log. .0003 and 4in. Dial, 6/9. S.L.F. No. 3 same price. We always stock all ORMOND PARTS.

**P.R. VALVES STOCKED**

**OSRAM MUSIC MAGNET**  
Kit of Parts and Valves.  
£8 : 12 : 6  
BOOKLET FREE.

### SPECIAL COUPON

Only available at K. Raymond's. POST or CALL with this coupon. If your order is £3 or over, FOR 6d. EXTRA you can buy one of the following. State which required.

2-mtd. Mansbridge Condensers; .0005 S.L.F. Variable Condenser; 4-in. Slow-Motion Dial; 100 ft. Silk Frame Aerial Wire; .0001 Reaction Condenser; 16-volt Grid Bias tapped 1/4.  
12 yds. heavy double rubber Lead in; 5-way Battery Cord for H.T. and L.T.; 10 Engraved Terminals (take plug or spade); State names required.

**Don't Forget the Coupon**

## Broadcast Music of the Month

(Continued from page 172).

One interesting series, "The Future of the Cinema," has proved particularly attractive, probably by reason that men of world-wide experience have been the exponents.

Maurice Elvy has produced more films than dreamt of in our philosophy. He has produced all over the world, and for every big British and American company; it would be hard to find one more qualified to speak on the subject. Sidney Bernstein, founder of the Film Society, and the Hon. Ivor Montague, actively engaged in making films, may be considered equally *au fait*.

Singers must always abound, and the number is so great that it is impossible to make but a very small choice.

### B.N.O.C. Singers

One is always glad to hear any members of the B.N.O.C., for these artists have long realised the significance of the microphone. Four famous names occur to one directly—those of Miriam Licette, Trefor Jones, and Joseph Farrington, who sang from Cardiff with the choir and National Orchestra of Wales, and Bernard Ross, one of the best of the younger school of singing.

The work, also, of Leonard Gowing, Gwladys Naish, the "Welsh Nightingale," Megan Thomas, and Herbert Heyner is too well known to need detailed comment.

Many singers from the provincial stations have been heard, too, through 5GB. Harry Sennett, Vera Gilman, Dorothy Daniels, William Pegg, Louise Martin, Lucia Rogers, John Armstrong, and Astra Desmond—all have been heard recently to good advantage. One would like to hear more popular music and less of foreign composers amongst our own vocalists.

### For Amusement Only

In some programmes, the items might be labelled "for amusement only." Most listeners welcome The Roosters, who appeared again on February 8. This veteran concert party, the only real military concert party that has survived the passage of time, contrives to make its turns thoroughly up-to-date and yet does not lose its semi-military character. Most listeners will say "Carry on, Roosters."



**THE 100% Broadcast Receiver**  
 BUILD and OPERATE in ONE EVENING  
 FORMO Screened Grid

**FAMOUS FORMO COMPONENTS** as used in this Set and in ALL NOTABLE Published CIRCUITS



**BRITISH Components Throughout**  
 SEND FOR CATALOGUE.

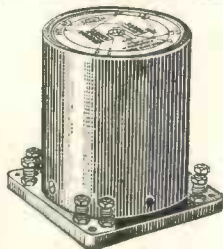

**TRANSFORMER-OUTPUT FILTER CHOKE**  
 25/-

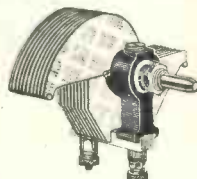

"1928" LUG CONDENSER 5/-  
 '0005 '00035 '00025



"DE LUXE" MODEL COILS SG 1 & 2  
 '0005 6/- '00035 10/6 each  
 '00025 '00015

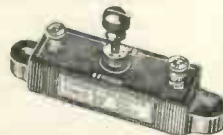

**FORMO-DENSOR 2/-**  
 In four variable capacities

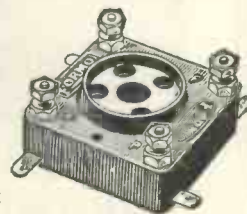

**VALVE HOLDER 1/3**

THE FORMO CO., CROWN WORKS, CRICKLEWOOD LANE, LONDON, N.W. 2

**Northern Radio Co.**  
 THE PREMIER SET BUILDERS

THE "LODESTONE THREE"

	£	s.	d.
Ebonite Panel, 16 in. x 8 in.		7	6
2 .0005 Variable Condensers (with slow-motion dials) at 10/-	1	0	0
1 Lewcos "Lodestone" Aerial Coil		15	0
1 Lewcos "Lodestone" H.F. Transformer		15	0
1 12-ohm Panel Rheostat		2	0
3 Lotus Valve Holders		3	9
1 Gambrelli Neutrovermier		5	6
1 2-mfd. Dubilier Condenser		3	6
1 Ferranti A.F.3 Transformer	1	5	0
1 Terminal Strip, 16 in. x 2 in.		2	0
10 Indicating Terminals		2	6
1 Siemens 1 1/2-volt "T" Battery		1	6
1 Cabinet (Pickett)	1	2	6
2 Wander Plugs			6
Flex, stiff Wire, Screws, etc.		1	3
<b>Total</b>	<b>£6</b>	<b>7</b>	<b>6</b>
Marconi Royalty		10	0
Set completely wired up, aerial tested and guaranteed	<b>£6</b>	<b>17</b>	<b>6</b>

THE "SIGNAL BOOSTER"

Complete set of parts (list on application)	£3	5	9
Marconi Royalty		5	0
Unit completely wired up and aerial tested	£3	10	9

We wire up free of charge, any set described in the technical Press if components bought from us.

THE KILOMAG FOUR (2 S.G., Det., and 1 Low). An exceptional set. £12 10s.

We specialise also in the following sets: THE COSSOR MELODY MAKER, MULLARD MASTER THREE, REYNERS' FURZE-HILL FOUR, THE MEGAVOX THREE. Quotations by return.

An Amazing Bargain: THE NORTHERN SCREENED-GRID FOUR. Marconi Royalties paid, £7.0.0.

Send your inquiries along. Special quotations for kits.

**NORTHERN RADIO CO.**  
 TEMPLE ROW, WREXHAM

**WEARITE COMPONENTS**  
 WRIGHT & WEAIRE, LTD.  
 740, High Road, TOTTENHAM, N.17.

**JAMES SPECIAL 3 Coils 25/- pair**  
**"BINOWAVE" Coils 25/- pair**  
**"Q" COILS**  
 AERIAL 15/- each S.P. H.F. 21/- each  
 REINARTZ 21/- each  
 Mullard Master 3 Star 15/- each

**WEARITE H.F. CHOKES.**  
 STANDARD 6/6  
 SHORT WAVE 4/6  
 HEAVY DUTY (ELIMINATOR) 10/6  
**DUAL RANGE TUNER W.G.2.**  
 as used in FERRANTI SETS 15/-  
 600-ohm Resistances 1/6 each  
 Telephones: Tottenham 3847 and 3848

**WIRELESS CABINETS in SOUND QUALITY of WOOD**

Highly Polished First-class Cabinet Work

MAKERS OF ALL DESIGNS FOR OLD AND NEW WIRELESS SETS AS PERIODICALLY ANNOUNCED IN THIS JOURNAL

Special line of closed cabinets totally enclosing Batteries and Accessories

Thousands of satisfied users. Send for Illustrated Price List

Money returned if quality and workmanship not equal to our guarantee

**CAXTON WOOD TURNERY CO., MARKET HARBOROUGH**



**'A CASH SAVER'  
WITH FREEDOM  
FROM TROUBLE**

Why tolerate the expense and trouble associated with Dry H.T. Batteries, and the irritating re-charging of unreliable Accumulators?

The best Dry Batteries are costing you anything from 50/- to £3 per annum. This is poor economy. The first cost of an "Atlas" Eliminator is the last, and the current consumed even on the largest Multi-Valve Set would not amount to more than 2d. per week with the Receiver in normal 5 hours daily use.

There are models for either Direct or Alternating Current to suit any Receiving Set, at prices within reach of every set owner. The model illustrated, A.C.56 for Alternating Current, has one variable Tapping of 0/100 Volts and two fixed ones of 60 and 120 Volts respectively.

This model has no Valves to burn out, a Westinghouse Patent Metal Rectifier being incorporated. Price complete £8 15s., including Royalty.

All "Atlas" Eliminators are backed by the "Atlas" Guarantee and are designed to ensure maximum safety.

Send for our beautifully illustrated Brochure, No. 32 (post free), which gives full details of all

**CLARKE'S  
ATLAS  
BATTERY  
ELIMINATORS**

Sole Manufacturers

**H. CLARKE & CO.  
(M/CR) LIMITED,  
ATLAS WORKS,  
OLD TRAFFORD,  
MANCHESTER**

**Helping the  
Inventor**

**Suggested Patent Reforms**

THE grant of patents to protect invention is now an established institution in every civilised country. Our own patent system, which dates back for more than 300 years, is the oldest, and in many respects still the most efficient, of them all.

Its recent effects, upon the wireless industry in particular, have been such, however, as to point the need for further reform if it is to keep pace with modern scientific progress.

**Representative Committee**

With the object of considering what changes could with advantage be made in the present practice the British Science Guild some time ago appointed a representative Committee, comprising distinguished scientists and lawyers, together with representatives of the leading industries.

The report of the Committee has now been published and contains the following interesting proposals:

A special short-term patent to be introduced to protect minor inventions at a lower cost to the inventor than at present. The new type of patent to be issued quickly and for a term not exceeding seven years. The ordinary or existing patent grant will still be available for inventions of more substantial importance.

**Cheapening Litigation**

Infringement cases and similar issues affecting patent rights to be heard with the consent of the parties by the Comptroller of the Patent Office. This would have the effect of cheapening patent litigation, and should help to clear up conflicting claims between patentees and manufacturers.

More assistance to be given to inventors by the Patent Office, particularly in the direction of helping them to find out how much has already been done in any given field of research.

The official search into novelty made by the Patent Office staff to be extended to cover all available text books and other technical publications.

A wider form of patent to be instituted to have effect throughout the British Empire.

**"MICROMETER-  
LIKE  
ADJUSTMENT"**

**Essential  
for  
Perfect  
Radio**



Even the most inexperienced can adjust the Gam-brell Neutrovernia with that accuracy necessary for fine working. Movement is perfectly smooth yet decisive from minimum to maximum capacity (2/38 m.m.fds.).

This, together with the fact that it functions perfectly as either a Neutralising Condenser, a Balancing Condenser or a Capacity Reaction Control, is the reason for its so frequent inclusion in receivers described in the technical press.

Two Gam-brell Neutrovernia are specified for the

**"LODESTONE"**  
by W. James. See the article in this issue.

**"NEUTROVERNIA"**  
**PRICE 5/6 EACH**

The Gam-brell Neutrovernia is a perfect Volume Control for Radio Receivers or Gramophone Pick-ups. Send for Components Booklet (A) in which this and other components are fully described.

**GAMBRELL RADIO, LTD.,  
6 Buckingham Street, Strand, W.C.2.**

**OMNORA  
LTD.  
THE SET BUILDERS SUPPLY STORES**

**Build the LODESTONE THREE  
as described in this issue.**

	£	s.	d.
1 Cabinet, 16 in. by 8 in.	1	4	0
1 Ebonite panel, ready drilled, 16 in. by 8 in.	1	7	0
2 Variable 0003 condensers with 8/10 control	1	4	0
1 Set Lodestone coils (Aerial and H.F.)	1	10	0
1 Geophone 12-ohm panel rheostat	2	9	
3 Anti-microphonic valve holders	5	3	
1 Gambrell neutralising condenser	5	6	
2 Dial indicators	3	6	
1 Dubilier 2-microfarad condenser	3	6	
1 Ferranti AF3 L.F. transformer	1	5	0
1 Terminal strip, 16 in. by 2 in. with 10 terminals	4	6	
1 Siemens 1½-volt cell, type T	1	5	
2 Wander plugs	1	6	
1 On-off switch	1	6	
Flex and connecting wire	1	6	
3 Valves	1	13	6
	<b>£8</b>	<b>10</b>	<b>0</b>

Any of the above parts supplied separately as required. The above set, ready wired and tested, including Valves and Royalty .. £10 10s.

The following can be supplied ready wired and tested or as constructional kits:—  
"Signal Booster H.F. Unit." "Fidelity Five."  
"Simple Screen Three." "Titan Three."  
"Binowave Four." "Touchstone Four."  
"Cossor Melody Maker." "Master Three Star."  
Etc., etc.

We specialise in Constructional Kits described in all the leading radio journals, also kits described by leading manufacturers.

Overseas readers will be interested in the MAGNUM UNIVERSAL THREE RECEIVER. Perfect reception from 15 metres to 2,000. Lists on application. Carriage and packing free on inland orders value £2 and over.

**OMNORA LTD.** Home Construction Specialists.  
258 NEW CROSS ROAD, LONDON, S.E.14  
Phone: New Cross 1273.



THE  
**BEST WAY**  
TO ACHIEVE  
**IDEAL RADIO RECEPTION**  
*to scrap your OLD and OUT-OF-DATE Components  
and build a set with the latest products of TECHNICAL  
SKILL.*  
OUR  
**EASY TERMS**  
*Enable you to reach this Ideal*  
ALL COMPONENTS SUPPLIED FOR MULLARD  
MASTER 3\*; COSSOR MELODY MAKER; LISSEN  
S-G-3; MASTER 6 PORTABLE, Etc.  
**EVERYTHING WIRELESS**  
PORTABLE SETS from 16 gns.—Pye, Lotus,  
Halcyon, Lissen, etc.  
H.T. UNITS from 17/6—EKCO, ATLAS, MARCONI,  
etc.  
LOUD SPEAKERS from 29/6—Celestion, Ampion,  
M.P.A., etc.  
BEST MONTHLY TERMS QUOTED BY RETURN  
**CASH ORDERS promptly executed**  
Call or send list of requirements. Hundreds of  
Satisfied Customers recommend us.  
**The P.D.P. Co., Ltd.**  
(Dept. W.M.), 121 CHEAPSIDE, London, E.C.2  
Phone: City 9846.

**SIFAM**  
**RADIO FUSE**  
completely  
**PROTECTS**  
RADIO CIRCUITS

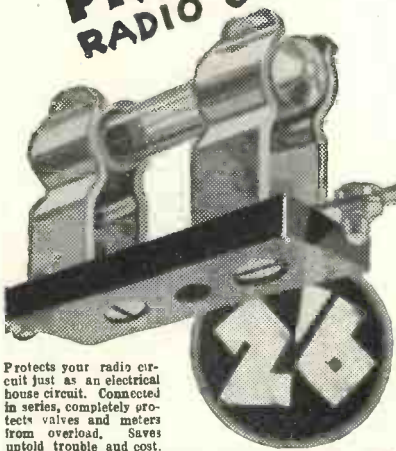

Protects your radio circuit just as an electrical house circuit. Connected in series, completely protects valves and meters from overload. Saves untold trouble and cost.  
Price, 50 up to 500 M.A. 2/6, 1.5 to 4.5 amps 2/-. Complete with clip from dealer or direct. SIFAM LTD., Dept. W.M. Bush House, 41dvy. London, W.C.2

**CLAROSTAT**  
VARIABLE RESISTANCES FOR VOLUME, TONE, DISTANT CONTROL, ELIMINATORS ETC.  
As frequently specified by "The Experts."  
• HIGH QUALITY • LOW PRICE •  
New 20 Page Brochure free on request.  
*Many unique circuits.*  
**CLAUDE LYONS LTD.**  
76, OLDHALL ST., LIVERPOOL.

**BULGIN**  
RADIO PRODUCTS

PRICE  
**2/6**  
EACH

**FILAMENT TESTER**  
Don't uncouple your Accumulator and hunt for the Voltmeter. Plug your valves in this tester and see instantly whether the filament is intact. Use an L.C. Bulb in holder.

PRICE  
**1/6**  
EACH

**SAFETY MAINS PLUG**  
No possibility of shock or short-circuiting if you use one of these fittings on your eliminator or mains receiver. Made to correct electrical specification.

PRICE  
**3/9** EACH

**PICKUP ADAPTOR**  
Suitable for use with any make of Gramophone Pickup. Arranged for alternative connections. Fitted with terminals and Nickel-plated metal parts.

**A.F. BULGIN & CO.,**  
9/10/11, CURSITOR STREET,  
CHANCERY LANE, LONDON, E.C.4  
TELEPHONE Nos.: HOLBORN 1072 & 2072

**TOUCHSTONE**  
COVER ALL WAVELENGTHS  
on this fine receiver with  
**BERCLIF COILS**  
SET OF FOUR £3-16-6  
COILS & BASES  
(Specified Coils 30/- pair)  
Made by the original EVERYMAN Specialists  
**SIMMONDS BROS.,**  
SHIRELAND ROAD, SMETHWICK  
Illustrated List Free. Trade Supplied

Write for the New  
**DARIO**  
Folder  
See Page 189

USE  
**EEX**  
**TREBLE DUTY TERMINALS**  
AND OTHER WIRELESS ACCESSORIES  
J.J. EASTICK & SONS,  
EEX HOUSE, BUNHILL ROW, LONDON, E.C.1.

**CLIX**  
The Better Terminal

**CLIX PANEL TERMINAL**  
**4<sup>D</sup>**

Better in many ways. It takes Spade, Pin, or bare wire connection quickly and gives perfect contact. Has polished insulated knob with metal inserts. The non-soldering wiring device gives excellent contact and makes assembly easier. Is highly nickel-plated and improves the appearance and performance of any receiver.

**CLIX SPADE TERMINALS**  
"Clix" Spade Terminals are far ahead of all other makes because the patented Bridge Wiring Channels and Shank Slot present the most effective and convenient means of wire attachment ever devised. Made of best brass and obtainable either nickel-plated, or lead-plated for accumulators. Red or Black Insulators. Obtainable in two sizes suited to all types of Screw Terminals.  
PRICE 2d. EACH  
*Ask your dealer or write for Clix catalogue*  
**LECTRO LINX LTD.,**  
254 Vauxhall Bridge Road,  
London, S.W.1

# The Easy Way TO PERFECT RADIO

In addition to their own extensive range, PETO SCOTT offer YOU every Known Radio Receiver or Component—all on

## EASY TERMS!

The Easy Way also is available for all kits of parts for Home construction of sets advertised by leading valve makers and publications including "Wireless Magazine" sets.

**COSSOR MELODY MAKER.** Send only 10/—, balance in 11 monthly instalments of 14/7.  
**MULLARD MASTER THREE STAR.** Send only 10/—, balance in 11 monthly payments of 15/3.

**LEADING MAKES OF H.T. ELIMINATORS** from 4/7 down, balance in 11 monthly payments of 4/7.

**ULTRA DOUBLE ACTION AIR COLUMN LOUD SPEAKER.** Send only 8/3, balance in 11 monthly payments of 8/3.

**BRANDESET THREE.** Send only 13/4, balance in 11 monthly payments of 13/4.

**PHILIPS TWO-VALVE A.C. MAINS RECEIVER.** Send only 23/—, balance in 11 monthly payments of 23/—.

**AMPLION LION LOUD SPEAKER.** Send only 11/—, balance in 11 monthly payments of 11/—.

Build your own set the Easy Way NOW! Our Catalogue contains all leading makes of Receivers, Accessories, Kits of Components for the Home Constructor.

Mail Coupon in unsalid envelope under 4d. stamp.

**PETO SCOTT CO., LTD.**

Please send me your big Illustrated Lists.

NAME .....

ADDRESS .....

W.M. 1/3

Free Demonstrations & Advice by Qualified Engineers at our Shops:—

77 CITY ROAD, LONDON, E.C.1.  
62 HIGH HOLBORN, LONDON, W.C.1.  
4 MANCHESTER ST. LIVERPOOL.  
33 WHITELOW RD., CHORLTON-CUM-HARDY, MANCHESTER.

# EPOCH MOVING COIL SPEAKERS

Full particulars from

EPOCH RADIO MANUFACTURING CO., LTD.,  
25 Laurence Pountney Ln., E.C. Phone Mansion Hs. 4683

IF YOU WANT TO KEEP  
IN TOUCH WITH THE  
LATEST DEVELOPMENTS  
WATCH THE NEW FEAT-  
URE AND NEW SERVICE  
ON PAGE 169, GET "IN  
TUNE WITH THE TRADE!"

Buy  
**AMATEUR WIRELESS**  
3d. Weekly

## English As She IS Spoke— at Oxford!

"ENGLISH As She Is *Not* Spoke!" is the subject on which I dilated at length in last month's issue of the WIRELESS MAGAZINE.

Among the letters I received regarding this was one from an "M.A. (Oxon.)" who takes violent exception to my views on broadcast English. On reading through my article again, just to make quite sure of myself, I feel that some of the criticisms are rather unjustified. I understand the Editor is publishing "M.A. (Oxon.)'s" letter as it stands.

### "M.A. (Oxon.)'s" Letter

"In common with most readers of the WIRELESS MAGAZINE, I believe Kenneth Ulyyett to be a name without significance.

"I should be obliged, therefore, if, before I assimilate his criticisms of pronunciation in general and the Oxford accent in particular—which latter, as a matter of fact, exists solely in the imagination of misguided female novelists, and Mr. Ulyyett—I might be vouchsafed answers to the following questions:

- (1) Where (if anywhere) was Mr. Ulyyett educated?
- (2) On what grounds does he appoint himself a critic of English pronunciation?
- (3) And, anyhow, why he publishes these views?

"It is quite obvious to one who has lived in Oxford for many years that his cheap sneers at the Oxford accent are bred of either (a) ignorance, (b) jealousy, or (c) both.

### Borstal or Bow

"As an Oxford man I have always refrained from holding up to ridicule the dialects of Borstal or Bow for the simple and sufficient reason that of these, I am complacently ignorant.

"Were it not for my diffidence in seeking the opinion of the immature, I might be tempted—if ever I require a closer intimacy with the above—to consult Mr. Ulyyett.

"As it is, however, I am usually content to buy my WIRELESS MAGAZINE for hints on wireless circuits, etc. Neither do I consider that magazine is improved when it diverges from its usual sphere, and embarks under the doubtful pilotage of Mr. Ulyyett, on the perilous seas of pronunciation—Oxford or otherwise.

"P.S.—Is Mr. Ulyyett's photograph edifying or necessary?"

### The Stinging Postscript

I gather that there are only four lines of my article to which "M.A. (Oxon.)" takes exception. These are "when you have heard an Oxford-educated announcer give it out that 'a concherto will now be performed by the Waaliss Orchestwah' you will agree that some sort of standard must be set for broadcast speech." If that kind of thing is *not* the Oxford accent then I must apologise.

It is the postscript which stings me! It is not my photograph!

KENNETH ULYYETT.

## DARIO

This week's best bargain

See page 189

## EVISON & PAYNE

83 Borough High St., London Bridge, S.E.1.

'Phone: Hop 1221

Can supply at once correct parts for any of the sets described in this issue. Before purchasing your parts see our price lists free, on application.

### Hear the "Lodestone Three"

Demonstrations during broadcast hours up to 7 p.m. or by appointment.

Inland: All orders post free. Abroad: Carriage paid over £5  
Cash, C.O.D., or Easy Terms

Blueprints free with each order for complete kits.  
Panels drilled free.

WIRELESS, TELEVISION & ELECTRICAL EQUIPMENT

## INDEX TO ADVERTISERS

	PAGE
Alestran Gramophone Co., Ltd.	191
Bedford Electrical & Radio Co.	193
Belling & Lee, Ltd.	194
Bird, S. S., & Sons, Ltd.	189
British Ebonite Co., Ltd.	197
British General Mfg. Co., Ltd.	109
Brown, S. G., Ltd.	183
Bulgin, A. F., & Co.	203
Burndept Wireless (1928), Ltd.	187
Cantophone Wireless Co.	193
Carlington Mfg. Co., Ltd.	194
Caxton Wood Turnery Co.	201
Celestion, Ltd.	199
Clarke, H., & Co. (M/C), Ltd.	202
Cospor, A. C., Ltd.	107, 173
Day, Will, Ltd.	197
Dubier Condenser Co. (1925), Ltd.	109
Eastick, J. J., & Sons	203
Epoch Radio Mfg. Co. Ltd.	204
Ever Ready Co. (G.B.), Ltd.	179
Evison & Payne	204
Ferranti, Ltd.	106
Fluxite, Ltd.	197
Forno Co.	201
Gambrell Radio, Ltd.	202
Garnett Whiteley & Co., Ltd.	175
Graham Farish, Ltd.	106, 193
Hobbies, Ltd.	196
Hughes, F. A., & Co., Ltd.	181
Huntly, Norman	106
Igranic Electric Co., Ltd.	181
Impex Electrical, Ltd.	189, 195, 203, 204
Jackson Bros.	198
Lectro Linx, Ltd.	203
Lets, A. W. (1929), Diary	106
Lever, Eric J. (Trix), Ltd.	195
Lewis, S. W., & Co., Ltd.	196
Lissen, Ltd.	110
London Electric Wire Co. and Smiths, Ltd.	Cover ii
Lyons, Claude, Ltd.	203
Marconiphone Co., Ltd., The	Cover iv
Morris, J. R.	195
Mullard Wireless Service Co., Ltd.	191
Northern Radio Co.	201
Omrona, Ltd.	202
Paroussi, E.	194
P.D.P. Co., Ltd.	203
Peto Scott Co., Ltd.	204
Pickett Bros.	197
Potter, H. B., & Co., Ltd.	196
Raymond, K.	200
Ready Radio Supply Co.	195
Regentone	191
R.I. & Varley, Ltd.	183
Sifam Electrical Instrument Co., Ltd.	203
Simmonds Bros.	203
Stone Mfg. Co.	193
Telegraph Condenser Co., Ltd.	177
Whiteley Boneham & Co., Ltd.	187
Wireless Pictures (1928), Ltd.	185
Wright & Weaire, Ltd.	201



# FULL-SIZE BLUEPRINTS FOR EVERY REQUIREMENT

Each blueprint shows the position of each component and every wire and makes construction a simple matter. Copies of the "Wireless Magazine" and of "Amateur Wireless" containing descriptions of all these sets can be obtained at 1s. 3d. and 4d. respectively, post free. Index letters "A.W." refer to "Amateur Wireless" sets and "W.M." to "Wireless Magazine" sets.

## CRYSTAL SETS

All these 6d. each, post free.

Two-programme Set	WM25
Centre-tap Set	WM50
Super Set	AW 64
"Best-yet" Set	AW114
1929 Crystal Receiver	AW165

## ONE-VALVE SETS

All these 1s. each, post free.

Long-range Hartley	WM54
Reflexed One for the Loud-speaker	WM66
Special One	WM116
Reinartz One	WM127
All-wave Reinartz	AW 2
Hartley DX	AW 27
Economy One	AW 71
Loud-speaker Special	AW 78
Ultra-sensitive Hartley One	AW103
Fan's Short-wave One	AW119
Super Reinartz One	AW127
Beginners' One-valve	AW140

## TWO-VALVE SETS

All these 1s. each, post free.

British Broadcast 2 (D, Trans)	WM44
Two-programme 2 (D, Trans)	WM56
Q-coil 2 (D, Trans)	WM62
Crusader (D, Trans)	WM69
Flat-dweller's 2 (HF, D)	WM76
Two-Daventry Two (D, Trans)	WM97
Tetrode Short-wave Two (SG, D)	WM99
Key-to-the-Ether Two (D, Pentode)	WM107
Meteor Two (D, Trans)	WM114
Wide-world Short-wave (D, Trans)	AW 11
Empire Short-wave	AW 28
Next Step 2 (D, Trans)	AW 34
Centre-tap 2 (D, Trans)	AW 42
Rover 2 (HF, D)	AW 53
General-purpose 2 (D, Trans)	AW 55
Yule (D, Trans)	AW 59
30/- 2 (D, Trans)	AW 61
Economical 2 (D, RC)	AW 66
Two-wave (D, Trans)	AW 83
Ultra-selective Hartley (D, Trans)	AW 90
Oceanic Short-wave (D, Trans)	AW 91
"Trapped Reinartz (D, Trans)	AW 92
"Q" 2 (D, Trans)	AW 99
Long Distance Two (HF, D)	AW110
Three-waveband Two (D, Trans)	AW112
DX Headphone Two (HF, D)	AW134
Ace of Two (D, Pentode)	AW143
Home Two (D, Trans)	AW146
Chapman-Reinartz Two (D, Trans)—4d. with copy of "W.M."	AW148
Globe DX Two (SG, D)	AW157
East to West Short-wave Two (D, Trans)	AW159
Beginner's Two (D, Trans)	AW171

## THREE-VALVE SETS

All these 1s. each, post free.

Five-guinea 3 (HF, D, Trans)	WM29
Mains Three-valve (D, 2LF)	WM34
Tuned-anode from the Mains (HF, D, LF)	WM43
Metropolitan (D, 2LF)	WM48
Everyday (D, 2 Trans)	WM52
Music Charmer (D, RC, Trans)	WM60
Britannia (D, RC, Trans)	WM67
Pole-to-Pole Short-wave (D, RC, Trans)	WM89
Glee-singer Three (D, 2 RC)	WM92
Aladdin Three (HF, D, LF)	WM95
Inceptor Three (SG, D, Pentode) Price 1s. 3d. with copy of "W.M."	WM105
All-wave Screened-grid Three (HF, D, Pentode)	WM110
Gramophone Three (D, 2RC)	WM115

A blueprint of any one set described in the current issue of the "Wireless Magazine" can be obtained for half-price up to the date indicated on the coupon (which is always to be found on page iii of the cover) if this is sent when application is made. These blueprints are marked with an asterisk (\*) in the above list and are printed in bold type. An extension of time will be made in the case of overseas readers.

Standard Coil Three (HF, D, Trans)	WM117
Festival Three (D, 2 LF-Dual Imp)	WM118
Wide-world Short-wave (SG, D, 1 Trans)	WM120
New Year Three (SG, D, Pentode)	WM123
The Q3 (D, RC, Trans)	WM124
*Lodestone Three (HF, D, Trans)	WM129
*Simple Screen Three (HF, D, Trans)	WM131
Split-primary (HF, D, Trans)	AW 24
Modern Tuned-anode (HF, D, Trans)	AW 35
Tetrode 3 (HF, D, Trans)	AW 36
Special (D, 2LF)	AW 44
Economy 3 (D, 2RC)	AW 48
Short-wave (D, RC, Trans)	AW 50
Ether-searcher (D, RC, Trans)	AW 52
Standard (D, 2 Trans)	AW 56
Hartley DX (D, RC, Trans)	AW 63
Broadcast 3 (D, RC, Trans)	AW 76
Selectus 3 (HF, D, Trans)	AW 81
Q-coil 3 (D, RC, Trans)	AW 84
Clarion 3 (D, 2 Trans)	AW 88
Miniature Hartley Three	AW101
Summer-time DX Three (HF, D, Trans)	AW106
Three-valve Mains Receiver (HF, D, Trans)	AW109

British Station Three (HF, D, Trans)	AW122
Optional Two-three (D, 2LF)	AW124
"Simpler Wireless" Mains Three (D, 2LF)	AW126
Simplicity Screen-grid Three (HF, D, Trans)	AW132
"Proms" Three (D, 2 RC)	AW137
Adaptable Three (D, 2 Trans)	AW139
New-style Baffle Three (D, RC, Push-pull)—Price 1/6	AW141
All-wave Mains Three (HF, D, Trans, Rectifier)—Price 1/6	AW144
All-purpose Short-wave Three (D, RC, Trans)	AW147
Screen-grid Q-Coil Three (HF, D, Trans)	AW150
New-style Mains Three (HF, D, Trans)—Price 1/6	AW151
All-Round Three (D, RC, Trans)	AW155
James Special Three (HF, D, Trans)	AW156
All Britain Three (HF, D, Trans)	AW158
Bantam Three (D, RC, Trans)	AW160
Hartley Dual-range Three (D, RC, Trans)	AW166
Listener's Three (HF, D, Trans) Price 4d. free with copy of "A.W."	AW169

## FOUR-VALVE SETS

All these 1s. 6d. each, post free.

Revelation (HF, D, RC, Trans)	WM24
Simplicity (HF, D, 2 Trans)	WM49
Astral (HF, D, 2 RC)	WM53
Trapped 3-4 (D, 2RC Paralleled)	WM61
Gramo-Radio 4 (D, RC, 2 Trans Push-pull)	WM70
Q-coil 4 (HF, D, Trans, RC)	WM71
Screened grid 4 (HF, D, 2RC)	WM77
Five-pounder Four (HF, D, RC, Trans)	WM91
Frame-aerial Four (HF, D, 2RC)	WM85
Touchstone (HF, D, RC, Trans)	WM109
Reynier's Furzehill Four (SG, D, 2 Trans)	WM112
Economy Screen-grid Four (SG, D, RC, Trans)	WM113
Binowave Four (SG, D, RC, Trans)	WM119
Standard-coil Four (HF, D, 2RC)	WM122
All-purpose 4 (HF, D, RC, Trans)	AW 43
Special 4 (HF, D, 2LF)	AW 70
"Q" 4 (HF, D, RC)	AW 98
Explorer Four (HF, D, RC, Trans)	AW120
Summertime Searcher (2HF, D, Trans)	AW128
Overseas Shortwave (HF, D, 2 Trans)	AW133
Ranger Four (SG, D, RC, Trans)	AW145
Facility Four (HF, D, 2 RC—Q-coil)	AW154
Broadcast Picture Four (HF, D, 2RC)	AW163
The Orchestra Four (D, RC, Push-pull)	AW167

## FIVE-VALVE SETS

All these 1s. 6d. each, post free.

Exhibition 5 (2HF, D, RC, Trans)	WM33
Phoenix (2HF, D, 2LF)	WM42
1928 Five (2HF, D, 2 Trans)	WM46
All-the-world 5 (2HF, D, 2RC)	WM63
Cataract 5 (HF, D, RC, Push-pull)	WM79
Empire Five (2SG, D, RC, Trans)	WM96
Individual 5 (2HF, D, 2 Trans)	AW 25
School 5 (HF, D, 2RC)	AW 85
"Q" Gang-control Five (2HF, D, 2Trans)	AW161

## SIX-VALVE SETS

1s. 6d. each, post free.

Nomad (2HF, D, RC, Push-pull, Trans)	WM31
Connoisseur's Six (2HF, D, RC, Push-pull)	WM88

Eagle Six (3HF, D, RC, Trans)	WM106
Short-wave Super-6 (Super-het, Trans)	AW 67
Adaptor for above (see miscellaneous list)	AW67a

## SEVEN-VALVE SETS

1s. 6d., post free.

Simpladyne (Super-het)	WM22
------------------------	------

## PORTABLE SETS

	Price	Post Free
Springtime 2 (D, Trans)	WM12	1/-
Countryside 4 (HF, D, 2 Trans)	WM17	1/6
Chummy 4 (1HF, D, RC, Trans)	WM80	1/6
Chummy 4 (with modification for LS and HT)	WM 80a	1/6
Pilgrim Portable (D, Trans)	WM 94	1/6
1 Holiday 3 (D, 2 Trans)	AW 32	1/-
Table Grand 4 (HF, D, 2RC)	AW 93	1/6
Attaché Portable 2 (HF, D)	AW 96	1/6
Daventry Portable (D, Trans)	AW 105	1/-
Daventry Loud-speaker Portable (2HF, D, RC, Trans)	AW 107	1/6
Town and Country (HF, D, RC, Trans)	AW 111	1/6
House and Garden (SG, HF, D, RC, Trans)	AW 116	1/6
"Best-yet" Portable (SG, D, 2 Trans)	AW136	1/6
House Portable (SG, D, RC, Trans)	AW168	1/6

## AMPLIFIERS

All these 1s. each, post free

True-tone Amplifier (3 valves)	WM47
Gramo-radio Amplifier (2 v.)	WM72
Super-power Unit (2 v.)	WM103
*Signal Booster (H.F. Unit)	WM128
One-valve DX Unit	AW 37
Utility (RC, Trans)	AW 68
Screened-grid HF Unit	AW 75
One-valve L <sup>1</sup> Unit	AW 79
Super-power Push-pull	AW 86
Hook on Short-waver	AW104
Purity-Amplifier	AW108
Add-on Distance-getter	AW117
Screened-grid HF Amplifier	AW138
"A.W." Gramophone Amplifier (3RC)	AW162

## MISCELLANEOUS

	Price	Post Free
A.C. Mains Eliminator	WM41	1/-
Cone Loud-speaker	WM55	1/-
A.C. Adaptor for "Simpler Wireless" Sets	WM57	1/-
Moving-coil Loud-speaker	WM58	1/-
D.C. Mains Eliminator	WM59	1/-
Wavetrap	WM64	1/-
Portable Cone Loud-speaker	WM73	1/-
"Junior" Moving-coil Loud-speaker	WM81	1/-
Universal Short-wave Adaptor	WM82	1/-
Linen-diaphragm Loud-speaker	WM90	1/-
Valveless A.C. Power Unit for L.T.	WM100	-/6
Valveless A.C. Power Unit for H.T.	WM101	-/6
Simple Cone	WM111	1/-
Buzzer Wavemeter	WM121	-/6
James H.T. Unit for A.C. Mains	WM125	1/-
Lodestone Loud-speaker	WM126	1/-
Heterodyne Wavemeter	AW 7	1/-
Rectifying Unit for "Simpler Wireless" Sets	AW 62	1/-
Adaptor for Short-wave Super 6	AW 67a	-/6
H.T. from A.C. Mains	AW 73	1/-
"AW" Moving-coil Loud-speaker	AW 97	1/-
H.T. Eliminator for A.C. (200 v. output)	AW 102	1/-
L.T. and H.T. Mains Unit (DC)	AW 123	1/-
Knife-edge Wavetrap	AW 131	-/6
All-metal Eliminator for H.T.	AW 135	1/-
Duplex-diaphragm Loud-speaker	AW 142	1/-
Power-plus Loud-speaker	AW149	1/-
Linen-diaphragm Loud-speaker with Baffle	AW152	1/-
Pedestal Cone Loud-speaker	AW164	1/-
Listener's Speaker, price 4d. with copy of "A.W."	AW170	0/4

Send, preferably, a postal order (stamps over sixpence in value unacceptable) to

## Wireless Magazine

Blueprint Dept., 58/61 Fetter Lane - E.C.4

Half-price **BLUEPRINT** Coupon Valid until March 31, 1929  
FOR ANY ONE SET CONSTRUCTIONALLY DESCRIBED IN THIS ISSUE.

Fee of **INFORMATION** Coupon Valid until March 31, 1929  
NOT MORE THAN TWO QUESTIONS TO BE ASKED AT A TIME

# MARCONIPHONES TRANSFORMERS



Marconiphone Universal Transformer

The Marconiphone Universal Transformer, with its even, distortionless amplification, emphatically leads the way in the class of moderately priced transformers. Properly used, it will give results usually associated with much more expensive models. Its windings are thoroughly insulated, and rendered safe from moisture. Its generous cross section, together with high quality iron, prevents any saturation of the core. It is provided with full-sized terminals and reversible feet, and can be mounted in any convenient position.

Two ratios are available: 2.7 to 1 and 4 to 1. Price, either type, 16/-.

**"Popular" Transformer.**—An inexpensive but efficient little instrument suitable for small receivers or portable sets. Price 12/6.

## MARCONIPHONE POWER UNITS

A generous smooth-flowing stream of power is transmitted from the nearest lighting socket. The touch of a switch provides at all times an economical current supply sufficient for every requirement.

**All-Power Units for supplying H.T. and L.T.**

**Model A.C.4, All-Power Unit for A.C. Mains.**—

With power supply costs only 2d. per week. Model B.1153 for 100-125 volts, and 200-250 volts, 40 cycles and over. Price, including valve and royalty, £4 15s.

**Model D.C.4, All-Power Unit for D.C. Mains.**—

Entails little or no alteration to existing circuits.

Model B.1154 for 200-250 volts. £5 5s.

## H.T. SUPPLY UNITS

**Model A.C.2 for A.C. Mains.**—Supplies H.T. to receivers of almost any type. Output 40 milliamperes at 120 volts. Two models available for 100-125 and 200-250 volts. Price, including U.5 valve, £6 10s.

**Model D.C.2 for D.C. Mains.**—Output 50 milliamperes at 120 volts. Tappings at 42 and 84 volts.

Suitable for use on 100-250 volt mains. £4 2s. 6d.

**For One- or Two-valve Receivers, Models A.C.3 and D.C.3.**—Model A.C.3 for A.C. mains, for 100-125 or 200-250 volts. Complete with valve and royalty, 70s. Model D.C.3 for D.C. mains, for 100-125 or 200-250 volts. Price 35s.

Write for Catalogue. No. 453, mentioning WIRELESS MAGAZINE.

## THE MARCONIPHONE CO. LTD.

(Dept. P), 210-212 Tottenham Court Road, London, W.1

Showrooms: 210-212 Tottenham Court Road, W.1, and Marconi House, Strand, W.C.2



Model A.C.4

# MARCONIPHONES POWER UNITS