

The Wireless Constructor

Vol. XVI.

AUGUST, 1933.

No. 82.



How To Make
**THE ALL-WAVE
THREE/FOUR**



FOR DISTANCE AND DIVERSITY
ALSO
IN THIS NUMBER

Articles by **JOHN SCOTT-TAGGART**, A.M.I.E.E., F.Inst.P.

MODERN WIRELESS

FOR JULY

On sale everywhere, contains full details for building a
MAGNIFICENT "CLASS B" SET
THE CLASSIC PORTABLE

A thoroughly up-to-date design of outstanding merit, containing its own compact loudspeaker and housed in a home-made cabinet.

It makes an ideal touring companion, for it has a remarkably wide range of reception at first-class strength.

ALSO

"The Safe-Lag Mains Unit"
FOR A.C. MAINS.

TWO SPECIAL SECTIONS

A Supplement entitled
PROGRESS

giving

A complete review of Modern Component and Accessory Development

—AND—

"THE WORLD'S PROGRAMMES"

containing articles dealing with foreign stations, their programmes, and how, when, and where to listen for them

are contained in the July

MODERN WIRELESS

MODERN WIRELESS

is

BRITAIN'S LEADING RADIO MAGAZINE
and contains
ARTICLES ON EVERY
ASPECT OF WIRELESS

No matter whether you are specially interested in home construction, B.B.C. programmes, foreign stations, technical

matters, or the latest developments, you will find articles that appeal to your taste. Place a regular order for "Modern Wireless" and keep your radio knowledge

UP TO DATE.



Among the features in the
JULY NUMBER
of
MODERN WIRELESS
are articles on:
What Set Shall I Buy?

BY P. P. ECKERSLEY

How to Use Your "Class B" Valve.

At the Western Regional.

Theory v. Practice.

Radio Notes and News of the Month
etc., etc., etc.

AT ALL BOOKSTALLS PRICE 1/-

MODERN WIRELESS

CONTENTS

	Page		Page
The Editor's Chat	159	Economy Push-Pull	183
The Month on Short Waves	160	"Pointers" on A.V.C.	185
"On the Grid"	160	Tone Control and the Pentode	187
The All-Wave Three/Four	161	Parasitic Oscillation	189
Questions I Am Asked	167	The Baffle Problem	190
Seasonal Radio	168	As We Find Them	191
These New Circuits	169	A Universal Soldering Iron	192
The Modern Midget Two	171	In Lighter Vein	194
Round the Dials	176	Radiograms Out of Doors	196
Points For Purchasers	176	Stop That Hum	198
From My Armchair	177	Changing to Variable-Mu	200
B.B.C. News	179	Our News Bulletin	202
A Practical Man's Corner	181		

As some of the arrangements and specialties described in this Journal may be the subjects of Letters Patent the amateur and trader would be well advised to obtain permission of the patentees to use the patents before doing so.

Published by The Amalgamated Press, Ltd.,
The Fleetway House, Farringdon Street,
London, E.C.4.

COLVERN FERROCART COILS

COLVERN.....always associated with all that is best in radio frequency coils. FERROCART Coils are synonymous for outstanding selectivity, compactness and efficiency.

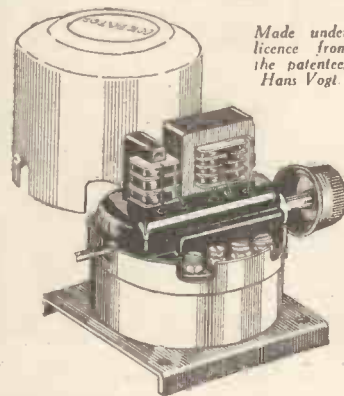

Made under licence from the patentee, Hans Vogt

TYPES F1 F2 F3

For single S.G.H.F. stage receivers
37/6 per set

TYPES F10 F11 F12 F13

Suitable for 2 S.G.H.F. stage receivers
50/- per set

Mounted on sub base with ganged wave-change switches.

COLVERN LTD., ROMFORD, ESSEX

London Wholesale Depot:-
150, King's Cross Road, W.C.2



"MAINS VOLUME" from BATTERY SETS

WITH

COSSOR CLASS "B" VALVES

By adapting your present Battery Set to use a Cossor Class "B" Valve you can obtain volume at least equal to that of the average Mains Receiver without extravagance in High Tension Battery Consumption.

TWO TYPES:

COSSOR 240 B

Filament volts 2.0., Filament amps 0.4 ; Anode volts 150 max.; Max. Anode Current Swing 50 mA.; Max. Peak Applied Signal (Grid to Grid) 40 volts; Static Anode Current at $V_a = 100$, $V_g = 0$ (each half) 1.5 mA. Price **14/=-**

COSSOR 220 B

Filament volts 2.0 ; Filament amps 0.2 ; Normal Anode volts 120 ; Max. Anode Current Swing 35 mA.; Max. Peak Applied Signal (Grid to Grid) 40 volts; Static Anode Current at $V_a = 100$, $V_g = 0$ (each half) 1.25 mA. Price **14/=-**



To A. C. COSSOR LTD.,
Melody Dept., Highbury Grove, London, N.5.

Please send me, free of charge, a copy of Folder No. L93, which tells me how to use Class "B" Amplification.

Name

Address

W.C.8/33

Send for a copy of Folder L93 which tells you all about Class "B" Amplification—what it is—how it works and how to use it. Please fill in the coupon.

A. C. Cossor Ltd., Highbury Grove, London, N.5. Depots at Birmingham, Bristol, Glasgow, Leeds, Liverpool, Manchester, Newcastle, Sheffield, Belfast, Cardiff & Dublin.

The WIRELESS CONSTRUCTOR

The EDITOR'S CHAT

Prospects for the Radio Exhibition—Novelties for Next Season—British Share of Lucerne Wavelengths—"The All-Wave Three/Four" and "The Modern Midget."

Coming Events

THE great Wireless Exhibition opens on the 15th August and, once again, Olympia will be the Mecca of all that is latest and best in radio design.

Olympia will be the home of radio this year from 15th to 24th August, and an even bigger and more attractive show is forecast. In fact, several manufacturers are taking elaborate precautions to prevent the leakage of details concerning their season's products, and we are promised several real surprises when the Show opens.

The New Developments

There are bound to be some very interesting designs in the new models on show at Olympia, for "Class B," Q.P.P., and the new unbreakable Catkin valves are but three of the important developments which have occurred in the radio world during 1933. Others obviously may be expected, and we should not be surprised if Olympia provided more sensations this year than ever before.

Naturally, THE WIRELESS CONSTRUCTOR will occupy one of the most prominent stalls at the Exhibition; and here we may tell you that every reader of THE WIRELESS CONSTRUCTOR will be warmly welcomed, and will be invited to inspect the original models of the "S.T.300" and the "S.T.400." Don't forget to pay us a visit when you are at Olympia.

Our New Wavelengths

Great Britain hasn't done so badly as a result of the Lucerne Conference. To begin with, provision has sensibly been made in the allocations of British wavelengths for more stations than we at present possess, and this rather suggests that the unofficial

rumour that the B.B.C. is contemplating the building of two more Regional stations has some good foundation in fact.

It must also be remembered that a new North-Scottish Regional station is practically certain to be erected in the near future. It is good news to note that the Daventry long-wave station under the new arrangement will have a much greater separation from its neighbours than is the case

IN A DRAGON-MOTH

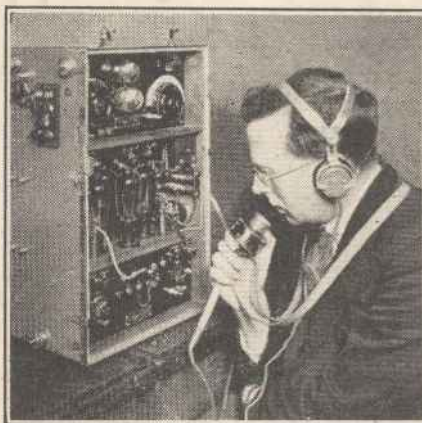

Testing the Marconi aircraft equipment of a Dragon-Moth, by means of which the machine can keep in touch with the various airports. Remarkable compactness is achieved, the whole outfit being but little larger than an ordinary receiver.

with most of the other European long-wave stations.

Daventry's long-wave will be 9 kcs. away from Königs Wusterhausen, while the nearest other station is Minsk, separated by 8 kcs. Daventry has obviously been lucky.

To Start The Year

As was expected, Russia proved a difficulty, and it has always been regretted that, under the Madrid

arrangement, she was allowed to use wavelengths denied to other stations.

On the whole, however, the Conference turned out more successfully than was anticipated. As in most conferences, when thirty or more countries get together and try to reach a unanimous agreement, difficulties crop up which often seem insuperable. The majority of the thirty four countries represented at Lucerne, however, have signed the new wavelength agreement, which will come into force early in January, 1934.

This Month's Sets

In this issue of THE WIRELESS CONSTRUCTOR there is a full description of an 'All-Wave Three/Four' by Mr. Victor King, which we think you will agree is definitely a set for everyday use. Frankly, it has not been designed for record-breaking, but for all-round general efficiency. "The All-Wave Three/Four" can be changed in a second from a medium-wave or long-wave programme to a station somewhere down on 30 metres, without any loss in efficiency.

"The Modern Midget Two" is another interesting little receiver, its great point being its amazing compactness. The set is capable of giving foreign stations on a moving-coil loudspeaker, and has been specifically designed and described by an expert in THE WIRELESS CONSTRUCTOR laboratory, who has had many years of experience in the designing of midget receivers.

Our distinguished contributor, Mr. Scott-Taggart, is again represented in this issue by his enormously popular "From My Armchair" feature, while his ever-growing post-bag has resulted in a page of Questions Asked which cover a multitude of little problems of interest to every reader.

THE MONTH ON SHORT-WAVES



All the latest news about this interesting waveband.

FOR summer-time the results on short waves during the last month—particularly towards the end of it—have been nothing short of remarkable.

I should hesitate to isolate any particular waveband as being outstanding, for no matter at what time of day I have listened, results have been extraordinarily good. But I must add that listening on the right waveband at a particular time of day has had a lot to do with it.

Remarkable Transmissions

For instance, I have found that during almost the whole of the daylight period it is precious little good searching for distant stations on waves appreciably over 25 metres. At dusk, the best results have been forthcoming on the 31-metre band; while from about midnight onwards excellent

signals have been received on the 49-metre band, reaching a peak at about 2 a.m.

The month's "star" turn, I think, has been one of our old friends—W 3 X A L on 16.87 metres. Quality and volume from this station really have been excellent, and from about 6.30 p.m. onwards he has been almost up to "alternative programme" standards.

Incidentally, it is worthy of note that the high level of signal strength has in most cases been well maintained until after midnight, which is rather remarkable for a 16-metre transmission.

Another remarkable transmission has been D J B on 19.73 metres. While it is true that Zeesen always does come over particularly well in my district, his recent performance gives me strong grounds for thinking that

there must have been an increase in power. He is certainly swamping W 8 X K on 19.72 metres these days.

CT 1 A A during the period under review has been as good as ever; in fact, I think his transmissions are even better. Strength is rarely less than R8-9, and intelligibility is very good. Occasionally the transmission is subject to interference from a station, the identity of which I have not yet been able to determine, but CT 1 A A is the more powerful signal.

World's Record Created

Incidentally, my reference to CT 1 A A is made in anticipation of a special transmission for British listeners which is to take place on the evening of July 12th. By the time this issue reaches you the broadcast will be over, but I should greatly appreciate reception reports, all of which will be acknowledged.

There appears to be a great amount of activity at the present time on the ultra-short waves. Our contemporary, "Popular Wireless," recently created a world's record for five metres, and they have followed it up with some special tests from the air.

I am following the experiments with the keenest interest, and I am hoping to be able to let the CONSTRUCTOR gang into a little secret in this connection at an early date.

G. T. K.

IN spite of the great things expected from the World Economic Conference, the need for radio economy is still felt by most of us. And where records are concerned this means we have to make do with some of the older ones instead of having all new ones.

So I expect you have at times, like myself, thought over the question of how to get the best results from a pick-up on worn records. There seems to be two distinct views on the subject.

One is to use soft or fibre needles and plenty of amplification to ensure enough volume, and the other to use loud needles and little amplification. It is difficult to say which gives better results, and the type of record and, no doubt, the amount it is worn have a bearing on the matter.

Personally, I prefer the loud needle method, because loud needles undoubtedly fit the grooves better than soft-tone ones, and wear on the recorded "bumps" should thus be less noticeable. Or so it seems to me.

* * *

Although warned never to do it,

 * "ON THE GRID" *
 * Record Economy—Adjusting *
 * Grid Bias—a Radiogram *
 * Hint. *

there are plenty of people who adjust the grid bias to their power valves without switching off the filament. And it is surprising how many get away with it without damage to the valves.

The reason, of course, is that a grid "up in the air" is by no means the same thing as one at zero potential.

Although the current kicks up when G.B. is disconnected, electrons immediately begin to collect on the grid, and since they cannot leak away (except very slowly across dust on the valve holder, or similar extremely high resistance path), the grid builds up a negative potential.

This acts like a small negative grid bias applied in the ordinary way, and so prevents the current rising to such detrimental heights that it might otherwise reach. But it is

nevertheless bad enough for the valve.

* * *

While writing about grid bias there is another little point I should like to mention.

It is usual to note the total grid volts, represented by the distance along the base line, from the beginning of the valve's bottom bend to zero grid volts, and to halve it.

Actually, it is always best to add a few volts to this. The normal curves are static, and when the valve is under load, the straight part to the left of zero grid volts is lengthened, so that the higher value of G.B. is desirable.

* * *

A friend of mine who has quite a good mains set, recently complained that the pick-up "always sounded awful, just like a hurdy-gurdy at a fair!" Nothing he tried seemed to improve matters. Actually, the trouble was due to a weak turntable motor which slowed up slightly on anything in the nature of a "bit of loud recording." The moral is obvious.

A. S. C.

Here is the set for everyday use. Not designed for record-breaking, yet unamainly efficient in its all-round performance. It will delight the man who is satisfied, as a rule, to listen to ordinary broadcasting, but who would like, now and again, to vary the monotony with a "spot of short-wave work."



A real general-purpose design, using nothing but standard components, and with ease of operation which is a real joy, the "All-Wave Three/Four" can be changed in an instant from, say, the London National programme to a station down somewhere on 30 metres—and that without any loss of efficiency.

THERE is always a number of people who will have the very last word in anything mechanical or electrical. If they go in for a car it must be of the super-sports high-efficiency type; while in the world of radio the urge for *le dernier cri* results in their buying or building set after set, each one to do a special job especially well.

If they take up short-wave reception, nothing but the very latest superhet will be looked at; while a big mains-driven superhet radiogram is essential for their adequate pleasure on "broadcast wavelengths."

The Sets We Use

Such exactitude, however, is costly and is certainly not for the majority of us, who are financially restricted, and content and happy in that restriction to tread a more moderate path.

In the realm of mechanics we go for the average "useful" car, one that has a fair speed coupled with comfort, rather than a specially hotted-up machine in which comfort is a secondary consideration.

The same happens regarding radio. Quite average sets are our lot. Not that they need be inefficient, but they are not necessarily designed for record-breaking either in DX reception or

Combining the charms of short-wave searching with facilities for all ordinary broadcast reception, this is a first-class set for "wireless touring."

power of output. They give good quality results from some score or so broadcasters, and we are well satisfied. If it comes to short waves we may use a simple but effective adaptor, or we may build a small short-wave two.

Always hankering in our minds, however, is the wish that we could use our standard set for short waves as well, avoiding the bother of coupling up an adapter, or of turning out a special set when we want to listen to the very low-wave stations.

The
**ALL-WAVE
THREE/
FOUR**

BY VICTOR KING

Not that we want to do so very often. Our main interest is in the normal broadcasting programmes, but occasionally it is very enjoyable to turn to 20 metres or so and pick up a few "Yanks." Probably if we could do it on our standard set we should do it more, even though we should realise that we were bound to pay a little in efficiency for our laziness.

Satisfying a Want

A combination set of simple design can hardly be expected to be as efficient on the short waves as a specially hotted 20-50-metre "streamlined" receiver. The touring car, with its comfort, is not quite so speedy as the super-sports model.

All this we realise, and we are willing to pay that small sacrifice, for we do not want to range the Antipodes in search of radio fare—we want an occasional short-wave European or American to break the monotony of listening on the standard wavelengths.

That is how a great many of us think, and it is to those who have such thoughts that I address the following description of the "Three/Four" receiver. It is just such a

receiver which will combine broadcast and short-wave searching in one set. It is a real general purpose radio tourer.

Originality in Design

I do not claim for it the hot-stuff super-charged efficiency of the special short-wave design, nor the ultra-selective and ear-drum shattering power of the large mains receiver. The "Three-Four" is a "family bus," designed for comfortable, easy listening of those European stations that are worth getting on the normal wavelengths, and a few short-wavers as an added and refreshing diversion.

The set has been designed with simplicity of operation as its main feature, and ease of construction is an important second point, and these two properties have been achieved by the use of a rather unconventional but efficient method of change-over scheme from "broadcast" to "short-waves" and vice versa.

Let us study the theoretical circuit a little, and we shall see exactly how the system operates without the need for complicated multiple switching points.

At the outset in this design I was determined to use nothing peculiar to the set save the circuit. In other

A screened-grid amplifying stage which is operative only for the ordinary and medium wavelengths is one interesting feature of this novel and distinctive design.

words, no special components were considered, only quite normal ones being employed, though they have admittedly been connected up in an unusual manner.

In the design of an all-wave set it is usual to take the two sections (medium-long waves, and short waves) separately, consider their requirements and then to connect them together by means of a switching system that merely places the valves in one or other section of the set.

This system I have discarded in

Simplicity of Operation is the Main Feature

favour of a more intimate blending of the parts which obviates any complication where the switching is concerned by calling upon certain of the components to do "overtime."

Fundamentally the set is a three-valver, detector and two resistance-coupled low-frequency stages, and on this basis I worked the all-wave scheme. A detector and low-frequency stages are all that need be for good short-wave reception, but they are not adequate for selective tuning of stations on the 200-2,000 metre waveband.

Surveying the Circuit

So I added to the fundamental circuit an H.F. stage that is operated only on medium and long wavelengths.

The H.F. stage is perfectly normal, therefore, the aerial feed to it being through a .0001-mfd. maximum capacity preset condenser to a primary winding on a Colvern K5 canned coil. The grid winding of this is tuned in the usual way and connected to grid of the S.G. valve.

This is of the variable-mu type, and its bias is controlled by a potentiometer of 50,000 ohms shunted by a .01-mfd. condenser, and having combined on it a three-point make-or-break switch. The reason for this will be manifest shortly.

From the anode of the valve we are shunt-fed to the secondary of

another K5 coil acting as grid tuning of the detector, and to one "outside" point of a one-pole change-over switch. The "centre" of this switch is connected to the grid condenser of

that either H.F. amplified impulses on the medium or long waves can be passed to the detector, or the direct aerial impulses of the short-wave stations. That is all the switching

CONTROLS WHICH CANNOT PUZZLE YOU

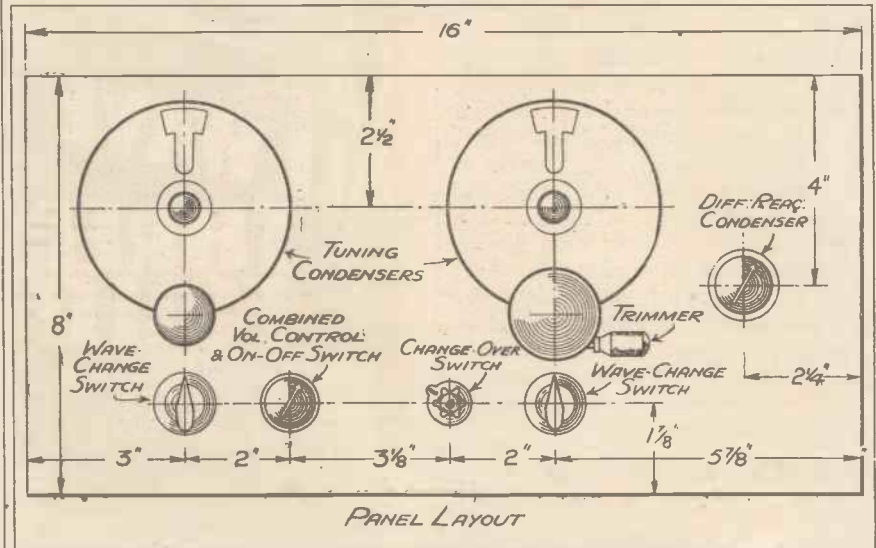

This diagram, besides giving you all the measurements necessary for drilling the panel, shows how only the addition of the change-over switch distinguishes the appearance of the receiver from an ordinary broadcast set.

the detector and the other "outside" is connected to a plug-in short-wave grid coil, and also to the aerial via a neutralising type condenser.

Now it is obvious that the detector grid feed can be taken from either the K5 coil or the short-wave coil, so

there is in the whole scheme apart from the switching off of the S.G. when short waves are to be received.

It will immediately be asked how the aerial is changed over from the medium- and long-wave coil unit to the short-wave side, and what steps

NONE BUT STANDARD COMPONENTS ARE USED.

Component	Make used by Designer	Alternative makes of suitable specification recommended by Designer	Component	Make used by Designer	Alternative makes of suitable specification recommended by Designer
1 panel 16 x 8 in.	Peto-Scott	Goltone, Becol	1 rotary change-over switch	Bulgin S.88	Tunewell
1 baseboard 16 x 10 in.	Peto-Scott	—	1 1,500-ohm resistance and horizontal holder	Graham Farish "Ohmite"	—
1 vertical screen 19 in. x 6 in.	Magnum	—	1 50,000-ohm do. do.	Do. do.	—
2 coil units	Colvern-K.5	—	1 30,000 do. do.	Do. do.	—
1 set plug-in coils	Atlas (see text)	—	2 20,000-ohm do. do.	Do. do.	—
2 plug-in coil holders	Igranic	Polar "Utility"	1 1/2-megohm resistance with vertical holder	Do. do.	—
2 .0005-mfd. tuning condensers	Ormond No. 6	—	1 1-megohm resistance with vertical holder	Do. do.	—
2 vernier dials	Igranic "Indigraph" 2290/24 and 2296/56	—	1 2-megohm grid leak with wire ends	Dubilier	Goltone
1 .0003-mfd. differential reaction condenser	Graham Farish	Telsen, Polar	1 1/2-megohm do. do.	Dubilier	Goltone
1 .25-mfd. fixed condenser	T.C.C. type O.F.	—	1 two-point on-off switch	Tunewell	Telsen, Lissen, Wearite
2 .01-mfd. fixed condensers	T.C.C. type 34/95a	Dubilier, Telsen, Ferranti	4 insulated terminals	Belling and Lee type R	Igranic, Ealex, Bulgin
2 2-mfd. fixed condensers	Dubilier type 9200	T.C.C., Telsen, Ferranti	2 vertical mounting terminal blocks	Belling and Lee	—
1 .01-mfd. fixed condenser	T.C.C. type "S"	Dubilier, Telsen, Ferranti	6 wander plugs	Clix	Ealex, Belling and Lee
1 .0005-mfd. fixed condenser	T.C.C. type "M"	Dubilier, Telsen, Ferranti	1 wander fuse	Belling and Lee	Bulgin
1 .0002-mfd. fixed condenser	Dubilier 670	—	1 S.G. anode connector	Belling and Lee	—
1 .0001 preset condenser	Sovereign	Telsen, Goltone	2 accumulator connectors	Bulgin	Belling and Lee, Clix
1 neutralising condenser	Bulgin N7	Igranic, Peto-Scott	5 yds. insulating sleeving	Goltone	—
1 H.F. choke	Lewcos "Super"	—	7 yds. 18 S.W.G. tinned copper wire	Goltone	—
1 H.F. choke	R.I. "Quada-static"	—	1 sheet copper foil, 16 x 10 in.	—	—
1 combined 50,000-ohm potentiometer and 3-point on-off switch	Lewcos	—	Screws, flex, etc.	—	—
4 four-pin valve holders	W.B.	Bulgin, Telsen			

The H.F. Stage Can Be Cut Completely Out

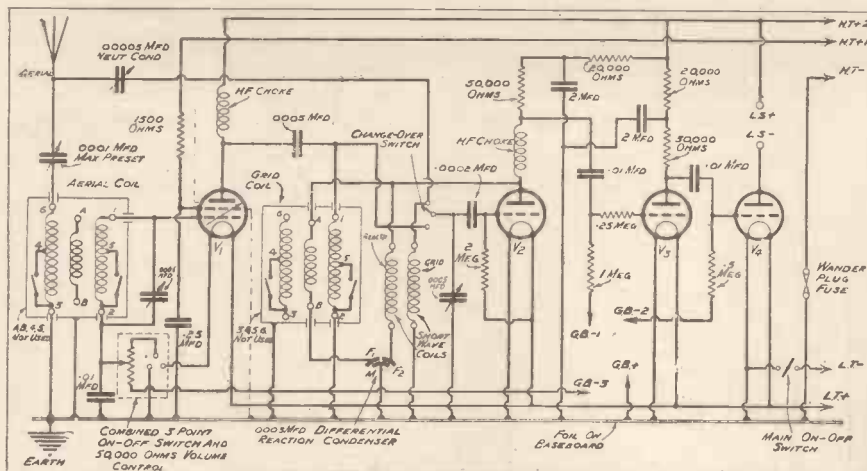

Note the ingenuity of this circuit, which employs a multi-mu screened-grid valve for "broadcast work" only. The change-over switch puts the aerial straight on to the grid of the detector, via the .00005-mfd. neutralising condenser.

are taken to provide reaction for both sets of waves without any more switching.

This is done in a rather ingenious way, which obviates the need for switching and yet retains efficient circuits on all wavebands.

The aerial is fed, as we have seen, to a primary of a "canned" coil, and this primary is in parallel with the aerial feed to the short-wave coil in the detector circuit. When the set is used on the short waves the detector grid is switched to the short-wave coil, and is thereby completely disconnected at the high-potential end from the medium- and long-wave feed.

Ingenious Reaction Scheme

Thus, even if the S.G. valve were left "on," nothing would reach the detector in the way of reception through that valve, although the aerial is still coupled to it. In proper use the valve is switched off by the switches on the variable-mu control resistance to save current.

But short-wave impulses arrive to the detector through the neutralising type condenser, and at the same time they are prevented from being by-passed to earth by the choking effect of the primary winding of the first dual-range coil. There is, therefore, no need whatever for any switch in this part of the circuit.

Now for the reaction. It is well known that for ordinary broadcast reception it is desirable to use a differential reaction condenser if no plate-to-filament condenser for the detector valve is to be used.

With short waves, however, the differential condenser is not advisable, so that to carry out effective reaction with any switching scheme it would

be essential for a very complicated arrangement to be used, or else to employ, with necessary switching, two separate reaction condensers, one of the differential type and the other a plain one.

In the scheme I have adopted the same reaction condenser is used for both sets of wavelengths; on the medium and long waves it is employed as a normal differential condenser, while for short-wave reception it is used as an ordinary condenser.

A Pretty Effect

This is done quite simply by making use of the choking effect of the normal reaction winding of a dual-range coil as applied to short waves.

The anode of the detector valve is connected to both the "canned" coil reaction winding and to that of the short-wave coil, while the differential reaction condenser is connected

LOOKS CONVENTIONAL—SOUNDS AMAZING !

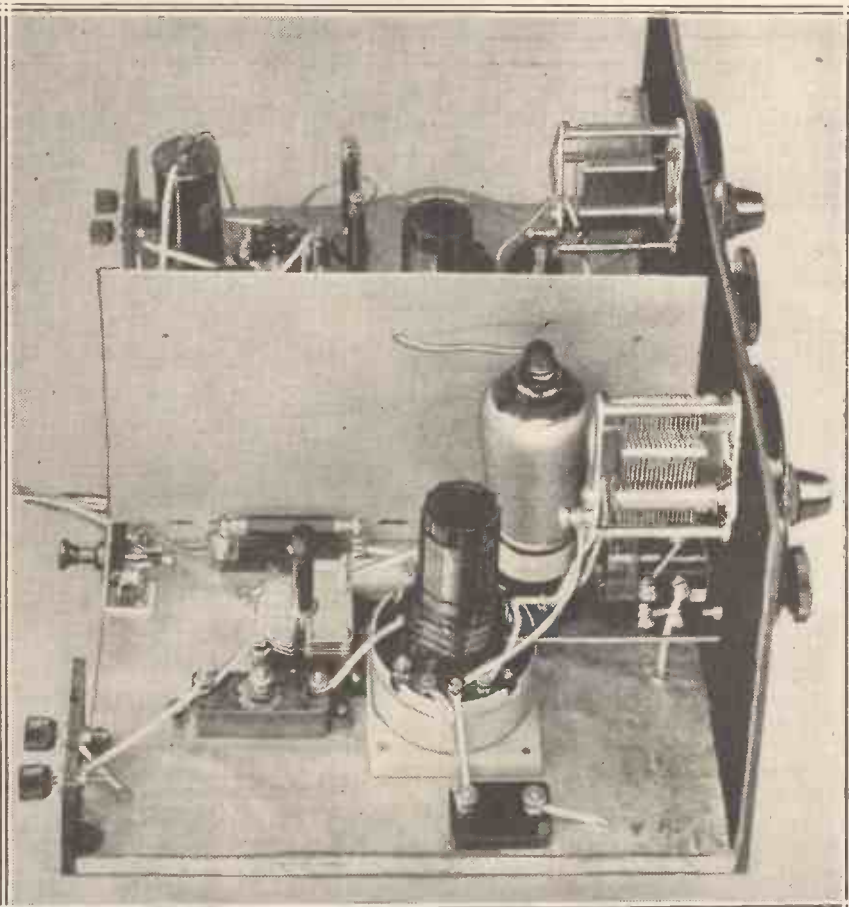

The photograph of the H.F. end of the receiver shows the neutralising condenser for short-wave working and the main on-off switch, which is mounted on a special bracket at the back of the baseboard.

Differential Condenser With Two Uses

with its moving vanes to earth. Then one set of fixed vanes is taken to the short-wave reaction coil, and the other set to the reaction winding of the dual-range coil.

Now we come to the rather pretty effect of this circuit. On medium and long waves the reaction is supplied by the meshing of the moving vanes and the fixed plates connected to

the medium-wave reaction coil. At the same time, as regards the frequency at which we are operating the short-wave reaction coil acts as a dead short (it has only between

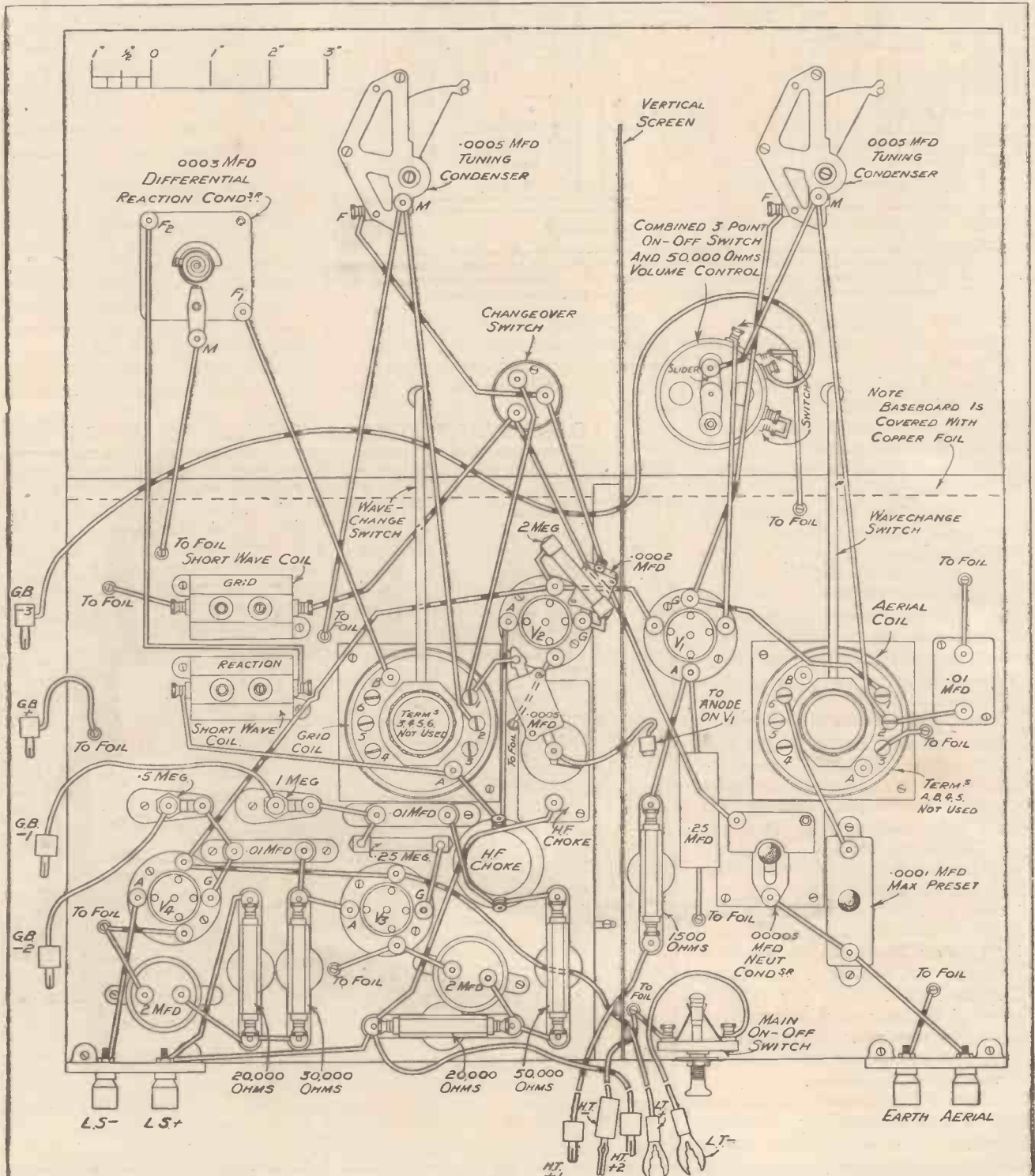

The simplicity of the wiring is enhanced by the special method of showing crossing connections. Note that the entire baseboard is covered with foil to which many earthing leads are taken.

Nothing in the Building to Cause Trouble

two and six turns), so that we have, in effect, a differential reaction control over the medium and long wavebands.

With the short-wave section in operation the reaction control is provided by the moving vanes and the other set of fixed plates, in which case the medium-wave coil reaction winding acts as a choke to short waves, and the reaction condenser acts in a straight (not differential) manner.

Ensuring Stability

It may be asked concerning the aerial feed on "normal" wavelengths whether the parallel circuit through the neutralising type condenser has any by-pass effect on the incoming impulses. It would have this effect if the value of the neutralising condenser were large enough, but as this has a maximum capacity of some .00005-mfd., and in use is set at something less than half-way "in," the reactance to ordinary broadcast frequencies is very large, large enough to have a negligible effect from the by-pass point of view.

Thus we have got over the trouble of complicated switching in quite a simple manner, by making some of the key components carry out double tasks.

From the detector the set is completely normal, there being two stages of resistance-capacity-coupled L.F. amplification, so that there is no chance of threshold howl being generated. The receiver is amply decoupled, while a grid stopper is inserted in the first L.F. stage to prevent H.F. getting into the L.F. side of the receiver.

Foil Connections

In the construction the usual baseboard and panel method has been employed, with copper foil covering the entire baseboard. To this foil many of the earth returns are taken, but it is not advisable to take these to the foil without due consideration, as haphazard connections of this nature can often lead to trouble. The wiring diagram should, therefore, be followed carefully in this respect.

There is nothing in the actual building to cause any difficulty, so we can push on to the operation of the set. This is easy, but requires a little explanation owing to the peculiar circuit employed.

For instance, the reaction control acts in two ways. When it is used on medium or long waves it follows the usual practice, and increases regeneration as the knob is turned clockwise, but on the short waves the knob has to be turned in the reverse

stage of L.F., and a power output valve. This latter should be chosen in accordance with your own power supply.

If a mains unit is used, and this can be used on short waves if it is a good one, the power valve can

THE DOUBLE-PURPOSE END OF THE SET

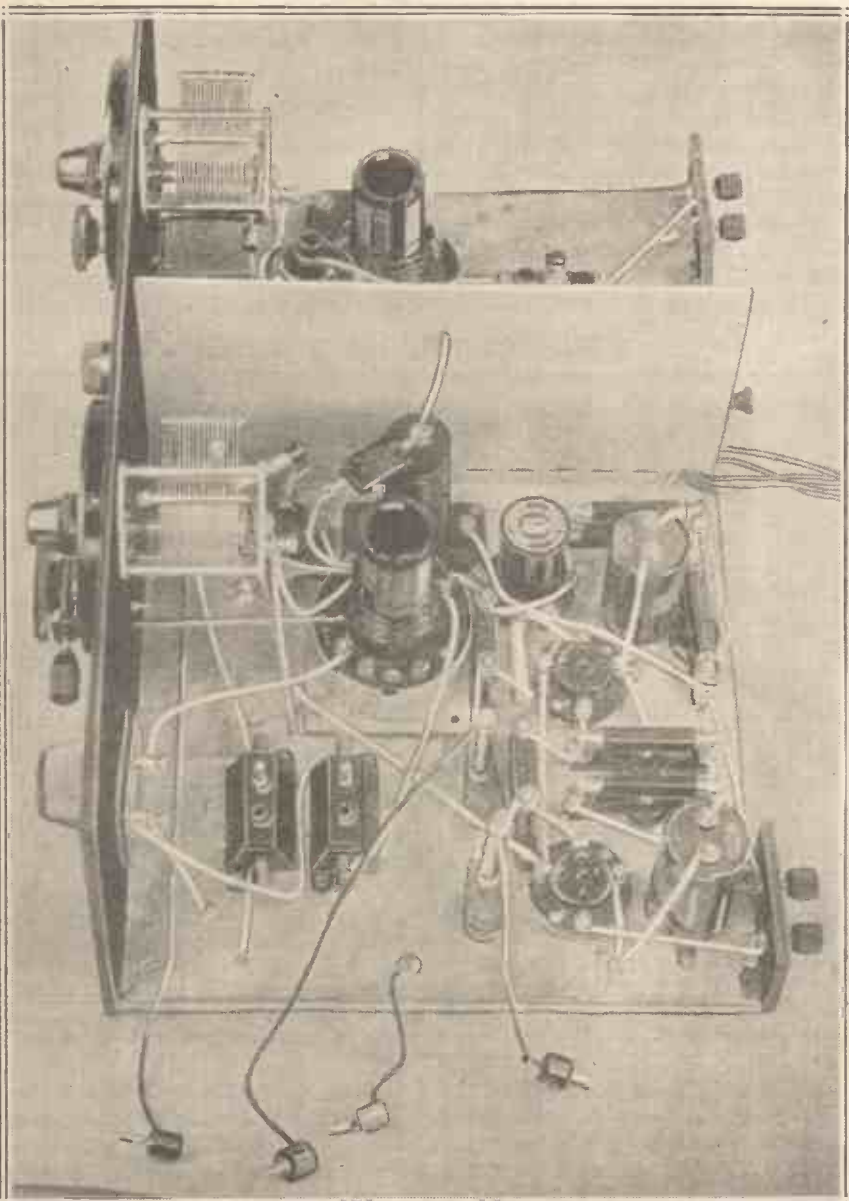

This very comprehensive view of the L.F. end shows how the broadcast and short-wave components are neatly combined. Note the short-wave coil holders in the foreground, and the wiring of the differential reaction condenser.

direction in order to increase the reaction.

The set uses ordinary valves, a variable- μ S.G. in the first stage, a detector of the H.L.2 type, another H.L.2 or an L.F. valve for the first

obviously be "larger" than if a battery H.T. is employed, for the mains unit will be able to provide the large anode current taken by the output stage.

With a mains unit I would

Covers All the Important Wavebands

recommend something like the P.2 or P.220A, while with battery H.T. the P.220 or L.P.2 type will be more economical. This decision, however, must obviously rest with the set builder himself.

Valves and Voltages

The H.T. voltages best used are 80 for the screen of the S.G. valve and 120 for the rest of the set. This means that the mains unit need have only two taps, but it should be capable of supplying an anode current of several milliamps. more than required by the receiver if satisfactory results are to be obtained.

To set the receiver for short waves insert the plug-in short-wave coils in the sockets (Nos. 2 or 4 for grid coil and 2, 4, or 6 for reaction), and turn

out by the right-hand condenser, rough searching being done very slowly with the special vernier control pulled down out of engagement with the drive of the dial. This should only be engaged when it is required for fine control, like the resolving of a telephony carrier. Reaction is increased on short waves by turning the knob anti-clockwise.

On Short Waves

The neutralising type condenser should be set nearly all out, the further it is out giving the better reaction control, though the actual amount of plate intermesh here will depend upon trial under

For medium and long waves leave everything as it is except the volume control and change-over switch. The former should be turned clockwise to

THE VALVES AND ACCESSORIES.

Make	S.G.	Det.	L.F.	Power
Cossor	220V.S.G.	210H.F.	210L.F.	230X.P.
Mullard	P.M.12.M.	P.M.1H.L.	P.M.2D.X.	P.M.202
Mazda	S.215V.M.	H.L.2	L.2	P.220A.
Marconi	V.S.2	H.L.2	L.210	P.2
Osram	V.S.2	H.L.2	L.210	P.2

LOUDSPEAKER.—B.T.H., Blue Spot, Ferranti, Atlas, Amplion, Magnavox, Rola, Celestion.

BATTERIES.—H.T. 120 volts. Ediswan, Lissen, Ever Ready, Petrix, Drydex.

G.B. to suit valve. Siemens or as above.

L.T. 2-volt. Exide, Lissen, Ediswan, Block, Petrix.

AERIAL AND EARTH EQUIPMENT.—Goltone "Akrite," Electron "Superial," Radiophone "Receptru," Graham Farish "Filt" earthing device, Bulgin lightning switch.

COMPACT BUT UNCROWDED

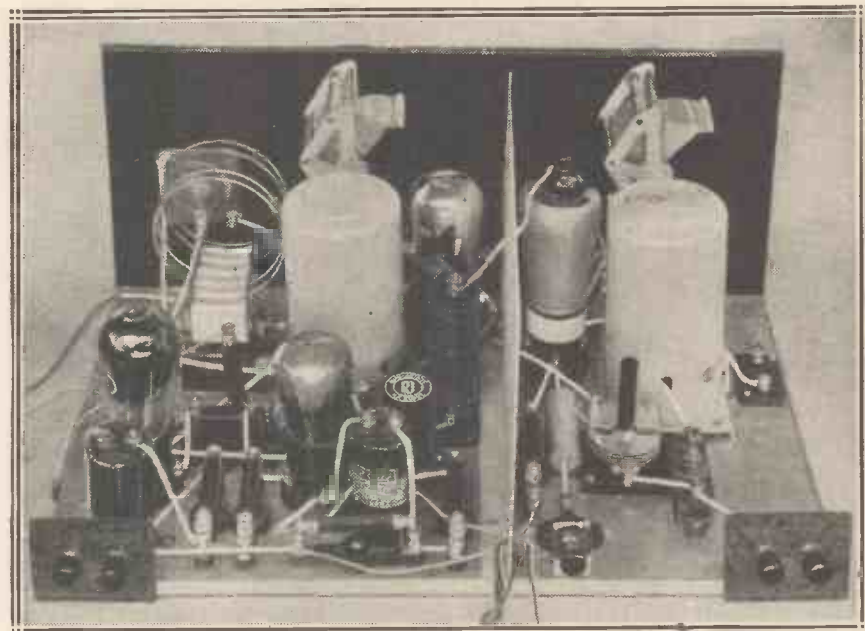

A final glimpse of the "All-Wave Three/Four" showing the receiver as it appears when ready for use. The short-wave coils remain in place when the broadcast band is being covered.

the grid switch on the panel to the left. The variable-mu volume control should be turned fully anti-clockwise, when the switch will click over and break both L.T. and G.B. circuits to the S.G. valve.

The G.B. for this valve should be either 6 volts (if the special Mullard short base valve, the P.M.12M, is used), or 15 volts for the variable-mu valves. For the L.F. valves the G.B. should be adjusted according to the valve maker's instructions.

Tuning on the short waves is carried

individual conditions. The setting should be that which gives best overall reaction control.

As regards the short-wave coils, you will need two 2's, two 4's, and a 6-turn coil, and these will cover from about 20 to 80 metres or so. Probably the set will not oscillate all the way up on the 2-turn coils (one in each holder), even with the "neutralising" condenser all "out," but substitution of a 4 for tuning and 4 for reaction will enable you to cover all the important wavebands.

switch on the S.G. valve, while the latter should also be turned to the right to change the grid of the detector over to the canned coil.

Tuning is as usual, and reaction control now is of the differential type operating clockwise. Selectivity is controlled by the preset condenser on the baseboard and by reaction.

Preventing Bias Wastage

Don't forget, however, on switching off the set for the night, or any long period, the switch at the back must be used as well as the volume control. The switch at the back breaks all the filament circuit, while that on the volume control (in addition to the filament of the S.G. valve) breaks the bias circuit through the potentiometer, thereby preventing any bias wastage.

Another word about mains units. It will be noticed that no mains equipment has been definitely specified for use with the "All-Wave Three/Four." This is not because mains H.T. supply is unsuitable with the set, but because there is a possibility that on the short waves a certain amount of hum may be heard if a mains unit is employed.

On normal broadcast wavelengths the set operates perfectly with the usual types of H.T. supplies, and in many cases it is possible to use the same mains units on the short waves, but this depends very largely on local conditions, the "quality" of the mains and so forth.

This is specially true where D.C. mains are being used, though mains interference of the induced kind can often be completely removed by the use of screened aerial down leads.



QUESTIONS I Am Asked

by JOHN
SCOTT-
TAGGART

Q. 35. Which form of resistor do you think is best: spaghetti, strip, or the metallised?

A. I have decided to avoid using spaghettis where possible in future as it seems impossible to produce a reliable job. They are, however, very convenient and flexible.

Strip resistors (wire-wound) have their points, but are not very convenient things. The metallised Dubilier or Erie resistors are exceedingly useful and are very largely used by set manufacturers. Their short wire attachments are too short very often, and the constructor does not desire to solder an extra length of wire.

I should like to see these resistors with much longer wires attached so that the superfluous length in any particular case can be cut off by the constructor. A piece of oiled cotton sleeving or systoflex can be slipped over each wire to prevent short-circuits.

Alternatively, I should like to see some resistors fitted with terminals. My own ideal would be a resistor with long wires attached to each end and any metalwork on the resistor itself, together with the first half-inch of each wire, coated with an insulating varnish. This would eliminate risks of short-circuiting.

Q. 36. I have built the "Push-Push Five." Do you advise a change-over to "Class B" amplification?

A. No. Why should I? The Q.P.P. system gives superb results and admirably suits the "S.T.400." "Class B" will give a greater output for the same expenditure of cash, but as the Q.P.P. scheme will deliver 1,300 milliwatts of undistorted output, you can rest content.

Given a suitable circuit, "Class

B" will, however, probably prove the more popular scheme.

Q. 37. What is your opinion of Ferrocart coils?

A. It is a little early to say. Their merit lies in their low resistance for their size. You can make an ordinary air-core coil of equally low H.F. resistance, but it would be bulky and not easily screened. The Ferrocart coils have a core of "powdered" iron and are very compact.

In band-pass circuits and, in general, where reaction is not applied to the coil, the Ferrocart shows up to great advantage.

A selection of queries likely to arise sooner or later in the minds of every reader, is here dealt with briefly but clearly by Mr. John Scott-Taggart, whose reputation as an "explainer" is evidenced by the sale of three-quarters of a million of his text-books.

In "ganged" circuits, careful ganging is imperative because the Ferrocart coils make the circuits tune sharply.

Q. 38. Why does my A.C. mains set hum loudly when first switched on but not afterwards?

A. Irregular heating-up of the material coating the cathode may cause the trouble. A loud hum is also attributable to the absence of a load on the detector anode circuit. If this contains the primary of an L.F. transformer, it is far more likely to pick up hum from the A.C. wiring, mains transformer, etc. As the detector valve cathode heats up, the increasing anode current has a damping effect on the transformer winding through which it passes.

There are several other possible causes of the effect.

Q. 39. The background noise is worse when my set is tuned in to a signal, especially when only the carrier is "heard." The set is

silent with the aerial disconnected. Is this usual?

A. Background noise is not necessarily produced by external agencies. On the other hand, a set may be a noisy set and yet be absolutely silent when the aerial is disconnected.

The old rule about "dissing" the aerial and seeing if the source of noise is in the set or outside is not infallible. In fact, many a set only misbehaves and becomes noisy when signals are coming in.

The most likely explanation is that the incoming carrier wave is modulated by small voltage variations, emission irregularities, etc. The modulated signal is now amplified by the H.F. stages of the set and the rectified result is magnified by the L.F. side.

No wonder that an apparently innocent and silent set produces background noises when a carrier is tuned in.

Q. 40. Why when a Ferranti A.F.5 is used do I get motor-boating, but on substituting a transformer of other make I get good quality but not a trace of motor-boating? Is the A.F.5 at fault?

A. No. Just the contrary. The A.F.5 reproduces notes down to about 30 cycles very effectively. The decoupling of your set is satisfactory for the higher notes in the case of both transformers, but when the A.F.5 is reproducing the very low notes the decoupling is inadequate and there is an impedance (the mains unit) common to different valves, and there is thus a feed-back. The trouble is not experienced with the other transformer because it does not reproduce the low notes which give the trouble. The good quality you speak of is a relative matter, and a question of taste and musical experience.



SEASONAL RADIO

By E. H. CHAPMAN, M.A., D.Sc.

This is an article from an unusual angle, in which our contributor classifies the months according to their radio merits.

NATURE compels us to recognise her four seasons. Our clothing, our food, our games and our holidays are indeed very largely determined by those seasons. We know the difference between summer heat and winter cold, between the green of spring and the brown of autumn. The seasons are there, and we are always conscious of them. It is a pity, perhaps, that we are not compelled by Nature, or in some other way, to recognise the four seasons of wireless, which are just as real and just as different from each other as spring, summer, autumn, and winter.

Summer Performance

Were recognition of the wireless seasons far more general than it is, there would be less dissatisfaction with the performance of wireless receivers in the summer months, and we should hear very little more of that foolish notion that wireless was essentially a pastime for the winter months.

Those of us who have reached what we like to call years of discretion, know the consequences of defying the seasons. We know, for example, what would happen to us if we shed our thick woollen garments on the first sunny day of spring. How many of us who have, or who ought to have, reached years of wireless discretion, realise the great amount of disappointment which comes of defying the summer season in wireless?

The Best Months

We are all of us aware that the best season for wireless coincides with the whole or the greater part of the four months November to February. During those four months conditions for reception, and especially for distant reception, are at their best. Thunderstorms, electrical disturbances in the

atmosphere, and the resultant atmospheric conditions which cause interference of the most annoying type in the summer months, are unknown in those four winter months. Moreover, the long, dark nights are conducive to the quiet enjoyment of wireless.

After the best season for wireless, there follows a season of three months, March, April and May, in which conditions for wireless reception get steadily worse. Then comes the

MUSIC ON THE HOLIDAY



"Have you ever taken a portable set with you on holiday? If not, you have still to experience one of the most interesting sides of wireless."

worst season for wireless, the summer months, during which there are days when conditions for wireless reception can only be described as atrociously bad, and when atmospheric conditions may spoil even the programmes of the local broadcasting station. Lastly, there

follows a season of two months, September and October, during which conditions for reception, and especially for distant reception, steadily improve. Summarising these four wireless seasons, we have:—

November, December, January, and February:

Best season for wireless. No atmospheric conditions. Conditions for distant reception excellent.

March, April and May:

Conditions for distant reception slowly deteriorating.

June, July, and August:

Worst season for wireless. Atmospheric conditions bad. Conditions for distant reception very bad.

September and October:

Conditions for distant reception improving.

Reception Conditions

The first step towards the proper enjoyment of wireless in summer is the realisation of the existence of the wireless seasons described above. Once you realise that these wireless seasons are as real as Nature's four seasons, you are well on the way towards a proper appreciation of the conditions governing reception in summer. You will not make the mistake of expecting the same excellent conditions, and therefore performance, in summer as in winter.

When you receive a certain distant station one summer night under temporary and freakish conditions, and fail to get that same station the next night under more normal summer conditions, you will not jump to rash conclusions. You will not conclude that your receiver has suddenly developed a serious fault. No, you will remember the season, and you will put the incident down in your records as another example of "summer madness" in reception conditions.

Portable Sets

The listener who can ignore the wireless seasons more than anyone else is the listener who lives near a broadcasting station, and who takes all his programmes from that one station. Even such a listener, however, may get rude reminders of the arrival of the wireless summer.

The summer season is our holiday season. Have you ever taken a portable set with you on holiday? If not, you still have to experience one of the most interesting sides of wireless: outdoor reception and wireless on holiday. Surely for these two things alone we should look upon summer as one of the best parts of our wireless year.

THESE NEW CIRCUITS

by VICTOR KING



IN a few weeks' time the Radio Exhibition at Olympia will open.

Meanwhile, I suppose many of my readers are a'holidaying. Therefore, it would seem to be a convenient opportunity for a little "stocktaking."

Even those who run (about the country-side and sea-side) may read, and though set construction is, perhaps, rather out of season just now, it is soon going to be in full swing again.

Which are Just Novelties?

Well, then, what shall we expect our new circuits to be based on, out of the spate of novelties that has appeared this year?

Which of them are, in fact, just novelties, and which are likely to find a permanent place in reception technique? These are the questions to be answered.

I propose to discuss the following: Q.P.P., "Class B," the "cold valve," the double-diode triode, H.F. pentode, double-diode pentode, iron-cored coils and, finally, two entirely new developments which, at the time of writing, have not quite emerged from the laboratory.

Q.P.P. is easily dealt with. It formed a kind of stepping-stone for "Class B" and, I fancy, it is already obsolescent if not already obsolete. Anyway, I can see no place for it next season.

Here to Stay

On the other hand, "Class B" is, in my opinion, here to stay for a very long time. I cannot visualise any other method by which a battery set can be made to provide a big output for a modest H.T. consumption.

A further indication of its definite place in the future of British radio is afforded by the facts that it has already had a good run in the U.S., and that its present state of development in this country tallies with American practice; and this has long been "ironed out" in fundamentals.

Of what importance to the set-builder are the various recent radio developments?

Our famous contributor frankly appraises Q.P.P., "Class B," "cold valves," double-diode triodes, the new pentodes, and so forth, as well as some of the latest, just-out-of-the-laboratory ideas.

It is quite on the cards that "Class B" will also be applied to mains sets in a somewhat limited way. But, of course, its main application, at least in the immediate future, is to battery outfits.

I cannot visualise "Class B" achieving a tremendous popularity unless there is greater standardisation and, therefore, interchangeability.

At the present moment there are some half-dozen different "Class B" valves, each necessitating its own individual circuit conditions.

If there were only one or two types of valves, I fancy the price of

"Class B" components would be lower and the whole thing become much more popular.

You see, "Class B" is in the nature of a refinement. It is not a fundamental necessity. It doesn't make the ubiquitous S.G.-det.-L.F. cheaper to run. But you can make it deliver an immensely greater volume at little additional running cost.

For Large Volume

That is a fact which must not be lost sight of.

The listener who doesn't want much volume any way is offered nothing by "Class B."

However, there are undoubtedly a vast number of constructors who would be and are eager to build up "mains volume" on battery sets, and to these "Class B" is a god-send.

The "cold valve," as the Westestor metal rectifier for H.F. is being styled, will probably be used widely

A DEFINITE PLACE IN FUTURE RADIO

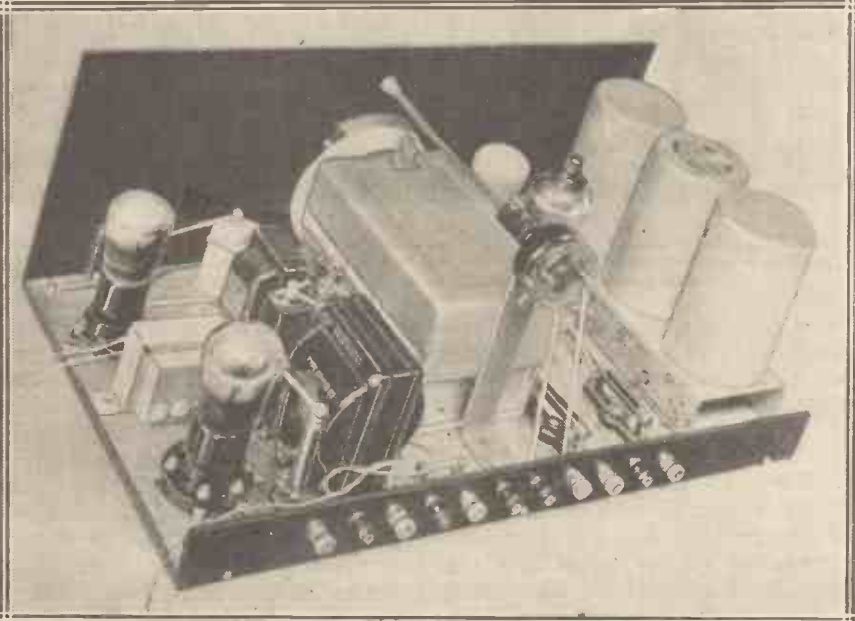

Victor King says that "Class B" is, in his opinion, a method of amplification that is likely to be with us for a long time. This set is "The 'Class B' Four," the first British design for constructors incorporating the method.

These New Circuits—continued

in superheterodyne sets. And therefore its ultimate popularity largely depends upon the popularity of that class of receiver.

In my view, the superhet will tend to grow in favour and will not, as many appear to think, slip back this coming season.

Now what of the double-diode triode and the double-diode pentode?

Worth-while Proposition

So far these have been used almost solely for Automatic Volume Control circuits, but they have other uses. Inasmuch as they provide diode detection plus and practically independent of either triode or pentode

Anyway, I shall be greatly surprised if "A.V.C." or either of the above-mentioned valves, figures in the "top-liner" sets of even 1934. But I expect a very respectable proportion of constructors will dabble with them all the same.

A Best-Seller

The multi-mu pentode is likely to prove something in the nature of a best-seller. You see, it couples with either of the two valves we have just discussed in A.V.C. arrangements as well as having definite attractions as an alternative to the variable-mu S.G. in straightforward circuits.

I know I shall be using it quite a

cored coils than I have been traversing with most of my preceding remarks.

And when I predict that the coming season will be an "iron age" for tuning coils, I do so with the knowledge that at least six famous firms are going "all out" on this new technique.

Indeed, the managing director of one of these concerns informs me that his firm is to discontinue the manufacture of air-core coils.

Lower Screening Losses

These iron-cored coils are not just stunts. Properly designed and made, they are actually definitely superior to the air types. Moreover, they enable screening to be applied with less consequent losses.

Their almost fantastic smallness is not, in my view, of itself of any great importance.

Another coil development which is maturing even as I write is a coil having no wavelength gap between 160 and 2,000 metres.

The advantages of such a wide wave coverage are obvious and are likely to be emphasised in the future as new broadcasting stations spring up in Europe.

"No-Gap" Coils

The present 200 to 550 and 1,000 to 2,000 metres bands covered by the average coil unit are even now inadequate to tune-in all the stations that are "on the air," though it must be admitted that they bring in the great majority.

So far I know of only one firm which is to manufacture the "no-gap" type of coil, but I shall be surprised if they retain a monopoly for such a good idea.

Finally, a word or two about permeability tuning. This has been "in the offing" for years. At last, however, it would seem as though the snags in it which hitherto rendered it impracticable are being overcome.

Permeability Tuners

There will be no need for me to tell you what permeability tuning is, because there was an excellent article all about it in the last issue.

But I can add that there is considerable activity in numerous factories and that any time now there may suddenly be quite an outbreak of permeability tuners.

DIODE DETECTION FOR THE SUPERHET

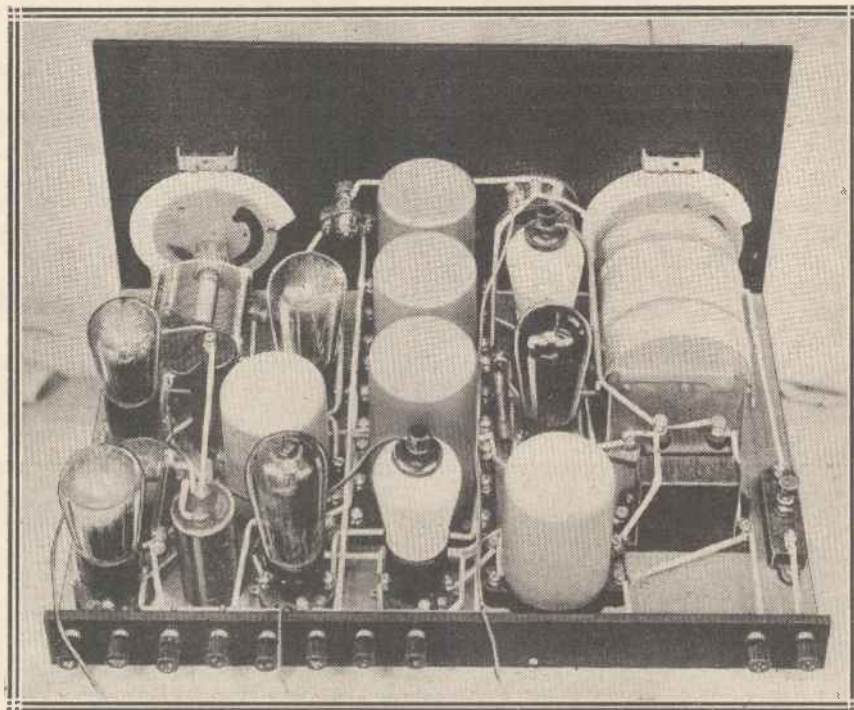

A recent improvement which makes for distortionless rectification is the diode detector used here in the famous "Diodion Super Seven."

amplification, as the case may be, they do seem to be propositions to which designers must give extremely close consideration.

De-Luxe Items

Nevertheless, I visualise them as being for some long time in the de-luxe category. One of these days Automatic Volume Control may be as popular as, for example, an ordinary manual volume control, but I fancy we look rather a long way ahead in suggesting that.

bit in my own sets unless something radically new of a similar nature comes along, and I don't think that is at all likely to happen.

My experience with H.F. pentodes is that while one does not obtain from them in practice quite as much extra amplification as theoretical conceptions promise, there is a very satisfactory gain for a given higher degree of selectivity. And that is, in the vernacular, the stuff to give 'em!

I feel on safer ground with iron-



The Modern Midget Two

by A. S. Clark

COMPACT receivers always did have an irresistible appeal for me. And there are many other constructors who are similarly attracted by sets of diminutive size.

Years ago, in the May, 1925 number of THE WIRELESS CONSTRUCTOR, I described what was probably the first really tiny receiver—The “Midget” Single Valve Receiver. It turned out to be one of the most popular single-valve sets ever described.

Appeal of Miniature

Why should sets of small dimensions have such an appeal? Novelty alone certainly cannot account for it, and they are no easier to construct than the more conventional designs.

The reason lies in a reputation for efficiency. A small set properly designed always seems to score in sensitivity. The reason for this is not far to seek; it lies in the short wiring that is made possible.

We are continually being admonished to keep wiring as short and direct as possible. And with this in mind, I expect you have often felt when wiring up a simple set such as a two-valver, that if only you could bend the panel round, how much shorter the leads would be.

That reaction condenser, for instance—possibly it seems miles away from where it ought to be! How much shorter its leads would be if the panel went round in a semi-circle!

Thinking It Out

It is on det. and L.F. sets that wiring considerations are so important, because small losses here and there cannot be made up by colossal magnification, as in multi-valvers of more ambitious type. It was through thinking in terms of circular, and even

Designed on unique lines, this receiver is particularly compact, has short wiring, and is unusually sensitive. It is capable of giving foreign stations on a moving-coil speaker, and is designed and described by an expert who has had considerable experience in the field of midget receivers.

spherical panels, that “The Modern Midget” Two came to be designed.

While juggling with some loose components on a baseboard, it became evident that the corner was the best place for them, with controls arranged along two adjacent edges. From this stage it was only a matter of moments to decide upon a design with a triangular baseboard, having a point

in the front and controls on either side of the point.

As you can see from the photographs, the angle made by the two panels is somewhat less than a right angle. But that proved a natural development.

Surpassing Expectations

When completed, the “Modern Midget” more than lived up to expectations, and I can tell you these were by no means easy to live up to. As a matter of fact, it proved to be one of the most sensitive “twos” it has been my pleasure to handle for a long time.

I was immediately filled with enthusiasm, and can truthfully

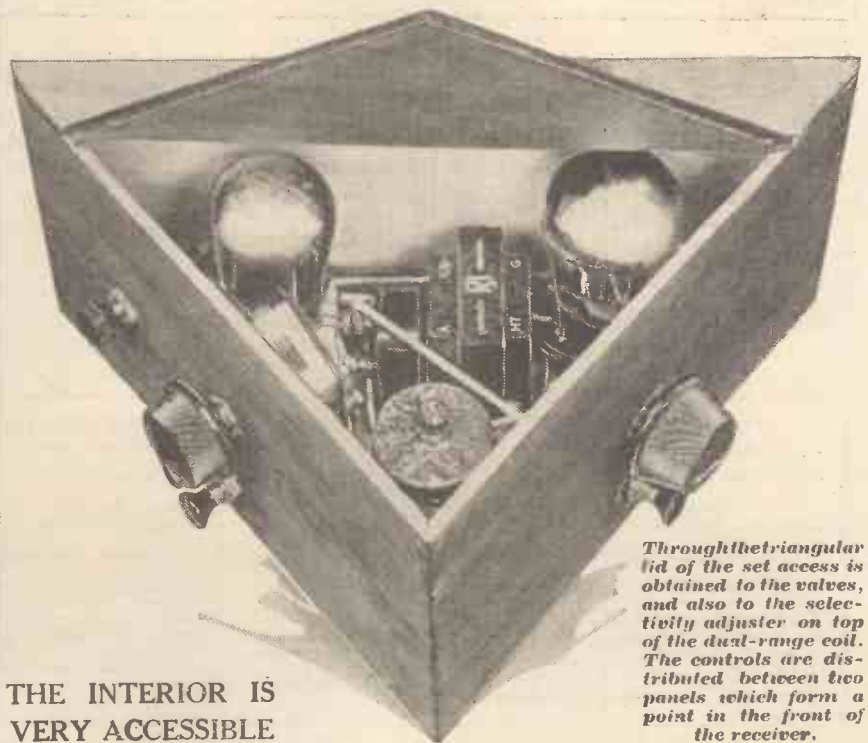

Through the triangular lid of the set access is obtained to the valves, and also to the selectivity adjuster on top of the dual-range coil. The controls are distributed between two panels which form a point in the front of the receiver.

THE INTERIOR IS VERY ACCESSIBLE

The "Modern Midget" Two—continued

recommend it as a real modern counterpart of that "Midget" One which thrilled constructors in the early days of broadcasting.

Naturally, being modern, it had to have two valves to make it capable of working a loudspeaker, for only short-wave enthusiasts and crystal set users have any time for headphones these days. The output valve is coupled in the usual way to the detector by an L.F. transformer.

Other normal features, such as a wavechange coil and differential reaction, find a place in the circuit, and there is a series aerial condenser to

conditions, is the medium-wave breakthrough that occurs so often at the bottom of the long waveband. To avoid this a special choke, or loading coil, is connected in series with the aerial lead, and provided with a shorting switch so that it shall not upset reception on the medium waves.

Disposition of Controls

This switch is fixed, together with the tuning condenser and the on-off switch, on the left-hand panel. On the right-hand one is the reaction condenser and the wavechange switch.

for the top and back, and details of the dimensions for these various pieces of wood are given in a clear diagram.

First of all, cut out the pieces of wood for the baseboard (which is $\frac{3}{8}$ -in. thick) and the two panels. The latter are both of the same size, but must be cut at an angle where they join in a point, so that their edges fit close together. If you do not trust yourself to make a success of this cutting on the slant, the bevelling can be done after the wood is cut by using a rough wood rasp. The back edges should also be bevelled.

HOW TO DRILL FOR THE FEW PANEL COMPONENTS

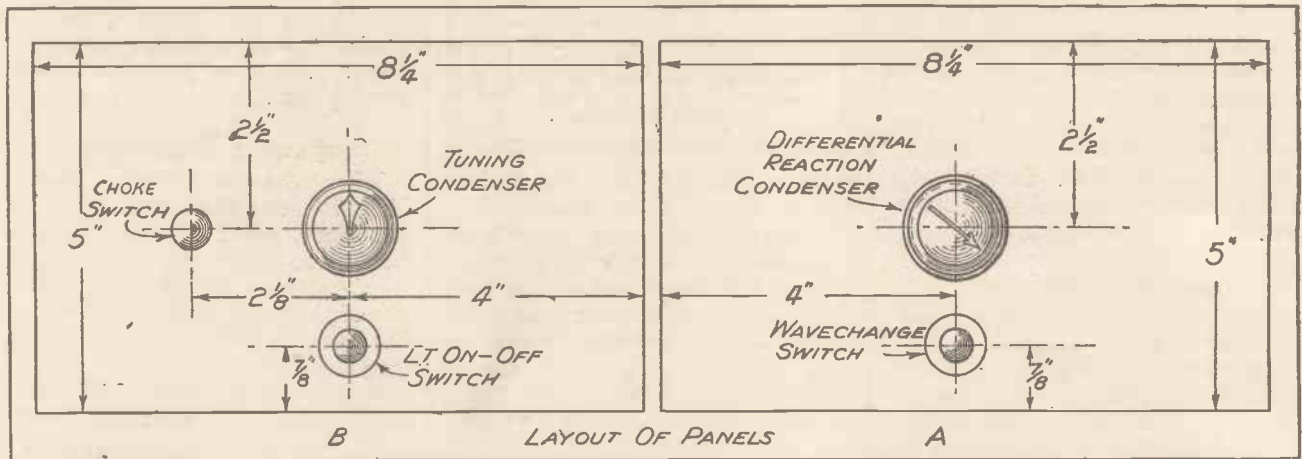

take care of selectivity variations. This condenser, although situated "behind the panel," is not shut away so that it is difficult to get at.

If you desire to alter its capacity when changing over from medium to long waves, it is instantly accessible. Just raise the pointed lid on its hinges and there it is, right in the apex of the triangle.

One of the biggest bugbears of simple sets under the difficult modern

Terminals are provided for aerial, earth and loudspeaker, but the battery leads are taken direct to various points on the components. A hole has to be cut in the back of the set to accommodate these leads.

Constructional Details

Actually no cabinet is required for this set, the back and top being fitted to the baseboard and panels. The latter are of similar wood to that used

The next step is to mount the panel components. Before screwing the panels to the baseboard, mount the coil and the aerial choke, and attach wires to the terminals on the coil.

Now, before fixing any of the other baseboard components, secure the panels and wire up as far as possible. The bevelled edges of the panels can be joined either with glue or one or two very fine wood pins.

THE PARTS USED BY THE DESIGNER—AND SUITABLE ALTERNATIVES

Component.	Make used by Designer.	Alternative makes of suitable specification recommended by designer.	Component.	Make used by Designer.	Alternative makes of suitable specification recommended by designer.
Baseboard and cabinet (see text)	—	—	1 2-megohm grid leak	Lissen	Graham Farish, Ferranti, Dubilier, Igranic
1 '0005-mfd. tuning condenser	Telsen type W.193	Ormond, Polar, J.B.	2 two-point push-pull switches	W.B.	Wearite, Ready Radio
1 dual-range coil	Lissen type L.N.5189	—	1 two-point push-pull switch	Ready Radio	Lissen, Telsen
1 anti-break through choke	Lissen L.N. 5145	—	2 four-pin valve holders	W.B.	Wearite, Lissen, W.B.
1 '0003-mfd. differential reaction condenser	Graham Farish	Telsen, Polar, J.B.	5 battery plugs	Chix	Benjamin, Telsen, Lissen
1 H.F. choke	Lissen L.N. 5092	Telsen	2 accumulator spades	Chix	Goltone, Belling-Lee, Igranic
1 L.F. transformer	R.I. 'Hypermite'	Varley, Bulgin, Igranic	4 terminals	Goltone	Eelox
1 '0003-mfd. fixed condenser	Dubilier type 665	T.C.C.	2 yds. insulating sleeving & 3 yds. 18-gauge tinned copper wire	Goltone	Belling-Lee
			Wire, flex, screws, etc.	—	Wearite

The "Modern Midget" Two—continued

When you reach this stage, fit the wooden terminal blocks in the slots cut for them at the back of the baseboard. A little more bevelling of the edges is required here. You are now in a position to fix the remaining components and complete the wiring.

Leave the battery flexibles amply long. Also mark them clearly so that you don't connect high-tension up to the filament circuit.

Inserting the Valves

The final step in the construction is to fit the top and back pieces of wood. The top is in two parts, the triangular piece being hinged to the strip that runs along the back of the set.

This piece of wood, as well as the back itself, is fixed with small wood pins or glue, as in the case of the join in the panels. The back piece will call for your sawing skill again, or the use of that rasp.

You will find that there is just room conveniently to remove the valves through the triangular lid of the set.

And now a few words about the set "on the air."

Use a valve of the H.L. type in the detector position, namely, in the holder nearer to the aerial and earth terminals, and a small power valve in the other holder. It is also desirable to use an outdoor aerial if this is possible.

Selectivity Adjustments

A point to note is that the selectivity control knob on top of the tuning coil works in the opposite direction to an ordinary preset condenser. Selectivity is increased by

screwing this knob in a clockwise direction.

I suggest you start with this condenser fully turned anti-clockwise, and only increase selectivity as far as you find necessary to separate stations properly. When on medium waves the wavechange switch is pulled out.

The shorting switch for the aerial loading coil is also permanently pulled out when on the medium waveband. On long waves you can try the set both with this switch out and with it in.

IT HAS MANY GOOD POINTS!

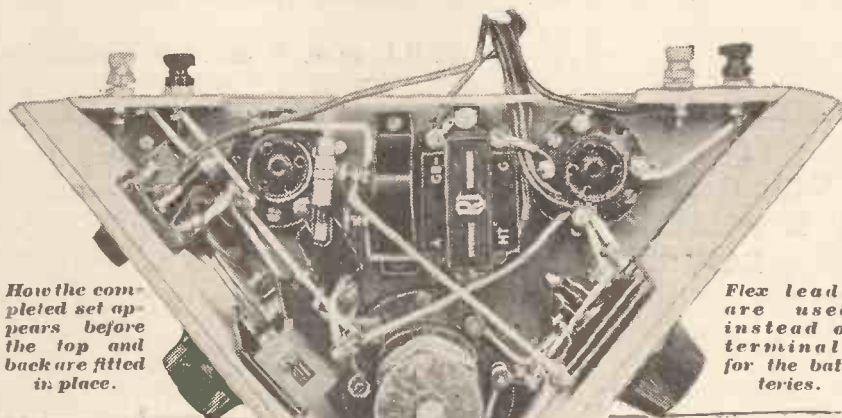

DIMENSION DETAILS OF THE CABINET WOODWORK

CUT THE WOOD CAREFULLY

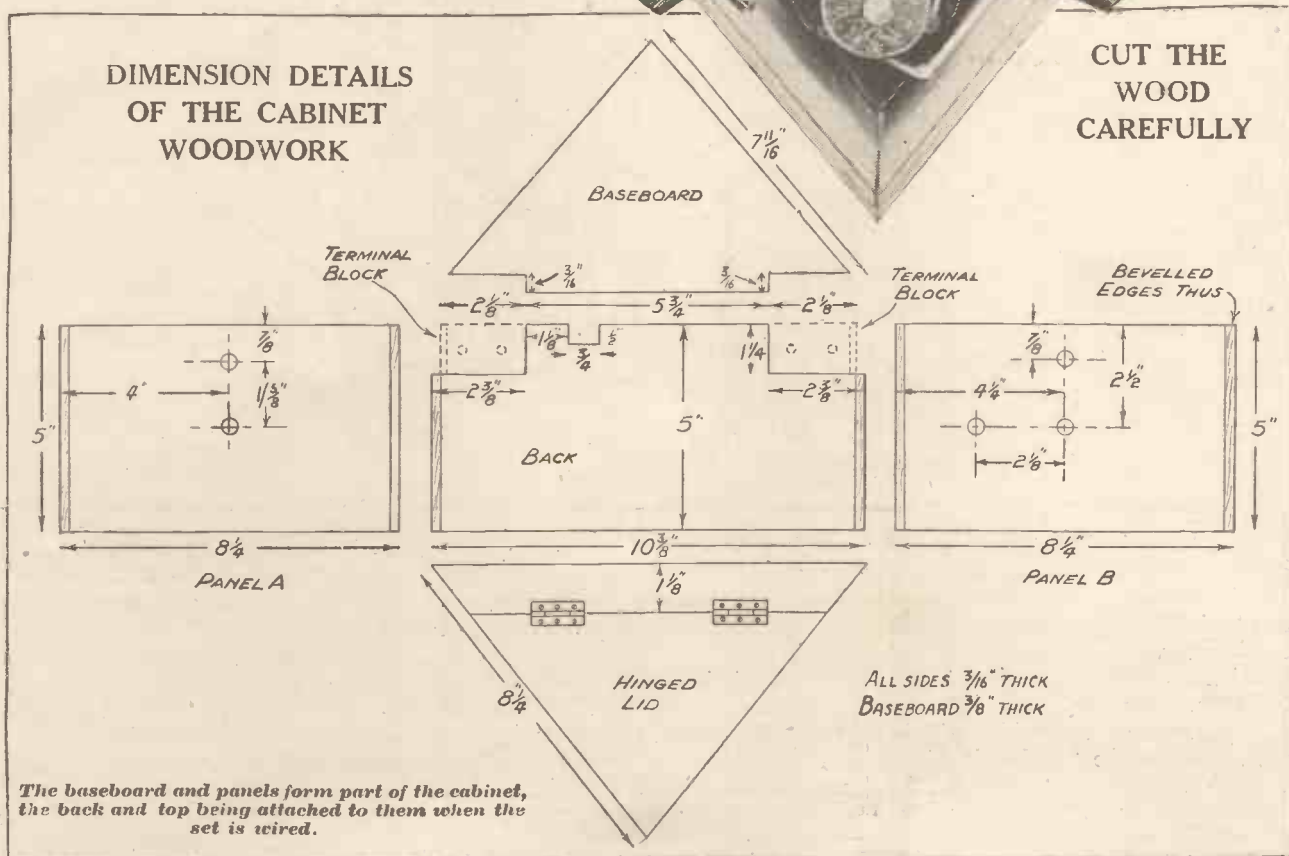

The baseboard and panels form part of the cabinet, the back and top being attached to them when the set is wired.

The "Modern Midget" Two—continued

If you are not troubled by break-through there is no reason why the switch should not be out for long waves as well as medium.

For maximum results you may find it as well to readjust the selectivity control when changing over to long waves. It is also feasible that the best setting of this condenser will vary on the long waves according to whether the aerial choke is in series or shorted out of circuit.

Excellent Performance

Separate H.T. positive leads are provided for each valve. You should take full advantage of this in obtaining smooth reaction, a necessary feature if distant stations are to be received well

separated the London programmes with the greatest ease in South-West London.

RECOMMENDED VALVES		
Make.	Det.	Output.
Cossor	210H.L.	220P.A.
Mullard	P.M.1H.L.	P.M.202 P.M.2A
Mazda	H.L.2	P.220
Marconi	H.L.2	L.P.2
Osram	H.L.2	L.P.2
Eta	B.Y.1815	B.W.604
Hivac	H.210	P.220

Two or three stations were also received from the Continent at good speaker strength in daylight—quite a good feat for a small set. Lastly, a point which often puzzles prospective builders of a set, "Will it work a

(the detector acting as the first in this case) will provide ample volume. At least the small power valve will easily be fully loaded.

If you desire to try a pick-up with the "Modern Midget," it can be done without making any alterations to the wiring whatever. A volume control in the form of a 50,000-ohm potentiometer should be used, and the connections for it are as follows.

Simple Connections

One end of the resistance of the potentiometer (that is, one of the outer terminals) goes to one side of the pick-up. The other outer terminal goes to the other pick-up terminal, and also to a 1½ volts negative tap on the grid-bias battery.

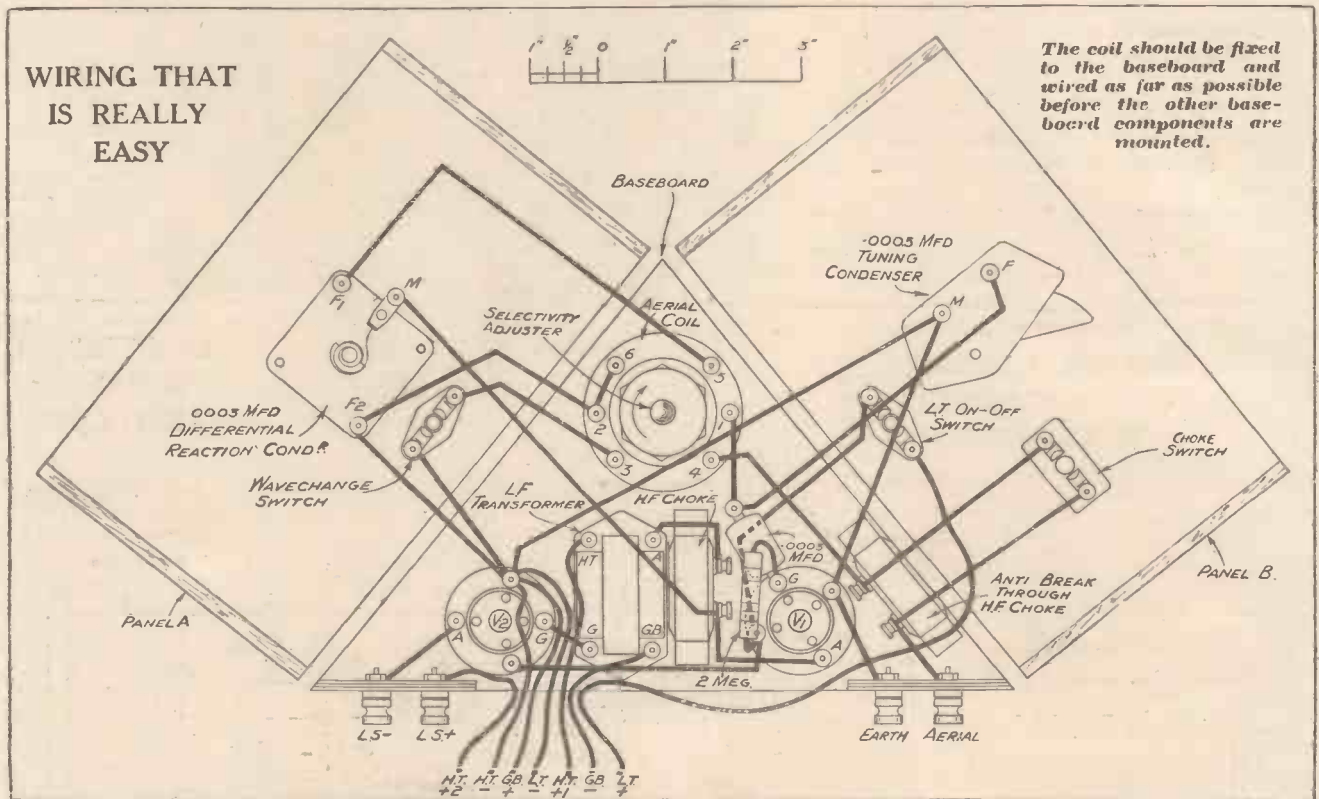

Don't stint the high-tension on the output valve, use 120 to 150 volts. The idea where the detector is concerned is to use as high a voltage consistent with sufficiently smooth reaction control to make tuning of foreigners fairly easy.

Let me give some idea of the performance of the "Modern Midget." While it would be incapable of sufficient selectivity for use right within the shadow of a twin broadcaster, it

moving-coil speaker?" Most definitely yes. The daylight results just mentioned were on a moving-coil speaker with a small power valve in use.

Whilst it is usual to associate the electrical reproduction of records with the powerful radiogram type of set, the "Modern Midget" itself is nevertheless suitable for this purpose. Most pick-ups are quite sensitive these days, so that two L.F. stages

(It is necessary for the grid of the detector valve to be made negative now that this valve is to operate as an amplifier.)

The slider of the potentiometer is taken direct to the grid terminal of the V₁ valve holder, which takes the detector valve. The aerial should be disconnected while the pick-up is in use, otherwise you will have radio programmes coming through at the same time as the records.

The "Modern Midget" Two—continued

Due to the fact that the 2-megohm detector grid leak, connected to I.T. positive, is joined in circuit the whole time as well as the grid-circuit through the potentiometer and grid-bias battery, there will be a continuous though extremely tiny current through the grid leak and the potentiometer resistance. It can be prevented when not using the pick-up if desired (although it is so small that it would

Finally, don't expect to get a tremendous volume from the speaker when using a pick-up. Generally, a valve seems to overload sooner on a record than it does when being worked by radio.

Make full use of the potentiometer volume control. You will be better pleased with a small undistorted output than with a large volume and bad quality. Of course, if you use a large output valve, matters will be different and considerable volume will then be possible.

tuning coils I have found it convenient to utilise a symbol consisting of a broken or dotted line instead of the usual full line normally used for an iron-core coil.

I am suggesting that this convention be adopted, and I believe a number of radio workers are already utilising my suggestion.

The use of a broken-line is actually symbolical of the exact nature of the core, and it therefore appears to be a very appropriate symbol. As inductances with ordinary iron cores are frequently shunted by variable or fixed condensers, and as both dust-core and air-core coils are used together, the need for differentiation seems to be very desirable.

It is to be hoped that the suggested symbol will be recognised by the standardisation committees to whom the suggestion is being communicated.

Yours faithfully,
PAUL D. TYERS.

17, Woodland Drive,
Watford, Herts.

MANY CIRCUIT REFINEMENTS

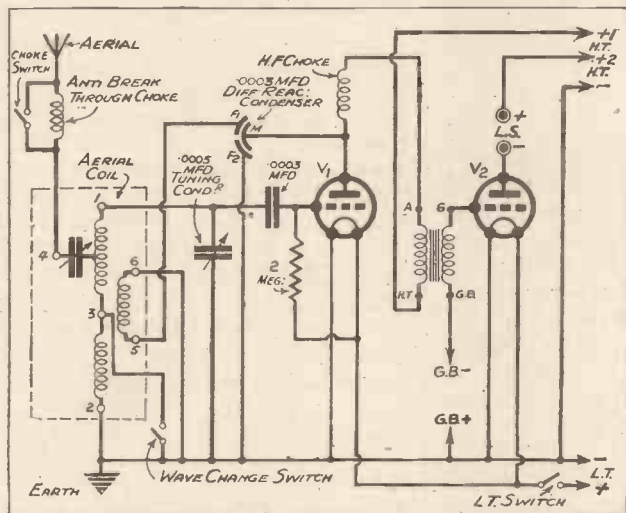

One of the most useful refinements in the circuit is the anti-break-through choke in the aerial circuit to prevent medium-wave interference on the long waveband.

not be likely to affect even the shelf life of the G.B. battery), by removing the plug in the 1½ volts negative socket of the grid-bias battery.

Pick-Up Bias

Incidentally, it is due to this slight current through the grid leak and potentiometer resistance in series, which act as a potential divider across the G.B. and L.T. in series, that the 2 volts positive on the detector's grid from the L.T. is prevented from tending to more than neutralise the 1½ volts negative from the G.B. battery. When used for pick-up work, the grid is to all intents and purposes fully 1½ volts negative.

ACCESSORIES TO USE

- LOUDSPEAKER.—W.B., Rola, Amplion, Marconiphone, Blue Spot, Atlas, G.E.C., H.M.V., Epoch, Ferranti, Ormond.
- BATTERIES.—H.T. 120 volts. Ediswan, Lissen, Ever Ready, Pertrix, Drydex. G.B. to suit valve. Siemens or as above. L.T. 2-volt. Lissen, Ediswan, Exide, Block, Pertrix.
- AERIAL AND EARTH EQUIPMENT.—Goltone "Akrite"; Electron "Superial"; Radiophone "Receptru" down lead; Graham Farish "Filt" earthing device; Bulgin lightning switch.

SYMBOL FOR DUST-CORE COILS
An engineer's interesting suggestion.

The Editor,
THE WIRELESS
CONSTRUCTOR.

Sir,—The universal application of dust-core radio-frequency inductances seems to call for standardised representation.

In the development of Nucleon

EDITOR'S NOTE:

The suggestion of Mr. Tyers is a very interesting one, and as a matter of fact we had already instructed our draughtsman to use a dotted symbol for such inductances. Obviously it is to the advantage alike of amateurs and of radio engineers that the symbol chosen should be a truly representative one, easily associated with the apparatus it denotes.

EFFICIENT COMPONENT GROUPING

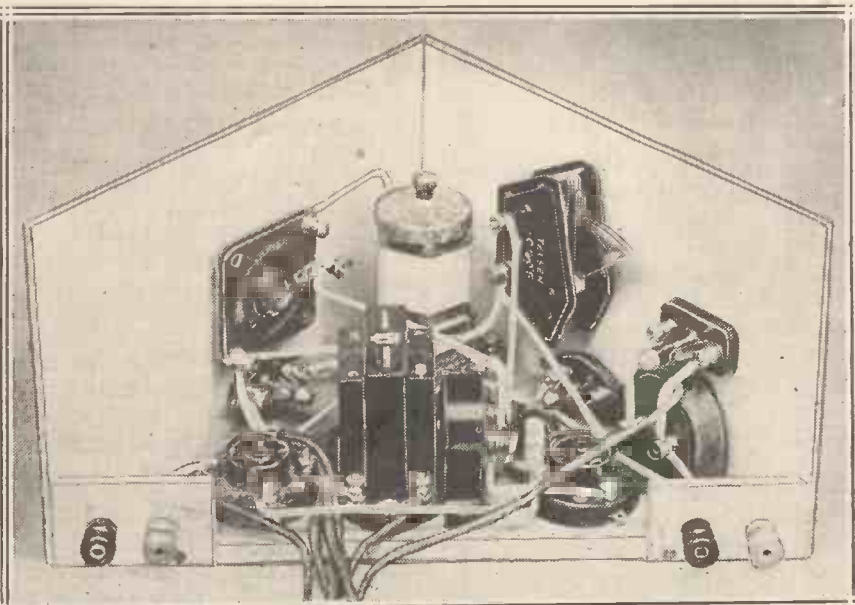

The dual panel not only enables all components to be close together, but also permits the wiring to be kept short by the adjacent positions of parts that have to be joined.



Practical notes on what stations to look for and how to get the foreigners that are coming over well.

THE much-talked-of Lucerne Plan, upon which wavelengths of the European stations will be based during the coming winter, will be more or less accurately appraised by the time these words appear; and it already seems certain that the familiar gap between about 600 and 1,000 metres, which has for so long been a no-man's-land for listeners, will in future hold some very interesting transmissions.

No doubt the set-makers will be disgruntled about this fact, but it was inevitable that the width of the broadcasting bands should be increased some day; and encroachment on that gap would certainly seem to be the best way to cover more programmes and attain better spacing between them.

(An incidental effect will be that the old nomenclature of "long waves" and "medium waves" will have to

be revised. But it was time that something more scientific should be adopted, and any difficulties in starting the Lucerne Plan will be more than counteracted by the better broadcasting reception that will follow in its train.)

The new Vienna station, on 517 metres, is proving to be of great interest to the British listener. If you have not heard its programmes, try after dark, about one degree above the Brussels No. 1 dial reading.

If the new station happens to be in form you will be surprised at the strength from this 760-odd-miles-distant transmitter. It is situated at Bisamberg, just outside the Austrian capital.

As a matter of fact, all the top-of-the-dial stations seem to be going particularly well just now. Florence on 500.8 metres is sometimes easily

mistaken for the North-Regional if a gramophone record in English is being played. Whilst Brussels No. 1, Prague, and the group immediately below—Langenberg, Lyons La Doua and Beromünster, on 473, 465.8 and 459 metres respectively—often romp in after dark on a good evening.

So far there does not seem to be much point in trying to get daylight results from the new Vienna. Not necessarily because the 100-kilowatt is incapable of them, but because in the daytime the engineers revert to the old transmitter, according to the news at the time of writing. But, of course, this arrangement may be altered at any time.

Lower down the dial there is the usual prolific crop of good programmes. And of special interest is the curious behaviour of Stavanger, the little Norwegian on 240.6 metres.

With a power of merely half a kilowatt it sometimes contrives to get over to this country quite clearly in daylight. This is surely one of the most curious freaks which the keen set-owner is able to encounter, the distance from Stavanger to English aërials being some nine hundred miles or so!

On long waves the X's (atmospherics) have been very troublesome at times, but on the whole there has been no cause to grumble at the entertainment provided by this waveband.

Correct Matching

THE importance of correctly matching the loudspeaker impedance with that of the output valve is a subject that has often been dealt with in this journal, and most readers will have realised by now how necessary such a procedure is. But it has not always been easy to decide from the available literature what is the correct speaker impedance for a given output valve.

With the object of providing a handy guide, Messrs. Reproducers & Amplifiers, of Frederick Street, Wolverhampton, have prepared a comprehensive chart, available to any reader of THE WIRELESS CONSTRUCTOR on application to the above address.

To cover postage a 1½d. stamp should be forwarded. The details supplied cover dozens of valves—no fewer than nine different makes, in fact.

Simple Soldering

Those who are particular about the quality of their soldering will do well

POINTS FOR PURCHASERS
 Interesting details from manufacturers about recent trade activities.

to make a note of Solon Resin-Cored Solder, a product of W. T. Henley's Telegraph-Works Co., Ltd.

It complies with the British Standards Institution specification, being 50 per cent lead and 50 per cent tin, with pure resin as the flux. The requisite quantity of resin is contained in the hollow of the solder, and as its melting point is low it flows on to the work in time to form an adequate flux.

"Solon" is put up in convenient-sized sixpenny reels.

Further Aids to Constructors

Following the success of their folder, "A Matter of Connection," Lectro Linx, Ltd., have issued a new leaflet descriptive of other "Clix" components.

It is called "Further Aids to Constructors," and will be forwarded to any reader who applies to the firm at 79a, Rochester Row, Westminster, London, S.W.1.

A Pocket Aerial!

An aerial which can be carried in the pocket is obviously one of considerable interest, and there are many advantages in "Plastape," the new ribbon-wire product of Kenden, Ltd., 134, Pentonville Road, London, N.1. Particulars will be supplied on request.

For "Class B" Output

"All battery sets without quiescent push-pull or 'Class B' amplification must be out of date," boldly proclaim Sound Sales, Ltd., and certainly the rapid success of their specialised lines for these purposes would lend strong support to that view. Leaflets giving full details of this enterprising firm's products are obtainable from them at Tremlett Grove, Junction Road, Highgate, London, N.19.



As I write, the clouds gather round and trouble is in the air—or rather the ether.

I recently ventured the opinion that it was not impossible that war might be provoked by broadcasting.

We have already had Russia telling us about the trial of the Britons and promising "a Russian picture post-card to those who write and give their opinions."

We have also had varied comments on the religious service from the B.B.C., which included topical but certainly provocative references in the prayer for "our slanderers and persecutors." Many people, even in this country, felt that this was a cynical abuse of religion.

A Sinner's View

I don't mind saying that the circumstances encouraged cant and humbug. My imagination boggles at the idea of a million listeners reverently praying for the so-called slanderers and persecutors. Those who felt the Russian trial an outrageous travesty of justice would not be in the mood to follow the great example. While those—an equal number—who reserved their opinion would resent the attack and the gratuitous assumption that heavenly opinion could be mobilised against the Soviets.

Perhaps I am too much a sinner to pray in true Christian spirit for someone I might consider a slanderer and persecutor. To pray for the Ogpu may or may not be good Christianity.

In many cases, however, it must be sheer hypocrisy.

The Curse of Radio

It is not to be wondered at that many people even talked of blasphemy. These columns, however, are not concerned either with religion or politics; but I *am* concerned with the B.B.C. programmes and the use made of the ether.

As I have no politics (I have not

tation to use classic beauty preparations. But if you or I think we can close our ears to it we are very much mistaken.

Propaganda is going to be the curse of radio. Press censorships of the continental type will be futile. Country will clash with country.

Look what is happening now.

Czechoslovakia has passed a law making it illegal to hear Nazi propaganda in public places, through open windows, or even in the family circle if friends are present.

"Nation Shall—"

Tuning-in a German station may thus land the Czechoslovakian listener in prison for two years! All three monkeys must be imitated; it is not enough to speak no evil and think no evil; he must hear no evil.

It must be a hard life for the "DX" hound in Prague.

As a matter of fact, Germany is too close to the Czechs and Slovaks for real comfort, and the lingo of the Teutons is too well understood by their neighbours.

This is not the whole story, however. The Nazis, fearful of lying tongues wagging in front of foreign microphones, are proposing (according to the *Nachtausgabe*) to broadcast "denials" from a special station.

Germany, of course, has a complete censorship, and with national thoroughness is now attacking the radio invaders.

The idea is that the special station

ARRESTED AS A SPY!

Slanderers and persecutors, nightingales and beauty preparations, the anti-decibel campaign and false rumours, all help to enliven this month's dose of armchair chat. Other topics include Mrs. Beeton, the Odessa factory chimney, Kurdish naughty boys, cruelty to performing animals, the snuff habit, and WHAT DADDY DID IN THE GREAT WAR.

voted for ten years or so), and no very definite religious opinions, I may be permitted to say that praying for political enemies is likely to be interpreted as disingenuous, unctuous and hypocritical cant.

The foregoing contains no indication of my own personal feelings towards Russia. But I am not altogether surprised that the U.S.S.R. should desire to propagate their opinions in this country.

Personally I loathe propaganda—whether it is a Muscovite injunction to wear a red tie or a Norman exhor-

Turbulent Kurds and the Loudspeaker Way

shall have a movable wavelength which is adjusted to that of the offending foreigner. The listeners to the foreign station will in the next interval be regaled with "denials" made in Germany.

Picking the Winner

It sounds highly fantastic but quite amusing. What will Prague say to this? It certainly sounds a contravention of the Prague plan.

If the German station ever wants to say "You're a liar" to the B.B.C., it will certainly find plenty of intervals in which to say it. And in a verbal scuffle between a refined Oxford and a lager-fortified old Heidelberg, all my money would go on the latter.

My campaign against the decibel is progressing very favourably. The "sight" and the "street" are coming into their own, and the decibel is now likely to receive its death-knell north of the Tyne or Tweed, or wherever Scotland is, by the popularising of the "mickle."

The only trouble is that no one knows exactly how many mickles make a muckle.

To Fécamp-fans: I am pleased to announce that there is no truth in the rumour that smash-and-grab raiders broke the window of Spinks, in Piccadilly, and carried off three hundred I.B.C. badges.

News from the Broadcasting Centres:

Odessa.—A falling factory chimney struck a workman while he was eating his lunch. He complained of shock, but after treatment at a local hospital he was allowed to proceed home.

Writes a Lanarkshire disciple:

"You are the Mrs. Beeton of radio."

I suppose that this is a compliment on my recipes for better radio. I hope it is not a suggestion that my results are cooked.

Have you ever pictured to yourself the famous authoress who took ten

new-laid eggs, three gallons of cream, half a pound of pâté de fois-gras, and simmered them for two hours and served hot garnished with parsley?

Stout? Middle-aged? As gruff as Miss Brough? A formidable, forbidding female?

Wrong as usual. Mrs. Beeton was a delightful, charming girl who married when she was twenty-five. Unhappily, she died two years later. Her portrait is in the National Gallery.

I see that Kurdish rebels (who most unreasonably believe in "Kurdistan for the Kurds") have been "warned."

Not by disguised Lawrences, or anything romantic like that, but just by a plain yell from an aeroplane.

By amplifying the human voice "a couple of million times," a political officer, the pilot, or even a

THE VOICE FROM THE AIR



This aeroplane is equipped with a giant loudspeaker capable of making its voice heard for miles! It is used for crowd control, for quelling riots, or for warning seditious tribesmen of the errors of their ways.

common wireless operator (who is only half a sahib) can shout down a loudspeaker and from the security of the skies tell the gathered and rebellious clansmen where they get off.

Adding Insult

To be a Kurd at all must be a trial, but to be yapped at all day by an aeroplane must be insufferable. Probably the race will die out, and then there will be no one for us to bomb.

Of course, this telling the Kurds to be good boys and to run along home is the new humane system of warfare. Personally, I should rather be bombed.

I wonder how you actually do tell a conglomeration of Kurds to go home? Perhaps you cry:

"Now, boys, you know quite well the white raj doesn't like you all getting together like this and sulking. Be off with you, or we'll take your orange off you."

"Now don't stand there looking up at us. Get a move on and go away. Come on now and be good or mummy will be unhappy, and you wouldn't like mummy to be unhappy, would you?" If this doesn't do the trick, a B.B.C. announcer might be employed:

"His Excellency the Viceroy desires me to inform you that the Council have expressed the view that it is not in the public interest that you should follow the course you are pursuing and request that you will kindly disperse. Unless this is done, further consideration will have to be given to the matter by His Majesty's Government in India. We are now taking you over to the Metropole Hotel for the . . ."

Probably, however, they have recourse to a fruity bit of Kurdish rhetoric:

"To your tents, oh ye sons of *****, lest worse befall you."

Good; the House of Lords last night rejected Lord Danesfort's Performing Animals (Regulation) Amendment Bill which sought to prohibit the exhibition or training as perform-animals of apes, lions, tigers, leopards, pumas, hyenas, cheetahs and bears.

Taming the Critics

This list (read it again) covers all the more ferocious of my critics. There is now nothing to stand in the way of their being trained.

One, however, wants to train me. He dislikes the comfortable pipe which every month helps to ornament these notes. He wants to reform me. He offers me a genuine guaranteed remedy for the vicious tobacco or snuff habit. It is mild, pleasant, strengthening. For either sex. It overcomes that peculiar nervousness and craving for cigarettes, cigars, pipes, chewing tobacco or snuff.

It is, apparently, unsafe and torturing to attempt to rid yourself of the tobacco or snuff habit (dash it all, why keep bringing that up?—I've never sniffed snuff in my life) by will power. The correct method is to eliminate the nicotine poison from the system. . . .

Oh, go and sniff snuff!

(Please turn to page 199)



B.B.C. NEWS

*Reorganisation at Headquarters—Those
Empire Programmes—Changes in B.B.C.
Control.*

By Our
Special Correspondent

Reorganisation

THE present attack of "reorganisationitis" from which the B.B.C. is suffering is certainly more prolonged than any other attack of the kind I have observed in the past eight or nine years. But now at long last the conclusions are becoming apparent.

It is understood that the Board of Governors asked Sir John Reith to arrange matters so that he would have more spare time for dealing with problems outside the ordinary run, and the only way to achieve this was to reduce the number of people with whom he would have to deal personally. So there emerged the idea of dividing the B.B.C. into two main sections, one concerned with "output" and the other with "administration."

The New Controller

This meant appointing a duplicate controller to work alongside of Sir Charles Carpendale. Col. Dawnay, of the War Office staff, has been chosen for this post and will take up his duties in September.

After that date Sir John Reith will deal directly with Sir Charles Carpendale and Col. Dawnay, in addition, of course, to Major Gladstone Murray, whose public relations and policy functions inevitably keep him close to the head of the business. The new executive committee, corresponding to the old Control Board, will consist of the Director-General (in the chair), Sir Charles Carpendale (Deputy-Chairman), Col. Dawnay, Major Gladstone Murray, and Mr. Noel Ashbridge.

This is obviously less unwieldy a body than the old Control Board.

Brighter Programmes

There are signs of a new endeavour to brighten B.B.C. programmes, not

only on the entertainment but on the talks side as well. This move is overdue, but welcome.

The idea of presentation has been too long absent from the conception of talks; what is wanted now is a clear realisation that a good talk must have real entertainment value; in other words, must be attractive listening.

I hear that Col. Dawnay has ideas on this subject; if so, then his advent should effect some much-needed reforms.

The Empire Broadcasts

The B.B.C. keeps on hammering away at the Empire short-wave service, which is a good deal more popular now than it was even a few months ago. There is, however, still one serious obstacle to the acceptability

of these programmes in the Dominions, and that is the general distrust of "tinned programmes."

Those "Tinned" Items

Time difficulties have made it necessary for the B.B.C. to use the Blattnerphone a good deal, always with acknowledgment. As the situation improves, no doubt the B.B.C. will be able to arrange a larger proportion of direct performances in place of some of the Blattnerphone reproductions.

But critics of the service should not lose sight of the fact that the B.B.C. is still paying the whole of the considerable cost involved. When the Empire Overseas is ready to contribute something to the maintenance of the service, there will be a stronger case for reducing electrical transcriptions.

THE VATICAN CITY RADIO STATION



H.H. the Pope in the Station Director's office at Vatican City.

B.B.C. News—continued

Room at Headquarters

The B.B.C. has been making inquiries of various contractors and furnishers concerning the fitting out of the two houses adjacent in Portland Place which have been acquired as an extension.

It is expected that work will begin shortly, but I have not yet heard to what special purpose the new property will be devoted. There is a plausible rumour that it will be used as an overflow place, accommodating such auxiliaries to broadcasting as television.

Of course, the B.B.C. will now have to face the consequences of timidity in gauging the size of Broadcasting House three or four years ago. It should have been a good deal bigger,

There have been changes the past two years, and it was certainly the intention of the Crawford Committee and the drafters of the Royal Charter that new blood should be introduced annually. Sir Gordon Nairne, retiring at the end of 1931, was replaced by Mr. Harold Brown; Lady Snowden and Dr. Rendall stood down at the end of last year in favour of Mrs. M. A. Hamilton and Lord Bridgman, while Mr. Norman replaced Lord Gainford as Vice-Chairman.

Thus there is now no member left of the original Board appointed by Mr. Baldwin in 1926.

Of the present Board, the Chairman, Mr. Whitley, is likely to continue until the end of the Licence—that is, until December 31st, 1936. Mr.

popular and would increase the efficiency of the B.B.C. His Majesty may by Order in Council add two members to the Board of Governors, and if only one is added he should have specialised entertainment experience.

It is absurd that the controlling body at Broadcasting House contains no representative of entertainment, which is, after all, the basic function of the B.B.C.

Morale of the B.B.C. Staff

I am informed there is more discontent among the B.B.C. staff than ever before. The chief reason ascribed is the uncertainty created by all the rumours of drastic reorganisation and overhauling.

For months Broadcasting House has been aware that the Governors and Sir John Reith were intent upon making drastic changes, but the exact nature of these changes has not yet been divulged officially. Naturally enough, the place is full of rumours of conflicting character, and the result is anxiety for many and restlessness for all.

What puzzles me about it is this: the organisation of the B.B.C. has always been extolled as ideal for its purpose; no opportunity has been lost of pointing out its perfection. Why now the necessity of drastic alteration?

My own feeling is that there is a real danger of the intrusion of bureaucracy.

The more the B.B.C. thinks of organisation the less it thinks of programmes, which, after all, are the reason of its existence.

The Next Inquiry

The next Parliamentary inquiry into the B.B.C. will take place in about eighteen months' time, and will report on what is to be done when the Licence expires at the end of 1936. This will be a much more searching inquiry than any so far held, and for the reason that many more people know about broadcasting now than was the case ten years or even five years ago.

If the B.B.C. hopes to continue in its present form after 1936, it should avoid refinement of organisation and over-staffing, making it clear that it is a factory of programmes all the time.

WORLD ECONOMIC CONFERENCE BROADCAST



The Royal microphone used by the King when broadcasting from the World Economic Conference in London.

and the cost of the provision of the extra space now will be much greater than the added cost would have been of making the place the right size in the beginning.

New Blood

There is already the usual speculation in political circles as to what, if anything, will happen to the B.B.C. Board of Governors at the end of this year.

Harold Brown, who has served second longest, has been in office only two years, and therefore has three years to run in the ordinary course.

Thus, if there are to be changes this year they will have to be in the form of additions rather than substitutions.

A Bigger Board?

This situation provides an excellent opportunity for action that would be

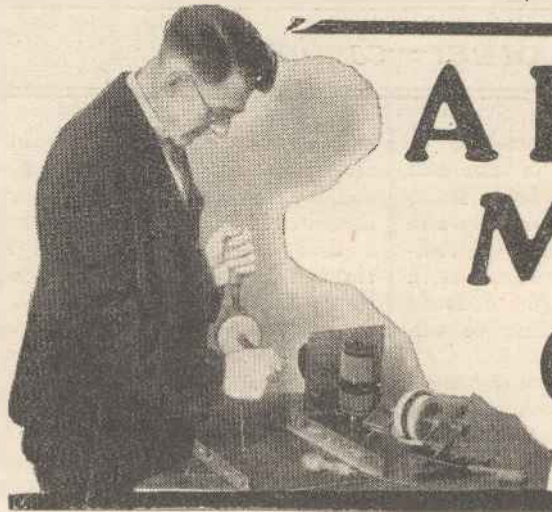

A PRACTICAL MAN'S CORNER

By R. W. HALLOWS, M.A.

Grid Bias for "Class B"

Most of the new "Class B" valves require no grid bias at all, the return being taken to earth or to a negative filament terminal; some of them, though, need half a volt negative bias to be at their best. How exactly is a bias of half a volt to be obtained? It could be done by connecting up a single cell for biasing purposes in the ordinary way and wiring a potentiometer across it.

But there are two objections to this method. The first is that unless you provide a switch for the potentiometer the dry cell is always under load and its life is short. The second is that unless you have an accurate high-resistance voltmeter it is no easy matter to discover the setting of the potentiometer needed to make the bias exactly half a volt negative.

A Satisfactory Method

A very satisfactory method of applying half a volt negative grid bias to any kind of battery valve is illustrated in Fig. 1. Two resistances, R_1 and R_2 , of exactly equal value, are connected across the low-tension bus-bars. Since grid potential is measured

HALF-VOLT VARIATIONS

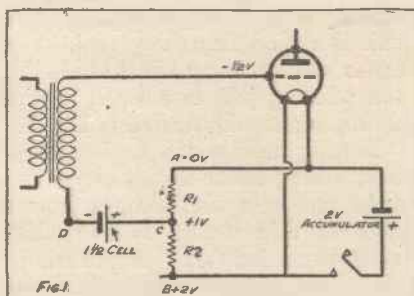

The method of "splitting up" the total voltage available.

Grid bias for "Class B" and flexible connectors are among the subjects helpfully dealt with below. Into these pages, month by month, our contributor packs a wealth of practical information and advice on constructional work, and the regular reader of this "Corner" cannot help picking up a more or less complete training in radio workshop practice.

with respect to the negative end of the filament, the potential at the point A is 0, whilst at B it is 2 volts positive.

As R_1 and R_2 have the same value

EASILY MADE

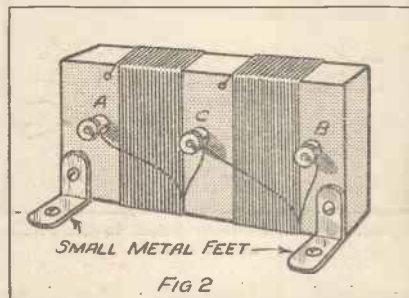

Although so simple, this gadget is very satisfactory in use.

the potential at point C is 1 volt positive. To point C—that is, the join between the two resistances—is connected the positive pole of a single $1\frac{1}{2}$ -volt dry cell, whose negative pole goes to the G.B. or earth terminal of the transformer. The biasing potential at point D is +1 volt - $1\frac{1}{2}$ volts, or $\frac{1}{2}$ -volt negative.

It should be noted that not only "Class B" valves of certain kinds, but also some screen grids, give their best and most economical working with a negative grid bias of about half a volt. The suggested scheme,

therefore, has more than one application in the wireless receiving set.

The Resistance Wire

The two resistances R_1 and R_2 can conveniently be made up, as shown in Fig. 2, in the form of a fixed potentiometer or potential divider. A high value for the two resistances in series is not necessary, since we have only 2 volts from the filament accumulator to deal with. Suppose that we make R_1 and R_2 each 50 ohms, then the total resistance across the accumulator will be 100 ohms.

Two volts, as Ohm's Law shows us, drive .02 amp., or 20 milliamps, through 100 ohms. The total resistance of 100 ohms will mean a negligible drain upon the filament accumulator, and this will be imposed only when the filaments are switched on. No. 34 Eureka wire (double cotton or double silk-covered should be used) has a resistance of just over 10 ohms to the yard.

We shall therefore require ten yards for the windings of the potential divider. There is no need to measure the resistance accurately; all that matters is to make each half of the potential divider of the same resistance

NON-INDUCTIVE

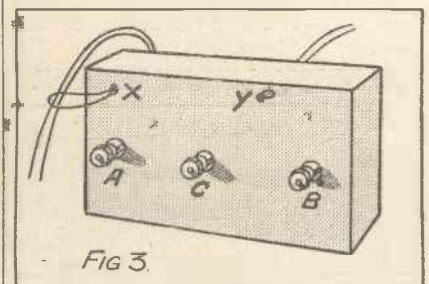

How the wire is arranged to prevent unwanted inductive effects.

A Practical Man's Corner—continued

as the other. We start, therefore, by measuring off two five-yard lengths of the wire.

Making the Component

Cut out a piece of quarter-inch ebonite, hard wood, or any other suitable insulating material about

SIDE BY SIDE

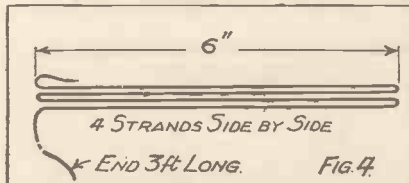

How the wire is folded to begin with.

2½ in. in length by 1 in. in breadth. On this mount three small terminals, one in either end and one in the middle, as shown in Fig. 2. Two small feet made from any odd scraps of sheet metal will be required for mounting purposes, but it is best not to put these on until the windings are in position.

The simplest method of construction is to attach one end of the first piece of wire to terminal A, to wind it on and to connect the "out" end to terminal C. A second piece of wire is then dealt with in the same way between terminals C and B. This may answer well in most cases, but it must be remembered that wire wound on in this way forms an inductance, and the presence of an inductance even of small value is not always to be desired in grid circuits, particularly those which are somewhat prone to developing parasitic oscillations.

A way out of this difficulty is to double each piece of wire before winding it on. The current in adjacent turns of the windings is then moving in opposite directions and the windings as a whole are virtually non-inductive.

Drill a small hole as shown at X in Fig. 3 just above terminal A and

ALMOST UNBREAKABLE

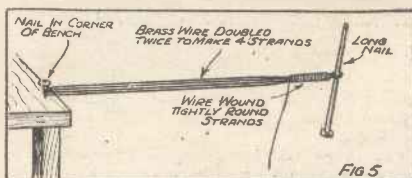

When constructed in this way a very strong connector results after a comparatively easy task.

another at Y near terminal C. Double the first length of wire and pass its loop through the hole. Bring the two ends through the loop and pull tight. Now wind on in the ordinary way, and when the turns are in place fix one of the two ends to terminal A and the other to terminal C.

Treat the other length of resistance wire in the same way, anchoring it at Y and attaching its ends to terminals C and B. Cut out the feet, attach them with 4 B.A. or 6 B.A. bolts to the former, and the component is finished. Its connections are as shown in Fig. 1, the terminals being lettered in the same way in all three diagrams.

Useful Links

Flexible connectors are useful for many purposes in the wireless receiving set. They are, for instance, just the things for the plates of screen-grid valves, for joining grid or H.T. battery units in series and for many other jobs. I have just evolved an extremely handy form of flexible connector which has many advantages. It costs almost nothing to make; it is

THE CONNECTORS

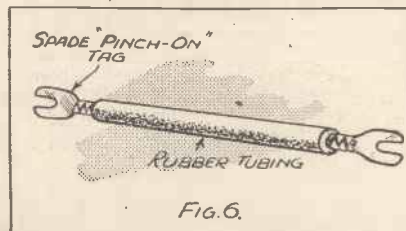

Spade tags are easily fixed to the ends, as shown.

practically unbreakable; though so flexible that it can be bent just as you like, it is firm enough to "stay put" in any position; it can be made in any length and its construction is both easy and quick.

The best material for the purpose is the plain soft brass wire of No. 26 gauge that can be bought in hanks from almost any ironmonger. A hank, which appears to contain untold yards, costs threepence. Here is the way in which a connector 6 in. in length is made.

Begin by cutting off 5 ft. of the wire. Now fold the wire at one end, as shown in Fig. 4, so that you have four strands 6 in. long side by side, and an end 3 ft. in length. Drive a

nail into a corner of the bench and pass the loops made at one end by the four-fold wire over it, as shown in Fig. 5. Put a large nail, a drill or something of the kind through the loops in the other end to give you a handy grip. Hold this in your left hand and stretch the strands tightly. With your right hand wind the long end of the wire tightly round the strands.

You can, if you like, wind the long end of the wire on to an empty cotton reel. Hold this in your right hand and binding becomes easy. Bind the

USING A NETTING NEEDLE

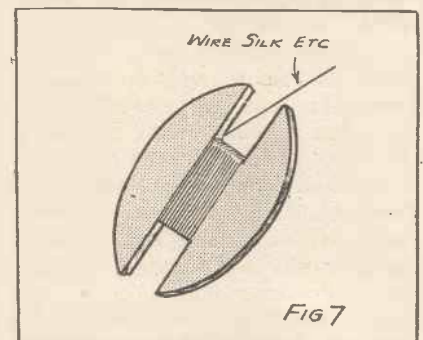

This makes an excellent accessory for binding and winding.

whole length of the strands and secure the end by a pinch with the pliers. Cut off the loops with wire nippers, and on one end of the connector pinch a spade tag as shown in Fig. 6.

Slip on a piece of thin rubber tubing, attach a spade to the other end and the connector is finished. If you want to make a flexible connector for grid or high-tension batteries, don't cut off the loops, but use them for attachments to the wander plugs.

A Binding Tip

In the preceding paragraph I mentioned the use of an empty cotton reel for avoiding the awkwardness of binding with a longish end of wire. This is a good emergency tool, but a better one for many kinds of binding and winding jobs is a small netting needle, such as illustrated in Fig. 7.

Netting needles can be bought at most fishing tackle shops, or you can make one in a few minutes from a piece of thin wood. It is nothing more than a flat "H"-shaped winder which can be filled with cotton, silk, wire, or any other material with which you are working.

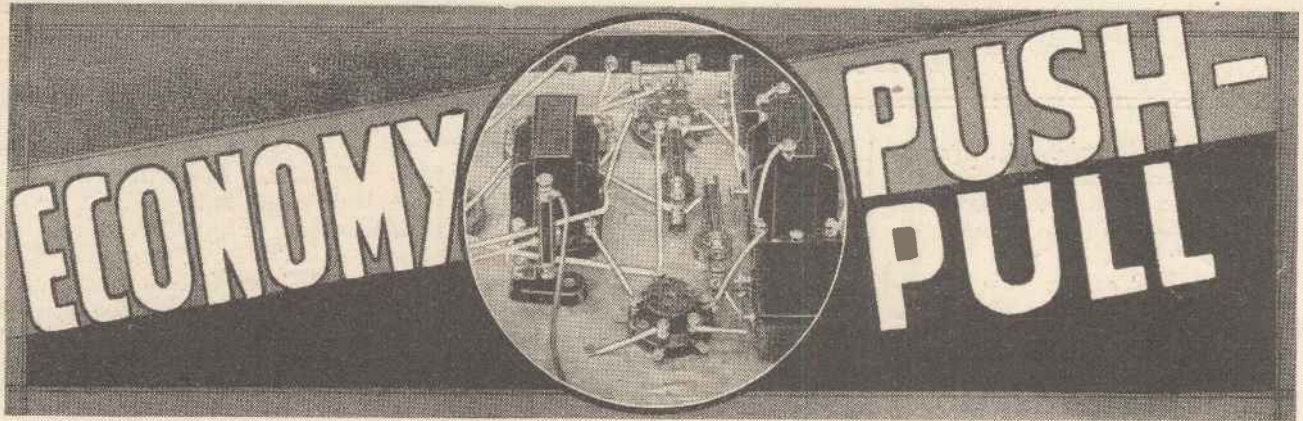

The up-to-date topics of Quiescent Push-Pull (Q.P.P.) and "Class B" Amplification are the subjects dealt with by our contributor, Mr. F. C. McNeil, and he certainly makes this outline both informative and really interesting. It is full of practical suggestions about the new systems.

THERE would appear to exist a good deal of misunderstanding regarding the newly-developed systems for obtaining large power output in conjunction with economy in H.T. consumption, known respectively as Quiescent Push-Pull (Q.P.P.) and "Class B" power amplification. On the one hand the terms are regarded as being more or less synonymous, and are equally applied to the system which originated in this country (Q.P.P.); whilst, on the other hand, many who are aware of the existence of the two systems are unacquainted with their distinguishing characteristics, and are therefore apt to confuse the terms.

Distinguishing Features

This confusion is due to the fact that both systems have features in common which distinguish them from normal power, or "Class A" operation. At the same time, however, the Q.P.P. and "Class B" systems are differentiated both by the type of valve employed and the operating

conditions, and are, therefore, recognised as two distinct systems by the leading technicians.

THE THREE METHODS

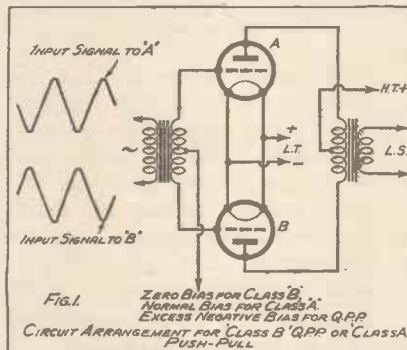

Although the circuit arrangements for "Class B," Q.P.P. and ordinary push-pull are very similar, there are, nevertheless, wide differences in practice. This applies both to the operating conditions and the design of the special input transformers employed.

Let us first of all consider the features common to both Q.P.P. and "Class B" systems which distinguish them from "Class A" or normal

push-pull operation. They may be enumerated as follows:

1. Two valves are employed, the input signal to the grid of one valve being of the same value, but 180° out of phase with the input signal to the grid of the other valve. In this respect they correspond to "Class A" push-pull (Fig. 1).

Small Standing Current

2. The standing anode current when no signals are being received is of the order of 1 or 2 milliamps. only, much less than the standing anode current for "Class A" push-pull giving the same output.

This is illustrated by Figs. 2(a) and 2(b), on which are marked the operating points O, P and Q for "Class A," Q.P.P. and "Class B" operation respectively.

3. When signals are being received the increase in anode current produced by the positive half-cycle of the input signal is much greater than the decrease produced by the

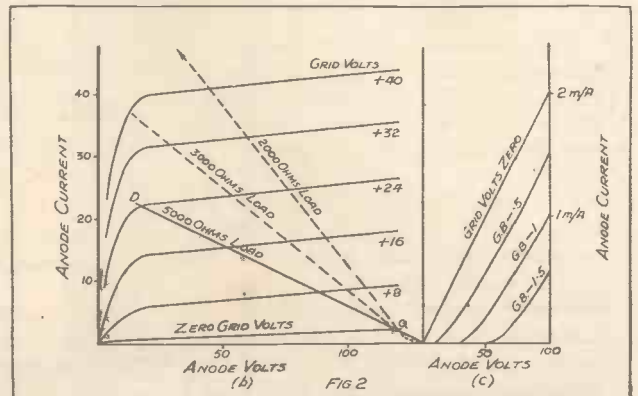
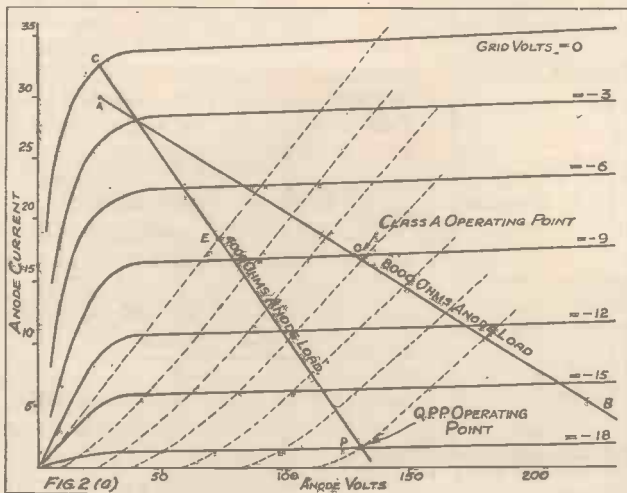

Fig. 2(a) shows the anode-volts-anode-current characteristic for a high-efficiency pentode (full lines) and medium-power triode (dotted lines) applicable either to ordinary "Class A" or Q.P.P. operation. Fig. 2(b) depicts the anode-volts-anode-current characteristic for a high-impedance triode such as might be used for "Class B" output. Fig. 2(c) is the anode-volts-anode-current characteristic plotted for the negative bias region of the same valve.

Economy Push-Pull—continued

negative half-cycle. As a result the average H.T. consumption varies in accordance with the strength of the input signal.

For "Class A" push-pull the average H.T. consumption remains at practically the same value as the standing H.T. consumption for varying input signals.

"Flattened Out"

Fig. 3(a) shows the anode current fluctuations for a sine wave input of varying magnitude operating along the load line P.C. in Fig. 2(a) (Q.P.P. system), or along the load line D.Q. in Fig. 2(b) ("Class B" system). It will be seen that the negative half-cycles are "flattened out" in the output current, and that the average H.T. consumption is in proportion to the input signal.

ANODE CURRENT

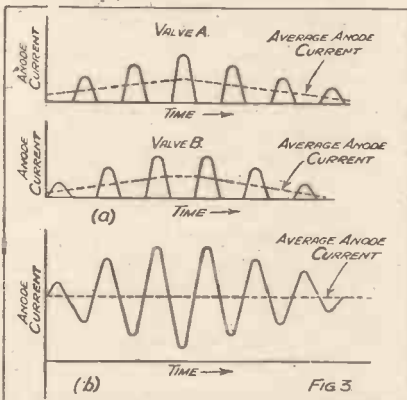

a) shows the current change for Q.P.P. and "Class B" effects, whilst (b) shows anode-current fluctuations in ordinary or "Class A" amplification.

The corresponding anode current fluctuations for "Class A" operation are shown in Fig. 3(b), from which it is evident that the average anode current is independent of the input signal.

4. Severe even harmonic distortion occurs in the wave-form of the output current from each valve. By combining these outputs with a centre tapped output transformer this distortion is eliminated in the current supplied to the loud-speaker.

Combined Currents

It is evident from Fig. 3(a) that the wave-form of the output current is severely distorted as compared with the sine wave input.

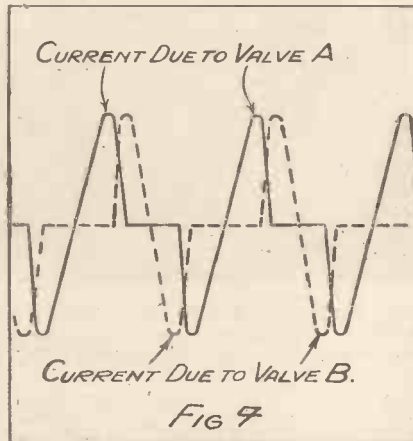

The current in the output transformer secondary due to the Q.P.P. or "Class B" valves is shown by the dotted lines. The full line illustrates the resulting current in the loudspeaker.

Provided, however, that the wave-form of the positive half-cycles is unaltered, the resulting wave-form, after combination by the output transformer, will be a pure sine wave as shown in Fig. 4.

5. The maximum theoretical power efficiency (max. undistorted power output Average H.T. power consumption in anode circuit)

for both systems is 78.5 per cent.

For "Class A" operation the power efficiency can never exceed 50 per cent, and is usually much lower.

Q.P.P. and "Class B"

We now come to consider the features that distinguish "Class B" from the Q.P.P. system. For "Class B" output high impedance triode valves are employed, working at zero bias, whereas for Q.P.P. a low impedance triode or power pentode is employed

GRID IMPEDANCE

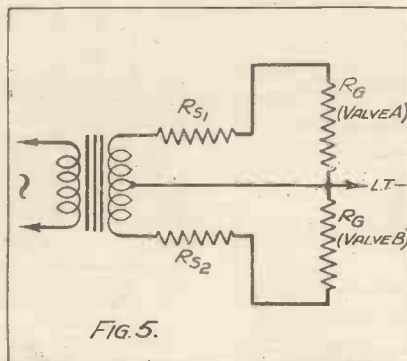

The grid impedances R_G are in series with the transformer secondary resistances R_{S1} and R_{S2} .

negatively biased practically to the cut-off point. Apart from this, the main difference is in the grid circuit functioning. For Q.P.P. this is the same as for "Class A" push-pull. With "Class B," on the other hand grid current will flow during the positive half-cycles and the grid impedance for the active portion of the input signal will be low (with large type valves as low as 1,000 ohms).

BALANCED LOAD

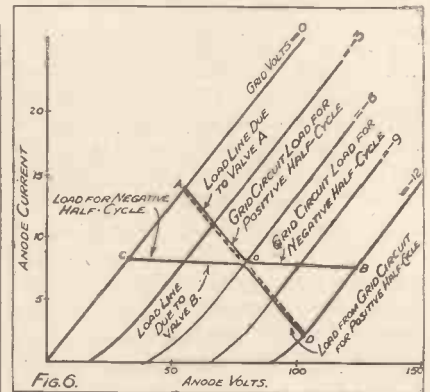

If the input to the grids of the output valves is to be undistorted, the load in the anode circuit of the "driver" valve must be constant. The load line due to each valve individually would cause distortion, but in conjunction they balance to give the load indicated by the dotted line.

This grid impedance is in shunt across each half of the input transformer secondary as shown in the equivalent circuit of Fig. 5. It is obvious that the transformer secondary resistance R_S is in series with the grid impedance R_G . A portion of the input signal will, therefore, be wasted across R_S , in proportion to its value as compared with R_G . Hence the transformer secondary resistance must be chosen to be small in comparison with the grid impedance, in practice less than 2-300 ohms. Grid stoppers are, of course, out of the question!

Special Transformer

Secondly, if a transformer with a normal step-up ratio is employed, the anode load of the preceding valve, which for practical purposes is roughly equivalent $\frac{\text{grid impedance}}{\text{ratio}^2}$, will be reduced to an exceedingly small value, and the amplification will as a consequence be negligible.

In order to obtain a reasonable

(Please turn to page 204)



POINTERS ON A.V.C.

by **CARDEN SHELLS**

THE object of automatic volume control is to increase the sensitivity of the set when receiving weak or distant signals, and to cut it down for strong signals. This keeps the loudspeaker volume at the same level whether one is receiving a foreign station or the local B.B.C. programme. What is perhaps even more important, A.V.C. serves to smooth out the changes in signal strength caused by fading, particularly when listening to a distant station.

Simple in Theory

The control is applied by running the output from the detector valve through a resistance, and using the potential drop across that resistance to regulate the grid bias of the preceding H.F. valves, so that they amplify at their best on a weak signal but below their best on a strong one.

This sounds quite simple in theory, but there are certain "snags" to be overcome in practice. To begin with, the reason why the first attempts at A.V.C. did not prove very successful was mainly because we had not got the right kind of valves for the work.

A TYPICAL ARRANGEMENT

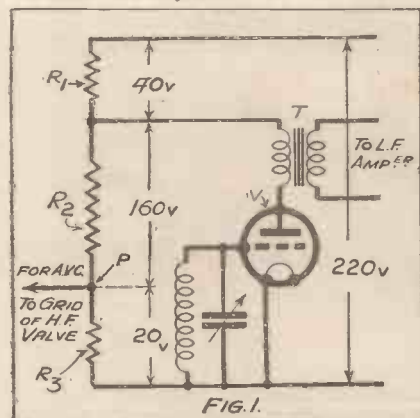

The automatic volume control (A.V.C.) bias is obtained from the voltage developed between R_2 and R_3 , as shown.

AUTOMATIC VOLUME CONTROL

—which strengthens a programme when it fades, without the slightest assistance from the set-owner—is bound to become more and more popular. The advantages are manifold. And here is a review of the main features which will put you at fault with this important improvement in radio reception methods.

The variable- μ valve was the first step in the right direction. The next was the introduction of the double-diode detector which, by giving full-wave rectification of the carrier-wave, increased the amount of "control" voltage that could be produced. Alternatively, an extra valve is sometimes used in order to amplify the rectified voltage before it is applied to the grids of the amplifiers.

Useful Innovation

Still another useful innovation is the double-diode triode valve, which combines the role of a full-wave rectifier for the C.W. with that of an ordinary detector for the signals proper.

All this of course puts an entirely fresh complexion on the problem, and automatic volume control is now a definitely practical proposition and has certainly come to stay.

Quite apart from the particular form of rectifier used to produce the "control" grid bias, the application of A.V.C. to a set raises a number of interesting side issues, which are well worth consideration, specially by those of an inventive turn of mind.

Effect on Tuning

Take, for instance, its effect on tuning. If the automatic volume control is working properly, there will be no rise and fall of signal strength as one moves the tuning-knob to and fro. A station comes in suddenly at full strength, and then, as the tuning-knob is rotated, as suddenly disappears.

The correct setting is obviously somewhere between these two points—probably midway; but as it is important from the point of view of quality that the circuits should be accurately in tune—and not slightly "off" the resonance point—the element of "chance" is ruled out by using a "visual" tuning indicator. This usually consists of a small neon lamp which "flashes" at the precise point when all the circuits are properly in tune.

Speed of Action

Another important point is the rapidity with which the A.V. control bias comes into action. If it is too slow, it will not boost up a distant station sufficiently quickly, and so one may lose it altogether when searching. Also, it tends to "hold" the local station at full strength too long, and so may "mask" a weak station transmitting on a near-by wavelength.

On the other hand, the control should not be too quick on the uptake, because then it is likely to cause distortion. There is certainly nothing to be gained either by increasing the general background of "noise," or by trying to bring in a station that is really outside the effective reach of the set.

AN INGENIOUS VARIATION

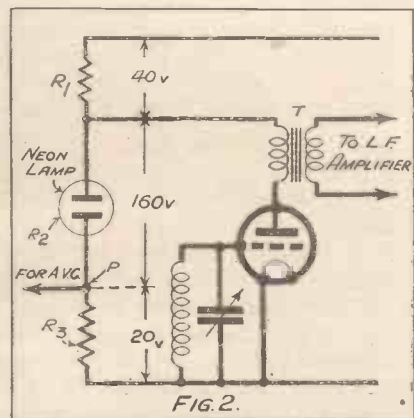

The neon lamp takes the place of R_2 (in Fig. 1), and a much greater voltage variation is made available for A.V.C.

“Pointers” on A.V.C.—continued

For this reason designers prefer to employ what may be called “retarded A.V.C.” Here one of the valves is deliberately put out of action by applying a heavy negative bias to it, so that no very weak signal can get through the set. In other words, the

IN PRACTICE

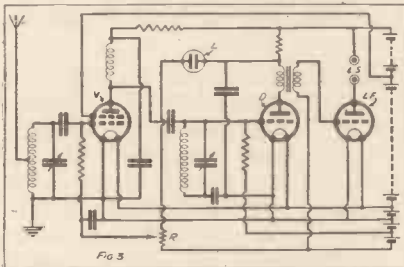

How the Fig. 2 method with neon lamp is applied to a typical three-valve receiver.

loudspeaker is kept “mute” until a carrier-wave of a certain minimum strength comes in. Too-distant stations are not heard at all, whilst the usual background of noisy “static” is also completely wiped out at in-between settings.

Like “Switch Tuning”

In practice, searching the ether with retarded A.V.C. is very much like “switch tuning.” One hears a station at full strength, and then there is a dead quiet interval until the next station is tuned in, and so on.

An outstanding problem, a solution of which would simplify A.V.C., is to produce enough rectified voltage from an ordinary detector to control the preceding H.F. amplifier.

A typical circuit arrangement is shown in Fig. 1, where the rectified signals from the detector V pass on to the L.F. amplifier in the usual way through the transformer T, whilst the rectified H.F. components flow through a potentiometer resistance to produce the A.V.C. biasing voltage, which for effective control should have a maximum value of 20 volts.

Voltage Drop

Now the tapping point P is connected directly to the H.T. supply, and also to the grid of the preceding H.F. amplifier. In order to “drop” the 220 volts H.T. to the proper value for the grid, we must have first a decoupling resistance R₁ which accounts for, say, 40 volts, and then resistance R₂ sufficient to drop another 160 volts, so that the control resistance R₃ carries the required 20 volts.

Obviously, such an arrangement is very inefficient, because most of the total voltage drop caused by changes in the plate current of the detector valve (as the signal strength rises or falls) is lost in the resistance R₂. Only a very small fraction appears across the resistance R₃ where it can be used for A.V.C.

Use of Neon Tube

An ingenious way out of the difficulty is shown in Fig. 2, where the resistance R₂ has been replaced by a neon lamp, which has the property of maintaining a constant voltage drop (approx. 160 volts) across its terminals irrespective of any small changes in the current passing through it.

It will be seen that the tapping point P still carries the same voltage as before, but any change in the plate current of the detector valve (due to a rise or fall in signal strength) is now concentrated in the resistance R₃, so that a greater voltage variation becomes available for automatic control.

The arrangement is shown applied to a simple three-valve set in Fig. 3, where the neon lamp L, shunted across the detector valve D, allows the full P.D. to appear across the

series resistance R, from which it is fed back to control the amplification factor of the variable- μ valve V.

 * EASY CONDENSER FIXING *

A SIMPLE method of fixing electrolytic condensers in a set is illustrated below. This arrangement is applicable only to those types which can be mounted in any position, however.

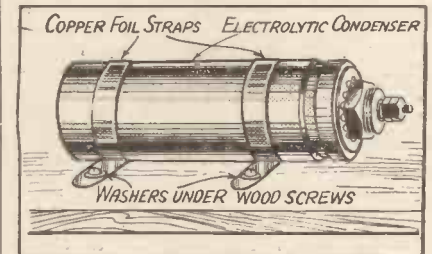

The small straps that hold the condenser in place can be cut from scrap pieces of copper foil, or any similar material. And if washers are used at the points where the holding down screws are located, it will prevent the latter “chewing” up the foil.

A SET WITH AUTOMATIC VOLUME CONTROL

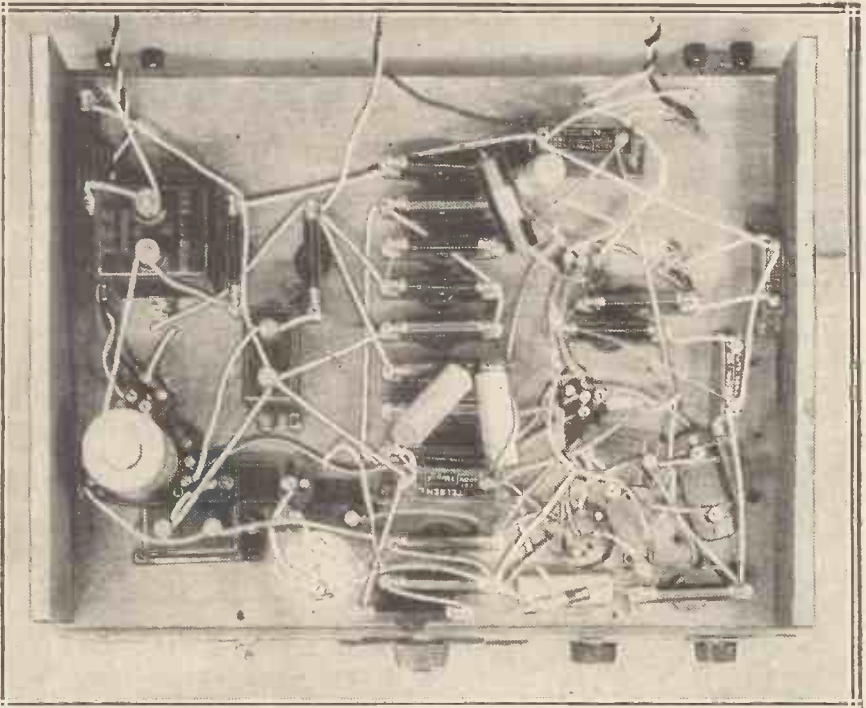

This is the underside of a powerful up-to-date receiver in which the new double-diode triode and multi- μ H.F. pentodes are used. The tremendous amplification of the latter is controlled automatically, the set being designed on the lines dealt with in the above article.



IT is the purpose of this article to dispel the widespread misconception that tone correction in a pentode output stage provides a complete and satisfactory method of overcoming frequency distortion, or that a pentode valve, in conjunction with a loudspeaker with a rising treble characteristic, will effectively compensate for high-note loss in the previous stages of the receiver.

"Power Sensitivity"

In order that the explanation may be fully grasped, it is desirable that the reader should have a clear conception of the meaning of the terms "power sensitivity" and "power output."

Power sensitivity is a term which defines the relationship between the power in the load impedance (loudspeaker) in the anode circuit of the valve and the oscillatory signal voltage applied to the grid of the valve. As an example, suppose that we take a medium and super-power pentode and apply to the grid of each a small signal voltage having the same value in each case. If the signal voltage is not too great it will be found that the loudspeaker volume from the medium-power pentode is greater than that from the super-power pentode. Since for the same input signal it provides the greater output, the former valve can be said to have a higher power sensitivity. As within certain limits the output volume is proportional to the square of the input signal voltage, or grid swing, it is reasonable to define power sensitivity as

$$\frac{\text{Power dissipated in load}}{(\text{Grid swing})^2}$$

The power output, on the other hand, is the greatest amount of power that the valve is capable of handing over to the loudspeaker without audible distortion under the given

operating conditions irrespective of the grid swing required. In the case of the two valves which we have mentioned, it is the super-power pentode which will give the greater power output, although on account of its lower-power sensitivity it will require a much larger grid swing.

Both power output and power sensitivity are dependent upon the value of the anode circuit load—that is, the effective loudspeaker impedance. With triode output valves the power sensitivity is a maximum when the L.S. impedance is equal to the valve impedance, but the power output is a maximum when the loudspeaker impedance is about two and a half times

point corresponding to these operating conditions is marked O. If the valve is working with zero anode load—i.e. with the anode connected directly to H.T.+, and a sine wave input signal is applied so that the grid is swinging from 0 to -18 v., the only effect will be a variation of anode current between 2 and 38 milliamperes, the anode voltage remaining constant.

Operating Conditions

This state of affairs is indicated by the line A O B—the "no-load" condition. If we now insert in the anode circuit a load, consisting of a loudspeaker whose impedance at the frequency of the oscillating grid voltage is 5,000 ohms, for the same amplitude of grid swing the anode voltage will now fluctuate as well as the anode current. The anode voltage fluctuations correspond to the power dissipated in the load—the power output or loudspeaker volume. This operating condition is shown by the load-line C O D. By increasing the load to 10,000

ohms we can obtain still larger fluctuations of anode voltage for the same variation of anode current and grid voltage (load-line E O F). The power output is therefore increased. For a further increase in load to 20,000 ohms, however, there is a reduction in the output, due to the fact that it is no longer possible to apply the same value of grid swing and obtain the same amplitude of anode-current fluctuation on account of overloading in the anode circuit. This state of affairs is indicated by G O H.

The table below summarises the performance for the various operating conditions.

Anode load	Power output	Power sensitivity
5,000	370 mw.	4.5 mW./V ²
10,000	780 mw.	8 mW./V ²
20,000	250 mw.	15.5 mW./V ²

QUESTIONS OF QUALITY

Some very important aspects of quality reproduction are reviewed in this outspoken article. The author scouts the popular idea of using a non-compensated pentode to boost high-note response, and he is equally frank and illuminative about certain commonly used arrangements for tone-control and correction.

By F. C. McNeil

the valve impedance. It is usually arranged, therefore, for the load to have such a value, either by the choice of a loudspeaker with a suitable impedance or by means of a variable ratio output transformer.

The Chief Concern

It is the behaviour of the pentode valve under varying load conditions that chiefly concerns us. In order to illustrate the facts the diagram (Fig. 1) has been prepared. This illustrates a graph showing the relationship between anode current and anode voltage, for different fixed values of grid voltage, for a typical 2-volt pentode valve.

We will assume that the steady H.T. voltage applied to the anode of the valve is 150, and 9 volts negative bias is applied, so that the steady anode current is 20 milliamperes. The

Tone Control and the Pentode—continued

From a consideration of these figures the following facts can be readily inferred :—

(1) Starting with zero anode load the power output increases as the load increases until a maximum value is reached for a critical value of load, after which a further increase in load causes a decrease in the power output.*

(2) The power sensitivity increases very nearly in direct proportion to the load value.

Effect of Frequency

Now, with moving-iron loudspeakers, and some of the cheaper types of moving-coil loudspeaker, the impedance varies considerably throughout the frequency range. Usually, it has a minimum value in the 50–200 cycle region, increasing, with a number of resonance peaks en route, to a maximum value in the 5,000–10,000 cycle region. It is therefore evident that a loudspeaker of this type is unable to provide a constant load, and when operated with a pentode valve its performance will vary according to the frequency of the note being reproduced.

When connected, in fact, directly in the anode circuit of a pentode

UNDER VARYING LOAD

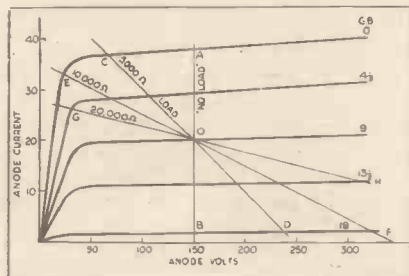

Fig. 1. The relationship between the anode current and anode voltage, for different values of grid voltage, when employing a typical 2-volt pentode.

valve such as the above, the following state of affairs would arise :—

(a) For the lower frequencies for which the impedance is below that required for the maximum undistorted power output (M.U.P.O.) the power sensitivity will be low, so that the bass response will be deficient.

(b) Apart from resonance peaks, the M.U.P.O. will be obtainable

* That value of load which gives the maximum undistorted power output (M.U.P.O.)—in this case about 10,000 ohms—is called the "optimum load."

only for a narrow band of frequencies in the middle register.

(c) For the higher frequencies, where the impedance is above that required for the M.U.P.O. the power sensitivity is high, so that the response to weak, high-pitched signals will be greatly accentuated. On the other hand, the power output is limited, because larger signals cannot be accepted without overloading; in fact, for any but weak signals the response in the upper register will be accompanied by severe harmonic distortion.

Speaker Shunting

The tone-correction or tone-control circuit was introduced to overcome this defect. It consists of a resistance and condenser in series, shunted across the loudspeaker (Fig. 2). It functions by reason of the fact that the condenser reactance will be less for the higher than for the lower register, so that the resistance in series with the condenser will have a marked shunting effect, reducing the total anode circuit load for high notes to a reasonable value, and so counteracting the overloading.

In doing so, however, it is taking a proportion of the power which should be given to the loudspeaker—i.e. whilst reducing the undesirably excessive power sensitivity, it is also reducing the power output. In fact, although it is possible by a choice of suitable values for the tone-control to ensure that the anode load does not far exceed the maximum, the greater the excess of loudspeaker impedance over the optimum load value, the greater the waste of power in the tone-control circuit.

High-Note Sensitivity

In brief, the excessive power sensitivity for high notes which characterises a loudspeaker with a rising treble characteristic can be overcome only by a sacrifice both of power output and power sensitivity in proportion to the excess of impedance. To avoid distortion, the high-note response must be reduced below that for the middle register.

A numerical example will make the matter clear. Let us take the case of the above-mentioned valve operating a loudspeaker with the following impedance values.

Frequency	Impedance
500	5,000
1,000	10,000
5,000	20,000

The tone control may be assumed to consist of a resistance of 10,000 ohms and a .05 mfd. condenser.

Wasted Power

The M.U.P.O. will, in this case, be obtained at a frequency slightly over 1,000 cycles.

At 5,000 cycles the condenser reactance can, in comparison, be neglected, and the load will consist effectively of two shunt impedances

FOR TONE CONTROL

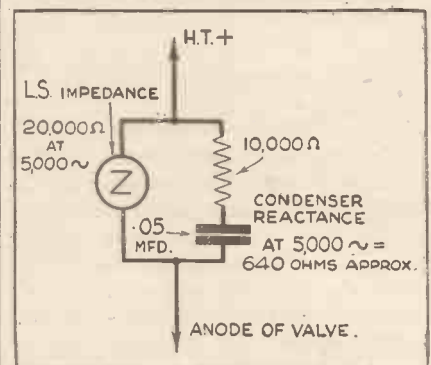

Fig. 2. Resistance and condenser are in series and shunted across the loudspeaker in this representative arrangement.

providing a total load of about 7,000 ohms.

For this load the power output is 600 mw., but two-thirds of this power, or 400 mw., is actually wasted in the tone-control resistance, the remaining 200 mw. only being available for the loudspeaker, as compared with the 750 mw. output in the 1,000-cycle region.

It is therefore evident that when operating an unsuitable loudspeaker with a pentode valve we have no choice but to limit the high-note response to prevent high-note distortion.

A Fallacious Idea

It will also be clear that the idea of using a non-compensated pentode to boost high-note response is quite fallacious. If the high notes are severely weakened, it is true that the response will be improved, but nothing like sufficient to compensate for the loss. If the response is only moderately weakened there will be slight compensation—and severe distortion.

(Please turn to page 201.)



PARASITIC OSCILLATION

By L. DIVER

Some information about a curious fault you may have experienced and practical suggestions for putting it right.

OUT of the number of owners of the five-valve portable type of receiver—and their name must be legion—at least a goodly percentage must have suffered from the evil effects of parasitic oscillation. Not that it is only the five-valver that suffers; far from it, for its baneful effects are sometimes found in the humble two-valve set. In fact, almost any set which has a frame aerial comes under suspicion.

On the Long Waves

And now I suppose you are wondering what it is all about, and whether you—or, rather, your set—suffers from it. Parasitic oscillation, then, is nothing more than uncontrolled oscillation, but of the wrong frequency—generally of a very high one, and is mostly manifest on the long waves.

The symptoms are generally as follows. You turn the reaction knob to increase signal strength, and at a certain point the set falls into oscillation with a nasty plop, and, if you listen carefully, you will

hear an awful lot of mush, together with a fair sprinkling of Morse signals. Should you hear Morse, you can bet, with safety, that you are receiving something from the short-wave band, probably round about the region of 30 metres or so.

GRID STOPPERS

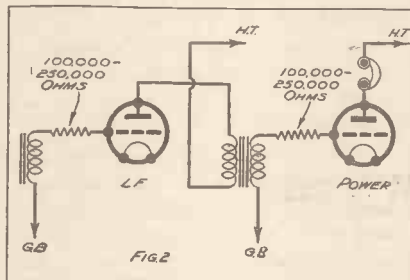

The "stopper" is joined in series between the grid terminal of the valve holder and its wiring.

Short-wave working, in itself, is very fascinating, but not when you want to receive a programme from, say, Radio Paris or Daventry.

An Indication

Probably you will be able to hear the carrier of the long-wave station which you want to tune in, but will not be able to resolve it—i.e. no speech or music when you come off oscillation. Another indication of parasitic oscillation is that tuning is abnormally flat, a heterodyne note being spread all over the dial. Again, the Morse signals which you hear do not respond to proper tuning, but blithely continue their "dot and dash," no matter where you turn the tuning condenser. Such, then, are the symptoms of parasitic oscillation, or, as a friend of mine learnedly puts it, "oscillating at some obscure frequency."

And now you may well ask what are the possible cures for this unhappy state of affairs. The following are some suggestions for curing it, any one of which may do the trick—but probably two or more will be required before the beastie is laid low.

Likely Cures

First and foremost, then, a resistance of from 200 to 600 ohms in the reaction lead (Fig. 1); that is the

A LAST RESORT

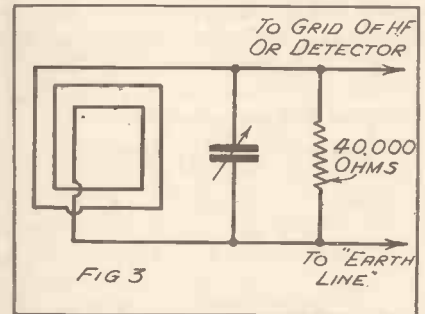

Sometimes a high resistance across the tuning circuit will cure the "parasitics."

first thing to try, and may do the necessary—without any further bother.

Next, a grid stopper in the grid lead of the L.F. or power valve, or both, value 100,000 to 250,000 ohms, or even more (Fig. 2). Failing this, a resistance might be placed across the frame, value round about the 40,000-ohm mark (Fig. 3). If you have any H.F. chokes in the anode circuits of the H.F. valves, try replacing them by resistances of 40,000 to 250,000-ohm value.

WELL SCREENED

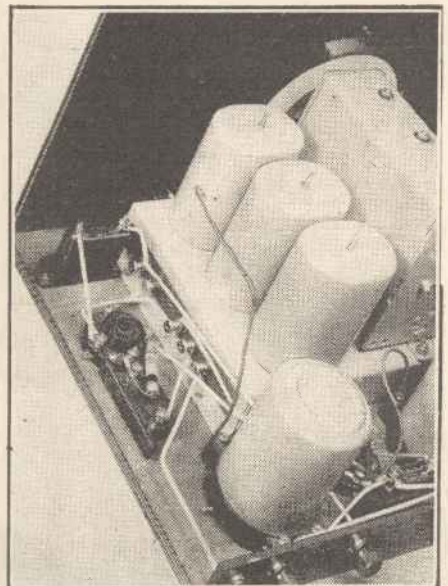

Modern high-magnification valves have to be used with thoroughly screened sets, or unwanted oscillation would be a continuous nuisance.

ADDING RESISTANCE

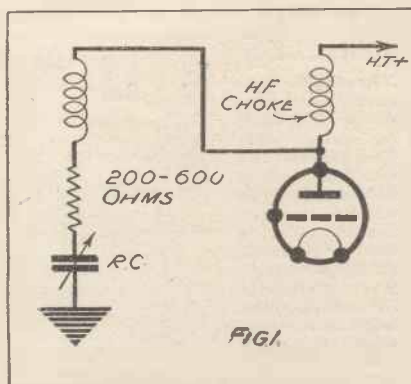

A few hundred ohms inserted in the reaction circuit often stops the trouble.

THE BAFFLE PROBLEM

How to get over the difficulty of housing a plain speaker baffle.

By G. E. MOORE, A.M.I.E.E.

OWING to the fact that, by using a large baffle board, harmful circulatory air currents are prevented, such form of mounting for the reproducer gives very effective results. This is now fairly well known by constructors, but there is no doubt that, for various reasons, many fight shy of the arrangement.

GIVES GOOD RESULTS

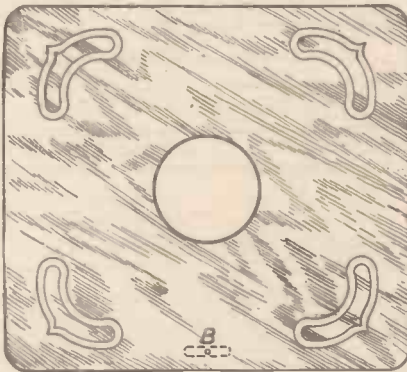

FIG. 1

Here is a simple but very effective baffle measuring 2 ft. 6 in. by 2 ft. 3 in., the corners being rounded off to a radius of 1½ inches. The ornamental fret is readily made with the aid of a fretsaw.

Naturally it is not the light, small, and handy speaker to which most listeners are accustomed. The baffle must be of solid or ply-board about 1 in. thick and at least 2 ft. 6 in. square, and, with the addition of the reproducer and other parts, the total weight becomes a matter of consequence.

Domestic Problems

The writer's speaker, for example, has a large permanent-magnet moving-coil reproducer, and the whole weighs 30 lb. Nevertheless, the very massiveness of the apparatus has a marked bearing upon the performance.

Again, its appearance does not commend itself to many people—particularly the “domestic authorities”—for it seems to take up so much of the space which is so precious in modern houses and in the older small ones. And it does so, too, in a manner which can hardly be called ornamental—another likely bone of contention in the home! Then, finally, its size and weight make it difficult to dispose satisfactorily.

The writer will endeavour to show that much can be done towards accommodating “the big brute” satisfactorily—without, however, “building-in” the speaker in one room of the house.

In the first place, there is no necessity to insist upon a perfectly square construction, nor, for most of us, need the minimum recommended size be exceeded. Hence the writer's board was cut somewhat rectangularly and actually measures 2 ft. 6 in. by 2 ft. 3 in.—a longer side forming the base. This shape is markedly better in artistry than that of a square. Also, the corners are rounded to a radius of 1½ in. (Fig. 1).

Scope for Artistry

In order to relieve the rather bleak appearance of the face, a simple ornamental “fret” (purchasable very cheaply or readily made by any wielder of a fretsaw) is attached to each corner.

The resultant plyboard is stained and french-polished, the mahogany finish according nicely with the furniture of the room in which the speaker functions on state occasions. This finish gives such a superior and lasting effect to the wood that no constructor should begrudge having this work carried out by a professional polisher for a few shillings.

No speaker is truly serving its purpose if its zone of action is limited to one room. The writer has always aimed at radio services throughout the whole household. Though the baffle speaker is no light weight, there is no reason why its work should be too limited.

Firm Supports

In the writer's case its size is such that, for example, the useful and effective picture-rail method of suspension is barred—even if appearance and acoustic considerations had been favourable. Hence an addition of two heavy 12 in. by 10 in. iron brackets for self-standing was decided upon. With the 12-in. sides screwed to the rear face of board a quite stable arrangement was given, in spite of the somewhat high mounting of the heavy reproducer (Fig. 2).

The circular aperture in the baffle-board is filled with fine muslin attached by thin glue to the rear surface and tautened before the felt ring and chassis were fixed over it. The muslin is of a neutral colour—died so, in fact, by immersion in common or garden tea! The enclosure of the rear parts by the same material was abandoned when it was found that, as used, the appearance was not unfavourable. The reproducer is completely enclosed, and who, after all, wishes to collect dust or impede the sound?

A Useful Tip

In general, the speaker is used in either dining-room or sitting-room. These rooms are typically different in regard to accommodation.

In the dining-room it is practically impossible effectively to dispose the speaker on the floor. A special, solid shelf was therefore erected giving an effective cone height of about 5 ft. And though the speaker stands (as has been explained) solidly, two ½ in. stops (one of them threaded and provided with nut) pass through the bracket feet and retain it in place (Fig. 2 “S”).

The sitting-room is more sparsely furnished. Thus the speaker can stand near its plug-point, on the carpet. In order to better its appearance and direct the sound somewhat higher, a flat wooden button on the rear surface can be turned and the front suitably tilted (Fig. 1 “B”).

Pleasing Appearance

By following the lines indicated, a baffle speaker of pleasing appearance and effective properties has been installed in the household, at a comparatively low cost, and with very little trouble as regards construction.

PLACED ON A SHELF

The baffle can easily be secured to a shelf by using iron brackets as shown. In this case the shelf is arranged so that the effective cone height is about five feet. The aperture in the centre of the baffle is covered with muslin attached by thin glue to the rear surface.

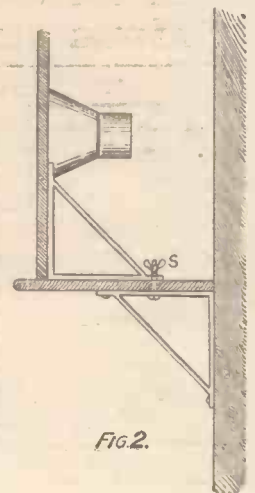

AS WE FIND THEM



NEW APPARATUS TESTED

Improving Contact

It is not always easy to ensure a perfect contact with the slight variations in the sizes of H.T. battery sockets existing to-day.

A wander plug which is a good fit in one make of battery may be a bad fit in another.

Messrs. J. J. Eastick & Sons, who have had considerable experience in the manufacture of wander plugs, have produced a new type.

Outwardly the plug is similar to the standard pattern, but it differs in so far as the prongs are adaptable to various sizes of sockets, simply by turning the grub screw in the side of the insulated portion. A good idea, this!

Rawswood Transformer

The Rawswood L.F. transformer is a value-for-money instrument capable of giving very satisfactory results in circuits where the primary current does not exceed 5 milliamps.

IN BAKELITE CASE



This Rawswood L.F. transformer is suitable for direct connection or parallel feeding.

The core is of patented silicon iron and is specially suited to parallel feeding, although, as mentioned above, the instrument can also be used for direct-feed, provided the current is kept within the limit specified.

Attractively housed in a bakelite moulded case, the transformer retails at the extremely moderate figure of 4s. 11d. and is available in ratios of 1:3 and 1:5.

Interesting reviews of newly introduced apparatus submitted by radio manufacturers and traders for examination and test in "The Wireless Constructor" laboratories.

The makers are the Rawswood Electrical Co., Preston New Road, Blackpool.

HANDY TIME SWITCH



This clock will automatically turn on your radio set or any other electrical apparatus at a pre-determined time.

Automatic Wireless Clock

The Kallmann Automatic Wireless Clock is an ingenious contrivance. Externally it is an extremely attractive timepiece of modern design, having a chromium-plate finish and luminous hands.

Its appeal lies mainly in the automatic switching arrangement with

Apart from its radio utility the clock can be employed in a variety of ways, such as for switching on lights or other electrical devices.

Every clock is guaranteed for twelve months, and the price, which must be regarded as very reasonable, is 45s.

For Portable Sets

Illustrated on this page is a new permanent magnet moving coil for use in portable receivers. In the past the need for compactibility and weight saving in these designs has often precluded the moving coil, which with its substantial magnets (if it is to have any claims to high sensitivity) has been impracticable both on the score of weight and size.

The special Goodman speaker is extremely compact, since the chassis also forms the magnet; added to this is a high-flux density, thus ensuring good sensitivity, and making the speaker particularly suited to portables. Output transformers enabling the correct matching to be achieved with Q.P.P. and "Class B" valves can be supplied, the retail price of the speaker being 27s. 6d.

COMPACT MOVING-COIL SPEAKER

Specially designed for use in portable receivers, this permanent magnet speaker has a high degree of sensitivity in spite of its remarkably compact size.

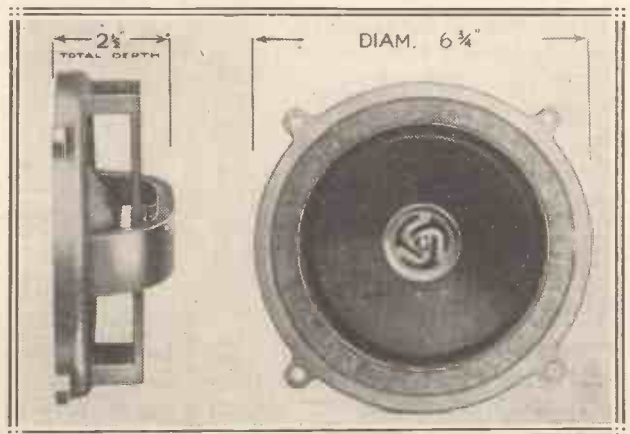

which the owner is enabled to switch on his radio set at any pre-determined time up to ten hours in advance.

The makers are Messrs. Goodmans, 69/97, St. John Street, London, E.C.1.

As We Find Them—continued

Screened Down-Lead

In some localities a certain amount of trouble arises owing to a form of interference which is often alluded to as "man-made static." This term, which has been borrowed from America, is an apt one denoting such noises as are caused by neon signs and other electrical devices.

Much of the interference is picked up by the aerial down-lead, and can often be reduced or even eliminated by suitable screening.

But a lead-in is not an easy thing to shield satisfactorily. There is, for instance, the possibility of capacity losses since the capacity to earth of a totally screened conductor is by no means negligible.

Messrs. Ward & Goldstone, the well-known radio and electrical engineers, have, however, carried out a considerable amount of research on this matter, and as a result have produced a very effective screened down-lead

NO HOLE NEEDED



This flat-type Goltone lead-in can be fitted without drilling the window frame.

having a capacity per foot of only 20.1 mmfd.

This has been achieved by a method of air-spacing in which the down-lead passes through a flexible rubber tube having spokes or internal ribs to keep the conductor in the centre of the tube. Over the tubing there is a metallic covering, which has a weatherproof covering for outdoor use, while for indoors a special braided finish is available.

The down-lead is best fitted to a cowl insulator, and the metallic sheathing is, of course, joined to earth. Those who are experiencing interference from electrical apparatus may well find it worth their while to

THE "CONTROLATONE"



Two models of this Bulgin tone control unit are available, one for pentode and one for ordinary valves.

get into touch with Messrs. Ward & Goldstone, who are happy to advise on any queries relating to this particular trouble.

The cost of the screened down-lead is 8d. per foot, and the maker's address—Frederick Road, Pendleton, Manchester.

Lead-In Strip

Most lead-in insulators are of the rigid, tubular type, and to use them successfully entails drilling a hole in the window-frame, or wherever it is convenient, a task which sometimes presents difficulty to the constructor. Consequently a flexible lead-in insulator is not without its advantages.

The Goltone lead-in strip is worthy of note. Consisting of a tinned flexible conducting ribbon, adequately

insulated and provided with terminal connections, it will particularly appeal to those listeners who find difficulty in using a rigid lead-in insulator.

The Goltone strip is completely effective, and is available in 6-in., 9-in. and 12-in. lengths.

Bulgin Components

The Bulgin "Transcoupler" is already known to THE WIRELESS CONSTRUCTOR readers, the original model being reviewed in these columns some months ago.

Messrs. Bulgin inform us that they have effected an improvement by increasing the turns ratio to 1:4 (it was originally 1:3), thus effecting a higher voltage amplification.

The inductance of the unit is 75/95 henries, depending upon the signal input—there is, of course, no D.C. magnetising current in a parallel-fed transformer. The price remains as before, viz. 11s. 6d.

Another Bulgin component that we recently had the opportunity of testing is the "Controlatone." This is a variable resistance in series with a fixed condenser, and is designed for use in cases where a tone control is desirable for minimising heterodyne whistles, excessive needle scratch, peaks due to the loudspeaker, etc.

Normally the control is joined across the output choke or transformer in the same way as the familiar fixed resistance and condenser, but its adjustability gives it a distinct advantage over tone compensators of the fixed type.

Two models are available, one for triodes and the other for pentodes. Both are priced at 5s. The makers are A. F. Bulgin & Co., Ltd., Abbey Road, Barking.

**A UNIVERSAL
 SOLDERING IRON**

*How to make a soldering iron
 with adjustable bit.*

THE soldering-iron shown is useful on general work and is particularly useful on wireless work. The rod in the diagram was made forked to fit over the end of the copper, and pivoted at the centre as shown.

An extra hole was drilled in the end of the fork, and several holes were drilled in a radius to correspond with the hole in the forked end. A steel pin locates the angle of the iron and keeps it firm in position.

Split-Pin Used

As the rod is pivoted to the copper, a large split pin may be used in the locating holes. This is preferable to an ordinary solid pin, as a certain amount of corrosion takes place which would render an ordinary pin difficult to manipulate, but the split-pin will be quite suitable.

VARIABLE ANGLE

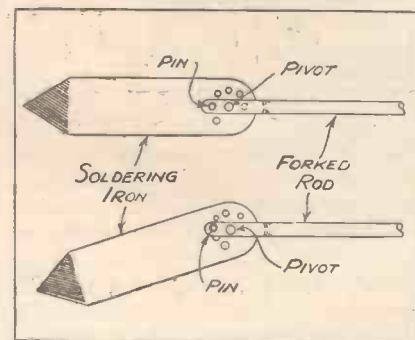

The angle made by the copper bit with the long part of the iron is quickly adjustable.

NEXT MONTH

THE NATIONAL RADIO EXHIBITION

NEXT MONTH

READ ALL ABOUT IT IN THE SEPTEMBER

WIRELESS CONSTRUCTOR

which will contain a special profusely illustrated section describing the Show,

AND

A FULL DESCRIPTION OF A

Special New Set Design for Constructors

by

JOHN SCOTT-TAGGART,
A.M.I.E.E., F.Inst.P.

OUT AUGUST 15th.

PRICE 6d.

ORDER YOUR COPY WELL IN ADVANCE

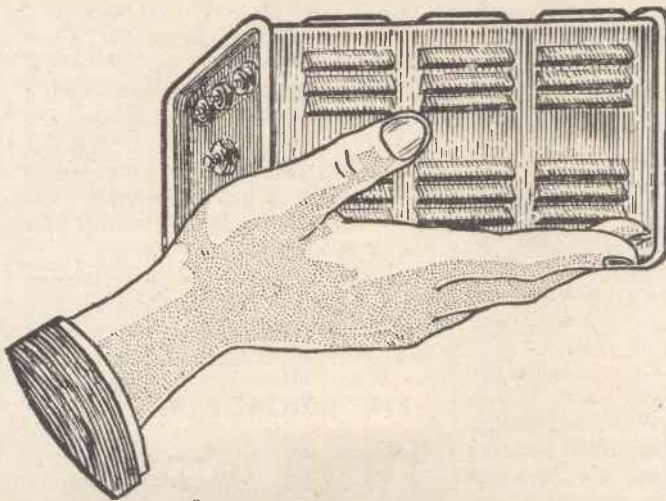

A "PRESENT" for the "FUTURE"

Now is the time to make provision for a permanent, ample and constant power supply throughout the winter—and for many winters to come—by giving your A.C. set a reliable rectifier. Give it a

WESTINGHOUSE METAL RECTIFIER

and remove the worry of periodical renewal.

THE WESTINGHOUSE BRAKE & SAXBY SIGNAL CO. LTD.,
82, YORK ROAD, KING'S CROSS, LONDON, N.1.

Engineers' Guide

Containing the widest choice of engineering courses in the world

Qualify for a well-paid post in Engineering by studying at home with The T.I.G.B. Become an A.M.I.C.E., A.M.I.Mech.E., A.M.I.E.E., A.F.R.Ae.S., etc. Training until Successful is Guaranteed for the one fee. WRITE NOW for "The Engineers' Guide to Success," stating the branch, post, or qualification that interests you, to

THE TECHNOLOGICAL INSTITUTE OF GT. BRIT.
21, Temple Bar House,
London, E.C.4.

Founded 1917. 19,000 Successes



Free!
144 PAGES

To Success

We invite readers to support our Advertisers—care being taken to accept only announcements of reputable firms!

A NEW CABINET for your SPEAKER

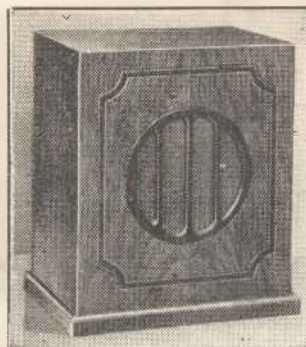

House your Moving-Coil Speaker in this Camco Cabinet—the "Nutone"—and get results equal to those obtained with a large baffleboard. Supplied in Oak, Mahogany or Walnut finish. Price 32s. 6d.

See the complete range of Camco Cabinets in our Showrooms, open 9.15 to 5.45 (Sat. 12.30) and send coupon for free illustrated catalogue.



CARRINGTON Manufacturing Co. Ltd.
Showrooms: 24, Hatton Garden, London, E.C.1.
Holborn 8202.

Works: 8, Croydon.

Post in *gd.* envelope.

Name

Address

12 W. C.

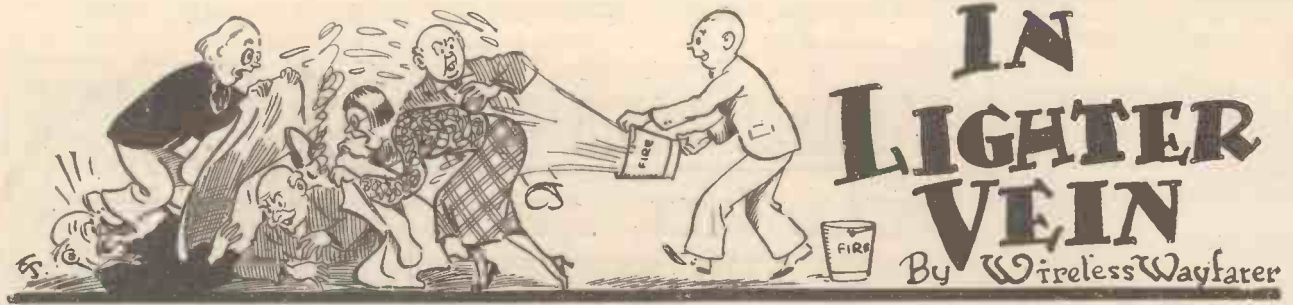

IN LIGHTER VEIN

By Wireless Wayfarer

REALLY, I suppose the Professor should not have kept depositing the ash from his cigar in Captain Buckett's pocket. But he is in many ways a tidy soul; no ash-trays were provided at the meeting of the Mudbury Wallow Wireless Club, and he did not like to drop it on to the floor.

The cigar, one of Sir K. N. Pepper's Flor de Stinkadoros, was a large one, and there must have been a considerable accumulation of ash in the receptacle so thoughtfully—or rather I should say so thoughtlessly—provided by his neighbour at the table. This, however, might have passed unnoticed had not the Professor, on rising to his feet to deliver to the

HOW THE FIRE STARTED

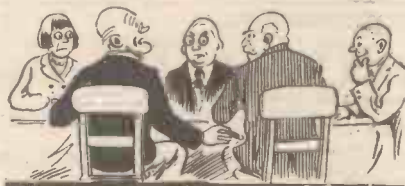

The Professor uses Captain Buckett's pocket as an ash-tray.

meeting his paper on "Should Electrons Be Hypergrolised, And If Not, How?" consigned the glowing end of his weed to the same convenient place.

Hardly had the Professor warmed up to his subject when it became clear that Captain Buckett was also warming up. Fascinated, I watched him for a few moments shifting uncomfortably in his seat. Then he sprang into the air with a volley of nautical language and a cloud of smoke. In an instant flames were bursting from his coat.

The Flying Mariner

Miss Worple promptly went into hysterics, Tootle dashed to the telephone and called the fire brigade, whilst Pimpleston and Goshburton-Crump loudly instructed each other to roll him up in the hearthrug.

There wasn't a hearthrug, but Pottleson and Gubsworthy fetched an assortment of other members' over-

The Mudbury Wallow Wireless Club always seems to be in trouble, and the adventures related this month are certainly not the least amusing that have happened to its devoted members.

As usual, Wireless Wayfarer himself manages to dodge many of the results of his own suggestions.

coats from the lobby and endeavoured to apply them to the flying mariner, who was now rushing round the room with a close approach to ether-wave velocity.

I was the only person in the room who kept his head. Walking calmly out to the lobby I unhooked from their pegs two red buckets labelled FIRE. I then approached the struggling group in which the captain was by this time the centre.

Motor-Car Set

With a quick right and left I discharged the contents of my buckets amongst them. Accurate aiming was impossible, but I felt sure that some had reached the captain.

Two more bucketfuls and he was safely put out, but by this time the fire engine had arrived outside. True to their early training, some of the brigade proceeded to smash a way into the building with axes.

Alone in hearing the engine run up, I was outside the hall before it had fairly come to a standstill, and though I say it myself, I did noble work in instructing the gallant lads to direct jets from their hoses into every possible opening. Seldom has fire been so efficiently extinguished.

The meeting not unnaturally came to a premature end. Most of us adjourned to Sir K. N. Pepper's, where those who had become slightly damp sat round the fire in dressing gowns and overcoats borrowed from their host. It was then that the Professor was able to announce his latest and greatest contribution to the progress of wireless.

"I have perfected," he said, "a receiving set for use in motor cars. My model is completed. It but

remains to demonstrate its amazing powers. It is unfortunately a trifle large for my own little baby Forcadin, but I shall be happy to fit it into a larger car, and to make a present of it to the owner thereof. Now what about your new saloon, Sir K. N.?"

We Make a Start

"Well, that's jolly kind of you, Professor," replied the great man. "As a matter of fact, I'm just going off for a week at the seaside and leaving the car behind. If you really mean it—"

The Professor declared that he would be only too delighted to make a real job of installing wireless in Sir K. N.'s bus.

* * * * *

Two days later the Professor burst in on me as I lay in my bath singing "Drink to Me Only With Thine Eyes" and reading THE WIRELESS CONSTRUCTOR.

"Come and give a hand with fitting my new set to Sir K. N.'s car," he cried.

I agreed with alacrity, promised to be round at his place before he could say knife and really did roll up in a couple of hours later.

As the set was found to be too big for us to carry round to Sir K. N.'s garage, the obvious thing was to bring the mountain to Mahomet, or in other

THE BRIGADE ARRIVES



"I was outside before the fire engine had fairly come to a standstill."

words to go and fetch the gleaming Super-Shifter Saloon. I was deputed to undertake this duty, and the thing looked so magnificent and responded so gloriously to the slightest touch of toe or finger that I could not resist taking a little drive through the streets of the town.

IN LIGHTER VEIN

—continued

In that wonderful bus my progress was rather reminiscent of a royal procession. It was so pleasant to have everybody bowing and smiling at me that I went several times round the town. In fact, it was quite dark by the time that I got back to the "Micro-farads."

The Professor, I suppose, must have ceased to expect me, but that does not excuse him for having closed the gates of his drive. I naturally took it that they were still open and, approaching at a cool fifty, swirled straight on.

I can't think why wings and things are made so flimsy on even the best

THE GATE CRASHER

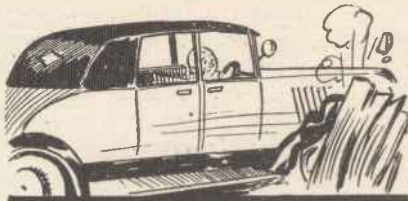

"That does not excuse him for having closed the gates of his drive."

of cars, but we made a pretty good job straightening them out next morning with the coal hammer.

Then came the business of installing the set.

"Where does it go?" I inquired.

"Under the back seat," said the Professor.

One trouble about these modern saloons is that the doors are too narrow to admit a large-sized set. Another is that even if you got it inside you would have to do the rest of the work practically in the dark owing to the presence of the roof.

The Professor was all for removing the roof and lowering the set in from a crane rigged up outside his bedroom window. It seemed to me, though, that by far the best tip would be to take off the body altogether for the moment, replacing it when we had finished the job.

Work with Hacksaws

My opinion of coachbuilders has gone down quite a lot since we undertook the task of removing that body. I mean, why can't they make these things really detachable? If you will believe me, we had to do hard work with hacksaws, monkey wrenches and tin shears before we got it right off. However, we succeeded in the end.

Then we found ourselves up against

a real problem. The A.C. generator supplying the set was designed to rotate in precisely the opposite direction from that of the car's engine. I suggested using a crossed belt, but the Professor would have nothing to do with such makeshift expedients.

The engine, he explained, could easily be re-timed so as to reverse its rotation, and we proceeded to carry out this intriguing task. When we had finished it the Professor pointed out that Sir K. N. Pepper could now claim to be the only person in the world who owned a car with one speed forward and four reverse.

Honolulu on Speaker

The set, once placed in position, worked like a charm, Honolulu and Oskösh and Omsk and Tomsk and Spitzbergen all being received with ease at full loudspeaker strength.

That wretched body, though, simply refused to go back again. Very fortunately, Miss Worple happened to be away, so that we were able to borrow her new hen-house, which fitted the chassis to perfection.

Feeling that the gabled roof might be too high to accord with modern ideas of car body design, we cut it off short just above the windows and covered it neatly with sheets of corrugated iron. I can say, with pardonable pride, that few jobs of the kind have ever been better carried out.

"A pleasant surprise for Sir K. N. when he returns to-morrow," cooed the Professor as we surveyed our handiwork.

"Pleasant," I said, "is the word."

Manœuvring a car with one forward and four reverse speeds is by no means easy until you get used to it, but I can assure the reader who contemplates fitting the "Goop

AMATEUR COACHWORK

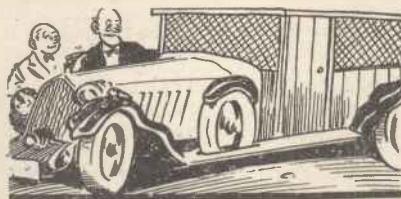

"We were able to borrow the new hen-house, which fitted the chassis to perfection."

Screech-Owl" Ten to his bus that it becomes second nature after a little practice.

Incredible as it may seem, Sir K. N. Pepper had several things to say about our work and hardly any of them were genuinely flattering. A bit thick, I think, considering that the whole business hadn't cost him a single penny.



The PARROT talks—but

his tongue is not harnessed to his brains. Some Radio Sets talk, play music, get a station or two, but the results may not be harnessed to real efficiency unless the components are "Graham Farish." Graham Farish components are instruments of precision, definite in their electrical values and reliable. That's why experts and home constructors alike can use them to maximum advantage.

OHMITE Resistances

The most popular and efficient type of fixed resistance for all general purposes. "Better than wire-wound." All values 50 ohms to 5 megohms. Each **1/6**

100° F. Temperature rise.

Ohms	Milliamps	Ohms	Milliamps
1,000	40	20,000	8
2,000	35	30,000	6.75
3,000	29	40,000	6
4,000	24	50,000	5.5
5,000	20-25	60,000	5
10,000	12	80,000	4.24
Other values pro rata.		100,000	3.5

Heavy Duty type, approximately double the above ratings, price 2/3.

LIT - LOS

Condensers

Compact and efficient. Accurately gauged bakelite dielectrics and solid brass pigtail connection to moving vanes. All capacities up to .0005 mfd. in tuning straight line capacity and differential types.

2/- Each



L.M.S. Twin Screen H.F. Choke

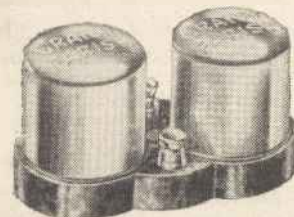

suitable for the long, medium and short wave-lengths. **4/6** Each

Graham Farish Components

Graham Farish Ltd., Masons Hill, Bromley, Kent. Export Office: 11/12, Fenchurch St., E.C.5.

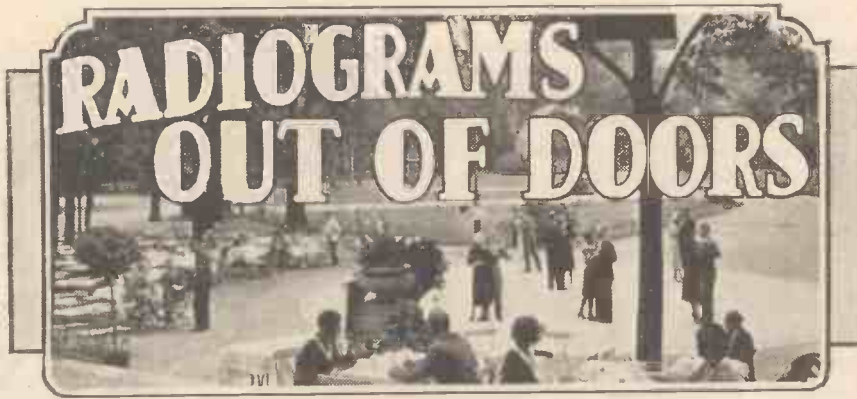

With the summer season in full swing, you may be called upon to supply music at one of the open-air functions that are so common at this time of the year. Here are some very practical hints on the subject.

By F. N. GANDON.

WITH the coming of the summer season and its outdoor sports and social events, it is to be expected that a few of us will be called upon to supply some incidental music via our radiograms or amplifiers. A few seasonable notes, therefore, would not be out of place.

"Phasing" the Speakers

Firstly, there is the vexed question of the necessary volume, and as we have not, as yet, a common standard of measurement for this, we have to express it in terms of "watts input to speaker." This is not altogether satisfactory because with the same input different speakers give different volumes. In the following table, therefore, it has been assumed that the loudspeaker is one of the better types of standard moving-coils.

Watts	Position	Remarks
1	Normal living-room	Good, general listening volume.
3	Large living-room or small club-house	Good volume for dancing, etc.
3-5	Outdoors	Dancing on lawn, etc., if not too far from speaker.
5-10	Outdoors or small hall	Incidental music in area of two tennis courts. Dancing one court.
10-12	Outdoors or small hall	Good general volume for small outdoor functions. Dancing in small hall, though music may be weak at end of room if many couples on floor.

NOTE.—It requires nearly four times the "power input" to double the aural volume.

It is not practical or economical to attempt anything in the nature of real "public address" work with ordinary standard speakers, although they can be quite effective at small affairs. If, however, the operator is able to borrow or hire one of the special "power" speakers developed for this purpose, such as the Western

Electric or Voigt units, then more ambitious things can be handled.

These speakers, which are horn-type moving-coils, are extremely sensitive, and with an input of 2-3 watts will usually exceed the volume from an ordinary speaker with 10-12 watts. They have the further advantage that the sound is mainly directional owing to the horn, so that all the available power may be directed at the most important point in the proceedings.

If the operator is not well acquainted with the site of the function, then this should be inspected beforehand, especially if the affair is something more than the informal variety. It will be necessary to find the nearest point for current supply, and to obtain a general idea of the arrangements. The position for the

speaker or speakers should be carefully selected, full advantage being taken of reflecting surfaces such as a club-house, walls, banks, etc., all of which tend to throw back the sound.

Two speakers a little distance apart give better distribution than one, and for the best results they should be "phased," so that the coils move

in unison. To do this, connect a 2-volt cell intermittently to the main speaker lead and note whether the diaphragms go in or out together. If one goes in and the other out, reverse the connection to one of them. Speakers out of phase give patchy results when heard from various angles.

Making Announcements

The musical programme will vary, of course, with the particular function. Outdoors at bazaars, fêtes, garden parties, etc., it should be light and airy—popular string orchestras and military bands interspersed with dance tunes and novelty numbers. Songs and "heavy" music are taboo unless the latter is of a sensational nature.

A microphone is a great advantage for the announcement of sports items, speeches, prize-givings, etc., and is a distinct attraction from the novelty aspect. Club secretaries like to hear their own voices and the "mike" department always does overtime. It must be connected to the set through a transformer, and the leads made as short as possible. Shielded wire is the best, but if ordinary flex is used it must be kept away from mains leads to prevent hum.

Avoiding Feed-Back

Another trouble is "feed-back howl," caused by the sound from the speaker getting back into the "mike."

HEARD BY EVERYONE

A powerful "public address" equipment was used at Twickenham during the reading of the Charter of Incorporation.

The assembled crowd was thus able to hear clearly every word spoken.

Two of the special loud speakers can be seen in this photograph of the proceedings.



If this occurs, the microphone should be turned so that its face is not exposed to direct sound from the speaker, or it can be shielded on each side with pieces of cardboard.

The announcer should be instructed to speak close to the "mike" in low, even tones. It is not a bit of use

RADIOGRAMS OUT-OF-DOORS

—continued

standing back and shouting. Finally, fit a quick change-over switch from "gram" to "mike," otherwise half an announcement may be lost while you are fiddling with wires and terminals.

It will have been noticed in the Press recently that the Performing Rights Society won their court case with regard to the performance of musical works in public. It is of general interest, therefore, to quote two paragraphs from one of their latest pamphlets.

The Copyright Position

"The Society's licence or permission is necessary for any public performance of the copyright music it controls without regard to the object of the entertainment, the means by which the performance is given (whether mechanical or otherwise), the nature or designation of the premises at which the performance takes place, and irrespective of whether a charge for admission is made or otherwise.

"It should be noted that all British music published since the coming into force of the Copyright Act, 1911, is *ipso facto* copyright, and no notice of the reservation of the right of public performance is required to be printed on copies of such music. There is, in addition, a considerable volume of music, both British and foreign, published before that Act, which is also copyright."

Adding Interest

It would appear, therefore, that if, for example, a tennis club organised an impromptu dance for members in its club-house, they would not be infringing the Society's rights by playing tunes with a power outfit. On the other hand, they would do so if they organised a garden fête to which friends and the public were admitted, whether for payment or not. In cases of doubt, however, information should be obtained from The Performing Rights Society, Ltd., 13, George Street, London, W.1.

Finally, showmanship is better than tremendous, distorted, uncontrolled volume. Fade in and out on all records. Run novelties, if possible, such as a competition for the best "mike" voice or guessing the names of pieces in a selection record.

The VALUE of T.C.C. RESEARCH to YOU....



EVERY T.C.C. announcement has been a plain statement of fact—of achievement. No extravagant claims have been needed. Year by year T.C.C. research has been going on, large sums of money have been expended on pioneer work, the best brains employed. The T.C.C. efforts have been rewarded. Every development of note in condenser practice has emanated from the T.C.C. laboratories. The following facts provide the reason for the wonderful confidence held by set designers, serious experimenters and amateurs in T.C.C. Condensers.

MILESTONES IN RADIO HISTORY

- 1906 T.C.C. founded with factory operating solely on Condensers and artificial line for submarine cable work.
- 1914 T.C.C. introduce Mansbridge Condensers, and manufacture under original licenses.
- 1915 T.C.C. working on Condensers for War Office, Admiralty—Air Service—etc.
- 1918
- 1920 T.C.C. manufacture heavy duty Transmitting Condensers.
- 1922 T.C.C. manufacture Power Condensers.
- 1926 T.C.C. contract with B.B.C. to supply Condensers for 2LO.
- 1927 T.C.C. discard Mansbridge type, and introduce Rolled Condensers using Aluminium Foil of higher conductivity—and greater reliability.
- 1928 T.C.C. introduce Dry Electrolytic Condensers of very high capacity for low tension smoothing.
- 1929 T.C.C. introduce Dry Electrolytics for 100 volt working.
- 1930 T.C.C. introduce Moulded-in Mica Condensers—the now famous "M" Type.
T.C.C. introduce Non-inductive condensers.
- 1931 T.C.C. introduce Wet Electrolytic Condensers.
- 1932 T.C.C. manufacture Dry Electrolytic High Voltage Condensers—(550v. peak).
T.C.C. first to publish Surge Voltage ratings of paper condensers.
- 1933 T.C.C. research still building up data, still adding to its specialised knowledge so that Radio Technicians may have available not only a "pedigree" range of condensers, but a range ahead of time.

T.C.C.

ALL-BRITISH
CONDENSERS



The Telegraph Condenser Co., Ltd., Wales Farm Rd., N. Acton, W.3

✓2977

STOP THAT HUM!

How to make a simple unit for removing residual D.C. mains hum.

RECEIVERS that take all their power from direct current mains are particularly liable to hum; this is chiefly due to the fact that the radio frequency circuits are more or less directly connected to the supply cables, there being no mains transformer or other isolating

HOW IT IS CAUSED

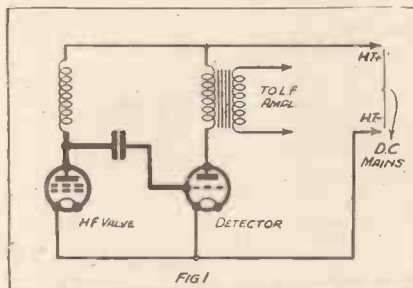

A frequent path for the "hum current" is that shown by the blacker line, viz., from the anode of the S.G. valve to the grid of the detector.

equipment, and therefore the slightest ripple or variation in the supply will find its way to the grids of the H.F. valves and so be amplified up to audible volume.

Normally the presence of hum in a modern radio receiver is a reproach to either designer or constructor of the set, but there are some D.C. supplies that are so bad that mains hum has been regarded as almost inevitable. The chief offender is the D.C. main which is supplied via mercury arc rectifiers which produces a hum that is like a high-pitched continuous whine.

Amplified Ripple

In practice, very few commercially-made receivers will function silently on mercury arc supply although they are perfectly satisfactory on normal D.C., and it is therefore not necessarily to the discredit of amateur constructors if their D.C. operated sets are not entirely hum-free.

In most cases the ripple in the supply that causes the hum finds its way into the receiver through the H.T. feeders; the most usual path taken by a "hum current" is shown in Fig. 1. This is a skeleton diagram of an ordinary leaky-grid detector in conjunction with the anode circuit of the preceding H.F. valve.

The path for the "hum current" is shown in blacker ink that the rest of the circuit; you will notice that it skips the grid condenser and finds its way to the grid of the detector valve.

Actually it is considerably weakened at this point, but as the note is of fairly high audible frequency, sufficient of it passes through to be amplified by the subsequent stages.

All mains receivers that employ ordinary, filament valves provide another ready path for hum; in effect the filaments are connected direct on to the main, and any ripple will cause a fluctuating filament voltage with consequent audible effect.

With sets of this type the trouble can usually be cured by connecting a small electrolytic condenser across the filaments of the H.F. and detector

A CONVENTIONAL CIRCUIT

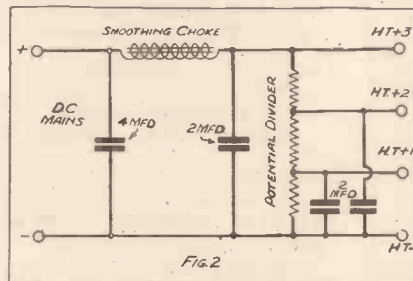

Although the conventional mains eliminator circuit is perfectly satisfactory with normal supplies, additional smoothing is sometimes required to cope with particularly noisy mains.

valves; this will effectively by-pass the "hum current" in the filament circuit. The present-day receiver for D.C., however, employs indirectly-heated valves which are immune from this particular source of trouble, as is the ordinary battery set with H.T. eliminator.

In order to prevent H.T. hum on these latter types it is necessary to ensure that only pure smoothed D.C. gets past the eliminator into the receiver.

Normal Equipment

The normal smoothing equipment provided in an ordinary D.C. high-tension eliminator is shown in Fig. 2.

This equipment is adequate for use on normal mains, but unfortunately only about one D.C. main in ten can be designated "normal" from the wireless point of view; the one

choke and its associated condenser can deal with the normal ripple in the supply that originates from the commutator of the power station generators, but in cases where there is a definite unwanted current (which is alternating at audio frequency) superimposed on the D.C., it is hopelessly inadequate.

It is therefore necessary to discover some means of increasing the efficiency of our smoothing gear so as to reject all but pure direct current from the receiver itself.

In order to do this we can actually double the smoothing components in the eliminator.

Few Components

The only parts required are a good smoothing choke and a large capacity fixed condenser which will withstand a working pressure of 250 volts.

The capacity of the condenser is not critical, and you will find that the more microfarads that you can press into service, the greater the efficiency of the extra smoothing.

The connections are shown clearly in Fig. 3. In most cases the choke will have to be connected in the negative main, but it will be as well to try both positions.

If the unit is housed in a small box and connected in circuit at the power point from which the set draws current there can be no question of its not being isolated from the set.

When you are trying the unit in both mains leads, don't forget to reverse both input and output plugs to the smoother or you will feed the mains into the set with polarity reversed and will obtain no reception.

B. B.

FOR NOISY MAINS

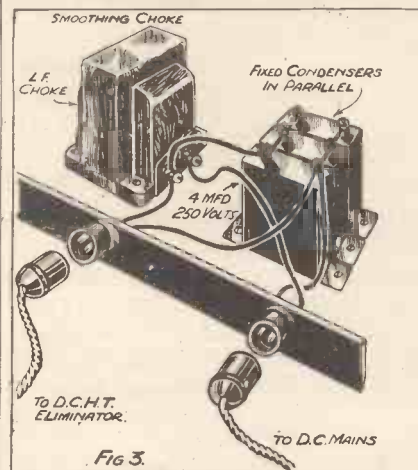

The unit is connected between the mains and the D.C. eliminator, thus supplying the extra smoothing needed. The total capacity of the condensers should not be less than 4-mfd.

FROM MY ARMCHAIR

—continued from page 178

I can't get those Kurds out of my brain. (No jokes, please.) To think of their having an aeroplane hovering over them and shouting at them to go home, when they're already at home. (Although it can't feel like home with the sky full of loud-speakers.)

Aerial talk, however, is technically surprisingly good. Three years ago while attending the Cleveland (U.S.A.) Air Races, I (together with about 15,000 other rubber-necks) was kept in touch with events by shouts from the sky. The 'plane throttled the engine back to give the speaker a chance. He became, however, an awful bore, and one longed to yell back at him.

I did say, "Oh, shut up!" but I don't think he heard.

As THE WIRELESS CONSTRUCTOR is read in Kurdistan (for my "brilliant and provocative" writings—how tiresome these adjectives are, by the way!), let me advise the Kurds to set up their own loudspeaker and shout back.

Probably my next Notes will be from prison—or more likely from the Tower—The Engineer in the Tower. Treason, of course, helping the King's enemies.

* * *

As a matter of fact, I was once arrested. Not for treason exactly, but as a spy. Gather round, chicks, and hear what daddy did in the Great War.

I do not think I am committing any breach of the Official Secrets Act 1911 when I disclose that the first use of valves by the army in the field was in connection with a then very secret French instrument which was called I.T. These letters were pronounced "eye-tock" in the British Army.

Somewhere in France

The I.T. was nothing more or less than a multi-valve low-frequency amplifier with a tapped input L.F. transformer.

To the input terminals were connected cables ending in earth-pins, which would be placed in the ground at a distance of, say, a hundred or two hundred yards apart.

The object was to pick up the Germans' trench telephone and telegraph messages, and I could write a book on the results obtained. The nearer one placed the earth-pins to the enemy's lines, the stronger would be the signals.

The placing of these interception posts was organised by G.H.Q., and often the infantry on the spot was ignorant of what was going on. It was obviously vital that the enemy should not get wind of the fact that their messages were being tapped.

One day I was out reconnoitring in front of our advance posts and was returning on wavering hands and shaking knees when my head appeared over the edge of a brand new trench and I found myself blinking into the muzzle of an equally brand-new Webley. I very nearly let off my own revolver out of sheer fright.

Nightingales Don't Care

My opponent was a very young, pink-faced but determined second-lieutenant, and as he was quite alone in the trench I did not, in my irritation, see any reason why he and not I should do any suspecting and arresting that was to be done. Unfortunately, his little bit of armament was pointing with remarkable precision at where my heart is popularly supposed to be, whereas my instrument of destruction was just pointing nowhere at all.

"If you attempt to escape I shall fire," was the warning which accompanied the grim look he gave me.

It was a very undignified O.C. Wireless who was prodded first to company headquarters and then to battalion headquarters. Nor was I able to give a proper account of my activities without breaking the oath of secrecy about the I.T.

I was kept under arrest until I was identified by an officer from Brigade headquarters.

Unhappily, the young fellow who captured me was killed in a raid three days later.

* * *

Have you ever heard a nightingale other than the Italian and B.B.C. birds? There is one which I can hear from my garden. It started operations on April 29th. Is this a record? I heard the cuckoo first on May 4th, but it is useless asking if this is a record.

My particular nightingale sings during the day-time as well as at night. It must get very little sleep. Those who remember the early efforts to broadcast the bird's song probably regard the nightingale as very elusive, only to be coaxed into song by playing a 'cello in some thicket.

My own experience is that nightingales don't care a dash for anyone. Traffic noises, daylight, thunderstorms are all the same to it.

(Continued on page 201)

PILOT
AUTHOR
KITS
Exact to Specification
CASH - C.O.D. - H.P.

ALL-WAVE THREE-FOUR
(Described in this month's issue.)

KIT "A" Author's Kit of Delivered Carriage Paid on First Payment of
Components, including ready-drilled panel and screen, but less valves and cabinet. CASH or C.O.D. Carriage Paid, £6-4-5 **11/6**

- ACCESSORIES**
Set of specified valves £2-2-6
Peto-Scott Cabinet, to specification .. 15-0
Peto-Scott Vertical Screen, 10" x 6" .. 2-0
2 Colvern Coil Units K5 19-6
1 Set Atlas Plug-in Coils 12-10

S.T. 400
BATTERY MODEL

"KIT A" DELIVERED CARRIAGE PAID ON FIRST PAYMENT OF
Author's Kit of specified parts, including FREE BLUE-PRINT, ready drilled panel and foil-covered baseboard, but less valves and cabinet. **8/9**

- Balance in 11 monthly payments of 8/9 OR CASH or C.O.D. £4-15-0 Carriage Paid.
- | | |
|---|--|
| KIT "B" As Kit "A," but with valves less cabinet. 12 monthly payments of 12/3. Cash or C.O.D., £6.14.3. Carriage Paid. | KIT "C" As Kit "A," but with valves and cabinet. 12 monthly payments of 14/-. Cash or C.O.D., £7.11.3. Carriage Paid. |
|---|--|

ROLA PERMANENT MAGNET MOVING-COIL SPEAKER P.S. With Universal tapped input transformer. Cash Price, £2/9/6. Carriage Paid. **4/6**
Balance in 11 monthly payments of 4/6. only

MODERN MIDGET TWO
(Described in this month's issue.)

KIT "A" Author's Kit of Delivered Carriage Paid on First Payment of Components, less valves and cabinet. First Payment CASH or C.O.D. Carriage Paid, £2-2-0 **5/9**
Balance in 7 monthly payments of 5/9

- ACCESSORIES**
Set of 2 Specified Valves 15-9
Special Cabinet, to specification .. 15-0
Lissen Dual Range Coil 6-6
R.I. Hypermite L.F. Transformer .. 12-6

PILOT "CLASS B" CONVERSION KIT

Converts your present Battery Set to "Class B" Amplification. Complete with all necessary components, including Peto-Scott driver transformer, Peto-Scott "Class B" output choke, W.B. 7-pin valve holder, B.V.A. "Class B" valve, wire and screws, etc. Full-size Blue-print, assembly instructions and diagrams. Cash or C.O.D., 37/8. **5/-** only
Balance in 7 monthly payments of 5/2.

All "Class B" Components and other Parts unobtainable from your local dealer SENT C.O.D. We have the largest stocks in the country. Orders over 10/- Sent Post Paid. Easy Terms available on orders value over 35/- Quotation by return. No obligation.

NEW ROLA P5 "CLASS B" MOVING-COIL SPEAKER. With "Class B" input transformer, £1/12/6. Carriage Paid. Model P.M.32 (formerly P.M.14) for Cossor Valves, Model P.M.35 for Mazda and Mullard. State for which type when ordering. **5/2** order
Balance in 6 monthly payments of 5/2.

IMPORTANT. MISCELLANEOUS COMPONENTS, Parts, Kits, Finished Receivers or Accessories for Cash C.O.D. or H.P. on our own system of Easy payments. Send us a list of your wants. We will quote you by return. C.O.D. orders value over 10/- sent carriage and post charges paid.

PETO-SCOTT CO. LTD.
77, CITY ROAD, LONDON, E.C.1.
Telephone: Clerkenwell 9406/7 EST. 1919
W. St End Showrooms: 62, High Holborn, London, W. C.1

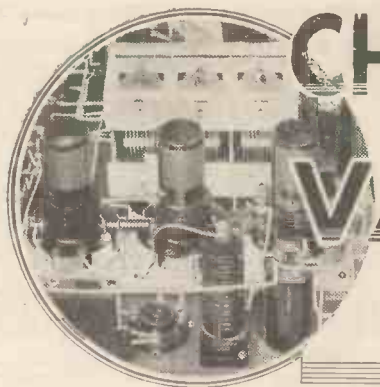

CHANGING to VARIABLE- MU

By BERNARD BARNARD

For an expenditure of not more than ten shillings your old set can be endowed with one of radio's most recent refinements.

IN order to meet the requirements of owners of old favourites who desire to take advantage of the variable-mu valve, I am going to describe the alterations necessary for its incorporation in straightforward types of sets.

I have kept a watchful eye on the cost, and strictly limited the expense

REPRESENTATIVE CIRCUIT

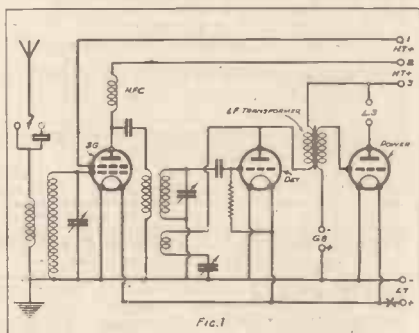

A popular circuit which lends itself readily to modification.

to ten shillings; in the majority of cases, however, you will find that the alterations will run into very much less than that. (This, of course, does not include the replacement of old valves with modern types; this should be regarded as normal "upkeep" expenditure.)

Three New Parts

I have chosen the circuit shown in Fig. 1 as being as nearly representative of the "two-year-old" as possible. It is a three-valve, S.G., detector and power output battery set and is completely lacking in "frills."

Turn up the circuit diagram of your own set and compare it with this one. It is highly probable that you will find a marked similarity between the two; your set may be a "four," but the inter-valve couplings and tuning

arrangements are almost certain to be nearly identical with those I have shown.

Apart from the valve itself, you will need the following additional components:—

- One 3-point shorting switch.
- One 50,000-ohm potentiometer.
- One 1-mfd. fixed condenser.

The shorting switch and potentiometer will have to be mounted on the front panel; in most cases it will be a simple matter to substitute the new switch for the existing one, but a fresh hole will probably have to be drilled to take the potentiometer.

L.T. Switch Position

Make this hole as near the H.F. end of the set as possible and mount the fixed condenser as close to it on the baseboard as space will allow.

Before proceeding any further it will be necessary to disconnect the tuning coil "bottom" end from the rest of the set; this will be the end remote from the grid of the S.G. valve, and is normally connected to earth and the fixed plates of the aerial tuning condenser.

FOR BETTER CONTROL

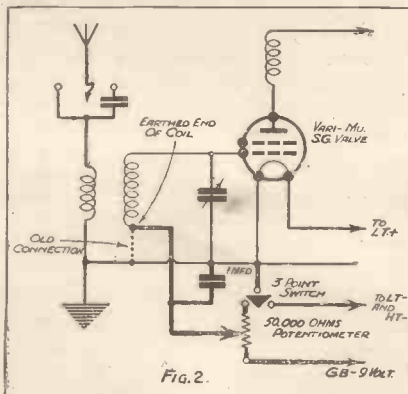

The heavy lines indicate the few extra connections needed when incorporating a multi-mu valve.

By the way, you may find the L.T. switch in your receiver is wired in the positive lead as indicated in figure 1; with variable-mu, it is necessary to connect the three-point switch in the negative L.T. lead. If your set has the on-off switch in the positive lead, join the leads that went to it, and break the L.T. negative lead to obtain two L.T. wires for joining to the 3-point switch.

Point-to-Point Connections

You will notice that there are three terminals on the potentiometer; the middle one is joined internally to

THE EXTRA COMPONENTS

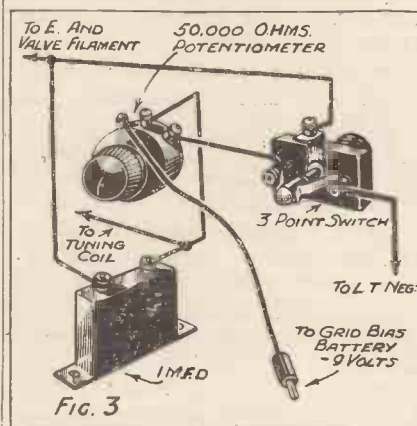

Only three extra components are required, wired up as shown here.

a "wiper" that moves over a resistance element. The two other terminals connect to the two ends of this element.

You may now proceed to connect up the new components as follows:

Connect the wires from the old switch to any two of the three terminals on the new 3-point switch.

Connect the third terminal on switch to one outer terminal on the potentiometer.

Centre terminal on potentiometer to free end of tuning coil.

Take flex lead from third (outer) terminal on potentiometer to grid-bias battery, -9 volts or more.

One side of 1-mfd. condenser to centre terminal on potentiometer.

Other side of 1-mfd. condenser to earth.

Shown Pictorially

These connections are shown pictorially in Fig. 3, whilst Fig. 2 is a conventional circuit diagram with the additional parts and connections drawn in in heavy lines.

You may now insert a suitable variable-mu screened-grid valve and the conversion is completed.

A MULTI-RANGE METER

How to obtain different ranges by means of fixed resistances.

MULTI-RANGE meters are expensive; and yet, if one is in possession of a low-reading milliammeter and a few resistances, a very useful instrument can be made up for an extremely small outlay.

CONNECTED EXTERNALLY

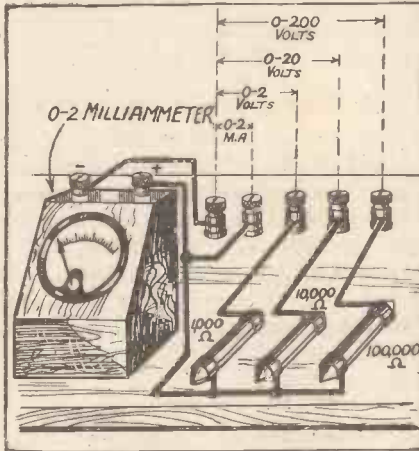

The resistances are connected in series.

The components required are one 0-2 milliammeter; one 1,000-ohm resistance; 1 10,000-ohm resistance, and one 100,000-ohm resistance. If the foregoing are connected up, as shown in the accompanying sketch, the reader will have a useful four-range instrument covering 0-2, 0-20 and 0-200 volts, besides 0-2 milliamps.

F. B.

FROM MY ARMCHAIR

—continued from page 199

Last summer, when the B.B.C. broadcast the nightingale, I received the signals, amplified them to a terrific extent (but retaining excellent quality), and then let the loudspeaker speak into the night.

I was most interested to see what the effect would be on the nightingales in my own neighbourhood. I

should like to report that the local birds responded or closed down, or something.

But no effect whatever was discernible. The local product ignored the B.B.C. bird completely.

I have no objection to lending the B.B.C. my nightingale, which works three times as hard as their own and, in fact, is a nuisance to the neighbourhood.

Local lovers do not, with arms around each other, gaze romantically up at the bird whose notes fall like liquid silver from the shadowy trees. They throw stones at it.

tone CONTROL AND THE PENTODE

—continued from page 188

With the foregoing facts in mind, let us now consider the matter from its other aspect—the use of a pentode in conjunction with a loudspeaker whose impedance increases with frequency to compensate for high-note loss in the preceding stages. We will assume that the increase in impedance is such as to provide an increase in power sensitivity in proportion to the high-note loss. It follows, then, that for very small signals the response will be perfectly balanced.

An Important Point

Now there will be some frequency in the extreme upper register for which the impedance will be a maximum. This impedance value will be considerably above that for which the M.U.P.O. is obtained, so that the power output at this frequency will be considerably less than the M.U.P.O.

WARNING!

Retail Prices of the



are fixed and no increase or reduction of these prices may be made without the consent of the manufacturers.

No guarantee will be issued to anyone purchasing a Milnes H.T. Supply Unit at less than the fixed retail price, and purchase at a cut price renders the buyer liable to an action for damages for infringement of patent rights.

The Milnes Unit is sold by all good wireless dealers at the following fixed prices:

90 volt ..	£3 3 0
100 volt ..	£3 9 5
120 volt ..	£4 2 3
150 volt ..	£5 1 6
180 volt ..	£6 1 9

Single capacity.

Ask for full particulars.

Made and Guaranteed by

MILNES RADIO CO.
 CHURCH ST., BINGLEY

PLEASE be sure to mention "Wireless Constructor" when communicating with Advertisers. THANKS!

Famous Maker's Offer! **£5** Radio-Gram CABINET for **65/-**
7 DAYS' FREE TRIAL (OR 10/- MONTHLY).
 Polished Oak! and Piano built! The Acoustic Tone brings a fine thrill. Makers to (Radio-Press, E.P.O., 3,000 clients etc).
 Other Models 35/- to £15. Photographs and List FREE.
PICKETTS Piano-Tone Cabinets. (G.W.) Albion Road, Bexleyheath
FOR "S.T.400" PICKETTS CABINETS
 As Recommended by John Scott-Taggart.

THE BELLING-LEE PICK-UP
27/6
 MODEL A.L. 1096

A pick-up with a brilliant response. Distance from centre of base to needle point adjustable from 7 1/4 to 9 3/4 inches. Head angle also adjustable. Ball bearing swivel. Supplied complete with length of copper screened flex.

BELLING & LEE LTD
 CAMBRIDGE ARTERIAL ROAD, ENFIELD, MIDDXX.

Write for Publication. P218.



"J.B." SHORT WAVE "SPECIAL"

Designed in every detail for Short Wave work. Bearings carry no current. Special screened "pigtail" to rotor. Very small minimum capacity. Insulating material is carefully placed and proportioned so as to reduce H.F. losses. Design of frame minimises closed loop effects. Capacities .00005, .0001, .00015, .0002, .00025.

Price 5/9 each

Advertisement of Jackson Bros. (London), Ltd., 72, St. Thomas' St., London, S.E.1. Telephone: Hop 1837.

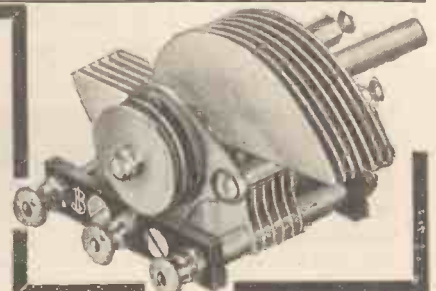

FOR THE SHORT WAVES

LATEST MAINS TRANSFORMERS

by Heayberd

Your mains transformer must be soundly constructed from first-class materials; it must be absolutely safe and must give its rated output without variation. Specify Heayberd transformers and you are assured of all those essentials. Here are three popular models:

MODEL W.35
For use with Westinghouse H.T.11 Rectifier. Rectified Output 500v. 120 ma. L.T. 4v. 5 amps. and 4v. 2 amps. C.T. Price 65/-

MODEL 803
Suitable for A Class Valves. Tappings: 250+ 250v. 75 ma. 4v. 1 amp., and 4v. 5 amps. C.T. Price 32/6

MODEL 723
Filament Transformer 4v. 3 amps. C.T. Price 12/6



Send 3d. stamps NOW for 36-page book packed with hints, tips and circuit diagrams incorporating these transformers.

F. C. HEYBERD & CO.,

10, FINSBURY STREET, LONDON, E.C.2.

NICORE TUNING COILS

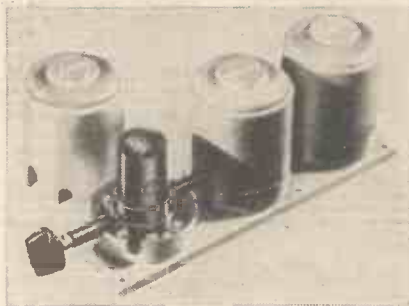

Varley NICORE Coils mark the biggest advance in radio tuning since the introduction of "Square Peak." Consistency has been the great aim, and has been attained with an even greater efficiency than was thought possible. Coils 10/6 each (also supplied in 3 or 4-gang on base.)

Write for FREE literature.



(Proprietors: Oliver Pell Control Ltd)

Adet. of Oliver Pell Control Ltd., 103, Kingsway, London, W.C.2



OUR NEWS BULLETIN

programmes in this country very soon. Anyway, this is the view expressed by Major Gladstone Murray, the B.B.C. Director of Public Relations, who recently returned to London after a three month's visit to Canada and the United States.

A Transatlantic Exchange

In an interview recently, Major Murray said: "I was able to make a new working arrangement between the Americans and the Canadians for an exchange of programmes, and I believe there will be a development in the near future for an extended exchange between the North American continent and ours."

In the U.S.A.

"Over there," went on Major Murray, "there is a tremendous keenness about our national events, such as the Trooping of the Colour and the Aldershot Tattoo. I heard the Derby broadcast in New York, and the Americans were as excited about it as I was."

100,000,000 Listeners!

"The American broadcasting system," said Major Murray, "is colossal, and it is estimated that they have a hundred million listeners. I think their best programmes are as good as ours, but their average programmes do not compare very favourably."

"That is not so much their fault, for it is due to the fact that the programmes are controlled by the advertisers; whereas our Programme Committee has a free hand. Where I think we can profit from American methods is to put some of their cheerfulness and snap into our broadcasts."

"Excelsior!"

Professor Jean Piccard, the brother of Professor Auguste Piccard—who holds the world altitude record for a balloon ascent—is reported to be setting out in a balloon from the World's Fair at Chicago in an adventurous attempt to break the altitude record.

But what is more interesting to

(Continued on page 203)

THE Lucerne Conference of broadcasting delegates recently concluded its labours. After five weeks of argument, a wavelength plan for European broadcasting stations has at last been accepted by a large majority of countries.

The new "Plan de Lucerne" is embodied in a convention which has been signed by twenty-seven countries. The delegates of seven countries—Finland, Holland, Greece, Hungary, Lithuania, Poland and Sweden—did not sign the convention, but it is hoped that they will, in fact, adopt the wavelengths allocated to them.

Needs of the New-comers

Since the last wavelength plan was drawn up in Prague in 1929, many countries have started broadcasting services, and their inclusion in the new plan has necessitated sacrifices, chiefly in the quality of the waves allotted to the older stations.

So far as this country is concerned, the number of waves available will be the same, but in general the wavelengths are slightly lower than formerly. Several of them, also, are shared with distant countries.

Great Britains Share

The actual wavelengths allotted to Great Britain, in metres, are as follows:

1,500	296.2
449.1	285.7
391.1	267.4
373.1	261.1
342.1	203.5
307.1	

The plan will come into force on January 15th, 1934. In due course we shall publish in THE WIRELESS CONSTRUCTOR full details as to the exact use to which the new wavelengths allotted to this country will be put.

Good News

A piece of good news is that we are likelier to have snappier broadcast

OUR NEWS BULLETIN

—continued from page 202

wireless enthusiasts is that he will investigate the possibilities of the stratosphere with the aid of radio.

A Nation-Wide Hook-Up

Professor Piccard will carry with him a complete transmitting outfit, and in the United States they have arranged a nation-wide hook-up to broadcast his comments.

The B.B.C. may decide to relay Professor Piccard's running commentary when he goes up in his balloon, and, if so, listeners will have the opportunity of hearing a man ten and a half miles up in the air telling them what it feels like.

Advice for an Adviser

Mr. Filson Young, who is the Adviser of Programmes to the B.B.C., has recently published a book entitled "Shall I Listen?" (Constable, 7s. 6d. net).

Mr. Young urges producers at the B.B.C. to forget the theatre, to reduce their incidental effects to a bare minimum, and to rely boldly on the voice to carry the whole burden of dramatic expression.

Are You a Bad Listener?

Writing about listeners, Mr. Filson Young says that bad listeners are those who listen too much; the sort of people who turn on the wireless without any idea what they are going to hear, and then—if they are not pleased with what they hear—express disapproval, and wonder why they spend 10s. a year on a licence.

There is one thing in which we very much agree with Mr. Young, and that is when he says it was a mistake in 1931 to abandon studio Opera broadcasts.

The West Regional

About a month ago the West Regional transmitter at Washford Cross began transmitting a service for Wales and the West Country, but at the time of writing the B.B.C. has not yet stated the exact date when the West National transmitter will commence a permanent service.

We understand that experiments in the synchronisation of the London National transmitter and the West National station on a wavelength of 261.6 metres (the London National wavelength) are still being carried out, and that the delay in bringing the National wavelength into operation at Washford Cross was because of difficulties of harnessing the single wavelength to the two transmitters without causing interference.

High-Power Synchronisation

In the past the B.B.C. has confined its experiments at synchronisation to low-powered stations, but the problem of the West National—London is more difficult because of the high power used at both centres.

However, we understand that the B.B.C. is generally satisfied with the results recently obtained, and that during day-time it is expected that the range of each station will be almost as big as would be the case if an exclusive wavelength were used.

Although experiments are still being carried out, we understand that a full alternative programme service will probably start soon.

Off Duty!

The "News Chronicle" had some interesting information the other day about the B.B.C. officials and their hobbies. It appears that Sir John Reith's hobby is breeding cattle at his Berkshire dairy farm, while Mr. Noel Ashbridge, the chief engineer, spends most of his spare time patronising the theatres.

Admiral Sir Charles Carpendale is keen on ice skating, and he has already won a number of cups and medals.

Eggs are so Cheap!

The Director of Programmes, Mr Roger Eckersley—brother of the celebrated P.P.E.—is reported by the rather facetious correspondent of the "News Chronicle" to have once had an interesting poultry farm; but now he has given it up because he finds he can buy eggs so cheaply in the Broadcasting House restaurant.

The only woman Governor of the B.B.C.—Mrs. Mary Hamilton—spends her spare time walking and sketching.

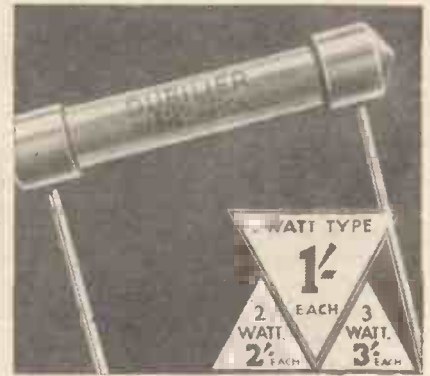

Resistance life is all important

Therefore always build with-

DUBILIER RESISTANCES

DUBILIER CONDENSER Co. (1925) LTD.,
DUCON WORKS, VICTORIA RD., NORTH ACTON, W.3

Write for Illustrated Catalogue of **RADIO-CRAMAPHONE CABINETS** of exclusive modern design, made by craftsmen in highly figured Oak, Walnut, or Mahogany, post free. **REMARKABLE VALUE** Cabinets made to order a speciality. **HOWE BOX BAFFLE.** Maker, under licence, of the **GILBERT** Cabinet Maker, **SWINDON** Estimates Free. Estd. 1866

HAVE YOU HAD? particulars of the "Magnum" Slow Motion Dial with the smooth non-slipping drive. Pilot Lampholder for rear illumination. Adaptable to all Air-spaced and solid Dielectric condensers. **3/-** Retail price

BURNE-JONES & CO. LTD.
298, BOROUGH HIGH STREET, LONDON, S.E.1.

* WE invite readers to support *
* our Advertisers—care being *
* taken to accept only announce- *
* ments of reputable firms! *

SOMETHING BIG IS COMING



ECONOMY PUSH-PULL

—continued from page 184

stage-gain an intervalve transformer with a 1:1 or step-down ratio must be employed, and a valve of a type such as is capable of giving maximum amplification for small load values must be used—e.g. a high slope medium power valve. This is termed the “driver” valve.

The effect of grid-circuit damping upon the load value of the “driver” valve is illustrated in Fig. 6. If the grid impedances of the output valves are identical, and remain constant for different values of the positive half-cycle, the average load will be constant, and the voltage and output across the transformer secondary will therefore remain undistorted. Distortion will result if the grid current characteristic of the output valves is curved (non-linear grid impedance); but this can, to some extent, be overcome by using a driver valve of lower impedance.

As compared with Q.P.P., it will be seen that “Class B” has the disadvantages of requiring a heavy duty coupling transformer and a power valve in the driver stage, and it would therefore seem that “Class B” is inferior for practical purposes to Q.P.P.

Where “Class B” Scores

That this is not the case is due to the fact that the output with Q.P.P. for a given H.T. voltage is limited by the fact that the input signals cannot be increased beyond the point at which grid current commences to flow—i.e. beyond zero grid, and there is a more or less critical value of load for which the output is a maximum. With “Class B,” this limitation obviously does not occur, and by increasing the input, and correspondingly reducing the load, it is possible to obtain any value of output

up to the point at which the valve is overrun.

When the signals are sufficient to reduce the anode voltage practically to zero during the peaks of the positive half-cycles, the power output will be increased in proportion as the load is decreased, as indicated by the dotted lines in Fig. 2(b).

A Common Disadvantage

Furthermore, with Q.P.P. it is essential to use high-efficiency pentodes in order to obtain full power and efficiency. The power triode characteristic curves, superimposed in

by affecting the performance of the preceding stages and causing distortion.

If the supply is from batteries they must be of low internal resistance; whilst if an A.C. eliminator is used it must have good regulation, obtained by the use of transformer, chokes, and rectifier of low resistance.

From a consideration of the comparative merits and disadvantages of the “Class B” and Q.P.P. systems, it will be evident that the latter system is most useful for providing undistorted output in the region of 1,000 milliwatts, with battery-operated

RADIO EXHIBITION AT OLYMPIA

*Our September issue will be a
Special Enlarged Exhibition Number*

*Profusely illustrated and containing
all the news of the Show.*

On Sale August 15th.

Price 6d.

THE WIRELESS CONSTRUCTOR

dotted lines in Fig. 2(a), show that the positive grid swings would be limited by zero grid long before the swing large enough to reduce the anode voltage nearly to zero at the peak (the condition necessary for 78.5 per cent efficiency) is reached (load line PE). For “Class B” high impedance triodes, which with “Class A” operation would provide negligible output, are adequate.

It must not be overlooked that both systems have the common disadvantage that any impedance in the H.T. supply current will result in a variation of the H.T. voltage with the strength of the signal received, there-

receivers. For outputs much in excess of this figure, a “Class B” output stage should be employed.

For Mains Sets

In small mains-operated receivers neither system can be employed with advantage in place of a “Class A” output stage, since their principal advantage—economy in H.T. consumption—is of little interest.

Using valves such as the Radiotron type 46, the “Class B” system is capable of providing outputs of 20-30 watts, with anode voltages as low as 300-400. For this class of work it is definitely unrivalled.

INDEX TO ADVERTISERS

	PAGE
Belling & Lee, Ltd.	201
Burne-Jones & Co., Ltd.	203
Carrington Manufacturing Co., Ltd.	193
Colvern, Ltd.	157
Cossor, A. C., Ltd.	158
Dubilier Condenser Co. (1925), Ltd.	203

	PAGE
Edison-Swan Electric Co., Ltd.	Cover iv
Gilbert, J. C. (Cabinets)	203
Graham Farish, Ltd.	195
Hayberd, F. C., & Co.	202
Jackson Bros. (London), Ltd.	201
Milnes Radio Co.	201
“Modern Encyclopedia”	Cover iii
“Modern Wireless”	Cover ii
Peto-Scott Co., Ltd.	199
Pickett Bros. (Cabinets)	201

	PAGE
Telegraph Condenser Co., Ltd.	197
Technological Inst. of Gt. Britain	193
Varley Products	202
Westinghouse Brake & Saxby Signal Co., Ltd.	193
Whiteley Electrical Co., Ltd.	203

All communications concerning advertising in “Wireless Constructor” must be made to John H. Lile, Ltd., 4, Ludgate Circus, London, E.C.4. Telephone: City 7261.

This Wonderful £1-1-0

PRESENTATION BOOK

The Modern Encyclopedia
FOR EVERY READER OF "THE WIRELESS CONSTRUCTOR"

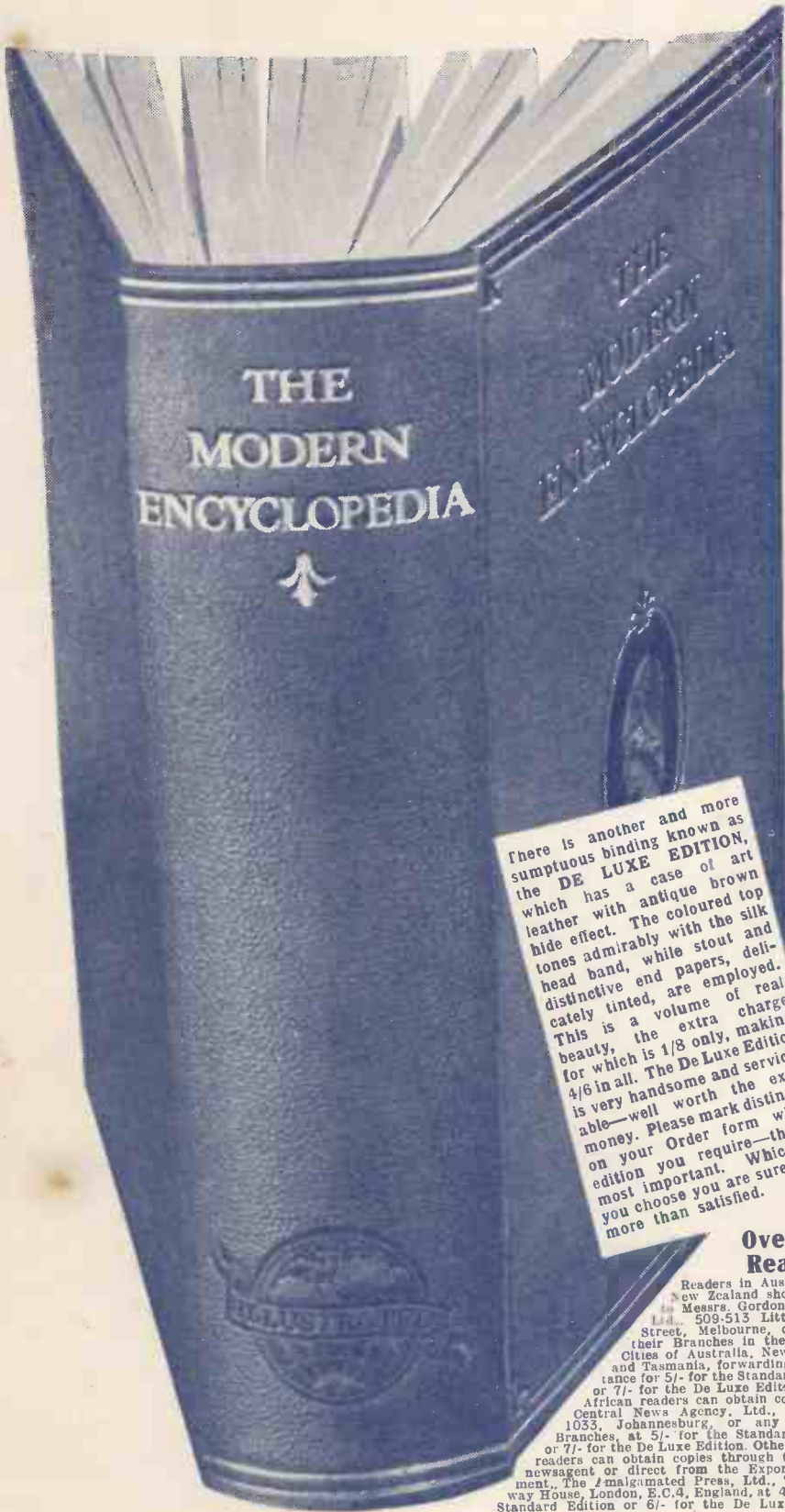

FROM the letter A to the last entry, FZYMOTIC, THE MODERN ENCYCLOPEDIA is, in its present form, a new and entirely up-to-date work. It has been produced under the direction of Sir John Hammerton, the leading encyclopedist of the age and editor of the great UNIVERSAL ENCYCLOPEDIA. It contains no fewer than 17,500 articles, conveying 200,000 distinct and individual facts in something over 1,000,000 words. It contains over 1,000 specially drawn illustrations. Its information on every subject is authoritative, exact, and up to the minute.

This great Encyclopedia contains 1,024 pages of closely printed but easy-to-read matter, each page measuring 9½ in. by 6 in. The completed volume is 2 in. thick, weighs nearly three pounds, and is strongly bound in stout covers of superfine maroon cloth, with delightful seal-grain effect. There is chaste lettering on the spine in real gold leaf, and a polished title and design on the same.

Readers who wish to obtain a copy of this magnificent volume must place an order with their newsagent or bookseller for "THE WIRELESS CONSTRUCTOR" for at least three months. Now fill in and post the order form below, enclosing a postal order for 2/10 to cover cost of carriage, cardboard container for packing, insurance, etc. This is for the Standard Edition.

There is another and more sumptuous binding known as the DE LUXE EDITION, which has a case of art leather with antique brown hide effect. The coloured top tones admirably with the silk head band, while stout and distinctive end papers, delicately tinted, are employed. This is a volume of real beauty, the extra charge for which is 1/8 only, making 4/6 in all. The De Luxe Edition is very handsome and serviceable—well worth the extra money. Please mark distinctly on your Order form which edition you require—this is most important. Whichever you choose you are sure to be more than satisfied.

For Overseas Readers

Readers in Australia and New Zealand should apply to Messrs. Gordon & Gotch, Ltd., 509-513 Little Collins Street, Melbourne, or any of their Branches in the principal Cities of Australia, New Zealand, and Tasmania, forwarding a remittance for 5/- for the Standard Edition or 7/- for the De Luxe Edition. South African readers can obtain copies from Central News Agency, Ltd., P.O. Box 1033, Johannesburg, or any of their Branches, at 5/- for the Standard Edition or 7/- for the De Luxe Edition. Other Overseas readers can obtain copies through their local newsagent or direct from the Export Department, The Amalgamated Press, Ltd., The Fleetway House, London, E.C.4, England, at 4/6 for the Standard Edition or 6/- for the De Luxe Edition.

THE MODERN ENCYCLOPEDIA ORDER FORM

To A.P. PRESENTATION BOOK DEPT.,
[G.P.O. Box 184a],
Cobb's Court, Broadway, London, E.C.4.

I have given an order for "THE WIRELESS CONSTRUCTOR" for three months, and wish to take advantage of your offer. Please send me immediately the Special Edition of THE MODERN ENCYCLOPEDIA as specified below.

STANDARD EDITION	DE LUXE EDITION
I enclose Postal Order value 2/10 to cover carriage, packing, insurance, etc. Please send me the Standard Edition.	I enclose Postal Order value 4/6 to cover carriage, packing, insurance, and extra cost of binding. Please send me the De Luxe Edition.

Please cross out section NOT required.
PLEASE WRITE CLEARLY

Signature

NAME
(Block Letters)

FULL ADDRESS

Cross P.O. & Co. and make payable to
"Amalgamated Press, Ltd."

IMPORTANT.—This Order Form, together with remittance, must be enclosed in a sealed envelope bearing 1½d. stamp.

Irish Free State readers should apply to 73, Middle Abbey Street, Dublin (for the Standard Edition only).



EDISWAN

The name that means 'EXCELLENCE'

★ THE NEW MAZDA 'CLASS B' VALVE IS READY!

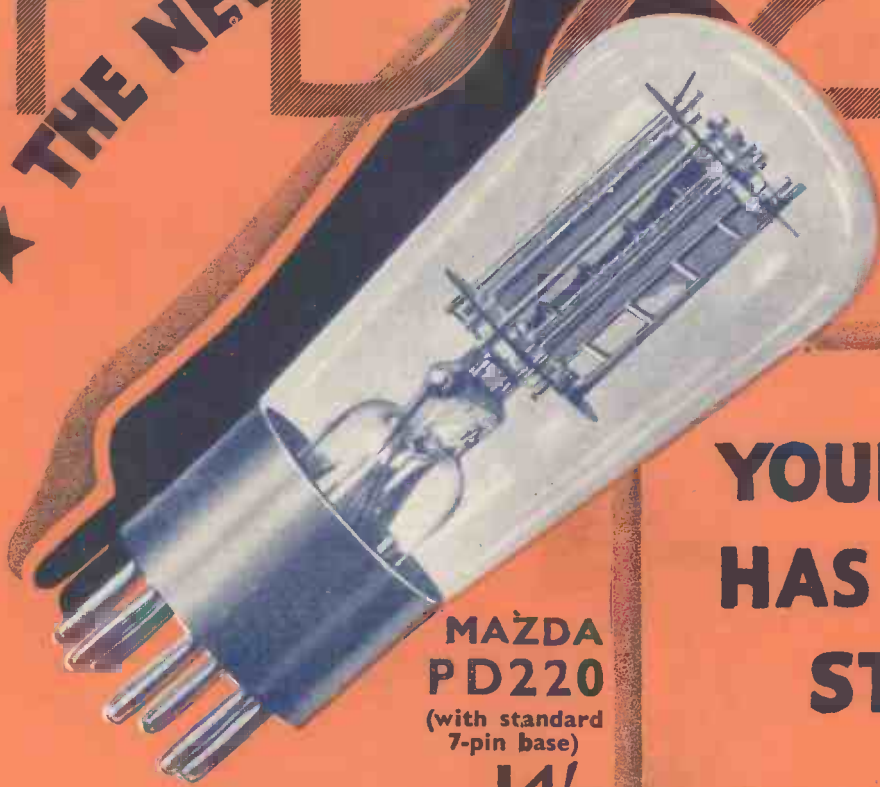

MAZDA
PD220
(with standard
7-pin base)
PRICE 14/-

**YOUR DEALER
HAS AMPLE
STOCKS**

The New Mazda PD220 is a 2-volt low consumption valve for a "Class B" ("positive drive") output stage. It is designed for use with 135 v. H.T., but batteries of 120 v. or 150 v. may be used. No bias is necessary with any value of H.T. voltage. *No special driver valve is required, a Mazda L.2 supplying sufficient power for the PD220 to operate a small M.C. speaker.*

MAZDA THE BRITISH VALVES

The Edison Swan Electric Co. Ltd.  155 Charing Cross Road, W.C.2

Mazda Radio Valves are manufactured in Great Britain for The British Thomson Houston Co. Ltd., London and Rugby.

RECOMMENDED BY ALL GOOD RADIO DEALERS