

# The Wireless Constructor

6<sup>D</sup>  
MONTHLY

EDITED BY  
PERCY W. HARRIS, M. I. R. E.  
Vol. VIII. AUGUST, 1929. No. 34.

DWPLCATE

→ BUILD OUR  
ALL-ELECTRIC  
GRAMOPHONE!  
QUALITY-VOLUME-PURITY!

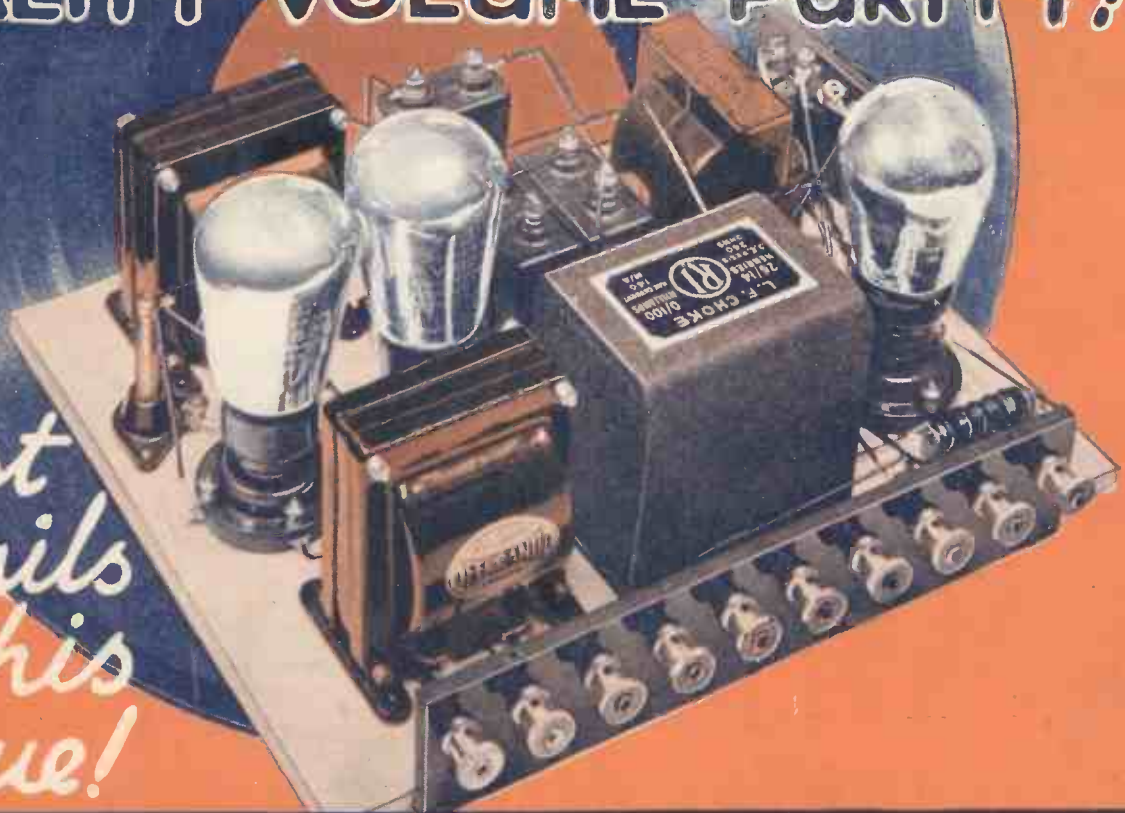

*First  
Details  
in this  
Issue!*



**JUDGE** our argument by results.

Try a set of Mullard P.M. Valves in your set to-night.

Your speaker will give instant, unsolicited proof of the value of the research and brains that go to the manufacture of Mullard radio valves.

**Mullard**  
**THE MASTER-VALVE**

Advert: The Mullard Wireless Service Co., Ltd., Mullard House, Charing Cross Road, London, W.C.2



# CONTENTS

	Page		Page
The Editor's Chat .. . . .	187	Within the Vacuum .. . . .	211
Queer Queries .. . . .	188	Chats at the Work-Table .. . . .	213
The 1929 Super-Quality Amplifier .. . . .	189	Laboratory Notes .. . . .	215
The Exodus from the B.B.C. .. . . .	193	Radiogramphonics .. . . .	216
S&M Picture News .. . . .	195	What's New .. . . .	217
Build Our All-Electric Gramophone .. . . .	198	In Lighter Vein .. . . .	219
H.T. From A.C. Mains .. . . .	199	Bias Without Batteries .. . . .	221
Happenings At Savoy Hill .. . . .	203	Valves That "Ring" .. . . .	224
Summer Reception .. . . .	205	Moving-Coil Speakers .. . . .	228
The "Shortrode" Two .. . . .	207	Our News Bulletin .. . . .	232

*As some of the arrangements and specialities described in this Journal may be the subject of Letters Patent the amateur and trader would be well advised to obtain permission of the patentee to use the patents before doing so.*

EDITED BY

PERCY W. HARRIS, M.I.R.E.

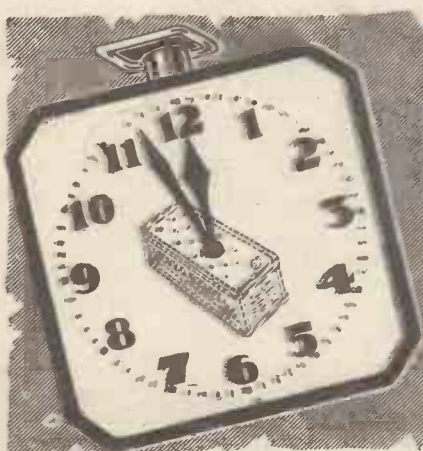
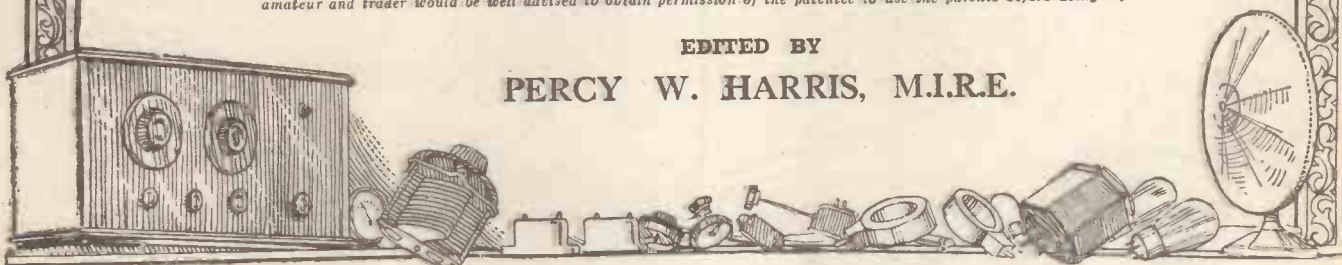

**TIME**  
will prove  
the wisdom  
of your  
choice

THE  
"POPULAR PORTABLE"  
H.T. DRY BATTERIES  
(In Brown Containers.)  
For all Portable Sets.

PORTABLE 1 63 volts 8/6  
PORTABLE 2 99 volts 13/6  
PORTABLE 3 108 volts 15/-

For Perfect Reception  
and long life—buy

**EVER READY**  
BRITAIN'S BEST BATTERIES

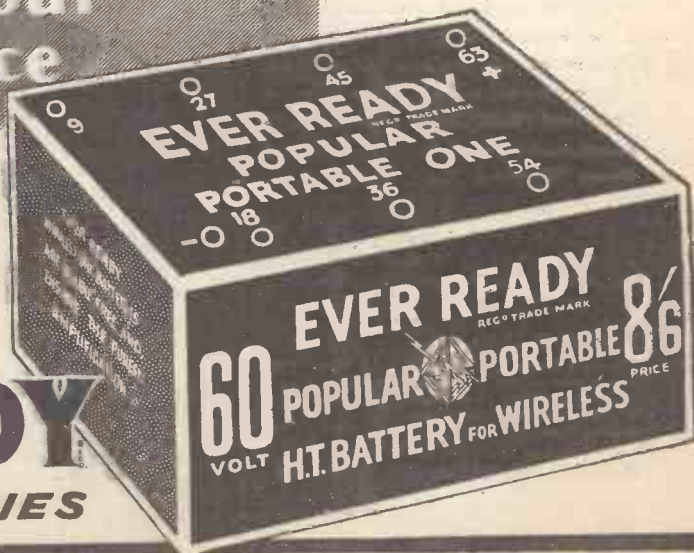



Interlocked construction makes Cossor the strongest and most dependable Screened Grid Valves ever produced. Even the hardest blow cannot disturb the perfect alignment of their electrodes. These wonderful new Cossor Screened Grid Valves are shock-proof, noise-proof, and break-proof. Every Wireless Dealer sells them.

Made in 3 types for use with 2, 4 and 6-volt Accumulators.

**Technical Data.**

Filament Amps. .1, Max. Anode Volts 150, Impedance 200,000, Amplification Factor 200, Grid Bias 1.5 volts at max. anode Volts. Price **22/6** (either type)

A. C. Cossor, Ltd., Highbury Grove, London, N.5.

# Cossor

## Screened Grid

BRITAIN'S FINEST S.G. VALVE

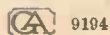



# THE WIRELESS CONSTRUCTOR



Edited by  
PERCY W. HARRIS, M.I.R.E.

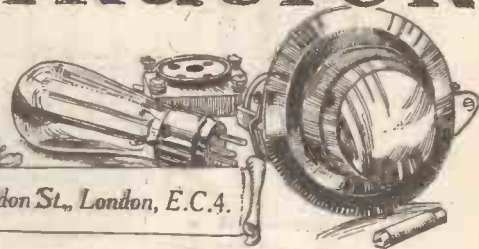

Published by the Amalgamated Press, Ltd., Fleetway House, Farringdon St., London, E.C.4.

## THE EDITOR'S CHAT

In this article Percy W. Harris, M.I.R.E., the Editor of "The Wireless Constructor," introduces the new All-electric Gramophone described in this issue.

If any one prophecy has been hopelessly inaccurate it is that the broadcast service would kill the gramophone. Actually, as everybody knows, the gramophone industry is in a far more prosperous position than ever before, while, far from being enemies, both industries are now the firmest friends.

Technically the progress in both radio and the gramophone has been enormously interesting. The technique of one has been applied to the other, and there has been a general interchange of ideas for the benefit of both. The amplifier, which was primarily developed for loud-speaker work in conjunction with radio, has been applied to the electric pick-up, so that by using a pick-up, an amplifier and a good loud speaker we are able to get results far superior to those obtainable with the most expensive non-electric gramophones.

Similarly, in the studio the techniques of broadcasting and recording are identical, and only beyond this do we find evidence of essential difference.

### All-Mains Amplifier

As there is so much that is common in the technique of both arts we have decided to give our readers a series of articles of a unique character. We are, for example, publishing in the current issue a design for a special A.C. power unit, and also a design for a new low-frequency amplifier of the highest quality. The power unit, designed to work from alternating current mains, will provide the reader with an adequate supply of hum-free high-tension current for any set, there being one fixed high voltage for the output valve or valves, and three

variables for any other purpose. The power unit also supplies, if required, five volts alternating current for filaments.

The amplifier is truly a general-purpose instrument. By connecting it immediately following the detector valve of any ordinary receiver the reader will be able to obtain not only first-class quality, according to the highest modern standards, but also full undistorted power for working a moving-coil loud speaker. Used in conjunction with the power unit, and taking both its high-tension and low-tension supply from that source, it thus becomes an all-mains amplifier, making no further demands for high- or low-tension. If the reader is a gramophone enthusiast, then all he has to do is to attach any good quality pick-up to the input side, and a suitable loud speaker to the output

end, whereupon he has a first-class modern all-electric gramophone.

Both units, the power unit and the amplifier, are built on small baseboards, and in a subsequent issue we shall publish the design of a cabinet, together with turntable and electric driving motor and a new loud speaker, so that the reader will be able to assemble the unit in the most convenient form.

### Suitable for Batteries, Too

Subsequently, too, we shall publish a radio attachment in which both the power supply unit and the amplifier will be used with a specially designed radio receiver.

It should be mentioned that the amplifier has been designed so that, if required, and with no change of wiring, it can be used from accumulators and high-tension batteries.

### HAVE YOU HEARD THIS ONE?

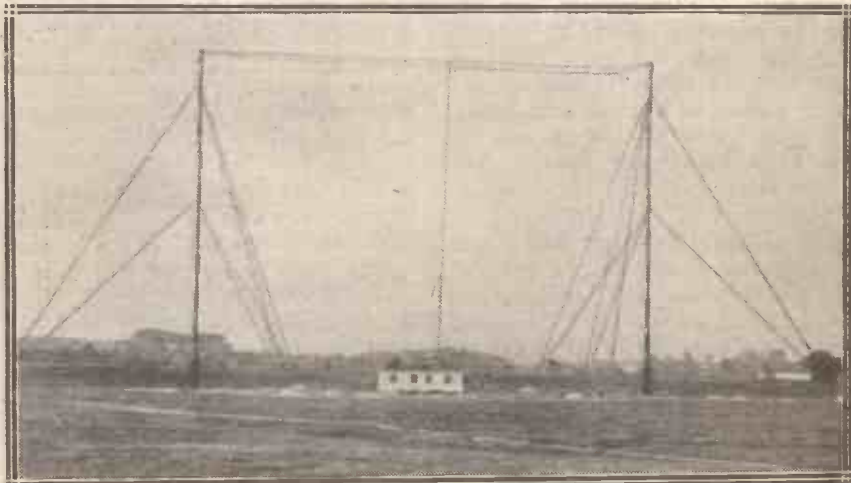

This photograph shows the aerial and station building of the Hamar broadcasting station in Norway.

# QUEER QUERIES



Some typical radio faults reviewed and questions answered.

By P. R. BIRD.

## Overcome by Hum

SOME of the most despairing documents that it has ever been my luck to read have been penned by people cursed by hum interference. Any electric-light or power main is a potential source of this trouble, but in most districts the chief electricity suppliers, such as the light companies, are *not* the principal offenders.

Most of the trouble comes from small cinemas, flashing electric signs outside shops, H.F. apparatus as used by doctors, etc., and similar privately-owned ventures. This being so, unfortunately, every case requires treatment on its merits, and there is no general rule by which such interference can be eliminated.

The placing of large condensers across machinery such as generators, the re-spacing of leads, the avoidance of concealed leads from the mains in the walls, and the provision of screening are all well-known cures. Other lines of attack which are not so widely known are the avoidance of direct connection of the receiving apparatus to the receiving aerial, by using a variable weak inductive coupling, and the use of a "counterpoise" earth instead of a direct connection.

## Telephones for Testing

One of the best methods of testing a wireless set or wireless components is by means of a battery and a pair of 'phones. Quite 50 per cent. of the faults which arise in receivers could be located in a few moments in this way if only the owner of the set realised how to go about the business.

The first thing to do, of course, is to find out that the 'phones themselves are O.K. Fortunately, it is a very simple thing to test these, and as telephones are extraordinarily sensi-

tive instruments, there is no need to use an external battery such as must be used when testing the set. To make sure that the 'phones are O.K., disconnect them from the set and place them over the ears in the usual way. Then hold one of the

## THE TECHNICAL QUERIES DEPARTMENT

Are you in trouble with your set?

Have you any knotty little Radio problems requiring solution?

The WIRELESS CONSTRUCTOR Technical Queries Department has been thoroughly reorganised and is now in a position to give an unrivalled service. The aim of the department is to furnish really helpful advice in connection with any radio problem, theoretical or practical.

Full details, including the scale of charges, can be obtained direct from the Technical Queries Department, WIRELESS CONSTRUCTOR, Fleetway House, Farringdon Street, London, E.C.4.

A postcard will do. On receipt of this all the necessary literature will be sent to you free and post free, immediately. This application will place you under no obligation whatever. Every reader of the WIRELESS CONSTRUCTOR should have these details by him. An application form is included which will enable you to ask your questions, so that we can deal with them expeditiously and with the minimum of delay.

London readers please note: Inquiries should not be made in person at Fleetway House, or at Tallis House.

little metal tags which was formerly attached to the telephone terminals between your lips.

Now take a piece of metal—a key, or some such object—and rub it along the other 'phone tag. If the 'phones are in good order you will hear a distinct crackling sound in them which corresponds exactly with the rubbing of the key. This sound is due to the minute currents set up in the body, and these being extremely weak they can only be detected by an efficient instrument.

If no sound is produced, the telephones are faulty, or there is a dis-

connection in the cords. If the former, by listening first to one earpiece and then to the other you can find if only one is wrong or both of them.

When the 'phones have been proved to be O.K., they can in conjunction with a dry cell be made to test the continuity of wiring, or of components such as L.F. transformer, etc.

## Checking Continuity

All that is necessary is to join up one tag of the 'phones to one terminal of the dry cell, and then to secure two flexible leads. These should be connected one to the remaining 'phone tag, and the other to the remaining terminal of the dry cell. When this has been done, if these two leads are touched lightly together they will produce a strong double click in the 'phones.

One of the clicks is made when they make contact and the other when they are separated. Thus a brief touch gives a strong double click. This may be used for testing the continuity of leads, etc., for if the strong double click is heard it is ample evidence that the circuit which is being tested is making good electrical connection. Valve connections, for instance, could be tested as follows.

## Valve-Holder Connections

The 'phones and dry cell would be provided with flexible leads as stated, and one of these flexible leads would be connected to the valve grid socket. If now the other flexible lead is tapped on this lead, the loud double click will be heard. Any of the wires which go direct to the grid terminal will also give this double click, because when a lead is screwed down under the terminal this becomes, in effect, a part of that wire.

Inside the valve holder there should be a concealed wire making contact between the grid socket and the grid terminal. If this wire is in sound condition and making good contact at both ends, the flexible lead, when touched upon this socket (or, indeed, upon the valve leg itself when placed into the socket), will give the loud double click indicating that continuity is O.K. But if the internal connection is defective in any way the flexible lead which is attached to the grid terminal of the valve holder will not be connected when the other flexible lead is touched on the grid leg of the valve, because of the broken circuit, and consequently the click will be absent, thus showing where the break lies.



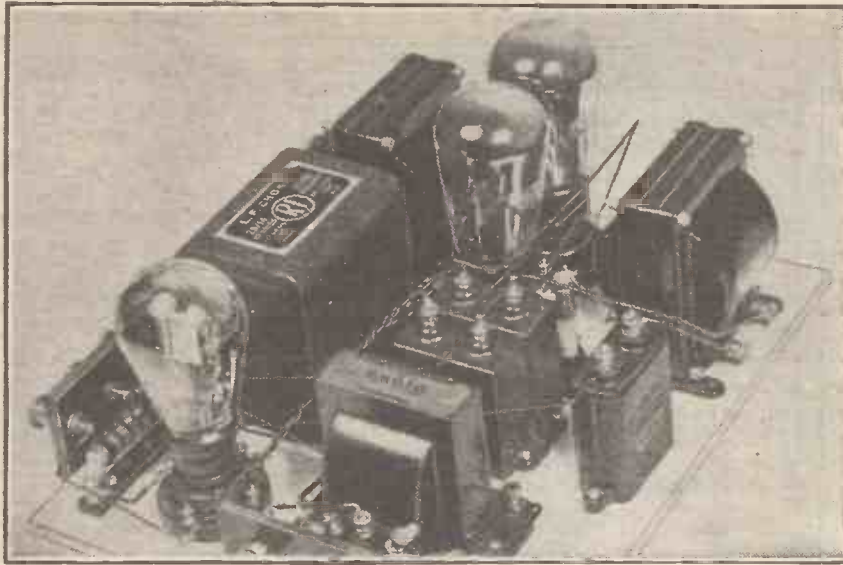

# The 1929 Super- Quality Amplifier

By  
PERCY W. HARRIS,  
M.I.R.E.

A YEAR ago we published in these columns a design for an amplifier which could be added to any existing receiver so as to give the user the benefit of modern high-quality reproduction, together with sufficient power-handling capacities to do full justice to a modern moving-coil or other high quality loud speaker. A large number of appreciations of this amplifier were received and the general reception of the instrument was such that we feel that a 1929 "edition" might meet with a further welcome among our readers.

The new amplifier which is presented in this issue has, therefore, been designed to take advantage of new developments, and, in particular, new valves. Furthermore, the amplification given is appreciably in excess of that obtainable with last year's model and has been particularly designed to function with the many excellent gramophone pick-ups now available.

### A Complete Outfit

In a companion article is published the design for a new high-grade A.C. mains unit which will provide the necessary high-tension current, together with low-tension raw A.C. which, strange as it may seem, is a perfectly satisfactory filament supply for the new amplifier.

Thus with this amplifier and the companion mains unit (which incidentally will supply not only H.T. for this amplifier, but for the ordinary receiving set as well) the reader will have a unique combination. By

attaching a pick-up to the input terminals of the amplifier, a loud speaker to the output, and by connecting the power unit, a complete A.C. electric gramophone equipment will be obtained, and will give the

*In conjunction with the H.T. power unit described elsewhere in this issue, and a gramophone pick-up, this amplifier forms an exceptionally fine electric gramophone.*

marvellously realistic quality only obtainable with the modern electric gramophone. Details of the combination of these two units will be found in another article, entitled "Build Our All-Electric Gramophone," in the current issue.

Coming now to a detailed con-

sideration of the 1929 Super-Quality Amplifier, an examination of the theoretical circuit will show that transformer coupling is used throughout. It has been made clear on several occasions that in our opinion there is no longer any need to consider that resistance-coupling is essential for good reproduction, for modern transformers are capable of doing full justice to both high and low notes, with the additional ability to give a magnification unobtainable with resistance-capacity-coupling.

### Good Reproduction

Examination of the curves of a modern high-grade transformer will show that it gives substantially uniform amplification over the whole scale that can be utilised on any loud speaker, and if we only use the

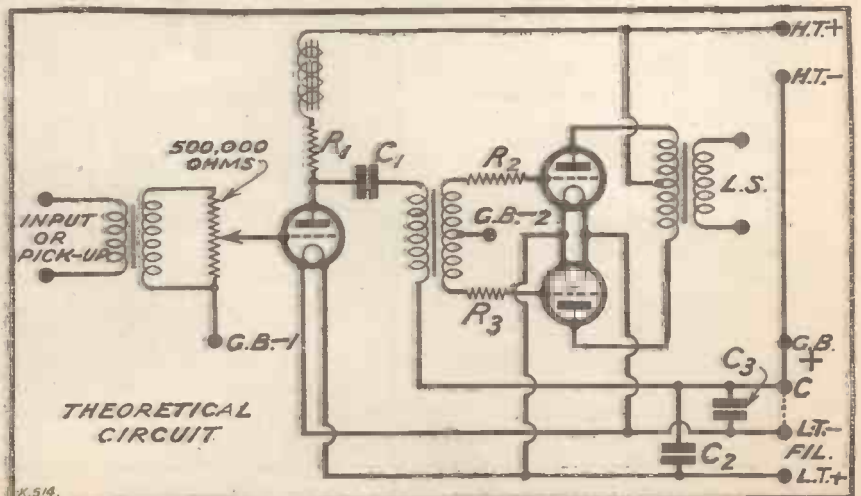

The circuit employed for the 1929 Super-Quality Amplifier.

## The 1929 Super-Quality Amplifier—continued

transformers correctly we can obtain with them reproduction which is astounding in fidelity.

The input to this amplifier is by means of a high-grade low-frequency transformer, across the secondary of which is placed a high-resistance potentiometer to act as a volume control. The secondary of this transformer feeds a valve of moderately low impedance, which is choke-coupled to the primary of an input push-pull transformer, the output of which feeds modern super-power valves of high grade. The output of these valves is combined in an output transformer so as to feed the loud speaker.

### Preventing Saturation

By using the choke-condenser feed we can use a power valve to precede the push-pull transformer, and keep the comparatively heavy plate current

out of the primary winding. It must be remembered that a good modern pick-up is capable of giving a relatively powerful input to the valve it feeds, and it is a distinct advantage to precede the output stage by a valve which can handle sufficient grid swing without distortion. A wire-wound resistance is included in the plate circuit of this first valve, so as to reduce the voltage applied to it, as one input voltage is used throughout, in accordance with the practice recently adopted by this journal.

### Anti-Parasitic Resistances

In each grid circuit of the output valves a 100,000 vacuum type resistance is placed to prevent troubles which sometimes occur when the valves are not quite matched. The whole unit is made up, as will be seen, in a distinctly attractive form.

The filament circuit is more than

usually interesting. It will be noticed that grid bias positive and H.T. negative are both connected to a terminal marked "C." When the valves are fed with raw A.C. this terminal C goes to the centre-tapping on the filament winding of the mains unit transformer, while the two terminals marked L.T. + and L.T. - are connected to the two ends of the low-voltage A.C. winding. The grid returns are thus taken to the centre point of the winding, this being one of the means of reducing hum.

### COMPONENTS REQUIRED.

- Baseboard, 12 in. × 10 in.
- Ebonite strip, 10 in. × 2 in.
- Ebonite strip, 4 in. × 2½ in.
- 12 Terminals.
- 3 Valve holders (Precision). (Lotus, Benjamin, Igranic, Marconi, W.B., etc.)
- 1 L.F. choke (R.I. 28/14). (Pye 32-henry, Ferranti type B1.)
- 1 L.F. transformer (Brown). (Ferranti, R.I., Igranic, Cossor, Lissen, etc.)
- 1 Push-pull input transformer (Ferranti AF5C).
- 1 Push-pull output transformer (Ferranti OP3C).
- 3 2-mfd. condensers (T.C.C., Dubilier). (Hydra, Lissen, etc.)
- 1 20,000-ohm wire-wound resistance (Ready Radio, Ferranti, Varley, etc.).
- 1 Holder for same.
- 2 Vertical type grid-leak holders (Dubilier).
- 2 100,000-ohm vacuum resistances (Ediswan).
- 1 Volume-control potentiometer, 500,000 ohms (Igranic Megostat). (Pilot, Voluvernica, Centralab, etc.)

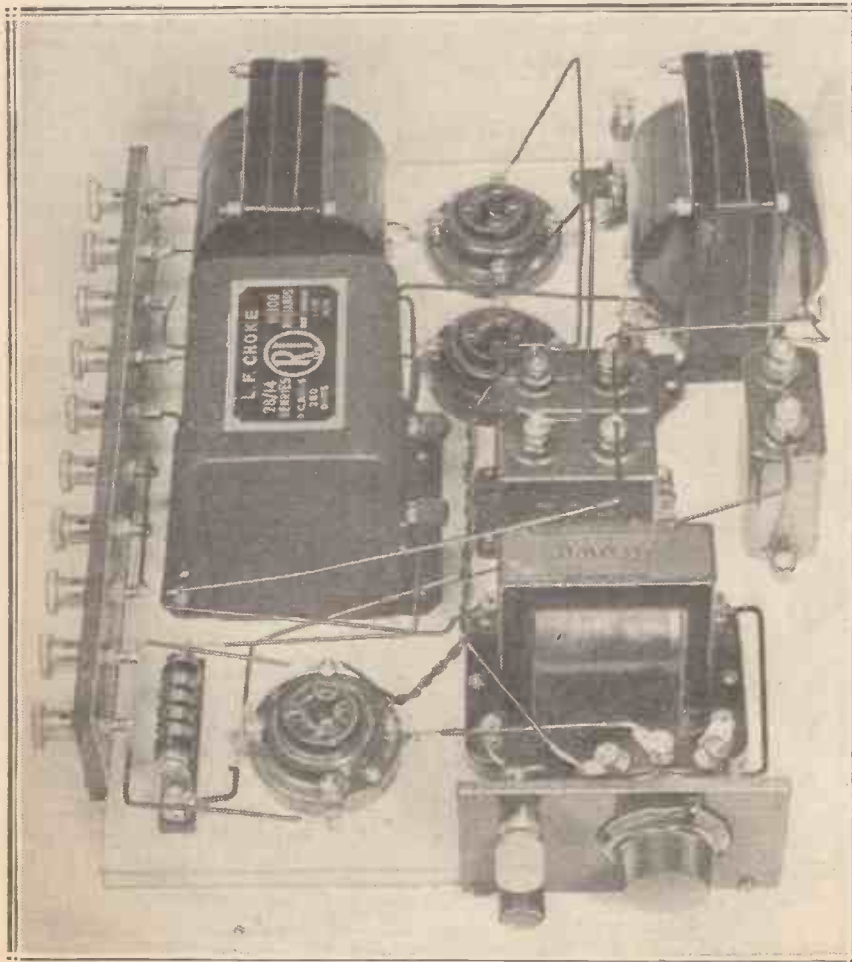

Insulated wire is used throughout in this amplifier, which is designed to carry quite a high H.T. voltage. As will be seen it is not at all complicated or tricky to build.

If, however, it is desired to run this amplifier from a "Stedipower" L.T. unit, or off accumulators, then it is only necessary to connect the terminal C to the terminal L.T. -, using L.T. - and L.T. + in the usual way. Equally conveniently those readers who already have a suitable mains unit providing H.T., and who would like to utilise A.C. for filament supply in this amplifier, can obtain at comparatively low cost a suitable filament transformer with a centre-tap, or even one with a suitable voltage and no centre-tap on the winding—for, as will be explained later, it is quite feasible to utilise a potentiometer to give a centre-tap effect.

### Efficient Volume Control

The use of a potentiometer across the secondary winding of the input transformer has been one found to be of distinct advantage when using a



## The 1929 Super-Quality Amplifier—continued

pick-up, for this method of volume control does not seem to upset the characteristics of the pick-up in the way many of the usual volume controls do when included on the primary side.

one end to the other and enabling us to obtain maximum volume with the slider at the grid end and minimum volume when it is at the opposite or grid-bias terminal end.

The presence of this high resistance across the secondary terminals only very slightly reduces the magnification (the loss is generally inaudible), while giving a slight flattening to any characteristic which may tend to peak at the upper end. So long as distortion does not precede this transformer (due, for example, to an overloading of the detector valve), alteration of the volume control will make no difference to the quality but only to the strength, which is, of course, what we aim to achieve.

Experience also shows that it is wise to use a valve which will stand a considerable grid swing without distortion for the stage preceding the last.

### Shunt-Feed

The difficulty which arises here is generally that the plate current for such a valve is higher than it is advisable to pass through the primary of the transformer following it. In the present amplifier, by using a choke condenser combination the steady plate current is kept out of the primary of the transformer, the coupling condenser, however, passing freely the audio frequencies which need to be magnified. We can,

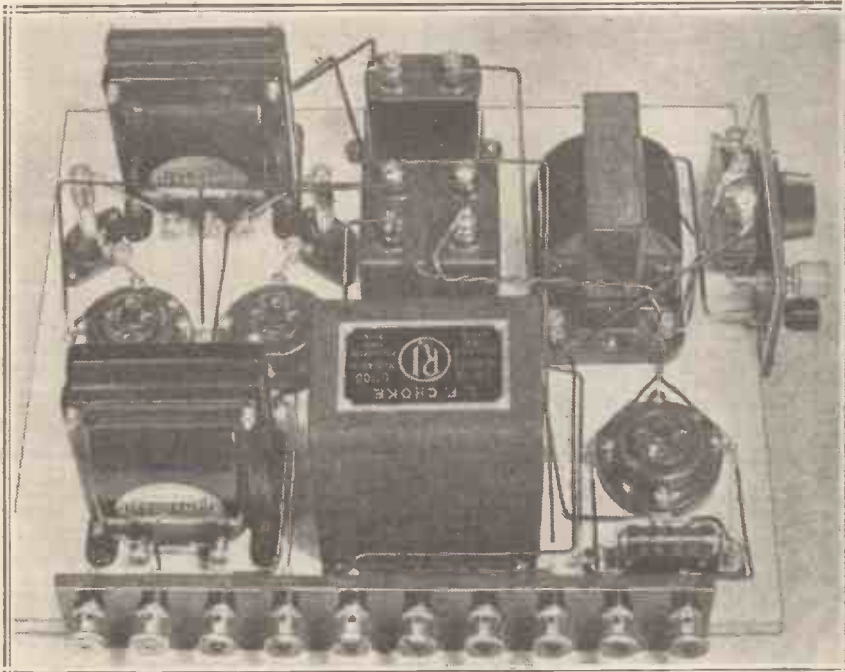

The two upright grid leaks, one on either side of the furthestmost Ferranti transformer, are anti-parasitic leads in the grid leads of the two push-pull valves.

It will be well perhaps to consider this amplifier from several different aspects, according to the use to which it will be put, but before doing this I would like to touch upon a few technical details which have a bearing on the design as a whole. It is high time that every wireless experimenter realised that however good single units may be when measured separately, the ultimate test of an amplifier is always its fidelity "overall," and it is first-class overall amplification that has been aimed at throughout.

### Large Input Valve

The method of using a potentiometer across the output terminals of a low-frequency transformer immediately following the detector is one which has a number of advantages and is distinctly superior to any scheme which controls the volume at a later stage. In the present arrangement, as will be seen by examination of the theoretical diagram, a 500,000-ohm resistance is shunted across the secondary terminals of the transformer, the slider running from

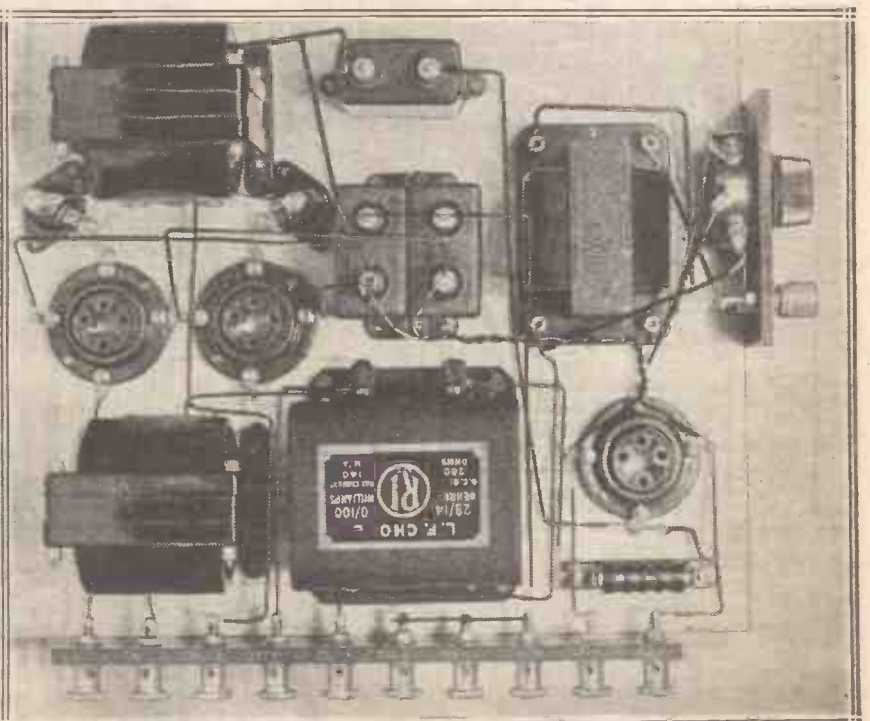

A bird's-eye view of the amplifier. The choke is the shunt-feed anode choke for the first valve.

# The 1929 Super-Quality Amplifier—continued

therefore, if we like, put even a super-power valve in the first socket of our amplifier without any risk of saturating the core of the transformer following it. In most cases, however, a good L.F. valve or power valve is all that is needed.

The two 100,000-ohm resistances, one of which is in series with each grid, take the place of the quarter-megohm resistances used in the previous amplifier, the 100,000-ohm value being more suitable but hitherto difficult to obtain in inexpensive form. I have used the Ediswan vacuum resistances which are now sold at very low prices and which are just what we want here.

In the centre of the assembly two 2-mfd. condensers will be seen. These are shunted across the filaments, one coming from each filament lead to the

centre-tap lead. When working with raw A.C. on valve filaments the grid return goes best to a centre point, for if we connect the grid return to one or the other end of the filament, bad hum is caused.

### Either A.C. or D.C.

By using the centre-tap on the transformer (or equally effectively by placing a potentiometer across the valve filament, and joining the grid return to the centre point on this), a much better effect is obtained. If, however, it is desired to run the valve filaments from D.C., then all we have to do is to join the terminal marked C to the terminal marked L.T.— and dispense with these 2-mfd. condensers shunted across the filament leads.

Some readers may wonder how it is

possible to use raw A.C. to light the valve filaments without getting a terrible hum, but experienced workers have long since found that provided one chooses the right type of valve and does not use raw A.C. on the detector filament, the hum will be practically negligible.

The type of valve to choose is one having a filament which does not cool too quickly, and a quarter-ampere filament was found to be far the best in this regard. Seeing that super-power valves almost invariably have quarter-ampere filaments, we have no trouble in the last stage.

Furthermore, no magnification takes place after this stage. In the case of the low-frequency stage preceding this, however, more care is necessary, for there are comparatively few

(Continued on page 242.)

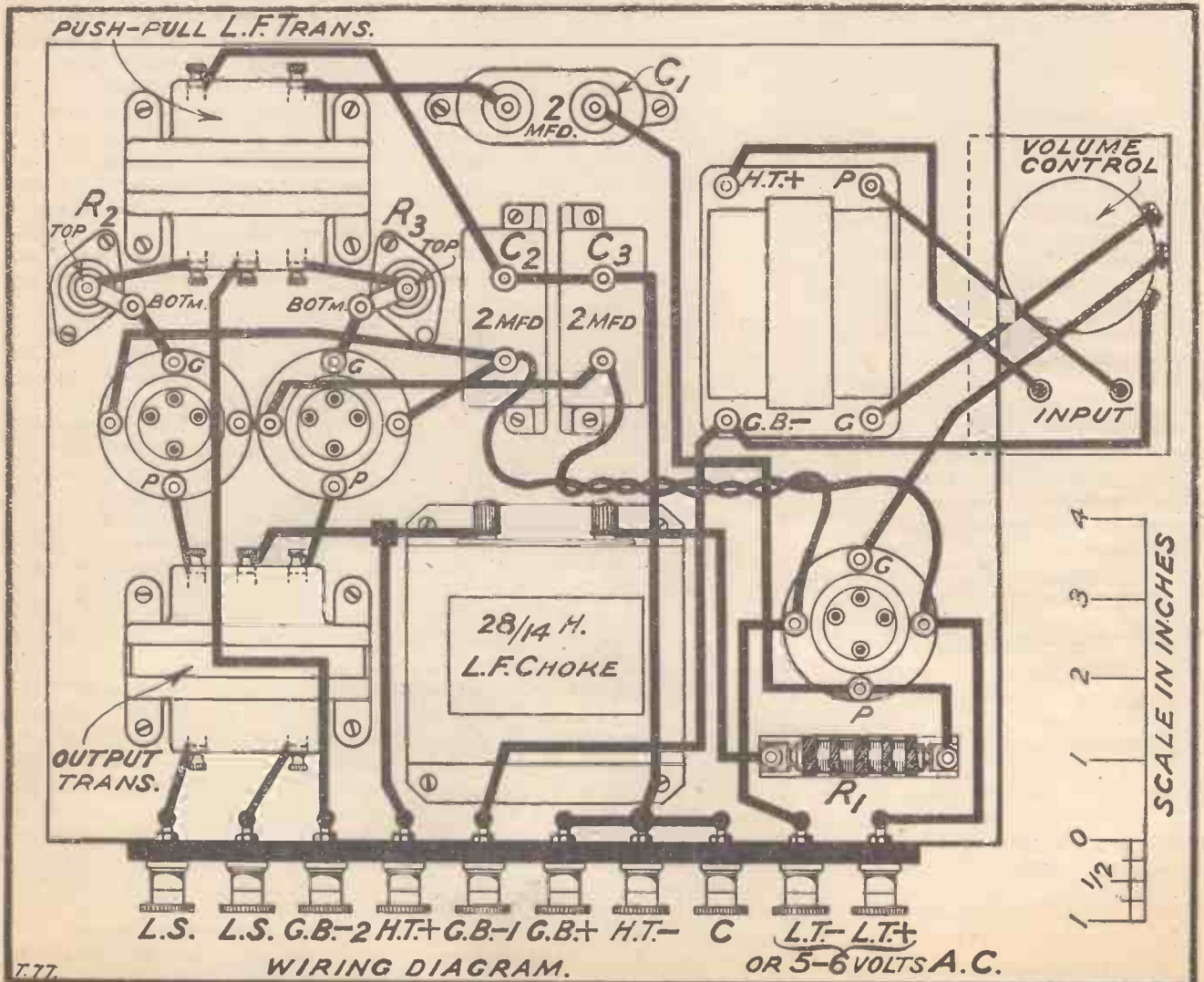





THE resignation of Captain Eckersley naturally brought to a head the intense public interest in the reason for the numerous staff resignations which have occurred at Savoy Hill during the last few months.

We were aware some months ago that Captain Eckersley intended resigning from the position of Chief Engineer in September, but at his request, and also at the official request of the B.B.C., we refrained from publishing that fact; and it was only because of a sudden decision of the Governors of the B.B.C. that Captain Eckersley's resignation was announced to the public in June instead of in September.

In deciding to announce the fact so suddenly, the B.B.C. has only itself to thank for the searchlight of enquiry which has been turned upon it because of Captain Eckersley's resignation. Everybody is asking: "What is wrong with the B.B.C.?" and columns in the newspapers have been filled with speculations, suggestions, and theories concerning the exodus of so many prominent staff members from Savoy Hill.

#### Various Suggestions Made

Some suggestions have been made to the effect that various heads of departments have not been in receipt of satisfactory salaries, and that Mr. Jeffrey, for example, naturally resigned when he was made a very good offer by a British talkie concern.

Other suggestions have been made that there is dissatisfaction among the staff members at Savoy Hill, and that owing to red-tape, bureaucracy, etc., Mr. Jeffrey, Captain Eckersley, and other well-known people have found it impossible to carry on and satisfactorily continue their work for the B.B.C.

## THE EXODUS FROM THE B.B.C.

*Some reflections upon the recent staff changes which have culminated in the resignation of Capt. P. P. Eckersley.*

Unfortunately, the B.B.C. has decided to maintain a close secrecy concerning the whole business. One can understand Captain Eckersley refusing to talk about his resignation, because he holds, like other prominent members of the B.B.C., very strong views on what we might call the value of *esprit de corps*, and it would certainly not be in the best of taste if, just after the announcement of his resignation, he was to turn round and say unkind things about the B.B.C.

#### Long and Complicated Story

On the other hand, Mr. R. E. Jeffrey, who resigned some time ago now, has been more or less forced to come into the open and explain exactly why he left the B.B.C., and we should like to say at once that we congratulate Mr. Jeffrey on his courage in doing so, because the reasons he has given are undoubtedly true, and will serve to enlighten the public as to the unfortunate state of affairs



*Capt. Eckersley—here shown returning from a trip to America—has recently announced that he is leaving the B.B.C.*

which does exist at the B.B.C. headquarters.

The story in connection with these resignations is a long one, and in some ways a complicated one, and no doubt many of our readers have already read in our contemporary, "Popular Wireless," the inside history concerning B.B.C. resignations. But, on the other hand, there must be many thousands of readers of the WIRELESS CONSTRUCTOR who are still more or less mystified about the whole business, and in this short article we propose briefly to outline the cause and effect of the trouble at Savoy Hill.

With the formation of the British Broadcasting Corporation and the granting of a Royal Charter and a practical monopoly for ten years, a new spirit insidiously crept into the departmental side of broadcasting. That, unfortunately, usually happens with any Civil Service department; more unfortunately in connection with broadcasting because the spirit of the old B.B.C. was undoubtedly the best. There was a spirit of enthusiasm, new ideas and general buoyancy which is, to say the least of it, conspicuous by its absence to-day at Savoy Hill.

#### Too Much Red-Tape

Consequently, men like Mr. Cecil Lewis, Mr. Rex Palmer, Mr. R. E. Jeffrey, and Captain Eckersley, found it more and more irksome to work under such red-tape conditions, and when better offers came along it was not unnatural that they should accept them.

Let us refer to the case of Mr. R. E. Jeffrey. He handed in his resignation six months before he actually left the B.B.C., and, at that time, was earning more than a thousand a year. According to an interview in the press, he has stated that he told Sir John Reith when he first resigned that he had not a job to go to, but that, with such a vacillating policy in the B.B.C., work for him was impossible. Sir John, however, persuaded Mr. Jeffrey

## The Exodus from the B.B.C.—continued

to withdraw his resignation; but, unfortunately, six months later Mr. Jeffrey realised that he could not continue under the present B.B.C. regime and he resigned.

### "Entire Lack of Decision"

Mr. Jeffrey's complaint is that there is no one at the B.B.C. who will say "Yes" or "No" to an idea in a day. To quote Mr. Jeffrey: "It has to be pondered over, analysed, discussed in Committees and generally massacred until it is only a ghost of an inspiration, and the heat of enthusiasm has gone. This goes on right through the building.

"If my subordinate had an idea, I could not put it through for him. I had to tell him to wait, and I would do my best; and so he lost heart. He left two years before I did. Then, again, there is no one on the programme side who knows enough about the entertainment side of the business. The salaries offered are just as likely to be too large as too small in proportion to what a man earns on the stage.

"Suppose a famous American star arrives, would it be possible to get him on here a day later to broadcast before appearing on the stage? Not at all. It would have to be discussed, and meetings held and, during the delay, the novelty or 'scoop' has gone.

"There is, in the B.B.C., an entire lack of decision. They are too confident, and too afraid to take a definite step. Nothing must be done in a hurry, and meanwhile the public can go on waiting and the staff keep on leaving."

### Ridiculous Statement

As a result of this interview, the B.B.C. sent out a statement reprinting Mr. Jeffrey's first letter of resignation to the B.B.C., in which Mr. Jeffrey paid a high compliment to Sir John Reith and regretted his resignation. The B.B.C., after quoting this letter, states in the circular: "Although the resignation had been accepted; it was arranged to give Mr. Jeffrey another chance." And when Mr. Jeffrey's attention was drawn to the B.B.C. circular, he said:

"This is a very unfair statement. I withdrew my first resignation because I thought things would improve, after I had several talks with Sir

John Reith. Here is the letter which I wrote in withdrawing my resignation, which I think should, in fairness, have been included in the B.B.C. statement: 'Dear Sir John,—May I be allowed to remove the unhappy impression caused by my letter of the 15th inst. It was entirely contrary to my wish that it should have appeared either impertinent or disrespectful. However, as it seems that it was so, I would ask that this letter be accepted as an apology. Further, I ask that the withdrawal of my resignation be allowed. The very kind talks you have been good enough to afford me have guided me in this decision.'

"It is laughable," stated Mr. Jeffrey, in an interview to the Press, "when the statement says I was given 'another chance.' Why should



Mr. Eric Dunstan, who left the B.B.C. while the General Election results were being broadcast.

a man who has resigned be given another chance? When I tell you that I was engaged at £500 per annum, that my salary rose to £1,215, plus expenses, within six years, and that a special position was created for me, you will agree that it is ridiculous to talk of being 'given another chance.'

"You do not give a man another chance when you are constantly and heavily increasing his salary. My final letter of resignation does not bear the interpretation which has apparently been placed upon it. Of course, I regretted resigning, and I

regretted severing myself, from the purely personal point of view, from Sir John's leadership.

"There was no question of money, whatever," Mr. Jeffrey went on to say. "The question at issue was whether or not I should be allowed to do my work in the way I thought proper. My whole point when I discussed my resignation with Sir John was that I insist on being a man, on being allowed to think as a man, on doing my job as a man, and not as an automaton.

### Governors or the Public?

"I did not agree with the methods on the entertainment side of the B.B.C. I felt I could be successful at Savoy Hill in a very much higher degree than I was if I said to myself: 'I have five people to entertain with my programmes; five people who are in a superior position to myself.' If I put on something which was quite popular with the public, that item was quite often unpopular with the five people whose position was superior to mine, and who were able to tell me what they thought of me.

"The thousands of people who constituted the listening public had to become less important to me if I wanted to keep my job. The people who are now engaged in arranging programmes and trying to find suitable Acts for broadcasting would, if they dared, tell you the same as I am telling you now. It was on behalf of the staff I resigned. I thought that perhaps this gesture might lead to making things easier."

### Not Merely Coincidence

Now, that's a straightforward statement from a man who occupied a very responsible position at the B.B.C. for six years, and it is a statement which the public must regard seriously, because if Mr. Jeffrey found conditions so insupportable at the B.B.C., there is obviously a very close connection between his resignation and the resignations of other important members of the B.B.C. staff.

We venture to say that Captain Eckersley also found conditions at the B.B.C. insupportable, that he was constantly cramped and interfered with, and that is not the sort of treatment a man of his calibre is going to tolerate.

That Sir John Reith did not interfere with Captain Eckersley we know

(Continued on page 240.)





*A Koenigswusterhausen picture received on the Colvergraph.*

ALL who have examined Fultograph pictures received within the last month or two will have noticed a big improvement in results compared with those given when the service first started last year. While the first pictures were good, the present ones are much more brilliant in detail, this being mainly due to the use of a photo-electric transmitter in place of the original instrument.

Not only are the results far better with the photo-electric transmitter, but there is considerable speeding up of the process of preparation, for whereas with the original transmitter special foils had to be prepared from the photographs before transmission could take place, a certain degradation of image occurring in the production of the foil, with the new photo-electric transmitter a special film is used which can be prepared in a far shorter period. Thus topical pictures can be broadcast much earlier than was previously possible.

#### Home Constructor's Kit

We have recently received from Messrs. Wireless Pictures (1928), Ltd., the complete kit of parts which they are now supplying to home constructors who like to assemble their own Fultograph. The kit is very attractively boxed, as a whole, in a decorative container, inside of which the various parts are separately boxed and clearly marked.

A well-written book of instructions on how to assemble the instrument is provided, and, as the parts supplied are identical with those used in the

complete Fultograph sold by this company, the home constructor is assured of having at the end of his job (provided he has carried out the simple instructions) a Fultograph receiver which is in every way the equal of that sold commercially. Everything is provided except the necessary boxes, which are easily

## STILL PICTURE NEWS

*Improvement in Fultograph pictures—The Home Constructor's Kit—A New Picture Receiver—Transmission of Weather Charts.*

home-made, obtainable from Wireless Pictures, Ltd., or from one of the firms supplying cabinets.

Although we have in regular use a complete factory-built Fultograph receiver, the idea of assembling this kit was so attractive that we lost no time in getting on to the job ourselves, just for the pleasure of building it. We can imagine a no more interesting present for the wireless enthusiast than this kit.

#### Well-Made Outfit

Incidentally, examining the various parts during the assembly only serves to confirm the very high opinion we

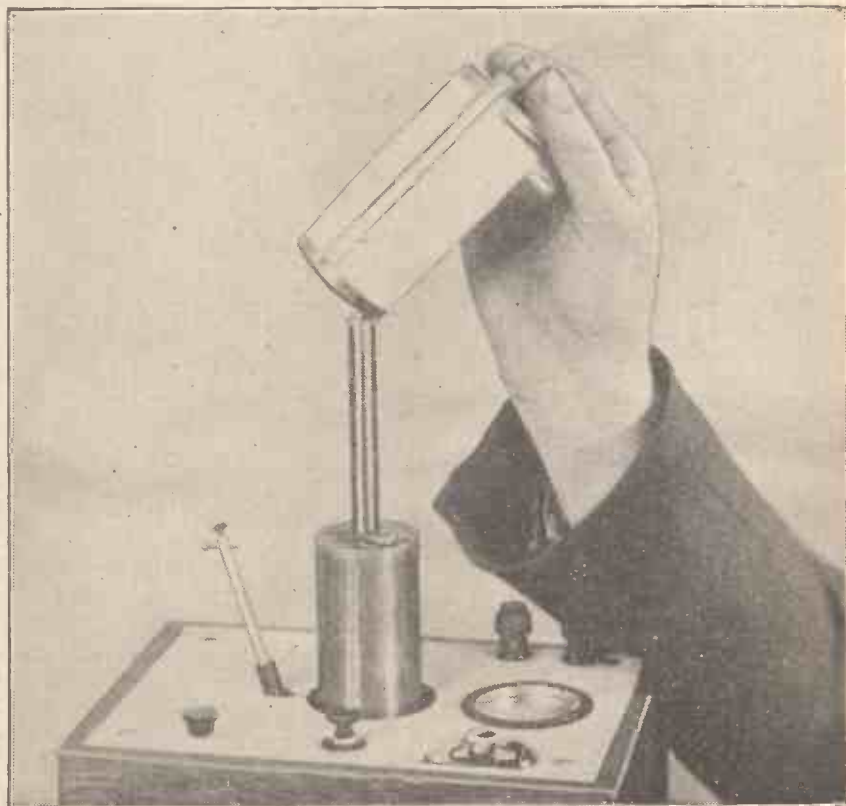

*The cylinder complete with paper can be detached from, or slipped on, the Colvergraph in a moment.*

## Still Picture News—*continued*

earlier formed, on examining the first Fultograph receiver, of the ingenuity and mechanical excellence of the design.

### Another Picture Receiver

With regular picture transmissions "on the air" it is not surprising to find that others are working on picture receivers, so to utilise the signals which are now to be picked up from so many stations. We have recently examined a new picture receiver called the Colvergraph, designed and built

ing photograph, utilises the Fultograph picture transmissions and the same electro-chemical method of recording the picture, but the actual methods of actuating the mechanism are somewhat different and display considerable ingenuity.

An examination of the photographs will show that the receiving cylinder is placed vertically, with the stylus stationary. Thus during reception the receiving cylinder rotates and steadily mounts the central rod. A novelty in this instrument and one which

ception, in this way avoiding loss of time between pictures.

A clockwork motor is used to drive the central spindle. The drive is not direct, for, as our readers know, in order to utilise the broadcast picture signals it is necessary that the cylinder should stop for a fraction of a second at the end of each revolution and be started again by the synchronising signal. In the Colvergraph an extremely ingenious stopping and starting mechanism is used, for which certain definite advantages are claimed. The clockwork motor carries a driving wheel which is bedded against and drives a second wheel attached to the spindle carrying the cylinder. In the edge of this second wheel is a small gap, so that after the driving wheel has turned it through practically a complete revolution, the gap is reached, and contact and therefore turning ceases, as the arrival of the gap causes the edges of the two wheels to be separated.

### No Relay Used

During a revolution of the spindle an arm is moved sideways against a spring and held ready by a catch. The arrival of the synchronising signal operating through a rectifying valve and electro-magnet mechanism releases the catch, causing the arm to drive the spindle wheel forward again by means of a peg in a slot in this wheel.

Thus the two bearing surfaces (that of the wheel attached to the motor and that on the wheel attached to the cylinder) are brought together again, and at the moment of contact the wheel attached to the cylinder is moving at the same speed as the driving wheel. This means that no sudden starting load is imposed upon the clockwork drive and very uniform running is obtained with extremely accurate synchronising. No relay is used, and the whole mechanism is very cleverly designed.

### A Compact Instrument

Examined in detail the instrument will be seen to be made up as follows: The top panel carries a milliammeter, the necessary terminals and switches, together with a speed regulator of the clockwork motor. Below this panel is a platform carrying the driving wheel connected to the clockwork motor, the wheel attached to the

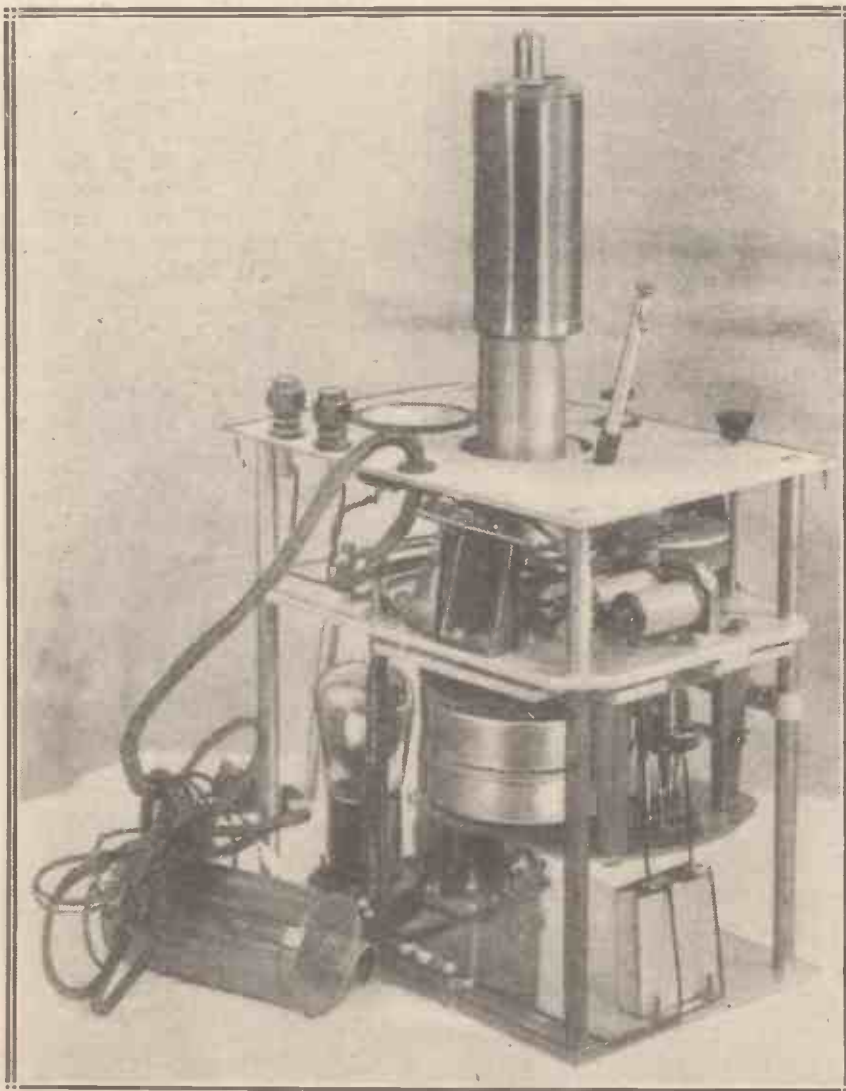

The photograph shows the works of the Colvergraph and the second cylinder ready for the paper to be put on.

by the Collinson Precision Screw Co., Ltd., of Walthamstow, a firm associated with Colvern, Ltd., whose highly efficient coils are well known to our readers. The Colvergraph, which is illustrated in the accompany-

ing photograph, makes a considerable appeal is the interchangeability of the cylinder carrying the moistened paper. Thus one can attach a moistened sheet of paper at leisure to one cylinder, while the other is being used for re-



## Still Picture News—continued

threaded spindle, a wide bearing for the stylus bar, the cam lever, and other mechanism just described.

In the lower part of the instrument (below the platform) are found the clockwork motor, the input transformer and the rectifying valve. A multiple cable is taken from the instrument to the necessary batteries and the whole is provided with a suitable cabinet and dust cover. An examination of the instrument in operation certainly shows that remarkably good results are obtainable with it, and a degree of accuracy of synchronisation which we have not seen excelled in any picture receiver.

The Colvergraph is not yet on the market, but we understand from the Collinson Precision Screw Co., Ltd., that it is to be marketed towards the end of the year.

### Weather Charts By Radio

An interesting development in the use of wireless picture transmission has recently taken place in the wireless transmission of weather charts. By utilising the Fultograph process the weather chart broadcast from the observation point can, within four minutes, be reproduced in facsimile in thousands of different places all over the world if required—on ships at sea, aerodromes, coastal stations, lightships, and so forth.

Facsimile transmission of weather charts was carried out recently from the wireless station at the Royal Airship Works, Cardington. These transmissions were received at the Royal Meteorological Society's rooms, South Kensington, during a lecture by Mr. R. A. Watson-Watt. A general inference and weather forecast based on the chart was also transmitted in facsimile. If, as expected, a series of experimental transmissions of weather maps are undertaken from Daventry (5 X X) a further interest will be added to reception on Fultograph receivers.

required are all procurable easily. A very interesting feature of the Ferranti S.G. Three is that H.F. transformer coupling is used instead of the more common method of tuned-anode coupling, and, also, anode-feed system is incorporated. This latter obviates much of the trouble

### A Condenser Catalogue

The "Cyldon" people (Sydney S. Bird & Sons, Ltd., Cyldon Works, Enfield Town, Middlesex) have not only prepared a new price list for their line of variable condensers, but have gone the whole hog and

### ALL READY FOR THE PICTURES

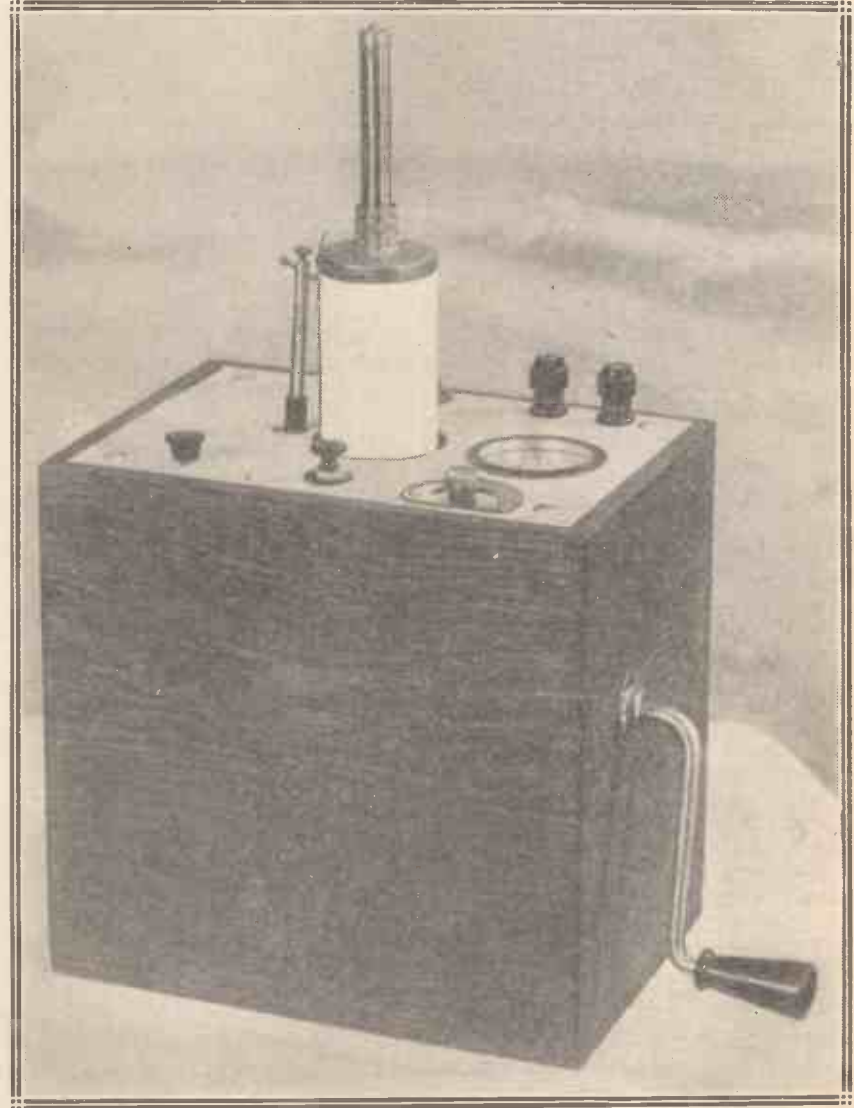

Note the stylus on the left of the cylinder. The stylus remains stationary and the cylinder moves upwards whilst rotating.

\*\*\*\*\*  
\* **TRADE JOTTINGS** \*  
\*\*\*\*\*

### The Ferranti S.G.3.

SCREENED-GRID enthusiasts will learn with interest that charts of the Ferranti Screened-Grid Three are now available to everyone on request, and the components

which might occur through internal shorts in the valves. (It is pointed out by Ferranti, Ltd., that although protection can be obtained by means of a fuse in the common negative lead, the resistance of this must inevitably be included in all the anode circuits and is therefore liable to introduce a certain amount of back-coupling.)

revised this as regards prices in the right direction. All kinds of condensers are illustrated, from the five-bob "Bebe" to the huge four-gangers which come out at 70s. each. A point of particular interest is that despite the big price reductions the quality and finish of the products will in no way be impaired.

P.R.B.

# BUILD OUR ALL ELECTRIC GRAMOPHONE! BY THE EDITOR

WOULD you like to possess a musical instrument in a neat polished cabinet which will give a reproduction from modern gramophone records with a quality equal to the finest broadcast? Would you appreciate in the same instrument a simple knob control enabling you to vary the strength from a whisper to that of a full orchestra? Would you like to hear a fidelity and range of tone which you have not previously thought possible even with the finest possible moving-coil speaker? And, finally, would you like an instrument containing a high-tension mains unit, a first quality amplifier and a loud speaker, all of which can be connected in a moment to your existing wireless receiver?

### Remarkable Development

All this and more you will find in the WIRELESS CONSTRUCTOR electric gramophone, full particulars of which will appear in our next issue. This month we are describing the construction of the mains unit and the amplifier. Next month we shall describe and illustrate the electric motor, the pick-up, the cabinet and the special loud speaker.

The developments in the recording of sound on a gramophone record and its reproduction have been some of the most remarkable features of recent years. Indeed, but for these developments the modern and highly successful talking picture would have been impossible.

There seems to be a fairly widespread impression that talking films all have a record of the sound wave on

*In this article are given the first details of a remarkable home constructor's gramophone. Built in unit form it comprises an easily constructed instrument capable of giving first-class results.*

the edge of the film, but, as a matter of fact, while this method is used in some systems, notably the Movietone of The Western Electric Co., and the system of The Radio Corporation of America; the Vitaphone, which is also a Western Electric system, and by which a very large number—perhaps the majority—of the talking films so far have been produced, is a scheme in which a gramophone record is reproduced synchronously with the picture.

A number of other talking systems also use synchronised gramophone records, the reproduction of which is by means of a pick-up and a super-power amplifier with its output connected to a number of loud speakers distributed in suitable places.

### Useful Instrument

The records used are not quite the same as those we buy for our own gramophones, being generally much larger and run at different speeds. In the case of one system the records play from the inside to the out. The length of these records is such that a whole reel can be run with one disc, but arrangements are also made, by means of twin turntables and a "fade in and out" mechanisms, so that one record can be "faded" into another to preserve continuity.

The system of reproduction used in the WIRELESS CONSTRUCTOR electric gramophone closely resembles that used for the "talkies," although, of course, as it is used without any film there is no elaborate synchronising system. At the same time, readers—and there are a considerable number—who own home cinema projectors will welcome the WIRELESS CONSTRUCTOR electric gramophone as a means of providing suitable orchestral music as an accompaniment to their own home films.

### Critics Enthusiastic

At parties, socials, and the like this accompaniment adds greatly to the pleasure, and, as there is no motor to wind and as semi-permanent needles can be used when desired, it is but the work of a moment to change from one record to another. In a test we made for this purpose exactly six seconds elapsed between the last note of one side and the first note of the other when turning the record over.

Demonstrations of the WIRELESS CONSTRUCTOR electric gramophone have already been given to a number of critics, who have given most enthusiastic praise to its performance. Arrangements have been made for suitable cabinet work, and the whole constructional work has been reduced to such a degree of simplicity that any reader who is capable of constructing the sets which are described from time to time in this journal will have not the slightest difficulty in assembling what is undoubtedly one of the finest musical instruments ever made available to the public.



The H.T. power unit and the amplifier section of the All-Electric Gramophone.



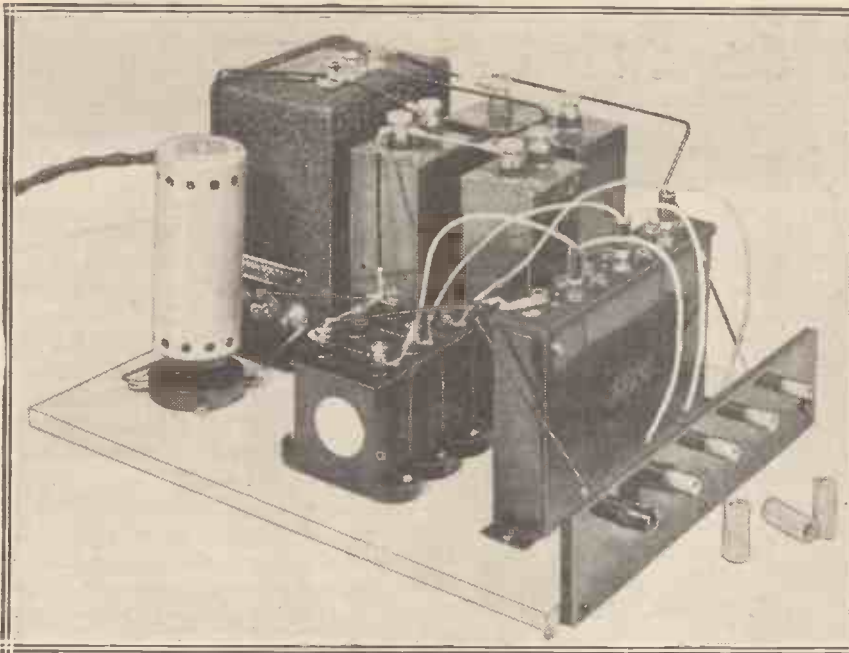

# H.T. From A.C. Mains

*A Compact and Efficient  
High - Tension Power  
Unit.*

**R**EAL fidelity of reproduction makes a number of demands upon our receiving set. First of all (and assuming that the received signals are distortionless, which is practically always the case), our tuned circuits must be properly designed, or some frequencies may be selected at the expense of others. Secondly, our detector must be able to handle the signals fed to it without distortion; thirdly, the magnification given at the low-frequency end of the set must be distortionless; and, lastly, our loud speaker must be able to reproduce accurately the tones handed to it by the receiving set.

## The Importance of H.T.

Obviously the whole chain will break down unless we have an adequate supply of high-tension current, for without this our output valve or valves cannot handle the necessary power. For supplying a really first-class modern amplifier, capable of feeding a moving-coil loud speaker, the high-tension dry battery is hopelessly extravagant. High-tension accumulators are excellent, but in order to get high voltage together with an adequate capacity they must be bulky and expensive, although they have many virtues of their own. Lastly, we have mains units deriving their power entirely from the lighting mains, and here, if you have alternating current in the house, you will find the best all-round source of supply.

Unfortunately, a really sound and well-designed mains unit using first-class quality components cannot be built cheaply. Several designs have

already appeared in this journal, notably the "Stedipower" H.T. mains unit described in the autumn of last year. This has remained a standard instrument in the WIRELESS CONSTRUCTOR laboratory, and its all-round performance has not been excelled by any other unit we have tested.

## A New Unit

At the same time, being made of the best components, it is not cheap to build, and although it could be constructed with much cheaper parts, the performance would not then come up to the standard we set before ourselves in such designs.

It is felt, however, that such refinements as the permanent voltmeter and the continuously variable resistances for adjusting voltage were features which some readers might care to dispense with, if only the

general performance were not affected, and therefore a new unit has been designed using a modification of the same circuit. The result of the changes has been to bring down the cost of building very considerably while still retaining the high-grade performance.

At this point we may consider the question of circuits for mains units, and readers who have previously studied the series of articles published last year in this journal on the subject of mains units designs will know that there are many combinations.

## The Four Sections

A mains unit of this nature consists of four parts. First, we have the transformer to take the current from the mains, converting it to a voltage suitable for our purposes; secondly, we have the rectifying device; thirdly, the smoothing

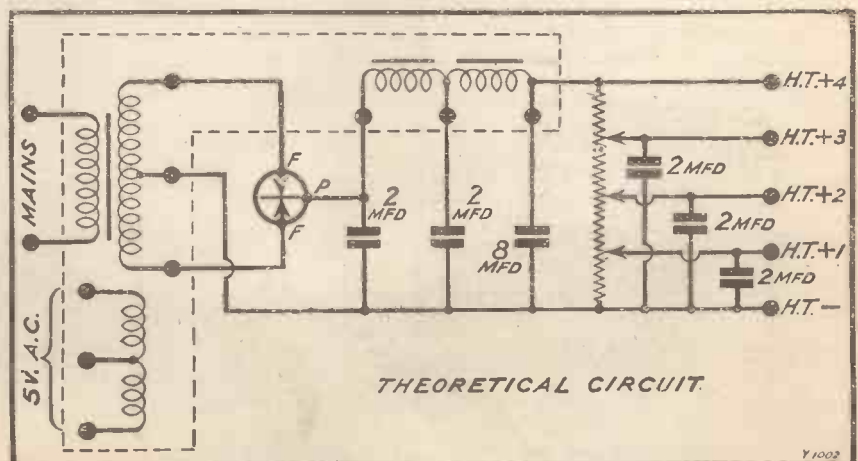

The circuit of the A.C. H.T. power unit.

## H.T. from A.C. Mains—continued

circuit; and, fourthly, the output arrangement which enables us to obtain several voltages simultaneously and to adjust these voltages to suit our own requirements.

In the "Stedipower" H.T. mains unit the transformer supplied low-tension A.C. for the filament of a rectifying valve and high-tension for the plates of this rectifying valve. The smoothing circuit consisted of two chokes and three condensers, the values of these condensers being 2, 2, and 8 mfd. respectively. The output device consisted of two potentiometers in series, there being one fixed voltage and two variable voltages (adjusted by the sliders of the series potentiometers).

### The Dry Rectifier

The present mains unit consists of a transformer which also gives low- and high-tension voltage, but in the present instance we use not a rectifying valve but a new form of dry rectifier requiring no filament heating. This leaves the low-voltage A.C. current free for feeding the valves of the special 1929 Super-Quality Amplifier described in another article, but if we care to alter the power unit slightly we can use this winding to light the filament of a U.5 valve.

The smoothing circuit consists of two chokes and three condensers as before, the values of the condensers being the same as in the "Stedipower" H.T. unit, while the output device consists of a resistance with nine tapings on it. We get, as before, a fixed high voltage, but instead of two continuously variable voltages, three voltages adjustable in small steps are provided. Thus while sacrificing the feature of continuously variable voltages on two tapings we gain one more adjustable tap. This is rather useful in those sets which have a screened-grid valve requiring a particular voltage tapping.

A special feature of this unit is that the transformer and choke are comprised in one metal casing which considerably simplifies the construction. The choice of this unit has been dictated not only by its efficiency, but by the fact that it is considerably cheaper than the usual transformer and two separate chokes, while it also contains two small fixed condensers, across the high voltage winding, which are of value with certain types of rectifier.

### Valve Can Be Used

The rectifier we are using is known as the "Elkon," and is being mar-

keted by the Igranic Electric Co. in this country. It is fitted to a base corresponding with an American valve; in fact, it is designed to replace, if necessary, the Raytheon rectifying valve, which can be used equally well in the present unit. Thus those readers who happen to have a Raytheon rectifying valve of the B.H. type can use it in place of the dry rectifier illustrated without any change of circuit or alteration of output voltage.

### The Voltage Regulation

The particular form of voltage regulation has been chosen, after considerable experience with various

#### COMPONENTS REQUIRED.

The list of components is very short, and, apart from whatever form of box or cabinet is chosen, is as follows:

- 1 Baseboard, 12 in. by 10 in.
- 1 Thordarson type R171 power compact (Rothermel).
- 1 American type rigid valve holder (Rothermel).
- 1 Elkon H.T. unit (Igranic) or
- 1 Raytheon tube type B.H.
- 1 Condenser, 8 mfd.
- 2 Fixed condensers, 2 mfd.

**SPECIAL NOTE.**—The condensers used here should be of the type which have been tested to at least 500 volts D.C., for the working voltage should not exceed half test voltage in these condensers. Those illustrated are T.C.C., tested to 600 volts; Dubilier type B.D. condensers, or the Hydra 500-volt tested condensers are also suitable here.

**3** 2-mfd. Mansbridge condensers (Lissen, T.C.C., Dubilier, Hydra, etc.).

**NOTE.**—These condensers, which are not subjected to the same stresses as the filter condensers previously mentioned, can be of the ordinary receiving set type.

- 1 Igranic potential divider for mains unit (Igranic Electric Co.).
- 3 Wander plugs (Lisenin, Clix, Igranic, etc.).
- Ebonite strip, 9 in. by 2 in.
- 5 Plugs and sockets (Belling-Lee). These are of the special safety type and should be marked for H.T.—, H.T.+1, 2, 3, and 4.

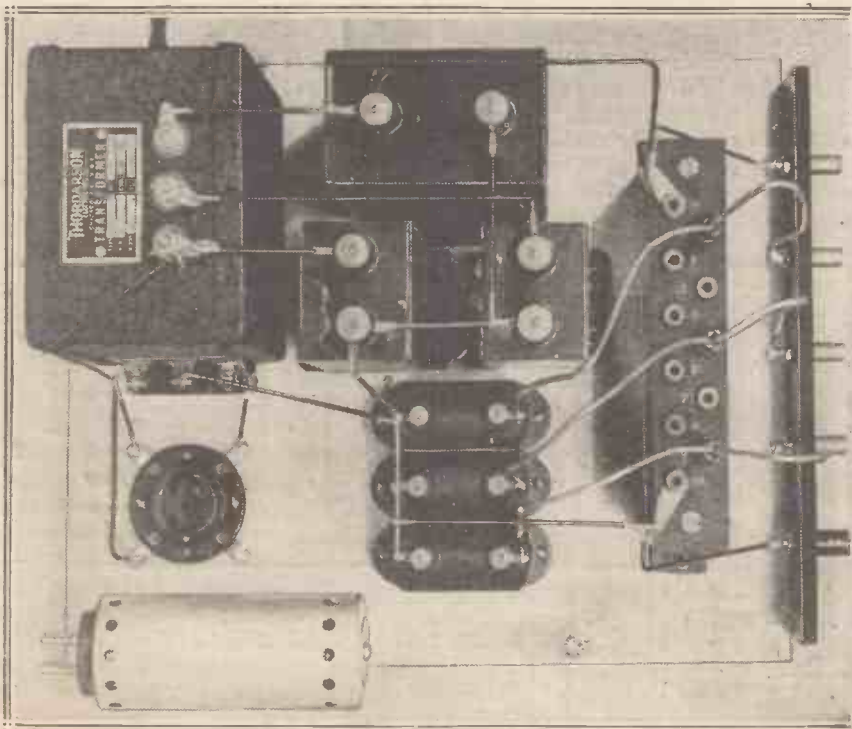

A general view of the A.C. H.T. unit. Note the potential divider on the right.

types, as the most generally satisfactory for experimenters, provided adequate capacity is shunted across the output terminals, as is the case in the present unit. True, in one or two sets which are inherently unstable a tendency to "motor-boating" may be found with this type of output, but, on the other hand, the series-feed method, while being more stable with such freaky sets, is rather troublesome to handle when we want to change our voltages often.



## H.T. from A.C. Mains—continued

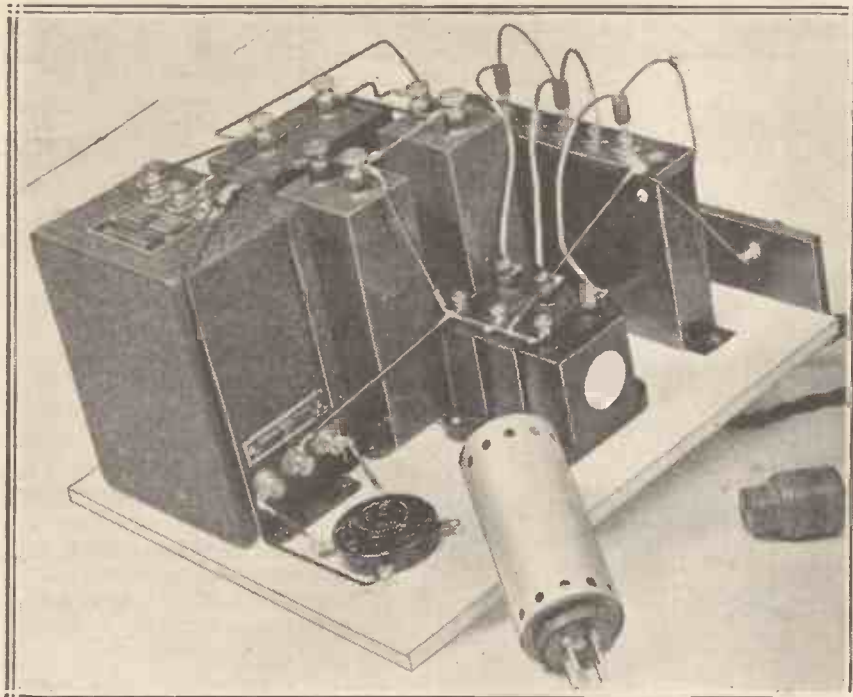

The dry rectifier is here shown detached from the unit, and in the foreground you can see the valve holder into which it is plugged.

So far as stability is concerned, for a long time all WIRELESS CONSTRUCTOR designs have been of the type which is free from the instability to which we have referred, and no design is put out which will not work perfectly satisfactory on any ordinary type of mains unit, either home or factory-built. Many sets, indeed, such as the "Air Commander," "Champion" Three, "Ten Pound" Four, etc., are so designed that only one H.T. voltage is required from the mains unit, the series-feed scheme being incorporated in the set itself.

### Making a Case

In order that this unit may be incorporated in the WIRELESS CONSTRUCTOR electric gramophone the baseboard has been made of the same size as the amplifier described on another page, viz. 12 in. by 10 in. Here again no cabinet has been provided, but we would like to emphasise that in all cases such power units should be enclosed before use.

A simple wooden box will suffice, a slot being made in one side so as to allow the terminal strip to project. Special safety terminals have been provided in this receiver so that the user cannot obtain a shock when touching the output terminals. Nevertheless the voltages applied

to the chokes and condensers in this unit are naturally high, for which reason it is dangerous to use the unit with the transformer and condenser terminals exposed. This remark applies equally to

any mains unit of the high voltage variety.

There is no need to buy an expensive cabinet, as any carpenter can make you a simple and inexpensive box to take the unit.

When making this box (you will probably make it yourself if you are handy with carpentry tools) a number of holes should be drilled in the top of the box above the dry rectifier, as a fair amount of heat is generated in this unit. A few holes about  $\frac{1}{4}$  in. diameter immediately above the rectifier, and half a dozen holes in the side of the cabinet lower down, will provide the necessary circulation of air.

### Extremely Simple Wiring

If, of course, the unit is to be used in the WIRELESS CONSTRUCTOR electric gramophone, then it will slide on to its proper shelf inside the cabinet, which will be described next month.

Follow the layout shown in the drawings and photographs, not because any electrical efficiency would be sacrificed by altering it, but because the particular arrangement chosen makes for extremely simple wiring. Notice that each wander plug has two leads, one going to its condenser and the other to the output terminal. There is no need to bring out the terminals marked "filament"

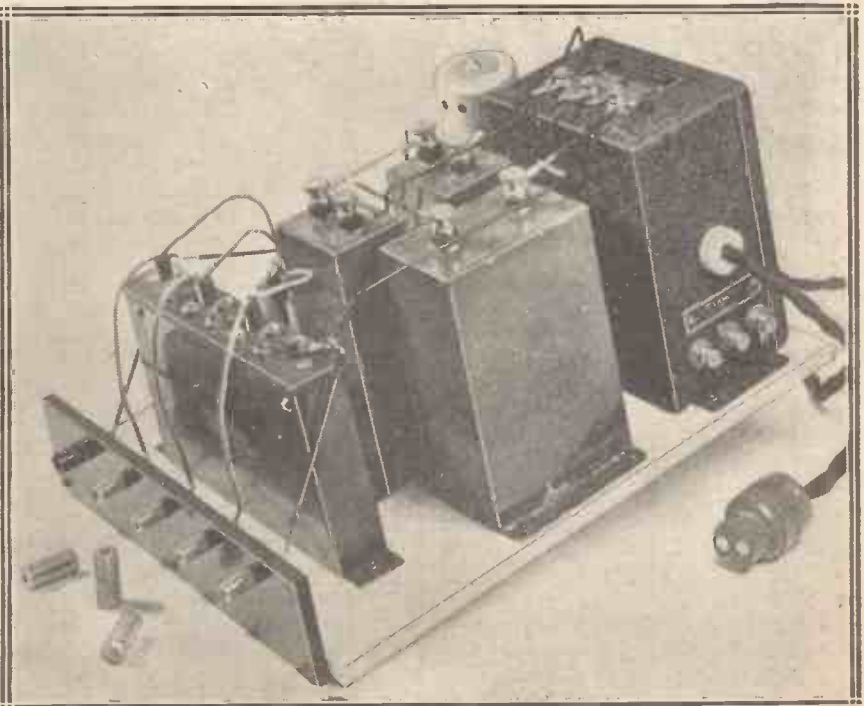

Insulating sleeves are used to cover the H.T. tapping sockets on the little panel in the front of the unit.

## H.T. from A.C. Mains—continued

on the transformer to any special terminal board as these will not be required when supplying the ordinary receiving set, but only in special cases such as the amplifier described on another page.

A long flexible lead terminating in a plug for the lamp holder is provided with the power compact.

### Voltage and Current

No switch on the power unit is provided as it is better to switch off at the mains direct. The capacity of the unit is ample for all general purposes, a maximum voltage of about 200 being obtained when 50 or 60 milliamperes are being drawn from the instrument. Thus one can use two good modern 6-volt super-power valves in either parallel or push-pull

the detector, 120 volts on the first L.F. (off the same tap as the plates of the screening-grid valves), and 180 to 200 volts on the output terminals.

When used with the 1929 Super-Quality Amplifier the maximum voltage only is used, the other tapplings being left free. If the unit is being used with a set using one H.T. voltage and it is not desired to give it more than, say, 150 volts, on everything, then a tapping into socket No. 3 or 4 can be used (counting tapping 0 as the maximum H.T. positive). When only one tapping is being used the idle Mansbridge type condensers on the other tapplings can be joined in parallel with the tapping used.

It should be noted that many valves are designed to work with a maximum voltage of 150, and before

one grid-bias valve will be needed, in this country the variety of valves and therefore the variety of grid-bias voltages necessary would call for either a number of interchangeable fixed resistors or continuously variable resistances, with the accompanying difficulty of knowing exactly what grid bias is being applied.

### The Grid Bias

Seeing that the current taken from the grid-bias battery is negligible and that the cost of this battery is low, and seeing furthermore that in a power unit the grid bias is obtained by subtracting a certain voltage from the available H.T., it was considered altogether to be far more satisfactory to arrange for the reader to use the ordinary grid-bias batteries for this purpose. The cost of these is very low, their life is very long and in addition we have the advantage of knowing what we are doing, which, of course, is a powerful safety factor.

This unit is good for anything up to 60 or 80 milliamperes when used with the Elkon dry rectifier, and up to 100 milliamperes when used with the Raytheon B.H. valve, which, as mentioned previously, is interchangeable with the Elkon dry rectifier.

Attention is specially drawn to the article dealing with the WIRELESS CONSTRUCTOR electric gramophone in this issue, from which it will be seen that this power unit will supply not only H.T. but also the L.T. to the pick-up amplifier used with the instrument.

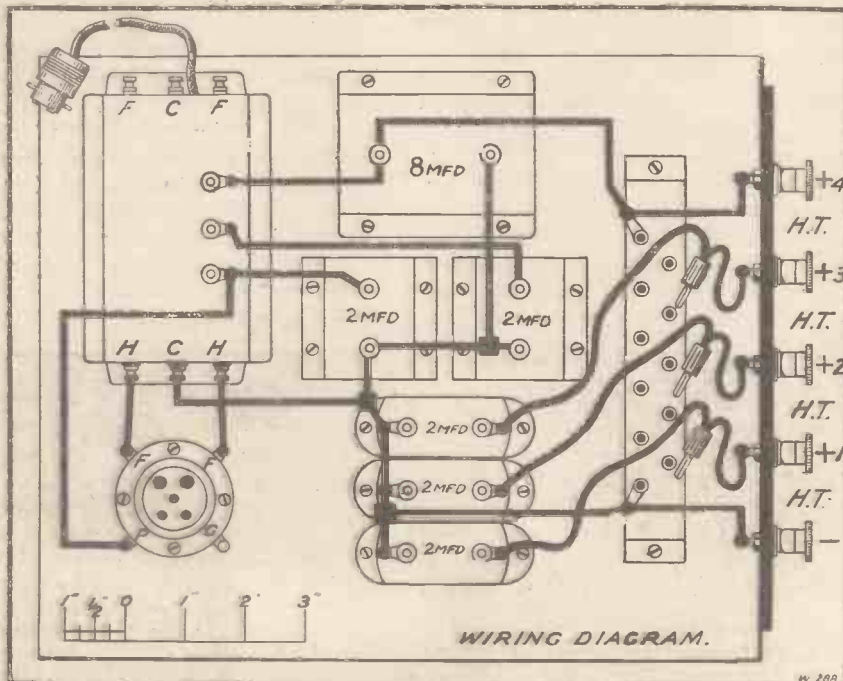

The wiring is quite simple and no difficulties will be encountered if this diagram is carefully followed.

in the output of a receiver and still get a high-tension voltage capable of handling very considerable power.

Provision of no less than three variable voltage taps is of great assistance in the case of those receivers where the voltage is not automatically reduced by the set, as in the case with the receivers mentioned above. Thus one can use 80 volts on the screening grid, 120 volts on the plate or plates of the screened-grid valves, 80 or 90 volts on

using the full voltage of this mains unit on them you should make sure that the type you are using will stand it and that you have adequate grid bias.

Speaking of grid bias, some readers may ask why in this power unit we did not provide grid bias from the mains. The answer is that while this can be done quite simply when, as in America, one can be certain that practically only one type of output valve will be used, and therefore only

### THE FERRANTI TRANSFORMER

WE are informed that in future all audio frequency and output transformers made by Ferranti's will have their primary and secondary terminals reversed from what has hitherto been their standard positions. Looking at the transformer from the primary side, the plate terminal will in future be on the right-hand side, and in the same way observing the secondary side the grid bias terminal will be on the right hand side. This alteration, whilst in no way affecting the performance of the component, will, the makers state, in future lead to an appreciable simplification of wiring.



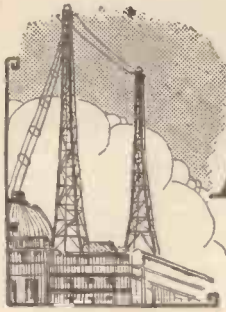

# HAPPENINGS AT SAVOY HILL

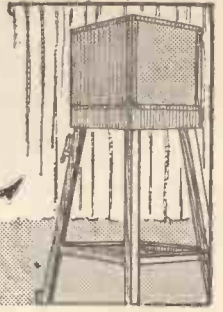

By OUR SPECIAL COMMISSIONER

## Resignations and Changes

EVENTS are moving so fast round Savoy Hill way that it is difficult to keep up even with the "peaks" in a monthly causerie such as this. Perhaps undue attention was paid to some of the earlier batch of resignations. Those which are about to be announced, or, at least, are now under serious consideration, will have a good deal more effect.

For one thing, I should not be at all surprised to see Sir John Reith throw in his hand before the end of the year. Several big concerns have been in touch with him, and although it is true he turned down a big offer at the beginning of the summer, subsequent developments may well have influenced his attitude towards going.

I believe the key to everything in the B.B.C. is the state of relations between the Board of Governors and Sir John Reith. The former have not been leaving as much to the Director-General as they used. Also, they have a great dislike of publicity; hence the furtiveness that has come over the B.B.C. in its attitude towards the public. A friend of Sir John's tells me that although he has sacrificed much and would sacrifice even more for broadcasting, he would not tolerate a state of affairs in which his outside reputation would suffer. Tension is undoubtedly acute.

## Captain Eckersley's Views

Captain Eckersley's enigmatical smile when he declined to criticise the B.B.C. on leaving it was more eloquent than the most devastating attack would have been. But he was undoubtedly wise to avoid recriminations in connection with work which has meant so much to him, and with which he may well be associated more actively than ever in the future.

Captain Eckersley's ambition is to return to broadcasting if and when the present Governors have either evacuated or changed their attitude towards broadcasting. If this condition were fulfilled, the

attainment of the objective would entail the displacement of at least two important officials.

But probably Captain Eckersley would argue that as there has been no quarrel between him and the other two, relations could be adjusted in some way. For the present, Captain Eckersley goes on quietly developing the Regional Scheme for the B.B.C. Some of his admirers in Parliament are arranging for him to address a large group of Members at the House before the Commons disperses for the recess.

## Regional Realities

A tremendous lot of nonsense has been talked and published about the centralisation policy of the B.B.C. The old multi-station plan of distribution, with numerous local programmes, is as dead as mutton. Listeners in all parts of the country want much the same fare and the same kind of choice.

First of all, they want to be able at any moment to have easy access to the main London programme; secondly, they would like to be able to satisfy another mood by a good contrast programme, made up in London or anywhere else provided the material is satisfying.

And, thirdly, now and then they would like to hear really good local programmes; but these need not be of the immediate locality. It is good enough that they be "national" for Scotland, "group" for the North of England, Wales and West Country for the Cardiff transmitters; with Birmingham, through 5 G B, for the Midlands, east as well as west.

## Mr. Gielgud's Work

About six months have now elapsed since Mr. Val Gielgud was made responsible for the dramatic work at Savoy Hill. It is merely recording a fact that more progress has been made in this period than in the

## TESTING A POPULAR PORTABLE



The "New Roadside" Four, the popular and highly efficient portable, due to the Editor, being tested in Surrey.

## Happenings at Savoy Hill—continued

previous two years. Mr. Gielgud's success is proof that journalism and literature form the ideal background for the good broadcaster; much better, indeed, than stage experience. Covetous eyes are already being trained on Mr. Gielgud, and the B.B.C. will have to fight for him.

### Holding the Pivotal Men

The B.B.C. attitude towards Mr. Gielgud reminds me that insufficient attention has been paid to the fact that, with the exception of Captain Eckersley, the B.B.C. has not yet lost any member of its staff regarded by the Corporation as pivotal.

Who, then, are these pivotal indispensable? Here is a short list. In administration, Sir John Reith, Mr. Goldsmith, and Mr. Lochhead; in programme work, Mr. Wellington,

something of his plans for his work at the B.B.C., where he will be Director of Music after this year. His close association with the Festival movement and other efforts aimed at keeping alive and encouraging "executant" music, made it almost a foregone conclusion that he would change the policy of the B.B.C. about studio reproduction.

This is now borne out by his emphatic declaration. Mr. Boulton will so administer the music of the B.B.C. that the maximum support will be afforded to deserving musical organisations in existence throughout the country. There is no longer to be room for the semblance of suspicion of competition. In practice this means that wherever and whenever a musical work can be performed efficiently by an outside orchestra or

### Broadcast Education

The present state and future of broadcast education are confused and uncertain. The formidable bodies brought into existence last year to sponsor schools' work and adult education by radio had declined into periodical meetings of angry protest. This is not their fault. It is due primarily to the delays in the completion of the Regional Scheme and to the understandable reluctance of the B.B.C. to mix more highbrow fare in its already well-weighted programmes on the present restricted means of distribution.

Whatever the balance of blame, the educationists are "fed up," and they make no secret of their determination to prod the B.B.C. into activity even if it is necessary to do this through Parliament. But if they are so ill-advised as to quarrel with Savoy Hill, I am sure they will strike some bad snags. For one thing, the B.B.C. would have no trouble at all in beating off an attack because it did not give enough highbrow stuff. The very novelty of the situation would appeal instantly to the Corporation. Incidentally, I doubt very much whether Parliament would respond in the way sought.

### Facts of Administration and Expenditure

The agitation to force the B.B.C. to give more information of its internal administration than is required by its constitution continues to flourish. But as any communication of the kind would inevitably be turned to the disadvantage of the B.B.C., Savoy Hill will not yield until it must, which is still a long way off.

Some critics appear not to know that the Auditor-General inspects and passes the B.B.C. accounts and balance-sheet, which are really submitted to more rigorous examination than the accounts of any regularly constituted Government department.

### A NEW SIAMESE STATION

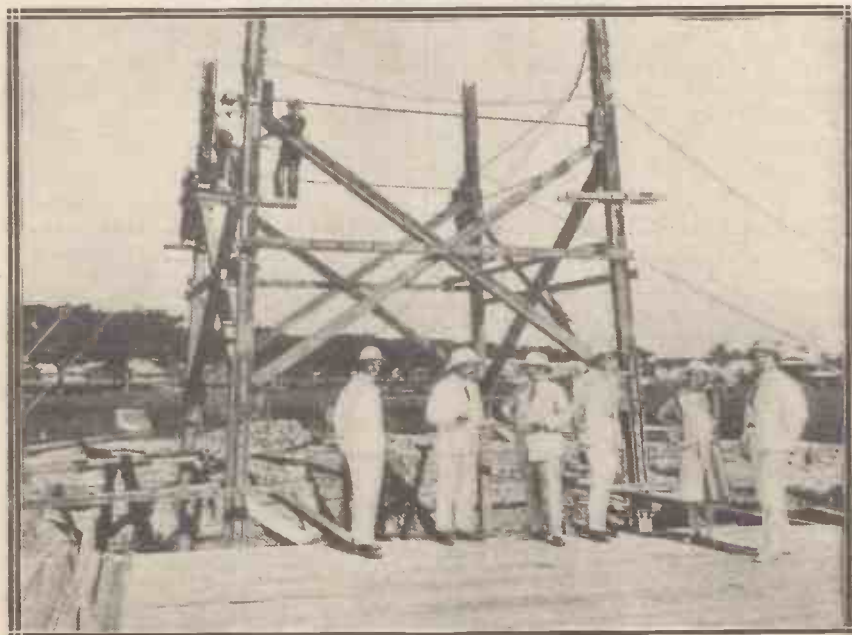

Work has recently started on the first mast of the new wireless station at Bangkok.

Mr. Gielgud, Mr. Boulton, Mr. Graves, Miss Matheson, Mr. Cock, and Mr. Filson Young; on the engineering side, Mr. Ashbridge, Mr. Kirk, Mr. Hayes, and Mr. Bishop; on the information side, Major Murray and Mr. Maschwitz. It is apparently for these that the Corporation is prepared to fight, even if it might be necessary to regard the "sky as the limit."

### Mr. Boulton's Plans

During his recent visit to the States, Mr. Adrian Boulton told the Americans

choir, that orchestra or choir will be used in preference to a studio orchestra or choir.

It remains to be seen how he will overcome that unevenness of performance which even now is an object of criticism of B.B.C. work. But the point of view will undoubtedly commend itself to the vast body of listeners as well as to music lovers throughout the country. It looks as if at long last there is a chance of reconciling B.B.C. policy with the legitimate aspirations of the musical idealists.

READ

POPULAR WIRELESS

for all the latest Radio News

Every Thursday. Price 3d.





# Summer Reception

An article of general and topical interest to all listeners and constructors.

By J. ENGLISH.

danger from lightning, and of decreasing very considerably the interference from atmospheric and static. You can then listen in comfort to your local station or indulge in

it would be helpful if I gave you fuller details, so that you can employ the scheme with your own sets if you wish to do so.

**D**URING the summer months in this country, usually in the evening, we get quite a number of storms, and occasionally some of them are rather severe. Many listeners are still fearful of the danger of lightning striking the aerial, while a great many people turn off their sets and earth the aerial whenever a storm is brewing.

Actually the danger of lightning striking the aerial is very remote, as statistics compiled in this country and in America prove conclusively. Nevertheless, it is rather asking for trouble to use your set with an outside aerial when storms are about. Either a spark-gap or "lightning arrester" should be installed, or the aerial lead-in connected to earth when the storm approaches.

D.X. reception when reception on the outside aerial would be very noisy and perhaps dangerous.

The remedy is quite simple, and consists in substituting a frame aerial for the outside wire; and although you do not get such loud reception, you gain considerably in selectivity with a quieter background. Also, the receiver can then be used quite safely whatever the atmospheric conditions, even if a thunderstorm is raging overhead.

Most types of portable and "transportable" receivers working on a self-contained frame aerial are ideal for summer reception, as there is no danger whatever from lightning with such sets.

If you do not already possess a frame aerial, it is easy enough to make up a simple one for reception on the medium wave-lengths. The larger the frame, the better your reception, but for an ordinary living-room a convenient size is one having sides about 2 ft. long. If you procure two pieces of 1 in. square wood and lap them together, you can wind the wire on four pieces of ebonite screwed on the end of each arm at right-angles, as shown in Fig. 1.

These ebonite spacers should be about 4 in. long, notched on one edge with a hacksaw every  $\frac{3}{16}$  in. so that the wire will not slip. You should wind on 14 turns of wire, a convenient material being No. 26 enamelled copper. There is no need to use thick or stranded wire, and the latter is difficult to keep taut. The spare 6 in. on the bottom arm of the frame should be attached to a firm base, so that the frame can be rotated without falling over.

The two free ends of the winding should be left long enough to reach to the receiver; but, if possible, do not make them longer than 3 ft.

## Static Noises

Another bugbear of summer-time reception is the prevalence of atmospheric or "static" noises. In sultry weather you often hear so many crashes, crackles, and like noises that distant reception becomes painful, while even the local station's programme is spoiled. This outbreak of static noise in summer often occasions alarm among inexperienced listeners, who conclude that something must be wrong with their receivers.

"Atmospherics" are due to waves of no particular frequency set up by lightning discharges, often many hundreds of miles away; while the louder crashes are often produced by local static charges collected by the aerial, and thus discharged through the set to earth. As you know, there is much atmospheric electricity about in hot weather, so that these local discharges are continually taking place.

There is one sure way of getting over the disadvantages of the outside aerial from the point of view of

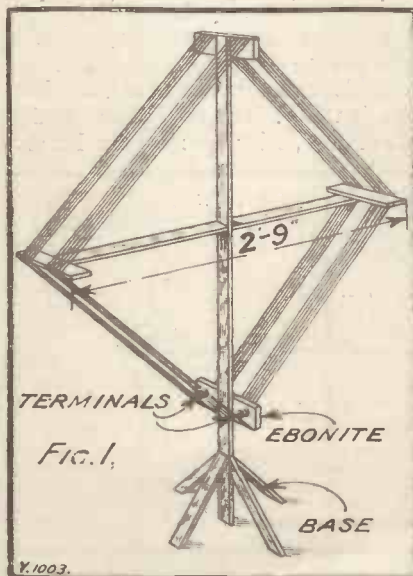

As for the usual home receiver designed for use with an outside aerial, it is not a difficult matter to adapt it for use with a frame aerial. As this modification is one that I can well recommend for summer reception, and one that is adopted by many experienced amateurs, I think

## The Simplest Method

The simplest way of using the frame aerial without altering the wiring of the set in any way is to disconnect the aerial and earth leads from your receiver and connect the two leads of the frame one to each side of the main tuning condenser. This will place it in parallel with the tuning coil in the set, supposing this to be an ordinary detector followed by one or two L.F. stages. Reaction can still be obtained, although more freely. The setting of the tuning condenser will be altered somewhat, but you will find tuning much sharper, so that you can cut out the local station with ease.

With your receiver modified in this way, you will obtain ample loud-speaking volume on the local station, provided you are not more





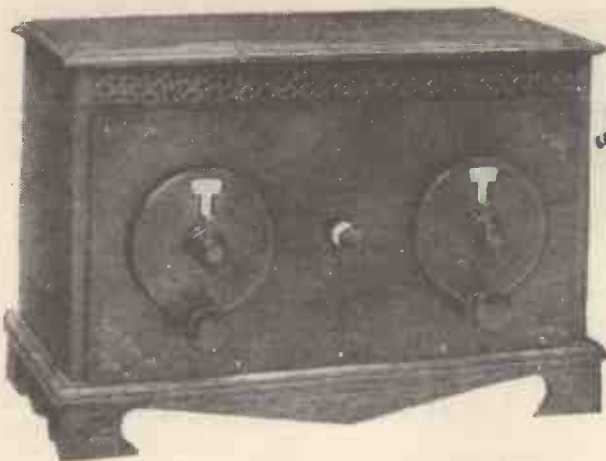

# The "SHORTRODE" TWO

*A powerful and compact receiver which employs a pentode and is capable of providing a wide variety of short-wave programmes from all over the world.*

By L. H. THOMAS.

No one who has handled a detector and pentode receiver for short-wave work can have failed to be impressed by the excellence of this particular type of receiver from several points of view:

not by the valves themselves, but rather by the interstage coupling and by various losses in the components and wiring. Certain it is, in any case, that the use of a pentode permits one to enjoy the advantages of

a great amount of extra amplification of the signal without the increase in background noise that one has been accustomed to with three valves in use. As a matter of fact, a friend's first remark on hearing my original detector and pentode set in operation on short waves was: "three-valve signals with two-valve background"!

### Other Advantages

Luckily the use of a pentode in a short-wave receiver seems to introduce no difficulties whatever. The one and only drawback is the extra price of the valve and the extra H.T. consumption, both of which are inevitable at the moment.

Among the other advantages are, of course, saving of space and general complications in the set.

The reader will see for himself that the "Shortrode" Two is a very

### COMPONENTS REQUIRED

- Ebonite panel, 14 in. × 7 in. (Ebonart). (Radion, Becol, Raymond.)
- Cabinet for same, with baseboard 7 in. deep (Artercraft). (Camco, Caxton, Lock, Raymond, etc.)
- 2 Non-microphonic valve holders (Bowyer-Lowe). (Benjamin, Lotus, Magnum, Formo, Marconiphone, Igranite, etc.)
- 2 .00025 variable condensers (Lotus). (Lissen, J.B., Dubilier, Igranite, Ormond, Utility.)
- 1 L.F. transformer, preferably 6:1 (Igranite). (R.I., Ferranti, Brown, Cossor, etc.)
- 1 Pentode output transformer (R.I. Pentamu). (Igranite, Pye, Marconiphone, etc.)
- 1 2-mfd. condenser (Dubilier). (T.C.C., Hydra, Lissen.)

- 1 20,000-ohm fixed resistance (Varley). (Ready Radio, Ferranti, Precision, etc.)
- 1 Fixed condenser, .0001 (T.C.C.). (Dubilier, Atlas, Mullard, Magnum, Igranite, Lissen.)
- 1 5-megohm leak (Dubilier). (Lissen, Mullard, Igranite, Pye, Ediswan, Loewe.)
- 2 Single-coil mounts (Raymond). (Lotus, Ready Radio, Wearite.)
- 1 Formodensor, type F (or Igranite Preset).
- 1 L.T. switch (Lissen). (Lotus, Benjamin, Lissen, Bowyer-Lowe, etc.)
- 1 Six- or seven-terminal strip and 1 two-terminal strip.
- 1 Set of short-wave coils (Atlas, Igranite, etc.).

My own "standard" short-waver for some considerable time took the form of a detector followed by two resistance-coupled note-magnifiers, with switching allowing one of the latter to be cut out of circuit. It has now changed to a detector and pentode, with a volume control.

### A Quieter "Background"

I have always had a rooted objection to two stages of transformer-coupling for short-wave work, because of the noisy background of "mush" that is nearly always produced. Resistance coupling seemed to me to be preferable in some ways, but I was never particularly happy with three valves, since for some reason all weak signals seemed easier to read when one stage was cut out, the strength of the background being reduced to a greater extent than that of the signal.

It appears, however, that most of the background noise is produced,

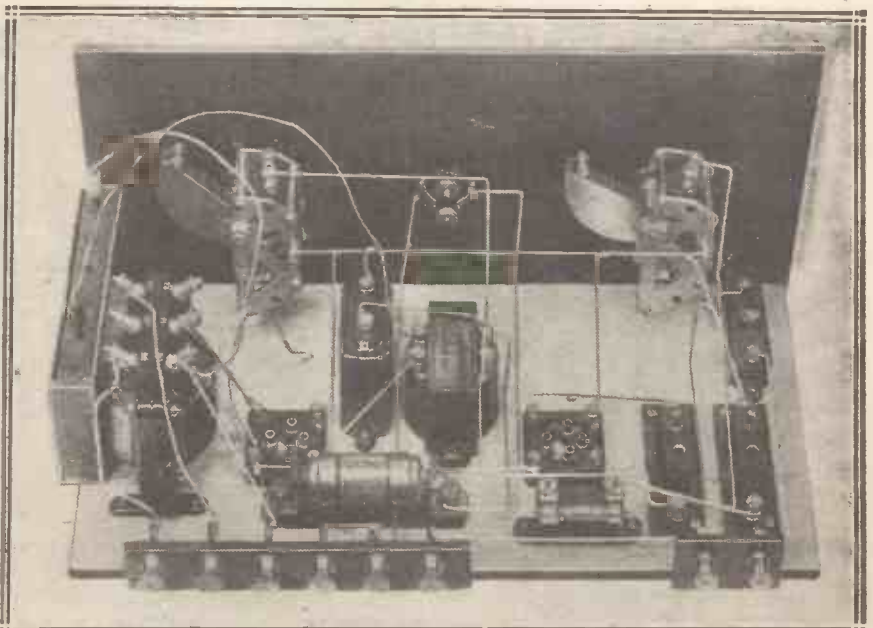

The set is L.F. transformer-coupled, the resistance shown in the foreground being inserted in circuit for stability's sake.

# The "Shortrode" Two—continued

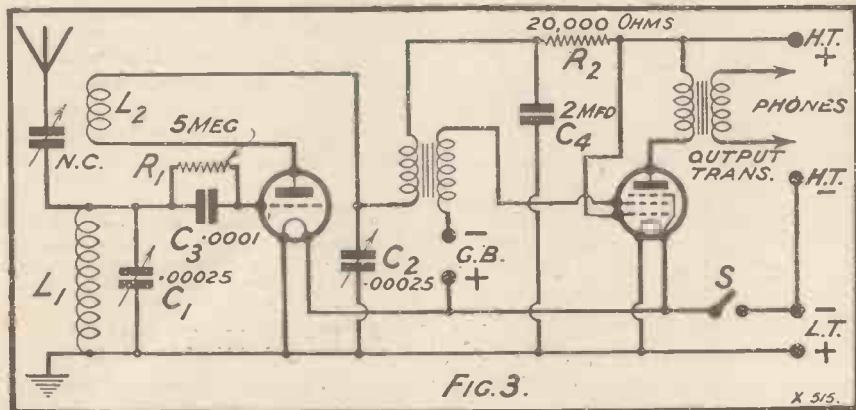

FIG. 3.

X 5/5.

small and compact set for a short-waver, and yet that ample spacing has been allowed all round for the components. Plug-in coils have been used, enabling the reader to employ the set for an almost unlimited wave-band, although rather small variable condensers have been used, bearing in mind that the primary object of the set is definitely short-wave work.

### Ideal Broadcast Set

Although my own particular use for a short-waver is usually to search the various amateur bands in conjunction with my own transmitter, looking for fresh countries and "DX" records of all kinds, thereby depriving myself of many hours of valuable sleep, I think a detector and pentode set of this kind is equally ideal for this type of work and for mere broadcast reception on the short waves. After all, if the set is capable of bring-

ing in 10-watt signals from Kenya, Peru, Alaska, Kentucky and the various "ends" of the earth, it must be quite useful on a 50-kw. broadcast transmission from a mere 3,000 miles or so!

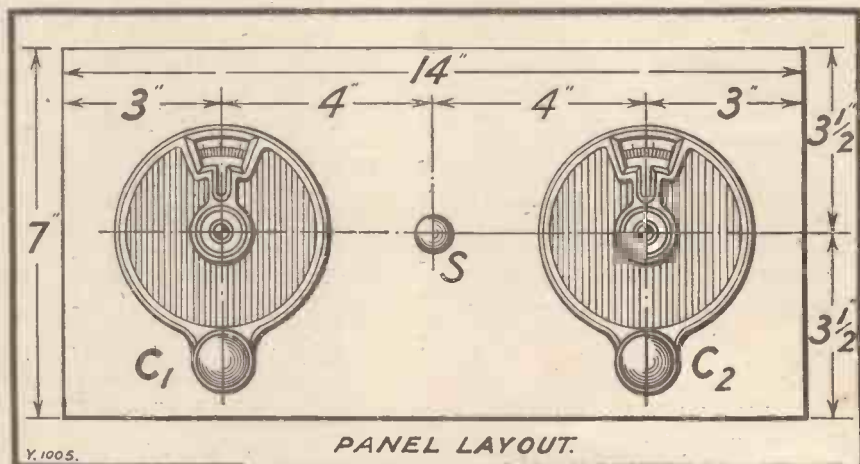

PANEL LAYOUT.

X. 1005.

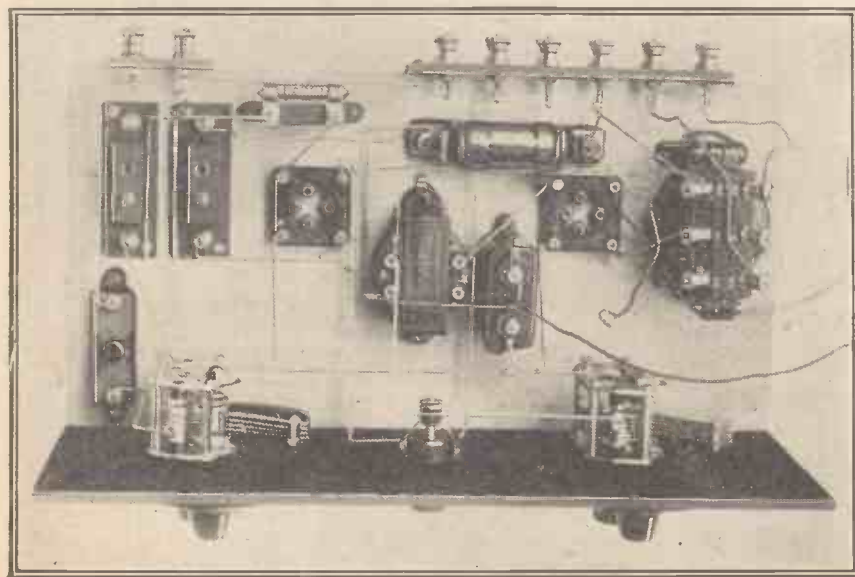

Simple and straightforward—as a good short-waver should be!

As a matter of fact, I am convinced that there should be no difficulty with this set in operating a loud speaker quite consistently on some of the more powerful broadcast transmissions on the shorter wave-lengths.

With this at the back of my mind, I have dispensed with the volume control that I usually use with this type of receiver; it was only used when headphone-work was the order of the day, and then only when a passing Ford or a neighbour's vacuum cleaner made life unbearable.

As an example of the usefulness of the pentode, by the way, I might mention that very early one morning a lorry broke down not far from my aerial, and the engine was spluttering away for some solid two hours, just while I was particularly anxious to keep a schedule with a friend in a

distant part, whose signals were none too powerful.

On my usual three-valver he was completely wiped out by the noise caused by the unshielded magneto of this lorry; changing over to the detector-and-pentode set, which was then only "lashed up" in a very experimental state, I was able to copy him practically solidly throughout a number of lengthy messages.

### Circuit Details

And now to come down to details. The detector portion of the circuit, which is naturally of the greatest interest, is essentially "straight." An anti-motor-boating resistance of 20,000 ohms is inserted in the H.T. feed to the detector, and by-passed to earth by a condenser of 2 mfd. This, incidentally, reduces the detector H.T. voltage slightly, and for



## The "Shortrode" Two—continued

this reason I have used only one H.T. positive terminal, since I have recently become a confirmed disciple of the "90 volts on detector" sect, as far as short waves are concerned. This naturally means that, using one of the freely-oscillating valves of to-day as detector, one has to employ rather a small reaction coil, but this appears to be all the better, as far as reaction control and general efficiency are concerned.

### The Reaction Arrangement

Throttle control is used for reaction, and no H.F. choke is employed as the H.T. is series fed. In the case of some particular L.F. transformers it may be necessary to insert an H.F. choke between the "P" terminal of the transformer and the reaction coil (the connection from the fixed vanes of the reaction condenser remaining on the end of the reaction coil, not on the transformer itself, if this is done), but, as a rule, it will be unnecessary.

Naturally, in that case it will be employed only as what might be styled a "reaction choke," and any good H.F. choke (not necessarily of the short-wave variety) is sufficient.

Both variable condensers are of .00025 capacity, which gives an ample tuning range. In my own opinion .00025 is too large for precise short-wave operation, but anything smaller means very frequent changing of coils, especially if one wishes to operate the set on the normal broadcast band, and the whole thing becomes unwieldy and inconvenient.

Incidentally, one of the latest "QST" receivers (designed by the staff of the American Radio Relay League) has plug-in variable condensers!

### No Screening Used

The trouble with the short waves nowadays is that the broadcasting stations are so well spread out that one has to search, in all, over a band many hundreds of times the width of the ordinary broadcast band if one wishes to receive all that is going. However, it is worth while changing coils frequently if one's patience is rewarded by a large "bag" of distant stations!

Both sets of vanes of the variable condensers are connected to positive L.T. and to earth; this is the greatest possible safeguard against hand-

capacity effects, and should never be neglected.

No screening of any kind has been thought necessary, and this opinion was completely justified by the behaviour of the final set, which is as

third coil for inductive coupling repaid. I have used capacity coupling on all the most successful short-wavers that I have handled, and, provided that one does not attempt to use too large a capacity in series with the

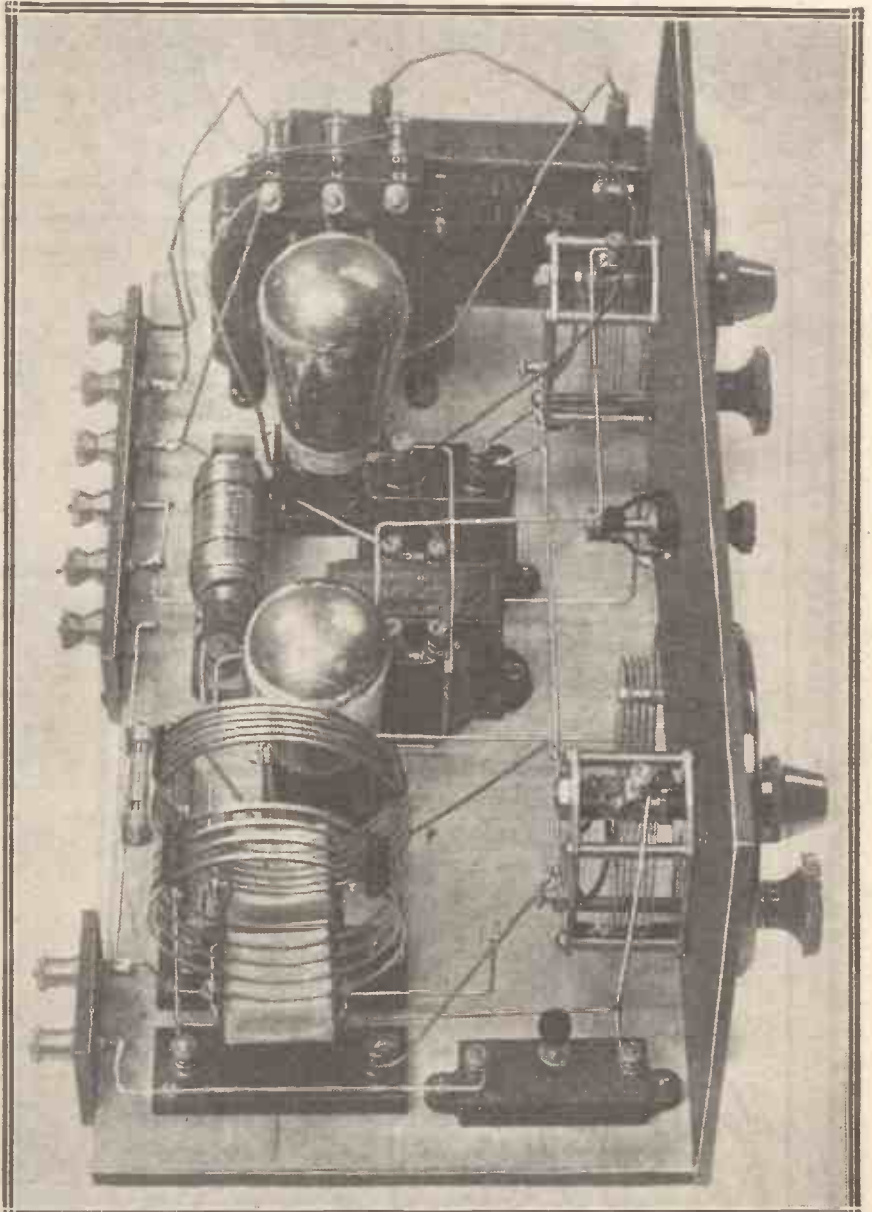

Here is the "Shortrode" Two from the aerial end, showing coils and valves inserted. It will be noted that plug-in coils are employed, so that if desired the set can be used upon ordinary or long wave-lengths.

"tame" as any broadcast receiver.

Aerial coupling is through an adjustable condenser with a maximum value of the order of .0001. I have carefully weighed up the merits and demerits of this form of coupling, and have decided that only in rare isolated cases is the trouble of providing a

aerial, the selectivity and sensitivity obtainable are beyond reproach.

A setting that may be counted upon to give good results with the average aerial is about midway between maximum and minimum on the condenser. Incidentally, the type "F" Formodensor is necessary here.

## The "Shortrode" Two—continued

The low-frequency side of the receiver consists simply of a low-frequency transformer feeding the grid of a pentode valve, the output from the latter being through one of the special transformers on the market for this purpose.

A flex lead coming from the H.T. positive terminal is, of course, connected to the extra terminal on the base of the pentode. Some people prefer to insert a fuse, such as a "Microfuse," in series with this lead,

but I have not actually included it in the set, as I use the mains for supply and have adequate protection in the way of fuses externally!

### Very Simple Layout

The output transformer used has four secondary terminals, and so that the reader may use those most suited to his particular requirements (and to the pair of 'phones or loud speaker that he uses) I have made the secondary connections by means of

flex leads. The actual portion of the winding that one uses is, of course, settled by experiment.

There is really nothing to be said about the constructional part of the set—the layout is of the very simplest order and the wiring should not take much more than an hour. It will probably be worth while to complete all the baseboard wiring first, then assembling the two condensers, slow-motion dials, and L.T. switch upon

(Continued on page 240.)

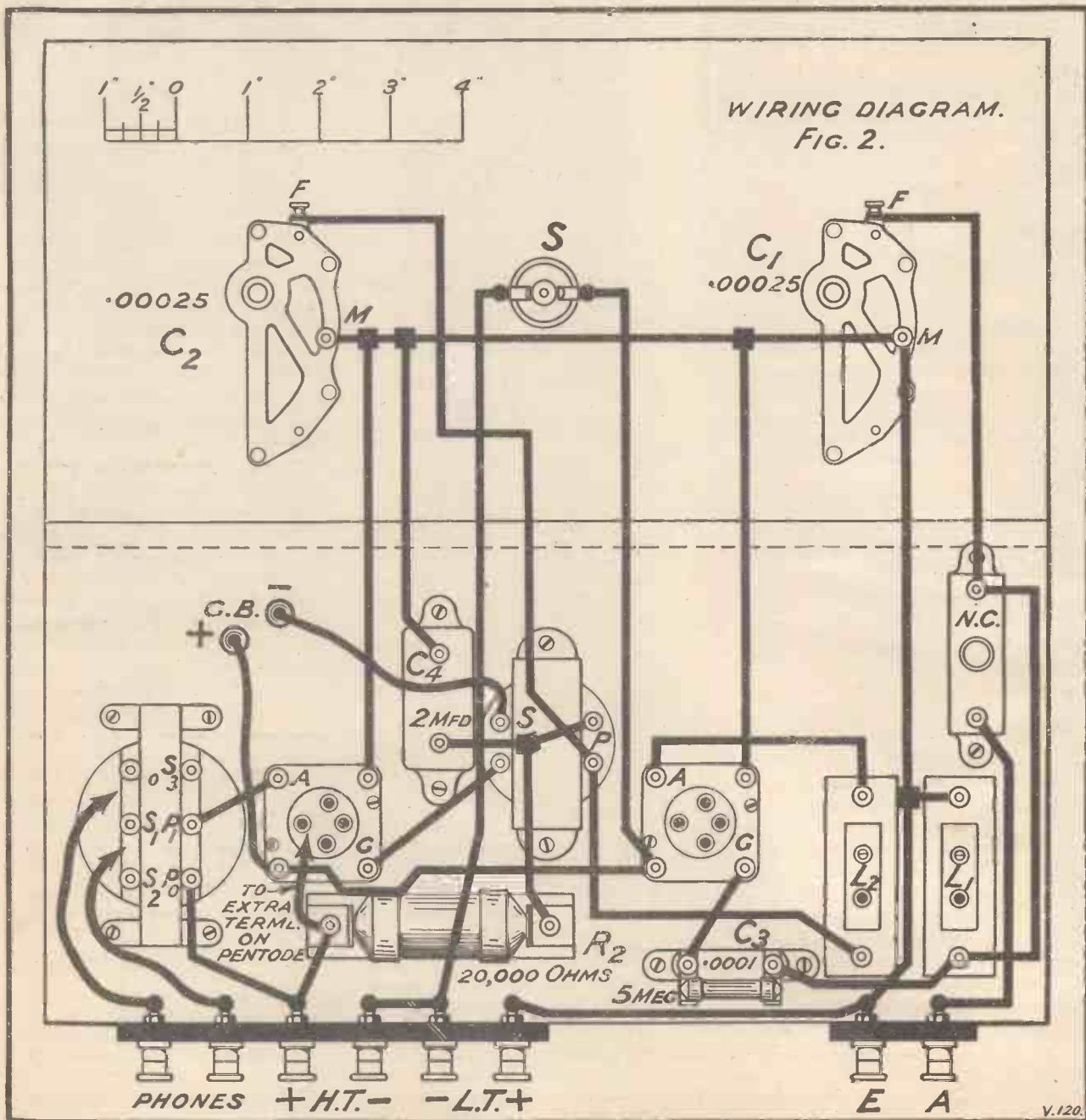





The new Prague Plan wave-lengths have made set designers look seriously into the question of selectivity. This article tells how this often may be improved in the ordinary set.

By KEITH D. ROGERS.

WITH the alteration of wave-length of the 5 G B Daventry station it has become increasingly difficult to choose a design of receiver which will give good quality and at the same time sufficient selectivity to enable perfect immunity from interference to be maintained, even though the wave-lengths of some of the more powerful stations have been brought closer together.

A good wave-trap may do a very great deal to assist an unselective detector and L.F. circuit, but for really good all-round reception one needs an H.F. stage if "easy" selectivity is to be obtained.

Constructors who live within six or seven miles of their local station, especially if it be 2 L O, will have difficulty in cutting this out in order

to receive 5 G B on the new wave-length of 399 metres, while those who live well out, where 2 L O's strength is approximately that of 5 G B, will have difficulty in many cases in separating one from the other, unless a wave-trap or a good selective circuit is employed.

**Add an H.F. Stage**

By the time these lines appear in print a number will have had experience of interference due to the new wave-lengths, and will be looking round for some way of improving matters. One of the best schemes, apart from a wave-trap, is to apply a stage of high-frequency amplification, using a valve on the neutralised principle.

A great deal has been said lately

about the advantages of the screened-grid valve, and as a "distance getter" this valve certainly has no equal, but when it comes to selectivity and silence of background, such as is essential when one is dealing with interference problems, the neutralised valve, using the ordinary split-primary form of neutralising, has the screened-grid valve beaten.

It is possible to obtain quite good selectivity with a screened-grid valve if one does not mind sacrificing a considerable amount of magnification, but if one is going to reduce the magnification in order to get selectivity, then one might just as well use the neutralised valve, which is considerably cheaper to buy and, moreover, is more silent in background than the screened-grid type.

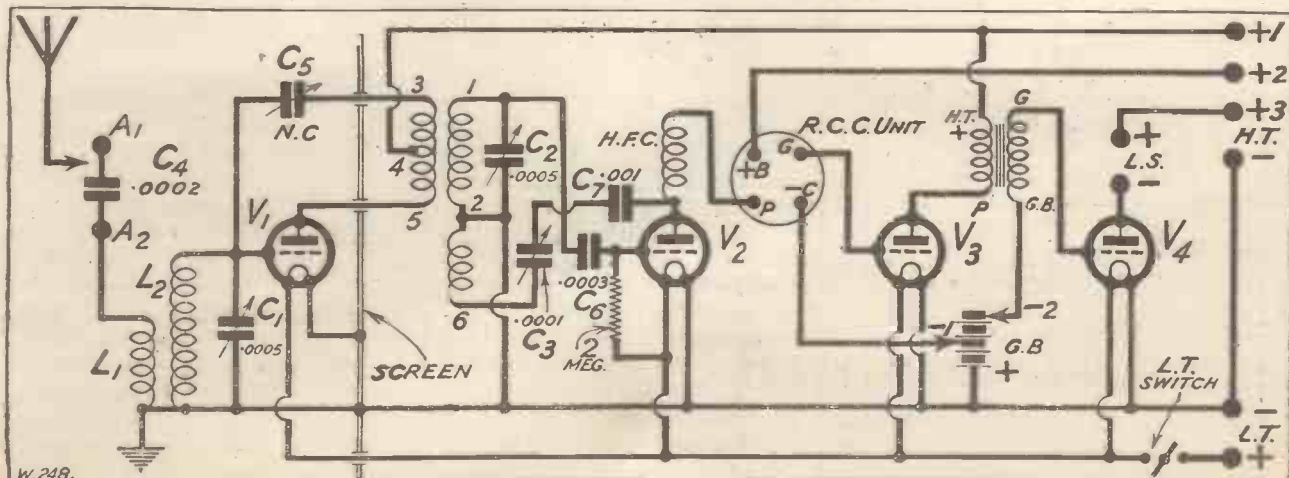

A typical four-valve circuit, in which a neutralised stage of H.F. amplification is employed.

## Within the Vacuum—continued

Where two H.F. valves are used, or desired, then a compromise between the screened-grid and the neutralised valve is a very good plan, using the neutralised stage first to 'clean up things,' so to speak, and then following this with the screened-grid valve in order to get the best magnification possible from the amplifier.

### No Fixed Rule

Where selectivity is not an acute need, the screened-grid valve may very well be used, for it certainly has the advantage of great sensitivity and powers of amplification.

Unfortunately there is no golden rule as to which is best in any particular circumstance, and experience is really the only thing that can tell whether a neutralised or an S.G. stage will best suit any particular person.

However, I think it can be assumed that the neutralised stage will be best when one is within seven or eight, or even ten, miles of the local station and only one stage of high-frequency is being employed, and when one wants to cut out the local and get distant stations or an alternative programme on a nearby wave-length.

neutralised valve, and will fully repay the extra trouble taken in the building of a set with this type of amplifier.

Readers will probably think that I have some particular "grouch" against the screened-grid valve, but that is not the case, and I merely want readers to be aware of the facts of the difference between the screened-grid and neutralised valves, and, as I said before, while there is no doubt that the magnification power of the screened-grid valve is really valuable, and while it will bring in stations with remarkable and powerful volume, unfortunately it lacks that clearness of background which is associated with a neutralised high-frequency stage. This clearness of background is so essential when one has to slip between adjacent wave-lengths to pick out any particular station, completely clear of any background, either of the local or any other interfering station, or of internal noises due to the valve itself.

### Very Effective

A well-designed H.F. neutralised stage can be made very effective indeed, and will pull in the distant

really near to a broadcasting station the neutralised stage of H.F. amplification is going to be more satisfactory than the screened-grid stage.

The man living more than ten or fifteen miles from the local station has a greater choice, as his demands on selectivity are not so great, and he may quite likely benefit from the higher magnification of the screened-grid valve than the man who lives close in.

### Effect of Prague Plan

In conclusion I should like to add that it would be interesting if readers would write in and tell us how they are getting on since the change of wave-lengths, with especial regard to interference between 2 L O and 5 G B, or between 5 G B and any other station which really acts as an alternative programme for them.

Also those of you who are troubled with interference I would strongly advise to use an H.F. stage if you have not already done so, and if you already have a screened-grid H.F. stage not to despair, but to try a wave-trap.

Others might convert the screened-grid stage into an ordinary neutralised stage if they find that the wave-trap is not enough. This will cure a great deal of the trouble due to interference between two powerful stations.

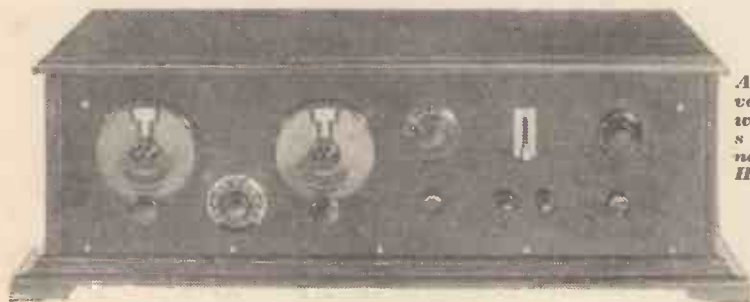

A typical five-valve receiver with two stages of neutralised H.F. amplification.

If the screened-grid valve is used in these circumstances, it is almost essential to have a wave-trap in addition to the H.F. stage, when it not infrequently happens that the extra amplification powers of the screened-grid valve are really lost due to absorption of the wave-trap and to the need for moderately high selectivity in the H.F. stage, so that one might just as well have had a neutralised valve all the time.

### Clear Background Essential

In other cases where interference is not bad and one lives some distance from the local station, the screened-grid valve will often bring in the signals considerably better than a

stations very well if properly handled. Moreover, it is usually dead silent in operation and has nothing of that rushing background noise which is typical of the screened-grid valve when working at its maximum amplification.

I am afraid that the new wave-lengths will have caused quite a number of screened-grid enthusiasts living around London to pause and think, and possibly to re-design their sets in order to obtain a higher degree of selectivity. Razor-sharp selectivity is not good for quality, but it is necessary to have a certain amount of selectivity in these days of crowded wave-lengths, and I really do think that for the constructor who lives

AMONG THE TRADE

Garnett, Whiteley & Co., Ltd.

THIS firm, well known as the makers of the Lotus components, have now taken offices at No. 125, High Holborn, London, W.C.1. The London representative is Mr. W. J. Holland.

### Radio Pictures

Fultograph enthusiasts and those who are toying with the idea of picking up radio pictures will be interested to know that Wireless Pictures (1928), Ltd., are now issuing a leaflet upon this subject. As it contains some untouched reproductions of Fultograph pictures received from Davenport, and also direct from Berlin, it gives an excellent idea of the present state of the art and of what kind of pictures may be expected to find their way down your aerial.



# CHATS AT THE WORK-TABLE

Many points of practical interest to amateurs and set constructors are dealt with under this heading.

By R. W. HALLOWS, M.A.

## Making Large Holes

NOT long ago a well-known expert wrote in the WIRELESS CONSTRUCTOR that after trying out all kinds of gadgets for making large holes in ebonite he was firmly of opinion that the best of all methods was the old-fashioned one of drilling a series of holes round the periphery and, subsequently, removing the webs with a file or keyhole saw.

I have come across one or two fairly satisfactory tools for cutting large round holes, but taking everything into consideration I quite agree with the writer in question that the old method is the best. One of the little bothers

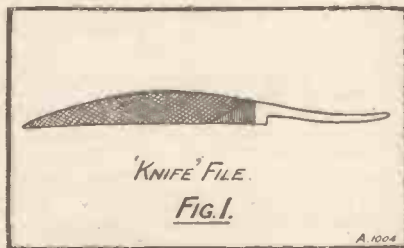

that one has in drilling a series of holes along the line or lines marking out the proposed large aperture is that, unless one leaves fairly large gaps between them when centre-punching, the point of the drill is very apt to run off, shortly after it is started, into the hole previously drilled.

This can be prevented in a simple way which will probably be found useful by many readers. Make your punch marks only slightly farther apart than the diameter of the drill, and when this job has been done, take a drill of a size considerably smaller and run it about half-way through the ebonite at each punch mark.

## A Useful File

No difficulty will then be experienced in getting the bigger drill to run straight through. In this way only very thin webs are left, and the business of removing them is simplicity itself. A most useful tool, by the way, for the purpose of cutting out webs is a small file of the shape shown in Fig. 1.

Its technical name is a "knife" file,

and a suitable size for most wireless constructional work is the 4½ in. length. Another very handy little file for all kinds of fine metal work is that known as the magneto file, which can be purchased from any shop or garage that deals in car or motor-cycle supplies.

## Valve-Cap Coils

I came across recently the very neat and effective way of making short-wave coils which is illustrated in Fig. 2. Most of us, I suppose, have a number of old burnt-out or broken-down valves lying about at the bottom of drawers or in the corners of shelves.

To make one of these into a coil former all that is necessary is to worry off the bulb; often it is unnecessary to smash the glass, which can be loosened in its seating by holding the valve cap in one hand and the bulb in the other, and working the two about.

The best kind of valve cap for the purpose is one of the "open-work" type adopted by many firms nowadays. The kind I mean has all unnecessary material cut away at the bottom, only small lugs being left for mounting the pins. For the 20-metre band of wave-lengths the grid winding, whose ends may be connected to the grid and anode pins, consists of six turns of No. 24 D.C.C., and the reaction windings, connected to the other two pins, of six turns of No. 36.

For the 30-metre band a fifteen-turn grid coil and a six-turn reaction coil will be suitable, the same gauges of wire being used as in the previous case.

It is not absolutely necessary to space the turns of the grid windings; in fact, if two coils are made up, one spaced and the other not, it is remarkable what little difference one finds between their performances. I have tried-out coils made with valve caps as



formers and I can recommend them as being convenient and effective.

The valve holders used on the base-board as coil mounts should be of the anti-capacity type, and it is important that they should be of the very best quality. With coils made in this way a change over from one band of wave-lengths to another is the easiest thing in the world; one wound former being simply replaced in the holder by another.

## Detailed Construction

The make-up seen in Fig. 2 is for a plain aerial arrangement, both the aerial and the grid of the valve being attached to the "top" of the grid coil. Most short-wave enthusiasts, however, make use of tappings for the aerial connections.

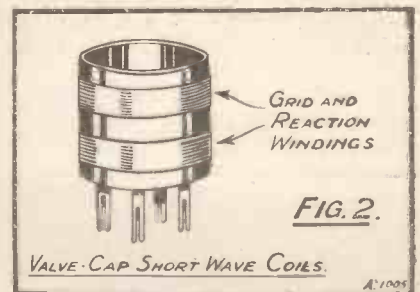

These, as we shall see in a moment, are quite easily incorporated. To wind the coils begin by piercing, near the top of the holder and immediately over the grid pin a hole just large enough to pass the No. 24 D.C.C. comfortably. Thread the end of the wire through and solder to the grid pin. Pull tight, wind on the requisite number of turns, pierce the second hole over the plate pin, cut the wire,

## Chats at the Work-Table—continued

pass the end through and solder to the plate pin. Then put on the reaction winding in the same way.

If tappings are required, simply twist small loops at the required turns, arranging these so that they are staggered. Fig. 3 shows how the tappings are made. When the "out" end has been soldered up, remove the insulation from the loops.

A crocodile clip attached to the grid terminal can now be fixed to any

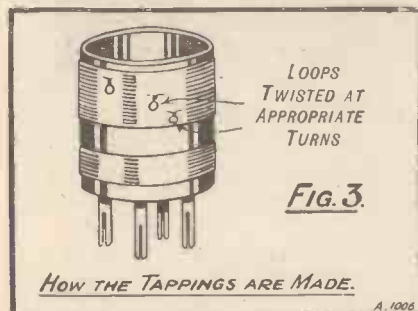

one of these with the greatest ease. Of course, if only one tapping were required, a pentode valve cap would be ideal for the purpose. Not many people, though, I imagine, are likely to have any old pentodes lying about!

### A "Head-Room" Problem

The other day I came across rather a curious problem in set construction, or, rather, in set conversion. The particular set concerned had a panel of 7 in. in height, but as resistances, large fixed condensers and a greater part of what a friend calls the "dirty work" wiring were under the baseboard, which was raised 1½ in. above the bottom of the panel, the total "head-room" above the baseboard (which was ¾ in. thick) was only 5 in.

It was desired to use in the output stage a P.625 valve, which measures 5½ in. overall in height or, say, 6 in.

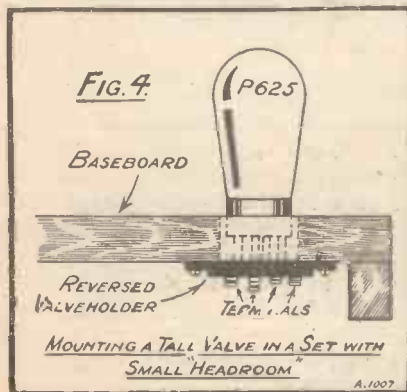

when mounted in its holder. In the particular cabinet employed there was only a very thin batten above the panel when the baseboard had been pushed home, so that had the valve been mounted in the ordinary way, two things would have happened: the lid would not have closed, and if that trifling inconvenience had been put up with there would have been every likelihood of breaking the valve when withdrawing or inserting the set into its case in one of those careless but expensive moments that most of us know only too well.

### Simple Solution

The problem is not unlikely to come the way of a good many readers in these days when bigger and fatter valves seem fashionable. How is it to be solved? Fig. 4 shows a simple but effective way of tackling it. There are several makes of valve holder which consist of an ebonite ring, carrying the terminals, within which the portion carrying the valve legs is, so to speak, slung by means of four springy arms which make the connections to the grid, plate and filament terminals.

Normally, the middle portion of the holder is inserted into the ring from below, so that its top is more or less flush with that of the ring. It is held in position by four screws which form the shanks of the terminals. For our purposes we must remove the middle portion and reverse it, thus practically turning the holder inside out.

The portion bearing the valve legs now points upwards, whilst the terminals on the ring point downwards. Through the baseboard is drilled a hole 1½ in. in diameter. The reversed holder is now mounted as shown in Fig. 4. This will mean that the top of the portion bearing the valve legs is just a little below the level of the upper side of the baseboard. When the valve is inserted there is now ample clearance for it, the top of its bulb being considerably below the level of the upper edge of the panel.

### Mounting Lever Switches

Lever-operated switches of the anti-capacity type are most useful in the wireless receiving set in conjunction with wave-length changing devices, and for a whole host of other purposes.

Several constructors have told me lately that they find it difficult

to make the necessary slot in the panel in exactly the right place; the tiniest error in marking out often leads to a very obvious appearance of lopsidedness when the job is finished.

### Not a Difficult Task

Actually the mounting of these switches is a very simple business, if one sets about it in the right way. To begin with, the cover-plate (that is, the plate mounted on the front of the panel) should be used as a jig, both for drilling the necessary screw-holes and for cutting the slot in which the lever is to travel.

Before you do anything else, detach this plate, turn it upside-down, and scribe lines as shown in Fig. 5 from the mid-points of both long and short sides.

On the back of your panel scribe cross lines parallel with the long and short sides indicating the exact position to be occupied by the middle of the switch. Lay the cover-plate, with its scribed lines uppermost, on the back of the panel and move it until these lines coincide perfectly with those upon the panel.

Holding it firmly in position,

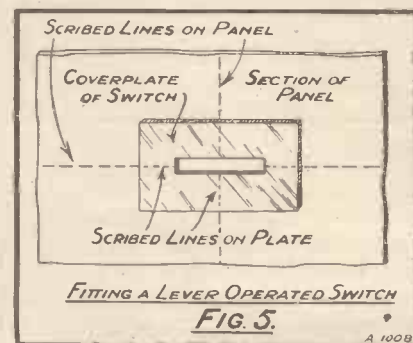

insert a sharp scriber into one of the screw-holes, and turn it round two or three times so as to mark the exact position of that hole. Centre-punch and drill. Insert the screw, centre up the cover-plate, and make the other screw-hole.

Put the second screw in position, then take the scriber and mark out on the ebonite the rectangular slot. This is cut in the ordinary way, after which the job is completed. It is well worth while to go to the little extra trouble of making the scribed lines on the underside of the cover-plate, for when this is done one can make dead sure about mounting it perfectly true on the panel.



# LABORATORY NOTES

*by the Editor*



**A** PECULIAR aspect of reception, the significance of which is only just dawning upon listeners generally, is the response of the human ear to what may be termed strengths of sound other than normal. If, for example, we reproduce through some loud-speaker equipment a perfect quality reproduction of the human voice, but of several times the normal strength, then the effect on the listener will be one of distortion, and some frequencies will appear to be over-accentuated. The reason for this is that the "response curve" of the human ear is somewhat different for different sound intensities.

### Peculiar Problems

A good deal of data in this connection has been collected by telephone engineers and is being explored very carefully by those who are studying the filming and reproduction of talking pictures. The problem also has to be faced in connection with public address systems. The problems of the response of the human ear to various sensitive sounds are quite different from those connected with loud-speaker design, and would have to be faced even if we had (which we certainly have not!) the loud speaker which has a perfect frequency response—or even one comparable in this respect to the response of the best modern receivers.

### The Average Speaker

Very pleasing reproduction can be obtained from loud speakers which have quite poor response curves, and it is interesting to note what happens when certain frequencies are repressed or accentuated. While, as has been frequently pointed out in this journal, we have a number of low-frequency transformers giving,

*Under this heading the Editor discusses some of the many interesting points revealed during experiments carried out in the "Wireless Constructor" laboratory.*

when used in proper conditions, excellent and almost uniform reproduction down to 25 cycles or below, the response of the average loud speaker to a 50-cycle note, or even, for that matter, to a 100-cycle note, is, if anything at all, so small as to represent a negligible percentage of that given at a frequency of, say, 300. Many loud speakers on the market which fall off very rapidly below 200 give very pleasing reproduction, and for this reason are deservedly popular.

When the low frequencies are cut off (below 200 or so) reproduction

loses its roundness, fullness, or "body." Speech, however, and many musical instruments are perfectly clear and natural, and will certainly sound far better than when reproduced by a loud speaker which has a full low-note response, but a meagre high.

### Loss of "Distinction"

A poor response to the high frequencies takes away distinctness, crispness, and that clean and sharp effect the absence of which is so irritating. For pleasant reproduction it is far better to have a loud speaker which has a good medium- and-high note response and a deficiency in the low, rather than one which has a good low-frequency response and falls off badly on the high.

### A WELL-KNOWN "CONTINENTAL"

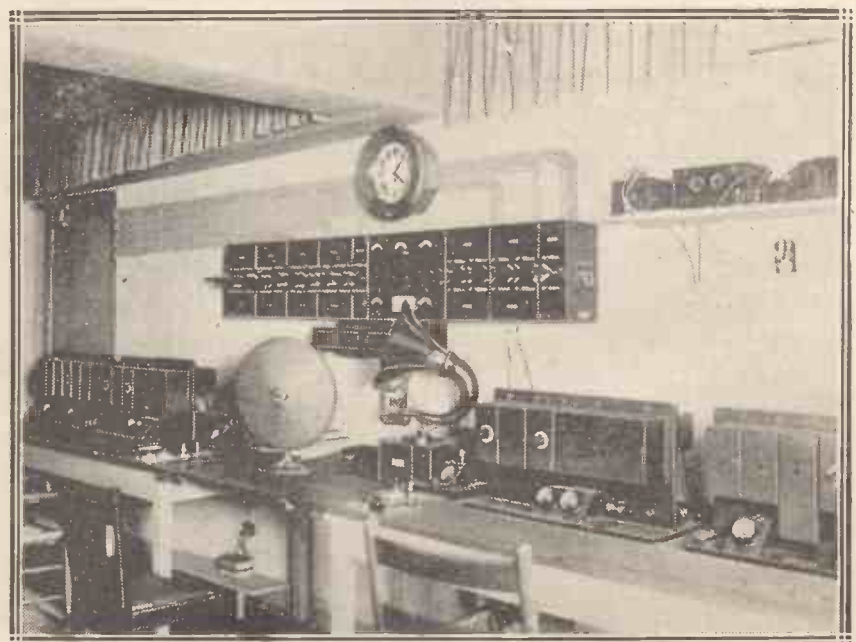

The control-room of the Königsberg broadcasting station.

# RADIOGRAMPHONICS

*This month radio-gram apparatus is reviewed, and the subject of jacks on sets for plugging-in pick-ups is dealt with.*

By A. JOHNSON-RANDALL

**I**N our last issue, it will be remembered, we gave a brief review of the B.T.-H. pick-up and carrier. We have since had an opportunity of carrying out our usual tests on this component, and, as we rather anticipated, it has given very satisfactory results.

## Good Sensitivity

From the point of view of sensitivity it compares very favourably with the average, in fact, it is rather more sensitive than many we have tested. In the tests so far conducted, it is, of course, impossible to say very much about absence of record wear (quite apart from quality) due to the angle at which the pick-up is mounted, but theoretically it seems a very sound proposition, and we can thoroughly recommend it to our readers.

This month we have received from the Cromwell Engineering Co. a specimen of their "Meltrope" pick-up arm for test and report.

can be raised or lowered to suit any particular gramophone.

By means of an ingenious spring arrangement at the pick-up end of the arm the weight of the pick-up on the actual record can be adjusted. Another good point about this particular arm is that the angle of the pick-up can be altered merely by swivelling the small sub-arm.

The importance of this last feature may not at first be realised, but in point of fact it enables the degree of error in tracking to be reduced very considerably.

Next month we hope to have something to say about our practical tests of this instrument, but would like to say meanwhile the workmanship and arrangement of the sample submitted give one the impression that it is a very well-designed job.

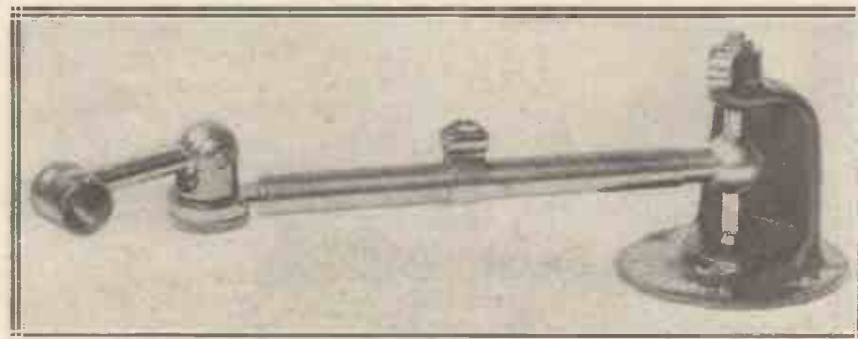

*The "Meltrope" pick-up arm supplied by the Cromwell Engineering Co.*

This consists of a base upon which the tone-arm is pivoted and an extending arm at the end of which is mounted a small sub-arm to carry the actual pick-up.

The main arm is supported on a circular tube which is pivoted at each end on a conical bearing. Complete freedom of movement is thus obtained for the arm which supports the pick-up. The position of the main arm on the vertical support

Our post-bag this month contains rather an interesting letter from a reader in Cornwall, who appears to be in doubt as to the method usually employed for fixing a pick-up jack in a receiver.

## Quite Easy

This is not nearly such a difficult matter as it may at first appear, and for the benefit of readers who may not have seen our previous references

to the subject the following details will be helpful.

First of all it is necessary to decide the valve in the grid circuit of which it is desired to use the pick-up jack, and this, of course, depends upon the number of L.F. valves.

The H.F. side of the set can be ignored, but the detector and L.F. valve or valves must enter into the consideration. In cases where there is only one L.F. stage, the detector valve will obviously be required, and the jack will therefore have to be arranged in this grid circuit.

With a fairly sensitive pick-up and a set with two L.F. stages, however, it is probable that the detector valve will not be required, in which case the pick-up jack will have to be arranged in the grid circuit of the first L.F. stage.

## How to Connect It

If you carefully examine the single closed jack (the one required) you will find it has three contacts. Two of these contacts come together when the plug is withdrawn, whereas the other (the one that makes contact with the shank of the plug) is not connected to anything when the plug is out.

This latter single contact should be joined direct to L.T. negative, or, if desired, to G.B. negative.

Of the other two contacts it will be found that one makes contact with the plug, and this particular contact should be joined to the grid terminal of the valve holder, after the wire at present going to this position has been removed.

To complete the connections it is merely necessary to join the remaining jack contact to the wire which has already been removed from the grid terminal of the valve holder.





### Orphean Popular Cone

THE LONDON RADIO MFG. CO., LTD., produce a number of loud speakers of various types, some models of which have been previously reviewed in these pages. The latest received is the Orphean Popular Cabinet Cone, priced at 30s., and measuring 11 ins. square. The appearance is neat and pleasing, as will be judged from the accompanying photograph, and unlike some inexpensive cone speakers the movement is adjustable.



A popular cone speaker—the "Orphean," made by the London Radio Mfg. Co., Ltd.

Another point we like is that good long leads are provided with the speaker and do not have to be purchased separately. On test the cone put up a good performance in its price class, but naturally one does not expect to get the same wide range of tone in a cheap model as in the more expensive instruments.

Nevertheless the effect is pleasing, and the cone is commendably free from the unpleasant resonances which too often mar cabinet loud-speaker performance. The sensitivity is rather lower than one would expect,

### A MONTHLY REVIEW OF TESTED APPARATUS

(Note: All apparatus reviewed in this section each month has been tested in the Editor's private laboratory, under his personal supervision.)

but altogether the instrument is good value and will, we are sure, find many satisfied purchasers.

### A Good Valve Holder

Among a number of good lines marketed by the Marconiphone Company, Ltd., the valve holder, specimens of which we have recently received for review, is well worthy of attention. Departing from the more usual circular formation, the designers of this holder have wisely placed the terminals in those positions where they are most easily wired up, while at the same time enabling the valve holder to be placed "all square" in a manner which enhances the appearance of the set.

It will be noticed that when so placed on the baseboard the anode terminal comes in the middle of the left side and the grid in a similar position on the right, the two filament terminals being front and back. The valves fit into this holder easily yet firmly, and the metal portions which make contact with the pins are well sunk in insulation so as to prevent accidental shorting.

Another practical point is that only two fixing holes are provided instead of the conventional four. Why four fixing holes are provided on the average valve holder is a mystery to us, as two are ample. During the tests the suspension proved to be particularly good, and on the holder being taken to pieces it was discovered that no metal springs are

used, the centre portion of the valve holder being supported between four blocks of rubber. Contact between



The new Marconiphone valve holder.

terminals and sockets is provided by flexible copper wire carefully soldered to each socket. This is an excellent valve holder which can be recommended with confidence.

### Useful Wire-Wound Resistances

The Ready Radio Company, Ltd., who make a number of good com-

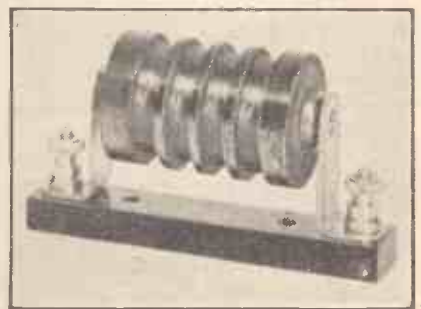

This is the wire-wound resistance made by the Ready Radio Co., and discussed in this column.

ponents, are now marketing an excellent wire-wound resistance of the interchangeable variety, the resistance wire being wound in a number of

## What's New—continued

slots, the size of the bobbin used depending upon the resistance.

Actual tests showed that the resistances stand up well under load, whilst the marked values are well within reasonable limits of accuracy. Now that the use of such resistances, in conjunction with large condensers, is general, for cutting down voltages to valves, and in avoiding battery and mains units coupling effects, these resistances should find a ready sale and can be recommended.

### British General L.F. Transformer

The British General L.F. transformer is made in two ratios, 3 to 1 and 5 to 1. The instrument is handsome in appearance, with clearly marked terminals for plate, H.T. +, grid and grid bias —, with good substantial terminals conveniently placed and soldering lugs. On practical tests the performance was good, both high and low tones being well reproduced.

The 3 to 1 ratio is recommended for first stage following the detector, the primary impedance here being high. The 5 to 1 is specially designed for second stage use, where a relatively low impedance valve will be used in the plate circuit. Tested with such a valve, and in suitable conditions, with a fairly heavy plate current, the performance of the 5 to 1 ratio was thoroughly satisfactory. Both of these transformers sell for a reasonable price, and prove well up to the standard one expects from a modern British L.F. transformer.

### A Useful Compound

From the makers of the Perfection Duplicator Ink, of Preston, we have received a stick of "Radiolastic" composition, which has many uses in radio work. The manufacturers recommend it for sealing accumulators, filling holes in panels, finishing off the ends of flexible wires, attaching small components, etc., etc., its insulating properties being thoroughly satisfactory for any such work.

Our tests show that it has an almost phenomenal holding power, for when we stuck two pieces of wood together with it it was quite impossible to break them apart without tearing the wood, after the joint had been left for about ten minutes. It also proved very useful in repairing broken bakelite and other composition

mouldings, and, as it hardens comparatively slowly, it can be pressed into the required shape as it sets.

While it can be used for filling holes in panels it is a little difficult to finish off the surface neatly, owing to the power of the substance to seize hold of fluff and lint, and for such purposes we prefer a wax, but there are numerous other uses which will occur to any wireless enthusiast, and we can heartily recommend this substance for repairing and general wireless work.

### Novel Variable Condensers

The experimenter accustomed to air-dielectric condensers will be rather surprised at the appearance of the Graham-Farish variable condensers, which, by the use of a thin, solid dielectric between the moving and

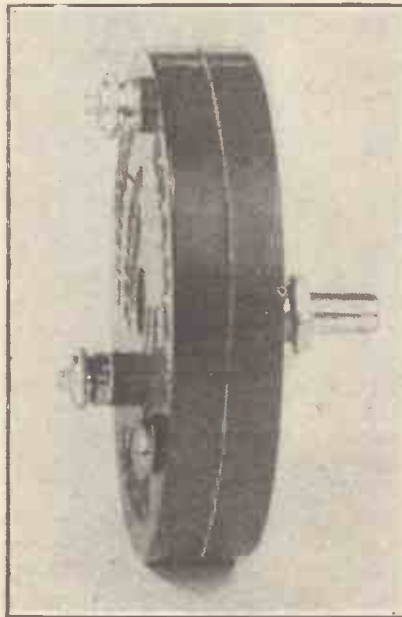

The Graham-Farish variable condenser.

fixed plates, are made to occupy much smaller space than usual, the "Micro-efficient" variable condenser illustrated (nominal maximum .0005 mfd.) measuring only 3 in. diameter and  $\frac{5}{8}$  in. thick.

Substantial terminals are fitted, the fixed plates being clearly marked, and the usual one-hole-fixing is provided. We notice that when the condenser is attached to the panel, the teeth on the centre boss bite into the back of the panel and prevent rotation—quite a good point, and one which will commend itself to home constructors.

On test the movement of the spindle proved to be smooth and even, and quite free enough to be used with any of the modern friction-driven vernier dials. The maximum capacity proved to be .00063 and the minimum .00001 mfd. The former figure is on the high side for a nominal .0005, but the latter is certainly well below what one would expect from this type of construction, and is a particularly good figure.

The whole condenser is extremely light (the one we tested weighs exactly  $2\frac{3}{4}$  ozs.!), and so will appeal to portable-set builders, who should find it perfectly satisfactory. In all cases, save where extreme low-loss construction is required, this condenser should serve excellently, and it can be recommended for all general purposes.

### Excellent Cone Loud Speaker

Some time ago we reviewed in these columns the M.P.A. Popular Plaque loud speaker. Recently we have given a thorough test to the M.P.A. "De Luxe Plaque," a somewhat larger instrument, very handsome in appearance and selling for £2 7s. 6d.

Disregarding for the moment the price of this speaker and considering it solely from the point of view of reproduction, we can state without hesitation that the tone is most pleasing and easily stands comparison with a number of cones sold for double the price. The sensitivity is good and the speaker stands any reasonable load for a living-room without signs of distress. Tests with an audio-frequency oscillator show that the low-note reproduction is as good as one can expect with this type of construction, and the instrument is free from the unpleasant resonances on certain frequencies which frequently mar cone speaker reproduction.

Due to its method of construction, the speaker is quite free from "boxiness." The actuating mechanism is attached to a front wooden frame, and the gilded paper cone lightly supported at four points on the edge by pieces of spongy rubber. An adjusting screw is provided on the front of the instrument and the fretted panel carrying the actuating unit and the cone is placed at slight angle to the perpendicular by means of wooden feet. This speaker represents remarkably good value for money.





"I HAVE a nice little job for you," said Mr. Parris. I made hastily for the door, murmuring something about catching a train, for the mention of anything that sounds like work positively makes me go goosey all over.

Mr. Parris got there first. I have noticed before that when he is going to suggest to me anything of an active nature he usually places himself somewhere near the door before getting under way.

"I want you to try out my new set, the very latest. Of course, I have



"Night-cap," I shouted in triumph.

tested it here, but I know that conditions at your place are quite different. I can't think of a name for it."

"The Wayfarer," I suggested.

"Shut up!"

"Since you like ornithological names, how about 'Parris's Warbler'?"

"Do be quiet! Yes, I am fond of bird names. Let me see now, we have had the 'Night-Hawk'; 'night' is good. Can't we think of another combination of that kind. 'Nightingale' is too obvious."

### Some Suggestions

"How about 'Night-jar'?"

"Shut up! 'Night-falcon,' 'Night-eagle.'"

"Night-howl?"

"\* \* \* ? ? ? ! ! ! 'Night-finch.'"

"Night-linnet."

"Nightmare?"

"No, I can't find a suitable nocturnal bird."

"'Yellow-hammer.' 'Bullfinch.' 'Blackcap.'"

"Nightcap," I shouted in triumph.

Mr. Parris cowed me with an awful look and was equally unappreciative of my suggestion that it might be called the "Ten-Guinea Fowl" or the

"4 B.A. Nuthatch." Eventually it was decided to call it the "Kestrel." He made a careful note of my ideas for a "Buzzard" wave-meter and a "Bittern" loud speaker, though he would not consider the "Emu" crystal set.

"Why 'Emu'?"

"It seems to fit in with the cat's whisker, don't you think?"

In the cold grey dawn of the following morning I was awakened by a knock on my bedroom door.

"What on earth's the matter?" I cried, looking at my watch and observing that it was barely a quarter past eleven.

"There's two men brought one of these 'ere wireless sets for you in a car," called Gladys Emily from the other side of the door. "You've gotter sign for it."

I instructed her to take it in, signing "per pro." She objected to this, saying that she had always understood that I was an amateur, but at last went away, leaving me in peace.

### A Big Business

When I ran downstairs somewhat later, humming a gay little song and thinking what a jolly day it was, I fell over a large packing-case in the hall, finding myself quite literally on the mat.

To judge from the size of the case, testing out the "Kestrel" was going to be a big business. On retiring to my den to think it over I was lucky enough to observe through the window young Edward Buggsnip passing down the street. Him I bribed with a whole shilling to get one of his pals to carry it down to what I call the laboratory, though Mr. Buggsnip, senior, who obliges as jobbing gardener, will insist on calling it the potting shed.

A week later Mr. Parris rang me up on the 'phone.

"How do you like the 'Kestrel'?" he asked.

I told him that I was much impressed with it so far as I had gone.

He inquired whether I had had any trouble of any kind. I told him that I had not.

"Do you find it quite stable?"

"Absolutely so. It hasn't moved an inch since it reached my laboratory."

"Have you logged many foreign stations?"

"Well, not—er—foreign stations."

"Well, how about the home ones?"

"Oh, the home ones?"

"Yes."

"Well, I haven't exactly got any home ones yet."

"I don't believe you have even unpacked it."

"Well—er—you see—it's been a very busy week."

### I Get Some Help

Mr. Parris, I believe, then began to say things, but being wise in my generation I had quietly hung the receiver on its little hook before he got under way.

Next morning I was awakened again at an unconscionable hour by Gladys Emily, who announced the arrival of Captain Buckett and Goshburton-Crump. I arrived down in my den with my right arm in a sling.

"Such bad luck," I exclaimed.

"There's a big case out in my laboratory containing a most wonderful set, and, as you will see, I can't open it. I wonder if you fellows would be good enough—"



"Two men brought one o' these 'ere wireless sets."

They left the room clamouring for hammers and case-openers and things. Having smoked the first and most delightful pipe of the day, I floated down to see how they were getting on. They had got the case open all right, and nobly agreed, in view of my obviously useless arm, to carry it up to the den. I do love watching other people work. The "Kestrel" made quite an imposing show when placed

## In Lighter Vein—continued

on the big table in the corner. They were frightfully keen that I should try it out at once, but glancing at my right arm I told them that I could not do so until I was quite myself again.

That afternoon I set off gaily for the tennis courts, swinging the new racket that I had borrowed from Pimpleson whilst he was away from home. Round a corner I came face to face with Captain Buckett and Goshburton-Crump and changed the racket hastily from the right hand to the left, explaining that I was just walking down to the tennis courts to look on and that I was hoping to meet Pimpleson to whom I could return his property. As I felt that people at the courts might possibly talk, I thought it might be wiser to go and call on Professor Goop instead.

### A little "Improving"

The professor was out, I found, when I entered his study through the French window; but that did not matter very much, for there, on the wireless table, was a most interesting receiving set, which obviously demanded to be tried out. I spent a whole hour at the controls, shaking my head every now and then, as one always does when trying out a friend's set, and discovering how jolly good it is except that the selectivity would do with a little improvement, the sensitiveness is not quite up to the

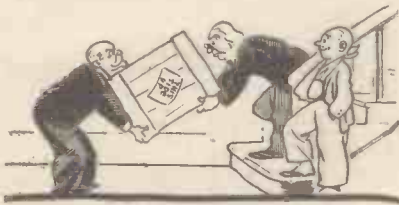

*I love watching other people work.*

mark, the reaction is just a little rough, signal strength is not what one gets oneself, and for quality, well—

It occurred to me that I could very easily improve the professor's set, thereby earning his undying gratitude. The screen-grid high-frequency valve would clearly be better with parallel-feed instead of plain tuned-anode coupling. There wasn't a high-frequency choke handy, but I soon found one in what he calls his quality set. In fact, by taking parts from his short-waver, his long-waver, his medium-wave DX set, and several other models that were lying about,

I very soon improved the thing out of all recognition. It would, I think, have given practically perfect reproduction after the last addition had I not made a trifling mistake in the wiring which blew up all the valves. As I couldn't find any others I had to leave it at that.

### A "Good Turn"

It then struck me that it would be best not to wait for the professor, but to return quietly home, leaving the improvements as a joyous surprise for him.

Gladys Emily met me in the hall as I entered my own abode.

"The professor's 'ere," she said. "Bin in your den all the hafternoon, 'e 'as, busy as hanythink over some job as 'e were doing."

"Ah, yes," I said. "He'll have been juggling with the electric bell, I expect. He promised to come and put it right for me, you know. In fact, he said that he would fit one of his latest inventions, his new Silent Bell, which will not get on your nerves and mine so much as it used to."

With a cheery whoop of welcome I burst into my den. The sight that met my eyes was certainly a little startling. Most of the professor seemed to be inside the "Kestrel," and most of the inside of the "Kestrel" appeared to be strewn over the table and the floor.

"Ah, my dear fellow," cooed the professor. "I have just been doing you a good turn. I came round to see you some hours ago and was unlucky enough to find you out. However, I observed the wireless set which you told me had been sent down for you to test, so I thought that I would save you trouble by doing the job for you."

### The "Same" Set

"I see," I said thoughtfully.

"It wasn't half bad as it stood," said the professor, "not half bad; but, naturally, one or two little improvements suggested themselves to my mind as soon as I began to handle the controls."

"I know," I agreed. "These things do happen."

"You see, I didn't quite like the arrangement of the tuning-condensers, so I took them out and made fresh holes for mounting them in different places. That necessitated certain alterations in the placing of the switches, and so on, so I have had a

busy afternoon with the hand-drill, as you will observe. And, as a matter of fact, your  $\frac{3}{8}$ -in. drill broke some little time ago, so that I had to get Gladys Emily to heat me up a poker with which to make the remaining necessary holes. There are rather a lot of them, because I had to try about half a dozen positions for each component before I was satisfied."

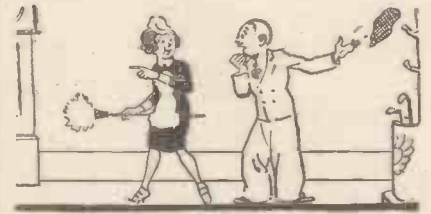

*"The professor's 'ere," she said.*

"The panel looks rather like a bit of lace," I quavered.

"All to the good," cried the professor. "The apertures will provide ventilation to keep the valves cool. I have made a few other little alterations, too, as you will see. I didn't quite like the high-frequency circuit, so I changed it. And then the rectifier didn't seem quite right, so I had a go at that. The reaction control has been modified and I have introduced different types of low-frequency coupling. Otherwise the set is, of course, exactly as it stood."

### The End of the Story

Next morning I spent another shilling in getting young Edward Buggsnip and his pal to pack up the "Kestrel" again and send it off. Then I ate four penholders one after another in the throes of composing a letter to Mr. Parris.

"I am so sorry," I wrote at last. "The tests were going on splendidly and I had almost completed them when the 'Kestrel' was struck by lightning. You can see the marks of the burns on the panel!"

Since then I have heard no word from Mr. Parris and can only hope that the shock experienced by the return of the "Kestrel" had not proved too much for him. Anyway, I do not expect he will ask me to carry out any further tests—not with the same set at any rate, if with any other.

It's amazing how some people cannot leave other people's sets and accessories alone just because they happen to come across the aforesaid gadgets during their owner's absence. Some people have no idea of propriety.



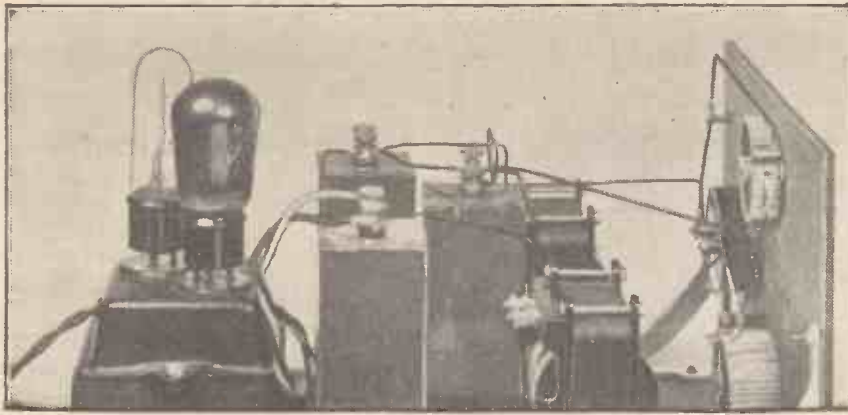

# BIAS WITHOUT BATTERIES

From a Correspondent

*If you have mains, you need not use grid-bias batteries, for bias may be obtained from an H.T. mains unit.*

PROBABLY only few radio amateurs are aware of the fact that it is possible to obtain adequate grid bias for their receiving sets without the use of separate grid-bias batteries, or using part of their high-tension batteries for this purpose, as suggested for instance by the designers of certain H.T. batteries.

Although the method described in this article may be successfully used when high-tension is supplied by batteries or accumulators, its

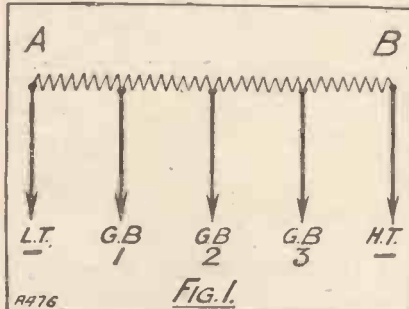

advantages are becoming very marked in the case of high-tension supply from the mains by means of a H.T. unit. Think of adding to the reliability of an unaltering supply of high-tension from a H.T. unit the benefit of a steady grid bias of the exact required value for the particular valves in use.

There will be no trouble of adjusting from time to time the bias from a steadily declining battery, and no expenses, however small, for renewing same at more or less regular intervals, and no more adjusting of the plate tension with regard to the wearing out of the grid-bias battery, in short, no wearing out.

### In Practical Form

As a matter of fact, the small unit which I will describe at the end of this article is supplying an exactly adjusted grid bias to different audio-frequency valves I have used in a

five-valve neutralised receiver with 4-volt accumulator for filament current and A.C. H.T. unit for plate current. The result is a very pure, steady and strong reproduction of programmes from any output valves of the power type that have been tried in this receiver, 4-volt valves being used throughout.

Let me make, first, some theoretical remarks.

I pointed out that the full value of this method will be appreciated when the G.B. unit is used in conjunction with a H.T. unit drawing current from the mains. This lies in the fact that the bias to be obtained is not drawn from the air, but from the H.T. supply. Now, in the case of a battery this bias has to be supplied by this very battery, with its limited maximum voltage, and paid for in pounds sterling, or shillings and pence.

### Advantage of a Unit

On the other hand, a properly designed mains unit has always some reserve of power which it preserves during its whole life, and it does not matter a pinch for our pockets whether we use it or not, whereas an ordinary H.T. battery, whenever it possesses such a reserve in the beginning of its life, is losing it quickly as its first youth is passing, and symptoms of senility are becoming marked after a couple of months.

To apply the method the receiver must be connected to the current supplies in such a manner that there are no connections between H.T. and L.T. Therefore, the connections in most receivers between H.T. negative and L.T. positive or negative must be eliminated altogether. G.B. positive connections are not used. Furthermore, I prefer L.T. negative connected to earth whenever possible.

Now, for any valve to act at the correct point of its characteristic for obtaining the full amplification

aimed at we must apply to its grid a certain negative potential with regard to the filament. If no resistors are used, or if they are connected in the positive filament lead, the filament can be considered as at zero or earth potential, which is the same as the negative filament lead. But if a resistor or rheostat is placed in the negative filament lead, the filament itself will be less negative than the accumulator negative lead—which is the same as the earth connection—and a small bias depending on the value of the resistance in circuit can be applied to the grid by connecting it to this negative accumulator lead.

### Resistor Connections

The value of this bias is, however, too small to obtain the best results in an audio-frequency amplifier, although it may be quite sufficient in the H.F. part of a set if suitable valves are used with a medium H.T. voltage to the plates. However, it

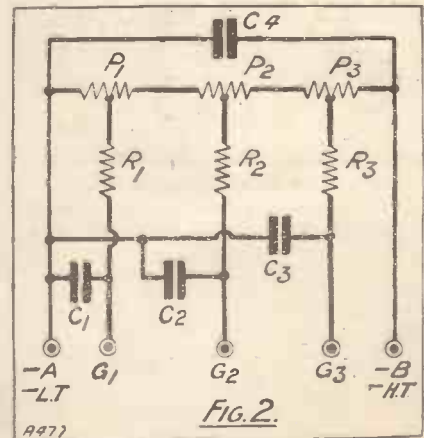

will be clear that this does not matter in this respect very much if the resistors are connected in the plus or the minus leads or if they are omitted. In the second case only a very slight voltage is added to the

## Bias Without Batteries—continued

negative voltage, which we can obtain for bias purposes in the following manner:

If we connect L.T. negative, which is the same as earth potential, through a resistance to H.T. negative, as in Fig. 1, we may consider connection A as at zero potential and connection B at full negative potential, while the intermediate tapplings at  $G_1$ ,  $G_2$ , etc., are at intermediate values of negative potential. This negative potential bears a certain proportion to the plate current flowing, that is to say, to the milliamps your receiver is consuming, in conjunction with the value of the resistance in series.

For instance, if your receiver is consuming 10 milliamps we can obtain at B a negative potential of 20 volts if we use a resistance of 2,000 ohms. At a tapping just in the middle we find a potential of 10 volts, or at every third part of the resistance 6.7 and 13.3 volts negative, provided that no current is flowing through these tapplings.

### Calculating the Bias

This is just all we want, because in a well-devised and adjusted set no grid current is flowing. If we take a potentiometer of the same value as the resistance in the former case we can slide its revolving contact arm to every point of the resistance and obtain potentials of any value between zero and full negative.

To calculate the negative voltage when H.T. current and resistance are known factors we must multiply the resistance in ohms by current consumption in milliamps and divide by 1,000 to find the negative voltage in volts. When the current consumption and the voltage to be obtained are given, we can find the value of the resistance in ohms by dividing the voltage by the milliamps consumed by the set and multiplying by 1,000.

### A Ready Reckoner

For the benefit of the reader, and being anxious not to trouble him any more than strictly necessary with formulae and theory, I have prepared a table of different values of H.T. consumption in milliamps and maximum negative potential when putting resistances of 1,000 or 2,000 ohms in series as suggested.

Plate current	1,000 ohms	2,000 ohms
10 milliamps	10 volt	20 volt
12 "	12 "	24 "
16 "	16 "	32 "
20 "	20 "	40 "
25 "	25 "	50 "
etc.	etc.	etc.

I might remind you that the plate current consumption of your set may be measured by connecting a milli-ampere meter in series with the negative H.T. lead, or else you can calculate it approximately from the number and types of valves you are using in your receiver.

### Usual Values

If you reckon from 1 to 3 milliamps for your H.F. valves, about 1 milliamp for the detector, 3 to 7 for the first audio-frequency amplification valve, and from 8 to 13 for your output valve, you will see that for an ordinary receiver for home use 25 milliamps is about the highest value which may occur, and that in most cases a consumption of about 15 milliamps is a reasonable average, while 10 milliamps will be about the minimum in any modern set for loud-speaker work which we might take into consideration.

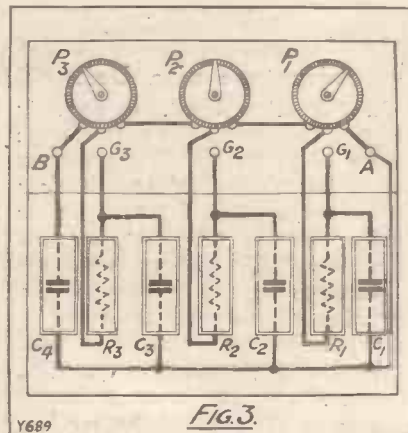

If we are now going to construct a grid-bias unit on the foregoing lines, there is another point we must take into account. This is the unwanted couplings across the resistance akin to "battery couplings." I would suggest combating these unwanted couplings with the two weapons at our disposal, the first being a shunting condenser between each tapping and earth, and the second a series resistance in each tapping.

As I pointed out that there will

be no current consumption by the grids, and no current will flow in the tapplings, and for this reason such a series resistance has no influence whatsoever on the value of the different negative potentials in the grid leads.

### A Compact Unit

The object I had in mind when constructing my grid-bias unit was to obtain an instrument capable of providing bias of different values not only for the receiver I am using at the present (consuming about 15 milliamps), but also applicable for higher anode current consumption as well as for lower values, and giving values of grid bias for different types of valves. At the same time, I wanted to introduce the necessary shunting condensers and resistances to avoid any unwanted couplings.

Fig. 2 gives the theoretical diagram of the unit. A is connected to accumulator negative, B to the H.T. mains unit negative; both are shunted by a 4-mfd. Mansbridge condenser.  $P_1$ ,  $P_2$ , and  $P_3$  are three potentiometers of 700 ohms each, giving in series a total value of 2,100 ohms. The sliders of same are connected through 100,000-ohm series resistances to the sockets  $G_1$ ,  $G_2$ , and  $G_3$ , giving three tapplings over the whole range of the bias obtainable.

Each tapping is shunted by a 2-mfd. shunting condenser of the Mansbridge type. It is, of course, a necessity to use components of high quality throughout to obtain first-rate results. As a matter of fact, my unit has a rather international character, as I used Pilot potentiometers (American), T.C.C. condensers (British), and Loewe resistances (German), and these nationalities seem to agree quite wonderfully!

### A Flexible Arrangement

Fig. 3 gives a sketch of the layout. An ebonite panel is used for mounting the potentiometers and sockets, while the resistances and condensers are screwed down on an ordinary plywood baseboard. The dimensions of the cabinet can be kept quite small. The connections are made with Glazite, carefully soldered with resin to obtain dependable soldering connections. The outside connections are made with "banana plugs" to the different flex leads.



## Bias Without Batteries—continued

The foregoing unit provides for the following values of G.B. at different plate current consumption:

Plate current in milliamps.	Grid Bias in volts.		
	G <sub>1</sub>	G <sub>2</sub>	G <sub>3</sub>
10	0-7	7-14	14-21
15	0-10½	10½-21	21-31½
20	0-14	14-28	28-42
etc.	etc.	etc.	etc.

You will see that this gives a very flexible arrangement with ample reserve of possibilities whenever valve makers will provide us with valves taking a higher grid swing for our output valves. It can be used with such super-power output valves as well as with valves wanting only a very low value of bias.

Whether your set consumes 10 milliamps or less, or over 25 milliamps, the unit can supply three or even four different values of grid bias, the fourth tapping being made through an extra resistance of 100 ohms from socket B. This is sufficient for any set for ordinary home use.

In my receiving set the necessary grid voltages for the audio-frequency stages are about 5 volts from tapping G<sub>1</sub> and 24 volts from tapping G<sub>3</sub>, the anode current being approximately 15 milliamps. The results are as I indicated a revelation, and when once properly adjusted quite steady. When I turn the filament current and the mains unit on the reproduction is invariably of a supreme quality at the full strength of any transmission of the broadcast stations.

### Scope for Experiment

I might remark that you can obtain the grid bias for the high-frequency valves inside the receiver in almost the same manner. The filament resistors of these valves are connected in the negative filament leads and the grids through a 1-megohm leak with the negative accumulator lead. In this way a potential fall of nearly 1 volt is available for grid bias, a sufficient value for the ordinary types of H.F. valves when the plate potential is adjusted to 60-100 volts in most cases.

There is, however, no objection in splitting up the P<sub>1</sub> potentiometer into two potentiometers, say of 200 and 500 ohms each, and adding another tapping for the H.F. or anode-bend detector grid bias on the 200-ohm potentiometer. Of course, I advise the intro-

duction of an extra resistance and shunting condenser.

No doubt the method leaves full scope for experimenting to the constructor who wishes to adopt it specially for his own receiver, to build it into his set, to simplify it for the case in hand and to try different values of resistance and condensers, but I strongly advise not to reduce the values of the shunting condensers and tapping resistances. This would, I think, tend to affect the proper working and the quality of reproduction. The method can safely be used in mainsfed A.C. receivers, too.

### IF YOU PLACE AN ORDER FOR POPULAR WIRELESS

you will be kept in touch  
with radio development by  
**Britain's Best Radio Weekly.**  
Every Thursday      Threepence

For fine adjustment I advise to tune your set to a strong transmission on the verge of overloading the output stages. Strong passages will then be distorted just a little and your ear will

guide you for obtaining the very best results.

It is not advisable to control volume by switching of one or more valves as this will reduce the anode current consumption and the G.B. unit will have to be adjusted every time accordingly. It is much better to control volume by varying the input in the set or by reducing the filament voltage of the H.F. stages and leaving the set itself properly balanced.

### A Word of Warning

Finally I must warn you against changing the plugs in the sockets when the receiver is on. This will cause heavy surges in your H.T. unit, the transformers, condensers, and the valves, and may spoil them or impair the emission of the valves. Always disconnect the mains first, alter the tapping afterwards, and then reconnect the mains. I likewise should like to point out that it is advisable to move the potentiometers slowly and to avoid as much as possible too low a value of grid bias.

Once properly adjusted, leave the potentiometers alone. Only when putting other valves into your set a new adjustment may be necessary.

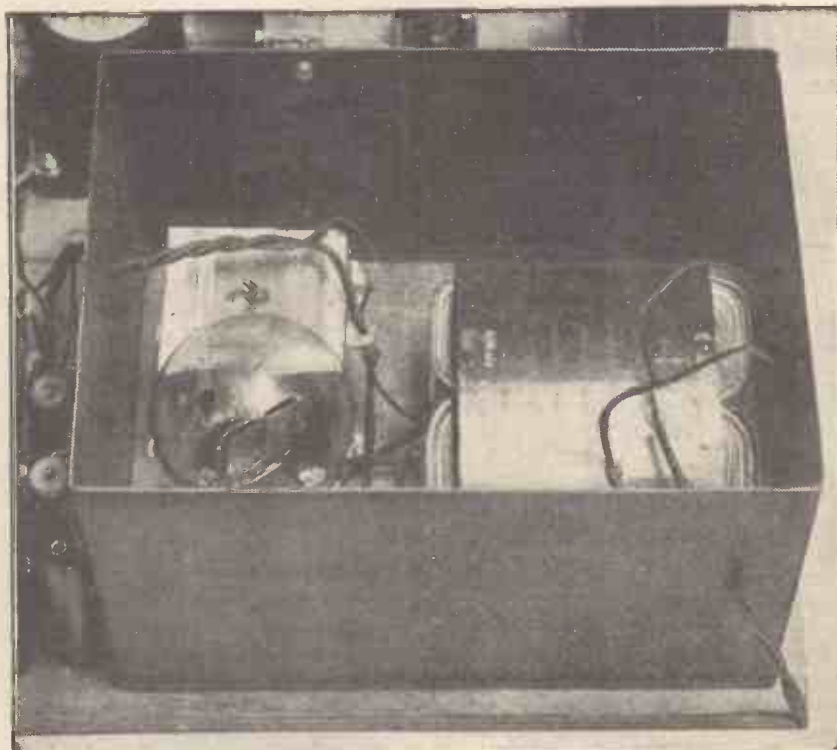

Whether you use A.C. or D.C. for H.T. supply, an adaption can be made to provide grid bias as well as H.T., no matter how large the set.



# VALVES THAT "RING"

This eminently practical article tells you how to deal with microphonic detector valves.

By R. W. HALLOWS, M.A.

THE detector is the most important part of any receiving set, since without it signals cannot be made audible. The best rectifier that we know at present is the three- or four-electrode valve, for this combines with great sensitiveness a measure of amplification, besides possessing one other very important advantage.

When a crystal rectifier is used, current from the aerial-earth system actually passes through it. At five or six miles from a broadcasting station this current may amount to 100 micro-amperes, or even more, and at the extreme range at which crystal reception is possible it still runs to something quite considerable.

### A Cause of Inselectivity

The fact that current passes through the rectifier means that the aerial (or the plate circuit of a preceding valve,

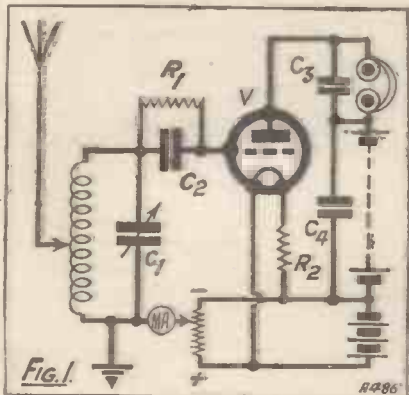

if a high-frequency amplifier is used) is placed under a pretty heavy load, with the result that damping is introduced. It is for this reason that the tuning of crystal and many valve-crystal sets is apt to be rather flat.

When we use the valve as detector we can do so in two quite different ways; we may employ either the grid leak and condenser, or the anode-bend system. The former is extraordinarily sensitive, and if reaction is used it allows a very considerable amount of amplification to be obtained. Here again, though, we are bothered by the fact that a flow of current takes place.

The leaky-grid-condenser detector depends for its working upon a small flow of grid current. We often hear the term "grid current" used, and I wonder just how many readers could say offhand exactly what it means!

Suppose we take a circuit like that seen in Fig. 1, which is that of one of the simplest kinds of single-valver. Between the low-tension busbars a potentiometer is wired, and the slider of this is connected to one contact of a micro-ammeter, whose other contact is taken to the lower end of the grid coil. It will be found that as the slider of the potentiometer is moved over towards the positive end a greater and greater flow of current is registered.

### Grid-Leak Rectification

What actually happens is this. Electrons flung out by the filament speed at very high velocity towards the positively charged plate. Some of them, however, are caught by the meshes of the grid and return to the positive terminal of the filament battery by way of the grid leak and (if the leak is in parallel with the grid condenser) of the grid coil. The more positive the grid is made the greater is the proportion of electrons that it catches, and therefore the larger is the flow of grid current. In the average receiving set using grid leak and condenser rectification the grid is set at a comparatively high positive

potential, and the flow of grid current is therefore fairly heavy.

It should be pointed out, though, that supposing that we use a 6-volt valve and arrange the circuit as shown in Fig. 2, the grid is not 6 volts positive with respect to the negative end of the filament. There are two resistances in series, the grid leak and the grid filament resistance of the valve. There is a potential drop across the former; hence the grid potential of the valve is something less than 6 volts positive. Actually it varies considerably, for if the grid receives a positive charge from an incoming half-wave the filament-grid resistance is lowered, and therefore the D.C. potential drop across the grid leak is raised; in other words, the direct current positive bias is reduced.

### Counteracting Damping

The presence of the current in the grid circuit of the rectifying valve leads inevitably to a certain flattening

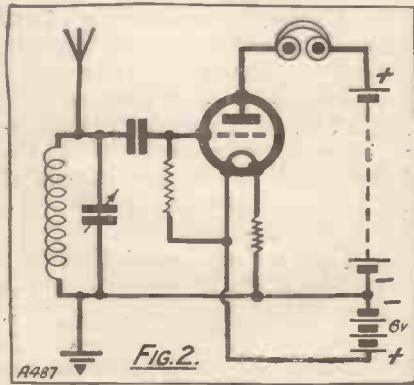

of the tuning through the damping that it introduces.

This may, however, be counteracted to a very large extent by the use of reaction. In a multi-valve set, though, the condenser tuning the grid of a rectifying valve working on this system will never read quite the same as those operating other tuned circuits. Further, the valve may become exceedingly microphonic if so much reaction is used that it is only just below the oscillating point.

The effects of grid current may be avoided and the tuning greatly sharpened if instead of the leaky-grid-condenser method we make use of the



# SILENT POWERED

**FROM BIG CELLS**



**MADE IN ENGLAND**

**PRICES :**

60-volt (reads 66) .. .. .	7/11
100-volt (reads 108) .. .. .	12/11
36-volt .. .. .	4/6
60 (super power) .. .. .	13/6
9 volt Grid Bias .. .. .	1/6
4½ volt Pocket Battery (4/6 a doz.)	each 5d.
Single Cell Torch Battery .. .. .	4½d.

The power of a Lissen Battery flows steadily, smoothly. The big cells are packed with energy. The secret process keeps it pure and sustained. The quality lasts throughout the longest programme—there is never a sign of ripple in the current, never a trace of hum.

Hear how well your own loudspeaker will reproduce a heavy orchestral item when you have the power of a Lissen Secret Process Battery flowing through your set—test it on opera, vaudeville, speech, song or sports event. Hear how natural and true everything sounds.

*Obtainable at every good radio dealer's—ask for Lissen New Process Battery and be sure to take no other.*

**LISSEN LIMITED, 26-30, Friars Lane, Richmond, Surrey.**

*Managing Director : THOS. N. COLE.*



## Valves That "Ring"—continued

anode bend. Here the grid is set at a negative potential sufficient to bring the working point to the top of the lower bend in the grid volts-plate current characteristic. The negative bias prevents any flow of grid current from taking place, and no damping from this cause is introduced.

Unhappily the anode-bend rectifier is little more sensitive to weak signals than the crystal. It is therefore of no great use in the single-valve set, though it is exceedingly good in the multi-valver provided with high-frequency amplification.

For long-range work the grid leak and condenser rectifier is very widely used owing to its sensitiveness, and for short-wave reception, where high-frequency amplification is seldom employed, it holds the field unchallenged. Whether the leaky-grid or the anode-bend system is in use it will nearly always be found that the rectifier is the most microphonic valve in the set.

### A "Conversion" Valve

Tap the others and there is little response in the telephones or the loud speaker, but give the bulb of the

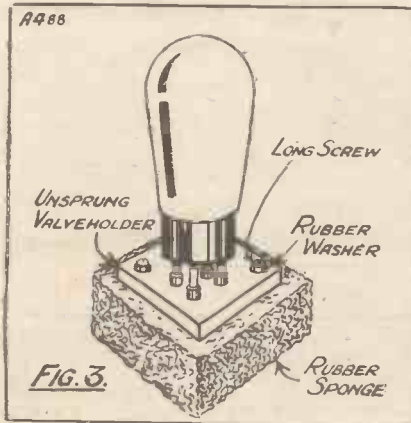

rectifier the lightest touch and a ponging noise is heard at once. Other valves may pong if they are oscillating, but the rectifier will give a certain unwelcome response to vibration even if the reaction coupling is loosened to the utmost.

It must be remembered that the rectifier performs a duty quite different from that of any other valve in the set. It is a conversion valve. The grids of high-frequency amplifiers receive impulses at high-frequency, and their plates pass on

similar impulses in magnified form. So with the note-magnifiers; they receive and deliver impulses at audio-frequency. The rectifier has an input to its grid of radio-frequency impulses and an output from its plate at audio-frequency.

It has, therefore, a three-fold function to perform: it rectifies, it amplifies, and it converts. Its very functions make it peculiarly liable to respond to the slightest variation in the relative positions of its electrodes.

### When the Filament Vibrates

When the bulb of a valve is tapped it vibrates just as does any other hollow glass vessel. The vibrations are conveyed from the bulb to the "foot"—the stem which supports the electrodes—and from this to the electrodes themselves. Both grid and plate are made of comparatively stout metal, and their inertia prevents them from responding to any but very violent vibrations.

The filament, though, is exceedingly light. It consists in the dull-emitter valve of a piece of very fine, specially treated wire suspended under a certain amount of tension between supports. When the bulb is tapped, the filament is set vibrating at its natural frequency. This means that it moves now closer to the grid, now farther away from it. In a word, when the filament is vibrating the characteristics of the valve are continually altering.

As it approaches the grid the latter exercises greater control over the electron stream; as it recedes the control is lessened. The result is that there is a periodic change in the valve characteristics, and if the grid has, as is usually the case, a natural frequency within the audible range, a ponging noise is heard.

### "Ghosts From the Past"

Owing to its heavier filament the bright valve is much less microphonic than the dull emitter. At first sight, therefore, it might seem that those who are bothered by microphonic troubles could find an instant solution of the difficulty by substituting a B.E. rectifier for an existing D.E. valve. Unfortunately it is not quite the case. All of the bright valves generally available are, so to speak, ghosts from the past. If, therefore, you replace a dull-emitter rectifier

with a bright valve, you will find that though you are no longer troubled by microphonic noises, signal strength is very much reduced.

This is especially noticeable on the short waves, where the microphonic nuisance is at its worst. Any short-wave enthusiast may readily test out the truth of this statement for himself. Let him tune-in, say, 2 X A D



with his present dull-emitter rectifier and then put in the holder a bright-filament general-purpose valve. He will find the tuning slightly different, and once he has picked up the station again he will be astonished to discover how great is the diminution in its strength.

### "Inherently Microphonic"

The only thing to do is to realise that, with a very few exceptions, the highly efficient dull emitter of to-day is inherently microphonic, and to take all possible measures to prevent vibrations from being set up in its bulb. In the first place select for your rectifier the least microphonic of the dull emitters of suitable characteristics that you possess. If three or four valves of the same class are tried out, it will often be found that one of them is much less noisy than the others.

This, however, is not to say that it will always continue to be so; valves that are not particularly microphonic when new are apt to become more and more so with use, since the tension of the filament may alter slightly. It pays, therefore, to change the rectifying valve from time to time, testing out the valves in one's stock as before and selecting

(Continued on page 238.)



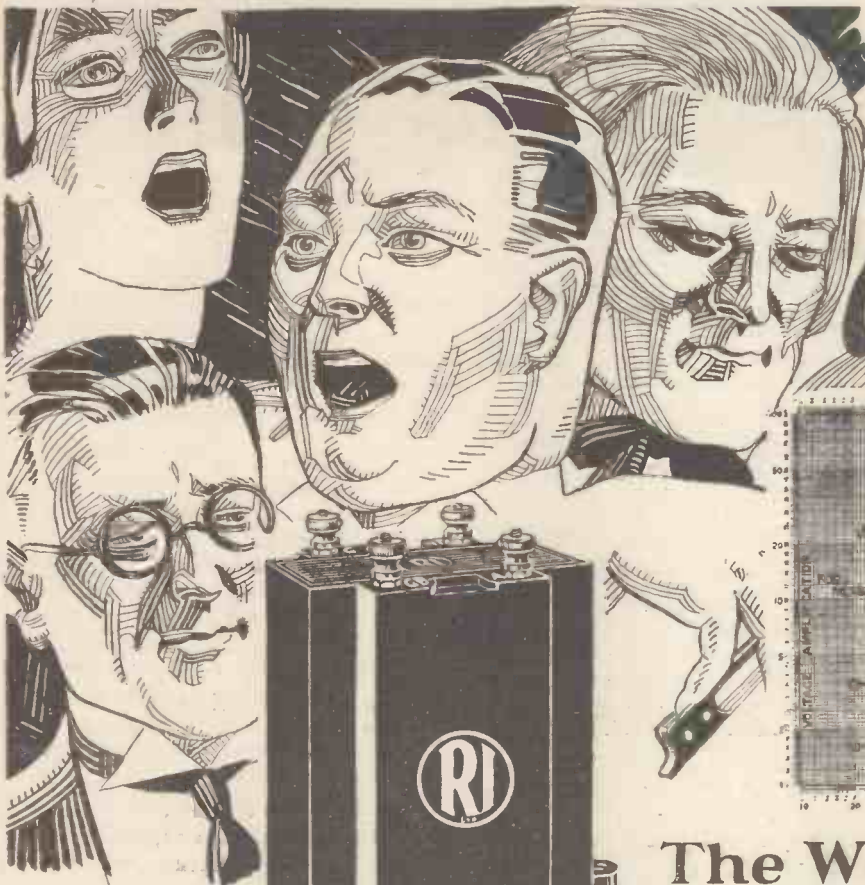

*True  
Correlation*

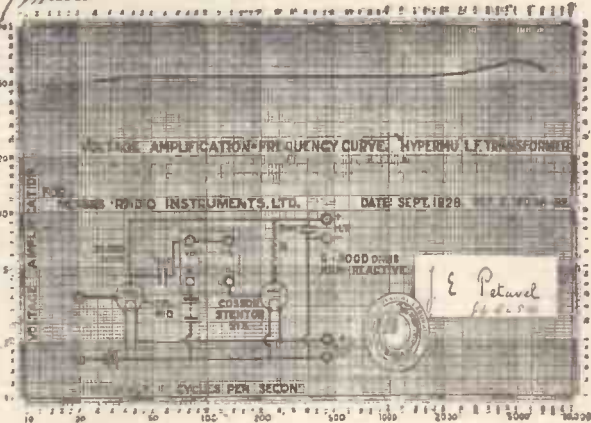

THE  
CURVE  
PERFECT  
**HYPERMU**  
L.F. TRANSFORMER

**The World's Greatest  
Triumph in Radio  
Science and Research**

The amazingly enormous and uniform amplification of the "Hypermu" is proved by the N.P.L. curve above, which shows that the voltage amplification at 25 cycles reaches the colossal figure of 50, which is maintained well up to 6,000 cycles where a slight rise occurs which assists the retention of sideband frequencies. MANUFACTURERS ARE FITTING THE "HYPERMU" IN THEIR SETS, which is highly significant of its superiority; also it has won the approbation of the wireless technical expert contributors who, having tested it, have praised it in the Wireless press.

The world's experts have declared the "Hypermu" to be the greatest advance in Modern Radio Amplification of music and speech—a tribute to the golden record of 28 years' Radio practice that is behind every R.I. production.

**R.I. SCIENTISTS HAVE WORKED  
IN CONJUNCTION WITH THE  
SINGER, MUSICIAN & ELOCUTIONIST**

and have for ever banished the outstanding defect of many modern receivers, gramophone and talking picture outfits, which now by the inclusion of the "Hypermu" give

**PERFECT REPRODUCTION OF THE  
CONSONANTS AND SIBILANTS.**

That exasperating suppression of consonants and sibilants in speech and song, or of the high or low frequencies, or both, in music, need no longer be tolerated.

**PERFECT RECEPTION IN THE HOME**

All wireless enthusiasts or listeners can enjoy the perfect results of laboratory reproduction by fitting the "Hypermu" in their sets. Write for the "Hypermu" leaflet to-day.



"Hypermu," is the first metal-screened transformer encased in Bakelite. It is unique in size, being only 3" x 1½" x 1½" and weighing only 14 ozs. Ask your dealer to **21/-** show you one.

**RADIO INSTRUMENTS LTD., SPECIALISTS IN SOUND REPRODUCTION**  
Sole Address: Offices, Showrooms and Works, 12, HYDE STREET, LONDON, W.C.1

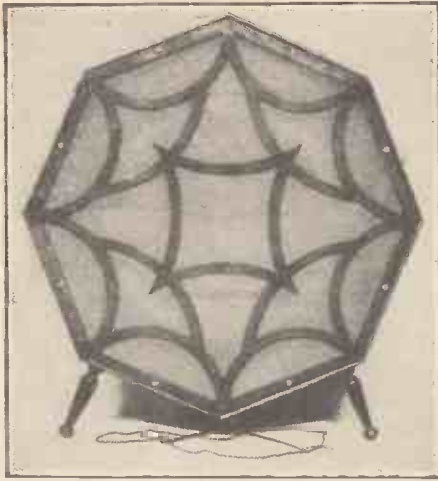

# MOVING-COIL SPEAKERS

*A chat about their power capabilities.*

By L. E. T. BRANCH, B.Sc.

WHEN the moving-coil loud speaker first became prominent in the world of the wireless amateur, it had the reputation of being insensitive. This was certainly a very serious drawback because it meant that in order to get adequate volume of sound it was necessary to use much more powerful valves with much higher high-tension current and larger filament currents also.

The net result was that the would-be user of a moving-coil loud speaker deterred from purchasing or making one chiefly on account of the serious increases in upkeep cost which would ensue in endeavouring to get reasonable power.

Since that time many investigators have studied in a very exhaustive manner the reasons for the insensitivity of moving-coil loud speakers, and, as a result of their labours, it has been shown that it is quite easy to make a moving-coil loud speaker which will give even more power for the same input from the set than a good sensitive speaker of the ordinary cone type.

## A Peculiar Phenomenon

In speaking of sensitivity and volume it is necessary to explain what appears at first sight to be a rather peculiar phenomenon that arises when comparing the capabilities of a moving-coil loud speaker with one employing the usual reed and cone or diaphragm and horn.

Imagine we have plugs on the leads of an ordinary cone-type loud speaker and on the leads of a good moving-coil speaker, so that each can be plugged instantly into the receiving set for making comparative tests.

Now if the set is adjusted to give only a very small volume output, that is to say, it is decidedly on the quiet side, and we plug the two speakers,

one after the other, into the set, it will be noticed that the moving coil is not as loud as the other.

On the other hand, by adjusting the set so as to give good, full, realistic volume, and then making a similar comparison, it will now be found that the moving coil is the louder of the two. In other words, if a comparison test is carried out between two speakers on a weak set, it is also necessary to make a similar comparison on a more powerful set if the test is to be a valuable one from a practical point of view.

## What Really Happens

Now, a few words as to the reasons for this apparent anomaly. The reed in the ordinary cone speaker—and the same will apply to the diaphragm in the horn-type—is a fairly rigid piece of metal which cannot move as a whole, but being sufficiently elastic or springy, although it is fastened down at one or both ends, can respond to the magnetic vibrations. Consider,

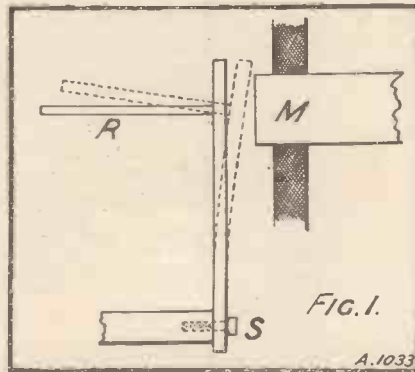

for example, the diagrammatic illustrations of a reed shown in Fig. 1.

This reed is shown edgewise-on and is imagined to be anchored rigidly at S by a screw securing it to the frame of the instrument. R is the rod on to which the cone is fastened, and M represents the magnet. Now, as the magnet increases in strength under the influence of the current

passing through the coil round it, the reed is attracted and strained over into a position shown in an exaggerated form by the dotted lines.

Now, everyone knows from his own experience that the farther the reed is pulled over the greater will be the power required to pull it still a little farther. Anyone can easily test this for themselves by screwing one end of a strip of heavy spring steel down on to the edge of a bench, and then, by gently pressing on the overlapping end, it will be seen to move, say,  $\frac{1}{8}$  in., while to move it another  $\frac{1}{8}$  in., and then another, and so on, requires disproportionately much greater pressure.

It will now be appreciated that in order to double the power given out by a reed-type loud speaker, which, of course, depends for its operation upon the bending backwards and forwards at a terrific rate of the reed, it is necessary that more than double the power be put into the speaker by the set.

Similarly, if the power delivered by the set to the speaker is increased, say, tenfold, the volume given out by the speaker will not be increased anything like to the same extent.

## M.C. Speaker Different

Now, in the case of the moving-coil loud speaker, quite different conditions exist.

The coil to which the cone is attached is only very loosely held; so loose, in fact, that usually a good puff of air, blown with the mouth on to the cone, will move it  $\frac{1}{16}$  in. or more; such a thing being quite impossible in the case of the reed instrument. As the whole coil and cone is suspended so comparatively lightly and can move with such great freedom, the peculiarities which arose when putting increased power into the speaker do not arise as they did in the case of the reed instrument. In other words, for differences of power input, the moving-coil speaker responds in proper



**Magnetic Power!**

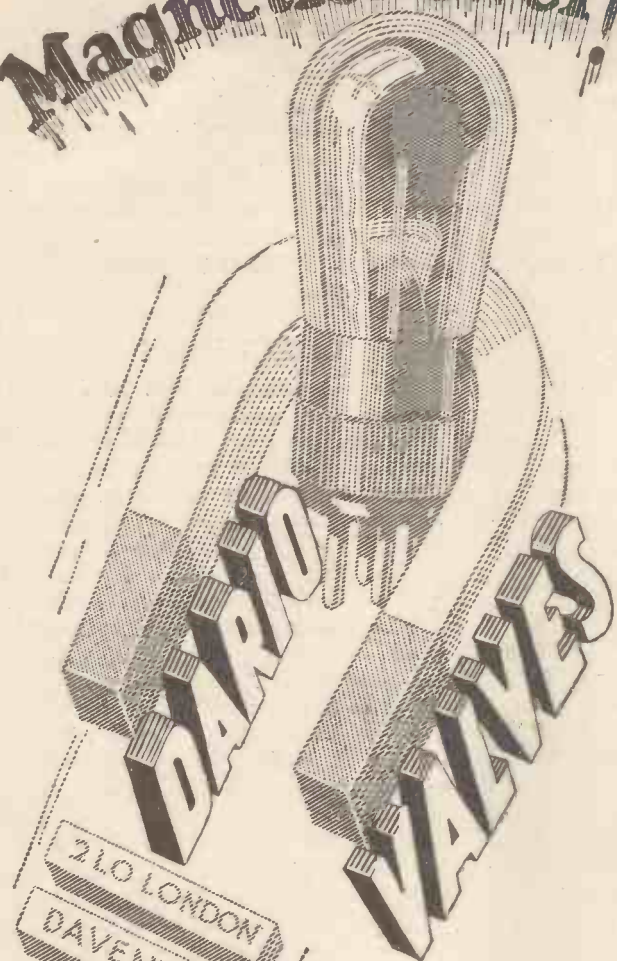

**Magnetic Dario Valves.** Stations you heard faintly, now heard at full loud speaker strength. No radio enthusiast should be without Dario.

Dario prices are little short of marvellous. They are due to one of the biggest and most modern Valve outputs in the world.

**5/6**

**TWO VOLTS**

General Purpose,	
'05 amp. . . . .	5/8
R.C.C., '06 amp. . . .	5/8
Super Power, '18 amp.	7/8
Super H.F. & R.C.C.,	7/8
'18 amp. . . . .	7/8
Pentodion, '3 amp.	21/-

**WRITE FOR DARIO FOLDER!**

**7/6**

**FOUR VOLTS**

General Purpose,	
'05 amp. . . . .	5/8
R.C.C., '07 amp. . . .	5/8
Super-Power, '1 amp.	7/8
Super H.F. & R.C.C.,	7/8
'1 amp. . . . .	7/8
Pentodion, '15 amp.	21/-

From your dealer or direct:

- 2LO LONDON
- DAVENTRY
- RADIO PARIS
- BARCELONA
- BERLIN
- BUDAPEST
- MILAN
- AMERICA
- MELBOURNE

**IMPEX ELECTRICAL LTD.,**

DEPT. L, 538, HIGH RD., LEYTONSTONE, LONDON, E.11

# IGRANIC



## SMALL BUT MIGHTY

Igranich proved that bulk was not essential to purity and amplification in an L.F. Transformer. Others followed but the Igranich "J" Type still stands supreme as the small low-priced transformer with the long, straight curve.

For your portable, where space is restricted and weight must be kept down, use the Igranich "J" Type Transformer. Use it in your domestic receiver, too, and enjoy truly magnificent magnification. Ratios of 3-1 and 6-1. Price 17/6 each.



Igranich Q.M.B. Switch. Solid construction, certain action. Price 2/6



Igranich H.F. Choke. Small in size, high in efficiency. Price 5/-

If your dealer cannot supply you, please write direct to Dept. J893.



Works BEDFORD

## Moving-Coil Speakers—continued

proportion, and therein lies one of its greatest attributes.

There is still one other important fact that is nearly always overlooked, or, at least, is not sufficiently appreciated. I am now referring to the illusion of volume. Let me explain a little more clearly.

Imagine yourself near a military band and thoroughly enjoying the music. As long as the band continues to play in the customary manner you sit listening in comfort—aural comfort, I mean. But suppose all the drums, bassoons and other low-toned instruments were suddenly to cease playing, while all the high-toned instruments continued on.

Although there would now be actually less volume of sound coming

to the situation. Irritating music has been mistaken for loud music. Now, if we imagine that the band, still lacking in the low-toned instruments, were to start playing quite quietly, we should then get the impression that they had receded to some little distance, and should, no doubt, find the music quite pleasing.

The reader will doubtless have noticed that if he walks away from a full band playing in the open air, the low notes are the first ones to become inaudible.

Now, all this helps us to understand much about the moving-coil loud speaker, especially when comparing it with other types of speakers. The reed-driven or horn-type speaker, because of the stiffness of the reed or

Consequently, if operated at low volume it can be likened to the full band at a distance and, like the band, sounds pleasing under these conditions. But the same speaker, operated at fairly large volume, must be likened to the nearby band in which all the low-toned instruments have practically stopped.

### Badly Balanced

The net result is that at large volumes this speaker is very irritating and cannot be tolerated at all; moreover, it appears to sound very loud indeed, whereas we now know that this loudness is mostly an illusion arising entirely from the disproportionate balance of the low and high notes.

Now, granting the set is a reasonably good one, possessing well-designed transformers and other components, it will be delivering power for the low notes as well as for the high notes, so that by plugging on to it a good modern moving-coil loud speaker we now get all the high notes as before, but together with the low ones as well.

We can liken this state to that in which we were listening to the nearby full band which did not seem so loud as the band when devoid of low-toned instruments. Hence, although the moving-coil speaker may now be delivering actually greater overall volume, it will be more pleasing, and, in consequence, will sound less powerful.

### No Need for Insensitivity

Apart from what has been already stated, there is no doubt that the early forms of moving-coil loud speakers were very insensitive, but now it is so easy to make them at least as sensitive as their older brothers there is no excuse for not possessing one on the score of insensitivity. In a further issue I hope to discuss the various points which have to be observed when making a moving-coil loud speaker which is required to be of the highest possible sensitivity.

### A POPULAR NORWEGIAN BROADCASTER



This is the control-room of the Oslo station. Oslo uses the comparatively low power of 1 kw., but is frequently heard in this country even on simple sets.

from the band, you would almost certainly say that it had become louder. You would know that in actual fact there was now less sound and would, naturally, look for some explanation of this apparent anomaly. Now, if you continued for some little while to sit and listen to the band playing only with the high-toned instruments, your explanation would soon become a self-evident one.

You would find that the "music" would be very dissatisfying, and even very irritating. Here, then, is the key

diaphragm, and also because for equal loudness of low and high notes the cone or diaphragm would have to move much greater distances for lower notes, this speaker cannot respond properly to the low notes.\*

\*For equal sound intensity the cone or diaphragm would have to move very much greater amounts on the lower notes; in fact, the lower the note the more the cone must move. For this reason a loud speaker with a stiff reed cannot give much volume on a very low note. The cone of the moving-coil speaker, however, is so loosely suspended that it does not suffer this restraint.

Read  
**POPULAR WIRELESS**  
Britain's Best Radio Weekly.



# A GOOD SPEAKER DESERVES A GOOD AMPLIFIER.

TO APPRECIATE THE REAL MEANING OF  
 TRUE RADIO REPRODUCTION  
 EMPLOY  
 PUSH-PULL AMPLIFICATION

## FERRANTI

FERRANTI LTD.

HOLLINWOOD

LANCASHIRE

Essential for  
 best results  
 with a  
 Moving-Coil  
 Speaker.

List Wb412  
 tells you  
 all about it.

THE **100%** Broadcast  
 Receiver  
 BUILD and OPERATE in  
 ONE EVENING  
 FORMO  
 Screened Grid



BRITISH  
 Components Throughout  
 Send for Catalogue.

FAMOUS FORMO COMPONENTS as used in this  
 Set and in ALL NOTABLE PUBLISHED CIRCUITS

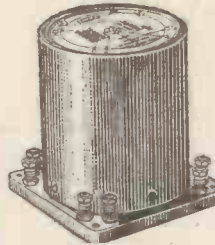

TRANSFORMER-OUTPUT  
 FILTER CHOKE 25/-

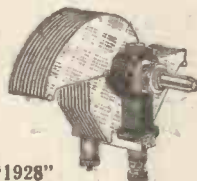

"1928"  
 LOG CONDENSER 5/-  
 '0005 '00035 '00025



COILS SG 1 & 2.  
 10/6 each



FORMO-DENSOR 2/-  
 In four variable capacities.

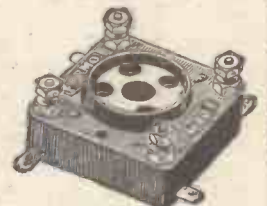

VALVE-HOLDER 1/3

THE FORMO CO., CROWN WORKS, CRICKLEWOOD LANE, LONDON, N.W.2.

## The New W.B. 5-PIN VALVE HOLDER For A.C. Valves

The most scientifically designed 5-Pin  
 Valve Holder on the market. Fitted with  
 patent expanding leg sockets suitable  
 either for resilient or solid valve legs.  
 Already this new W.B. Valve Holder is  
 in use in the laboratories of the leading  
 Valve Manufacturers in this country.

Ask your Dealer to show you one to-day.  
 Price 1/6

WHITELEY BONEHAM & CO., LTD.,  
 Nottingham Rd., Mansfield, Notts.

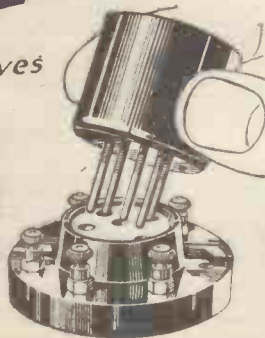

For 3, 4 or 5  
 Valves. Panel  
 14 x 6. Complete 45/-



for  
**RADIO-GRAMOPHONES,  
 PORTABLES  
 AND CASE-WORK OF  
 EVERY DESCRIPTION**

Send for Latest List to  
 CARRINGTON MFG. CO., LTD.,  
 CAMCO WORKS, SANDERSTEAD ROAD,  
 SOUTH CROYDON.  
 TELEPHONE: CROYDON 0823 (2 lines)

\*\*\*\*\*  
**OUR NEWS BULLETIN**  
 \*\*\*\*\*

*Some of the More Interesting Happenings  
 in the Radio World this Month.*

**Flying Squad Plans**

As a result of the visit of the Paris Prefect of Police, M. Jean Chiappe, and of Herr Zörgrebel, Chief of the Berlin Police, conferences with Lord Byng, our Chief Commissioner of Police at Scotland Yard, have been held with the idea of discussing plans for the creation of an International Flying Squad of police airplanes, which would bring the great police forces of Europe into closer touch with each other in times of emergency.

It is also understood that plans have been discussed for the utilisation of the latest developments in television and wireless picture transmission.

**Premier's Surprise Item**

A good deal of surprise seems to have been occasioned when Mr. Ramsay MacDonald broadcast a talk from 2 L O as a Surprise Item a few

weeks ago. The question has been asked whether the B.B.C. microphone may be utilised by the Government *ad lib*.

The fact is that Mr. MacDonald's talk was a result of the Postmaster-General approaching the B.B.C., and an official at Savoy Hill said that no general rule is laid down as to the method of dealing with an intimation by an individual Minister that he wished to make use of the microphone.

The official went on to say that it was impossible to discuss a hypothetical case of a Minister walking into a studio and insisting on broadcasting a message.

**An Important Clause**

It must be remembered that the B.B.C. works under a licence issued by the Government, and one of the conditions is that: "The Corporation shall, whenever so requested by any

department of His Majesty's Government, at the Corporation's own expense, send from all or any of the said stations any matter which such department may require to be broadcast."

So it looks as though, under this clause, Mr. Ramsay MacDonald and his colleagues may broadcast whenever they please.

**German Short-Wavers**

Our readers might like to be reminded that there are four excellent short-wave stations in Germany, and that altogether these four stations transmit at various times on thirteen different wave-lengths.

For instance: Dobreizt (A F K) uses the wave-lengths of: 175.6, 105, 67.6, 45.3, 43.1, 37.8 metres; Bergedorf (A F L) works on 75, 70, and 52 metres; Nauen (A G E) works on 56, 17.2, and 14.85 metres; Königswusterhausen (no call-sign) uses 75.3 metres.

Another station, Welt Rundfunktender, with a power of 20 kilowatts, is an experimental station, and the only one which transmits telephony exclusively. Listeners will shortly be able to hear its transmissions on wave-lengths between 15 and 50 metres.

(Continued on page 234.)



SAY  
 'T  
 C  
 C'

WHEN you think of Condensers, think of T.C.C.—and you won't go wrong. For, because T.C.C. have made nothing but Condensers for over 22 years, the letters T.C.C. on a Condenser are recognised throughout the World as the undisputed hall-mark of accuracy and dependability.

Remember, there is a T.C.C. Condenser for every purpose. Here is an illustration of the Electrolytic Type. All Wireless Dealers stock it—capacity, 2000 mfd. Price 15/-. Double Type: (capacity 4000 mfd.) Price 27/6

WHENEVER

YOU WANT

**CONDENSERS**



Are you making an All Mains Set?



Use the new  
**LOTUS**  
5-pin valve holder  
for A.C. valves

If you are building an All Mains set, this is the valve holder you need. It is rigid—not anti-microphonic; the stronger filament of an A.C. valve does not demand the anti-microphonic type. Made for 5-pin valves, it will also accept a 4-pin valve, and can be used for screened grids and pentodes with equal ease and success. You will find this new Lotus valve holder in every detail as well-constructed as the famous Lotus buoyancy type. It is only 1 1/8" in diameter and is available both with and without terminal nuts.

Price 1/5



And for other sets—the  
**LOTUS**  
Buoyancy Anti-Microphonic valve holder

This famous little valve holder is still supreme for ordinary valves. It is anti-microphonic, absorbs shock and protects the most delicate valve. Made in the very best of materials and most carefully constructed, it is only 1 1/8" in diameter, and for everyday use is the best valve holder you can buy.

Price 1/3

# LOTUS

## VALVE HOLDERS

Made by the makers of Lotus Components and sold by wireless dealers everywhere.

Garnett, Whiteley & Co., Ltd.,  
Lotus Works, Liverpool.

# Weston sets the world's standard



Model 528, Pocket Size  
A.C. Tester

A small and reliable instrument essential to maintain accuracy and efficiency in Voltage control. The sensitivity is remarkably high, 6 m.A. for 600 volts with self-contained resistance. The scale is very legible and the damping excellent. This instrument is capable of continuous service at full load.

Write for your copy of "Radio Control," which explains simply the electrical operation of a radio set. Sent free on receipt of a postcard, addressed to:—

Prices from  
£3.10.0 to £4.15.0

**WESTON**  
ELECTRICAL INSTRUMENT  
CO., LTD.,  
15, Great Saffron Hill, London, E.C.1

### HIGH-GRADE JACOBAN STYLE FIGURED OAK CABINET

Height 3 ft. Depth 1 ft. 4 ins.  
For Panels up to 21 ins. X 7 ins.  
Baseboards up to 11 ins.

£4.4.0

Carriage Paid.

Prices of other sizes in proportion. Manufacturer of all types of wireless cabinets and furniture of every description. Illustrated lists free.

**GILBERT,  
CABINET MAKER,  
SWINDON.**

Estimates Free.

Estd. 1866.



## NOW ON SALE

Full constructional details of  
**The "Radiano" Three**  
and

**The "Concert" Four**  
are obtainable in Envelope form in

**THE WIRELESS CONSTRUCTOR  
ENVELOPE SERIES, Price 1/6  
ON SALE EVERYWHERE**

By post, 1/6, from Wireless Constructor Envelopes, The Amalgamated Press, Ltd., Bear Alley, Farringdon St., London, E.C.4

**OUR NEWS BULLETIN**

—continued from page 232

**A Question of £ s. d.**

The B.B.C.'s decision to reduce Aberdeen to the status of a central relay station has alarmed Aberdeen traders, and there is talk of a petition being drawn up protesting strongly and urging the retention of the Aberdeen station as a main station. It is estimated that the loss in salaries and fees to performers will be between £10,000 and £12,000 annually, and it is urged that this is a fact which merits the serious consideration of the trading community of the city.

**"Journey's End"**

That well-known author, Mr. Henry Williamson, author of "Tarka the Otter," winner of the Hawthornden Prize for Literature in 1928, pointed out in the "Daily Mail" recently that about three months before the success of that great play, "Journey's End," he went to Savoy Hill and spent more than an hour trying to persuade many officials to consider the broadcasting, as a Surprise Item, of the last fifteen minutes before zero hour of one of the big attacks in the Great War.

**In the Firing Line**

He suggested that he was to be "the voice beyond time and space," moving from place to place describing what was happening in gun-pit and on tape-line, in first-aid post and aeroplane cockpit, inside a tank, outside a battalion headquarters, and so on. His idea also contained arrangements for an aural background,

If you want to  
**KEEP IN TOUCH**

With week-by-week radio developments, you must  
READ

**POPULAR WIRELESS**

"BRITAIN'S BEST."

All "P.W." Sets are guaranteed.

Price 3d. :: :: Every Thursday.

faithful to reality, of voices, sound of shells, crack of a sniper's rifle—all designed for the climax of zero.

**Shoulder Shrugging**

The result was that Mr. Williamson left Savoy Hill lopped and shorn of all enthusiasm. Shoulders were shrugged, the idea received in stagnation. Surely, he was told, the

public was sick of the war, and also the question of children listening to this particular item was brought up in dissuasion of his idea. Mr. Williamson tried to explain that it would not be a 1914 war correspondent's account, but a re-creation of reality.

\* \* \*

Eventually the B.B.C. officials promised to write to him about the matter; but they didn't. And then, as Mr. Williamson points out, after the obvious and established success of "Journey's End," the B.B.C. broadcast a scene from that play as a Surprise Item!

**News of Newcastle**

A lot of inquiries have been made lately as to what is going to happen to the Newcastle station. We are officially informed that it will eventually relay the bulk of its programmes from London when the Regional Scheme develops. However, Newcastle's transmitter will not be removed, and local programmes will also be broadcast from time to time. But as the activities of the station are gradually reduced, a smaller staff will undoubtedly be required.

(Continued on page 236.)

**The "MAGNAFILTER"**

BUILD THE  
1929  
**SUPER-QUALITY  
AMPLIFIER**

As described in this issue.  
Complete kit of parts  
**£7 10. 0.**

**A.C. MAINS UNIT**

As described in this issue.  
Complete set of parts  
**£6 6. 0.**

The above can be supplied ready wired and tested if required.

Catalogue and lists including particulars of the Magnafilter M All-Electric Reproducer free on application.



*Make your set super-selective to meet the new wavelength scheme.*

As a result of the regional scheme very few sets are capable of eliminating interference between 2 LO and 5 GB, separated only by 43 metres.

The "Magnafilter" solves this problem cheaply and efficiently and without alteration to your set. It is simply connected between the aerial and receiver, and when once adjusted needs no further attention. 2 LO and 5 GB can readily be tuned in without interference by merely turning the tuning dials of your receiver.

Careful design and workmanship have reduced the losses incidental to this type of wave filter to an absolute minimum, and it can therefore be utilised without affecting the general reception of other stations.

**PRICE** If unable to obtain from your local dealer a "Magnafilter" will be sent post free on 7 days' approval against cash.  
**12/6**

**BURNE-JONES & CO., LTD.,**

**"MAGNUM" HOUSE,**  
296, Borough High Street, LONDON, S.E.1

**NEW!**

*a The*  
**ROYAL-THORDARSON**  
**R.171 POWER**  
**COMPACT**



**PRICE**  
**56/6**

Here is an entirely new and revolutionary unit for the construction of H.T. mains supply eliminators or power push-pull A.C. amplifiers. The Royal-Thordarson R.171 Compact consists of a high voltage power supply transformer with 220/240 volt primary and 320 volt (no load) secondary. Also two 30-henry 85 m/a chokes and two 1-mfd. buffer condensers. In addition there is a 5-volt 1-amp. centre-tapped filament supply. The whole is contained in a beautifully finished crackle finish housing measuring only 3½" x 5½" x 6". This Compact is specified for use in the Harris A.C. Mains Supply Unit described in this issue.

**THE ROTHERMEL CORPORATION Ltd.**

24/26, Maddox St., London, W.1  
Phone: Mayfair 0578/9.

The 3rd edition of our "Great Voice" booklet tells you how to make an all-A.C. push-pull amplifier also a simple H.T. Eliminator from this Compact. Send 6d. to-day for a copy of this audio Manual.



THE  
**SECRET  
OUT**



Here is  
the Wonderful  
NEW

**Brown**  
"VEE" UNIT

HERE it is! A wonderful new loud speaker unit that sets an entirely new standard of Radio reproduction. Though it only costs 25/-, it will re-create the living artiste in your home as no other loud speaker unit has ever done. But then . . . it's made by Brown! See it at your dealer's soon



**PRICE 25/-**

(Chassis : 15/-).

**"AS BRITISH  
AS BRITANNIA"**

Advt. S. G. Brown, Ltd., Western Avenue, North Acton, W.3

9201

**PICK UP  
AMERICA!**

On the short waves you can pick up America—even on your one- or two-valve set.

But remember that short-wave success depends upon the coil—make it certain—  
fit

**LEWCO'S**  
REGD.  
SHORT-WAVE COILS

Reduction in Price  
of

**GLAZITE**  
MULTI-PHASE MADE RECP.

Old Price :  
10d. per 10 ft. coil.

New Price :  
8d. per 10 ft. coil.



Lewcos Coils are available for the MULLARD S.G.P. MASTER 3

235/550 metres. Ref. A.M.5 - 10/-  
1000/2000 metres. Ref. A.M.20 - 10/-  
Six Pin Bases. Ref. S.P.B. - 2/9

RECOMMENDED FOR USE WITH THE  
**"MASTER 3"**

THE LONDON ELECTRIC WIRE COMPANY  
AND SMITHS LIMITED

Church Road

Leyton, London, E.10

**OUR NEWS BULLETIN**

—continued from page 234

**“Depressions” from Daventry**

The Air Ministry recently announced that arrangements have been made by the Meteorological Office, the Air Ministry, the B.B.C. and Messrs. Wireless Pictures (1928), Ltd., for the experimental transmission from Daventry 5XX of weather maps by the Fultograph process of picture transmission. The maps are broadcast between 2 and 2.25 p.m. on Tuesdays and Thursdays. No doubt many of our readers possessing Fultograph receivers have been receiving these maps and we shall be glad to hear from them concerning the success of this new scheme.

**Huddersfield’s Regional ?**

There is a rumour that the new North of England high-power Regional Scheme station will be erected at Pole Moor, Slaithwaite, near Huddersfield, on a site of roughly 30 acres. The “Daily Dispatch” reports that the valuation terms with the Dartmouth Estate owners have also been concluded.

**Marconi Royalties**

The result of the lawsuit in the Chancery Division when Mr. Justice Luxmoore gave a decision in favour of the Marconi Company, who had appealed against the Comptroller-General’s ruling that lower royalties should be paid, has come as a great blow to the radio trade, and it is anticipated in consequence that, as the royalties will be re-imposed, in all likelihood sets in the near future will be more expensive.

Readers will remember that in a recent issue the facts of the case were fully given by our Legal Correspondent.

Marquis, and it is understood that the title will be hereditary.

**Mihaly Television**

Denes von Mihaly, the Hungarian television expert, was in London recently, seeking permission to co-operate with the General Post Office and the B.B.C. with regard to his new television outfits. It is understood that these are now being used in Germany, the small ones costing 50s. and the larger ones £5.

Mihaly said that he had negotiated with a big English Company, whose directors were willing and anxious to form an all-British firm to manufacture and sell his television sets. The sets are fool-proof, and he hopes in due course to be able to demonstrate them to officials in this country.

**New Musical Director**

As we forecast in our contemporary, “Popular Wireless,” several weeks ago, Mr. Adrian Boult has now definitely decided to accept the post of Musical Director to the B.B.C. He will be leaving the City Orchestra of Birmingham at the end of the next concert season. Mr. Boult has been selected to succeed Mr. Percy Pitt, who will be retiring at the end of the year.

**KEEP IN TOUCH**

WITH ALL

**RADIO DEVELOPMENTS**

BY READING

**POPULAR WIRELESS**

Every Thursday. Price 3d.

**Honour for Senatore Marconi**

The King of Italy has raised Senatore Marconi to the dignity of

**TELSEN TRANSFORMERS**



**12/6**

**BRITISH MADE**

The **RADIOGRAND**, as shown above, is a component of outstanding merit and remarkable value. Used by all the high-class set manufacturers and sold everywhere. **TELSEN ELECTRIC CO., LTD.** Head Offices: **ASTON ROAD, BIRMINGHAM.**

**WEARITE COMPONENTS**

**“TEN POUND” FIVE**

D.P.D.T. Switch, I.22 .. .. .	3/6
On-and-Off Switch, G.22 .. .. .	1/-
Valve Holders, L.A.S.5. .. .. .	2/6
H.F. Choke .. .. .	6/6
Wave-Trap .. .. .	12/6
Output Choke .. .. .	21/-
Paxolin Tube, 3" x 3½" .. .. .	1/2½
Panel, Paxolin, 21" x 7" x ¼" .. .. .	8/9
Screen, 7" x 6" .. .. .	2/6

**“ONE-COIL” TWO**

2-Pole D.T. Switch, I.22 .. .. .	3/6
L.T. Switch, G.22 .. .. .	1/-
H.F. Choke .. .. .	6/6
Panel, 14" x 7" .. .. .	6/-
Coil .. .. .	21/-

**“TITAN” COIL .. .. . 15/-**

**WRIGHT & WEAIRE, LTD.,**

740, High Rd., Tottenham, N.17  
Telephones: Tottenham 3847/8





## ARE YOU GOING TO BUILD A SET?



If so, you must not miss the new

### "BESTWAY" WIRELESS BOOKS

## Four Fine Sets in Each!

"Bestway" No. 328 tells you how to build

A Wave-Change One-Valver

The "Bestway" Wave-Change Three

A Two-Valve Amplifier

The Home-Circle Four

"Bestway" No. 329 contains full details of

A "Regional" Crystal Set

An All-Wave Two-Valver

A One-Valve Amplifier, and

The S.G. & Pentode Three

PRICE  
**6d.**  
NOW  
on  
SALE



# HYDRA

stands up to  
high pressure

Hydra Condensers are made to stand up to high voltages and heavy rates of discharge. You can buy Hydra Condensers suitable for every radio purpose, and you can always be certain that they will live up to their reputation as "the condenser that never breaks down under normal conditions."

NEW  
REDUCED  
PRICES



Never risk disaster—  
**SAFETY FIRST AND  
HYDRA ALWAYS.**  
Prices: Tested at 500 A.C.  
Work Volts 240 A.C. 1 mf 2/6,  
2 mf 3/4, 4 mf 6/-.  
Tested at 1000 V.D.C. Work  
Volts 300 A.C. or 450 D.C.  
1 mf 3/6, 2 mf 4/9, 4 mf 8/6.  
Do not accept a silver grey  
condenser without the  
HYDRA label. Others are imitations  
and we are not responsible  
in case of breakdown.  
**LOUIS HOLZMAN**  
37 Newman St., London, W.1  
Telephone: Museum 2641.

## CLIX HOOK TERMINAL

This new Clix product is just the thing for certain and quick make-and-break connections to terminals. The hook design prevents this connector shooting away when screwing down or loosening terminal. It incorporates, of course, the Clix patented method of wiring which ensures a strong grip, a perfect connection and no exposed wires.



Lead-coated or Nickel-plated.  
Write for the Clix Catalogues  
containing details of 21  
aids to perfect contact.

**LECTRO LIX, LTD.**  
254, Vauxhall Bridge Road,  
London, S.W.1

2 D.  
EACH

## REPAIRS

Any make of L.F. Transformer, Loudspeaker or Headphones repaired and despatched within 48 HOURS—TWELVE MONTHS' GUARANTEE with each repair. 4/- Post free.

Terms to Trade.

**TRANSFORMER REPAIR CO.,**  
Dept. "C,"  
214, High Street, Colliers Wood, London, S.W.19

For the Best in Radio

**WILL-DAY LTD.**

(THE BEST IN THE WEST)  
10 LISLE STREET, LIMEHURST SQUARE, LONDON, W.1.  
Telephone: Palmer, 0101, 0102, 0103, 0104, 0105, 0106, 0107, 0108, 0109, 0110, 0111, 0112, 0113, 0114, 0115, 0116, 0117, 0118, 0119, 0120, 0121, 0122, 0123, 0124, 0125, 0126, 0127, 0128, 0129, 0130, 0131, 0132, 0133, 0134, 0135, 0136, 0137, 0138, 0139, 0140, 0141, 0142, 0143, 0144, 0145, 0146, 0147, 0148, 0149, 0150, 0151, 0152, 0153, 0154, 0155, 0156, 0157, 0158, 0159, 0160, 0161, 0162, 0163, 0164, 0165, 0166, 0167, 0168, 0169, 0170, 0171, 0172, 0173, 0174, 0175, 0176, 0177, 0178, 0179, 0180, 0181, 0182, 0183, 0184, 0185, 0186, 0187, 0188, 0189, 0190, 0191, 0192, 0193, 0194, 0195, 0196, 0197, 0198, 0199, 0200, 0201, 0202, 0203, 0204, 0205, 0206, 0207, 0208, 0209, 0210, 0211, 0212, 0213, 0214, 0215, 0216, 0217, 0218, 0219, 0220, 0221, 0222, 0223, 0224, 0225, 0226, 0227, 0228, 0229, 0230, 0231, 0232, 0233, 0234, 0235, 0236, 0237, 0238, 0239, 0240, 0241, 0242, 0243, 0244, 0245, 0246, 0247, 0248, 0249, 0250, 0251, 0252, 0253, 0254, 0255, 0256, 0257, 0258, 0259, 0260, 0261, 0262, 0263, 0264, 0265, 0266, 0267, 0268, 0269, 0270, 0271, 0272, 0273, 0274, 0275, 0276, 0277, 0278, 0279, 0280, 0281, 0282, 0283, 0284, 0285, 0286, 0287, 0288, 0289, 0290, 0291, 0292, 0293, 0294, 0295, 0296, 0297, 0298, 0299, 0300, 0301, 0302, 0303, 0304, 0305, 0306, 0307, 0308, 0309, 0310, 0311, 0312, 0313, 0314, 0315, 0316, 0317, 0318, 0319, 0320, 0321, 0322, 0323, 0324, 0325, 0326, 0327, 0328, 0329, 0330, 0331, 0332, 0333, 0334, 0335, 0336, 0337, 0338, 0339, 0340, 0341, 0342, 0343, 0344, 0345, 0346, 0347, 0348, 0349, 0350, 0351, 0352, 0353, 0354, 0355, 0356, 0357, 0358, 0359, 0360, 0361, 0362, 0363, 0364, 0365, 0366, 0367, 0368, 0369, 0370, 0371, 0372, 0373, 0374, 0375, 0376, 0377, 0378, 0379, 0380, 0381, 0382, 0383, 0384, 0385, 0386, 0387, 0388, 0389, 0390, 0391, 0392, 0393, 0394, 0395, 0396, 0397, 0398, 0399, 0400, 0401, 0402, 0403, 0404, 0405, 0406, 0407, 0408, 0409, 0410, 0411, 0412, 0413, 0414, 0415, 0416, 0417, 0418, 0419, 0420, 0421, 0422, 0423, 0424, 0425, 0426, 0427, 0428, 0429, 0430, 0431, 0432, 0433, 0434, 0435, 0436, 0437, 0438, 0439, 0440, 0441, 0442, 0443, 0444, 0445, 0446, 0447, 0448, 0449, 0450, 0451, 0452, 0453, 0454, 0455, 0456, 0457, 0458, 0459, 0460, 0461, 0462, 0463, 0464, 0465, 0466, 0467, 0468, 0469, 0470, 0471, 0472, 0473, 0474, 0475, 0476, 0477, 0478, 0479, 0480, 0481, 0482, 0483, 0484, 0485, 0486, 0487, 0488, 0489, 0490, 0491, 0492, 0493, 0494, 0495, 0496, 0497, 0498, 0499, 0500, 0501, 0502, 0503, 0504, 0505, 0506, 0507, 0508, 0509, 0510, 0511, 0512, 0513, 0514, 0515, 0516, 0517, 0518, 0519, 0520, 0521, 0522, 0523, 0524, 0525, 0526, 0527, 0528, 0529, 0530, 0531, 0532, 0533, 0534, 0535, 0536, 0537, 0538, 0539, 0540, 0541, 0542, 0543, 0544, 0545, 0546, 0547, 0548, 0549, 0550, 0551, 0552, 0553, 0554, 0555, 0556, 0557, 0558, 0559, 0560, 0561, 0562, 0563, 0564, 0565, 0566, 0567, 0568, 0569, 0570, 0571, 0572, 0573, 0574, 0575, 0576, 0577, 0578, 0579, 0580, 0581, 0582, 0583, 0584, 0585, 0586, 0587, 0588, 0589, 0590, 0591, 0592, 0593, 0594, 0595, 0596, 0597, 0598, 0599, 0600, 0601, 0602, 0603, 0604, 0605, 0606, 0607, 0608, 0609, 0610, 0611, 0612, 0613, 0614, 0615, 0616, 0617, 0618, 0619, 0620, 0621, 0622, 0623, 0624, 0625, 0626, 0627, 0628, 0629, 0630, 0631, 0632, 0633, 0634, 0635, 0636, 0637, 0638, 0639, 0640, 0641, 0642, 0643, 0644, 0645, 0646, 0647, 0648, 0649, 0650, 0651, 0652, 0653, 0654, 0655, 0656, 0657, 0658, 0659, 0660, 0661, 0662, 0663, 0664, 0665, 0666, 0667, 0668, 0669, 0670, 0671, 0672, 0673, 0674, 0675, 0676, 0677, 0678, 0679, 0680, 0681, 0682, 0683, 0684, 0685, 0686, 0687, 0688, 0689, 0690, 0691, 0692, 0693, 0694, 0695, 0696, 0697, 0698, 0699, 0700, 0701, 0702, 0703, 0704, 0705, 0706, 0707, 0708, 0709, 0710, 0711, 0712, 0713, 0714, 0715, 0716, 0717, 0718, 0719, 0720, 0721, 0722, 0723, 0724, 0725, 0726, 0727, 0728, 0729, 0730, 0731, 0732, 0733, 0734, 0735, 0736, 0737, 0738, 0739, 0740, 0741, 0742, 0743, 0744, 0745, 0746, 0747, 0748, 0749, 0750, 0751, 0752, 0753, 0754, 0755, 0756, 0757, 0758, 0759, 0760, 0761, 0762, 0763, 0764, 0765, 0766, 0767, 0768, 0769, 0770, 0771, 0772, 0773, 0774, 0775, 0776, 0777, 0778, 0779, 0780, 0781, 0782, 0783, 0784, 0785, 0786, 0787, 0788, 0789, 0790, 0791, 0792, 0793, 0794, 0795, 0796, 0797, 0798, 0799, 0800, 0801, 0802, 0803, 0804, 0805, 0806, 0807, 0808, 0809, 0810, 0811, 0812, 0813, 0814, 0815, 0816, 0817, 0818, 0819, 0820, 0821, 0822, 0823, 0824, 0825, 0826, 0827, 0828, 0829, 0830, 0831, 0832, 0833, 0834, 0835, 0836, 0837, 0838, 0839, 0840, 0841, 0842, 0843, 0844, 0845, 0846, 0847, 0848, 0849, 0850, 0851, 0852, 0853, 0854, 0855, 0856, 0857, 0858, 0859, 0860, 0861, 0862, 0863, 0864, 0865, 0866, 0867, 0868, 0869, 0870, 0871, 0872, 0873, 0874, 0875, 0876, 0877, 0878, 0879, 0880, 0881, 0882, 0883, 0884, 0885, 0886, 0887, 0888, 0889, 0890, 0891, 0892, 0893, 0894, 0895, 0896, 0897, 0898, 0899, 0900, 0901, 0902, 0903, 0904, 0905, 0906, 0907, 0908, 0909, 0910, 0911, 0912, 0913, 0914, 0915, 0916, 0917, 0918, 0919, 0920, 0921, 0922, 0923, 0924, 0925, 0926, 0927, 0928, 0929, 0930, 0931, 0932, 0933, 0934, 0935, 0936, 0937, 0938, 0939, 0940, 0941, 0942, 0943, 0944, 0945, 0946, 0947, 0948, 0949, 0950, 0951, 0952, 0953, 0954, 0955, 0956, 0957, 0958, 0959, 0960, 0961, 0962, 0963, 0964, 0965, 0966, 0967, 0968, 0969, 0970, 0971, 0972, 0973, 0974, 0975, 0976, 0977, 0978, 0979, 0980, 0981, 0982, 0983, 0984, 0985, 0986, 0987, 0988, 0989, 0990, 0991, 0992, 0993, 0994, 0995, 0996, 0997, 0998, 0999, 1000.

OPEN TILL 7 P.M.  
WRITE FOR OUR CATALOGUE  
POSTAGE 6d. 10/- TO COLLECT

The Picture Paper with the MOST News  
:: SUNDAY GRAPHIC ::

## VALVES THAT "RING"

—continued from page 226

the one that offends to the least extent. Some of the special rectifying valves now on the market are almost non-microphonic.

The question of valve holders is a vexed one. There are those who swear by the very springy holder, contending that it absorbs vibrations, which are thus prevented from reaching the glass. Others, of whom I am one, are more inclined to swear at them. My own experience is that certain valve holders, at any rate, increase rather than diminish microphonic tendencies.

### Caused by Valve Holders

The reason, I believe, is that the springs themselves have often a natural frequency within the audible range. Any shock forces them to vibrate at this frequency, and the vibrations are passed on to the valve, causing it to pong wholeheartedly. If you ride in a car with very lively springing, your passage along a rough road is, to say the least of it, not very comfortable.

To obtain smooth travelling over rough surfaces the springs must be damped by shock absorbers. So with the valve. In order to diminish the microphonic nuisance we should aim rather at damping our vibrations than giving them full play by means of a very springy mounting.

[EDITOR'S NOTE.—WIRELESS CONSTRUCTOR laboratory experiments go to prove that some valves have their microphonic tendencies increased, and others reduced, by the modern sprung holders. Holders, too, vary greatly in their "anti-ponging" properties.]

By no means a bad tip is to cover the whole of the bulb with a binding of insulating tape, and it is still better to place a layer of cotton wool between the tape and the glass. It should be noted, though, that this must not be done if the valve is of the semi-dull type, which means that the glass becomes too hot to handle comfortably when the valve is working.

### "Singing Round the Ring"

Binding the bulb is particularly useful in cases where what is known as "singing round the ring" occurs. It is sometimes found that soon after the loud speaker is switched on a low moaning sound becomes audible which rapidly increases in strength until it becomes positively deafening. What

happens is rather interesting. Sound waves travelling through the air from the surface of the loud speaker impinge upon the bulb of the rectifying valve, causing it to vibrate slightly. Owing to the vibration, movements of the electrodes occur which give rise to modifications in the output current.

These are passed on to the next valve, which amplifies them and delivers them to the output valve. Amplified again by this they reach the loud speaker, in which they are transformed into sound waves similar to those originally emitted, but, of course, much amplified. From the loud speaker these larger waves travel once more to the bulb of the rectifier and the process continues. A build-up in strength takes place. The

## Going To Build A Set ?

Why not get one of the  
WIRELESS CONSTRUCTOR  
Envelopes ?

**No. 1. The "Radiano" Three**  
**No. 2. The "Concert" Four**

Price 1/6 each at any Booksellers,  
or 1/9 by post from The Amalgamated Press, Ltd. (Wireless Constructor Envelopes), Bear Alley, Farringdon Street, London, E.C.4.

more the valve vibrates the greater is the energy delivered by the loud speaker, and the greater this energy the more the valve vibrates—a very perfect example of reaction.

### Curing Microphonic Troubles

No form of valve holder with metal springs will cure "singing round the ring," and it is of little use to stand the set, as is some times recommended, on several folds of thick material. The trouble is caused, as we have seen, by sound-waves reaching the bulb itself and not by vibrations transmitted to it indirectly from the panel or the baseboard.

Where "singing round the ring" is not experienced, but microphonic noises are heard when the table upon which the set stands is shaken or even when anyone walks across the floor of the room in which it is situated, the tip illustrated in Fig. 3 may be found useful. Use a plain, unsprung valve holder, placing between it and the baseboard a pad about half an inch in thickness cut from a piece of rubber sponge.

(Continued on page 239.)





## PERFECT VOLUME CONTROL

The ideal volume control for radio receivers and gramophone pick-ups is the VOLUVERNIA. It gives firm, yet smooth action, has correct resistance value, accurate in construction and most compact. One turn of the knob controls volume from full strength down to the merest whisper without impairing quality.

### The Gam-brell VOLUVERNIA

PRICE 6/9

No mains user can afford to be without the Gam-brell Twin Fuse Unit. Designed to blow at 1 amp., it fully protects Eliminators, Chargers, etc., also the house lighting system from damage. PRICE 6/6

Write for Components Catalogue (C).

**GAMBRELL RADIO LTD.**  
6, Buckingham St., Strand, W.C.2.

## VALVES THAT "RING"

—continued from page 238

Employ only two screws to fix the latter to the baseboard and let these be of such a size that they are a very easy fit for the holes in the holder. Under the head of each place a thick rubber washer. Tighten the screws down only enough to make the holder rest on the top of the sponge pad. The valve holder is now free to move up and down a little on the fixing screws. The rubber acts as a shock absorber, mopping up and damping out vibrations and preventing them from being transmitted to the valve.

It should be noted, though, that to obtain the full benefit of this device connections of stiff wire to the valve-holder terminals must not be used, for such wires themselves may vibrate, transferring their vibrations directly to the holder. Instead, make use of flex leads, keeping these as short as is reasonably possible, but being careful not to stretch them at all tightly.

### A Better Method

A still better, though rather more drastic, method is illustrated in Fig. 4. This is particularly useful for short-wave sets, where it has the most remarkable soothing effect upon even badly microphonic valves. Obtain from any chemist a small rubber sponge, and cut off from this a piece about 2½ inches square. In it scoop out a hollow with a pair of scissors, into which the top of the bulb of the valve fits tightly.

Glue the sponge with the hollow uppermost to the baseboard of the set in place of the existing valve holder, and put the valve into it upside down. Connections to the valve pins may be made either by soldering flex leads to them or by fixing small valve legs to the ends of the leads. In addition to preventing the microphonic nuisance, this tip has the added advantage of dispensing altogether with the valve holder, and thus reducing unwanted inter-electrode capacities—a very important matter on wave-lengths below 25 metres or so.

### Next Month

More about the  
**ALL-ELECTRIC  
GRAMOPHONE**



The Great Arahuni dam, part of New Zealand's new hydro-electric scheme.

## ENGINEERING PRECISION

Imagine the genius, the inspiration, the tireless labour expended on this vast dam—a supreme achievement of modern engineering. One flaw in design, one slip in workmanship, might cause untold disaster. With wireless instruments such inaccuracies would lead to a defective set—surely damage enough—damage, however, that can be prevented by using J.B. precision instruments.

The J.B. Log Condenser (Plain Type), illustrated, is the last word in high-class design, possessing great mechanical strength combined with the highest possible electrical efficiency. An important feature of this model is the Variable Friction Brake, by means of which the turning tension of the rotor may be varied to suit individual requirements, while at the same time the movement of this condenser is extraordinarily smooth.

Prices, complete, 4-in. Bakelite Dial:—  
‘0005 .. 11/6    ‘0003 .. 10/6  
‘00025 .. 10/-    ‘00015 .. 10/-



## PRECISION INSTRUMENTS

Adv. of Jackson Bros., 72, St. Thomas St., London, S.E.1. Telephone: Hop 1837.

## A Bureau for Your Wireless!



### ADAPTABLE TO ALL SETS!

Nothing to touch! The snug way those untidy, dusty parts, trailing wires and batteries are compactly enclosed will delight you. As a beautiful piece of furniture, the "RADIOLA" will add pride to the home because it is modern and stylish. Already over 3,000 delighted users. Highly recommended by the Radio Press and leading experts. "Radiola" de luxe, from £5.5 to £11.11. "Popular" Oak Model, from £3.15.

Cash or Easy Payments. A stately British-made Cabinet, trade-marked and guaranteed, sent on APPROVAL. (If you wish to part with it we will willingly refund FULL MONEY and pay return carriage too!)

Full particulars, Booklet and Photographs FREE (they will interest you!) from the actual makers:

**PICKETT'S, WIRELESS FURNITURE MAKERS,**  
"W.C." WORKS, BEXLEY HEATH, KENT.  
Established since the beginning of Broadcasting.

## MICROFU

Stocked by all first-class Dealers

### Saves Valves

Complete Microfuses embody an entirely new principle in fuse construction. This is a gold fuse—not wire. Absolutely reliable. 100 per cent. British. As specially specified for use in the Air Commander, by Mr. Percy W. Harris, M.I.R.E.

Refills 1/6  
MICROFUSES LTD., 3, Finsbury Sq., London, E.C. 2

## Make The DAILY SKETCH YOUR Picture Paper

PLEASE be sure to mention "Wireless Constructor" when communicating with Advertisers. THANKS!

## THERE MUST BE A REASON

Why Celestion has come  
to mean "The Very Soul  
of Music."

### REALISM

Celestion possesses the  
most exclusive feature  
that it is possible for any  
reproducing instrument  
to possess; REALISM.

The only sure proof of  
our Statement is to hear  
Celestion yourself. You can  
do so without obligation at  
any good Wireless Dealers.  
Models range from £5 10 0  
in oak or mahogany. British  
Throughout. Made under  
Licence.



Model C.10. £5 10s. 0d.

## CELESTION

The Very Soul of Music

LOUD SPEAKERS

The new Celestion Booklet is free  
and gives you briefly and interest-  
ingly all particulars.

Write to

CELESTION LTD. (Dept. L.),  
KINGSTON-ON-THAMES.

SHOWROOMS:  
106, VICTORIA ST.,  
LONDON, S.W.1

WHEN A BETTER LOUD-SPEAKER  
IS MADE—CELESTION WILL MAKE IT.

## THE EXODUS FROM THE B.B.C.

—continued from page 194

for a fact, but we certainly have heard from more than one source that the Governors of the B.B.C. constantly criticised and interfered, and when Mr. Jeffrey talks about pleasing five people more than the thousands of people who constitute his public, he is pretty obviously referring to the Governors. In any case, we have heard many and many a time expressions of resentment and annoyance at the criticisms and petty interference of the Governors of the B.B.C. If the public wants to know why so many good men are leaving the B.B.C. they had better ask the Governors.

### No Special Qualification'

When the Governors were appointed there was a good deal of criticism because none of them had any special qualification for the job. They are safe and secure in those positions for another seven years; but unless their powers are severely curbed, there will be constant friction in the B.B.C. It is not likely that men who have built up British broadcasting in this country and who have made it the finest organisation of its kind in the world are going to be dictated to—or, if not dictated to, interfered with—in the execution of their jobs.

One day we hope that Captain Eckersley will be prevailed upon to tell the full story of his resignation, and why he found it impossible to continue in his position as Chief Engineer. When that day does dawn, the public will realise that it is not so much a question of salaries as a question of atmosphere and trust. When a man does a job well, the worst thing that can happen is for someone to come along and interfere with him, not so much by direct orders as by criticism, and if a man has a brilliant idea which should be put into effect at once, nothing is so disheartening than to find that half a dozen meetings have got to be held and interminable wrangling and argument carried on before anything approaching a decision can be arrived at.

### Are They Coincidences?

We sincerely hope that the recent publicity given to the B.B.C. in connection with these resignations will have the effect of making some of the bureaucratic-minded officials at the B.B.C. headquarters realise that

bureaucracy is the last thing which should be allowed to pervade Savoy Hill, despite the fact that it is nominally a Civil Service Department; and we further sincerely hope, now that Sir John Reith has decided to refuse a £10,000 a year post in order to remain at the head of the B.B.C., that he will arrange for more publicity to be given concerning salaries and general treatment of the staff.

Sir John very rarely gives an interview, but the other day he was persuaded by the "Daily News" to discuss the subject of resignations. He was asked whether the resignations were coincidences. Sir John replied: "Absolutely."

Captain Eckersley, asked by the "Daily News" whether he realised that in view of all the resignations which have occurred lately the reticence which is being observed on his resignation would be ascribed to a difference of opinion, replied: "I can only refer you to the B.B.C."

We will refrain from further comment; but we hope that this exodus from Savoy Hill will be stopped and that what remains of the old staff, who carried on so marvellously in the early days, will not be discouraged, but will in future be allowed to work without interference; and that the Governors, in particular, will realise that in this way, and in this way only, will the B.B.C. regain its former efficiency, harmony, and happiness.

## THE "SHORTRODE" TWO

—continued from page 210

the panel, fixing this to the baseboard, and completing. There are, however, no awkward corners at all.

Now, as regards the operation of the set and the choice of valves. Here we are naturally somewhat limited—the note-magnifier should be a pentode, although one can, of course, dispense with the output transformer and use an ordinary valve here without making further modifications, although this rather spoils the whole point of the set.

The detector is preferable a fairly high-impedance valve, such as one of the "H.L." type. By this I mean a valve with an impedance of about 25,000 ohms. In the 2-volt class, valves that come in this category and make excellent detectors are the H.L. 210, Ediswan and Cossor H.F. 210, Mullard P.M.1 H.F., or L.F. (although the P.M.2D is excellent), etc. Since 6-volt pentodes are not very

(Continued on page 241.)



**—those  
“other stations”**

If you experience difficulty in bringing in those ‘other stations,’ just able to hear them but unable to tune them properly, fit a Polar ‘Ideal’ Condenser. The Polar combination of Direct and Slow Motion drive will enable you to tune in those other stations with accuracy and ease.

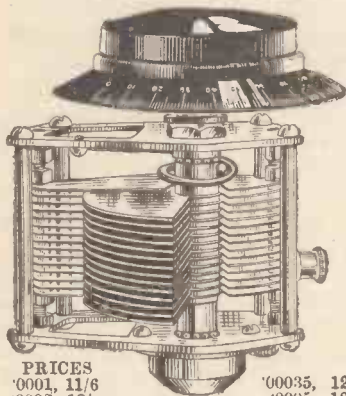

PRICES  
‘0001, 11/6      ‘0003, 12/3  
‘0003, 12/-      ‘0005, 12/6

The Polar “Q.J.”

A strong and compact slow motion condenser for reaction, closed circuit tuning or balancing. ‘0001, 10/-; ‘00015, 10/3; ‘00025, 10/6.

Send for the Polar Catalogue (C).

**WINGROVE & ROGERS, LTD.,**  
188/9, Strand, London, W.C.2

Please be sure to mention “Wireless Constructor” when communicating with Advertisers. Thanks!

**THE ONLY UNIVERSALLY  
STANDARDISED COMPONENT  
IN RADIO!**

TYPE ‘B’ 6d.  
TYPE ‘M’ 4½d.  
TYPE ‘R’ 3d.

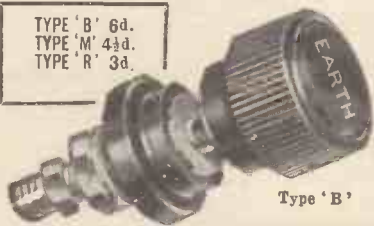

Type ‘B’

**BELLING-LEE  
TERMINALS**

BELLING & LEE, LTD., Queensway Works,  
Ponders End, Mdx.

**Advertisements**

As far as possible all advertisements appearing in “Wireless Constructor” are subject to careful scrutiny before publication, but should any reader experience delay or difficulty in getting orders fulfilled, or should the goods supplied not be as advertised, information should be sent to the Advertisement Manager, “Wireless Constructor,” 4, Ludgate Circus, London, E.C.4.

**THE “SHORTRODE” TWO**

—continued from page 240

readily obtainable at the time of writing, I have been using 2-volt and 4-volt valves myself for the tests of the set. About 100–120 volts H.T. should be used. The most interesting part of the short-wave spectrum is covered with a four-turn coil as grid coil, and a six-turn reaction coil (although another four will answer admirably if you happen to have two).

**Plenty of Programmes**

This combination should cover a range of, roughly, 19 to 28 metres. W 2 X A D (Schenectady) on 19.56 metres is heard right at the bottom of the condenser scale. C J R X, 5 S W, W 8 X K (K D K A.) and several others are heard in the region of 25 metres, and the other batch of stations, including 3 L O and 7 L O, on about 31–33 metres are found with a six-turn aerial coil and a four- or six-turn reaction coil.

**“POPULAR WIRELESS”**

Is the Leading  
Radio Weekly

Price 3d.      Every Thursday

Below 19 metres, with a two- or three-turn aerial coil, we have Kootwijk (Holland, PCK) on 16.3, Huizen on 16.88, Radio Malabar (Java) on 17.00, and one or two others rather less interesting.

Higher up we have Radio Vitus on about 40 metres and Vienna on about 37.

Taking it all round, there are more alternative programmes available for the two-valve man than there are on the ordinary broadcast wave-lengths! The trouble is, of course, that the stations cannot be relied upon to be all transmitting at once. Some of them, in fact, seem to forget to work at all for weeks on end. Generally speaking, however, any evening there are plenty of stations to interest the listener.

The only other point that need be mentioned is that if the set will not oscillate at the lowest wave-lengths you should, of course, reduce the capacity of the aerial series condenser still further. Remember also that too large a reaction coil will sometimes prevent oscillation on the ultra-short waves.

**USED IN THE  
“WIRELESS  
CONSTRUCTOR”  
ALL - ELECTRIC  
GRAMOPHONE**

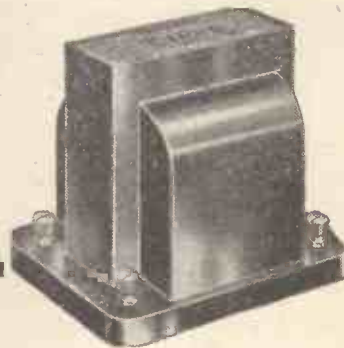

**Y**OUR Set needs a Brown L.F. Transformer. For the Brown amplifies every note at its true value. Treble and bass — you hear them all distinct and clear at their correct strength. National Physical Laboratory Tests prove its even amplification throughout the whole musical scale. These are the reasons why the Brown Transformer is used in the “Wireless Constructor” All-Electric Gramophone.

Type ‘A’      30/-  
Ratio 3.5-1

Type ‘B’      17/6  
Ratio 3.5-1

**THE  
Brown  
L.F.  
TRANSFORMER**

Made only by:  
**S. G. BROWN, Ltd.,** Western Ave.,  
North Acton, London, W.3.

Ⓐ 9201

# Ready Radio

## SERVICE SERVICE SERVICE

- (1) Only correct parts supplied.
- (2) Expeditious despatch.
- (3) Orders packed in useful sealed cartons.
- (4) All goods sent postage or carriage paid.
- (5) Helpful advice on your technical difficulties.
- (6) Everything Radio supplied.

The Ready Radio despatch department has been organised to give complete satisfaction to all.

### Remember!

You can order ALL your radio requirements C.O.D. at list prices, postage free.

### Immediate Despatch

OF ALL THE CORRECT PARTS

### NEW ROADSIDE FOUR

Complete Kit - £12 17 0

(With Valves, Batteries, etc.)

For Lists see June and July issues "Wireless Constructor."

### Ready Radio Service Home & Abroad

**INLAND.** All orders despatched post free in sealed cartons, or by rail, carriage paid. Packing cases 2/6, credited on return.

**OVERSEAS.** All orders carefully packed and insured, all charges forward.

Cash with order or C.O.D.

# Ready Radio

159, BOROUGH HIGH ST.,  
LONDON BRIDGE, S.E.1.

Phone: HOP 5555

## THE 1929 SUPER-QUALITY AMPLIFIER

—continued from page 192

valves of the power type using suitable filaments for direct A.C. heating, and, furthermore, any hum introduced by this stage will be magnified in that following it.

Tests with a number of valves showed that the Marconi and Osram D.E.5 fills the bill well. The resulting hum from the whole amplifier, while being present, is not sufficient to be noticed when a programme item starts or a record is played. Incidentally, when used with a pick-up and good loud speaker the hum is appreciably less than occurs with many expensive models of electric gramophone.

### Alternative Methods

For simplicity all three valve filaments are run from the same source, and when the amplifier is used with the accompanying power unit a 5-volt winding supplies all three valves perfectly satisfactorily. The man who already has a good power unit, but who still desires to run his valves from A.C., can adopt one of several alternatives as follows:

1. Obtain a transformer giving 5 to 6 volts A.C. with a centre-tap, whereupon the three terminals provided on the amplifier will be used as if supplied from the power unit described in this number.

2. Obtain a 5- to 6-volt transformer without centre-tap, shunting across the output winding an ordinary potentiometer with the slider set at the centre, this slider being then used as if it were a centre-tap terminal.

3. Take any of the existing A.C. transformers giving 4 volts output (designed for indirectly heated valves), and use either (a) one of the new A.C. indirectly heated valves with 4-volt filaments for the first L.F. and a pair of 4-volt super-power valves of the ordinary type for the output stage—this will require some rewiring, or (b) 4-volt indirectly heated valves throughout, the last two being of the power variety.

4. Use a transformer giving 8 filament volt and use the 8-volt valves throughout.

Neither the 4-volt indirectly heated valves or the 8 directly heated have super-power output valves comparable with the 4- and 6-volt ordinary type, but where less output is needed they are quite practicable.

## Use of the Amplifier with a Pick-up

Pick-ups vary considerably in sensitivity, as do loud speakers. With a really sensitive pick-up, such as the new B.T.H. reviewed in our last issue, and a good sensitive loud speaker, the volume obtainable with dance records will be far greater than can be borne in an ordinary living-room and will be sufficient for quite a large dance hall. With less sensitive pick-ups and less sensitive loud speakers, such as some of the moving coil types, the volume will always be adequate for home needs, while in many cases the volume control will be needed. Where it is desired to use the output for very large dances, then a further low-frequency stage can be used to precede the amplifier.

Next month we shall describe the WIRELESS CONSTRUCTOR Electric Gramophone in complete form, using this amplifier, the power unit, a suitable pick-up and electric motor together with a new loud speaker. The whole combination will be found to give what may be termed "dance orchestra strength" when required and more than adequate power for the largest room on any musical records when the volume control is turned full on.

## Use with Ordinary Wireless Receiving Sets

In using this amplifier with an ordinary wireless receiving set several methods are possible. In the case of receivers where only one low-frequency stage follows the detector, the output terminals of the set can be joined to the input terminals of the amplifier. You will then be able to drive a moving-coil loud speaker, with wonderful volume and purity, and, in fact, any other loud speaker, but in such cases you will probably have to turn the volume control well down to avoid, not overloading, but too great a volume!

You can still do the same with some receivers using two low-frequency stages, but here, save on very weak stations or very small aerials, the volume will be far too great for ordinary purposes. The best thing to do, in such cases, is to insert a jack in the receiving set as if you were plugging in telephones following the detector. How to do this was shown in the "Thirty-One More Tested Circuits," the booklet given free with the December, 1928, issue of the WIRELESS CONSTRUCTOR. (See diagram 31b).

This method is strongly recommended for this amplifier on any

(Continued on page 243.)



# ALL WIRELESS CONSTRUCTORS

should read

## "POPULAR WIRELESS"

if they want to keep in touch with the latest modern wireless developments.

## "POPULAR WIRELESS"

contains articles by all the leading radio engineers and

## "POPULAR WIRELESS"

### SETS

are Guaranteed.

Furthermore, if you are in trouble

## POPULAR WIRELESS"

will help you by means of its unique Technical Query Department.

Make "P.W." your weekly radio paper.

The paper that made Wireless Popular.

Every Thursday. Price 3d.

## THE 1929 SUPER-QUALITY AMPLIFIER

—continued from page 242

ordinary receiving set, for then, when required, you can plug in your amplifier and substitute it for the existing L.F. side of your set.

### Constructional Work

Constructional work is of the simplest, as will be made clear from the various photographs and diagrams. It will be noticed that some of the filament wiring is twisted, and where this is shown in the photographs and diagrams it should be adopted. It is not, however, necessary when accumulators are used. Any good half-megohm volume control can be used, and suitable alternatives for all the parts are given in the list of components.

It will be noticed that no attempt has been made to build the 1929 Super-Quality Amplifier into a cabinet, the taste of the user having much to do with the final decision in this matter. If, for example, the owner desires to use it in conjunction with the power unit described in another article for electrical gramophone reproduction work, the amplifier and the power unit can be stood one above the other on shelves in the cabinet, for which reason the baseboards of both units have been made of the same size.

Again, many users may care to incorporate the amplifier as a whole in their existing sets, discarding all that at present follows the detector and substituting this unit. It will be found that the depth of this amplifier from front to back is that generally used for the baseboard of the larger sets, namely, 10 in., while the width is just suitable for the average length of the low-frequency end of any modern receiver. For convenience, at the moment the volume control has been placed on a small panel at one end of the receiver, but can obviously be placed in other positions to suit the convenience of the user.

### Valves to Use

The first valve should be a Marconi or Osram D.E.5, with about 9 volts grid bias. The two push-pull valves should be Marconi or Osram P.625 or P.625A (I prefer the latter in this particular amplifier), or in the Ediswan valves P.V.625X or P.V.625A. The P.V.625A seems a little better in this

(Continued on page 244).

## WORTH THEIR WEIGHT IN GOLD HEAYBERD Power TRANSFORMERS

Over 50 types available from stock for all methods of rectification.

The following for H.T. Eliminators—

All Centre Tapped.

200v 20ma, 4v 12/6	500v 100ma, 5v 32/6
400v 20ma, 4v 17/6	440v 120ma, 7.5v 32/6
300v 20ma, 5v 17/6	750v 60ma, 5v 40/-
440v 30ma, 4v 20/-	800v 120ma, 8v 55/-
400v. 50ma, 5v 25/-	1000v 120ma, 8v 60/-
500v 50ma, 5v 28/-	2000v 120ma, — 85/-
440v 30ma, 4v and 4 volts 5 amps 28/6	

The following for Westinghouse Rectifiers—

230v 160ma 17/6	12v 1.5 amps 15/-
8.5v 1.5 amps 12/6	12v 3.2 amps 20/-
230 v 160ma, 12v 1.5 amps 45v 10ma 32/6	

The following for A.C. Valves, etc.—

4 volts 3 amps 8/4	2 volts 3.5 amps 10/-
4 volts 5 amps 12/6	7.5 volts 3 amps 12/6
5 volts 3 amps 12/6	6 volts 3.5 amps 12/6

The following Power Chokes—

50 henrys 25ma 12/6	50 henrys 100ma 20/-
100 " 25ma 17/6	100 " 100ma 25/-
30 " 50ma 12/6	17 " 100ma 15/-

See article "Bias Without Batteries" in this issue, page 221.

Details with diagrams free on request.

**F.C. HEAYBERD & CO**  
10, FINSBURY ST. EC2  
One Minute From Moorgate Station.

**BE SAFE!**

Are you helpless when reception is in the least "off colour"? **BE SAFE**—control your set with a Sifam Radio Meter. Fit one to-day—and your set won't let you down to-morrow! You can trace and rectify distortion, avoid burnt-out valves and costly repairs to run-down batteries, and correctly regulate plate and filament supply.

**SPECIFY SIFAM RADIO METERS**

Send a P.C. for free leaflet "What simple meters can show you."



Sifam Pocket Model Voltmeter 0-6-120 volts Hgh Res. 40000 Ohms. Heavy Nickel finish.

**7/6**

SIFAM ELECTRICAL INSTRUMENT CO., LTD. (Dept. W. Con.), Bush House, Aldwych, W.C.2. M.B.

**USE ELEX TREBLE DUTY TERMINALS AND OTHER WIRELESS ACCESSORIES**

J. J. EASTICK & SONS  
ELEX HOUSE, BUNHILL ROY, LONDON, E.C.1.

ALL APPLICATIONS for ADVERTISING SPACE in "WIRELESS CONSTRUCTOR" must be made to the Sole Advertising Agents, JOHN H. LILE, LTD., 4, LUDGATE CIRCUS, LONDON, E.C.4.

**THE 1929 SUPER-QUALITY AMPLIFIER.**

—continued from page 243

amplifier than the P.V.625X. Grid bias should be as follows: P.625 as recommended for 200 volts; P.625A as recommended for 180 volts; P.V.625X as recommended for 200 volts; P.V.625A as recommended for 180 volts.

The voltage drops somewhat with the larger current of the 625A type, hence the difference in the two readings. Three or four volts more than maker's recommendation does no harm, but less should not be used.

(More about the Amplifier next month.)

**RADIO TEXT BOOKS**

There Once Was a Young Man Who Refused to Read Radio Text-books, Opining that to Do so was a Waste of Time and a Confession of Weakness. He was not Unaware, However, of the Pleasures of Listening to the Broadcast Programmes, and Consequently Resolved to Purchase a Receiving Set.

In Due Course he Entered an Emporium Given to the Sale of Such Sets, and Solicited the Assistance of a Salesman. The Salesman, Scenting a Client, Brought Forth a Set of Ancient Design though Impressive Appearance.

He Pointed Out to the Young Man that the Set In Question was Capable of Receiving Forty Foreign Stations at Loud Speaker Strength. He Drew his Attention to the Solidity and Good Appearance of the Set, and, in

Short, Painted It in such Glowing Colours that he Persuaded the Young Man to Pay the necessary Large Sum for its Purchase.

Upon Personal Trial Some Time Later, However, the Young Man was Compelled to Admit to Himself that the Salesman's remarks upon the Quality of Reproduction were Not Fully Borne Out.

Also, he Noted that he had been Grossly Deceived as to the Reception of Foreign Stations, and he Regarded It As the Last Straw when he Learnt that the Valves were of an Obsolete Type no Longer Used, and There Then he Resolved to Study the Subject before Making another Purchase.

MORAL: One is never too old to learn.

**HOW MANY TURNS?**

The right number of turns for a tuning coil to cover a particular range on the short waves is not always easy to determine. The turn numbers for a given diameter of

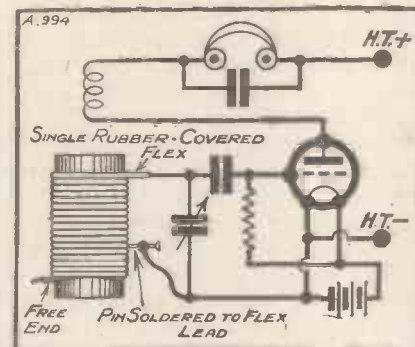

former are sufficiently standardised on the broadcasting ranges, but no two people make their short-wave coils in quite the same way.

To find the correct number of turns for the main tuning coil for, say, 25 to 60 metres usually means a good deal of laborious "trial and error" work, involving starting with a coil obviously too big and gradually taking off turns, with frequent practical tests till the coil is right. You can, of course, make a tapped coil, and with its help find the number of turns you want, but this, again, is a troublesome business.

Single rubber-covered cable comes to your aid in this difficulty. We will suppose that you have a cylindrical former on which you propose to wind your final coil. On this wind rather more turns than you are likely to want of the rubber-covered flex. One strand of twin electric lighting flex will do, or the heavier stuff used for the aerial lead-in.

**Dead-End Effects**

Wind the flex on with turns touching, and connect it up in the grid circuit of the set you are going to use. One end of the coil will go to the grid side of the tuning condenser, the other being disconnected. Now to the filament side of the condenser connect a flex lead with a pin soldered to the end (see diagram). This pin you will be able to push through the rubber insulation at any point on the coil, and you can thus try any number of turns until you find what you want.

The final coil, when put on the former, is not likely to be more than a turn or two out if you give it the number of turns found in this manner. Do not be tempted to leave the cable-wound coil in the set as a permanency. The odd turns at the end will produce undesirable dead-end effects, and the large amount of rubber insulation will render it inefficient on short waves.

A. V. D. H.

**INDEX TO ADVERTISERS**

	PAGE
Belling & Lee, Ltd. . . . .	241
Brown, S. G., Ltd. . . . .	235, 241
Burne-Jones & Co., Ltd. . . . .	234
Best Way Wireless Books . . . . .	237
Carrington Mfg. Co., Ltd. . . . .	231
Celestion, Ltd. . . . .	240
Cossor, A. C., Ltd. . . . .	186
Day, Will, Ltd. . . . .	238
Eastick, J. J., & Sons . . . . .	243
Ever Ready Batteries . . . . .	185
Forno Company, The . . . . .	231
Ferranti, Ltd. . . . .	231
Gambrell Radio, Ltd. . . . .	230

	PAGE
Garnett, Whiteley & Co., Ltd. . . . .	233
Gilbert, J. C. (Cabinets) . . . . .	233
Heyberd, F. C., & Co. . . . .	243
Holzman, Louis . . . . .	238
Igranic Electric Co., Ltd. . . . .	229
Impex Electric, Ltd. . . . .	229
Jackson Bros. . . . .	239
Lectro Linx, Ltd. . . . .	238
Lissen, Ltd. . . . .	225
London Electric Wire Co. & Smiths Ltd. . . . .	235
Metro-Vick Supplies . . . . .	Cover iii
Microfuses, Ltd. . . . .	239
Mullard Wireless Service Co., Ltd. . . . .	Cover ii
Pickett's Cabinet Works . . . . .	239
"Popular Wireless" . . . . .	243

	PAGE
Ready Radio Supply Co. . . . .	242
Rothermel Corp., Ltd. . . . .	234
Radio Instruments, Ltd. . . . .	227
Sifam Elect. Inst. Co., Ltd. . . . .	243
Telegraph Condenser Co., Ltd. . . . .	232
Telsen Electric Co., Ltd. . . . .	236
Transformer Repair Co. . . . .	238
Varley Products . . . . .	Cover iv
Weston Elect. Inst. Co., Ltd. . . . .	233
Whiteley Boneham & Co., Ltd. . . . .	231
Wingrove & Rogers, Ltd. . . . .	241
Wright & Weaire, Ltd. . . . .	236
"Wireless Constructor" Envelopes . . . . .	233

All communications concerning advertising in "Wireless Constructor" must be made to John H. Lee, Ltd., 4, Ludgate Circus, London, E.C.4 Telephone: City 7261.



# Perfect Coupling at Low Cost

## MET-VICK MOULDED RESISTANCES

### ANODE AND GRID LEAK

Similar to those embodied in the Coupling and Detector Units 'Met-Vick' Moulded Resistances are available as separate components. They are chemically inert, the entire material being the actual resistance element. They

1. Carry heavy currents 5-10 milliamps without becoming noisy;
2. retain their values;
3. are non-inductive. They are ideal and inexpensive.

Anode Resistances:—	
100,000 ohms .. .. .	1/2
250,000 " .. .. .	1/2
500,000 " .. .. .	1/2
Eliminator Resistances:—	
25,000 ohms .. .. .	1/2
50,000 " .. .. .	1/2
Grid Leaks:—	
1 megohm .. .. .	1/2
2 megohms .. .. .	1/2
3 " .. .. .	1/2
Clips for mounting .. .. .	1/3



### MET-VICK DETECTOR UNITS

The use of moulded resistances in 'Met-Vick' Skeleton Detector Units ensures freedom from 'rushing' noises often experienced with surface deposit leaks. Both the condenser and the grid leak components retain their original values, quite unaffected by climatic or other variable conditions.

Met-Vick Skeleton Detector Unit for Mains Operation:—

Grid Condenser '0003 mfd. } 2/6  
Grid Leak 1/2 megohm — } 2/6

Similar for Battery Operation:—

Grid Condenser '0003 mfd. } 2/6  
Grid Leak 2 megohms — } 2/6

Extra for Moulded Base — — 1/3

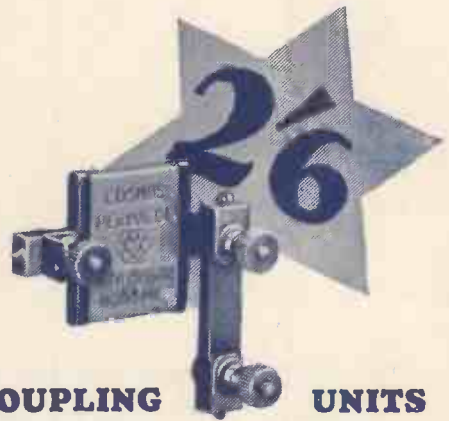

### MET-VICK COUPLING UNITS

The results obtained from 'Met-Vick' Skeleton Resistance Units cannot be improved upon, even by using expensive wire-wound resistances. The values of the components have been carefully calculated to give maximum amplification per stage, and as moulded resistances and leaks are used, their values are retained indefinitely and they are noiseless in operation.

Met-Vick Skeleton Resistance Coupling Units for Mains Operation with Met-Vick A.C. Valves:—

Anode Resistance 200,000 ohms .. .. .	} 5/-
Grid Leak 1 megohm .. .. .	
Coupling Condenser '005 mfd. .. .. .	} 5/-
Similar for Battery Operations:—	
Anode Resistance 400,000 ohms .. .. .	} 5/-
Grid Leak 1/2 megohm .. .. .	
Coupling Condenser '005 mfd. .. .. .	} 1/3
Extra for Moulded Base .. .. .	

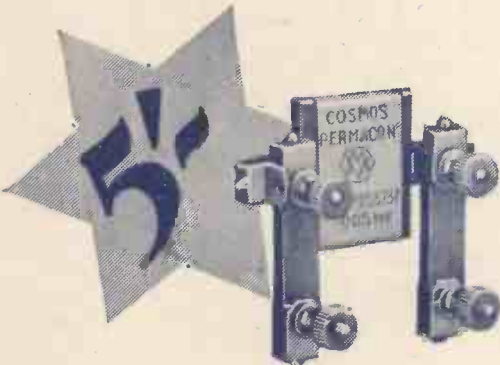

### MET-VICK ELASTIC AERIAL UNITS

The 'Met-Vick' Elastic Aerial Unit enables you, in effect, to vary the aerial backwards or forwards to any required length from maximum to minimum. It is as though you had a thousand aerials at your command, and gives utmost selectivity, combined with signal strength for any station.

Prices from 12/6 to 17/- according to type of set.

Ask your dealer for copy of Section 'D' of Radio Catalogue



# MET-VICK

## Components, Valves and Sets

Metro-Vick Supplies, 155, Charing Cross Road, London, W.C.2

R.P. 146 (Prop.: ASSOCIATED ELECTRICAL INDUSTRIES LTD.)

# L.F. TRANSFORMERS

In the early days of Broadcasting, the coils for most of the well-known Low Frequency Transformers were wound by VARLEY. At that time we were one of the very few firms who could claim to have any experience in the design and production of Transformer Coils, and other manufacturers were not slow to take advantage of our experience and to profit by the resources we were able to place at their disposal. The design of L.F. Transformers has been in no way neglected by us in the intervening years. The fruits of the research and the experience gained during those years have been concentrated in the design and production of the most up-to-date Low Frequency Transformers—two of which are even now on the eve of being released to the public.

*Full particulars will be published later.*

*One of the most interesting of our new products will be a constant inductance L.F. Choke. 30 henrys over the whole range (0-100 m/a).*



Advt. of OLIVER PELL CONTROL, LTD., KINGSWAY HOUSE, 103, KINGSWAY, LONDON, W.C.2. Telephone: Holborn 5303