

The Wireless Constructor

Edited by

PERCY W. HARRIS, M.I.R.E.

6^D
MONTHLY



Vol. II JULY, 1926 No. 9

Special Features:

- A Five-Valve Set for Fifteen Pounds
By J. H. Reynar, B.Sc., A.C.G.I., D.I.C., A.M.I.E.E.
- Distant Reception in the Summer
A Two-Valve Receiver for Long Distance Work
By C. P. Allinson, A.M.I.R.E.
- Log that Station's Wavelength
Constructional Details of a Buzzer Wavemeter
By B. G. R. Holloway
- A Multi-Reaction Single-Valve Set
By A. S. Clark
- An Experimental Crystal Set
By Philip H. Wood, B.Sc., F.P.S.L.
- A Rectifier Testing Panel
By H. J. Barton-Chapple, Wh.Sch., B.Sc., A.C.G.I., D.I.C., A.M.I.E.E.
- Talks to Beginners—Your H.T. Supply—Faults in Note Magnifiers—Workshop Hints, etc.

The "FIVE FIFTEEN"

By

J. H. REYNER,
B.Sc.(Hons), A.C.G.I., D.I.C., A.M.I.E.E.



AN OLD FAVOURITE

For those who still prefer it



Filament Volts, 3.2-3.8
Filament Current, 0.6 amps.
Anode Voltage, 30-90 volts

The remarkable features of rigid and efficient construction that characterise the famous MULLARD SINGLE RING BRIGHT FILAMENT VALVES have won for them the staunch appreciation of thousands of the radio public. For long life, powerful operation and long distance reception ask for Mullard Red Ring Valves for H.F. amplification Mullard Green Ring Valves for L.F. amplification

8'
EACH

OBTAINABLE FROM ALL RADIO DEALERS

Mullard

THE · MASTER · VALVE

The WIRELESS CONSTRUCTOR

— Edited by Percy W. Harris —

Vol. II. No. 9	CONTENTS	JULY
The "Five Fifteen" By J. H. REYNER, B.Sc., A.C.G.I., D.I.C., A.M.I.E.E.	795	What is the Best Source of H.T. Supply? By A. V. D. HORT, B.A.
The Strike and Impromptu Wireless Receivers.	802	A Multi Reaction Single Valve Re- ceiver
Log that Station's Wavelength	804	By A. S. CLARK.
Distant Reception in the Summer . .	811	An Experimental Crystal Set
By C. P. ALLINSON, A.M.I.E.E.		By PHILIP H. WOOD, B.Sc., F.P.S.L.
How a Frame Aerial Works	816	"Noise" or Quality?
By J. H. REYNER, B.Sc., A.C.G.I., D.I.C., A.M.I.E.E.		By L. H. THOMAS.
Abolish Programmes	821	Workshop Hints
Talks to Beginners—IV	825	Switches on the Low Frequency Side..
By PERCY W. HARRIS, M.I.R.E., Editor.		By JOHN UNDERDOWN.
		A Rectifier Testing Panel
		By H. J. BARTON-CHAPPLE, Wh. Sch., B.Sc., A.C.G.I., D.I.C., A.M.I.E.E.
		Apparatus Tested
		869



START RIGHT by Building Your Set on a—

TROLITE

PANEL · DE · LUXE

EASILY WORKED—use acetone as adhesive, thus making a strong and neat joint without screws

EFFICIENT & ELEGANT

4 Finishes:

- Polished Black
- Polished Mahogany
- Polished Walnut
- Wavy Etched Black

Supplied Ex Stock

Thickness $\frac{3}{16}$ " $\frac{1}{4}$ "

A most attractive panel finish which does not show scratches or finger marks

PRICES	Polished Black ...	$\frac{3}{16}$ "	$\frac{1}{4}$ "	Sq. inch
		$\frac{1}{2}$ "	$\frac{3}{4}$ "	
Mahogany, Walnut and Wavy	}	$\frac{3}{16}$ "	$\frac{1}{4}$ "	"
		$\frac{1}{2}$ "	$\frac{3}{4}$ "	

IF YOUR LOCAL DEALER IS OUT OF STOCK, PLEASE INFORM US HIS NAME AND ADDRESS AT ONCE

F. A. HUGHES & CO., LIMITED
204-6, GT. PORTLAND STREET - - LONDON, W1

To Purchasers of Radio Sets:
You require
FAITHFUL REPRODUCTION

Therefore, when you order your Set
SPECIFY

FERRANTI

L.F.

TRANSFORMERS

Type AF4 - - 17/6
Type AF3 - - 25/-

The "Nearly Perfect" Transformer.
Ask for Leaflets Wa401 and Wa402.

FERRANTI LTD., HOLLINWOOD, LANCASHIRE

0.06 CURRENT CONSUMPTION
THE VALVE FOR PORTABLE SETS

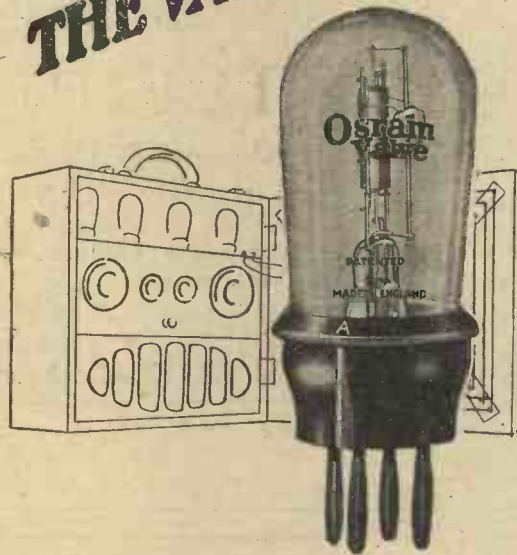

Osram
D.E.3.

for Dry Batteries &
4-Volt Non-Spillable
Accumulators

PRICE 16/6 EACH

Osram Valves

for Broadcasting

For 2-Volt Accumulators use D.E.2. Osram Valves
2-Volt Valves with a 6-Volt Result
Current Consumption 0.12 Amps

The G.E.C. - your guarantee

Advt. of The General Electric Co., Ltd., Magnet House, Kingsway, London, W.C.2.



Published by Radio Press, Ltd., Bush House, Strand, W.C.2. 'Phone: City 9911.

THE "FIVE FIFTEEN"

By J. H. REYNER, B.Sc. (Hons.), A.C.G.I., D.I.C., A.M.I.E.E.

A combination of efficiency and cheapness is made possible with this five-valve receiver which, with valves, only costs about £15. A neutralised circuit is embodied while stray coil coupling is avoided, and in one test twenty-seven British and foreign broadcasting stations were received at full loud-speaker strength.

THE art of radio reception has been developing very rapidly during the past year, and in particular the problem of high-frequency amplification has been brought to a considerably more advanced state. As a result of its development it is now possible to design a receiver which is completely stable from top to bottom of the range, and in which a real amplification in the high-frequency valves is obtainable.

Twenty-Seven Stations on the Loud-Speaker

The receiver to be described employs an arrangement of two H.F. valves, detector, and two L.F. valves, and as will be seen from the test report, some 27 stations were obtained on the loud-speaker in one run from top to bottom of the range, while numerous other stations were audible in the telephones. Such a receiver, therefore, really gives a choice of a large number of alternative programmes, and in several cases they are quite pleasant to listen to just as musical items pure and simple.

The Art of Compromise

As we have stated, it is desirable for the receiver to be completely stable over the whole of the tuning range. There are various methods whereby this can be achieved, but unfortunately they tend to introduce extra complications and expense into the receiver. The present model is the result of an attempt to obtain a

reasonably efficient high-frequency receiver having a moderate measure of selectivity, but which could be constructed at a comparatively small cost, being neither difficult to make up nor requiring much skill in handling.

A Question of Valves

Another important consideration in a five-valve receiver is the actual valves in use. In many circuits the $\frac{1}{4}$ -ampere types of power valve, such as the D.E.5, D.F.A.1 and similar valves give extremely good results and are used to a considerable extent.

slightly less than £15, I have called the instrument the "Five Fifteen."

Retaining Simplicity

In order to retain simplicity as far as possible, a simple tuned anode arrangement was adopted, the actual circuit details being shown in Fig. 1. The grid circuit of the first valve contains a straightforward tuned circuit, the aerial being tapped across a small portion of the coil. The anode circuit of this valve is tuned, but it will be observed that a split coil has been employed, and the high-tension connection is taken to the centre tapping on the coil. The remote end of the coil is connected back through a neutralising condenser to the grid of the first valve.

Balancing Capacity Feed Back

This is a very common method of neutralising. The capacity feed back through the valve itself is balanced out by the feed back through the neutralising condenser when this latter has been correctly adjusted. Moreover, since this

arrangement is perfectly symmetrical, the adjustment will remain steady over the whole tuning range.

A further advantage in this method lies in the fact that the valve is only shunted across half the tuned circuit. The valve has the effect of introducing extra damping or losses into the tuned circuit, and by connecting it across only half of the circuit such as has been done here, the losses are considerably reduced while the signal

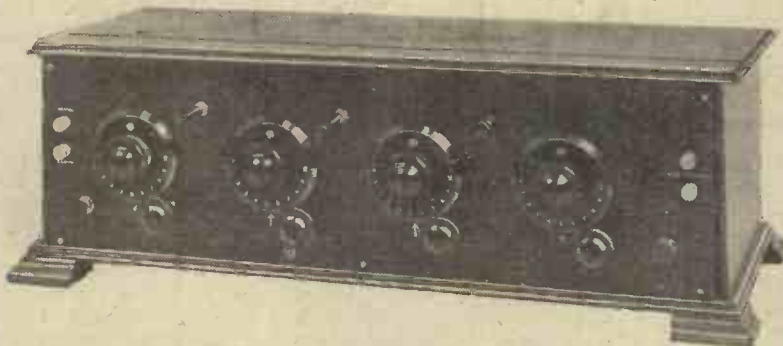

The controls on the completed receiver are arranged in a symmetrical manner.

Such valves, however, are comparatively expensive, particularly if five have to be purchased, so that the present receiver has been designed to operate quite satisfactorily on smaller and cheaper types of valves.

In this connection very good results were obtained, using the Cosmos Shortpath valves, which only cost 12s. 6d. each, and since the total cost of all the components, including a set of five Cosmos valves, comes to

The "Five Fifteen"—continued

strength, if anything, is somewhat increased. Both sensitivity and selectivity, therefore, are increased by this arrangement.

Curious Oscillations

The anode of the second high-frequency valve contains a straightforward tuned anode circuit. It is not possible to split this circuit as is done with the previous one, because if two split coils are used certain difficulties arise due to the generation of what are known as *parasitic oscillations*. These are oscillations which occur at very high frequencies of the order of 5,000 kilocycles (60 metres), and they have the effect of spoiling reception completely. As a matter of fact, it is the suppression of these parasitic

operating on the usual Reinartz principle. Also this same reaction coil has been utilised for another purpose. It is often desired to receive the local station only, and not to employ the full five valves. In such cases provision is usually made for cutting out some of the low-frequency stages.

An Interesting Departure

In the present arrangement, however, facilities have been provided for cutting out the two high-frequency valves, when the circuit becomes a simple Reinartz receiver with two note magnifiers. The simplified circuit diagram with this arrangement is shown in Fig. 2. In order to effect this change-over, it is simply necessary to disconnect the aerial from its

methods are often not satisfactory owing to the presence of capacity coupling between the circuits.

Screening the Coil

I have been experimenting for some considerable time in order to find a satisfactory solution of these difficulties, and as a result I developed a coil which is completely enclosed in a metal screen. It is then impossible to obtain any appreciable capacity or magnetic coupling between this coil and adjacent coils. At the same time the efficiency of the coil is not seriously impaired so that the arrangement becomes quite a practical proposition.

Reducing Coil Coupling

These screened coils, however, are

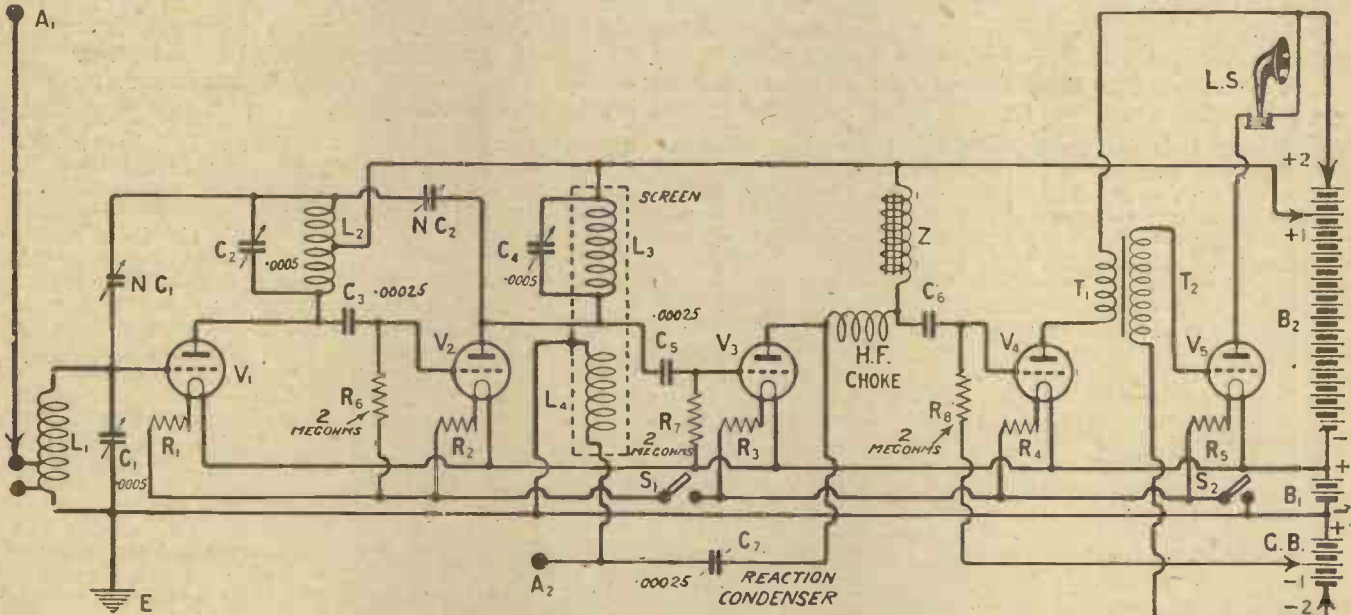

Fig. 1.—Capacity and magnetic coupling between the coils L4 and L3 and adjacent coils is reduced by screening.

oscillations in multi-valve receivers which leads to the introduction of the expensive complications.

A Small Sacrifice

In this particular case it was decided, for the sake of simplicity, to sacrifice a little efficiency and to employ a full circuit in the anode of the second valve. If this is done there is no tendency to parasitic oscillations, but of course the valve damping exercises its full effect, and the circuit is not so sharply tuned. Neutralisation of this second valve has been obtained by connecting a small neutralising condenser between the anode of V₂ and the remote end of the coil L₂.

A Dual Purpose

Finally, in order to reduce to some extent the damping of the last circuit, a reaction control has been provided,

usual terminal and connect it to the auxiliary terminal provided. The first two valves may then be switched out by means of a small push-pull switch, while the aerial is then connected direct to the end of the reaction coil, so obtaining a simple Reinartz arrangement. This is quite satisfactory for the local station, while the whole five valves may be used for distant work.

The Result of Experience

Having decided on the circuit to employ we come then to the constructional details. Now, my experience in the past two months has indicated very strongly that one of the biggest bugbears in a high-frequency receiver is the stray coupling between the coils. Many methods have been devised from time to time for placing three coils in such positions that there is no appreciable coupling between them, but these

naturally a little expensive, so that in the present case I have only employed such an arrangement for the third coil. We can, therefore, place the first two coils in such a position that the coupling between them is comparatively small, while the third coil is enclosed in its metal shield, and there is, therefore, no coupling either between the second and third or the first and third coils.

A Detail to Note

This arrangement has proved quite satisfactory, the only difficulty being in ensuring a zero coupling between the first and second coils. To this end I have placed the coils in a certain definite position, and while this position is not very critical the layout given must be followed exactly, as far as these two coils are concerned.

I shall give very careful instructions later in this article as to how to ensure

The "Five Fifteen"—continued

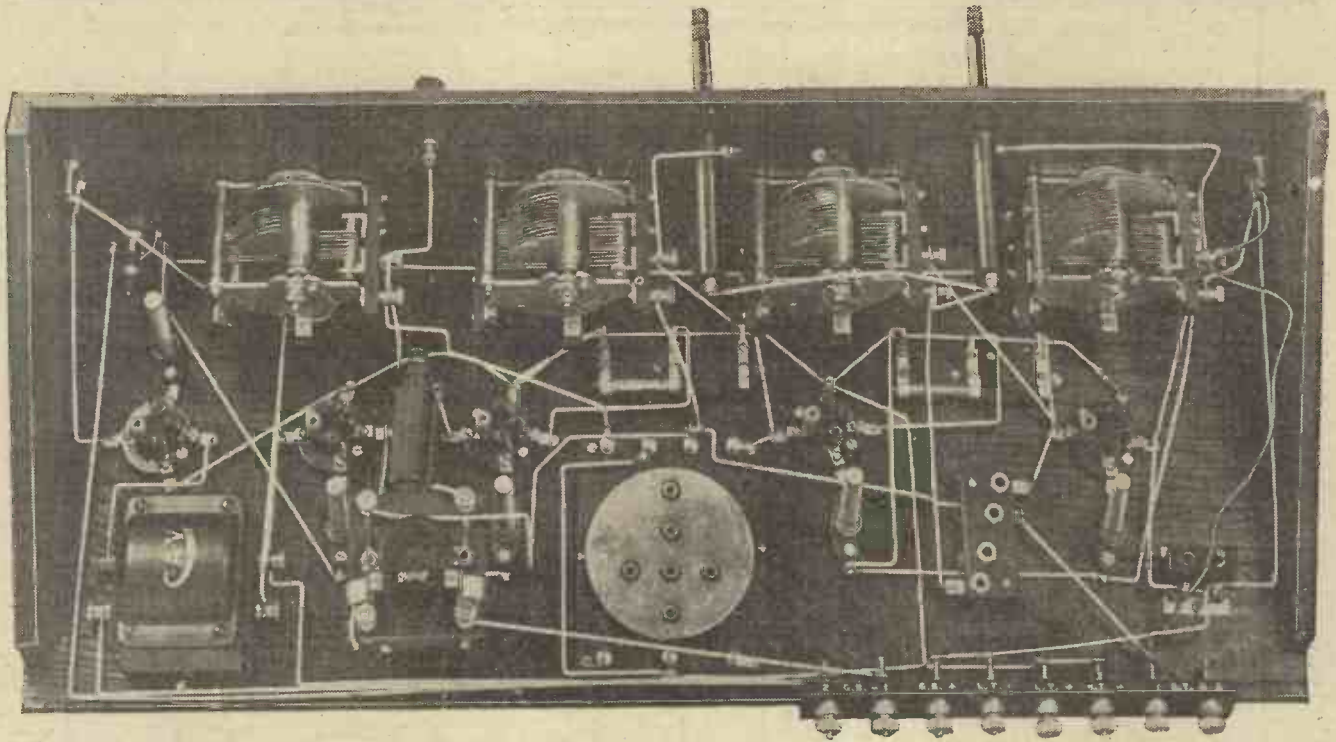

The fixed resistors for the filament circuits must be chosen to suit the particular valves employed.

that the first and second coils are correctly spaced. Particular care must be taken to follow out these instructions as this is an important point in the satisfactory operation of the receiver. The remainder of the receiver requires no special attention whatever, and can be constructed in a straightforward manner.

Components Required

Coming now to the actual constructional work you will require the following components:—

One ebonite panel, 24 in. by 7 in. by ½ in. (Clayton Rubber Co., Ltd.)

One cabinet to suit. American type with baseboard 8½ in. deep. (Caxton Wood Turnery Co.)

Three .0005 variable condensers, with slow motion fitting. (Metro-Vick Supplies, Ltd.)

One .00025 variable condenser, with slow motion fitting. (Metro-Vick Supplies, Ltd.)

One G.R.C. low loss coil, No. 277C. (Claude Lyons.) (This is the centre-tapped coil used in the first tuned anode circuit.)

One screened coil. (Peto-Scott Co., Ltd.). (This component is made in two parts. The base and the screening cover which fit over it are made up as one unit, while the coil itself is made to plug in to the base. It can thus be changed for coils suitable for another wavelength, if so desired, without purchasing another screening case.)

Two neutralising condensers. (Neutrovernia.) (Gambrell Bros., Ltd.)

Five anti-phonic valve holders. (A. H. Hunt, Ltd.)

One high-frequency choke. (Metro-Vick Supplies, Ltd.)

One A.J.S. choke unit, complete (1st stage). (A. J. Stevens.)

One all-purpose low-frequency transformer. (C. A. Vandervell, Ltd.)

Two on-off switches, push-pull type. (Lissen, Ltd.)

One terminal strip, 8 in. by 1½ in., containing eight terminals.

Four 4 B.A. terminals.

One Belling-Lee terminal marked "Aerial." (This pattern of terminal

was obtained to match the neutralising condensers on the front of the panel, but an ordinary terminal may be employed if desired.)

Packet Radio Press panel transfers.

Four 2-ft. lengths Glazite wire.

Five fixed resistors, to suit the valves employed. (Burndept Wireless, Ltd.)

Two .00025 fixed condensers with series grid leak clips. (Dubilier Condenser Co., Ltd.)

Two 2 megohm grid leaks. (Ditto.)

One baseboard mounting coil holder.

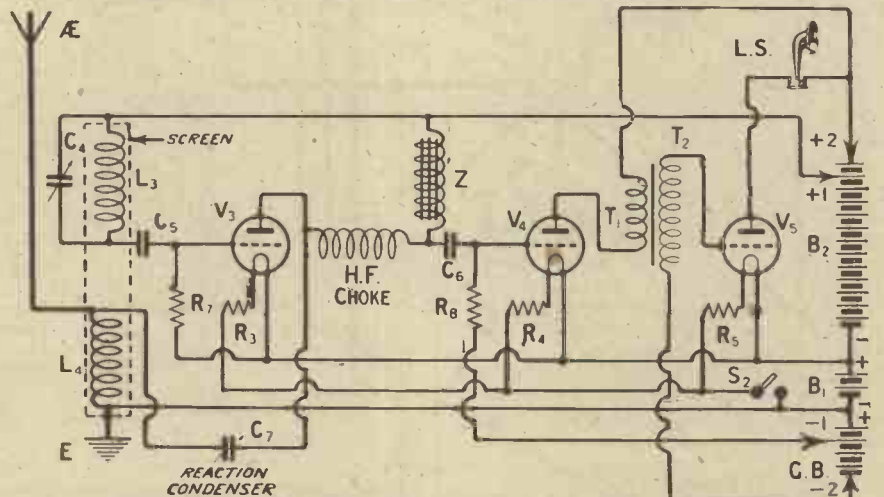

Fig. 2.—By connecting the aerial to terminal A2 of the Fig. 1 diagram and opening switch S1, the local station can be received on the last three valves.

The "Five Fifteen"—continued

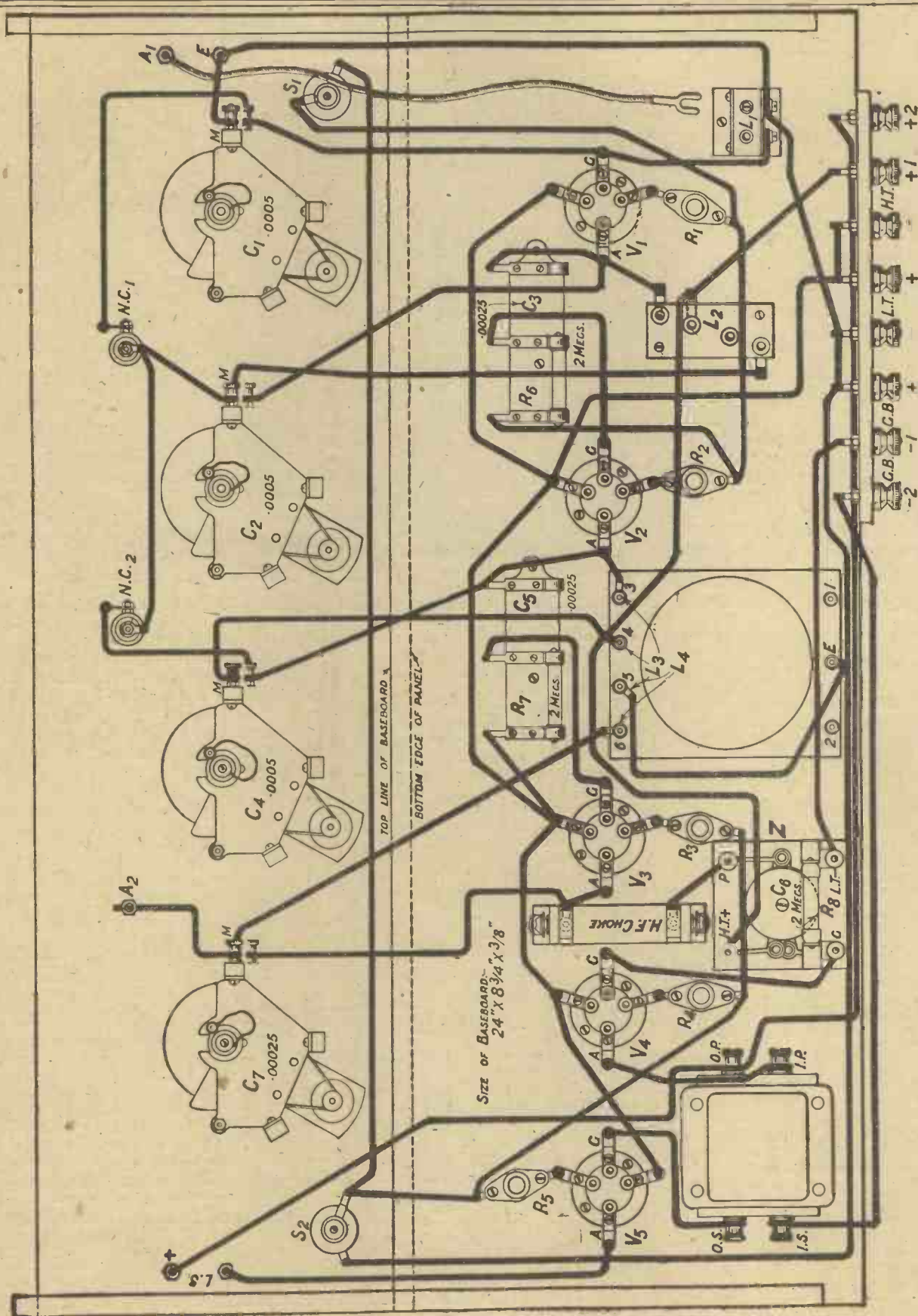

Fig 3.—Take care to dispose the components on the baseboard in the manner indicated in this diagram. Blueprint No. C1050B.

The "Five Fifteen"—continued

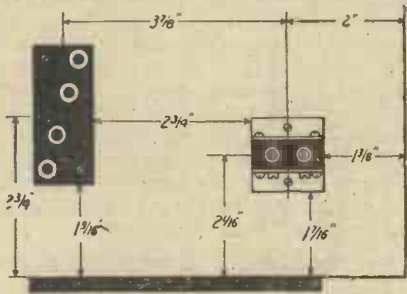

Fig. 4.—To avoid stray coil coupling the coil sockets should be fixed to the baseboard according to these dimensions.

A Straightforward Layout

The layout of the components on the baseboard may be seen from Fig. 3, and it will be observed that a straightforward arrangement has been adopted. The only components about which any special care has to be taken are the first two coils. It will be noticed that the Lissen X coil is placed end on to the second coil, but it is not placed centrally. This is because there is a certain capacity coupling existing between the coils, and it is found that the coupling between the two coils is a minimum with the first coil slightly off the centre as shown in this layout.

Coil Positions

The actual details of the positions are shown in Fig. 4, and these positions should be followed as far as possible. It is particularly important that the connections to the coils should be exactly as on the original set, and if this is done and the coils are placed in the positions shown no difficulty whatever should be experienced. It will be necessary to make connection between the pins on the G.R.C. coil and the winding, and these should be made in accordance with the diagram given in Fig. 6.

Drilling Details

Having laid out the components on the baseboard in the positions shown

the panel components may next be mounted. Mark out the panel in accordance with the dimensions given in Fig. 5. Two holes will be required for each of the variable condensers, one for the main spindle and one for the slow-motion device. Two further holes will be required for the two push-pull switches, one being placed at each end of the panel, while three holes are necessary at the top of the panel, two for the neutralising condensers and one for the additional aerial terminal. Finally two holes should be drilled at each end of the panel to take the aerial, earth and loud-speaker terminals.

The Initial Wiring

The components may now be mounted on the panel, and the panel placed temporarily in its correct position in order to ensure that none of the components foul the baseboard components. If the correct position

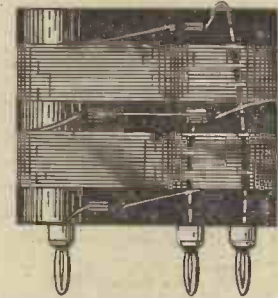
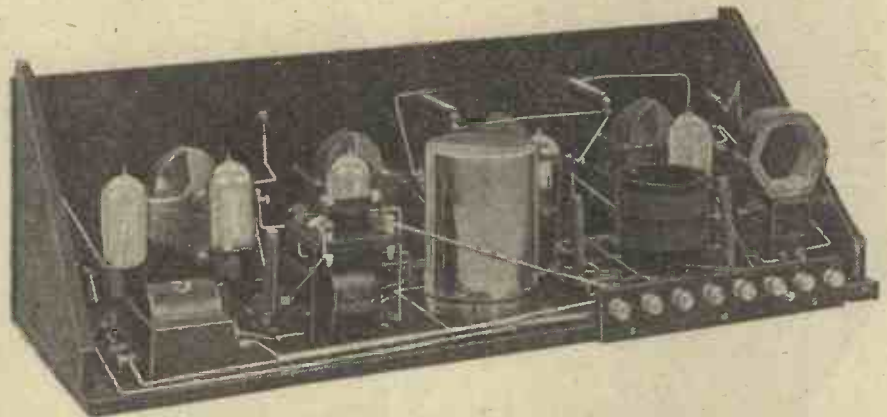

Fig. 6.—Connections between the pins and the G.R.C. coil are clearly shown in this figure.

wired with the exception of the final connections to the filament leads, the connections to the variable condensers, and the aerial, earth and loud-speaker connections.

The Next Step

After this has been completed the



With the coils and valves in position the receiver presents a very compact appearance.

has been obtained, no difficulty will be experienced here. The panel should now be placed on one side and the wiring commenced.

Wire up the baseboard components first of all. The whole circuit may be

wiring on the panel should be completed as far as possible. The neutralising condensers are connected to the appropriate points on the variable condensers, the spare aerial terminal connected to one side of the

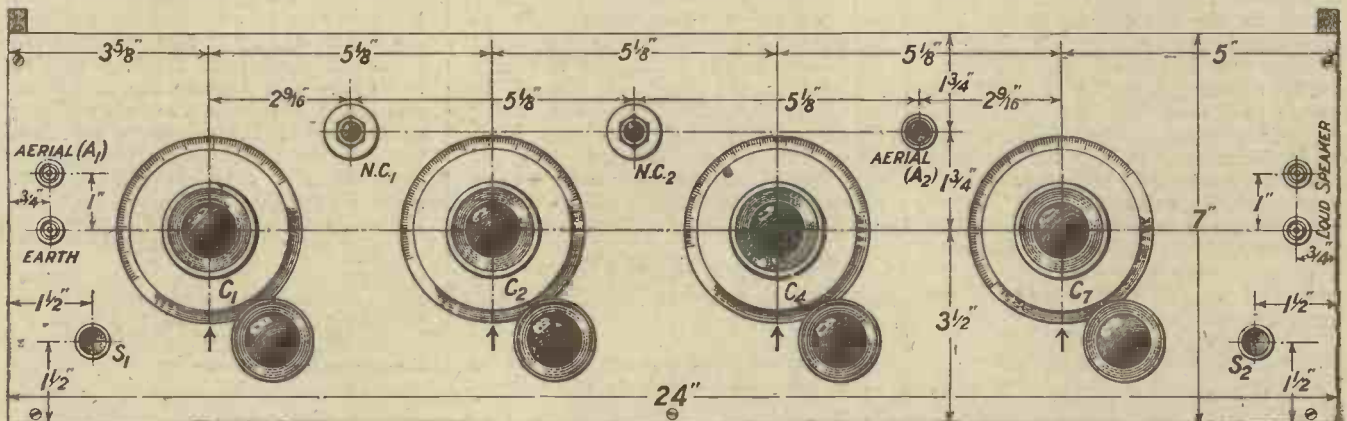

Fig. 5.—Front of panel details are given in this diagram and Blueprint No C1050A can be obtained if desired.

The "Five Fifteen"—continued

reaction condenser, and finally a lead is run between the two push-pull switches, as can be seen in the wiring diagram Fig. 3. The panel should now be mounted in position, and the remaining wires connected. These are the connections from the coils to the variable condensers, the aerial and earth connections, the loud-speaker connections and the other connections to the push-pull switches.

All in Readiness

The receiver is now ready for testing out. Carefully check over the wiring to ensure that no mistake has occurred. Then connect up the low-

valve for the last stage. I actually tested the receiver with Cosmos S.P.18 Green Spot valves for the first four stages, and S.P. 18 Red Spot for the last stage, using 60 volts for high-tension H.T.1 and 100 volts for H.T.2. Other valves tried were D.E.5b and D.E.5, D.F.A.4 and D.F.A.1, D.E.2H.F. and D.E.2L.F., and similar types of valves.

Choosing the Fixed Resistors

The filament resistors must obviously suit the particular type of valves employed. Using the Cosmos valves running off a 2-volt accumulator, the resistors should have a resist-

short, thick leads for the filament connections, so that the voltage on the set itself shall be nearly equal to that of the accumulator.

Using D.E.5 or D.F.A. types of valves, the resistors should be 4 ohms each, but the actual resistor suitable for any given valve may be obtained on application to the various manufacturers of fixed resistances.

The First Step in Neutralising

The receiver may be tested out as follows. Connect the aerial to the auxiliary terminal in the middle of the panel. Switch on the right-hand push-pull switch, and push the left-

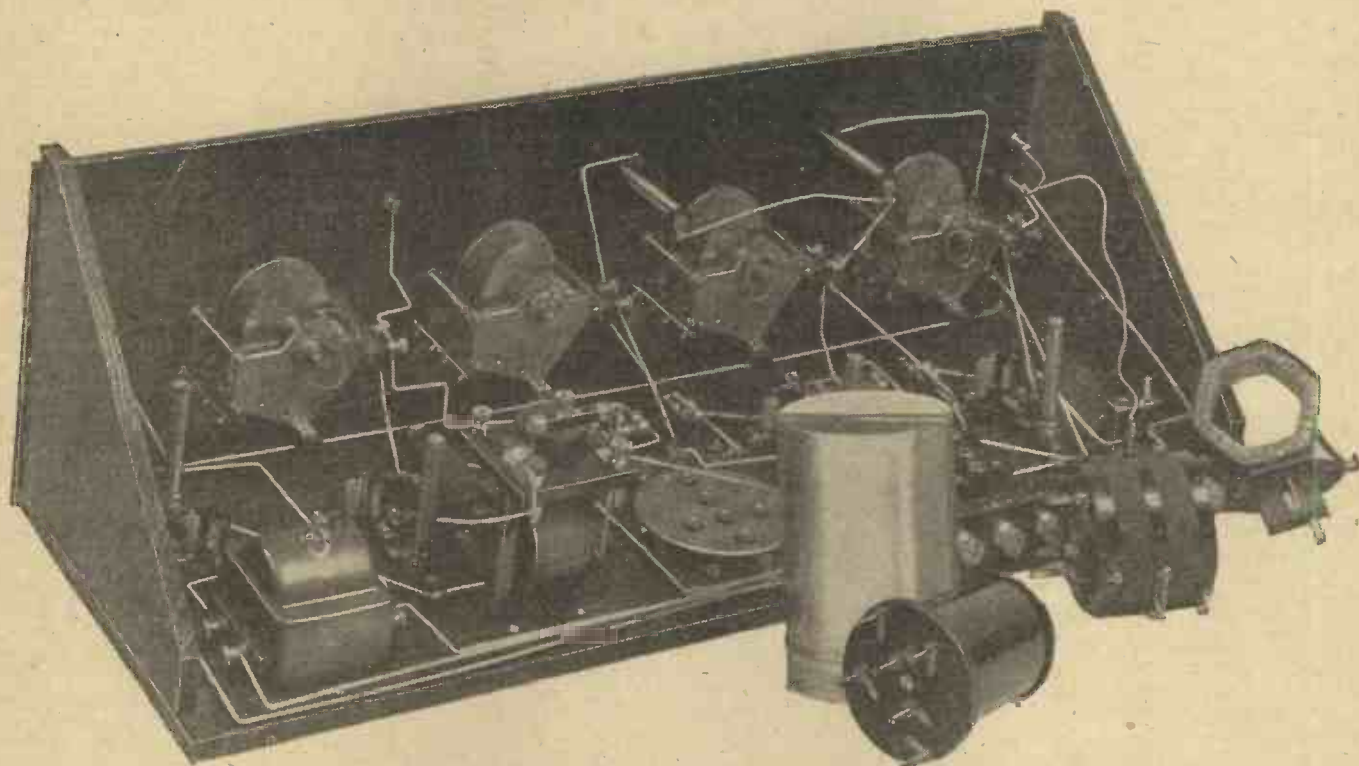

The special shielded coil with case is shown in the foreground in this photograph.

tension battery, and insert suitable valves in the various sockets. The right-hand push-pull switch controls all the filaments, while the left-hand switch (looking from the front of the panel) switches off the first two (high-frequency) valves. If everything is correct the high tension may then be connected, starting with a very small voltage, and noting whether there is any change in the brilliancy of the valves. If there is not, the wiring may be assumed correct, and the full high-tension voltage can be employed.

Suitable Valve Combinations

The valves to use may be any make of high-impedance valve for the first four stages, and a suitable power

valve for the last stage. This will drop the voltage on the valve itself to between 1.7 and 1.8, allowing for a small drop in the leads from the accumulator to the set. It should be noted particularly that when using fixed resistors like these the leads from the accumulator to the set should be short and thick, and capable of carrying the current without much voltage drop.

Avoiding Voltage Drop

Obviously if the voltage on the terminals of the set in the case just quoted was only 1.7 to start with, then no resistors at all would be required, because this is the voltage at which the valves should work. Care should be taken, therefore, to use

hand switch in, thereby cutting out the first two valves. Set the reaction condenser at zero, and adjust the third condenser until the local station is heard. Now remove the first fixed resistor, place both the neutralising condensers at the minimum position, transfer the aerial to the terminal on the left-hand side of the set and close the switch S_1 .

True Neutralisation

Place the first two condensers approximately in the same position as the third condenser. It will be found by a slight readjustment that the local station can be heard at quite good strength with this arrangement. Having tuned in the local station in
(Continued on page 873.)

CIRCUMSTANCES ALTER CASES!

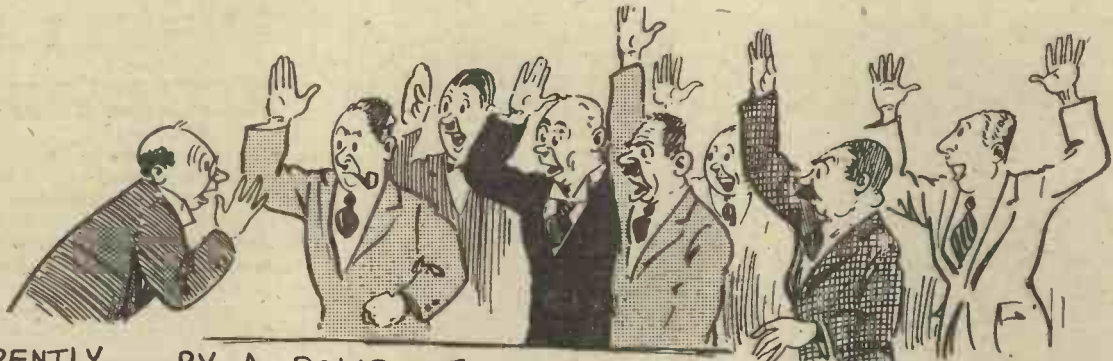

RECENTLY — BY A SOLID VOTE OF THE WIRELESS CLUB IN OUR SUBURB
 - WAR WAS DECLARED ON SIMKINS - THE PRIZE
 "ASS-CILLATOR" OF THE DISTRICT —



- THEN THE GREAT
 COAL AND
 TRANSPORT
 STRIKE WAS
 DECLARED.
 SIMKINS HAS
 A NICE CAR AS
 WELL AS A WIRELESS SET —

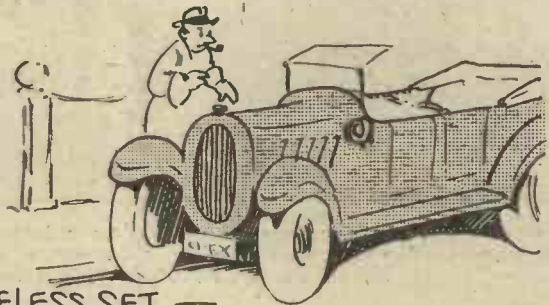

- SO OF COURSE WE ALL AGREED
 THAT IN A NATIONAL CRISIS —
 ALL OUR PRIVATE PETTY
 GRIEVANCES SHOULD BE
 OVERLOOKED!



- CARRIED UNANIMOUSLY!

CON SHAW

THE STRIKE AND IMPROMPTU WIRELESS RECEIVERS

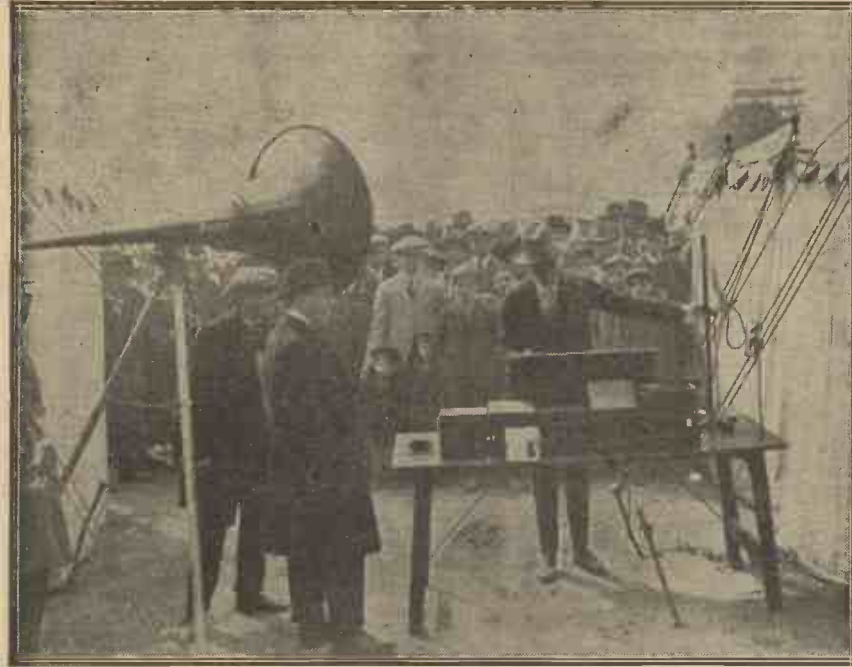

The public demand for news was filled in one instance by the installation on the Horse Guards Parade, in London, of a superheterodyne set with a large power loud-speaker.

LONG, long ago, someone said that if the Editor of this paper were wrecked upon a desert island with a keg of nails and a few biscuit boxes, with perhaps a coconut or two, he would establish radio communication with the outside world within a day or so! It seems to me that the strike we have just passed through has shown that the Editor is by no means the only fortunate person in this respect. Some of the sets I met during that memorable fortnight were eye-openers to me as regards the ingenuity of the British public.

Using up Junk

It really is astonishingly simple to collect together a few miscellaneous bits of junk and to construct with them a set that really and truly works! If the constructor lives within a mile or so of the broadcasting station he needs no other components than a pair of headphones, and those who reside within the same town need nothing more elaborate than a hastily-constructed crystal set.

Can It Be True?

During the strike I am told that certain people living almost under the shadow of 2LO's aerial were able to receive news bulletins by the simple expedient of wearing a pair of 'phones, and holding one tag in their fingers while letting the other dangle under a thin stream of water from the tap. Others found that a pair of leads,

one to the gas pipe and the other to the water main, acted as an aerial, earth, inductance, capacity and detector all in one! (So they said.)

A Set in Half-an-Hour

In the first issue of *Wireless*, which appeared on September 19, 1925, Mr. Percy W. Harris described a crystal set that could be constructed in half an hour, and I am told by a member of the staff that several readers have written in reporting excellent results with sets made to this specification. Apparently one of them broke all speed records with a set constructed in 14 mins. 45 secs.! In every single case the local broadcasting station was received quite clearly.

For the benefit of readers who do not remember the set in question, I had better state that the components used were a piece of board, a length of bell-wire, some staples, some small pieces of tin, two small wood-screws and a crystal.

A One-Valve Set for the News Bulletin

Such a set as this would ensure reception of the news, etc., in such an event as another general strike, as far as anyone who lived in a town which possessed a broadcasting station was concerned. Those within about 200 miles of a main station were similarly catered for in *Wireless*, Vol. 1, No. 10, in which Mr. Reyner described "A Complete Valve Station for 35s." As

Everyone has stories to tell about events of the general strike, and wireless has its own contributions to make to the general store. Some amusing incidents and curious feats of reception are recorded on these pages.

far as all outward appearances were concerned, this set was apparently no more complicated than the crystal set, but the results were just as good as could be expected from the best of single-valve sets.

Wholesale Conversions

Most enthusiasts are rather inclined to "turn up their noses" at sets of this description, but several of them were converted during the strike, when they had their standard set in pieces, or were overhauling it, and you should have seen some of the contraptions turned out by the most firm advocates of soldered connections!

Oh, Those Aerials!

As a rule, however, less ingenuity was exercised in the construction of the actual sets than upon the erection of the aerials and earths. The memory of some of the aerials I saw still makes me shudder for the lack of insulation, now that we have time to set about things properly again. In one case the aerial itself (of bare wire) was used as the halyard, being passed round a chimney-stack, along a metal gutter, and pulled tight down the side of a house. Even a bedstead seemed to be thoroughly well insulated after that!

Did You Notice It?

In another case the gas-pipe was used as an aerial and the water-pipe as an earth, while an aerial was constructed in about five minutes by dangling a piece of wire netting out of a third-storey window. No one seemed to think of using the overhead power supply wires for the trams or trains as an aerial, but I wonder how often the G.P.O. telephone lines were utilised for this purpose? I heard that several users of telephone boxes were surprised to hear the news bulletins or some music superimposed upon the voice of the subscriber at the other end.

Even the Bedstead

A bedstead makes quite a respectable aerial for the owner of a valve receiver, but unfortunately is of very little use to the crystal man unless he

The Strike and Impromptu Wireless Receivers—*continued*

is within a mile or so of the local station. Instead of an earth, a counterpoise, consisting of a wire hidden away under the carpet or nailed round the skirting, may be used.

Establishing Communication

Talking of counterpoises, the manager of a well-known firm of radio manufacturers foresaw possible trouble with the telephones and telegraphs, and established low-power short-wave transmitters and receivers at the London showrooms and at the works, 120 miles distant, during the second

between the rushes of customers who chose the times at which the news bulletins were broadcast to call for a demonstration, by chatting with sundry "short-wave acquaintances" of his, using a small aerial and a counterpoise running across the floor of the demonstration room.

Strange Detectors

Others there were who derived help from Mr. Reyner's article in an early issue of *Wireless*, entitled, "Some Strange Detectors." Such appetising detectors as sugar, potatoes, carrots

time ago, were stranded in the mountains with a motor-car. They used the ignition coil with two nails as a spark transmitter, and the receiver consisted chiefly of a piece of graphite (provided by a lead pencil) resting on an iron nail.

Within a few minutes of the first call they received a warning to stop transmitting, as their signals were interfering with the broadcast reception in the nearest town, eighty miles away! Truly a strike gives one an excellent opportunity for showing initiative and ingenuity in matters wireless, at any rate, but we have not yet heard of a case parallel with this!



The headquarters of the British Broadcasting Company at 2, Savoy Hill were closely guarded throughout the strike to prevent unauthorised persons from gaining admittance and possibly interfering with the broadcasting service.

week of the strike. With about 200 volts in dry batteries and a small receiving power-valve at each end, quite reliable communication was maintained, and he was quite disappointed at not being forced to use this improvised equipment.

He amused himself, however, in

and coke were employed, to say nothing of such methods as using flames, carbon microphones and pieces of "Plasticene."

A Story Worth Telling

Finally, let me quote the story of two Americans (of course!) who, some

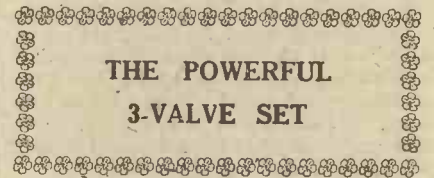

THE POWERFUL 3-VALVE SET

SIR,—In response to the request usually made by your periodicals for reports on sets as designed by yourself and others, I am forwarding these few remarks.

I have completed the "Full Power from Three Valves" set described by Mr. Harris in the April, 1925, issue, and I must say that it is giving splendid results. Needless to say, Daventry, at about 100 miles, Cardiff at 28, and Bournemouth 76 to 80 miles, are really loud on the loud-speaker. Most of the B.B.C. stations are enjoyable on the 'phones, and reception from the Continent has been equally good. During the recent International tests, I enjoyed the short programmes from 7 (seven) Continental stations, including Prague, Breslau, Madrid, Stuttgart, and Munich. As regards the Daventry, Cardiff, and Bournemouth stations, music and speech can be heard sweetly and easily over the whole house.

I have built several sets designed by writers in *THE WIRELESS CONSTRUCTOR*, but this is easily the best for volume and what I call sweetness (no distortion).

May I add a few words about your papers? I do not often write in praise, but I feel compelled to say that *THE WIRELESS CONSTRUCTOR* is the cream of the bunch, with *Wireless* and *Modern Wireless* running very close. I keep every issue, and find them invaluable when experimenting and building. I only wish *THE CONSTRUCTOR* was issued fortnightly instead of monthly.

With every good wish for the success of the Radio Press periodicals. Believe me,

Yours faithfully,

Bristol. F. J. LEALAN.

P.S.—By the way, my aerial is a short twin, and rather badly screened by adjoining buildings; 10 ft. earth to tap.



LOG THAT STATION'S WAVELENGTH

BY B.G.R. HOLLOWAY

To be in a position to measure the wavelengths of broadcasting stations is both advantageous and desirable. The wavemeter described in this article possesses many novel features, sharp tuning being only one of its merits.

THE buzzer wavemeter to be described in this article possesses several novel features, the chief of which is the use of interchangeable calibration scales, to which are permanently attached their respective coils. These scales are divided into two parts, so that both frequency and wavelength can be registered.

Single Layer Coils

The coils themselves are of the single layer type wound with comparatively fine wire on a cylindrical former. The tuning coil is not connected directly in the buzzer circuit, but is coupled to it by means of a three-turn coil, as such an arrangement was found to give sharper tuning.

It has the further advantage that any adjustments to the shunts and buzzer, or the replacement of discharged dry cells, do not affect the calibration to any perceptible extent. Again, a greater tuning range is possible owing to the reduction of stray capacities, the tuning range in this wavemeter being from 200 to 600 metres with the coil for the lower broadcasting waveband.

A Useful Feature

Another useful feature is the inclusion of two filament rheostats of the non-inductive type. Although a wire-wound resistance—supplied with the buzzer—is shunted across the buzzer coil, it was found that a variable resistance in parallel was a great aid

in controlling the buzzer note. The second resistance is utilised to adjust the voltage applied to the buzzer terminals for the same reason.

buzzer windings, R_3 being supplied with the buzzer, while the third resistance R_1 controls the terminal voltage.

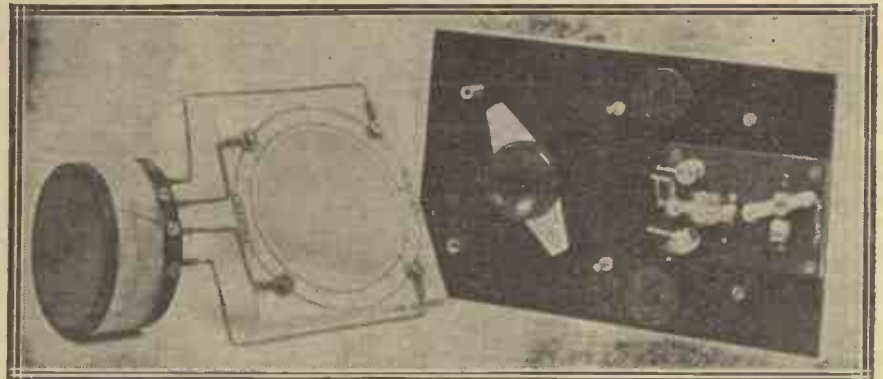

The coil and scale are detached readily from the ebonite panel, valve pins and sockets allowing satisfactory replacement.

Dry cells will require renewing sooner or later, consequently provision has been made for quickly replacing the discharged batteries. A large clip holds the battery in place while the necessary connections to the battery terminals are made with two spring clips.

The Theoretical Diagram

The complete circuit is given conventionally in Fig. 1.

L_1 , C_1 is the tuning system and L_2 , the coupling coil. R_2 and R_1 are the two resistances in parallel with the

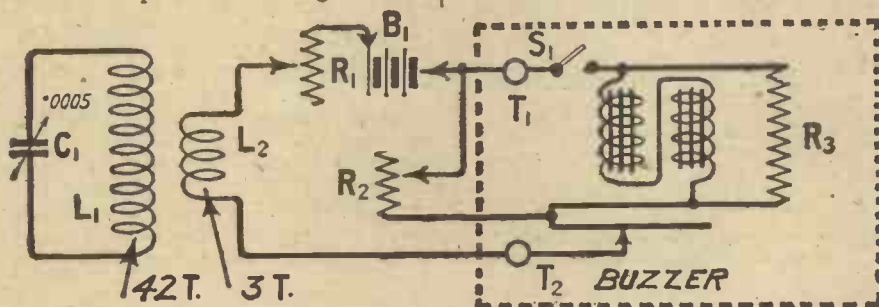

Fig. 1.—The tuned circuit $L_1 C_1$ is coupled to the buzzer circuit by means of a three-turn coil L_2 .

Components Required

The components employed in this particular case are listed below:—

- One buzzer (Silvertown Co.).
- One "Utility" .0005 low-loss variable condenser (Wilkins & Wright, Ltd.).
- Two Lissenstat Majors (Lissen, Ltd.).
- One ebonite panel, 8 in. by 5 in. by $\frac{1}{16}$ in. (American Hard Rubber Co.).
- One special cabinet (Peto-Scott Co., Ltd.).
- One sheet of Ivorine (Hobbies, Ltd.).
- One 4½-volt Ever-Ready Battery No. 15.

Also miscellaneous articles consisting of 3-in. diameter ebonite tube, 4 BA nuts and bolts, soldering tags, two spring clips, valve pins and sockets ($\frac{3}{16}$ -in. long), 2 ounces of 32 S.W.G. d.c.c. copper wire, square tinned copper wire, rubber-covered flex., small wood screws, and some 24-gauge sheet brass.

Constructing the Coils

Before the assembly of the set is undertaken, the coils, scales and battery clips should be constructed.

Log that Station's Wavelength—continued

The coils are wound on ebonite tube formers 3 in. in diameter and 1½ in. long. Cheese-headed 4 BA screws and nuts serve as terminals for the two coils on one former, and in Fig. 2 are lettered A, B, C and D.

One end of the 32 SWG wire is twisted under the head of the screw marked A, and three turns are wound on the former and finished at screw D to form coil L₂. B is the beginning of the tuning coil L₁, of 42 turns wound directly after the three-turn coil. The coil end is passed through two small holes drilled in the former and then fastened under C.

As a protection from the damp the coil is wiped with a cloth pad which has been previously soaked in a little thin shellac varnish.

Coils for higher wavebands can be wound with finer wire on formers up to 3 in. long, as this size is accommodated easily in the special partition of the cabinet.

Making the Scale

The scale is constructed from a sheet of ivorine 4 in. square, and it is important that it should be cut out carefully. The positions for the valve pins and sockets are shown in Fig. 2. Three concentric circles, 4 in., 3½ in., and 3 in. in diameter, are deeply scored with a pair of sharp dividers, and the 3-in. circle is cut away with a pair of sharp scissors, the remaining two circles being rendered visible by filling with Indian ink. The points where the 4-in. circle cuts the dia-

gonals of the 4-in. square are the positions of the valve pins and sockets, and ¼-in. diameter holes must be drilled to accommodate them.

cator attached to the underside of the variable condenser knob by two screws. It has a centre line scored as shown and marked with ink. In order to

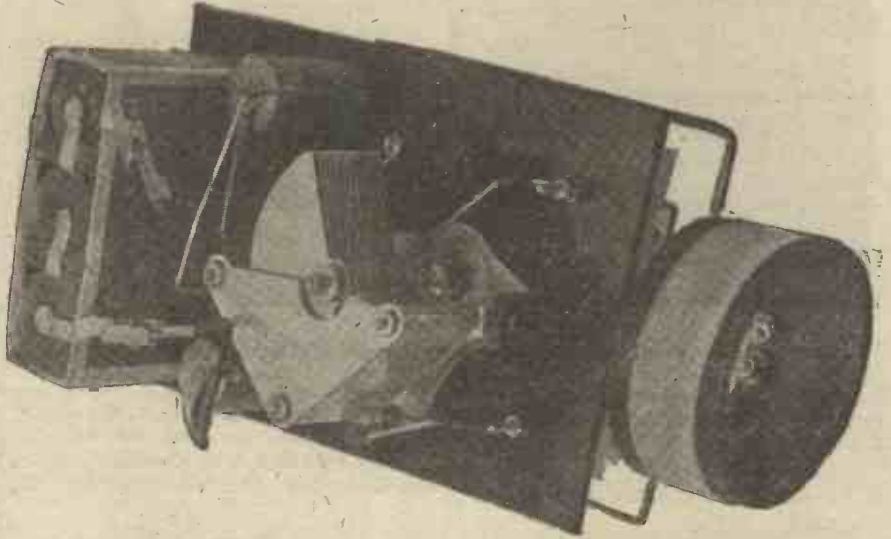

The battery is accommodated in a spring clip to allow of renewal when occasion demands.

After fixing the valve pins and sockets the coil former is held in position by four lengths of 16-gauge square copper wire. The shape to which these connectors are bent is clearly shown in Fig. 2.

make the set screw hole in the knob and bush coincide it may be necessary to use a little packing of some sort (the writer used a wad of paper) to compensate for the thickness of the dial, which, of course, is removed.

The Double Indicator

Do not discard the ivorine centre, as it can be used to make the double indi-

The Battery Clip

Details of the battery clip are given in Fig. 3, a rectangular piece of sheet

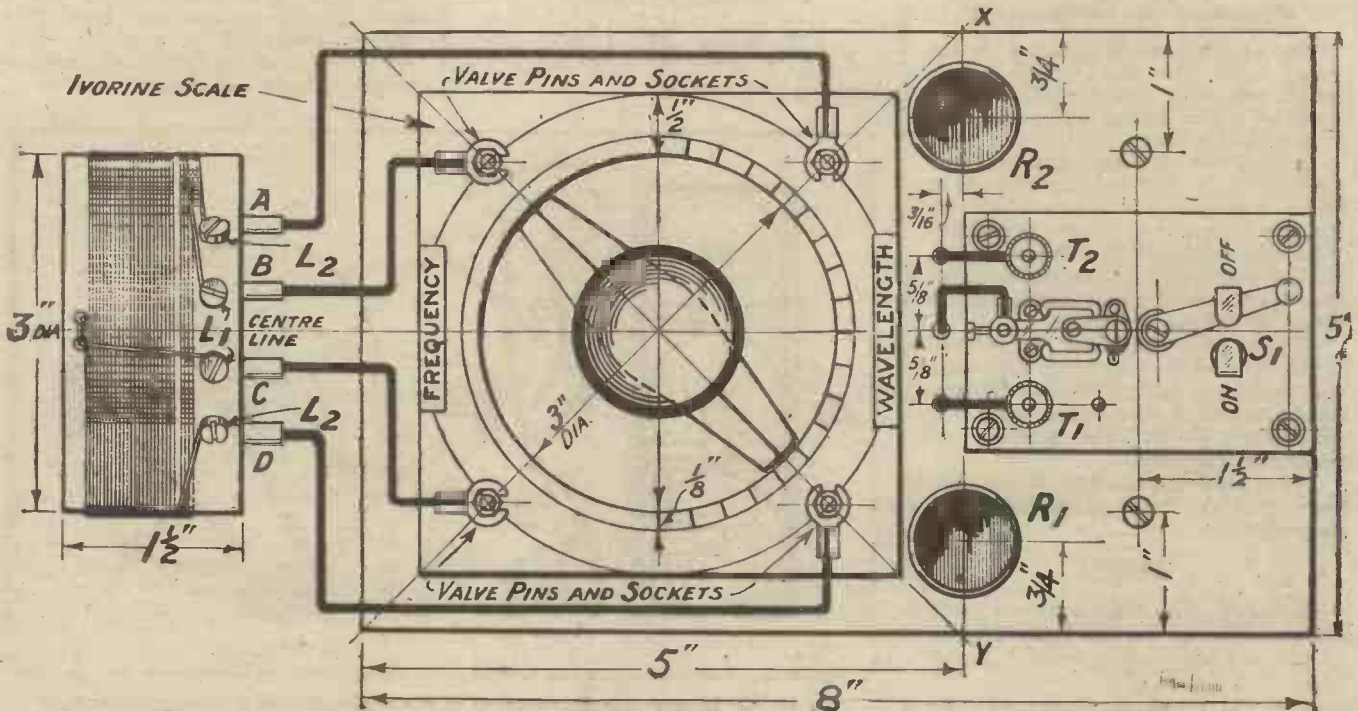
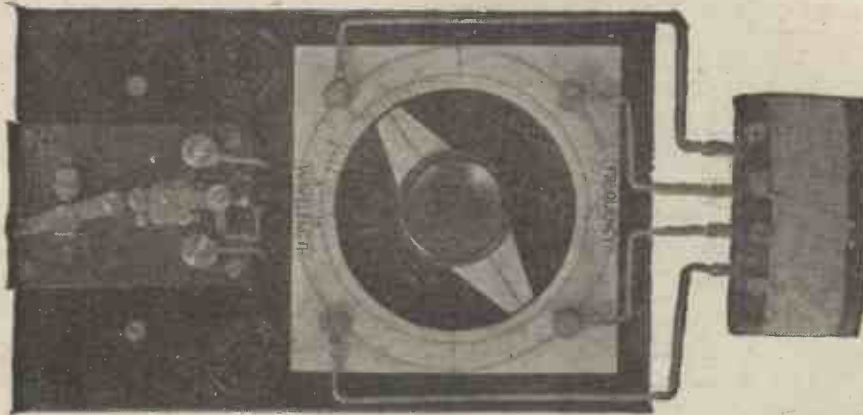

Fig. 2.—Complete front of panel details are given herewith. Blueprint No. C 1047A post free.

Log that Station's Wavelength—continued



Careful adjustment of the buzzer note is essential with this wavemeter.

brass 4 in. square being bent in the manner indicated with the fixing holes 3 in. apart.

Preparing the Panel

To determine the centres for the valve pins and sockets on the panel, it is recommended that a line XY should be scribed on the reverse side of the panel 5 in. from one end. The centre of the square thus formed is found by the intersection of its diagonals, and serves also as the centre of the 9/16-in. diameter hole, drilled for mounting the condenser. The centres of the valve pins and sockets are then located by the 4-in. diameter circle cutting these diagonals.

Mounting the Components

The buzzer base is mounted on the panel with four small wood screws, which cut their own threads in pilot holes of a diameter slightly less than that of the screws.

Having mounted the valve pins and sockets, the scale should be plugged in place and the pins shortened if too long. Retain the scale in position while the condenser is being mounted, as the position of the condenser must be adjusted until the indicator rotates centrally within the scale.

Finally, the indicator is secured firmly so that the pointer is flush with the scale and is in line with the two marks dividing the scales when the condenser is in the position of maximum capacity.

Fig. 2 gives the necessary dimensions for placing the components in position.

Wiring

The wiring is quite simple, and with the exception of the two battery leads, is carried out with square tinned copper wire, and the wiring diagram Fig. 4 will be of assistance at this juncture.

The three connections to the buzzer pass through three holes in the panel. Two of these wires connect to the terminals provided, and the third, which connects the variable resistance R,

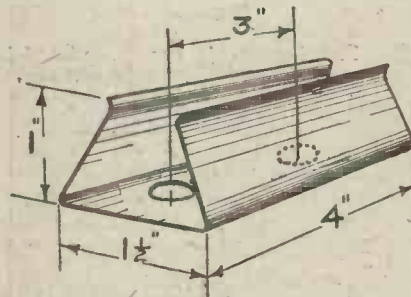

Fig. 3.—Details of the clip for holding the battery in place.

across the buzzer coils, is soldered to a tag held under the small set screw securing the vibrator.

Preliminary Testing

A certain amount of testing is essential before the instrument is ready for calibration.

The battery is clipped in position and connections made with the spring clips. The voltage controlling resistance is turned to its minimum value, while the variable shunt is turned to its maximum value. Carefully adjust the vibrator and R₁ and R₂ until a shrill note is emitted by the buzzer, as this will facilitate tuning operations.

To ascertain if the instrument possesses sharp tuning, the wavemeter is placed far enough from an ordinary receiving set until the note at resonance is just audible. In this condition, rotating either the wavemeter condenser or that of the set through one degree should reduce the strength of the note by about 50 per cent., while on de-tuning three degrees, the note should become inaudible.

Calibration

Those readers who have availed themselves of the unique service afforded by the Radio Press Calibration Scheme, details of which have appeared in Radio Press journals from time to time, will find no difficulty in drawing up a calibration chart from their previously logged readings. Further readings of the accurate wavelengths of certain broadcasting stations will be published in due course, and the reader is advised to keep a sharp look-out for the announcements.

Of course, if any other known source of oscillations which has been previously calibrated is available, then resort can be made to this for the completion of the wavemeter.

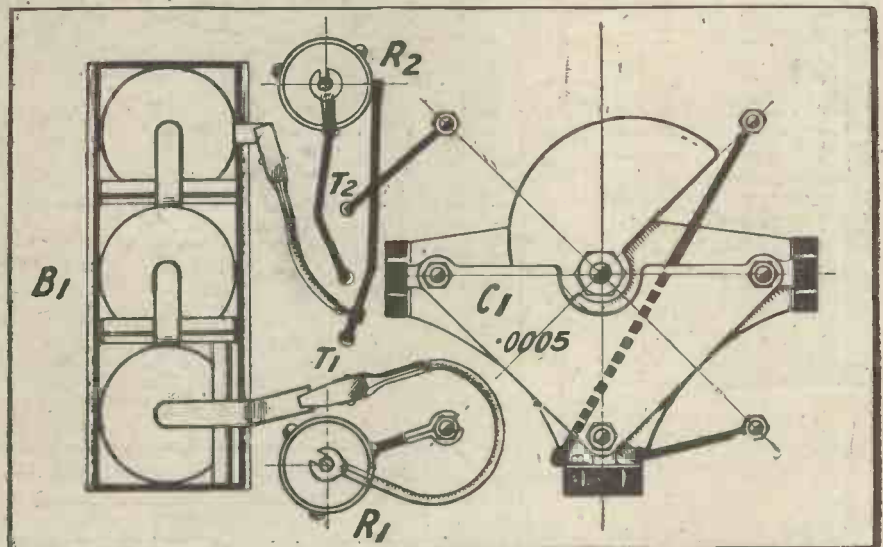

Fig. 4.—Wiring this instrument is a simple operation and Blueprint No. C 1047B is available for those constructors desiring same.



**WIRELESS CONSTRUCTOR
SETS
STILL TO THE FORE**

**THE "TWIN-VALVE"
LOUD-SPEAKER
RECEIVER**

SIR,—I feel compelled to write and thank Mr. Scott-Taggart for his "Twin-Valve" receiver (Radio Press Envelope No. 10). I have had the set about three months, and have tried it against various detector and L.F. circuits, and find for volume and selectivity it is unsurpassed. Living three miles from 5NG, that station comes in well on the loud-speaker (Brown H4), as do also Daventry, Birmingham and London. The following stations have been received at good 'phone strength:—Newcastle, Aberdeen, Glasgow, Manchester, Bournemouth, Dublin, Belfast, Radio-Toulouse, Hamburg, Madrid, San Sebastian, Cardiff, Stoke, Sheffield, and Hull. Using two D.E.3 valves, I find selectivity good, being able to tune in Manchester with little trace of Nottingham. I am now a regular reader of THE WIRELESS CONSTRUCTOR. Please accept my thanks for such a fine circuit and my best wishes for the CONSTRUCTOR.

Yours faithfully,
F. YAXLEY.

Carlton, Notts.

SIR,—It may interest you to know that I have built the "Twin-Valve" Loud-speaker Receiver described by Mr. John Scott-Taggart, F.Inst.P., A.M.I.E.E., in the January, 1925, WIRELESS CONSTRUCTOR and in Envelope No. 10.

The valves, transformer, etc., are mounted on a baseboard at the rear of the panel. The cabinet has a small ebonite plate let into each end; that on the left-hand side carries the "Aerial-Earth" sockets and C.A.T. condenser, and that on the right the L.T. and loud-speaker sockets. I am using two B.T.H. B.5 valves. The set gives excellent results, and is very sharp-tuning. The Cardiff station two miles away is much too loud on an Amplion Dragon (A.R.111). I have also received the following stations:—London, Bournemouth, and Daventry

on the loud-speaker; Paris (Radio-Paris), Madrid, and the Marconi station, Rome (the latter testing) at good 'phone strength.

I think these results are very good considering my aerial is only 16 ft. high by 40 ft. long, 20 ft. being badly screened. The Cardiff station comes in exceptionally well on a frame aerial.

Wishing your journals every success,
Yours faithfully,
C. R. THORN.

Cardiff.

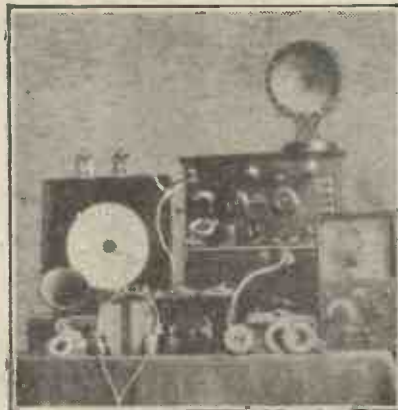

The enthusiasm of Mr. H. G. Brown is reflected in this photograph showing mainly home constructed apparatus.

**THE NEUTRODYNE
TWO**

SIR,—I have constructed the "Neutrodyne Two" set described by A. S. Clark in the February, 1926, issue, of THE WIRELESS CONSTRUCTOR, and am delighted with the results. I have added two stages of L.F. amplification, and it thus makes a wonderful four-valve set. I have also added constant aerial tuning by means of a fixed condenser, and find it extremely selective. I am situated about four miles from the Hull relay station, and can cut out that station and get London, Manchester, Newcastle, etc., at very good strength on the loud-speaker with four valves.

The set is extremely stable. With best wishes for the success of your excellent journal.

Yours faithfully,
ROBT. AKESTER.
Cottingham, Yorks.

**ANOTHER
"TWIN-VALVE"
ENTHUSIAST**

SIR,—I thought perhaps the enclosed photograph might interest you, as it shows gear that I have made practically without exception, from your very fine monthly. I have read THE WIRELESS CONSTRUCTOR from its first appearance, and am certain that no other book in its line can touch it for sheer value for money and clear information.

I have proved the "Twin-Valve Receiver" to be a marvellous set for range, purity and simplicity. I have just come out here, and hope to find a set in your monthly on which I can get British broadcasting. The ether out here is very quiet in that respect, and is very noisy in regard to X's. The tests I carried out with the twin-valve receiver took place at Ongar, Essex, and, to be brief, I received all the B.B.C. stations, absolutely scores of foreign stations, and worked a home-made pleated loud-speaker on 2LO, 5XX, 6BM, and 5IT, and Radio-Paris, and received Madrid very comfortably on two pairs of 'phones. D.E.3 valves were used; H.T., 100v. and 45v.; G.B., 3v. to 6v. My aerial and earth are fairly good. Trusting your paper will continue its success,

I remain,
Yours faithfully,
H. G. BROWN
(Now an Overseas Reader).

R.A.F.,
Ambala, India.

Have you seen
MODERN WIRELESS
for June?
1s. PRICE 1s.



SOME HINTS ON FAULTS IN NOTE MAGNIFYING CIRCUITS

By G. P. KENDALL, B.Sc.

Have you ever been troubled by faults in your note magnifiers? Mr. Kendall gives some inside information which will prove invaluable when tracing the probable causes.

THE low-frequency amplifying portion of a receiving circuit is not by any means the easiest in which to find faults, and the matter is specially difficult when the fault occurs in a new set which perhaps has never worked properly, but gives symptoms of trouble immediately it is put on test upon completion. If your set has worked once properly, the development of objectionable symptoms is generally a somewhat easier matter to rectify.

A Common Fault

As these notes are meant to be of assistance in such cases, they deal mainly with the more probable faults, rather than attempting to treat the whole matter exhaustively. We will accordingly take the commonest fault first, namely, that of "howling," or oscillation, at audio frequency, which

most often occurs in sets with two stages of low-frequency amplification, transformer coupled. The first thing to try is reversing either primary or secondary winding of the second transformer, which in the majority of cases effects a complete cure. If the howl is not removed by such a reversal, it usually means that there is something radically wrong with the lay-out of the low-frequency circuit, and a greater spacing of the transformers, wiring, etc., should be tried.

Suggested Remedies

In some circuits, if the howl still persists, it may be necessary to adopt some of those rather crude remedies such as the use of shunting condensers of perhaps .001 to .0001 across the secondary winding of one or even of both the transformers, the use of a resistance of 100,000 ohms in the same

position, or of both these expedients together. In rare cases it is possible for a broken secondary winding to set up an audible howl, although the result of this fault is more often than not a slow and steady ticking sound.

Is it the Wiring?

There yet remains one other fairly common cause of howling on the low-frequency side, and that is the isolation of the battery circuit from earth by some fault in the wiring. It is fairly widely realised that if the battery of a two-stage transformer-coupled amplifier is not connected to earth, the whole apparatus will become exceedingly unstable, and if this should occur actual howling may result.

For example, in some cases a potentiometer is provided to control the grid potential of the first valve

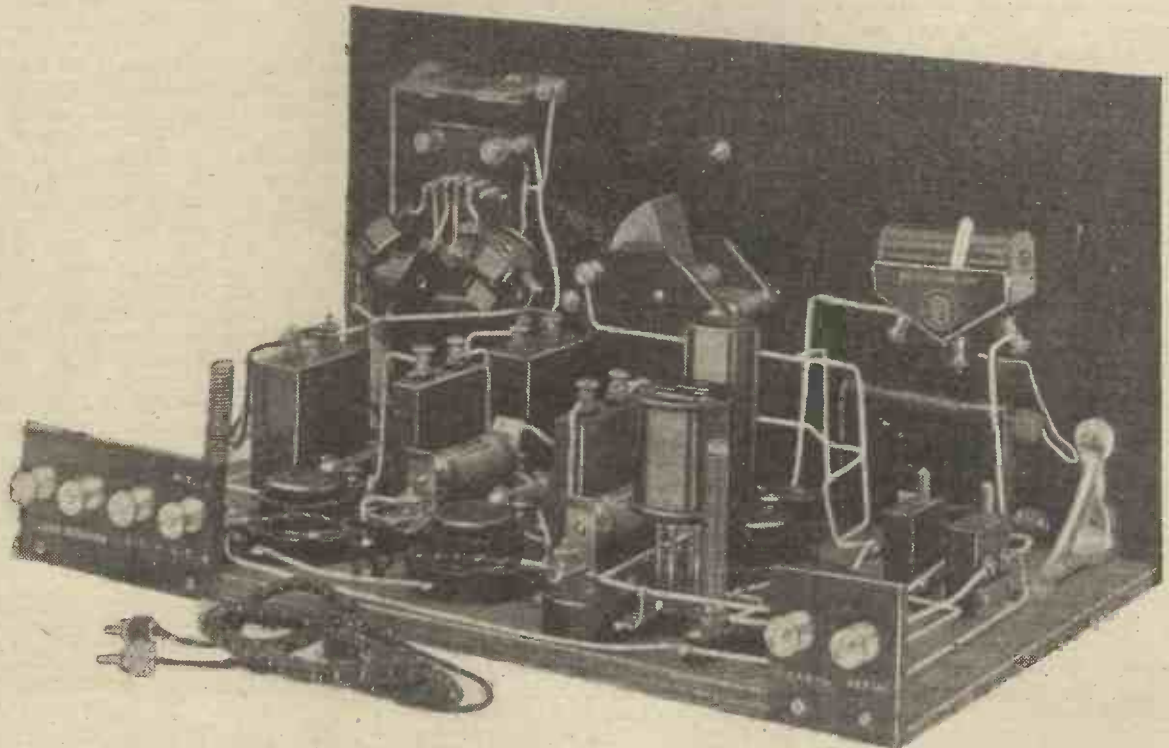

A common trouble with resistance-coupled circuits is a ticking noise, and when this occurs the grid-leak value is usually too high.

SOME HINTS ON FAULTS, Etc.—continued

or valves (the H.F.), and if a break should occur in the winding of this component, the battery circuit will be isolated from earth at some setting of the potentiometer. Accordingly, a really obstinate case of low-frequency howling should lead one to think it is the potentiometer which is at fault if one is present.

Ticking Noises

In resistance- and choke-coupled amplifiers the common trouble is not howling, but ticking, the periodicity of the ticks varying from quite a slow beat up to almost an audible note. The cause is usually a grid-leak of too high a resistance, and the first step should be to try one of, say, $\frac{1}{2}$ megohm or even $\frac{1}{4}$ megohm in place of whatever value was in use previously. At the same time carefully examine the connections from the grid-leak to the grid-bias battery and so on, for the purpose of detecting any possible broken contacts.

for a fraction of a second while the excess charge leaks from the grids.

The remedy previously given of the use of a lower value grid-leak should be tried in a case like this, and attention should also be given to the question of the correct amount of grid-bias to apply.

A Transformer-Coupling Trouble

Similarly, with transformer-coupled amplifiers a tendency towards self-oscillation at audible frequency may make itself manifest solely as distortion in the reproduction, either because audio-frequency reaction is taking place almost to the verge of self-oscillation, this type of distortion sounding very much like that produced by the use of excessive reaction from the detector valve, or because self-oscillation at a super-audible frequency is taking place.

The usual remedies for actual L.F. oscillation should be tried, and it must

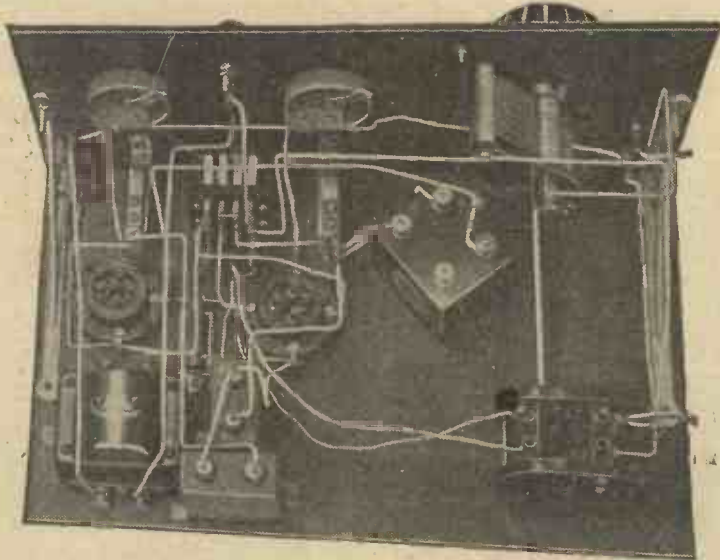

.....
The correct disposition of the transformers on the baseboard of a receiver must only be settled after careful thought.

The Working Impaired

A number of troubles may develop in note magnifiers which, although perhaps not, strictly speaking, faults, are worthy of consideration in an article of this sort, since they impair the working of the amplifier in much the same way as a true fault will do.

An example will show the kind of trouble to which I am referring: the fault referred to as "ticking" in a resistance-coupled note-magnifier may, in its less pronounced form, completely spoil the reproduction given by that amplifier, although not actually setting up audible ticks. What will happen will be something like this: the amplifier will work satisfactorily for a few seconds, and then an extra loud note will choke up the grids, and about half that note will be heard in a distorted form, and then there will be silence

not be forgotten that an old high-resistance H.T. battery may be at least a partial cause of the trouble. Therefore, try the effect of a really large shunting condenser across the battery, say, of three or four microfarads.

MAKING YOUR OWN DRILLS

A NUMBER of small drills are indispensable to the home constructor, and it is a relatively easy matter to make suitable ones for B.A. and Whitworth tapping and clearance holes.

For this purpose a few lengths of $\frac{3}{32}$ in. and $\frac{1}{4}$ in. diameter silver steel rod will be required, allowing about $2\frac{1}{2}$ ins. length for each separate drill.

Heating the Metal

Take one of the pieces of silver steel and heat it in a gas flame until it is a good cherry red. It should be held, of course, by suitable gas tongs during

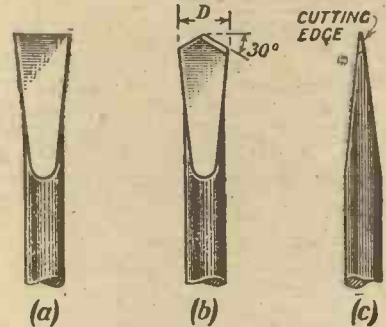

If due attention is paid to the shaping of the cutting edge a good drill is obtained.

the heating process. Now hammer out the end so that it takes the shape shown in Fig. 1a. It may be necessary to heat the steel two or three times before this is successfully accomplished, for it is necessary to keep the flattened part quite symmetrical, a side view being indicated in Fig. 1(c), the width of this end being slightly larger than the diameter of the hole for which the drill is being made.

The Next Step

Having done this file the end to the shape indicated in Fig. 1(b), the slope of the cutting edge being about 30 degrees. The distance marked D must be the diameter of the required hole, for which the drill is to be employed and, of course, should be evenly balanced about the centre line so that the drill runs true.

The Cutting Edges

When filing the small face shown clearly in the figure, great care must be exercised to ensure that it slopes away from the cutting edge, as can be seen by reference to Fig. 1(b), otherwise the drill will not function successfully; indeed, it is in the shaping of the two cutting edges that the secret of a good drill lies.

Tempering the Drill

Having performed these simple operations there still remains the tempering to be done, i.e., imparting to the drill the correct degree of hardness, so that it will cut. The drill should be heated to a cherry red in a gas flame once more, and then allowed to cool in the air. Rapidly clean the largest flat surface of the drill with a piece of emery paper, and you will notice several different colours which appear to be travelling towards the thin end. When the straw colour reaches this end dip the drill quickly into some cold water.

The drill can now be tried, and if it tends to blunt somewhat readily the tempering process should be repeated until the right degree of hardness or temper is secured.

CONVERTING YOUR BROADCAST RECEIVER FOR SHORT WAVES

WHEN the owner of a broadcast receiver decides to "take the plunge," as it were, and investigate the mysteries of short-wave reception for the first time, he is generally worried by the question, "Shall I convert my broadcast receiver so that I can use it occasionally for short-wave work and still keep it for broadcasting, or shall I construct an independent set and keep one receiver for each purpose?"

Problems of Efficiency

This is certainly a problem in many cases, for most short-wave receivers employ low-loss coils specially mounted, and condensers of much smaller capacity than would generally be necessary to cover the broadcast band of wavelengths. It is also generally realised that the average receiver for use on the longer waves, though it could be converted very easily, would not be anything like as efficient as a well laid out receiver built specially for the purpose.

It is the purpose of this short article to show that one receiver may be used, with a very reasonable degree of efficiency, to cover the entire range from, say, 30 metres to 1,600 metres, without any serious complications.

Changing the Coils

The interchangeable plug-in coil method is obviously the simplest that can be used in a receiver required to cover all wavelengths, but the standard plug-in coils and sockets are, unfortunately, rather unsuited to short-wave work, for which it is essential that all "stray capacities," such as may be present in these, should be cut down to the absolute minimum. The method advised by the writer is that explained by Mr. C. P. Allinson in an earlier number of *THE WIRELESS CONSTRUCTOR*, home-made coils being used. These can be wound, as far as the short-wave coils are concerned, with thick bare copper wire (about No. 12 being a suitable gauge), the turns being spaced either with string or by some form of ebonite support. It is essential that there should be as little solid dielectric as possible.

The coils for the longer waves may be of the standard plug-in type, and an adaptor may be provided so that these may be fixed in the special low-capacity sockets, which consist of strips of ebonite about 3 in. long with two valve sockets near their extremities. The short-wave coils are, of course, mounted on similar strips of ebonite, with valve pins fixed in such a position that they slip easily into the sockets. Two or three more of

these strips, with valve pins similarly fixed, but with the connections taken, not to a coil, but to a standard coil socket fixed in the centre of the strip, form the adaptors for the long wave coils.

Laying Out the Set

The rest of the receiver, apart from the fact that all wires should be carefully spaced and as short as possible, may be laid out in a manner exactly similar to that of any broadcast receiver. Practically any of the circuits at present used for broadcast reception, with the exception, perhaps, of certain reflex circuits, will work perfectly well on the shorter wavelengths. The coil-holder is, as a rule, the only component that needs any drastic alteration.

Reducing Condenser Capacity

The variable condensers will probably be rather too large for efficient work on the shorter waves, since if any capacity larger than about .0002 is used for wavelengths below about 100 metres the tuning is almost incredibly sharp, and the receiver will need very skilful handling if it is to yield any results at all! This can be arranged very conveniently, however, by connecting fixed condensers in series with the variables.



A view of the Rugby Station taken from the top of one of the 820 ft. masts.

A variable condenser of .0005 maximum capacity, for instance, may be reduced to .00025 by connecting a fixed condenser of .0005 in series with it. If a much smaller fixed condenser is employed, such as one of .0001 capacity, the capacity of the variable itself is reduced to approximately .0001, the actual figure being .00008. Thus, by the use of fixed condensers of the interchangeable type, the variable condensers can be arranged to have almost any effective capacity that the reader requires!

KDKA

As regards the stations that are to be heard on the shorter waves, there are probably not enough working on telephony to make it worth while for the ordinary "listener," with no knowledge of the Morse code, to convert his receiver, even though it may be such a simple matter as has been described. However, KDKA may be heard almost any evening after 11 p.m. on a wavelength of about 62 metres, his strength on a detector and two stages of L.F. amplification being quite enough to fill a small room if a loud-speaker is used.

WGY Transmissions

WGY is considerably lower down, working on several wavelengths, among which are 40 metres, 35 metres, and 32 metres. From reports received it appears that the 35 metre transmission is received best in this country. It should be mentioned that the call-sign WGY is not always used, but a series of call-signs beginning with "2X" are employed. 2XAS is the 35 metre transmission, and the others are designated by 2XK, 2XAF, 2XAL and other call-signs.

For the Enthusiast

For the more fortunate listener who has been keen enough to learn Morse, however, short waves are quite a different proposition. Hundreds of amateur stations work between 30 and 50 metres, and on a good night the writer has logged as many as 170 American amateurs in two hours. New Zealand and Australia may also be heard with very little trouble, both at about 6.30 p.m. and 7 a.m. As a matter of fact, all five continents can be heard in one day when a spell of "good conditions" is holding.

The enthusiast who is keen enough to rise early in the morning is, however, far more likely to build a special set for the purpose than to attempt to convert an ordinary receiver, but the description of such a set is outside the scope of this article.

L. H. T.

DISTANT RECEPTION *in the* SUMMER

C. P. Allinson, A.M.I.R.E.

If you have difficulty in bringing in the distant stations on your single-valve set during these summer evenings, you will find that the two-valve receiver described here will give just the extra range that you require. Furthermore, it is selective and non-radiating.

THERE are few experimenters who have not experienced the thrill of long-distance reception with only one valve during the winter months, when conditions are peculiarly suited to this type of work. With the coming of summer, bringing with it long light evenings, when the logging of distant stations is more uncertain, the single-valve receiver is then often found inadequate.

Under these circumstances it is necessary to consider the addition of an extra valve in order to bring the signal strength of weak transmissions up to a satisfactory value, or the pleasure of listening to programmes other than those from the local station is reduced.

Solving the Problem

The question to settle is whether to employ a stage of low-frequency or

strength the difficulty of cutting out the local station becomes more pronounced, while a pair of headphones are exceedingly uncomfortable when atmospherics become strong and a low-frequency valve is employed.

Added Selectivity

The use of a stage of high-frequency amplification, though introducing another "knob to turn," gives the added degree of selectivity that is certainly needed, while by using some form of neutralised circuit the fullest possible amount of amplification is obtainable. The increased selectivity also improves the signal-static ratio as well as helping to reduce interference.

Outward Appearance

The receiver to be described makes use of two valves, consisting of a

Although three variable condenser dials are seen, only two of these are for tuning, the one on the right being the reaction condenser.

The two small knobs at the bottom are for the filament resistances and the four terminals for aerial, earth and telephones. All the terminals for the batteries are carried on a terminal strip fixed to the back edge of the baseboard, so that the battery leads may be kept out of sight.

Special Features

The theoretical circuit diagram is shown in Fig. 1. The aerial is auto-coupled to the grid circuit of the first valve, the grid circuit being tuned by a variable condenser of .0005 capacity. Transformer coupling is used between the H.F. and detector valves, the primary of the transformer being provided with a centre tap which is connected to H.T. + 1. The opposite end to the anode end of the winding is connected back to the grid of the first valve via a neutralising condenser N.C., which enables stability to be obtained at all settings of the tuning condensers.

Reaction

An inductance L_4 is coupled to the secondary winding of the H.F. transformer $L_2 L_3$, one end of this coil being connected to the anode of the detector valve through a variable condenser of .0003 capacity and the other to L_3 . This, in conjunction with a H.F. choke L_5 , placed in the anode circuit, enables Reinartz reaction to be obtained. With this arrangement, provided that the neutralising condenser is correctly adjusted, the detector can be made to oscillate with little risk of any energy being radiated and thus disturbing other listeners.

This, of course, is a great advantage, since carrier waves may be picked up by the beat-note method and then resolved. Further, the application of reaction to the detector circuit assists in obtaining a high degree of selectivity.

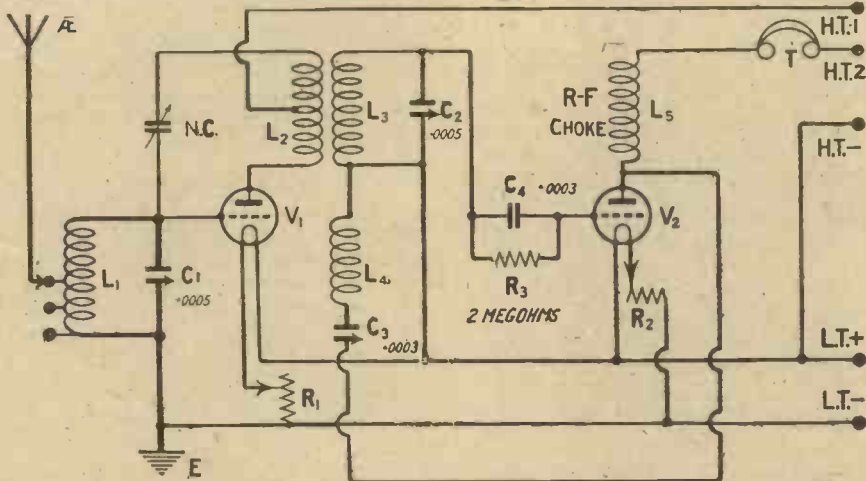

Fig. 1.—The aerial is auto-coupled to the grid circuit of V1, while Reinartz reaction is employed for smooth working.

high-frequency amplification. It is claimed by many that a greater degree of amplification is given by a stage of low frequency and that no extra tuning controls are introduced, but it must be remembered that with distant transmissions reduced in

stage of high-frequency amplification followed by a detector. The complete set is shown in the photographs, and it will be gathered from these that the front of the panel is neat in appearance, the controls being conveniently disposed for operation.

Distant Reception in the Summer—continued

Components Utilised

The components required to construct this receiver are given in the list below, and though it is not indispensable to the working of the

$\frac{3}{8}$ in., may be used both for the variable condensers and the rheostats; the drill for the terminals will depend on what size these are, while three small holes are drilled along the bottom

then fixed in place, and Fig. 2 should be referred to for dial positions, etc.

The terminals and filament resistances should be fixed to the panel which is then screwed to the baseboard, certain connections requiring to be done before the variable condensers are mounted in position.

Filament Rheostats

The values of the filament resistances given in the list of components have been chosen in order to allow different valves to be tried out, but where it is definitely intended to use certain valves, the filament resistances may be chosen to suit these valves and the L.T. voltage employed with them. With bright emitters, for instance, a suitable value will be 6 or 7 ohms, and for .06 valves with a 4-volt battery 30 ohms will be correct.

Where two valves of different types are being used it may be necessary to use filament resistances with different values. This, however, is a matter the experimenter will decide for himself according to his circumstances.

Baseboard Components

The components that are fixed to the baseboard are next screwed down, and it will be found that the back of panel wiring diagram in Fig. 3 will prove of assistance in doing this, since

receiver that the actual makes named be used, the makers' names are given so that those who wish to make an exact copy of the set may do so.

One ebonite panel 14 in. by 7 in. by $\frac{1}{4}$ in. (British Ebonite Co., Ltd.)

One cabinet for same with baseboard $8\frac{3}{8}$ in. deep (Pickett Bros.)

Two .0005 variable condensers, square-law type (Messrs. H. Clarke & Co. (Manchester), Ltd.)

One .0003 variable condenser, square-law type (Messrs. H. Clarke & Co. (Manchester), Ltd.)

Two valve holders (C. A. Vandervell & Co., Ltd.)

One H.F. choke (Beard & Fitch, Ltd.)

One neutralising condenser, baseboard mounting (Peto-Scott Co., Ltd.)

One Universal Transformer and mounting (Peto Scott Co., Ltd.)

Two single-coil sockets, baseboard mounting (Burne-Jones & Co., Ltd.)

Two 30-ohm filament resistances (Edison Swan Electric Co., Ltd.)

One .0003 fixed condenser type 600A and

One 2-megohm grid leak and mounting (Dubilier Condenser Co., Ltd.)

One terminal strip (Burne-Jones & Co., Ltd.)

Four terminals, quantity of Glazite, and

One set Radio Press panel transfers.

Components on the Panel

The only work in constructing this receiver that requires other than the most elementary tools is drilling the panel for mounting the variable condensers, filament resistances, and terminals. The same size drill, namely,

edge of the panel and one in each side edge so as to mount it to the baseboard. Provided that the ebonite panel is known to be free from surface leakage, this work may be carried out at once, otherwise the panel should be rubbed down on both sides

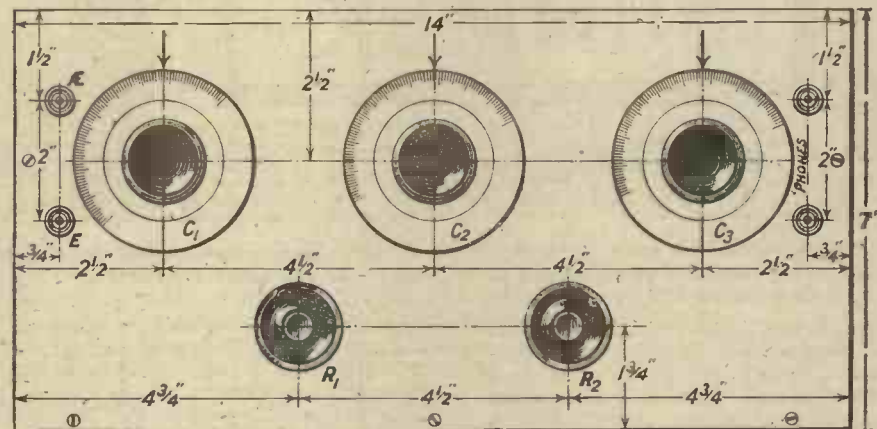
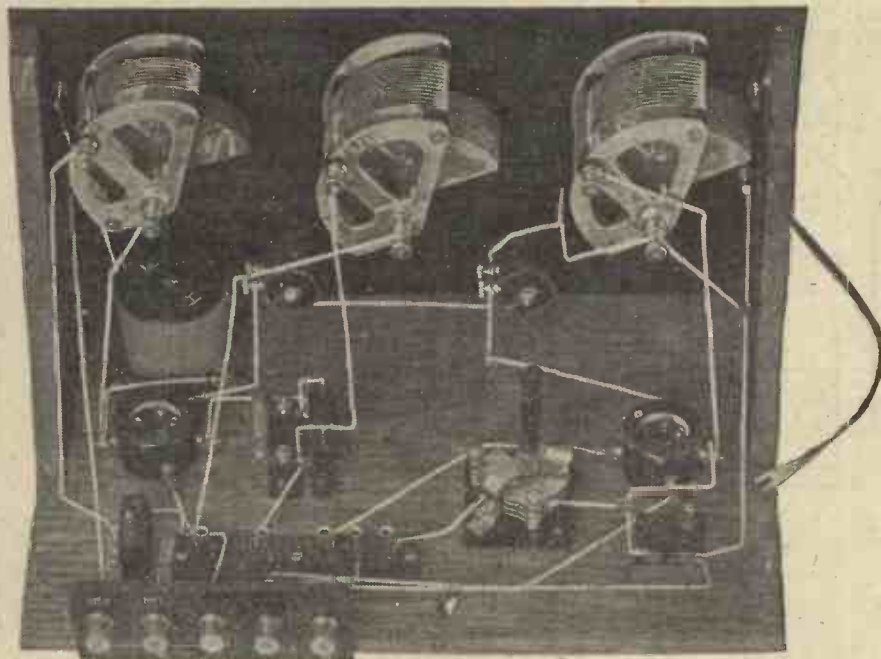

Fig. 2.—The symmetrical arrangement of the front panel can be easily laid out from this diagram. Blueprint No. C 1049A.



This photograph will be of assistance in wiring up the receiver. The leads to the coils L2 and L3 and to the neutralising condenser should be as short as possible.

with No. 0 glass paper so as to remove the surface skin.

The positions for the panel transfers should next be determined and

it is a scale drawing of the reverse of the panel and the baseboard. The aerial coil and the Universal transformer should be kept well apart and

Distant Reception in the Summer—continued

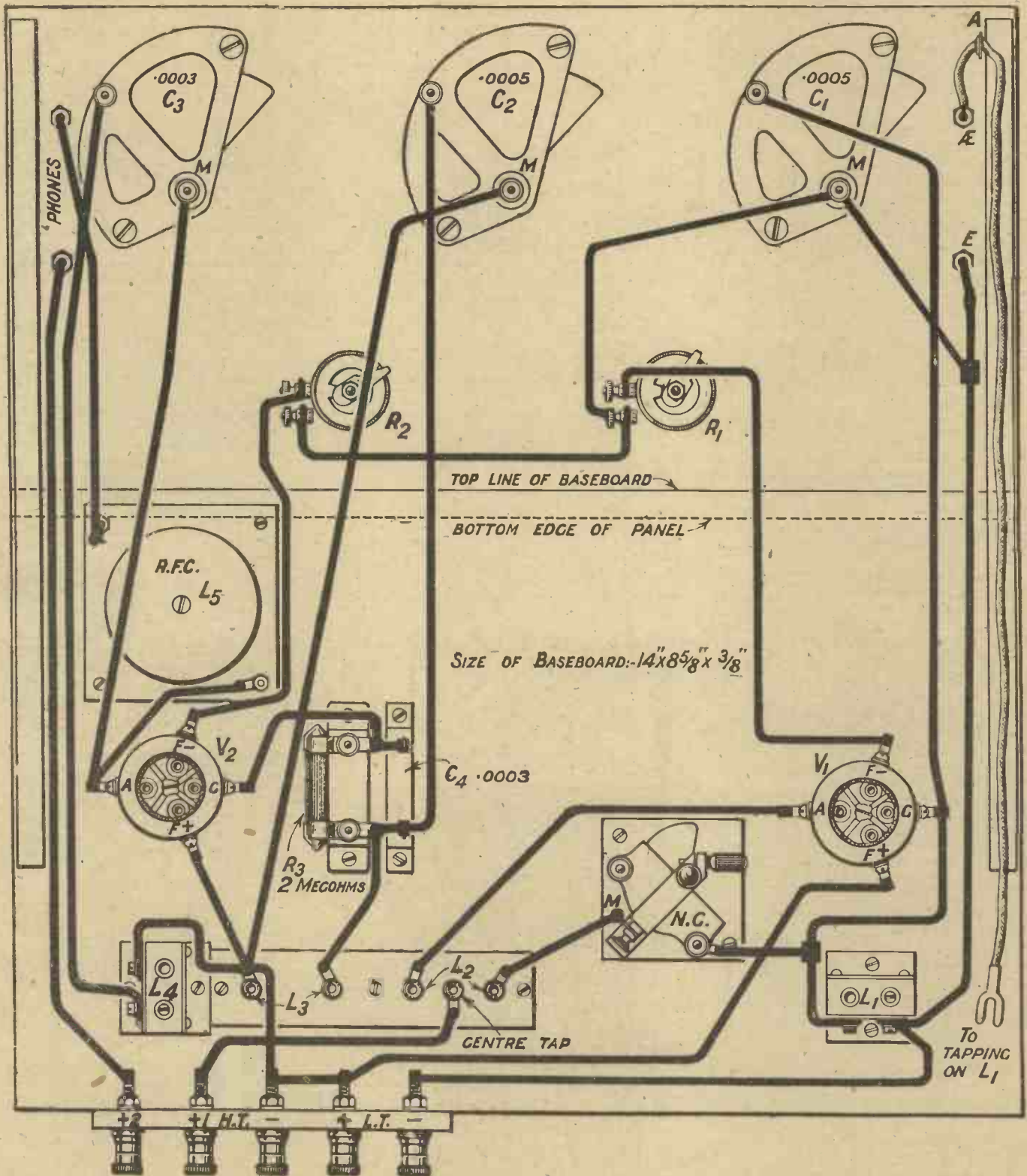

Fig. 3.—Note carefully the disposition of the leads to the sockets for the coils L2 and L3. The screw at A keeps the flexible lead clear of the variable condenser C1. A full size Blueprint No. C 1049B can be obtained post free if desired.

Distant Reception in the Summer—continued

mounted with their fields at right angles, as shown in the various views taken from behind the panel.

Adapting the Valve Holders to Baseboard Mounting

The valve holders used, although not apparently actually intended for baseboard mounting, are easily adapted. The fixing screw is cut short so that only about $\frac{3}{8}$ in. of it protrudes. A hole is then drilled in the baseboard at the point where the holder is to be mounted, the hole being somewhat smaller than the external diameter of the screw. The screw may now be forced in with a screwdriver and will tap itself into the wood, holding the valve socket quite firmly. Soldering tags may be placed under the fixing screws before mounting the holders, as they will be found to simplify the making of connections to the holders, otherwise it may be an advantage to secure lengths of wire beneath these screws to be bent into position later.

Before the H.F. choke is fixed in position the lead from this to the top telephone terminal should be cut to length and soldered to the tag (or fixed beneath the nut) on the choke. The choke may then be mounted and the wiring commenced.

however, recommended to practice the art of soldering, for not only is it much quicker to wire up a receiver with soldered joints and connections, missing the soldering tags, but a far

that requires mention is the flexible lead ending in a spade tag that connects the aerial terminal to the tap on the coil L_1 . This has been brought over a screw fixed to the

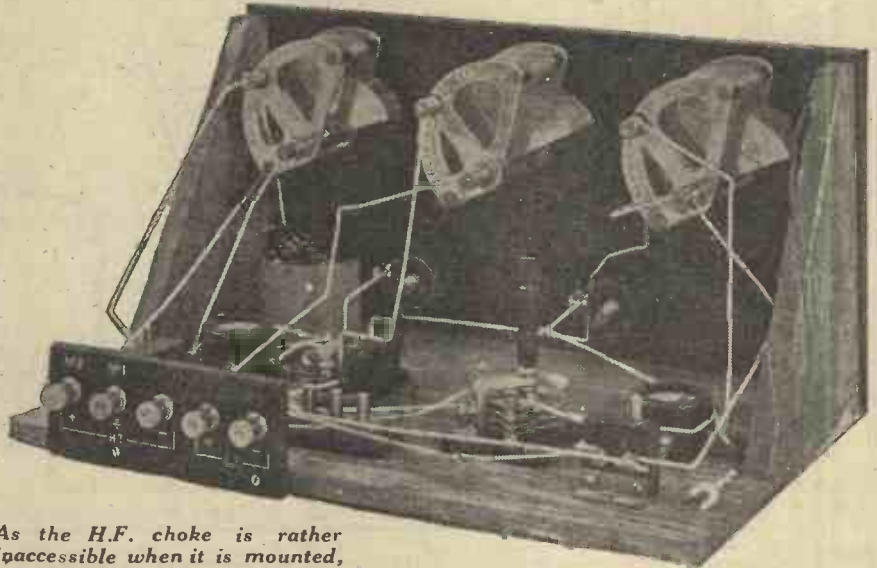

As the H.F. choke is rather inaccessible when it is mounted, it will be found best to solder the leads to it before fixing it in position on the baseboard.

better contact may be obtained, while should any mistake be made in the wiring it is more rapidly rectified.

wooden angle bracket so as to keep it clear of the moving vanes of the variable condenser C_1 , and is shown at A in the wiring diagram.

All grid and anode leads should be kept as well spaced as possible, and the connections and positions of the plugs and sockets for the two fixed coil holders carefully noted.

Initial Tests

Having completed the wiring, the connections should be checked over and any soldered joints examined to see that they are sound. The receiver may then be given its preliminary tests. First try out the L.T. circuits. Insert two valves, and connect the L.T. battery with the rheostats in the off position, then turn on the valves and see that they are correctly controlled by the resistances. Now place a couple of coils in the coil holders and plug the Universal transformer into its mounting and test out the H.T. circuits. Although often repeated, advice to the effect that a small H.T. voltage is applied at first should always be followed, as it may save the cost of new valves should a short be present.

Coil Sizes

The set having passed these tests satisfactorily, it may be connected to the aerial. For the reception of the ordinary broadcast wavelengths the coil required for L_1 is a No. 60 Lissen X or a Gambrell AT trap coil or any similar inductance, while the reaction coil L_2 will be a No. 40 or 50. The coils marked L_2 and L_3 repre-

(Continued on page 842.)

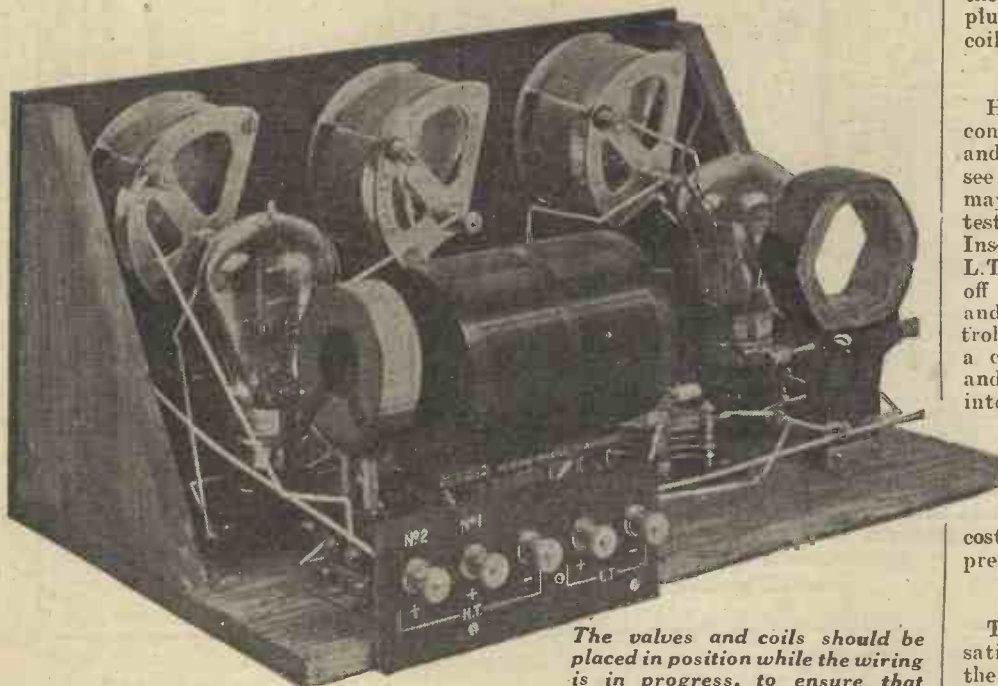

Soldered Connections

The novice with the soldering iron will find that the only components without fixing nuts, screws, or terminals are the grid condenser and the Universal transformer mount. He is,

The valves and coils should be placed in position while the wiring is in progress, to ensure that ample clearance is allowed for these components.

Flexible Aerial Lead

As many connections as possible should be made before the three variable condensers are mounted on the panel, and the only point

Co-axial Mounting

The new Constructional System which ensures (a) longer life (b) lower running costs and (c) greater uniformity in results. Used for the first time in this wonderful new Cossor Dull Emitter.

FOUR years ago Cossor astonished the Radio world by evolving a method of valve construction which, for the first time, utilised almost the whole of the electron stream. Two years later this success was followed up by the introduction of a unique triple-coated filament which operated at a phenomenally low temperature.

And now Cossor—in introducing the new Cossor Point One—demonstrates that the same spirit of progress which has always dominated its activities is as vigorous as ever.

Why valves vary in performance

It is well known that if a batch of valves were made up using identical filaments, grids and anodes without due regard being paid to the accurate spacing of the elements that every valve would vary considerably in results. There would be hardly two alike. Any variation of distance between filament and grid or between grid and anode exercises considerable influence upon performance. All elements must be mounted co-axially to obtain the best results and any method which *guarantees* this must result in an incomparably higher standard of efficiency.

In the new Cossor Point One there is at last available a patented system of mounting which infallibly aligns the filament, grid and anode from top to bottom.

How Co-axial Mounting is achieved

Owing to the peculiar advantages possessed by the shape of the Cossor grid and anode it has been found possible to secure these

two elements together at the top by means of a seonite insulator. The grid itself ends in two prongs which are inserted into the base of the seonite insulator. The anode rests on a wide flange provided, and is welded at its base to two stout nickel supports. Even extreme force cannot disturb the exact relative positions of these two elements—once fixed in their places, to a hundredth part of an inch, they are there for all time.

The new Shockproof Filament Suspension System

Through the centre of the seonite tube runs a fine wire which holds the filament in its

correct position. Unlike other valves the filament in the Cossor Point One is not held under tension. Its shockproof support provides exactly the degree of elasticity to enable it to absorb the sharp concussion caused by an accidental blow. A knock which would shatter the filament in an ordinary valve is rendered harmless by this amazingly efficient suspension.

Greater uniformity and economy

Thus with the filament, grid and anode in permanent alignment it is reasonable to expect a greater uniformity in results. The supreme importance of this will be instantly appreciated by users of Neutrodyne Receivers employing several stages of *matched* H.F. amplification.

But in addition this new valve is exceptionally economical. Its triple coated filament consumes only one-tenth of an ampere at 1.8 volts. A super-heterodyne using 7 of them would actually consume less current than a little one-valve set with a single bright emitter.

Bearing in mind, too, the fact that this filament operates at a glow which is practically invisible, it will be obvious that at last wireless enthusiasts have available a valve which must give an incredibly long and uniform service.

Types and Prices

Cossor Point One	
RED TOP: For H.F. use 1.8 volts	15/6
Consumption 1 amp	
PLAIN TOP: For Detector use 1.8 volts	15/6
Consumption 1 amp.	
Cossor Stentor Two	
GREEN TOP: For power use 1.8 volts	18/6
Consumption 1.5 amp.	



The new COSSOR Point One

— the long-life Dull Emitter with the new .1 amp. filament



Gilbert Ad. 5110

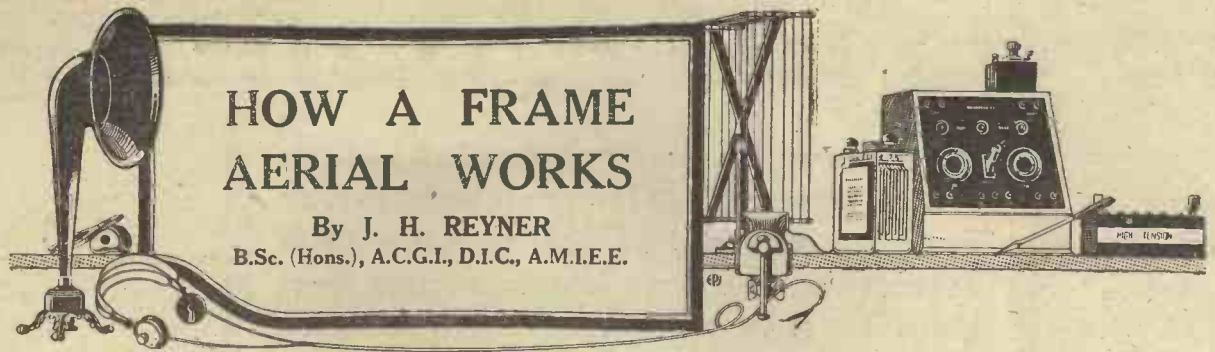

To construct and use a frame aerial successfully requires some knowledge of the principles underlying its operation. Mr. Reyner gives here a clear explanation of how a frame aerial works and how it can be utilised to the best advantage.

NOW that the summer season is upon us, one's attention is naturally turned to portable sets, and in the majority of cases these sets are designed to operate on a frame aerial. It is interesting, therefore, to consider just how a frame aerial works, how the best results may be obtained from it, and what is the best type of frame to use under any given circumstances.

Size of the Aerial

A frame aerial is really a very simple arrangement. With an ordinary receiver we erect a wire running to a considerable height above the ground, and we may or may not provide a horizontal top as the case may be. It is well

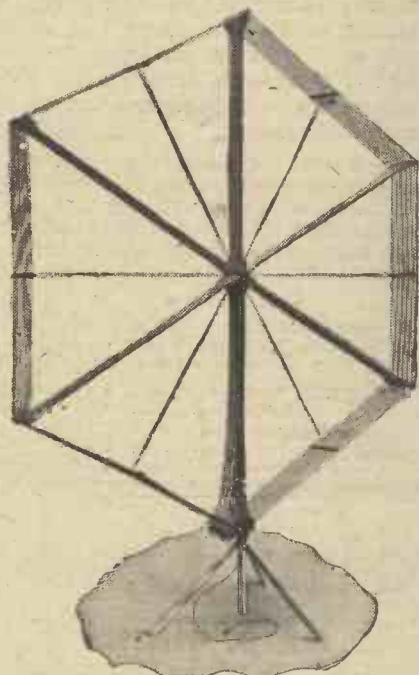

A frame aerial which will fold up when not in use forms a handy adjunct to a portable receiver.

known, however, that even if the horizontal top is removed from the aerial the actual vertical wire picks up a large percentage of the original

energy. If now we reduce the actual height of the wire, we shall still pick up energy in the normal manner, although the quantity will be somewhat reduced. In other words, the signal

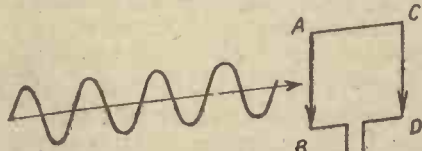

Fig. 1. — With the frame in this position the voltages induced in its two sides by the incoming signal are in opposite directions, but slightly separated in time.

strength obtained with the short aerial is distinctly weaker than with a full-size one.

Removing the Earth Connection

We may even remove the earth connection, and still obtain signals, although still further somewhat reduced in volume. Continuing this sequence of events, therefore, we see that a single vertical wire only 2 ft. or 3 ft. long acts as a small aerial, and will pick up energy from a transmitting station.

Now suppose we have a loop of wire arranged as shown in Fig. 1. The vertical portion, A, B, will pick up a small amount of energy from the transmitting station. The horizontal top and bottom will have little effect, but the other vertical side, C, D, will also pick up energy in the same manner as the side, A, B.

A Time Factor

Now a reference to Fig. 1 will show that the two voltages induced in each side of the frame are in the opposite direction as far as the frame itself is concerned, and therefore tend to cancel each other out.

As a matter of fact, however, the wireless waves take a certain time in travelling across the gap between A, B, and C, D. This time is very, very small, but, nevertheless, it serves to make the voltage in C, D, a little bit later than that in A, B; and as a result

of this slight difference, the two do not completely balance out, but a very minute residual voltage is left.

Rotating the Frame

If, therefore, we arrange to pick up and make use of this small residual voltage in some suitable manner, we shall be able to hear signals on an arrangement such as this. In the case shown, however, the direction of the frame was the same as that of the wireless waves. Suppose we turn the frame through a right angle as shown in Fig. 2, so that the wireless waves in travelling outwards from the transmitting station, reach the side A, B, and the side C, D, together. In such a case there would be no difference between the two voltages in each side with the result that a cancelling out results, and no signals would be heard.

Reducing Interference

It is this property of a frame which gives rise to its directional effect and is often used to minimise interference from unwanted stations. As long as the frame is pointing towards the station which is to be received (or approximately in that direction) signals will be heard, but if the frame

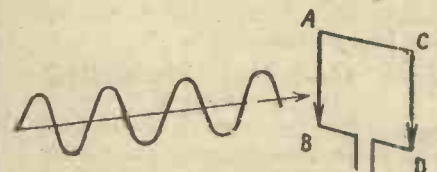

Fig. 2.—When the frame is at right angles to the incident waves, the opposing voltages are induced simultaneously in its two sides.

is turned at right angles to the direction of the transmitting station then the signals die away to nothing.

Now it will be obvious that the action of a frame depends on the difference between the voltage produced in the two sides, each of which is only 2 ft. or 3 ft. in length in the average broadcast frame. Obviously, therefore, the voltage, even in the maximum position, will be extremely small. Hence if we are to use a frame to

How a Frame Aerial Works—continued

the best advantage we must seek methods of increasing the efficiency of the arrangement.

Improved Efficiency

We may do this by increasing the number of turns on the frame. Suppose instead of just having a single turn loop we employed a frame with two turns on it. We should then obtain a similar effect in the second turn

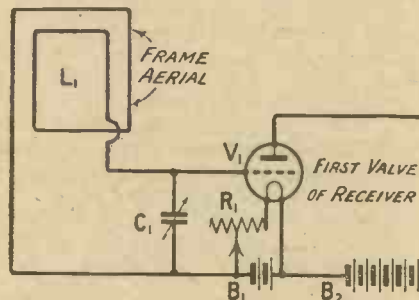

Fig. 3.—Showing how the frame aerial takes the place of the coil in the grid circuit of the first valve of a receiver.

as in the first turn, and these two effects would add together, so giving us very nearly twice the effect of one turn. Similarly as more turns are put on so the effect gradually increases, although not in the same proportion to the number of turns.

We have now to consider how to utilise the voltages picked up by the frame. It will be seen readily that an arrangement such as we have just discussed is nothing more or less than a large coil, and as such it must be tuned with a variable condenser in order to obtain the maximum results from the very small voltages set up therein.

H.F. Amplification Necessary

A circuit such as that in Fig. 3 therefore would normally be employed. The two ends of the frame are connected to a variable condenser of such a value as to tune the inductance of the frame to the required frequency, and the voltages produced across this condenser are then applied across the grid and filament of a valve. This valve may be a simple detector, or may be the first valve of a high-frequency amplifier.

Since the voltages, even in a frame having several turns, are still very small, it is usual to employ some high-frequency amplification in a receiver designed to operate on a frame aerial, so that this latter is the more usual arrangement. The question of the actual circuit to employ, however, can only be dealt with briefly in this article.

Questions of Size

It will be obvious that if we are going to tune the frame to the fre-

quency being received, then very obviously we shall reach a limit to the number of turns which we can put on the frame, just as in a coil we are limited in the number of turns to cover a particular band of frequencies or wavelengths. The larger the diameter of the frame, the less the number of turns which we can put on before this tuning limit is reached. It is found that in general it is better to use a large frame with a smaller number of turns rather than a small frame with a large number of turns. The signal strength in the former arrangement is usually found to be better.

Considerations of portability prevent one from using a frame of greater diameter than 3 ft. or 4 ft., and even so, the frame has usually to be made collapsible in order to carry it about.

ant effect which has to be taken into consideration. A 2-ft. frame having about 10 turns on it would only give the signal strength that one could obtain on an aerial somewhere about 1 ft. in length. This is, of course, less than the actual height of the frame itself, so that it will be obvious that the frame will act as an aerial due to its capacity effect to earth. Moreover, this aerial effect may be at least equal to, if not several times greater than, the actual signals picked up by the frame acting as a proper and true frame.

A Secondary Effect

This increase of signal strength is, of course, all to the good, but it serves to mask the directional properties of the frame. Obviously if we have a permanent voltage in the circuit, due to the frame behaving as an ordinary

.....

The compactness of a frame aerial is not the least of its advantages. In the "Frame Aerial Cabinet" receiver, described by Mr. G. P. Kendall in "Modern Wireless" for Jan. the frame is wound inside the back of the cabinet.

.....

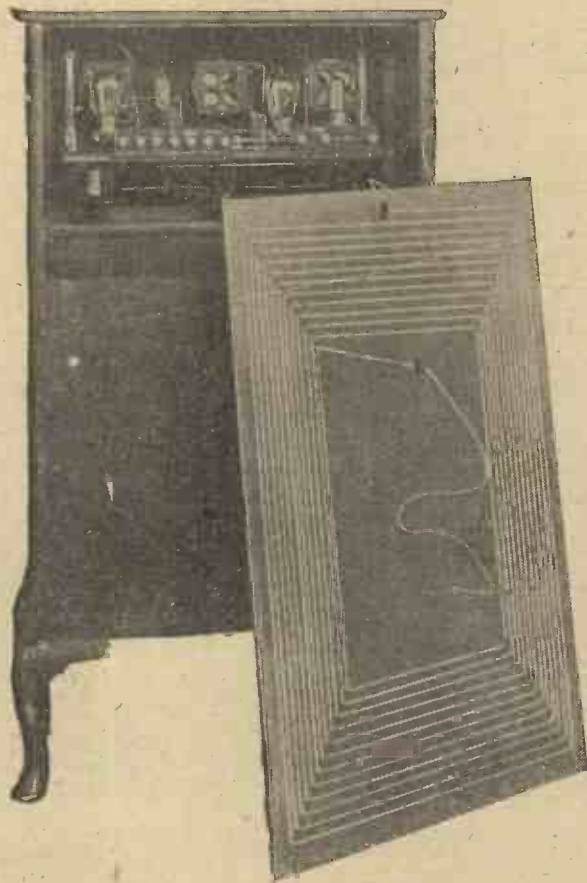

Suitable dimensions and number of turns for a frame aerial to cover the broadcast band have been given from time to time in Radio Press journals.

A Capacity Effect to Earth

The average broadcast frame, however, as we have seen is only 2 ft. or 3 ft. in diameter, and with such small frames there is another very import-

aerial, and this voltage is practically independent of the direction of the signal just as with an ordinary aerial, then the variation in the voltage produced by the rotation of the frame will be quite small. The only effect of rotation would then be a weakening or strengthening of the given signal, instead of a definite reduction to zero at one particular point.

How a Frame Aerial Works—continued

Portable Receivers

The designer of a portable set, therefore, must decide whether the directional properties of a frame are of sufficient importance to warrant special precautions being taken. If, as is often the case, the directional effect is of minor importance, then full advantage may be taken of the increased signal strength obtained by permitting it to act both as a frame and as an aerial.

A Proper Idea

It is of interest to obtain a clear idea of how this aerial effect really is obtained. The circuit shown in Fig. 4 represents a very common circuit employing a coil tuned with a condenser, having the aerial and earth connected across the condenser as well. Suppose now we remove the earth lead. Anyone who has experimented with a wireless circuit will realise that this has very little effect on the operation of the circuit beyond the slight weakening of the signal, due to a reduction in the voltage induced on the aerial, and possibly a sharpening of the tuning due to the reduction in the earth losses.

Aerial and Coil Combined

Now suppose that we gradually reduce the actual length of the aerial lead and increase the size of the coil. The length of the wire in the coil now

acter with the original, with the exception that the aerial and the coil are, as it were, combined. It will be realised that this effect is due to the frame acting as an aerial pure and simple, and is quite different from the true frame effect, which, as we have seen before, is due to the wireless waves striking one side of the frame before the other.

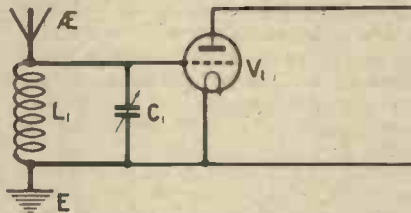

Fig. 4.—Removal of the earth lead from a receiver using an ordinary aerial system does not usually have a particularly noticeable effect.

Special Precautions

The directional properties of frames are utilised for many purposes. For example, the direction-finding equipments at large coast stations employ the directional properties of a frame in order to obtain the positions of ships at sea, and there are other similar uses such as for the reduction of interference from a particular direction, etc. In order to obtain these effects to the best advantage, special

means of collecting the wireless energy in order to operate his set. In such circumstances, therefore, the design of the frame itself is not very critical. As long as the frame tunes with the particular condenser in use, then reasonably satisfactory results will be obtained.

Correct Connections

Many people desire to use frame aeriels with circuits which they have already constructed to suit ordinary outdoor or indoor aeriels. In such cases it is of little use to connect the frame straight across the aerial and earth terminals of the set. The frame must be so connected in circuit that it definitely replaces the original tuning coil connected to the first valve, the old coil being removed from the circuit completely. The tuning condenser of the set then tunes the frame as a simple coil.

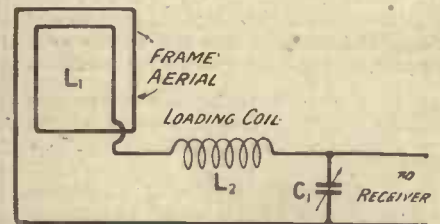

Fig. 5.—The correct method of adding a loading coil to a frame for longer wavelengths is shown in this diagram.

For the Higher Wavelengths

In some cases the frame employed is not sufficiently large for the wavelength to be received. This state of affairs should not occur on the broadcast band because if the inductance of the frame is insufficient to tune to the required signal, then the number of turns on the frame should be increased slightly. It is often, however, desired to receive 5XX or some of the longer wave stations on a small frame, in which case a loading coil may be inserted in series with the frame as shown in Fig. 5. This will result in the inductance of the frame circuit being increased to a suitable value, and in general a No. 200 or No. 250 coil will be found satisfactory for this purpose.

For the Purposes of Reaction

This arrangement cannot be considered very efficient, because a small frame does not act in a very efficient manner on the longer waves. As a compromise, however, in portable sets this arrangement is often satisfactory. The use of a small loading coil—No. 25 or so—in series with the frame is often employed on the lower broadcast wavelengths in order to enable a reaction coil to be coupled to the frame circuit, but this is a matter outside the scope of the present article.



.....
Portable sets, in which compactness and light weight are important, are frequently designed to work with a frame aerial or an open aerial and frame combined.

increases, and obviously the coil itself behaves as an aerial to some extent, while the actual external aerial effect is decreased. The circuit, therefore, will continue to operate, although the signal strength will gradually fall off until we reach the limiting conditions where we have the coil 2 ft. or 3 ft. diameter and no external aerial at all. The circuit is then identical in char-

precautions have to be taken to eliminate all aerial effects as far as possible and to make sure that the frame is operating as a true frame.

Under Usual Circumstances

As we have stated, these precautions are generally of minor importance to the average amateur who is concerned simply with using the frame as a

THE "ELSTREE SIX"

An Outstanding Achievement by the Radio Press Laboratories

TO receive sixty broadcasting stations on the loud-speaker needs a set possessed of a high degree of selectivity and a not inconsiderable range. To accomplish this feat within the space of a single hour, and to tune in the stations on the loud-speaker alone, means something more. It implies simplicity of control.

The Outcome of Research

By careful investigation of the problems of efficient high-frequency amplification, the Radio Press Laboratories at Elstree have produced a set which brings in all the British main and relay broadcasting stations on the loud-speaker in daylight, and practically all Continental stations at loud-speaker strength after dark.

A Remarkable Set

This receiver, the "Elstree Six," is without doubt the finest set yet designed for the home constructor. Anyone can build a replica of the "Elstree Six," and details of its construction will be found in *Modern Wireless* for June, which is now on sale everywhere.

Absolutely No Interference with Other Receivers

In addition to its ease of construction, the "Elstree Six" is quite simple to operate.

Full reaction amplification is provided in the set, and this control can

be utilised to the limit without the least risk of causing interference with other receivers in the vicinity.

Three stages of high-frequency amplification, a rectifier, and two stages of low-frequency amplification are used in this set, provision being made to cut out the last valve if desired.

A Question of Appearance

The handsome appearance of the "Elstree Six" will be apparent from



Four tuning controls are provided in the "Elstree Six" receiver, dual condensers being employed.

the upper photograph on this page. It will be seen, too, that in spite of the wonderful capabilities of the receiver, the front panel gives an impression of simplicity, which, in fact, is borne out in practice.

For Full Details

The second photograph shows the interior of the receiver with all the valves and coils in position. The dignity which characterises the exterior of the receiver finds a parallel in the

symmetrical layout of the components seen in this view.

The constructor will see at a glance that complication is nowhere a feature of the receiver. It is in fact a set which anyone can construct for his own use. Do not fail, therefore, to secure your copy of the June issue of *Modern Wireless*, in which the "Elstree Six" is fully described and illustrated.

Logical Development

It is due to the research work carried out by the Radio Press Elstree Laboratories that the problems incidental to the design and production of a receiver with such wonderful capabilities have been successfully solved.

The reader is referred to an article elsewhere in this issue of *THE WIRELESS CONSTRUCTOR* (page 854) for references to the story of these interesting investigations and the possibilities of the future.

A Special Invitation

The Editor of *Modern Wireless* invites each purchaser of the first five hundred blueprints of the "Elstree Six" to visit the Elstree Laboratories and try the original set himself, so that readers may judge for themselves the remarkable efficiency of the set.

Further details of this invitation are to be found in the June issue of *Modern Wireless*.

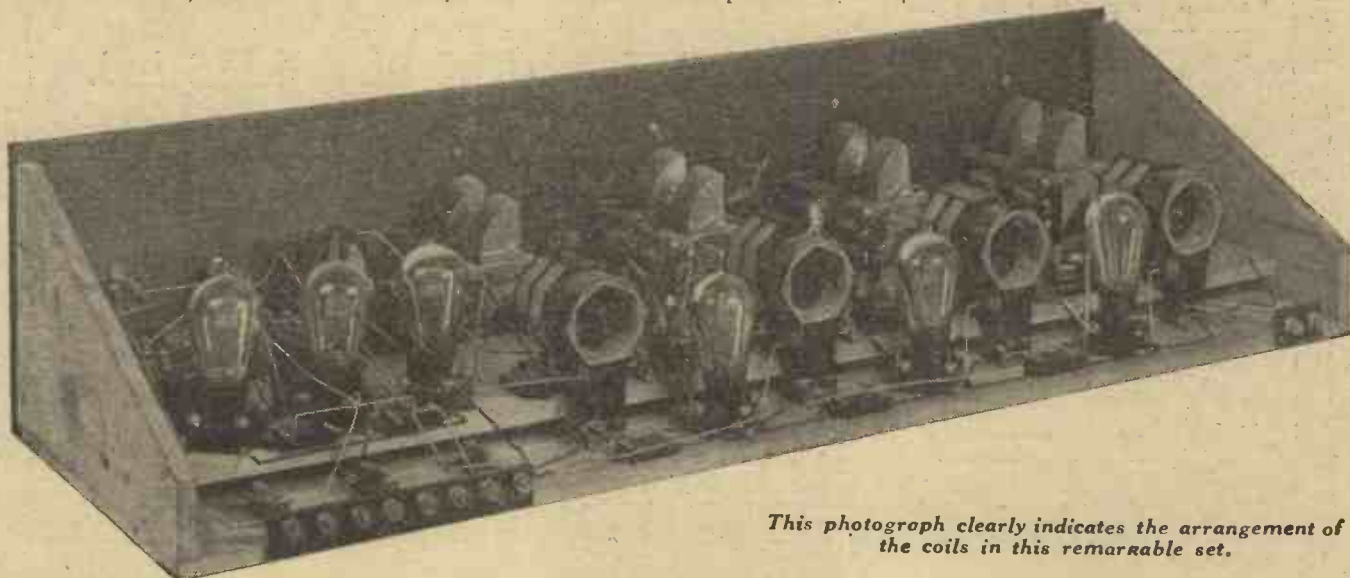

This photograph clearly indicates the arrangement of the coils in this remarkable set.



Another SHORTPATH Valve SP18/B (BLUE SPOT).

THIS new S.P. 18 Valve supplements the well-known S.P. 18 Red Spot and Green Spot Valves. It is designed especially for use in resistance-capacity coupled sets and for use as a Detector and in H.F. neutrodyne tuned anode stages using 80-120 Volts H.T. so that where this H.T. is employed in the last stage the difficulty of two H.T. supplies is avoided.

In addition it gives still more amplification and consumes very little H.T. current.

The S.P.18/B (Blue Spot) is an excellent valve for anode bend detection.

Designed to work in parallel with the S.P. 18 Red Spot and Green Spot Valves it operates for a 2-volt accumulator and consumes only 0.09 amp. filament current.

“Cosmos” **SHORTPATH S.P.18** Valves are recommended for use as shown below with alternative H.T. values.

Stage.	Coupling.	Recommended Valves	
		H.T. 20-80 v.	H.T. 80-120 v.
H.F. AMPLIFIER	Tuned Anode (neutrodyne)	Green	Blue
	Tuned Anode (not neutrodyne)	Green	—
	Transformer (loose coupled)	Red	—
	Transformer (tight coupled)	Green	—
DUAL OR REFLEX STAGE	All Couplings	Red	Red
DETECTOR (Grid Leak)	Resistance Coupling	—	Blue
	L.F. Transformer or Choke	Green	Blue
DETECTOR (Anode Bend)	All Couplings	—	Blue
L.F. Stages	Resistance Transformer or Choke	Green	Blue
		Green	Green
Last Stage	All Couplings	Red	Red

Prices of “Cosmos” **SHORTPATH S.P.18** VALVES

RED SPOT	GREEN SPOT	BLUE SPOT
12/6	12/6	12/6

Obtainable from most Wireless Retailers.

METRO-VICK SUPPLIES Ltd.

(Proprietors: Metropolitan Vickers Elec. Co. Ltd.)

Metro-Vick House, 145, Charing Cross Road, LONDON, W.C.2

The “Cosmos” D.E 11 Dull Emitter Valve takes 0.25 amp. at 1.1 Volts. and is a splendid Dry Cell Loud Speaker Valve.
12/6

The “Cosmos” A45 Bright Valve is a highly efficient Valve for all reception purposes.
7/6

Have you got your copy of “A Talk to Valve Users”?

Cosmos

RADIO VALVES



ABOLISH PROGRAMMES

Real Wireless Entertainment

By our IRRESPONSIBLE EXPERT.

MUCH has been said about the art of tuning. I frequently have quite a lot to say about it myself when my next door neighbour starts out to rake the ether for 2LO. This fellow does not believe in neutralising, or in fact in any sort of contrivance for taming the receiving set. Nor does a large array of valves appeal to him. What he likes is a single stout valve and a fat reaction coil.

With this combination he will amuse himself for hours. Though he has been trying now for six months he has never yet got 2LO quite to his liking; and I begin to believe that he never will. Sometimes he goes rather further afield, travelling, as ecstatic writers have it, on the magic carpet of wireless. And then things begin to happen.

Neighbourly Co-operation

One of his best performances occurred a few nights ago when my neighbour on the other side almost got Rome. Not quite though, for the best that neighbour No. 2 could do was to produce a steady moan, above which he probably heard strange noises that he subsequently logged in his diary as speech and music without a trace of distortion. The net which neighbour No. 1 was casting at a venture into the ether caught the moan. "Ah, ha!" said he to himself with a triumphant smile, "a foreign station. Let us tune it in."

Doing it Still

Neighbour No. 1 was busy for some time in an endeavour to resolve No. 2's moan, and then No. 2 suddenly realised that the squeaks that he was hearing were not those of jazz music from Italy's capital. For the next hour or two No. 1 and No. 2 were trying to tune each other in. For all I know they may be doing so still, for I have since given Rome a wide berth.

Helpful Hints

The time, I think, has come when a few genuinely helpful hints on tuning from my able pen are due. It is all very well to say "Please don't do it." Anyone can say that. I have said it myself lots of times, without the please, but with additions. And now I propose to tell you a means whereby the torrent of oscillation may be dammed rather than damned.

When you are searching with a single-valve set or with one of those lively multi-valvers you can be perfectly sure of causing no interference with your neighbours if you switch off the high-tension battery until the

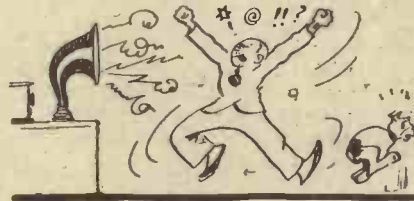

I have a lot to say.

desired station is found. Alternatively the high-tension battery may be left switched on and the filament rheostats turned to the off position. This is probably the more economical method since the filaments eat far more juice than the plates.

Nothing Heard

Friends, or perhaps I should say ex-friends, to whom I have recommended these methods tell me after trial that they find them unsatisfactory since they can hear nothing at all. To them I reply that this does not matter in the least since in the ordinary way they never hear anything intelligible from the stations for which they are searching. I then tell them that if they wish to hear the sounds to which they are accustomed, without interference with



Keep a Thomas pussy under the table

their neighbours, their best way is to adopt the switching off tip and to keep a Thomas pussy under the wireless table.

The Characteristic Howl

A steady pressure of the toe of the right shoe upon the animal's tail at intervals will enable them to recapture all their old pleasure in searching for distant stations. The highest authori-

ties have recommended the C.A.T. system.

A Free-Wheel Dial

There are, of course, some who will always insist on having both batteries in full blast whilst searching is in progress and who cannot forego the joys of incessantly twiddling knobs and other panel fungi. To such I would strongly recommend the installation of the free-wheel knob and dial recently patented by that versatile expert Professor Bonehead.

The Professor's free-wheel dial is really an extension of the slow motion device in which, by means of an arrangement reminiscent of the innards of a clock, a large movement of the knob imparts but a tiny movement to the spindle. With Professor Bonehead's free-wheel dial even the largest movement has no effect whatever upon the spindle.

Customary Exercise

The enthusiast's twitching fingers can therefore obtain the exercise for which they yearn without there being the slightest possibility of his causing those in his neighbourhood to foam at the mouth or scatter handfuls of hair upon the carpet. A rival to Professor Bonehead's knob is the neutralised aerial now being developed by Dr. Glump. Perfect freedom from radiation is ensured by earthing the aerial at both ends.

The Real Expert

But why, after all, should one respect the feelings of one's neighbours in the matter of tuning? Those who complain about whistles, shrieks, groans, squeals, yells, chirps and cat-calls are the miserable people who use their wireless sets purely for the purpose of listening to the broadcast programmes.

Any real expert will tell you that he never dreams of doing such a thing. He would a thousand times rather capture an atmospheric from across the Herring Pond or heterodynes from the Far East than listen to such childish stuff as a pianoforte solo by Paderewski or a song by Tetrizzini from some nearby station. All the complaints about oscillation come from those unfortunate creatures who revel not in wireless but in programmes. They are merely brakes upon the wheel of progress. You, who log thirty stations in twenty minutes, realise how their loud-voiced protests

Abolish Programmes—continued

impede the work of genuine experimenters.

Abolish the Programmes

Something will really have to be done about this programme business. The best solution that I can see is for stations to abolish programmes altogether and to send out the tuning



Scatter handfuls of hair on the carpet.

note steadily from mid-day until mid-night. This would solve the wavelength problem at once. A piano of full compass contains eighty-five keys, black and white included. Possibly you may say to yourself: "By Jove! the fellow who writes this must be something of a musician." He is not. He has just carefully counted them. And now that you have done so too we will get on. This means we have room on the broadcast band for eighty-five stations each with its individual tuning note.

Identifying Stations

Having tuned-in an unknown station, all that you have to do is to



let the forefinger of the right hand stray over the keyboard of the piano until the right note is found. Then by referring to the official list of tuning notes you can identify the transmission at once, and pass on rapidly to something else. If this

idea of mine is adopted an enterprising firm intends to bring out a series of transfers which will enable the call sign of the station to be stamped upon the appropriate key on the piano.

This instrument, which has hitherto served merely as a resting place for loud-speakers, high-tension batteries, wavemeters and other gadgets will thus justify its existence by becoming really useful.

Popular Music

And there is much more in the idea than you might think at first sight. Your real expert will be able to play upon the wireless stations of Europe as coal-black musicians play upon the saxophone. Careful manipulation of the tuning controls will produce a rendering of "Home Sweet Home," or "The Ukelele Lady" that will bring tears to the eyes of all who hear it. Instead of being tied down merely to what is ladled out to us by the broadcast programmes we shall be able to obtain any tune we like from the wireless set.

Unfortunate Difficulties

Naturally there are certain difficulties. The unskilled player upon the wireless receiver might swoop through the harmonic scale when he required to ascend from the G below to the E above. The real virtuoso, however, will overcome this by deft application of the earthing switch, which will be attached to a pedal beneath the wireless table. A second

pedal. The battle between the wavelengthers and the frequencyites will end in an honourable peace. Instead of either of these things we shall find on the left-hand side of the table a neatly printed musical scale, like the thing that used to worry you in the days of your infancy when what your elders fondly believed would one day be a brain reeled before the complexities of Mrs. Thingmejig's Simple Pianoforte Method For Tiny Tots.

The musical scale has already inserted, so to speak, the thin end of its wedge into wireless, for it has been widely used by transformer manufacturers to prove that the best L.F. transformers can deal quite effectively with notes above the Middle C.

Prophecies

In the happy future, when my scheme has secured universal adoption, we shall not score bad marks in the recording angel's ledger by the prating of the perfect orchestral transmission

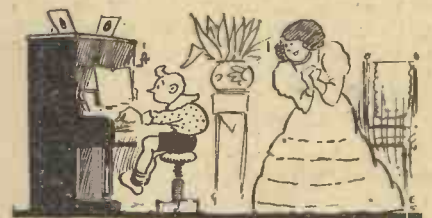

In the days of your infancy.

that we heard from this or that distant station. The high-brows amongst us will merely say that on the previous evening Vienna was a thought sharp or Moscow a fraction of a tone flat. Low-brows (like myself, and possibly like you) will content themselves with remarking that these stations sounded a bit wonky, a more concise and probably a more true way of expressing the same thing.

Food for Thought

The genuine radio liar will tell us in the morning train that he can run right up and down the scale whenever he wants to; and when we go round to hear him do it we shall find, just as we find to-day, that his set has been struck by lightning, that his accumulator is run down, or that he has incinerated the windings of one of his transformers.

I have no doubt that enterprising firms of manufacturers will put upon the market a special type of loud-speaker containing a keyed whistle worked by compressed-air; this will enable the expert to keep his end up when his friends come round for a demonstration. If any note is missing from the scale the whistle will supply it.

.....
After having conversed with a station in India Mr. R. L. Royle (2WJ), who owns the amateur station depicted here, once found blue electric sparks flashing across his apparatus. A lightning discharge is said to account for the phenomenon.

pedal will control the coupling between the reaction coil and the aerial tuning inductance.

Simplifications

And just think how the tables of regular transmissions will be simpli-

ARE YOU A PATIENT MAN ?

£200

IF YOU ARE



"Let's see—five separate units give five capacities, taken singly. Then I can have the first two in series or parallel—total seven. Then the first three all in series or all in parallel—two more. The first and third and second and third in series, total 9. Ditto, in parallel, 11. First and second in series, and in parallel with the third—12 And the total number of different capacities with the five units is ———?" What is it?

**If you get it right,
you win £200!**

Whatever your skill in counting capacities, however, the purchase of a Dubilicon will bring you one sure reward. The Dubilicon gives any capacity up to 0.011 mfd. simply by varying the connections of the eight unit capacities of which it is composed; so that by using the Dubilicon you will be able to select with unfailing certainty the best value of fixed capacity for any desired part of your circuit.

The Dubilicon is a multiple condenser containing eight separate units, the terminals of each unit being brought out to sockets on the lid. By using Clix plugs (made by Messrs. Autoveyors, Ltd., 84, Victoria Street, S.W.1) of which two are given with every Dubilicon, the units can be connected in a variety of series, parallel and combined series parallel arrangements giving a very large number of different capacities.

The uses and advantages of the Dubilicon, which we have summarised above, make it more than worth its low price of 30/-.

In addition, the purchase of a Dubilicon entitles you to enter for the £200 prize competition. All you have to do is to estimate the number of different capacities you can get by connecting up the first five units in various ways.

Ask your dealer about one to-day—and mind you enter for the £200 competition! He will tell you all about it!

*The
Dubilicon*

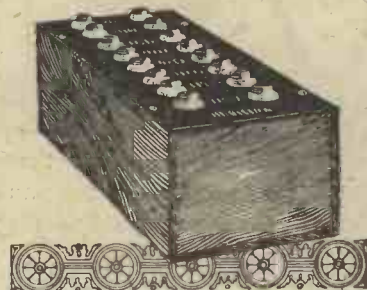

REGISTERED  TRADE MARK

DUBILIER

CONDENSER CO (1925) LTD

ADVERT. OF THE DUBILIER CONDENSER CO. (1925) LTD., DUCON WORKS, VICTORIA ROAD, N. ACTON, W.3. TELEPHONE: CHRISWICK 2241-2-3. E.P.S. 193

You can improve your set by using

B.T.H. VALVES

Made in six types, three general purpose and three power amplifying.

General Purpose
 R. 4 volts, 0.7 amps. 8/-
 B3. 1.8 " 0.35 " 14/-
 B5. 2.8 " 0.06 " 16/6

Power Amplifying
 B4. 6 volts, 0.25 amps. 22/6
 B6. 2.8 " 0.12 " 22/6
 B7. 6 " 0.06 " 24/6

Ask for the Valve with the monogram

B.T.H.

2157E

Advert. of the British Thomson-Houston Co., Ltd.

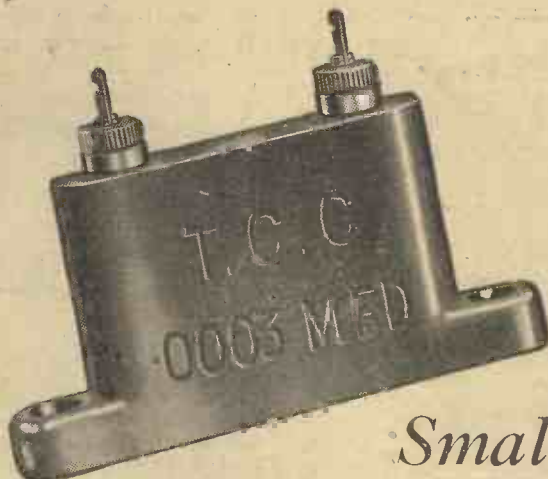

*Small—
but important!*

THE efficient working of a large machine very often depends upon some very small item of its mechanism; car-owners know only too well how the engine can be put out of action by some very minute fault such as the choking of a jet or the loss of a nut.

In Wireless, too, experience proves that reception can be marred or rendered impossible through some very small error in construction or fault in a component. The fixed condenser is perhaps the smallest component in a set—in size and cost—yet how often are faults traceable to badly insulated condensers. It is false economy to buy an unknown Condenser, which for perhaps a few pence more there is the T.C.C. with its positive guarantee of accuracy. In the T.C.C. you choose a condenser backed by 20 years experience; one which has passed so many tests before being released for issue that its accuracy within a very small percentage of error is a foregone conclusion; a condenser which is heat proof and impervious to atmospheric action; and finally one which has been the repeated choice of experts throughout the world for many years.



PRICES AND CAPACITIES:

Mansbridge, 2 mfd. - 4/8	Mansbridge, '1 mfd. - 2/6
Mansbridge, 1 mfd. - 3/10	Mansbridge, '09 to '01 - 2/4
Mansbridge, '5 mfd. - 3/4	Mansbridge, '009 to '005 - 2/-
Mansbridge, '4 mfd. - 3/2	Mica, '004 to '001 - 2/4
Mansbridge, '25 mfd. - 3/-	Mica, '0009 to '0001 - 2/4

T.C.C.
CONDENSERS
 (Mica & Mansbridge)

Telegraph Condenser Co., Ltd., Wales Farm Rd., N. Acton, W.3

G.A. 5134

TALKS TO BEGINNERS

By

PERCY W. HARRIS, M.I.R.E., Editor

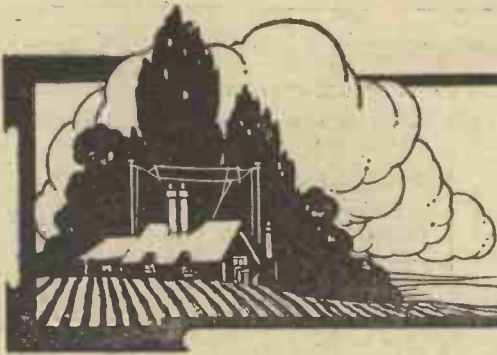

This is the fourth of the series of talks to the beginner, the first of which was published in the April issue.

IV.—A CHAT ABOUT CRYSTALS

LAST month we considered some of the peculiarities of the minute currents set up in the receiving aerial by the broadcasting waves, and I gave you a few facts about oscillations and about the telephone receivers. You will remember that we reached the point where we had to consider how the currents which change their direction with such tremendous rapidity could be turned into currents flowing in one direction only, suitable for operating the telephone headpieces or loud-speaker.

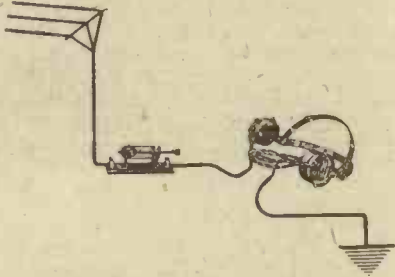

Fig. 1.—This arrangement of crystal and telephones would be very inefficient, and would only give signals if quite close to the transmitting station.

A Strange Property

I mentioned that certain mineral substances possess the strange property of allowing electric current to pass through them in one direction and not in the other. Exactly why they have this property I do not propose to discuss here. In any case, scientists are by no means agreed upon the actual processes taking place within the crystal, and if we knew them it would not help us to any great extent in understanding the general working of a wireless receiver.

The Early Crystals

Carborundum, as I mentioned last month, was one of the first substances found to possess the peculiar property of allowing this uni-directional flow. Very soon a number of minerals were found to act in the same way, in greater or lesser degree, among them being galena (a natural ore of lead), iron pyrites, copper pyrites, zincite (a

natural zinc ore), and many other ores.

Some of these substances require a contact to be made by means of fine wire, using very light pressure, while others were found to work excellently in pairs. For example, a crystal of zincite pressing against a crystal of copper pyrites was found to give a very excellent and stable detector. Before broadcasting days a wide variety of substances were used as crystal detectors, but soon after the war, as it was found that galena could be treated in such a way as greatly to increase its sensitiveness, this substance soon became the most popular of all crystals.

Few Sensitive Spots

The surface of a crystal of galena, in its native form, will be found to possess relatively few sensitive spots. If you mount the average natural crystal of galena in the usual crystal cup, you will probably have to hunt all over the surface to find just one or two really good sensitive points. Most of the surface will be found quite insensitive. In a very few cases it is

possible to find natural galena with a multitude of sensitive surfaces, but generally this substance was not popu-



Zincite is most commonly used in "Perikon" detectors, in conjunction with another crystal, such as bornite or copper pyrites.

lar in the early days of wireless, owing to the few good spots that could be found.

A Re-Crystallising Process

A few years ago it was found possible to produce really excellent rectifying crystals by fusing natural galena and re-crystallising it into the granular structure which every crystal user knows so well, the treatment giving to

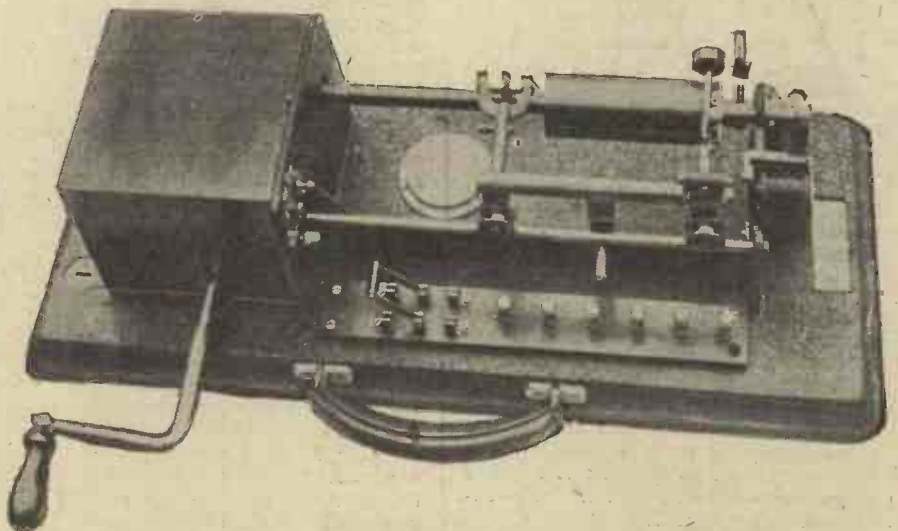

A commercial form of the apparatus for the reception of wireless photographs designed by Mr. Thorne Baker. It is claimed that this instrument may be worked from an ordinary loud-speaker receiver.

Talks to Beginners—continued

the re-crystallised substance high sensitivity over practically the whole surface. Re-crystallised galena is now sold under a multitude of fancy names, and most of the special crystals, the names of which end in "ite," consist in the main of this substance.

An Inefficient Arrangement

In an earlier article I explained how an aerial, by being adjusted to the proper electrical length, could be brought in resonance or tune with the transmitting station, and how the maximum current would be built up in an aerial under such conditions. If, now, we connect the crystal "in series" with the aerial, that is to say, if we bring the aerial to the crystal cup, the other side of the crystal by means of the catwhisker to the telephones, and the telephones to earth, it might seem that the property possessed by the crystal of allowing currents to pass in one direction only could be utilised to give us currents which would operate the telephones in the manner we desire.

Not Recommended

A few minutes' consideration will show that such an arrangement is highly inefficient, as not only would the high resistance of the crystal itself tend to prevent the building up of oscillations, but the fact that the telephones were joined in this way would put the aerial entirely out of tune.

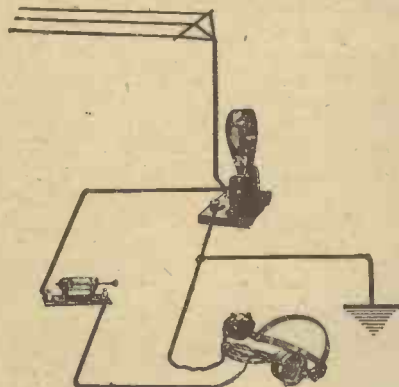

Fig. 2.—So long as the coil tunes the aerial to the wavelength desired, this circuit arrangement will give good reception.

While this is so, a crystal and telephones connected in the aerial as explained will give signals quite close to a broadcasting station, due to the fact that the strength of the incoming waves is such that no building-up effect is needed to give good signals. However, the arrangement is not one to be recommended, even in such conditions. (See Fig. 1.)

Improving the Circuit

A much better way of joining up the crystal and telephones is to place them

across the tuning coil, as shown in Fig. 2. We can thus tap off some of the energy oscillating in the aerial without seriously interfering with the tuning or other adjustments. Such an arrangement gives quite an efficient crystal receiver, provided that the size of the coil is correct for



The pin lying beside this piece of Hertzite crystal will give some idea of the degree of magnification of the photograph.

tuning the aerial to the wavelength it is desired to receive.

Tuning the Aerial

How can we tune this aerial? One way is to make the coil of wire variable turn by turn. This was the method adopted in the earliest broadcasting receivers, and consists in making a coil of wire on a cylindrical former and arranging for a movable metallic contact to touch any desired turn when slid backwards and forwards along the coil. Rough tuning is possible by such a method, and quite good results are obtainable. The disadvantage is that the arrangement is clumsy, and the constant friction of the slider on the coil of wire tends to wear out the wire.

A better mechanical job is to bring wires from various tappings to studs on a stud switch, arranging that the arm of the switch will pass from stud to stud as we desire to select the turns we want. This method is called the "tapped coil" method.

A Variometer Method

A third method, giving perfectly smooth tuning, is to arrange two coils of wire to rotate in relation to one another, the electromagnetic effect of one coil upon the other varying as the angular relation of the two coils is changed. Such an arrangement, called a "variometer," enables the electrical length of the aerial to be progressively and smoothly changed from one end of the scale to the other without any stud switches or rubbing contacts. Many commercial crystal

receivers are made up with variometers and operate quite successfully.

Another Variation

Perhaps the most popular of all forms of tuning is to have a tuning coil of a definite fixed size and to arrange across it a variable condenser, as shown in Fig. 3. The bigger the capacity of the variable condenser, the longer the wavelength to which the given coil and aerial will tune. A tuning coil is always shown in a wiring diagram as a curly line, and a variable condenser as two lines with an arrow through them, as indicated in Fig. 4.

A Chat About Variable Condensers

The variable condenser and its purpose seem to puzzle the beginner, and I am often asked questions about this instrument which show that its purpose is very imperfectly understood. To understand something of its functioning, let us consider a simple analogy. Everyone knows of the elastic motors used by boys to drive their model aeroplanes. These strips of elastic cord are twisted by turning

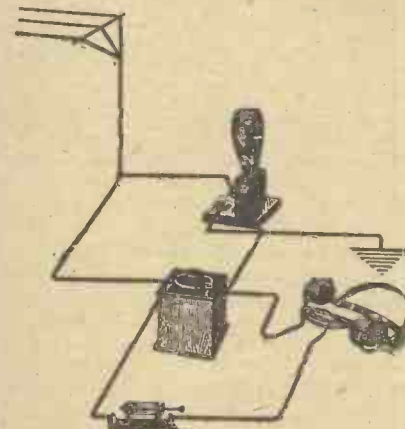

Fig. 3.—If a variable condenser is added to the Fig. 2 arrangement, the circuit may be tuned to any wavelength within the limits determined by the coil and condenser in use.

the aeroplane propeller round and round, and the energy so stored in the elastic is given back in the untwisting movement, so as to rotate the propeller at high speed and draw or push the aeroplane forward.

Storing the Energy

If, now, we take two metal plates separated by an insulator such as air and connect wires to these plates, we

Figures to Remember



The Highwayman

“STAND AND DELIVER!”

—the command of the Highwayman—yes, and the valuables delivered were well worth having. Now, we deliver **SIX-SIXTY VALVES**, and if you value really good reception, they too are well worth having. With these perfectly designed valves the delicate gradations of music are reproduced in all their original beauty, while the remarkably clear reproduction of speech is a proof of the real contribution which 6-60 Valves have made to modern radio science.

Take the S.S.3.L.F. (green disc), for small or medium-sized Loud Speakers. This 3-Volt Valve consumes only .06 amps filament current—which in itself means a big economy in accumulator recharging—and in addition works at such a low temperature that the life of the filament is immeasurably increased. The S.S.3 (red disc) gives excellent results both as an H.F. amplifier and as a detector. Owing to the low current consumption of both types, dry cells may be used.

Then for a real Power Valve—the S.S.7 has no equal. It is absolutely non-microphonic, and when operating at the correct voltage there is no glow whatever from the filament. This valve consumes only .1 amps filament current, and combines remarkable volume with unequalled purity of tone.

Six-Sixty Valves are recommended by all the leading Wireless Journals of to-day. For **PERFECTION OF QUALITY** insist on **SIX-SIXTY VALVES**.



S.S.3 L.F.
(Green Disc.)

Voltage - 3 volts.

Consumption '06amps.

PRICE 16/6

Leaflet S.S. 1.7 gives full particulars. Your Dealer will be pleased to order Six-Sixty Valves for you if he is out of stock.



SIX-SIXTY VALVES
Better by Six times Sixty

The Electron Co., Ltd., Triumph House, 183, Regent Street. London, W.1. 10



SYMPHONY

HAVE YOU EVER listened to a symphony concert and wondered at the order in the music? Each sound blending, every note harmonizing. Not an instrument playing false nor one instrumentalist out of time. A radio set should have the same unity as a symphony concert. All the components should work in unison. With Pye components this occurs naturally. They co-ordinate to bring in the concerts clear, loud, and easily. Why not write for the illustrated booklet to-day showing the full range of Pye products?

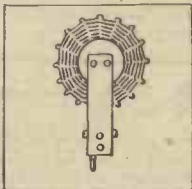

PYE TUNING COILS

Very strongly made. Wire (enamelled and double silk covered) wound on stout wooden pegs. Very low capacity and effective resistance. Four coils cover a range of from 300-3150 metres. (Ref. Nos. 28-206.) From 5s. each.

PYE TRANSFORMERS

High amplification without distortion: no noise or crackle. Coils wound in special Bakelite bobbins; turns carefully insulated. Can be fixed in two positions. Guaranteed for twelve months. L.F. Transformers (Ref. 651, 653), £1 2s. 6d. (Ref. 654), £1 7s. 6d. Telephone Transformers (Ref. 655, 656, 657), £1.

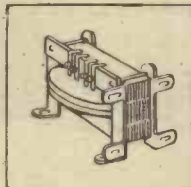

PYE DUAL RHEOSTAT

For bright and dull emitter Valves. Resistance tightly wound on fibre and element mounted around heat-resisting compound. Smooth action. One hole fixing. (Ref. No. 850.) Price 4s. 6d.



W. G. PYE AND CO. GRANTA WORKS
MONTAGUE ROAD, CAMBRIDGE
Manufacturers of Scientific Instruments and Radio Apparatus



COMPONENTS

Talks to Beginners—continued

can drive a charge of electricity into the "condenser" so formed, which charge can be given back as electric current when the two plates are joined together by a wire or other conductor. The energy is not stored in the metal plates, but in the space between them known as the "dielectric." The larger the plates (provided the space between them is kept constant), the greater the ability to store a charge, or put in another way, the greater the energy we can put into the condenser for a given applied pressure.

Constructional Details

Obviously the plates must be "insulated" from one another to prevent leakage, and as air is practically a

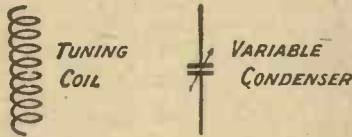

Fig. 4.—The conventional methods of indicating in a circuit diagram the coil and variable condenser shown in Fig. 3.

perfect insulator, this is the material between the plates of most variable condensers. It is frequently inconvenient to make our plates very large, so a number of smaller plates are joined together. As it is only the

overlapping portions of the plates in which we are interested, it follows that the more overlap of plates, the greater the "capacity" of the condenser.

For this reason it is frequently the practice to connect one set of plates to a moving spindle and the other to a fixed support and arrange the plates so that by turning a knob, a greater or lesser portion of the assembly of moving plates can be made to interleave with the fixed plates. In this way the capacity of the condenser can be progressively varied.

Increasing the Capacity

In condensers of fixed capacity as distinguished from variable condensers it is often convenient to place some insulating material other than air between the plates, for some of these materials, apart from having greater mechanical strength than air, give a much greater capacity for the same plate separation. For example, if we have two pieces of metal separated by, say, a thirty-second of an inch of air space, the capacity may be 10 units. If we substitute for this air space a sheet of good mica of the same thickness, the capacity will immediately jump to six or eight times the value.

A Time Factor

When we connect a source of elec-

tricity to a condenser, a certain time is taken to charge it. The larger the condenser, the longer the time taken to charge it, and similarly the longer time taken to discharge it when the two plates are joined together. In my

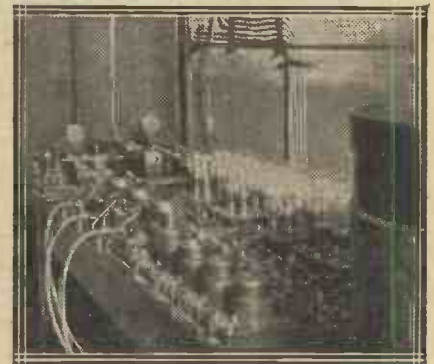

The keys used for automatic transmission at the Rugby wireless station.

next article I will tell you something about the times taken to charge condensers and discharge them. This will lead us up to the point where we can understand how the frequency of a circuit can be varied by means of a variable condenser.

No unnecessary handling with the "Lotus"

Moving block cannot fall.

The fewer adjustments, the easier it is to get accuracy. The "Lotus" is designed and proved in actual tests to respond to the most delicate operation without the exasperation caused by ordinary coil holders. The moving block remains rigidly in position with the heaviest coil and no screws are needed to tighten it. It also moves in the same direction as the knob, which prevents any confusion. Three sets of enclosed precision machine cut gears ensure this.

LOTUS

VERNIER COIL HOLDERS

From all Radio Dealers.

Two Types:

For outside panel mounting:

Two-way ... 7/-
Three-way ... 10/6

For inside baseboard mounting, with 6 in. handle:

Two-way ... 8/-
Three-way ... 12/6

Garnett, Whiteley & Co., Ltd.,
Lotus Works, Broadgreen Road, Liverpool.
Makers of the new improved "LOTUS" Valve-Holder.

Bakelite mouldings for the side plates, coil blocks and knobs; heavy nickel plating for the metal parts.

YOURS FOR 20/-

The 'Tonyphone' G.II. is a two valve receiver of remarkable selectivity, having a range of well over 1,000 miles. Receives all B.B.C. and most Continental Stations. Will be sent on approval complete with all Accessories on receipt of 20/-. You pay a further £1 each month or 5/- each week afterwards until completed.

The 'Tonyphone' G.II. In handsome Mahogany Cabinet Complete with Accumulator, H.T. Battery, Aerial, 1 pair of 4,000 ohms Headphones and 2 Valves—1 High Frequency and 1 Detector. All Royalties paid.

Send to-day and enjoy broadcasting NOW. Illustrated Price List free on application.

BRITISH ENGINEERING PRODUCTS CO.
(Battery Dept.), Abbey House, Victoria Street, London, S.W.1

S.S.A.

CUT THIS OUT FOR CABINETS

and post to us for FREE list illustrating Cabinets as shown in "Wireless Constructor," etc., etc.

NAME.....

ADDRESS.....

(Write in block letters please.)

CARRINGTON MFG. CO., Ltd.
18/20, Normans Buildings,
Mitchell St., Central St., E.C.1
Trade enquiries especially invited.



**Try the coil that
"makes all the difference"!**

Every listener who has tried the new LEWCOS Coil is talking about the difference it makes. Some say that this coil in the blue box is as different from ordinary coils as "Glazite" is from the old connecting wire. The LEWCOS Coil embodies high electrical efficiency with great mechanical strength. It gives extremely fine tuning and, having an exceptionally low high frequency resistance, increases signal strength.

Try the LEWCOS Coil for yourself—it makes **all** the difference!

Your radio dealer stocks or can obtain this new coil.

No.	25	35	40	50	60	75	100	150	200	250	300
Price	4/6	4/6	4/6	5/-	5/6	5/6	6/9	7/6	8/6	9/-	10/-

LEWCOS

Inductance Coil

The LONDON ELECTRIC WIRE COMPANY & SMITHS, LTD.

Manufacturers of Glazite Connecting Wire.

Playhouse Yard, Golden Lane, London, E.C.1

This mark



guarantees quality.

JUDD

In replying to advertisers, please mention THE WIRELESS CONSTRUCTOR.



**Take the speaker
into the garden
—leave the set
indoors.**



IGRANIC-PACENT JACKSET



IGRANIC-PACENT AUTOPLUG



With the use of Igranic-Pacent Jacks and Plugs it is perfectly simple to have your loud-speaker and head-phones wherever you wish in the garden. No need to move the set about—thus securing maximum enjoyment with a minimum of trouble.

No need to worry about loss of signal strength through faulty connections—good contact is certain when Igranic-Pacent Jacks and Plugs are used.

Here we illustrate four of the range—write for the Booklet J35, which describes them all, and see how easily they will solve your own particular problem.

All reputable dealers stock Igranic-Pacent Jacks and Plugs.



IGRANIC-PACENT UNIVERSAL PLUG



Exclusive Manufacturing Licensees of Patent Radio Essentials.

149, QUEEN VICTORIA ST., LONDON.

Works: BEDFORD.



IGRANIC-PACENT OPEN CIRCUIT JACK

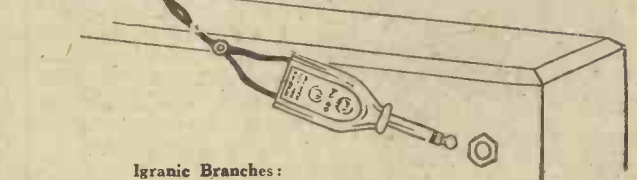

Igranic Branches:

BIRMINGHAM BRISTOL CARDIFF GLASGOW
LEEDS MANCHESTER NEWCASTLE

TWO USEFUL HINTS FOR THE CONSTRUCTOR

WIRE MEASURING WITHOUT A GAUGE

A WIRE gauge is a rather expensive addition to one's workshop equipment, and the average constructor so seldom needs it that it is hardly worth while for him to purchase it. It does, however, sometimes happen that one wants to know the gauge of a quantity of wire. It may be that the label has come off the reel, or again that the wire may have been obtained by unwinding a discarded inductance, transformer or other component. Here is quite a simple method of discovering the gauge of wire of any kind. Wind a portion of it on to any round object, putting the turns on evenly and tightly and making the wound portion half an inch in length.

Now count the turns, and refer to the columns marked "turns per inch" in a table of wire sizes. Suppose, for example, that the wire is double cotton-covered and that there are 20 turns in your half-inch of

winding. Double the number of turns, and look for 40 in the d.c.c. column. You will find that No. 28 makes 40.2 turns per inch, and this is the gauge of the wire in question.

HOLDING SCREWS AND STUDDING IN THE VICE

MOST constructors will have encountered the difficulty of holding screws or studding in the jaws of the vice for cutting or other purposes. Here is a very simple tip

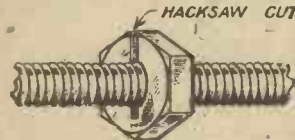

Fig. 1.—For holding screws or studding in the vice an ordinary nut cut as shown will prove of value.

which makes it possible to hold the work as firmly as can be desired without in any way injuring the threads. Obtain a big nut of the size required,

and with a fine-bladed hacksaw make a cut from one of the corners into the threaded hole and a little beyond it. The nut can be run on to the screw that it is desired to hold, and when the jaws of the vice are tightened the presence of the hacksaw cut permits the nut to be compressed so that it holds the work as tightly as could be wished.

Make Up a Set of Holders

When the work is removed from the vice the nut springs back to its original shape, allowing the screw to be withdrawn. Should the nut bind at all after being squeezed in the vice, it is easily prised open by inserting the point of the screw-driver into the cut. I have found this tip so useful that I have made up a set of holders on the same principle for all the B.A. sizes that one uses.

Actually they are not nuts, but short lengths of round rod tapped to suit the various sizes and with flats filed at either side to enable the jaws of the vice to obtain a good grip upon them. If you have any old worn dies in your scrap box, you will find that these answer equally well for the purpose.

The COLVERN LOW LOSS SELECTOR

The Colvern Selector Low Loss. Reading to 1/8,600th capacity. Capacity .0005 mfd. £1 ls. - .0003 mfd. £1 Type F. without gear attachment. Capacity .0005 mfd. 15s. 0d. .0003 mfd. 14s. 0d. One hole fixing. Other capacities if required. Descriptive folder upon request. Colvern Independent Vernier - Price 2s. 6d. Ask your dealer also for the Colvern Low Loss Coil Former - Price 6s. 0d.

Collinson Precision Screw Co. Ltd. Provost Works, Macdonald Rd., Walthamstow, London, E.17. Telephone: W. Hthamstow 532.

for Superhets also

"It may interest you to know that I consider that your Selector to be the only Variable Condenser on the market which is suitable for incorporation into the 'Split Coil Neutrodyne' Circuits which have recently become so popular. With this circuit the Condenser tuning the Anode Coil has both the rotor and stator at High Frequency potential and with most Condensers this means that hand capacity effects are so troublesome as to make the circuit 'not worth while.' I find however that your Selector—even in this circuit—is quite free of hand capacity. I wonder that you do not make a point of this in your advertisements."

Your dealer stocks the Colvern!

ARTCRAFT Cabinets "Popular Type"

Oak or Mahogany Cabinets of Artcraft design and construction are a credit to the set you build

Panel Size	Depth	Price in Oak	Price in Mahog.
9 X	6 X 6	6/0	10/0
10 X	8 X 6	8/0	12/0
12 X	10 X 8	12/0	16/0
14 X	10 X 8	14/0	19/0
16 X	8 X 8	14/0	19/0
18 X	12 X 9	21/0	29/0

Baseboards Free. Hinged Lids 1/6 extra. Prices include packing, carriage and insurance to any station in England and Wales. Prompt delivery guaranteed.

The ARTCRAFT Co.
156, CHERRY ORCHARD RD., CROYDON
Farr's Ad.

Finston SUPER COILS

Are totally enclosed in moulded Bakelite cases giving great mechanical strength, without impairing their efficiency. The coils have been so constructed that the centres are always in alignment when two or more are used, thereby securing maximum results from their magnetic field.

All connections are soldered, so as to give constant electrical continuity throughout. A loose plug is provided so that the winding of the coils can be reversed if so desired.

Prices:—25, 35, 40, 2/6 each; 50, 60, 3/- each; 75, 100 150, 3/6 each; 175, 200, 4/- each; 250, 300, 4/6 each.

FINSTON MANUFACTURING CO., LTD.,
45, HORSEFERRY ROAD, WESTMINSTER, LONDON, S.W.11.

WHAT IS THE BEST SOURCE OF H.T. SUPPLY?

By A. V. D. HORT, B.A.

Are you satisfied with your high-tension supply? Does your battery run down quickly and appear extravagant in cost? Have you attempted to use the supply mains for high tension? This article discusses various methods of obtaining H.T., and indicates their suitability for particular circumstances.

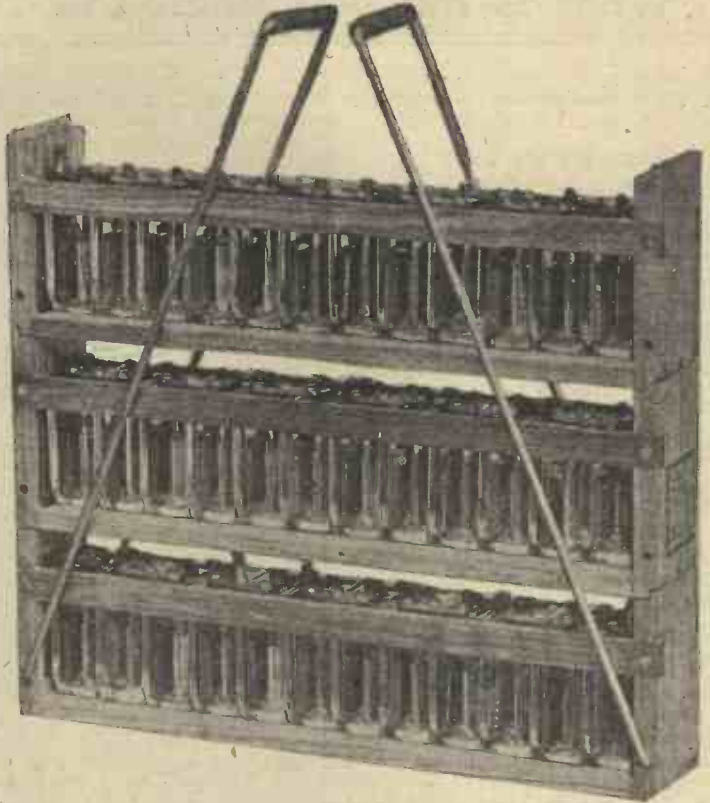

THERE are three principal sources of high-tension supply for the valve set which are open to the regular user of a receiver. The first of these is a battery of primary cells, the most commonly used form of these being of the "dry" type, either made up into block form ready for use or purchased in the form of separate cells and made up into a battery by the purchaser. An alternative to the battery of primary cells is one composed of secondary cells, a number of accumulator units. The third possibility lies in the use of the electric light mains, with suitable apparatus for adjusting the voltage to that required by the receiving set.

Needs of the Moment

In the following article it is proposed to indicate the relative merits of these various forms of high-tension supply under different circumstances. Some people may be so situated that only one form is really convenient to them, while others may be fortunate enough to be in such a position that they can choose whichever appears most suited to their needs. A further method of obtaining high-tension which need only be mentioned and which will not be dealt with further here is that which makes use of a high-tension generator run from an accumulator of comparatively low voltage.

Dry Cells

Dealing first with primary cells as the units of the battery, these possess first of all the advantage over the accumulator of compactness. Their life, on the other hand, is shorter, and once they are run down they must be discarded as useless. The owners of sets employing only two or three valves and not conveniently situated as regards the necessary charging facilities for accumulators will find that these batteries will fill their needs. It should always be borne in mind, however, that a multi-valve receiver, especially one in which power valves are used in the last stages of amplification, may make a very considerable drain on the high-tension battery.

For sets of this kind, if dry cells are to be employed, these must be chosen

with due care, attention being paid to the size of the individual cells in the battery. Small cells will give out very soon, and also they will be more liable to rapid polarisation, giving rise to an uneven flow of current and consequent noises in the loud-speaker.

A Wasteful Item

It is possible nowadays to obtain wet primary cells made up into batteries of reasonably small dimensions. These batteries are, of course, more bulky than the dry cells of the same kind, but they possess the advantage that they are rechargeable. The ordinary dry cell type of high-tension battery is in reality a wasteful item in the running equipment of a wireless set. When the cells run down and the battery is thrown away, there is still a large part of each cell capable of useful service, if it could be brought into use again. The cells simply run down for lack of the necessary chemicals to maintain their action, while the carbon centre with its packing of depolariser and also usually a large part of the zinc container remain intact.

Necessary Attention

It is in this direction that the wet cell has the advantage. The life of the carbon rod and its packing is comparatively long, and in order to keep the battery going it is only necessary to refill the container with the necessary chemical solution from time to time, and occasionally to renew the zincs. It is true that a wet battery

needs a certain amount of attention if it is to give continuously satisfactory service; scrupulous cleanliness is needed in order to avoid creeping of the solution and consequent corrosion of the terminals or connections.

But against this must be set the fact that the greater part of the battery will remain serviceable for a long time. The same warning with regard to the size of the individual cells as was given in the case of the dry cell battery applies here.

The battery of primary cells, then, may be regarded as the most convenient form of high-tension supply where no other electrical facilities are available and also where prime cost is a consideration.

An H.T. Accumulator

Turning next to the accumulator form of high-tension battery, this has much to recommend it where charging is convenient. From a high-tension accumulator of reasonable capacity, the current which can be drawn for long periods is quite large, comparatively speaking, that is to say, since the maximum anode current used will be reckoned in milliamperes. The first cost of an accumulator of this type is not unduly high, when one considers the length of its useful life and the service that it will give.

The life of the average accumulator, with careful use, is in the first instance normally calculated to be about seven years, though this figure will vary somewhat. At the end of this time the positive plates will require re-

What is the Best Source of H.T. Supply?—continued

renewal, after which the cells will continue to give good service for a further period.

Grouping the Cells

It is most important that an accumulator receive proper attention, both in use and in charging. Excessive discharge rates, which may cause buckling of the plates, are to be avoided. In charging, since the charging rate for accumulators of this type is low, special attention needs to be paid, to ensure that this is correctly carried out. If the charging is done at home, and it is not easy to provide a sufficiently low value of charging current, this difficulty may be surmounted by connecting groups of the cells in parallel for charging, restoring to their normal method of connection when they are in use. If this is done, a higher charging rate may be utilised without damage to the cells.

A Common Mistake

It is fatal to imagine that a high-tension accumulator can be installed and used, charging being the only thing which receives attention. The cells need regular inspection and checking, in order that the electrolyte may be kept up to the proper level and so that faults such as corroded terminals may be noticed before the affected cell is put out of action. With reasonable care, however, the

yet. In America the "battery eliminator" is a common adjunct of the wireless receiver. Perhaps the principal difficulty in this country over such apparatus is wide variation in the supply systems. Different power stations supply current at widely differing voltages, and the periodicity of alternating current supplies is also by no means standardised.

A Safeguard

The man who has mains supplying between 50 and 100 volts direct current from large storage accumulators is well placed, since he can apply the mains direct to his receiver, merely inserting a lamp or fuse in series between the set and the supply as a safeguard against short-circuits. Where the direct current mains are of much higher voltages than this, a common voltage being 220 or thereabouts, it is necessary to reduce the voltage by means of apparatus placed between the mains and the set, and also to provide means for smoothing out the slight voltage variations of the power station dynamo. When once this has been installed and adjusted to suit the requirements of the set, it can be disregarded altogether in most cases.

An Uneconomical Method

A method sometimes employed for obtaining the required voltage is to

any required voltage may be tapped off, from zero up to the voltage of the mains. A disadvantage of this method is that it is not very economical, since current is being taken from the mains and is flowing through the resistance during the whole time that the receiver is in use, and a large part of this is running to waste, so to speak.

Complications with A.C.

Where the supply consists of alternating current, the ordinary method

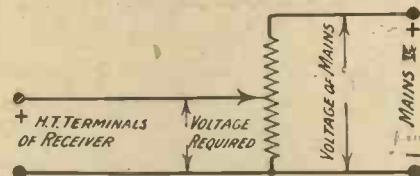

Fig. 1.—With D.C. mains the potentiometer method may be used to tap off the required voltage for the receiver.

of obtaining the required voltage is to use a transformer with its primary connected in series with the mains and the secondary connected to the receiver through suitable rectifying apparatus. By means of a suitably designed transformer for the particular supply voltage and the voltage required at the set, this latter is readily obtained. The additional complication required is the rectifying equipment and also filter circuits for smoothing the output from the rectifier.

A Distinct Advantage

One advantage of getting the high-tension supply from the mains is that once the apparatus is installed, very little attention to it is usually needed, and a constant and unfailing supply is assured to the user. The convenience of this system, too, is obvious, and if the low-tension current is obtained from the same source, the receiver may be switched on and off in the same way as the electric light. This method of supplying receivers, as applied to an up-to-date house, was described in *Wireless Weekly*, Vol. 8, No. 12, where a full description was given of the Model Radio House recently opened in America by Capt. Eckersley.

First Place

The actual cost of running from the mains is not easy to compare with the battery methods, owing to the wide variation of the cost of the unit in different localities. On the score of convenience the mains must take first place, while the choice of the form of battery to be used will in most cases depend on convenience, not much difference in efficiency being noticeable so long as the battery is suitable to the requirements of the receiver.

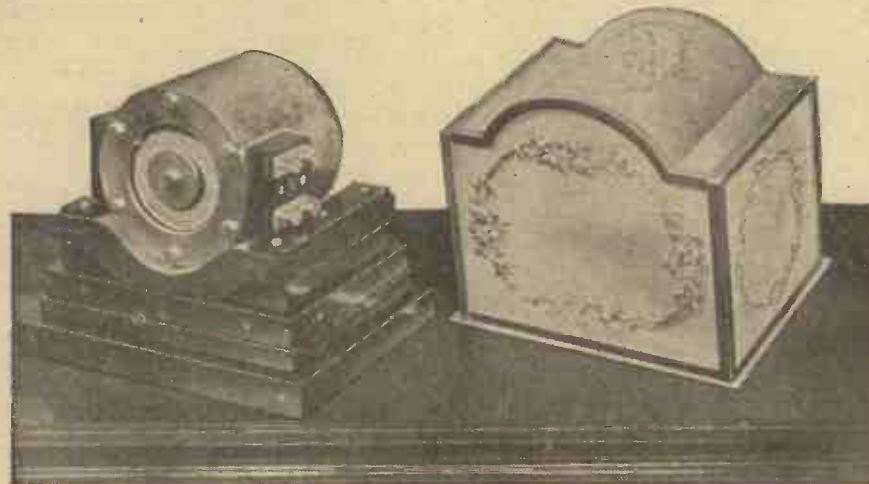

On the cover of the microphone used by H.M. the King are engraved records of the various occasions on which the instrument has been in operation.

accumulator should prove a most satisfactory source of supply for all purposes.

Present Difficulties

Apparatus for charging accumulators from the electric light mains has for some time been available in this country, but instruments designed to provide high-tension current direct from the mains have no great vogue as

place across the mains a resistance, of a suitable gauge of resistance wire, only quite a small current being required. The high-tension terminals of the receiver are connected between one end of this resistance and a sliding contact on the resistance. Neglecting the resistance of any leads that are used, the voltage drop across the whole resistance is equal to the supply voltage. By adjustment of the slider

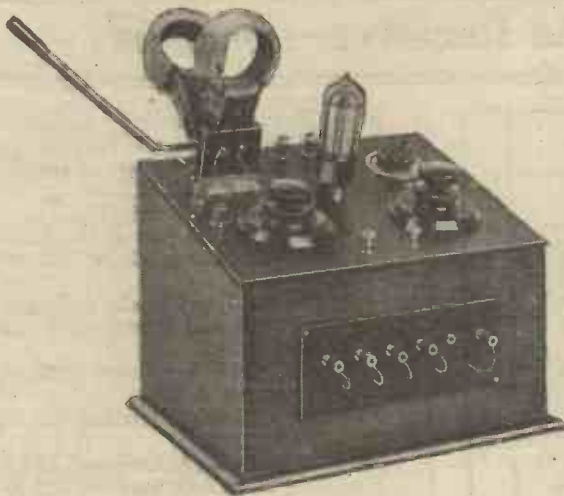

A MULTI REACTION SINGLE VALVE RECEIVER

By A. S. CLARK

By an ingenious arrangement of plugs and sockets in this receiver useful comparative tests can be made between different forms of reaction control.

MANY different forms of reaction control are in use at the present time. Each one has its advantages and its disadvantages, and sometimes one and sometimes another is incorporated in the design of a particular single-valve set. It is not possible to pick out one of them and say it is the best, since in one case one will be found best, whilst in another case an entirely different one would give better results.

Many Types in One

It is thus necessary for the constructor to decide the point for himself, but this cannot be done unless comparisons are made. Under ordinary conditions this would necessitate the construction of several sets, so the design incorporated in the receiver described in this article has been developed to make it possible to try many types of reaction and reaction control on one set.

General Design

On looking at the photographs it will be seen that the set is built on a panel without a baseboard, the panel being fixed to the top of a sloping cabinet. A small ebonite strip will also be seen fixed to the front of the cabinet. This strip carries Clix plugs and sockets which make it possible to change quickly from one circuit to another without altering any connections, by plugging the Clix into different sockets.

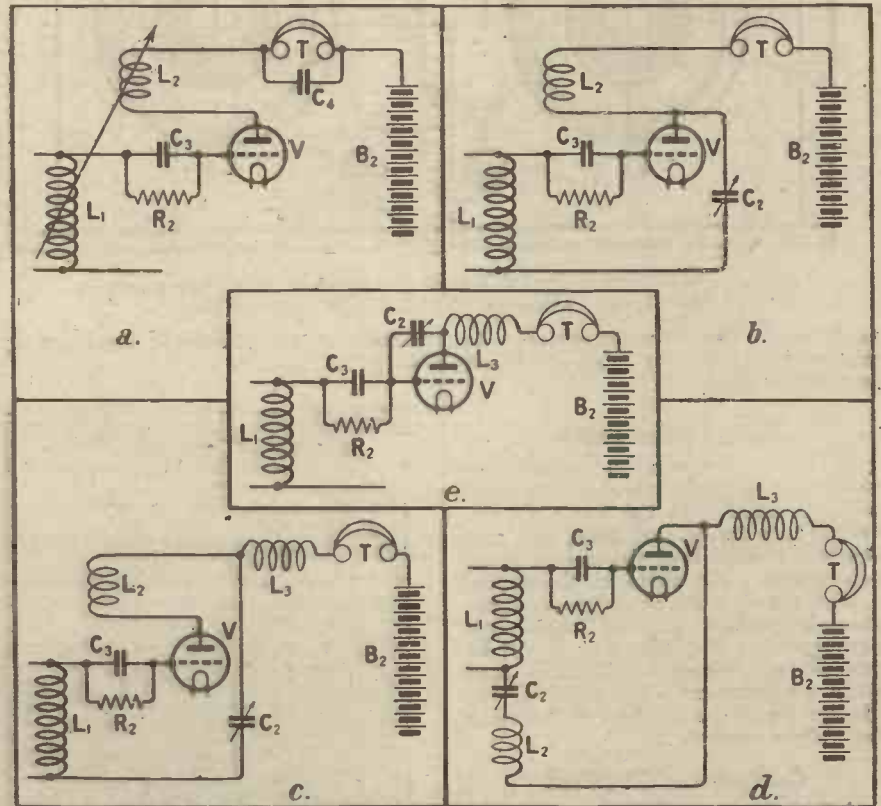

Fig. 2.—This skeleton diagram indicates circuits which can be tested conveniently with this receiver.

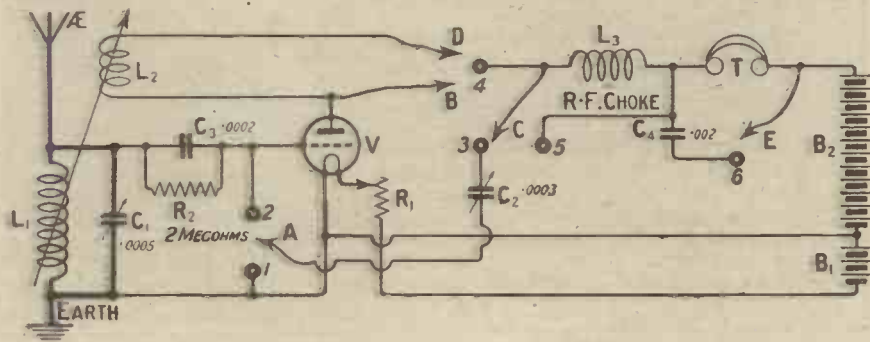

Fig. 1.—By an arrangement of Clix plugs and sockets at least five types of reaction control may be tried with this circuit.

The battery terminals are carried on the main panel in the usual way, as also are the variable condensers, coil-holder and other components.

The Circuit

The theoretical circuit is shown in Fig. 1. The Clix sockets are all numbered, and the Clix plugs are given letters to distinguish them. Corresponding figures and letters will be found marked on the small ebonite strip in the wiring diagram. It can be seen that a reaction coil L_2 is provided as well as a reaction condenser C_2 . L_3 is a fixed radio-frequency choke, and C_4 a telephone shunting

A Multi-Reaction Single Valve Receiver—continued

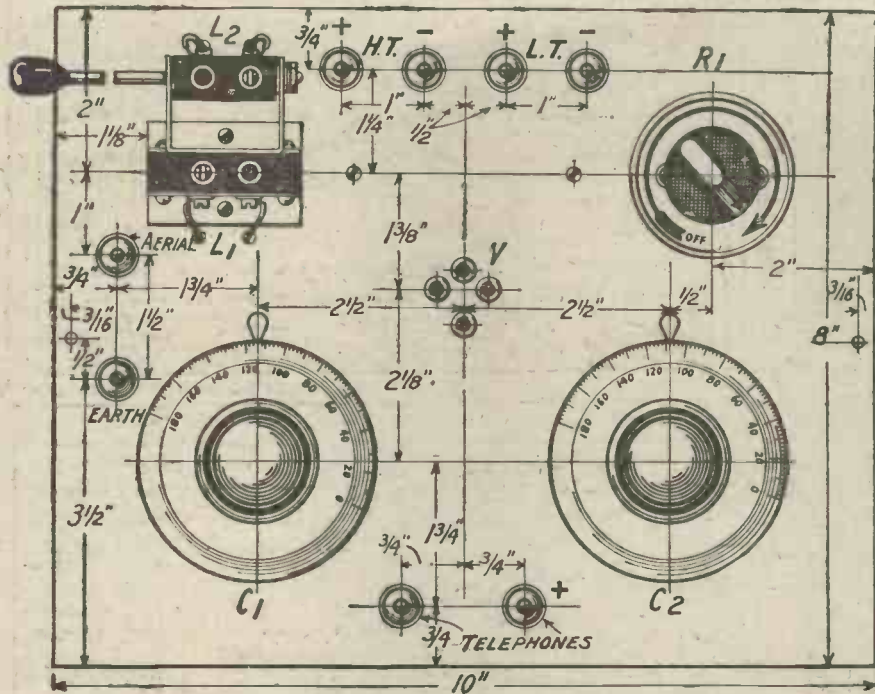

Fig. 3.—The complete dimensions of the front of panel are given in this figure. Blueprint No. C 1651A is available.

- One 30-ohm filament resistance (Pacent) (Igranic Electric Co., Ltd.).
- One two-way coil-holder (Magnum) (Burne-Jones & Co., Ltd.).
- Four valve legs (Security).
- Eight large nickel plated terminals.
- One radio-frequency choke (Lissen, Ltd.).
- One combined grid-leak and grid condenser, .0002 and 2 megohm (Wattmel Wireless, Ltd.).
- One .002 fixed condenser (Efesca) (Falk, Stadelman & Co.).
- Two dial indicators (Decko) (A. F. Bulgin & Co.).
- Six Clix sockets (Autoveyors, Ltd.).
- Five Clix plugs (Autoveyors, Ltd.).
- One packet Radio Press panel transfers.
- Quantity of 16-gauge Glazite and flex wire of some kind.

Commencing Operations

Having collected together all the parts as given in the previous list the construction of the set may be undertaken. The first thing to do is to mark out the panel. This must be done in accordance with the drilling diagram which is given in Fig. 3, and should be done on the back of the panel with a sharp scriber. Before any of the holes are drilled, all points at which they are to be made should be centre punched in order to prevent the drill wandering.

condenser. These components can be used at will and connected in circuit just where desired.

Refer to the Table

In Fig. 2 five common methods for obtaining reaction are shown, and it will be noted that the complete circuit is not drawn each time, only the reaction essentials of the circuit being reproduced. Elsewhere in the article a table showing the necessary combination to obtain any of these five arrangements is given, and it will be realised on studying this table that little adjustment is required to change from one method of reaction control to another.

Components Required

A list of the components required to construct the receiver is given, together with the makes of those actually used by the author. Of course, it is not necessary to keep strictly to the makes given, but if any changes are made, make sure before purchasing that there is sufficient room on the panel for them. The set is quite compact, and therefore the components will be found fairly close together.

- One ebonite panel 10 in. by 8 in. by 1/4 in. (Clayton Rubber Co.).
- One ebonite strip 6 1/4 in. by 2 1/2 in. by 1/4 in. (Clayton Rubber Co.).
- One .0005 variable condenser, slow-motion type (Ormond Engineering Co.).
- One .0003 variable condenser, slow-

motion type (Ormond Engineering Co.).

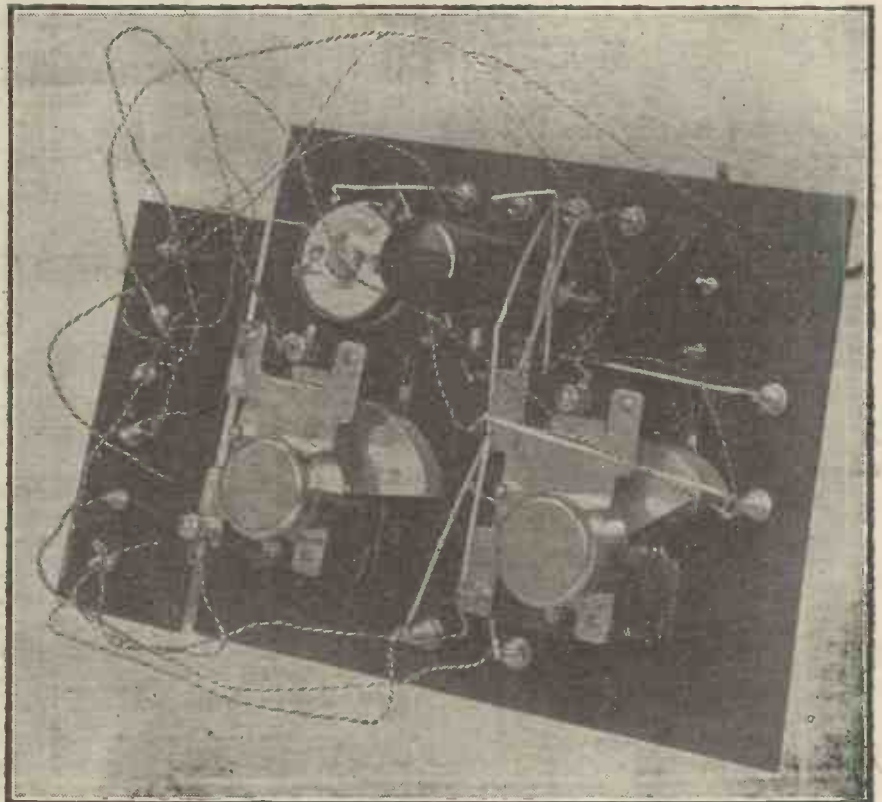

The sub-panel shown on the left accommodates the plugs and sockets to which are attached flexible leads.

A Multi Reaction Single Valve Receiver—continued

The small ebonite strip has to be treated in the same manner, after which the components may be mounted. Small parts, such as terminals and valve legs, are fixed first, leaving the variable condensers till last. The fixed condenser and the grid condenser and leak are held in place by the wires to which they are connected and do not need to be screwed to the panel.

Follow the Wiring Diagram

Attention can now be turned to the wiring of the set. It will be noted that there is not much wiring apart from the flexible leads, and all except these is done with the Glazite wire. Before any wires are attached it is as well to clean and tin heavily all points to which soldered joints are to be made. The Glazite wires are put on before the flexible ones and Lewcos frame aerial wire, as supplied by the London Electric Wire Stores, Ltd., was used for the flexible wiring in this particular case.

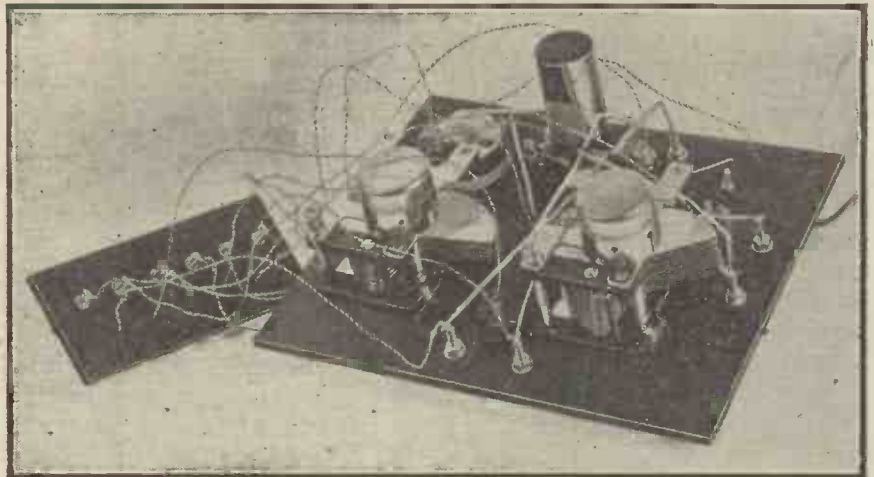

Take care to solder the leads properly to their correct positions.

An Easy Matter

Since there is no rubber covering under the silk covering of this wire,

it is very easy to connect. It is not necessary to bare the wire by scraping with a knife, since all that has to be done is to simply slide the silk covering along the wire away from the end. Throughout the process of wiring, the diagram of Fig. 4 must be accurately followed. The final stage of the constructional work consists in putting on the panel transfers, as shown in the drilling diagram.

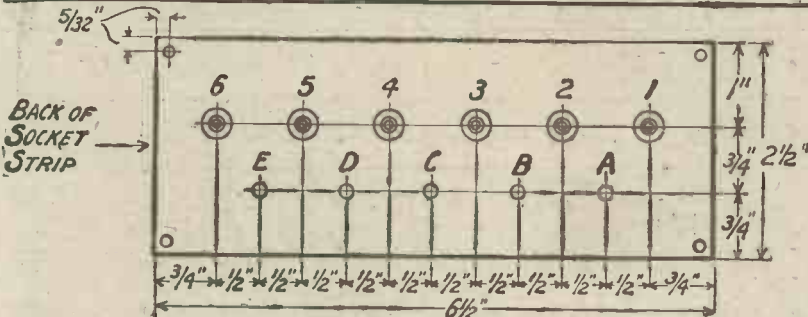
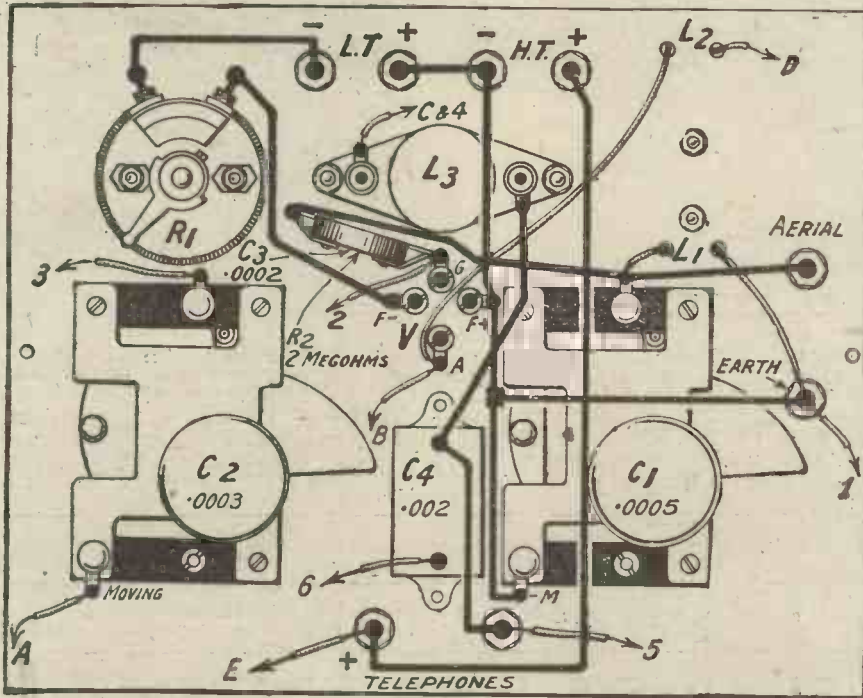

Fig. 4.—Flexible leads are joined between the figures and letters of the socket strip and the numbered and lettered points shown on the back of panel. Blueprint No. C 1051B.

Ready for Testing

To test the set connect the aerial, earth, telephones and batteries to their terminals. Plug a No. 35 or No. 50 coil in the fixed socket and a No. 50 or No. 75 in the moving socket. Turn the filament resistance on until the valve is working.

It will be best to start with the reaction arrangement of Fig. 2a, which is a standard reaction circuit. The reaction condenser will not be in use and reaction control is obtained with the movable coil. If no reaction effect is noticed the leads to the reaction coil should be interchanged.

Circuits to Try

When it has been found that the set is working satisfactorily, the other circuits of Fig. 2 may be tried. A table is given to show the connections necessary to give any of these circuits. For circuits "b" and "c" the moving coil is left fairly close to the fixed coil and reaction control is obtained by the rotation of the variable reaction condenser C₂. In circuit "d," which is a Reinartz type of reaction control, it is necessary to find the best position for the reaction coil, and it may also be necessary to try different sized coils.

Two Possibilities

Circuit "e" is a static reaction one and two sets of connections are given. This is so that if desired the reaction coil may be used as the choke

A Multi Reaction Single Valve Receiver—continued

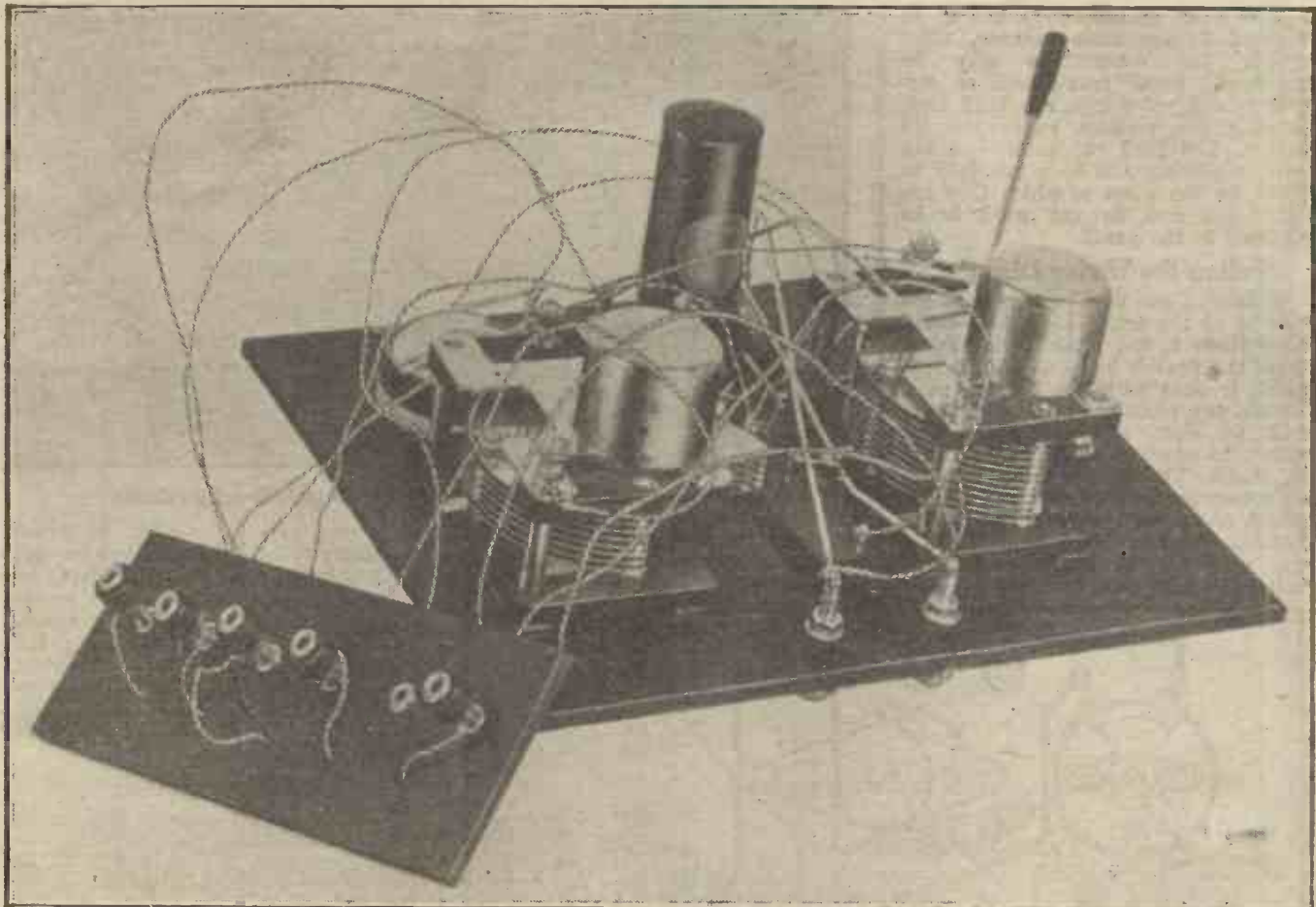

When mounting the fixed condenser ensure that it does not foul the moving plates of the reaction condenser.

coil instead of the fixed choke incorporated in the set, since the value of the choke in this circuit is often critical. If the second arrangement is used the moving coil must be put at right angles to the other, and a coil of about 200 turns used.

Long-Wave Reception

All these circuits may be tried and used on the long waves, such as Daventry. For the reception of this station the coil for the fixed socket should be a No. 150 or a No. 200. The size of reaction coil is best found by trial.

The Set on Test

When testing the receiver it was immediately noticed what a great difference there is between the various forms of reaction.

The circuit which gave best results under these conditions was undoubtedly the Reinartz arrangement of "d." With this circuit in use it was possible to tune in many other stations easily, and at good strength, while 2LO was working.

On all circuits the local station was strong enough to give loud speaking

for a small room on a Lissenola. It was, however, found a little difficult to get good reaction effects on circuits "c." and "e."

The signal strength on the local

station did not vary much between one circuit and another, but on distant stations the strength was naturally better on the circuits which gave best reaction control.

Circuit.	Connections.
a	Plug D into 5 and E into 6.
b	Plug D into 5, B into 3, and A into 1.
c	Plug D into 4, C into 3, and A into 1.
d	Plug D into 3, B into 4, and A into 1.
1	Plug B into 4, C into 3, and A into 2.
e	2 Plug D into 5, B into 3, and A into 2.

This table must be used in conjunction with Fig. 2 in order to obtain the various reaction arrangements.

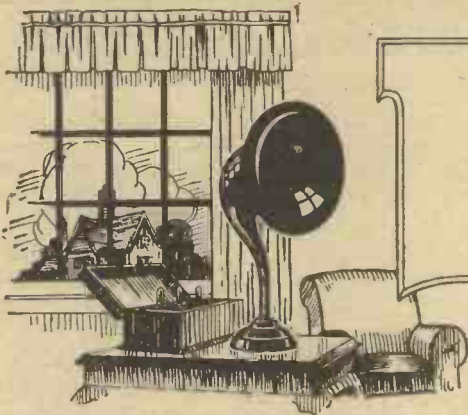

HOW TO MAKE A NON-RESONANT LOUD-SPEAKER

By H. BRAMFORD

Many constructors take a delight in trying their hand at making apparatus to use in conjunction with their receiver, and the information contained in this article will be an aid for those desiring a loud-speaker.

THOSE who are fond of doing constructional work in their leisure time, at home, should find this article on how to construct a loud-speaker both interesting and useful. In the first instance, the financial outlay amounts to considerably less than that which would be entailed in the actual purchase of such an article.

Two Main Types

Many loud-speakers are provided with metal flares, which give out a metallic discord when full volume is being obtained. On the other hand, those of the pleated diaphragm or non-metallic type are usually more expensive. Several wireless enthusiasts are undoubtedly in favour of the flare type of loud-speaker, however, and several also have found the construction of pleated diaphragms to be no easy matter.

In addition to this, a reed type of earpiece is required for use in conjunction with the pleated diaphragm, whereas with the flare an ordinary type of earpiece will do. The reed earpiece is usually more expensive to purchase, while the cheaper type is quite suitable for the purpose for which it is intended.

Reasonable Purity and Volume

The loud-speaker about to be described will be found, when constructed, to be quite free from resonance or metallic vibrations, and should be capable of taking any reasonable volume with remarkable purity. Care, however, must be taken to follow the remarks made in the constructional part of this article. The material which will be required is given below:

Material Required

A quantity of figured oak three-ply wood.

A quantity of figured oak $\frac{1}{4}$ in. thick. The amount of wood required depends upon the size of flare made. Figured oak has been suggested by reason of its durability, its pliability and its natural beauty. Those who prefer other wood, however, may, of

course, choose that which suits their individual taste, but soft woods are not recommended.

Any suitable wood for the box base or figured oak as for the flare.

An ordinary high-resistance telephone earpiece or a Lissen loud-speaker attachment.

A piece of bent brass tubing such as is used for gas fittings.

A piece of brass strip about $\frac{1}{4}$ in. wide.

represents the $\frac{1}{4}$ -in. thick sides of the flare, while pieces B and C represent the ply-wood wood pieces which are shaped upon the side pieces A. The shapes shown are very suitable, and may be plotted out to any size from the diagram.

The Method in Practice

The method of doing this is to first lay out upon a large sheet of paper a similar number of squares on a larger scale. Then draw upon the squares the outline of the three pieces intersecting at the same points as shown in the diagram. If this is done carefully all four pieces when cut from the wood will fit perfectly. Those who prefer, however, to design their own shapes may do so on similar lines. Having plotted out the three shapes required upon the paper, cut out pieces C and B and paste or preferably pin to a sheet of three-ply wood.

Two Similar Shapes

Secure piece A to a piece of $\frac{1}{4}$ -in. thick wood, and clamp a further piece of similar wood underneath. By doing this the two pieces may be cut out in one operation, and exact similarity is thus ensured. A fretsaw is the best tool to use for this purpose. Next cut out pieces B and C, and finally remove the paper templates.

Assembling the Flare

The assembly and finish of the flare is the most important part of the work, as this governs to a large extent the quality of tone obtainable from the finished product. Having cut out the four wood pieces, carefully sandpaper each piece on both sides, and finish with very fine sandpaper. Do not touch the edges of the wood, however, at this stage. It is now advisable to fill the grain of the wood on both sides.

Filling the Grain

This is done by preparing a mixture of plaster of Paris and water and a little vinegar. Rub this into the wood, rubbing across the grain, and allow to thoroughly dry. Finally

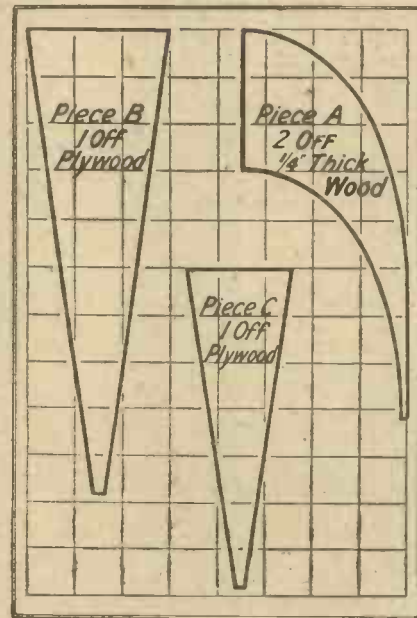

Fig. 1.—The shapes shown in this figure must be drawn on a large sheet of paper with the correct number of squares marked off.

This completes the apparatus required, with the exception of stain, if used, and pure shellac varnish for finishing.

Plotting Out

The first process of construction is to plot out the shape of the flare. In order to help in this direction, a diagram is given, Fig. 1. The drawing shows how the shapes required are plotted out upon squares. Piece A

How to Make a Non-Resonant Loud-Speaker—continued

sandpaper in order to remove all surplus plaster. The next operation is to varnish with pure shellac. Each piece should be varnished on the side which would be inside when the flare is assembled, and this operation is done in this order as it would be a difficult process after assembly.

When the varnish is dry, lightly sandpaper each surface thus treated and varnish again. If this part of the work is executed well a great improvement in tone is obtained.

Finishing off

The four wood pieces may now be assembled. Glue the edges of the pieces A and secure pieces B and C thereto in their relative positions so that the varnished faces come on the inside. To ensure a perfect fit screw pieces B and C to pieces A in addition to glueing. Very small brass wood screws are suitable for this purpose if placed at intermittent equi-distant points. It is a good idea to punch small starting holes in pieces B and C for this purpose.

When the glue is thoroughly dry sandpaper all the edges and slightly round them off to present a neat appearance. The flare is now ready for external treatment with varnish, which is done as before. Those who prefer to use stain first, however, may do so.

Complete Assembly

The complete assembly is shown in Fig. 2. A base box of suitable size is made as shown. Before screwing down the top of the box the earpiece is firmly clamped on to the upper surface by means of a suitable piece of brass

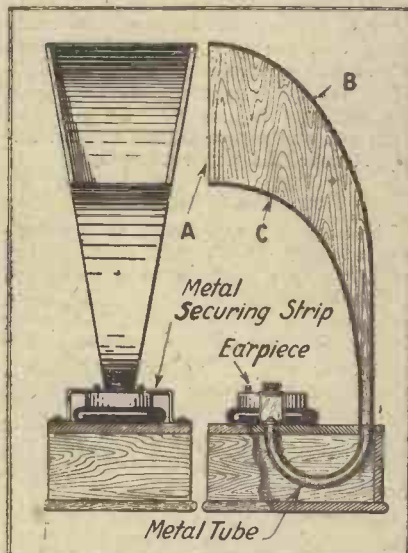

Fig. 2.—An assembly of the constructed horn and box in conjunction with a telephone earpiece will produce a loud-speaker giving reasonable volume and purity.

strip and screws, holes having first been drilled in the positions indicated. A semi-circular piece of brass tubing passes from the diaphragm of the earpiece to the mouth of the flare.

Remarks

The chief points to observe in the construction of this instrument are as follows:—First, see that there are no cracks in the wood used for the construction of the flare, and also that all joints are perfect. Provide a good

surface inside and outside to the flare itself. See that the earpiece is firmly clamped, and ensure this by providing a thick felt or rubber ring between the earcap and the upper surface of the box base. See that the passage from the earpiece to the flare via the brass tube is quite clear and the fitting good.

If these points are observed reproduction will be good. The other points relating purely to the appearance of the instrument are left entirely to the constructor.

.....
Some of our readers may have heard the Croydon station at work when searching for stations on the longer wavelengths.

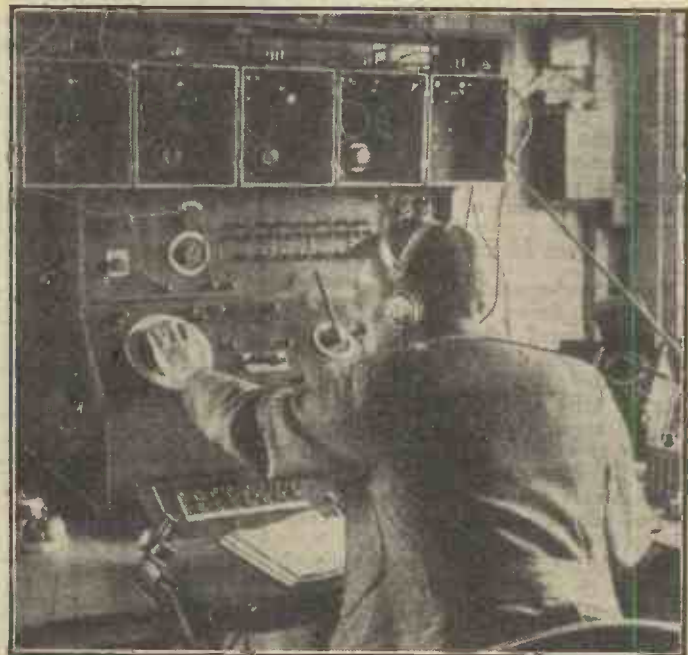

TWO NEW RADIO PRESS ENVELOPES

For two sets of outstanding merit our readers are referred to the two new envelopes, details of which are given below.

ENVELOPE No. 12.

HOW TO BUILD "THE SUPER SEVEN."

By Percy W. Harris, M.I.R.E., Editor of "THE WIRELESS CONSTRUCTOR" and "WIRELESS."

Operating on a small frame aerial this powerful seven-valve superheterodyne receiver gives remarkable selectivity while the tuning is extremely simple. In the envelope are given complete constructional details and full instructions for operation, and the eleven photographs reproduced on special art paper together with the full-size blueprints of the wiring and panel layout, enable the constructor to make this receiver without any difficulty.

PRICE 5/- or 5/4½ post free.

ENVELOPE No. 13.

HOW TO BUILD "THE THREE-VALVE DUAL RECEIVER."

Designed by John Scott-Taggart, F.Inst.P., A.M.I.E.E.

This receiver, employing a reflex circuit, is capable of giving loud-speaker results from B.B.C. and Continental stations.

Four sheets of special photographs and two full size blueprints are supplied, and with the accompanying directions all constructional work will be quite straightforward.

PRICE 2/6 or 2/9 post free.

EBONITE AND HOW TO WORK IT

By W. H. FULLER

The working of ebonite possesses a technique of its own, and this article describes the correct method of applying tools to this indispensable material for the constructor.

EBNONITE plays such an important part in the construction of wireless receivers that one sometimes wonders what would be done without it. There is scarcely a single component which does not employ this very useful commodity in some form or other, either for the insulation of its terminals or in its mechanical construction.

Ebonite Sheet

Ebonite is manufactured mainly from rubber and sulphur, the composition being mixed with a few other ingredients, differently favoured by

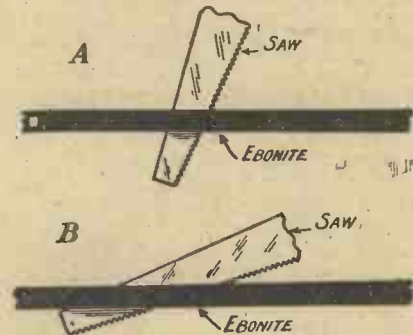

Fig. 1.—Cutting ebonite with the saw held as at A may result in a split panel. The correct method is shown at B.

actual makers, while large rolling machines compress and work the material to a consistency of stiff dough. The ebonite to be made into sheets is reduced to the certain thickness by rolling or "calendering," as it is called, different thicknesses of sheets being obtained by the addition of several layers to one another before it is cured.

Rods and Tubing

Rods are obtained by "squirting" the material in machines which are nothing more or less than large sausage machines, the shape of the orifice through which the material extrudes deciding the shape of the finished product. Tubes and equal section articles are generally done in the same manner, while very large tubes are often made by wrapping several layers of the material round a metallic tube.

Curing

The material is then cured by being heated in an oven filled with steam, which also exerts a certain pressure.

After a certain length of time the

material is withdrawn from the ovens and allowed to cool off, when it takes the appearance of the familiar ebonite, or hard rubber, as the Americans call it.

Moulding Properties

Ebonite can be more or less easily moulded as far as commercial practice is concerned, but the process would be fairly expensive for the amateur to attempt. Ebonite, as everyone knows, softens when heated (witness the loose terminals when the soldering iron is allowed to remain in contact too long), and may be pressed into shape in steel moulds while in this condition, being then allowed to cool, after which the material will retain the shape of the mould.

If, however, the material is again heated, it will attempt to regain its former shape, exhibiting the usual elasticity of ordinary rubber while hot, but hardening after the heat has gone.

For the Constructor

The constructor may bear in mind that ebonite can be bent to shape with comparative ease if it is first heated in boiling water, or before a fire, and allowed to cool off while in the desired form. When the material is hot it may be cut with a sharp knife, but the precaution of first warming the blade to prevent cooling the material at the point where it is being cut is advisable. Lubricating the knife with water will help considerably, and heating and lubricating may be done conveniently in one operation by dipping the blade into boiling water fairly frequently.

Cutting Sheet Ebonite

The cutting of large sheets is best accomplished by parting the material, when cold, with a saw. Suppliers usually cut ebonite with a circular or band saw; the amateur may do this with an ordinary hand saw, but he must be warned that if the saw is used for some time on this class of job it will not be fit for anything else afterwards.

This is partly due to the nature of the material, which wears down even hardened tools in a surprisingly short time. An occasional cut, however, will not seriously damage the saw.

Holding the Saw

When cutting ebonite with a hand saw, the saw must be kept at a very small angle to the surface of the

material, as shown in Fig. 1B, which first considerably reduces the liability of splitting the sheet by wrenching the saw sideways, and, secondly, prevents the teeth chipping away the under surface of the material. A little oil or thick grease may be smeared on the sides of the saw to ease the operation. Never on any occasion cut ebonite sheet with a hand saw across the section as shown in Fig. 1A, as an accident is sure to happen.

Wear on the Drills

Small cuts are best made with a hack saw, and shapes may be cut out with a fret saw. In very cold weather, when the ebonite is liable to fracture easily owing to its increased brittleness, the material may be first warmed before cutting it.

Holes can be made in ebonite by



Capt. Ranger, controlling the apparatus in use at Radio House, London, for transmitting pictures by wireless to New York.

twist drills held in the usual form of brace, and one or two hints as to the care of such tools may be helpful to the constructor. As mentioned above, ebonite wears away tools with astonishing rapidity; not only does it wear away the tip or cutting edge of the drill, but also the sides or flutes. This may be avoided to some extent by the use of a lubricant such as water, turpentine, or Russian tallow. If water

Special Wireless Cabinets to Customer's orders

Cabinets that at any time are illustrated or described by the Editor of this Journal we can make to order. Ask for prices. Delivered free anywhere in the United Kingdom.

Hundreds of readers of this Journal have expressed their satisfaction with workmanship and price of our cabinets

Specialist makers of Wireless Cabinets
Caxton Wood Turnery Co.
Market Harborough

On Guard!

There is no leakage with a "Lotus" Buoyancy Valve Holder on guard. Immediate and lasting connection made when valve pins enter valve sockets. The leg socket expands and automatically locks.

Absorbs shock, protects the valves and eliminates all microphonic noises.



Made from best bakelite moulding with springs of nickel silver and phosphor bronze valve sockets.

Garnett, Whiteley & Co., Ltd.,
Lotus Works, Broadgreen Rd., Liverpool
Makers of the famous "Lotus" Vernier Coil Holder.



Without Terminals 2/3

With Terminals 2/6

Cōpex Shielded Coils for The "Five Fifteen"



Pat. applied for.

MANY attempts have, in the past, been made to effectively deal with the problem of losses due to stray coupling. Now, however, in collaboration, with Mr. J. H. Reyner, B.Sc. (the designer of the "Five Fifteen"), Peto-Scott's have evolved the Cōpex Coil. This new Coil gets right to the root of the interference trouble; the metal screen which covers the coil definitely eliminates all inter-action.

Using Cōpex Coils, the "Five Fifteen" (described in this issue) is remarkably stable, and exceedingly selective and sensitive. Before building this set you would do well to write for particulars of the Pilot System of Construction—whereby you can be assured of satisfactory results. Sixpence in stamps will bring you the famous Pilot Manual.

For the "Five Fifteen"

Cōpex Coil Unit and Base ... 15/-
Special H.F. Transformer ... 7/6

Particulars and prices of other Cōpex Transformers and Coils on application.

Build the PILOT WAY—we guarantee you good results.

"THE FIVE FIFTEEN" Designed by Mr. J. H. Reyner, B.Sc., described in this issue.

	£ s. d.		£ s. d.
4 Keystone Spiral Contact Condensers .0003 mfd with 4' dials	1 18 0	5 Burndept Fixed Resistors	8 9
1 Claude Lyons Low Loss Coil, No. 277c	.	5 Mark III Terminals	0 10
1 Cōpex Shroud & Base	15 0	Square Tinned Copper Wire, Screws, &c.	1 8
1 Cōpex H.F. Transformer 250-550 M.	7 6		*£7 11 6
2 Peto-Scott Neutralising Condensers P. M.	12 6		
5 Benjamin Anti-microphonic Valve Holders	13 9		
1 "Keystone" H.F. Choke	10 0	1 "Red Triangle" Panel 24 x 7 x 1/4" drilled and matted	13 6
1 A. J. S. 1st stage Coupling Unit	1 0 0	Engraving extra	3 6
1 Max. Amp. L.F. Transformer	19 6	Polished Mahogany Cabinet with baseboard	2 0 0
2 "On and Off" Switches	4 0	Terminal Strip drilled and engraved	1 6

When a complete set of parts is purchased at the same time as the panel, a Marconi Royalty of 12s. 6d. per valve holder must be remitted with order.

PETO-SCOTT CO., LTD.

Head Office, Mail Order and Works: 77, CITY ROAD, E.C.1, and at 62, High Holborn, W.C.1, Walthamstow, Liverpool and Plymouth.

PILOT SERVICE ENSURES SATISFACTION

P.S. 5131



Two in One!

The new Dual Rheostat—a "Peerless" product in every way. Specially designed to meet the demand for a resistance equally applicable to bright or dull emitters. It has two windings—one offering a

resistance of 6 ohms, whilst a continuation of this is of 30 ohms resistance. The resistance element is wound on a hard fibre strip under great tension. One hole fixing is provided and the terminals are placed in convenient positions. The contact arm has a smooth, silky action, and all metal parts are nickel-plated.

Ask your Dealer or send direct

3/9 PEERLESS 3/9
DUAL RHEOSTAT
THE BEDFORD ELECTRICAL
& RADIO CO., LTD.,
22, Campbell Road, Bedford.

Ebonite and How to Work It—continued

is used care must be taken to dry the drill thoroughly after it has been used.

The Art of Drilling

When drilling, do not spin the drill round and wear through the material, but attempt to take a steady cut right through, so that instead of powdered waste being extruded from the hole, two spirals, one from either side of the drill, clear their way up. To do this, a certain pressure must be exerted, which, however, must not be too great for fear of bursting the back of the hole, but much depends on the constructor's ability and experience. Large holes are cut more easily if a small guide hole is first drilled right through the material.

Holes 1 in. or more in diameter may be cut with a wood centre bit, but unless the constructor wishes to keep the bit essentially for this class of work, it is advisable to use a fret saw, for once such a bit is used on ebonite it is of very little use for anything else.

Square holes for the fitting of switches, etc., are best cut with a fret saw, or failing this a line of small holes may be cut round the hole, and the sides cleaned up with a flat file after the centre has been removed.

Employing Wood Screws

Tapping holes in ebonite is an awkward procedure, as the material is so likely to heat up and soften unless the utmost care is taken, and the writer prefers the use of wood screws wherever possible. The method consists in drilling a hole large enough to accommodate the core of the wood screw and then inserting the screw as when dealing with wood.

Hints on Tapping

However, if it is essential to tap a thread in a hole, the correct drill should be used to commence with, and the tap continually withdrawn from the hole, cleaned and re-lubricated with turpentine or grease. A stiff hair brush will be found useful for clearing the tap of the ebonite dust, and any dust remaining in the hole must also be blown, scraped or knocked out before continuing the operation.

Withdrawal of the tap is advisable after every two or three complete turns of the tool. The liability to failure is generally more marked when tapping small holes.

Cleaning Panel Edges

Cleaning up the edges of a panel may be accomplished by cutting down any saw marks with a rough file at the start, and in this connection it should be remembered that a file is used for "cutting," and not for rubbing. This tool, more often misused than any other, should be regarded as

a precision instrument. It does not merely consist of a number of ridges made in the surface of a piece of steel, but is actually a carefully cut tool having a number of perfectly shaped cutters, and should be used as such.

An Analogy

The motion when using a file is analogous to that of a wood plane, a hard forward, downward, cutting drive, and a light slide back, barely touching the material at all.

After a file has been used the teeth should be thoroughly cleaned out, and any waste removed. An ordinary file, unfortunately, has no means of automatically getting rid of the material which it cuts as has a wood plane. There is, however, a file on the market, necessarily a very expensive tool, which does this. It consists of a large number of small fixed plates set at an angle in grooves cut into two side plates. This file may be sharpened by removing the plates and grinding the faces of the sets on a milling machine, or by rubbing on a flat stone. The

off with smooth emery paper will result in a clean edge.

Some kinds of ebonite may, if soft enough, be smoothed with a wood plane, but as the plane iron is likely to be damaged beyond the worth of the job, it is not advisable to use it.

Care in Polishing

Ebonite may be polished by the constructor if sufficient care is taken. The work must first be rubbed down with varying grades of emery cloth until all scratches are removed. A soft cloth rolled up so that a steady grip may be obtained on it is fed with powdered rouge, slightly damped with spirits of turpentine. First rub hard up and down the panel, and then across it, finally finishing with a soft circular motion over the whole panel. Two or more hours may sometimes have to be spent before a really high polish is obtained, and heat should not be generated by too vigorous expenditure of energy, or the surface may soften and become pitted.

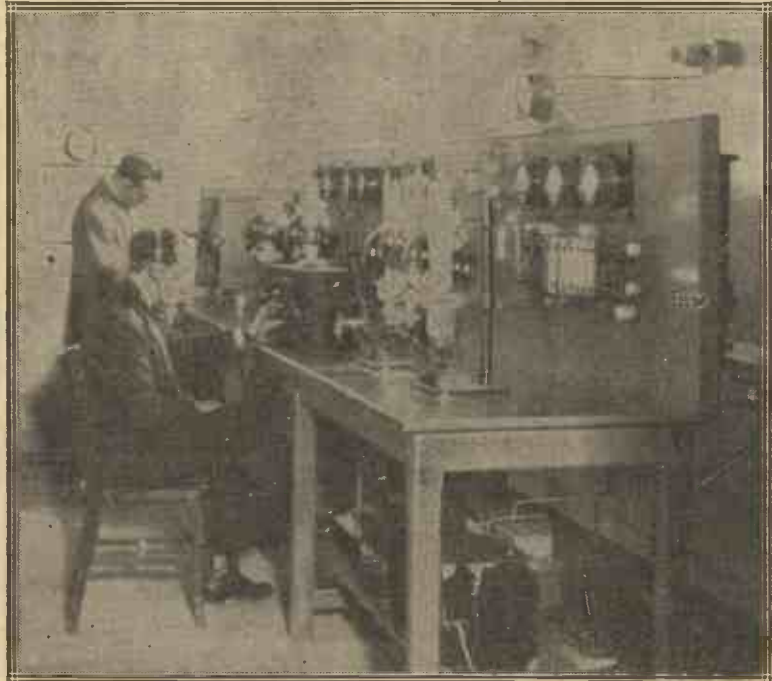

A view of the control board of the Radio-Paris Station, which is well known to many listeners in this country.

price of this tool sets it beyond even the average manufacturer's pocket, let alone the amateur's, which is a great pity.

However, if a file is used as a cutting tool and not as a rubber, a considerable saving in file cost will be effected.

Finishing Off

After having produced a fairly smooth surface, a fine file may be used to remove any marks, and a final finish

IMPORTANT NOTICE.

Owing to numerous applications from our readers for back numbers of our publications, we have decided to make no extra charge on any of our periodicals for issues published within six months. The charges for back issues prior to six months will be as in the past.

Lo! Hear the gentle lark—



accompanied by the valve!

"Accompanied by the piano," the programme said, but "accompanied by the Valve and piano" would be truer of songs heard on many sets. Every time the door shuts, or a cart passes, or someone treads heavily "Ping!" goes the valve and the best notes of your favourite melody are drowned.

But this unwanted accompaniment can very easily be stopped—by floating your valves in Benjamin Clearer Tone Valve Holders.

The extraordinary success of the Benjamin Clearer Tone Valve Holder is due to the fact that it is perfect in every detail. No loophole has been left where vibrations could possibly reach the filament—a fact you can judge for yourself from the accompanying brief descriptions of its construction.



2/9 each.



There are terminal connexions for the experimenter and soldering tags for the permanent set. The Benjamin Clearer Tone Valve Holder is easily cleaned—little or no dust can collect in the sockets. The springs themselves, as shown in the lower of the two diagrams, form the valve pin sockets. No soldering joints—all one solid metal piece from tags to valve leg. No flexible wire connexions. The spring supports are not affected by stiff bus bar wiring.

2/9 each

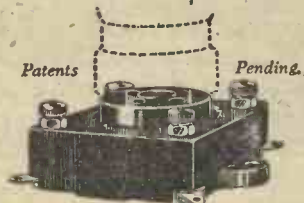

BRITISH **BENJAMIN** MADE
CLEARER TONE VALVE HOLDER
(ANTI-MICROPHONIC)

From your Dealer or Direct from
THE BENJAMIN ELECTRIC Ltd.,
Brantwood Works, Tariff Road,
Tottenham, N.17.

The Benjamin Battery Switch gives
perfect current control, 2/- each.

DISTANT RECEPTION IN THE SUMMER—continued

sent the primary and secondary of the Universal transformer, which can be obtained not only for the reception of the short broadcast waves, but also for the reception of 5XX.

Correct Neutralisation

The reaction condenser is set at zero, and with aerial, earth and a pair of telephones connected to their respective terminals and correct values of H.T. applied to both valves, the local station may be searched for. The neutralising condenser will need to be set about a third of the way in when D.E.5 type valves are used, and rather less for most other types. The final adjustment to this should be made with the tuning condensers at about 20 deg., so that no setting of either of these results in the set oscillating. The reaction should be set at zero during this adjustment.

Having picked up the nearby transmission, the result of increasing reaction should be noted, and as the value of this is increased the set should go into oscillation. If this

type valves a high voltage will in most cases be found the best, but with .06 valves and some other types a much lower value will probably give the maximum signal strength. Those who are in the possession of a soft valve can try a voltage as low as 18, and a little time spent in determining these values will be time well spent.

For the reception of 5XX and Radio Paris the coil L₁ will be a No. 250 Lissen X, while the corresponding Universal transformer will be used with a No. 200 or 250 reaction coil.

Selectivity

This receiver was tested on a small aerial less than 2 miles in a straight line from 2LO, and it was found that on the broadcast wavelengths a satisfactory degree of selectivity was obtained. Bournemouth could be received very nearly clear of 2LO, and came in at excellent strength.

A French station just below Cardiff came in at good strength in the 'phones without interference from the

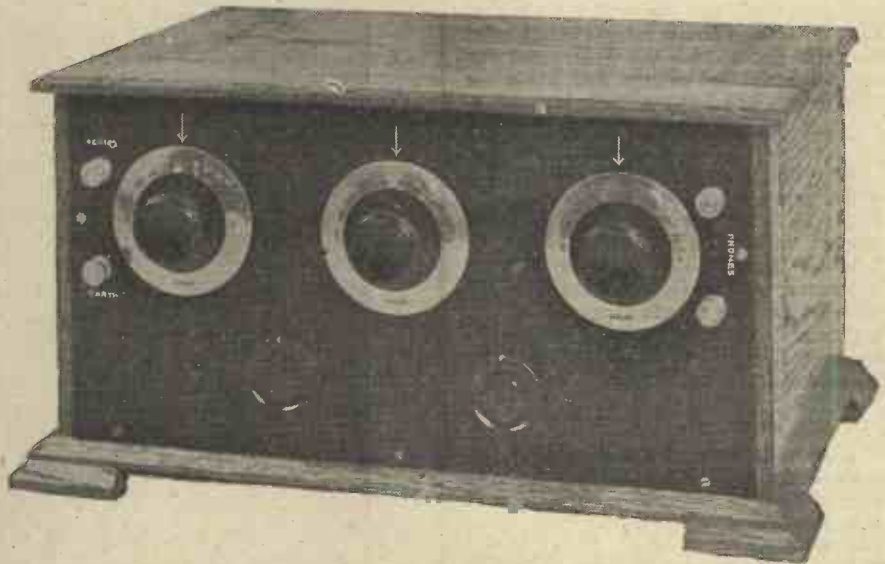

The finished receiver is handsome in appearance. Our Elstree laboratories state that the set was easy to handle, while Manchester was received free from London.

does not occur the effect of reversing the connections to the reaction coil holder should be tried.

Suggested Valve Types

The effect of varying the H.T. voltages applied to the valves may then be tried. With a D.E.5 type valve for the H.F. valve a suitable voltage will be found to be between 45 and 60 volts, while with some valves as high a voltage as 90 may be used before maximum amplification is obtained.

For the detector any value between 60 and 100 volts may be found suitable, depending on the type of valve employed. With D.E.5b and D.E.3b

local station. On the long waves 5XX came in very well indeed, while Radio Paris was received without any trace of jamming from Daventry.

Stations Heard

Foreign and distant B.B.C. stations were picked up with ease, no difficulty being experienced in searching; in fact, over a dozen transmissions were picked up in a little over quarter of an hour. Among these were Bournemouth, Newcastle, Munster, F.P.T.T., Madrid, Birmingham, a station just above Birmingham that came in very well, Brussels, Hanover, and Radio Toulouse. Many other stations were heard, but not identified.

AN EXPERIMENTAL CRYSTAL SET

By Philip H. Wood, B.Sc., F.P.S.L.

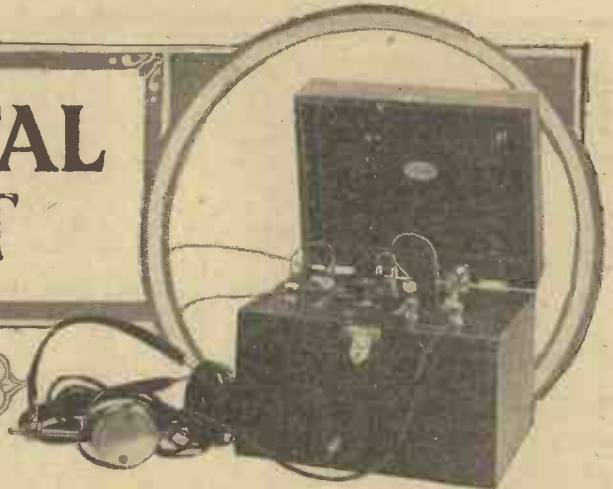

There is a wide field for experiment in crystal sets, and the set described in these pages should give scope for investigation along lines sufficiently removed from the conventional to provide interesting results.

PRESENT tendencies in the design of crystal receivers point to the fact that more attention is being given to those little details which decide whether a set will give good or only mediocre results. The simple coil tuned by a variable condenser has given place to the tapped coil designed

arrangement incorporated in the crystal receiver described by Mr. H. J. Barton-Chapple in the May issue of *The Wireless Constructor* under the title of "Auto-Coupling and the Variometer."

An Experiment

The writer, after some consideration of the matter, decided to conduct a few experiments with the object of discovering if the tapped coil crystal circuit could be applied in principle to the variometer. The result was the receiver described in this article, and at this stage it must be made quite clear to readers that this set is, quite frankly, an experimental one.

Selectivity and Signal Strength

By connecting the aerial to one of the tappings near the earth end of the coil a certain degree of selectivity is obtained, while if the crystal is connected to a second suitable tapping point no loss of signal strength should result as compared with the ordinary direct coupled arrangement, which can, of course, still be utilised by connecting both aerial and crystal to the "top" end of the variometer. A loading coil socket connected between earth and the lower end of the variometer winding allows the reception of Daventry to be attempted.

Materials Required

The following are the components, etc., required for building the set depicted in the photographs, other reliable goods being as a rule quite as suitable as those makes mentioned

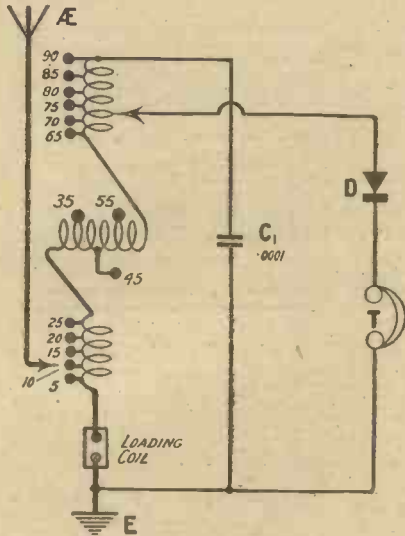

Fig. 1.—The more conventional variable condenser and coil are replaced by a fixed condenser and tapped variometer.

to give greater selectivity without any loss in signal strength.

A Popular Method

The variometer was and is still a very popular form of variable inductance which seems especially suited to the demands of the crystal set user, i.e., simplicity of operation, cheapness and ease of construction. But however useful the variometer may be in the usual straightforward circuit, it cannot in its ordinary form be utilised in the types of circuits employing aerial and crystal tappings now in vogue.

One departure from the more conventional use of the variometer must be mentioned, however. This was the

Circuit Used

Fig. 1 shows the theoretical circuit of the receiver. It will be seen that a variable inductance (in the shape of a variometer) provided with suitable tapping points and shunted by a fixed condenser C_1 takes the place of the

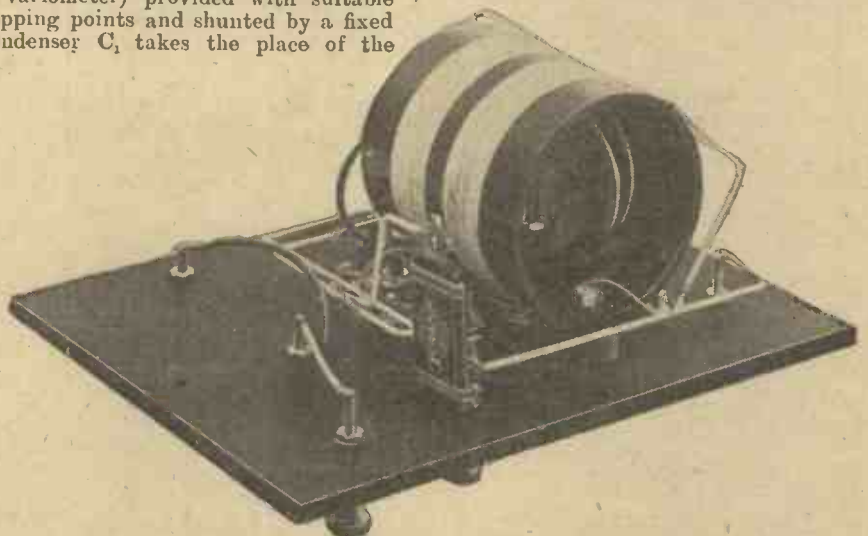

Both the stator and rotor windings of the variometer are wound in two separate portions, with tappings from each.

more usual tapped coil and variable condenser arrangement familiar to readers of this journal. Thus the inductance in the circuit has been made the variable quantity, instead of the capacity.

below, provided they otherwise agree with the specifications:—

One ebonite panel, 8 in. by 6 in. by 1/4 in. (Paragon Rubber Manufacturing Co., Ltd.).

One ebonite tube for stator of vario-



SCREENED COILS
Developed by Mr. J. H. REYNER, and used in the "Magic Five" described in "Wireless," May 29th and June 5th. Magnum Screening box complete with 6-pin base mounted on ebonite 15/-
Aerial Coil 250/550 metres 4/6
H.F. Transformer for use with above 7/6



APERIODIC H.F. TRANSFORMERS
300/600, 550/1200, 1100/3000 metres
EACH 10/-



MAGNUM All-Season PORTABLE RECEIVER.
A highly efficient 3-Valve Set in Leather Case.
Complete and ready for immediate use. PRICE £15 15s. Plus royalties £1 17s. 6d. Weight only 20 lbs. Size 17 x 10½ x 6 ins.
Components supplied for all sets described in this issue. Send stamp for Lists.

MAGNUM "STRAIGHT-TWO."
A popular "straight" Receiver at a popular price.
RECEIVER ONLY £3 17s. 6d.
Or Complete with H.T., L.T., Valves, Coils and Telephones £6 12s. 6d.
Plus royalties £1 5s.

BURNE-JONES & CO., Ltd.
Magnum House, 296, Borough High Street, London, S.E.1

Safeguard Your set!

The Etherplus + combined Aerial-earth, lead-in Tube and Switch is a permanent lightning conductor, whether set is off or on.

With every Etherplus + Lightning Switch there is £100 Free Insurance against lightning damage.

PRICE 3/9



Stock size lead-in tube 6½ in. (9½ in. lead-in tube 6d. extra).

ETHERPLUS

RADIO ACCESSORIES — ENSURE PERFECT RECEPTION

SUBSCRIPTION RATES

FOR RADIO PRESS JOURNALS.

MODERN WIRELESS
15/- per annum United Kingdom. 13/6 per annum Canada and Newfoundland.
15/- per annum Other Countries. Lesser periods than 12 months pro rata.

THE WIRELESS CONSTRUCTOR
8/6 per annum United Kingdom. 7/6 per annum Canada and Newfoundland.
8/6 per annum Other Countries. Lesser periods than 12 months pro rata.

WIRELESS (Incorporating Wireless Weekly)
13/- per annum United Kingdom. 13/- per annum Canada and Newfoundland.
13/- per annum Other Countries. Lesser periods than 12 months pro rata.

THE WIRELESS DEALER (Available to the Trade only)
7/6 per annum (10/- abroad).
N.B.—Business letter heading or trade card must be sent with subscription.

RADIO PRESS LTD., Bush House, Strand, London, W.C.2

WHERE THE DEALER SCORES

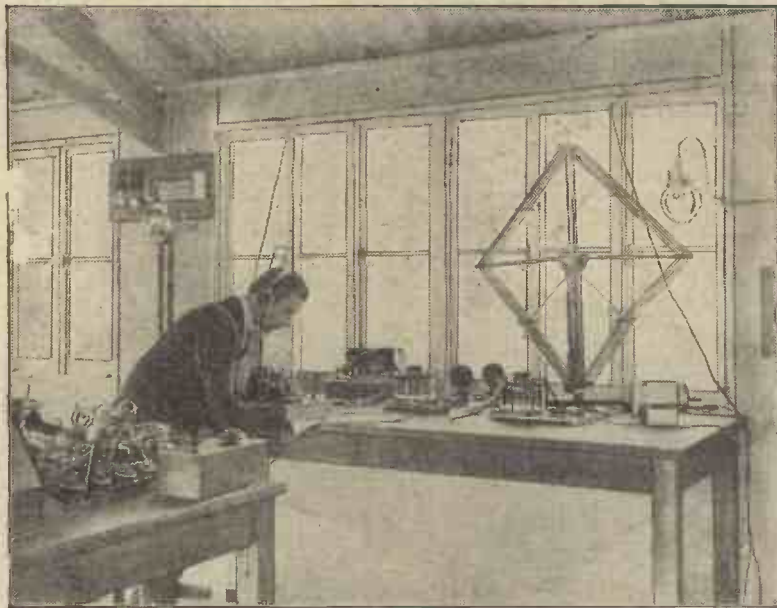

Testing Apparatus on Broadcast at our Elstree Laboratories.

Use the Advertisement pages of THE WIRELESS DEALER for your business announcements. All communications regarding "space" should be addressed to The Advertisement Manager, THE WIRELESS DEALER, Bush House, Strand, London, W.C.2.

Subscription rates 7/6 per annum (10/- abroad), available only to bona fide members of the trade. Business letter heading or trade card should accompany every subscription.

Write to the Sales Manager now for Specimen Copy.

RADIO PRESS LTD., BUSH HOUSE, STRAND, LONDON, W.C.2

An Experimental Crystal Set—continued

meter, 3 in. long, 2½ in. external diameter.

One ebonite tube for rotor, ¾ in. long, 2½ in. external diameter, preferably grooved.

(These tubes can be obtained ready grooved and finished from Messrs. The Peto-Scott Co., Ltd.)

One panel-mounting crystal detector (Service Radio Co., Ltd.).

Four 4B.A. terminals.

Fourteen Clix sockets and two plugs (Autoveyors, Ltd.).

One small knob, tapped 2B.A., and pointer.

Loading-coil pin, socket and shorting link.

One .0001 fixed condenser (Igranio Electric Co., Ltd.).

About 4 in. of 2B.A. studding, seven 2B.A. nuts, two spring washers, one 2B.A. bush, two 4B.A. counter-sunk head screws, 1 in. long, with nuts, rubber covered flex, and 2 ozs. of 28 S.W.G. d.c.c. wire.

Glazite for wiring.

Radio Press panel transfers.

Leatherette-covered "Camco" box to take panel 8 in. by 6 in., 4½ in. deep, with lid 1½ in. deep inside (Carrington Manufacturing Co., Ltd.).

Notes on Wire

Little need be said regarding the components beyond the fact that the

are grooved or cut away to take the wire. The gauge of wire specified need not be strictly adhered to, 30 or

panel, details of which are shown in Fig. 2. All the tapings on both rotor and stator of the variometer are taken

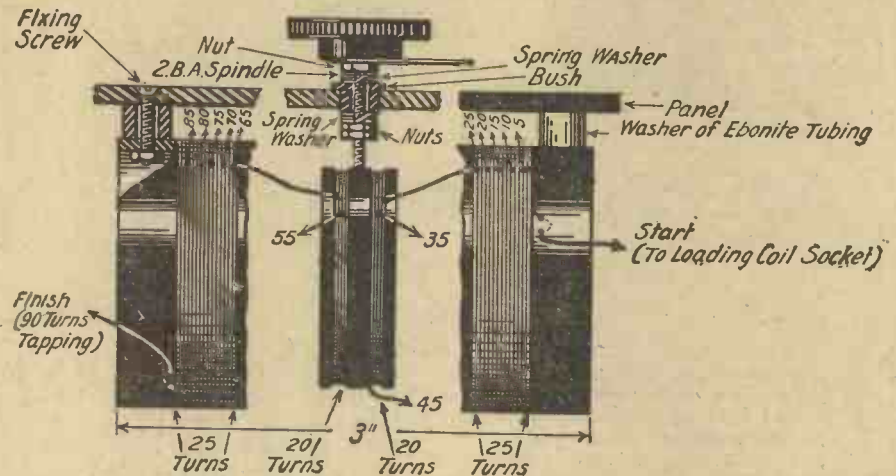

Fig. 3.—The arrangement of the tapings will be clear from this sketch. Note also the washers and nuts which make for smooth working of the rotor spindle.

26 S.W.G. wire serving equally well, but do not use wire thinner than 30 S.W.G., as otherwise the windings will be rather fragile. On the other hand, if too thick a gauge of wire is employed, difficulty will be found in getting it on in the space allowed.

to Clix sockets, and these sockets are disposed symmetrically along the three sides of a rectangle. Between the side rows of sockets is the control knob of the variometer, the spindle of which passes through a metal bearing or bush let into the panel.

Holes for Fixing Screws

Additional holes are needed for the two screws used for fixing the stator of the variometer in position. These holes are in line with the knob, one behind and one in front of it. The terminals, detector and loading-coil socket account for eight more holes, while two extra small holes are drilled to take the flex leads to which the aerial and crystal tapping plugs are fixed. One of these holes lies midway between the aerial and earth terminals, while the second is placed in a similar position, relative to the control knob, near one end of the crystal detector.

Mounting Components

All the panel components, with the exception of the variometer and its knob, can now be mounted together with the terminals and, if desired, the sockets may be labelled with the Radio Press panel transfers. In mounting the telephone terminals do not forget to fasten one tag of the small fixed condenser under the nut of the left-hand terminal, looking from the top, as indicated in Fig. 4.

The Variometer

The winding of the variometer is the next task, and this calls for a certain amount of patience. Thread one end of the cotton-covered wire through two small holes drilled near

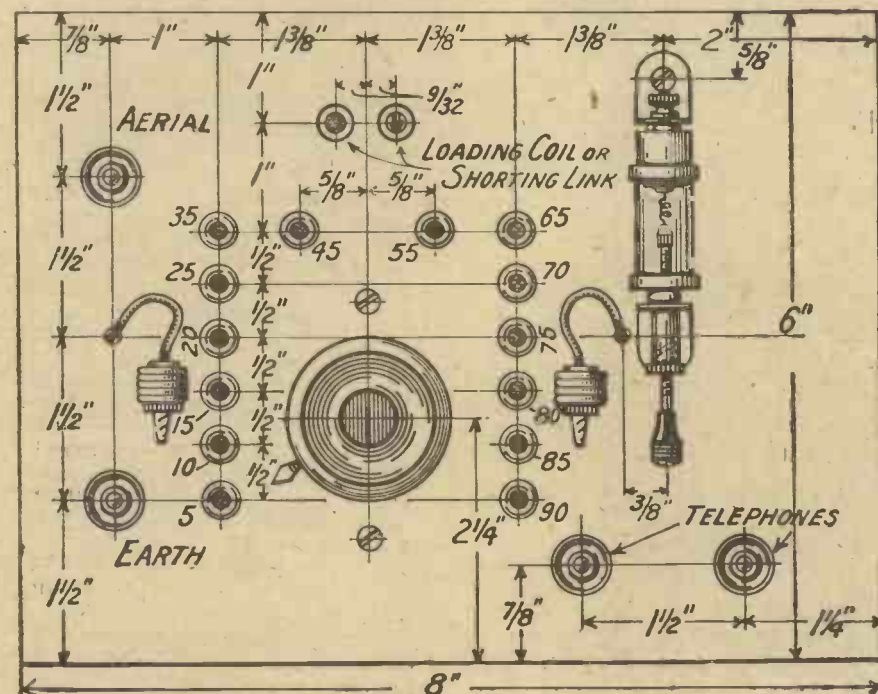

Fig. 2.—The Clix sockets are symmetrically spaced round the rotor knob, and the remainder of the lay-out on the panel should present no difficulty. Blueprint No. C 1048A.

operation of winding the variometer will be greatly facilitated if the formers (especially that for the rotor)

Drilling the Panel

Most constructors will prefer to commence operations by drilling the

Air Spaced for sharp tuning

ASK your dealer to show you one of these new Eureka Low Loss Coils. You won't need to hold it up to the light to realise how each turn of the wire is well spaced from its neighbour. You'll see the advantages of its unique method of winding at a glance. Right from the time you began to be interested in Wireless you'll remember always reading how coils should possess a low self-capacity. Here is the coil with the lowest self-capacity on the market—a glance at the illustration will show you how well-spaced are its turns. Low self-capacity means sharp tuning and greater selectivity—you need it to-day with so many stations crowding the ether.

Great Mechanical Strength

But don't think that because the new Eureka looks a perfect network of spaced wiring that it is weak. Actually it is probably the strongest coil ever made, because it is wound on a solid ebonite former. Further it is reinforced just at the base where the most strain comes. It can be removed from its socket and roughly handled without the possibility of any harm being done. The Eureka method of mounting is another improvement. The ends of the coil are brought through the centre of the mount and soldered to the sockets. Electrical losses are reduced to a minimum. With its handsome green silk wire the Eureka Low Loss Coil will add distinctiveness to any set—you would certainly expect to pay more for such a beautifully made coil. And, finally, bear in mind the fine reputation enjoyed by all Eureka guaranteed Radio Products.

Reasonable Prices:

E20	40-150 metres	4/3	E100	285-1000 metres	6/3
E25	55-250 metres	4/3	E150	360-1500 metres	7/-
E35	80-375 metres	4/3	E200	470-1375 metres	8/-
E50	120-560 metres	4/6	E250	530-2725 metres	8/6
E75	185-760 metres	4/10			

All the above wave-lengths are obtained with a '0005 mfd. variable condenser in parallel.

EUREKA

Low Loss Coils

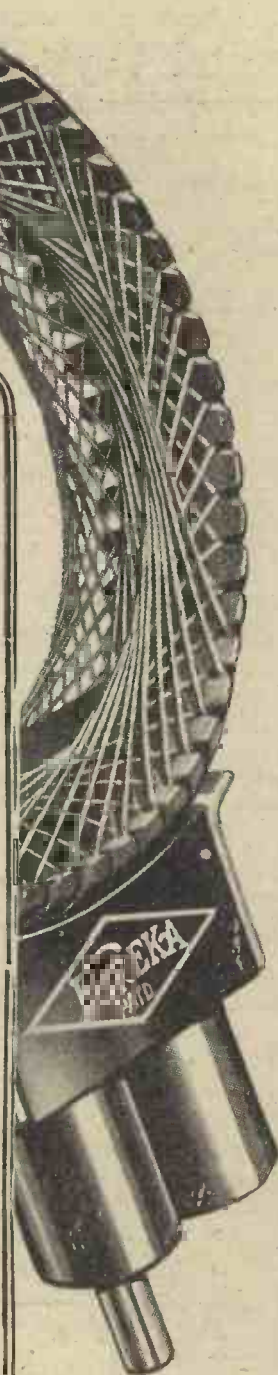

AN EXPERIMENTAL CRYSTAL SET—continued

one end of the former of the stator and commence winding evenly until five turns have been put on.

Clip the wire in position to prevent it from slipping back, and with a pen-knife scrape the cotton insulation off for a distance of about a quarter of an inch where the fifth turn finishes. To the bared portion solder one end of a piece of flex—this is for connection to one of the sockets. Then continue winding until 25 turns in all have been wound on, making similar tapplings every five turns, i.e., tapplings at the 5th, 10th, 15th, 20th, and 25th turns.

Leads to Rotor

The last turn of the 25 will finish somewhere near the middle of the tube and should be fastened off in some manner and have an additional flexible lead soldered to it, this lead passing through to the inside of the tube for connection to one end of the rotor winding. The tapping lead should be left on the outside as in the other cases.

Second Half of Stator Winding

Now commence winding in a like manner from the other end of the tube, again putting on 25 turns with a tapping every five turns and finishing near the centre as before with two flexible leads—one for a tapping and the other for the rotor connection.

A clearance hole for the 2B.A. spindle should be drilled through the top side of the tube at the central point, while two smaller holes are required to take the fixing screws near the ends of the tube, the positions of these latter corresponding to the holes drilled in the panel for the purpose.

The Rotor

The rotor is wound in two sections of 20 turns each, and the windings (put on in hank fashion) are tapped at the 10th, 20th and 30th turns, long flexible leads being soldered to the tapping points. Holes for the 2B.A. spindle are drilled through the tubular former and the assembly of the variometer can then be proceeded with.

Place the rotor in position inside the stator, and while things are still accessible solder the two "extra" flexible leads joined to the inner ends of the stator windings to the free ends of the rotor winding. This operation places the rotor and stator windings in series with one another.

Assembly of Variometer

Next pass the end of the spindle through the hole drilled for it in the stator tube and through one hole of the rotor tube. Thread four 2B.A.

[Advt. of
Portable Utilities Co., Ltd.
(Eureka Radio Products),
Fisher St., London, W.C. 1]

Gilbert Ad. 5123

An Experimental Crystal Set—continued

nuts on to the spindle and push it through until its end rests in the second hole in the rotor tube. Screw a nut tightly up against the inside of each wall of the tube, and run down a locknut on each of these, thus securely clamping the rotor in position on the spindle.

Mounting

Bring out the leads to the rotor tappings and put all the tapping leads in order. Now thread two nuts and a spring washer over the projecting end of the spindle and pass the latter through the metal bearing in the panel from the underside. Fasten the stator to the panel by means of the 4B.A. screws, keeping it well clear of the latter by means of spacers about $\frac{1}{2}$ in. long made from ebonite tubing or other suitable material. Before tightening up, adjust the two nuts which keep the spring washer against the bush until the rotor swings freely inside the stator, add a spring washer and nut *above* the panel surface and fix the knob and pointer in position.

Tapping Points

After the tension and position of the variometer bearing and spindle have been satisfactorily adjusted a start may be made with the connections. Join one free end of one half of the stator winding to the pin of the loading coil plug, and the five-turn tapping to the socket nearest the earth terminal, the ten-turn tapping lead

Remaining Wiring

The remainder of the wiring is quite simple and may be followed from the

At the start the usual crystal circuit can be utilised by placing the aerial plug in the socket nearest the tele-

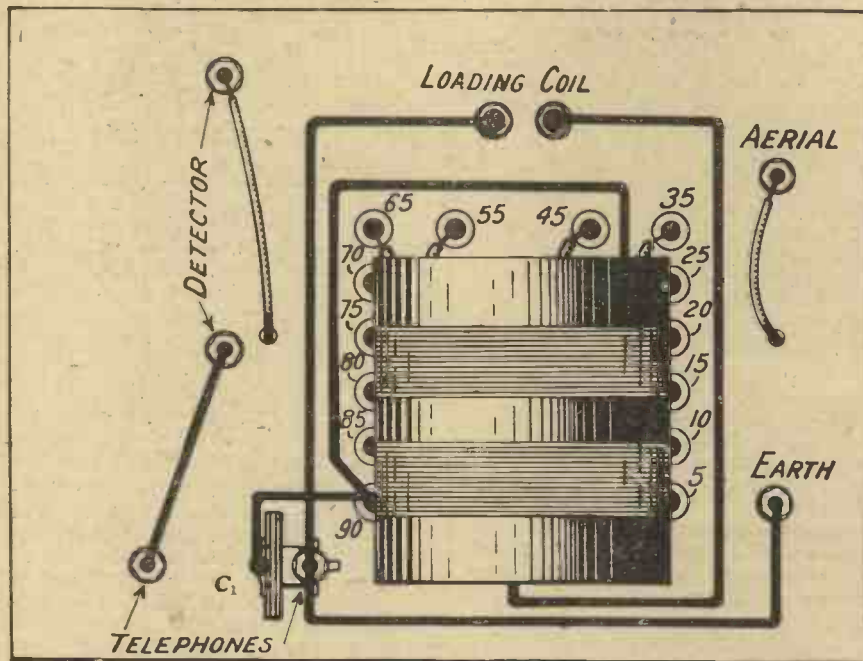

Fig. 4.—Be sure to see that the tapping leads on the variometer are connected in their correct order to the Clix sockets. Blueprint No. C 1048B.

wiring diagram shown. The set is now complete except for the fitting of

phone terminals and plugging the crystal plug on top of it, the shorting link being in position in the loading-coil sockets. Having tuned in the local station and adjusted the cats-whisker, a more selective arrangement can be tried by placing the aerial plug in one of the sockets near the earth end of the coil and varying the position of the crystal plug to give the best signals, retuning when necessary.

For Daventry

For 5XX remove the shorting link from the pin and socket and insert a suitable loading coil—say a No. 200 or lettered equivalent. The direct coupled arrangement should be employed.

Tests

Good signals were obtained from the London station at a point $8\frac{1}{2}$ miles from 2LO, while Daventry was also received at satisfactory strength with a suitable loading coil. Selectivity without loss of signal strength could be obtained with a suitable arrangement of the plugs, and the set proved quite efficient.

When tested at our Elstree laboratories the London station was received at reasonable strength, the tappings for connection to the aerial and crystal allowing a reasonable degree of selectivity to be secured.

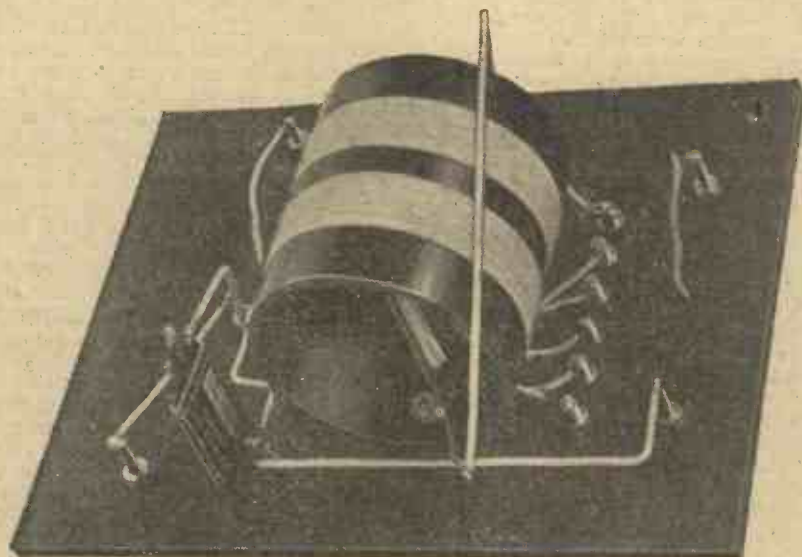

Flexible leads are soldered to the tapping points on the variometer before this is mounted on the panel.

to the next socket, and so on, continuing with the rotor tappings and then with the tappings to the second half of the stator. (See Fig. 3.)

Clix plugs to the flexible leads from the aerial and crystal. The set can then be tried out on the local transmission.



Notes & Jottings

A page of information of interest to all constructors.

By H. J. BARTON-CHAPPLE, Wh.Sch., B.Sc. (Hons.), A.C.G.I., D.I.C., A.M.I.E.E.

IT is surprising how often wireless amateurs fail to understand the meaning of the term "capacity of an accumulator" as expressed in ampere-hours (Ah). Actually an accumulator is designed to furnish a certain current (generally stated in amperes) for a certain length of time (generally stated in hours), and it is the product of these two quantities which is called the ampere-hour capacity.

For example, an accumulator with a 40-ampere-hour capacity will give an ampere for 40 hours, or $\frac{1}{2}$ ampere for 80 hours, and so on, before a re-charge becomes necessary.



IN connection with the subject of accumulator capacity, it is necessary to point out that there are two ways of expressing the rating, i.e., "ignition" rating and "continuous" rating.

The former is applicable to the cases where intermittent discharges are made, and is generally about double the continuous rating, this latter term being the one affecting wireless accumulators, giving the capacity for continuous use, such as lighting valve filaments.

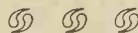

WHEN the wooden carrier of an accumulator is placed on the floor any spilt acid which has got on to the bottom of the crate is liable to



Fig. 1.—The attachment of "Absorbos" to the base of an accumulator crate proves useful in many circumstances.

cause damage to the carpet, etc., depending upon the situation. A useful expedient to overcome this possibility is to attach "Absorbos" to the

base of the crate. These consist of Sorbo balls cut in halves and fitted into metallic frames. (See Fig. 1.)

An additional benefit accrues from this, as when accumulators are being transported in vehicles for charging or other purposes, the shocks due to travelling will be minimised as far as the accumulator itself is concerned.



WHEN receiving sets are constructed so that the majority of the components are mounted on an ebonite panel instead of a baseboard, the operation of testing the receiver is greatly facilitated if temporary panel supports are used. They enable the panel to be held with either the controls or mounted components and wiring uppermost, and many designs are possible to enable this to be satisfactorily accomplished.

A simple type is illustrated in Fig. 2, and consists of a piece of wood $\frac{3}{8}$ in. thick, measuring 6 in. by 6 in. (or other dimensions, according to the size of the panel and depth of the wiring). Two wooden cross-bars serve as clamps, the distance between these pieces being settled by the thickness of the ebonite panel.



IT is often necessary for testing purposes to utilise a variable condenser with a maximum capacity higher than that immediately available. In this connection it should be borne in mind that a fixed condenser joined in parallel with the variable condenser will often meet the needs of the moment.

For example, a .0005 fixed condenser in parallel with a .0005 variable condenser will give a maximum capacity of .001. This fact is often lost sight of by experimenters, and has many practical applications when trying out new or special circuits.



DO not forget to make full use of the adjusting mechanism on your loud-speaker when the reproduction from a particular receiver is not all that one would desire. The exact position of the diaphragm with reference to the pole faces must be care-

fully altered by means of the usual milled nut or lever, before attention is turned to the set, according to the

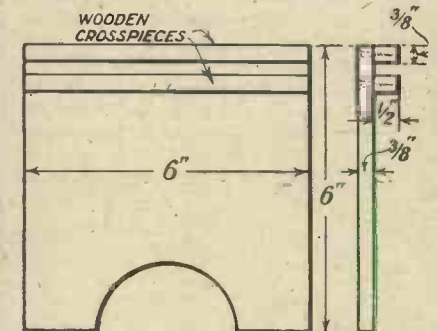
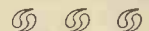
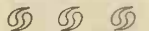

Fig. 2.—Temporary supports of this type for holding up a panel during testing operations will be found very handy.

strength of the signals being received at the time, and an improvement is invariably found to take place.



WHEN drilling holes in thin sheet-metal constructors will no doubt have noticed that it is not an easy matter to ensure the drilling of a good clean hole. This is primarily due to the fact that the drill bites the metal when just on the point of emerging. The difficulty is best overcome by backing the thin sheet of metal against a piece of hard wood, or, better still, a thicker sheet of metal. The sheet must be tightly clamped to the backing material, otherwise no real benefit will result.



HOW many times has a constructor drilled holes in an ebonite panel and then found them wrongly situated? The appearance of the panel will be spoilt unless steps are taken to remedy the error, and this can be done quite effectively by filling the holes with black sealing wax or Chatterton's compound and finishing off with emery cloth and an oily rag.

Another way is to file up carefully ebonite pegs with a slight taper so that they form a good driving fit into the holes. Cut off the projecting portions, and then finish off with a smooth file, fine emery and an oily rag.

"NOISE" OR QUALITY?

By L. H. THOMAS

The L.F. transformer is often blamed for distortion when the adjustments are really at fault. These operating notes will prove useful in making good this trouble.

SOME little time ago a well-known authority on wireless matters, while lecturing on the subject of broadcast receivers, made the remark that "hardly anyone in England knew how to work a low-frequency amplifier." This statement, though no doubt put somewhat strongly for the sake of emphasis, is, nevertheless, not so far-fetched as it may appear at first sight. In the writer's opinion, those who know just how to operate a note-magnifier and

the receiver will be most often employed. It is fairly generally realised now that for sheer excellence in purity of tone the resistance-capacity and choke-capacity forms of coupling are generally preferable to the transformer method, but yet the latter is the most popular on account of the extra amplification obtainable from it.

Skill in Handling

A good transformer amplifier, properly designed and adjusted, will certainly not leave much room for criticism, but the writer's opinion is that it generally requires more skill to obtain pure reproduction from a transformer amplifier than from one of the other forms; this is somewhat compensated for by the fact that more skill is required to obtain good volume from one of the other forms of amplifier than from the transformer variety.

Thus, generally speaking, it may be taken for granted that the average listener will, if he places volume first, vote for the transformer method of coupling, or, if he desires purity and is not particular about the volume, or does not object to using another valve, he will decide on one of the other forms.

however, be borne in mind that the impedance of the primary winding of the transformer is of greater importance than the ratio, and that the golden rule is, "Choose the transformer for a definite purpose, not with the idea of changing its position from time to time."

Most good transformers on the market at the present time have the primary impedance stated as well as the ratio, either on the instrument itself or with the accompanying "directions." Most of them are, however, labelled for some definite use, e.g., "1st stage," "2nd stage" or "general purpose," and it is in most cases sufficient simply to go by the manufacturer's designation.

Pay Attention to Grid Bias

Assuming that the correct type of transformer is in use, the following points should be attended to. First and foremost, the correct value of grid bias for the amplifying valve must be employed. Some of the sets that the writer has heard working loud-speakers have not even had any provision for grid bias, nor have the owners ever heard of it! Not only is it quite impossible to obtain anything like good quality without the use of

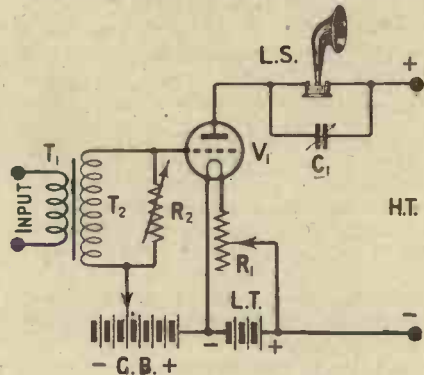

Fig. 1.—A variable high resistance connected across the secondary of an L.F. transformer provides a fine control over volume and tone.

obtain the best possible reproduction from a loud-speaker are very few indeed.

A Question of Adjustment

How many loud-speakers used as an "attraction" outside the doors of wireless shops have caused people to turn away in disgust, with a remark generally containing the words "bad gramophone"? Yet in most of these cases the loud-speaker itself is a perfectly good instrument, capable of giving really excellent reproduction provided that it is supplied with pure, undistorted speech and music. In ninety-nine cases out of a hundred it is simply the note-magnifier that is at fault, and in the majority of these cases the blame is put on the transformer or the valve, when it is really nothing more than a question of mere adjustment.

Forms of Coupling

It is always difficult to advise the constructor of a receiver as to the best form of coupling to employ for the L.F. valve, if one is used. The whole matter depends to such a large extent upon the purpose for which

.....
Experiments in L.F. amplification carried out by Messrs. Ferranti with large power transformers gave excellent amplification and reproduction. We are afraid that the size of cabinet required would be prohibitive to the general use of such transformers by constructors!



Operation

In this short article the few points that need careful watching in amplifiers of the transformer-coupled variety will be dealt with. First, the choice of transformer ratio must be correct or the best results will certainly not be obtained. It should,

grid bias, but it is extremely hard on the high-tension battery, which may easily be made to last twice as long in some cases simply by the provision of a small grid battery.

Suggested Voltage Values

For the first stage of amplification, generally speaking, the anode voltage

"Noise" or Quality?—continued

should never be less than 80 or 90 volts, and a negative potential of $4\frac{1}{2}$ -6 volts should be applied to the grid. A small power-valve will always give superior results to those obtained with a general-purpose valve, but will at the same time need quite different values of high-tension and grid-bias voltages.

This is mentioned to forewarn the reader against the common fault of leaving the set alone while taking out one valve and substituting a different type, and forming a comparison of the two valves simply from that, without even making certain that the operating conditions are as they should be in each case.

Power Valves

For the second stage (and, if they are used, succeeding stages), a power valve should *always* be employed; it will be found almost impossible to obtain good reproduction or even good amplification without one. It is generally the last stage of amplification that causes the trouble, if this takes the form of distortion, and

of grid bias used should also be as high—as is consistent with good results.

Reducing Current Consumption

It should be remembered that the higher the value of grid bias used, the lower is the consumption of current from the H.T. battery. For a second

resistance connected across the secondary winding of the L.F. transformer (see Fig. 1). For the first stage a variable grid leak (about .5-5 megohms) is quite suitable, but for the following stages a 10,000-100,000 ohm variable anode resistance will probably be necessary. This will provide a very fine control over both the volume and

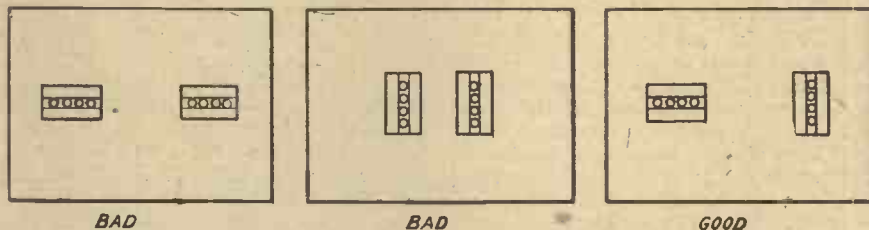

Fig. 2.—Where two stages of transformer-coupled L.F. amplification are used, much depends on the correct relative positions of the transformers.

stage of low-frequency amplification the writer generally uses a valve of the D.E.5 type (5.5 volts, .25 ampere), with 150 volts on the anode and 13 $\frac{1}{2}$ -15 volts negative on the grid. When this is properly adjusted, even a slight

tone obtained from the amplifier in a somewhat similar manner to the more usual practice of connecting a large "variable-fixed" condenser, or series of fixed condensers, across the windings of the loud-speaker.

Spacing

The proper spacing of the L.F. transformers is another matter of greater importance than is sometimes realised. They should, of course, be spaced as far apart as possible, and also should be arranged so that their windings are *not* in the same plane. The reason for this is that interaction between transformer windings can take place in just the same manner as interaction between the inductances in the set.

It may show itself by an audible howl when the set is switched on, or, more often, by an *inaudible* howl of which the owner may not be aware, but which may be causing very serious distortion of the output of the amplifier. Careful spacing and arrangement as shown in Fig. 2 will generally cure troubles of this nature.

Detecting Distortion

Lastly, mention ought to be made of a more reliable means of detecting distortion than the usual aural method. This consists simply of a low-reading milliammeter in the anode circuit of the last valve. When the set is switched on, the steady anode current will cause a deflection of the pointer, but there should be *no* fluctuations during the reception of music or speech. If the milliammeter is seen to "kick" violently when the announcer suddenly raises his voice, or if it "dances" in time with the performance of a dance band, distortion is present. It may be found impossible to keep the pointer dead steady, but there should never be more than the merest quiver of the needle when the receiver is correctly adjusted.

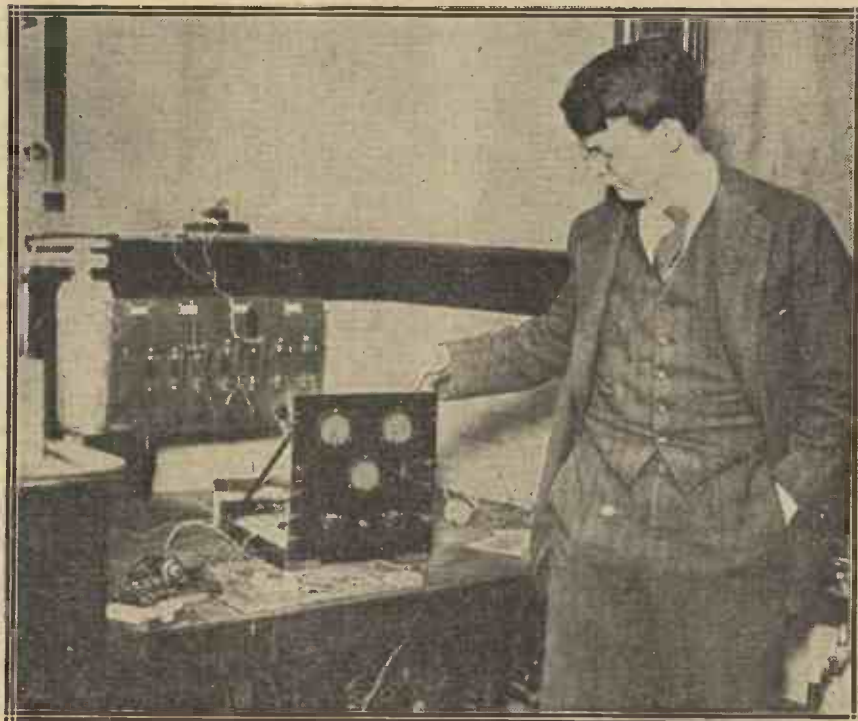

Penetrating the invisible. The tiny particles of matter called "electrons" are automatically counted as they pass across a wire by this ingenious piece of apparatus designed at the Bureau of Standards.

therefore special care should always be paid to the adjustment of this important part of the set. The high-tension voltage applied to the last valve should be as high as possible (that is to say, the highest value specified by the makers of the particular valve in use), and the value

alteration in either the grid potential or the anode potential causes an immediate depreciation in the quality of the reproduction.

A Tone Control Tip

A very useful addition to a note-amplifier consists of a variable high

A CHAT ABOUT FIXED CONDENSERS

By J. M. McARTHUR

Perhaps because it is usually totally enclosed, the fixed condenser is often "taken for granted" by constructors. That this policy may be disastrous in its effects is pointed out in these notes, while the author further indicates the details which need attention when purchasing fixed condensers.

THOUGH one of the smallest of radio components, the fixed condenser is by no means one of the least important. The fact that this view is not held by all home constructors was brought home to me rather forcibly by a keen set builder asking one day for advice as to why a newly-

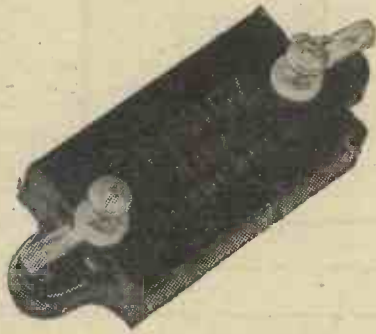

The means provided for making connections to a fixed condenser should be noted when choosing the component.

made set would not work. The facts were these. Not wishing to spend too much money, yet wishing at the same time to build a receiver from a published design, the enthusiast in question de-

A Foolish Conclusion

The first decision is, of course, bad practice, for were the condensers not necessary the designer would certainly not have included them, or at any rate made mention that their inclusion was optional. The second decision is

Poor Insulation

There are good condensers among the cheapest types, but their purchase is too speculative to be recommended since in the majority of cases their origin is unknown, while their capacity value is often only about 50 per cent.

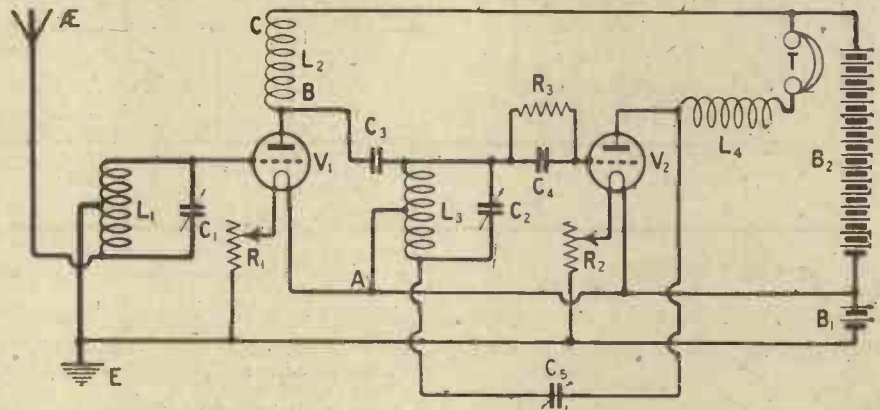

Fig. 1.—An internal short-circuit in the condenser C3 in this circuit brought disaster to the high-tension battery.

foolish, and more often than not more expensive than buying a good condenser to start with. Most of the

of what it is supposed to be. Further, their insulation properties are often poor and therefore unreliable. The latter point is one which is often overlooked by the home-constructor, and was incidentally the cause of the trouble referred to in the first paragraph.

The Danger

To show how important this question of insulation really is, the case of the troubled home-constructor already mentioned will give a good illustration.

The circuit of the receiver which he had built was that illustrated in the first figure, which arrangement, it will be seen, consists of one high-frequency amplifying valve, followed by a detector, a reaction effect being obtained by means of the variable condenser C₅.

The trouble in this particular instance was traced to the fixed condenser C₃, which had developed a short circuit, with the result that the high-tension battery was completely ruined.

The Result

A careful examination of the Fig. 1 circuit will show that when the C₃ condenser is short-circuited there is also a complete "short" across the

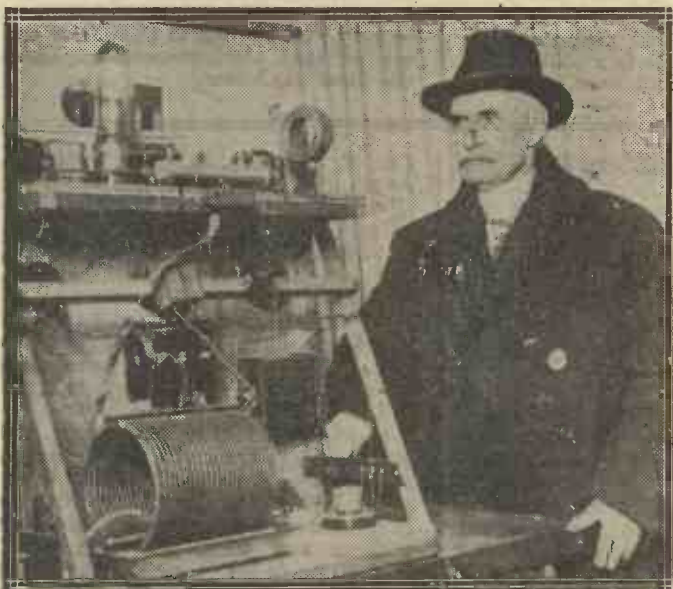

Some of the apparatus used by Dr. J. H. Rogers, who for some time past has been conducting experiments with underground aeri-als.

cided in certain cases to omit the fixed condensers, while in others he intended to purchase the cheapest possible kind.

cheap fixed condensers of unknown origin are of any capacity other than that for which they are rated, and are in some cases useless.

A Chat About Fixed Condensers—continued

high-tension battery in the following way:—The point A is connected to the H.T. negative and L.T. positive, while the H.T. positive is connected to the same point through the choke L_3 , through the shorted condenser C_3 , and

as in choosing, say, a variable condenser. A component of well-known make should always be chosen in preference to one of unknown origin, for should there be anything wrong when the purchase is put to practical use,

the terminals or soldering tags provided are of sufficient size to allow of easy connections.

Baseboard Mounting

If the component is to be screwed

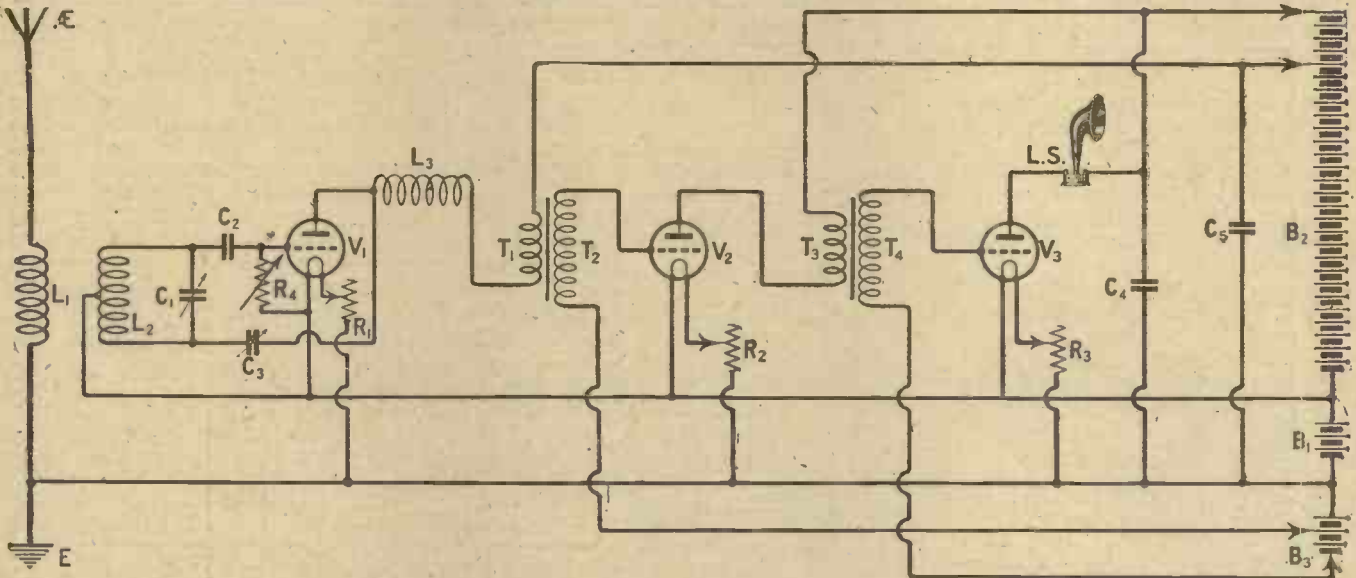

Fig. 2.—Good insulation in the condensers C_4 and C_5 in this diagram is essential, since they have to withstand the voltage of the high-tension battery.

the top half of L_3 , the path being indicated by A, B, C.

H.T. Condensers

One of the most common uses for a fixed condenser is to shunt the H.T. battery, the condenser in this case usually being one of not less than 2



The capacity value of a fixed condenser is usually marked on the case.

microfarads, and connected as shown in Fig. 2 as C_4 and C_5 . The question of insulation is again one which will decide the life of the H.T. battery (to say nothing of the L.T. battery with the connections given), for should either C_4 or C_5 have developed a short circuit then both the H.T. battery, or part of it, and the L.T. battery will also be short-circuited.

Care Needed

In choosing a fixed condenser as much care should be given to its choice

so long as the fault is due to the component and not due to the treatment of it, its exchange for another is largely a matter of course.

Look Before You Leap

When buying fixed condensers make sure that the values are those that you want, meaning by that, if you want a .0001, do not just pick it up, put it in your pocket and discover when you get home that it is a .001.

Look the component over, see that

to the baseboard, see that the holes for the fixing screws are in good order; if a parallel grid-leak is to be used, see that clips or some other device are available, or in the case of those condensers where the grid-leak is within the casing, make sure which type is being purchased.

There is an old saying that it is the little things which count, and this can be very well applied to the choice and use of that much-abused component the fixed condenser.

A SHARP-TUNING SINGLE-VALVE RECEIVER

SIR,—I constructed from the March, 1925, number of THE WIRELESS CONSTRUCTOR the "Sharp-Tuning Single-Valve Receiver" by Stanley G. Rattee, M.I.R.E. I have had what I consider great results. I have tuned in at different times most of the B.B.C. stations and a great many foreign ones, and have also been able to identify their call signs quite clearly. Here is a list of some of the stations: Nottingham, Hull, Sheffield, Manchester, London, Daventry,

Cardiff, Aberdeen, Edinburgh, Bournemouth, Leeds, Bradford, Newcastle, Birmingham, Hamburg, Madrid, Hilversum, Berlin, Radio-Barcelona, Catalana, Radio-Paris, Rome. I have only tuned in one amateur, 2BH of Barnsley.

My aerial is a poor one, 22 ft. high and 33 ft. long. I consider this circuit is one of the best I have come across, but I should like to add an L.F. valve to it.

I might add that I am only 500 yards away from the Nottingham transmitter, and by using the loose-coupled circuit I am able to cut out that station and receive Daventry without any local interference. I should like to hear through your paper, what success other readers may have had using this circuit.

Yours faithfully,
R. C. HANSON.

Nottingham.

A HOME MADE H.T. ACCUMULATOR

SIR,—Being highly in favour of H.T. accumulators, I decided to do some experimenting on my own account. I came across some old accumulators which had been discarded from a car and set about removing the plates as carefully as possible. Having cut away the bridges from the negative plates, I cut 60 smaller plates, $2\frac{1}{8}$ in. by 1 in., leaving a lug on one corner of each plate.

From the positive plates I cut 30 as before, and then proceeded to cut the

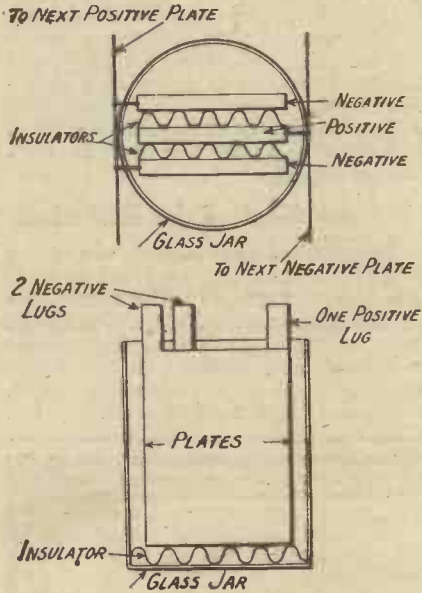

Fig. 1.—The construction of our correspondent's cells is clearly shown in this diagram.

insulators from the same accumulators into plates about 2 in. by 1 in., without a lug, of course; the insulators, I may add, were celluloid, perforated and corrugated.

You will see by my diagram how these were arranged in some glass jars, $2\frac{1}{4}$ in. high and $1\frac{3}{8}$ in. inside diameter, and after connecting all cells in series and putting vaseline on the square wire (16 gauge) used for connecting, I filled the jars with dilute sulphuric acid, usual strength, and charged it up at $\frac{1}{4}$ ampere for eight hours.

There will no doubt be many of your readers who, like myself, cannot afford to give £3 or £4 for an accumulator which, I believe, would not be any better than this; as for current, I think it is sufficient that I have run three bright-emitter valves taking .75 amperes each for over half an hour from three of these tiny cells.

I sincerely hope this may be of some use to you. I have gained some good hints from your paper, and wish it every success.—Yours sincerely,

HIGH TENSION.

Cleckheaton.

THE DI-KAST

CONSTANT SELECTIVITY CONDENSER

Rotor and Stator die-cast in one piece, affording results hitherto unattainable.

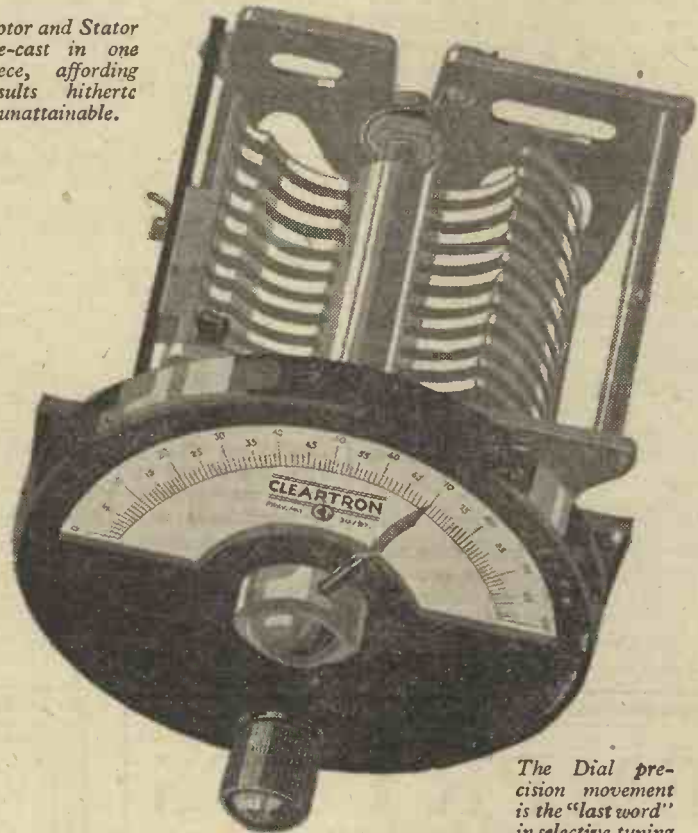

The Dial precision movement is the "last word" in selective tuning

ANOTHER CLEARTRON PRODUCT

A distinct innovation in Condenser design. Avoids the contact resistance losses experienced with separately assembled condensers. Rotor and Stator are die-cast in one, which means positive connection and perfectly matched characteristics. The specially designed vanes provide straight line reading, greater

range, easy short wave tuning and very low minimum capacity. Another feature of unusual interest is the MICRO STATION SELECTOR, a newly designed dial precision movement, allowing completely selective tuning and ten or more different adjustments between each degree. Play and back-lash entirely eliminated.

PRICES

Condensers : .0002, 13/9 ; .0003, 14/3 ; .0005, 14/9

"Station Selector" Dial, 10/6
(Gold or silver-faced).

Send for complete explanatory leaflet to :

CLEARTRON RADIO VALVES

12/6
Standard price

CLEARTRON RADIO LIMITED

CLEARTRON RADIO VALVES

15/6
Standard price

ONE, CHARING CROSS, LONDON,
(Works : BIRMINGHAM)

Regent 2231/2.

Cleartron, Westrand, London.

British  Made

48/577 A₂

GOOD NEWS FOR WEEKLY JOURNAL READERS

READERS of the *WIRELESS CONSTRUCTOR* who are not yet acquainted with *Wireless* and who appreciate a sound and interesting weekly journal at a popular price, will find in *Wireless*, which now incorporates *Wireless Weekly*, just the journal they require.

A Benefit to Readers

Readers of both *Wireless Weekly* and *Wireless* are benefited by the combination of the two journals, the former obtaining all the essential features of their journal for two-thirds of the previous price, and the latter being provided with a bigger journal at the same cost.

The joint editors of *Wireless* are Mr. Percy W. Harris, M.I.R.E., and Mr. J. H. Reyner, B.Sc. (Hons.), A.O.G.I., D.I.C., A.M.I.E.E., who has hitherto been the Technical Editor of *Wireless Weekly*.

An Extensive Demand

The demand for *Wireless* in its new form is very extensive, so do not forget to see that your newsagent reserves your copy each week. Look for the new coloured cover on Tuesday each week.

In the issue of *Wireless* for May 29 appeared the description by Mr. J. H. Reyner, B.Sc., of a new and interesting receiver. Low constructional cost is a feature of this receiver, which embodies the results of many months of research. High selectivity, ease of control and non-radiating properties are but a few of the attractive qualities of an instrument which anyone can build for his own use.

Radio's Future

The future of radio and the developments which are to come form a deeply interesting subject. The progress in receivers and circuits which will mark the coming autumn is discussed by Mr. John Scott-Taggart in the issue of *Wireless* for June 5. Mr. Scott-Taggart's grasp of present conditions and insight into the possibilities of the future combine to produce an article which is at once authoritative and fascinating to the reader.

A Useful Free Gift

With this issue of *Wireless* a most useful gift sheet was presented free to readers, this consisting of a Tuning

Chart for the broadcasting stations, which can easily be given a permanent place on the receiver. General hints on operating the receiver further increase the utility of a gift which every reader of *Wireless* will appreciate.

The "Elstree Six."

In another important article in the June 12 issue of *Wireless* Mr. Scott-Taggart tells the story of the wonderful "Elstree Six" receiver. He explains how the problems incidental to the design of this receiver were overcome, and describes how the research work carried out step by step by the Elstree Laboratories culminated in the remarkable achievement of producing a six-valve set which has received sixty broadcasting stations in one hour on the loud-speaker.

For the Single Valve Enthusiast

Single-valve enthusiasts, especially, should make a point of reading, in the issue for June 12, the description of the Single-Valve Neutralised Reflex Set, by E. J. Marriott. This marks a distinct step forward in the design of a type of circuit which is simple, economical and efficient in operation.

TEMPRYTES

(REGD. TRADE MARK.)

The Perfect Control for all Valve Filaments

Manufactured in values to suit all valves. From 3 to 55 ohms.	2/6 each.	Holder Mountings for Temprytes - 1/6 each.
---	---------------------	--

Full particulars on application.



Grounded Rotor Condensers

The absolute pinnacles of Condenser Perfection.

Square Law.		Straight Line Frequency.	
.001 Mfd.	21/- each	.0005 Mfd.	15/6 each
.0005 "	17/6 "	.00035 "	15/- "
.0003 "	16/6 "	.00025 "	14/6 "
.00025 "	16/- "	Large 4" Knob Dial, as supplied with Square Law Condensers - 2/- "	
.0002 "	15/6 "		
.0005 Dual	27/6 "		
.0003 "	25/- "		

ALL POST FREE BY RETURN ON RECEIPT OF REMITTANCE.

FROM THE MANUFACTURERS: **SYDNEY S. BIRD & SONS,**
Cyldon Works, Sarnesfield Road, Enfield Town.
Phone: ENFIELD 672.

Use THE **CLARITONE**
Britain's Best
FROM ALL RADIO DEALERS

PRACTICAL WORKSHOP HINTS

FOR THE HOME CONSTRUCTOR

The backs of cabinets—Wood strips—Flex leads for the experimenter—Removing Pitch—For awkward screws—File handles—Soldering stranded wires.

THE BACKS OF CABINETS

STOCK-SIZE wireless cabinets are generally supplied with openings cut in the backs to take terminal strips of a certain length and width. Often these openings are of just the size that one wants, but it occasionally happens that they are too small to suit the set that is to be housed in the cabinet. By far the most certain way of enlarging the opening neatly is to remove the back before cutting is done with a saw. This, however, can be done only if the back is attached to the cabinet by means of screws; if it is nailed on it is inadvisable to try to remove it. In such cases one can make a fairly good job by using a keyhole saw and going very carefully.

The Terminal Strip Opening

The outline of the enlarged opening should be drawn accurately with a

fix it to the baseboard. Slide the baseboard into the cabinet, taking care to see that it is properly "home," then put the terminal strip into the opening from the back of the cabinet and drive the screws in. When the job is done in this way the terminal strip fits properly, and there is then no difficulty in pushing the baseboard into the cabinet.



WOOD STRIPS

THE constructor will find it greatly to his advantage to keep amongst his workshop stock a supply of suitable wood cut into strips of various sizes and ready planed and squared. Good woods to use for the purpose are bass, walnut and oak. The strips should be in lengths of two or three feet, and handy sizes are $\frac{1}{2}$ in. square, $\frac{1}{2}$ in. by $\frac{1}{4}$ in., 1 in. by

coils upon a platform on the baseboard. The wide strips can be used for the platform, the supports being formed from other strips of suitable thickness. If you want to make a beading inside a cabinet for the ebonite panel to rest against, the $\frac{1}{2}$ -in. by $\frac{1}{4}$ -in. strips are ideal for the purpose. Dozens of other uses will suggest themselves immediately to the constructor, and the saving of time brought about by having a stock of

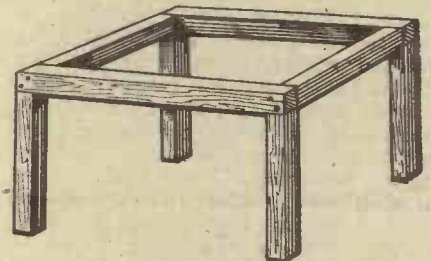
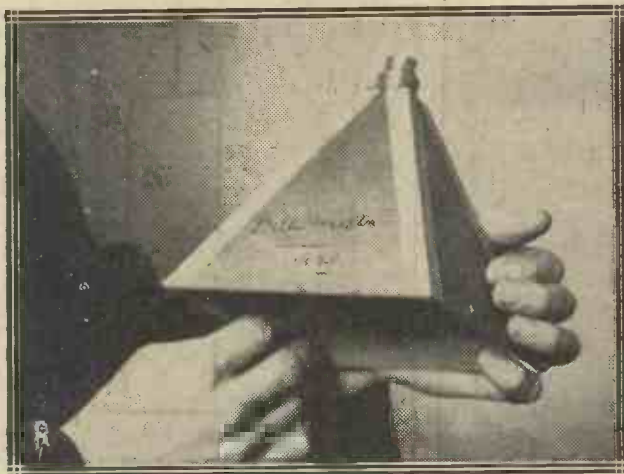

Fig. 1.—A wooden framework of this kind will be found handy as a mount for components on the experimental bench.



.....

For early broad-casts a trumpet was attached to the microphone. Here is the trumpet used, with Dame Nellie Melba's autograph upon it.

.....

the sizes mentioned will be apparent. From the $\frac{1}{2}$ -in. square strips very handy mounts for components used for experiments on the bench can be made. Fig. 1 shows how this is done.

A Handy Mount

A frame of the required size is made from four strips fixed together by screws driven into the corners. To this are fixed legs long enough to raise the particular component above the surface of the bench. The component itself, a variable condenser, rheostat, variometer or whatever it may be, is mounted upon a panel of ebonite or bushed wood, which is fixed to the frame by short screws.

Frames made in this way are surprisingly robust, and their cost is ridiculously small. If desired, the legs can be stiffened by means of the smallest size Meccano right-angle brackets. A wide range of walnut strips in 2-ft. lengths, and in all sizes from $\frac{1}{4}$ in. to 1 in. in thickness, is stocked by a well-known firm which supplies any material for the demands of woodworkers (Hobbies—"Strip-wood").

pencil on the back, and a half-inch hole should be made with brace and bit just inside each corner. This enables the saw to be turned, and the corners can be trimmed up afterwards with a rasp. When you are fitting a terminal strip to a baseboard you will find it best to proceed in the following way:—

Drill the necessary holes in the strip, for the screws which will

$\frac{1}{4}$ in., 2 in. by $\frac{1}{4}$ in., and 3 in. by $\frac{1}{2}$ in. If you are not yourself a good hand with the plane, any working joiner will prepare these strips for a small sum, and once you have them you will wonder how you ever got on without them.

Suggested Uses

Frequently, for example, it happens that one wishes to mount valves or

Practical Workshop Hints—continued

FLEX LEADS FOR THE EXPERIMENTER

MOST of us, I suppose, use flex leads for making experimental hook-ups on the bench, and most of us equally anathematise the way in which the bared ends come unstranded and break away after having been attached two or three times to terminals. Fig. 2 shows a very simple way of preparing the ends of flex leads which ensures the rapid making of connections and long-lived leads. The outer silk or cotton braided covering is best removed altogether; it serves no useful purpose for bench work, and it always frays out unless one goes through the rather tedious process of whipping it.

Remove Outer Covering

It can be slipped off quite easily by grasping the rubber covering of the lead between the forefinger and thumb of the right hand and working off the sheath with the left. Do not remove an inch or so of the rubber covering from the extreme end of the lead, as is usually done. Instead, cut through the rubber carefully with an old pair of nail scissors about a third of an inch from the end, and make a similar cut an inch further down. Scrape or snip away the rubber between the two cuts, and remove the inner silk or cotton covering, leaving the wire strands bare. The little piece of rubber left at the end of the lead serves to keep the wires from unstranding, and connections to screw-down terminals can be made in the easiest possible way.

A Further Refinement

Flex connections prepared in this way can be made to last almost inde-



Fig. 2.—When baring flex wires, leave a piece of insulation at the end to keep the strands together.

finitely if the bared portion of the wire is bent round into hook shape and a little solder is run into the strands. One very great advantage of the method, whether solder is used or not, is that one is not bothered by broken strands which get into the threads of the terminal and prevent the nut from being screwed down.

REMOVING PITCH

THERE are numerous little jobs that one is called upon to do which necessitate the removal of an existing pitch insulation. One of these came my way the other day when one terminal of a high-frequency choke of well-known make became loose. This particular choke has an ebonite base, recessed on the underside for the re-

ception of the terminals. The recesses are filled with pitch. The best way of going to work in such cases is to chip away the pitch carefully with a fine, sharp-pointed tool such as a scriber. When this has been done the terminal can be tightened up, or should a broken connection have occurred the fault may be remedied by soldering.

Another Insulator

When the job is done I recommend refilling the recess not with pitch but

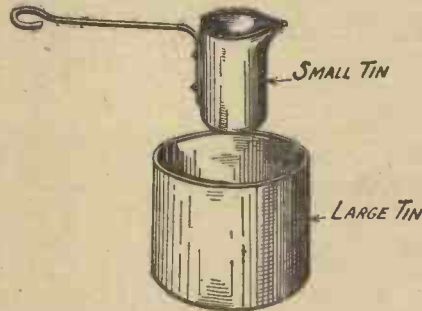
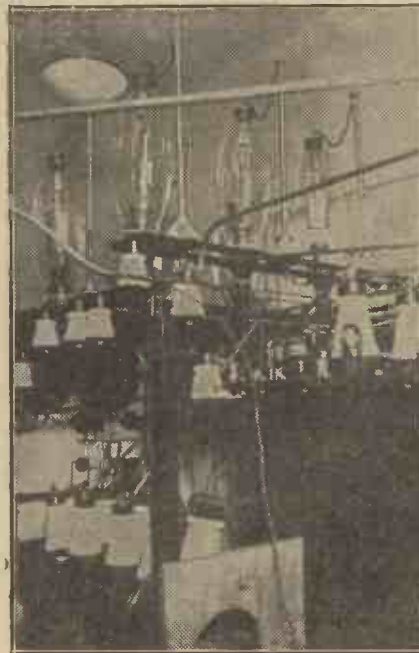

Fig. 3.—This apparatus for melting wax obviates the risk of the wax overheating and catching fire.

with paraffin wax, which, besides being a better insulator, is easier to work with. The most convenient way of melting wax is to make use of the



Six large rectifier valves are used at the Rosenhugel high-power broadcasting station, near Vienna.

easily constructed apparatus shown in Fig. 3. This is made from two cocoa tins, one small and one large. The small tin has a pouring lip, easily

made with pliers, and a handle of No. 18 copper wire is soldered to it. The large tin is used in its natural state. It is filled with water and placed over a gas ring or spirit lamp, the small tin being suspended in it by means of the wire handle and the lip. The heat of the water in the large tin causes the wax in the smaller to melt, and when it is liquid it can be poured easily into the places where it is required.

Tapping a Flashlight Battery

If it is desired to tap a 4½-volt pocket flashlamp battery the pitch should be chipped away in the manner previously described so as to expose the wire connections between the cells. When leads have been soldered to these a strip of gummed paper should be affixed to the top of the cell to replace the covering which will have been torn away in the process. The melted wax can then be poured in to cover the inter-cell connections.

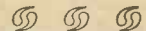

FOR AWKWARD SCREWS

I HAVE been using lately a little contrivance which makes the starting of awkward screws, either wood or metal, a very much less "fiddly"

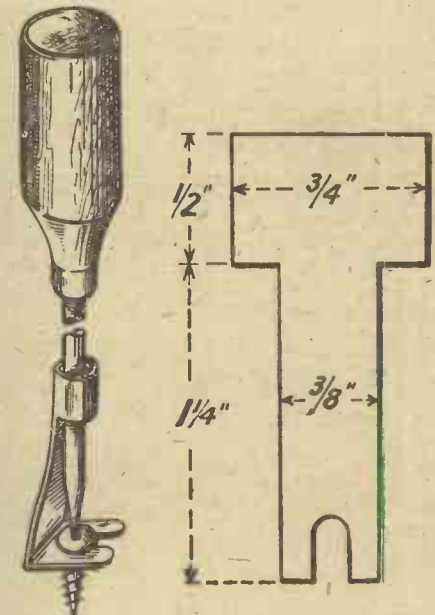

Fig. 4.—A piece of sheet brass cut to the shape shown on the right is bent to fit the screwdriver as indicated.

business than it usually is. The device, which is made from sheet brass, has a clip portion which fits round the shaft of the screw-driver and a shank about 1 in. in length, whose far end is bent round at right angles and deeply notched with a file so as to take a screw. When one wishes to drive a screw in some inaccessible place the method is as follows:—

PRACTICAL WORKSHOP HINTS—continued

The clip is pushed down so that the notched portion stands right away from the blade of the screw-driver. A screw having been inserted, the clip is pulled up until the blade of the driver engages in the nick of the screw. There is now no difficulty in manœuvring the screw into the place where it ought to be, for it is quite firmly held, and in getting it started with that first turn or two upon which everything depends. Once the screw is fairly started the screw-driver is pulled upwards. This causes the clip to pass down the shank, when the notched portion is easily slipped from under the head of the screw.

Details of the Clip

Details of the T-shaped piece of brass from which I made the gadget described are shown in the drawing. The dimensions may have to be altered slightly to suit the particular screw-driver for which the contrivance is intended. Unless the clip is made to spring on and off the shank of the screw-driver, a special driver fitted with the contrivance should be kept for the express purpose of dealing with awkward screws; but its use saves so much time and so much ruffling of the temper that it is well worth while to do so.

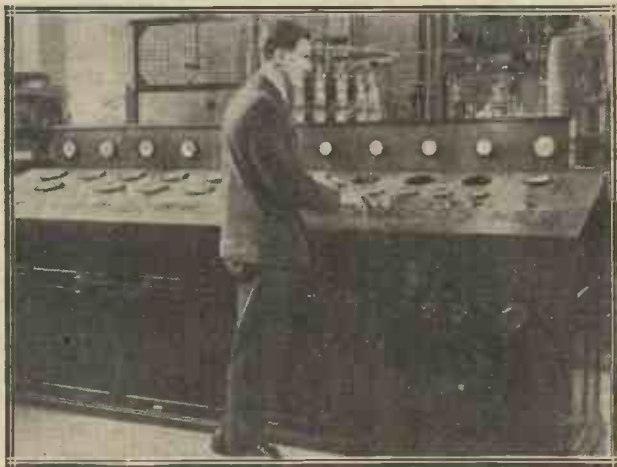

FILE HANDLES

THE task of using files is rendered very much easier if each is fitted with a wooden handle. Not every constructor knows that file handles are obtainable at about eighteenpence a dozen from any good tool shop. It is an excellent tip to fit these to all of one's files as well as to various other small tools. A very useful gadget to keep in the tool box is the metal universal file handle, costing about a shilling, which is shown in the drawing. If this is provided with a screw grip, it can be fixed to a file or other small tool in a moment.

No Injured Hands

When a handle of this kind has its place in the tool box one need never run the risk of incurring a nasty prick in the palm of the right hand from the sharp-pointed tang of a small file. By the exercise of a little ingenuity



Fig. 5.—This type of universal file handle forms a convenient grip for files or other small tools.

a broken hacksaw blade, previously ground to a point, can be fitted into a universal handle, in which case one has an improvised saw of the keyhole type which is most useful for cutting slots or large holes in ebonite.

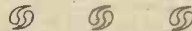

SOLDERING STRANDED WIRES

A JOB which constructors often find troublesome is to make a satisfactory soldered connection between the shank of a terminal and a piece of flex wire. Actually it is a very

.....
On the control board at the Rugby Station are mounted press buttons and switches controlling all the main functions of the transmitting apparatus.

easy job when it is undertaken in the proper way. When you have bared the end of your flex see that the strands are clean—sometimes, especially if the flex is old, the strands become dull and discoloured.

Should the wire be dirty, untwist it, spread the strands out flat, and draw them once or twice lightly over a sheet of the finest emery cloth. Twist them together again, and apply a very little flux. With a hot iron run a little solder into the strands so as to bond them together. Tin the shank of the terminal, and you will now have no difficulty in making a neat, firm joint.

The
Varley
Constant

Wire-wound
Anode
Resistance

Where Resistance Capacity is concerned—and this is the ideal form of intervalve coupling—the Varley has no equal.

Non-inductively wire wound on the famous Varley Bi-Duplex system, with turns silk separated, this resistance is absolutely constant under all atmospheric conditions, and ensures a wonderful purity of tone.

A specialists' job—that's what the Varley is. A coil winding job, scientifically designed and constructed by experts who for 27 years have been engaged in every form of accurate and intricate coil winding.

If you value permanence and reliability insist on a Varley.

Complete with Clips and Base **7/6**

Without Clips and Base, 6/-

60,000 ohms, 80,000 ohms, 100,000 ohms

Write for Leaflet



Constant always

The Varley Magnet Co., Woolwich.

(Proprietors: Oliver Pell Control Ltd.) S.E.18.

Telephone: Woolwich 888, 869.

SWITCHES ON THE LOW FREQUENCY SIDE

By JOHN UNDERDOWN

The employment of switches in note magnifier circuits is a feature which recommends itself to many constructors. Mr. Underdown gives many details which make interesting reading.



WHERE reception is not confined to any given station, or where it is desired to vary the volume at will, it is much more economical to arrange to cut a valve in or out of circuit, on the L.F. side, than it is to adopt some other form of volume control. Although the employment of switching on the high-frequency side of any set is to be avoided as far as possible, since it generally leads to instability, after the detector, however, switching is not fraught with such difficulties, providing it is not carried to excess.

A Point of Convenience

I would not advise that extremely complicated switches be used, necessitating somewhat bunched wiring, but the use of simple types is extremely convenient and has much to recom-

Rotary Stud Switches

Perhaps the simplest type of switch to employ is the rotary stud type, with which a moving arm can engage with one stud of a number which are arranged on the arc of circle.

In the circuit diagram of Fig. 1 the connections for utilising a switch with two studs, to cut out a note-magnifying valve, are indicated. It will be

and H.T. positive in the normal way, but with the right-hand connection (1) and the last valve extinguished, one note-magnifier only is in circuit.

Grid-Bias Adjustment

With a common high-tension tapping no alteration of grid bias is necessitated, and the loud-speaker is still left connected between its usual terminals. Where, however, the receiver is wired for separate H.T. supplies to the valves it should be noted that the voltage which is applied to the last valve when both are in circuit is transferred to the anode of the first valve, and in this case adjustment of grid bias may have to be made.

For the Local Station

The circuit diagram of Fig. 2 is that of a two-valve transformer-coupled amplifier in which it is arranged to cut out the first valve V_1 , instead of the second, when both are not required. This is of considerable advantage where V_2 is a power valve and adequate loud-speaker results can be obtained with one note magnifier only, for example, from the local station. Working with one note magnifier V_1 is switched off on its filament resistance R_1 , and adjustment of the first grid-bias tapping may be required here. It should be observed, however, that although the first note magnifier is out of circuit, the first transformer is still in use. This is somewhat important where the primary impedance of T_1, T_2 is chosen to suit the preceding valve.

Choke Coupling

In a receiver where choke coupling is employed throughout after the de-

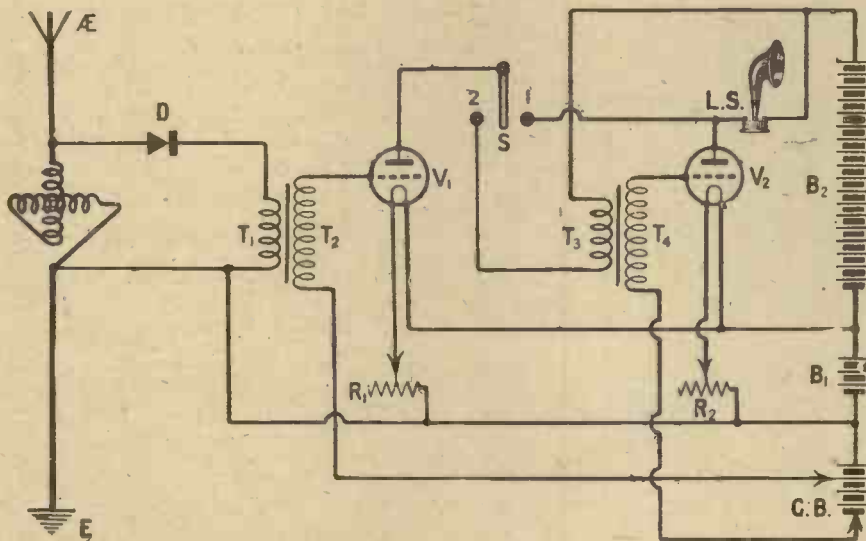

Fig. 1.—The switching arrangement indicated in this diagram is characterised by its extreme simplicity.

mend it. There are three kinds which are in most common use to-day, and it is proposed to deal with some of their applications in the following article.

observed that with the switch-arm in the left-hand position (2) and the second valve alight that the primary T_3 of the second L.F. transformer is connected between the anode of V_1 ,

Switches on the Low Frequency Side—continued

detector valve, a very simple application of the rotary stud switch will allow the detector to be used alone or followed by any number of the note magni-

S, allows either the telephones or loud-speaker to be used at will, and assuming, for the sake of example, that telephones are in circuit, it will be seen

the diagram, if a separate H.T. tapping is provided for each, as otherwise part of the H.T. battery is temporarily shorted through two chokes in series. This, however, is not of vital importance.

"Dead" Studs

The use of "dead" studs with switching arrangements of this type often puzzles beginners, since these studs have no connection taken from them. This is invariably to prevent

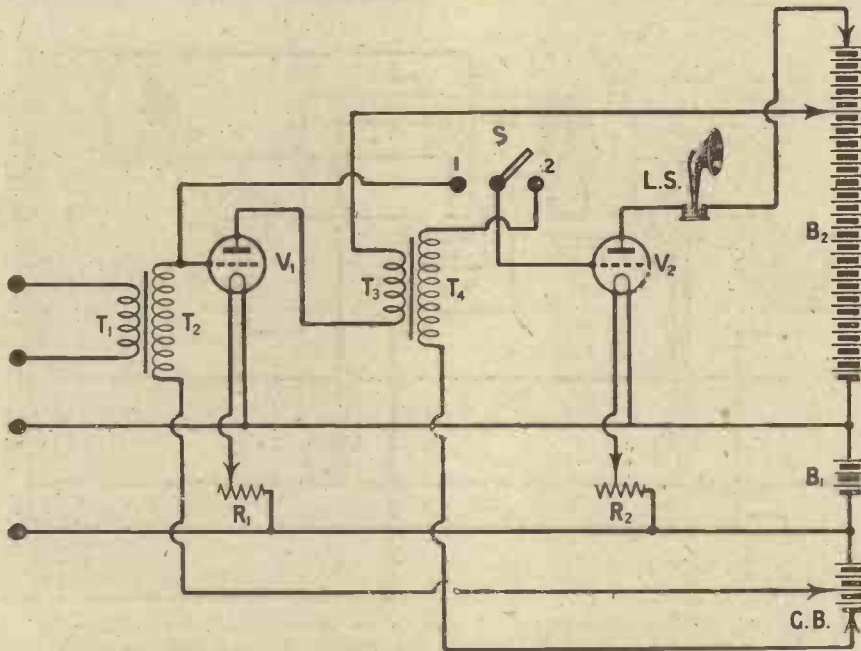
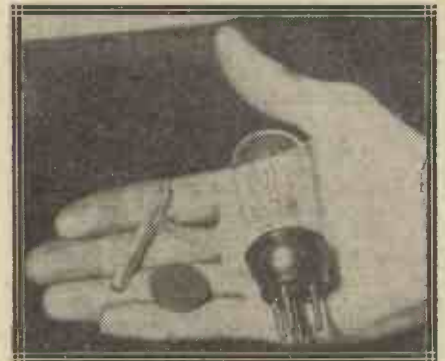

Fig. 2.—Where one note magnifier is desired for the local station this arrangement will be found suitable.

fiers. This is effected by utilising the well-known filter arrangement. A switch with one more active stud than the number of valves which are to be

that when the blade of S, is rotated from right to left, that the detector and one or two note magnifiers are brought into circuit, it being neces-



The present-day dull-emitter valve provides an interesting comparison with the detecting arrangement used by Senatore Marconi in 1895.

a somewhat wide blade, which is liable to touch two adjacent studs at once, short-circuiting the whole or part of the H.T. battery. It is advisable that

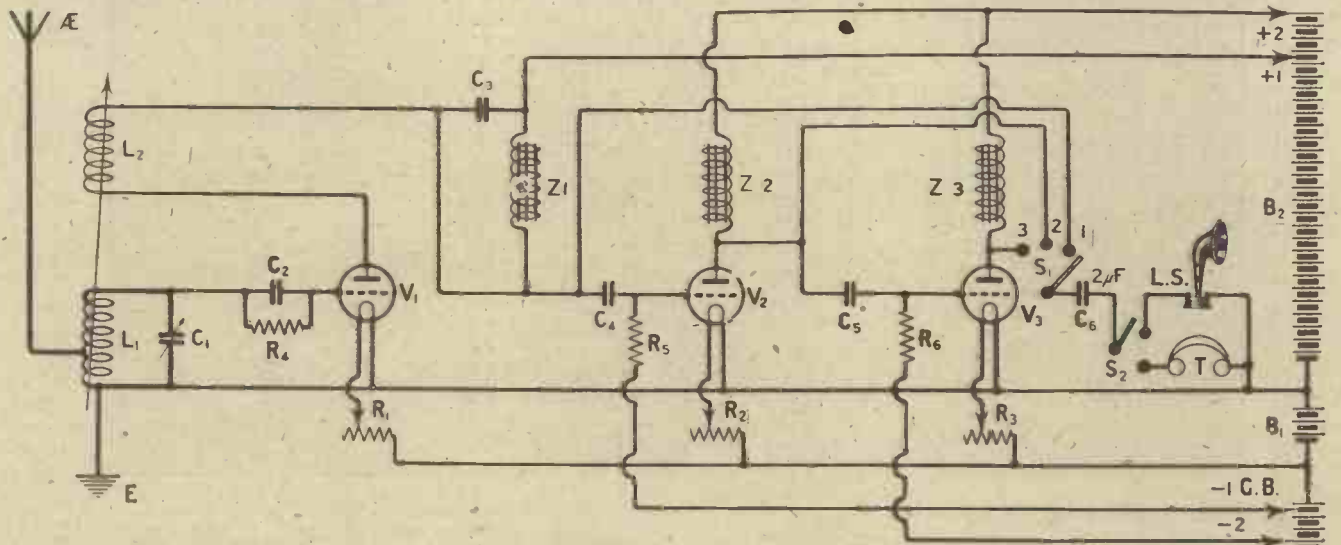

Fig. 3.—The loud-speaker or telephones can be used at will in this choke-coupled circuit.

cut out of circuit is required. The anode of each note magnifier is in turn taken to a stud, whilst the connection for the detector-valve stud is as shown in Fig. 3.

A Switch Detail

In this circuit the two-stud switch

sary, of course, to light the appropriate valves on their respective filament resistances.

Where the switch arm is so wide as to touch two studs at once it is advisable that blank studs be placed in between those shown as 1, 2 and 3 in

a wide switch arm be employed if smooth working is to be obtained when passing from stud to stud!

Multi-Pole Two-Way Switches

Although generally not so simple to wire, multi-pole two-way switches,

Switches on the Low Frequency Side—continued

usually associated with the word "anti-capacity," have very wide application and certain advantages over the previous type for which certain switching illustrations are given in the first three figures. In the fourth diagram a simple method of using a two-pole double-throw switch to cut out one note-magnifying valve in a two-valve amplifier is indicated.

Here, with the switch in the left hand position, the anode of V_1 is joined through the loud-speaker to H.T.+, and V_2 is automatically extinguished. With this arrangement only one H.T. tapping is employed for both valves, and, consequently, no re-adjustment of grid bias is required where valves with differing characteristics are used.

A Possible Drawback

The wiring of the switch in Fig. 4, although somewhat spectacular in use, in that the last valve is extinguished when not required, has the drawback of a common H.T. supply to both valves. In Fig. 5, however, a method of utilising a 2-pole 2-way switch to cut out the last valve, but permitting of separate H.T. supplies to the two valves, is shown. Here, with the switch in the upward position, the re-

This application of the switch will serve in the Fig. 4 type circuit, V_1 in this case being a note magnifier with its anode joined directly to the centre left-hand contact of the switch (Fig. 5).

to be transferred to another pair of terminals, by placing the switch in the lower position. When this is done V_2 must be extinguished on its own filament resistance R_2 , and instead of

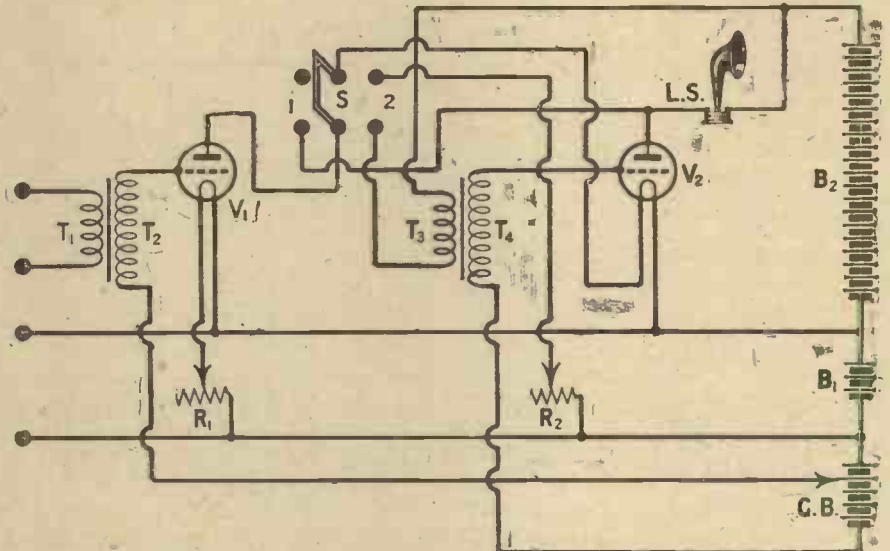
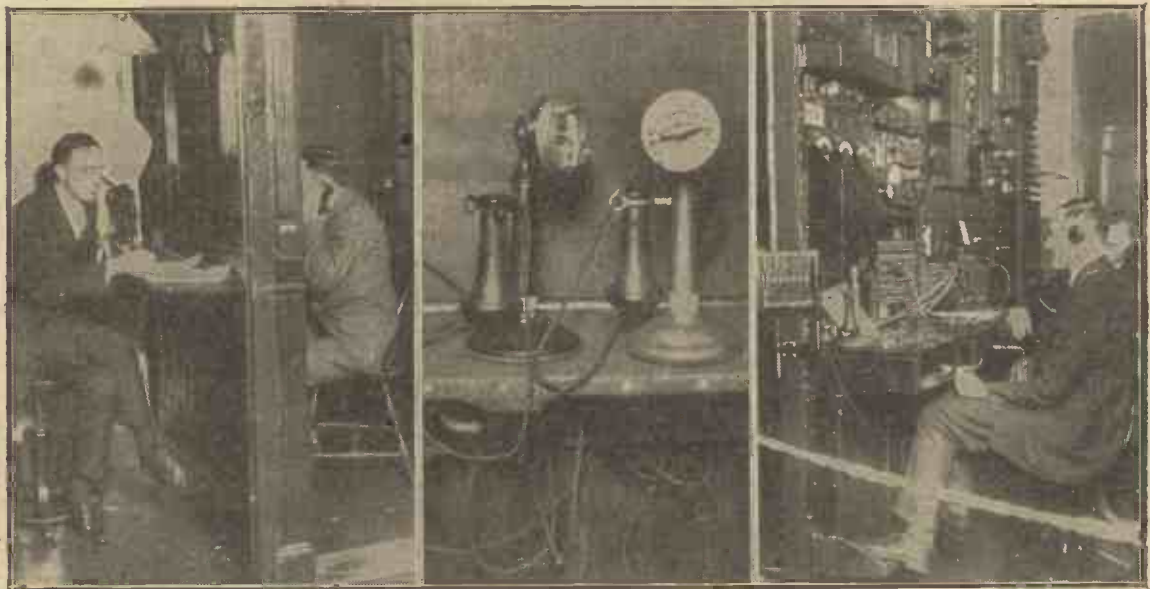

Fig. 4.—With a common H.T. supply to the two L.F. amplifying valves, a two-pole two-way switch can be used as shown.



A big step forward—some of the stages for the radio telephonic communication between London and New York are portrayed in this photograph.

action coil L_2 is connected through the primary T_1 of the L.F. transformer T_1, T_2 to the detector tapping in the H.T. battery, whilst the L.F. tapping, + 2, supplies the L.F. valve V_2 only.

Two By-Pass Condensers

Dealing with the Fig. 5 circuit in greater detail, it will be observed that the note magnifier is cut out of circuit, without requiring the telephones

only one by-pass condenser, namely, that across the primary T_1 of the L.F. transformer, two condensers, C_2 and C_3 , are required, as if C_3 is not provided the telephones will act as a choke when the second valve is not in

SWITCHES ON THE LOW-FREQUENCY SIDE—continued

circuit. If desired, a further set of contacts may be employed to switch the filament of the last valve, in which case a 3-pole 2-way switch will be necessary.

Connections for a 3-pole 2-way Switch

To wire the Fig. 5 circuit for a 3-pole 2-way switch is a very simple

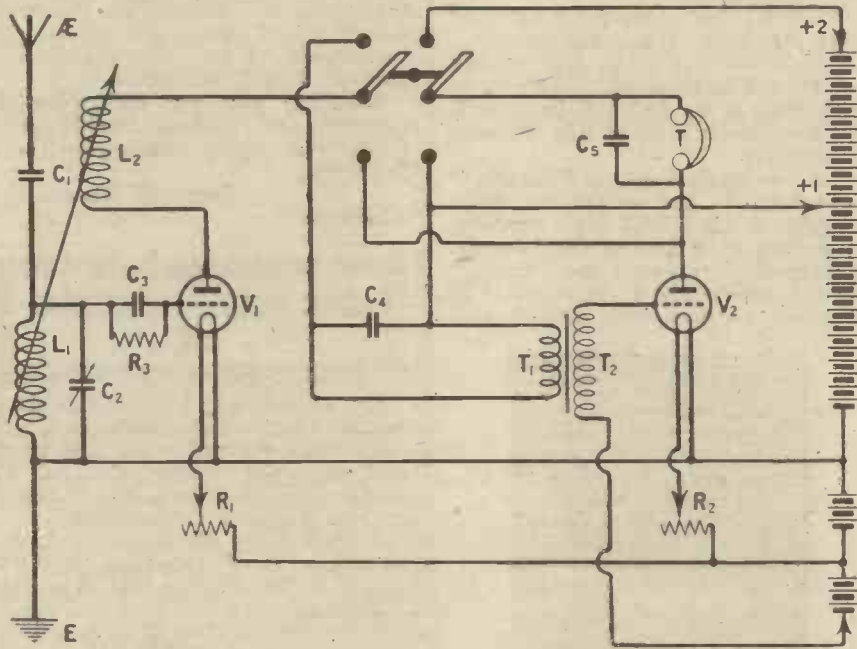

matter, and considering the three extra contacts to be placed on the right-hand side of the switch in the diagram, the lower contact will be left blank, whilst either the lead between low-tension positive and the positive filament leg of the valve V_2 , or that between the negative filament leg and the resistance R_1 , will have to be broken, the two wires thus formed being joined to the middle and upper contacts of the switch respectively.

A Point to Note

Where only one filament resistance is employed to control both valves it should be observed that more resistance will have to be brought into circuit when the note magnifier is cut out, as otherwise the detector valve will be over-run and its life correspondingly shortened. For this reason the writer prefers always to use a rheostat for each valve where these are switched, thus obviating such readjustment which is apt to be forgotten.

With "anti-capacity" type switches attention should always be directed to the contacts during assembly of the set, it being ascertained that all make properly, as generally when the wiring is completed it is difficult to reach these points.

Having indicated certain uses for stud and multi-pole switches in this issue, the jack type will be dealt with at some future date.

Fig. 5.—This arrangement is preferable to that of Fig. 4, since separate H.T. supplies to the two valves are made possible.

Free Blueprints for All!

THE SIMPLE CONDITIONS YOU MUST OBSERVE.

It has been decided to supply free a back-of-panel blueprint of *any* set in this and future issues of THE WIRELESS CONSTRUCTOR. Only one blueprint can be supplied to each reader, and only postal applications (accompanied by the coupon to be found in each issue) will be considered; callers will not be supplied. This offer applies only to THE WIRELESS CONSTRUCTOR, and will obviously be greatly to the advantage of readers.

REMEMBER:—

1. Only *one* blueprint supplied to each applicant. Extra blueprints are available at 1s. 6d. each.
2. Only a *postal* application for a blueprint will be considered, and it *must* be accompanied by the necessary coupon. Callers at our offices will not be supplied.
3. A coupon only covers the sets in the particular issue in which it appears.
4. Only back-of-panel blueprints are included in the *free* supply offer.
5. Coupons are available only up to the end of the month for which the issue is *dated*, i.e., the coupon in this issue, published on June 15, is available up to July 31.
6. When ordering state clearly the *number* of the blueprint you want as well as the name of the set,

Capacity scooped out-

That is what we have done to this new LISSEN VALVE HOLDER—in every conceivable place capacity and loss have been literally scooped out. This new LISSEN VALVE HOLDER should find a place in all efficient receivers, particularly those working on the low wave-lengths. (Patent pending.)



Price 1/8

Springs can be bent back for base-board use.

Daylight in a coil mount-

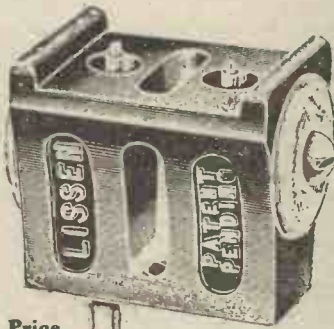

Price 1/-

Instead of capacity and loss there is daylight in the new Lissen Coil-Mount—the mount which is now being fitted to all LISSENAGON coils. You can buy this new LISSEN Coil Mount separately—fit it to your existing coils, or any coils you wind yourself.

LISSEN

LISSEN LIMITED,
26-30, Friars Lane,
Richmond, Surrey

150 Managing Director: Thomas N. Cole.

A READER'S ENTERPRISE

SIR,—I have been a reader since *The Wireless Constructor* first started, but have never written to show my appreciation.

However, having made up many of your circuits, I am sending you snapshots of three of them, and a brief list of results obtained. The set, in each case, is as designed by myself, but the circuit is from *The Wireless Constructor*.

"A" is my best set. A "straight" one-valver, it has at various times brought in all B.B.C. main stations, several relays, a host of Continentals, and (nearly a year ago) two "Yauks," KDKA and Oakland, California. It has been re-wired once, and is still



A.—Mr. Haskell's best one-valver with his home constructed loud-speaker.

going strong, working the small home-made loud-speaker, shown standing upon it, from Daventry. The panel is of bath-enamelled wood.

"B" is a one-valve reflex and one note mag. It is a fine little set, but



B.—This set serves a dual purpose.

is best for loud-speaker work when used as a two-valve amplifier after the one-valver above mentioned. If any reader cares to use a similar set as a note mag. I can give him a little

hint. Use a detector which has terminals outside the panel, and then the only correction necessary is a single wire from the crystal terminal to the 'phone negative on the receiving set.

"C" is a tapped-coil crystal set which closes up and goes comfortably in a match box. It will tune over the B.B.C. band, and gives us London (approx. 40 miles) at good strength on three pairs of 'phones. The terminals take standard spade and 'phone pin connections. I have also occasionally received Nottingham on it.

Thanking you for such splendid material and wishing *The Wireless Constructor* every success, — Yours faithfully,

FRANK H. HASKELL.

Hitchin.

THE ANGLO-AMERICAN SIX

SIR,—I have long been an interested reader of your wireless periodicals, and always look forward to the next issue, and especially results obtained by readers who have built sets described in *THE WIRELESS CONSTRUCTOR*.

I am writing about the "Anglo-American Six," described by Mr. Harris in the January and February, 1925, issues, the best I have yet built for long-distance reception, selectivity and tone, and as good as any "super-het."



C.—A diminutive set which gives remarkable results.

Here are some of my results, all on a full-sized loud-speaker.

All B.B.C. stations, Eiffel Tower, Radio Paris, Ecole Supérieure, Petit Parisien, Radio-Toulouse, Brussels, Graz, Vienna, Copenhagen, Berlin, Koenigs-wusterhausen, Breslau, Hilversum, Frankfort, Hamburg, Munich, Muenster, Stuttgart, Amsterdam, Rome, Milan, Oslo, Madrid (EAJ4 and EAJ7), Barcelona (EAJ1 and EAJ13), Cadiz, San Sebastian, Cartagena, Stockholm, Zurich, Geneva, Berne, Prague, Leipzig, and Bilbao.

On December 25 I received WGY, WJZ and WBZ at fair loud-speaker strength and WOR on the 'phones, but have not received any U.S.A. stations since with any good results.

Yours faithfully,
L. SMITH.

Cardiff.



A RECTIFIER TESTING PANEL

By H. J. BARTON-CHAPPLÉ
Wh. Sch., B.Sc. (Hons.), A.C.G.I., D.L.C., A.M.I.E.E.

Make up a rectifier testing panel similar to that described here, and then you will be able to find out the best circuit and component values for any valve which you intend using as the detector in your receiver.

WHAT is the best value of grid-leak and condenser for my particular rectifying valve? Should the grid-leak be in parallel with the condenser or connected direct to L.T.? Does a variable grid-leak make much difference?

A Useful Unit

These, and many other questions of a similar character, are often asked by home constructors and experimenters, who are at a loss to satisfy themselves as to the merits and demerits of the problems involved. An ordinary receiver does not always lend itself to the conducting of experiments of this character, and the rectifier testing

Bare Essentials

Only the bare essentials are incorporated in its construction, except for the addition of a crystal detector which can be put to a useful purpose as will be seen later. The apparatus for tuning, etc., must be connected externally and joined up to the appropriate points on the panel with flexible leads.

Nature of the Tests

Tests can be conducted to find the best value of grid-leak and condenser for a particular valve, whether a variable grid-leak is essential for the proper working of the valve and if

of a crystal detector direct in the grid circuit of the rectifying valve in lieu of a grid-leak and condenser.

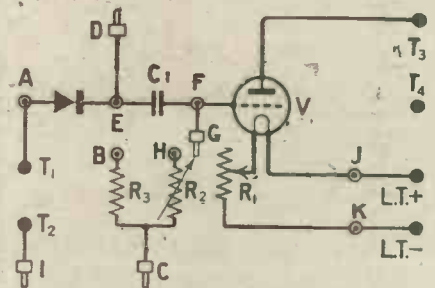

Fig. 1.—The circuit provides facilities for a number of different tests and experiments.

The Desired Flexibility

Reference to Fig. 1 will give the theoretical diagram and an examination of this will show that many combinations, and connections are made possible by utilising Clix plugs and sockets, a rapid interchange of the connections serving to facilitate tests.

R₁ is the filament rheostat, a dual type being used so as to permit tests to be made on both dull and bright emitter valves, while R₂ is a variable grid-leak whose resistance range is from 100,000 ohms to 10 megohms. R₃ is a fixed grid-leak mounted in spring clips to enable several grid-leak values to be tried.

External Connections when Desired

If the experimenter has any grid-leaks which cannot be accommodated conveniently in the clips suggested, then the terminals which have been provided allow external connections to be taken to the grid-leaks in question, thus providing ample flexibility.

C₁ is the fixed condenser, also mounted in clips and provided with terminals for the same purpose so that other fixed condensers, or even a variable condenser can be connected

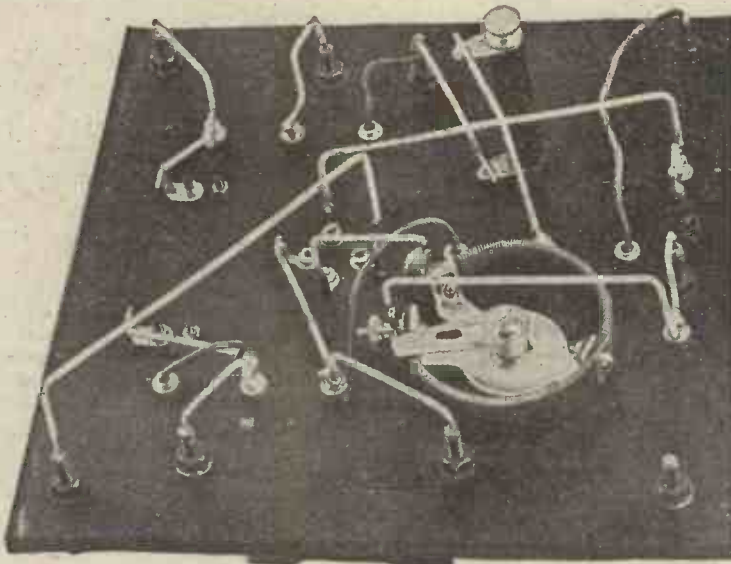

This photograph, showing clearly the spacing of the connections, will be of assistance when wiring the testing panel:

panel which I am describing in this article is for the purpose of examining and testing the rectifying properties of valves. It is therefore a particularly useful addition to the constructor's apparatus.

improvements are effected as the result of placing the grid-leak direct to L.T.+ instead of being in parallel with the grid condenser.

Also a very interesting experiment is made possible, i.e., the employment

A Rectifier Testing Panel—continued

in circuit when desired. The letters C, D, G and I indicate the four Clix plugs, while the remaining letters A, B, E, F, H, J and K indicate Clix sockets.

Components for Building the Unit

The complete list of components incorporated in this unit are appended below for the benefit of potential constructors, but, of course, if other apparatus of good quality is available there is no reason why it should not be utilised, provided the necessary allowance is made for the space required by the components in question.

It is advisable to retain the flexibility provided by the Clix plug and socket system, as this lends itself admirably to the rapid alteration of connections which is essential in a unit of this nature.

You will require:—

- One ebonite panel, 8 in. by 8 in. by 1/4 in. (Clayton Rubber Co., Ltd.)
- One polished oak cabinet to take

- One crystal detector. (Burndept Wireless, Ltd.)
- Four valve legs. (Williams, Ellis and Co., Ltd.)

- pair of clips (Dubilier Condenser Co. (1925), Ltd.)
- One variable grid leak (Bretwood, Ltd.)

.....
Fig. 3.—By placing the plug C in J, K or E, the effect may be investigated of connecting the leak direct to either filament terminal across the grid condenser.

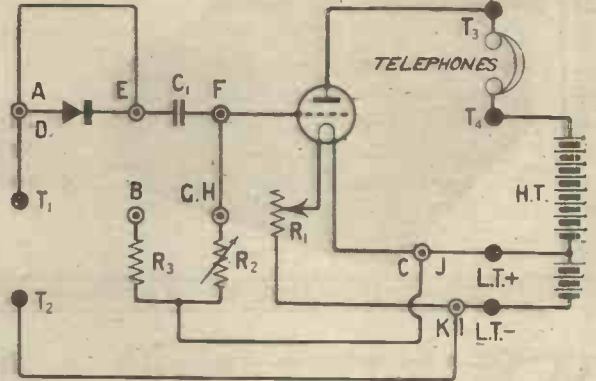

- One dual filament rheostat. (Ormond Engineering Co., Ltd.)
- Four fixed condensers (.0001, .0002, .0003, and .0004), with one pair of clips (L. McMichael, Ltd.)

- Four Clix plugs and eleven Clix sockets (Autoveyors, Ltd.)
- Ten terminals and a length of rubber-covered flex.
- Quantity of Glazite.
- Packet of Radio Press panel transfers.

I understand that at present only the 1- and 2-megohm Dumetohm grid leaks are available, but the other values are shortly to make their appearance on the market.

Drilling Operations

The diagram of Fig. 2 gives the full details of the front of the panel. If good quality ebonite is utilised, it will not need rubbing down, and the necessary drilling operations can be proceeded with at once. A drilling template is supplied with the Burndept crystal detector, while for the other apparatus the necessary dimensions are clearly stated in the figure previously mentioned, and should be followed with care.

Maintaining a Symmetrical Appearance

The Clix sockets marked C, D, G and I have been incorporated to retain the symmetrical appearance of the panel, and flexible rubber-covered cables pass through these sockets from the back of the panel, Clix plugs being attached to the ends of the flex.

To allow the wire to pass through the sockets about 1/8 in. should be cut from the end of each socket, and a drill the same size as the beginning of the taper hole employed to open out the hole.

An Additional Terminal

As far as the wiring is concerned, this should give little difficulty, and the wiring diagram of Fig. 4 can be followed with ease. One extra terminal, unconnected as far as the unit itself is concerned, is provided at the bottom right-hand corner of the panel, and will be of assistance when connect-

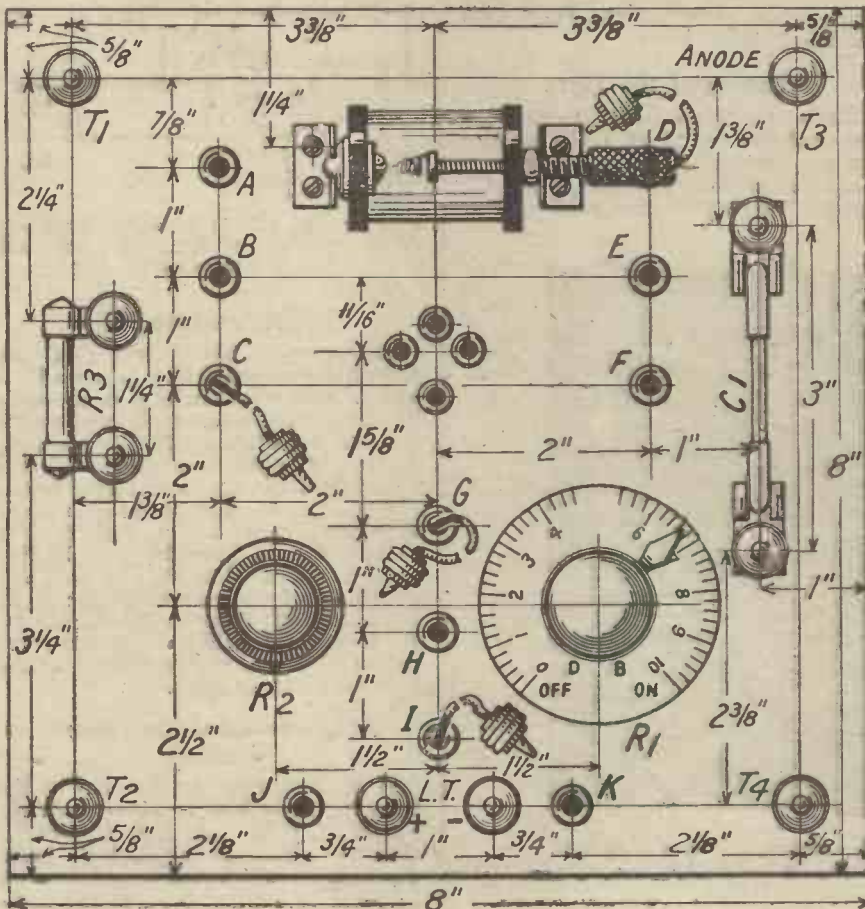

Fig. 2.—The holes for the flex leads are bushed with Clix sockets. Blueprint No. C1052A.

above panel, 4 in. deep with lid 1 1/4 in. deep. (Caxton Wood Turnery Co.)

- Four fixed grid leaks, Dumetohm (1, 2, 3, and 4 megohms), with one

THE MARCH OF THE PELICAN UNIVERNIER

The Pelican Univernier is steadily moving on to more panels because it does give absolute vernier control.

Simply take off the dials of your variable condensers and put on the "Pelican."

Price 6/-

Guaranteed throughout. Obtainable from all dealers.

Cahill & Company, Ltd.,
64, Newman St., London, W.1.

Farrs Ad.



J.B. LOW LOSS.	J.B. LOW LOSS GEARED VERNIER (60 to 1)
.001 .. 13/-	.001 .. 17/6
.00075 .. 11/8	.00075 .. 16/3
.0005 .. 10/8	.0005 .. 15/-
.0003 .. 9/-	.0003 .. 13/6
.00025 .. 8/9	.00025 .. 13/3
.0002 .. 8/6	.0002 .. 13/-
.0001 .. 8/3	.0001 .. 12/-

THROUGH MANY EXPERIMENTS

When your first receiver includes J.B. Condensers—you may be sure that further experiments—however exacting—cannot call for a better condenser.

J.B. Condensers are famous throughout the world for complete efficiency. The proud possessors of J.B. Condensers who have consequently contributed towards this world-wide renown, are your guides to the utmost tuning efficiency.

For successful experiments and the complete efficiency of any type of receiver you must build with J.B. Variable Condensers.

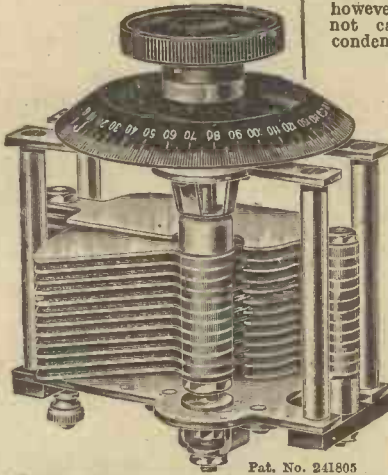

Pat. No. 241805

JACKSON BROS.
B. POLAND ST- OXFORD ST
LONDON - W.1.
(First Floor)
Telephone: GEF.RARD 7414

Agents for Holland: RADIO BEURS, Papestraat 8, Sgavenhage, Hague.

GAMBRELL COILS FOR MAXIMUM EFFICIENCY

All Gambrell Coils can be supplied centre-tapped.

Write for leaflets giving full particulars of the above and Gambrell Transformers, Neutrovernia Condensers and other components.

GAMBRELL BROTHERS, LTD.
76, VICTORIA STREET, LONDON, S.W.1

*—unfailing resistances—
—made of a rare metal*



Two-Way COIL HOLDER
Behind Panel, one-hole fixing, vernier, geared pointer. Pat. app. 5/6 for. No. 272

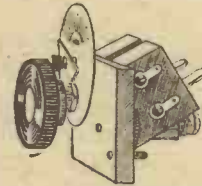

CONSTANT and silent high resistances need not be wire-wound, but they must be metal.

Patented, tested, guaranteed Anode res. any value, ebonite base, No. 277 .. 4/9 Grid Leak, No. 278 .. 1/9

ERIC J. LEVER,
33, Clerkenwell Green, London, E.C.1
Branches: Birmingham, Liverpool, Halifax, Glasgow

SELENIUM is the Metal



EFESCA

Regenerative AERIAL TUNER

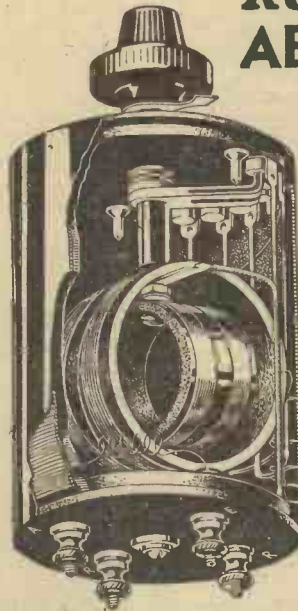

The Efesca Regenerative Aerial Tuner is a specially designed form of Tapped Aerial Coil incorporating Aerial Reaction in a self-contained Unit.

Reaction is effected by means of a rotor revolving in a separately wound section of the Aerial Coil, thereby effecting maximum reaction over the whole wave band covered by the coil. Wavelength range 150 to 2,600 metres in conjunction with a '0003 variable condenser in parallel.

Complete with Knob, Pointer and Scale

Price 32/- each

Ask your Wireless Dealer or Electrician for

EFESCA
COMPONENTS

Write for Catalogue No. 559/4 describing and illustrating EFESCA COMPONENTS

FALK STADELMANN & CO., Ltd.

83-93, Farringdon Road, London, E.C.1

ALSO AT GLASGOW, MANCHESTER AND BIRMINGHAM

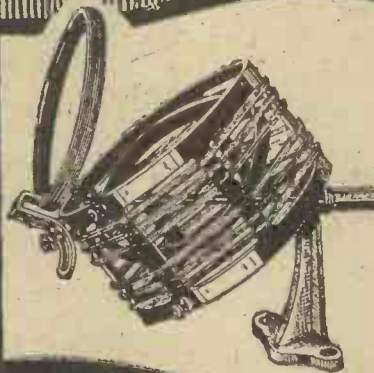

HIGH EFFICIENCY
LOW LOSS
VARIO COUPLERS
3 CIRCUIT
200-600 METRES 12/6
SEND FOR NEW CATALOGUE of Components of Advanced Design

THE FORMO COMPANY
Crown Works, Cricklewood, N.W.2
Phone: HAMPSTEAD 1787.

Northern Rep.: J. B. Levee, 23, Hartley St., Levenshulme, Manchester. Phone: Heaton Moor 475.

A Rectifier Testing Panel—continued

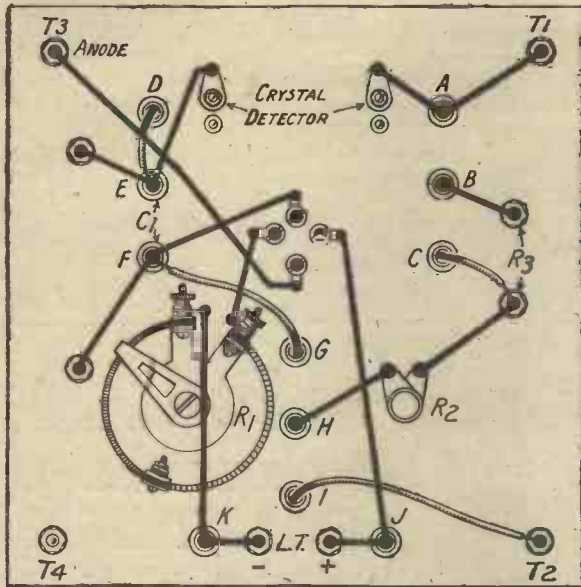

Fig. 4.—The wiring of the panel should present no difficulties to the constructor if this diagram is carefully followed. Blueprint No. C1052B.

piled if the results are recorded in a notebook.

For crystal reception alone plug D in J and I in K, the L.T. source being removed from the terminals L.T. + and L.T. — and replaced by a pair of telephones, while C and G are left disconnected.

Another Experiment

An experiment which will produce surprising results to some constructors is to replace the grid-leak and condenser with the crystal direct in the grid circuit of the rectifying valve. This is accomplished by connecting the input across terminals T₁ and T₂, plugging D into F, and leaving the L.T., H.T. and 'phones connected as before, I being inserted into J or K.

Unexpected Results

The reception under many circumstances will be remarkably clear when the catswhisker has been carefully adjusted on the crystal face. Note the effect of removing the short across C₁, which to all intents and purposes means a free grid.

ing up telephones, etc., during testing operations.

Making Observations

Having completed the wiring and checked it against the Fig. 4 diagram, rectifying tests can now be proceeded with. The tuning arrangements should be connected between the terminals T₁ and T₂, the plug I being inserted in both sockets J and K during the course of the test for comparison purposes.

The high tension and telephones must be connected in series across T₃ and L.T. +, and with the valve in position observations may be made. With G in H, C in E, D in A, and I in K, we have the familiar circuit of a variable resistance in parallel with the grid condenser.

Altering the Circuit

The effect of I in J can be tried, and also O in J and K, which connects the grid directly to the L.T. through the grid leak without passing through the tuning coil, as shown in Fig. 3. Different values of C, and adjustments of R₂ will give much useful information, while if plug G is removed from H and inserted in B, the fixed grid leak is automatically brought into circuit.

Reaction Inadvisable

Since the connection to the anode of the valve is brought out to the terminal T₃, a reaction coil can, when desired, be added externally so as to give the usual reaction effects, but it is generally best to make comparative tests without reaction.

Anode current rectification can be tried by shorting the crystal detector and grid condenser C₁ (i.e., plug G in A), and inserting the necessary grid-bias battery between T₂ and L.T. —.

Employing the Crystal Alone

After a very little practice these alterations can be made quite rapidly, and interesting and helpful data com-

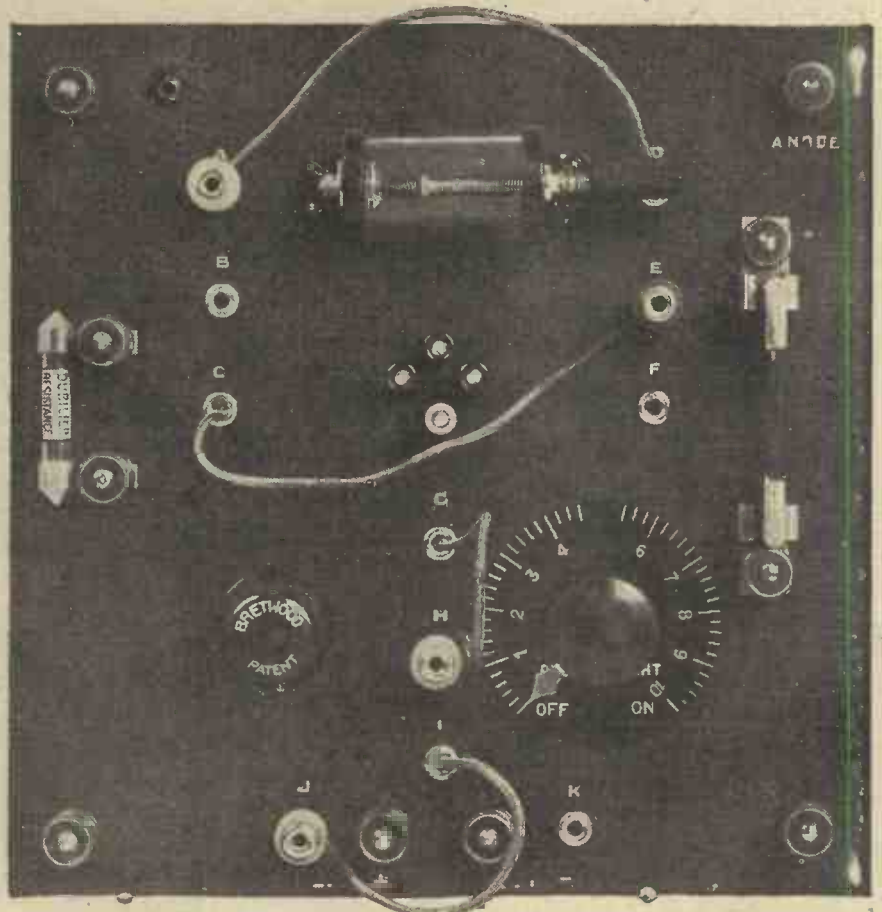

It is advised that the completed panel be lettered as shown here, so that the experiments indicated in the accompanying article may be more readily carried out.

NEWS FROM THE ANTIPODES

DIFFICULTIES IN AUSTRALIA

SIR,—I am taking advantage of the invitation given in the January issue of THE WIRELESS CONSTRUCTOR to give you my opinions.

We live in a land of distances, variable climate and spasmodic temperatures, and when we read of your correspondents' achievements (to us, a few miles away from the broadcasting stations), we sometimes think (we dare not say so) how hopeless our lot is by way of being able to achieve anything worth while.

Now for my own tuning in. I have a 4-valve set, everything in it being the latest and best procurable. In winter time I can get loud-speaker strength from 3LO (Melbourne) and 2BL (Sydney), the maximum distances being 1,000 miles. 4QG (Brisbane), only 190 miles away, gives no sound whatever. All these stations are on the coast, slightly above sea-level.

In summer time 3LO and 2BL can be obtained on the headphones only, while 4QG is still "dead." It is said by some that our locality is a "dead" spot, the country about here being on a granite belt. Tin mining is carried on, and the soil generally is of a loose sandy nature. The electric telegraph and telephone departments have to carry their earth wires some distance to a creek, and they advance the theory that the rocky nature of the ground accounts for the difficulty in getting a good earth.

What remedy do you advise me to try in my difficulty?

Recently I was distant some 600 miles on plain country and heard 3LO from the street even a block away

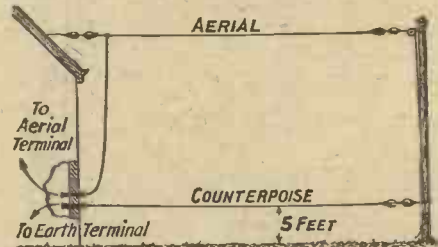

When difficulty is found in making a good earth connection a counterpoise may be resorted to.

from the loud-speaker, yet at this tiny house there was "nothing doing."

Now these are the difficulties we Australians encounter when trying out your new sets, to say nothing of the "static" we are subject to in the

hotter months, when our thunderstorms are so prevalent that we scarcely notice them in the ordinary course of events.

Yours faithfully,

GEORGE ROSS
(A Regular Subscriber).

The Summit, Queensland,
Australia
(3,300 feet above sea-level).

[We suggest that our Australian correspondent should use a "counterpoise earth" instead of the usual buried earth. A suitable counterpoise may consist of a length of insulated wire laid along the floor of the house and connected at one end to the earth terminal of the set, or a wire below and parallel to the aerial supported about 5 feet above (and insulated from) the ground and connected in a similar manner. The sketch will explain matters.—ED.]

A USEFUL TIP FROM A NEW ZEALAND READER

SIR,—Having noticed in your magazine from time to time various ideas for preventing leakage and capacity losses in valve-holders, I should like to submit an original idea which greatly reduces losses in the grid and plate circuits of valves, and is at the same time very simple. It may be adopted with noticeable improvement in place of any "low-loss" or "anti-capacity" holder, and is, of course, specially suitable in ultra-short wave sets and H.F. units.

The valve is supported on the two filament pins only, as shown in the sketch. The pins are spread slightly so as to fit tightly in the sockets and hold the valve rigid. Two "collars" to fit the grid and plate pins can be made from sheet brass or by cutting sections off a valve socket. The grid and anode leads are soldered on to these and slipped over the pins, which should fit tightly to ensure positive contact and freedom from noises.

During three years of experimenting I have found that such small refinements as this, used in simple "straight" circuits, give the best results.

The following are some of the stations heard at comfortable 'phone strength on my single-valve set, with approximate distances:—

- 2YM (Gisborne), 280 miles.
- 2YB and 2YK (Wellington), 475 miles.

4YA (Dunedin), 750 miles.

Eastern Australian stations (1,300 miles):—2BL (Sydney), 5CL (Adelaide), 7ZL (Hobart), and 2UE (Sydney).

Under prevailing conditions in New Zealand, where the broadcasting stations are, on an average, about 300 miles apart, it has been proved repeatedly that sensitivity depends not

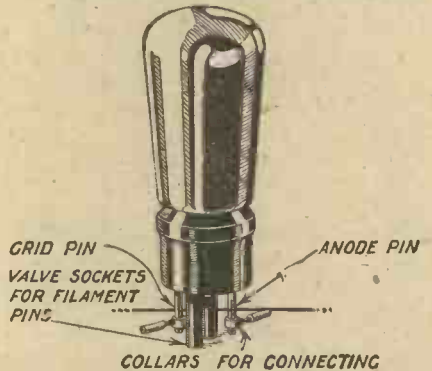

An Auckland reader's suggestion for avoiding valve-holder capacities.

so much on the use of ingenious reflexes or numerous valves, but on the reduction of losses and the obtaining of 100 per cent. efficiency from every component.

Yours faithfully,
LESLIE J. MASON.
Auckland, New Zealand.

"THE BEST 1-VALVER"

SIR,—I have constructed the "Midget" single-valve receiver described by Mr. A. S. Clark in the May, 1925, issue, and I think it is the best 1-valver I have heard. Using 45 volts H.T. and 2 volts L.T., I can get 5IT, 2LO, 6ST, 6BM, 5WA, 6LV, 2ZY, 5SX, 5NO, 2LS, 6FL, 6KH, 5NG, 2RN, EAJ6, SASA, IRO, Munster, Radio-Berne, Stuttgart, and Paris. I can also get a few of the amateurs, including 2FL, 2MV, 5ZX, and 2SA. I think this is a record for such a little set.—Yours faithfully,

A. BARBER.
West Bromwich.

The RADIO PRESS YEAR BOOK

A Reference Book for the Experimenter.

1/6 Price 1/6

Sidelights on the Elstree Six

Development of the Circuit told for the first time to the readers of the **NEW WIRELESS**



JOHN SCOTT-TAGGART, F.Inst.P., A.M.I.E.E., Technical Director of the **NEW WIRELESS**, whose article on "The Future of Radio" has set the Wireless Public thinking. Further articles by the Technical Director on subjects of vital interest to everyone appear in the current and future issues.

EVERY possessor of a home constructed receiver should make a point of reading about the historical step marked by the publication of this authoritative article. Go to your newsagent to-day and purchase the current issues, when you will find that in addition to this article the **NEW WIRELESS** provides a new outlook for every home constructor and everyone interested in radio reception.

The issue of June 12 contains full details on the building of a **Neutralised Single Valve Reflex Receiver**, and in June 19, a set by Mr. S. G. Rattee — **One Dial Long Distance Receiver**.

BUY YOUR COPY TO-DAY

Subscription Rates 13/- per annum. Lesser periods *pro rata*.

Obtainable from all Newsagents, Booksellers or Bookstalls, or direct from the Publishers:

RADIO PRESS, LTD.
BUSH HOUSE,
STRAND, LONDON, W.C.2

WIRELESS
INCORPORATING
WIRELESS WEEKLY **2^D** WEEKLY



Apparatus tested

For "The Wireless Constructor" at our Elstree Laboratories.

Lead-in Insulator and Earthing Switch

A COMBINED lead-in insulator and earthing switch submitted by Messrs. the Igranic Electric Co., Ltd., consists of an ebonite rod through which passes a metal rod, on the outer end of which is a wing nut for connection to the aerial. At the other end is mounted, on an ebonite base, a spark arrester gap with a lever switch to enable the aerial to be joined to the set or earth.

The insulation resistance of this component was found to be infinity, and the switch arm made good contact



The Igranic lead-in device includes a lightning arrester gap.

with the terminals. It is quite robust and well constructed, and can be recommended for use.

H.F. Choke

Messrs. Metrovick Supplies, Ltd., have sent one of their Cosmos H.F. chokes for test and report. This component is exceedingly compact, consisting of an insulating spool on which the windings of the choke are carried. The D.C. resistance was found to be 330 ohms, and when used as an H.F. choke in several circuits its functioning was perfectly satisfactory.

Dumetohm Grid Leak

A number of Dumetohm grid leaks made by Messrs. the Dubilier Condenser Co., Ltd., have been tested at our laboratories. The resistance of these leaks, which are of standard dimensions, is, we understand, of a metallic nature, its value being unaffected by the applied voltage.

The resistances which are contained in small glass tubes were found to have exactly the rated value when measured, and when used in conjunction with a detector valve they were satisfactorily silent in operation. The

special holders had terminals and soldering tags, and the insulation resistance was infinity. We can thoroughly recommend these grid leaks.

Filament Rheostat

We have received from Messrs. the Penton Engineering Co. a bright-emitter filament rheostat for test.

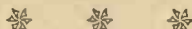

The provision of a scale and pointer is a noteworthy feature of Messrs. E. J. Lever's coil holder.



The resistance element is firmly wound on an insulating strip bent round a moulded insulating mounting. One-hole fixing is provided for, while contact to the resistance element is made by means of a three-leaf spring, the tension of which can be adjusted as desired.



The Dumetohm grid leaks are supplied with clips on an insulating base.

The resistance of the rheostat was 6.6 ohms, being thus entirely suitable for use with bright-emitter valves. The overall diameter is less than 2 in., and where rheostats of this type are desired this should prove a useful component.

Air-spaced Wire

Messrs. Belling & Lee, Ltd., have sent us a sample of their air-spaced wire which is specially intended for the winding of low-loss coils. The wire is served with two thick threads running in opposite directions which cross each other at intervals of about $\frac{1}{8}$ in.

When wound into a single-layer coil

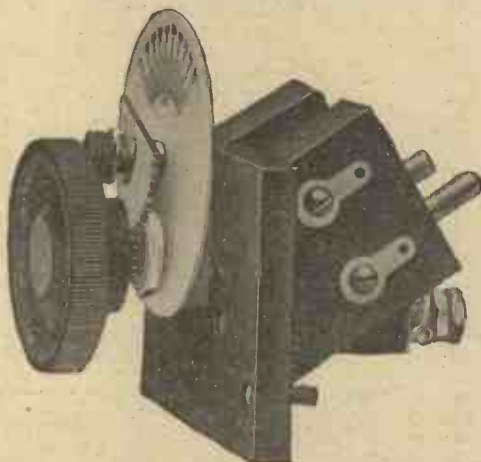

of 180 microhenries the test figures were extremely good. We can thoroughly recommend this wire as a means of enabling low-loss coils of high efficiency to be wound without difficulty.

Coil Holder

We have received from Messrs. E. J. Lever one of their Trix two-way coil holders for test and report. This instrument, which is of the one-hole fixing type, uses a geared control for the moving holder, a reduction in the neighbourhood of 4 to 1 being obtained. The moving and fixed holders are placed at an angle so that instead of the coils standing straight out from the panel they are inclined upwards at an angle of 45 degrees. A white ivory scale, graduated from 0 to 90 degrees, together with a pointer fixed to the control knobs, indicates the coupling in use.

The insulation resistance between both plugs and sockets was infinity, and a number of well-known makes of plug-in coils proved to be an excellent fit in the holder.

Regenerative Aerial Tuner

Messrs. Falk, Stadelmann & Co., Ltd., have forwarded an aerial regenerative tuner for test purposes. This

Apparatus Tested—continued

component, cylindrical in shape, has a large and small knob for controlling respectively the inductance in circuit and the amount of reaction. The wavelength range covered was 300 to 2,000 metres when used in conjunction with a .0005 variable condenser joined in parallel. The reaction coil functioned satisfactorily on all wavelengths received.

This component can be recommended for use where it is not desired to employ plug-in coils.

Auto Audio-Frequency Amplifier

We have received one of their Auto audio-frequency amplifiers from Messrs. Bretwood, Ltd., for test and report. This instrument, we understand, is a special form of choke-coupled amplifier, uniform amplification being claimed at all frequencies, in addition to a special filtering effect which produces a very silent background when two or more stages are employed.

On test it was found that in a first stage L.F. amplifier the degree of amplification was well up to standard, the quality of speech and music being particularly good, while the background was noticeably silent. In the second stage results were above the average, the quality of both speech and music being excellent.

H.T. Accumulator

Messrs. the General Electric Co., Ltd., have sent one of their high-tension accumulators for test. The tubular cells each contain two plates, and are mounted in a wooden cradle contained in a polished mahogany box.



The Auto Audio-Frequency Amplifier submitted for test by Messrs. Bretwood, Ltd.

Three leads fitted with plugs are provided, the latter fitting into sockets mounted on the connecting lugs; thus the battery can be tapped every two volts. The battery proved highly

satisfactory in operation, and we can thoroughly recommend it.

"Ironclad" L.F. Choke

An "Ironclad" low-frequency choke has been sent for test by Messrs. United Electric Works, Ltd. This instrument is contained in a small iron case carrying a panel on which two terminals are mounted. Its D.C. resistance was found to be somewhat low—600 ohms—hence the amplification obtained was rather below the standard, but it gave good quality reproduction when used as a second-stage amplifier. Finish and construction are good.

"Celestion" Loud-Speaker

From Messrs. the Electrical Manufacturing Plating Co. we have received a "Celestion" loud-speaker. This instrument is contained in a carved wooden case fitted with a grille through which the large diaphragm is visible. A milled knob is provided for adjustment purposes.

On test, this loud-speaker was found to be exceedingly sensitive, giving very natural reproduction of speech and music. It stood up well to heavy loads, and can be thoroughly recommended.

1/2d
per day
for keeping your
accumulator charged
For A.C. use only.



ONE halfpenny per day for keeping your accumulator charged—even if you own a five-valve set. That is how little it costs you with a Rectalloy Charger. And here is how it is done. The Rectalloy Charger is coupled permanently (a) to your Set, (b) to your Accumulator. (c) to the electric light socket. When you wish to use your set, the switch on the Charger automatically cuts out the Charger and brings the Accumulator in circuit. After the Broad-

casting is over reversing the switch disconnects the Set and immediately sets the Rectalloy Charger charging up your Accumulator.

No mess, no worry, no expense. You can forget your Accumulator exists—for the Rectalloy Charger keeps it perpetually at concert pitch.

A new model is now available for charging H.T. Accumulators. It is just as simple to use and has nothing to go wrong. No moving parts, no rectifying valves, nothing to require replacement.

Model A for a.c. voltage between 100 and 120 65/-
Model B for a.c. voltage between 200 and 250 65/-
Model C for recharging H.T. accumulators from a.c. mains 90/-
All 40 to 60 cycles.
Write for Folder "W.R." post free.

RECTALLOY
The ideal Battery charger

Rectalloy Ltd., Vulcan House, Ludgate Hill, London, E.C.4.

Why Clayton?

Because of its high resistivity and minimum surface leakage Clayton Ebonite is worth insisting on. It has withstood breakdown tests of no less than 35,300 Volts. Easy to work, it does not chip or split, and is very little dearer than the poorest substitute.

CLAYTON EBONITE
POLISHED or MATT.

CLAYTON RUBBER CO. LTD.,
Progress Works, Croft Street, Clayton, Manchester.



100% EFFICIENCY H-T BATTERY

Experimenter's Ideals realised. As tested "Modern Wireless," April, 1924, etc. Brass Terminalled, Giant Unit Dry Cells (compare standard cell), 300% capacity, 1 1/2 volts. 60 volts in leatherette case, 14/6. In polished oak box, as tested, 19/6. Carriage, 1/9. Spare cells, 4/- doz. plus carriage. Each cell replaceable. Sample cell, etc., free. Numerous repeat orders. Prompt delivery. Direct only from maker, saving 50%.
C. A. FINCHETT (Dept. C), Old Armoury, Oswestry.

The Free Blue Print Service
Coupon

is to be found on page 876

Apparatus Tested—continued

"M.H." Resistance Coupling Unit

The resistance-capacity coupling unit made by Messrs. L. McMichael, Ltd., consists of an anode resistance, coupling condenser and grid leak mounted on a special base. On test, the amplification was up to the standard for such an arrangement, while the reproduction was very good, with a satisfactorily silent background.



With a .0003 variable condenser the Trix H.F. transformer tunes from 230 to 3,600 metres.

Indicating Tags

Coloured indicating tags formed of some celluloid-like insulating material have been submitted by Messrs. F. E. Wilson & Co. They are lettered with the usual wording, and are intended for attachment to leads for identification purposes. These indicating tags can be recommended as useful accessories.

Clix Wander Plugs

The Clix wander plugs supplied by Messrs. Autoveyors, Ltd., are intended for taking tappings from H.T. and G.B. batteries, being constructed with two spiral slots on opposite sides of the plugs. Red and black coloured insulating sleeves are provided to fix the leads on to the metal body of the plug and indicate polarity. These plugs proved to be an excellent fit in various H.T. battery sockets, and are admirable for their particular purpose.

Variable H.F. Transformer

The Trix variable plug-in transformer sent for test by Messrs. Eric J. Lever plugs into an ordinary valve holder and carries a five-point switch. The wavelength range was found to be 230 to 3,000 metres, a .0003 variable condenser being used for tuning the secondary winding. In an actual receiver test the H.F. amplification appeared to be up to the average, and although the amplification is not quite so high as that given by an H.F. transformer designed to cover a narrow wave band, nevertheless it can be

recommended for use. It affords a means of obtaining H.F. amplification on both short and long waves combined in one instrument.

Devicon Bridge Condenser

We have received a Devicon bridge condenser for test and report from

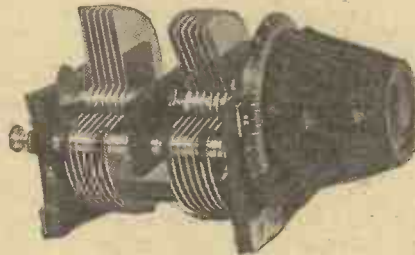

The Devicon bridge condenser submitted by Messrs. Autoveyors, Ltd.

Messrs. Autoveyors, Ltd. This condenser is constructed on low-loss principles, being provided with metal end plates, two sets of fixed plates which are electrically connected, and two sets of moving plates insulated from one another. The two sets of moving

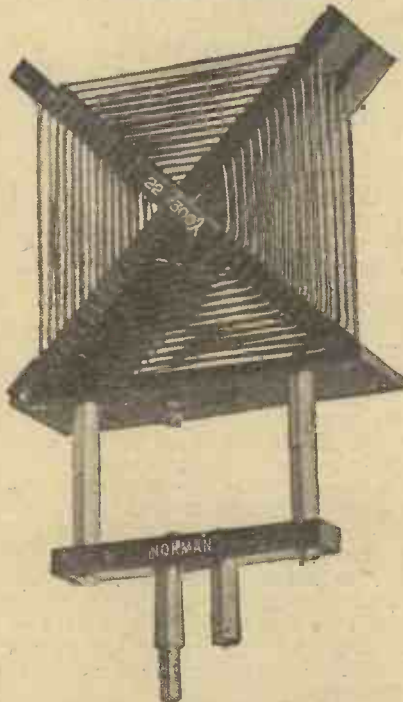

An adapter allows of the Norman Radio low-loss coil being plugged into a standard coil holder.

plates are controlled by two concentric conical knobs each provided with a white line for indicating the setting against a fixed graduated scale.

Test figures show a maximum capacity of .00027 between each set of moving vanes and the respective set of fixed vanes, while the insulation resistance was infinity. Careful ex-

amination of this condenser showed that it was well constructed and sufficiently robust to stand up to a considerable amount of rough usage.

Low-Loss Coils

We have received from Messrs. the Norman Radio Co., Ltd., several of their low-loss coils.

These are of the pancake type, being wound on special slotted X formers made of black insulating material. They have special low-capacity mountings, but adapters are provided by which they may be inserted in the usual coil holder. The largest of the coils submitted consists of four of these pancake coils connected in series, and

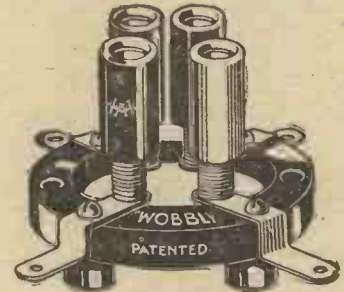

In the "Wobbly" valve holder each socket is supported by an independent coil spring.

is wound to cover a range of frequencies from 857 to 577 kc. (350 to 520 metres) in the aerial circuit.

The high-frequency resistance of these coils is satisfactorily low, and they certainly provide an efficient coil for the broadcast band. They are specially suitable, however, for the shorter waves, owing to the absence of dielectric, and the special low-capacity mounting is also an advantage in this case.

"Wobbly" Base Mounting Valve Holder

An interesting type of valve holder has been sent to us for examination by Messrs. A. H. Hunt, of Croydon. This holder represents one of the simplest forms possible, combining an anti-microphonic action with a minimum of capacity. Each leg is independently sprung, thus ensuring a minimum of metal parts being employed.

So as to ensure a smooth definite contact with the valve leg, a separate small brass sleeve is fitted inside each insulator, enabling the valve to be inserted or withdrawn without damage to the springs.

Four feet are provided so as to raise the brass contact strips from the panel or base board, while one of the sockets is coloured red in order to denote the anode contact to the valve. The valve holder is well made, simple to fit, and can be thoroughly recommended as an efficient and well made component.

KAY RAY WONDERFUL LOW-LOSS
STRAIGHT LINE
FREQUENCY
CONDENSERS

Including knob and dial as sketched.
With Vernier.

.0003 7/11 .0005 8/6
WITHOUT VERNIER.

.0003 5/11 .0005 6/6



Supreme SELECTIVITY. Each station has a CLEAR TUNING SPACE. CROWDING entirely ELIMINATED. SIMPLIFIED tuning. DISTINCT and DEFINITE Radio reception. PRECISION MATCHING HEAVY BRASS VANES. Rigid connection to rotor gives silent workings.

POST 6d. SET.

CALLERS! SPLENDID
CHEAP
LINES.

POST ORDERS not less than 5/- in value plus 9d. FOR POSTAGE will be executed from THIS COLUMN FULL POST LIST FOR POSTCARD.

ACCUMULATORS.—Ignition capacity. 2r. 40 amp. 7/11; 2 v. 80 amp. 9/6; 2 v. 80 amp. 12/6; 2 v. 100 amp. 15/11; 4 v. 40 amp. 15/8; 4 v. 60 amp. 18/11; 6 v. 60 amp. 27/8; 6 v. 80 amp. 35/11. SPECIAL CHEAP LINE.—4 v. 40 amp. 13/11; 4 v. 60 amp. 17/11; 6 v. 60 amp. 25/11. EBONITE PANELS, 3/18.—For crystal sets, 5 x 6, 1 1/2; 7 x 5, 1 1/2; 8 x 6, 1/8; 9 x 6, 1/8. EBONITE CUT TO SIZE.—While you wait, or posted. Best "Grade A" 3/16 at 1d. in., 1/4 at 1d. sq. in. Special Price Large Sizes. AMERICAN TYPE VARIABLE CONDENSERS.—Low Loss Model. Square Law, with knob and dial. .0003, 4/9; .0006, 4/11. With Vernier, 1/- each extra. AMERICAN TYPE BOXES, all hinged 18, and baseboard. Solid Oak, 12 x 8, 10/9; 16 x 8, 16/11; 18 x 8, 19/11. Wood Covered Leatherette, splendid value, 12 x 8, 8/6; 16 x 8, 11/6; 18 x 8 12/6. Many others stocked for callers only. HEADPHONES. 4,000 ohms.—N. K. Standard pattern, 8/11. ERICSSON CONTINENTAL 4,000 ohms, sample for 8/11. L.F. TRANSFORMERS.—Standard Ormond, 12/11. "Kay-Ray" 5.1, 7/11; 6.1, 8/11; 4/8; Water Supra Pattern, 7/11. COIL FLANGES.—Ebony shaped brass sides, 2 for 1/2, with fibre, 2 for 1/3. Standard 2 for 1/-; "Kay-Ray" Low Loss Nickel sides, 10d.; Back of Panel 2-way coil stands, 2/8, 4/11, 5/11. 2-way standard ext. handles, 1/6; 1/8. All makes stocked. B.T. BATTERIES Special 60 volts, 6/8, 6/9, 6/11. 66 volt Empire, Zaza, 6/11 ea.; 9 volt grid bias, tapped 1 1/2 various makes, 1/9, 1/11, 2/-. All EVEREADY stocked. PLUGS AND JACKS.—Single open, 1/4; Single closed, 1/11; Double C, 2/6; S. Fil., 2/2; D. Fil., 2/11; Plug, 2/6. VALVES.—For Undivide Circuit, Philips 4-pin, 8/11; Thorpe K.4 (6-pin), 9/11; 6-pin Valve Holder, 1/-; RADIO MICRO.—Power 4 v., 9/11. SPECIAL. ".06", 6/11. DUTCH.—.063 to 3.5, 7/6; Power 4-5, 9/6. D.C.C. WIRE 1/2 lb., 20 g., 9d.; 22 g., 10d.; 24 g., 11d.; 26 g., 1/-; 28 g., 1/1; 30 g., 1/2. Tin Copper round, 1/2 lb., 16, 18, 20, 22, 1/- reel. Bus Bar 1/16 square 2 ft. lengths, 2 for 2d. VALVE HOLDERS.—Cheap line, 8d.; Ebony standard, 1/-; Excelsior, 1/-; Anticap, 1/-; Baseboard Nickel legs, 9d., 10d., 1/- each; Lotus, Benjamin, Sterling, Bowyer-Lowe, Magnum, etc. BRASS PARTS.—Terminals, nut and washer, W.O. Pillar, phone, doz., 1/-; Nickel Ditto, doz., 1/8. Studs complete, 1/4 doz., 6d. Valve sockets, doz., 1/3. Spade or Pin screws, doz., 8d. Spade tags, doz., 2d. Nickel Soldering Tags, doz., 6d. Spades, Red and Black, 6 pairs, 1/8. Switch Arms, 1 in. arm Brass, 9d.; Nickel, 10d.; Ditto 1 1/2 in., arm, 8d. and 9d. Battery Clips, 6d. doz. Ormond screws, 4 and 6 B.A. with nuts, 6d. doz. CRYSTALS. Rhaw's genuine Hertizite, 8d., 1/-; AERIAL EQUIPMENT.—Insulated Rubber Stranded Lead-in, per 10 yds., 1/3. Lead-in Tubes, 8d., 10d., 1/-; Twin Flex. Marone, 12 yds., 1/4. Ditto, Red and Black, 12 yds., 1/6. Miniature twin silk, 12 yds., 1/-; Heavy stranded Lead-in, 6 yds. 2/-. Copper Indoor, 49 strand aerial, 100 ft., 1/6, heavy, 2/3. Insulated hooks, 6 for 6d. Copper Earth Tubes, Clinax Pattern, 2/11. BATTERY BOXES 6r.—Metal box, 1 1/2, 3/9. Leatherette ditto, 2/11. Both fitted clips. Battery Testers, 4d. Bulbcase Bulbs, 3d. SUNDRIES.—Adhesive Tape, 4d., 6 drilla, 1/3. 5 spanners, 6d. Taps 0, 2, 4, 6 B.A., 1/11. Screwdrivers, 8d. Breast drills, 0 1/2 chuck, 3/11. Screw Wander Plugs, 3d. pair. Extra quality, 4d. and 6d. pair. Valve windows nickel, 4d. and 8d. Bakelite coil holders, 10d., 1/-; 6 ft. phone cords, 1/-, 1/3, 1/8. Loud Speaker Corns, 1/6, 1/11. Empire Tape, 12 yds., 6d. Panel brackets, 6 in., 10d. pair. DETECTORS.—Enclosed, 1/-, 1/3, 1/6, 1/9. "Kay-Ray" Micrometers, 2/-, 2/3. Ditto, Permanent, 2/6. COILS.—Mounted inductance, 25, 1/-; 35, 1/4; 50, 2/9; 75, 2/6; 100, 2/-; 150, 2/4; 200, 2/8; 250, 2/10; 300, 3/2. MOUNTED AIRSPACED.—25, 1/2; 35, 1/4; 50, 1/8; 75, 1/11; 100, 2/-; 150, 2/6; 200, 2/10; 250, 3/-; 300, 3/3; 400, 3/6. Set of 5 O'Keefe Patent unmounted 25, 35, 50, 75, 100, 1/8 set. FILAMENT RES.—"Kay-Ray" Dual, 2/6; 6 or 30 ohms, 2/-. Potentiometer, 2/6. VARIOMETERS.—Ebonyite Ball Rotor, 3/11. Standard, 1/9, 1/11.

WEST END STOCKIST OF ORMOND, BOWYER-LOWE, BRUNET, N. & K., DUBILIER, EDISON BELL ALL MAKERS LEADING LINES. SET OF PARTS QUOTED FOR CHEAPLY. MAKE OUT LIST. SEND FOR PARTICULARS OF OUR EXCHANGE DEPARTMENT.

K. RAYMOND,
27 & 28a, LISLE ST.,
Leicester Sq., W.C.2.
Hours 9-8
Sat. 9-9
Sun. 11-1
Phone: Back of Daly's Theatre,
Gerrard 4637. Nearest Tube, Leicester Sq.

APPARATUS TESTED—continued

Rheostats

From Messrs. Igranic Electric Co., Ltd., we have a sample of their Igranic-Pacnet genuine bakelite rheostat.

This rheostat is of the usual construction, the resistance element being carried on a fibrous strip, which is bent in a circular form and attached to an almost completely solid frame of moulded bakelite. Both terminals and soldering tags are provided for making connections. The spring contact is well made and moves with a smooth and even pressure over the whole surface of the element. A special knob and dial are provided, the dial being of some white metal, engraved with an arrow pointing in the "on" direction, the tail of the arrow having the word "off" imprinted on it. The knob is of hemispherical section, and is fluted to provide a firmer grip.



The filament rheostat submitted by Messrs. The Igranic Electric Co., Ltd.

Fixed Condenser

We have received from Messrs. Falk, Stadelmann some samples of their new mica fixed condensers. These condensers, stated to be their new pattern, appear to be well and solidly constructed.

We were pleased to note that one was supplied in section, to show complete assembly, and another complete condenser was also sent, but minus the case, to allow of inspection of the manufacture preparatory to casing.

It is claimed that good quality mica is used, measured for thickness by a micrometer, and then for size with a steel gauge.

The method of construction is explained in a brief notice, and after assembly in skeleton form the condenser is tested on a capacity bridge, after which it is inserted into a moulded case and filled in. Before going into stock these condensers are again tested on a capacity bridge.

New Wander Plug

Messrs. Autoveyors have sent for test a sample of their new wander

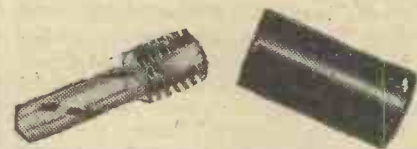

Messrs. Autoveyors' improved wander plug is neatly made and finished.

plug. This plug has an insulated grip, the plug itself having a double spiral cut, ensuring strength and spring. It is neatly made and finished.

Variable Condenser

We have received from Messrs. Igranic Electric Co., Ltd., a sample of their Igranic-Pacnet true straight line frequency condenser.

This condenser is of the conventional straight-line frequency type, the plates being rather similar to the square-law type, but longer and narrower in shape. It is well constructed in brass, the moving plates being prevented from accidental warping by means of a straight bar joining them at some distance from the spindle. It is of low-loss construction, porcelain being used

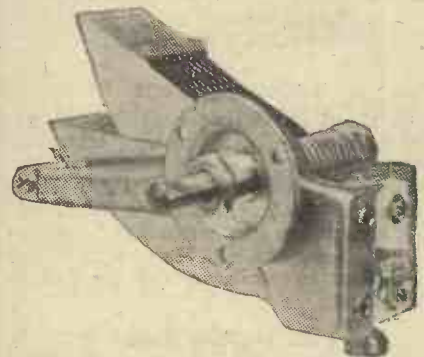

A straight-line frequency condenser, the Igranic-Pacnet, which is characterised by high-class workmanship and finish.

as the insulating medium. This component shows a high class of workmanship and is well finished. Soldering lugs are provided for making connections.

**OUR FREE
BLUEPRINT SERVICE**

Turn to page 861 for full details and conditions and then write for the blueprint you desire.

The "Five Fifteen"—continued

this manner, adjust the first neutralising condenser by increasing the capacity until the signals are reduced to a minimum. There is a point in the middle of the range of the condenser at which the signals suddenly decrease almost to zero, and then increase again the other side, and the point at which the signals vanish is the correct neutralising position.

Continuing the Process

I shall deal with any possible difficulties in this operation in a moment, so we will presume that this operation has been successfully performed. Now remove the second fixed resistor and re-insert the first one. This will cause the first valve to light, and the second valve to be turned out. The neutralising process can now be repeated with this valve, i.e., the neutralising condenser should be so adjusted until the signals are at a minimum. When this has been done satisfactorily for both valves, then the receiver is approximately neutralised, and only a very slight readjustment, if any, would be required in practical operation.

Remedying a Possible Fault

It may be noticed that there is no position on the first neutralising condenser at which the signals vanish, and if this is the case it is due to an excessive coupling between the first two coils. If the coils have been fixed in the positions given this difficulty should not arise, but should trouble be experienced, it may be remedied by altering very slightly the position of the first coil.

Not Normally Necessary

The holding down screws of the coil holder should be removed, and the coil rotated very slightly without altering its position appreciably. A rotation

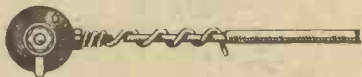

Fig. 7.—A means whereby the minimum capacity of the neutralising condenser can be reduced.

of a few degrees only in one direction or the other will serve to reduce the coupling to zero, and when this has been done a definite minimum position can be obtained about the middle of the range of the neutralising condenser.

It should be emphasised that this alteration is not normally necessary, because if the directions have been followed out the coils will already be in the correct position.

A Practical Tip

A second difficulty may arise when using the Shortpath valves or similar

valves having small inter-electrode capacities. It may be found that as the second neutralising condenser is decreased (while making adjustments as described previously) so the signals get weaker and weaker, but no definite zero position is obtained. This indicates that the minimum capacity of the condenser is a little too high. In such a case the difficulty may be overcome by removing the connection from the end of the neutralising condenser, and connecting a small piece of insulated wire in its place which is wrapped round the original connection two or three times.

This is indicated in Fig. 7, and has

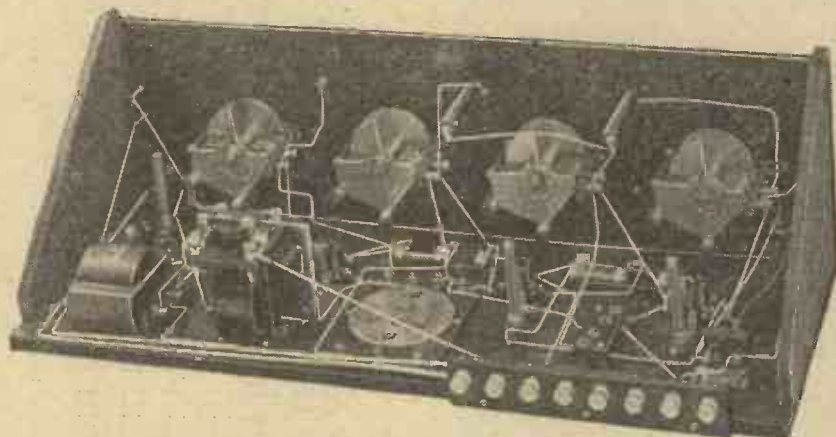

The wiring of this receiver is not unduly complicated.

the effect of introducing a small capacity in series with the neutralising condenser, and so reducing the capacity of the whole arrangement. This comparatively simple alteration will be found to result in a definite neutralising position being found within the range of the neutralising condenser.

A Little Patience Essential

When this operation of neutralising has been satisfactorily completed the receiver is ready for reception of distant stations. It may appear at first sight that the process of neutralisation is a comparatively difficult one, and it is certainly one on which no little time should be spent to ensure that the circuit is functioning correctly. With the aid of the information which has just been given, however, it should prove an easy matter to obtain the true adjustment of the receiver.

Those Distant Stations

The question of the reception of distant stations is now only a matter of a little practice. The receiver is first tuned in to the local station. Now rotate the dials a degree at a time one after the other, and as long as the receiver is correctly tuned there is a slight rushing noise, and even if no station can be heard the dials should

be adjusted so that this rushing noise is heard. By adjusting all three dials a little at a time in this manner it will be found that station after station can be picked up.

Employing Reaction

The reaction control may be used to increase the strength of any particular station once it has been obtained. For the majority of stations, however, the reaction control itself is not necessary for searching, which can be conducted by simply rotating the three dials. Once a station has been found the reaction condenser may be increased slightly, at the same time retuning the

last dial, and this will have the effect of increasing the signal strength and the selectivity to a considerable degree.

Suiting Your Own Aerial

The actual size of aerial coil employed and the tapping used should be chosen to suit the particular aerial employed. By the choice of a suitable coil the dial reading on the aerial condenser is practically identical with that of the other two dials. In my own test a Lissen X60 coil, used with the smallest tap, gave the best results.

Dial Readings Nearly Identical

Since dissimilar coils are used in all circuits, the dial readings cannot be exactly the same all the way up the scale, but they lie within a few degrees if the coils are suitably chosen. In order to facilitate the searching for various stations the accompanying test report gives the approximate dial readings for the various stations, and, once a little practice has been acquired in handling the receiver, the number of stations picked up will probably exceed that given.

Actual Tests

The receiver was actually tested out at Elstree, 12 miles from London, (Continued overleaf.)

A NEW BOWYER-LOWE JACKS

product, embodying all Bowyer-Lowe Refinements and Craftsmanship.

THE design of Bowyer-Lowe Jacks was evolved with the object of obviating faults usually apparent in Jacks adapted from telephone uses.

The following details indicate the superiority of these components:—

1. Girder Frame, ensuring rigidity.
2. Hard phosphor bronze springs (tinned).
3. Silver contacts accurately positioned.
4. Ebonite insulation.
5. No loose panel washers
6. Wide fan tail contacts.

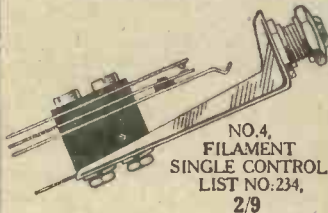

- No. 1. Single circuit open
List No. 231 2/2
- No. 2. Single circuit closed
List No. 232 2/7
- No. 3. Double circuit
List No. 233 3/-
- No. 4. Filament single control
List No. 234 2/9
- No. 5. Filament double control
List No. 235 3/3

To be absolutely certain of the efficiency of a component you MUST specify BOWYER-LOWE

BOWYER-LOWE

TESTED COMPONENTS

BOWYER-LOWE CO., LTD.,
LETCWORTH

THE "FIVE FIFTEEN"—continued

using the Cosmos S.P. 18 Green Spot valves for the first four valves and an S.P. 18 Red Spot for the last valve, with voltages of 60 for H.T.1. and 100 volts for H.T.2.

Only slight interference was experienced from London when receiving Manchester, but the interference during the period of the test when listening to Cardiff was rather severe. Distance distortion was particularly noticeable on Bilbao's wavelength.

The approximate dial settings for the reception of twenty-seven broadcasting stations are given in this table.

Station.	Dial Setting.
Elberfeld	20
Brussels	22
Cassel	23
Bremen	24
Dortmund	27
Hanover	29
Bradford	30
Agen	32
Nottingham	34
Hull	36
Cardiff	38
London	42
Manchester	45
Bournemouth	46
Hamburg	47
Dublin	48
Graz	49
Newcastle	50
Munster	54
Bilbao	55
Radio Toulouse	57
Belfast	59
Stuttgart	60
Frankfurt	65
Birmingham	66
Swansea	67
Aberdeen	70

THE POWERFUL THREE-VALVE SET

SIR,—I have very great pleasure in telling you that I have built up the powerful three-valve set described in April, 1925, issue of THE WIRELESS CONSTRUCTOR. I have had it in use since before Christmas, and I must say it is the best three-valve set I have ever made.

On a good outdoor aerial I can get Daventry, London, Manchester, Newcastle, Birmingham, Belfast, Dublin, Aberdeen, all at extra good loud-speaker strength and purity of tone, also many Continental stations. With headphones I can get all the B.C.O. stations at good strength.

Thanks to Mr. Harris, no one who is interested in wireless should be without THE WIRELESS CONSTRUCTOR.

Yours faithfully,
T. V. HESKETH.

Catforth, near Preston.

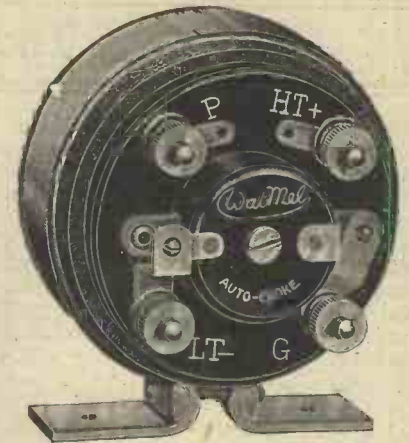

"...we might be in the studio—"

will be no uncommon remark now the Watmel Auto-Choke has come into being. Never before has there been such an amplifying instrument. Though building up whippers into voluminous sound, never does it sacrifice tone for volume. The secret lies in the patent core and specially balanced windings. Ask your Dealer for a demonstration and send to us for descriptive booklet—"Straight as a die."

Complete with Condenser and fixed resistance. Bright parts heavily nickelled. Price 18/6



THE WATMEL WIRELESS CO., LTD.
332a, Goswell Road London, E.C.1
Telephone: 7950 GLERKENWELL
Lancashire & Cheshire Representative:
Mr. J. B. LEVÉE, 23, Hatley St., Levenshulme, Manchester
Telephone: 475 Heaton Moor

REPAIRS

By specialists skilled in every form of accurate and intricate coil winding.

Headphones, Loud Speakers and Transformers rewound, remagnetised, and reconditioned

EQUAL TO NEW

and returned the same day on C.O.D. system.

The unsolicited opinion of one of our many satisfied clients—"all I can say is, they are better than when new."

VARLEY Magnet Co
Cable Dept.:
Woolwich,
S.E.18.



Proprietors:
Oliver Fell
Control Ltd.

C.O.D.
Any Wireless Goods advertised in "The Wireless Constructor" can be obtained by return of post on C.O.D. from
YOUNG'S (GLASGOW), LTD.
40, STOCKWELL ST., GLASGOW.

HONEYCOMB COILS FOR CRYSTAL SETS.

5XX Plug-in, 4/- unmounted, 3/-.

For sets without condensers 4s. 6d., unmounted 3s. 6d.

Also Local Coils at prices according to size.

Satisfaction Guaranteed or Money Returned.

H. SHAWL THE BUNGALOW, HOLBEACH FEN.

VALVES Repaired Quick

Let our valve making plant repair your broken or burnt out valves efficiently & promptly (most makes). Guaranteed equal to new. Bright emitters 5/-; "D.E." 3 and 3V types, 7/6. Power valves slightly more, see list. Not repairable: 8, Pa WR00 v. 34.



RADIONS Ltd., Bollington, Nr. MACCLESFIELD, Chesa.
Largest valve-repairing firm in the world.
List, Etc.

EXTENDING YOUR LOUD-SPEAKER LEADS

IN the last issue of this journal constructional details were given for building a loud-speaker filter unit.

When such a unit as this is in use, it may not be realised by all constructors that if it is desired to use the loud-speaker in a room some distance from the receiver itself, it is not always necessary to employ twin flex to connect up. A single wire between the unit and the loud-speaker will be found quite effective; the other terminal on the speaker being connected to earth locally.

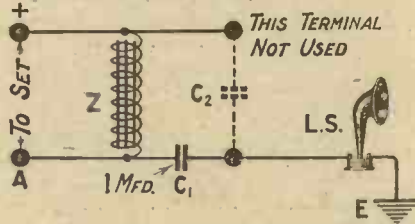

Fig. 1.—If this diagram is compared with that appearing last month it will be seen how a single wire can be employed in place of two for the loud-speaker leads.

Only One Terminal Used

Thus only one of the unit loud-speaker terminals need be used under certain conditions. It is essential, however, that this be the correct one, otherwise, on locally earthing the other terminal on the loud-speaker the H.T. battery would be short-circuited through the speaker itself to earth.

The correct unit terminal to which the single wire should be joined is that which is connected to the condenser C₁, as shown in the diagram. The earth connection from the loud-speaker might be made to a copper tube driven into the ground just outside a convenient window, or, if preferred, a nearby water pipe would be suitable.



Mr. J. Tring speaks volumes for the Anglo-American six receiver which he has constructed and is illustrated here.

Exit H.T. Crackling!

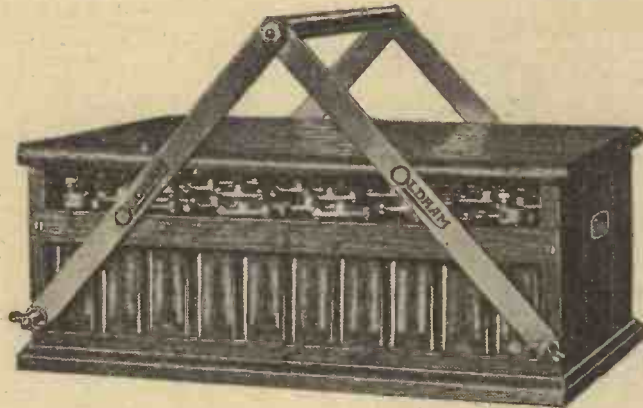

enter

1. Increased efficiency
2. Greater economy
3. Real Portability

THOSE tiresome crackling noises that have always been present in the H.T. dry battery and the heavy cost of constant renewals are unwelcome factors in wireless reception.

Now, however, comes this new Oldham H.T.—the greatest step towards solving the H.T. problem that has yet been taken. Constructed on expanding bookcase principles, each two volt unit is contained in a separate stout glass cell. These come in sections of 20 volts, so that you can start with, say, 60 volts (3 units) and add the others unit by unit as you need them. These units can be clamped together, a strong carrying handle ensuring absolute portability. All plates are made under the Oldham Special Activation Process, which ensures the charge being held over long periods even if left idle.

You will never regret the day you invest in an Oldham. At once your set will take on a new lease of life, and you'll be amazed at the increase in volume, greater sensitiveness and economy which this new Oldham brings.

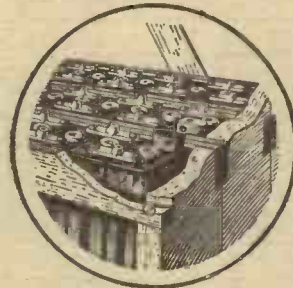

View showing stout glass cells arranged in rows, tapped at each 2 volts.

10d. per volt.

60 volts	£2 10 0	100 volts	£4 3 4
80 volts	£3 6 8	120 volts	£5 0 0

Solid oak base 3/6 extra if required.

OLDHAM & SON, Ltd., Denton, Manchester.
 London: Hazlitt House, Southampton Blds., W.C.2.
 Manchester: Looker's Ltd., Deansgate.



Gilbert Ad. 5126

INDEX TO ADVERTISERS.

	PAGE		PAGE		PAGE
Aircraft Company (The) ...	830	Falk, Stadelmann & Co., Ltd. ...	865	London Electric Wire Co. & Smiths, Ltd. ...	829
Ashley Wireless Telephone Co., Ltd. ...	854	Ferranti, Ltd. ...	793	Lustrolux, Ltd. ...	876
Bedford Electrical & Radio Co., Ltd. ...	840	Finchett (C. A.) ...	870	M.A.P. Co. ...	876
Benjamin Electric Co. ...	842	Finston Mfg. Co., Ltd. ...	830	M. & A. W. ...	844
Bird (Sydney S.) ...	854	Formo Co. ...	865	Metro-Vick Supplies, Ltd. ...	820
Bowyer-Lowe Co., Ltd. ...	874	Gambrell Bros., Ltd. ...	865	Mullard Wireless Service Co., Ltd. ...	Cover. ii
British Engineering Products Co. ...	828	Garnett, Whiteley & Co., Ltd. ...	828, 840	Oldham & Son, Ltd. ...	875
British Thomson-Houston Co., Ltd. ...	824	General Electric Co., Ltd. ...	794	Peto-Scott Co., Ltd. ...	840
Burne-Jones & Co., Ltd. ...	844	Hughes (F. A.) & Co., Ltd. ...	793	Portable Utilities Co., Ltd. ...	846
Cahill & Co., Ltd., ...	865	Igranic Electric Co., Ltd. ...	829	Pye (W. G.) & Co. ...	827
Carrington Mfg. Co., Ltd. ...	828	Jackson Bros. ...	865	Radiax, Ltd. ...	876
Caxton Wood Turnery Co. ...	840	Lever (Eric J.) ...	865	Radio Instruments, Ltd. ...	Cover iv
Clayton Rubber Co., Ltd. ...	870	Lissen, Ltd. ...	862	Radions, Ltd. ...	874
Cleartron Radio, Ltd. ...	853			Raymond (K.) ...	872
Collinson Precision Screw Co. ...	830			Rectalloy, Ltd. ...	870
Cossor (A. C.), Ltd. ...	815			H. Shawl ...	874
Darex Radio Co. ...	876			Telegraph Condenser Co., Ltd. ...	824
Dubilier Condenser Co. (1925), Ltd. ...	823			Varley Magnet Co. ...	857, 874
Electron Co., Ltd. ...	827			Watmel Wireless Co., Ltd. ...	874
				Young's (Glasgow), Ltd. ...	874

RADIAX
H.T. ACCUMULATORS

Give a perfect H.T. Supply for many months with one charge. Improve reception wonderfully.

10 Volt Unit ... 6/9. Postage 6d.
80 Volt Battery 50/- " 1/-

RADIAX LTD.
44 Accessory House, Palmer Place, Holloway, London, N.7.



EBONITE BUSHES

FOR MOUNTING ON WOOD. PERFECT INSULATION.

Orders under 1/- send 1/4 Postage. Two required for each hole.

NUMBER	0	1	2	3	4	5	6
Hole in Bush ...	6BA.	4BA.	2BA.	1/4"	5/16"	3/8"	7/16"
Price each:	1d.	1d.	1d.	1 1/2d.	2d.	2d.	2d.

DAREX RADIO CO.
Waldram Road, Forest Hill, London, S.E.23



LUSTROLOX

WIRELESS VALVES
THE ECONOMICAL COMBINATION.

2V '06 H.F. & L.F. - - 9/- each
2V '34 P.V. - - - - 11/-

Obtainable from LEWIS'S Ltd., Liverpool and Manchester, & LUSTROLOX LTD., West Bollington, nr. Macclesfield.



LITTLE WIRELESS GADGETS

MAP

Small Parts to the Trade

MA P Co., 246, Gt. Lister St., Birmingham.



COUPON

Questions and Answers

This Coupon must be accompanied with a 2/6 P.O. and Stamped Addressed Envelope.

"WIRELESS CONSTRUCTOR"

July, 1926.

FREE BLUEPRINT SERVICE

COUPON

Wireless Constructor. Vol. II. No. 9. July, 1926

This coupon entitles the reader to one back-of-panel blueprint of any set described in the above issue, and must accompany each postal application.



**A GREAT ACHIEVEMENT OF
RADIO PRESS LABORATORIES
60 STATIONS IN AN HOUR
ON THE LOUD SPEAKER**

All B.B.C. Stations—including the relays—can be received at full Loud Speaker strength in daylight.

Such a powerful and highly selective receiver as the "Elstree Six" represents the latest word in radio set design and gives to every home constructor a set far better than any previously obtainable, regardless of cost.

This receiver may be easily constructed from the diagrams, reproductions of photographs and description in the June issue of

"MODERN WIRELESS"

NOW ON SALE.

1/-

MONTHLY.

Obtainable from all Newsagents, Booksellers or Bookstalls, or direct from the Publishers
Subscription Rates 15/- per annum (13/6 per annum Canada and Newfoundland).
Lesser periods *pro rata*.

Start Building the "Elstree Six" Now

RADIO PRESS LTD.,
Bush House, Strand, London, W.C.2.



Don't leave it to Chance



To buy a few components, mount them up and wire them together, may give you a wireless set, but will it give you reception of broadcast programmes just as you would like it?

Some of those components may be square pegs in round holes, not quite "in tune" with the rest of the circuit—transformers especially.

That is why there is such a large sale for the R.I. Multi-Ratio Transformer. It is absolutely at home in any circuit and with any valve; it is made by a firm whose products in the Radio Industry have never been excelled, and those products give you confidence.

Many conflicting statements have been made as to whether the impedance of a transformer should match that of the valve, but it is a fact that, whatever valve you may be using, one of the impedances available in the R.I. Multi-Ratio Transformer will be absolutely suitable.

You need leave nothing to chance; the R.I. Multi-Ratio Transformer eliminates all risk of failure.

Price 27/6

Write for Special Leaflet W.C.

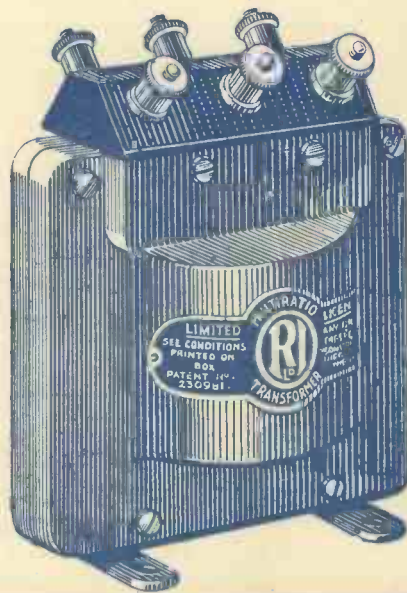

◆ THE MARK OF BETTER RADIO ◆



Advt. R.I. Ltd., 12, Hyde St., New Oxford St., London, W.C.1.

P.C.32