

The Wireless Constructor

6^D
MONTHLY

Edited by

PERCY W. HARRIS, M.I.R.E.

Vol. II

MARCH, 1926

No. 5

Special Features:

A Useful Selective Receiver
By E. J. Marriott

The "Two-in-One" Receiver
By Philip H. Wood, B.Sc., F.P.S.L.

A Variometer Tuned One-Valve Set
By G. P. Kendall, B.Sc.

The Octagon Crystal Set
By H. Bramford

Erecting a 25-ft. Aerial Mast
By A. V. D. Hort, B.A.

Testing Your Receiving Set
By H. J. Barton-Chapple, Wh. Sch.,
B.Sc., A.C.G.I., D.I.C., A.M.I.E.E.

The "HUNTSMAN" TWO By PERCY W. HARRIS, M.I.R.E.

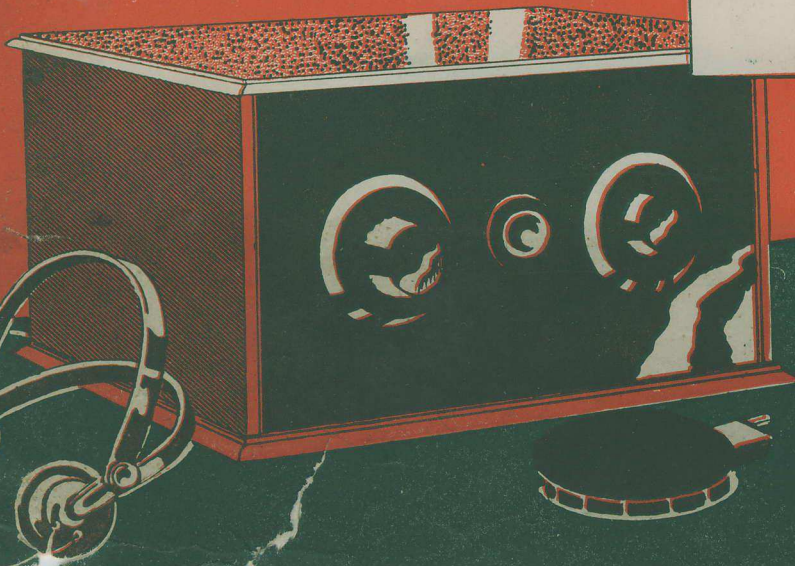
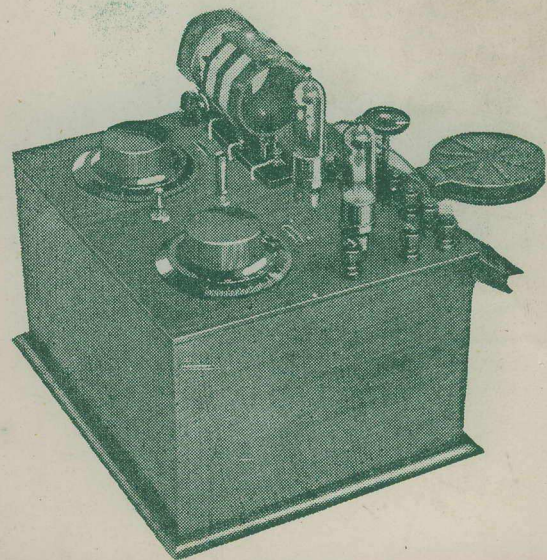

The REAL Pure tone Valve

GIVES EVERY NOTE IT'S TRUE VALUE

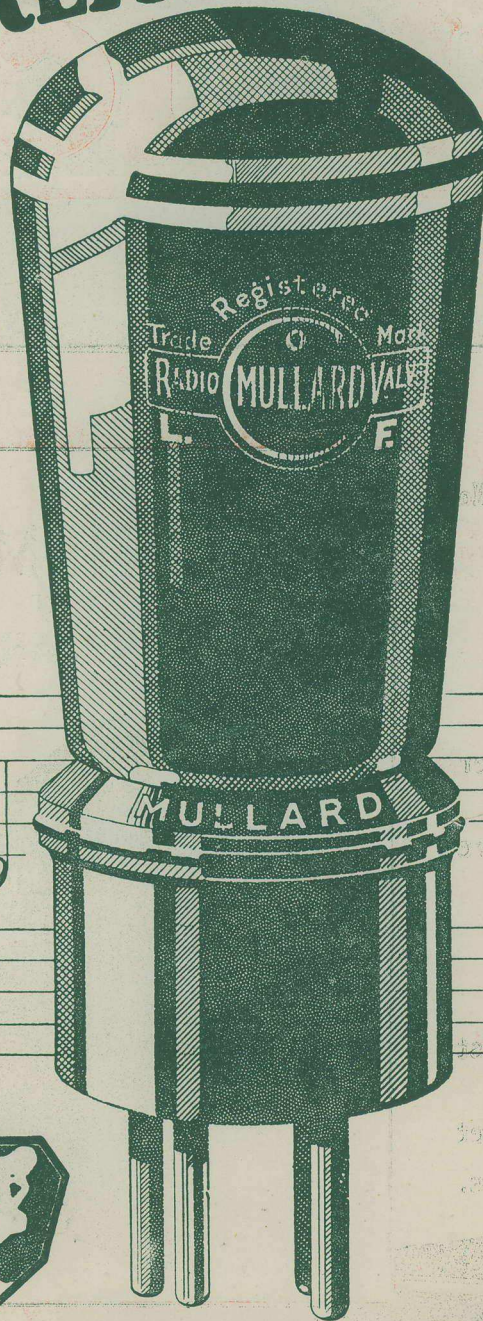

DESIGNED to give pure and strong amplification in all L.F. stages. Produces abundant volume free from distortion and will operate all loud speakers.

MULLARD DOUBLE GREEN RING VALVES

Type D.3 for 2-volt accumulator **14/-**

Type D.06 for 2 or 3 dry cells or 4-volt accumulator **16/6**

NOTE: MULLARD D.3 DOUBLE GREEN RING VALVE IS A 2-VOLT POWER AMPLIFIER.

GET ONE FROM YOUR DEALER

Mullard

THE MASTER VALVE

ADVT., THE MULLARD WIRELESS SERVICE CO., LTD., NIGHTINGALE LANE, BALHAM, LONDON, S.W.12

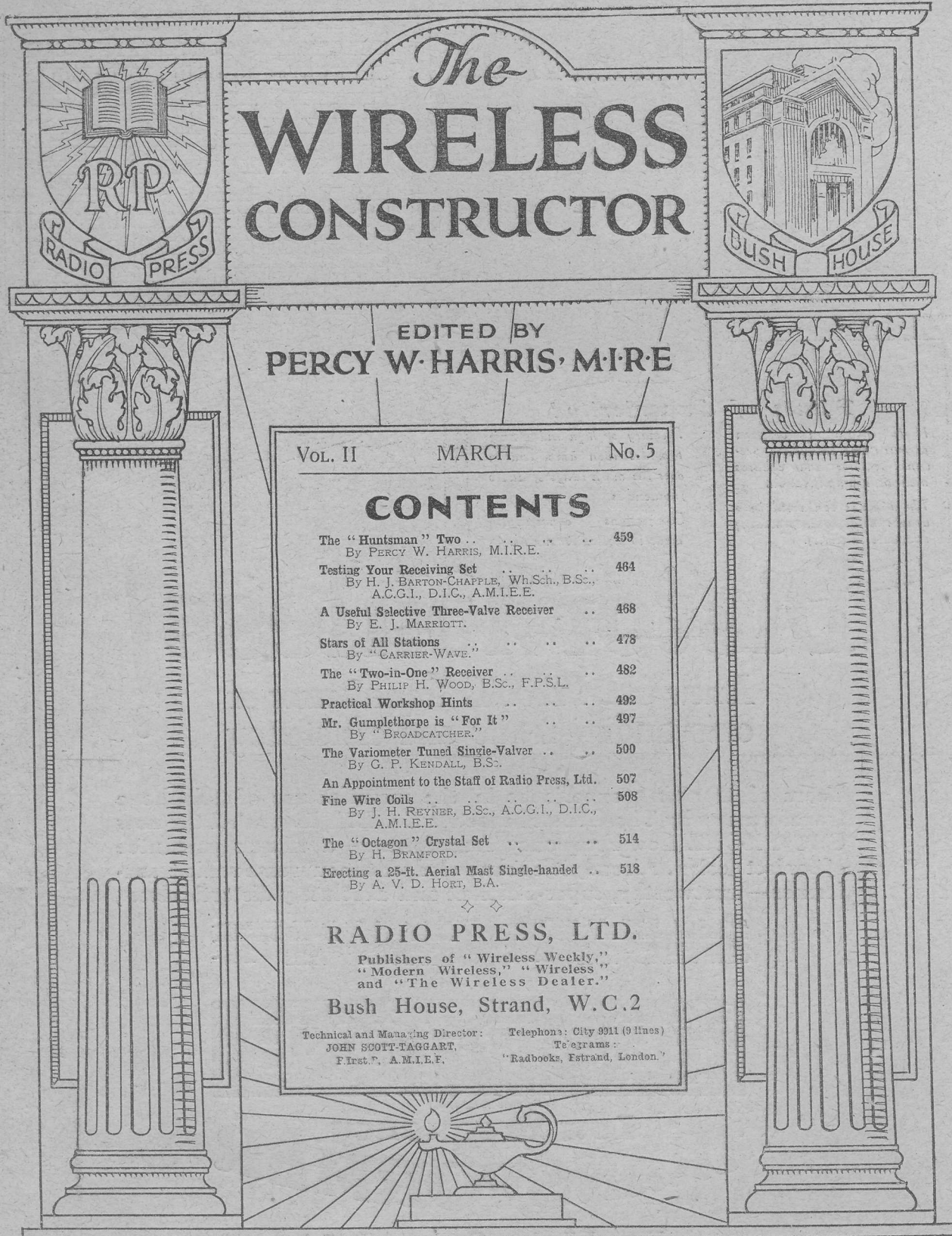

The WIRELESS CONSTRUCTOR

EDITED BY
PERCY W. HARRIS, M.I.R.E.

Vol. II MARCH No. 5

CONTENTS

The "Huntsman" Two	459
By PERCY W. HARRIS, M.I.R.E.	
Testing Your Receiving Set	464
By H. J. BARTON-CHAFFLE, Wh.Sch., B.Sc., A.C.G.I., D.I.C., A.M.I.E.E.	
A Useful Selective Three-Valve Receiver	468
By E. J. MARRIOTT.	
Stars of All Stations	478
By "CARRIER-WAVE."	
The "Two-in-One" Receiver	482
By PHILIP H. WOOD, B.Sc., F.P.S.L.	
Practical Workshop Hints	492
Mr. Gumplethorpe is "For It"	497
By "BROADCASTER."	
The Variometer Tuned Single-Valver	500
By C. P. KENDALL, B.Sc.	
An Appointment to the Staff of Radio Press, Ltd.	507
Fine Wire Coils	508
By J. H. REYNER, B.Sc., A.C.G.I., D.I.C., A.M.I.E.E.	
The "Octagon" Crystal Set	514
By H. BRAMFORD.	
Erecting a 25-ft. Aerial Mast Single-handed	518
By A. V. D. HORT, B.A.	

RADIO PRESS, LTD.

Publishers of "Wireless Weekly,"
"Modern Wireless," "Wireless"
and "The Wireless Dealer."

Bush House, Strand, W.C.2

Technical and Managing Director: Telephone: City 9911 (9 lines)
JOHN SCOTT-TAGGART. Telegrams:
First F. A.M.I.E.E. "Radbooks, Estrand, London."



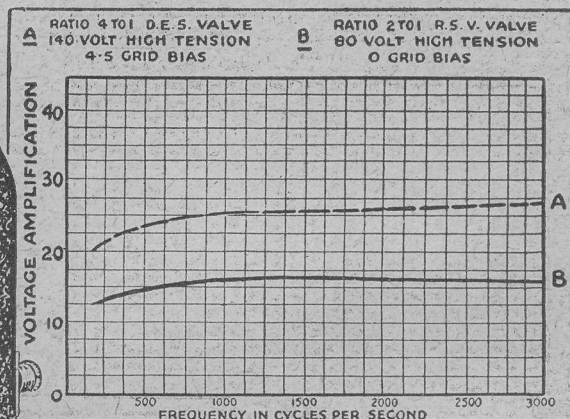
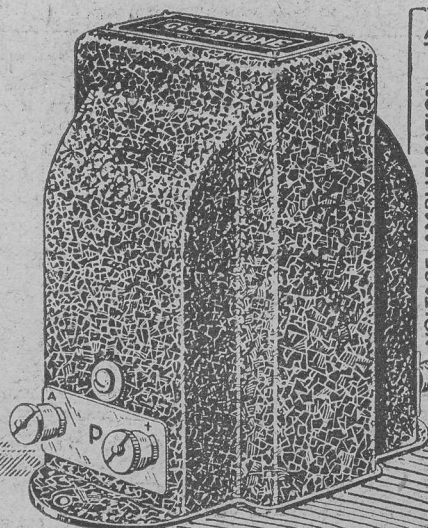

Points of Superiority!

High insulation between primary and secondary prevents leakage and ensures maximum amplification.

The whole is contained in a drawn metal case, providing adequate shielding.

Primary of high inductance provides even amplification over the main range of audio frequencies.

Connections conveniently made to slotted terminals.

Distortionless!

A new GECophone Transformer of outstanding merits and efficiency

Years of *working* experience in the manufacture of telephone transformers by The General Electric Co., Ltd., lie behind the new GECophone Low Frequency Transformer—a unique guarantee of perfect design. Already it is acknowledged the supreme radio transformer—trustworthy, super-efficient and absolutely distortionless!

Ratio 2 to 1. Cat. No. B.C. 720. Recommended for use with general purpose valves, such as OSRAM types R, D.E.R., D.E.3, etc. **PRICE 22/6**

Ratio 4 to 1. Cat. No. B.C. 725. Recommended for use with low impedance valves, such as OSRAM types D.E.4, D.E.5 or D.E.6. **PRICE 25/-**



(Registered Trade Mark)

Low Frequency TRANSFORMER

Your Wireless Dealer sells it!

Advt. of The General Electric Co., Ltd., Magnet House, Kingsway, London, W.C.2.

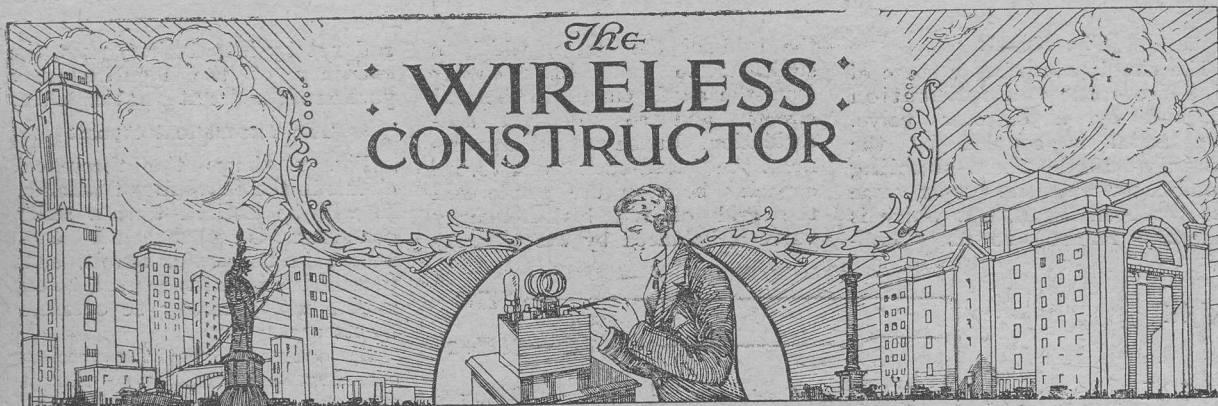

The "Huntsman" Two

A sensitive non-radiating two-valve receiver for long-range work

By PERCY W. HARRIS, M.I.R.E., Editor

THE name "Huntsman" suggested itself for this receiver as the set can be used for "hunting" stations and made to oscillate freely, when searching for carrier waves of distant stations, without the slightest fear of creating interference with nearby listeners. Tests at the Radio Press Laboratories show that another listener working a set in the same laboratory is not interfered with in the slightest degree, by persistent oscillation in the "Huntsman" receiver.

Persistent Oscillation

Notwithstanding the view held by many writers, I have felt for a long time that the majority of howling set up by oscillating receivers is due, not to ignorance on the part of the user, but to apathy or selfishness. I am afraid it is too much to expect many inexperienced listeners to sacrifice considerable sensitivity in their valve receivers by keeping well away from the oscillating point, and comparatively few people take the trouble to adjust their apparatus so that they can get the high sensitivity possible with a valve receiver without occasionally making their set oscillate.

Furthermore, unless one possesses a set with really efficient high-frequency amplification preceding the detector valve, it is almost impossible for the unskilled experimenter to pick up distant

stations without working dangerously near the oscillation point. Indeed, the simplest way to find a distant station is to make the set oscillate, pick up the carrier wave, and then lessen the reaction coupling until the set is just below the oscillation point. The unskilled hunter for distant stations generally adopts this procedure, although he expresses himself very strongly when other listeners, using precisely

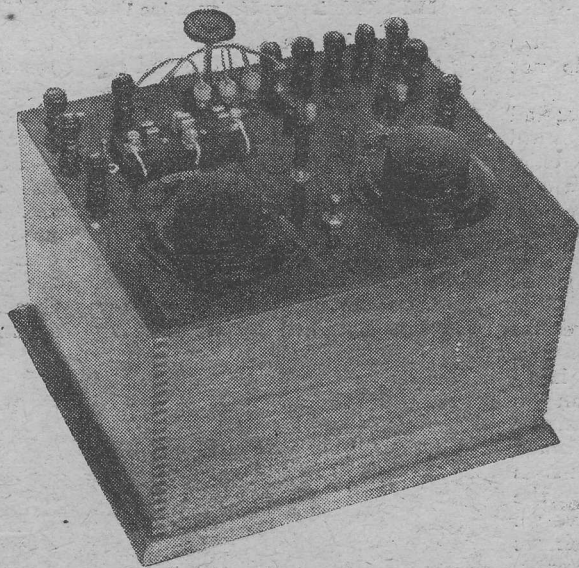

the same method, thus interfere with him.

Overcoming Interference

Bearing this in mind, and with the idea of alleviating, to some extent at least, the present and all-too-prevalent oscillation trouble, I have devoted considerable thought to the design of a receiver which, while being very sensitive, can yet

be made to oscillate freely for the purpose of picking up carrier waves without any risk of causing interference with one's neighbour's reception. Let me say at once that the problem is not solved simply by a particular circuit. The result is possible only by the combination of a suitable circuit with a suitable lay-out. If the lay-out of the apparatus is departed from, I cannot guarantee that the same non-radiating properties will be obtained.

Simple Construction

As many people will desire to build such a receiver with the minimum of trouble, I have made the constructional work as simple as possible, appearance being to some extent sacrificed to simplicity of construction. All parts (with the exception of the two-coil holder) are mounted on a single ebonite panel measuring 12 in. by 10 in., and essentials only are included. If desired, additional stages of note magnification can be added without in any way affecting the operation of

the receiver. Doubtless many readers already possess one or two-valve amplifiers which they may desire to attach to the "Huntsman" Two, or, if they have not such instruments, any of the one- or two-valve note magnifiers described in recent issues of THE WIRELESS CONSTRUCTOR can be joined to the output terminals for the operation of a loud-speaker.

the panel by wire as shown. A base should be obtained with the coil in order that different values of inductance may be plugged in to the receiver when it is desired to use it for stations not included in the normal broadcasting band.

Filament Resistances and Valves

For the tuned-anode and reaction coils any of the well-known makes can be used, and the reader has a considerable choice in variable condensers, fixed condensers, valve sockets and other components. Following the rule adopted in all Radio Press designs, the names of the actual components used are given. For compactness and simplicity of handling, the ordinary types of filament resistances have been dispensed with, and in their place two special resistances, known as "Amperites," are employed. These are special fixed resistances. Two different patterns can be bought, to pass either 1/4 ampere or .06 ampere respectively, with either a 4- or a 6-volt accumulator, as

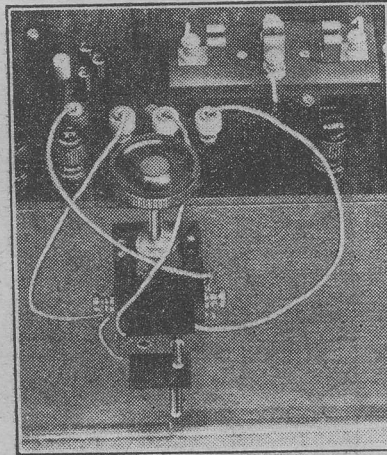

Connections to the coil-holder are made by flex and Clix.

desired. They thus enable the now popular small-power valve or the .06 amp. dull-emitter to be used. If the reader desires to use bright-emitter valves or any valves the current of which is different

from that for which the "Amperites" are made, conventional filament resistances should be incorporated instead of the "Amperites."

If 4-volt valves are used with a 4-volt accumulator, it is possible to dispense with filament resistances entirely. As to valves, I, personally, prefer for both sockets a 1/4-ampere valve of high impedance, such as the D.E.5B. or its equivalent in other makes. The H.T. voltages should be about 60 volts for the first and 40 volts for the second valve. The set, however, is not particularly sensitive to valve changes, and variations of valve types will not affect the ability of the receiver to be used for the purpose for which it is designed. The panel layout is shown in Fig. 2.

List of Components

The following components are those needed for building the set:—
 One ebonite panel, 12 x 10 x 1/8 in., Radion Mahoganite (American Hard Rubber Co., Ltd.).

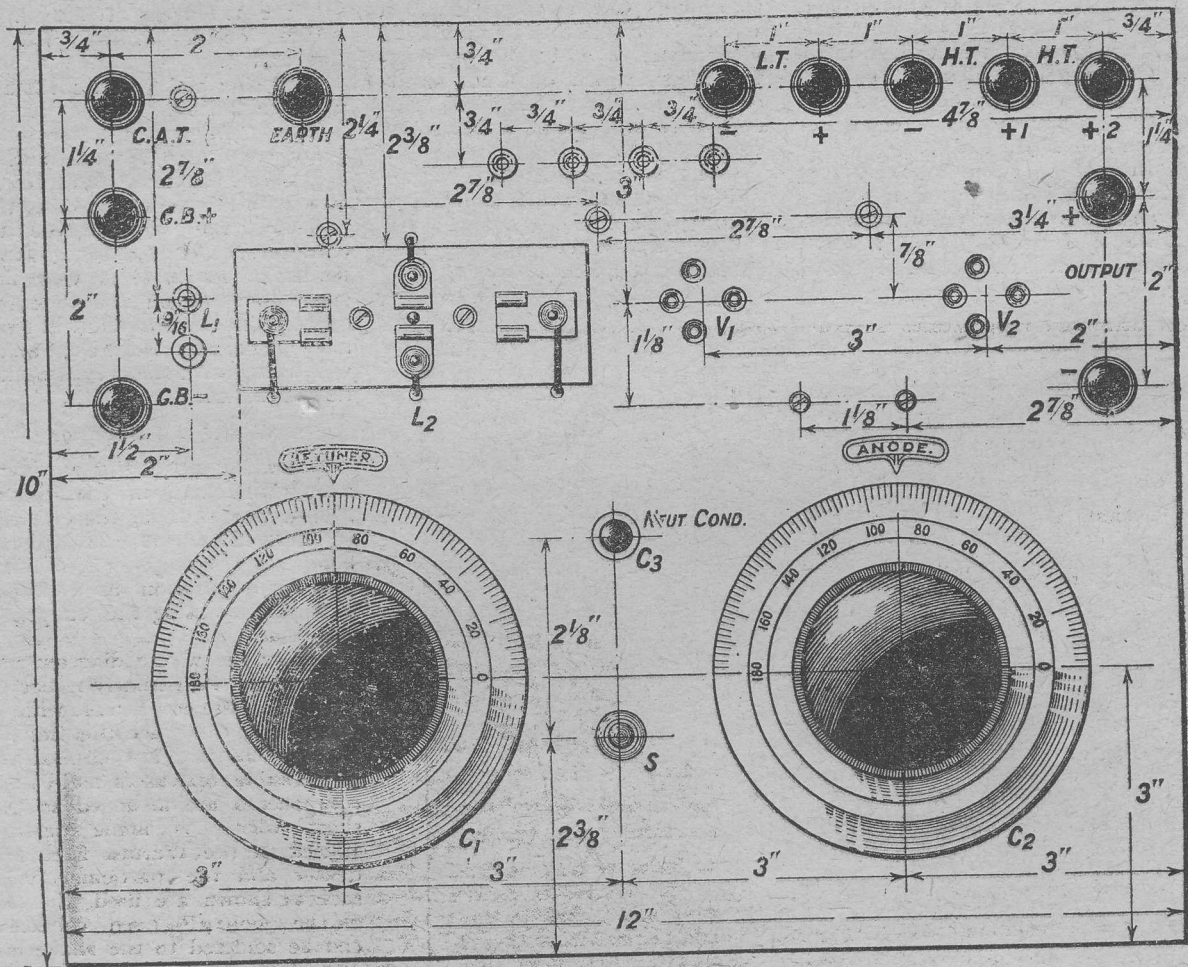

Fig. 2.—The panel layout of the "Huntsman." Readers may obtain a full-size blueprint No. C1030A for 1/6, post free.

If a panel of a different material is used, it should be guaranteed free from leakage.

One suitable cabinet. (It is as well to choose one of fair depth, in order that the coils in the coil-holder may have ample space without touching the table.)

Two valve sockets (Williams, Ellis & Co.).

Two Cyldon variable condensers, .0003 μ F (S. S. Bird).

One Dimic coil (L. McMichael, Ltd.). (For the broadcast band that marked 1A is needed. Ignore the wavelength marking 450-900 metres, as the coil is used in a special fashion.)

One flush mounting coil socket (Bowyer-Lowe Co., Ltd.).

It is essential to use a coil socket which fits flush with the panel, otherwise the position of the coil in relation to the Dimic coil will be altered.

One tapped fixed condenser (C.A.V.).

Terminals for C.A.T., Earth, Grid-bias Positive, Grid-bias Negative, L.T. Negative, L.T. Positive, H.T. Negative, H.T. Positive 1, H.T. Positive 2, Output Negative, Output Positive (Belling-Lee, Ltd.).

One fixed condenser, .0003 μ F (Watmel Wireless Co.).

One neodyne condenser (Gambrell Bros., Ltd.).

In the actual instrument illustrated I have used the older type Gambrell condenser, in which there is a possibility of a short circuit between the plates. I would,

however, recommend the reader to use the newer type made by Messrs. Gambrell, called the "Neutrovernia," or one of the other makes of neodyne condensers, such as the Polar, which does not short-circuit. Short-circuiting of this condenser will mean a burnt-out valve!

One two-coil holder (L. & P.).

Two dial indicators as marked (Belling-Lee, Ltd.).

One grid leak in clips, 2 megohms (L. McMichael, Ltd.).

One fixed condenser, .001 μ F (Watmel Wireless Co.).

Six 2-ft. lengths of Glazite.

One on/off switch (R. A. Rothermel).

Four Clix and 4 Clix sockets for panel mounting.

Two "Amperites" for either $\frac{1}{4}$ ampere or .06 ampere, and for 4- or 6-volt accumulator, as desired. If you wish to use valves other than the .06 or the $\frac{1}{4}$ ampere, then two compact filament resistances should be used. As there is very little space to spare on the panel, the conventional type of filament resistance is hardly suitable, and I would suggest a small type such as the Microstat.

Wiring the Receiver

The wiring-up of this receiver is simply indicated in the diagram Fig. 3, which, under the extension of THE WIRELESS CONSTRUCTOR blueprint system, can be obtained free on application as a full-size blueprint by using the coupon in this issue.

Follow the wiring diagram very accurately. Particularly notice the position of the coil-holder, which is arranged in this place intentionally. Drilling templates are supplied with the variable condensers, and various components are arranged so that short wiring is made possible. Indeed, if the Watmel fixed condenser and the particular valve sockets shown are used, the lugs of the .0003 μ F fixed condenser can be soldered to the anode and grid lugs of the valve sockets themselves without additional wiring. The .001 μ F Watmel fixed

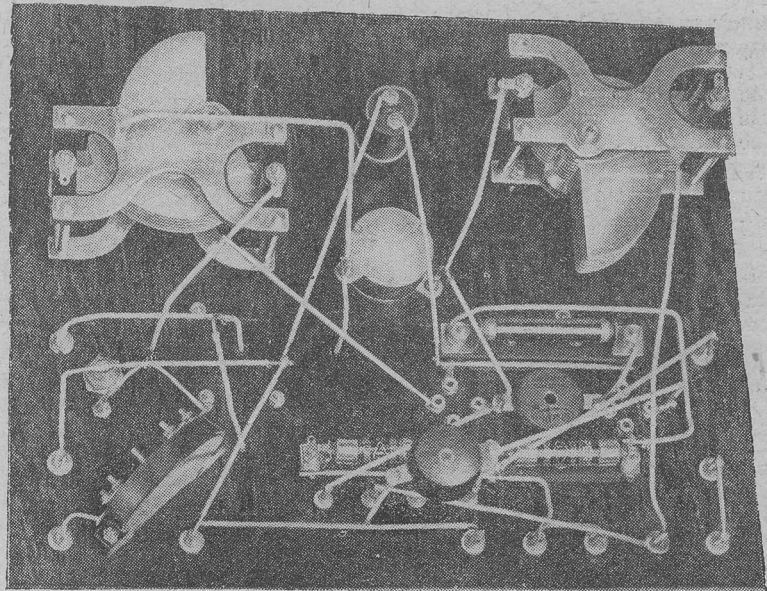

This photograph will aid constructors in wiring up the receiver.

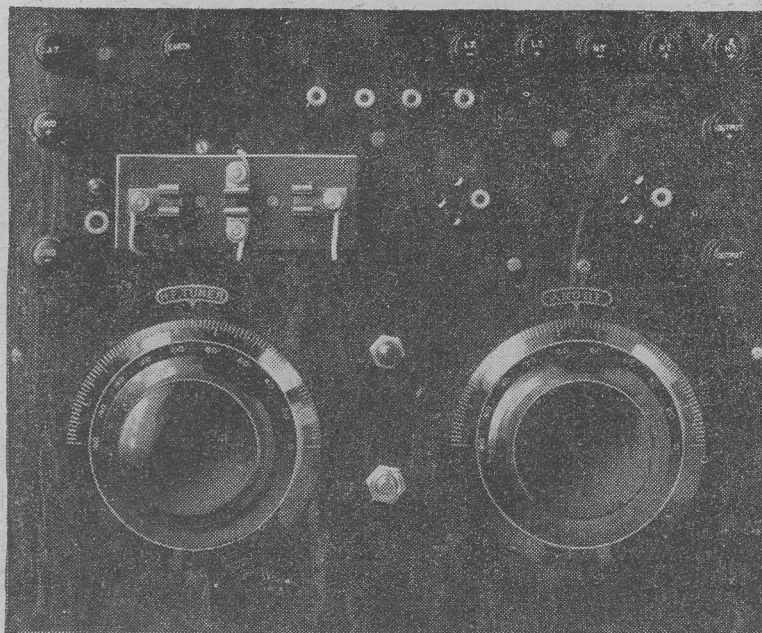

The appearance of the panel is clearly shown in this photograph.

Condenser, joined between the reaction coil and the negative filament, is held away from the panel on two pieces of stiff wire which are more than strong enough to support it without the condenser itself needing to be secured to the panel.

Adjustment

When the receiver is wired up, join the coil holder to the Clix sockets on the panel by means of flexible leads, without connecting aerial and earth or inserting the aerial coupling coil in its socket, but using suitable coils in the coil-holder (for the fixed coil I suggest a No. 75 of the numbered makes or C of Gambrell's, or its equivalent in other makes, and for the reaction coil a No. 50 or a Gambrell B or its equivalent in other makes).

Connect up low-tension and high-tension of suitable value for the valves used and a single cell for the grid-bias. Join up the telephones and listen carefully. For the preliminary adjustments, set the neutrodyne condenser at its minimum capacity position, and, setting the left-hand tuning con-

denser at about, say, 30°, separate the reaction coil and anode coil as widely as possible. Now turn the anode condenser backwards and forwards, when you will find that over a number of degrees oscillation will occur. You will recognise this by the "plonk" which is heard when the set starts to oscillate and by a corresponding "plonk" when it goes out of oscillation. Note the width of the oscillation band on the anode condenser and increase the capacity of the neutrodyne condenser step by step. After a few adjustments, you will find the width of the band of oscillation decreases until a point is reached when, however you turn grid or anode condensers, no oscillation will take place. If now you continue to increase the capacity of the neutrodyne condenser, you will probably find the set will oscillate again. Turn back and keep the neutrodyne condenser position at the point where no oscillation occurs for any setting of either of the condensers.

Best Signals

Now gradually bring the reaction

coil up against the anode coil, when, if the direction of connection is correct, you will hear oscillation again. If no oscillation occurs, even when the reaction coil is brought close against the anode coil, reverse the connection to this coil by means of the Clix leads. With the correct connections, it should be possible to bring the anode circuit in and out of oscillation by variation of the setting of the reaction coil. Leave the neutrodyne condenser setting at the point already indicated, and insert in the socket for the aerial coupling coil a coil of, say, 50 turns, and re-tune. You should now hear your local station with very considerable strength, and best signals can be found by a suitable adjustment of the condensers and the reaction coil setting.

As soon as you have become used to the adjustments just indicated, you will probably wish to search for distant stations. To do this, bring up the reaction coil against the anode coil until the set just oscillates, and by varying the two

(Continued on p. 466)

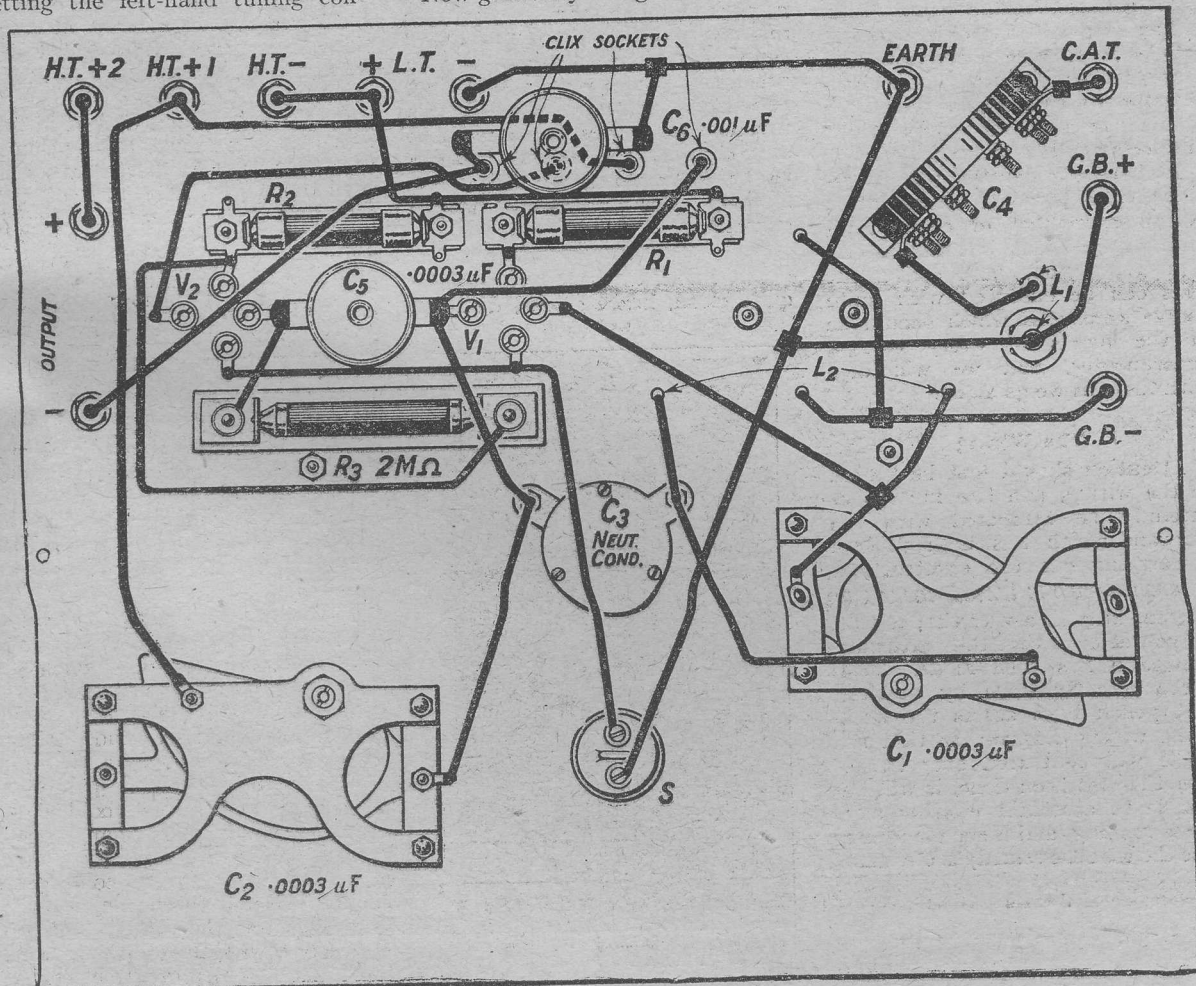
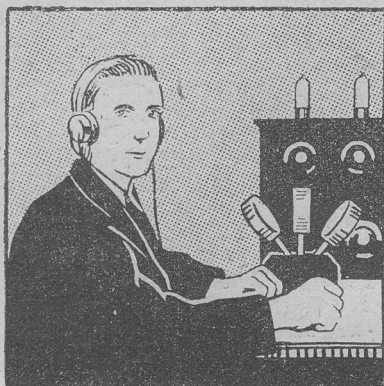

Fig. 3.—This wiring diagram is reproduced in the full-size blueprint, No. C1030B.



Testing Your Receiving Set

By H. J. BARTON-CHAPPLE, Wh.Sch.,
B.Sc.(Hons.), A.C.G.I., D.I.C., A.M.I.E.E.

*Practical hints which will enable the home constructor to
locate and remedy possible faults*

AFTER a receiving set has been made, it is very vexing to find that it will not work, or that a set which has been functioning perfectly for a certain period of time suddenly develops a fault, or faults, which incapacitate it as far as good reception is concerned. The obvious question then arises—What is wrong with the apparatus? An expert can be called in to examine the set, or it can be left with a local dealer for overhaul, but this will mean that perhaps undue expenditure is incurred, and the object of this article is to give a few practical hints to enable the home constructor to locate and remedy a number of different faults which may occur in his own receiver.

Elaborate apparatus will be required if a thorough examination and measurement of every component is desired, but this is not always necessary, and convenient tests can be executed with quite simple apparatus which should be in the hands of every earnest experimenter, and we will deal with these as we go along.

The Wiring

Attention should first be turned to the wiring, and this must very carefully be compared with the diagram which has been utilized in carrying out the construction. As each circuit is traced, mark the diagram in such a way that it will tell you at once that the particular connection has been made. This is conveniently done by making faint pencil lines across the lines of the wiring diagram, so that no circuit will be traced over twice. After this has been done, it will be possible to ascertain whether any wire is missing, and if such is found to be the case the remedy is obvious.

Joints

A thorough examination of all joints should be made to see whether any have worked loose, and no

pains must be spared to ensure that all contact joints, *i.e.*, those made by pressure with a nut or screw, are scrupulously clean and quite tight. The presence of dirt or grease, and possibly a loose contact, is answerable for many serious faults in wireless receivers. When solder has been employed in making a joint, see that the joint is quite sound and will stand a reasonable strain. It is surprising how many constructors, while realising that circuits as far as possible should have a continuous metallic path, *i.e.*, no "contact" connections, fail to realise this in practice owing to poor soldering. It will not be out of place at this juncture to digress for a moment and consider the salient features to be borne in mind when performing this relatively simple operation.

Soldering Details

The metal to be joined must be quite clean, hence grease, dirt and

the film of oxide which forms when metals are heated in air, must be carefully removed. The grease or dirt can be removed by scraping, filing and rubbing with emery cloth, but a flux is required to remove the film of oxide. This flux dissolves the oxide and prevents its further formation by providing a protecting film over the hot metal to keep out the air. The soldering iron should preferably be heated in a good gas flame and not in a fire.

After a certain amount of practice, it is possible to judge the correct heat for the iron by holding it near the face. When the iron is properly heated and dipped in the flux, the flux should fizzle off in a moment; no further heating is then needed. The end of the soldering iron must be tinned, *i.e.*, made clean and bright while hot, and the flux applied *quickly* and rubbed with a stick of solder to give the iron a good coating.



Mr. J. L. Baird and the apparatus with which he claims to have accomplished television.

Actual Operation

Clean the metallic surfaces to be soldered and tin them, using very little flux, place the surfaces together and heat carefully. After adding more flux and joining with melted solder, allow the joints to

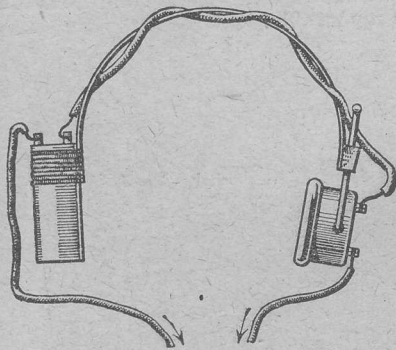

Fig. 1.—The testing instrument is made from a pair of telephones and a battery.

cool before attempting to alter the position of the metals being joined. The secret of success lies in being scrupulously clean, not overheating the iron or joints and being sparing with the flux. Refrain from getting the flux on any part of the apparatus except the metals being joined. If any of the flux has got on to the panel, it can be removed by the judicious use of methylated spirits on a small piece of cloth, and any foreign matter on the panel which may cause leaks can also be removed by the same process.

Simple Apparatus

It now becomes necessary to test the individual components, and for this a very simple piece of apparatus can be employed here, as has been mentioned before in the columns of this journal, viz., the telephones and a battery. It will be found useful, however, to make these two components into one unit by removing one of the ear-pieces from a pair of telephones and replacing it by a small dry cell, as shown in Fig. 1. The ear-piece and battery are connected in series and the two leads terminated in contact points or clips; this unit will prove very handy.

Variable Condenser

No metallic connection should exist between the moving and fixed plates of a variable condenser, and the telephone tester will enable this to be verified. Good connections must be made to the two sets of plates by clips, and on rotating the condenser dial no sound should be heard in the telephones if the con-

denser is satisfactory. Examine the connection between the moving plates and the terminal to verify that this is complete, and remove any dust or dirt between the individual plates with the aid of an ordinary pipe cleaner. To ensure a smooth and steady movement, any backlash between the dial and moving plates should be remedied.

Fixed Condenser

If a fixed condenser is satisfactory, a click should be heard in the telephone ear-piece on touching with the testing contacts the terminals connected to the plates. No sound will be heard when the test contacts are removed, because the condenser has been charged, and it must be discharged by short-circuiting its terminals if the operation is to be repeated. A common fault found in fixed condensers is that the screws marked A and B (Fig. 2) have been tampered with when connecting it into the receiving circuit. These screws usually make contact with the plates of the condenser, and should not be touched, but connections can be made to screws C and D or to the soldering tags which project from the side, as indicated in Fig. 2.

Measurement of Capacity

A further refinement may be made by actually checking the rated

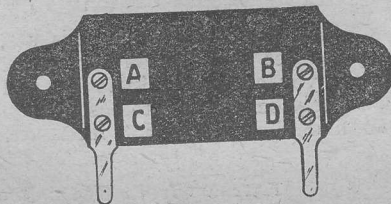

Fig. 2.—Screws A and B should not be used for connections.

capacity of the condenser to see if the true value compares favourably with that given or stamped on the components by the manufacturers. This can be done with the apparatus shown in Fig. 3. The condenser to be tested is connected by short leads to the terminals X, and with the change-over switch on this side, a buzzer wave-meter, loosely coupled to the inductance coil L, is tuned until the loudest sound is heard in the telephones.

Now put the switch in position Y, which is connected to a calibrated variable condenser, with known fixed condensers in parallel if high capacities (up to about 0.1 μ F) are to be measured. With the wave-meter working in its previously tuned position, the variable condenser is rotated till the loudest

sound is again heard in the telephones, and the capacity of this condenser will then give the value of the condenser under test.

Resistances

The continuity of resistances can be verified by calling in the aid of our telephone tester once more. If there is no disconnection, faint clicks will be heard with grid leaks or anode resistances on touching the tester across them. Loud clicks will be noticed with potentiometers and filament resistances, and if these should be absent, attention should be turned to the moving arm to see that proper contact is made on the resistance wire, and also that the terminals of these components are satisfactorily joined to the moving arm or resistance, as the case may be (see Fig. 4.).

Transformers or Inductances

A transformer winding should give a click on both make and break if the winding is continuous, but if the winding is broken, no click will be heard when the testing contacts are removed. A faint click may be heard at "make" in the last-named case, but this is due to the charging of the self-capacity of the winding. With iron-core transformers the click on break will be louder than the click on make when the winding is satisfactory.

Valves

If the valve fails to light when inserted in the socket, and the connections to the filament legs as well as the filament resistance are quite satisfactory, examine the valve-holder to ensure that the sockets are not dirty. In anti-vibratory holders the springs supporting the sockets may be broken. The valve legs should be opened with a penknife, as in some cases the fit into the holders is slack.

Batteries

The batteries must not be forgotten, since they may be run down and require replacement or recharg-

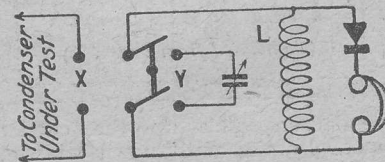

Fig. 3.—Simple apparatus for checking condenser capacities.

ing, and the terminals of the L.T. accumulator must be free from corrosion. After cleaning these terminals, a little vaseline should be applied to resist further corrosion. Of course, a voltmeter will be

Invaluable for giving an indication as to whether the batteries are giving their correct voltage or not.

Substitution Method

The substitution test should be employed where possible if a faulty component is suspected, and this will give quite a definite result if

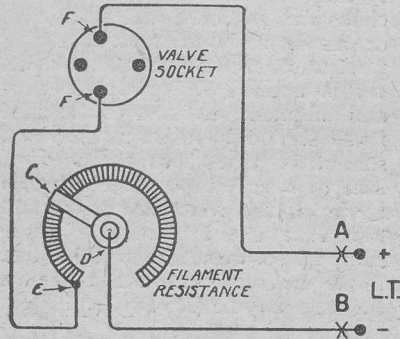

Fig. 4.—The letters indicate the position of possible faults.

each test is made separately. The aerial and earth call for more than a cursory examination, and it is a good policy to try the receiver on another aerial to ensure an acquittal of the receiver itself from faults, if it is observed that reception is still poor.

Aerial System

The aerial insulators must be washed to remove accumulated dirt and soot, and while the aerial is dismantled it is a good plan to make sure that the wire has not developed any weak point in its length due to strains brought about by winds, storms, etc. The junction between the down lead and the aerial may need overhauling, and the earth lead may also require replacing. Contrary to the belief of some constructors, an improvement may result if this last-named wire is insulated from the wall and kept as far away from it as possible.

The "Huntsman" Two Valve Set
(Concluded from page 463)

condensers pick up the carrier wave by the well-known whistle. Stop at the neutral point of the whistle and slacken the reaction coupling and re-tune until you get good undistorted telephony at the best strength.

Series Condenser and Aerial Coupling

Experiments should now be tried with the best value of series

condenser and aerial coupling coil. A 35 or a 50 will generally give good results, but a 75 may be better on some aerials. A few experiments will soon show you the correct value of coil and fixed condenser. Probably .0002 μ F will be a suitable value for the latter. In case you do not follow the connections of the C.A.V. condenser, it should be mentioned

with. On an average aerial on a night when conditions are normal, you should hear most, if not all, of the B.B.C. main stations with ease on the telephones, and probably several of the relays, together with a number of continental stations. The set is sensitive enough to hear American stations if conditions are favourable.

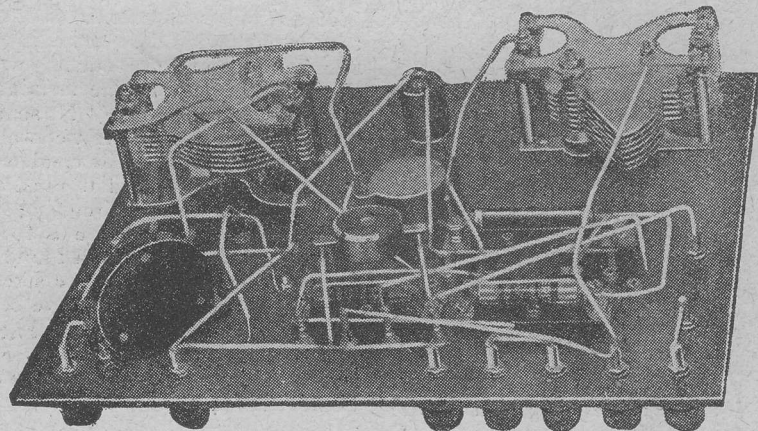

All components except the coil-holder are mounted on the panel.

that one connection goes to the terminal marked ".000" and the other to the terminal marked "2" (if you require .0002 μ F).

Testing Oscillation

When you have made this set, try to get a neighbour to listen while you are oscillating. He will probably be as interested as you are to find that he is not interfered

Selectivity

The selectivity is higher than that of the ordinary single-valve set, but is not so high as that obtainable with a receiver using more than one stage of high-frequency amplification. As far as sensitivity is concerned, it gives better results on long distance than any I have previously obtained with two valves.

Extracts from Radio Press Laboratory Test Report

- (a) Comparative strength of signals. Better than the average.
- (b) Reproduction. ... Good.
- (c) Ease of oscillation control. Very good.
- (d) General simplicity of operation. Very simple to operate once the set has been adjusted. However, to get satisfactory working from this receiver, it is necessary to have the neutrodyne condenser adjusted accurately. After once being adjusted, it was found to be quite constant throughout the whole range, and does not need to be touched again provided the valve is not changed.
- (e) A single-valve receiver was fixed on an aerial about 10 or 20 ft. away from the aerial this particular set was receiving on. Provided the neutrodyne condenser was accurately adjusted and the receiver was set into oscillation by means of the reaction, none of these oscillations reached the aerial, and the oscillations could not be heard on the neighbouring receiver.

LOUD SPEAKERS!

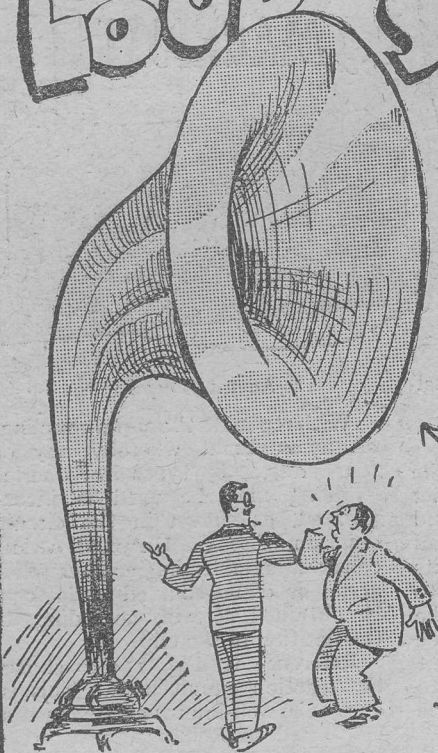

= ON A RECENT VISIT TO BUSH HOUSE THE EDITOR SHOWED ME A GIANT LOUD SPEAKER THAT HAD JUST ARRIVED.

- OF COURSE THIS SORT OF THING IS ALL RIGHT FOR BUSH HOUSE

- BUT ITS A BIT BULKY FOR "GRID-LEAK COTTAGE"



= OF COURSE IN THE CASE OF THE NEW DWELLINGS THERE'S NO DIFFICULTY -

- YOU SIMPLY INSTAL THE LOUD SPEAKER AND THEN BUILD THE HOUSE ROUND IT!

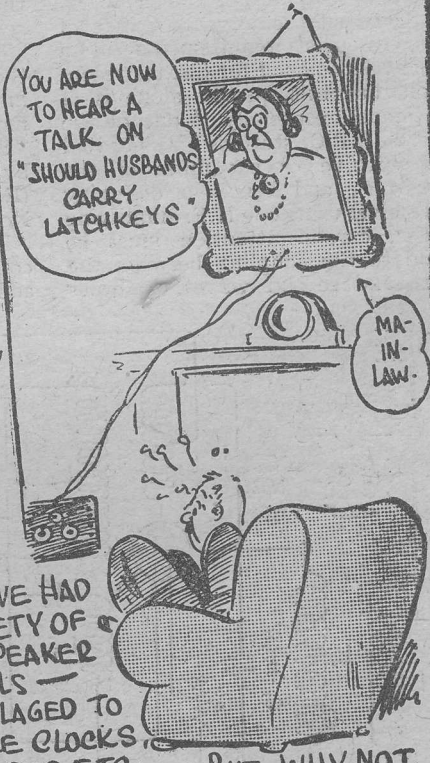

- WE HAVE HAD A VARIETY OF LOUD SPEAKER MODELS - CAMOUFLAGED TO LOOK LIKE CLOCKS, LAMP SHADES ETC - BUT WHY NOT ADAPT THE FAMILY PORTRAITS?

RON SHAW

A USEFUL SELECTIVE RECEIVER

By
E. J. MARRIOTT



Selectivity combined with sensitivity has been attained to a commendable degree in this three-valve set

IT is known that for general-purpose reception a receiver using three valves, H.F. amplifier, detector and L.F. amplifier, is extremely popular. The reason for this popularity is not very hard to find, since, whilst the cost of upkeep is reasonably low, three valves arranged as indicated above in a carefully-designed receiver will give excellent results when properly operated:

Sensitivity and Selectivity

Sensitivity is, of course, one of the essential requirements in a receiver designed for distant reception, but this quality alone is of little use, especially if one of the main B.B.C. stations is situated within five or six miles of the receiver; and hence in designing a receiver using one H.F. amplifying stage, careful attention must be paid to the coupling between the first and second valves, in order

that selectivity, as well as sensitivity, will be secured.

Self Oscillation

The H.F. valve also must be stabilised in some manner in order to overcome self-oscillation; and in this respect one of the several possible neutrodyne arrangements offers one of the best solutions to this problem. It will allow the greatest amplification to be obtained from the valve without introducing deliberate damping into the circuits, and thus aids the selectivity.

In the receiver to be described the above points have been borne in mind, a neutrodyne arrangement similar to that used in the "Special Five," which was described by Percy W. Harris, M.I.R.E. (Editor) in *Modern Wireless* dated November, 1925, being employed.

Further, reaction on to the grid coil of the detector valve has been added.

Aerial Couplings

With regard to the aerial coupling, an arrangement whereby any of four different types of aerial coupling may be used is incorporated, as shown in the circuit diagram, Fig. 1. Untuned aerial, constant aerial tuning, auto-coupled aerial or direct-coupled aerial can be obtained at will, according to the position of the clip.

Reference to Fig. 1 also shows the reaction circuit used. This is one of the well-known arrangements attributed to Reinartz, a variable condenser controlling the magnitude of the reaction effect obtained.

Reaction on to the Aerial

In several neutrodyne receivers ordinary magnetic reaction from the anode of the detector valve directly on to the aerial coil is used, allowing the H.F. valve to be brought into its most sensitive state—i.e., on the threshold of

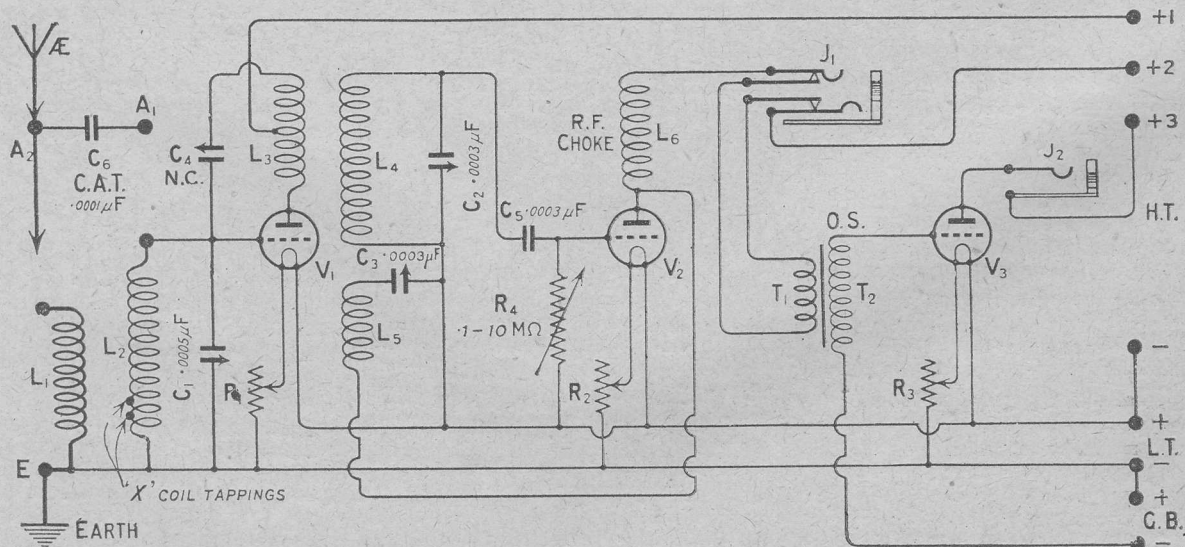

Fig. 1—Various forms of aerial coupling are provided for in this three-valve set. Reaction is obtained by coupling L_4 and L_5 .

self-oscillation. If, however, we examine such an arrangement, it will become apparent that the H.F. valve can be brought into this same state by means of the neutralising condenser.

Thus it appears as though the reaction coil adjustment and the neutralising condenser adjustment are simply alternatives, and that the use of a reaction coupling on to the aerial does not necessarily give us any greater signal strength than we could already obtain by a careful manipulation of the neutrodyne condenser.

Reaction on to the Detector

If, however, after having brought the H.F. valve to its most sensitive state by means of the stabilising condenser, we now apply reaction from the anode of the detector valve on to the grid circuit of the detector valve, it seems that we should obtain further amplification of signals over and above that already obtained from the H.F. amplifying stage.

This is what has been done in the set under discussion. After considerable experiments, Reinartz reaction was decided upon as the arrangement lending ease of control and least likely to upset the stability of the first valve, there being no moving coils in this method. Constructors are strongly advised to adhere strictly to the layout of components shown in the drawings and photographs, otherwise results may be very disappointing. While there may be other layouts which are quite effective, it must be remembered that the arrangement shown has been tried and proved satisfactory.

Outward Appearance

As will be seen by the accompanying photographs, the finished receiver presents a pleasing appearance, the symmetrical arrangement of the components on the panel being a good feature. Although three condensers might at first suggest complicated operation, remember that only the two left-hand components are for tuning purposes, the one on the right-hand merely controlling the reaction effect.

Use of Jacks

Telephone jacks are used for making connection to the telephones or loud-speaker, and these will be found extremely convenient in operation when it is desired to change over quickly from telephones to loud-speaker or *vice-versa*. All the necessary terminals for connection to the batteries, and to aerial and earth, are placed on

ebonite strips along the back edge of the baseboard, and project through apertures made in the back of the cabinet for this purpose.

Components Required

In order to construct this receiver exactly as described the following components will be required. If it is desired in some instances to utilise components of different manufacture, the only stipulation is that those of similar quality shall be used.

- One mahogany cabinet, 21 in. × 8 in. (The Aircraft Co.).
- One ebonite panel (matt), 21 in. × 8 in. × ¼ in. (Paragon).
- One battery terminal strip with eight terminals (Peto-Scott Co., Ltd.).
- One aerial-earth terminal strip with three terminals (Peto-Scott Co., Ltd.).
- Two H.F. low-loss neutrodyne transformers—one for 250-550 metres (tight-coupled type), one for

- One .0003 μF fixed condenser (Watmel Wireless Co., Ltd.).
- One H.F. choke (Lissen, Ltd.).
- Two board mounting coil-holders (Burne-Jones & Co., Ltd.).
- One telephone jack, double circuit (Rothermel Radio Corporation).
- One telephone jack, single circuit, open (Rothermel Radio Corporation).
- One spring clip (Peto-Scott Co., Ltd.).
- Quantity of Glazite for connecting up (London Electric Wire Co., Ltd.).
- Short length of flex wire.
- Screws, etc.

Construction

In commencing the actual construction of the instrument, the drilling of the panel must first receive attention. In Fig. 2 all the necessary dimensions for marking out are given, and as the panel layout is symmetrical no difficulty

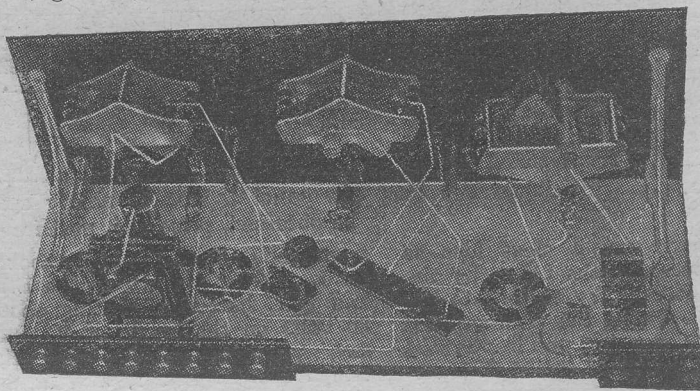

Care is necessary when arranging the baseboard layout, and this photograph forms a useful guide.

- 900-1,800 metres (Peto-Scott Co., Ltd.).
- One mount for above (Peto-Scott Co., Ltd.).
- Two reaction coils to suit above transformers (Peto-Scott Co., Ltd.).
- One mount for above (Peto-Scott Co., Ltd.).
- One pair panel brackets (Camco).
- One L.F. transformer, A.F.3 (Ferranti).
- Three "Antipong" valve holders (Bowyer-Lowe Co., Ltd.).
- Three square-law type low-loss variable condensers—one .0005 μF, two .0003 μF (Igranic Electric Co., Ltd.).
- One stabilising condenser (Type N.), Polar (see note later) (Radio Communication Co., Ltd.).
- One variable grid leak (Bretwood).
- Three variable filament resistances (C.A.V.).
- One .0001 μF fixed condenser ("Therla").

should be experienced. With regard to the variable condensers, templates are supplied with each of these, and should be used when marking out the fixing holes.

When the drilling is complete, place the panel against the baseboard, in position in the cabinet, and the three wood screws for fixing it to the baseboard can now be inserted.

The terminal strips must also be attached to the baseboard whilst it is in the cabinet, this method ensuring a good fit into the apertures provided on the back of the cabinet. It will not be found difficult to mark the exact positions for the panel bracket fixing screws if this is done whilst the panel and baseboard are fixed together.

Now mount the various components on the panel, and with these in position screw down the components which are mounted on the baseboard itself, taking

great care to follow as closely as possible the arrangement shown in the accompanying diagrams and photographs.

Wiring

Having fixed everything in position, the wiring may be carried out. First clean and tin all those points to which soldered connections will be made, remembering that a little time and trouble taken at this stage may save a great deal of worry later on.

Fig. 3 shows the point to point connections very clearly, and the

to the type of aerial coupling it is desired to use.

Having completed the wiring, check over all the connections very carefully against Fig. 3, and when satisfied that everything is correct, proceed to stabilise the H.F. valve in the following manner.

Stabilising the H.F. Valve

Insert a D.E.5 valve in the first socket and a D.E.5B. or a general-purpose valve, in the second socket. Plug in the H.F. transformer and reaction coil for the 250- to 550-metre wave band, and

that the H.F. valve will break into self-oscillation over a certain number of scale degrees of this condenser.

When this takes place, the neutrodyne condenser, which should now be at its minimum adjustment, must be adjusted a little towards its maximum position and another test made for oscillation. It will be found that a certain adjustment of C_1 will completely stabilise the H.F. valve, and no oscillation should take place whatever the relative adjustments of C_1 and C_2 .

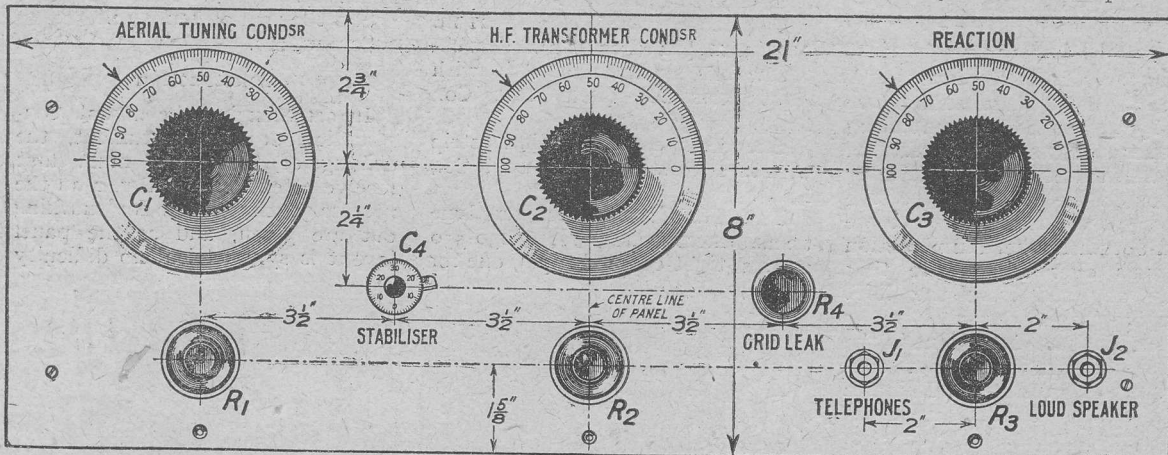

Fig. 2.—It will be noticed that the panel layout is nearly symmetrical. Blueprint C1033A may be obtained, price 1/6, post free.

photographs give a clear idea as to the actual paths taken by the various wires. Try to imitate the wiring shown in the photographs, and make sure that you leave room for the valves and the H.F. transformer and reaction coils to be mounted without fear of fouling any connections.

Those leads which are shown near the baseboard should be joined up first, as later on these positions may be difficult of access. It will probably be noticed that I have, for convenience in wiring, reversed in direction two of the soldering tags on the H.F. transformer mount.

Variable Coupling

A short length of flex will be required for joining one side of each of the two coil-holders to the earth terminal, in order that the holder for L_1 , which is secured by only one screw, may be swivelled slightly when it is desired to loosen the coupling between L_1 and L_2 .

The lead from the terminal A_2 is also carried out in flex wire, and this lead has a spring clip soldered to its end in order that connection may be quickly made to any of several points, according

to a number 50 or 60 coil in the socket for L_2 . Now connect up the L.T. and H.T. batteries, putting about 80 volts on the anode of V_1 and, say, 50 volts on V_2 ; plug the telephones in jack 1, and adjust the valves to their correct voltage by means of the filament rheostats.

The condenser C_3 must be adjusted to zero capacity. Now, if the transformer condenser C_2 is set to a low value adjustment, say 30 degrees on the dial, and C_1 is swung slowly backwards and forwards, it will be found

When this position has been found, C_1 can be locked in position by means of the locking nut provided, and it should not need alteration unless the H.T. on V_1 is substantially changed or a different wavelength H.F. transformer used. In actual practice, these instructions will be found quite simple to carry out.

Testing

When you are quite sure that V_1 is correctly neutrodyne, connect up your aerial to A_2 , and earth to

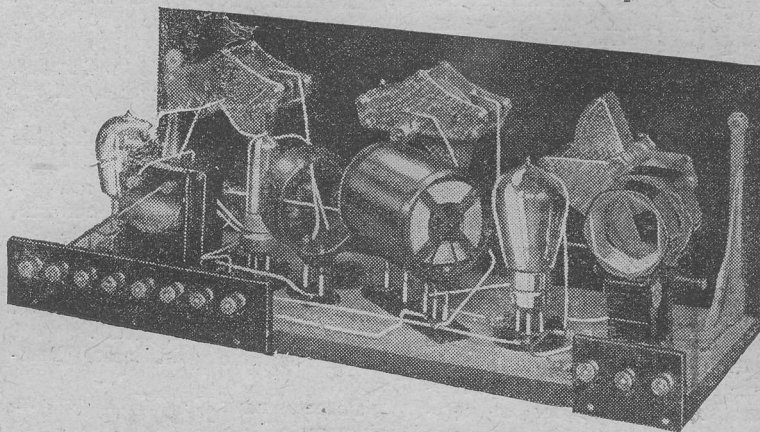

The coupling of the coils is shown here. Note that the aerial tuning condenser is mounted differently to the others.

Q The illustration shows a simple but really effective loud speaker horn—that can be covered with fancy paper or painted so as to resemble a factory article—made for a few pence by following the easy directions supplied with every 'Lissen' Loud Speaking Unit, a new Lissen product yielding results equal to the most expensive instrument on the market and sold at the record low price of **13/6**



A powerful loud speaker that costs less than headphones

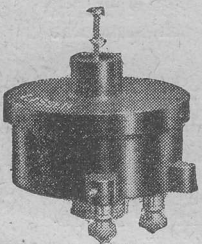

The complete Unit with 'Lissen' Reed attached ready to receive a cone—or any other diaphragm working on the reed principle.



The 'Lissen' Reed Attachment (patent pending) Price 1/-.



Showing method of attaching Reed to the 'Lissen' Loud Speaking Unit.

Hardly credible—but true. For less than the price of a pair of 'phones you can buy the 'Lissen' Loud Speaking Unit that only needs the addition of a horn to make it a powerful, full-sized instrument, equal in volume, purity and tone to the most costly on the market.

Any good horn will do. If you have a spare one in the house from a gramophone or a loud-speaker it will serve admirably. If not, there are directions with every 'Lissen' Loud Speaking Unit and full-sized patterns, telling you how to make a simple but attractive and really efficient horn for a few pence. Or, by using

the Lissen Reed (price 1/- extra), a cone or any other diaphragm working on the reed principle can be quickly made and fitted, yielding results equal to an expensive speaker. By removing the sound-box and substituting the 'Lissen' Unit, any gramophone can instantly be converted into a loud speaker.

Make this test. Go to your nearest dealer and ask him to put on the most expensive loud speaker in his stock. Then put the same horn on the 'Lissen' Unit—keep the input voltage the same, no matter how high—and see if you can notice any difference.

Your Dealer will gladly demonstrate.

LISSEN LIMITED

Lissenium Works, 26-30, Friars Lane, Richmond, Surrey.

'Phone: Richmond 2285 (4 lines).

'Grams: "Lissenium, Phone, London."

In replying to advertisers, please mention THE WIRELESS CONSTRUCTOR.

OURSELVES — AND THE ELECTRICAL IMPULSE

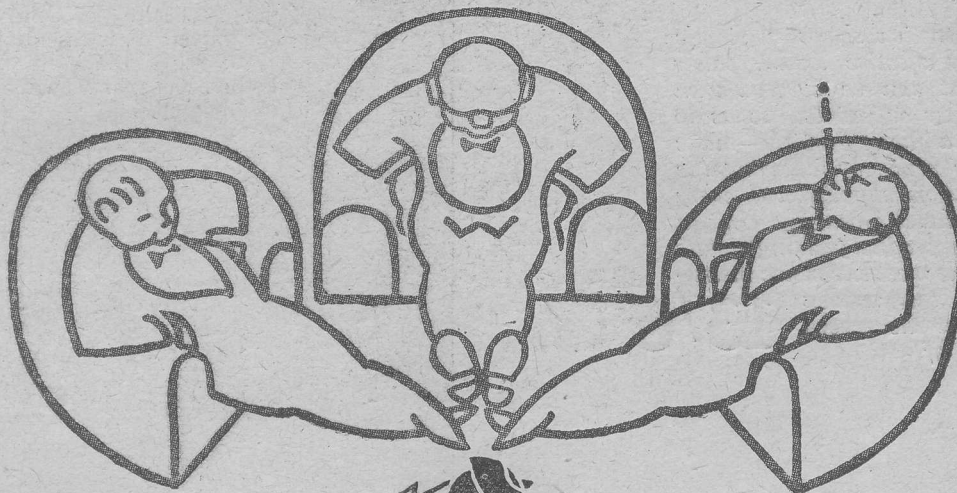





Brandes

"That radio contrivance of yours, Smith; it talks very naturally. The fellow holding forth on what to plant in the garden might well be in this room."
 "Ah yes! It's a Brandes; an old friend of mine. Always did sound clearly and well. Thank Heaven the fellow is not in the room, anyhow. It too easily reminds me that my wife will probably lend her moral support to my doing some gardening on Sunday morning."
 "Yes, but why is it so appreciably better than most? I had dinner with Brown-Jones last week. His port is excellent, but his radio is excruciating; I wanted to throw things."
 "Well, these Brandes fellows claim that they build their instruments from an expert knowledge of radio acoustics."
 "I don't know what radio acoustics is from Adam."
 "My dear Jackson, of course you don't. Neither do I, technically."
 "Well, tell me what you know about it."
 "You perhaps know that acoustics is the science of sound?"
 "Well, ye-es!"

"Right! Radio acoustics is the science of transforming the electrical impulse into audible sound."
 "Do you mean that the electrical impulse is the electrical energy which carries the transmitted power from the studio to the receiver?"
 "Precisely!"
 "And that the Brandes instrument is constructed with the correct scientific elements for a most able transformation into audible sound?"
 "As you say, dear fellow! Brandes are thoughtful radio builders and seventeen year's intimate association with the electrical impulse must have given them a lift above the others."
 "Well, that youngster of mine is pestering me for a loud-speaker—I'll see that it's a Brandes."
 "I should! You have heard mine—ah! the Savoy Bands coming through. Don't give John any more whisky. He'll probably want us to fox-trot with him."
 "No sir! On the contrary, I am thinking of investing in a Brandes."

MATCHED TONE HEADPHONES THE TABLE-TALKER THE BRANDOLA AUDIO TRANSFORMER

 <p>20/=</p>	 <p>30/=</p>	 <p>90/=</p>	 <p>17/6</p>
---	---	---	---

Obtainable from any good Dealer

BRANDES LIMITED
246 Regent Street W.1

EXPERTS IN RADIO

ACOUSTICS SINCE 1908

Service Advertising

the terminal so marked, and clip the flex lead from the aerial terminal on to the free side of the coil block for L_1 , into which a No. 30 coil must be plugged.

Now, if your local station is transmitting, you can tune it in on C_1 and C_2 in the normal manner, and if C_3 is gradually increased in value, it will be found that signals will gradually increase in strength until the detector valve will oscillate. The reaction condenser should be adjusted so that V_2 is well off the oscillation point, otherwise signals may be somewhat distorted.

Aerial Arrangements

On plugging the loud-speaker into jack 2, inserting a small power valve in the third socket and applying appropriate H.T. and grid-bias, loud signals can be obtained, provided you are situated within, say, 25 miles of a main station. Any of the several aerial couplings available may be tried, but the writer found the

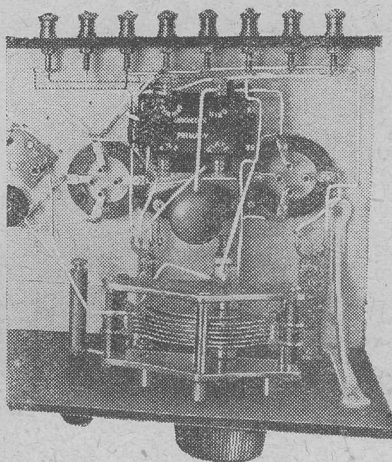

This photograph may help to explain how leads are taken to the terminals.

untuned aerial arrangement preferable for all round work. Regarding the valves to employ, the following will be found satisfactory: V_1 ,

D.E.5; V_2 , D.E.5B. or a general-purpose valve of suitable filament rating; V_3 , D.E.5 or other small-power valve. It is essential, however, to use a D.E.5 in the first socket in order that V_1 will oscillate in the first place.

Coil Sizes

Suitable coils for the ordinary broadcast band are: L_1 , No. 30; L_2 , No. 50 or 60. When it is desired to receive Daventry, the suitable H.F. transformer and reaction must, of course, be plugged in, and the coils will now be: L_1 , No. 150; and L_2 , No. 250.

Stabilising, on the longer waves, must be carried out in a similar manner to that described above for the ordinary broadcast band.

Generally it will be found that the use of reaction, when receiving the local station, is not necessary if it is situated within five or six miles, but when receiving distant stations C_3 will be found invaluable.

An interesting and important

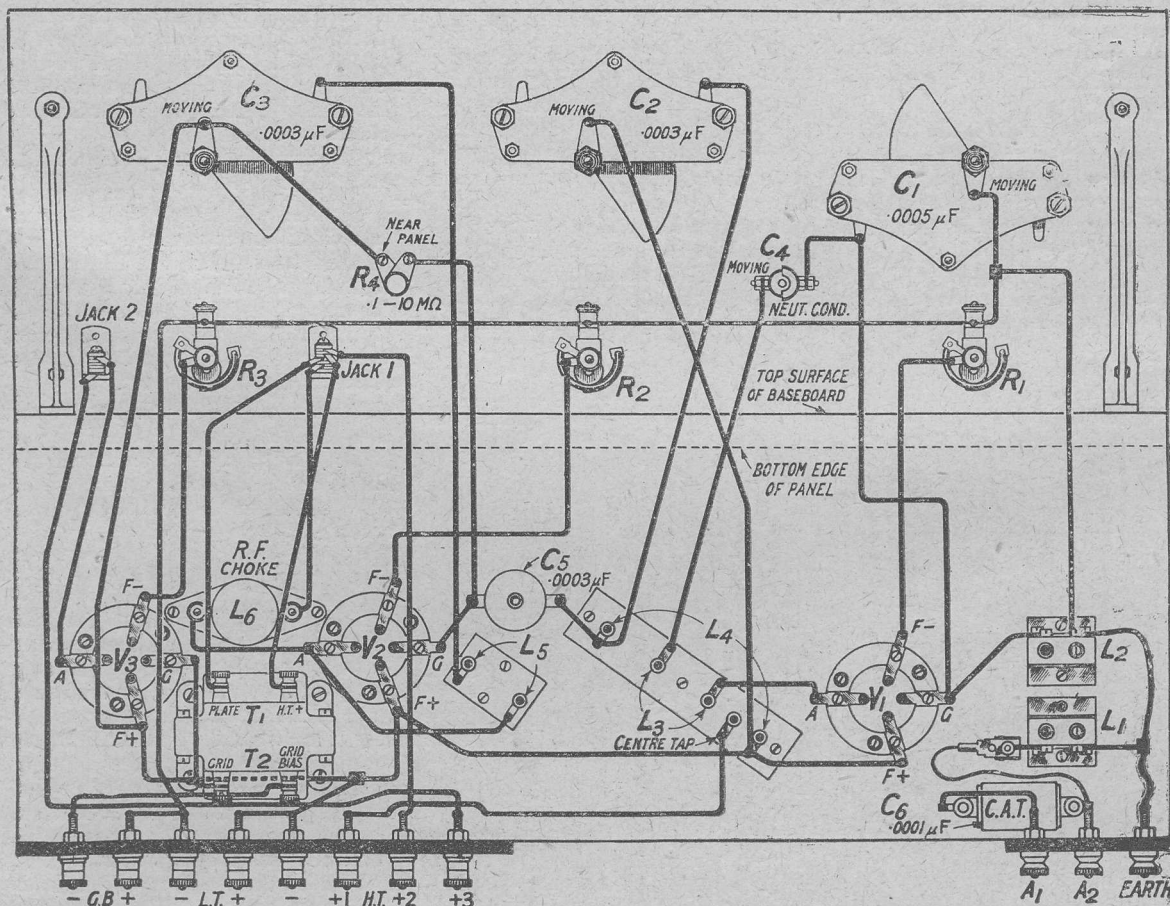

Fig. 3.—The wiring diagram. If a transformer of other make is used, "OS" should be connected to the grid of V_3 and IS to GB—. The blueprint C1033B is included in the new extended scheme.

point is that so long as V_1 is correctly neutrodyne, when V_2 is oscillating due to reaction, radiation from the aerial will be exceedingly small.

For the Best Results

For the benefit of those constructors who have had but little experience in operating wireless receivers, one or two points which should be carefully noted are given below.

Stabilising

With some aerial and earth systems, and the use of different types of tuning coils, it may be found that one adjustment of the neutrodyne condenser is not sufficient to stabilise the H.F. valve (V_1) over the complete range of the tuning condensers. This will simply mean that C_4 must be adjusted to one value for working on, say, the lower half of the tuning condensers, and slightly readjusted when it is desired to work on the upper half. In all cases, however, oscillation of V_1 should be perfectly controllable if the wiring is carried out correctly.

Valves and H.T. Connections

Remember that, looking from the front of the cabinet H.T. +3 is on the extreme left of the battery terminal strip, and that this terminal feeds the anode of V_3 , the L.F. valve, whilst the third terminal from the left, H.T. +1, connects to the anode of V_1 .

As previously stated, a D.E.5 type of valve is recommended for V_1 . Whilst a D.E.5B. and a D.E.8H.F. gave good results under some conditions, a valve of the

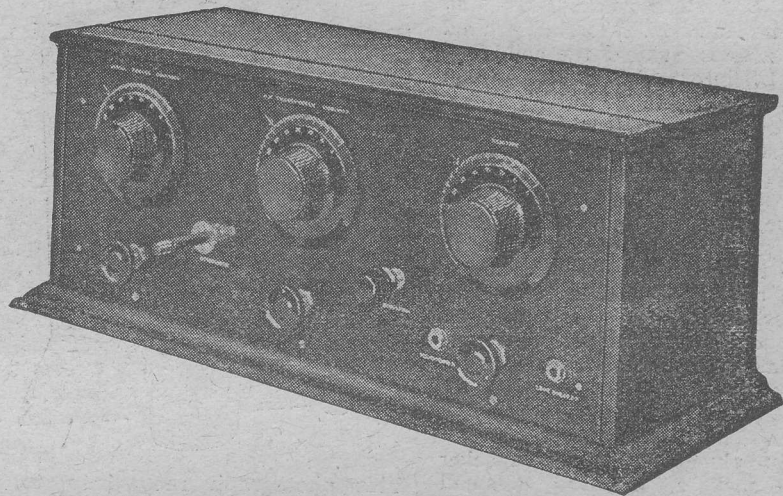

When completed the receiver presents a distinctive appearance.

type advised was found to be eminently suitable in this position.

For V_2 any general purpose valve of a suitable filament rating should be found satisfactory, whilst for V_3 best results will in most cases be obtained when one of the several small power valves of a suitable filament rating is used. The H.T. + value and grid-bias applied to this last valve must be in accordance with the maker's instructions.

Test Report

In actual operation, this receiver showed a good degree of sensitiveness combined with selectivity. On a poor aerial situated about $3\frac{1}{2}$ miles west of 2L.O, that station was unpleasantly loud on an Amplion loud-speaker, whilst Bournemouth was received at fair strength, London being audible in the background,

but not sufficiently loud to prevent 6BM being understood. Birmingham, and several Continental stations came in at fair loud-speaker strength, the tuning on the transformer condenser being very sharp.

Tested again on a better aerial situated about 10 miles from 2L.O, the following stations were received on the speaker at varying strengths: Dublin, fair (slight background from 2L.O); Hamburg, moderate; Radio - Toulouse and Ecole Supérieure, fair; and Union Radio-Madrid and Radio-Berne, good.

On the longer wave-band, Davenport came in at very good loud-speaker strength, whilst Radio-Paris was received at ample strength for a moderately-sized room. Selectivity on the longer waves, however, was not so definitely sharp as on the normal broadcast band.

Tests were also carried out on this receiver at the Elstree laboratories, which fully confirmed the above results, Bournemouth being received there with 2L.O only just audible.

Slight Radiation

It was found by test that, as previously stated, when the detector valve was made to oscillate, so long as V_1 was correctly neutrodyne radiation from the aerial was very slight, and control of oscillation was quite simple. Whatever type of neutrodyne condenser is employed, however, it must not be of such construction that it is possible to short the two plates, otherwise the H.T. will be placed across the valve filaments with the obvious result.

The writer would welcome reports regarding results obtained in different localities, by any who may construct this receiver.

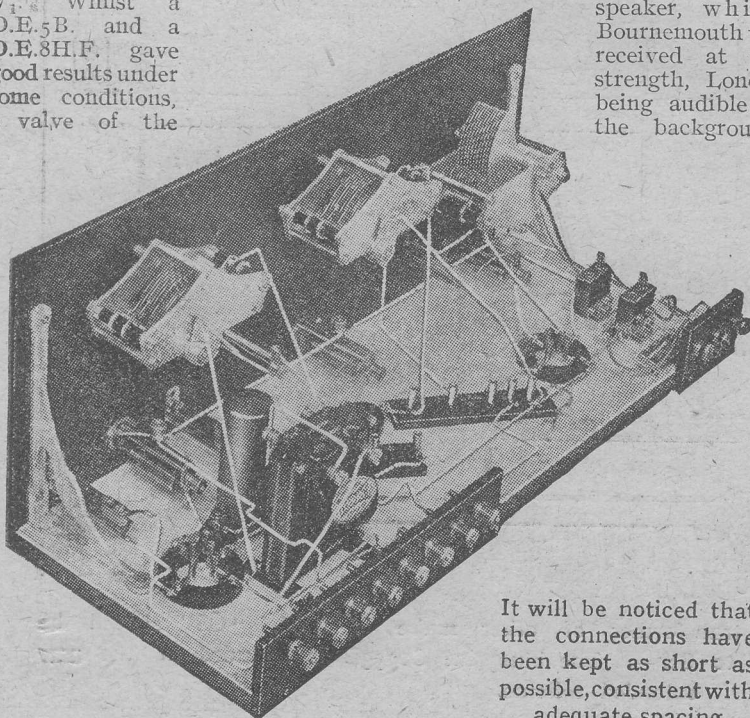

It will be noticed that the connections have been kept as short as possible, consistent with adequate spacing.



aids to better reception

**MICA FIXED CONDENSERS, GRID LEAKS
RESISTANCE CAPACITY COUPLINGS, etc.**

IMPORTANT components these, performing distinctly important functions in radio. The **MH** Products have been developed with this fact always in mind, and the result is a range of components that are without equal in quality, efficiency and the capacity to give the best results. **YOUR DEALER STOCKS THEM!**



MICA FIXED CONDENSERS.

Are of the permanent capacity engraved thereon and instantly interchangeable. 0.0001 μ F to 0.0009 μ F - 2/6 each. 0.001 μ F to 0.01 μ F - 3/- each. 0.015 μ F to 0.02 μ F - 4/- each. (Two clips supplied with each condenser)

Above mounted on ebonite base with terminals as illustrated, any value 1/- extra.



GRID LEAKS.

Embody a special constant resistance compound. Are easily interchangeable. All values 2/6 each. Two clips supplied with each grid leak. Mounted on ebonite base as illustrated, 1/- extra.

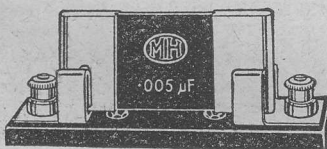

RESISTANCE CAPACITY COUPLING.

Consists of three well-known **MH** units — a .005 μ F Mica Fixed Condenser, a 0.5M Ω Grid Leak and an 80,000 Ω Resistance mounted on ebonite base. Illustrated below.

PRICES.

- Complete with Base - 12/6
- Anode Resistance only, with clips 4/6
- Leak only, with clips - 2/6
- Condenser only, with clips - 3/-
- Base only, with fittings - 3/6



COUPLING GRID LEAK AND CONDENSER

For L.F. Choke Amplification.

Consists of the following **MH** Units: — A 1 Megohm Grid Leak and a .02 Mica Fixed Condenser. Mounted on ebonite base with terminals. Price 8/-

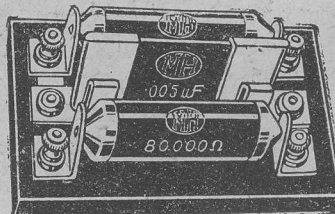

COMBINED GRID LEAK AND CONDENSER UNIT.

Consisting of a 0.0003 μ F **MH** Mica Fixed Condenser and a 2M Ω **MH** Grid Leak. Price 5/- each.

CONDENSER TEST PANEL.

Fitted with four condensers—0.0001, 0.0002, 0.0004 and 0.0008. By simple combinations of these values, fifteen values of capacity can be obtained. Complete with 4 condensers on polished ebonite, baize covered base. Price 11/6 Base Board only - Price 5/-



ANODE RESISTANCES.

An improved resistance tested to give a safe working load of from 2 to 3 milliamperes, all values. Price 4/6 (Each supplied with two clips.) Mounted on ebonite base with terminals as illustrated - 1/- extra.

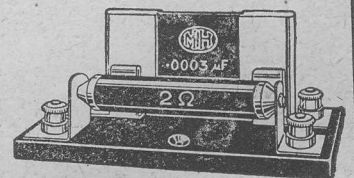

Head Office & Works
WEXHAM ROAD
SLOUGH, BUCKS
Telephone: SLOUGH 441 & 442
TELEGRAPHIC ADDRESS:
RADIETHER, SLOUGH

L.M. MICHAEL LTD.

Manufacturers of Wireless and Scientific Apparatus
WEXHAM ROAD, SLOUGH, BUCKS.

London Office & Wholesale Showrooms:
HASTINGS HOUSE,
Norfolk St. STRAND, w.c. 2
Telephone: CENTRAL 8272
CABLE ADDRESS:
RADIETHER, SLOUGH



Another "LOTUS" Product

The LOTUS BUOYANCY VALVE HOLDER (ANTI-MICROPHONIC)

PATENTS

PENDING

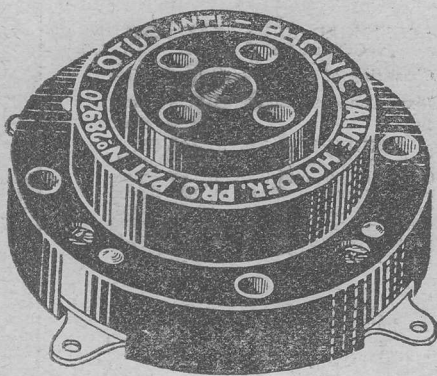

Top View

Price
2/3

The delicacy of your Valve filaments is subject to microphonic elements from numerous sources. The "LOTUS" Buoyancy Valve Holder has been specially designed and constructed to counteract and dissipate these disturbances, and will, by its original and unique spring construction, absorb any shock, protect your valves and eliminate all microphonic noises.

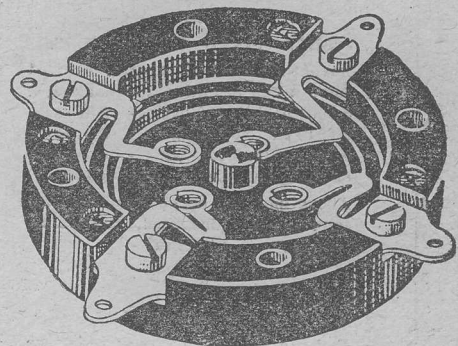

Underside
Showing Springs

Price
2/3

Bakelite
Mouldings
Nickel Silver
Springs
and
Phosphor Bronze
Valve Sockets
Nickel Plated

The LOTUS VALVE HOLDER

is scientifically designed and made
by the manufacturers of the

LOTUS VERNIER COIL HOLDER

OBTAINABLE FROM ALL RELIABLE RADIO DEALERS

Valve Sockets
and Springs
are Locked
Together by a
Mechanical
Process, making
a Definite and
Permanent
Connection

GARNETT, WHITELEY & Co., Ltd.

LOTUS WORKS, BROAD-
GREEN RD., LIVERPOOL





The "Midget" Single-Valve Receiver

We continue to receive enthusiastic letters concerning this compact little one-valve set, and print below further opinions from our readers

A CANADIAN READER'S EXPERIENCE

SIR,—I feel that I must tell you about the remarkable results I have enjoyed with the "Midget" single-valve set described by A. S. Clark in the May, 1925, issue of THE WIRELESS CONSTRUCTOR.

I have logged 97 stations in one month, so you see that it must be an excellent set.

The only alteration that I have made in the set was due to the fact that I was unable to get the Lissenstat Minor, and so had to use a different rheostat. The panel is the same size, however, and as I have to use the American method of mounting, I have had to put the valve inside. The valve used is called a Peanut valve, and is about the size of the Weco valve, using 1.5 volts on the filament and 45 on the anode.

Using the Midget coupled with the unit choke amplifier, as described by John W. Barber in the April 1925 issue, I could work the loud-speaker excellently. Although not up to many sets in volume, it beats them easily in purity and tone. Both units together cost only \$20, or £4. The only difficulty I experienced was in getting a suitable choke coil, and so I had to make one. It was constructed on a $\frac{1}{2}$ in. soft iron core, being wound with 24 S.W.G. d.c.c. wire. All the same, the set is one to be proud of.

The American sets advertised here are not up to it for selectivity and distance, and anyone who wants to get these things at a minimum of cost should make this set.

It might interest you to know that I am only 16 years of age, and the knowledge that I have of wire-

less has been picked up from THE WIRELESS CONSTRUCTOR.

Yours faithfully,
LESLIE NEWTON.

Montreal,
Canada.

HE WON'T PART WITH IT

SIR,—I made up the "Midget" set described by A. S. Clark last May, and the results for one valve are really excellent. As I am writing you I am listening to this evening's programme on a small loud-speaker, and results 3 ft. away from loud-speaker are quite

The "Midget" does not belie its name. The panel measures only 6 ins. x 4 ins., while the box is 4 ins. deep

remarkable (no extra amplification).

My aerial is a single one of the 49 stranded phosphor-bronze type, only 22 ft. long, but 52 ft. high at one end and 45 ft. at the other.

Of course the above results are from Daventry, but it is 100 miles away. When added to an amplifier it is really good strength. I logged 12 stations on headphones, including foreign ones. I shall look forward from time to time to Mr. Clark's further sets. Many thanks for the valuable set. I am building a four-valve, but can assure you I would not part with this little set for anything.

Yours faithfully,
Cleethorpes. A. HARP.

A YOUTHFUL CONSTRUCTOR

SIR,—I am another of your boy constructors, and give you some of my results on the "Midget" single-valve receiver described by A. S. Clark in the May, 1925, issue

of THE WIRELESS CONSTRUCTOR. I get Liverpool, Manchester and Daventry very loud in phones. Other B.B.C. stations received are Belfast, Newcastle, Glasgow, Cardiff, Stoke-on-Trent and Bourne-mouth, although with the latter I experience a little difficulty owing to the proximity of Manchester's wavelength. My foreign ones are San Sebastian, Hamburg, Madrid (EAJ7), Radio Toulouse and Radio-Paris, the first named coming in the best.

All these are obtained on an indoor aerial, the longest stretch being about 15 ft. I have since added a valve amplifier, which considerably improves the strength of signals.

I have had the first volume of THE WIRELESS CONSTRUCTOR bound, and this certainly forms a reliable book of reference.

Wishing your publications every success,

Yours faithfully,
L. WALKER.

Birkenhead.



Mr. Herbert Browne, a well-known tenor, broadcasting from 3LO, Melbourne, Australia.



Stars of All Stations

By "CARRIER-WAVE"



Notes on singers and players we have heard during the past month

FROM a musical standpoint the area served by wireless music might be likened to a solar system. It has its planetary stations, circled in their turn by one or more satellite relay stations. On these the light of certain "fixed stars" may be said to fall constantly, while "constellations" pay periodical visits to all, with the "nebulae" of concert parties, and occasional "comets" of world-famous names which "shoot" across the broadcast path before passing on their way to other worlds beyond the seas. Such names as those of Chaliapine, Tetzlaff, Paderewski and Zacharewitch come readily to our minds.

This month has seen a very steady balance maintained, especially in the provinces, where the predilection for Elizabethan music is not so marked, and the visiting "constellations" have been of the greatest brilliance.

London

Amongst the classical features of the month was the recital of the great Russian pianist Wassili Sapellnikoff. He has broadcast on many previous occasions, and proved his power to play as well before the microphone as on the concert platforms of the world.

He was a prodigy at the age



London listeners have had the pleasure of hearing a recital by M. Sapellnikoff.

of seven, though not of the piano, but of the violin, and made his first appearance at Odessa. Studying both instruments, he was heard at the piano by the great Rubinstein, who immediately advised that he should concentrate on this instrument. With this end in view, Sapellnikoff went to the Conservatoire of Petrograd for five years.



Miss Felice Hyde, who has broadcast from 5WA.

Composer and Pianist

His next appearance was under Tchaikowsky at Hamburg, where his immediate success led to a great Continental tour, which eventually brought him to London, where he introduced Tchaikowsky's own Concerto, once more playing under the baton of the composer. As a pianist and a composer Sapellnikoff has won world-wide honours, and his programme this month included his own "Elfentanz," which has always proved so popular.

Another Virtuoso!

From the classic pianoforte recital to the banjulele is a long step, but there are many admirers of both instruments, and a star performer was Alvin Keech, who has made himself a virtuoso on the banjulele. He was heard in co-opera-

tion with Mr. Liam Walsh, to the accompaniment of Irish pipes.

Manchester

The classical atmosphere also prevails in the district of 2ZY, for is it not the birthplace of the Hallé Orchestra, whose performances for over thirty years have become famous throughout the kingdom? The midday classical concerts at Houldsworth Hall have also made it outstanding, as well as the International concerts organised by Mr. Edward Isaacs, a pianist who has broadcast frequently. Apart from his own recitals, both in the studio and at the concert hall, he has been instrumental in introducing to the city such famous performers as the Flonzaley and Lener Quartets and the Russian Trio.

The 2ZY Operatic Company

On the vocal side, one of the most popular of artists is Mr. Lee Thistlethwaite. To him is given the credit of founding the 2ZY Operatic Company, and with a personal repertoire of forty operas he is able to take up almost any rôle. His voice has been compared to that of Antonio Scotti, and seems to be peculiarly suited for wireless purposes, by reason of its sweetness and subtle timbre. In



Better known as "Cousin Mabel" and "Aunt Maria"—Miss Mabel France, of 5IT.

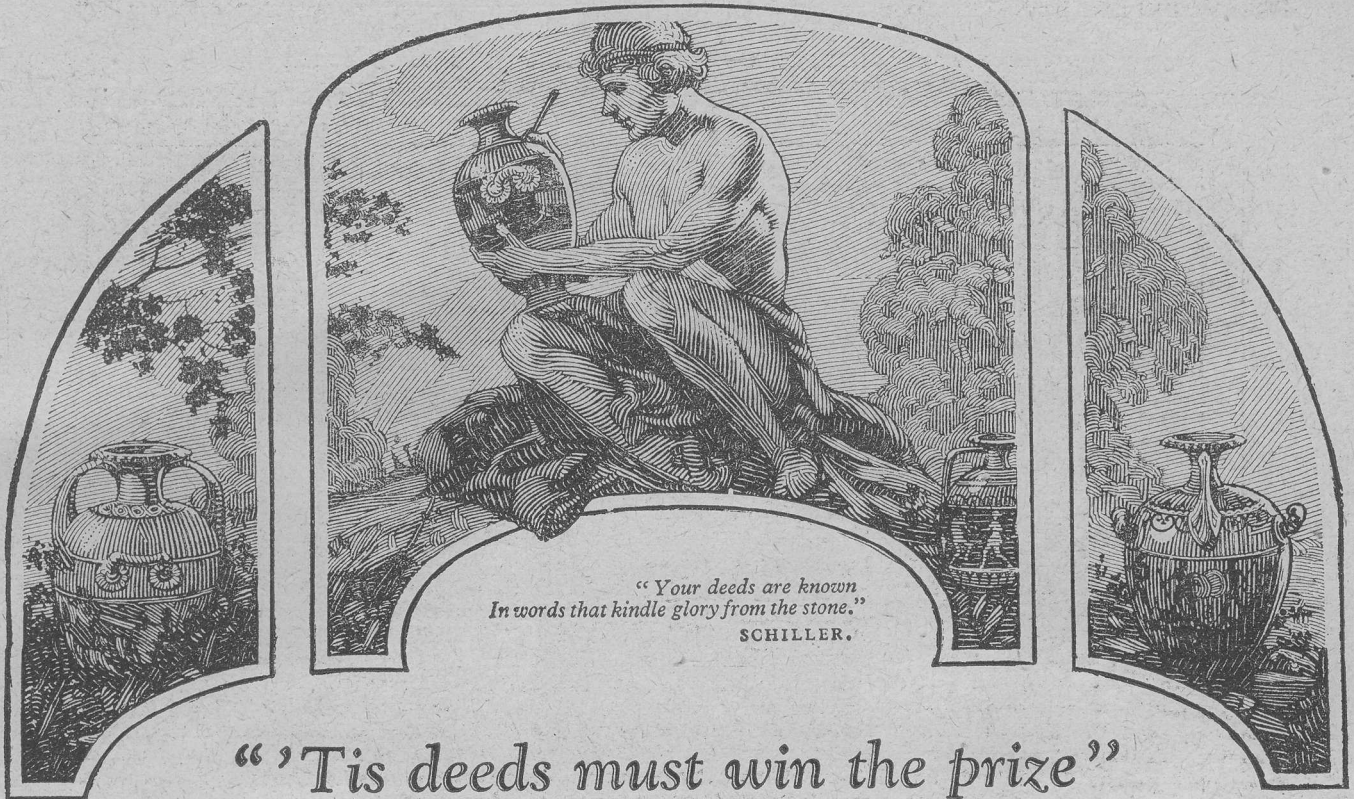

“ ’Tis deeds must win the prize ”

IN years to come, when the story of the Valve is written, certain developments will stand out like landmarks and win imperishable fame for their inventors.

First, the discovery of the electron theory. Later, Dr. Fleming's great contribution to the cause of Radio—the original two-electrode valve and the father of all valves. Afterwards, the addition by Dr. Lee de Forest of the grid, which resulted in the three-electrode valve. And then Valve development halted for several years. A long straight filament enclosed by a spiral grid—the whole being surrounded by a tubular anode.

This was the standard Valve until the year 1922. Obviously it had many disadvantages. A large proportion of its electron emission inevitably escaped from each end of the anode and served no useful purpose. This clearly caused a very serious loss in efficiency.

The spiral grid—owing to its lack of rigidity—was a fruitful cause of microphonic noises. The straight filament—tightly stretched to prevent sag—readily fractured and the Valve became useless. In 1922 there appeared a new Valve—one destined to win immediate recognition—the Cossor.

For the first time there was used in any Valve an arched self-supporting filament. A grid so rigid as to be utterly vibration-proof. And a hood-shaped anode which enclosed practically the whole of the electron stream. All of which were entirely original and exclusive features.

In three short years Cossor has triumphantly vindicated that its unique principles of design are correct. More than one of its features have been adopted by other makers. But Cossor users are not misled—for Cossor results are obtainable only by the combination of *all* these features.

For 2-volt Accumulators.

- W.1. For Detector and L.F. use - 14/-
Consumption: .3 amp.
- W.2. (With red top) For H.F. use - 14/-
Consumption: .3 amp.
- W.3. The Loud Speaker Valve 18/6
Consumption: .5 amp.

For 2, 4 or 6 Volts.

- W.R.1. Similar to W.1 but with special resistance which can be short-circuited when not required - - - 16/-
- W.R.2. Similar to W.2 but with resistance as above 16/-

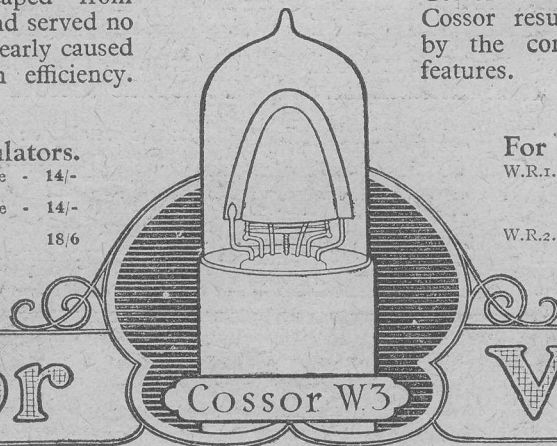

Cossor Valves

A. C. Cossor, Ltd., Highbury Grove, N.5

Gilbert Ad. 4350

In replying to advertisers, please mention THE WIRELESS CONSTRUCTOR.

THE FIRST WIRELESS LOUD SPEAKER WAS A BROWN



Hear the liquid-clear tones of the incomparable Brown

UNTIL you have heard the Brown you can have no idea of the true beauty of its tone. Designed and perfected by an eminent scientist and built in one of the finest factories of its type in this country, it has indeed won an international reputation. In almost every country of Europe, in Canada, in Australia, in South Africa, in Japan, you'll find Brown prestige steadily growing. Each week sees the Brown making new friends—radio enthusiasts who for the first time are obtaining the mellowness and fidelity of tone which can only come from an instrument

scientifically correct in every detail from base to flair. Each week sees existing users steadfastly proclaiming their loyalty and enthusiasm for the Brown superb standard of performance.

In all probability you own a good Receiving Set—in justice to yourself—and to those you aim to entertain—you should use a Brown Loud Speaker. With its unique aluminium diaphragm and super-sensitive tuned reed, it is able to reproduce every note of the harmonic scale with a truthfulness and accuracy which is almost uncanny. There is no substitute for a Brown.

Description of Brown Instruments shown above:

Brown H.1
Height 27 ins.
£5-5-0 to £5-10-0
according to resistance

Brown H.4
Height 10 ins.
2000 ohms only
30/-

Brown Cabinet
In Mahogany or Oak
2000 or 4000 ohms
£6-6-0

Brown Headphones
New A-type.
2000 ohms
30/-

Brown H.Q.
Height 20 ins.
2000 or 4000 ohms
£6-0-0

Retail Showrooms: 19 Mortimer St., W. 1. 15 Moorfields, Liverpool; 67 High St., Southampton.

S. G. Brown, Ltd., N. Acton, London, W. 3

Depots (Wholesale only): 13 Bushy Park, Bristol. Cross House, Westgate Road, Newcastle

BRITISH

Brown

THROUGHOUT

one of the earliest of the festivals he was chosen as Valentine for the Marguerite of Mignon Nevada, Mephistopheles of Robert Radford and the Faust of Vladimir Rosing, all three of the above artists having



Miss Mary Lohden is a vocalist familiar to Bournemouth listeners.

broadcast during the past month. Though this fact is not so generally known, Mr. Thistlethwaite is a virtuoso of the oboe, and that rarest of wood-wind instruments, the oboe-d'amore, which instrument he has played for several seasons in the Hallé Orchestra.

Birmingham

It is very difficult to choose the stars of 5IT, because of the high standard maintained. An artist, however, who enjoys acting in a dual rôle is Miss Mabel France, who has "faced the microphone" nearly a hundred times. Her first broadcasts were made at Birmingham, where she began her famous series "Everyday Problems," and since then she has toured the stations.

She says that she most enjoys being "Cousin Mabel" in the Children's Hour, and "Aunt Maria" in the evening. Some of her most recent talks are now to be published. Miss France is closely connected with the stage, and her sister, Miss Isabel Thornton, has been in the whole run of "The Farmer's Wife" at the Court Theatre, London. Birmingham has had its fair share of celebrities recently, these including Mrs. George Cadbury, in an address, and the B.N.O.C. stars, Gertrude Johnson, Constance Willis and Parry Jones.

Cardiff

No other country, except Australia, has produced so many fine singers as the "Principality," and it is safe to say that singing is one of the "chief occupations of the people," to quote our old geography

books. Miss Gwladys Naish, who paid another visit recently to her native city, is known as the Welsh Nightingale, and her knack for bravura and singing of the coloratura type stands supreme. A graduate at the University of Wales, Miss Naish was one of the early broadcast stars, and her singing of the difficult "Bell Song" from Delibes' opera "Lakmé," as well as her capacity for turning to the simpler themes of Hurlstone and Purcell, have established her claims very firmly.

Cardiff has another fine singer in Felice Hyde, her operatic performances being known over a very wide area.

Newcastle

Singing is a great feature of 5NO, and artistes with good voices are appreciated by the Tynesiders. A singer heard recently was Miss Beatrice Paramor, who tells a good story against her stature. Miss Paramor is small, but her voice is powerful, and at her early appearances it was feared that unless she stood near the microphone, she would not be heard "over the æther." Miss Paramor knew better, but obeyed, and after her first few notes she was literally "grabbed away," and henceforward allowed to choose her own distance.

Miss Mavis Bennett, whom wireless music has literally brought to the hearts of the public, Vivienne



Mr. Lee Thistlethwaite is the founder of the 2ZY Operatic Company.

Chatterton and Dennis Noble are also amongst the other celebrities.

Bournemouth

In the south a highly cultivated musical taste prevails, and it is always safe to tune in to 6BM for real artistic concerts. A familiar singer at this station is Miss Mary Lohden, who sang in London last year. Frequent broadcasts have

been obtained through the medium of the Royal Bath Hotel String Quartet, directed by a brilliant musician, Mr. Gilbert Stacey. Other recent visitors have been Jaye Kaye and Ray Wallace for the entertain-



A folk-song enthusiast—Mr. Dale Smith, baritone.

ment side, and Yorke Bowen for classical music.

The Northern Cities

In the North, Mr. Augustus Beddie is always appreciated both for his stories and his readings, while Mr. Herbert Carruthers has continued throughout the month his scheme of playing Beethoven. Two famous singers have figured at Aberdeen, Mr. Leonard Gowings and Mr. Dale Smith. The latter is a Manchester man, who commenced his musical career as a choir boy at Manchester Cathedral, and was a former student of the Royal Manchester College. He has made a special forte of Lieder and Folk Songs, and his visit to Aberdeen showed a fresh type of music.

*The Simply-Made
Single-Valve Set*

SIR,—These are the stations I have logged on the "Simply Made Single Valve Receiver," described by Percy W. Harris, M.I.R.E., in the December, 1924, issue of THE WIRELESS CONSTRUCTOR, although no amplifier of any description was used: 2LO, 2BD, 2BE, 5IT, 6BM, 5WA, 5XX, 2EH, 6LV, 2ZY, 5NO, 5NG, and the following Continentals: Madrid, Hamburg, Lausanne (HB2), Munich, and Hilversum. These Continental stations were faint, but nevertheless their call-signs were heard.

Wishing the CONSTRUCTOR every success.

Yours faithfully,
H. P. CHATHAM.

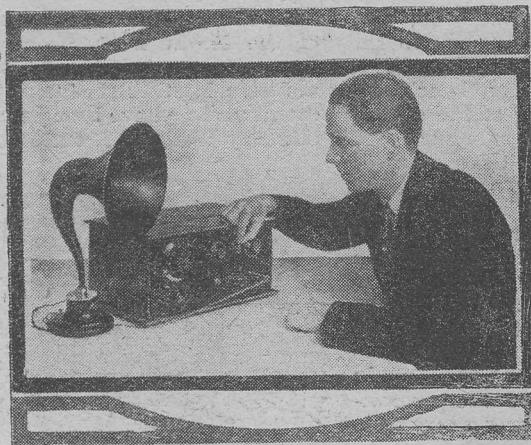

The "TWO-IN-ONE" RECEIVER

By
PHILIP H. WOOD, B.Sc.(Hons.), F.P.S.L.

A loud-speaker set employing crystal or valve rectification as required

THE home-constructor is not infrequently torn between conflicting desires when he contemplates building something more pretentious than a single-valve or crystal receiver. Probably the most popular two-valve set at the present time is that employing a valve as rectifier, with reaction, followed by a single stage of note magnification, usually transformer-coupled.

The Oscillation Nuisance

Unfortunately, such a receiver, though very efficient and comparatively "harmless" in the hands of its owner, can give very disappointing results when controlled by any inexperienced members of the family. Indeed, it is extremely likely under such circumstances to cause serious inconvenience to neighbouring listeners, as quite unintentionally the novices in the

radio art will probably push the reaction coupling too far, over-run the valve filaments, or in some other way cause the set to go into oscillation.

Now, while not wishing to deprive Captain Eckersley of an opportunity to continue his game of chasing the oscillator, it must be admitted that a man whose set re-radiates is an intolerable nuisance to other listeners. Hence, in designing the present receiver provision has been made both for the "expert" who uses reaction and for the other uninitiated members of the family who wish to listen without fear of causing trouble to others.

Purity of Tone

Another point is that in the "safer" of the two circuits employed a crystal is used as a detector. Probably most readers are familiar with the purity of tone

associated with this means of rectification, and all who construct this set will have an opportunity of testing the superiority of the crystal over the valve as far as faithful reproduction is concerned.

Circuits Employed

The theoretical circuit is shown in Fig. 1. A four-pole double-throw switch has been used, shown diagrammatically for the sake of clearness as four separate switches S_1, S_2, S_3 and S_4 . Three dots are used to denote each switch, the centre dot representing the terminal to which the switch arm is pivoted, and the other two dots representing the alternative points to which connection may be made in each case by means of the switch arm. It must be remembered that in the actual receiver all four switches are incorporated in one component,

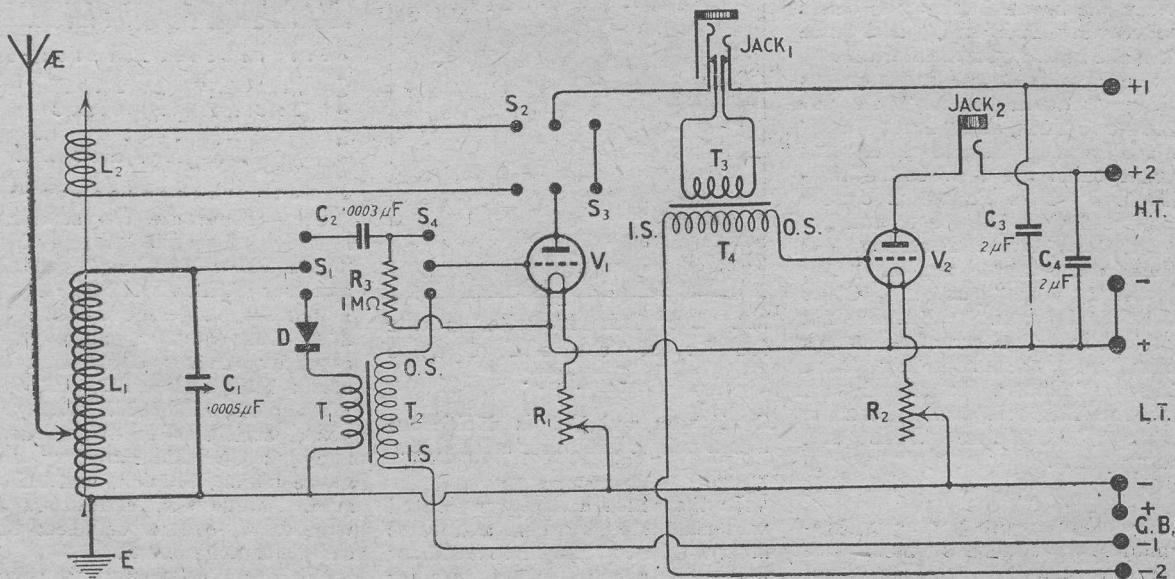

Fig. 1.—The theoretical circuit of the receiver, in which the four-pole double-throw switch is represented by S_1, S_2, S_3, S_4 .

a single lever effecting the change-over of all four at once.

Switching Arrangements

If the switch arms are now set over to the left in the case of S_2 and S_3 and to the upper points in the case of S_1 and S_4 , we shall have a circuit consisting of a detector valve V_1 , in the anode (or "plate") circuit of which is the reaction coil L_2 coupled to the aerial coil L_1 , followed by a transformer-coupled amplifying valve V_2 . L_1 is tuned by the variable condenser C_1 , and connected at one end to the grid of V_1 by the switches S_1 and S_4 and the grid condenser C_2 . R_3 provides the necessary leak from the grid of the valve to the positive filament lead. The rectified current then passes from the anode of V_1 through the reaction coil L_2 via switches S_3 and S_2 to the primary T_3 of the low-frequency intervalve transformer T_3, T_4 , the other end of the primary being connected to H.T. +r.

One end (OS) of the secondary T_1 of the transformer is connected to the grid of V_2 , the amplified anode current being taken to the telephones or loud speaker plugged into jack 2, and thence to H.T. +2. The other end of the secondary goes to a negative tapping on the grid-bias battery, the positive of which is connected to I.T. -.

The Alternative Circuit

In the case of the alternative circuit, with all four switches set in the opposite direction, S_1 connects the tuned aerial circuit L_1, C_1 to the crystal detector D (see Fig. 1), the other side of which is connected to the primary T_1 of the transformer T_1, T_2 . The secondary of this is connected to the grid of V_1 via switch S_4 , the anode going to the second transformer T_3, T_4 .

Both the valves act as note magnifiers, a negative bias being applied to each grid via the secondaries of their respective transformers. The switches S_2, S_3 completely cut out the reaction coil L_2 , and we have a straight-forward circuit consisting of a crystal detector followed by two transformer-coupled note magnifiers—a combination which normally will cause no interference to other listeners, and which has but one tuning control, the variable condenser C_1 .

Points of Interest

There are certain features common to both circuits which are worthy of mention. The first is that the aerial tuning circuit L_1, C_1 remains the same in both cases, while low-tension negative is always

connected to earth to avoid the trouble of low-frequency howls which might otherwise occur. The valves are provided with separate high-tension and grid-bias valves, but the negative bias on V_1 is automatically converted to a positive bias when this valve is used as a detector.

The condensers C_3 and C_4 are of Mansbridge type, each of $2\mu F$ capacity, and act as reservoir or smoothing condensers to minimise the effects of slight variations in H.T. voltage due to a battery which may have deteriorated to some

By changing over the four-pole switch:—

(c) Crystal detector plus one stage of low-frequency amplification ($D+V_1$; telephones or loud-speaker plugged into jack 1).

(d) Crystal detector plus two stages of low-frequency amplification ($D+V_1+V_2$; loud-speaker plugged into jack 2).

Components Needed

Beyond the extra transformer, four-pole switch and crystal detector, the list of components varies little from that necessary for

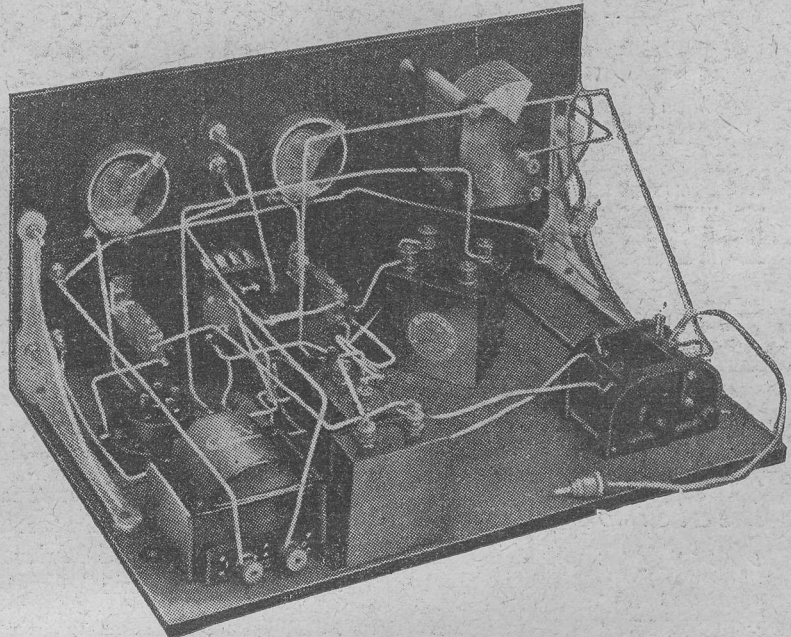

A back-of-panel view. The first-stage transformer T_1, T_2 is in the foreground. Note the G.B. + Plug.

extent. These condensers are not essential to the effective operation of the set, but will help to prolong the useful life of your high-tension batteries.

Use of Plugs and Jacks

Another feature is the use of jacks in the anode circuits of both valves, enabling the telephones or loud-speaker to be plugged in after either the first or second valve to obtain the volume desired. Thus, if the telephones are plugged into jack 1, the transformer T_3, T_4 and the valve V_2 are cut out of circuit.

Hence you have as a matter of fact four possible circuits at your disposal:—

(a) Valve detector with reaction (V_1 ; telephones plugged into jack 1).

(b) Valve detector with reaction plus one stage of low-frequency amplification ($V_1 + V_2$; telephones or loud-speaker plugged into jack 2).

an ordinary two-valve set. The complete list is given below, together with the names of the manufacturers whose components were used. It is understood, of course, that goods of other reputable makes should give equal results, although the question of size must be borne in mind as this may seriously affect the layout of the receiver.

You will require:—

One 4 in. Radion dial (American Hard Rubber Co., Ltd.).

Panel, $14 \times 7 \times \frac{3}{8}$ in., Radion Mahoganite (American Hard Rubber Co., Ltd.).

One $.0005\mu F$ square-law variable condenser (Jackson Brothers).

One "Therla" $.0003\mu F$ grid condenser, with clips (Sel-Ezi Wireless Supply Co., Ltd.).

One $1M\Omega$ Ediswan grid-leak (Edison-Swan Electric Co., Ltd.).

Two $2\mu F$ Mansbridge condensers (Telegraph Condenser Co., Ltd.).

For Range, Selectivity and Stability

The



"DIMIC" COIL

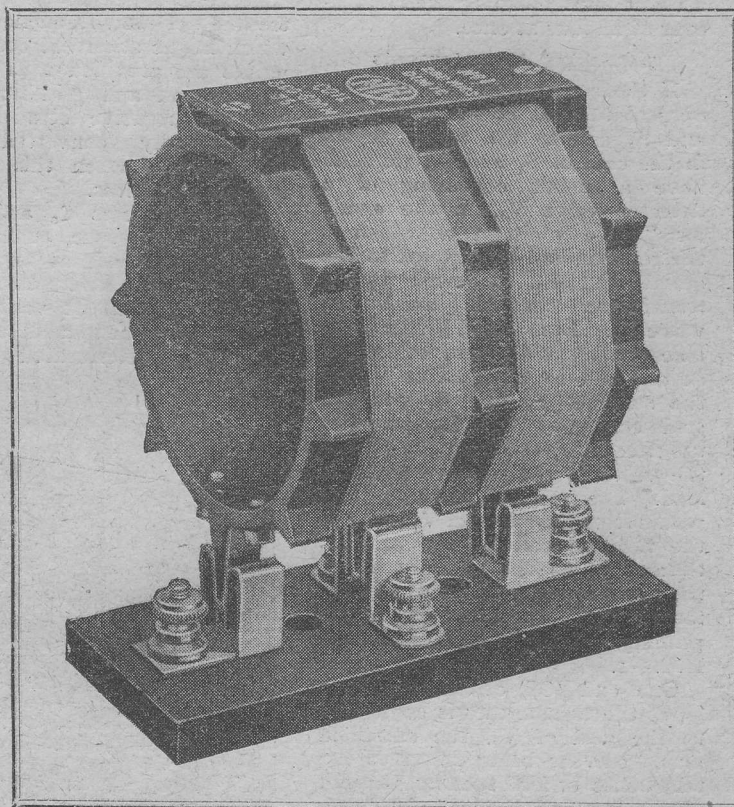

Reg. No. 717674. No. 1. 200 Microhenries. 300-600 M. Pats. pending.

Ask your
Dealer to
show you
the
"DIMIC"

TO those who, constructing their own sets for the first time, desire range selectivity and stability, the "Dimic" Coil offers a certain and satisfactory solution. To those who wish to improve or add to existing sets this component

gives an adaptability and efficiency hitherto unobtainable.

To the advanced experimenter the design speaks for itself. The complete series will finally be available covering all wavelengths from 20 to 7,000 metres and fitting the standard base.

PRICE	
"DIMIC" COIL No. 1 (300-600 M)	10/-
"DIMIC" COIL No. 1a (450-900 M)	10/-
"DIMIC" COIL No. 3 (1100-3000 M)	10/-
Base extra	2/6

What the "DIMIC" COIL is—

First and last a highly efficient inductance of a particular form. (Patents pending).

What the "DIMIC" COIL does—

- Provides:
- (a) A perfect aerial tuning inductance of two ranges, or "centre tapped."
 - (b) A perfect H.F. intervalve coupling. (Auto transformer, Neutrodyne, Tuned Anode or loosely coupled transformer.)
 - (c) A unit applicable to a multiplicity of uses, details of which will be published from time to time.

What the engraving on each "DIMIC" COIL means—

- "No. 1." Equivalent in wavelength to our standard barrel type transformer.
- "200 μ H." The actual inductance of the whole coil plus or minus 1 per cent.
- "300-600M." Wavelength covered by the whole when tuned with a '0005 variable condenser.
- "75." The number of duolateral coil for which the "Dimic" with its higher efficiency may be substituted.

Head Office & Works:
WEXHAM ROAD, SLOUGH
BUCKS.

Telephone: SLOUGH 441 & 442
TELEGRAPHIC ADDRESS: RADIETHER, SLOUGH.

L.M. MICHAEL LTD

Manufacturers of Wireless and Scientific Apparatus
WEXHAM ROAD, SLOUGH, BUCKS.

London Office & Wholesale Showrooms:
HASTINGS HOUSE,
NORFOLK ST. STRAND, W.C.2

Telephone: CENTRAL 8272
CABLE ADDRESS: RADIETHER, SLOUGH

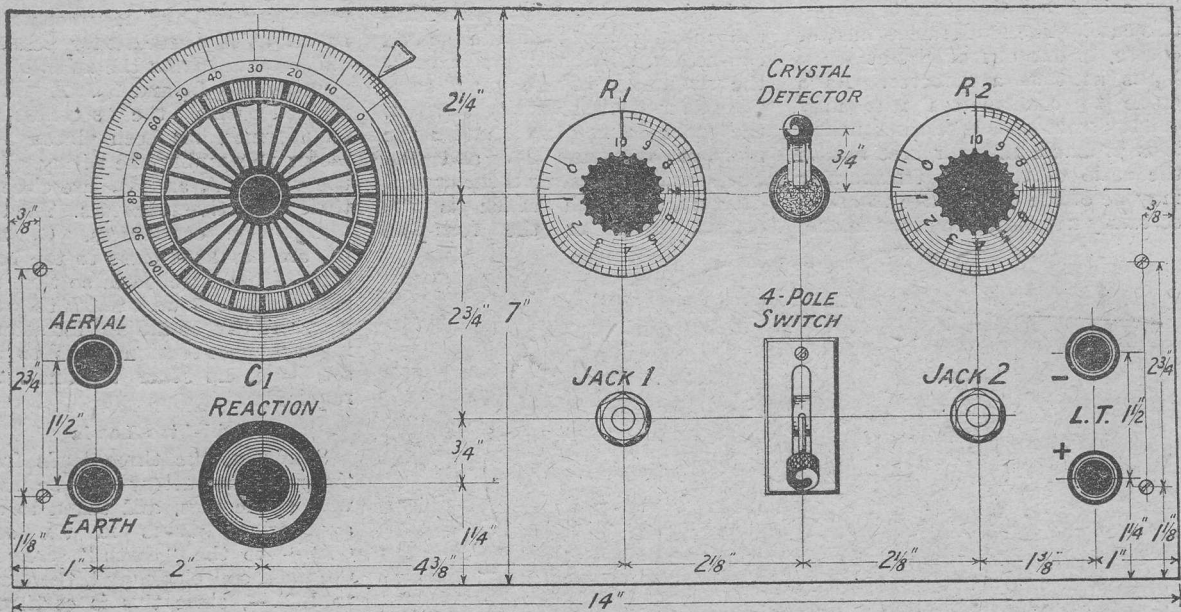

Fig. 2.—The panel layout and drilling dimensions. Blueprint No. C1031A, price 1/6, post free.

One "Utility" four-pole double-throw switch, lever type (Wilkins & Wright, Ltd.).

One C.A.V. first-stage L.F. transformer (C. A. Vandervell & Co., Ltd.).

One Ironclad L.F. transformer, type B.4 (Fuller's United Electric Works, Ltd.).

One Lotus two-coil holder (Garnett, Whiteley & Co., Ltd.).

Two Magnum Vibro valve holders (Burne-Jones & Co., Ltd.).

One single-circuit telephone jack (Ashley Wireless Telephone Co.).

One double-circuit telephone jack (Ashley Wireless Telephone Co.).

Two telephone plugs (Ashley Wireless Telephone Co.).

Polar crystal detector (Radio Communication Co., Ltd.).

Two Camco panel brackets (Carrington Manufacturing Co.).

Two Peerless rheostats (Bedford Electrical & Radio Co.).

One Decko dial indicator (A. F. Bulgin & Co.).

One spring clip (Peto-Scott Co., Ltd.).

Four Belling-Lee indicating terminals (L.T.—, L.T.+, aerial, earth) (Belling & Lee, Ltd.).

Glazite, for wiring (London Electric Wire Co., Ltd.).

Four 3/4 in. 4B.A. countersunk screws (for fixing brackets to panel).

Spade tags, flex, wood screws, wander-plugs, etc.

Cabinet to take panel 14 x 7 in., with loose baseboard 14 x 8 1/2 or 9 in. ("S.A. Cutters," Ltd.).

Notes on Components

There are one or two points worthy of mention in connection

with the components listed above. In the original set shown in the accompanying photographs I have used 30-ohm rheostats, since dull-emitter valves were employed. These rheostats are not, as a rule, wound with a sufficiently heavy gauge of wire to carry the current demanded by a bright-emitter valve without overheating, so, if you intend to use bright emitters, you should get filament resistances of the 7- or 10-ohm pattern. Better still, buy the dual type of rheostat (either of the make mentioned above or some other good brand), and you will then be prepared for all eventualities.

The Mansbridge condensers have been mentioned previously, while the grid condenser is of usual value. The grid-leak R_3 used has a resistance of 1 megohm, but this value, while suiting my own particular requirements, is not critical. The grid leak, however, should certainly not have a resistance exceeding 2 megohms, otherwise there will be a tendency for the grid to get "choked up."

Transformer Ratios

A ratio or "first-stage" transformer has been used in the set to couple the crystal to V_1 , while the second transformer T_3, T_4

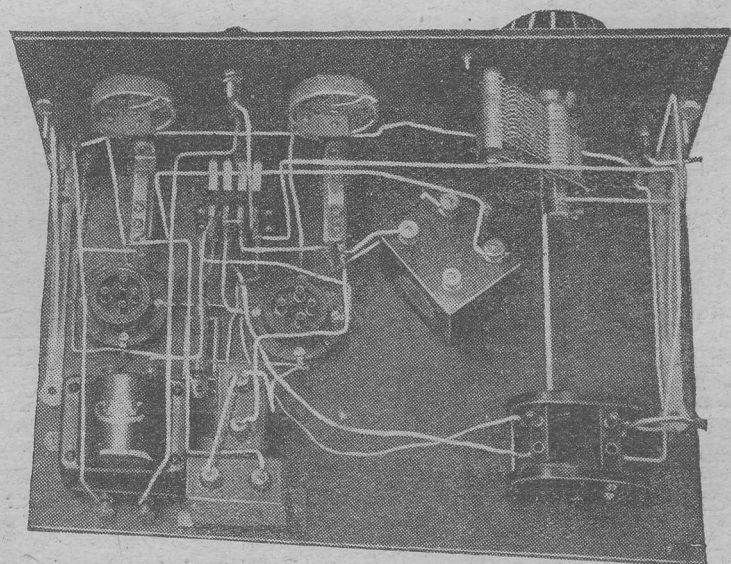

The relative positions of the baseboard components are shown in this photograph.

has a higher ratio—four to one in this case. The first transformer, of course, is cut out of circuit when V_1 is used as a detector. As a guide to constructors who may employ transformers of other makes, it is probable that for best results the ratio of the first transformer may be of the order three to one—certainly not more than four to one,

which is seen the knob controlling the moving block of the geared coil-holder. To the right of these the remainder of the panel components are symmetrically disposed, the jacks being placed under the filament rheostats R_1 and R_2 . Between the rheostats is the crystal detector, beneath which is the control lever of the four-pole

transformers have been separated, as far as is conveniently possible, and removed from the fields of the plug-in coils L_1 and L_2 . It will be noticed that the second-stage transformer, has been placed near jack 1 to simplify the wiring, while the valves V_1 and V_2 are close to their respective rheostats. The two Mansbridge condensers, C_3 and C_4 , are mounted close to the back edge of the baseboard, so that the small terminals with which they are provided can be utilised for attaching the high-tension leads to the set, hence no other terminals are required.

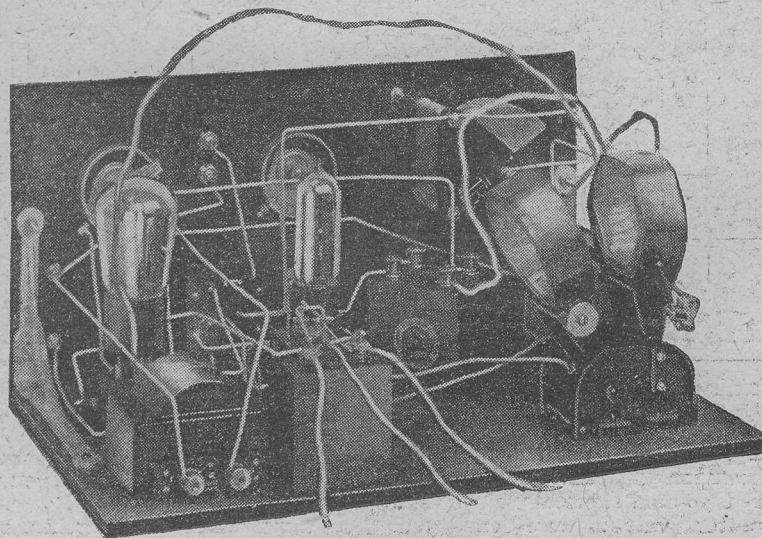

A view of the set with coils and valves inserted. The grid-bias battery is placed behind the coil-holder.

while the second transformer T_3, T_4 may have a ratio of four or five to one.

Useful Refinements

You will notice that a 4 in. dial has been specified for the receiver. This is intended for the variable condenser C_1 , being fitted instead of the knob and dial supplied with the instrument. This is really in the nature of a luxury, but it greatly improves the appearance of the set and facilitates tuning. Those who do not wish to purchase a large dial will use the 3 in. dial supplied with the condenser.

Since, as mentioned above, dull-emitter valves are used, anti-vibration valve-holders to minimise microphonic noises are specified. The "Polar" detector consists of a strip-metal contact mounted with a knob on a pin, and a screw-in crystal mounted in an ebonite cup on a second pin. This form of "whisker" gives the stable contact necessary when a detector is followed by one or more amplifiers, while the pin-and-socket mountings enable crystal and contact to be interchanged should such a course appear desirable.

Panel Layout

The panel layout is shown in Fig. 2. On the left is the dial of the variable condenser C_1 , under

switch. The four insulated-type indicating terminals are placed as shown, those for aerial and earth on the left and the two low-tension terminals on the right.

If panel brackets are used, holes must be drilled for them in the

Grid-bias Leads

Similarly, the three leads from the grid-bias battery may be fitted with spade tags, and taken to the appropriate places in the set: G.B. + to the "earth" screw of the fixed coil block (and, therefore, to L.T. -, since this is earthed); G.B. -1 to the IS terminal of the first-stage transformer; and G.B. -2 to the IS terminal of the second transformer. Sufficient space has been allowed for many types of grid battery to be placed inside the cabinet between the coil-holder and variable condenser.

Jack Connections

The jack connections deserve special mention, as it is essential that they should be arranged in such a manner that the steady anode current will flow through the telephones or loud-speaker in the same direction irrespective of the jack into which they may be

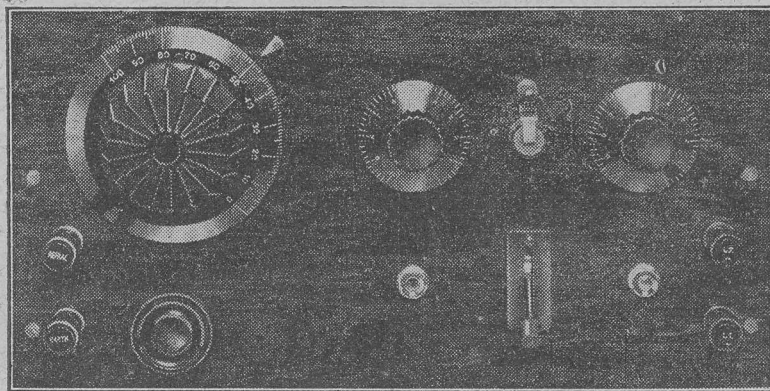

The large dial greatly improves the appearance of the panel.

positions indicated; but if the panel is merely screwed to the baseboard by means of wood-screws, the necessary holes should be drilled and countersunk near the lower edge.

Baseboard Arrangements

In Fig. 3 may be seen the baseboard layout and wiring. The

plugged. The primary of the transformer T_3, T_4 has its ends connected to the two short inner contact arms of jack 1, while the shorter of the two outer arms—that to which the knob of the plug makes contact—is connected to one soldering tag of condenser C_3 , the terminal being utilised for the H.T. +1 lead.

The remaining contact of this

WIRELESS IN EVERY ROOM - 10/-!



The Ducon

If your house has electric light a Dubilier Ducon enables you to do two things:—

1. To run your set without erecting an aerial.
2. To use your set in any room you like.

The Ducon converts your electric wiring system into an aerial. All you do is to plug it into the lamp socket, and connect it to your set according to the instructions.

The Ducon does *not* use any electric current, and does *not* interfere in any way with your lighting system.

Over 500,000 Ducons are now in use all over the world. The price is 10/-. (Note that the Ducon is not recommended for use with crystal sets.)

The Dubilier Condenser Co. (1925) Ltd., manufacture Fixed Mica Condensers, Variable Air Condensers, Anode Resistances, Grid Leaks, the Dubrescon Valve Protector, the Ducon Aerial Adaptor, the Minicap Switch, and the Mansbridge Variometer.

The company are also sole concessionaires for the products of the Mansbridge Condenser Co., Ltd.

Specify Dubilier



ADVERT. OF THE DUBILIER CONDENSER CO. (1925) LTD., DUCON WORKS, VICTORIA ROAD, NORTH ACTON, LONDON, W.3.

TELEPHONE: CHISWICK, 2241-2-3
E.P.S. 153

In replying to advertisers, please mention THE WIRELESS CONSTRUCTOR.

The Microstat

This sectional drawing shows the ingenious spring device which entirely eliminates the danger of "packing."

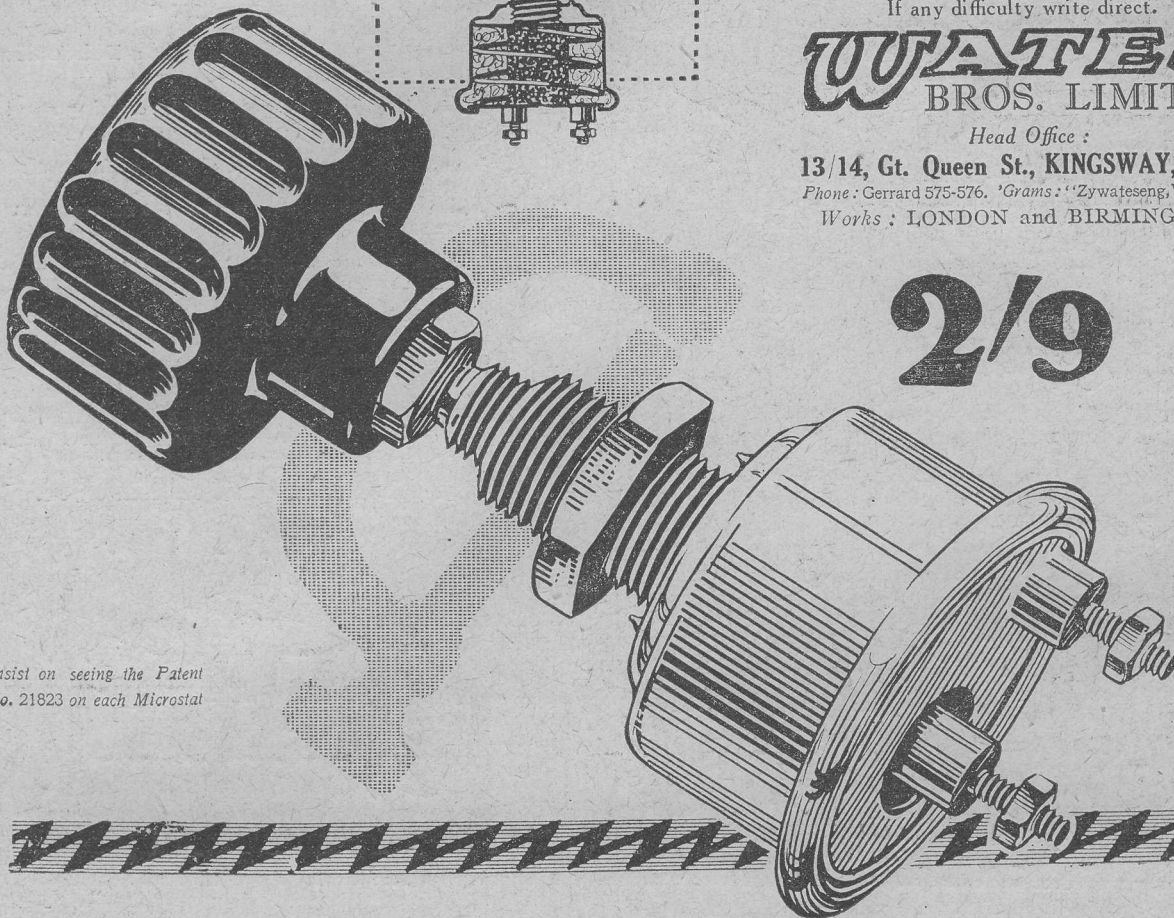
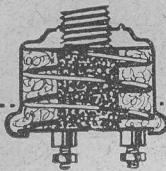

Insist on seeing the Patent No. 21823 on each Microstat

FILAMENT RESISTANCE

Gives the most delicate Filament Adjustment

Its silky and silent action gives an infinite graduation of resistance which will reduce your valve costs considerably.

The sudden "switch on" or "switch off" of the ordinary wire resistance does considerable damage to the delicate filament. With the Microstat these shocks are eliminated and the life of your valves lengthened in consequence. No other rheostat—even if it costs twice as much—can possibly be a more effective protection for your valves, or give you greater assistance in obtaining the most delicate tuning. Its resistance ranges from zero to 100 ohms.

Use a Microstat on your H.F. Stage and note the improvement in tuning. You will soon change all your other rheostats.

Our files contain many letters of appreciation from users, and the Microstat has received lavish praise throughout the whole of the Radio Press.

One Hole "Fast Lock" Fixing.

Minute Underpanel Space.

No Soldering.

Suitable for Bright or Dull Emitter Valves.

Yet its price is but

2/9

Your Dealer stocks Microstats—get one to-day.

If any difficulty write direct.

WATERS
BROS. LIMITED

Head Office:

13/14, Gt. Queen St., KINGSWAY, W.C.2

Phone: Gerrard 575-576. 'Grams': 'Zywatereng, Westcent'

Works: LONDON and BIRMINGHAM

2/9

jack is the one with which the stem of the plug comes in contact, and should be connected to the reaction coil L_2 via switch S_2 .

In the case of jack 2 the socket and frame of the jack are connected to the anode of V_2 , while a lead from the single contact arm is taken to C_1 , and therefore to H.T.+2. Hence in both cases the knob of the plug is connected to high tension+, and the steady anode current will always flow in the same direction through the telephones. The positive tag of the telephones or loud-speaker must be connected to the knob when fitting the tags to the plug or plugs.

It is as well, of course, to employ one plug for the loud-speaker and another for the telephones, so that either may be used at will, plugged into either jack.

At first sight one might imagine that the four-pole switch would cause a great deal of trouble in the wiring operations. This is not the case, however, if the wiring procedure is carried out as below, especially as these switches are sold to the public with their twelve soldering tags ready tinned.

Mounting Panel Components

First mount all panel components in the positions indicated in Fig. 2. The one-hole fixing components

will require $\frac{3}{8}$ in. holes, and the terminals $\frac{1}{16}$ in. holes. In mounting the variable condenser I made use of the hint given in last month's "Practical Workshop Hints," and threaded a small screw through the panel and end-plate of the condenser to prevent the latter slipping round on the highly-polished surface of the panel.

Slot for the Switch

A slot $\frac{3}{8}$ in. wide by $1\frac{1}{4}$ in. long is required for the lever of the switch, and this may be made by drilling a row of $\frac{1}{16}$ in. diameter holes in the appropriate position, and cutting away the webs between them with a small file or

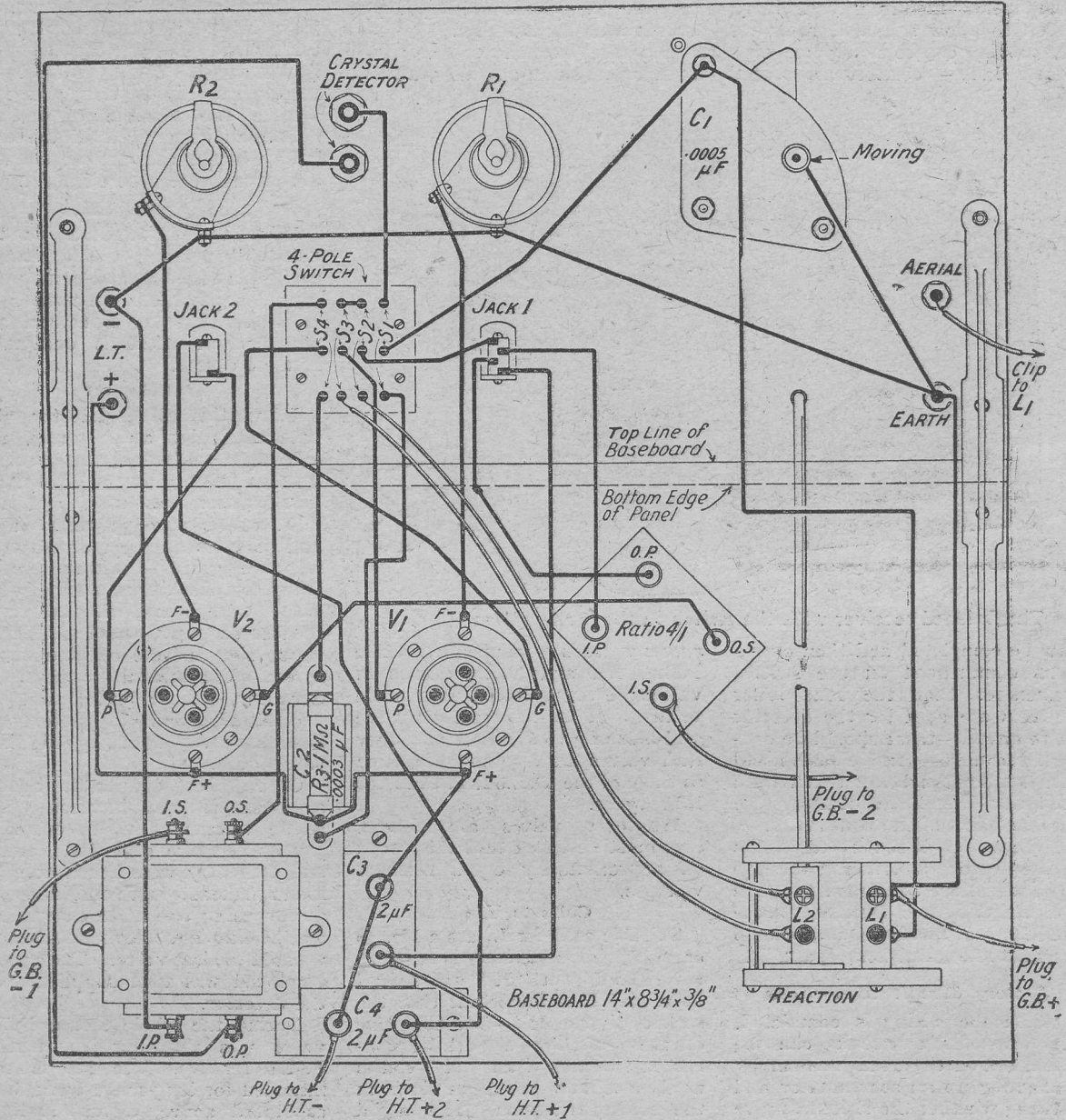

Fig. 3.—This wiring diagram is a small reproduction of blueprint No. C1031B. Note the battery and transformer connections.

saw. The slot can then be finished off with a file, and the two additional holes for the switch fixing screws drilled. The dial indicator requires a 6B.A. clearance hole, and its position will depend on individual taste.

Wiring Procedure

First of all solder the lead from the L.T. — terminal to the rheostats and earth. A flexible lead fitted with a coil clip should be soldered to the aerial terminal, and a lead taken from earth to the moving plates of the variable condenser. The panel should now be fitted to the baseboard, and the remaining components mounted, care being taken to allow sufficient room for the moving coil to swing freely.

The L.T. — connections should

appropriate flexible leads, which may be brought outside the cabinet by drilling small holes in the back.

Valves and Coils

The first valve V_1 should preferably be of a general-purpose type, since it has to function as both detector and L.F. amplifier, according to the setting of the switch. If you intend to use dull emitters, a .06 ampere G.P. valve, such as the D.E.3 or A.R.06 should be employed, with 30 to 50 volts H.T. when used as a detector, and about 80 volts H.T. with 3 volts grid-bias when used as a first-stage amplifier after the crystal. R., D.E.R. and R.5V. type valves are also suitable.

For the second valve, which always acts as an amplifier, a small

lead which goes to the socket of the fixed coil block.

For the reaction coil L_2 a No. 35 or 50 plug-in coil will do, the former size probably being ample in most cases.

When Daventry is to be tuned in a No. 150 coil is suitable for L_1 with a No. 200 for L_2 .

Operation

The operation of the set is very easy. It will be best to start with the valve detector arrangement—*i.e.*, with the switch-lever in the "up" position, and the telephones or loud-speaker plugged into jack 2. Using suitable coils, the local station should be heard at good strength without the use of reaction. Now bring L_2 closer to L_1 , re-tuning on C_1 as the coupling is increased. Signals should get louder as this is done; if not, reverse the flexible connections to the moving block of the coil-holder, when the desired reaction amplification will be obtained.

The Crystal Circuit

With the switch-lever in the "down" position the crystal is used as a rectifier, and tuning and crystal adjustments are carried out as in the case of a crystal set. No reaction effect is obtainable here, of course.

Test Report

Using the valve detector plus note magnifier arrangement, full loud-speaker strength was obtained 8 miles from 2L.O. A Brown H₃ loud-speaker was used, and the H.T. values were 39 volts on V_1 and 96 volts on V_2 , with 4½ volts negative grid-bias on the latter. Daventry, Birmingham and Radio-Belge were heard at fair loud-speaker strength, while good telephone signals were obtained from several Continental stations in Germany, France and Spain.

5XX, 2L.O and 5IT gave strong headphone signals using the first valve only.

On switching over to the crystal arrangement and increasing the anode voltage of V_1 to 60, with 3 volts negative grid-bias, London and Daventry were heard at good loud-speaker strength and increased purity using two note magnifiers, and at excellent telephone strength without the last valve. The crystal employed was that supplied with the detector.

During the whole test a D.E.3 valve was used for V_1 , and a P.M.4 for V_2 . The set is not intended for long-range work, but, as stated above, distant stations may be received under favourable conditions. On testing this receiver at our Elstree Laboratories the above features were borne out.

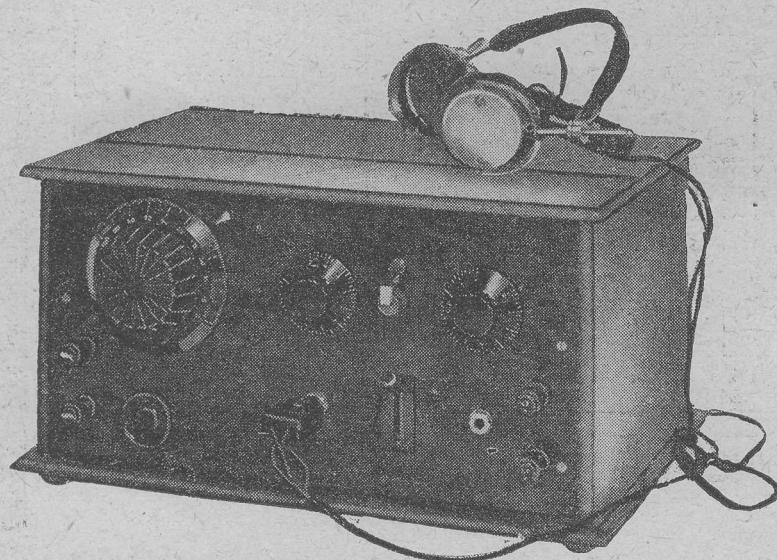

The finished receiver with the switch in the "valve" position.

now be completed and then operations commenced on the switch. Remember that the four lower contacts are used for the detector valve circuit—these should be connected up first—flexible leads fitted with spade tags being taken from the lower S_2 and S_3 contacts to the moving block of the coil-holder.

Next wire up the four central tags of the switch, and finally the top ones, which are concerned with the crystal circuit. Finally, make the L.T. + connections, and wire up the reservoir condensers C_3 and C_4 .

Battery Circuit Connections

When the wiring is completed, the low-tension circuit can be tested out in the usual manner by connecting up an accumulator and noticing whether the rheostats give adequate control with valves plugged into the valveholders. The grid-bias and high-tension batteries may also be attached to the

power valve is recommended. The P.M.4, B.4 and D.E.5 classes of valves are very suitable, with anode voltages of 80-120 and negative grid-bias of 3 to 6 volts. Ordinary L.F. valves are also suitable, such as those of the D.E.8 L.F. and D.06 L.F. types.

Whatever valves are chosen, care must be taken that they work off approximately equal filament voltages.

Coils to Use

Suitable coils for L_1 are a No. 50 or 40, while if selectivity is required a No. 60 Lissen "X" coil should be used. It is important that the socket of the coil—*i.e.*, the *plug* of the *coilholder*—should be connected to earth if an "X" coil is used, and this has been done in the wiring diagram. The aerial clip is taken to one of the tappings if an "X" coil is used, or, if ordinary plug-in coils are employed, to a bared portion of the Glazite

KEEP YOUR WIRELESS
SET IN "TUNE"

Osram Valves

for Broadcasting

The G. E. C. - your guarantee

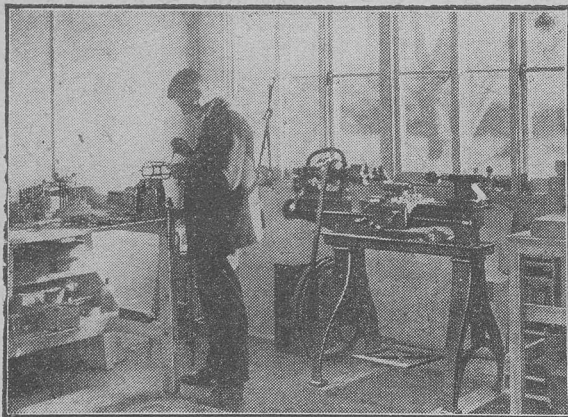

Practical Workshop Hints

Putting a Thread on Ebonite—Dies—How to Centre Holes—A Useful Locking Nut—Fixing Brass Rod—A Vice that Swivels

Threading Ebonite Rod

ONE of the most popular types of low-loss coil former consists of two circular or hexagonal end-pieces joined together by means of six rods which serve to support the windings. In order to get the wire on neatly and with perfectly even spacing it is almost essential to notch the rods in some way, and one of the best methods of doing this is to put a screw thread on to them. If a thread with a suitable number of turns per inch is chosen, any gauge of wire can be wound on with the turns regularly spaced, and once the coil is finished the wire has no tendency to slip.

Cutting the Grooves

This is also a most useful tip when fixed resistors are to be made by winding resistance wire on to a former of round ebonite rod. Thread the rod first, and bare wire may be used, winding being exceedingly easy to perform, and there will be no risk of a partial short-circuit through the touching of two neighbouring turns. In neither case is it necessary to cut a full thread on the rod; as a rule, quite a shallow groove will suffice to hold the wire in place. B.A. dies are not of much use, owing to the large number of turns per inch, which ranges from 353 for No. 25 B.A., to 25.4 for No. 0. The best things that I know for the purpose

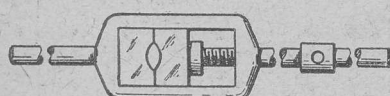

Fig. 1.—The die is held in an adjustable screw plate.

are the Whitworth standard "gas" dies, which form part of the equipment of every plumber's workshop and every garage, in case the con-

structor does not possess a set of his own.

Whitworth Dies

These dies are split, and are used in an adjustable screw plate like that seen in Fig. 1. They are intended primarily for threading pipes, and their size denominations refer to the *inside* measurement of pipes. Thus a one-eighth gas die when used to cut a full thread leaves

low: File a small flat on the end of the rod and fix it into a tap wrench. Clamp the screw plate into the vice by means of its fixed handle. Slacken off the two halves of the die and place the end of the ebonite rod between them. Now tighten up until the die is biting, and unscrew the rod until its tip is only just held by the die. Tighten once more, and then run the rod

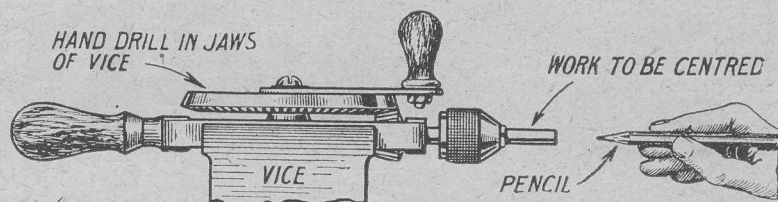

Fig. 2.—A hand drill can be utilised as a guide when marking the centre of material to be drilled.

the work .382 in. in diameter over the threads, and .336 at their bottom. The 1/8-in. gas die is thus intended for putting threads on to metal objects with an outside diameter of about two-fifths of an inch; it can, however, be used for threading lightly pieces of much larger external diameter by separating rather more widely the two portions of the die. If the two halves of the die are brought very close together it will cut a thread on a rod of much smaller external diameter.

Threads per Inch

The number of threads per inch made by Whitworth gas dies are as under:—

Die.	Threads per inch.
1/8 in.	28
1/4 in.	19
3/8 in.	19
1/2 in.	14
5/8 in.	14

The simplest way of putting a thread on to ebonite rod of any diameter with gas dies is as fol-

low: This can be done quite quickly with the help of the tap wrench. When you have reached the far end of the rod tighten the two parts of the die quite hard together, and go back again to the starting end.

By this time the rod will show a very respectable thread, quite sufficient to prevent any wire up to No. 18 gauge from slipping. So long as care is taken not to bring the two halves of the die so closely together that the rod binds in them (in which case it may break if force is used) no difficulty will be found in the process. Constructors who do not possess sets of gas dies can get rod-threading jobs done for them quite easily by plumbers or garage handy-men. If you are using your own dies do not forget to lubricate them well with turpentine, otherwise they may wear rapidly.

Finding the Centre

Probably the majority of those who construct wireless sets do not possess lathes; yet they are frequently called upon to do small

drilling jobs in round material, when it is rather important, if only for the sake of neatness, that the hole made should be properly centred. It is extraordinarily difficult to find by eye alone the centre of, say, the base of a coil-plug or of a piece of $\frac{3}{8}$ -in. round ebonite rod intended for an extension handle. No matter how carefully you go or how much time you spend over the job it will nearly always happen that if the centre is guessed the drilling punch-mark will actually be made slightly out of its proper position.

The Method Explained

Here is a method of finding the true centre which can be used by anyone who possesses a hand drill, and nobody who does not own this useful tool can do any kind of wireless constructional work worth speaking about. Remove the hand-grip, which is in line with the axle of the driving wheel, and fix the drill into the vice, as shown in Fig. 2, by means of the boss into which this handle fits. In the chuck of the drill place the piece of rod or studding whose centre it is desired to find. Get an assistant to turn the crank of the drill fairly fast, so that the work is spun rapidly. There is now little diffi-

culty in locating the exact centre, which may be marked as shown in the drawing by means of a pencil.

Errors Eliminated

If by any chance a slight error should be made it will be at once obvious, since the pencil mark will be seen to wobble as the work rotates. In this case stop the drill, rub off the pencil mark with a finger, and make another, using

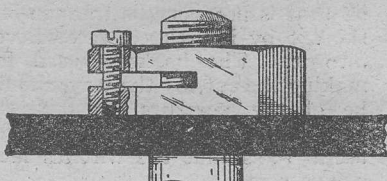

Fig. 3.—The small screw provides a means of locking the nut.

greater care. Once the pencil mark has been made, the work is removed from the drill chuck and centrepunched. A hole may now be made with certainty that it will start centrally. Whether or not it follows the axis of the work throughout its length depends upon the ability of the workman to hold the drill in a vertical position.

Locking Nuts

Most of us have been bothered at one time or another with nuts

that will work loose despite all ordinary precautions to clamp them securely in position. There are many ways of locking nuts. That most commonly used is to tighten a second nut, usually of a thinner type, hard down upon the first. This, however, does not always answer, and there are cases where it is difficult owing to the inaccessibility of their position to get the two nuts properly jammed against one another. A tip which I have found most useful in the case of nuts of rather large size is that seen in Fig. 3. The nut is placed in the vice, and a hacksaw cut is made on one of the faces about half-way through it.

For Small Nuts

A small hole is then drilled and tapped, and a screw is inserted as shown in the drawing. Once the proper position of the nut has been found it can be fixed absolutely by tightening down the screw, which has the effect of making the threads of the nut seize tightly upon those of the bolt or spindle to which it is applied. In wireless constructional work one frequently uses nuts that are not sufficiently large to allow even a small screw to be used in the manner shown. In this case the cut is made as

MAXIMUM EFFICIENCY AT REDUCED PRICES

GAMBRELL BROS., LTD., have pleasure in announcing that *great reductions* in the price of various components, etc., come into force on 15th February, 1926. Following are shown some of the reductions.

GAMBRELL COILS							
Size	Nearest size in ordinary coils	Old Price	NEW PRICE	Size	Nearest size in ordinary coils	Old Price	NEW PRICE
a/2	18	5/9	4/10	E1	150	8/9	6/9
a	25	5/9	4/10	E	200	9/6	7/9
A	30	5/9	5/-	F	300	10/3	8/6
B1	40	6/-	5/3	G	500	12/-	10/-
B	50	6/-	5/6	H	750	14/-	12/6
C	75	6/9	5/9	I	1000	16/-	14/-
D	100	8/-	6/3	J	1500	19/-	17/6

L.F. TRANSFORMERS, STAGES I & II: Old Price 27/6. New Price 25/6

Write for Complete New Price List

GAMBRELL BROS., LTD. 76, VICTORIA STREET, LONDON, S.W.1.

Telephone: VICTORIA 9938

Back of Panel "ONE-HOLE" fixing

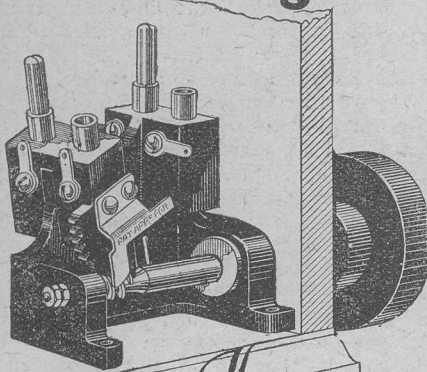

The Newey Vernier Coil Holder

Wireless enthusiasts will welcome this perfectly designed coil holder which can be fixed in any position including back of panel one-hole fixing. A coil holder which in addition is provided with lugs so that it can readily be fixed to the panel if desired.

The moulding is Bakelite throughout, ensuring perfect insulation together with high finish. The adoption of worm gearing enables the heaviest coil to be used without any fear of its position being altered by a jar or through its own weight, and further gives a vernier movement—ratio 8 to 1—so necessary for the fine critical tuning.

A special stop is fixed on the spindle which prevents the coils from being over-wound, thereby affording complete protection to the teeth of the Bakelite sector.

Fit a coil holder which can be protected from all dust, decorates the panel and has no equal for accuracy, precision and beautiful finish.

Price 6/6

Newey's

Ask your nearest dealer. If you have any difficulty write direct.

Wholesale Distributors —
Pettigrew & Merriman (1925) Ltd.
122-124, 100ley St., London, S.E.1
Telex 1103 134

before, but the tapped hole and the screw are omitted. When the nut is in position a strong pair of pliers is used in order partially to close the hacksaw cut. If there is plenty of room a hammer and a punch may be used instead of the pliers.

The nut is thus made to bind upon the threads, and remains absolutely immovable. If at any time it is required to remove a nut that has been locked in this way, all that is necessary is to open out the cut by inserting a screwdriver into it. The hacksaw used for making the cut, by the way, should be of the jewellers' or dentists' variety, which is one of the most useful tools that the wireless man can possess.

A Problem Solved

It happens not infrequently that one wishes to insert into a piece of brass a rod or pin which will be quite tightly fixed once it is in place. The obvious way of doing this is to pass the pin through the drill plate, and to select a drill which will make a hole into which it is a driving fit. More often than not it happens that no such drill can be found, since the rod is just too large for the hole made by one size, and just too slack for that made by the next size larger. In such cases the best method is to make a hole with the larger drill, to insert the rod, and then to fix it by making a couple of deep punch-marks immediately above that part of it that lies in the hole. Fig. 4 will make this plain.

If the rod is of comparatively large diameter it is better to pin it rather than to rely upon punch marks. In this case a small hole should be drilled right through both

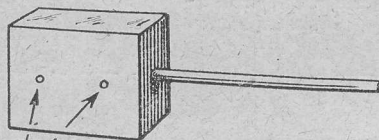

Centre Punch Marks

Fig. 4.—The rod may be gripped by making punch marks in the metal above it.

the larger piece of metal and the rod into which it has been inserted. The diameter of this hole should be such that it is a fairly tight fit for the pin, which may be a small piece of copper wire or a fine nail. Having inserted the pin, cut off its point fairly close, and rivet over hard with the round end of a light hammer. If a nail is used, its head may be trimmed up afterwards

with a file, and hammered almost flat.

A Handy Vice

An exceedingly useful tool for the constructor is a small swivel vice, an inexpensive little appliance obtainable from most good tool shops. Some of these are made, like that shown in the drawing, Fig. 5, to screw down to the bench, but the type which I prefer has no base, there being simply a lug at the

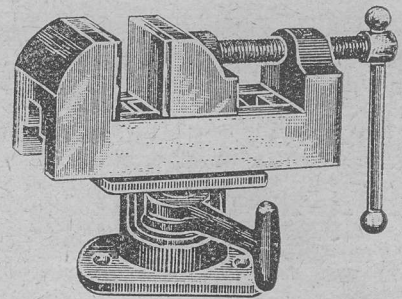

Fig. 5.—A typical form of swivel-vice.

bottom, which enables it to be fixed into the jaws of the larger bench vice. The latter is rather too big and clumsy for holding fine work, but the small swivel vice when held in its jaws enables all kinds of small jobs to be tackled with the greatest ease.

How it is Used

A small catch below the jaws enables it to be turned at will to any position, so that one can always place it most handily for whatever job is being done. These vices are provided with detachable grooved faces, which may be placed between the jaws when wanted. With their help rods of small diameter may be held firmly for cutting, threading, and so on. This is really a handy little tool, which makes it much easier to perform fine work than when only a fixed vice of medium or large size is available.

Modern Wireless

Published on the
first of every month

1/-

The Transatlantic Broadcasting Tests

IN the period between and including January 25 and January 30 this year's Transatlantic Broadcasting Tests took place. Important practical results are expected as the outcome of these tests, and the reports from those listeners participating were carefully examined and classified by Radio Press, Ltd., who were responsible for the organisation on this side of the Atlantic. A full and detailed report of the results appeared in recent numbers of *Wireless Weekly* and *Wireless*, so readers are referred to these publications for this interesting information.

Are Valves Necessary?

In the February issue of *Modern Wireless*, Capt. H. L. Crowther discusses a very interesting item, which should have a wide appeal to all owners of wireless receivers. The article in question is: "Why are Valves Necessary?" and the writer compares and contrasts the valve with other methods for amplification purposes. In the same issue Mr. J. H. Reyner brings to light some important facts concerning the neutralising of valve capacities in "Split Coil Methods of Neutrodyning."

A Quality Receiver

To meet the tastes of those constructors who particularly desire quality in their signal reception, Mr. John W. Barber has designed "The Quality Four" and full details for making this set appear in the February number of *Modern Wireless*. Other features in this interesting number include the "New Days" Crystal Set, by Mr. Percy W. Harris, for rapidly finding the best adjustment under certain conditions, and a discussion on all the factors influencing high-frequency resistance is given by Mr. H. J. Barton-Chapple in "What is High Frequency Resistance?"

Coil Fields

It is surprising how many experimenters, when engaged in making their own receivers, fail to appreciate the supreme importance of stray fields. The influence of these fields, together with some of the differences that arise by sundry modifications, are explained by Mr. Percy W. Harris in *Wireless Weekly*, Vol. 7, No. 17, in a highly illuminating article entitled "Coil Fields and their Influence on Set Design."

Regular Features

Commencing in *Wireless Weekly*, Vol. 7, No. 18, are two new regular features which will contain a fund of information for the experimenter. Under the heading of "Operating Your Set," notes and hints will appear upon a variety of topics concerned with the operation of wireless receivers to obtain the best results. "Circuits for the Experimenter" is the other feature.

Using Plugs and Jacks

It is sometimes thought that the use of plugs and jacks for switching purposes makes the wiring of a receiver rather complicated. This is proved to be a fallacy by Mr. Stanley G. Rattee in "Circuits with Plugs and Jacks," featured in *Wireless*, Vol. II, No. 7. Following the policy of reducing controls

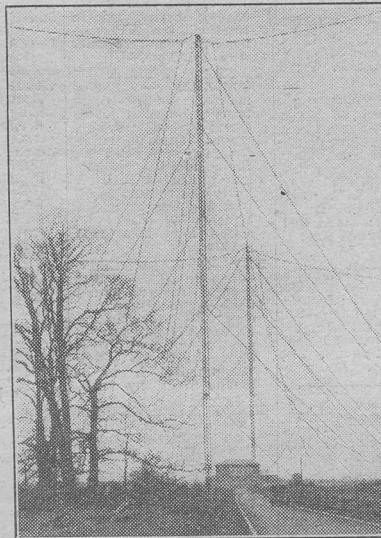

The Rugby Station and part of its aerial system.

to simplify the operations of tuning, Mr. J. H. Reyner describes a "Two-Valve Set with One-Dial Control" in the same issue.

The admirable standard of articles in this weekly journal is fully maintained, and to quote a few, we have: "How Far is it Heard?" by Mr. G. P. Kendall, in the above-mentioned number; "A Talk on Wiring," by Percy W. Harris; "Transatlantic Broadcasting," by Captain A. G. D. West; and "What is Distortion?" by Mr. H. J. Barton-Chapple, the last-named three being in Vol. II, No. 6.

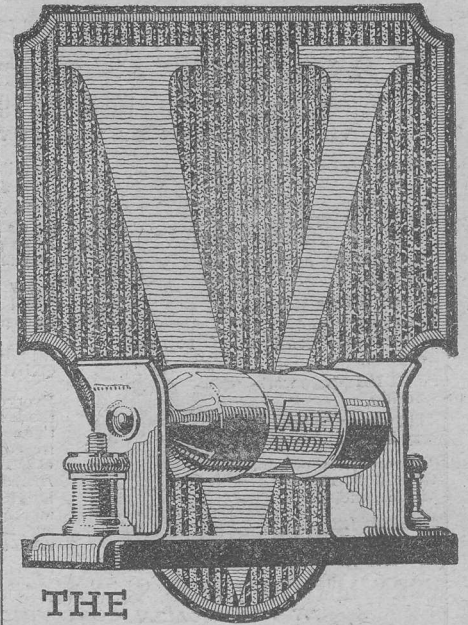

THE VARLEY Anode Resistance

There is a best in every field, and where Resistance Capacity is concerned, the Varley has sought, and found that standard.

A little dearer perhaps, but what a great deal better. It is the only resistance wound with the finest quality bare wire, with turns silk separated on the Varley Bi-Duplex Principle, giving absolute constancy and perfect tone, and remaining entirely unaffected by atmospheric conditions.

The Varley Magnet Co. hold many years' reputation for intricate coil winding—and this is a coil-winding job.

Complete with Clips and base

7/6

60,000, 80,000 and 100,000 ohms.

Write for Leaflet.



Constant always

VARLEY MAGNET CO.

Woolwich, S.E.18

Phones: Woolwich 888, 889

KAY-RAY WONDERFUL LOW LOSS STRAIGHT LINE FREQUENCY CONDENSERS THE CONDENSER OF THE FUTURE

Supreme SELECTIVITY. Each station has a CLEAR TUNING SPACE. CROWDING entirely ELIMINATED. SIMPLIFIED tuning. DISTINCT and DEFINITE Radio reception. PRECISION workmanship. Solid Brass vanes (a very important factor). Central position of rotor INSURES MINIMUM panel space. ONE HOLE FIXING



Pigtail connection to rotor gives silent working. Special Spring top Bush gives a firm but easy movement. LOW LOSS SKELETON ENDS or Ebonite if preferred. All HIGHEST possible QUALITY.

Everyone AMAZED at the beauty and finish of these Condensers, and to compete with the OUT OF DATE AMERICAN CONDENSERS now on the market, we ask you to try the BRITISH ARTICLE.

FOR A LIMITED PERIOD, introduce them to you, if you mention "The Wireless Constructor," I offer them at PRACTICALLY COST PRICE and guarantee them to be equal to many Condensers at treble the price. Including Knob and Dial sketch. .0003 5/11 Low Loss or .0005 6/6 Ebonite Ends .0003 7/11 .0005 8/6 Post 6d. per set.

- LISSEN PARTS. Anode or Variable Grid Leak, 2/6 ea.; L.F. or H.F. Choke, 10/-; Switches, D.P.D.T., 5 point Reversing, 4/- each; 2-way series Bar., 2/9 each; Minor, 3/6; Major, 7/6; Universal, 10/6. Potentiometer or Wire Rheostat, 4/- each. Neutrodyne Condenser, 4/5. Coils 25, 35, 410 each; 50, 55, 60, 75, 54 each; 100, 69; 150, 7/-; 200, 8/5; Lissen X 50, 6/-, 60, 6/4; 75, 6/5; 250, 9/9. Tuner, 25/6. Mark III. Var., 17/6. CHOKES—Lissen H.F. or I.F., 10/-; R.L., 10/-; Success, 10/-. PHILLIPS 4 ELECTRODE 4 pin for ordinary use, can be used on ordinary circuit, 10/- post free. RECOGNISED WEST END DISTRIBUTOR of the manufacturers of Edison Bell, Gramme, Peerless, Eureka, Magnum, Burned & P.T., Lotus, Dabill's, Marconi, Dorwood, Sterling, Success, B.T.H., McMichael, Lissen, Woodhall, Utility, R.L., Bowyer-Lowe, Ampion, Kormo, Branet, Ormond, Yesly, Newey, P and M and everything that is worth stocking. Very endeavoured to obtain goods not listed.—VERNIER CONDENSERS.—3-plate, 3/11; 5-plate, 4/6; Michon, 2/6; Colvern, 2/6; Ormond, 2/6; Gamble, 5/6. STRADA H.F. TRANSFORMERS.—Barrel type, B.P.C., 5XX and Neutrodyne, 6/5 each. Made by Sterlings, Ltd. LOTUS.—Geard 8.1 Coil stands, 2-way, 7/- (with exchanges, 8/-), 3-way, 10/-. DORWOOD FIXED.—01 to .008, 3/4 each; .0003 (with grid leak cap), 2/6. CO-MOS MET-VICKERS.—VA LIVE—A45 7/6; G.P. 8/18 12/6 Red or G. cen. Spot, D.E. 11 12/6. ACCUMULATORS.—Very special. Best make: 2 v. 4, 8/11; 2 v. 60, 1/11; 2 v. 80, 13/11; also 4 v. 40, 4/11; 4 v. 60, 17/11; 4 v. 80, 24/6. Post 1/- extra. COIL STANDS.—2-way Standard, 2/9; Cam, V., 4/6; Geard, 4, 4/6, 6/-; 3-way Standard, 5/-; Cam, 6/6; Geard, 7/6. H.F. TRANSFORMER.—Barrel Type, Stradia, 6/-; Bowyer-Lowe, 7/-; Magnum, 7/-; McMichael 10/-; Do., Superionic A7, 12/6; Energo Standard B.B.C., 3/11; 5XX, 4/6. L.F. TRANSFORMERS.—Ferranti 17/6; New Model 25/-; Ormond, 14/1; Shrouded, 17/3; Royal, 20/-; Powquipp, 14/6; Formo, 10/6; Croix, 9/-; Wates Supra, 12/6; Lissen T1, 21/-; T2, 15/-; T3, 12/6; Bureka Concert Grand, 25/-; 2nd Stage, 21/-; Baby Grand, 15/-; Reflex, 15/-; Success L.F., Black, 21/-. J. B. JACKSON BROS.—Variable Condense s, Su. 1-w. 100, 9/7; 200, 8/5; .0003, 7/-; with vernier, 4/- each extra. Geard 4-0005, 15/-; .0003, 13/-; Low Loss, 10/6 and 9/-. MOUNTED COILS, GOSWELL.—25, 1/6; 35, 1/9; 50, 2/-; 75, 2/3; 100, 2/9; 150, 3/-; 200, 3/6; 250, 3/6; 300, 6/-. STAR.—25, 1/3; 35, 1/3; 50, 1/9; 75, 2/-; 100, 2/3; 150, 2/6; 175, 2/9; 200, 3/-; 300, 3/3. IGRANIC.—Honeycomb, 55, 35, 43; 50, 4/6; 75, 4/10; 100, 6/3; 150, 7/-; 200, 8/-; 250, 8/6; 300, 9/-; 400, 10/-; 500, 10/3; 600, 11/-; 750, 12/6; 1,250, 15/6; 1,500, 17/6. LISSEN.—25, 35, 410 each; 50, 55, 60, 75, 54 each; 100, 69; 150, 7/-; 200, 8/5; Lissen X50, 6/-; 60, 6/4; 75, 6/5; 250, 9/9. VAR. GRID LEAKS.—Lissen 2/6; Watmel, 2/6; Bretwood, 3/-; Anode Res., Lissen, 2/6; Watmel, 3/6; Bretwood, 3/-. VALVE FOLDERS.—Sterling, 4/-; Burned & P.T., Magnum, 5/-; 2/3; Bon Jamini, 2/9; Apex, 1/6; Aermonic, 1/6; Standard, 1/3; Anti-cap shrouded, red for plate, 1/3; or for 3/4; Ditto, nickel legs, 1/3; Athol, 1/3; H.P.C., 1/6; O.P., 1/9. LOUD SPEAKERS.—Dinkie, 30/-; Baby Sterling, 50/-; Floral, 55/-; Ampion A.R. 111, 50/-; 114, 65/-; A.R. 19, 45/55; Radiolux Mod. 15, from 44 15s.; Ultra, 27/6; Sparta, 50/-; 95/-; Beco Hornless, 50/-; C.A.V., 27/6. Browns, all models. N. and K. PATTERN.—High class, splendid tone, 8/6. SIEMENS EBONITE.—Cut to size, squared edges; 3-16 in. sq. inch, 4 in. is 3d. sq. inch. Postage extra. PELICAN UNIVERNIER DIAL.—12 to 1 ratio, 6/-.

K. RAYMOND

Hours of Business (LISLE STREET) 9 to 8 DAILY 9 to 9 SATURDAY 11 to 1 SUNDAY

TWO SHOPS—so you will ALWAYS find ONE OPEN

27 & 28a, LISLE ST., LEICESTER SQUARE, W.C.2

Opposite Daly's Gallery Door. (Back of Daly's Theatre) BE SURE IT'S RAYMOND'S. Phone: Gerrard 4637

UNSOLEICITED TESTIMONIAL 382, Cranbrook Road, Ilford, ESSEX. Messrs. Raymond, I am writing to let you know the wonderful change your new type condenser has made in my one valve Straight set. On Sunday evening (with 20 work) I was successful in receiving Radio Berne, Dub in, Hamburg and Newcastle at excellent 'phone strength. All these stations had previously passed me by. I can only say that if there is a 100 per cent. condenser on the market, yours is IT. Harry R. Procter.

SPECIAL OFFERS! VARIOMETERS.—Soli Ebonite former, Ball Rotor, one-hole fixing, 330/600 metres, smooth rotation, terminal connections, wound green silk wire 4/3. Post, 6d. TAPPED VARIABLE COUPLER.—200/800 metres. Solid ebonite former, wound best double covered green silk wire, tapped tens and units terminal connections, Ball Rotor Reaction, one-hole fixing, Knob & Dial. A lovely instrument, 8/11, post 6d. Also with 5XX attachment, special reaction for same, 12/11 post free.

DUPLEX VARIOMETER, (series parallel) Best ebonite former, wound double covered green silk wire, stator, Bal rotor coupling, 5XX or B.B.C. V. forming small knob. A very high class and efficient article. 7/11, post 6d. Extends on handle to fit any knob, nickel fittings 1/4. COMBINED LEAD-IN TUBE and Lightning Switch, with indication tablet, 1/6 to each. "to set", 12 in. 2/-.

FINSION LOW LOSS COILS.—35 1/6; 50, 1/9; 75, 1/6; 100, 2/6; 150, 3/6; 200, 3/9; 300, 4/6. 2-WAY COIL HOLDERS.—Ebonite base nickel (or brass), extension handles, very compact, 2/-.

PANEL COIL HOLDER.—To mount coils on the back of panel. Only knob and dial seen above panel, holder has reaction side movement. Beautiful little article, 2/6 post 3d. NEWBY 4-POINT CONDENSER.—Zero Loss, Lowest Min. cap. 360 in. gear control. Sq. law tuning, .001, 20/-; .0005, 17/6; .0003, 15/-. CLEARTRON VALVES C 8 12/6 Fil v. 3, an-de 30-120 C.T. 15 12/6 Fil v. 1, 8 015 amps., anode 30-120.

KAY-RAY VARIABLE CONDENSERS "DE LUXE" LOW LOSS MODEL SQUARE LAW With Vernier .001, 8/11; .0005, 7/11; .0003, 7/6; Without Vernier, .001, 7/6; .0005, 5/11; .0003, 5/6. High grade Ebonite ends one-hole fixing, knob and dial.

ORMOND Square Law Low Loss, Ebonite or Skeleton ends .01 10/6, .005 9/6, .0003, 9/-. Above with vernier (1.6 each less no vernier). IGRANIC. .0003 21/- .0005 24/- POL & R STOCKIST. Crystal 1/6 Detector 3/6 Bobbin Rheostats . . . 5/6 Junior .0005 5/6 Junior .0003 5/6 Coil Unit 7/6 2-way CV 6/- 3-way CV 9/6 Neutrodyne Condenser 5/6 RCC Unit 15/-

SETS OF PARTS Author's selection. Less Box, Panel, Valves, S.T. 100 7/6 Twin v. Loud Speaker 80/- One valve reflex . . . 41/- Efficient 1 valve set . . 30/- All Concert de Luxe 118/- Simplicity Three . . . 62/- P.M.4 MULLARD. Loud Speaker valve . . 22/6 Your old valve allowed for.

VALVES.—Bright, 8/- each; Mullard Red or Green Ring; Marconi, R. 15; B.T.H., "R", Ediswan A.R. Cossor, P. 2, 14/- each; Mullard D3 Cossor, W1, W2 Ediswan A.R.D.E., B.T.H. B3, Marconi DEE, 16/6 each; Mullard, W1, DEE, Cossor WRI, W12, Ediswan B.T.H. B, Marconi DEE, 18/6 each; Cossor W3, 3, Marconi DEE, 22/6; Mullard DF, "A0", "A1", Ediswan PVI, 2, 5, 8, B.T.H. B4, B6, Marconi DE4, 5B, etc.

FERRANTI. L.F., A.F.3 25/- L.F., A.F.4 17/6 R.I. L.F. Sealed Box . . . 25/- Perm. Defector . . . 6/6 Do. 1 hole fixing . . 7/6 Tuner 39/6

ORMOND. L.F. New Model . . . 15/- Latest shrouded . . 17/6 Rheostats 6 ohm . . . 2/6 New Model 6 ohm . . . 2/6 30 ohm with vernier . . 2/6 See variable condensers.

CROIX L.F. 5 to 1 or 3 to 1 in new boxes 7/6 RADIO MICRO. .06 Special, 10/- post free. GRAMMOPHONES.—Manufactured under patent Decreted ins'n Electric No. 206233, etc. Very fine mounted plug-in, air-spaced coils. Highly finished and admirable instrument. No. 25, 1/6; No. 35, 1/6; No. 50, 1/8; No. 75, 1/11; No. 100, 2/3; No. 150, 2/6; No. 200, 2/11; No. 250, 3/3; No. 300, 3/6; No. 400, 3/9; Don't forget these are mounted.

Lissen Loud Speaker Unit, 13/6. NEUTRON.—06 valves. Fil v. 3—5-4v. An. 30-100 12/6. H.F. and Detector, L.F. Amplifier. Post free.

QUOTATIONS given for LISTS OF PARTS Please write plainly Send a Postcard for our Folders & Bargain Lists

This Column is for CALLERS ONLY Post Orders Elsewhere. Nett Prices. CABINETS AMERICAN TYPE, covered leather cloth 12 x 8 x 8, 8/-; 16 x 8 x 8, 10/9; 18 x 8 x 11, 6/-; 20 x 8 x 8, 12/6. All with base board, open front, hinged lid. Open boxes, imitation crocodile, 7x5x5, 1/4; 8 x 6 x 6, 1/6; 9 x 6 x 6, 1/11; 10 x 8 x 6, 2/6. Polished 6 x 6, 7 x 5, 3/3; 8 x 6, 3/6; 9 x 6, 3/9; 10 x 8, 4/6, upwards. ACCUMULATORS—High class 2v. 40, 7/11; 50, 8/11; 80, 10/11; 100, 14/6, 4v. 40, 13/11; 6/-; 17/6; 80, 23/6; 6v. 60, 26/6; 90, 35/-; These are a very special class, all guaranteed ed.

EBONITE, SIEMENS—3/16, 1d. sq. in. 1/4 for 1 in. Cut while you wait. Grade B for crystal sets, 6 x 6 or 7 x 5, 1/-; 8 x 6, 1/4; 9 x 6, 1/8; 10 x 8, 2/4. Many sizes stocked. TERMINALS—Complete Brass Pillar, W.O. 1 hole id.; Nickel, 3 for 4d. Studs, Stop pins, 2 a id.; Nickel, 4 for 3d. Screwed spades or pins 2 for 1d.; Nickel, id. All Brass, 6 a id.; Nickel, 4 a id. Red or black spades, 3d. per do. screwed plug and scket, 3d. and 6d. Wander plugs, 2d., 2d., 4d. per do. Ormond screws and nuts, 2 a id. Fl-sh panel sockets and nuts, 10d. doz.; id. ea. All kinds of adjustments on counters.

SWITCH ARMS LARGE—With 12 studs, 10d.; Small, 1/-; Nickel, 4d. extra. 8 twist drills, 1/2. Copper earth tub s. 3/3. Aerial, 7/22, 1/11; 100 feet (ext a heavy 2/3). Ins. Rubb. lead in 10 yds. 1/-; Extra heavy 2/6 open; 3d., 4d., yd. 1/-; Twin maroon flex, 12 yds. 1/4; Red and black, 12 yds. 1/6. Min. silk, 6 yds. fd. Winder aerial, 110 feet, 3/-; Phosphor Bronze, 49 strands, 180 feet, 0 v. indoor, 2/6. Empire tape, 12 yds. 6d. 10 ft. cold, connecting wire, 10d. Glazite, 10 ft. 12. Shaw's genuine sealed herzite, 8d.

EBONITE COIL STANDS—2-way, generous size, 2/-, 2/6. Cam Vernier or geared, 2/11, 3/3, 3/6. Ebonite shaped plugs, extra qual, 6d. or 2/6 for 8/-; With fibre stop 7d. Push or pull switches, 1/3. DCC WIRE—4 lb. 20g., 9d.; 2g., 10d.; 24g. 11d.; 20g., 1/-; 28g., 1/2. Tin copper, 16, 18, 20, 22g., 11d. 1/2 lb. reel. Square Busbar, tinned copper, 16 or 18, 6d. 12 feet. Enclosed screws, small, 6d.; Large, 1/2, 1/4, 1/6, Brass & Nickel. Noted micrometer, nickel, 1/9. LEAD IN TUBES, g od quality, 61, 8d., 10d., or made to size. Panel switches, nickel D.P.D.T., 10d., S.P.D.T., 1d. Ins. hooks or eggs, 2 for 1d. 6 in. panel brackets, 10d.

H.T. BATTERIES—BBC, 6v. 6/11; Extra large, 8/11; 20v., 5/6. Crown long life, 60v. 6/11. Advco, 6/11. Grid Bias, 1/9. 121, 2/3 (v. Tapped, 1/3 v. Neutron 4/5 batteries, 41d., 6 for 2/-). Bulls eye bulb, 3d. SPECIAL PRICES given over the counter for sets of parts for various circuits, usable valves bought or taken in exchange for new ones. Any parts you have no use for entered in exchange or purchased. Goods may be brought without obligation either side. If you purchase new British valves I will buy a burnt out one for each valve you take. Right reserved to cancel this list without notice.

HEADPHONES, all 4,000 ohms; Special purchase 500 pairs N. & K. pattern lightweight cost 8/6 pair. Now clearing at 5/11 pair. Famous Ericsson E.V. Continental 10/6 pair; 3 pairs 50/- Adjustable. Nespa style, 8/6 pair; Standard N. & K. pattern, 8/11. Brunet 11/9. Latest improved models, 12/6, 14/11. Genuine N. & K. stamped name on outside cases, 12/11; Lightweight, new model, 13/6; Genuine, Telefunken, sealed boxes, 14/11; De Neper, genuine, 12/11, (adjustable) a 14,000 ohms.

FAMA VALVES PHILLIPS VALVES 4v. Detector 2/9 "R" Bright 5/6 4v. Amplifier 2/0 Unidyne 4 pin 9/6 .06 (1.5-3v.) 7/11 6v. D.E. 9/6 Battery Boxes 63v., take 14 batteries, complete with clips Power D.E. 7/11 .06 Radio Micro 9/- .06 Radio Micro 9/- NO POST ORDERS ABOVE COL.



POOOR Mr. Gumplethorpe is at present not quite the man that he once was, for during the last few weeks he has been through a series of terrible ordeals, in the course of which life has been just one blessed thing after another. His troubles began shortly after the return of his youngsters to school towards the end of January, when the local arm of the Law, Police Constable Whiskerton, called to ask why, whereas his garden was decorated with no less than three aerials, he possessed only one receiving licence.

Mr. Gumplethorpe explained that the two funny looking ones belonged to his sons, and that he thought that one licence covered the whole household. Whiskerton pointed out emphatically that this was not so,



..... a snowdrift obligingly broke his fall.

and threatened Mr. Gumplethorpe with the direst pains and penalties. Remembering the old formula—

$$P.C. + \frac{1}{2} s. d. = P.C.^2,$$

Mr. Gumplethorpe hastily passed over half-a-crown, and promised to take out any number of licences up to a dozen that the Law demanded.

Unsquareable

The incident might have, in the ordinary way, been considered closed. Whiskerton, however, is no ordinary policeman, and it was not long before he called in a new capacity. This time he appeared, not as the strong hand of the Law, but as inspector of aerials under the local authority. He promptly condemned all three of Mr. Gumplethorpe's, and ordered their instant removal. Mr. Gumplethorpe attempted to apply the formula once more, but this time he found Whiskerton as unsquareable as the circle.

He was commanded to dismantle instantly the offending wires, and told that if he failed to do so awful things would happen to him. Being a law-abiding citizen, Mr. Gumplethorpe proceeded without delay to do as he was told. It is one thing for an agile boy to put up an aerial and quite another for his stout papa to take it down unaided. He had not been long engaged in his task when Mr. Gumplethorpe was cursing heartily the day on which he had been inspired to plant in his garden trees of the variety known as monkey puzzles.

Monkey Puzzles

I do not know whether these really puzzle monkeys; they cannot have worried seriously the junior Gumplethorpes, who are certainly young monkeys, but they did undoubtedly puzzle Mr. Gumplethorpe himself, who, on falling out of the first one, was not quite sure whether he was standing on his head or his heels. In point of fact he was doing neither, being firmly planted in a sitting position in the midst of a snowdrift which had obligingly broken his fall.

If at First You Don't Succeed

After several unsuccessful and painful attempts to scale the quaint trees that had served his youngsters as aerial masts, Mr. Gumplethorpe decided that other methods were called for if the aerials were to be dismantled as required. He recalled that there was in his study an ancient rook rifle with which as a young man he had shown no inconsiderable prowess. Why should he not shoot down the offending wires with it?

A Lethal Weapon

If the bad man of the cowboy films can shoot the points off the hero's moustache, surely, Mr. Gumplethorpe argued, it should be possible for him to lay low these wires with the aid of the lethal weapon. Unluckily he was shivering so much with cold when he fired the first shot that the rifle went off before he intended that it should do so, and the bullet found its billet

in one of his neighbour's top floor windows. The second shot was also a wide, as far as the wire was concerned, though it gave Priscilla, his other neighbour's cat, who had looked over the wall to see what was happening, such a fright that she disappeared from the neighbourhood with a velocity approaching that of light, and has not been seen since.

The P.C. Reappears

He had not been engaged long in his rifle practice when the now hateful face of Whiskerton appeared over the fence at the bottom of the garden, and its owner's voice called upon him to desist instantly. Whiskerton jotted down laboriously full particulars in his notebook, which done he announced



..... jotted down full particulars

that he would summon Mr. Gumplethorpe for having discharged a firearm (a) within thirty feet of the roadway, (b) to the common danger, and (c) without a licence. Sighing a little, Mr. Gumplethorpe resigned himself to his fate, and returned the rifle to its resting place.

When he had thought the matter well over it seemed to him that the only thing to do was to fell the trees. Mr. Gumplethorpe is not an experienced woodman, nor was the coal chopper, which was the only likely weapon available, such an implement as an expert like George Washington would have chosen for the purpose. Still, it's dogged as does it, and Mr. Gumplethorpe tackled the first monkey puzzle with a perfect whirlwind of blows.

An Elusive Chopper

If he had not lost so much time in retrieving the head of his chopper, now from the cucumber frame, now

from the ashpit, now from the greenhouse, his work would have gone forward with much greater speed. As it was, at the end of an hour he had been successful in denting the trunk of the tree nearly all round. Mr. Gumplethorpe reflected that dynamite was sometimes used for tree felling, but as he was not quite sure whether it was permissible to employ explosives within thirty feet of a roadway, and as he was sick of the sight of Whiskerton, he decided that dynamite had better be left out of account.

Battered but unbeaten, Mr. Gumplethorpe sallied forth to the



..... followed by a string of urchins.....

nearest ironmonger, from whom he purchased a large axe, guaranteed to deal faithfully with any tree that ever grew. Armed with this, and followed by a string of urchins, who told each other in piercing screams that you had only to look at his face to see that he was about to commit a most satisfactory murder, Mr. Gumplethorpe returned home bent upon another onslaught upon the monkey puzzle. When he went out into the garden he found that the small boys had ranged themselves along the fence at the end of it. Several of them told their friends that they could see blood on the axe. The majority, however, were sceptical, and decided to await developments. When Mr. Gumplethorpe got to work upon the tree they cheered every stroke of his to the echo.

An Enthusiastic Audience

After a few minutes' work Mr. Gumplethorpe, who was now being hailed by his audience as the "Kayser in disguise," had come to the conclusion that so far as axes were concerned he was no Geddes. He flung the thing angrily from him, and merely smiled wearily as he heard it crash through the long-suffering cucumber frame. The audience cheered. They cheered yet more lustily when Mr. Gumplethorpe, having decided that attacks from the ground would prove fruitless, began once more the ascent perilous.

Ever Upward

Mr. Gumplethorpe's imitation of a puzzled monkey delighted the

audience, if it failed to delight Mr. Gumplethorpe. After immense efforts, in the course of which he parted with considerable portions of both his face and his hands, Mr. Gumplethorpe began to feel that he was getting the knack of it. Higher and higher he climbed until the wire was almost within his grasp. A little further, and his hand was upon it. It was just at this moment that he heard a loud crack in the tree, and began to wonder what was going to happen. He very soon found out. Weakened by his attacks from its base, the monkey puzzle decided that it could no longer support Mr. Gumplethorpe's sixteen stone at its top.

How are the Mighty Fallen!

It began to lean a little. Then it leaned rather more. Then quite gently it sank earthwards, demolishing on its way the dividing wall between the two gardens, and depositing Mr. Gumplethorpe upon the roof of his neighbour's chicken house. The young Gumplethorpes, of course, had attached the house end of the wire securely to the window frame of their playroom, so securely that, as the tree folded up, the window was extracted from its moorings as a cork is pulled from a bottle. The noise made by the combined crashes of Mr. Gumplethorpe, the tree and the window brought both his wife and the neighbour, upon whose hen house our hero was roosting, out to see what had happened. The neighbour dashed in for a moment to telephone for Whiskerton, and then issued forth to tell Mr. Gumplethorpe pretty pointedly just what he thought of him.

Further Charges

Meantime Mrs. Gumplethorpe was doing the same kind of thing from her own garden. Upon the arrival of Whiskerton Mr. Gumplethorpe learnt that there would be several fresh charges against him, including one of causing an obstruction in the highway, owing to the vast crowd which had by then collected to watch the proceedings. "This," remarked Mr. Gumplethorpe, a little bitterly, "is what comes of trying to be a law-abiding citizen." "Never saw such goin' on," snapped Whiskerton. "Orter know better, you did. Fancy, birds' nestin' at your age." Naturally rumour was soon busy with Mr. Gumplethorpe's name.

It was reported on the best authority that he had suddenly gone raving mad, that he had smashed all the windows in his

house, that, possessed in his frenzy of superhuman strength, he had torn up trees, and flung them into his neighbour's garden, that he had battered down the dividing wall with a pick, and that entering through the breach he had attacked his neighbour with an axe. Mr. Gumplethorpe has not lived it down yet.

Summoning the Expert

When he had sufficiently recovered from his mental and physical wounds to be able to attend to business once more, Mr. Gumplethorpe summoned the local wireless expert and commanded him to remove the second superfluous aerial, which was slung just like the first between a window frame and a monkey puzzle. Having shown him what was to be done, Mr. Gumplethorpe retired to his study, feeling that it would hardly be kind to stand and watch the man undergoing the terrible ordeal that lay before him.

So Simple

A quarter of an hour later there was a knock at the door, and the fellow came in, holding a neat coil of wire in his hand. "Shall I put this in your workshop?" he inquired. Mr. Gumplethorpe gazed at him, lost in amazement, for the man was intact and smiling. "H-h-how d-d-did you m-m-m-manage it?" he quavered. "Oh, t'wasn't much of a job," replied the handy-man. "I just went up to the room and unfastened the wire from the window frame. Then I went out into the garden



..... "H-h-how d-d-did you m-m-m-manage it?

and pulled till the thin branch 'twas fixed to gave way." "M-m-m-m," said Mr. Gumplethorpe, meditatively. "Yes, I suppose I ought to have thought of that."

By the time that he had escaped from the clutches of Whiskerton and the Bench, Mr. Gumplethorpe had parted with not a few of his hard-earned Fishers. His enthusiasm for wireless, however, remains unabated, but if you want to see him really excited, just mention the name of Whiskerton,

Six of the Best from the double IGRANIC range

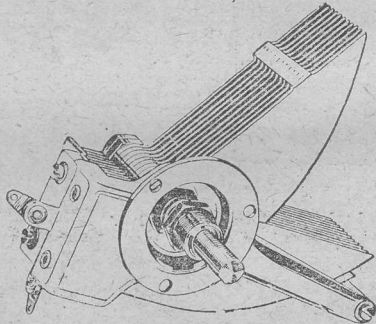

THE IGRANIC-PACENT TRUE STRAIGHT LINE FREQUENCY VARIABLE CONDENSER

A high-grade variable condenser with low-loss characteristics, a true straight line frequency curve and negligible minimum capacity. Fixed and moving plates are of brass, riveted together and soldered, ensuring permanent alignment and sound electrical connection.

Rigid channel-shaped framework in continuous electrical connection with moving plates, prevents hand capacity effects.

Only two small pieces of highest quality insulating material are used, so arranged that the absorption losses are negligible.

Dust-proof bearing results in smooth, silky movement. Positive stops at minimum and maximum are contained within the bearing.

Single or three-hole fixing is provided for. Two condensers can be mounted to form a dual instrument with single dial control.

Prices: '00035 mfd., 14/6; '0005 mfd., 18/6

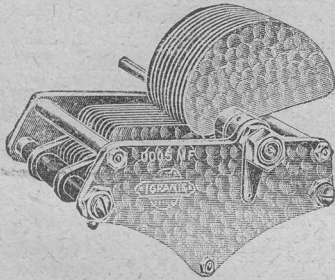

IGRANIC LOW-LOSS SQUARE LAW VARIABLE CONDENSER
(Pat. No. 220312).

Igranic Low-Loss Square Law Variable Condensers are equally suitable for reception or transmission on low power and will give excellent results in all types of circuits. They are manufactured from the finest materials only, and, while the construction is extremely robust, the finish is of the highest possible standard.

Prices:
'00015 mfd. 19/6; '0003 mfd. 21/-; '0005 mfd. 24/-;
'001 mfd. 27/6

IGRANIC RADIO DEVICES INCLUDE:

Honeycomb Duolateral Coils, Variable Condensers, Fixed Condensers, Filament Rheostats, Intervalve Transformers, Variable Grid Leaks, Variometers, Vario-couplers, Coil Holders, Potentiometers, Combined Instruments, Vernier Tuning Devices, Switches, Anti-Microphonic Valve Holders, Knobs and Dials, Stand-off Insulators, etc., also the Igranic Super-Heterodyne Receiver Outfit.

149, Queen Victoria Street :: London

The range of Igranic Radio Devices is now *doubled* by addition of the famous American Patent Radio Essentials—of which the Igranic Electric Co., Ltd., are exclusive manufacturing licensees.

If an Igranic Radio Device is not suitable for your circuit then an Igranic-Pacent Radio Essential will be—and vice versa.

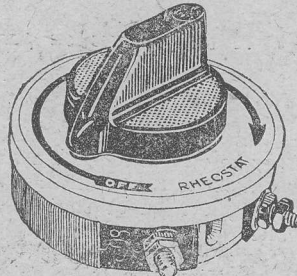

THE IGRANIC-PACENT PORCELAIN RHEOSTATS and POTENTIOMETERS
(Patent No. 238462)

A porcelain base is used on these Igranic-Pacent Rheostats and Potentiometers. Fitted with moulded knob and gold or silver finished dial. Two unit construction; winding spaced to give maximum cooling effect. A 3/16 in. shaft with flat sides to facilitate mounting. Elongated holes to accommodate varying spaced mounting holes on panel.

RHEOSTATS

Supplied in Resistances of 6, 10, 20, 30 or 50 ohms, with current carrying capacity of from '3 to 1.5 amps. Price 2/6 each.

POTENTIOMETERS

Supplied in Resistance of 400 ohms, with current carrying capacity of '25 amp. Price 2/6 each

IGRANIC FILAMENT RHEOSTAT

(Plain type) (Pat. No. 195903).

Supplied with 4, 6, 8 or 10 ohms resistance. Specially suitable for highly efficient filament control and critical control of regeneration. Prices with fixing screws and drilling templates for panel mounting. Plain type, 3/6; Vernier type, 5/6; and Dull Emitter type, 20 or 30 ohms, 5/6.

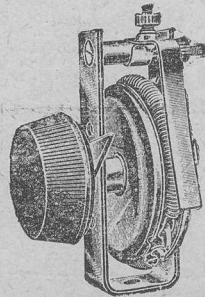

Write for the IGRANIC Booklet Z 965 which gives full details of them all.



Exclusive Manufacturing Licensees of Patent Radio Essentials.

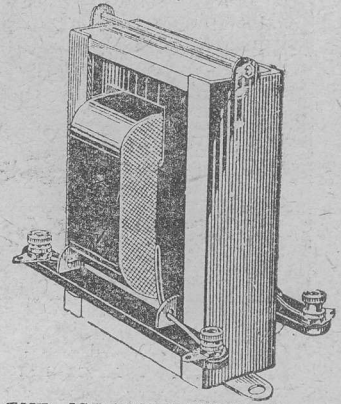

THE IGRANIC-PACENT SUPER "AUDIOFORMER" (Regd.)

A low frequency transformer, remarkable for its unique amplification curve. The special construction of the core and coils gives a uniform amplification of frequencies as low as 100 and as high as 8,000, resulting in perfect distortionless amplification of speech and music.

It is eminently suitable for use with general purpose valves and particularly for power amplification up to plate voltages of 500 volts.

Robust construction and careful manufacture eliminate breakdowns or other troubles. Soldering tags and terminals are provided to the clearly marked primary and secondary. Price 27/-



IGRANIC "E" TYPE AUDIO-FREQUENCY TRANSFORMERS

(Pat. No. 235013) (Regd. Nos. 697459 and 1701359)
Igranic "E" Type Audio Frequency Shrouded Transformers possess a high amplification factor which is constant over a very wide range of audible frequencies. They are absolutely free from distortion and from parasitic noises which are so detrimental to faithful reproduction.
Ratio 1.5 (First Stage) 21/-
Ratio 1.3 (Second and subsequent stages) 19/6
The 1/3 ratio Transformer is highly efficient for power amplification.

IGRANIC-PACENT RADIO ESSENTIALS INCLUDE:

The Super "Audioformer," Porcelain and Bakelite Rheostats and Potentiometers, The True Straight Line Frequency Variable Condenser, The Elegant Microvern Dial, The Balcon, The most complete line of Plugs, Jacks and Switches in the world, Jack Nameplates, The Radiodyne, The Radiofile, etc.

Works: Elstow Rd. Bedford

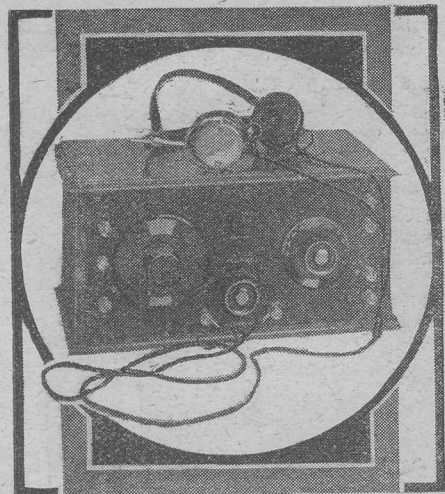

The VARIOMETER TUNED SINGLE VALVER

By G.P. KENDALL, B.Sc.

A set for use on poor aerials which employs condenser reaction control

THIS receiver is primarily intended for comparatively local work, that is to say, reception of a main station up to distances of something like 30 or 40 miles, and its special feature is that it has been designed to meet the needs of the man who wishes to hear his local station effectively upon a poor or improvised aerial. Since the instrument is intended for use upon poor aerials, pains have been taken to ensure that it possesses a good degree of sensitivity, one of the more effective schemes of reaction being incorporated, but no special devices have been used to obtain an abnormal degree of selectivity.

Degree of Selectivity

Since the set has been designed to take full advantage of the sensitivity which a good scheme of reaction can confer, it is capable of giving quite good long-distance results when used with a normal outdoor aerial, and, as a matter of fact, quite a large number of foreign stations have been heard with it at good telephone strength when used in this way. The fact that no special circuit arrangements have been made to attain selectivity must be borne in mind by those who are considering its construction, and if it is to be used within a short distance of a main broadcasting station, it must be realised that a wavetrap will be

necessary to enable reception to be performed of stations working upon a wavelength close to that of the local one.

The Circuit

The circuit used is a relatively simple one, the tuning arrangement consisting of one of the improved patterns of variometers now available, the provision of an optional fixed condenser in series or in parallel with this variometer serving

the anode of the valve to the filament are a variable condenser and reaction winding in series with each other. The coil is arranged to couple with the windings of the variometer, being wound in the form of a "hank" coil of such diameter that it fits inside one end of the tube which acts as a protecting cover to the variometer windings. This point will become clear upon an inspection of the photographs and diagrams.

Fine adjustment of tuning is cared for by the provision of a small vernier condenser in parallel with the windings of the variometer, and this accounts for the third knob upon the panel. The only other control is the filament rheostat, which is of the dual pattern, and serves also the function of an on-and-off switch (Fig. 2).

Components

In building the set the usual modern scheme was adopted of a vertical front panel carrying the various controls and an internal wooden shelf for the valve and the various components which do not require adjustment. To duplicate the original instrument exactly the following parts and materials are—

One cabinet with baseboard, brackets and panel $6\frac{1}{4} \times 13\frac{1}{2} \times \frac{1}{4}$ in. (Peto-Scott Co., Ltd.)

One variometer, type B. (Igranic Electric Co.)

One variable condenser, standard type $.0003 \mu\text{F}$ (Bowyer-Lowe Co.)

One vernier condenser (Igranic micrometer pattern).

One dual purpose rheostat (McMichael, Ltd.).

One base with clips for clip-in condensers (McMichael, Ltd.).

One fixed condenser for use in the above clips (McMichael, Ltd.).

One combined grid condenser

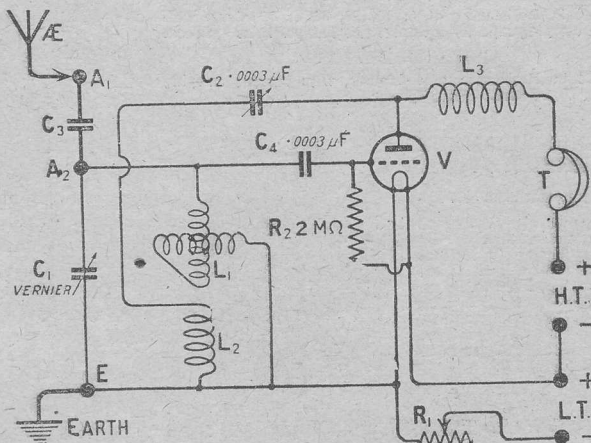

Fig. 1.—The receiver makes use of the "Reinartz" method of reaction control.

to adjust the arrangement to suit quite a variety of types of aerial. This is an important point in a set designed for use on all sorts of good and bad aerials, and it will be dealt with in greater detail at a later point (see Fig. 1).

Reaction Control

The reaction scheme makes use of the method of reaction control associated with the name of Reinartz, this scheme consisting of a choke coil in the anode circuit of the valve, while connected from

and leak, .0003 μ F and 2 megohms (Watmel Wireless Co.).

One Clearer Tone Valve Holder (Benjamin Electric Ltd.)

Six ounces No. 24 d.c.c. wire.
Nine brass terminals.

Glazite or other wire for wiring up.

The constructional work in building this little set is very simple, and I do not propose to waste the reader's time going into elaborate details. I think the diagrams accompanying this article will give the necessary assistance for practically all the work, though one or two points require explanation.

The Choke

The high-frequency choke required was, in the original set, actually a home-made one, but, of course, one of the bought variety can be substituted if the constructor does not regard coil-winding as an enjoyable pursuit. Certainly it calls for a little patience, but the cash saving resulting from the winding of one's own choke coil is worthy of some consideration. The amount of wire required is relatively small, a shilling or so covering it, and the coil can be wound inside half an hour.

The coil used in the original set as a choke was a lattice which happened to be at hand, but any type of multi-layer coil containing the required number of turns will serve the purpose perfectly well. For example, the honeycomb, slab, lattice or even at a pinch a single-layer coil will do. If a single-layer coil is to be used, it should be noted that really fine wire should be used in winding and not the gauge specified in the list of components.

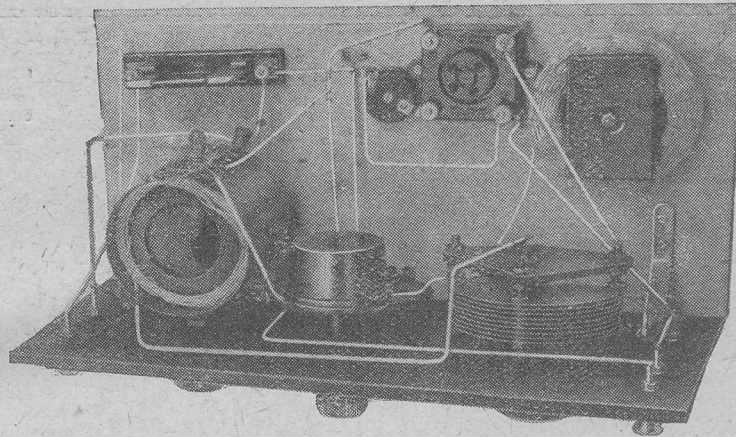

The reaction coil is placed on the stator of the variometer.

A Single-Layer Choke

A single-layer choke can be made quite easily by using a piece of ebonite tube about 2 in. in diameter and 3 in. long, and winding upon this 200 turns of No. 34 gauge double silk-covered wire. A certain amount of patience and care is needed in carrying out the winding of such fine wire, and the multi-layer type is recommended, since quite a robust gauge can then be used without the coil becoming unduly bulky.

For example, the simple type of coil known as the "hank" winding is eminently suitable, and can be wound without the aid of any particular apparatus, by simply winding on the wire quite roughly round a tumbler or suitable-sized bottle, slipping off the mass of wire which results, crushing it up into a hank, and binding with tape. A suitable diameter is 2 in., and

this can be fastened down to the baseboard in the way illustrated, viz., by means of a small piece of ebonite through whose centre a screw is passed into the wooden base. The number of turns for the choke coil is not at all critical, anything from 200 turns upwards being perfectly satisfactory.

Reaction Winding

The reaction winding consists of another hank of No. 24 double cotton-covered wire, and the number of turns required for this will depend upon the type of aerial with which the set is to be used. With a full size outside aerial, or with a poor type of improvised aerial, somewhere between 30 and 40 turns will be correct, but a little experimenting here is advisable and is very easily carried out. For a small indoor aerial, on the other hand, a smaller number of turns

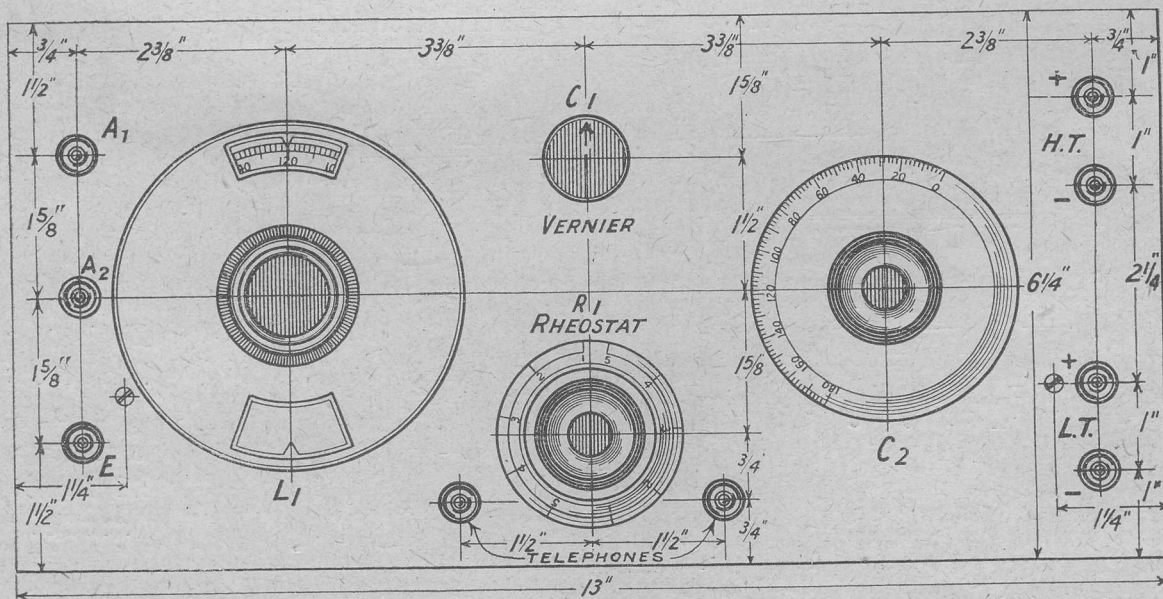
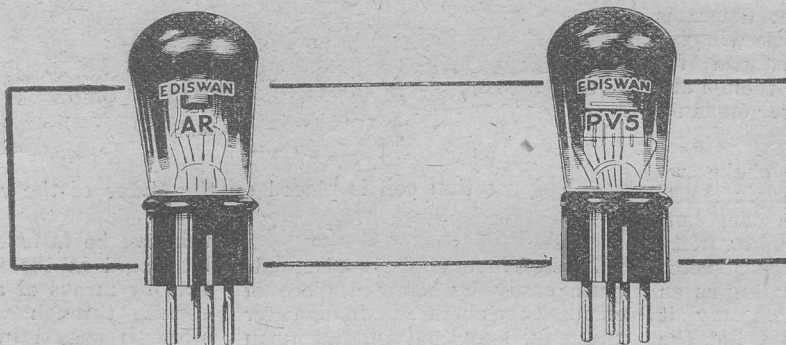

Fig. 2.—Panel layout of the receiver. Readers requiring a full size blue print may obtain C1034A for 1/6, post free.

THE HAPPY FAMILY

"Affinities"



There is a decided affinity, a quite definite link between each Edison Receiving valve and Edison Power valve. The Receiving valves are supplied either H.F. or L.F. and the best Power valve to use is shown in the table opposite.

They always get on well together. It's like that in every large family. Always two that will work—or play—better with one another than with anybody else. Every Edison valve has its family affinity. It gives good service in any conditions — the best service when it is employed with its "twin."

The Valves to use.

Receiving.	Accumulator or Battery Volts	Power.
AR	6	PV5
ARDE	2	PV6
AR'06	3	PV8

With these groups and Edison H.T. and L.T. Accumulators the ideal is attained.

THE EDISON SWAN ELECTRIC CO. Ltd.,
123-5, Queen Victoria Street, London, E.C.4.

EDISWAN VALVES

Will Improve ANY Set

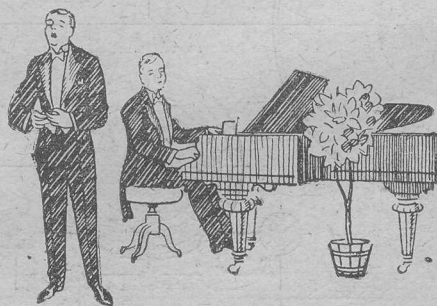
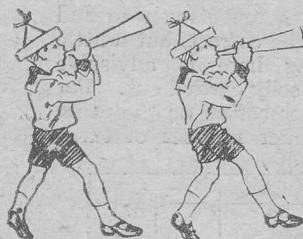

Ediswan Valves are entirely British made.

will suffice, about 25 being suggested. This is a point which really calls for experimenting with practically any set incorporating Reinartz reaction upon an aerial circuit, if the best of results are to be obtained. Probably the best thing to do is to make a "hank" coil of about 50 turns and strip off turns until a convenient and smooth control of reaction is obtained upon revolving the reaction condenser.

This winding is placed at the earth end of the variometer, inside the protecting tube which is a feature of the later Igranic instruments. The connections will be easily followed from the wiring diagram, but it should be remarked that if the set refuses to oscillate when first finished, the coil should be taken out of the tube, turned over and replaced *without* altering its connections (see Fig. 3).

Aerials

When the set has been finished, the question of the type of aerial with which it is to be used will come up for consideration. For reception of the local station at distances of up to, say, 10 or 15 miles, the crudest possible arrangement will serve, such as making the earth connection to a water pipe and the aerial connection to a gas pipe, to a wire mattress or

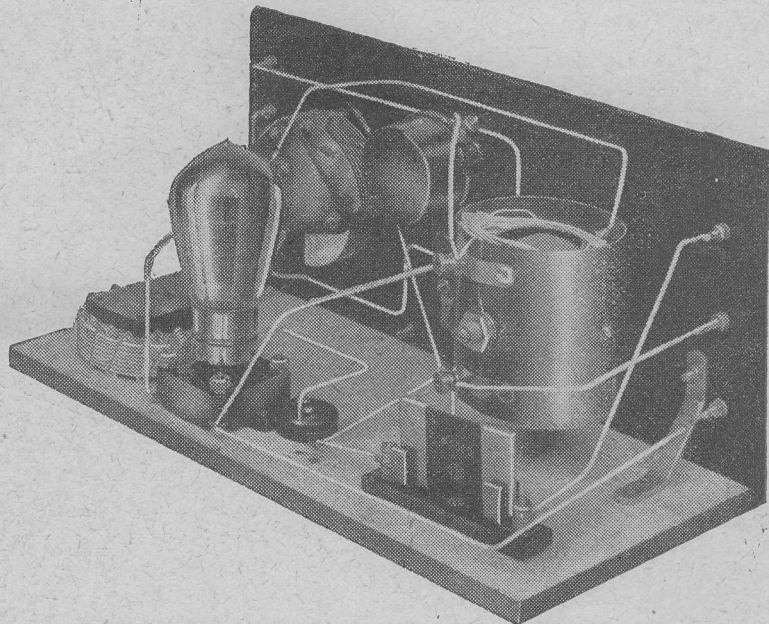

No plug-in coils are used, so that the valve is the only accessory inside the set.

almost any other large metallic object available.

Series Condenser

In the case of unconventional aerials of this sort, the desirability or otherwise of using the small fixed condenser in series with the

aerial circuit must be decided by experiment, and if it is desired to use it in the series position, the earth should be connected to the lowest of the three terminals on the left-hand side of the set and the aerial to the upper one (Fig. 2).

A suitable value for this condenser will probably be in the neighbourhood of $.0005 \mu F$, but this, again, is best decided by experiment. It will be well to obtain a $.0003$, a $.0005$ and a $.001 \mu F$ condenser, and try the effect of their insertion in the clips. These condensers, incidentally, are invaluable in experimental work, and the expenditure upon them will be found to be well justified at a later date.

Parallel Condenser

With the normal type of medium size indoor aerial, it will probably be unnecessary to use the fixed condenser at all, the earth being connected to the lower terminal as before, and the aerial to the middle one. With unusually small indoor aerials, on the other hand, it may be desirable to use the condenser in parallel, which is done by connecting the earth to the usual terminal, the aerial to the middle one, and linking the top and bottom terminals together with a piece of wire. A suitable value for the parallel condenser will be $.000 \mu F$. For outside aerials of anything approaching the full size, the condenser in the series position will probably be found the most effective, a capacity of $.0005 \mu F$ being suggested as a basis for experiment.

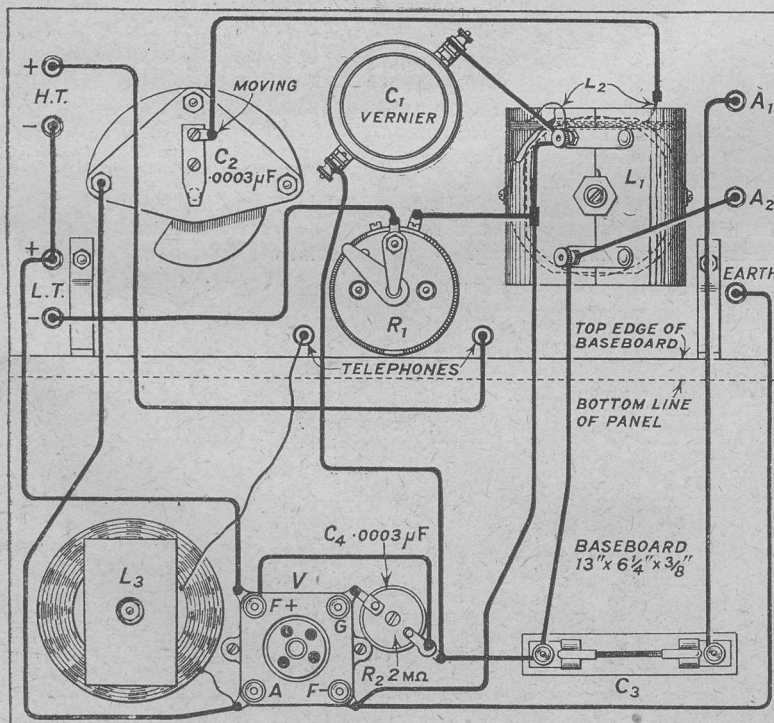
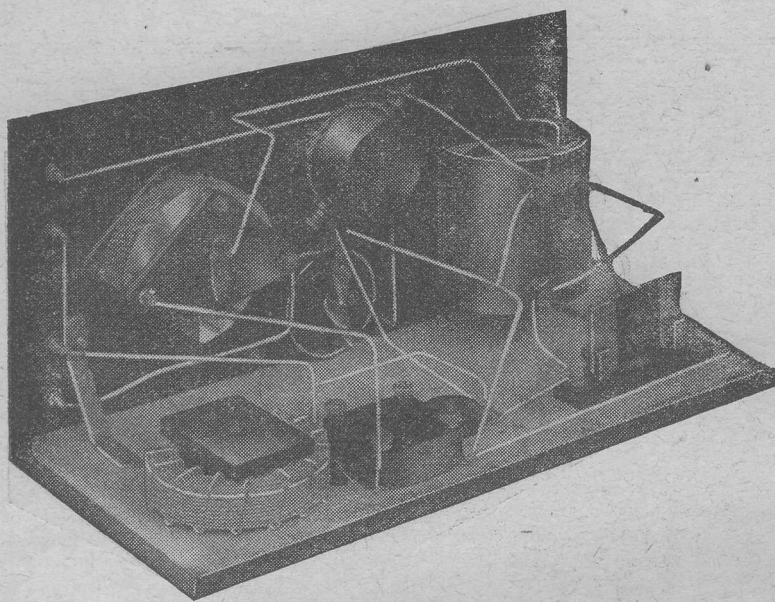

Fig. 3.—The wiring is very simple, especially if blueprint C1034B is used as a guide.



Only four components are mounted on the baseboard beside the panel brackets.

Operation

No particular instructions are needed for operating the set, since it is a very simple matter indeed: merely set the reaction condenser to zero and revolve the dial of the variometer until the local station is heard. Then increase the setting of the reaction condenser until the desired degree of reaction is obtained, and make any small final readjustments by tuning upon the vernier condenser.

Valves

The type of valve to use in the set will, of course, depend upon the nature of the filament supply which it is desired to use, but it may be said that very excellent results are obtained with those valves which are normally intended for resistance-capacity low-frequency amplification, such as D.E.5B., D.F.A.4, etc. In general the special high-frequency type of valve is also suitable if the best results with regard to smooth reaction control, etc., are to be obtained. For valves of this type a high-tension battery of 45 or 60 volts will be found perfectly satisfactory.

If the set is to be used for stations other than the local, *e.g.*, for the reception of Continental and distant B.B.C. stations, it is worth while taking pains to determine exactly the correct number of turns upon the reaction coil which gives the smoothest control of reaction and also the best value of high tension to achieve the same end. In searching for distant

stations it will be necessary to manipulate the reaction control with great care, so that the set is maintained on the very verge of self-oscillation as searching proceeds, since, of course, full use must be made of the reaction, short of the production of self-oscillation, if distant signals are to be received, as is usual in single-valve sets.

Operating the set in this manner it was found possible when using a full outside aerial in S.W. London to obtain good and clear signals from Bournemouth, Birmingham, Glasgow, Hamburg, Munster, Brussels and the School of Post and Telegraphs, Paris. All this, of course, was at a time when 2LO was not working.

The High Tension Accumulator Unit

SIR,—I have constructed the H.T. Accumulator Unit described by Mr. H. J. Barton-Chapple in the January issue of THE WIRELESS CONSTRUCTOR. On charging same I find that the voltage registered is 65 volts, but this value falls somewhat rapidly after normal use. In addition, sediment accumulates at the bottom of the containers. Can you please inform me how I can overcome this trouble?

Yours faithfully,
S. WILTON.

Harrow.

SIR,—In view of the fact that possibly other constructors may discover the same symptoms you have mentioned, I feel it advisable to stress two important details, which should not be overlooked.

(1) The serrations on the lead plates, in addition to increasing the plate surface, are of distinct advantage for preventing the formed material from detaching itself from the plate. Hence do not omit to make these serrations.

(2) The charging current must not exceed the stated value, and the battery must be handled carefully at the initial stages.

Yours faithfully,
H. J. BARTON-CHAPPLE,
Radio Press, Ltd.

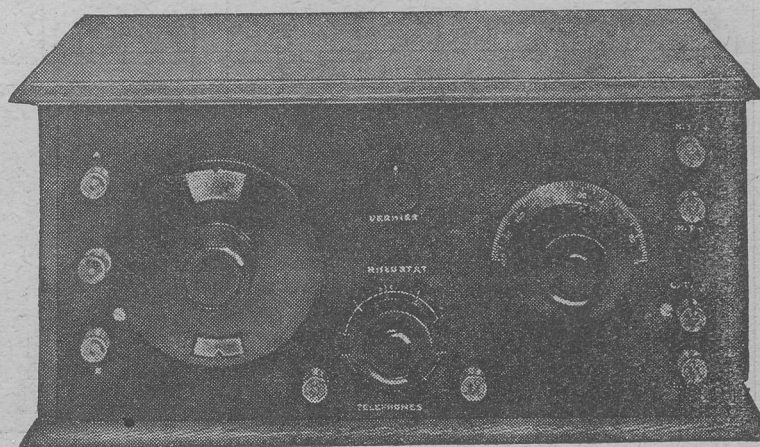

A view of the finished receiver. The large dial is that of the variometer.

Conscientious Constructors are Considering Chokes

Given a Choke and a Transformer costing the same, the Choke will be certain to give much more faithful reproduction. Like all A.J.S. Receivers, the one chosen by Sir Oliver Lodge was choke coupled.

CHOKE coupling on the L.F. side has not generally received the attention it deserves. Perhaps it is by reason of the fact that if a choke is used without due care in the choice of valves, necessary condensers and grid leaks, considerably less volume will result. If, however, valves of correct design are employed, there should be no falling off in signal strength.

Although this may not be obvious to all at first, it can easily be explained. Owing to the comparatively low impedance of the primary winding of the average transformer selling at a reasonable figure, low impedance valves must be used if good quality reproduction is desired. Now low impedance valves generally have a low amplification factor. The average good choke, and the one illustrated in particular, has a high impedance at all audio frequencies, therefore high impedance valves, valves whose amplification factor is generally high, should be used on the L.F. side, so that any loss of volume due to absence of the step-up effect of a transformer is compensated for by the high amplification obtained from the valves. The only position in a choke coupled receiver in which a low impedance valve should be used is the last position.

There is another great advantage in the use of chokes for L.F. coupling, and that is, a set so con-

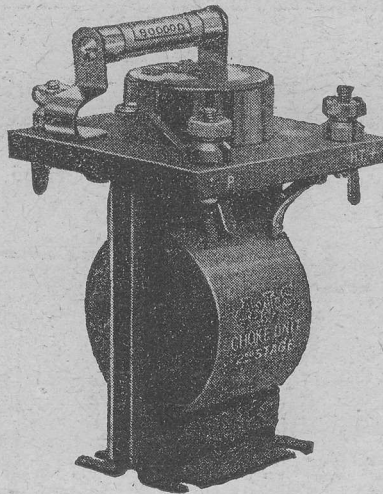

structed is not so liable to develop audio or L.F. "howls" even if three stages of amplification are used. While admitting that a correctly designed set should not "howl," many constructors may at one time or another have experienced much difficulty in this direction. The fact that a choke has only one winding, and a transformer two windings, makes a good choke a much more reliable piece of apparatus, and one less likely to break down.

The use of valves having a high amplification factor means that less drain is put on the H.T. Battery, whose life is consequently longer, and this means a direct saving, to say nothing of the saving in valve costs due to having to use a low impedance or power valve in the last position only.

The chief thing to remember is, that the valve with the loud-speaker in its plate circuit should be a low impedance power valve, any previous note magnifiers can be high amplification factor valves with considerable advantage.

If these instructions are adhered to, it will be found that the amplification with choke coupling is normally quite equal to transformer amplification, with considerable increase in purity.

Three types of Chokes are supplied:—

- (1) The Choke only.
- (2) A Choke Unit for the first stage of intervalve coupling. This Unit comprises the Choke, by-pass and coupling condensers and grid leak.
- (3) A Choke Unit for the second and subsequent stages of intervalve coupling, with coupling condenser and grid leak. These units only require the addition of a Valve-holder, Resistor and the necessary connections to complete a low frequency amplifier.

Choke only 15/-
Choke Unit, both stages ... 20/-

Publication No. 115 tells you all about chokes and the valves to use.

USE A.J.S. COILS
AND
VARIABLE
CONDENSERS.

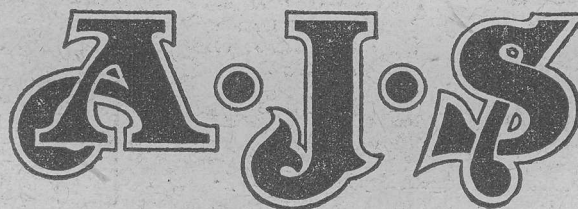

PUBLICATION No. 115
IS OF INTEREST
TO EVERY
EXPERIMENTER

A. J. STEVENS & CO. (1914), LTD.,
Radio Branch, WOLVERHAMPTON.

Telephone: 1748—(7 lines). Telegrams: "Reception, Wolverhampton."

London Showrooms: 122/124, Charing Cross Rd., W.C.2

Telephone: Regent 7161-2. Telegrams: "Ajayesco, Westcent, London."

Glasgow Showrooms: 223, St. George's Road, Glasgow

Telephone: Douglas 3449. Telegrams: "Reception, Glasgow."

A. J. STEVENS & CO. (1914), LTD.,
Radio Branch, WOLVERHAMPTON.

Please send publication No. 115.

NAME

ADDRESS

C./Mar./26.

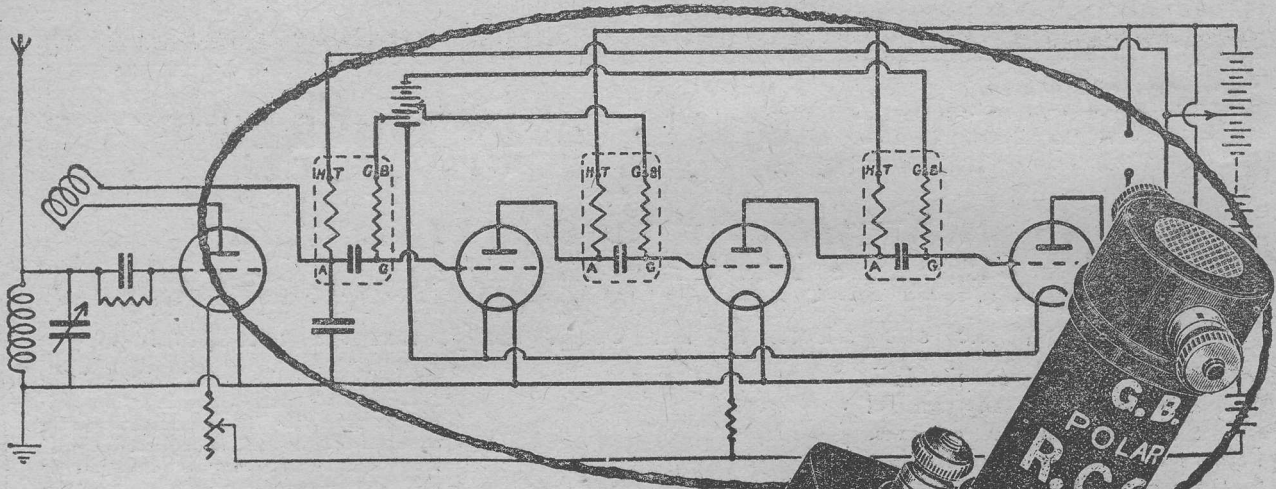

For the MUSICAL side of the circuit Polar R.C.C. Units

For *quality* of reception, resistance-capacity coupling has no equal. Its superiority over ordinary transformer or choke coupling is amazing.

Build your set with R.C.C. Units; use correct valves; adjust grid bias to suit the anode voltage; and, with a good loud speaker, you can achieve the nearest approach to *perfect* musical reproduction attainable.

With Red Seal
80,000 ohms
Anode Resistance. (Recommended for all stages, except the last, of amplifier).

12/6

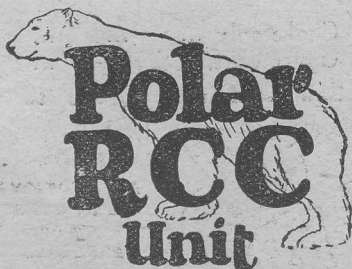

With Green Seal
40,000 ohms
Anode Resistance. (Recommended for the last stage of amplifier).

10/6

Polar R.C.C. Units are also available with interchangeable grid leak at 15/-

Sold by all reputable Radio Dealers.
Manufactured by:—

Radio Communication Co. Ltd.
34-35, Norfolk Street, Strand, London, W.C.2.

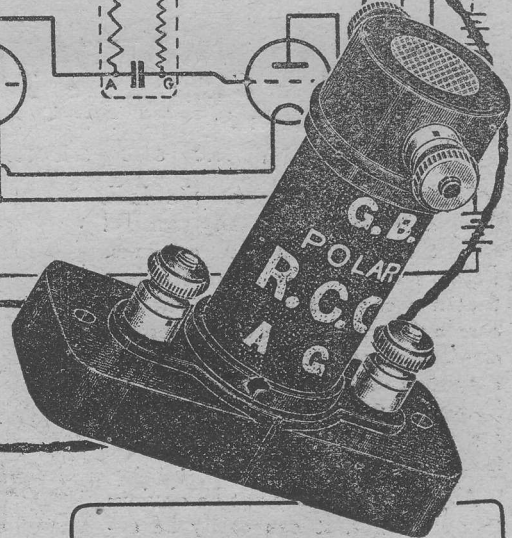

Resistance Capacity Coupling because

only by this method of inter-valve coupling can a practically constant Amplification Factor be obtained. With Polar R.C.C. Units the impedance varies less than 1 per cent., and the Amplification Factor is almost constant at all frequencies from 100 to 10,000 cycles per second.

Proof of the *quality* of Resistance-Capacity Coupling, if such is needed, is contained in the fact that this method is almost *universally* adopted by the B.B.C. in their transmissions. Moreover, the "Daily News" specified this method when equipping hospitals with wireless apparatus.

Polar R.C.C. Units because

they are the only complete units of their kind designed *especially* for L.F. Amplification purposes. They are logically designed for easy assembling of an amplifying circuit, and have four clearly-marked terminals spaced for convenient wiring-up. The Polar R.C.C. Unit consists of:—

An Anode Resistance wire-wound in such a way as to be free from crackling noises, with low self-capacity and small induction; high insulation; no joints; no danger of corrosion.

A Coupling Condenser specially constructed by the Dubilier Co., of mica di-electric type, of large enough capacity to bypass all frequencies down to 20 cycles per second.

A Gridleak of Mullard type having a resistance value high enough to avoid shunting of low frequency.

Rough handling of terminals cannot upset internal wiring.

Appointment of H. J. Barton-Chapple, Wh. Sch., B.Sc. (Hons.), A.C.G.I., D.I.C., A.M.I.E.E., to the Staff of Radio Press, Ltd.



A recent portrait of Mr. Barton-Chapple.

It is with great pleasure that we introduce to our many readers Mr. H. J. Barton-Chapple, who recently joined the staff of Radio Press, Ltd.

Qualifications

He is possessed of high qualifications, as a result of a particularly successful career. Before entering the City and Guilds (Engineering) College, Mr. Barton-Chapple secured a Whitworth Scholarship, which stands pre-eminent amongst open competitive scholarships in the United Kingdom, owing to the high standard of the examination and the rigid conditions for competing.

College Career

On entering College in 1919 he passed straight into the second year, and at the final examination of the third year secured the Associateship of the City and Guilds of London Institute (A.C.G.I.), heading the list of successful candidates, and as a result securing the Siemens Memorial Medal. He also obtained the Henrici Medal for Mathematics, being the student of greatest merit in this subject. In the same year Mr. Barton-Chapple graduated at the University of London, obtaining the B.Sc. degree in Electrical Engineering with first-class honours.

This was followed by a fourth-year Post-Graduate Course in Radio Telephony and Telegraphy under Professor Mallett, on the successful completion of

which he was awarded the Diploma of Membership of the Imperial College of Science and Technology (D.I.C.).

Further Experience

On leaving College in 1922, Mr. Barton-Chapple was appointed Lecturer in Electrical Engineering (specialising in High-Frequency and Thermionic Valve work) at the Bradford Technical College. Since that time he has conducted classes in Electrical and Radio Engineering, being entirely responsible for the courses in the latter subject, and his efforts have met with particular success.

His duties brought him into immediate contact with every type of student. Thereby much experience was gained in elucidating problems in such a manner that students were able to secure a clear conception of the normally intricate points.

Practical Research

Mr. Barton-Chapple has had considerable opportunity for research work, and several articles on the results of such investigations have appeared from time to time in the technical Press.

While at Bradford Technical College he was elected an Associate Member of the Institution of Electrical Engineers (A.M.I.E.E.), a qualification which, as our readers know, is of a distinctly valuable character.

Articles from the pen of Mr. Barton-Chapple will be a feature of subsequent issues of THE WIRELESS CONSTRUCTOR.

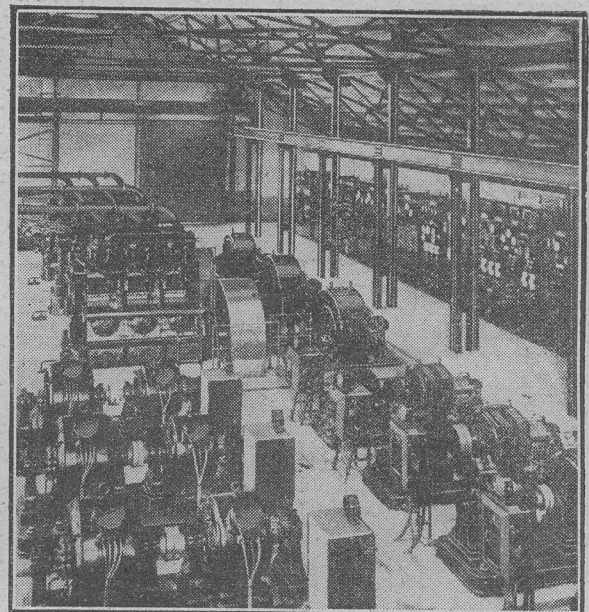

Generators and switchboards at the new G.P.O. beam station at Bodmin, Cornwall.

Fine Wire Coils

By J. H. REYNER, B.Sc.(Hons.), A.C.G.I.,
D.I.C., A.M.I.E.E.

An interesting article discussing the effects of the gauge of wire employed for winding coils

THIS is essentially an age of efficiency, and developments during the last year or so have been in the direction of improving the efficiency of the various portions of a wireless circuit. All the various parts of the circuit have come under review at one time or another, and one of the first components on which attention was concentrated was the coil itself. It was soon realised that there were several factors about the ordinary type of winding which made for inefficiency, and the ultimate result was that we entered into an era of low-loss coils.

"Low-Loss" Coils

The majority of such coils were wound with spaced windings upon skeleton types of former, and in order to obtain the necessary inductance they had of necessity to be made somewhat bulky. For this reason their use was hardly practicable in any receiver employing more than one or two tuned circuits, as otherwise the layout would have to be considerably bulkier than would be convenient.

Another aspect of the question is that, although considerable care was taken in winding these types of low-loss coils, the results very often were not much better than could be obtained with straightforward windings, so that it became questionable as to whether the additional trouble involved in the construction of such coils, was really justified.

I have recently been investigating the subject of low-loss coils generally with the object of finding out whether the special types of construction really gave any appreciable advantage; and, secondly, whether it was possible to construct a reasonably efficient type of coil which would occupy a much smaller space than was necessary with these somewhat bulky methods of construction. The results of these tests were highly interesting.

A Surprising Discovery

Perhaps the most surprising result was

that one type of low-loss coil, which consisted of a plain spaced winding on a skeleton former, was definitely worse than that which could be obtained by a plain straight-forward winding on an ordinary ebonite tube. This result was so remarkable that further investigations were made to discover the cause, and this was found to lie in the fact that the particular shape of coil employed was not at all efficient.

High-Frequency Resistance

In estimating the efficiency of a coil, we are concerned principally with the high-frequency resistance of the coil in proportion to its inductance. In a wireless receiver we receive a small voltage on the aerial, and we have to make the best possible use of this. Now, if we connect a battery across a lamp or some other form of instrument, a certain current will flow, depending upon the voltage of the battery and the resistance of the lamp or other device. In a wireless circuit we have an exactly similar state of affairs. Here we have a very small voltage which is induced in the aerial by the wireless waves, and this voltage will cause a current to flow in the circuit. In order that this current shall be a maximum, so that we may get the loudest possible signals from the given station, it is necessary for us to reduce the resistance as far as is practicable.

Basis of Comparison

I have shown previously in these columns that not only the signal strength but the selectivity of the circuit also depends upon the resistance in the circuit, so that if we can obtain some idea of the resistance of various coils, then we have some basis of comparing their relative efficiency. Obviously, however, it would be unfair to compare two coils, one wound with a very few turns only, and the other with 70 or 80 turns. We must, therefore, introduce another factor into the matter, and this is the inductance of the coil. In

Extension of Free Blueprint Service

HITHERTO we have presented with each copy of THE WIRELESS CONSTRUCTOR a free blueprint of one of the sets described.

Obviously, a large number of these must be wasted, and it is felt that those who desire to build one of the other sets described should also have an opportunity of having a blueprint free.

It has therefore been decided to supply free a back-of-panel blueprint of *any* set in this and future issues of THE WIRELESS CONSTRUCTOR. Only one blueprint can be supplied to each reader and only postal applications (accompanied by the coupon found in each future issue) will be considered; callers will not be supplied. This offer applies only to THE WIRELESS CONSTRUCTOR and will obviously be greatly to the advantage of readers.

REMEMBER:—

1. Only *one* blueprint supplied to each applicant. Extra blueprints are available at rs. 6d. each.
2. Only a *postal* application for a blueprint will be considered and it *must* be accompanied by the necessary coupon. Callers at our offices will not be supplied.
3. A coupon only covers the sets in that particular issue.

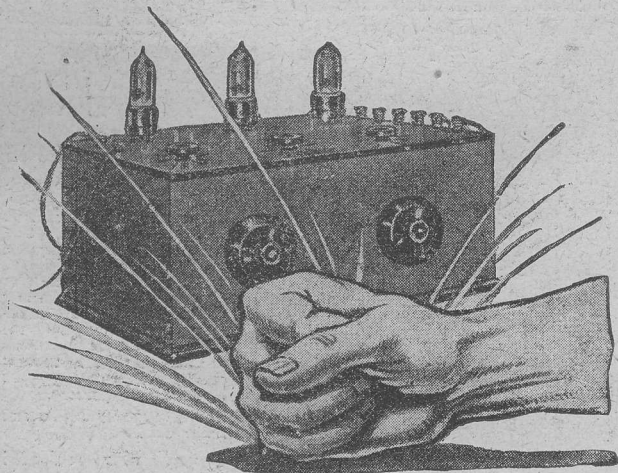

Bang! and not a complaint from Neutron Valves!

No need for "anti-microphonic" valve-holders now. Vibration doesn't produce a sound from Neutron Valves with their long-lasting, robust filaments.

With ordinary care, the Neutron Dull-Emmitter will last indefinitely, giving full volume and distortionless reproduction; it is more robust than other D.E. Valves, being made to work safely on 3.5 to 4 volts. And what extraordinary volume is given by Neutron Valves will be demonstrated by your Dealer, if you ask him. Clear, bell-like reproduction, too. Change over to Neutron Valves to-day.

NEUTRON VALVE

H.F.—Red Spot L.F.—Green Spot

CHARACTERISTICS:	CHARACTERISTICS:
Filament Voltage: 3.5 to 4 Volts.	Filament Voltage: 3.5 to 4 Volts
Filament Current: .06 Amperes.	Filament Current: .06 Amperes.
Anode Voltage: 20-100 Volts.	Anode Voltage: 20-100 Volts.
Total Emission: 9 Milli-amperes.	Total Emission: 15 Milli-amperes.
Impedance (Approx.): 22,000 Ohms.	Impedance (Approx.): 12,000 Ohms.
Amplification Factor: 9.	Grid Bias Voltage: Up to 6 Volts.
	Amplification Factor: 6 to 7.

Sold by Radio dealers everywhere. In case of difficulty send P.O. 12/6 for sample valve, post free. Address "Valve Dept. A." Neutron Distributors, Sentinel House, London, W.C.1. British made and guaranteed by Neutron, Ltd.

.06 for 12/6

In replying to advertisers, please mention THE WIRELESS CONSTRUCTOR.

BRITISH



THROUGHOUT

Super Transformer

—an engineering triumph

THE experience gained in building hundreds of audio transformers has enabled us to produce the U.S. Super Transformer—in every detail a perfect instrument. Every factor, electrical and constructional, has been co-ordinated to produce maximum volume without distortion. Low tones and high tones are amplified equally with the middle tones—the vital harmonics, qualities that distinguish music and speech from mere noise, are brought out in their full value.

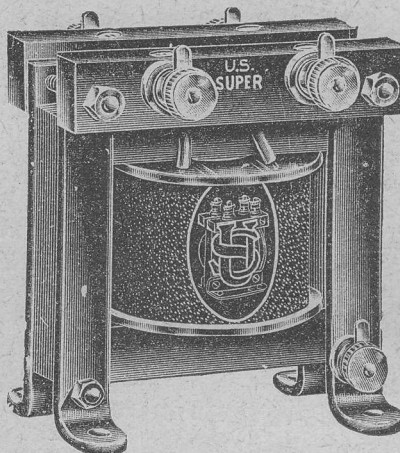

"MODERN WIRELESS" says of

The U.S. Super Transformer:

"The present instrument, if the high quality of the specimen submitted is an indication, can be heartily recommended, and indicates the vast strides that have been made recently in the design of really effective transformers for L.F. amplification."

For perfect audio amplification you must incorporate the U.S. Super. Get it from your dealer. Supplied in two guaranteed ratios, 5:1 and 3:1. PRICE

18/6 from all dealers or direct

The U.S. TWO VALVE CABINET SET

Complete Outfit including—Set (Two Valve cabinet), High Tension Battery 60 v. Low Tension Battery. Coils (for 300-500 metres). Valves (two Dull Emmitter). Standard Loud-Speaker. Aerial Equipment. Flex for connecting up. **£8 10 0** (Including Marconi Royalties). Nothing else required. Nothing else to pay. Absolutely Complete.

THE U.S. RADIO COMPANY, LTD.
Radio Works, Tyrwhitt Road, Brockley, S.E.4

Phone: Lee Green 2434

Wires: "Supertran, Lewis, London"

U.S. Transformers give Universal Satisfaction

ACHIEVEMENT

IN SUPER-HET. CONSTRUCTION

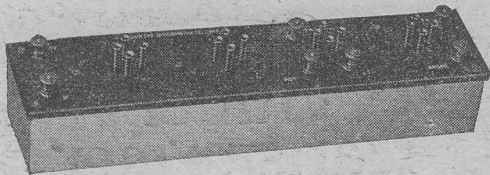

THE CURTIS INTERMEDIATE UNIT
 4 VALVES, 3 IF, 1 FILTER £7 10 0
 3 VALVES, 2 IF, 1 FILTER £6 6 0

The Curtis Intermediate Unit is a complete component consisting of the intermediate frequency and filter transformers, with corresponding valve sockets and accessories. Wired-up, boxed, tested and matched ready for use in any supersonic circuit.

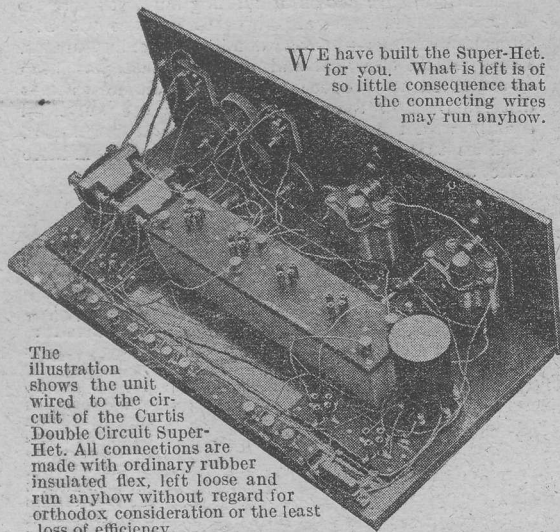

WE have built the Super-Het. for you. What is left is of so little consequence that the connecting wires may run anyhow.

The illustration shows the unit wired to the circuit of the Curtis Double Circuit Super-Het. All connections are made with ordinary rubber insulated flex, left loose and run anyhow without regard for orthodox consideration or the least loss of efficiency.

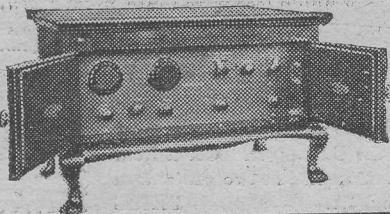

The Curtis Imperial Model Double Circuit Super-Het. 8.

ANYWHERE FROM ANYWHERE AT ANY TIME
 Free Demonstration at Your House
 PRICES FROM £40 CASH OR DEFERRED
 Your existing instrument taken in part exchange

BUILD YOUR OWN
CURTIS DOUBLE-CIRCUIT SUPER-HET. 8.
 Constructor's Treatise contains:
 1. Circuit Diagrams. 2. Simplified lay-out and wiring charts.
 3. Instructions for operation. 4. Complete schedule of components.
 PRICE 2s. 6d. Write now for Catalogues.

PETER CURTIS, Ltd.
 75a, CAMDEN RD., LONDON, N.W.1

Telephone—North 3112-3. Telegrams—"Paracurtex"
 MANCHESTER - - - - - 312, DEANSGATE
 Telephone—Central 5095
 GLASGOW - - - - - 47, CARRICK STREET
 Telephone—6759

The 'SUCCESS' SUPER AUDIO CHOKE

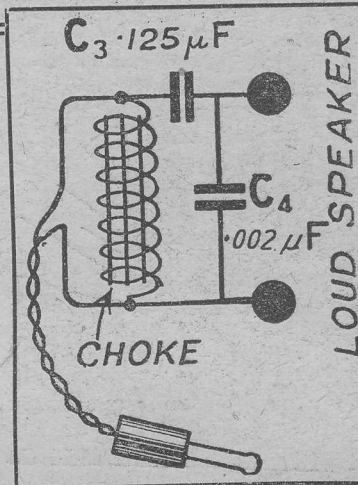

Use it in the Filter Circuit for two reasons

FIRSTLY: for the appreciable improvement made in the quality of your loud speaker reproduction. Secondly: as a protection against the burning out of the loud speaker windings by the direct current. Used in a Filter Circuit as shown in the accompanying diagram the Success Super Choke effects this dual purpose to an extent of efficiency that is unequalled by similar components. Therefore specify the Success Super Choke.

Your Dealer Stocks it!

The Success 18/6 Super Choke

Success Radio Frequency Choke

For Capacity Reaction and Reinartz Circuits Price 10/6

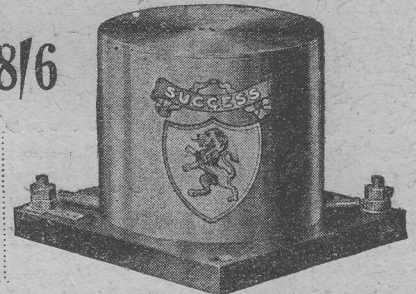

BEARD & FITCH LTD. 34, AYLESBURY ST., LONDON, E.C.1
 And at 1, Dean Street, Fieccadilly, Manchester

Cut out the CRACKLE

in your set by using the Ediswan Vacuum Grid Leak

The leak, manufactured by secret process, glass enclosed in a vacuum is absolutely constant in its resistance under all working conditions. Crackling and parasitic noises due to varying leak resistances are eliminated, as no chemical action due to atmosphere or light rays can take place.

The EDISON SWAN ELECTRIC Co. Ltd.
 123-5, Queen Victoria St.
 London: E.C.4

Made in six sizes, viz.: 0.5, 1.0, 2.0, 3.0, 4.0 and 5.0 megohms
 2/6 each



Ask your Dealer about them!

order to obtain a fair comparison, therefore, we must either test coils all wound to have the same inductance or else we must measure the ratio of resistance to inductance for any particular coil, and this is the method I have adopted in making the various tests.

At the same time, in order to avoid any discrepancies,

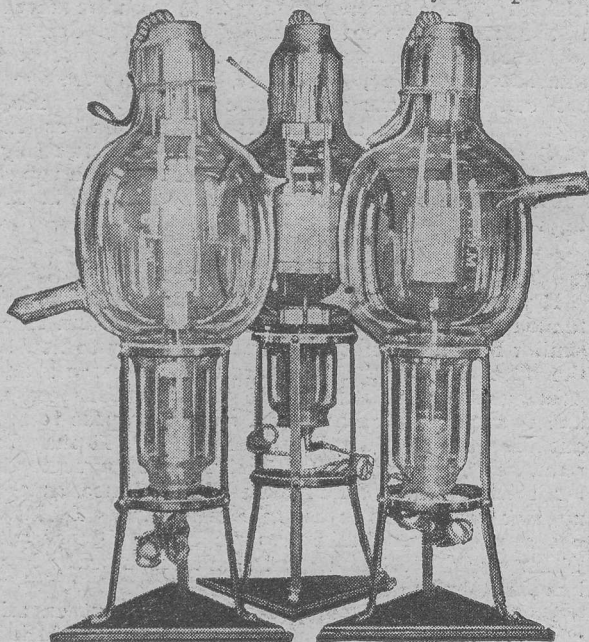

High power transmitting valves shown at the Physical Society's Annual Exhibition.

the actual value of the inductance was kept fairly constant. A reasonable value for the ordinary broadcast frequency is 200 μ H., and all the various coils tested, therefore, were adjusted to have an inductance of this order. It is with this question of inductance that the efficiency of the coil comes into play. We can wind a coil to have a given inductance in a variety of shapes. The coil can be made short and fat, that is to say, one having a relatively short length compared with its diameter; or we can make it long and thin. Alternatively, we can employ various types of multi-layer coils. Now, all these several types of construction do not give the same results. To confine our attention first of all to single-layer coils, if we wind a coil in such a way that its length is large compared with its diameter, then we find that the inductance for a given number of turns is less than if we construct the coil to have a short winding length only.

An Interesting Example

A particular example of this will be of interest. Two coils were wound, both having a diameter of 3 in., but one coil was wound with a spaced winding so that its total length was 6 in. The other coil was also wound on a 3 in. diameter former, but was so arranged that the whole of its winding came within a length of $\frac{1}{2}$ in. only. The first coil had 90 turns on, whereas the second had only 40, yet both these coils had the same inductance. That is to say, because the first coil was long and thin it was necessary to put on 50 more turns in order to obtain the same inductance as the second one. Now, it will be obvious that these extra 50 turns are using up wire unnecessarily, hence keep the length of wire to the minimum possible.

Here, however, we are faced with a second problem. In order to obtain 40 turns of wire in a space of $\frac{1}{2}$ in. only, it is obviously necessary to use a very fine gauge of wire. Now, with ordinary direct current, we know that as we reduce the size of the wire, so the resistance of the coil increases, and this fact would, at first sight, seem to rule the use of fine wire for inductance coils out of the question completely.

Secondary Effects

This, however, is not the case in practice. Owing to the high frequency of the currents which are employed in wireless transmission and reception, we find that certain secondary effects take place. The current in the coil, instead of being uniformly distributed throughout the wire, only flows in a certain small portion along the inside surface of the coil, producing a non-uniform distribution. We find in practice that owing to this "skin effect," as it is called, the increase in resistance due to the use of a finer gauge of wire is not as serious as one would suppose at first sight.

Added to this effect, we have the fact that the actual length of wire in the coil has been reduced to something less than one-half, so that the resistance of the coil is very materially reduced. The two effects, therefore, act in opposite directions. The use of the thinner wire tends to increase the resistance of the coil, but the fact that the coil is much more efficient enables us to use very much less wire in its construction, and this tends to reduce the resistance. Practical results appear to indicate that these two effects balance one another out to a large extent, and I have been able to construct coils in practice wound with 36 gauge wire which were every bit as efficient as coils wound with 22 gauge.

A New Type

This, therefore, gives us an entirely new type of low-loss construction for coils. A reasonably efficient coil may be made by winding a plain straightforward

IMPORTANT NEW PUBLICATION

THE RADIO PRESS YEAR BOOK FOR 1926

An indispensable reference book for the wireless constructor and experimenter, at a price within the reach of all, published in February. The Radio Press Year Book contains, among other important contributions, the following:

<p>Prophecies. By J. C. W. REITH, Managing Director of the B.B.C.</p> <p>Controlling Oscillation in H.F. Amplifiers. By MAJOR J. ROBINSON, D.Sc., Ph.D., F.Inst.P.</p> <p>American and English Radio Conditions. By PERCY W. HARRIS, M.I.R.E.</p> <p>Listening to America. By CAPTAIN A. G. D. WEST, M.A., B.Sc.</p> <p>The Effects of Self-Capacity. By H. J. BARTON-CHAPPLE, Wh.Sch., B.Sc., A.C.G.I., D.I.C., A.M.I.E.E.</p>	<p>Getting the Best from your Aerial. By CAPTAIN JACK FROST.</p> <p>Low-Frequency Magnification. By CAPTAIN H. J. ROUND, M.C., M.I.E.E.</p> <p>Some Facts about Valve Filaments. By CAPTAIN H. L. CROWTHER, M.Sc.</p> <p>What is Coil Resistance? By J. H. REYNER, B.Sc., A.C.G.I., D.I.C., A.M.I.E.E.</p>
--	--

The home constructor will find especially helpful the sections dealing with valves, calculations, tables, workshop hints, up-to-date call signs, etc.

Price 1/6 from your bookseller.

coil on a 3 in. ebonite former with any convenient gauge between 30 and 36. Double silk covered wire is preferable, as I have found peculiar effects with cotton covered wire. If enamelled wire is employed, then a slight spacing of the turns is advisable, as we shall see in a minute. Coils wound up on this principle have actually been employed in wireless receivers by various members of the Radio Press, and the results have been definitely better than with some more conventional types of low-loss coil.

In order to obtain the best results, the turns of the coil should be slightly spaced, and, if desired, a skeleton

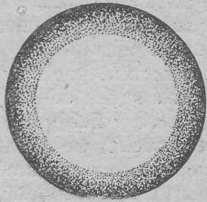

High-Frequency currents flow only in the "skin" of a wire, so a greater proportion of wire

is effective when the diameter is small.

type of former may be employed. It will be obvious, however, that with the fine wire coils, the spacing should not be as large as it is with coils wound with 22 gauge. The older types of coil employed spaced windings having only some 16 turns to the inch, but very inefficient results would be obtained if such a wide spacing were used when fine wire was employed. In general, it will be found that a spacing equal to the diameter of the wire and its covering is all that is required. The use of double silk covered wire at gauges between 30 and 36 gives a certain amount of spacing, because with fine wires the relative proportions of silk covering to wire are higher than with the

thicker gauges of wire. A type of coil which may be recommended is one employing 30 gauge wire with a spacing of 40 turns per inch.

Multi-Layer Coils

The question of multi-layer coils is one of some difficulty. The majority of plug-in coils on the market at the moment are of the multi-layer type, and certain of these are surprisingly efficient. In the case of a multi-layer winding, of course, we obtain the short fat coil by winding the wire in two or more layers. This gives an efficient construction as far as the inductance is concerned, but, unfortunately, it is found that the addition of further layers on top of the first give rise to a somewhat heavy increase in the high-frequency resistance.

A Complex Problem

It was previously shown that the current in the coil tended to crowd to the inside of the coil, and for a similar reason most of the currents will try to flow in the first layer only, so starving the second and subsequent layers. The whole question, therefore, is one of such complexity that I do not propose to say anything about it at the present stage. It may be remarked, perhaps, that in all my experiments so far I have found an increase of resistance, as the number of layers was increased, and I have not succeeded in finding a type of multi-layer coil which would give such good results as a really low-loss single-layer winding.

Readers, therefore, may care to carry out experiments with various types of coil on the lines which I have discussed. Should any reader have any particular type of coil which he considers is likely to be efficient, I shall be very pleased to test it for him.

IF
A NOISE
ANNOYS,
FIT



INTERVALVE



TRANSFORMERS
TO YOUR SET

Type AF4 = 17/6
Type AF3 = 25/-

THE NEARLY PERFECT TRANSFORMER
Ask your Dealer for Leaflets Wa 401 and Wa 402

FERRANTI LIMITED, Hollinwood, LANCASHIRE

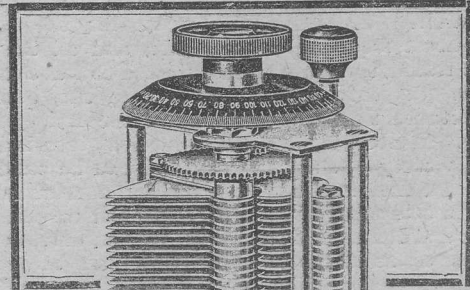

Pat. No.
241805

·001 ... 17/6
·00075 ... 16/3
·0005 ... 15/-

·0003 ... 13/6
·00025 ... 13/3
·0002 ... 13/-
·0001 ... 12/9

The J.B. Geared Low Loss Condenser
provides micrometer tuning

FEATURES:
A SECOND Knob is provided, by means of which the most hair-breadth adjustment may be obtained, controlling a gear having a ratio of 60-1. The gear in no way interferes with the free motion of the spindle to provide for quick searching.

WHETHER you need a precision condenser to search out distant stations, or a sharp tuning instrument to give you maximum results from local transmissions, you'll find the J.B. Geared Low Loss Condenser a revelation in real tuning efficiency.

Just as the engineer's micrometer makes it possible to determine minute measurements, so the J.B. Geared Low Loss Condenser makes it possible to obtain the minute variations in capacity so essential to efficient tuning.

Obtainable from all Dealers

JACKSON BROS
8, POLAND ST - OXFORD ST
LONDON - W.1.
(First Floor) Telephone: GERRARD 7414

CLEARTRON DULL Emitter VALVES

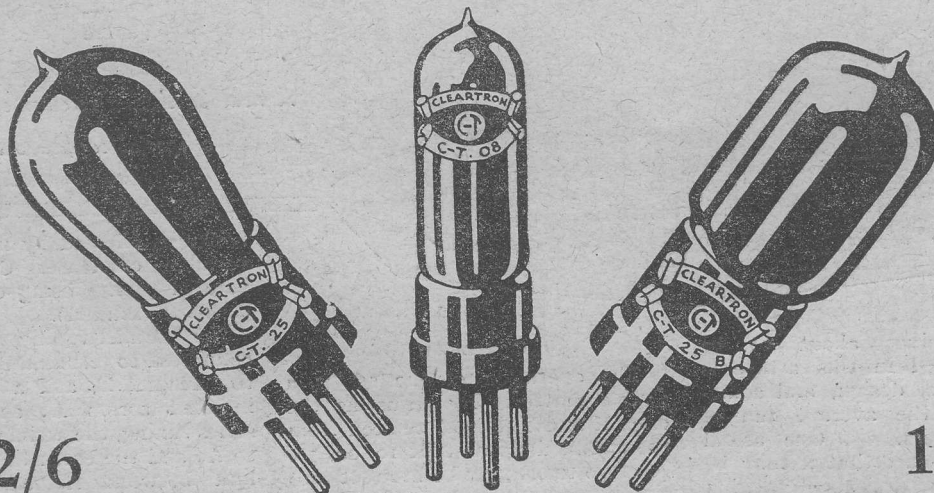

12/6

15/-

BRITISH MADE

IT has been brought to the notice of Cleartron Radio Ltd., that persistent rumours are being circulated to the effect that their valves are assembled in Birmingham from components made in the United States and imported to this Country. Cleartron Radio Ltd., wish it to be clearly understood that such statements are entirely without foundation and this Company have every intention of taking whatever steps may be necessary to protect their interests.

Cleartron Radio Limited is a British Company, fostered in British interests by British capital. The Cleartron Valve is, and always has been, built of British material by British labour in the Birmingham factory.

CLEARTRON RADIO LIMITED

1 CHARING CROSS, LONDON
AND BIRMINGHAM

Phone: Regent 2231/2

Grams: Cleartron, Westrand, London.

America's foremost Valve
made in
Britain's newest Factory

CLEARTRON

BRITISH  MADE

With British Bases for
British Sets and Sockets

The "Octagon" Crystal Set

By H. BRAMFORD



A neat baseboard receiver employing a special tapped coil

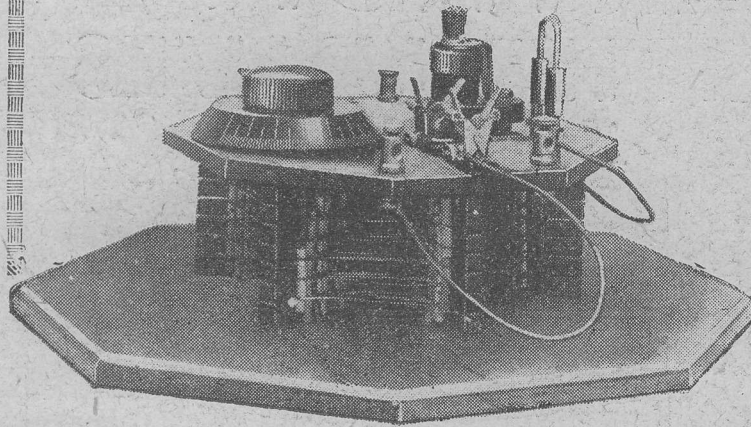

THE receiver about to be described in this article is of novel design, and somewhat unlike the average run of crystal receivers. One useful feature is the fact that it may be hung in any desirable position

Operation
The operation of the set is a simple matter. By adjusting the clips X and Y, it will be seen from the circuit diagram that 10, 20, 30, 40 or 50 turns may be brought into circuit as desired. For local reception a shorting plug is inserted in the loading-coil socket. The

tuning is effected by means of the variable condenser C, series or parallel tuning being employed as occasion demands.

For parallel tuning, the aerial is connected to terminal A₁, the earth to terminal E, and a wire link is inserted across A₂ and E. For series tuning, the aerial is connected to A₂ and the earth to E, the wire link between A₂ and E being removed. For long-wave reception, a loading coil is inserted in place of the shorting plug.

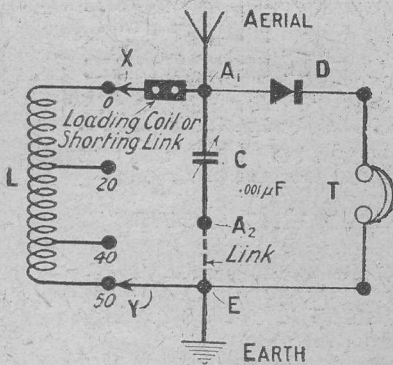

Fig. 1.—The theoretical circuit of the receiver.

upon the wall, and the telephones may also be hung upon the set.

A plug-in semi-permanent detector has been chosen, in order to simplify as much as possible the operation of the receiver. Therefore, when the crystal detector is satisfactorily adjusted and the dial of the condenser is set for local reception, the receiver is permanently ready for use.

Circuit

A theoretical circuit diagram is shown in Fig. 1. L represents the low-loss inductance coil, and theappings are indicated, 0, 20, 40, 50. X is the clip connector from the loading coil, and Y the clip connector from the earth terminal.

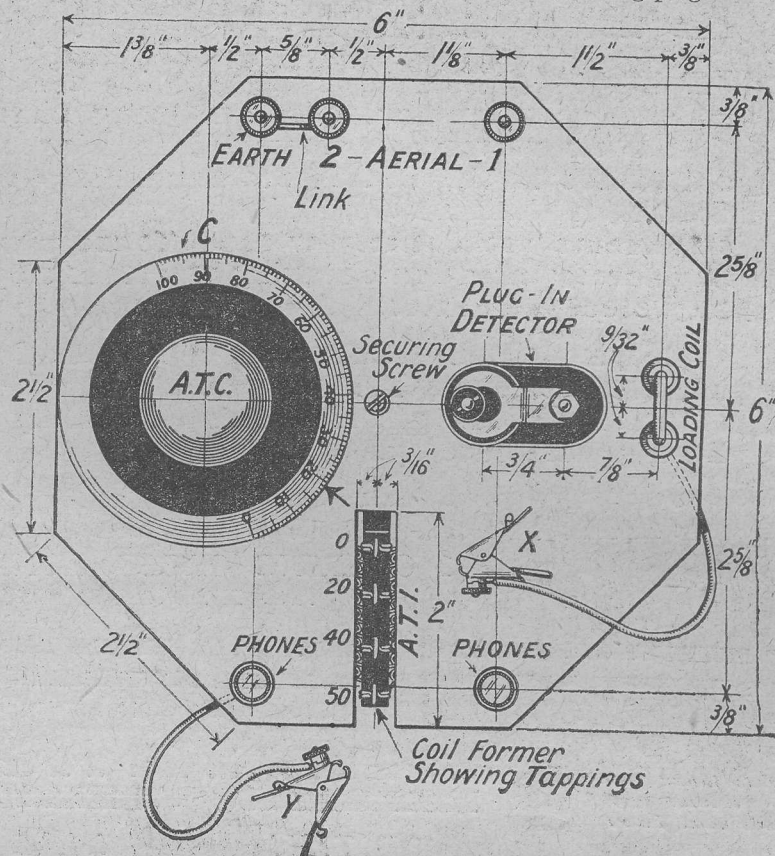

Fig. 2.—All components except the coil are mounted on an octagonal panel. Blueprint No. C1032A, 1/6 post free.

Materials

For the benefit of those readers who would wish to duplicate exactly the original set, the materials required for construction, together with the names of the manufacturers, are as follows:—

One Dial-o-denser $.001\mu F$ capacity (Portable Utilities Co., Ltd.).

One semi-permanent "K" plug-in detector (Wates Bros.).

One Daventry hexagonal coil former (cut down), Magnum (Burne-Jones & Co., Ltd.).

$\frac{1}{4}$ lb. No. 22 S.W.G. enamelled wire.

One length of Glazite (London Electric Wire Co.).

One loading coil plug and socket (K. Raymond).

Three small pillar terminals.

Two telephone terminals.

One piece of ebonite 6 in. square $\times \frac{3}{16}$ in. thick Radion (American Hard Rubber Co.).

Two spring clips (Peto-Scott Co., Ltd.).

One octagonal base board (Camco.).

One packet Radio Press panel transfers.

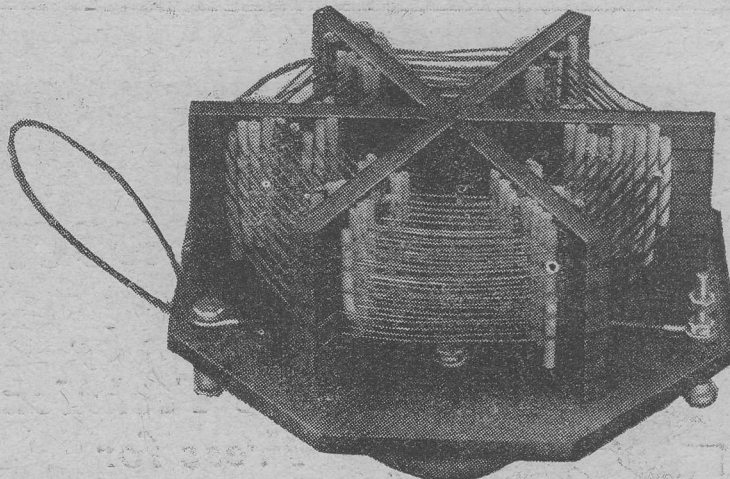

A photograph giving a good view of the coil and its construction.

Panel Drilling

We may first proceed to construct the octagonal top panel, details of which are clearly shown in Fig. 2. First cut a piece of ebonite 6 in. square, and form this into an octagonal shape by cutting off the four corners, so as to make each of the eight sides $2\frac{1}{2}$ ins. long.

The positions of the holes to be drilled are clearly indicated in the diagram. A $\frac{1}{4}$ B.A. clearance drill should be used for all the holes, with the exception of those made to take the centre spindle of the condenser, the sockets of the plug-in detector, and the pin and socket for the loading coil, for which the holes should suit the purchased components. A slot is cut in the position indicated $\frac{3}{8}$ in. wide by 2 ins. long, and this affords access to the windings on the coil itself. As the connections on this panel are entirely independent of the coil, this portion may be completed before proceeding further with the work.

Assembling the Set

The assembly of the parts is also shown in Fig. 2, and may be best carried out in the following order. First mount upon the panel the variable condenser in accordance with the instructions which are supplied with this component. Next mount the sockets for the plug-in detector and the pin and socket for the loading coil, and finally complete the assembly by fixing the three pillar terminals and the two telephone terminals. The appearance of the panel is enhanced by the use of Radio Press panel transfers, as will be seen from the photographs.

Wiring

Details of the wiring are given in Fig. 3, and this will be found a very simple process. The only remarks necessary are that the flexible lead of the variable condenser, which represents the moving vanes connection, is taken to terminal A2.

The Former

The inductance coil is wound upon a modified Daventry former,

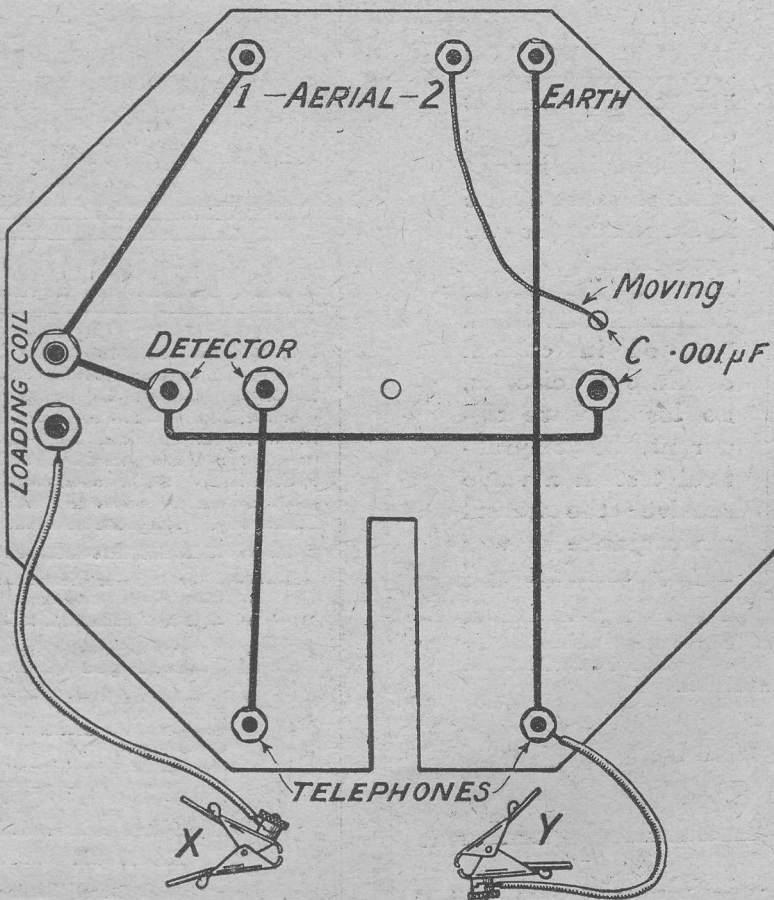
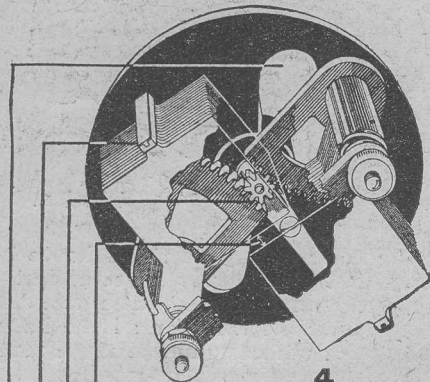

Fig. 3.—The back-of-panel wiring is shown above. Blueprint No. C1032B may be obtained under our new scheme.

The Newey "4 Point" Condenser



4 REVOLUTIONARY POINTS

①

NO HAND CAPACITY.
The bakelite mounting plate is specially designed to minimise self-capacity and to isolate the vanes from control.

②

ZERO LOSS.
All plates are welded into a slotted equaliser bar to secure true zero loss.

③

360° CONTROL.
No vernier is necessary since the condenser drive is calibrated over a range of 360°.

④

NEGLIGIBLE MINIMUM CAPACITY.
The lowest capacity position gives only 0.000003 mfd. as certified by the National Physical Laboratories.

PRICE:

Complete with knob and dial

0.0005 mfd. 17/6
0.0003 mfd. 15/-

The complete condenser operates on the square law principle, is beautifully finished and made by all British Labour in all British Factories from the finest available materials.



POINT
CONDENSER

Newey's

Ask any dealer for the "Newey" Leaflet for full information. If you have any difficulty, write for name of nearest supplier.
Wholesale Distributors: **PETTIGREW & MERRIMAN (1925) LTD.**
(and Branches), 122-124, Tooley Street, London, S.E.1. Telephone: Hop 134

Chosen by
the Technical
Press for
Super Circuits

THE WIRELESS WORLD

"The issue of Oct. 28 specified 3 Newey Four Point Condensers for the best results in the five valve NEUTRODYNE Receiver."

AMATEUR WIRELESS

"In construction it is of the ultra low-loss type, and in this respect it is one of the finest examples we have seen."

THE BROADCASTER

"Tested in critical oscillating circuits, no losses were apparent, while on practical test in a valve receiver the actual performance was highly satisfactory."

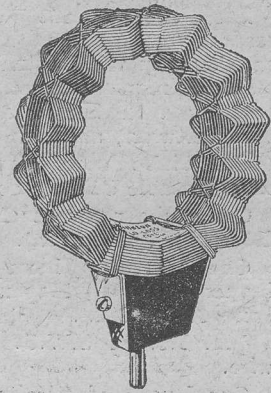

Finston

LO-LOSS COILS

No. 25 .. 1/3	No. 75 .. 2/9	No. 200 .. 3/6
No. 35 .. 1/6	No. 100 .. 2/6	No. 250 .. 3/9
No. 50 .. 1/9	No. 150 .. 2/9	No. 300 .. 4/0
	No. 175 .. 3/3	

Obtainable from all Dealers
FINSTON MANUFACTURING Co. Ltd.
45, Horseferry Road, London, S.W.1
Phone: Victoria 1614

LITTLE WIRELESS GADGETS

Receiver Terminal No. 84

STOCKED BY ALL DEALERS

MAP Co. 246 Gt. Lister St., Birmingham.

ELECTRADIX RADIOS

Have opened a large City Showroom at 218, UPPER THAMES STREET, E.C.4 and are selling an enormous stock of Radio and Electrical Goods of the highest grade—Marconi, Siemens, Sullivan, Brown, Western Electric, at bargain prices. Send 4d. for illustrated catalogue and price list. The Stores at 9, Colonial Avenue, Minorities, contain tons of goods at sacrifice prices to save removal. Callers only. Telephone: Avenue 4166.

"NEW WESTERN ELECTRIC LOUD SPEAKERS."

Complete with Cord in Maker's Sealed Carton, 20/-
Cheaper than elsewhere
4,000 ohms, 22/6. 2,000 ohms, 20/-. 70 ohms, 17/9



"The Catalogue that saves you pounds"

Its scope ranges from a 5s. pair of British Headphones or a 12s. 6d. Milliammeter to a 30,000 volt Generator, and covers all requirements.

If you cannot call and inspect goods in our showrooms between 9 a.m. and 6 p.m. it will pay you to send 4d. for our Catalogue at once. Goods promptly despatched all over the world.

ELECTRADIX RADIOS,

218, Upper Thames Street, London, E.C.4

Phones: City 191; Avenue 4166.

Address all Post Orders to City Showroom:

218, Upper Thames Street, London, E.C.4

which is built from three intersecting pieces, representing six sides when completed. In each side there are 10 slots, and for this particular receiver the former is cut down to a depth of six slots

the winding and also at the twentieth, fortieth and last turns.

Tappings

The method of forming the tapping points is shown also in

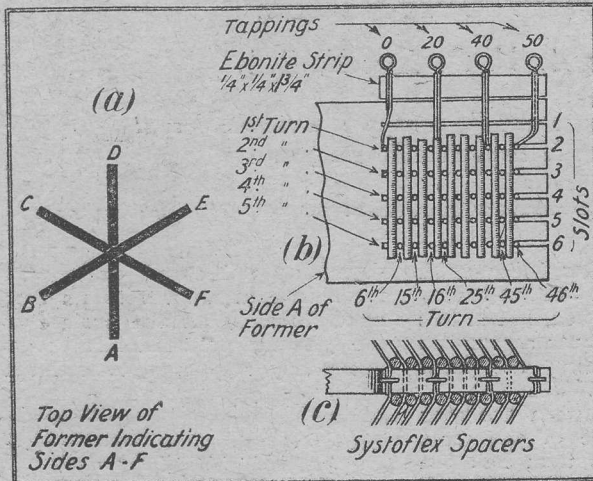

Fig. 4.—Constructional details of the coil-former, coil and tappings.

only, as shown in the details given in Fig. 4.

For the benefit of those who desire to construct their own former, the following are the principal dimensions for each of the three pieces: Depth $1\frac{3}{4}$ in., length $5\frac{1}{2}$ in., thickness $\frac{3}{16}$ in. or $\frac{1}{4}$ in. Each piece has six slots cut to a depth of $1\frac{3}{4}$ in., the width being sufficient to clear No. 22 S.W.G. D.C.C. wire. The slots are spaced $\frac{1}{4}$ in. apart. Intersection slots are also cut centrally in each piece so that they form into the shape of Fig. 4(a) when assembled.

Winding the Coil

Start the winding at the second slot from the top of the former at side A (see Fig. 4(a) and (b)). Travel round in a clockwise direction, looking from the top of the former, keeping the wire in the second slot of each side until side F is reached. Now drop down to slot 3 of side A and continue as before until side F is again reached, then drop down to slot 4 of side A and continue in this manner until side F of the sixth slot is reached.

During the winding of the next five turns (which travel upwards towards slot 2), interpose Systoflex spacers, as shown in Fig. 4(b) and (c). Alternatively, ebonite rod of small diameter may take the place of Systoflex for spacers. The winding is proceeded with in the manner described until 50 turns in all have been made, tapping points being formed at the beginning of

firm; if made long they will be weak and unstable. The wire should be scraped clean of its enamel covering where the loops are made, to ensure good electrical contact between the loops and the clips.

Finishing

Having completed the winding of the coil, secure the ebonite top panel to the top of the former by means of a single centre securing screw, in the position indicated in Fig. 2. The baseboard is secured to the underside of the former in a similar manner. The completed receiver may be fixed in any convenient position, up on the wall, a hook being provided on the baseboard to accommodate the telephones.

Test Report

Tests were carried out on a rather small aerial, situated six miles east of I.O. Signals were received at usual strength, using both parallel tuning and series tuning, the number of turns in circuit being varied accordingly. Daventry was easily received with the use of a Daventry loading coil.

These results were confirmed by tests carried out at our Elstree Laboratories.

by twisting the wire; no soldering is therefore necessary. The loops when formed should be short and

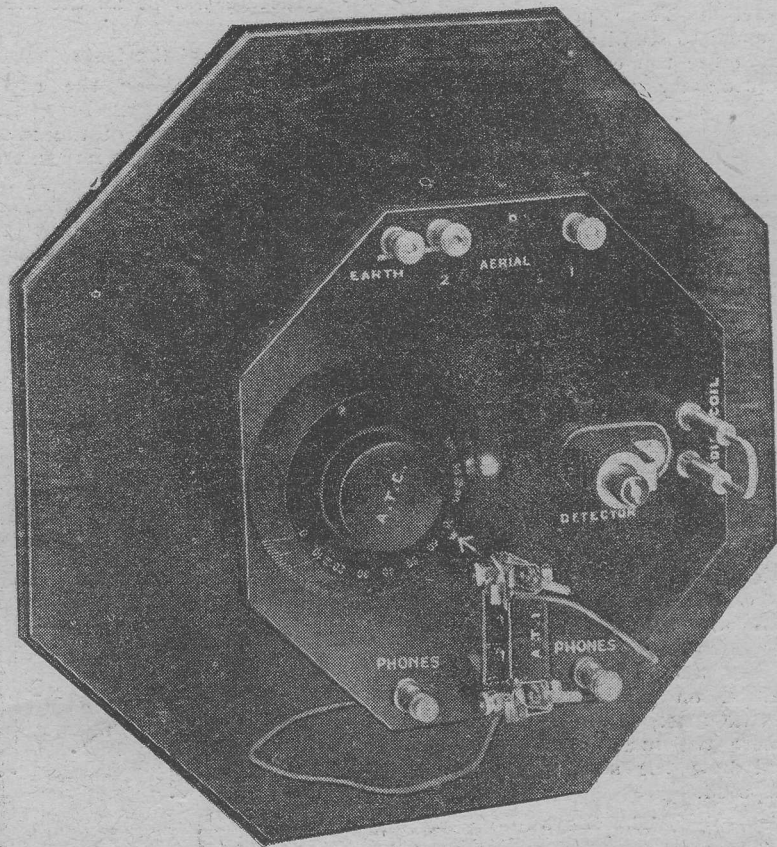

The completed set is mounted on an octagonal baseboard, and may be hung on the wall if desired.

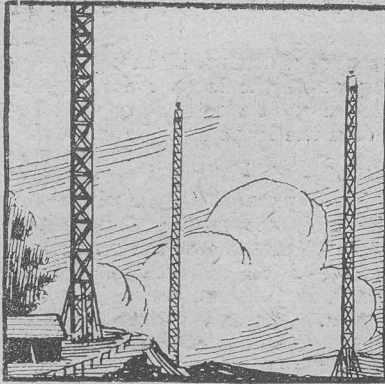

Erecting a 25-ft. Aerial Mast Single-Handed

By A. V. D. HORT, B.A.

Given sufficient space, the erection of a fair-sized mast can be carried out by one person

THE erection of a good stout mast to support the aerial is not infrequently regarded as too awkward a task for unskilled labour. It is not suggested that it is easy to put up a 25-ft. mast in a small back yard, where there is little room for stays, or even for manœuvring the mast itself into position. When space permits, however, the erection of such a mast can be accomplished by one person.

The Mast

The type of mast which the writer has in mind consists of a light scaffold pole, usually a larch pole. These poles are strong enough to stand rigidly with stays from the top end only, and it is unnecessary to add other stays

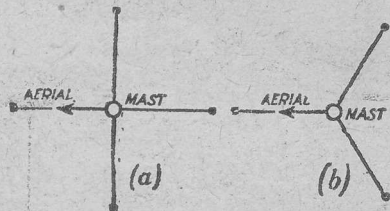

Fig. 1.—Alternative methods of arranging the stays.

half-way down the pole in order to prevent buckling.

As regards the actual space required for the erection of a pole 25 ft. long, 40 ft. by 20 ft. is sufficient to give room for laying out the stays and erecting the mast. Of course, only a small portion of this area will actually be needed for operations.

The first thing to do, having settled on the approximate site of the mast, is to decide exactly where the mast itself will stand and how the stay pegs will be disposed.

The Stays

The most suitable arrangement of the stays is that shown in Fig. 1(a), two sets of stays at right

angles to each other being used. The scheme shown in Fig. 1(b) may be adopted if preferred, but in this case it is not so easy to accomplish the task of erecting the mast without assistance.

The distance between the stay pegs and the base of the mast should not be less than half the height of the mast above ground. This is not an inflexible rule, and it may be necessary to shorten the distance at one or more points owing to local conditions. This minimum, however, should be aimed at, and if the pegs can be placed still further from the mast the structure will be all the more secure.

Depth of the Hole

Having decided on the exact position for the butt end of the mast may be dug. It is most important, if the mast is to stand well in all weathers, to keep this hole "straight-backed," and not to make it larger than is necessary. For a 25-ft. mast—that is to say, one which is to stand 25 ft. above the ground—the hole should be from 3 to 5 ft. deep, according to the nature of the soil. A hole in loose sandy soil will obviously need to be somewhat deeper than one in stiff clay.

Stability of the Mast

As a point of interest, it may be noted that a mast of the type under

discussion will stand quite well, for a time anyway, with its butt merely resting on the surface of the ground, provided that it is adequately stayed. Should the

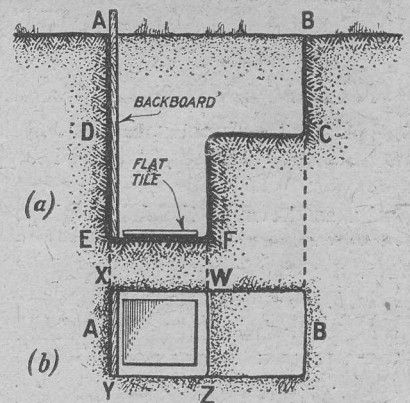

Fig. 2.—This diagram gives details of the hole for the mast.

stays become slack, however, the safety of the mast will be imperilled, and a pole of this length can do quite a lot of damage if it falls. If, on the other hand, the butt end is well sunk in the ground, even the breaking of a stay will not necessarily lead to collapse of the whole structure, and the breakage may be repaired before any damage is done.

Digging the Hole

Now, without special tools it is a laborious task digging a narrow

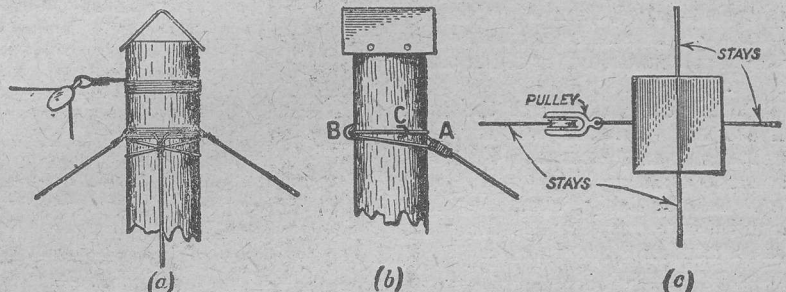
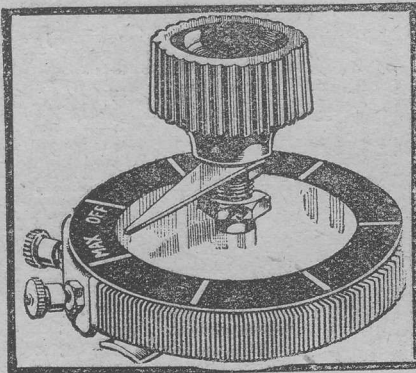

Fig. 3.—The stays are fixed to the mast as shown above, while a metal cap is nailed to the top.



Finston

**FILAMENT RESISTANCES
ON BAKELITE MOULDINGS**

7 ohms	-	2/3
15 ohms	-	2/6
30 ohms	-	2/6

FINSTON MANUFACTURING CO., LTD.
45, Horseferry Road, London, S.W.
VICTORIA 1644

BRITISH MADE

REPAIRS SETS PHONES
TRANSFORMERS

Officially approved by Radio Association

**ALL WORK GUARANTEED
LOWEST RATES—24 HOUR SERVICE**

John W. Miller, 68, Farringdon Street, E.C.4
Phone: CENTRAL 1950

SOLDERING ABOLISHED

THE
SUPER
TERMINAL

FOR
PERFECT
CONTACT

BY USING **TIXIT** TERMINALS
AND COUPLERS

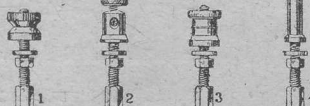

Brass: 2½d; Nickelled: 3½d each, COMPLETE
Simple and effective. Insert the wire through the base unit into the hole in the stem of the terminal, tighten up the lock-up and perfect contact results. NO soldering required.

8^{DOZ}



For connecting Junction Wires without Soldering
All Dealers or direct orders over 2/6 post free.

DESCRIPTIVE PAMPHLET SENT ON REQUEST
L. H. REID & CO.
32, VICTORIA ST. LONDON, S.W.1

DURABILITY



ON the Thames Embankment stand 186 tons of red syenite—a dual memorial to British seamanship and ancient Egypt's innate love of sculpture. The romantic story of Cleopatra's Needle is well-known. How it lay for centuries at Alexandria until shipped to England in 1878. Even then its adventures were not ended. A tempest sprang up and the little ship with its precious burden—but for the skill of the crew—would have foundered. For two thousand years this fine old monument has successfully braved the ravages of Time.

Durability, too, is a special feature of every Eureka Transformer. With its coppered steel case and its hermetically protected contents, a Eureka is fully equipped to resist the ravages of Time. Even moisture—the deadliest enemy that any Transformer has to face—is powerless against the Eureka. It is the last Transformer you ever need buy.

Eureka Concert Grand . . . 25/- No. 2 . . . 21/-
Baby Grand, Nos. 1 and 2 . . . 15/- Reflex . . . 15/-

EUREKA

Your
radio set
can be
improved
by using

**B.T.H.
VALVES.**

Made in England

Insist on
B.T.H. the
Best of All

The British Thomson-Houston Co. Ltd
Crown House, Aldwych,
London, W.C. 2.

SIX TYPES

R	0.7 A. 4 v. 8/-	B3	0.35 A. 1.8 v. 14/-	B4	0.25 A. 6 v. 22/6
B5	0.06 A. 28 v. 16/6	B6	0.12 A. 28 v. 22/6	B7	0.06 A. 6 v. 24/6



2442C

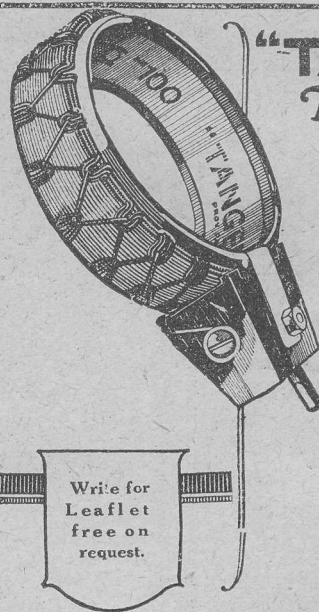

**"TANGENT"
The Better Coil!**

Better for many reasons

First of all it is designed to fulfil its job efficiently. To tune in signals sharply, without distortion, and with the minimum amount of self-capacity. Again the Coil is so designed that it will stand any amount of handling, yet in no way is it a clumsy Coil; on the contrary it is an elegant product made to fit all standard Coil Holders.

Most good houses sell
Tangent Fitments

Write for
Leaflet
free on
request.

London:
25, Victoria St.
S.W.1
Newcastle/Tyne:
Tangent House
Blackett Street.



GENT & CO., LTD., Faraday Works, Leicester

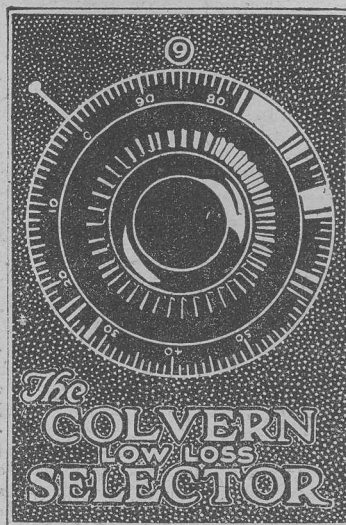

The
**COLVERN
LOW LOSS
SELECTOR**

**THE COLVERN SELECTOR
LOW LOSS**

Reading to 1/3,600th
capacity.

Capacity—
·0005 mfd. - £1 1 0
·0003 mfd. - £1 0 0
**TYPE F, without gear
attachment.**

Capacity—
·0005 mfd. - 15 0
·0003 mfd. - 14 0
One hole fixing. Other
capacities if required.
Descriptive Folder upon
request.

**COLVERN INDEPENDENT
VERNIER** Price 2/6

Ask your dealer also for
the Colvern Low Loss Coil
Former Price 6/-

—enables calibration
and relocation to
a high degree of
accuracy!

Calibration with certainty to the 1,000th part of the variable capacity. This is the tuning efficiency obtained with the Colvern Selector. The complete circle of the dial is divided to provide a value of 100 deg. for every rotation of the index. Pre-supposing your condenser and inductance to cover 300 metres, the degree interval represents 3 metres—obviously every station can be calibrated definitely.

The Colvern is logically the only condenser worthy of the attention of serious experimenters. An insulated spindle reduces the effect of hand capacity to a minimum, a point of paramount importance in the reception of distant signals. See the Colvern at your Dealers!

The Colvern Low Loss Selector (Gears 20-1)

COLLINSON PRECISION SCREW CO., Ltd., Provost Works, Macdonald Rd., Walthamstow, London, E.17
Telephone: Walthamstow 532

hole about 4 ft. deep. Reference to Fig. 2(a) and (b) will show how this work can be simplified. The part of the hole marked A B C D in Fig. 2(a) is dug out first, the "step" and "back" ends of the hole being in line with the positions for one pair of stay pegs. Then, with the "step" to give more room for working, one end of this hole is sunk to the full depth required. This lower portion of the hole, marked WXYZ in Fig. 2(b), should be kept as narrow as possible, very little larger in each direction than the spade used for digging.

The "back" of the hole, ADE in Fig. 2(a), must be as nearly vertical as possible. If the hole is properly dug in the manner described, the soil round the butt of the mast, when it is erected, will be undisturbed. It will therefore offer a considerable resistance to any lateral movement of the butt, and the mast will stand steadily. When the hole is ready, a flat tile should be placed at the bottom. The butt of the mast will rest on this, and hence will not tend to sink into the ground so much owing to its own weight and the downward pull of the stays.

"Dressing" the Mast

The next operation is to "dress" the mast—i.e., to put on the stays, aerial pulley and other fittings. The pulley may be attached first by a short length of wire round the mast an inch or two from the top. To prevent this binding wire from slipping down the mast, it should be stapled to the mast at two or three points. The exact method

of attaching the stays will depend on the material used. The wire sold under the name of "Electron" wire is quite suitable for this pur-

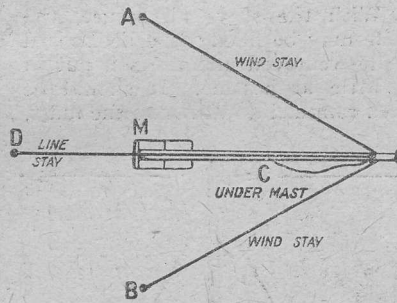

Fig. 4.—A plan of the arrangements prior to erection.

pose, as it consists of a number of strands of steel wire, and will stand quite a severe strain without breaking.

Fastening the Stays

The stays should be made off round the mast as shown in Fig. 3(b). Starting from the point A, the wire is taken twice round the mast and tied off at A, the second turn crossing the first at B, on the far side of the mast from A. Staples are then driven home over the wire, one at B, another at C and a third in a corresponding position to C on the opposite side of the mast. The four stays should be arranged on the mast at right angles to each other, two of them being in line with the wire carrying the pulley, Fig. 3(c).

A Cap for the Top

Some kind of cap should be fitted to the top of the mast, to prevent rain from soaking into the end grain of the wood. A square of tinplate may conveniently be nailed on in the form of an inverted V, as shown in Figs. 3 (a) and (b). Finally, and this should not be forgotten, the aerial halliard is run through the pulley, and its ends are temporarily nailed to the lower end of the mast.

Erection Details

The erection of the mast may now be proceeded with. The most important points in this operation are the laying-out of the stays and the careful preparation before actually raising the mast. The mast is laid down pointing in the direction of one of the stays, with its butt pressed firmly against the "backboard" in the hole, shown in Fig. 2(a). This backboard is put in the hole to act as a guide for the butt of the mast as the top is raised; and it is intended that the butt should slide steadily down this board to the bottom, instead of digging into the soil at the back of the hole, impeding the operation of lifting and possibly filling up a good deal of the hole.

Stay Pegs

Four pegs are hammered into the ground, at an angle sloping away from the mast (Fig. 5).

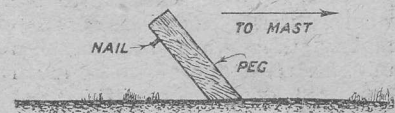

Fig. 5.—Stakes are driven into the ground to form stay pegs.

These may be stout stakes about 2 ft. 6 in. to 3 ft. long, driven into the ground until about 6 in. is left protruding. A nail driven into each peg near its top end, Fig. 5, will prevent the stays from slipping off.

The "wind stays," i.e., those at right angles to the mast (A and B, in Fig. 4), must now be pulled taut and securely tied to their pegs, but they should not be made off permanently, as it will be necessary to pull them tight again later on. The stay which is to come at C is next laid out over the stay to A and, assuming that the pegs A and C are equi-distant from the mast, the exact length required for it is noted. The stay is then tied temporarily, but securely, to peg C. If the distances AM and CM are unequal, the length required for the stay to C may be calculated or roughly gauged, and in this latter case it is better to tie it off slightly too long than too short.

The other "line stay," that to peg D, is about three times the length of the others; it is passed round peg D and brought back again to the top of the mast. Everything is now ready for raising the mast.

Actual Erection

The tip of the mast is raised from

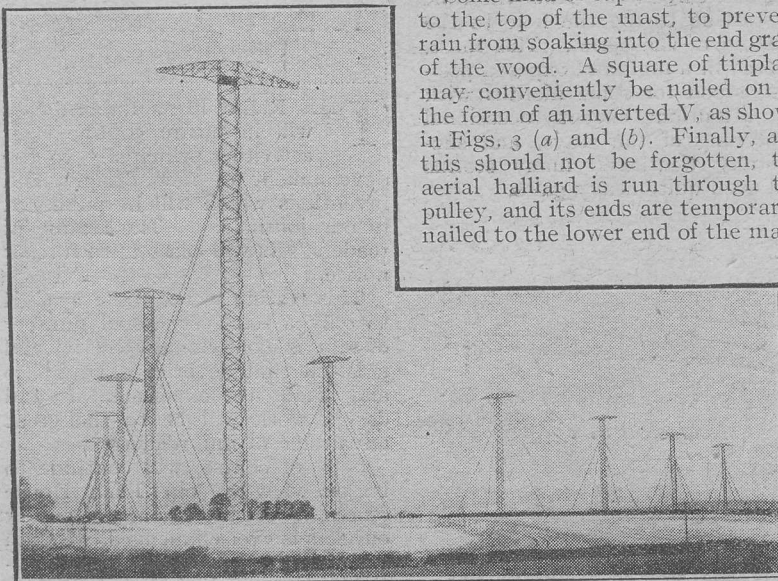

The ten huge masts at the Marconi short-wave beam station for Imperial communication at Bridgwater, Somerset.

the ground, and any "slack" on the stay round peg D is gathered in; this stay must be held and pulled up taut as the mast is raised (Fig. 6). Now raise the tip of the mast above your head till your arms are straight, and walk slowly towards the butt end, passing the hands along the mast and so raising it. Watch the butt to see that it is not catching on the board, while if it tends to roll over sideways off the board, it is best to lower the mast, reset it and start again.

The Time for Caution

As you get nearer to the butt of the mast, and it becomes more upright, you will find that you can assist the work of lifting by pulling on the stay round peg D. The point at which to take the greatest care and to work slowly, is when the mast begins to respond more readily to a pull on D. When this is first noticed, the stay on peg C should be watched to see whether it is going to be approximately taut when the mast is upright. If it appears to be much too tight or too loose, the mast should be lowered again till C can be reached and the stay adjusted.

"Matching Off" the Stays

Assuming that this stay is of about the correct length, when the mast finally arrives at a vertical position it will be prevented by this stay from going too far past the vertical, while with the stay round peg D it can be prevented from falling back again. Stay D can then be made off temporarily on its peg. There will be no need to touch the mast itself any more, as the set of it can be readily adjusted by the stays. Since the mast has sunk into the hole, the wind stays will be slack, so they may be pulled up taut and finally made off. After this the line stays

may be made off, the mast being set preferably leaning slightly away from pull of the aerial wire, as in Fig. 7.

Replacement of Soil

With the stays all secure, the hole may be filled; the backboard being removed and the soil put in a little at a time. It should be well rammed down round the mast,

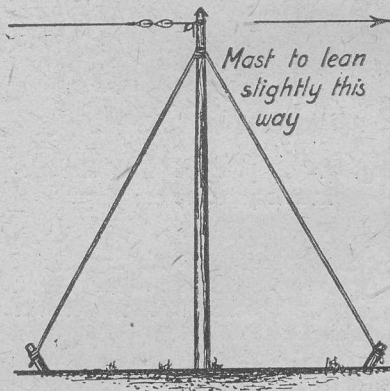

Fig. 7.—It is better to allow the mast to slope slightly.

a pick handle or a spade handle making a good makeshift ramming tool. The mast is then ready for service.

Importance of Details

It is important to be quite certain as the work proceeds, that no details have been overlooked. It is most annoying to raise the mast and then find that there is no halliard on the pulley! The erection of a mast in the manner described took the writer, on one occasion, between two and three hours from the time of starting to dig the hole to the hoisting of the aerial. This mast, erected in a high and exposed position, stood for some months with no attention except occasional tightening of the stays, and successfully weathered many storms and even quite heavy gales.

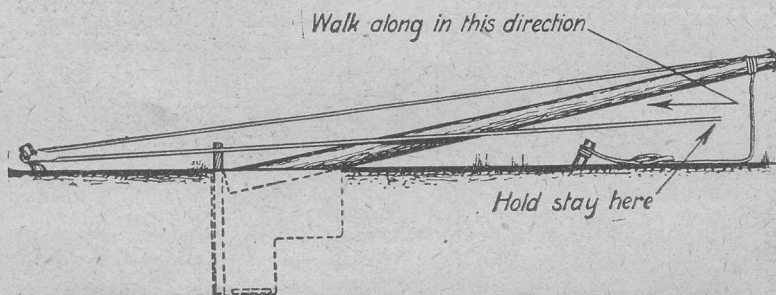
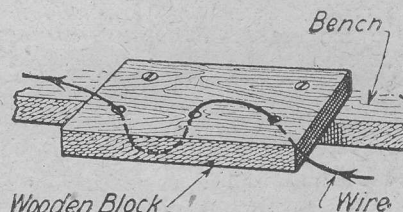

Fig. 6.—With the capped end of the mast held above the head, walk slowly towards the butt, pulling the stay to facilitate the erection.

How to Straighten Thick Wire

WHEN one buys heavy gauge wire it is often bent or kinked, and thus unsuitable for use until it has been straightened out. An easy way of doing this job is to pass the wire through a series of holes placed in a piece of thick wood. A suitable piece of wood for this job may be about 2 in. wide, 12 in. long and 3/4 in. thick, or even more. Drill three 3/8 in. holes in it about 3 in. apart in a line with one another. Near the edge of the wood drill two holes and fix it to the edge of the work bench with two large wood screws.

Pass the end of the wire through the first hole from the underside,



The apparatus required.

through the second from the top, and through the third from underneath. Pull the wire through the block with a large pair of pliers, and cut off into suitable lengths. If the wire has still little bends, it can be passed through again. This treatment will remove kinks from even the thickest wire, though it may have to be repeated in obstinate cases. W. H. F.

Testing of Readers' Sets Discontinued

THE Radio Press Laboratories will in future confine their activities principally to the development of new designs and inventions which will be published in our journals. The testing of readers' sets will cease until further notice.

This testing work, while applied to only a relatively small number of sets, is exceptionally costly, and it is felt that devoting extra space and staff to experimental and design work will be to the great advantage of our readers.

Sets, of course, will continue to be on view at our Bush House offices, and if the efficacy of any of our sets is ever challenged, we shall continue to be happy to demonstrate the results at our Elstree laboratories.



I'm proud of these jobs

NOT a tile chipped, not a crack in the wall—every fixture neat, firm, clean and workmanlike. You don't need to be an expert to put up fixtures that will stay fixed and be a credit to your home. Just get the handy Rawlplug Outfit and follow the simple directions :: Send for illustrated literature (free).

Household Outfit, 3/6	From Ironmongers, Electricians or Stores	Amateur Mechanic's Outfit, 5/6
-----------------------	--	--------------------------------

RAWLPLUGS

WALL PLUGS

THE RAWLPLUG CO., Ltd., LONDON, S.W.7. A53



"I'm going to make more money"

"I am tired of working for a small salary—tired of the strain of endeavouring to keep up appearances—tired of seeing others beat me in the struggle for promotion—tired of the fear of unemployment."

"I've been blind in some ways, but now I see clearly that diligence, integrity, and long service are not enough. To succeed one must have a special vocational training. The men who are going ahead of me have only one advantage—they are trained, while I am not; but I am determined to raise myself to their standard without a day's delay."

Many a man, at last realising the tremendous handicap of being untrained, has thought along those lines and then become an I.C.S. student, greatly to his advantage and happiness.

In every line of business men and women are holding important positions and receiving splendid salaries—because they became I.C.S. students.

The I.C.S. originated spare-time technical training by post 34 years ago, and is by far the largest institution of its kind in the world. It has teaching centres in eleven countries, and students in fifty.

Write to-day for full information as to how the I.C.S. can help you in your chosen vocation. There are 300 I.C.S. Courses, of which the following are the most important groups:—

- | | | |
|---------------------|---|---------------------|
| Advertising | Wireless Telegraphy (Elementary and Advanced) | Professional Exams. |
| Architecture | Engineering (all branches) | Salesmanship |
| Building | French and Spanish | Showcard Writing |
| Commercial Art | General Education | Textiles |
| Commercial Training | Market Gardening | Window Dressing |
| Draughtsmanship | Plumbing | Woodworking |

International Correspondence Schools, Ltd.
172, International Buildings, Kingsway, London, W.C.2



For Purity of Reception

It is because the Bowyer-Lowe Super-Heterodyne made with these Transformers gives PURE reception, free from background noise, that amateurs and experts both recommend it. The complete seven-valve receiver can be made in less than a week from the instructions provided with every set of Transformers.

BOWYER-LOWE TESTED SUPER-HETERODYNE TRANSFORMERS

Set of four complete £4 with booklet of instructions

Long Wave Reception on your Bowyer-Lowe Super-Het.

You can adapt your Bowyer-Lowe Super-Heterodyne to receive long wave stations by fitting the Model III Oscillator-Coupler.

The new coupler is made in two ranges either of which may be used in conjunction with a standard base. The coupler for wavelengths 250 to 550 metres and the one for 500 to 2,000 metres are each totally enclosed in a handsome ebonite case. Fit these couplers to your instrument and increase its range to receive ALL stations

BOWYER-LOWE MODEL III OSCILLATOR COUPLER

SPECIAL EXCHANGE OFFER

In order that those using our Model II Coupler may bring their sets up to date we offer to exchange this model for Model III 250 to 550 metres, complete with standard base at a nominal charge of 9/-. **ORDERS SHOULD BE SENT DIRECT**, enclosing old coupler, to Bowyer-Lowe Co., Ltd., Letchworth, marked "Exchange Dept." Be careful to enclose your name and address.

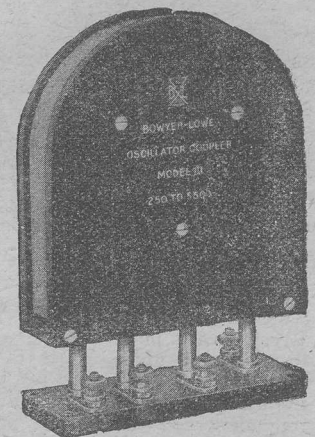

LIST NO. 222 MODEL III COUPLER 250 TO 550 METRES **20/-**

LIST NO. 223 MODEL III COUPLER 500 TO 2,000 METRES **20/-**

LIST NO. 220 BASE **4/-**

The "Twin-Valve" Loud-Speaker Receiver

(Radio Press Envelope No. 10)

SIR,—I have constructed the "Twin-Valve" Loud-speaker Receiver, as described by John Scott-Taggart, F.Inst.P., A.M.I.E.E., in the January, 1925, issue of THE WIRELESS CONSTRUCTOR. It is, I think, the best and most easily operated two-valve set I have ever constructed—results are unbeatable. I am a regular reader, and wish good luck to your book.

Yours faithfully,
Dover. A. CAPTAIN.

SIR,—Recently I was spending a holiday at my uncle's home at Birmingham. He had constructed the "Twin-Valve" Receiver, as described by John Scott-Taggart, F.Inst.P., A.M.I.E.E., in THE WIRELESS CONSTRUCTOR for January, 1925.

Although this set is quite different from the one I have always been used to, it did not take me long to get it going. During the first evening I was quite satisfied to listen to the local station (5IT) and Daventry. The next day, however, I succeeded in reaching London and Manchester. Other

stations that were picked up included: Dublin (2RN) testing, Nottingham and Bournemouth (these came through nicely on the loud-speaker). Two French and

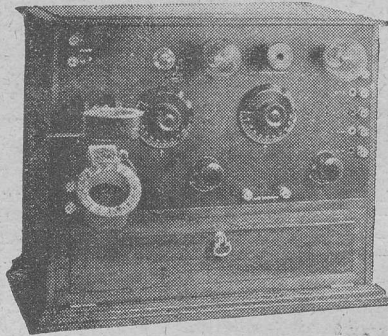

The Twin-Valve Receiver
(Envelope No. 10).

three German stations were also picked up on the phones. These results speak highly of the efficiency of the set, as only an indoor aerial was used. On an outdoor one Madrid came through well on the loud-speaker.

Wishing your paper every success in the future.

Yours faithfully,
ARTHUR H. ELLIS.

The Single-Valve Reflex Receiver

SIR,—I have constructed the "Single-Valve Reflex Receiver," described by Percy W. Harris, M.I.R.E., in the February, 1925, issue of THE WIRELESS CONSTRUCTOR, and am very well pleased with the results. I receive the following stations regularly at good phone strength: All main British stations, including Daventry and Belfast, Edinburgh (relay), Radio-Paris, École Supérieure, Munster, Hamburg, Dublin, Petit Parisien, Berne and a few more Continental stations unidentified. The set is very selective, since I can almost entirely eliminate 5SC (25 miles N.W.) to receive Newcastle or Belfast. My aerial is 40 ft. high and 60 ft. long, the earth being also very good. I must thank you for this fine receiver, the first valve set which I have constructed.

Yours faithfully,
MATTHEW JARDINE, JUN.
Lanark, N.B.

Transformers that carry a "sound" reputation



TYPE A—Intervalve, ratio 1-5, price 20/- TYPE B—Intervalve, B.25, ratio 1-2.5; B.4, ratio 1-4; B.6, ratio 1-6, price 24/- TYPE C—Intervalve, ratio 1-4, price 24/- Telephone Transformers—ratio, 1-10. Type T.A. 18/- Type T.B. 23/- Type T.C. 24/-

The spaced winding of the "Ironclad" Transformer gives high amplification—and pure tone. Coils are hermetically sealed in thick iron cases which effectively absorb external magnetic interference. The excellent reputation of the Sparta "Ironclad" Transformer is its own recommendation.

FULLER'S UNITED ELECTRIC WORKS LTD.,
CHADWELL HEATH ESSEX
Telephone: Ilford 1200. Telegrams: "Fuller, Chadwell Heath."
LONDON DEPOT—176, Tottenham Court Road, W.1
Telephone: Museum 9008.

174-35

Valve Sets

"Sparta" Radio Receivers are built in sectional units comprising high-frequency and low-frequency receivers and amplifying sections. The units are self-contained and can be supplied alone or in combination. Every detail of design is studied for convenience of operation and uniform dependability.

Ask for Illustrated List.



Standard

FORMERLY
Western Electric

WECOVALVES

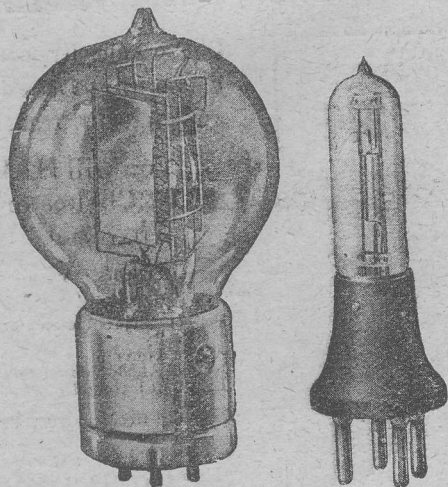

THERE is no more economical or robust valve on the market to-day than the Weco valve, in fact it has practically double the life of any other dull emitter. The provision of the new tape filament, and the fact that the valve only consumes a quarter of an ampere, give a double economy, together with all the sterling qualities that have made the Weco valve famous

Supplied in three forms for service:—	Operating Characteristics:
Red Spot indicates excellence as H.F. Amplifier.	Filament Current, 0.25 amps.
Orange Spot indicates excellence as L.F. Amplifier.	Filament Voltage, 0.8 to 1.1 volts.
Green Spot indicates excellence as Detector.	Detector Plate Voltage, 15 to 30 volts.
	Amplifier Plate Voltage, 30 to 60 volts.
	Amplification Factor, 5 to 6.5.

WECOVALVES each - - 16/6
P.A.4 POWER VALVE - - 45/-

Standard Telephones and Cables Limited
CONNAUGHT HOUSE, ALDWYCH, W.C.2
Telephone: Central 7345 (10 lines)
Works: NORTH WOOLWICH, NEW SOUTHGATE, AND HENDON
Branches: Glasgow, Leeds, Manchester, Newcastle, Birmingham, Cardiff, Southampton, Liverpool and Dublin

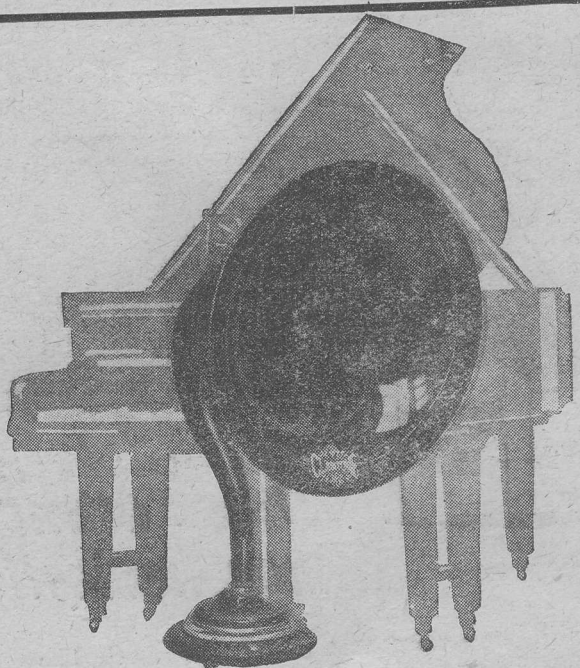

Just as you'd choose a Piano

—so the sweet purity of tone and magnificent volume of the Claritone Loudspeakers will appeal to the music in your nature and influence the choosing of your loudspeaker. The faithful reproduction and remarkable sensitivity of these instruments has made them favourites wherever they go and the results obtained are equal to many loudspeakers of considerably higher price.

Claritone Loudspeakers

Senior Model, 2000 ohms, W.290	£5 0 0
120 ohms, W.291	
Junior Model, 2000 ohms, W.295	£2 15 0
120 ohms, W.296	

Claritone Headphones

W.216 - - - - - £1 0 0

Sold by all Reputable Dealers

SOLE DISTRIBUTORS:
ASHLEY WIRELESS TELEPHONE COMPY.
(1925 Ltd.)

NOTE OUR NEW ADDRESS:
**17 Finch Place, Falkland Street
London Road Liverpool**



*Those aren't
atmospherics!!*

THEY sound very much like
atmospherics, though. Only
they seem too persistent to be
that. Have you any bright
suggestions?"

"Any condensers across your H.T. terminals?"

"No!—rather an unnecessary refinement, isn't it?"

"Ah, no! You see, every H.T. battery has minor or major spasms when it's in use. Partial polarisation, you know, or a sudden exposure of a larger area of carbon, and things of that sort. That's what's causing this crackling row. You want to put a Mansbridge Condenser across your H.T. Terminals to smooth out the jerks. You'll find that it will make all the difference!"

"So that's it, is it? What condenser did you say?"

"A Mansbridge. Manufactured by the Mansbridge Condenser Co., Ltd., and guaranteed and sold by Dubilier—THE Condenser people, you know!"

Look for the characteristic lettering—
"Mansbridge Condenser" on the case!

0.02 μ F to 2.0 μ F, 2/6 to 5/-

MANUFACTURED BY THE
MANSBRIDGE
CONDENSER CO. LTD.
GUARANTEED & SOLD BY THE
DUBILIER
CONDENSER CO. (1925) LTD.

ADVERTISEMENT OF THE DUBILIER CONDENSER CO. (1925) LTD., DUCON WORKS, VICTORIA ROAD, NORTH ACTON, W.3. TELEPHONE: CHISWICK 2241-2-3.

E.P.S. 5

SEAGULL

CHOKE COUPLINGS

*were the FIRST
and are still BEST*

PRICE
22/6



Choke capacity couplings have replaced the antiquated transformer

You will HAVE TO fit Chokes one day. Why not NOW?

Reasons why Seagull Chokes are unequalled:

- Perfect Reproduction and Tonal Purity
- Ample Power
- Normal Anode Voltage only required
- Long Life; cannot burn out or wear out
- Absolute freedom from undesirable noises
- No Howling

SEAGULL LTD.
Regent House, Kingsway, LONDON, W.C.2
Phone: HOLBORN 6550.

Ask your Dealer

ORICHTON AD

Forget Wavelengths —think in frequencies

WITH the growing congestion due to the ever-increasing number of broadcast stations, it has become essential to forget wavelengths and think in frequencies. Use the new Peto-Scott Straight Line Frequency Condenser and obtain even distribution of all wavelengths throughout the dial. Among the many excellent features of this condenser are special low-loss ebonite end-plates, spiral contact, eliminating all noise, thick felt friction pads, and 4-inch dial to facilitate tuning.

With helical 2 to 1 gearing and 0 to 360 degree dial.

19/6 .0005 .0003 **18/6**
With Direct Drive.

15/- .0005 .0003 **14/-**



The ordinary condenser gives you scale readings like this, with the lower wavelengths crowded together. The new Peto-Scott S.L.F. will space them out and enable you to "log" the difficult ones.

Catalogue of Wire-
less Components. **3d.**
Post Free.

PETO-SCOTT CO., LTD.
77, City Road & 62, High Holborn
E.C. W.C.

Also at WALTHAMSTOW,
PLYMOUTH & LIVERPOOL



PETO-SCOTT S.L.F.
(STRAIGHT LINE FREQUENCY)
CONDENSERS

P.S.4377

'The proof of the CONDIT is in the circuit,' says CLIXIE



"CLIXIE"

Fingers or round-nosed pliers to bend CONDIT please!

"Our postbag's full these days of enthusiastic letters about CONDIT," says CLIXIE. "Enthusiasm's a thing that many folk distrust, so I'm quoting a restrained one from Northumberland which I think is all the more convincing for its very restraint."

"Will you please send me another 2/- worth of H.F. Condit in a roll—it will save so much packing for so small a quantity. I have just wired up a single valve set with this Condit and find it a distinct improvement on anything I have used."

"CONDIT is copper tape curled up into the form of split tubing (=16-gauge wire). There you have the reasons for that 'distinct improvement'—two highly polished conducting surfaces and the minimum of capacitive metal."

"Prove it on your circuit."

RADIO CONDIT (P. Patd.)

The H.F. CONDUCTOR

Per packet of six 2-foot lengths 2/-
Per coil of 12 feet 2/-

Obtainable from all Wireless Dealers or direct from the Patentees:

AUTOVEYORS LTD., 84 VICTORIA STREET, LONDON, S.W.1

CAXTON 4-VALVE CABINET

Made for Editor of Wireless Magazine for Set "As good as money can buy" described in issue February, 1925.

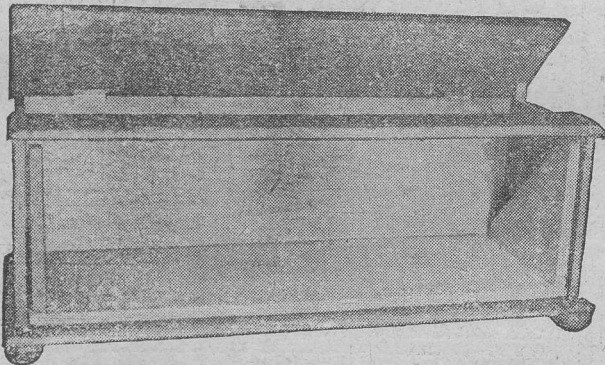

Cash with Order. Fumed Oak ... £1 5 0
or Real Mahogany polished ... £1 14 0

With detachable recess fitted Base Board to mount 21 in. by 7 in. panel to slide out of Cabinet front. Extra 10/- with two beaded front doors totally enclosing fitted panel. Cabinet overall length 22½ ins. Width 8½ ins. Height 9 ins.

Polished with the new enamel that gives a glass hard surface that cannot be soiled or scratched.

SENT FREE.—Catalogue of standard Wireless Cabinets in various sizes and woods. Special Cabinets made to customer's orders.

PACKED AND DELIVERED FREE IN U.K.

CAXTON WOOD TURNERY CO., Market Harborough

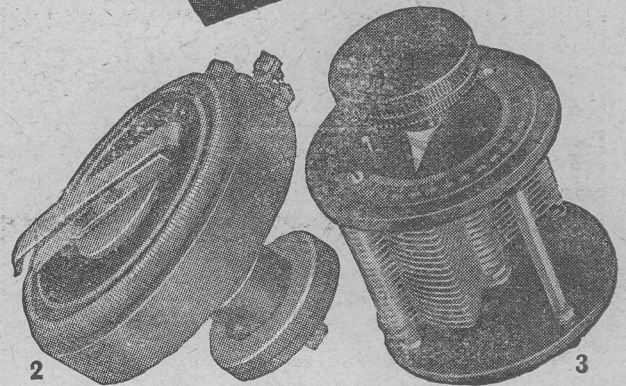

Build that Set with good components—let them be Ericsson's

Well begun is half-done—build well and you build for stability, range and selectivity. Put Ericsson transformers, rheostats and condensers behind your panel—and your set will be the envy of your friends.

- Ericsson Transformers have an amplification ratio which provide maximum volume without distortion. Carefully made in no great size (less chance of fouling other components behind the panel).
Ratio 1:4 Price 17/6
" 1:2 Price 17/6
- Should your phones or loud speaker be of the 120 ohms resistance pattern we can thoroughly recommend the Ericsson Phone Transformer for perfect coupling Price 17/6
- Only the special spring arm, the perfected bearing and the winding of the Ericsson Dual Rheostat permits such velvety smoothness. Indispensable where there is a need for changing valves about. By means of a small auxiliary knob the resistance of 6 ohms can be altered to one of 60 ohms. Complete with pointer, knob, scale and fixing screws. Price 8/6

Ericsson Tested Condensers are wonderfully low in losses. Built between ebonite end plates. Stoutly made and accurately spaced. Ideal for short wave DX work.

PRICES : .0005 mfd. 10/6

.001 " 12/6

With Vernier .0003 " 11/-

.0005 " 13/6

.001 " 15/6

Template supplied.

Write to-day for components handbook. Lists also sent fully describing super sensitive phones, receivers, crystal and valve.

The BRITISH L.M. ERICSSON Mfg. Co., Ltd.

67/73, Kingsway, London, W.C.2.



TESTED COMPONENTS

CYLDON

Pronounced "Sildon"

**GROUNDING ROTOR
SQUARE LAW
VARIABLE
CONDENSERS**

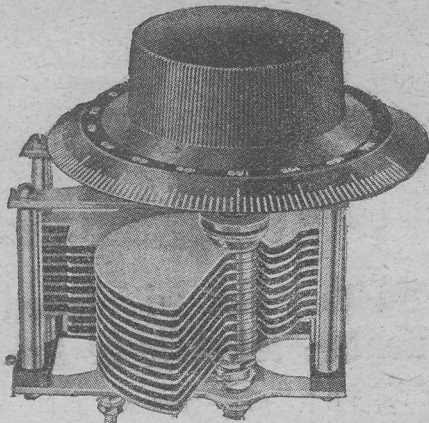

THE ARISTOCRAT OF BRITISH CONDENSERS

The condenser that meets a growing American competition, and acknowledged by all who have seen and tested it as the finest instrument made in this country.

Large bearings are provided, resulting in a delightfully smooth action. So certain are we of faultless operation of every "Cyldon" condenser under all conditions that we *unconditionally guarantee every instrument.*

Complete with large 4 in. Knob Dial as illustrated
 '0005 MFD cap. 17/6 '00025 MFD cap. 16/-
 '0003 " " 16/6 '0002 " " 15/6
 From your dealer, or sent post free from the makers:

SYDNEY S. BIRD
 "Cyldon" Works, Sarnesfield Rd.
 Enfield Town :: Middlesex

Telephone ENFIELD 672

YOURS FOR 20/-

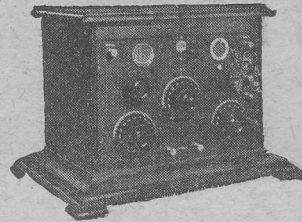

The 'Tonyphone' G.I.I. is a two-valve receiver of remarkable selectivity, having a range of well over 1,000 miles. Receives all B.B.C. and most Continental Stations. Will be sent on approval complete with all Accessories on receipt of 20/-; You pay a further £1 each month or 5/- each week afterwards until completed.

The 'Tonyphone' G.I.I.
 In handsome Mahogany Cabinet Complete with Accumulator, H.T. Battery, Aerial, one pair of 4,000 ohms Headphones and two Valves — one High Frequency and one Detector. All Royalties paid

Send to-day and enjoy broadcasting NOW. Illustrated Price list free on application
BRITISH ENGINEERING PRODUCTS CO.
 (Battery Dept.), Abbey House, Victoria Street, London, S.W.1
 S.S.A.

SOLDERED JOINTS SUPERSEDED!

The most complicated, or simplest set easily wired-up entirely without use of solder and with **BETTER RESULTS**

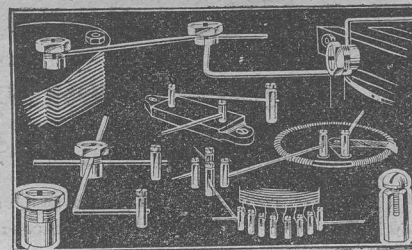

**PATENT
"KRISCROS"
CONNECTORS**

Perfect Joints. A "KRISCROS" for every thread, every component and every purpose. Ideal for experimenters.

Prices from 1/- doz.
 Send for list!

Kriscros Co., 50, Gray's Inn Road, W.C.1
 Tel.: Holborn 5256. (MAIL ORDER DEPOT)

COMBINED for CONVENIENCE

Valve-Holder—
Rheostat

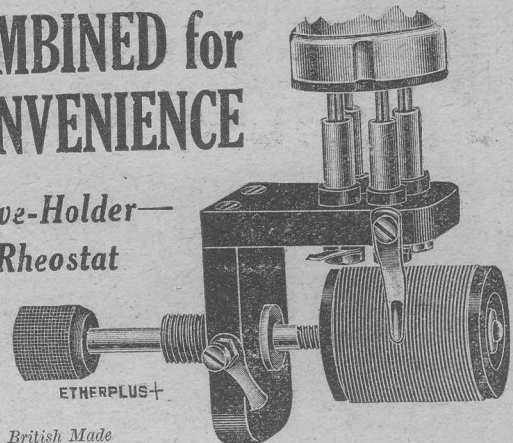

ETHERPLUS+
 British Made

YOU AMATEUR CONSTRUCTORS require parts which are not only of ultra-efficient design and soundest construction, but which must be compact.

You will instantly appreciate the convenience and utility of the combined "Etherplus+" Vernier Rheostat and Antivibro Valve-Holder.

One-hole fixing. Antivibratory valve legs with red rubber indicator or plate leg. Push-full type Rheostat, rotary movement for fine tuning.

Fixed Retail Prices:

W/58/3 — 6 OHMS - 5/6 each
 W/58/30 — 30 OHMS - 6/-

If your Dealer cannot supply, order direct from—

ETHERPLUS+

RADIO ACCESSORIES
 — ENSURE PERFECT RECEPTION

MANDAW

9-15, Whitecross Street,
 LONDON, E.C.1

THERIA

PRODUCTS

Guaranteed by Faraday House

THAT'S your cue: undoubtedly you must buy Theria Products when requiring Fixed Condensers or Grid Leaks. At no greater cost you obtain a product tested and guaranteed by this famous electrical Laboratory. Each Theria Condenser and Grid Leak is individually tested by Faraday House, and bears their guarantee to be correct to within a very narrow limit of its stated capacity. You can obtain Theria Products from your dealer



Therla Fixed Condensers
 PRICE: '0001 to '0015 mfd. 1/3 each. '002 mfd. to '006 mfd. 2/- ea.
 Grid Condenser with Clips, 1/3

Therla Grid Leaks
 Sizes: 250,000, 500,000 ohms, and 1, 2, 3 megohms, Price 1/3, Grid Condenser and Leak, 3/-

Sole Distributors:
SEL-EZI WIRELESS SUPPLY CO., LTD.
 6 CREEK ST., LONDON, W.1. & 20, OLD HAYMARKET, LIVERPOOL
 Telephone Regent 1140 LIVERPOOL Royal 1682

BUY GUARANTEED PRODUCTS & BUY SATISFACTION

Announcing

the New Range of Six Sixty Valves



THE increasing demand for all types of Receiving Valves has proved to us that, despite the excellent all-round qualities of the original 660 Electron Dull Emitter Valve, the general Radio public require specialised valves for definite circuits. Our new range, embodying the latest developments of modern scientific research, will prove the continued and greater success of Electron 660 Valves.

And remember, no matter what type you choose, each valve is carefully designed to carry out its particular job, and bears the Six Sixty Mark of

PERFECTION OF QUALITY

- S.S.1 (Blue Disc). Bright Emitter General Purpose Valve.** Voltage—3.7 volts, consumption '66 amps. **8/-**
- S.S.2 H.F. (Red Disc). D.E. Suitable as a Detector when followed by Resistance and Choke.** Voltage—2 volts, consumption '3 amps. **14/-**
- S.S.2 L.F. (Green Disc) D.E. Suitable for small & medium-sized Loud Speakers.** Voltage—2 volts, consumption '3 amps. **14/-**
- S.S.3 H.F. (Red Disc). D.E. Suitable as a Detector when followed by Resistance and Choke.** Voltage—3 volts, consumption '66 amps. **16/6**
- S.S.3 L.F. (Green Disc) D.E. Suitable for small & medium-sized Loud Speakers.** Voltage—3 volts, consumption '66 amps. **16/6**
- S.S.4 D.E. L.F. Amplifier and Loud Speaker Valve.** Voltage—5 volts, consumption '25 amps. **22/6**
- S.S.5 D.E. H.F. Amplifier and Detector Valve.** Voltage—3.5 to 6 volts, consumption '66 amps. **24/6**
- S.S.6 D.E. Resistance Capacity Amplifier & Detector Valve.** Voltage—5 volts, consumption '25 amps. **22/6**
- S.S.7 D.E. Power Valve.** Voltage—3.7 volts, consumption '1 amp. **22/6**

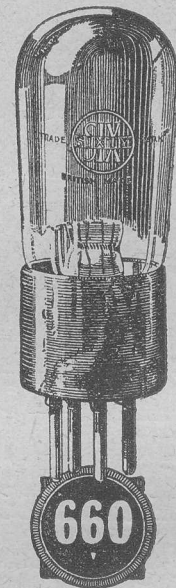

Write for leaflet
S.S.1. 7 for full
particulars



BETTER BY SIX TIMES SIXTY

The Electron Co., Ltd., Triumph House, 189, Regent Street, London, W.1

1/- solves the soldering question

With a box of Solclips you can solder up your whole set without any difficulty. Simply insert wires in the Solclip, drop in the solder pellet and flux supplied and touch with iron. Up to four wires at any angle with one clip. 18 clips, either Solclips for Wiring or Solclips for Terminal type, complete with flux and pellets **1/-**

DALE FORTY & Co., Ltd., BIRMINGHAM

Selling Agents:
Cooke & Whitfield Wireless Ltd.
 St. Paul's Square, Birmingham



Solclips.

Clip while you Solder.

REGD. DESIGN
 7148-2-3-6
 PRO. PAT. NO.
 229764-15299



**"Why didn't
I use
GLAZITE!"**

**The more complicated
the circuit, the more
important it is to use**

GLAZITE
BRITISH MADE REGD.

COLOURED CONNECTING WIRE
Red, Yellow, Blue, Black

10 ft. Coils
1/2 Per Coil
1/18 s.w.g.

Supplied by
all Radio Dealers

2ft. lengths
Per Packet
4 Assorted Colours **1/-**
1/16 s.w.g.

Write for
Descriptive leaflet

Genuine Glazite bears this
seal which guarantees
quality



Makers of Electric Wire
for over Forty Years

**THE LONDON ELECTRIC WIRE CO.
AND SMITHS LTD.**

Playhouse Yard, Golden Lane, London, E.C.1
Telegrams: "Electric, London." Telephone: Clerkenwell 1388, 1389, 1390, 1391

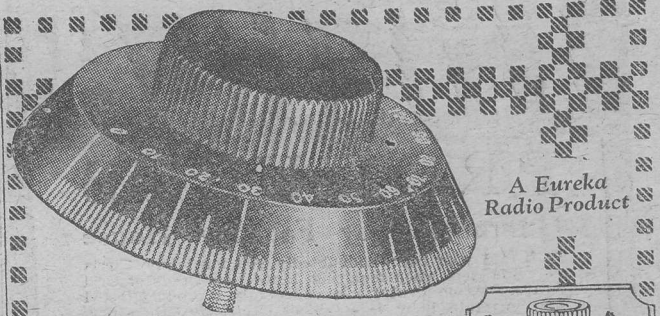

A Eureka
Radio Product

**Revolutionary
in design and performance**

MOST Sets fail to obtain selectivity through the use of inferior condensers. Two features are essential—low minimum capacity and the lowest possible losses. The Dialodenser is a multi-plate condenser, but instead of its plates being exposed to the air they are contained within a 2 1/2" dial. Its minimum capacity is the lowest of any condenser. Its exclusive design ensures true square law reading and permits a wonderfully high standard of efficiency. Smooth movement, one-hole fixing, permanent contact through armoured cable, long service, freedom from damage by dust—here are some exclusive Dialodenser features. Ask your dealer to show you one to-day, or get further particulars from us.

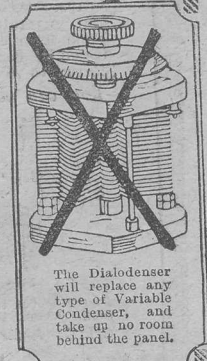

The Dialodenser will replace any type of Variable Condenser, and take up no room behind the panel.

10/-
Also .001 mfd. 12/6
Also .003 mfd. .005 mfd.

Portable Utilities Co. Ltd., 8 Fisher Street, W.C. 1

Dialodenser
THE CONDENSER WITHIN THE DIAL

Gilbert Ad. 4362

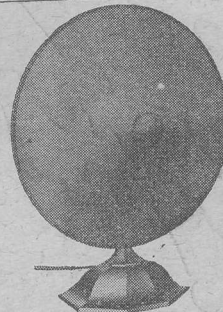

The First Loud-Speaker that is a Musical Instrument

The "Kone" Loud Speaker approximates perfection to the nearest degree. It will operate successfully on any amplifier having an output impedance of 2,000 to 5,000 ohms. The ideal output impedance is 2,000 ohms as in the "Kone" amplifier. Do not order your new loud-speaker until you have heard

**The KONE
LOUD-SPEAKER**

(Patent Nos. 206518 and 231556)
Price £6:6:0

Advt. of Standard Telephone & Cables, Ltd. (formerly Western Electric),
Connaught House, Aldwych, London, W.C.2

**F.W. LOWENADLER'S
TRELLEBORG**



**FAMOUS GENUINE
EBONITE
PANELS**

VALVES Repaired Quick
 Let our valve making plant repair your broken or burnt out valves efficiently & promptly (most makes). Guaranteed equal to new. Bright emitters 5/-; "D.F." 2 and 3 r. types), 7/6. Power valves slightly more, see list. Not repairable: 8.P.s WECO v.34, Cossor D.E.s.
RADION
 Reliable Repairs
RADIONS Ltd., Bollington, Nr. MACCLESFIELD, Ches.
 Largest valve-repairing firm in the world. List Free.

RADIO PRESS
 :: BOOKS ::

READ the R.P. Series of Books and add to your knowledge of Wireless!

No.	Price	Post Free
1 Wireless for All ..	9d.	11d.
By John Scott-Taggart, F.Inst.P., A.M.I.E.E.		
2 Simplified Wireless	1/-	1/2
By John Scott-Taggart, F.Inst.P., A.M.I.E.E.		
3 How to Make Your Own Broadcast Receiver ..	1/6	1/8
By John Scott-Taggart, F.Inst.P., A.M.I.E.E.		
4 How to Erect Your Wireless Aerial	1/-	1/2
By B. Mitchell, A.M.I.E.E.		
5 The Construction of Wireless Receiving Apparatus	1/6	1/8
By P. D. Tyers		
6 The Construction of Crystal Receivers	1/6	1/8
By Alan L. M. Douglas		
7 How to Make a "Unit" Wireless Receiver ..	2/6	2/8
By E. Redpath		
8 Pictorial Wireless Circuits	1/6	1/8
By Oswald J. Rankin		
9 Wireless Valves Simply Explained	2/6	2/8
By John Scott-Taggart, F.Inst.P., A.M.I.E.E.		
10 Practical Wireless Valve Circuits	2/6	2/8
By John Scott-Taggart, F.Inst.P., A.M.I.E.E.		
12 Radio Valves and How to Use Them	2/6	2/8
By John Scott-Taggart, F.Inst.P., A.M.I.E.E.		
13 500 Wireless Questions Answered	2/6	2/8
By G. P. Kendall, B.Sc., and E. Redpath		
14 12 Tested Wireless Sets ..	2/6	2/8
By Percy W. Harris, M.I.R.E.		
15 More Practical Valve Circuits	3/6	3/10
By John Scott-Taggart, F.Inst.P., A.M.I.E.E.		
16 Home Built Wireless Components	2/6	2/8
By E. Redpath		
17 Wireless Sets for Home Constructors ..	2/6	2/8
By E. Redpath		
18 Tuning Coils and How to Wind Them	1/6	1/8
By G. P. Kendall, B.Sc.		
21 Six Simple Sets ..	1/6	1/8
By Stanley G. Rattee, M.I.R.E.		
22 Switches in Wireless Circuits	1/6	1/8
By Oswald J. Rankin		
24 Wireless Faults and How to Find Them	1/6	1/8
By R. W. Hallows, M.A.		
Elementary Text Book on Wireless Vacuum Tubes	10/-	10/6
By John Scott-Taggart, F.Inst.P., A.M.I.E.E.		
Radio Engineering ..	15/-	15/9
By J. H. Reynier, B.Sc. (Hons.), A.C.G.I., D.I.C., A.M.I.E.E.		
Modern Radio Communication ..	5/-	5/6
By J. H. Reynier, B.Sc. (Hons.), A.C.G.I., D.I.C., A.M.I.E.E.		

Obtainable from all Newsagents and Book-sellers or direct from the Publishers, Dept. S.
RADIO PRESS LTD.
 Bush House, Strand, London, W.C.2

At last!
 —a real long-life
H.T. Accumulator

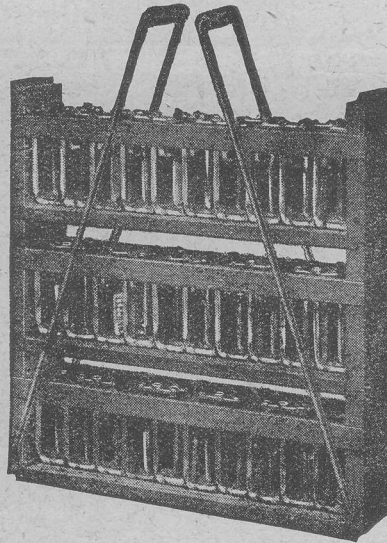

JUST as Oldham with its Special Activation Process has won an enviable reputation among wireless enthusiasts for dependable accumulators, so the new Oldham H.T. Accumulator is creating a higher standard of design and performance. Not flimsy glass test tubes, but stout glass rectangular containers—not special plates, but standard Oldham S.A.P. plates—not open cells but each one sealed against evaporation and provided with a vent plug. Before Oldham produced this new H.T. Accumulator, much research work was undertaken—obviously the wonderful name enjoyed by Oldham Accumulators could not be prejudiced to meet a clamorous demand from the public.

Oldham facts for Valve Set users—

Seasoned experimenters know that the new Oldham H.T. Accumulator is far superior in every way to an H.T. Dry Battery. Here are a few incontrovertible facts for the inexpert :

1. If yours is a multi-valve Set employing, for example, three valves, it will quickly drain the current from an ordinary H.T. battery and reception becomes lifeless. You may not think that your H.T. supply is at fault.
2. If you use a power valve, an Oldham H.T. Accumulator is imperative to obtain the greatest volume from your Set.
3. With an Oldham H.T. Accumulator you'll get a smooth current and absolutely no crackling noises.
4. An Oldham H.T. Accumulator will hold its charge for months. It can be recharged for a few shillings at any garage.
5. It is the only portable H.T. Battery on the market. Built up in 20-volt units, any voltage can be obtained as required. Can be tapped at every two volts.

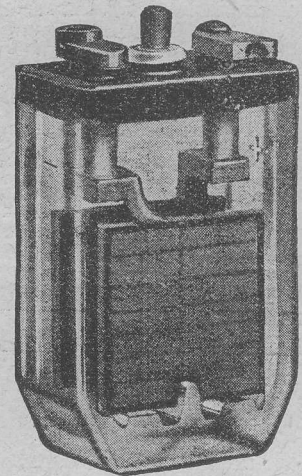

An Oldham H.T. Cell

Note the stout glass container and heavy plates. Each cell can be tapped. Slots in the container render separators unnecessary. Each cell sealed to prevent evaporation and the spilling of acid.

Prices of Oldham H.T. Accumulators

Each 20-Volt Unit complete with Tray. **20/-**
 Units can be arranged as shown, or side by side. Any voltage can be assembled as required. Carrying straps per pair, 1/3 extra.

OLDHAM & SON LTD., DENTON, MANCHESTER

London: Hazlitt House, Southampton Buildings, W.C.2
 London Service Station: 6 Eccleston Place, S.W.1
 Glasgow: 120 Wellington Street

Special Activation Process
OLDHAM
ACCUMULATORS



The **AERMONIC VALVE HOLDER**
Anti-Capacity
 SOUND MECHANICAL CONSTRUCTION
High Frequency Losses are reduced

NO set can be considered well designed unless high frequency losses are reduced to a minimum. The Aermonic Valve Holders reduce losses in the four pin type of valve holders to an absolute minimum.

The construction is sound and the material used is the best moulded insulation available and will withstand very rough usage.

The Aermonic Anti-capacity Valve Holder is made in two styles: Base Board mounting (model D) and "Behind the Panel" Type (model E)

Both Types 2/6 Each

Sole Distributors—London and South of England:
JAMES CHRISTIE & SONS, LTD., 246, WEST STREET, SHEFFIELD
 London Agents: **A. F. BULGIN & CO., 17, CURSTON STREET, LONDON, E.C.4**
 Sole Distributors—The British Isles excluding the above:
V. R. PLEASANCE, 56, FARGATE, SHEFFIELD

Sole Manufacturers and Exporters:
JAMES CHRISTIE & SONS, LTD., 246, West Street, SHEFFIELD

If your dealer cannot supply, please send his address to the distributors for your district and Holders will be sent direct on receipt of P.O.

Build your Set into this Cabinet

EVERY constructor would appreciate one of these handsome, solid oak cabinets. Charming design, sound construction and utility all combined. Made on mass production lines, hence the low prices. Take panels up to 30 x 48. They enhance the appearance and treble the value of any set. Lists free. Write to-day.

Model A	22 1/2 ins. wide inside	Solid oak	£4 15 0
" C	22 1/2 "	" "	5 10 0
" A	25 "	" "	5 5 0
" C	25 "	" "	5 10 0
" C	30 "	" "	6 15 0
" A	22 1/2 "	Solid mahogany	7 5 0

Carriage paid and packed free.
 Money returned if not satisfied.

MAKERIMPORT CO. (Dept. 20)
 Melville Chambers, 50a, Lord Street
LIVERPOOL



FORMO
 A. THORP PRELBY & CO. LTD.

ALL FORMO Apparatus is of advanced design and satisfies all requirements of Low Loss and Mechanical and Electrical Efficiency.

New Catalogue Now Ready
 Straight line frequency Condensers Square Law, Low Loss Condensers, LF Transformers, Plugs and Jacks, Choke Capacity Couplers, Low Loss, High Efficiency Couplers and Oscillators, etc.

THE FORMO COMPANY
 Crown Works, Cricklewood, N.W.2



The improved T.C.C. Mansbridge

THE new T.C.C. Mansbridge Condenser—the famous Condenser in the green metal case preferred by radio technicians for its accuracy and constancy—is now fitted with Duplex (patent applied for) terminals. Soldering is optional. If you want to use a quick "hook up" for experimental work you can use the milled heads, and obtain perfect electrical contact. The top of every T.C.C. Mansbridge is now all-metal and is, of course, quite impervious to the heat of the soldering iron or the action of the atmosphere.

T.C.C. Mansbridge Condensers have been made by the million, everywhere they are recognised as the standard fixed condenser for wireless use where a large capacity is required within a small compass.

T.C.C. genuine Mansbridge Condensers



RADIO PRESS : ENVELOPES :

BUILD your receiver with the aid of an R.P. Envelope. It will give excellent results

No.	Price	Post Free
1 How to Build an ST100 Receiver By John Scott-Taggart, F.Inst.P., A.M.I.E.E.	1/6	1/9
2 How to Build the Family 4-Valve Receiver By Percy W. Harris, M.I.R.E.	2/6	2/9
3 How to Build the "Simplicity" 3-Valve Set By G. P. Kendall, B.Sc.	2/6	2/9
4 How to Build the All-Concert de-Luxe Receiver By Percy W. Harris, M.I.R.E.	2/6	2/9
5 How to Build the Omni Receiver By John Scott-Taggart, F.Inst.P., A.M.I.E.E.	2/6	2/9
6 How to Build the ABC Wave Trap By G. P. Kendall, B.Sc.	1/6	1/9
7 How to Build a 2-Valve Amplifier-de-Luxe By Herbert K. Simpson	1/6	1/9
8 How to Make a 1-Valve Reflex Receiver By Herbert K. Simpson	1/6	1/9
9 How to Build an Efficient Single-Valve Set By Herbert K. Simpson	1/6	1/9
10 How to Make the Twin-Valve Loud-Speaker Receiver By John Scott-Taggart, F.Inst.P., A.M.I.E.E.	2/6	2/9
11 An Adaptable Crystal Set and How to Build It By Percy W. Harris, M.I.R.E.	1/6	1/9

'Modern Wireless' Coil Table

	Price	Post Free
For Aerial, Anode and Reaction Coils	6d.	8d.

Simplex Wiring Charts

No.	Price	Post Free
1 For 2-Valve Set	1/-	1/3
2 For 3-Valve Set	1/-	1/3
3 For 4-Valve Set	1/-	1/3

Radio Press Panel Cards

No.	Price	Post Free
1 How to Make the W1 Receiver By Herbert K. Simpson	1/-	1/3

Radio Press Panel Transfers

	Price	Post Free
Large Packet of 80 Labels	6d.	8d.

Obtainable from all Newsagents and Booksellers or direct from the Publisher



Radio Press, Ltd.
BUSH HOUSE, STRAND
LONDON, W.C.2

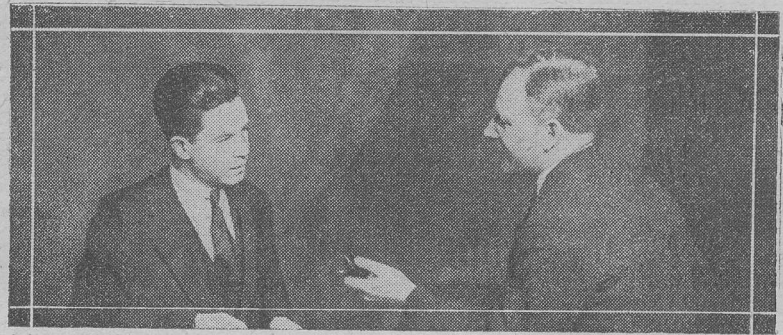

Said Jack Allen

"Why, I'd bet you could build up a Pilot Set with your eyes shut!"

This Month's Special

The "Wireless Constructor" Useful Three-Valve Receiver

Complete Kit of Components for building this Set (B type) £6 18 0

Drilled and engraved Red Triangle Panel 18/-

Polished Mahogany Cabinet to author's design with baseboard £1 17 6

Other Pilot Sets:

All Concert de Luxe			
Complete kit of components	£4	11	11
Drilled and engraved panel		16	6
Cabinet to fit		17	0
Harmony Four			
Complete kit of components	£6	19	6
Drilled and engraved panel		17	0
Cabinet to fit	1	15	0
4-Valve Family			
Complete kit of components	£5	11	6
Drilled and engraved panel		17	0
Cabinet to fit		17	0
Special Five			
Complete kit of components	£8	19	0
Drilled and engraved panel		1	10 0
Cabinet to fit		3	3 0
Anglo-American 6			
Complete kit of components	£9	8	6
Drilled and engraved panel		1	10 0
Cabinet to fit		3	4 6

All the above prices are for B type Kits, using Peto-Scott guaranteed Components. If the complete Kit is purchased the same time as the Panel, a Marconi Royalty of 12/6 per Valve Holder must be paid.

"WHAT? Not build up a Pilot Set? Why my young brother, fourteen years old built up a Pilot Three-Valve Dual last week. At his first attempt, too. Listen!" And as he spoke there floated into the room the well-known strains of the "Marche Hongroise." "That is pretty good loud speaker reproduction from a home-made Receiver, isn't it?"

I had to admit that it was astonishingly clear. Seeing that I was still rather incredulous that a youngster could build such a fine set, he explained to me exactly what this Pilot System is.

"Every Pilot Set," he said "is based upon the exact design of a Set described in the technical press. Peto-Scott's supply not only the correct components but also the panel drilled and engraved exactly to the author's measurements and specification. You can obtain a complete kit of parts right down to the last screw. Look," he explained, "here is the blueprint young George got with his set of parts. This shows how the parts must be mounted and wired up."

"It looks very simple," I replied, "I'm hanged if I don't feel tempted to have a shot at one myself. Anyway, I'll sport 3d. on the Pilot Manual* I see they are advertising."

*The Pilot Manual is a 56-page illustrated Guide to Set building, profusely illustrated from photos and diagrams. Post free 3d.

PETO-SCOTT CO. LTD.

77 CITY ROAD, E.C.1

BRANCHES: 62 High Holborn, London, W.C.1
Walthamstow: 230 Wood Street
Plymouth: 4 Bank of England Place
Liverpool: 4 Manchester Street

Pilot Sets

for home Constructors

Please send me a copy of the Pilot Manual, giving detailed working instructions and illustrations for building many of the well-known Radio Press Sets. I enclose 3d. to cover cost of postage, etc.

Name

Address

P.S. 4377

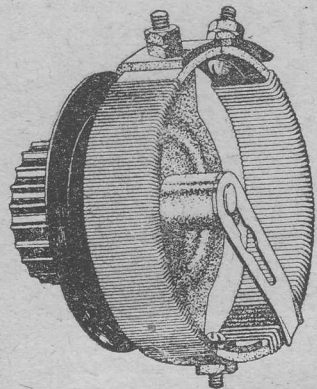

Two in One!

The new Dual Rheostat—a "Peerless" product in every way. Specially designed to meet the demand for a resistance equally applicable to bright or dull emitters. It has two windings—one offering a resistance of 6 ohms, whilst a continuation of this is of 30 ohms resistance. The resistance element is wound on a hard fibre strip under great tension. One hole fixing is provided, and the terminals are placed in convenient positions. The contact arm has a smooth, silky action, and all metal parts are nickel-plated.

May we send you also details concerning our new "Resicon" Condensers? Precision instruments made to an ideal

3/9 **PEERLESS** **3/9**
Retail **DUAL RHEOSTAT** Retail

Send now for full details

The Bedford Electrical and Radio Co., Ltd.
22, CAMPBELL ROAD - - - - - BEDFORD

EXTENSION OF FREE BLUEPRINT :: SERVICE ::

THE attention of our readers is drawn to the very important announcement on page 508 of this issue.

A FREE BACK-OF-PANEL BLUEPRINT OF ANY ONE OF THE SETS DESCRIBED IN THIS ISSUE MAY BE OBTAINED IN EXCHANGE FOR COUPON ON PAGE 536

SEE PAGE 508

Radio Press, Ltd., Bush House, Strand, W.C.2

Arecraft
"American"

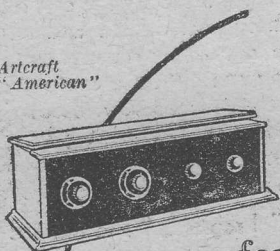

Cabinets of Distinction

for every Radio Set

MADE of high-grade materials, and unusually distinctive in appearance. Arcraft Cabinets are finding increasing favour with constructional authorities and constructors everywhere. The American Type specified is eminently suitable for present-day receiver design.

We illustrate also the Arcraft Popular and Enclosed Types, two designs that will make a strong appeal to you who seek a cabinet of practical utility combining artistic appearance.

Illustrated Brochure of Arcraft Cabinets, 6 Models in Oak or Mahogany from 6/-, sent free on request.

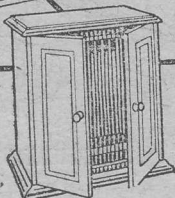
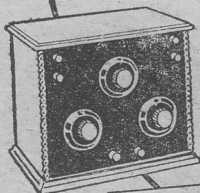

Above:
Arcraft
"Popular"

Below:
Arcraft
"Enclosed"

ARTCRAFT

THE ARTCRAFT COMPANY
156, Cherry Orchard Road, Croydon
Phone: Croydon 1981

If you are unable to obtain your favourite Wireless Journals from your Newsagent or Bookseller send a subscription Promptly delivered through the post

MODERN WIRELESS

Twelve months - 15/- Six months - 7/6

WIRELESS WEEKLY

Twelve months - 32/6 Six months - 16/3

THE WIRELESS CONSTRUCTOR

Twelve months - 8/6 Six months - 4/3

WIRELESS (The One-Word Weekly)

Twelve months - 13/- Six months - 6/6

WIRELESS DEALER

(Obtainable by Trade only)

Twelve months (U.K.) 7/6; (Abroad) 10/-

RADIO PRESS LTD.

BUSH HOUSE, STRAND, LONDON, W.C.2

SAXON GUIDE TO WIRELESS

THIS BOOK EXPLAINS EVERYTHING YOU WISH TO KNOW ABOUT WIRELESS, AND ENABLES ANY BEGINNER TO MAKE WIRELESS SETS WHICH ARE UNEQUALLED IN PRICE, QUALITY, OR EFFICIENCY.

FULL INSTRUCTIONS WITH CLEAR WIRING DIAGRAMS are given for making SUPER EFFICIENT CRYSTAL SETS, DUAL AMPLIFICATION RECEIVERS, SINGLE-VALVE SETS, ONE- AND TWO-VALVE AMPLIFIERS; TWO-, THREE-, AND FOUR-VALVE TUNED ANODE ALL-WAVE RECEIVERS AND THE VERY LATEST TYPE OF FIVE-VALVE RESISTANCE CAPACITY RECEIVER

NO SOLDERING, NO SPECIAL TOOLS, NO KNOWLEDGE REQUIRED. 176 PAGES

With this book any beginner will make a Wireless Set for one-fourth the price he would pay for an instrument not half so good.

If you are not more than satisfied return the book and your money will be refunded:

SAXON RADIO CO. (Dept. C), SOUTH SHORE, BLACKPOOL

PRICE
1/3 POST FREE

THE "SECURITY" VALVE HOLDER

(Prov. Pat. No. 2187/25).

ANTI-CAPACITY

PROTECTS THE VALVE

METAL DRILLING
TEMPLATE Included.

PRICE

1/-
NETT

OBTAINABLE
FROM ALL
RETAILERS & FACTORS.

Advert. of

Williams, Ellis & Co., London.

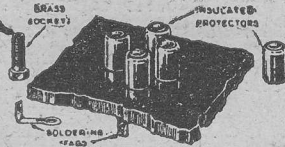

HAVE YOU READ "SALIENT FEATURES"

Our new 80pp. list containing full specifications, illustrations and prices of some 25 Receiving Sets including the most popular RADIO PRESS Circuits

also

Articles on set construction,
The care and use of valves,
Tables, data, pole finding paper, etc.

See that your bookshelf contains every number as issued.

Price 6d. (refunded on first purchase)

Test SALIENT SOLDERING FLUX
Non-corrosive, non-spluttering, price 6d. per tin

"S.A. CUTTERS" LTD.

18, BERNERS STREET, LONDON, W.1

Telephone: Museum 6273. Branches: BATH and MANCHESTER.



All communications respecting
advertisements should be
addressed to

The Advertisement Manager

"The Wireless Constructor"

BUSH HOUSE · STRAND · W.C.2

The New MAXEL Accumulator

Specially designed for Wireless

GUARANTEED TWELVE MONTHS.
If you live too far away to call and see the Battery Mail your Order to us for the size you want. We will willingly return your money if you are disappointed.

Now fitted with NON-CORROSIVE Wander Plug Terminal

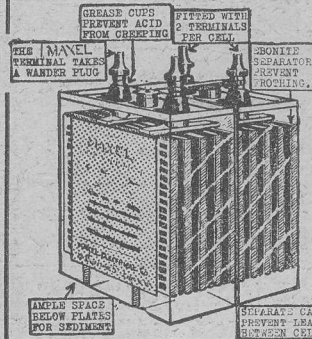

	AMPERE HOURS.			
	40	60	80	110
2 VOLT	7/6	9/6	11/9	14/6
4 VOLT	15/-	19/-	22/6	26/6
6 VOLT	22/6	27/9	33/6	39/-

Packing 1/- extra per battery.

60 volt

H.T. Batteries 7/6 post free.

MAXEL ELECTRICAL CO. 28, Clipstone Street, Great Portland Street, W.1

Telephone: MUSEUM 705.



RADION

the Panel de Luxe

The new Radion Book
shows how to make
this fine Unit Receiver

BEFORE you build your next Set you should send 6d. for a copy of the new Radion Book—a splendid constructional book of 24 pages packed with photographs and diagrams showing how to build the following sets: (a) a one-valve set, (b) a two-valve L.F. amplifier, (c) a self-contained Loud Speaker set, (d) a five-valve Neutrodyne set. You can build any of these fine sets with confidence—they have been designed by a practical radio engineer. They cost little to build but yet give extraordinarily good results. The set illustrated below is the one-valve receiver coupled to its two-valve amplifier. Ask your Dealer for a copy to-day, or send sixpence direct to us. **6d**

American Hard
Rubber Company
(Britain) Ltd.

Head Office:
13a, Fore Street,
London, E.C.2

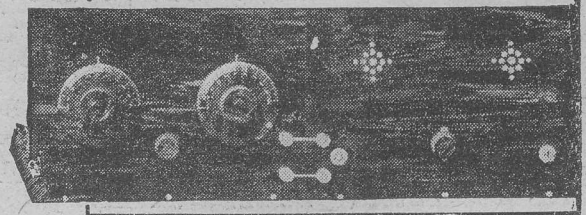

Gilbert Ad. 4372

LAMPLUGH

STRAIGHT LINE LOW LOSS CONDENSER

Separates the Stations—like splitting hairs! Electrically and mechanically sound. One night's tuning with a Lamplugh Condenser will convince you of its superiority in selectivity.

.0003 11/-; .0003 10/3; .0002 10/-



If your dealer cannot supply, we can. Send for list.

Britain's Best in Radio!

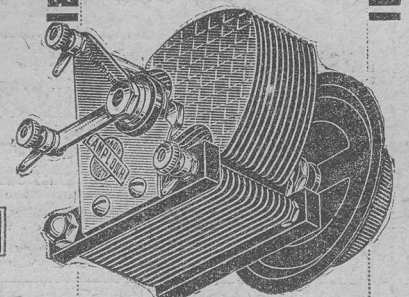

Type C.A.1

S. A. LAMPLUGH LTD.
Kings Road, Tyseley
BIRMINGHAM

PETO & RADFORD BULL DOG ACCUMULATORS

Every owner of a valve set should know the actual capacity of the accumulator he buys. Five of the most popular are listed below.

Type	Voltage	Actual Capacity in Ampere Hours	Price Complete, Unit without Crate* (Uncharged)
BD 5R	2	32	£0 14 0
BD 7R	2	43	0 19 0
BD 9R	2	64	1 3 6
BD 11R	2	80	1 6 9
BD 13R	2	96	1 10 0

*For 4 and 6-volt units prices are pro rata and include the requisite number of separate 2-volt. cells and the necessary cell-to-cell connectors. Carrying strap for each 2-volt unit, 1/- extra.

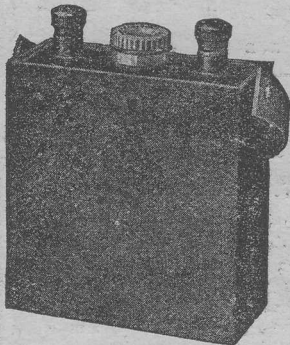

"Dagenite" containers are absolutely acid-proof and leak-proof. Ask your dealer for other details about P. & R. Bull Dog Accumulators, or write to us direct if more convenient.

PETO & RADFORD

Proprietors:

Pritchett & Gold & E.P.S. Co. Ltd.,
50, Grosvenor Gardens,
Victoria, London, S.W.1

Telephones: VICTORIA 3667 (5-lines)

There are many
'good' Coils-
But for
Complete Efficiency
Use
SLEKTUN

INDUCTANCE COILS

The following National Physical Laboratory Figures Constitute a Record:
COIL OF 200 TURNS INDUCTANCE: SELF-CAPACITY:
1770 MICRO-HENRIES 3 MICRO-MICROFARADS

Send a p.c. for illustrated booklet—

SLEKTUN, WELLINGTON HOUSE, BUCKINGHAM GATE, S.W.1

COUPON

QUESTIONS AND ANSWERS

This Coupon must be accompanied with a 2/6 P.O. and Stamped Addressed Envelope.

"Wireless Constructor," MARCH, 1926.

FREE BLUEPRINT SERVICE COUPON

Wireless Constructor. Vol. II. No. 5. March, 1926

This coupon entitles the reader to one back-of-panel blueprint of any set described in the above issue, and must accompany each postal application.

DORWOOD CONSTRUCTOR'S GAUGE

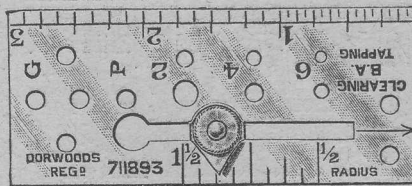

BRITISH MADE

1/9

From your dealer, or post free from makers

Will save you hours of labour, and turn out better work. Automatically spaces contact studs to any radius, sets out valve sockets truly, gives B.A. tapping and clearing drill sizes, and has 3 in. rule and square, on hard silvered metal. Will last lifetime, and is most useful gadget in tool kit.

DORWOODS, 274a, Kentish Town Road, London, N.W.5

Have you used Dorwood Precision Condensers? They are the standard of accuracy and construction. Ask for List.

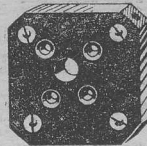

HERE WE ARE AGAIN!

Another of the RAPINET Famous Components is now ready for the market. The Rapinet Anti-capacity Valve Holder at 1/- each. Extremely smart in appearance, its capacity is practically Zero, it can be mounted on top or underneath the panel and in both cases connections are made under the panel. The "value for money" of Rapinet Components is again proved in this wonderful offer.

RAPINET LIMITED, 39-49, GROTON ROAD, EARLSFIELD, S.W.18.

PHONE: LATCHMERE 5788-9.

A
NEW
RADIO
SYMBOL



THE
MARK OF
PERFECT
EBONITE

Guaranteed Ebonite. TESTED Ebonite. No-trouble Ebonite.
From all good dealers, cut from the sheet or in stock size panels.
Matted ready for use.

CLAYTON RUBBER CO. LTD., Progress Works, Croft Street, Clayton, MANCHESTER

CABINETS



CABINETS

for your set

for the circuits

Described in "MODERN WIRELESS," "WIRELESS WEEKLY" and "THE WIRELESS CONSTRUCTOR," etc., or phone Clerkenwell 6903
WRITE NOW FOR ILLUSTRATED LIST

NAME.....
ADDRESS.....

Write
in
Block
Letters
Please

THERE IS A CAMCO CABINET FOR EVERY CIRCUIT
TRADE ENQUIRIES ESPECIALLY INVITED
GARRINGTON MANUFACTURING CO., LTD.
18/20, Normans Buildings, Mitchell St., Central St., E.C.1

EDDYSTONE

SHOCK ABSORBING FEET

THE IDEAL RADIO SET MOUNT

Pat. Applied For

They take up all outside shock, thus giving longer life to the valves and prevent microphonic noises. In addition they add an elegant touch to the cabinet besides preventing marking or scratching a polished surface. Simple to fix—delightful in use.

MADE IN TWO SIZES
2 1/2" Diam. (nickel finish)
1 3/4" Diam. (gold finish)

Price . 3/- per set

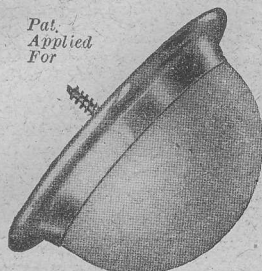

SHORT WAVE COILS for

K.D.K.A. and other low wave stations

These coils are ideal for short wave reception, there being no unwanted insulation to cause losses, while the self capacity of the coil is very low. Adaptable for ordinary sets.

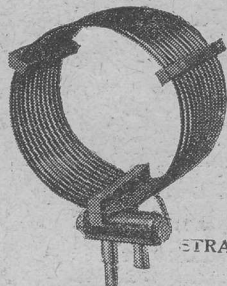

No. 9	25/80 Metres	.3/3	SET OF THREE
" 12	50/110 "	.3/6	10/6
" 15	80/150 "	.3/9	

Obtainable from all high-class dealers. If any difficulty write direct to:-

STRATTON & CO., LTD. Bromsgrove Street, BIRMINGHAM

TRADE ENQUIRIES INVITED

Send post-card for a copy of our latest catalogue. Something to interest you on every page.

ABOLISH HAND CAPACITY AND IMPROVE RECEPTION

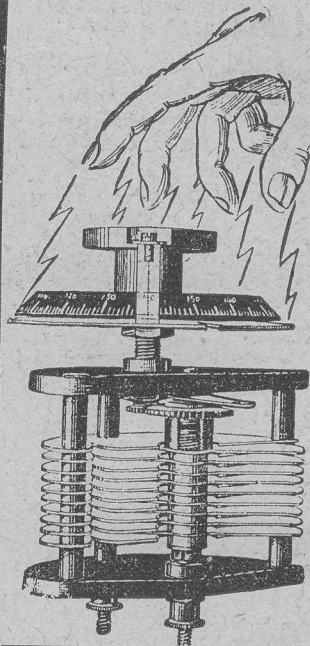

A Fulstop Condenser picks out individual stations with exceptional ease and remarkable audibility. For not only is it unconditionally guaranteed to abolish all hand capacity noises but it is designed for very accurate tuning.

In addition to being a square law condenser, the Fulstop dial is geared at 2 to 1 and is graduated over the complete circumference, thus allowing the finest adjustments to be made with ease. Every Fulstop is guaranteed for 12 months.

STANDARD FULSTOP (Geared 2 to 1)
0002 9/6 .. 0005 11/3
00.3 10/3 .. 001 13/6

SUPER FULSTOP
Dual Gearing giving 2 to 1 and 125 to 1
00025 .. 25/6 .. 0005 .. 28/3 .. 001 .. 30/6

Stocked by most Wireless Dealers
If any difficulty in obtaining write direct



J. H. NAYLOR, LTD., WIGAN



Bretwood Grid Leaks
bear inspection and stand constant use

"BRETWOOD" COMPONENTS are guaranteed for three years.

They include:

THE "BRETWOOD" FILAMENT RESISTANCE.

Price 3/6. Postage 3d.

THE "BRETWOOD" ANTI-CAPACITY VALVE-HOLDER.

Price 1/9. Postage 3d.

THE "BRETWOOD" ANTI-CAPACITY SWITCH.

Price 5/-. Postage 3d.

THE "BRETWOOD" Variable Grid Leak will satisfy critical inspection in every point of design, construction and practical efficiency. In addition, it is guaranteed to give efficient performance for a period of three years.

The Bretwood Variable Grid Leak and Anode Resistance (Patent No. 224295)

The only reliable grid leak. The plastic resistance gives smooth, perfect control, and is absolutely constant in action. Gives accurate readings consistently from 50,000 ohms to over 10 megohms. GRID LEAK OR ANODE RESISTANCE PRICE **3/-**

With Condenser (as illustrated) 4/- Postage 3d.

BRETWOOD LTD. 12-18, London Mews, Maple St. LONDON, W.1

The PELICAN UNIVERNIER

PRICE

6/=-

helps you to log distant stations

If previously you have found it difficult to tune in distant transmissions the fault probably lies in your tuning controls. Replace your present dials with the Pelican Univernier. The Univernier will prove in practical test that efficient tuning can make all the difference to the selectivity of your receiver. It responds to your slightest touch giving a "dead on wavelength" adjustment that brings in stations at full strength. You can make the "change to Pelican Univernier dials at once. Simply unscrew the existing dials of your variable condensers or varicome era, and replace with Univerniers.

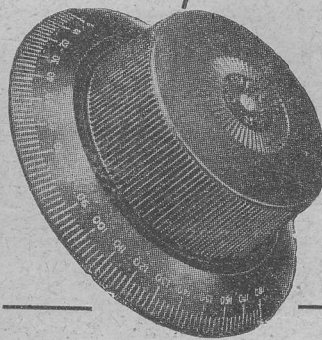

from all dealers

CAHILL AND COMPANY LTD.

64, Newman St., London, W.1

Telegrams: Pelcarad, Wesdo, London. Telephone: Museum 9236



"Wireless" the One-Word Weekly is read by all who acknowledge Wireless their hobby.

The topical news features will prove of great interest to you and its articles of immeasurable assistance. The result of careful experiment and exhaustive research, the circuits published in its pages are guaranteed to fulfil the claims of the authors. The contents of "WIRELESS" may be taken as the definite and considered opinion of experts.

Every article and viewpoint expressed is worthy of your perusal and consideration, helping you in the pursuit and extension of your hobby.

Obtainable from all Newsagents and Booksellers or direct from the Publishers.

"WIRELESS" is the only 2d. technical paper available.

Subscription rates: 13/- per annum. 6/6 for six months.

WIRELESS

 THE ONE-WORD WEEKLY **2^D**

Published every Tuesday by
 RADIO PRESS, LTD., Bush House, Strand, W.C.2



WRITTEN by Wireless experts for all classes of Wireless users, the February issue of "MODERN WIRELESS" features the following:—

THE QUALITY FOUR. *By John W. Barber.* A choke-coupled receiver designed for pure loud-speaker reproduction. Its design incorporates plug and jack switching, by means of which two, three, or four valves may be employed at will. Numerous Continental and B.B.C. Stations can be "tuned-in" with comparative ease.

A REMOTE-CONTROL SINGLE-VALVE SET. *By John Underdown.* Designed to be operated from a room other than that in which the set is placed, this receiver will make a very strong appeal to those listeners who wish to receive their local station with the maximum of convenience.

DISTANT RECEPTION WITH THREE VALVES. *By C. P. Allinson.* On this receiver employing one H.F. Detector and one L.F. the Test Report shows good reception from twelve or more foreign stations, as well as B.B.C. Stations.

In addition—this issue contains many technical articles of great interest to the experimenter, and in fact, to all who have made a hobby of Wireless.

"MODERN WIRELESS" is obtainable from all Newsagents and Booksellers or direct from the Publisher.

SUBSCRIPTION RATES: 15/- per annum, 7/6 for six months

RADIO PRESS LTD.
BUSH HOUSE, STRAND, LONDON, W.C.2

Modern Wireless

REGISTERED
HUNTS
TRADE MARK
THEY LAST LONGER

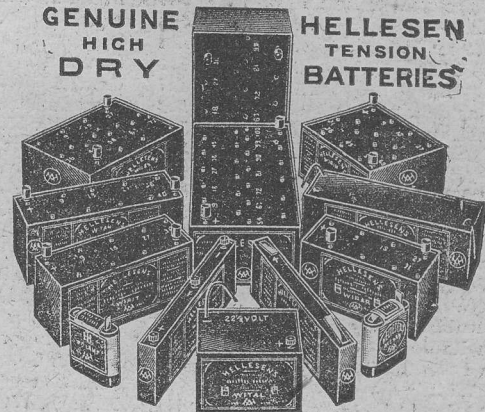

For the first time this season we have a stock of the famous long-life HELLESEN BATTERIES and we are therefore advising customers immediately so that they may know that HELLESEN BATTERIES are available from stock for the first time in three years. Such a demand is in itself the best recommendation possible.

MORE EXPENSIVE THAN SOME OTHERS
THEY SELL ON QUALITY BECAUSE

THEY ARE CHEAPER TO USE!

Delivery from Stock

A. H. HUNT, LTD. (Dept. No. 15), CROYDON, SURREY

H.P.

Satisfaction is guaranteed because if you have any cause for complaint, you have only to send the component back to us and we will replace it entirely free of charge. Every "Utility" product is unconditionally guaranteed.

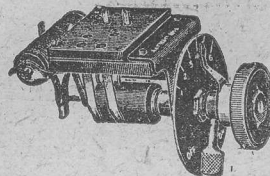

"Utility" Valve Switch Unit

embodies in one unit our well-known "Utility" switch, a valve holder and rheostat. It is for use in multi-valve sets, to control a valve and to switch it in and out whilst still preserving the continuity of the circuit. It has many advantages over separate components, such as lower self-capacity, less wiring, one-hole fixing and lower cost.

Resistance 6 ohms or 30 ohms as desired.
Nickel Plated 6d. extra.
Price (complete with wiring diagrams) 8/6 each.

Utility
GUARANTEED
COMPONENTS

Wilkins & Wright, Ltd.
Utility Works, Kenyon St., Birmingham

E.P.S.6

Index to Advertisers

	PAGE		PAGE
American Hard Rubber Co. ...	535	Electron Co., Ltd. ...	529
Artcraft Company (The) ...	534	Falk, Stadelmann & Co. ...	Cover iii
Ashley Wireless Telephone Co. ...	525	Ferranti, Ltd. ...	512
Autoveyors, Ltd. ...	527	Finston Mfg. Co., Ltd. ...	516, 519
Beard & Fitch, Ltd. ...	510	Forno Co. ...	532
Bedford Electrical & Radio Co. ...	534	Fuller's United Electric Works, Ltd. ...	524
Bird (Sydney S.) ...	528	Gambrell Bros. ...	493
Bowyer-Lowe Co. ...	523	Garnett, Whiteley & Co. ...	476
Brandes, Ltd. ...	472	General Electric Co., Ltd. ...	458, 491
Bretwood, Ltd. ...	537	Gent & Co. ...	520
British Engineering Products ...	528	Hunt (A. H.), Ltd. ...	539
British L.M. Ericsson Mfg. Co., Ltd. ...	527	Igranic Electric Co. ...	499
British Thomson-Houston ...	520	International Corr. Schools, Ltd. ...	523
Brown (S. G.), Ltd. ...	480	Jackson Bros. ...	512
Bulgin (A. F.) & Co. ...	540	Kriseros Co. ...	528
Burne-Jones & Co., Ltd. ...	540	Lamplugh, Ltd. ...	535
Cahill & Co., Ltd. ...	537	Lissen, Ltd. ...	471
Carrington Mfg. Co. ...	536	London Electric Wire Co. & Smiths, Ltd. ...	530
Caxton Wood Turnery Co. ...	527	Lowenadler (F. W.) ...	530
Christie, Jas., & Sons, Ltd. ...	532	Makerimport Co. ...	532
Clayton Rubber Co., Ltd. ...	536	M.A.P. Co. ...	516
Cleartron Radio, Ltd. ...	513	McMichael (L.), Ltd. ...	475, 484
Collinson Precision Screw Co. ...	520	M. & A. W. ...	528
Cooke & Whitfield Wireless, Ltd. ...	529	Maxel Electrical Co. ...	535
Cossor (A. C.), Ltd. ...	479	Miller (John W.) ...	519
Curtis (Peter), Ltd. ...	510	Mullard Wireless Service Co., Ltd. ...	Cover ii
Dixon (L.) & Co. ...	516	Naylor (J. H.), Ltd. ...	537
Dorwoods ...	536	Neutron, Ltd. ...	509
Dubilier Condenser Co., Ltd. ...	487, 526		
Edison Swan Electric Co. (The) ...	502, 510		
		Oldham & Son, Ltd. ...	531
		Pettigrew & Merriman (1925), Ltd. ...	494, 516
		Peto & Radford ...	536
		Peto-Scott Co., Ltd. ...	526, 533
		Portable Utilities Co., Ltd. ...	519, 530
		Radiax, Ltd. ...	540
		Radio Communication Co., Ltd. ...	506
		Radio Equipment Co., Ltd. ...	534
		Radio Instruments, Ltd. ...	-Cover iv
		Radions, Ltd. ...	531
		Rapinet, Ltd. ...	536
		Rawplug Co., Ltd. ...	523
		Raymond (K.) ...	496
		Reid (L.H.), & Co. ...	519
		"S. A. Cutters," Ltd. ...	535
		Saxon Radio Co. ...	535
		Seagull, Ltd. ...	526
		"Sel-Ezi" Wireless Co. ...	529
		Slektun ...	536
		Standard Telephone Co. ...	525, 530
		Stevens (A. J.) & Co. (1914), Ltd. ...	505
		Stratton & Co. ...	537
		Taylor (C.) ...	540
		Telegraph Condenser Co., Ltd. ...	532
		U.S. Radio Co., Ltd. ...	509
		Varley Magnet ...	495
		Wates Bros. ...	488
		Wilkins & Wright, Ltd. ...	539
		Williams, Ellis & Co. ...	535

TRADE DECKO MARK
ONE HOLE FIXING
VALVE HOLDER RHEOSTAT
ONLY OCCUPIES A SQUARE INCH OF PANEL SPACE. AIR COOLED RHEOSTAT.
OBTAINABLE FROM ALL THE BEST DEALERS.



PRICE 5/6 EACH
IDEAL UNIT FOR PORTABLE SETS

A.F. BULGIN & CO.
SOLE MANUFACTURERS
9-11 CURSITOR ST.
CHANCERY LANE LONDON.

2-VALVE AMPLIFIER, 35/-
1-Valve Amplifier, 20/-, both perfect as new; Valves, 4/6 each; smart Headphones, 8/6 pair; new 4-Volt Accumulator, celluloid case, 13/-; new 68-Volt H.T. Battery, guaranteed, 7/-; 2-Valve All-Station Set, £4. Approval willingly.

C. Taylor, 57, Studley Rd., Stockwell, London

TRADE DECKO MARK
ONE HOLE FIXING
"DIALITE"
USEFUL IN DARK CORNERS. ILLUMINATES THE PANEL. HANDSOME APPEARANCE.
OBTAINABLE FROM ALL THE BEST DEALERS.



PRICE 2/6 EACH
WITH HIGHLY PLATED REFLECTOR BULBS EXTRA

A.F. BULGIN & CO.
SOLE MANUFACTURERS
9-11 CURSITOR ST.
CHANCERY LANE LONDON.

TRADE DECKO MARK
NO. 2 PATTERN
DIAL INDICATORS
NEW RAISED DESIGN, FIXED, ANYWHERE BETTER THAN ENGRAVING.
OBTAINABLE FROM ALL THE BEST DEALERS.



PRICE 3/ EACH
N.P. or GILT

A.F. BULGIN & CO.
SOLE MANUFACTURERS
9-11 CURSITOR ST.
CHANCERY LANE LONDON.

Clearance Bargains Owing to Removal to New Premises

Variable Condensers, '00025 or '0003, 3/-; best quality, 4/6. Square Law Type, '00075, 6/9, with vernier, 8/9; '001, 9/6; Super quality, Copper Vans, '001, 11/6; '0005, 9/6; '0003', 7/6; with vernier, '0005, 10/9; '0003, 9/-; Coil Holders, popular 2-way panel, 1/9, Base, 2/9, 3-way Base, 4/3. Dutch Valves, 4 Electrode, 4/9. Twin Flex, 2/6 dozen yards. Rubber Covered Cable, 4 m/m, 2/3 dozen yards. Variometer with Knob and Pointer, 1/3. Knobs, bushed, 2 B.A. 11d. Vernier Filament Resistance, 1/6. Variety of Valve Receivers from 25/-.

Clearance List Free
Complete Catalogue Receivers, Components, etc., 3d.

RADIAX LTD., 16, Palmers Place, N.7

TRADE DECKO MARK
BASE BOARD
NEUTRALISING CONDENSER
THE BEST DESIGN FOR NEUTRODYNE SETS. MICROMETER PRECISION, ASSURED.
OBTAINABLE FROM ALL THE BEST DEALERS.



PRICE 3/ EACH
WITH INSULATED ADJUSTING ROD.

A.F. BULGIN & CO.
SOLE MANUFACTURERS
9-11 CURSITOR ST.
CHANCERY LANE LONDON.

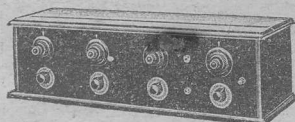

THE D.X. 5.

As described in December and January issues of MODERN WIRELESS.

A Highly Selective Set

Eliminates 210 at 11 miles, and receives B.B.C. and Continental Stations on the Loud Speaker.

Complete Set of Components **£19 10 0**
As above, ready wired and aerial tested **£22 0 0**
Plus Marconi Royalties **£3 2 6**

Send stamp for Latest Lists dealing with 15 Radio Press Sets, and new Illustrated Catalogues.

NOTE.—Where a complete set of components, together with a drilled panel, is purchased, Royalties at the rate of 12/6 per valve holder are payable.

The Huntsman Receiver

as described in this issue by Mr. PERCY W. HARRIS

	£ s. d.
1 Mahogany Cabinet as described	12 0 0
1 Mahogany Panel 12x10x1/2, Drilled	15 0 0
2 Cydon Variable Condensers '0003	1 13 0
1 Gambrell Neutrodyne Condenser	5 6 0
1 C.A.V. Fixed Condenser '0001—'0015	5 0 0
1 Push Pull Switch	2 6 0
1 M.H. Grid Leak on base 2MΩ	3 6 0
1 Watmel Fixed Condenser '0003	2 6 0
1 do do do '001	2 6 0
11 Belling Lee Terminals as described	4 2 0
1 M.H. "Dimic" coil on base	12 6 0
2 Amperite Self-adjusting Rheostats 1A	12 0 0
4 Clix Sockets and Plugs	2 4 0
2 Security Valve Holders	4 6 0
1 Plug and Socket	9 0 0
1 L. & P. 2 Coil Holder	8 6 0
1 Anode Indicator	6 0 0
1 H. F. Indicator	6 0 0
10 Feet Glazite and 2 feet Flex	1 3 0

£5 8 6

BURNE-JONES & CO., LTD.

MAGNUM HOUSE, 296, BOROUGH HIGH ST., LONDON, S.E.1
Telephone: Hop 6257. Telegrams: Burjomag, Sedist, London.
Cables: Burjomag, London. Trade Enquiries Invited.

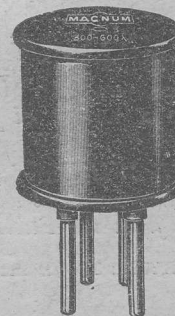

MAGNUM H.F. TRANSFORMERS.

An entirely new Design with Protected Windings.

Wavelength Range.

With .0003 Condenser.

No. 0 ... 150—300

*No. 0A 250—525

*Special Neutrodyne Unit for Broadcast

Range.

No. 1 ... 300—600

No. 2 ... 550—1200

No. 3 ... 1100—3000

No. 4 ... 2500—7000

Price 7/- each.

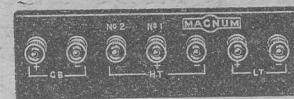

MAGNUM TERMINAL PANELS.

As used on several Radio Press Sets. Drilled and engraved, fitted with 7 terminals, 4/6.

Drilled only, supplied in any length up to 24in.

(Terminals are spaced 1 in. apart.)

Price 6d. per terminal.

e.g.—12in. Terminal Strip, 6/-

EFESCA COMPONENTS

embody many patents which enable the amateur constructor to design novel circuits and add greatly to the efficiency and appearance of the finished set. Wherever practicable Efesca Components are One-Hole-Fixing, making the task of panel-drilling and assembling as simple as possible.

Efesca Components are sold by all good Wireless Dealers. Send for Catalogue No. 559/4—it is free and full of interest.

EFESCA Type B Transformer

has been designed so that, while maintaining a 4 to 1 turns ratio—the accepted ratio for 1st stage low frequency amplification—the primary winding consists of the number of turns necessary to produce an impedance at average speech frequency to match the average impedance of an "R" Type Valve.

The Secondary Winding is of the correct resistance to obviate the possibility of grid current flowing, thus ensuring freedom from breakdown, purity of reproduction and maximum amplification.

An important feature is the heavy insulation between the primary and secondary windings. every Transformer being tested to withstand 2,000 volts. Price 21/- each.

EFESCA Regenerative Aerial Tuner

A specially designed form of Tapped Aerial Coil incorporating Aerial Reaction in a self contained unit. Reaction is effected by means of a rotor revolving in a separately wound section of the aerial coil thereby effecting maximum and uniform reaction over the whole wave band covered by the coil. Wave-length range 150 to 2,600 metres in conjunction with a .0005 Variable Condenser in parallel. Price complete with knob, pointer and scale, 32/- each.

EFESCA Vernistat

The Efesca Vernistat provides the most delicate filament control yet invented, and is particularly useful in circuits requiring individual control of valves, where filament temperature plays an important part in efficient reception. It is especially suitable for the control of H.F. and detector valves.

The Vernistat absolutely safeguards valves from accidental burn outs, as three complete turns of the knob are required to bring in or take out the whole resistance.

For Bright Emitter Valves, Resistance 5 ohms :: :: 6/-
For Dull Emitter Valves, Resistance 30 ohms :: :: 6/-

Send now for our
FREE CATALOGUE

Or
EFESCA
COMPONENTS

Wholesale only: FALK, STADELMANN & CO., LTD.
Efesca Electrical Works, 83/93, Farringdon Road, London, E.C.1
and at Glasgow, Manchester and Birmingham.

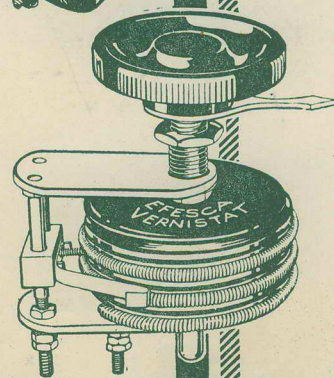
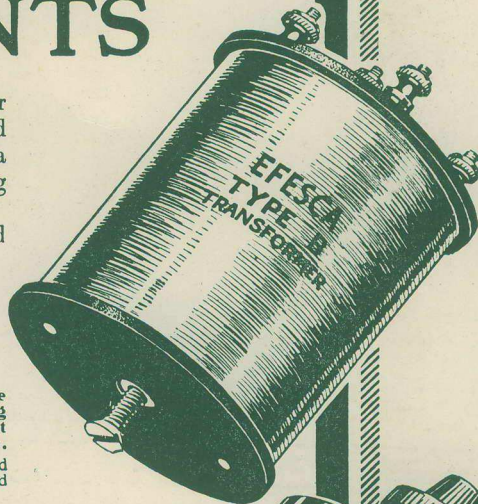

EFESCA
Popularity
Competition
£200
IN
CASH PRIZES
Ask your dealer
for entry form or
write direct to
FALK STADELMANN
& CO. LTD.
83-93 FARRINGTON
ROAD, LONDON, E.C.1

*James Warley
Albert Rd.*

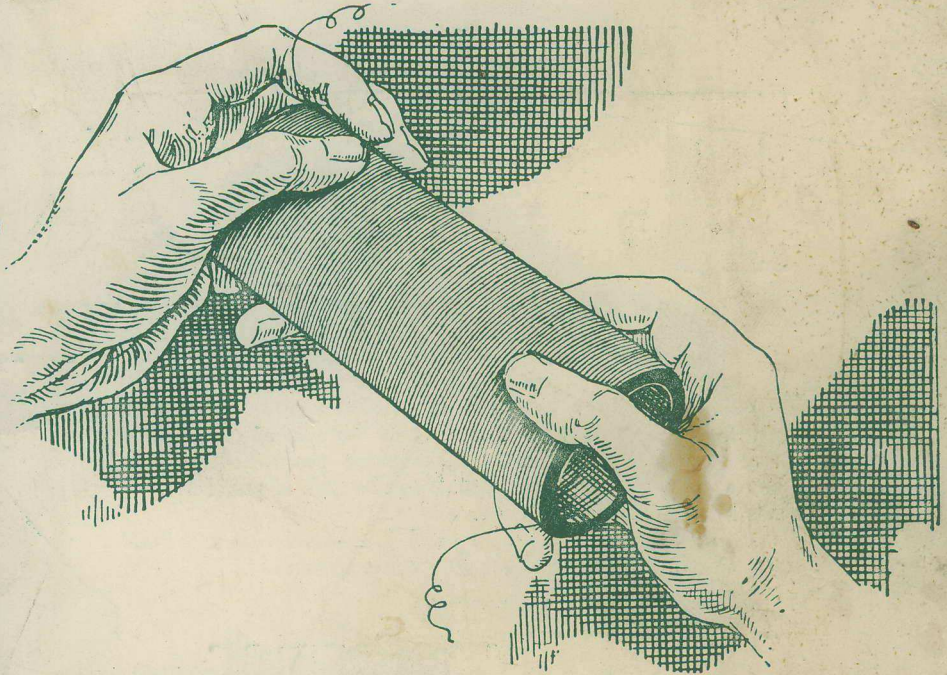
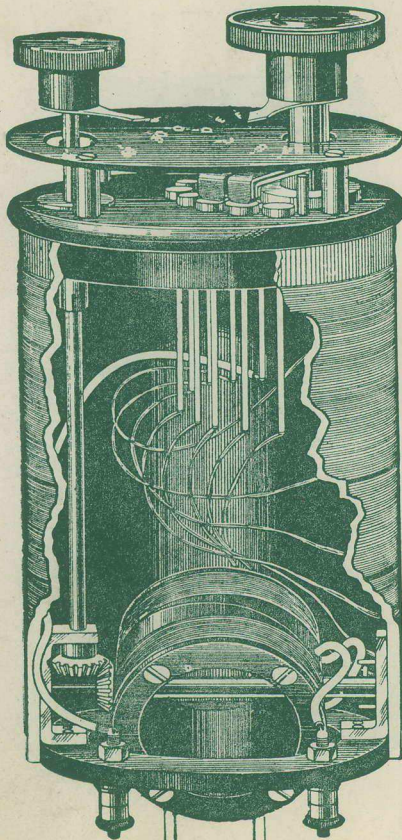

SINGLE LAYER

It has been established beyond doubt by eminent technicians that a more efficient coil can be wound of the single-layer type than the multi-layer type. Get the benefit of this increased efficiency by using the R.I. Retroactive Tuner, a component which, in addition, possesses the following advantages:—

1. The whole range from 175 to 4,000 metres can be covered in one instrument without the necessity for changing components.
2. High frequency losses are reduced to a minimum, by means of the special dead end switch, which short-circuits the adjacent turns and provides a magnetic screen.
3. The component is fixed behind the panel, and can be operated with absolute precision from the front of the panel.
4. Efficient aerial reaction is provided over the entire range of wavelengths covered by the inductance, a very important factor when it is recognised how difficult it is to obtain the best reaction value over a wide number of wavelengths.
5. The same station can be obtained in two or three different positions, by varying the inductance and the capacity.
6. Lastly, the R.I. Retroactive Tuner costs less than a set of plug-in coils with coil holder to cover a similar range.

Concise explanatory diagrams of circuits supplied with each instrument.

Price - 39/6

Write for the R.I. Blue and Gold Catalogue free on application.

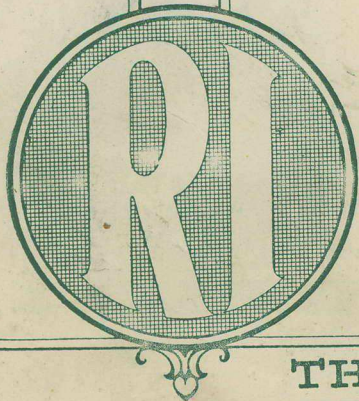

THE MARK OF BETTER RADIO

Advt. R. I. Ltd., 12, Hvd. St., New Oxford Street, London, W.C.1.

P.C.17.

Published for the Proprietors. RADIO PRESS, LIMITED, Bush House, Strand, London, W.C.2, on the 15th of each month, and printed for them by Messrs. FLEETWAY PRESS, LIMITED, 3/9, Dane Street, High Holborn, W.C.1. Address for Subscriptions and Editorial communications: Bush House, Strand, W.C.2. Address for Advertisements: Advertisement Manager, THE WIRELESS CONSTRUCTOR, Bush House, Strand, W.C.2. Phone, City 9911. Registered as a Magazine for transmission by Canadian Magazine Post. Subscription Rates: 3/6 per annum, 4/3 for six months, post free. Sole Agents for Australia GORDON & GOTCH. (AUSTRALIA), LIMITED. Sole Agents for South Africa: CENTRAL NEWS AGENCY, LIMITED.—March, 1926.