

The Wireless Constructor

6^D
MONTHLY

EDITED BY
PERCY W. HARRIS

Vol. 1
No. 10

AUGUST

1925

CONTENTS

HOW TO MAKE:

A TWO-VALVE DOUBLE-REACTION RECEIVER.

By Stanley G. Rattee, M.I.R.E.

A SINGLE-VALVE SET WITH BUILT-IN WAVE-TRAP.

By A. S. Clark

AN INTERESTING VALVE-CRYSTAL RECEIVER.

By John W. Barber

A SIMPLE CRYSTAL SET.

By H. Bramford

THE EDITOR IN AMERICA.

FAULTS IN L.F. TRANSFORMERS.

By G. P. Kendall, B.Sc.

HAND CAPACITY EFFECTS IN TUNING.

LOSSES IN WIRELESS CIRCUITS—HOW ENERGY IS WASTED.

HUNDREDS OF PRACTICAL HINTS AND TIPS FOR THE BEGINNER.

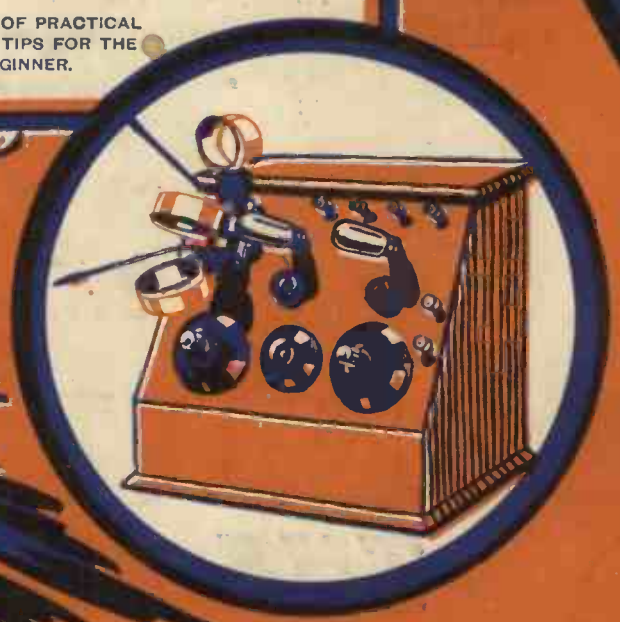

FREE BLUEPRINT INSIDE

*Do this for increased
Volume and Clarity*



JUST take out your last L.F. stage valve and insert a Mullard D.F.A. MASTER VALVE. You will be delighted with the immediate increase in volume and clarity from your loud speaker. The special construction of these Master Valves gives powerful and pure amplification and yet requires *LESS* current than your present valves.

- | | |
|--------------------------------------|-------------------|
| If you use a 4-volt accumulator | |
| ASK FOR A MULLARD D.F.A.0 (.35 amp.) | Price 22/6 |
| If you use a 6-volt accumulator | |
| ASK FOR A MULLARD D.F.A.1 (.2 amp.) | Price 22/6 |
| If you use dry cells (6-volts) | |
| ASK FOR A MULLARD D.F.A.3 (.06 amp.) | Price 24/6 |

Leaflet V.R. 25 gives full technical information

Mullard

THE MASTER VALVE

Advt.—THE MULLARD RADIO VALVE CO., LTD. (W.C.), NIGHTINGALE WORKS, BALHAM, S.W.12

The WIRELESS CONSTRUCTOR

— Edited by Percy W. Harris —

Vol. 1. No. 10.

AUGUST

CONTENTS

A Two-Valve Double-Reaction Receiver By STANLEY G. RATTEE, M.I.R.E.	879	Faults in Low-Frequency Transformers By G. P. KENDALL, B.Sc.	903
Where are the Losses P By G. P. KENDALL, B.Sc.	885	The Wave-Trap Single-Valve Receiver By A. S. CLARK.	912
The Editor's Experiences in America By H. BRAMFORD.	883	Stretching the Indoor Aerial	916
A Simple Adaptable Crystal Receiver By H. BRAMFORD.	891	A New Journal	920
Tuning Made Easy	895	Hand Capacity Effects in Tuning By A. V. D. HORT, B.A.	922
An Interesting Valve-Crystal Receiver By JOHN W. BARBER.	898	Workshop Hints	929
Stage, Screen and Microphone By "CARRIER-WAVE."	903	Improving Your Selectivity By A. JOHNSON-RANDALL.	934
		Pictorial Circuits	941



A WONDERFUL DIFFERENCE

GAMBRELL COILS

Approx. Number of Turns on nearest Ordinary Coil	PRICE	AERIAL CIRCUIT		ANODE CIRCUIT		Inductance	Self-Capacity			
		With 100 feet P.M.G. Aerial		Condenser '00025 mfd. max.						
		Condenser '0005 mfd. max.		PARALLEL						
		SERIES	PARALLEL	PARALLEL	Mics.			Mfd.		
		METRES	METRES	METRES						
18	a/2	5/9	54	131	150	195	45	125	14	'000004
25	a	5/9	76	155	180	260	65	185	24	'000004
30	A	5/9	95	198	230	360	90	255	51	'000004
40	B1	6/-	142	272	315	515	130	375	113	'000005
50	B	6/-	194	368	410	710	180	500	197	'000005
75	C	6/9	265	492	560	980	250	670	364	'000006
100	D	8/-	375	700	780	1370	355	960	745	'000006
150	E1	8/9	504	940	1100	1930	480	1300	1050	'000007
200	E	9/6	750	1350	1550	2700	725	1800	2880	'000008
300	F	10/3			2180	3800	900	2600	5720	'000009
500	G	12/-			3260	5600	1600	4000	12400	'000011
750	H	14/-			4600	7800	2100	5700	26300	'000014
1000	I	16/-			7700	12500	3150	8000	62260	'000017
1500	J	19/-			12400	21500	5500	13300	177300	'000021

will be made to your set if you replace ordinary coils with GAMBRELLS. They are better in every way—strength of signals, sharpness of tuning, etc. Why not try them out—get one or two to-day and convince yourself that the position they hold as the "Maximum Efficiency Coil" has been attained purely by merit.

SPECIAL NOTE. — Slight alterations and additions having been made to the "Efficiency" Inductance Coil series, you are PARTICULARLY REQUESTED to write for our Special folder giving Coil Tables and Coil Signs of principal Broadcasting Stations.

Have you had full descriptive details of the Gambrell Wavemeter, Coil Holder, L.F. Intervalve Transformer, Neurodyne Condenser, and other Gambrell productions giving maximum efficiency; if not, a postcard will bring same by return.

GAMBRELL BROS., LTD.

76, Victoria St., London, S.W.1

Works: Merton Road, Southfields, London, S.W.18
Phones: VICTORIA 5938 PUTNEY 9661-8

"Non-Pong"
ValveHolder
(for panel
mounting).

PRICE
4/3

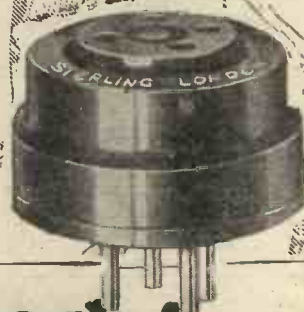

"Non-Pong" Valve
Holder Adapter (for
fitting into existing rigid
type sockets).

PRICE **5/-**

The Demons of Shock & Noise beaten at last!

At last appears the truly efficient Sterling "Non-Pong" Shock Absorbing Valve Holder to put the demons of shock and noise in their place, beaten and powerless. No more "pong noise" —no more shocks to break filaments that the ordinary rigid valve holder cannot prevent. For

the "Non-Pong" absorbs shocks, prevents irritating microphonic noises, and very considerably lengthens the life of a valve.

Use "Non-Pong" Holders in the set you are building, or the Adapter type in sets already fitted with ordinary holders.

STERLING 'NON-PONG' Shock Absorbing VALVE HOLDERS

At your radio dealer's

Announcement of **STERLING TELEPHONE & ELECTRIC CO., LTD.**, Manufacturers of Telephones & Radio Apparatus, etc.
210-212, TOTTENHAM COURT ROAD, LONDON, W.1
Works: DAGENHAM, ESSEX

The WIRELESS CONSTRUCTOR

Scientific Adviser;
 Prof. G. W. O. HOWE,
 D.Sc., M.I.E.E.
Advisory Editors;
 Prof. R. WHIDDINGTON,
 M.A., D.Sc.
 Prof. C. L. FORTESCUE,
 M.A., M.I.E.E.

Staff Editors;
 E. H. CHAPMAN, M.A.,
 D.Sc.
 A. D. COWPER, M.Sc.
 R. W. HALLOWS, M.A.
 G. P. KENDALL, B.Sc.
 A. JOHNSON-RANDALL,
 S. G. RATTEE, M.I.R.E.

Vol. 1.

AUGUST, 1925.

No. 10.

A Two-Valve Double-Reaction Receiver

By STANLEY G. RATTEE, M.I.R.E., Staff Editor

IN the more common types of receivers employing reaction coils, whether single or multi-valve, reaction is applied at only one point, whereas in the receiver under description it is possible to use the now common form of aerial reaction, or else to couple the reaction coil to the anode circuit in the manner shown in Fig. 3. The advantage afforded by this latter method is that the chances of causing interference to other listeners by the careless adjustment of the reaction coil are somewhat less and at the same time permit of instant comparison of this arrangement with that more commonly used, namely, coupling the reaction coil to the aerial circuit.

In the hands of the experienced operator, a receiver such as the one photographed also possesses the advantage that a double reaction effect may be used; but for the beginner, however, the application of reaction in this "dual" sense is not to be recommended until he has thoroughly acquainted himself with the opera-

tion and control of reaction applied to one point of the circuit.

The Circuit

The circuit of the receiver is that

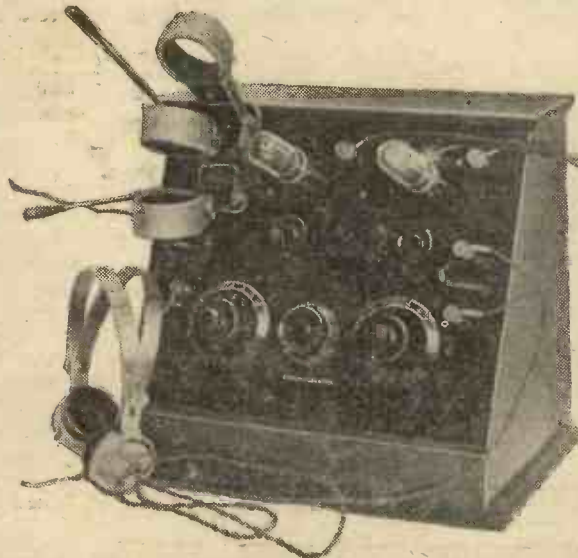

The receiver illustrated permits two forms of reaction to be used. The inclusion of a potentiometer gives a very fine control of oscillation.

of a straight high-frequency valve, coupled to the detector valve by the well-known tuned-anode method, and tuned by a .00025 μ F variable condenser. The aerial tun-

ing circuit is directly coupled to the aerial, and in order that self-oscillation of the receiver may be controlled when the aerial and anode circuits are in tune, a potentiometer is provided. This latter, though primarily intended for the purpose just stated, also permits a fine adjustment of reaction to be obtained, a particularly valuable refinement for the reception of distant stations. Separate filament resistances are provided for two valves, and these are of the type which permit the use of either bright or dull-emitter valves, the bobbins being easily changed to suit individual requirements.

Design

The appearance of the receiver may be gathered from the various photographs, and in that illustration where the front of the panel is shown the two terminals on the left and just below the three-coil holder are for the aerial and earth connections respectively, while those terminals along the top of the panel are, reading left to right, the two L.T. and the two



H.T. The telephones are connected to the terminals on the right of the panel. The aerial tuning condenser is situated on the left of the panel and the anode tuning condenser on the right, with potentiometer in between. The lower coil in the three-coil holder is the anode coil, while the centre coil is the reaction coil; the upper coil is that in the aerial circuit. Since the reaction coil lies between the two moving coils, it will be easily understood that either or both of these two coils can be coupled to the fixed or reaction coil.

Components and Materials

In the list given below will be found all the necessary materials and components required for the building of a receiver to the specifications given herein, and readers who desire to know the makers of the components actually incorporated in the set photographed will find below the names of the manufacturers or their trade mark against the components listed:—

One ebonite panel measuring 12 in. by 10 in. (The panel used in the present set is a Radion Mahogany, $\frac{3}{8}$ in. thick.)

One 0.0005 μ F square-law variable condenser with vernier (Radio Instruments, Ltd.).

One 0.0025 μ F square-law variable condenser with vernier (Radio Instruments, Ltd.).

Two filament resistances (Polar).

One three-way coil-holder (Burne-Jones & Co., Ltd.).

One potentiometer (L. McMichael, Ltd.).

Two fixed condensers of 0.003 and 0.01 μ F. (Those in the set are the clip-in type, supplied by L. McMichael, Ltd.)

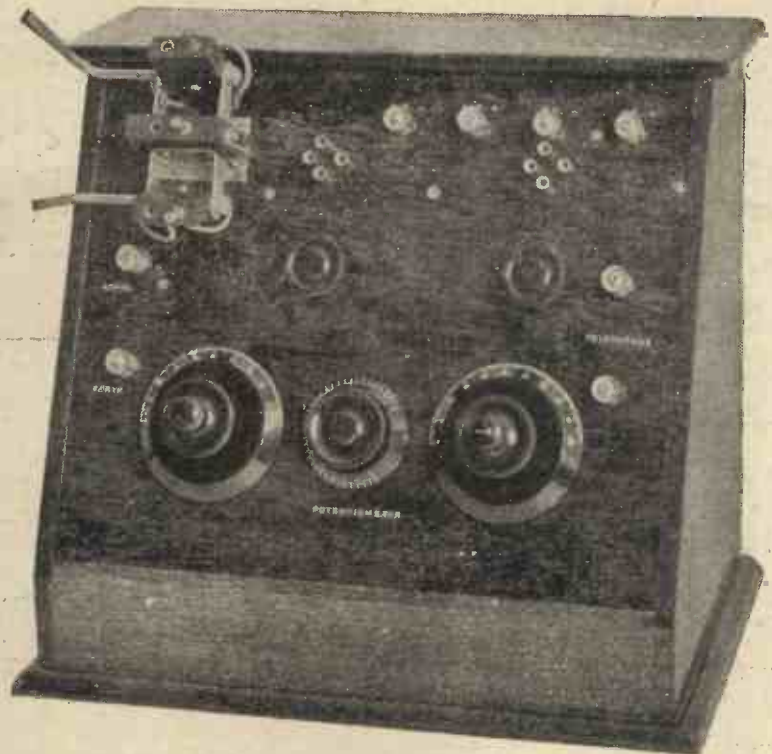

The pleasing appearance of the receiver, which results from the layout adopted, will be appreciated from this photograph.

One grid condenser of 0.003 μ F (Dorwood).

One grid-leak of 2 megohms (Darco).

Eight valve legs for panel-mounting.

Eight nickel-plated terminals.

One containing box. (That photographed is a "Camco.")

Quantity of connecting wire.

Packet of Radio Press panel transfers.

are concerned, are given in the illustration of the layout, and it is strongly recommended that readers do not depart from this layout, as considerable difficulty may result in obtaining the desired sensitivity of the finished set. Should the reader choose components other than those given above, it is suggested that he make sure that the dimensions given permit sufficient clearance for the valves. The spacing allowed has received some thought in this direction, and in most cases there will be no difficulty in this respect; nevertheless, it is as well that readers make certain of this point before commencing the operation of drilling.

The Panel

Complete details for the drilling of the panel, in so far as dimensions

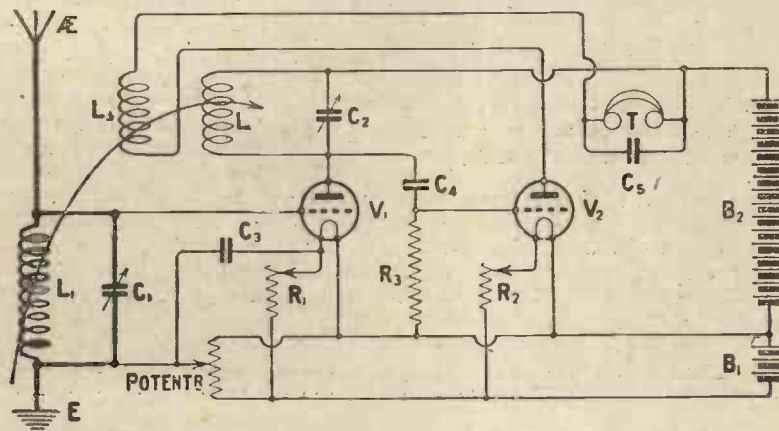

Fig. 1.—The circuit of the receiver. Reaction may be applied either to the aerial or anode circuit.

Wiring

In so far as the wiring is concerned the constructor should experience no difficulty, as there is quite easy access to the various components which have to be connected. Constructors should, as far as is within their power, copy the arrangement shown in the blue print in every detail, the reason being that any drastic departure from the original may quite conceivably bring about a very undesirable state of instability. All connections should be soldered and wires as well spaced as circumstances will permit,

Testing

When the receiver is complete, and the constructor is confident that the wiring is correct, the filament circuits should first be tested for continuity. To the two L.T. terminals an accumulator of a voltage suitable for the valves chosen should be connected, and with the two filament resistances turned to the "off" position, the two valves should be inserted in their sockets. By turning the filament resistances these should give control of the brightness of the burning of the filaments, and assuming that this control is given, the coils may be inserted in the coil-holder.

For testing purposes it is as well if the receiver be operated upon a wavelength little used by the broadcast listener, and for that reason use as the aerial coil a No. 75, with a No. 75 for reaction and a No. 100 for the anode. With the two moving coils well away from the fixed, connect the aerial, earth, H.T. battery and telephones, and turn the potentiometer to the full negative position. With the two

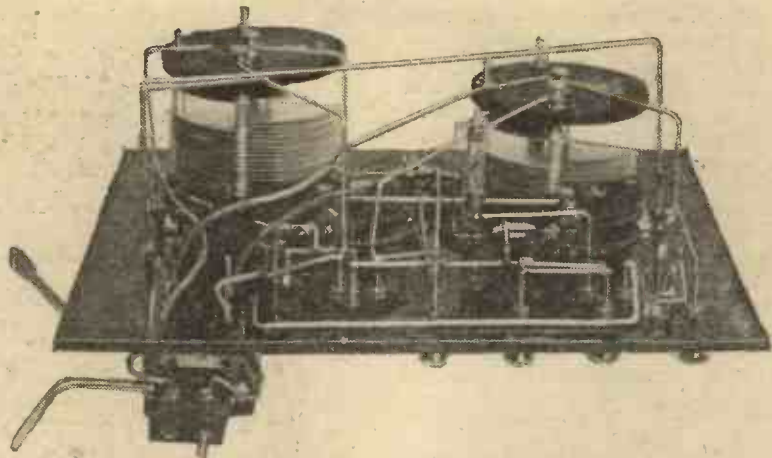

A back of panel photograph, showing the relative elevations of a number of the wires.

valves burning at a suitable temperature, turn the aerial tuning condenser to its zero position, and starting with the tuned anode condenser also at zero, slowly turn the same condenser until the set is about to oscillate; this will come about when the aerial and

anode circuits are almost in tune, and indicates that all is correct with the main wiring.

Oscillation

Now turn the potentiometer to the full positive position, and slowly bring the anode coil nearer

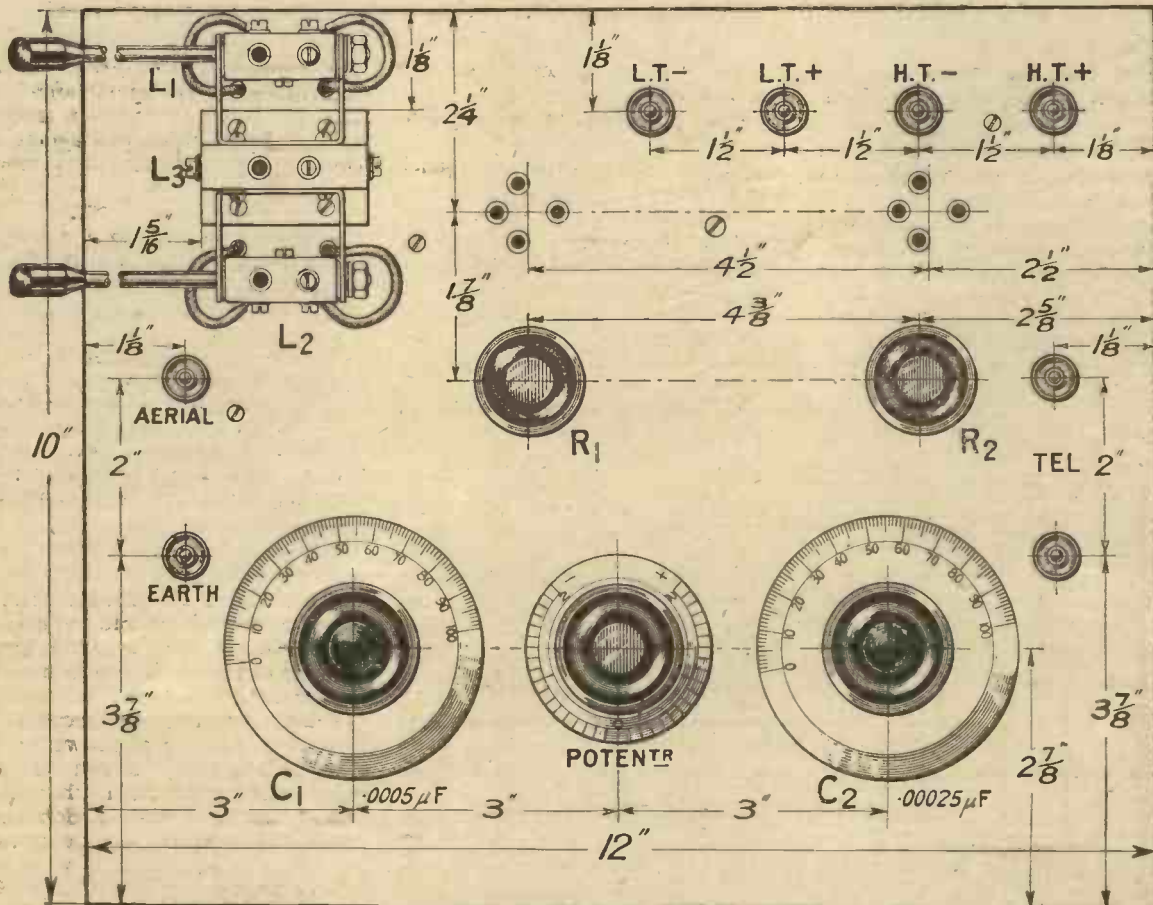

Fig. 2.—The necessary dimensions for drilling will be found above. Full size Blueprint No. C1018A may be obtained, price 1/6, post free.

to the reaction coil when the set should again show a tendency to oscillate; should it not do so, however, the two flexible connections to the anode coil should be reversed. With the anode coil in such a position that the set is well off the oscillating point, it may be found that by bringing the aerial coil nearer to the first the oscillating point will be again reached; should this not come about, however, then the connections to the aerial coil should be reversed.

Operation

In actual practice, that is, for the reception of the B.B.C. stations, exclusive of Chelmsford, a No. 35 or No. 50 coil is used in the aerial socket (according to individual aerial conditions), with a No. 50 or No. 75 for the anode, a No. 50 being used for the reaction coil; usually the smaller coils will be used for those stations with wavelengths between 300 and 400 metres, and the larger ones for wavelengths between 400 and 500 metres.

When tuning, the two moving coils should be well separated from the reaction coil, and the aerial condenser turned to its zero setting when the anode tuning condenser should be slowly turned from zero until the set is just near the oscillation point, with the potentiometer so adjusted that the set does not actually break into oscillation when the two circuits are in tune with each other. Now turn the potentiometer slightly in that direction which gives stability and adjust reaction by moving the anode coil nearer to the reaction coil, a finer adjustment of this operation being given by a further adjustment of

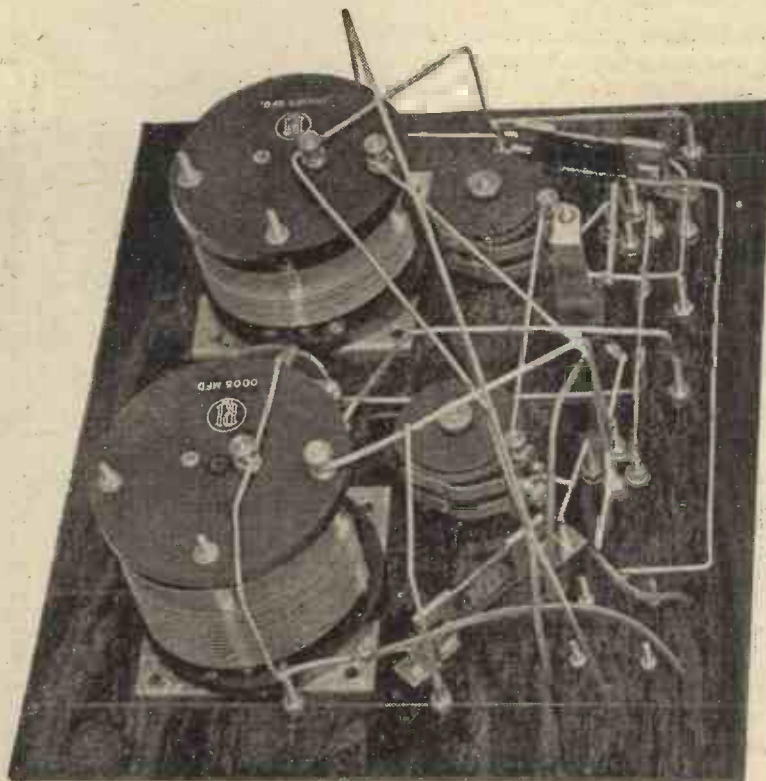

This close up view of the back of the panel will prove of assistance when wiring up.

the potentiometer. By gradually and carefully working round the scales of the condensers in this manner quite a number of stations will be picked up at good strength, and once the operation of the receiver is thoroughly mastered, with this form of reaction the anode coil may be set at right angles to the fixed coil, and the same performance gone through with the

aerial coil, though with this form of reaction extreme care is called for, otherwise considerable interference will result.

Retuning Necessary

It should be observed by the operator that the movement of either moving coil will necessitate a readjustment of the condenser in the same circuit in the following manner: Any variation of the coupling between the anode and reaction coils will necessitate retuning upon the anode condenser; similarly any variation of coupling between the aerial and reaction coils necessitates further adjustment of the aerial tuning condenser.

For the experienced operator who wishes to use double reaction, this is brought about by first adjusting one of the reaction coils to just below its maximum coupling, and then adjusting the second form for maximum results, not forgetting the potentiometer. In the present receiver it will be found easier if the anode reaction adjustment is made first, followed up by the adjustment of aerial reaction and readjustment of the condensers.

Long Wave Coils

For the reception of Chelmsford or Radio Paris, the operation is precisely the same as for the shorter

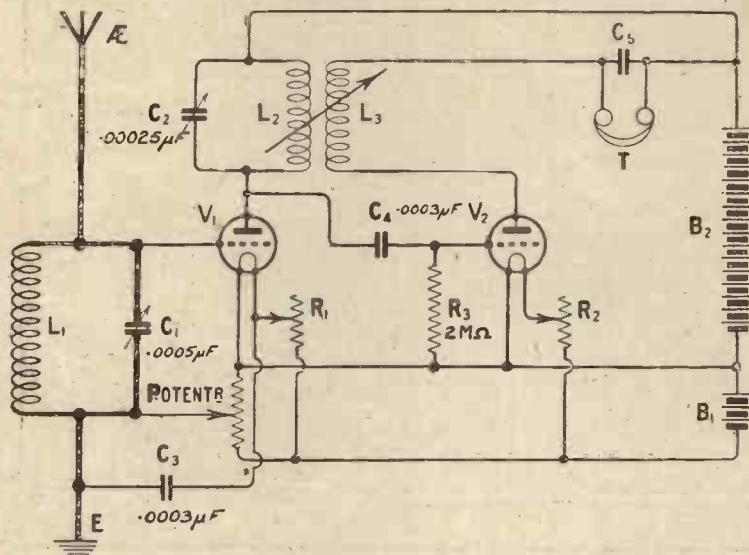

Fig. 3.—By coupling the anode coil to the reaction coil the above circuit is brought into use.

wave stations, but for these two stations the aerial coil should be a No. 150, the anode a No. 200, and a No. 100 for reaction. For the Eiffel Tower the aerial should be a No. 250, with Nos. 200 and 300 for reaction and anode coils respectively.

Potentiometer Control

Another interesting point which will appeal to the wireless experimenter is the fact that apart from the two methods of obtaining reaction described in the preceding paragraphs, there is still one other method by which a reaction effect may be obtained.

With the reaction coil short-circuited and the two moving coils well separated from each other, when the receiver is tuned in the manner previously described the set will either tend to oscillate or else actually oscillate (depending upon the position of the potentiometer slider then obtaining) when the aerial and anode circuits are brought into tune with each other. This condition, it will be remembered, may still be brought about even when the reaction coil is used.

Assuming that the aerial-earth system to which the receiver is connected is reasonably good, the fact that the aerial and anode circuits will oscillate when they are in tune with each other may be utilised to bring about a reaction effect which may be controlled by means of the potentiometer in much the same way as a fine adjustment of reaction is obtained when the coil L_3 is used.

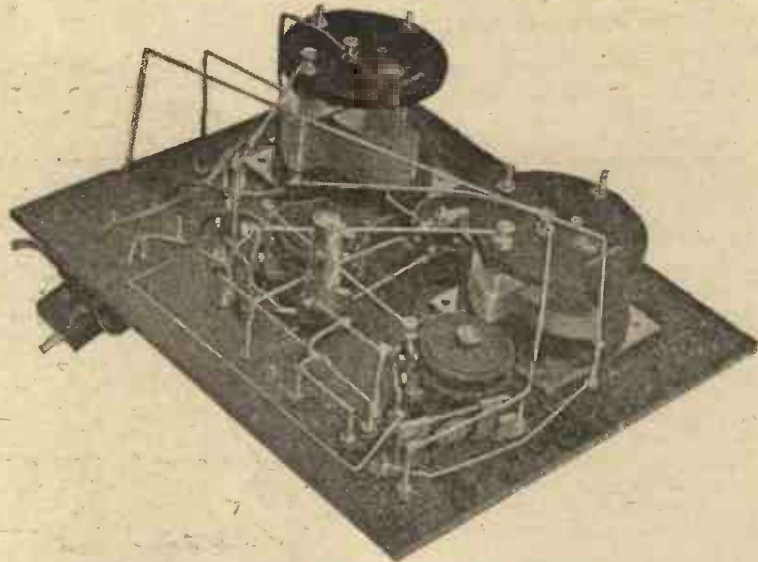

The wiring in the vicinity of the valve holders may be followed from this photograph.

Results Obtainable

Using the set as photographed, in South East London, good reception upon an indoor aerial is obtained from Birmingham, Newcastle, Bournemouth and a number of Continental stations, chief among which are the German stations. Radio Belgique and Radio Toulouse are received at excellent strength, whilst upon the longer wavelengths Chelmsford and Radio Paris are all that can be desired. The receiver is selective, and though quite a number of stations are received at good telephone strength there is

never sufficient volume to work a loud speaker satisfactorily, even though the station being received is the local one. This condition is, of course, due to the absence of any low-frequency amplification, and does not in any way reflect upon the circuit chosen. Should the constructor wish to work a loud speaker, however, then the addition of a single stage of note magnification will bring about the desired effect on the local station, a number of suitable magnifier units having been described in earlier issues.

To My Receiving Set

“Good-night! Good-night!” I
turn the rheostats,
I slip the headphones from my
eager ears,
And light my pipe again; Big Ben
has crashed
His notes of doom across the
dancers’ cheers.
“Good-night!” Good night indeed
it was for me;
From dusk until the midnight
chime rang out
You’ve charmed me, and the hours
have seemed to be
Fleet-footed, and have passed
with laugh and shout.

O, I am grateful to you, and the
brains

Of supermen, who gave their
toilsome days
To make it possible for me to hear,
Here, by my fire, the merry
songs and plays,
And speeches of the great; the
world that lies
Beyond this town, beyond this
sea-girt land,
Has sent me music, quicker than
the wind,
Because I turned a knob beneath
my hand!
And, up there in the blackness of
the night,
Stretches a single wire beneath
the sky,
Catching the flying music, Brahms,
Chopin,

Grieg, Liszt and Wagner’s swel-
ling melody.
I feel half sorry for you, so alone,
And yet, how can I sorry be,
for you
Have caught those glorious strains
the first of all,
And throbbled response as the
sweet music grew?
My friend, companion, link with
other climes,
I hail you as a blessing and a
boon;
I leave you with a little, faint
regret,
Knowing you’ll charm me yet
again, and soon.
You made me smile when I was
sad at heart,
You saved me from a melancholy
doom;
You gave me laughter, jesting,
and a sob—
You brought the Heart of Empire
to my room!
CHAS. P. CANDELAND.

WHEN OUR EDITOR RETURNS



P. W. H.—Meaning “Percy Will Hustle” !!!

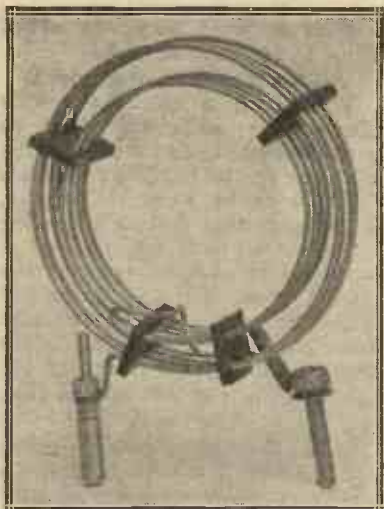

A well-designed form of low-loss inductance.

"LOW-LOSS" is rapidly becoming one of the hardest worked phrases in the wireless man's vocabulary, and signs are not lacking that its present vogue will be increased as British manufacturers extend the low-loss idea to more and more of the familiar types of components. The redesigning of many of our components with a view to a reduction in their losses is no doubt a commendable enterprise, and must result in increased efficiency in our sets, but a true sense of proportion must be retained in this connection, and probably the following elementary discussion of the points at which the principal losses occur in a wireless receiver and its associated equipment may be of use as showing which of the components and accessories are of the greatest importance from this point of view. A consideration of the sources of loss throughout a receiving installation should prove of considerable practical use, since it may in many cases lead the user to make efforts to minimise some of the losses which he at present tolerates.

The Aerial System

We will commence our considerations with a study of the aerial and earth system, since here the experimenter's own efforts will often lead to considerable improvement. We shall not here be considering the relative efficiencies of different aerials as collectors of energy, but rather the various sources of loss which reduce the energy after it has been picked up. Naturally, one of the first properties of an aerial which comes to mind is that of its degree of insulation,

Where are the Losses?

By G. P. KENDALL, B.Sc., Staff Editor

An interesting talk upon the sources of inefficiency in wireless receiving circuits

and it can be assumed that every possessor of an aerial knows that he must take real pains to make sure that his insulators really do *insulate* under all conditions of weather. The material of which insulators are made, of course, is decidedly important, and it is generally advised that those made of moulded ebonite or similar material should be regarded with suspicion for use in town atmospheres, since they are rather apt to form a film of conductive material when they become slightly corroded. In general, it is sound practice to use the porcelain type, preferably those whose shape is such that some part of their surface remains dry even during rain.

Dielectric Losses in Insulators

There are, however, other sources of loss connected with the insulators other than that of leakage through their substance or over their surface, and it is to these that I particularly desire to direct attention, since the other points are fairly well known to most experimenters. It should be remembered that the insulator at the end of the aerial really forms the dielectric of a condenser, of which the two "plates" are formed by the aerial wire, upon the one hand, and upon the semi-conductive halyard upon the other, it being assumed that the halyard has a more or less poor connection with earth. If the insulator is made of a material whose "dielectric losses" are somewhat high, there may be a quite appreciable loss of signal energy here. The losses which might take place here are rather of the order which the really keen experimenter likes to take into account, but which, nevertheless, cannot be regarded as being really heavy in nature. So long as a reasonably good insulator is used it may be assumed that these losses are fairly low, and for ordinary receiving purposes they certainly do not represent one of the main sources of loss in the equipment.

Reducing Aerial Losses

Those who are keen to reduce such losses as may take place in their insulators should remember that the longer the dielectric path the weaker the field through it, and therefore by using a number of insulators wired up in a chain the desired end can be achieved. Similarly, a good effect is produced by the use of an insulator consisting of a long and rather thin rod of suitable material, such as porcelain, although such insulators are not very easy to obtain at the present time. These remarks can, of course, be taken as generally applicable to the insulation of the whole aerial system, including the leading-in point, and it should not be forgotten that losses of a quite perceptible nature can occur if the leading-in tube is embedded in a large mass of poor dielectric material, such as a damp brick wall.

The Aerial Resistance

Turning to the actual conductor of which the aerial is composed, we must take a general view of the "high-frequency resistance" of the whole system. I should perhaps explain at this point that the high frequency resistance of an aerial is by no means the same thing as the resistance measured in ohms which it opposes to the flow of a direct current from the furthest point down to the earth connection. The high-frequency resistance is equivalent to the figure which would be obtained if the measurement could be carried out with high-frequency current, and this would take into account a great number of factors, such as the losses in the insulators which we have been considering, the energy lost by radiation from the aerial, and so on. When we are considering the wire from which the aerial is composed, however, we must bear in mind that the high-frequency resistance is governed largely by the material of which it is composed, and of the surface available for the currents to flow upon, it being remembered that high-

frequency currents confine themselves chiefly to the surface of the conductor.

Aerial Wire

The material used for the aerial conductor is at the present time almost invariably either copper or phosphor-bronze, and both these materials possess a high conductivity. Obviously, what we require is a conductor possessing a large surface, and for many years it has been more or less standard practice to use a multiple strand cable, consisting usually of seven wires of moderate gauge (say, No. 24 or 22) twisted together, and possibly enamel covered. The high-frequency resistance of the resulting conductor is reasonably low; but it is sometimes thought that a considerable increase in efficiency could be obtained by the use of a very much larger surface, such as that obtained by the use of a broad metal tape; as a matter of fact, by the time one has arrived at the surface area given by 7/22 cable, further increases do not seem to produce a really marked increase in efficiency, apparently because the resistance of 7/22 is so low that a further reduction produces an effect which is more or less swamped by the other higher resistances in the aerial circuit, of which the earth resistance is one of the more important ones.

It may, therefore, be taken as a fairly safe rule that by the time one has achieved the fairly low resistance given by 7/22 copper or phosphor-bronze wire for the aerial, the remaining resistance loss is fairly low by comparison with that which is taking place at other points in the circuit. An example will perhaps make this point clear. There may be in the aerial some 100 ft. or so of 7/22 copper wire, and connected in series with this at its lower end is a tuning coil, in which there may be as much as 40 ft. of wire consisting of a single strand of, perhaps, No. 28 gauge. Moreover, by the time the wire has been coiled up to form an inductance its resistance will be many times higher than the same length of wire stretched out in a straight line, and thus it will be seen that the resistance of this coil is so high that it has largely swamped that of the aerial.

Importance of Coils

This little example will at once emphasize the importance of the tuning coil as a constituent of the aerial circuit, and here any develop-

ments which can rightly be described as "low-loss" are sure of an instant welcome from the more discriminating experimenter. Here are some of the things which should be present in a good, low-loss coil design: One of the foremost essentials is that there should be considerable spacing between the various turns which constitute the winding, and when this is present a reasonably thick gauge of wire is desirable, although it must not be assumed that the mere use of thick wire constitutes the winding a low-loss one. It is quite possible for a coil to be wound with thick wire and yet possess only a very slight advantage in high-frequency

wire, with the turns spaced out slightly so that they run about 12 or 15 to the inch.

A Standard for Comparison

With such a coil the results obtained are sufficiently good to provide a real basis for comparison with any special low-loss specimens which may be available, and it is probable that further reduction of the losses will not produce a very material improvement in the results, since the high-frequency resistance of the coil has already been reduced to such dimensions that it would count as one of the smaller factors in the aerial circuit.

The Earth

When the resistance of a tuning coil has been reduced to such a value as we have just been considering, it is evident that it is time to turn our attention to other parts of the circuit, and we come next to the earth connection, which undoubtedly represents one of the more serious sources of energy loss. As a matter of fact, the high-frequency resistance of a bad earth is often so great that it will completely mask the effects of different types of tuning coils and so on, and it must undoubtedly be reckoned as one of the more serious points to which attention should be directed. I think that the general reader will be familiar with the desirable features in a good earth connection, and I only wish to make plain the relative

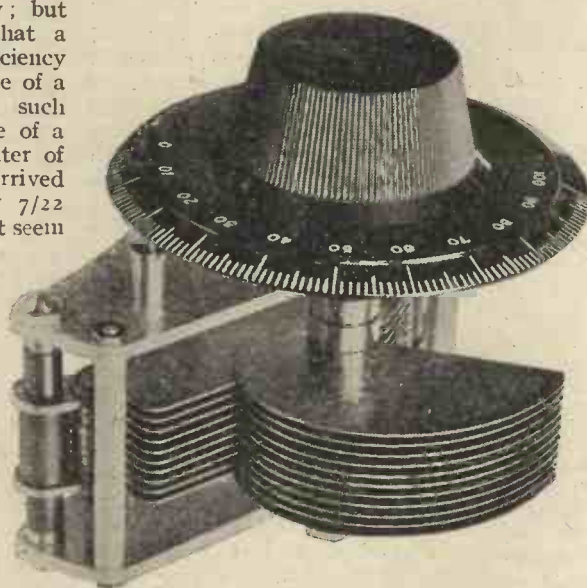

A modern type of low-loss variable condenser.

importance of this particular part of the installation. I will merely content myself with reminding the reader that the most important factor is that the earth connection shall make contact with a large area of damp soil as close to the down lead end of the aerial as possible.

importance of this particular part of the installation. I will merely content myself with reminding the reader that the most important factor is that the earth connection shall make contact with a large area of damp soil as close to the down lead end of the aerial as possible.

The Position of the Earth

I think it may safely be assumed that everyone is familiar with the undesirable effect of a long earth lead, but I do not think that it is equally safe to assume that all readers are aware that an earth connection should usually be located in some definite relation to the position of the aerial. I have known more than one case in which poor results were obtained from an earth connection which seemed to be good in every way, but which was located some considerable distance away from the aerial, and was connected by means of a

resistance as compared with one in which quite a thin gauge of wire has been used.

Minimum of Insulating Material

Another desirable feature is that the amount of dielectric material (*i.e.*, insulating substance) used in the supporting of the winding and the general construction of the coil should be as small as possible, since the losses introduced by including dielectric material in the field of the coil may be moderately serious. No doubt we shall see numerous new types of winding put out with claims as to their low-loss properties, but in the present state of development of the tuning coil it may be interesting to note that something approaching the maximum results can be obtained by the use of a winding supported upon a skeleton former composed of six ebonite rods fixed between ebonite end rings, the winding consisting of the requisite number of turns of No. 18 enamelled

moderately long earth lead to the set. The use of a similar earth connection immediately beneath the aerial, connected by an earth lead of similar length, gave much improved results.

Condenser Losses

The other important component in the aerial circuit is the variable condenser employed for tuning purposes, and it may perhaps be as well to get some idea of the relative importance of the losses which are normal in this component. The variable condenser appears to have been one of the first components to be re-designed along lines which could be described as low-loss, and we are hearing a great deal at the present time of new condensers in which certain types of losses have been considerably reduced, and one is apt to gather the impression that these losses are a very large proportion of the total in the tuned circuits.

Careful attention has been directed by manufacturers to the fact that considerable losses may occur in the insulating materials used to separate the fixed and moving plates, these losses being of the type commonly called "dielectric losses." Various designs are appearing in which the amount of insulating material has been reduced to quite small proportions, so arranged that the amount of the field which passes through them is relatively small. No doubt the improvement in efficiency thereby produced is worthy of consideration, but it is well to preserve a sense of proportion in this matter, and not to assume that very startling improvements in reception will result.

Research in America

Some very important work upon the actual magnitude of the losses in variable condensers has been done in the United States by Mr. Sylvan Harris, and his results seem to show that in most condensers of reasonably good design and workmanship, the losses are not so large that the condenser deserves to be classed as a really very serious source of loss in the tuned circuits.

The work of Mr. Sylvan Harris would seem to indicate that the high-frequency resistance of the condenser is more closely connected with skin effects in the distribution of the high-frequency currents than has been quite realised, and this of course may not be affected by changes of dielectric arrangement.

We therefore arrive at the conclusion that, although improve-

ments in condenser design deserve every encouragement, we must not expect to double our signal strength by the mere substitution of some new low-loss condenser for one of our old ones. It is pointed out by Mr. Sylvan Harris that the high-frequency resistance of a good variable condenser is probably so low as to be scarcely worthy of consideration beside that of one of the ordinary types of tuning coil. It is assumed in making these generalisations, of course, that we are considering only the good types of variable condenser, in which the features of perfect insulation between plates, really good contact upon the moving spindle, and so on, are present.

An Example

In the tuned circuits of the receiver other than the aerial circuit, such as tuned anodes, &c.,

Improvements Desired

It follows, therefore, that real improvements in tuning coils would be welcomed with much greater eagerness than those which are taking place in tuning condensers, and this applies to such details of coil construction as the method of mounting upon plugs, the type of impregnation used against damp, and so on, since both these points may represent some of the quite perceptible losses in a coil. However, it is not within the province of this article to go into the technical details of what constitutes a really low-loss coil, but merely to indicate the relative sources of loss in the complete equipment.

Other Components

Certain of the components which are related to the tuned circuits in a set are worthy of some consideration as possible causes of



A group of aerial insulators. It is important that the aerial shall be well insulated.

it may be accepted as a fairly definite rule that, although improvements in condenser design are most decidedly to be welcomed, yet the reduction in losses in an already moderately efficient piece of apparatus, must not be expected to yield really striking results, unless the losses at other points are also reduced to such a point that the condenser becomes proportionately a more serious source of loss. For example, if the high-frequency resistance of a variable condenser is reduced from 3 ohms to 2 ohms, while the resistance of the tuning coil remains at 30 or 40 ohms, little improvement will be observed. If, however, the resistance of our tuning coil can be reduced to something equivalent to the resistance of the variable condenser, improvements in the latter component will begin to assume a much greater importance.

loss, and as an example I would cite the average valve socket. It must be remembered that the grid and filament of the first valve are connected across the tuned circuit of the receiving set, and form in effect another possible source of loss such as that which is provided by the dielectric material in the tuning condenser. For example, if a valve socket is constructed of some poor insulating material, which is inefficient either from the point of view of ordinary insulation resistance or dielectric losses, and it is connected across a tuned circuit, quite appreciable losses may result.

It may thus be seen that a good low capacity valve socket serves another useful purpose besides the obvious one of reducing the tendency to self-oscillation on the part of a high-frequency valve,

(Continued on p. 925.)

The Editor's Experiences in America



The Studio at WAHG

THE preliminary reports received from Mr. Harris since his arrival in America indicate clearly that he is having an even more strenuous and crowded time than was anticipated, and as a preliminary to full accounts from his own pen, it is thought that a condensed description of his experiences up to date will be of interest to the readers of the magazine of which he is the Editor.

Mr. Harris's arrival in New York took place some eighteen hours after the schedule time, since the "Berengaria" had been delayed by bad conditions and a good deal of fog upon the trip. He reports little of interest regarding the voyage itself, but readers of this journal will not be surprised to learn that he rigged up a short-wave receiver for use on the way across, with which he was able to log a number of British experimental transmitters for a considerable part of the crossing.

The heat wave which has held New York practically ever since Mr. Harris arrived was just beginning when he landed, and he appears to have found the sudden heat very trying; so it was perhaps fortunate that his first two days (Saturday and Sunday) were of necessity devoted to a more or less leisurely investigation

of the windows of the radio stores of New York, with a view to the acquisition of useful information regarding the components and sets in greatest demand.

A Dinner at the Harvard Club

One of the more important events of Mr. Harris's first week of investigation in New York was a dinner given in his honour by the leading wireless writers and editors at the Harvard Club, and a photograph is reproduced herewith which was taken upon the occasion of this dinner. Mr. Harris will be seen at the head of the table, and, reading from the head towards the front of the picture, upon the reader's left hand side will be seen the following gentlemen:—

- Mr. Casem (*New York Telegram*).
- Mr. Paul McGinnis (*New York Journal*).
- Mr. Roe (*Radio News*).
- Mr. Arthur H. Lynch (*Radio Broadcast*).
- Mr. W. C. Alley (*Radio Retailing*).
- Mr. M. Clements (*Radio Retailing*).
- Mr. A. E. DeLacy (*Popular Radio*).
- Mr. L. M. Cockaday (*Popular Radio*).

While upon the right, and reading in the same direction, the following is the key to those present:—

- Mr. H. C. Bodman (*Radio Merchandising*).

A summary is given on these pages of the activities of the early part of the visit of Mr. Harris to the United States, pending the publication of his own accounts

Mr. M. B. Sleeper (*R. & M. Engineering*).

Mr. Nixon (*Radio Dealer*).

Mr. Paul C. Oscanyon (*Amateur Radio*).

Mr. Ch. H. Albrecht (*New York Graphic*).

Mr. Bragdon (*New York Sun*).

Mr. Sylvan Harris (*Radio News*).

An Enthusiastic Reception

The enthusiastic welcome for which the American wireless man is so famous is evidently being extended to Mr. Harris wherever he goes, and much of his first week appears to have been devoted to meeting well-known radio authorities, with whom he spent much time in discussing the salient features of American radio conditions, as a preliminary to his more detailed investigations. The first to claim his attention were such problems as the question of the amount of home construction which is done by the American wireless enthusiast, the type of set which he builds, the most popular types of components, and so on.

While his headquarters were still located in New York, the Editor spent a day upon a visit to Philadelphia, where he had the opportunity of going over the factory of Messrs. Attwater-Kent, who are among the principal manufacturers of receiving sets in the United States. His impressions at this point should be of particular interest in view of the fact that we are being informed from very many quarters of extraordinary drops in the prices of American ready-built sets, and a particular value attaches to information regarding the production methods of the American manufacturers.

Receiving Conditions

Besides his general enquiries into such points as we have been considering, it is gathered from Mr. Harris's reports that he is devoting a very great deal of attention to actual receiving conditions in America as regards the conditions governing long-distance reception, the interference problem, the oscillation nuisance, and so on. This, of course, is one of the most important aspects of Mr. Harris's investigations, and it is gathered that he has spent long periods in listening-in in a variety of localities, ranging from some only nine or ten miles out from New York to others thirty miles out; and he states that he has tried a great variety of different receivers, including neutrodynes of various types, and, of course, super-heterodynes, as well as simpler sets. A good deal of this listening-in has been done upon Long Island, where Mr. Harris spent his second week-end after arrival, and where he was given some valuable facilities by Messrs. A. H. Grebe, whose factory is located in Richmond Hill, Long Island, and whose name is so well known to the more advanced British experimenters as the designers of highly efficient short-wave receivers.

The conclusions at which Mr. Harris is arriving will no doubt be made public in due course in articles which he will write as soon as he feels that his impressions have reached a final form, but meanwhile it is apparent from his letters that he is arriving at some very remarkable views regarding the selectivity question, and also of the problem of the oscillating receiver and the extent to which that serious nuisance has been eliminated in the United States.

A Visit to WAHG

In the course of his stay upon Long Island, and during certain preliminary visits which he made before his week-end stop, Mr. Harris was given some valuable opportunities of testing a number of the sets produced by Messrs. A. H. Grebe, and during one of these visits he spoke from the Grebe broadcasting Station, WAHG. It would seem that his speech was made the occasion for a good deal of ceremonial, and an amusing episode took place in the presentation to him by the President of the firm of a "radio cake" of truly impressive dimensions.

Immediately after Mr. Harris had given his talk, the announcer of the station went on to explain to listeners what was taking place in the studio, since the presentation

of the cake followed at once. The announcer referred to the cake as being as large as a tub, covered with frosting, and bearing the British and American flags, and bearing an inscription: "To Percy Harris, leading Broadcast Authority of the British Empire, from WAHG." The announcer stated that the cake contained sixteen ingredients, all of which were closely connected with radio, so that we are left somewhat in doubt as to whether it was indeed edible or not, but it is hoped that the question will be settled by the arrival of the cake itself in London at an early date.

A few days before Mr. Harris actually spoke from this station, the authorities of WAHG distributed the usual matter known as "advance publicity" to the American Press. This notice was much more accurate than most of the matter which is appearing in the American daily Press regarding Mr. Harris, and gave an explanation of his position as Editor of

this journal and designer of so many of the home-constructed British receiving sets.

Broadcasting from WAHG

The actual talk given by Mr. Harris by way of WAHG was given the title of "Radio from an English Point of View," and in the course of his remarks he gave a general account of the British broadcasting system, with the scheme of main and relay stations, and explained the arrangement of programmes with the system of simultaneous broadcasting used for certain parts of them. He went on to describe the British licensing system, the position of the B.B.C., the trouble which we are experiencing in this country from the problem of the oscillating receiver, and so on.

Another broadcasting station visited by Mr. Harris during his first stay in New York was the one which is so familiar to all British listeners who have taken an interest in transatlantic reception—namely, that old friend WJZ



The Editor receiving the cake from Mr. A. H. Grebe (Right).

Here he writes appreciatively of the great freedom which he was given to see whatever he pleased anywhere in the station, as a result of which detailed investigation he gained the impression that

its regular service. Mr. Harris was shown over the station by the courtesy of *Radio News*, and he reports that it is a typical standard Western Electric broadcasting outfit, giving the usual range of

movements we depend upon information contained in cables. Up to the time when this number of **THE WIRELESS CONSTRUCTOR** went to press it was learnt that he had left New York for Washington, and here he visited the Bureau of Standards, where he met Dr. L. W. Austin and Dr. J. H. Dellinger, but details are lacking as to what transpired at the interviews.

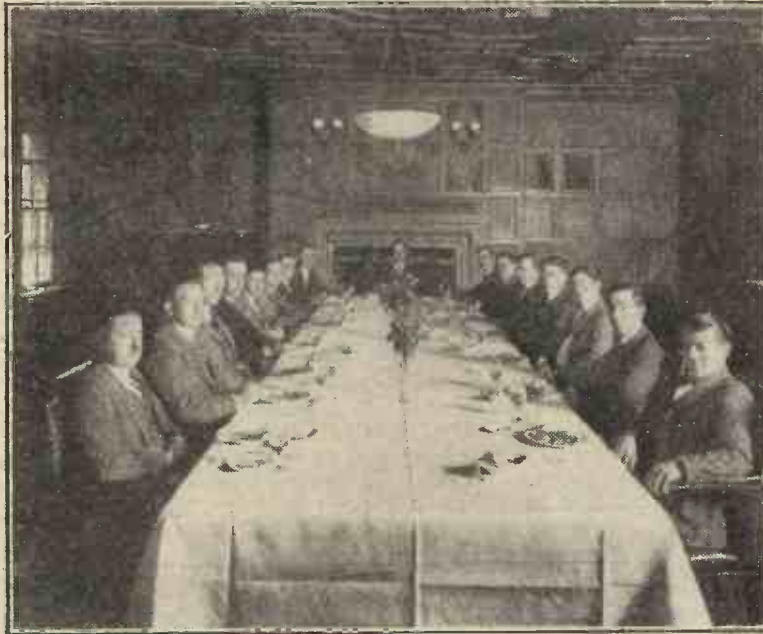

The dinner at the Harvard Club. The Editor may be seen at the head of the table.

WJZ was a particularly well-equipped station, and he seems to have been specially impressed by the fact that the modulation was continually checked with the aid of an oscillograph. He further remarks that the influence of WJZ upon the pronunciation of its listeners is well understood and realised by the authorities who direct its activities, and all the announcers employed at the station are University men.

Another visit which he paid towards the end of his first week was to the laboratory and experimental station belonging to the well-known American wireless magazine, *Radio Broadcast*, which is situated at Garden City, Long Island. The result of this visit should be some particularly interesting impressions, since in the laboratories belonging to *Radio Broadcast* are prepared some of the best of the American designs for the home constructor.

A Standard Broadcasting Installation

The next visit paid by Mr. Harris to the establishment of an American wireless magazine was to the new broadcasting station of the *Radio News*, to which the call sign WRNY has been allotted, and which is shortly to commence

power between 500 and 1,000 watts; but, of course, at the time at which he was present the official opening had not taken place.

A Visit to NKF

Here, too, he visited the Government experimental station, NKF, which is familiar to many short-wave enthusiasts, since it carries out transmissions in the neighbourhood of 20, 40 and 70 metres, and it is hoped that as a result of Mr. Harris's visit a regular schedule of experimental transmissions in which British listeners will be invited to co-operate will be arranged. Further details of these tests, it is hoped, will be announced at an early date, and they will be of particular interest in view of the fact that they can be carried out during the summer and many of the experiments upon the .20-metre wavelength may be carried out during daylight.

Mr. Harris reports that during his visit to NKF Dr. Taylor, who is the chief of the U.S. Naval Radio Laboratory, laid much stress upon the importance of the amateur experimenter in these short wave tests. He was particularly anxious



The Control Room at WAHG. The Western Electric microphone will be recognised, as will the Grebe receiver.

The details which have just been given were all communicated by Mr. Harris in the course of various letters, and for details of his later

reports upon the two shorter waves and expressed willingness to arrange schedules to suit British listeners.

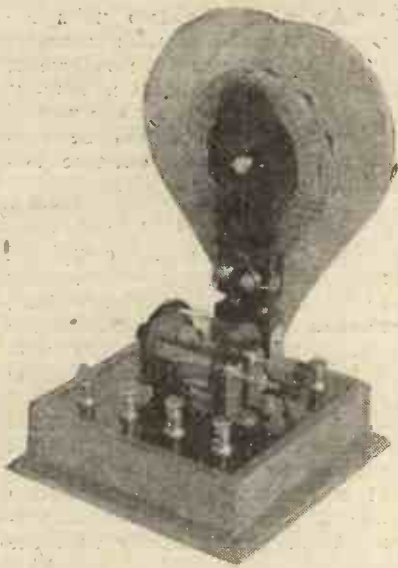

Tuning is effected by moving one or both of the copper plates.

THE receiver about to be described in this article is particularly simple in design, and may be constructed at a minimum of expense, although it is in every way efficient for local reception or for reception of 5XX. Direct coupling only is employed, for which purpose plug-in coils of a suitable size are used. The method of tuning is somewhat unusual, as the variable condenser is dispensed with and two large movable copper plates are used in its stead. These plates operate within the vicinity

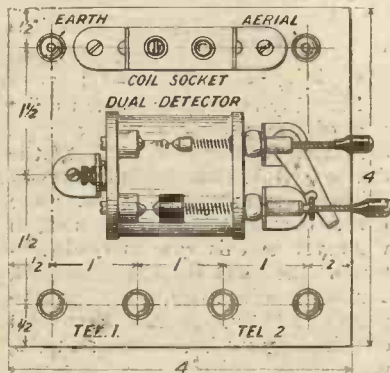

Fig. 1.—Showing how the panel is drilled.

of the magnetic field of the plug-in coil, and are electrically connected across the coil in a similar manner to that in which a variable condenser would be connected. A brief description is also given in this article explaining how eddy-current, or spade tuning, may be employed in place of the condenser arrange-

A Simple Adaptable Crystal Receiver

By H. BRAMFORD

A compact set which may be used either with perikon or catwhisker detector, and which may be adapted to eddy-current tuning

ment, in this case only one plate being necessary. Both methods described are efficient in practice, and the expense of a variable condenser is eliminated.

Materials Required

- One piece of ebonite, measuring 4 in. by 4 in. by 1/4 in. or 3/8 in.
- Four telephone terminals (K. Raymond).

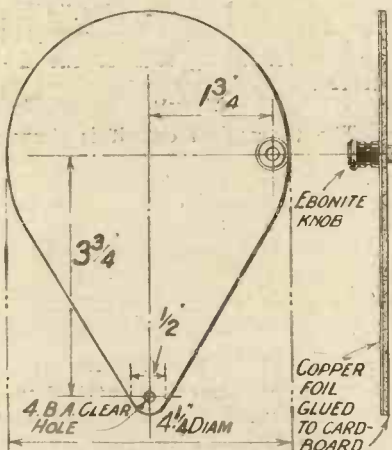

Fig. 2.—The construction of the copper plates.

- Two small pillar terminals (K. Raymond).
- One coil socket (K. Raymond).
- One basket coil adaptor (K. Raymond).
- One set of basket coils (Ledion).
- One dual crystal detector (Phillips).
- Small quantity of sheet copper.
- Wood for box.
- Set of Radio Press Panel Transfers.
- Wire for connections.

Panel Drilling

Full details of the panel drilling, together with dimensions, are shown in Fig. 1. A 4BA clearing drill is used for the holes to receive the terminals, likewise the holes for the detector mountings. If a different type of detector is used, holes should be made as required.

The coil socket in this instance is mounted by means of two 4BA screws and nuts, which secure the coil socket side brackets to the panel. If the coil socket is not provided with side brackets, it is only necessary to pass a 4BA screw through the panel into a hole tapped centrally on the under face of the socket.

Assembly

The assembly of the front of the panel is also shown in Fig. 1. First mount upon the panel the pillar terminals (aerial and earth), next the four telephone terminals (Tel. 1, Tel. 2). The detector is mounted in the usual manner, it being recommended, however, that the glass be kept in a safe place until the set is completed. The coil socket should not be mounted until it is prepared for the assembly of the tuning plates.

Two copper plates should be made as shown in Fig. 2. If the sheet copper used is particularly thin, the plates, when cut, should be mounted by means of glue upon cardboard plates cut to a

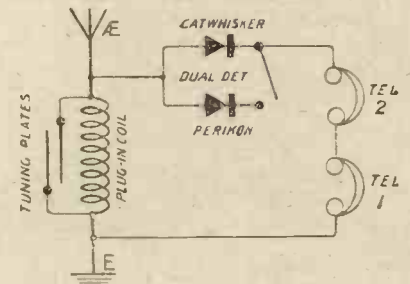

Fig. 3.—The circuit diagram, showing the connections to the tuning plates.

similar shape. A pivot hole is drilled at the apex of each plate to clear a 4BA screw. A further 4BA clearing hole is also drilled in each plate to accommodate a screw which secures a small ebonite knob. The two plates may be clamped together for purposes of accurate drilling.

Next make the necessary drillings in the coil socket, as shown in Fig. 4. Two 4BA tapped holes are drilled $\frac{1}{8}$ in. apart to make contact with the pin and socket respectively. A 4BA clearing hole is also drilled centrally in the side face of the coil socket to provide a means of experimenting with the spade-tuning method described later.

Further Details

Having prepared the plates and the coil socket, the three articles are assembled, as is also shown in Fig. 4. A spring washer should be interposed between the coil socket and the plate in each case to ensure a smooth taut movement. The outer plate is spaced at a clearing distance from the inner plate by means of spacer washer. The inner plate may also be spaced

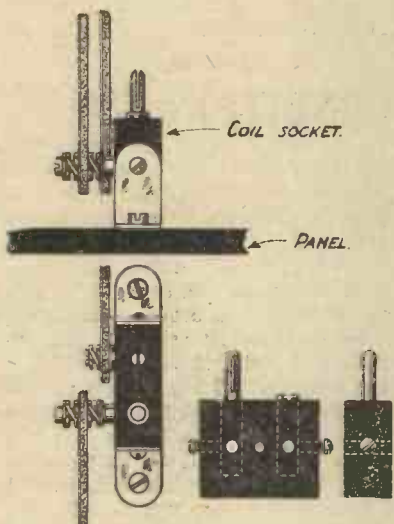

Fig. 4.—How the plates are assembled to the coil socket.

at a little distance from the coil socket in a similar manner to ensure that the plates clear the plug-in coil when in action. Care must be made to see that electrical contact has been made between the plate and the socket connecting screw. This may easily be done by means of a battery and flash-lamp. Place one tag of the battery on the plate pivot screw, the other battery tag on the outer rim of the flashlamp bulb, and the under contact of the bulb on the socket connecting screw. If the bulb lights up, contact is O.K.

Wiring

Details of the wiring on the back of the panel are given in Fig. 5. Join one of the socket's connecting screws to the aerial terminal and pass from this point

to the catwhisker side of the detector. The other coil socket connecting screw joins the earth terminal, passing from this point to one of the terminals "Tel. 1." If the coil

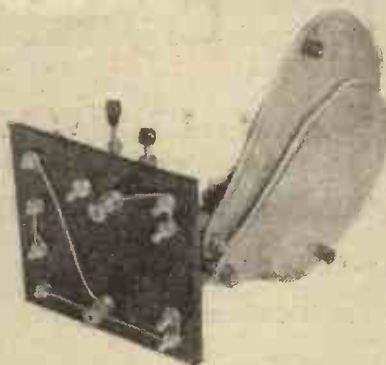

Wiring is very simple.

socket is provided with brass side brackets, these afford a method of connection as shown. The remaining "Tel. 1" terminal is connected to one side of "Tel. 2." The other side of "Tel. 2" is connected to the remaining side of the detector.

Circuit

The theoretical circuit is shown in Fig. 3. The connecting link across the detector provides a means of bringing the catwhisker or perikon into operation at will. When the perikon detector is in operation it is necessary that the catwhisker be lifted from contact with its crystal.

Two Pairs of Phones

The arrangement of the telephone terminals "Tel. 1" and "Tel. 2" permits of two pairs of telephones being

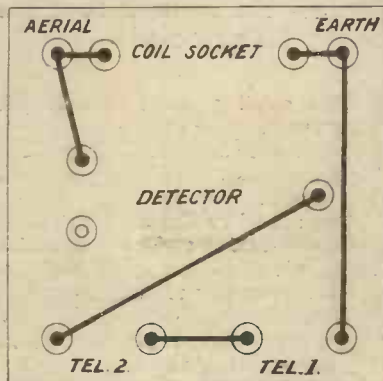

Fig. 5.—If one pair of telephones only is used, the tags are inserted in the extreme terminals.

used in series when desired. This method is distinctly advantageous when the phones differ considerably in the matter of resistance, for, in these circumstances uneven distribution of the phone current

results when the two pairs are placed in parallel, with a consequent difference in the volume of sound obtained with each. When it is desired to use only one pair of telephones, these should be connected to the two extreme terminals of the row.

Operation

The operation of the completed receiver is extremely simple. For reception from the local station, plug in a suitable coil having the tuning plates set at the greatest distance from each other. Having adjusted the detector, move the inner plate towards the coil until signals are at their loudest, then proceed to move the outer plate in a similar manner to obtain fine adjustment. Some experiment may be necessary with the

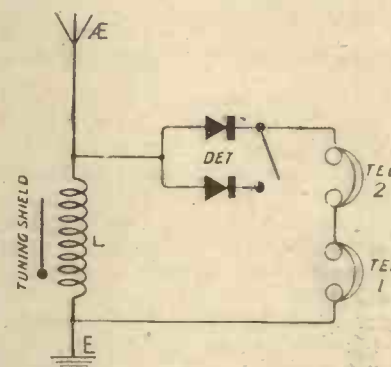

Fig. 6.—One copper plate may be used to employ eddy-current tuning.

size of plug-in coil used, no fixed rule being possible. For reception of 5XX coils ranging from 150 to 250 should be tried.

Eddy-Current Tuning

For eddy-current or spade tuning one of the copper plates only is attached to the coil socket, the centre 4 B.A. clearing hole already drilled therein acting as the plate pivot bearing. No connection whatever in this case is made between the shield and the coil. Tuning is effected by moving the plate radially. A theoretical circuit diagram is shown in Fig. 6, where the tuning shield is represented as an independent factor.

Test Report

The set was tested upon a 40 ft. twin aerial 28 ft. high, screened by houses at a distance of $4\frac{1}{2}$ miles east of 2LO. Using a No. 50 coil for reception of the local broadcasting station (2LO), signals were excellent. On plugging in a 200 home-wound coil, Chelmsford (5XX) was received at good strength, speech being easily readable.

LISSENIUM

PARTS *for* PORTABLE SETS

should be



**SMALL IN SIZE
HIGHLY EFFICIENT
THOROUGHLY DEPENDABLE**



and

EASILY MOUNTED

LISSEN PARTS FULFIL ALL THESE CONDITIONS



THE LISSEN MK. 2, MICA VARIABLE CONDENSER is only one inch deep under panel, although it has a maximum capacity of over '001 mfd. The capacity variation is so gradual that a separate vernier is quite unnecessary.

THE LISSENSTAT MINOR is only half inch in diameter and the LISSENSTAT MAJOR one inch. Both are suitable for the control of 'bright or dull emitters' and enable valves to operate with extraordinary efficiency.

THE LISSEN SWITCHES take up but an inch of space and each is as efficient as it is possible for a small switch to be.



*Other LISSEN Parts are equally suitable for portable sets.
Their efficiency is unequalled.*

The majority are mounted by the LISSEN one-hole fixing method.

If you would like to know more about LISSEN PARTS, please send for copy of TEXT BOOK, free to readers of this magazine.

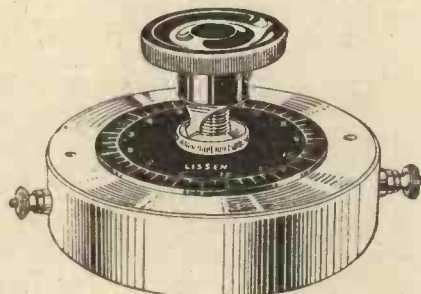

BUILD WITH ALL LISSEN PARTS—there is one for every vital place, and your receiver will give results which would never be possible with mixed parts.

LISSEN LIMITED

LISSENIUM WORKS, 30-32 FRIARS LANE, RICHMOND, SURREY

'Phone: RICHMOND 2285 (4 lines).

Telegrams: "LISSENIUM, LONDON."

LISSEN PARTS — WELL-THOUGHT OUT, THEN WELL MADE

Brandes

The name to know in Radio

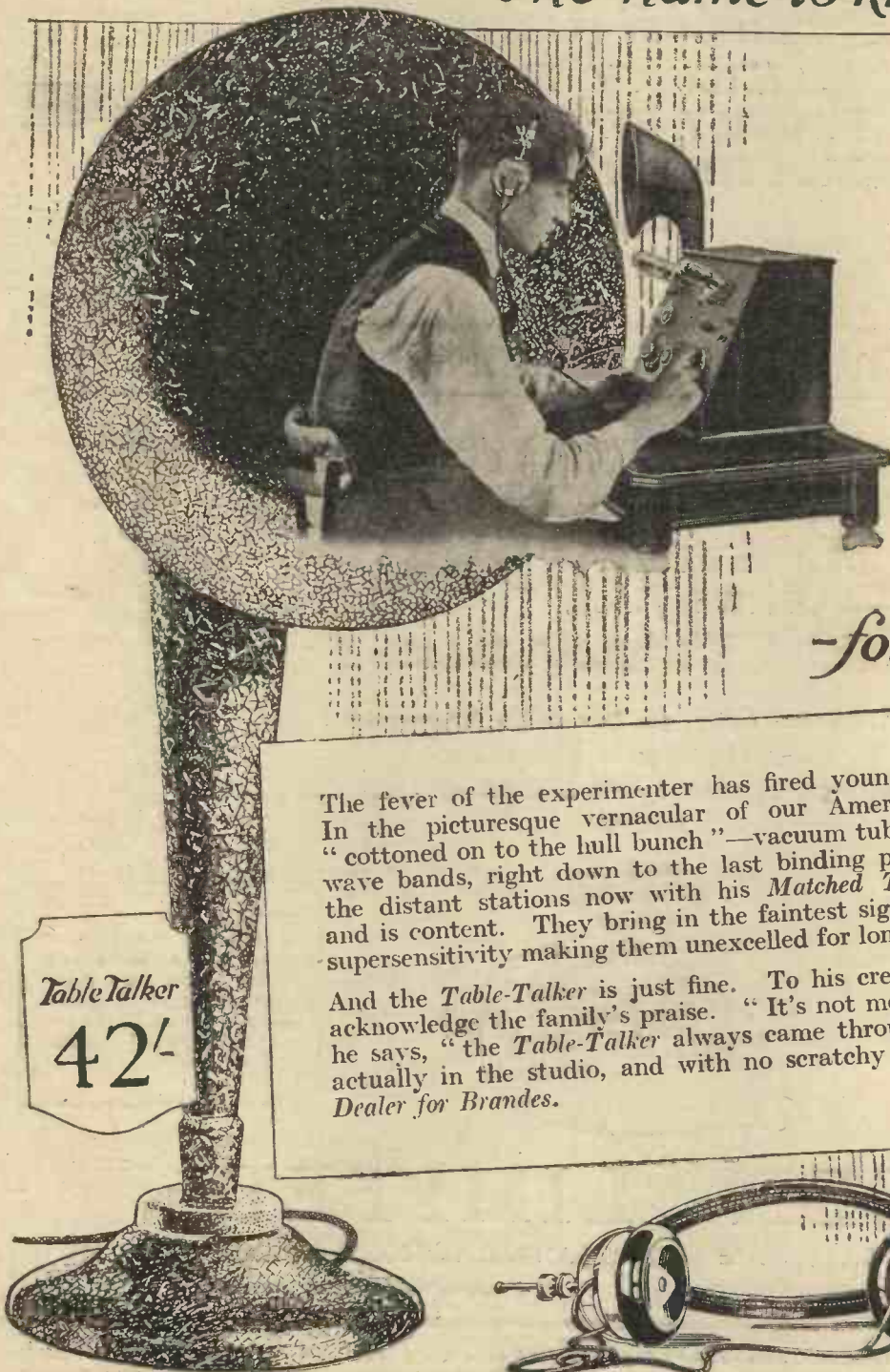

All Brandes products carry our official money-back guarantee, enabling you to return them within 10 days if dissatisfied. This really constitutes a free trial. Brit. Manuf. (B.B.C. Stamp)

BRANDES LIMITED,
296, Regent Street, W.1.
Works: Slough, Bucks.

-for Young Bill

The fever of the experimenter has fired young Bill's ambition. In the picturesque vernacular of our American friends he's "cottoned on to the hull bunch"—vacuum tubes, hook-ups, new wave bands, right down to the last binding post. He tunes in the distant stations now with his *Matched Tone* Headphones, and is content. They bring in the faintest signals, their delicate supersensitivity making them unexcelled for long range telephony.

And the *Table-Talker* is just fine. To his credit, Bill refuses to acknowledge the family's praise. "It's not me tinkering about," he says, "the *Table-Talker* always came through as if you were actually in the studio, and with no scratchy notes." Ask your Dealer for Brandes.

Table Talker
42/-

Matched Tone
Headphones
20/-

Tuning Made Easy

HINTS BY OUR IRRESPONSIBLE EXPERT

THE panel of a wireless set consists of a plane surface largely covered with knobs and other excrescences. The function of a knob is obviously to be either pulled (as in the case of a door bell or an organ stop), or twiddled (as in the case of gramophone speed regulators and of omnibus conductors' ticket punches). To understand thoroughly the great question of tuning we must discover first of all which knobs in the wireless set fall into category A, the pushed; and which are to be classed in

purpose. I have worked out a short course of physical exercises which may be performed in bed, bath, bus, train, tram or office, to the immense benefit of the wireless amateur.

Extra Hands

It must be realised that since a large set contains more than two knobs, the single pair of hands provided by nature is quite insufficient for the enthusiast's needs. So far, no method of growing a second pair has been discovered by science, though I have no doubt that as time goes on the defect may be remedied by a grafting process performed during infancy. As matters stand, all that we can do is to take a lesson from the lower animals. What does an ape do when he wishes to remove your hat or your pipe as you stand watching him when both his hands are engaged in holding on to a rope or a branch? He merely stretches out a foot and executes his purpose with neatness and despatch. Very well then. Like the apes, we human beings are fitted with a perfectly good pair of feet, and all that we need do is to learn how to use them. All real wireless men have done this. Have you not seen many references in accounts of long-distance reception to Mr. So-and-so's splendid feat? The spelling mistake is intentional, and has hitherto misled the world, as it was intended to do. The big guns of wireless have always kept as a jealously guarded secret the conversion of their lower extremities from mere beetle crushers into perfect knob twiddlers. This secret I now reveal, thus opening for you the path to glory.

labelled hot. Having taken up the correct position, with the knees straight, give a quick turn to each tap. A stream of boiling water will now descend upon the left foot, and the physical jerker will leap into the air with a scream. He has learnt his first lesson: knobs are twiddled in order to produce screams. The process should be repeated at least twenty times, the foot which receives the hot water being changed from time to time, either by crossing the legs or by standing with one's back to the taps and turning the feet so



What does an ape do?

category B, the twiddled. Matters will be made quite easy by reference to the following little table:—

Table of Wireless Knobs.

Category A— Push knobs	None
Category B— Twiddle knobs	The Rest

Having carefully examined this helpful little table and digested its contents, you will be able to deduce that all the knobs upon the panels of the wireless set are intended to be used for twiddling purposes. From this it becomes at once apparent that the first requisite in the would-be tuner of the wireless set is the possession of supple wrists capable of executing neatly and delicately, and without undue fatigue, the twiddling which is so essential to success. I advise you, therefore, before you think of attempting to tune a wireless set to put yourself into thorough training for the

Physical Jerks

The exercises to be performed by the would-be tuner are so simple that they will appeal to all. In the bath the wrists may be given the desired suppleness in the following way: Stand facing the taps and place the right hand upon that labelled cold, and the left upon that



He has learned his first lesson.

that they point rearwards. This last exercise has a wonderful effect upon stiff ankle joints. The exercises performed in bed are best done with the aid of the four knobs, fitted one pair to the top rail and one pair to the bottom rail of the bed. If these are arranged to work in very tight bearings, which should be left ungreased, very satisfactory squeaks will be produced as they are turned with hands and toes. For use in tram, train, bus or office, I recommend the new ball-bearing waistcoat button with squeaker device attached, which is being put on the market at a very reasonable price by Messrs. Guppit & Slobbs, the well-known makers of a multitude of useful gadgets. The ankles may be made supple by sitting always with the feet slightly raised from the ground and turning them incessantly with a rapid to and fro motion. If boots with heavy soles are worn, you will find that this exercise adds greatly to your convenience in crowded vehicles, since your next door neighbours will show no desire to sit too close. When strap-hanging, both

wrists and ankles may be exercised by drawing oneself up a few inches from the floor and allowing the motion of the train to swing one whilst the feet are turned as before. This also ensures that one has plenty of room even during the rush hours. The necessary squeaks and other noises are provided by one's fellow passengers.

Getting to Work

Having once acquired those india-rubber wrists and ankles that are the hall-mark of the successful wireless man, and having trained his toes to become thoroughly prehensile, the enthusiast may set to work upon a receiving set. A crystal set should not be used for the purpose. There is no fun at all in tuning these things, because they are so simple and because they are incapable of producing the chirps and the howls which add so greatly to the delight of wireless reception. I strongly advocate beginning with a single-valve set,



This ensures plenty of room, even during rush hours.

for this, if properly handled, will give the most soul-satisfying results. Sitting in front of the receiving set, grasp the knob of the aerial tuning condenser with the left hand and that of the rheostat with the right.

Fine Adjustments

The left foot actuates the reaction coupling, whilst the right is used for working the secondary condenser (if there is one) and for manipulating the wander-plugs of the high-tension battery. A large coil having been inserted into the reaction holder, the coupling is tightened and the plate and filament potentials are adjusted until oscillation is observed. The presence of oscillation can be detected, we are told, by tapping the aerial terminal with a wet finger. As all of the fingers and toes are engaged, it is best to use the nose for tapping purposes, having previously licked the end of it. If the tongue is not long enough, or if the nose is too short to allow this to be done, a saucer of water should be kept handy on the wireless table. It is

not desirable during the first month or two of practice to tune in any particular station. All that we require is to make sure that we can pick up their carrier waves. Practice should take place always during broadcasting hours since otherwise there will be few carrier waves to deal with.

Tuning

You are perhaps wondering why the process of bringing in stations is known as tuning. If you consult your musical friends they will tell you that the word tuning was simply filched by wireless people from musicians. The latter have used it from time immemorial to denote the process of producing ghastly noises from various instruments before the music proper begins. In the old days of wireless, before tuning was properly understood, the enthusiast used to be content with much the same kind of thing. He ran up and down his scale just like the flautist or the clarinet player for a few moments, and then settled down to the programme. To-day, however, we have come to recognise the great difference between the musician and the wireless man. The former becomes rapidly satisfied with his tuning and, having had his preliminary canter, settles down to work without further ado. The up-to-date wireless man, on the other hand, is never satisfied. He has the very right and proper feeling that his signals might be just a *leette* bit louder, and therefore continues to tune during the greater part of the evening. To him the actual programme (though he spends a large amount of his time in cussing at it) does not matter in the least. If he has a genuine wireless soul, he would much rather hear wheezes for a few seconds at a time from some distant station than be bothered with such tosh as a well-played concerto from a near-by one.

Carrier Waves

The carrier waves of far-away stations will afford both the neophyte and the old hand at tuning endless amusement. For the best results, a distant station on a wavelength quite close to that of the local one should be chosen. Your friends will then hear the cheerful noises that you are making and will smile contentedly as they say to each other, "Ah, there is dear Rupert still at it. What a worker that man is! What perseverance he has! A noble fellow!" There are two ways of dealing with a carrier wave. One is to move the

condenser knobs rapidly to and fro, which causes cheerful little chirps like those made by the birdies when they are feeling happy. The other is to work them slowly, which gives beautiful, sweeping squeals running grandly up and down. Given a suitable carrier wave and a nicely adjusted set, one may spend a whole evening playing with a single transmission without once finding the silent point. The station can be identified by means of the wavemeter, and one can then tell all one's friends that one got so-and-so for hours on end.

Louder Signals

If the tuner *does* happen to find the silent point, faint speech and music will probably greet his ears. He must not let matters rest here. It is his duty to convert a faint signal into a loud one. To do this, very fine work is necessary. Every control must be brought into play and adjusted with the utmost



Begin with a single-valve set.

delicacy. Whilst this is being done the silent point is pretty sure to be lost and the search for it must begin all over again. Fine work, it should be noted, is best done with the feet in order to avoid those annoying hand-capacity effects.

Non-prehensile Toes

Those who have not been able to develop prehensile toes will find that small adjustments are greatly facilitated if an old slipper is fixed by means of screws driven through its sole to each of the knobs that are worked by the feet. The foot can then be thrust into the slipper, where it will rest comfortably. I do not recommend that non-prehensile feet should be temporarily fixed to the knobs by means of Chatterton's compound. One friend of mine tried this in the case of a wavetrapp operated with the right foot and a crystal set worked by the left. The unfortunate fellow found himself so firmly attached to them that he had to have the cabinets cut away and use the panels as sandals until they were worn away.

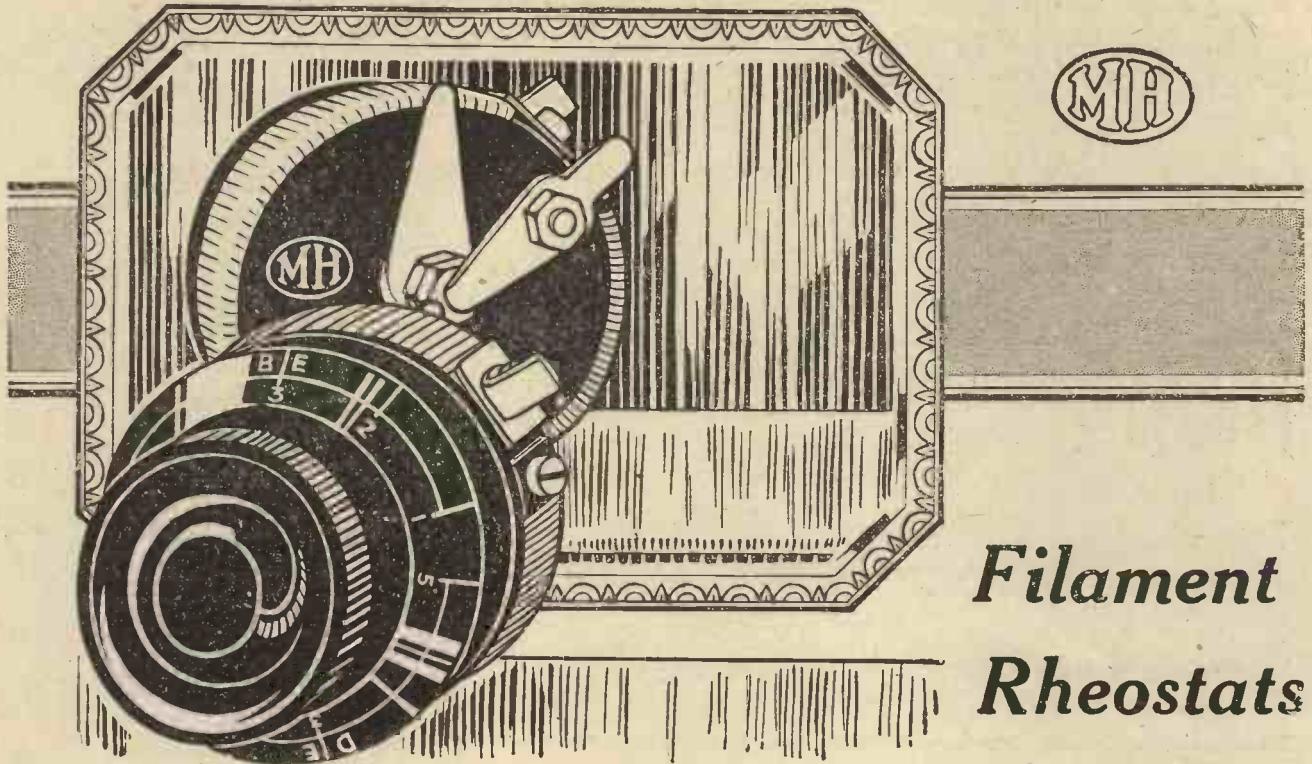

Filament Rheostats

from whatever point of view—

YOU examine a MB Filament Rheostat, and however long you may reflect on the question, you will always come to the same conclusion—that in every way the MB Filament Rheostat is the ideal component you are seeking.

Every detail in design and construction has been carefully considered.

Note the lipped edge to the moving contact. This ensures smooth action and positive control. See how the wire is wound on the former.

The gauge of wire employed will safely carry the necessary current without overheating.

The metal bridge piece separating the two windings of the dual type provides warning to the touch that the slider is at the end of the high resistance winding. The red and white engraved dial also tells the eye of this fact.

Both knob and dial are metal bushed.

These are a few of the salient features which make MB Rheostats instruments of precision that stand out from all others.

The MB Potentiometer

IS similar in build and design to the MB Rheostats. Its use enables you accurately to adjust the grid potential of a valve while its resistance of 300 ohms ensures that the current taken is negligible. It can always be relied upon to give satisfactory service.

PRICES

Bright Emitter Filament Rheostat	5/- each
Dull Emitter Filament Rheostat	6/6 each
Dual Type (for either Bright or Dull Emitters)		7/6 each
Potentiometer mounted with terminals	21/- each
Potentiometer for panel mounting	7/6 each

NOW—AS EVER—SPECIFY MB COMPONENTS

OBTAINABLE FROM ALL DEALERS

Works :—
WEXHAM ROAD, SLOUGH
Phone : SLOUGH 199

L. M. MICHAEL LTD

Manufacturers of Wireless and Scientific Apparatus

London Showrooms :—
179, STRAND, W.C. 2.
Phone : CENTRAL 69E8

Head Office :— HASTINGS HOUSE, NORFOLK STREET, STRAND, LONDON, W.C. 2. Phone : CENTRAL 8272/3
TELEGRAPHIC ADDRESS : RADIETHER, ESTRAND, LONDON

CABLE ADDRESS : RADIETHER, LONDON



A view of the set from the right rear, showing the terminals and valve.

An Interesting Valve - Crystal Receiver

By JOHN W. BARBER

This receiver will prove of value to those wishing to progress from the crystal to the valve stage

MANY crystal users desire at some time or other to pass on to the valve stage, but do not at the same time desire to dispense entirely with a crystal as a rectifier. This may be due in some respects to a demand for economy, as, of course, a crystal requires no filament or high-tension voltage, and thus is much less costly to run than a valve detector. Again, the

crystal, as a rectifier, may give purer signals than a valve in the same function, and many who desire the purest signals will, therefore, wish to retain the crystal.

There are several means of using a valve in conjunction with a crystal detector. In the first place, the valve may be added as a simple note magnifier, the telephones being replaced by the primary of a low-frequency trans-

former, the secondary of which is joined across the grid and filament of the valve. Again, the valve may be used as a high-frequency amplifier, the crystal being joined either across a coil in the anode circuit of the valve or across a coil which is variably coupled to the anode coil. Yet another method of using a valve in conjunction with a crystal is that described by Mr. John Scott-Taggart, F.Inst.P., A.M.I.E.E., in the March issue of this journal.

The Circuit

The present circuit is somewhat unusual, as will be seen on reference

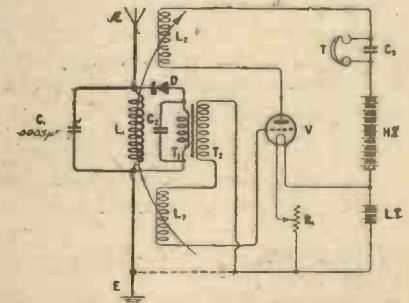
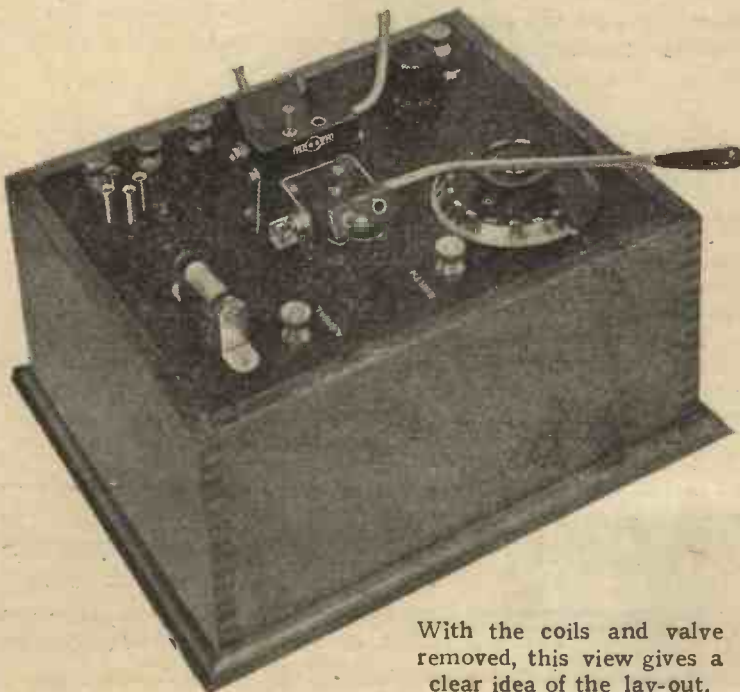

Fig. 1.—The dotted connection should be tried, and made if found advantageous.



With the coils and valve removed, this view gives a clear idea of the lay-out.

to the circuit diagram. The circuit $L_1 C_1$ —crystal—primary of the low-frequency transformer comprises a simple crystal receiving set, in which the telephones have been replaced by the primary winding of the transformer. The secondary winding of the transformer is connected between the filament of the valve and a coil which is coupled to the aerial coil, the other side of this second coil L_4 being joined to the grid of the valve.

In the anode circuit of the valve is another coil, L_2 , which is also coupled to the aerial coil so as to produce reaction effects. The circuit forms a very interesting departure from the standard crystal and note-magnifier circuit, and should prove of real interest to those who wish to graduate from the crystal stage.

In such a receiver it is desirable that the controls or adjustments should be as few as possible, and therefore in this case one of the permanently adjusted type of crystal detector has been provided, thus rendering that part of the circuit free from adjustment.

Components Required

In order to construct this receiver, the following components will be needed. For the benefit of those who wish to know the exact components used in the set described, the names of the manufacturers have been included, but it is to be clearly understood that any equivalent makes of components may be used without the results suffering in the slightest, provided that they will fit into the space provided.

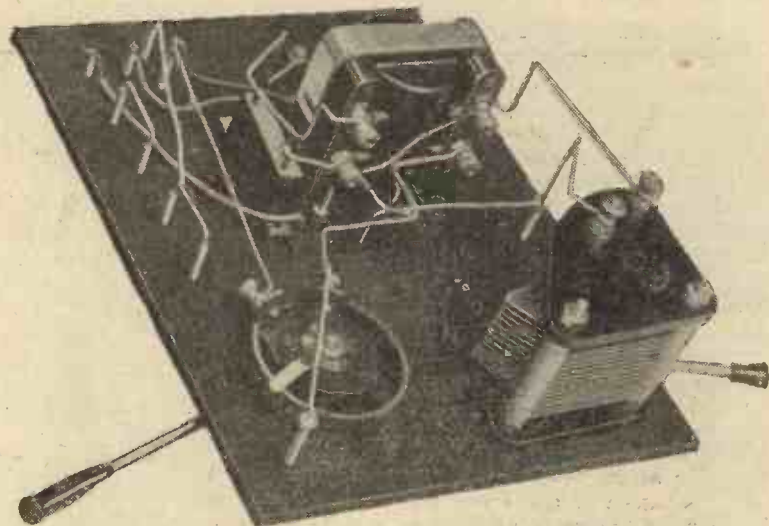

The transformer and terminal connections may be followed from the above photograph.

- One insulating panel 9 in. by 7 in. by $\frac{1}{8}$ or $\frac{1}{16}$ in. (In this case I have used Paragon ebonite.)
- Suitable box to suit the constructor's desire.
- One three-way coil holder (Magnum).
- One .0005 μ F variable condenser, square-law pattern (Jackson Bros.).

- One low-frequency transformer ("Royal," R. A. Rothermel, Ltd.).
- One crystal detector. (In this case I have used one of the permanent type.)
- One filament resistance. (R. A. Rothermel, Ltd.).
- One valve-holder, or, alternatively, four separate valve sockets.
- Eight nickelled terminals.
- One .0003 μ F fixed condenser (Dubilier Condenser Co., Ltd).
- One set Radio Press panel transfers.

No. 16 s.w.g. tinned copper wire for connections.
 In some cases a condenser may be needed across the telephone terminals in order that the reaction control may be smooth, and in this case a condenser of, say, .0005 μ F may be connected across the telephone terminals inside the receiver.

Drilling Operations

The panel is to be drilled in accordance with the diagrams giving the layout, and, provided that the components used are those specified the constructor may drill his panel exactly to this figure. Should, however, the constructor use components other than those specified, it is necessary that he should ascertain for himself as to whether the components to be used will fit into the space provided, and make any necessary alterations in the layout before drilling is actually commenced. The holes for terminals and valve legs may be drilled either 4BA tapping size and the holes tapped and the terminals and valve legs screwed into position, or, alternatively, the holes may be drilled of the clearance size, and nuts of the same size as the terminals and valve legs used behind the panel.

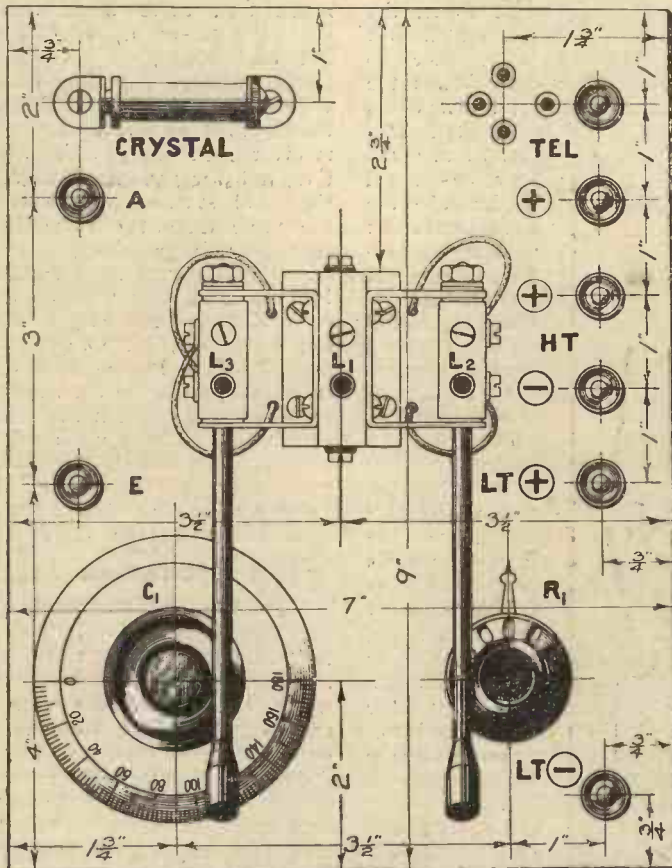

Fig. 2.—A half-size drawing of the front of the panel, giving all necessary details for drilling and mounting.

The wiring up of the receiver is carried out with ordinary stiff bare wire, and it should follow closely the lines of the original wiring of the set. This may be followed from the wiring diagram and from the photographs showing the underside of the panel. It is advisable to solder all joints, and in no circumstances should the flexible leads of the movable sockets of the coil holder be twisted together.

The type of valve used will depend entirely upon the constructor's own desire, but it should be noted that if a dull emitter valve is to be used, the filament rheostat should be of a suitable type. The accumulator and high-tension voltages will, again, depend entirely upon the valve used, and should be adjusted to the figure given on the maker's list. Some additional advantage may be occasioned by earthing the filament of the valve, and in this case a lead may be taken from the IS connection of the transformer to the earth terminal. In the writer's own particular case, using components as specified, this was not found to result in any appreciable benefit, and the connection was therefore omitted. The experiment was also tried of connecting a fixed condenser across the secondary winding T_2 of the iron core transformer, but as this was of

no advantage and was found to give slightly more "woolly" reproduction, this condenser was also omitted, but it may be desirable in some cases.

Coils

As regards coils, the aerial coil L_1 may be either a No. 35 or No. 50, according to the particular aerial used, while the coil L_3 will probably need to be one size larger than the aerial coil. The reaction coil L_2 should be of such a size that the receiver just passes into the oscillation point when the coil is close to the fixed coil L_1 . It will then be possible to obtain a good control over reaction, and if the coil L_2 is never put really close to L_1 the operator can be certain that he will not be causing interference to neighbouring listeners. When the receiver has been completed the aerial and earth may be joined up, and also the accumulator may be connected to its correct terminals. The filament resistance is then turned towards the "on" position, and it should be noticed that the valve lights correctly. If this is the case the high-tension battery and the telephones may be joined up, and the coils, as stated above, inserted in the correct sockets.

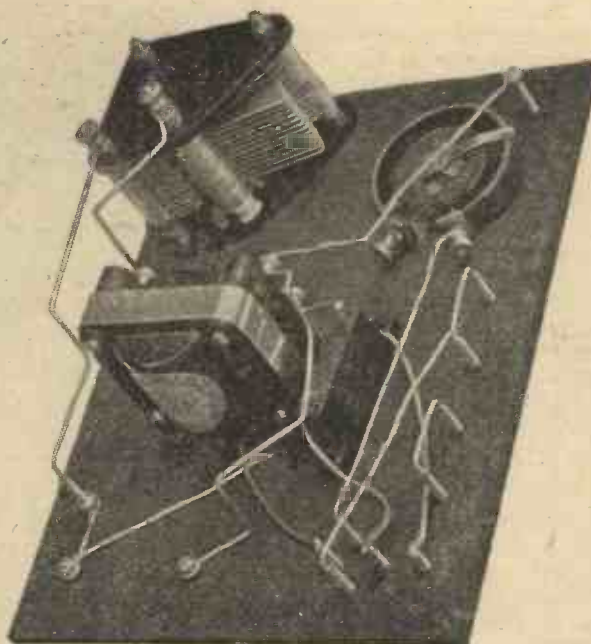

Showing the connections to crystal and valve.

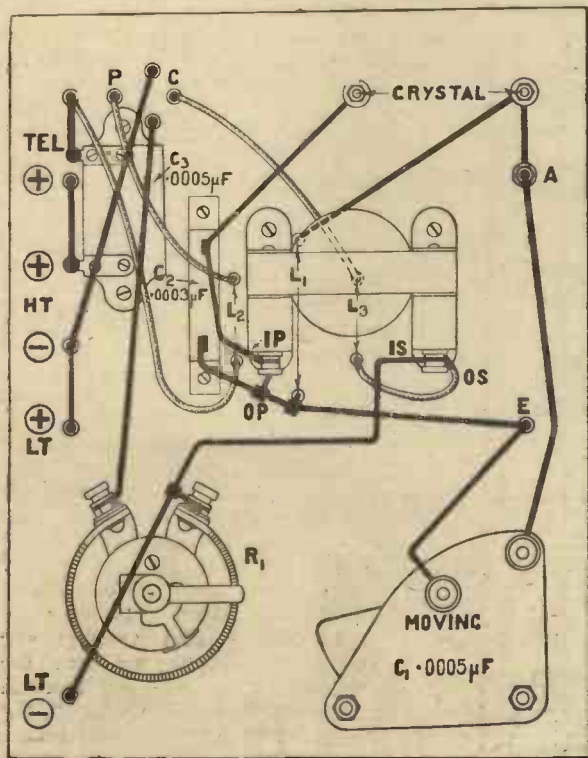

Fig. 3.—This shows the wiring of the set. The wires shown light are flexible leads.

until signals from the local station are heard, when the coil L_3 may be brought closer to the aerial coil, and it should be noted that there is an increase in signal strength. If this does not take place, the connections to the reaction coil should be reversed by changing over the leads to the moving coil socket. The receiver was found to be very selective, it being possible to eliminate the local station and to receive the more distant ones while the former was working. In the writer's case, the local station is London, and it is possible to receive Bournemouth with only very slight interference from 2LO, while several other British and Continental stations have been heard at good strength. When the receiver was initially tested upon a board hook-up, it was found possible to receive six stations other than London at easily readable strength in about a quarter of an hour.

Initial Test

When the completed receiver was first tested the London station had closed down, and three German stations were heard at good strength, while Radio Toulouse came in extraordinarily well. Upon another occasion Birmingham and Aberdeen were heard with no interference from London. In conclusion, the receiver will be found exceedingly simple to operate, once the idea has been grasped, and it will provide many interesting hours in logging distant stations.

To operate the receiver turn the coil L_3 fairly close to the fixed coil, having the reaction coil well away. Vary the condenser C_1

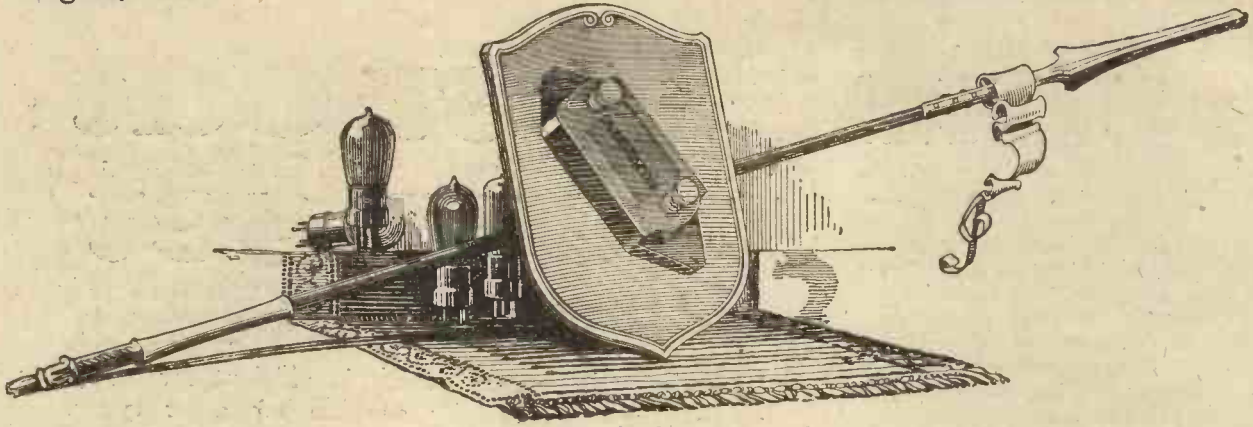

PROTECT YOUR VALVES *with the* "DUBRESCON"

THE disconcerting flash that occurs when the filament terminals of a valve are accidentally touched across the anode and grid sockets of the valve-holder is one of the expensive kind—say 8/- or more. Every amateur probably flashes away quite a lot of money this way every year. There is also a similar effect when the H.T. leads are mistakenly connected to the L.T. terminals, and the valves switched on.

These mistakes are like all others — expensive. Valve immunity, however, can now be purchased for **SIX SHILLINGS**. That is the price of the new Dubilier Dubrescon, which makes it impossible for valves to be burnt out by accidental short-circuiting or similar causes.

The Dubrescon must be inserted in series in one of the H.T. leads—quite a simple operation. The H.T. current can then never exceed the usual filament current, and your valves are secure for ever. The Dubrescon does not interfere with the passage of the H.F. currents.

It is advisable to buy one now, ready for next time. And in doing so, be sure that you

Specify Dubilier

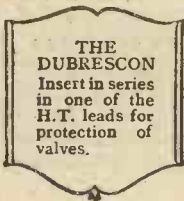

THE
DUBRESCON
Insert in series
in one of the
H.T. leads for
protection of
valves.

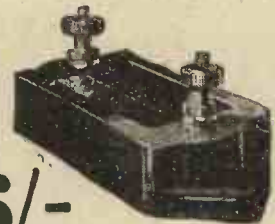
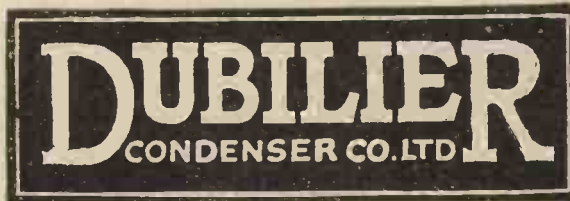

6/-

ADVERTISEMENT OF THE DUBILIER CONDENSER CO., LTD., DUCON WORKS, NORTH ACTON, LONDON, W.3. TELEPHONE: CHISWICK 2241-2-3.

In replying to advertisers, please mention THE WIRELESS CONSTRUCTOR.

Get the *best* out of your set!

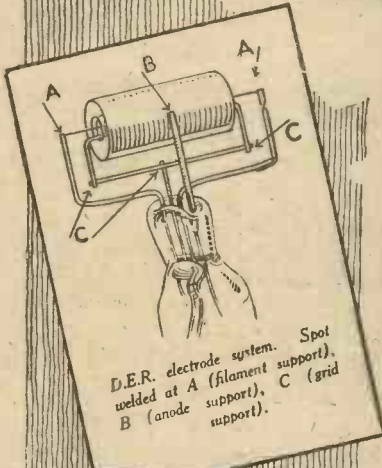

The electrode system which is efficient for one type of valve is not necessarily suitable for other types. To be efficient a valve must be designed with definite reference to the conditions under which it will be used.

TYPE D.E.R.

This was the *first dull emitter* on the British market. To-day, as when it was introduced, it is accepted as the standard of efficiency for 2-volt general purpose dull emitter valves.

OUTSTANDING FEATURES:—

ELECTRODE SYSTEM

Of horizontal arrangement. This makes for the minimum leverage and the least possibility of displacement.

LOW CURRENT CONSUMPTION

Emission from type D.E.R. (operating at a dull red heat) equals that from a bright emitter consuming up to four times the current.

PLATE

The maximum emission is obtained where it is most needed (i.e. in the centre). The ends of the filament are cool and non-emitting; there is, therefore, no tendency of the electrons to escape.

FILAMENT IMPREGNATED THROUGHOUT

The high emission of Type D.E.R. is not dependent on an outer coating which may rapidly wear away. The active material permeates the whole of the filament.

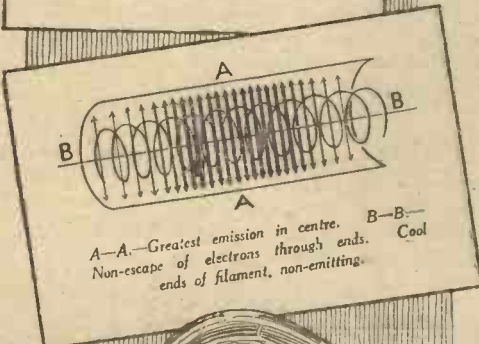
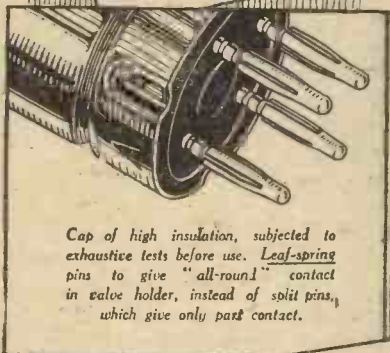

REDUCED PRICE 14/-

BUY THE VALVES BACKED BY THE NAMES

MARCONI & OSRAM

Sold by Wireless and Electrical Dealers, Stores, etc.

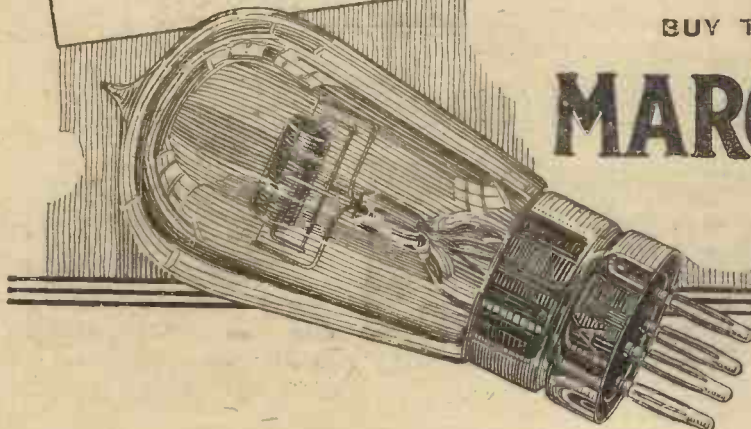



Colonel Bromhead, the famous producer, was one of the first in the film world to broadcast.

THE microphone might well be termed "the common denominator" of the entertainment world. Possibly in the beginning well-known masters of their craft crept guiltily into the B.B.C.'s studio, fervently hoping that no one would know their real names, or else believe their airy statement that "it was just for the experiment, old man—see what the rotten thing looked like, don't you know."

But to-day, fortified by the knowledge that the greatest artists in the world have faced that implacable "eye" of the microphone, not to have broadcast has become rather a reproach than otherwise.

Early Recognition

Whether or not the novelty of being heard, instead of seen, appealed to the film world, it is certain that wireless was early appreciated by film stars both here and in



Miss Mary Pickford, a favourite film star, who was heard during a visit to this country.

Screen, Stage and Microphone

By "CARRIER-WAVE"

A chat about those connected with the stage and film industry who have interested themselves in broadcasting

America. Rudolph Valentino aired his grievances during his dispute with his contracting company, and David Wark Griffith, the great producer, was the first to broadcast announcements of his film "One Exciting Night" on the opening performance, so that a welcome was "ready-made" in every long distant town.

On this Side

Although it was known that every film star was "listening in," and taking a lively interest in



Mr. Cecil Hepworth, of the film company bearing his name, who spoke on the subject of film interest.

"wireless," first on this side to take broadcasting interest were the two famous English producers, Colonel Bromhead, of the Gaumont Film Company, and Cecil Hepworth, of Hepworth films fame. They spoke respectively on the subject of film interest, and were heard with undoubted appreciation.

Colonel Bromhead, through his company, may be called the pioneer of the real feature film, for he has probably given more "super" films to the British public than can be imagined. His English productions have made famous one of the best known British-stars, Betty

Balfour, and who first came into stardom as "Squibs," the flower-girl.

Essentially English stories are to the credit of Mr. Hepworth and his famous stock company, which have included Henry Edwards, James Carew, Alma Taylor, Chrissie White, Gwyne Herbert, amongst others.

His productions of "Alf's Button," "Coming Through the Rye" and semi-historical films such as "Through Four Reigns" are film history.

Miss Alma Taylor will be seen again shortly in fresh successes, although not under the Hepworth banner.

Two other members of the old company, Miss Chrissie White and her husband, Henry Edwards, broadcast last year from Liverpool and Cardiff, Miss White also speaking in the "Women's Hour" on the subject of film dress.

Our Visitors

But it was when the "World's Sweetheart," Mary Pickford herself, came over last year that public excitement surged high.

Neither Mary, despite her nervousness, nor her husband Douglas Fairbanks are novices before the microphone, for after the completion of their respective films,



Mr. Douglas Fairbanks, who accompanied his wife, Miss Mary Pickford, when they both spoke from 2LO.

"Dorothy Vernon of Haddon Hall" and "The Thief of Bagdad," they made an "aerial" personal appearance to New York, and broadcast their respective messages from Station WJZ, Aeolian Hall, New York City, last year, being heard not only by America but, so it was reported, at Manchester on this side.



Mr. George Grossmith, who is now with the B.B.C.

D. W. Griffith. It was entitled "The Violin Maker of Cremona," just a short film—very far indeed from our Mary as she will look when her latest, "Little Annie Rooney," comes over. There is unique interest in this, for her first films were shown at the old Theatre de Luxe in the Strand, right next to the site where stood the old Tivoli, and "Annie Rooney" is the girl of the song with its office-racking refrain "She's my sweetheart," of the days when Michael Nolan introduced it to

Stage Interest

Very early in wireless history, the stage lent invaluable assistance, and when during the run of "The Last Waltz" at the Gaiety Theatre, in 1923, a "listening in" set was installed for the stars, Miss José Collins, and her confrères, Bertram Wallis, Billy Leonard and Kingsley



A favourite with picture-goers, Miss Betty Balfour.

Early Career

To Mary also has fallen the honour of having the prize orchid of the International Flower Show named after her, "Cympedium Mary Pickford." It is not generally known that Miss Pickford made a stage début in 1898 with the Valentine Stock Company as "Cissy Denver" in "The Silver King," and continued on the stage until 1913, when she returned to the screen again. I wonder if anyone remembers her very first film in the old biograph days under



Miss Alma Taylor, a well-known star.

Hall, it was not a far step to persuade Miss Collins to ascend to the top of Marconi House, "just next door," where 2LO was then housed, and to broadcast to the widest public in the world. Since then we have heard her both "directly and indirectly," the most recent occasion being when a part of "Fraschita" was relayed.

Children's Hour

Among other early stars may be mentioned Miss Sybil Arundale and Miss Edna Best, one of the most popular of "Peter Pans," whose broadcast in one of the first "Children's Hours" made it an epoch to most kiddies. Then there was Mr. Tubby Edlin who led the



Miss Cathleen Nesbitt, the famous Shakespearean actress.

Tivoli patrons and made it the rage of London.

The Wild West

Equally loved is that real "Cowboy" of the Western World, Tom Mix, and I don't doubt that scores of youthful admirers were allowed to sit up late "just this once" to hear the tones of their biggest hero. Mr. Mix is one of the real American ranchers, has fought through all the wars available, including the Chinese Boxer rebellion, and none of the scenes are "faked."



Tom Mix, the "Cowboy" of the Western World, who was recently heard at 2LO.



Mr. Hayden Coffin, who was heard at the end of 1923.

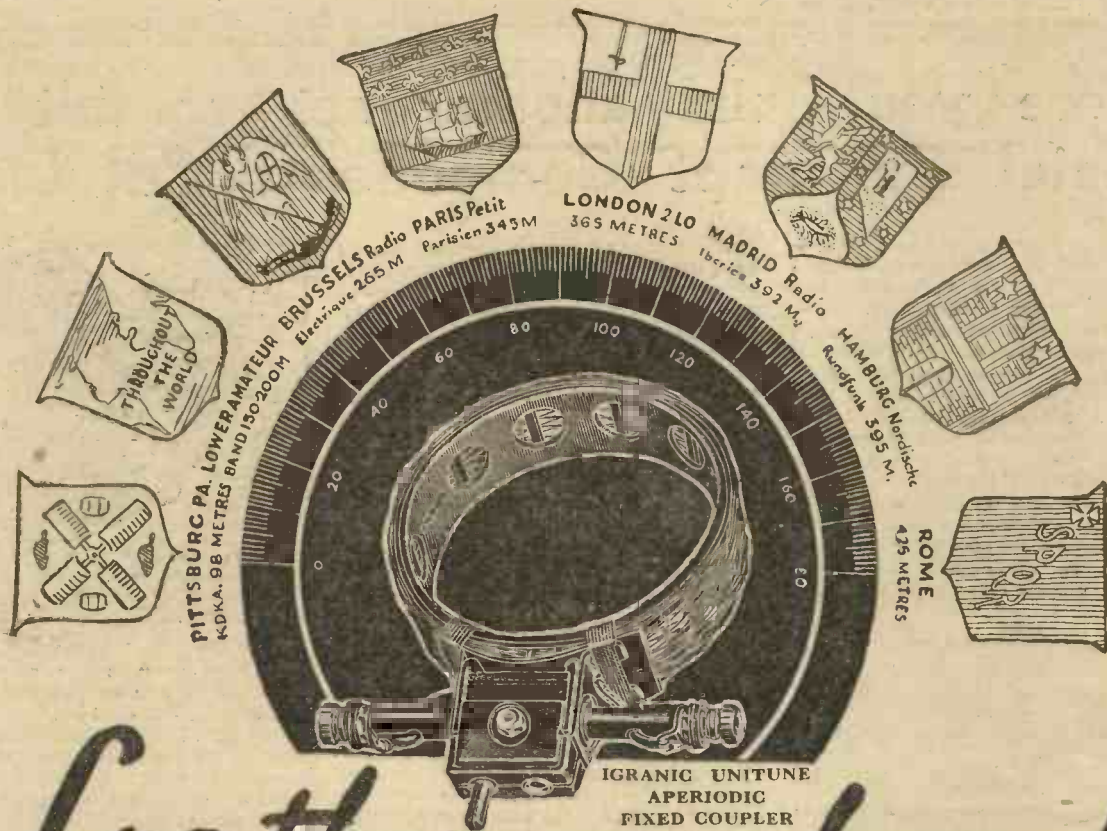

Log them - one by one!

THE difficulty of "overcrowding on the dial" is not always the fault of the condenser, especially if it be the new Igranig Square Law model. There are other factors which determine selectivity, as for instance the proximity to your receiver of a high power station working on approximately the wave-length of the distant station required. Then there is also the method of coupling High frequency valves upon which a lot depends. The surest way to selectivity lies in the adoption of the form of coupling made possible by the Igranig Unitune Aperiodic Fixed Coupler. This component combines many of the advantages of both direct and loosely-coupled methods of tuning without their attendant disadvantages. It is therefore particularly efficient when receiving on short wave-lengths.

The aerial coil is aperiodic and is responsive to all wave-lengths within certain limits. The secondary winding should be shunted by a variable condenser of .0005 microfarads, and is calibrated for various wave-lengths with given values of capacities in parallel. These wave-lengths remain constant no matter what the dimensions of the aerial may be. Both windings are of the Honeycomb Duolateral formation, thus reducing the self-capacity of the coupler to a minimum.

The difficulty of obtaining reaction is also overcome by using the Unitune Fixed Coupler. The Unitune Fixed Coupler may be used in any receiver employing standard coil-holders.

Unitune Minor for 75—180 metres Price 7/8
 Unitune Major for 300—600 metres Price 9/-

All reputable dealers carry stocks.

Write for **COMPANY** List Z 593



IGRANIC RADIO DEVICES

include: Honeycomb Duolateral Coils, Fixed Condensers, Variable Condensers, Filament Rheostats, Intervalve Transformers, Variometers, Vario-couplers, Variable Grid-Leaks, Coil Holders, Battery Potentiometers, Vernier Tuning Devices, Switches, etc., etc.

All carry the IGRANIC guarantee.

Branches:

BIRMINGHAM: 73-74, Exchange Buildings. CARDIFF: Western Mail Chambers. GLASGOW: 50 Wellington Street. LEEDS: Standard Buildings, City Square. MANCHESTER: 30, Cross Street. NEWCASTLE: 99, Pilgrim Street.

149, Queen Victoria Street, London.
 Works: BEDFORD.

Before you build another set, consult the special Burndept Components Catalogue

"Burndept Components and Accessories are designed with great care in a well-equipped Research Laboratory, furnished with all the necessary appliances for thorough electrical and mechanical tests. Every stage of manufacture is supervised, and the finished product is rigorously tested to make certain that it is up to a definite standard of efficiency. Burndept Components and Accessories are well packed in stout cartons, each containing full instructions, and a guarantee voucher offering free replacement or repair in the event of a fault developing within twelve months of purchase."

So runs the introduction to the new Burndept Components Catalogue, which

Every man who constructs sets should have the new Burndept Components Catalogue by him. It is a handy publication, and contains full particulars of some very interesting Burndept products, including components, loud speakers, batteries and sundries. The Burndept Crystal Detector, the Anti-Phonic Valve Holder and the Dual Rheostat are three components described therein, which every reader of THE WIRELESS CONSTRUCTOR will have noticed are frequently incorporated in sets described by Radio Press writers. The features of these Burndept Components will make an instant appeal to the constructor who wishes to make sure of good reception.



No. 222. Dual Rheostat, 5-30 ohms, for panel mounting, in carton with screws and drilling template, 7s. 6d.

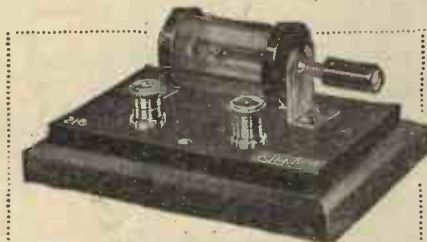

No. 215. Crystal Detector, for panel mounting, in carton with screws and drilling template, 4s.

No. 216. Crystal Detector, for experimental use, as illustrated, 11s. 6d.

The Burndept Crystal Detector gives the best possible results obtainable by crystal rectification. The cat-whisker is controlled by a micrometer screw, working through a ball-joint. The movement gives very fine adjustment. All moving parts and the sensitive synthetic crystal are enclosed in a glass tube, protected from dust. This Crystal Detector is neat in appearance, and looks well on any panel.

The Anti-Phonic Valve Holder, which was the first component for the elimination of microphonic noises is constructed of materials which are not affected by climatic conditions. There is no rubber to

perish, the valve holder proper being supported by four springs which absorb mechanical shocks and vibration. The use of Anti-Phonic Valve Holders will not only prevent microphonic noises, but will also help to lengthen the life of valves. They are ideal for use in portable sets, and should always be used with dull-emitter valves. The construction of the Anti-Phonic Valve Holder is shown in the centre column.

The Burndept Dual Rheostat enables one to use a bright or a dull-emitter valve without altering a set in any way. The first half of the element is wound to a resistance of 25 ohms, and the second half to a resistance of 5 ohms. The whole 30 ohms resistance is used to control a dull-emitter valve and the 5 ohms resistance, a bright valve. The movement of the brush is practically noiseless, and contact is perfect. The windings cannot be displaced.

Send the coupon to-day

Send the coupon to-day for a free copy of the Burndept Components Catalogue. The local Burndept Agent will be pleased to show you the actual components and give you any special information you may require.

has been prepared for the convenience of home-constructors. In a few words, it gives many facts which will lead builders of sets to buy Burndept products with the firm conviction that they are going to get full value for their money. Burndept Components are admittedly a little dearer than others; but that extra cost is more than justified when you have the satisfaction of getting perfect results with a minimum of trouble. It is very annoying to find that most of the time one has spent in building a set has been wasted just because some cheap components were not as efficient as they should have been. A penny saved at first may mean spending a pound later on, and the moral is, "Buy wisely before you start to build."



No. 401. Anti-Phonic Valve Holder, for panel or base mounting, in carton with screws, 5s.

BURNDEPT

WIRELESS LIMITED

Head Office—Aldine House, Bedford Street, Strand, London, W.C.2
 Telephone: Gerrard 9072 Telegrams: "Burndept, Westrand, London"
 BRANCHES at Manchester, Leeds, Birmingham, Bristol, Cardiff, Newcastle, Northampton and Nottingham

CUT HERE

To BURNDEPT WIRELESS LTD.
 Aldine House, Bedford Street,
 Strand, London, W.C.2

Please send me the special
 Burndept Components Catalogue.

NAME

ADDRESS

DATE..... *Wireless Constructor, Aug.*

way, for Variety, and although his fellow artists have been more bound by their contracts than members of the "legitimate," we have heard Sir Harry Lauder, Sir Walter de Frece, Charles Coborn, amongst others.

The real fashion was set when Miss Ellen Terry gave a reading of one of her favourite scenes from "King John," and in quick succession came Miss Violet Vanbrugh, Mr. Arthur Bourchier, Lady Tree, Mrs. Kendal, Sir J. Forbes Robertson, Ivan Berlyn,



Sir J. Forbes Robertson, who has closely associated himself with broadcasting.

Aubrey Smith, Lilian Braithwaite and the Misses Esmé and Vera Beringer.

The First Radio Playwright

As one might have expected, broadcast drama was attempted with the national poet Shakespeare, and here the genius of Miss Cathleen Nesbitt was called into account. One of our best-known actresses, Miss Nesbitt, in collaboration with Mr. L. Stanton Jefferies, then Musical Director of 2LO, produced "A Midsummer Night's Dream," "Romeo and Juliet," and "The Merchant of Venice," proving more than ever the poet's own dictum "The play's the thing," for here were neither scenery nor spectacle—only the sheer beauty of the words and thought.

Modern Drama

Later came the modern plays arranged by Mr.



Miss Esmé and Miss Vera Beringer, who have both been heard from 2LO.

William Macready and his brilliant wife, Edna Godfrey Turner, and Mr. R. E. Jeffrey, the standard operas, and here and there plays which included still more of our famous stage artists.

"Retrospective," for instance, engaged the art of Miss Lilian Braithwaite and Mr. C. Aubrey Smith. Detailed comment of the various rôles cannot be given the space, but I think most of us will remember Miss Braithwaite in the George Alexander plays at the St. James's, especially in "Old Heidelberg" and "Saturday to Monday."

Mr. Aubrey Smith will be remembered in a long list of rôles, particularly in "The Light that Failed." Of Mrs. Kendal, it is again difficult to choose the best of her many parts, but many playgoers will look back with great pleasure to her in "Pygmalion and Galatea" and "The Elder Miss Blossom."



Henry Edwards, the first British film actor to broadcast, is seen above with his wife, Miss Chrissie White, at the Cardiff station.

The two clever sisters, Miss Esmé and Miss Vera Beringer, have both long held the stage, the latter both as actress and authoress, for, as "Henry Seton," many plays stand to her credit, one of the best being the farce called "The Boys."

At 2LO Miss Esmé first appeared in the W. W. Jacobs farce "The Boatswain's Mate," and it was good to hear her, even if we could not see one who has appeared at every great theatre and play in the country.

Miss Athene Seyler is another well-known London actress whose



Mrs. Kendal, who will be remembered for her parts in several plays.

work has been much appreciated, and we would like to hear her often. Christine Silver, Dame May Whitty, and Mr. Ben Webster, Laurance Hanray, Ernest Thesiger, Hubert Carter, Ann Trevor and Milton Rosmer have all figured before the microphone, while Sir J. Forbes Robertson has associated himself very closely with broadcasting work, both on the acting and the educational side. He will be best remembered for his part in "The Passing of the Third Floor Back" and "Mice and Men."

Two other names recall themselves, namely, Hayden Coffin, whose songs at the turn of the year 1923-24 evoked tremendous response from an unseen world, and Mr. George Grossmith. The latter is now permanently attached to the entertainment staff of the Broadcasting Company, and it is to "G. G." that we confidently look to make "a Brighter London."

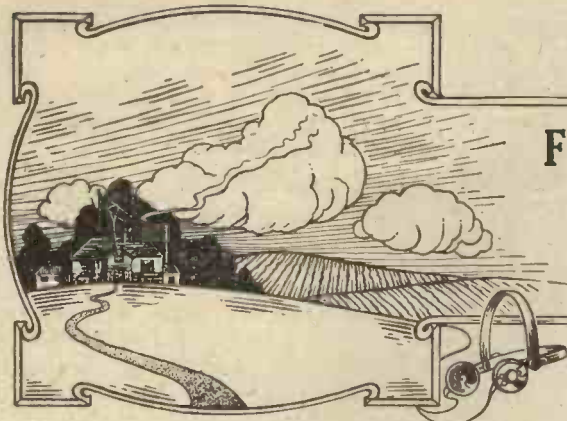

Finding Faults in Low-Frequency Transformers

By G. P. KENDALL, B.Sc., Staff Editor

IN the case of the majority of wireless components, it is possible by paying a reasonable price to obtain a good article, which will confer practical immunity from faults, but, strangely enough, the low-frequency transformer seems to be something of an exception to the rule. It is certainly a fact that one cannot be certain of entire freedom from faults in even quite expensive makes of L.F. transformers. In justice to the manufacturers, it must be remembered that they themselves are very much at the mercy of the makers of the fine gauges of wire which they use, and, furthermore, that the production of a low-frequency transformer, involving as it does the construction of large windings of extremely fine wire, is no easy business. Be that as it may, the fact remains that faults do sometimes occur in even quite good makes of transformers, and we must be prepared for their occurrence, and it is advisable to have some idea of how to locate them when they do make their presence known.

Breaks in Windings

Apparently the commonest fault which is likely to occur in a low-frequency transformer is an actual break in the primary or secondary, and I should like to digress for a moment to explain how such breaks most often occur. We often see it stated that a certain transformer has "burnt out" in use, possibly with some accompanying statement as to the strength of signals being such as to destroy it. This is sometimes regarded as an exaggeration, and figures are quoted which seem to show that the current-carrying capacity of the gauges of wire commonly used is such that a true burn-out is absolutely impossible. This contention is undoubtedly true, but it must not be forgotten that a winding can be injured by the passing of a current through it in other ways than the actual fusing of the wire as the

result of the passage of too heavy a current.

"Burn-Outs"

The current which will pass through the primary winding of a low-frequency transformer when speech or music is being amplified is of a fluctuating or pulsating nature, which produces corresponding fluctuations in the magnetic field about the windings, and this reacts upon the turns of the winding themselves, and if these turns are not rigidly held in place, actual physical vibrations may be set up in them of such strength that the wire itself may be broken. This is really how the so-called "burn-out" happens.

out, since a soldered joint is usually made here to a thicker piece of wire which constitutes the connection to the terminal. Bad soldering or the use of an unsuitable flux here will, of course, ultimately lead to trouble. Breaks in the windings, then, are to be regarded as one of the commonest types of faults which occur in L.F. transformers, and we will proceed to consider some suitable tests which will locate such breaks.

Continuity Tests

The usual simple test for continuity performed by means of a dry cell and a pair of telephones, connecting these up in a series with

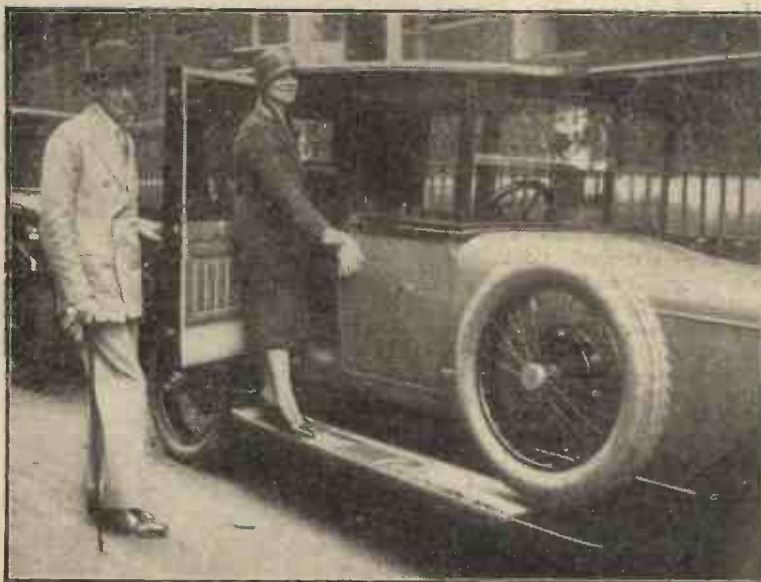

A man-hunt for children took place in London recently. Above are seen Auntie Sophie and Uncle Caractacus about to start for their "Wireless Thumbs-up."

Soldered Joints

Breaks may readily develop in a winding as a result of a fault in the wire which has been used, and disconnections may occur where the ends of the wire are brought

the suspected winding and touching one of the tags upon the terminal of the transformer, will serve our purpose quite well, but it is important that a preliminary idea of the nature of the indications

TWENTY-FIVE YEARS **ENGINEERING** MANUFACTURING EXPERIENCE



ENGINEERING COMPANY

ORMOND LOW LOSS CONDENSERS—SQUARE LAW

Supplied in the following sizes—

Size.	Price with Vernier.	Price without Vernier.
.00025 ...	8/-	6/6
.0003 ...	9/-	7/6
.0005 ...	9/6	8/-
.001 ...	10/6	9/-

All Cheques and Postal Orders should be crossed and made payable to "The Ormond Engineering Co."

A NEW DEPARTURE IN BRITISH CONDENSER DESIGN GIVING THE FOLLOWING ADVANTAGES—

- (1) Practically negligible losses.
- (2) One-hole fixing—one $\frac{3}{8}$ " diam. hole is needed to fix this condenser to panel.
- (3) Rigid construction—cannot warp; end plates of stout aluminium, perfectly flat.
- (4) Fixed vanes supported by $\frac{1}{4}$ " ebonite strips.
- (5) Smooth action, spindle tension is maintained by a specially designed friction washer.
- (6) Moving vanes and end plates are at earth potential.
- (7) One-piece knob and dial—supplied loose. Secured by 4 BA Set Screw.

This condenser is fitted with optional soldering Tags, or Terminals, and can be supplied with or without Vernier as desired.

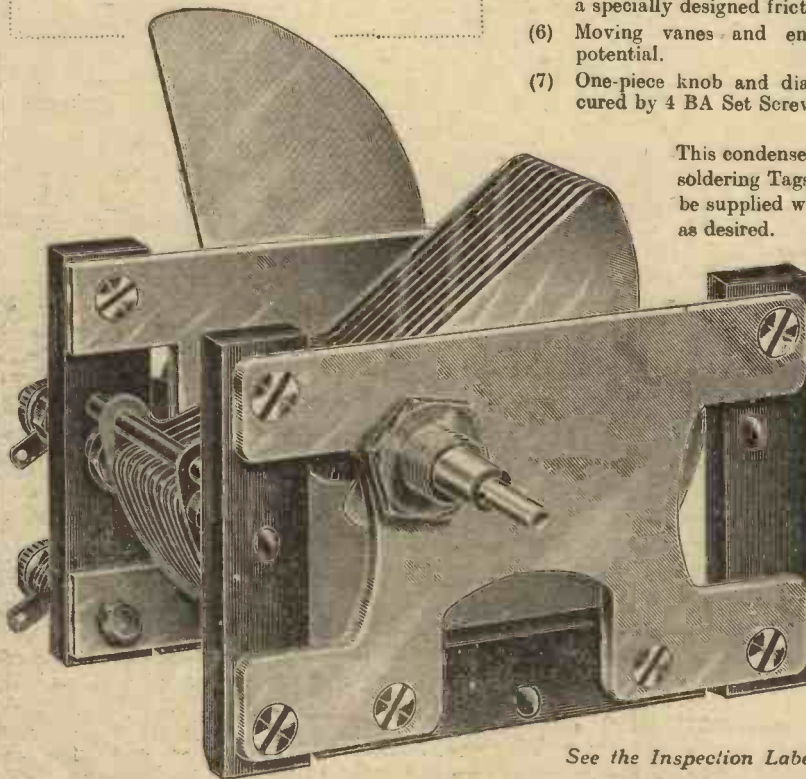

There is no variation in price, the prices being the same as our ordinary Square Law Condensers.

We specialise in turning Brass and Steel Screws and Machined Parts and Accessories of all descriptions.

Write for our new (1925) Catalogue and Trade Terms.

See the Inspection Label on every Condenser.

199-205, PENTONVILLE RD. KING'S CROSS, LONDON, N.1.

Factory:—Whiskin Street, Clerkenwell, E.C.1

THE BEST MEANS—

ORMOND

Telegrams:—**"ORMONDENGI, KINCROSS."**

Telephone:—**CLERKENWELL 9344 (3lines),**

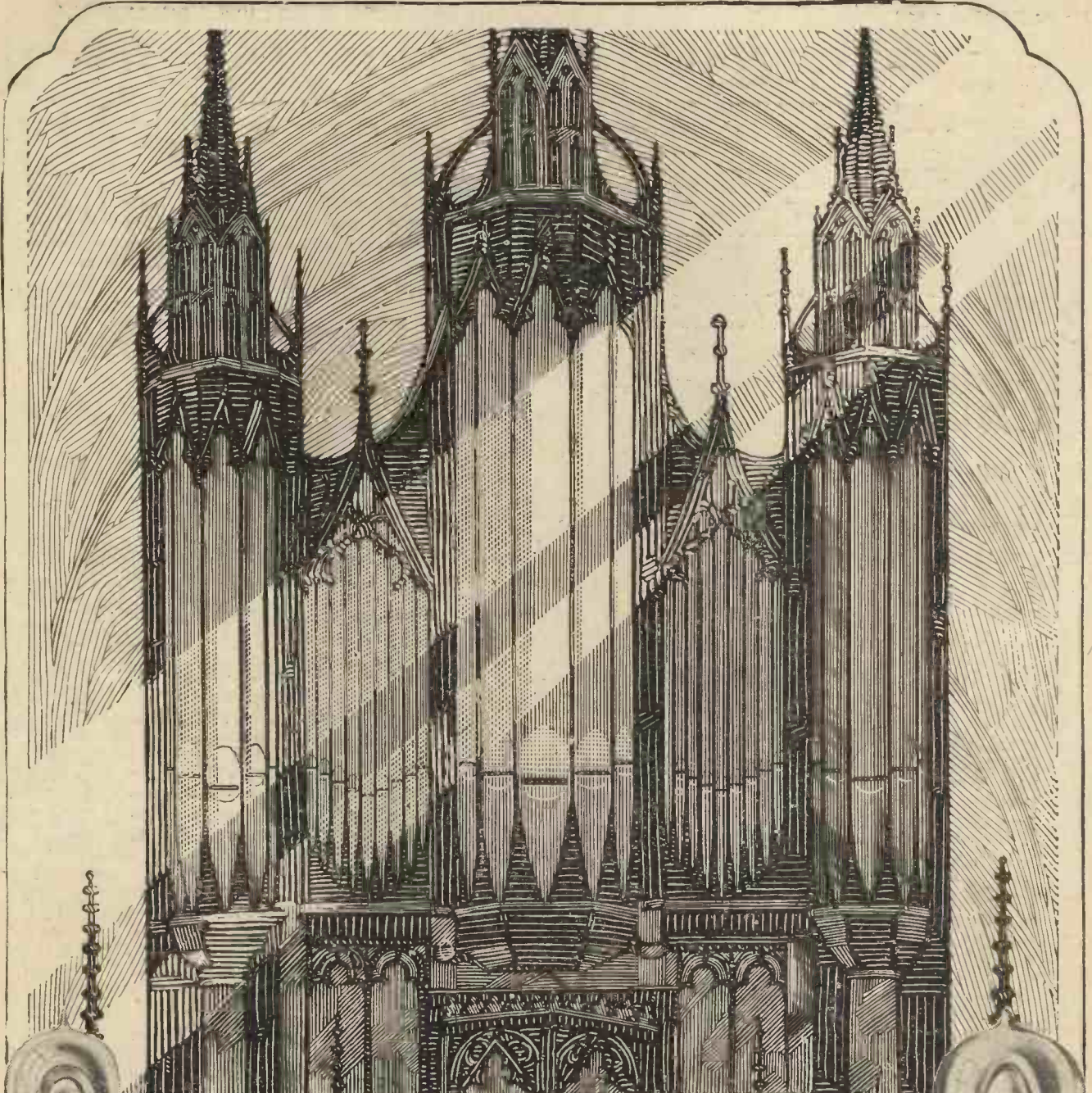

A demonstration of the new Cossor Loud Speaker Valve—the W.3—will instantly recall to the mind of the listener the majestic grandeur of the church organ. Such mellowness of tone, volume and clarity marks a new era in Loud Speaker reproduction and is destined to exercise a significant influence on broadcast reception in the future.

Cossor W.3
Loud Speaker Valve
 Filament Volts · 1.8
 Consumption .5 amps.
 Price 18/6

Cossor Valves

Cossor P.3
Loud Speaker Valve
 Filament Volts · 4.5
 Consumption .2 amps.
 (Available shortly)
 Gilbert Ad. 3015.

which are given by a healthy transformer be obtained. It is most desirable to obtain a transformer which is known to be in working order and test through both the primary and secondary windings with the telephones and dry cell in order to obtain a correct idea of the kind of clicks which will be heard when a proper circuit exists.

Faint Clicks

It is to be noted that faint clicks will often be heard through a winding which is actually broken at some point, since the two separate halves which are formed by the break may act as the two plates of a condenser, whose capacity may be sufficiently large to pass an impulse big enough to produce an audible click in the 'phones. This will always be somewhat weak, however, and by comparison with the standard already formed it will be possible to decide if the transformer is defective.

Symptoms

The symptoms produced in a set by a breakdown in one of the windings of a low-frequency transformer are somewhat varied, ranging from a complete absence of signals when the break is located in the primary winding, to a mere weakening of signals and production of distortion when the break has occurred at some particular point in the secondary winding. However, since the tests upon the transformer are so simple to carry out, I do not propose to go into the question of diagnosis in any detail, since whenever a fault occurs which conceivably is due to the L.F. transformer, it is a very simple matter to ascertain its exact nature by the application of these tests.

The telephones and dry cell test will show in a very few moments whether primary or secondary is partially or completely broken, and assuming that the test has given a negative result, we come to the various other possible faults which may occur in a transformer. Where it is found that there appears to be a "short" somewhere in the high-tension circuit,

so that the high-tension battery rapidly discharges, it may well be that the trouble is located in the low-frequency transformer, and is taking the form of a short circuit between the windings. This, of course, will produce the aforementioned high-tension battery short-circuit, and the test of the application of the phones and dry cell method across from primary to secondary should be applied. In a good transformer a very faint click should be heard, but when a fault of this nature is present the click will usually be quite strong between, for example, IS and OP, and weak between IP and OS, according to the location of the "short." This experimenting between the various terminals will soon confirm whether this fault is present or not, and of course the transformer should be rejected if there is any sign of it.

Insulation

In the majority of transformers it is intended that both windings shall be thoroughly insulated from the iron core, and a short circuit here may often produce an actual fault in the receiver. The test is very simply carried out, again by means of the telephones and dry cell, the test being applied between the terminals of the windings and some point upon the iron core to which good contact can be made. For example, in the case of a transformer of the type in which the clamping bolts pass through the core, the test can be made to one of these. In types in which the clamping bolts do not pass through the core, it will generally be convenient to scrape a little of the coating which is employed upon the iron laminations off the edge of one of them, and apply the test to the clean spot thereby produced.

Connections to Core

In most transformers it must be assumed that a fault exists if anything in the nature of a real click is heard upon carrying out this test, but it should not be forgotten that there are one or

two transformers upon the market upon which a connection is definitely made between one of the windings and the core, with a view to producing stability in the low-frequency amplifying stages.

Repairs

We have now concluded this very brief survey of simple methods of testing low-frequency transformers, and it should perhaps be mentioned that when it is found that a break is present attention should be directed to the terminals of the transformer, note being taken as to whether the leads from these terminals appear to be intact. In quite a number of cases it may be found that rough handling of the transformer has produced a break here, which may be readily repaired by means of the soldering iron. If the cause of the trouble is not, however, apparent, I certainly do not advise the experimenter to attempt to put matters right for himself, but rather to return the transformer to the makers, since in most cases a replacement will be given at once.

*A Simply Made
One-Valve Receiver*

SIR,—I have constructed the "Simply-made One Valve Set," as described by Mr. Percy W. Harris in the December issue of THE WIRELESS CONSTRUCTOR.

I can get 2ZY, which is twenty-five miles away, with sufficient volume to work a loud speaker.

I can also get 2LO, 5IT, 2BE, 5WA, 6BM, 5NO, 5SC, 2BD, very well, and also Madrid, Brussels, Hamburg and a few other Continental stations which I did not recognise.

My aerial is only 30 feet long and 24 feet high, and is of the single-wire type; my coils are Nos. 25, 35, 50, 75.

I might also add that I did not know a thing about wireless until I bought your journal.

Yours faithfully, J. W. FORREST.
Blackburn, Lancs.



Erecting our Aerial!



The Wave-Trap Single-Valve Receiver

By A. S. CLARK

A lead is taken from the aerial terminal to one of the tapings on the lower coil

MANY designs of single-valve receivers have been described, all of which have some definite point to recommend them. But without using complicated tuning very few of them will cut out the local station, and make it possible to listen with comfort to two or three others. This is, however, possible with the receiver described in this article, and whilst it is not claimed that there is no background whatever of the local station on wavelengths near its own, the interference from it is reduced to such an extent as to make listening to the other stations worth while. Also on stations whose wavelengths differ from that of the local station by a fair amount, it is possible completely to eliminate the local station, providing it is not nearer than about 7 miles.

The Circuit

The circuit which is used is shown in Fig. 1, and is very similar to that given by Mr. A. D. Cowper, M.Sc., in his article "Eliminating the Local Station" in *Wireless Weekly*, Vol. 6, No. 7. The wave-trap part is just the same, but ordinary reaction, by using a coil in the plate circuit coupled to the aerial coil, is used instead of the Reinartz method. A Lissenagon X coil is used to provide the grid coil and the aperiodic aerial coil, although home-made coils with similar taps may be utilised. The wave-trap consists of a variable condenser in series with a plug-in coil shunted across the aerial tap and earth. An explanation of how this wave-trap works is given by Mr. Cowper in his article already referred to. A .0005 μ F variable condenser is used

so that the wave-trap will be suitable for Chelmsford as well as the lower broadcasting wavelengths. The set is mounted in an All-Concert type of cabinet on a small scale, and has a compact and neat appearance, since the valve (which may be any bright- or dull-emitter general purpose type) and wave-trap coil are mounted behind the panel.

Components

The components required are given in the following list. The names in the brackets are the makers of the actual components used in the original set, but it is not necessary to keep to these in order to get good results. Any make of similar component which is of equal quality will be suitable.

- One 12" x 6" x 1/4" ebonite panel (Peter Curtis, Ltd.)
- Two .0005 μ F variable condensers, square law type. (Collinson's Precision Screw Co., Ltd.)
- One dual filament resistance. (L. McMichael, Ltd.)
- One valve window. (Burne-Jones & Co., Ltd.)
- Eight heavy lacquered terminals. (Burne-Jones & Co., Ltd.)
- One magnum "Vibro" valve holder. (Burne-Jones & Co., Ltd.)
- One 2-megohm mounted grid leak. (L. McMichael, Ltd.)
- One wood mounting coil socket. (L. McMichael, Ltd.)
- One .0003 μ F fixed condenser. (Electrical Research Laboratories.)
- One .002 μ F fixed condenser. (Electrical Research Laboratories.)
- One left-hand 2-way coil holder. (Peto-Scott Co., Ltd.)
- One containing box with separate baseboard.
- One packet Radio Press panel transfers.
- Square wire, flex, necessary screws, etc.

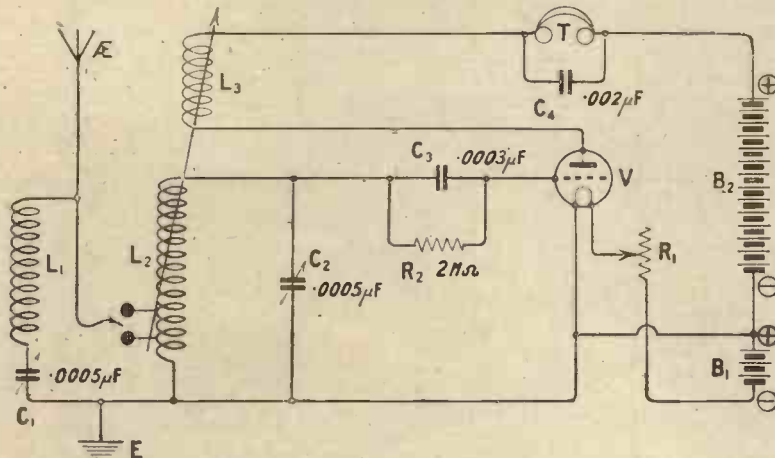
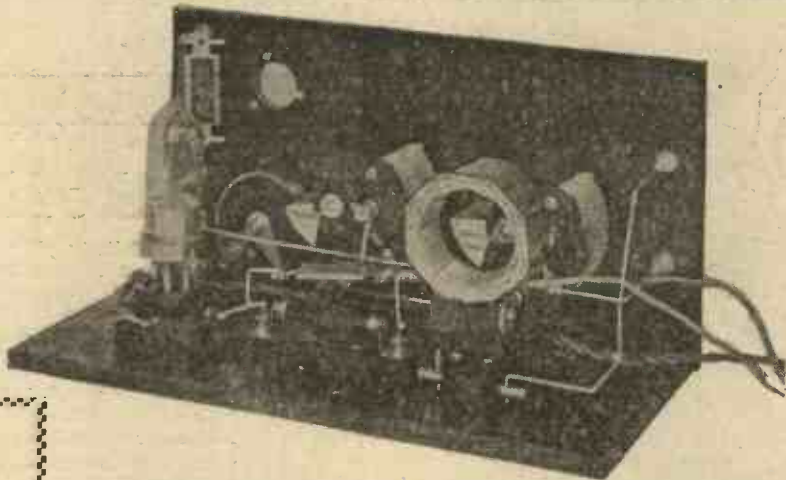

Fig. 1.—Showing the arrangement adopted. The circuit L₁ C₁ forms the wave-trap.

Apart from the above list, a set of Lissen X coils will be required; there are four, Nos. 50, 60, 75 and 250, the latter being for Chelms-

Those who are troubled with interference often have to use a wave-trap, and in this article is described a neat single-valve receiver in which the wave-trap is built into the same cabinet as the set



The valve and trap coil are mounted inside the cabinet

ford. These coils are not expensive, and will always be found useful, as they make it possible to try aperiodic aerial tuning on any receiver which employs plug-in coils.

Construction

Having collected all the necessary components together, the construction of the receiver may be started. It is advisable first of all to make sure that the ebonite panel will fit into the cabinet, as, should this not be the case, it will be found very difficult to file the edges when all the components are mounted and the set wired.

After making sure that the panel is going to fit into the cabinet, drill it in accordance with the drilling diagram, which is given in Fig. 2. Next put on the transfers as shown in the same diagram, and mount the necessary components

on the baseboard, and also mount all the components which have to go on to the panel. The next step is to join the panel to the baseboard, and it is best to fit both into the cabinet when this is done, so as to ensure that they will fit in again.

Wiring

There is not very much wiring to the set, and it is shown in Fig. 3. Care must be taken when bending the wires to leave ample clearance for the valve and the coil which go behind the panel. It will be noticed that the reaction coil leads have to run right from one end to the other of the set. They are of

twin flex, and are fixed to the baseboard by means of two wood screws with washers. Two pieces of flex must be soldered on where indicated for connection to the grid coil.

The Coil Holder

The coil holder is fixed to the top left-hand end of the cabinet, and four holes are drilled, through which the flex may be taken and connected to the coil sockets. If when working the set the reaction coil does not give the necessary reaction effect, the two leads to the socket of this coil must be changed over.

The construction is now com-

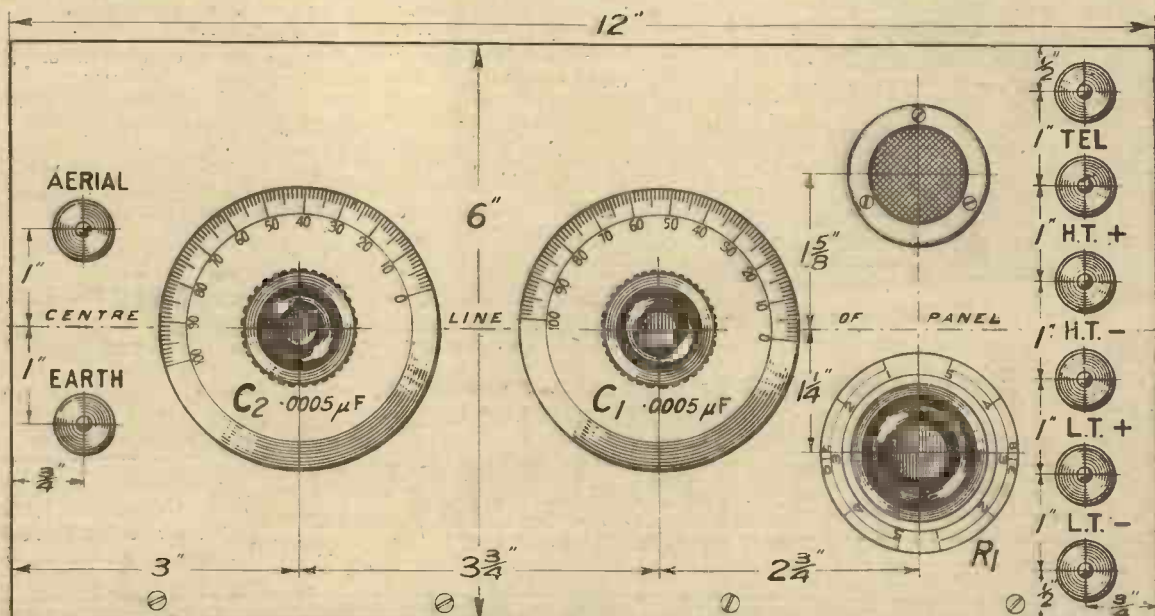

Fig. 2.—The panel layout is extremely simple, as this drawing shows. The aerial tuning condenser is that on the left, C₁ being the wave trap condenser.



Reflection

THE Heliograph was extensively used by our Armies abroad for transmitting news over fairly long distances. The Sun's rays were reflected from a mirror, which was rotated by a "key" giving the "dot and dash" intervals of the Morse code.

Radio has relegated this instrument to the interesting past, and we mention it here because its power of reflection is singularly in keeping with **MH** Radio Components, since they too reflect—the highest radio efficiency and best workmanship.

MH Fixed Condensers

The new improved type **MH** fixed condenser is now available. All capacities are a standard size and instantly interchangeable. Both sides are faced with high-grade insulating material with the capacity engraved on one side.

Capacity is within 10 per cent of its rated value, an important feature especially when condensers are used in critical circuits. They never change their value and will give you everlasting service.

PRICES

As illustrated, any value.

'0001 μ F to '001 μ F	1/9 each	Mounted on ebonite base, with terminals, any value.
'002 μ F to '01 μ F	2/3 each	
(Two clips are supplied with each Condenser.)		'0001 μ F to '001 μ F 2/9 each
		'002 μ F to '01 μ F 3/3 each



MH Condenser in Clips



MH Condenser mounted on Base



MH Grid Leak (mounted)



Grid Condenser and Leak mounted

Grid Leaks and Anode Resistances

If you would be sure of a Grid Leak or Anode Resistance that does not change its value with use and is always silent in action, be sure to get **MH** resistances. Can be obtained mounted (as illustrated) or unmounted (with two clips).

PRICES

Grid Leak, all values, 2/- each	Mounted on ebonite base with terminals.
Anode Resistance, all values 2/6 each	Grid Leak, all values, 3/- each
(Each supplied with two clips.)	Anode Resistance all values 3/6 each

Grid Leak and Condenser

An extremely useful and efficient unit containing a 0.0003 μ F. Condenser and 2 Meg. Grid Leak. PRICE (as illustrated), 4/- each.

You can't go wrong if you specify **MH** Components

Obtainable from all Dealers

Head Office:
Hastings House, NORFOLK ST.
STRAND, LONDON, W.C.2

L.M. MICHAEL LTD
Manufacturers of Wireless and Scientific Apparatus

Showrooms:
179, STRAND, LONDON, W.C.2
Works: SLOUGH; EUCKS.

pleted, and the set may be connected up.

Testing

The batteries, phones and aerial and earth are connected to their correct terminals as indicated by the transfers, and an extra piece of flexible wire is taken from the aerial terminal to one of the taps on the X coil; it does not make much difference which, and the best one must be found by trial, as it is governed to a certain extent by the particular aerial in use.

For the lower wavelength stations the 50, 60 or 75 should be placed in the aerial socket; the size depending on the aerial and the station to be received. Another plug-in coil about 75 or 100 is put in the reaction socket. The wave-trap coil should be as efficient as possible, although fairly good results are obtainable with any plug-in coil. The size required is about a number 50 or 75. On the Chelmsford wavelength the 250 X coil is used in the aerial socket and coils of proportional value in the other sockets, although the reaction coil may not need to be larger than the aerial coil.

Method of Tuning

When tuning in the local station the wave-trap condenser—i.e., the right-hand condenser on the panel—is not used, and should be set at its minimum. When tuning in other stations they may be tuned in through the local interference, and then the trap condenser turned until the local station cannot be heard, and the station retuned on the aerial condenser. Another plan is to tune in the local station, then reduce it to its minimum, by means of the trap condenser, and search round for other stations, with the condenser in this position. A slight readjustment of it may be necessary for accurate tuning.

The set will be found a little unusual to tune at first, but after a while it will be found extremely simple to tune in other stations and completely cut out the local one. The reaction will probably need increasing as the local station is tuned out.

Results

The set was tested on an aerial about 9 miles from 2LO, and as it was a fairly high one, the interference was greater than is usually experienced. For the reception of London the wave-trap condenser was turned to 0°. A 50 coil was used as the grid coil, with the aerial to the smaller tap; a No. 60 was used for the reaction, and a 75 for the wave-trap.

The strength was all that could

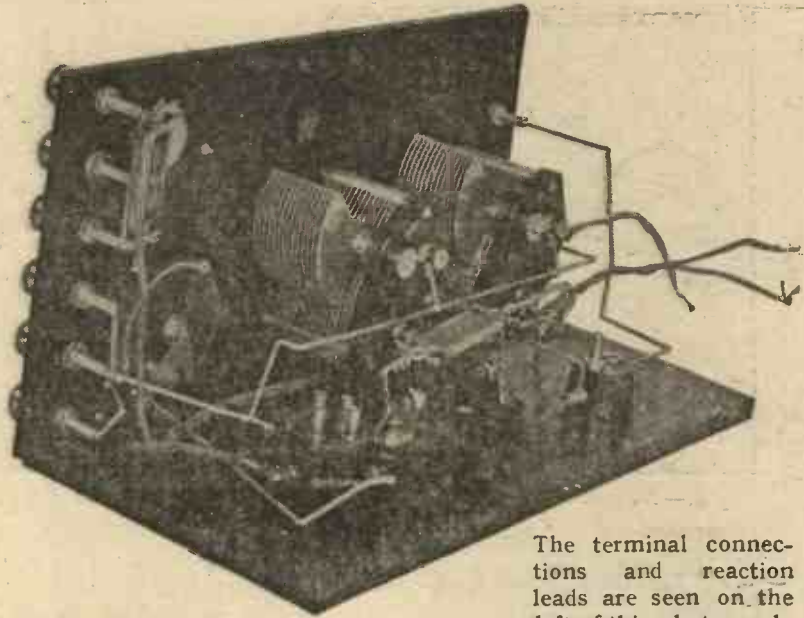

The terminal connections and reaction leads are seen on the left of this photograph.

possibly be desired on telephones, and the quality was very good. It may be mentioned here that in nearly all cases with the particular aerial in use the smaller tap was found to give the best results.

Several stations were then received while using the wave-trap without the slightest background of London. Their strength was good, and smooth control of re-

action made it easy to get them clearly as well. They included Birmingham, Glasgow, Radio Toulouse, and one or two other stations which were not identified.

When receiving Cardiff and Bournemouth, there was a little weak background from London, but it was still worth while to listen to them and possible to understand what was being said.

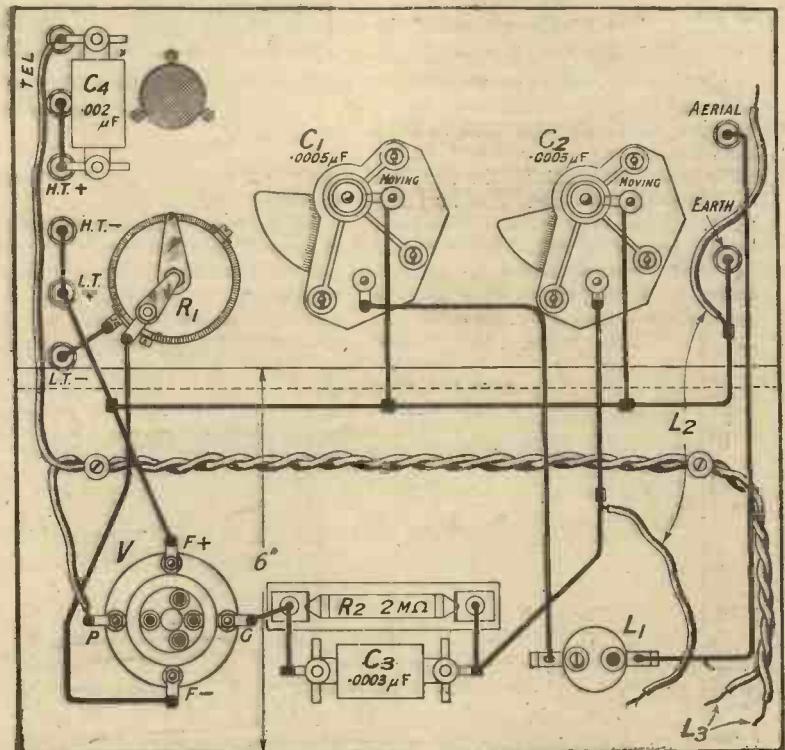

Fig. 3.—Showing the wiring of the receiver as if the panel and base-board were in the same plane.

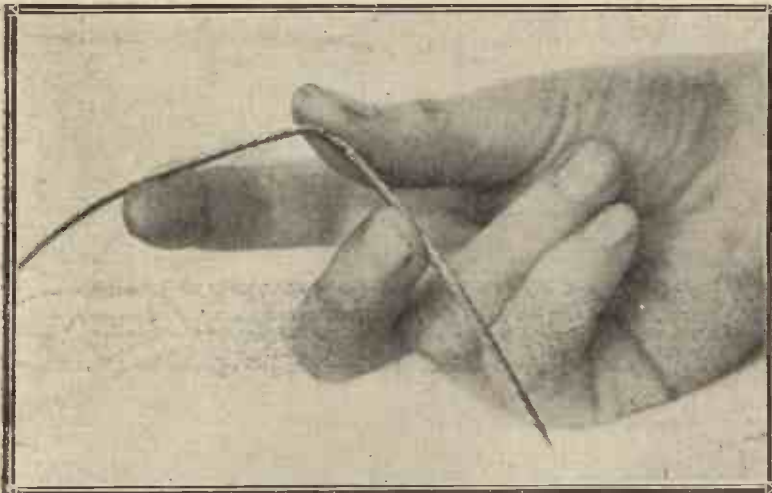

Fig. 1.—How to straighten a sharp bend in ordinary 7/22 aerial wire.

Stretching the Indoor Aerial

By D. CHARLES

An indoor aerial, especially if made from stranded wire, is quite difficult to straighten and tighten up. Here is a simple way of making a neat job

SOME men are born tidy; some manage to achieve tidiness, while others, again, submit to occasional reminders of their failing. Even in cases where "the wireless" has been installed mainly for the delectation of the feminine element in the house, a considerable set-off to the credit of one's achievement may possibly be experienced if, for instance, one's aerial straggles irregularly about the ceiling of the "best parlour." The latter term may be paraphrased to taste according to the reader's social sphere or local idiom.

Straightening Kinks

After a series of experiments the ordinary 7/22 aerial wire was found to give the best result in certain circumstances, but seemed particularly averse to taking the shortest cut between one insulator and the next. It is very easy, of course, to see plenty of kinks when a coil of this extraordinary substance is let loose in the average human habitation. Ordinary small bends are got rid of, when the monster

has been finally coaxed into comparative submission, by the simple application of two fingers and a thumb, in imitation of the primitive device employed to bend and straighten tram lines. This treatment, however, will never remove

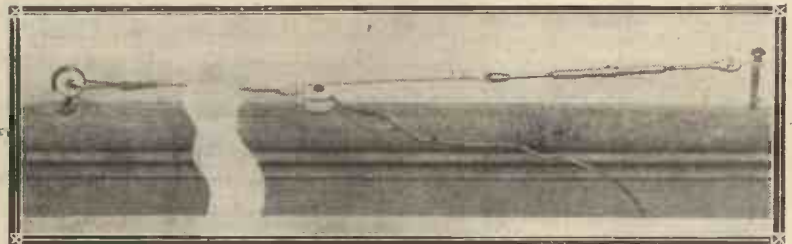

Fig. 2.—Showing how the aeroplane strainer referred to may be used for tightening up the aerial wire.

the "permanent wave" in a length of aerial wire.

If a wire can successfully be stretched just above the picture rail of a room it becomes scarcely noticeable. The difficulty is, of course, so to stretch it. After several failures by ordinary methods,

—that haven of the home craftsman—he may pick one up for twopence.

The aerial wire should be fixed at one end to an insulator, and a length of thin wire or string lashed to a spot rather short of where it is to reach the insulator at the other end of the room. This short piece is tied to one loop of the extended strainer while the other loop is temporarily tied to a stout screw put into the upper edge of the moulding. Revolving the strainer results in a tremendously strong pull being exerted, and the free end of the 7/22 can then be taken round the insulator and securely tied while its main length is stretched taut. After this the strainer with its screw and bit of wire can be removed to the next strategic point.

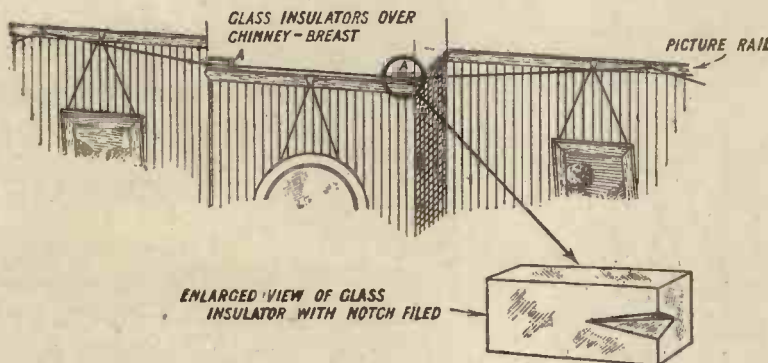

Fig. 3.—Where the wire passes over the chimney breast, glass insulators are used, as shown.

The Lashing Wire

It may be found that the lashing wire slips during the tightening

THE FAMOUS FORMO TRANSFORMER

IS THE FINEST VALUE OBTAINABLE

ITS HIGH QUALITY FINE WORKMANSHIP SUPERB PERFORMANCE AND LOW PRICE RENDER IT UNAPPROACHABLE

WHILE THE FORMO GUARANTEE IS MORE COMPREHENSIVE THAN ANY OTHER

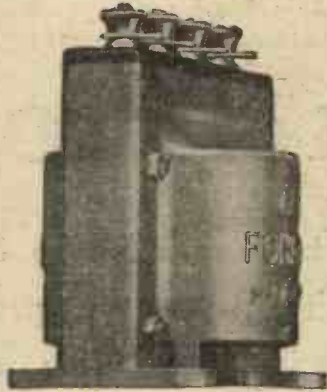

10/6 FORMERLY **18/-**

Although reduced in price, this World Renowned Transformer will remain the same in every particular and its High Quality maintained

THE FORMO CO.

(Arthur Preen & Co., Ltd.)
THE PIONEER TRANSFORMER MAKERS
Contractors to the War Office, Admiralty, Air Ministry, India Office and Post Office
Chief Office and Works:
Crown Works, Cricklewood Lane, N.W.2

OUR PROGRESSIVE POLICY

Our Progressive Policy in reducing the price of this famous line, has been more than justified by the enormous increase in the numbers sold, while we are daily receiving letters of congratulation and appreciation from both old and new customers, at home and abroad, heartily approving our efforts to provide a really good article at a fair price.



Therla / means **Efficiency**

Every individual Therla Condenser is tested for capacity by Faraday House — and guaranteed — and for all that the price of the Therla is less than that of many inferior products.

PRICE:

0001 mfd. to 0015 mfd. 1/3 each.
002 mfd. to 0036 mfd., 2/- each.

SMALL things are apt to be overlooked, yet in most cases they are the root cause of many troubles that occur. This is so in Radio. Consider fixed condensers as an example. Although quite small components, if at all defective they play havoc with the efficient functioning of other components. Then in the matter of capacity, condensers of indefinite value may easily prevent the efficient working of the rectifying valve. Weak and distorted reception is the result! Therefore, incorporate into your receiver THERLA Fixed Condensers, the capacities of which have been proved by individual test within very accurate commercial limits. This unique test is made by the Faraday House Testing Laboratory. This is your guarantee. It means ultra-efficiency.



Sole Distributors:

REGD NO: 457042

Telephone: Regent 1140

SEL-EZI WIRELESS SUPPLY CO., LTD. 6 GREEK STREET LONDON, W.1 and 20, OLD HAYMARKET, LIVERPOOL

Barclays 1233

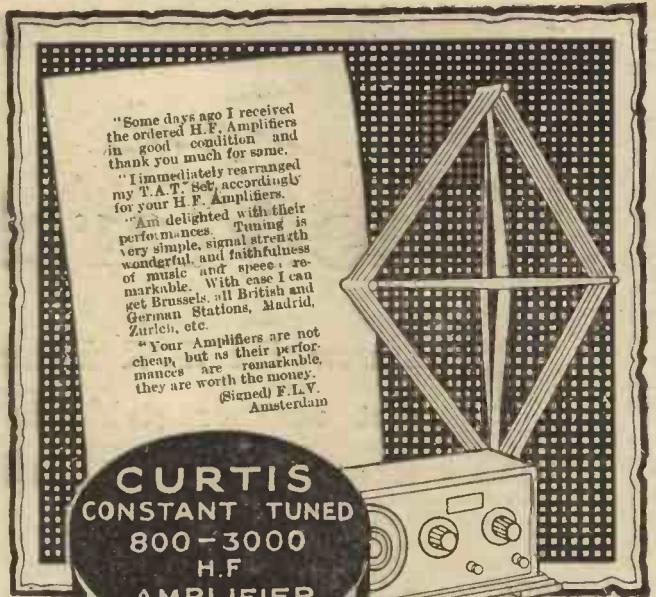

"Some days ago I received the ordered H.F. Amplifiers in good condition and thank you much for same."

"I immediately rearranged my T.A.T. Set, accordingly for your H.F. Amplifiers."

"Am delighted with their performances. Tuning is very simple, signal strength wonderful and speed of music and speech remarkable. With ease I can get Brussels, all British and German Stations, Madrid, Zurich, etc."

"Your Amplifiers are not cheap, but as their performances are remarkable, they are worth the money."
(Signed) F.L.V. Amsterdam

CURTIS CONSTANT TUNED 800-3000 H.F. AMPLIFIER

Here's the **PROOF** that—

The Curtis Constant-Tuned (Aperiodic) H.F. Amplifier reaches out!

Type A, 250 to 800 Metres Price 15/-
Type B, 800 to 3,000 Metres. Price 17/5
Type C 2,000 to 7,000 Metres. Price 18/5
Type C is especially designed for Super-Heterodynes.

A few old-fashioned and some very young people believe that multiplicity of tuning controls results in higher efficiency. The more knowledgeable know that multiplicity of controls increases instability and tendency to oscillate; thus efficiency is correspondingly reduced. Up-to-date wireless practice tends entirely to eliminate every possible moving control on a Receiver and aims at minimum control as the ideal.

THE CURTIS MICA VARIABLE CONDENSER — an amazing instrument

A few exclusive features

LOW LOSS

Wavelength Range 150 to 1

Low Minimum Earthing Plate.

Protected from dust and damp by hand-some brass case

No interaction

Silent operation

Square Law

Brass Plates

Price 12/6

In three capacities.

High-frequency Aperiodic coupling (i.e., Constant-Tuned Amplifiers) being absolutely automatic in its action, represents the most modern Radio practice.

The Curtis Constant-Tuned H.F. (Aperiodic) Amplifier eliminates the potentiometer — that hopeless bludgeon of Radio efficiency — all the tendency to self-oscillate and guarantees absolute stability with maximum Radio efficiency. Indispensable for maximum Efficiency and Purity of Reproduction, with all High Frequency and Super-Heterodyne Circuits.

BUILD YOUR OWN DUODYNE

The Genuine Long Range Receiver

1/6

The wholly inexperienced can build this long-range receiver with the aid of The Curtis-Duodyne Folder for home constructors, which includes—

1. Circuit diagrams for 3 and 5 valves
2. Simplified Lay out and wiring charts for 3 and 5 valves.
3. Instructions for operation
4. Complete schedule of all material required.

Southall, Middlesex,

June 10th, 1925

"... At the present time I can definitely say that it Duodyne V) is the best five-valve set I have operated, and I have made somewhere between sixty and seventy, from a crystal set to five-valve sets.—F.V."

PETER CURTIS, LTD.

75, GARDEN ROAD, N.W.1

Telephone NORTH 3112
Telegrams "PARAOURTEX"

Barclays

The March of Progress

THE new B.T.H. R Valve, now reduced to 8/-, represents yet another stride in the march of progress. It is undoubtedly the finest valve in the bright emitter class.

Amongst the special features which contribute to the remarkable efficiency of the new B.T.H. R Valve are the following:—

HIGH VACUUM, ensuring silent working and long life.

LOW ANODE CURRENT, with consequent increase in life of H.T. battery.

EXCEPTIONALLY LOW GRID CURRENT, ensuring excellent quality and volume without distortion, even when the means of giving suitable grid bias are not available.

TIPLESS BULB, giving better appearance and reducing risk of accidental breakage.

Filament voltage - - - 4 volts
 Filament current - - - 0.7 amp.
 Maximum anode voltage - 100 volts
 Voltage amplification factor - 7.5
 Anode resistance - - - 27,000 ohms.

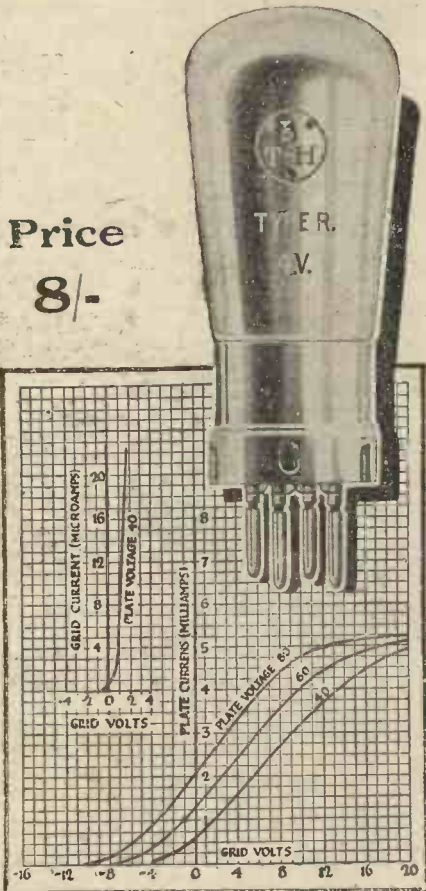

B.T.H. R VALVE

Insist on B.T.H.-the Best of All.



Advert of The British Thomson-Houston Co., Ltd.

process, but this tendency may be avoided by binding it upon the aerial wire as shown in the sketch.

The Chimney Breast

After a lapse of time the aerial wire will be found to have slackened, and a repetition of the straining process will then be advantageous.

At one part of the room the aerial wire may cross above the

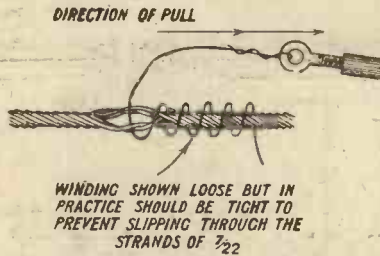

Fig. 4.—How to secure the lashing wire to prevent slipping.

chimney breast. A neat result can be obtained here by straining the wire across this as in Fig. 3 and inserting at the points AA a couple of slips of fairly thick sheet glass about 1½ in. by 1 in. with their edges resting upon the picture rail. To prevent the aerial slipping off the glass a notch is made in the end of each. This is ever so easy to do with a three-corner file and plenty of water to lubricate it.



Lubricating Bolts

Before inserting threaded brass parts, such as valve legs, terminals and bolts into the holes tapped in the panel to receive them, it is a good plan to give them a light coating of graphite. This not only makes it easier to screw them in, but also ensures that they will not jamb in case it is desired to remove them at any time. Ordinary black-lead or soft lead pencil will serve quite well for the purpose.

When round-section wire is used for wiring-up a receiver and loops are to be placed under terminal heads, a sound electrical contact will be assured if the loops are first flattened with a hammer; the loops are made slightly larger than is necessary, as they will close up when flattened. A. V. D. H.

Some Items of Interest
How to make your condenser dials work smoothly—Inserting bolts into panels—Wiring with round wire

Variable Condenser Dials

FOR the panels of a receiving set to present a neat appearance, it is necessary to set the dials of the variable condensers on their spindles without a wide gap between their rims and the surface of the panel; this also makes it easier to take accurate readings of dial settings, since the scale passes close to the indicator. But it frequently happens that the dial, if set too close, scrapes on the panel and becomes awkwardly

stiff to turn. This difficulty may be obviated in a simple manner, by glueing a ring of thin felt or plush to the underneath of the dial, inside the raised rim; if necessary, thin card rings are first glued to the dial, so that the surface of the felt projects slightly above the raised part of the rim. The dial may then be set down quite firmly against the panel, and it will be found that the condenser has acquired a delightfully "silky" feel round the whole of its scale.

Be Fair

—to your Receiving Set. Give it the opportunity it deserves, to show you what it can really do.

There are undreamed of "DX" possibilities in every Receiver—in your Receiver—if you will only provide a reproducer that won't hide the little signals it receives, so that you don't know that they have been received.

Any Receiving Set that is worth attaching to an aerial is worth treating fairly—is worthy of the best headphones—is worthy of "General Radiophones."



PER 20/- PAIR

Try them and see!

"THE BIG THREE"
FAMOUS FOR EFFICIENCY

General Radio

"GENERAL RADIO'S BROADCAST RECEIVER OR COMPONENT MEANS THAT IT IS GUARANTEED TO GIVE PERFECT SATISFACTION."

GENERAL RADIO COMPANY LIMITED
 RADIO HOUSE, 235, REGENT ST., LONDON, W. 1

Sound Speaker Strength For Everyone!

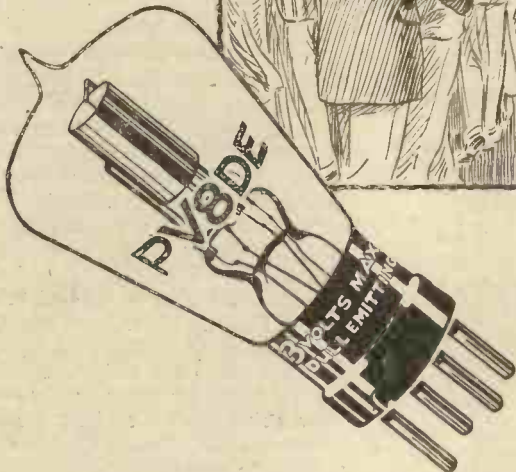

NO need to add another stage of L.F.—fit Ediswan Power Valves and increase the strength of reception without altering the purity of tone.

If you already use L.F. amplification, or contemplate using it, Ediswan Power Valves will give you considerable power without a trace of distortion. Filament current consumption is low and plate voltage moderate. Extremely satisfactory results in the dual stage of reflex circuits, too.

Write or ask your Wireless Dealer for particulars of Ediswan Valves and Royal "Ediswan" Lamps—made with the same skill and care as the valves.

EDISWAN POWER VALVES

will improve ANY set

EDISWAN VALVES	
PV.5DE.	22/6 FilVols 5-0
PV.6DE.	18/6 " 18-20
PV.8DE.	22/6 " 3
AR(L.F.or H.F.)	8/- " 4
R	8/- " 4
ARDE(L.F.or H.F.)	14/- 18-20
AR.06	16/6 " 25-3

THE EDISON SWAN ELECTRIC COMPANY, LTD.,
123, Queen Victoria Street ————— LONDON, E.C.4



Hand-Capacity in Tuning

By A. V. D. HORT

Some notes on how this undesirable phenomenon may be reduced

THE phenomenon known as "hand" or "body-capacity" at one time or another causes difficulties in tuning to most experimental users of wireless apparatus. A short explanation of the nature of this trouble may lead to a clearer comprehension of the methods employed in dealing with it, which it is proposed to describe in this article.

In Fig. 1 is shown an ordinary

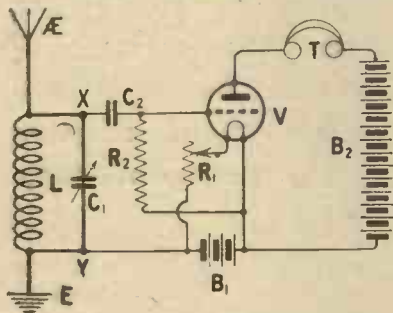

Fig. 1.—A simple circuit to illustrate the effects dealt with.

single-valve receiving circuit without reaction, in which the coil L , and the variable condenser C_1 , comprise the oscillatory circuit; the desired station is tuned in by adjustment of C_1 . Now the incoming oscillations present in this circuit set up differences of potential across the coil and condenser, and since one side Y of these is connected to earth, the other side X will be at an average high frequency potential above that of earth. The operator of the set is always earthed, so that if his hand or any part of his body is brought near the side X of C_1 , this is equivalent to adding more plates to the earthed side of the condenser, increasing its capacity and raising the wavelength to which the set is tuned. This is the effect often noted when tuning in

a weak distant station, that any movement of the operator near the receiver causes the signals to disappear; this will, of course, occur when the hand approaches not only the tuning condenser, but also the coil, and any part of the circuit which is at high frequency potential to earth, being usually most noticeable when tuning adjustments are being carried out. Hand capacity is specially troublesome in sets fitted with reaction, when the valve is operated very close to the oscillation point; under such conditions the receiver is in a very sensitive state, and slight movements on the part of the operator will alter the tuning and frequently cause the valve to start oscillating. Obviously such a state of affairs renders fine tuning an extremely difficult matter, and may, in sets fitted with reaction on to the aerial, cause interference with other listeners.

Reduction of Body-Capacity

It is possible on any receiver to reduce considerably, and on receivers used on the broadcasting wavelengths practically to eliminate this trouble. The first and most important point which must receive attention is the design of the receiver. If the components are mounted on a horizontal panel, they should be so arranged that the tuning condensers and the handles of the coil holders are placed in such a position that the hand need not pass over other parts of the set in tuning. The employment of a vertical panel to carry the main controls, the other components being distributed over a horizontal baseboard behind the panel, sometimes renders the design of the receiver a simple matter from this point of view. In this case the hand approaches the controls without going near the other parts, since these can be disposed on the base-

board in such a manner that those at high frequency potential to earth are, as far as possible, placed furthest from the panel.

Screening

Careful design therefore can minimise the effects of hand capacity on a large portion of the circuit. But even so, the tuning condensers may give trouble. It will frequently be found that connecting the moving plates to the earth terminal of the set solves the problem; the spindle carrying the moving plates of the condenser, which passes up inside the tuning dial and knob, is then at the same potential as the hand, so that there is no capacity effect between the hand and the spindle. But sometimes this precaution proves inadequate, and the further expedient may then be tried of placing a metal disc, of non-magnetic metal such as aluminium or brass, between the dial and the panel electrically connected to the condenser spindle. The hand, which previously acted as an additional moving-plate approaching the fixed plates below the panel, is now screened from them. It is still possible, however, that even this device will not completely get rid of the trouble. A glance at Fig. 2

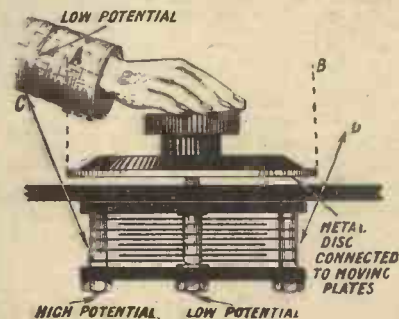

Fig. 2.—The reason why screening does not always eliminate hand-capacity effects.

Radio Construction under expert guidance

The Radio Press envelopes are the most dependable guides for the radio constructor ever devised. Every step in the construction of a radio instrument is fully explained in a lucid manner by an expert. Providing the instructions are carefully carried out, a radio instrument described in an R.P. envelope will always be a great success.

RADIO PRESS ENVELOPES

- | | | | |
|---|-------|-----|-----|
| 1 How to Build an S.T. 100 Receiver | Free. | 1/6 | 1/9 |
| By John Scott-Taggart, F.Inst.P., A.M.I.E.E. | | | |
| 2 How to Build a 4-Valve Receiver | 2/6 | 2/9 | |
| By Percy W. Harris, M.I.R.E. | | | |
| 3 How to Build the "Simplicity" 3-Valve Set | 2/6 | 2/9 | |
| By G. P. Kendall, B.Sc. | | | |
| 4 How to Build the All Concert-de-Luxe Receiver | 2/6 | 2/9 | |
| By Percy W. Harris, M.I.R.E. | | | |
| 5 How to Build the Omni Receiver | 2/6 | 2/9 | |
| By John Scott-Taggart, F.Inst.P., A.M.I.E.E. | | | |
| 6 How to Build the A.B.C. Wave Trap | 1/6 | 1/9 | |
| By G. P. Kendall, B.Sc. | | | |
| 7 How to Build a 2-Valve Amplifier-de-Luxe | 1/6 | 1/9 | |
| By Herbert K. Simpson | | | |
| 8 How to Make a 1-Valve Reflex Receiver | 1/6 | 1/9 | |
| By Herbert K. Simpson | | | |
| 9 How to Build an efficient Single Valve Set | 1/6 | 1/9 | |
| By Herbert K. Simpson | | | |
| 10 The Twin-Valve Loud-speaker Receiver | 2/6 | 2/9 | |
| By John Scott-Taggart, F.Inst.P., A.M.I.E.E. | | | |
| 11 An Adaptable Crystal Set | 1/6 | 1/9 | |
| By Percy W. Harris, M.I.R.E. | | | |

- RADIO PRESS PANEL CARDS**
- 1 How to Make the W.I. Receiver ... 1/- 1/3
- By Herbert K. Simpson
- SIMPLEX WIRING CHARTS**
- 1 For 2-Valve Set ... 1/- 1/3
- 2 For 3-Valve Set ... 1/- 1/3
- 3 For 4-Valve Set ... 1/- 1/3
- RADIO PRESS WIRELESS PANEL TRANSFERS** ... 6d. 8d.
- "MODERN WIRELESS" COIL TABLE for Aerial, Anode and Re-action Coils** ... 6d. 8d.
- All above can be obtained from Wireless Dealers, Booksellers—or direct from Dept. W.



RADIO PRESS, LTD.
BUSH HOUSE, STRAND, LONDON, W.C.2

Barclays Ad.

K. RAYMOND

HULLO EVERYBODY!

ALL GOODS POST FREE U.K. except where stated. Foreign orders over £10 post free, otherwise please send ample for post, etc. Trade orders U.K. less 20 per cent., post extra. Open all day Saturday.

- SUNDRIES.**
- | | | | | |
|------------------------------|----------|---------|-----------|-----|
| Aerial 722 100 ft. | 2/6 | No. 100 | 400-1,000 | 1/2 |
| 2-way coil stands | 2/9 | No. 150 | 6.0-1,500 | 1/8 |
| 3-way coil stands | 4/6 | No. 200 | 800-2,000 | 2/9 |
| 2-way nickel | 3/6 | No. 250 | 900-2,500 | 3/3 |
| 3-way nickel | 4/11 | | | |
| 2-way gen'd | 5/6 | | | |
| 2-way Shipton cam | 5/- | | | |
| 3-way Shipton cam | 7/6 | | | |
| 2-way Polar cam | 6/- | | | |
| 3-way Polar cam vernier | 9/- | | | |
| 2-way cam vernier | 3/6 | | | |
| Coil plugs, plain, 2 for 1/3 | | | | |
| Shaped wedge, 2 for 1/6 | | | | |
| Do. Edison Bell, 2 for 2/- | | | | |
| Do. Nickel sides, 2 for 1/6 | | | | |
| Do. fitted fibre, 2 for 1/6 | | | | |
| Ebonite do. | 4/11 | | | |
| Edison Bell do. | 10/- | | | |
| Fixed Condensers | 10/- | | | |
| Edison Bell | 0001 1/3 | | | |
| 0001 up to 0005 1/3 | | | | |
| 0002 up to 0006 2/- | | | | |
| Grid leak and clips | 1/3 | | | |
| 0003 and grid leak | 2/6 | | | |

- LOUD SPEAKERS.**
- | | |
|------------------|-------|
| C.A.V. Tom-Tit | 30/- |
| G.T.V. Junior | 55/- |
| Sterling Baby | 55/- |
| Sterling Dinkie | 30/- |
| Amplion Junior | 27/6 |
| Amplion Dagonfly | 25/- |
| Amplion do. III | 30/- |
| Amplion De Luxe | 55/- |
| Amplion A.R.19 | 105/- |
| Dulcevox | 42/- |
| True Music Minor | 21/- |
| Ultra | 27/6 |
- Transformers L.F.**
- | | |
|-----------------------|--------|
| Eureka Concert Grand | 30/- |
| Eureka Second Stage | 22/6 |
| Igramic Shrouded New | 21/- |
| Formo Shrouded | 10/6 |
| General Radio 83 | 15/- |
| Perro Success (black) | 21/- |
| Brunet shrouded, 3-1 | |
| or 5-1 | 13/6 |
| C.X. | 9/6 |
| Wates Supra | 12/6 |
| Terminals, complete | |
| Pillar, doz. | 1/ 1/3 |
| W.O. | 1/3 |
| "Phone | 1/1 |
| Nickel 9d. doz. extra | |
| Voltmeter, each | 5/6 |
| Rheostat and Dial | 2/3 |
- Adjustable Phones.**
- | | |
|--------------|-------|
| Dr. Nesper | 12/6 |
| Telefunken | 16/11 |
| Both Genuine | |

- Valves**
- R.T.H. Ediswan Mullard, Cossor, Marconi, Bright, D.E. '08 and po-er valves all stocked.
- Igramic Coils.**
- | | |
|---|--|
| Coils—25 5/-, 35 5/-, 50 5/2, 75 5/6, 100 7/-, 150 7/10, 200 9/2, 250 9/4, 300 9/5, 400 9/6 | |
| Rheostat 4.6. 30 ohms 7/- | |

- Ormond.**
- | | |
|------------------|------|
| L.F. Transformer | 14/- |
| Special Rheostat | 2/- |
- Ever-Ready.**
- | | |
|----------------|------|
| 108 volts H.T. | 20/- |
| 68 volts H.T. | 12/6 |
- COIL FORMERS FOR winding own coils**
- | | |
|-------------------------------|------|
| With handle | 3/6 |
| Without | 1/6 |
| Brass | 3/- |
| Spade or pin terminals, dozen | 10d. |
| Extension handles, doz. | 1/- |
| Twin Bell Wire, dozen yards | 2/- |
- Headphones.**
- | | |
|----------------------|------|
| British, 4,000 ohms. | 22/6 |
| Sterling's | 20/- |
| Ditto Lilliput | 20/- |
| each | 10/- |
| Brown's F Type | 20/- |
| Ericsson's | 22/6 |

- 2-VALVE SET** complete with valves accumulator, phones, aerial wire, insulators, post extras.
- £5:19:6** Post free.

- EBONITE**
- | | |
|-------------------------|------|
| Stock sizes 3 1/8th. | |
| 6 x 6—7 x 5 each | 1/2 |
| 8 x 6—9 x 6 each | 1/10 |
| 10 x 8—12 x 6 | 3/- |
| 12 x 9 | 4/3 |
| 12 x 12 | 5/6 |
| 14 x 10 | 5/6 |
| 1 1/2 in. also stocked. | |

WEST END STOCKIST OF Edison Bell, J.B. (Jackson Bros.), Polar, Igramic, Mullard, Sterling, B.T.H., McMichael's, Lissen, Woodhall, Dubilier, Marconi, Dorwood, H.T.C., Watmel, Eh,pton, Climax, goods.

- RAYMOND**
- Variable Condensers
- SQUARE LAW LOW-LOSS**
- One-hole fixing. Ebonite ends.
- | | |
|--------------|-----------------|
| With Vernier | Without Vernier |
| 001 .. 8/6 | 001 .. 7/6 |
| 0005 .. 7/6 | 0005 .. 5/9 |
| 0003 .. 7/- | 0003 .. 5/3 |
- Including Knob and Dial.

- "DE LUXE"**
- Standard.
- | |
|-------------|
| 001 .. 7/6 |
| 0005 .. 6/- |
| 0003 .. 5/6 |
| 0002 .. 4/- |
- Take up tiny space. Knob and dial free.
- ORMOND**
- "No. 3"
- Ebonite Ends.
- | |
|-------------|
| 001 .. 10/6 |
| 0005 .. 9/6 |
| 0003 .. 8/6 |
| 0002 .. 7/6 |
- Square Law with vernier. Knob and dial free.

- ORMOND "AMERICAN"**
- Square Law Low Loss. Skeleton ends, knob and dial.
- | | |
|--|--|
| 001, 5/-; 0005, 8/-; 0003, 7/6; 00025, 6/6 | |
| (with vernier 1/6 each extra). | |

- JACKSON BROS. "J.B."**
- Square Law Ditto with vernier.
- | | |
|---------------|---------------|
| 001 .. 9/6 | 001 .. 13/6 |
| 0005 .. 12/6 | 0005 .. 12/6 |
| 0003 .. 11/6 | 0003 .. 11/6 |
| 00025 .. 11/3 | 00025 .. 11/3 |
- "J.B." 001 .. 6/6 0005 .. 7/-
- Standard 0003 .. 5/9 0002 .. 5/-
- ALL with knob and dial. Post free.

- ACCUMULATORS.** Post free.
- | | |
|--------------|-------|
| 2-v. 40-amp. | 9/6 |
| 2-v. 60-amp. | 11/6 |
| 4-v. 40-amp. | 15/11 |
| 4-v. 60-amp. | 19/6 |
| 4-v. 80-amp. | 24/6 |
| 6-v. 60-amp. | 29/6 |
- All new, best makes. Harts also stocked.
- Goswell (quality) Mounted Coils.
- | | |
|-----------------------------------|--|
| 25 1/6, 35 1/9, 50 2/- | |
| 75 2/3, 100 2/9, 150 3/3, 200 3/9 | |
- 2-way Panel, 3/-
- 2-way, 5/- 2-way camvernier, 9/-
- All parts stocked.

- "LOTUS"**
- Geared 8:1, 2-way 7/6
- Geared 8:1, 3-way 10/6
- "Magnum."** All parts stocked.
- McMichael's Triple Rheostat ... 22/6
- Dual Rheostat ... 7/6
- H.F. Transformer ... 10/-
- (All wave-lengths)
- Potentiometer ... 7/6
- Fixed Condensers, 1/3, 2/3

- Burndepd Parts.**
- | | |
|---------------------|----------|
| Aerial | 4/- |
| Rheostats | 4/6, 7/6 |
| Antiphonic V.H. 5/- | |
- Success choke ... 10/6
- Athol V.H. ... 1/3
- Athol Coil Plug ... 1/3
- T.C.B., 6 ohms ... 4/-
- T.C.B., 30 ohms ... 4/-
- T.C.B., Potentiometer (500) ... 5/-
- Shipton do. (600) ... 4/6
- ERICSSON E.V.** (Continental)
- | | |
|------------|------|
| 4,000 ohms | 12/- |
|------------|------|

CALLERS: for Every British Valve or Purchase here I will buy one burnt-out valve from you. Prices given from 1/3 to 4/-; also open to take old parts in exchange for New British Goods.

- CALLERS' COLUMN ONLY**
- All Post Orders from Other Columns.
- H.T. Batteries. (Various makers)
- | | |
|-------|----------------|
| 60-v. | 5/6, 6/6, 6/11 |
| 80-v. | 12/6, 14/11 |
- 66-v. Ever Ready ... 12/6
- 108v. ... 20/-
- 30v. B.B.C. ... 8/6
- 38v. ... 5/6
- 16'3 ... 2/9
- 9v. (grid bias) ... 2/3

- Accumulators.** (Well-known makes)
- | | |
|-----------|--------------|
| 2r. 40a. | 7/6, 8/6 |
| 4v. 40a. | 13/11, 15/11 |
| 4v. 60a. | 17/6, 18/3 |
| 4v. 80a. | 22/6, 23/6 |
| 6v. 60a. | 25/11, 27/6 |
| 6v. 100a. | 33/- |
| 6v. 100a. | 38/6 |

- Square Law Variable Condensers.**
- | | |
|------|-----|
| 0003 | 4/6 |
|------|-----|
- Including knob and dial.
- D.P.D.T. Panel ... 1/6
- S.P.D.T. ... 10d.
- D.P.D.T. China ... 1/3
- S.P.D.T. ... 10d.
- Terminals, 1d; dozen, 10d.
- Nickel ... 11d.
- Valve sockets ... 4 for 3d.
- Stop or valve pins ... 1d.
- Washers ... 12 in 1d.
- Nuts ... 6 in 1d.
- Spade tags ... 6 in 1d.
- Spade terminals, 2 for 1d.
- Pin terminals, 2 for 1d.
- Pin terminals, 2 for 1d.
- Wandler plugs ... 2d.
- Copper foil, foot ... 2d.
- Red and black flex, 12 yards, 1/5
- Aerial, 722 100 ft. ... 1/11
- Battery clips ... 3 in 1d.
- Screening, 20 ft. ... 3d.
- Wandler plugs ... 2d.
- Contact studs complete ... 2 in 1d.
- Phone coils, 6 ft. ... 1/3
- Knobs ... 1d.
- Knobs and Discs ... 10d.
- Empire wire 12 yards, 6d.
- Valve Holders ... 8d.
- Plug and Jack ... 2d.
- 722 Aerial, 50ft. ... 1/7
- Ins. Hooks, 2 for 1/6
- Lou speaker cords, 14, 1/6
- Ins. Staples ... 5 in 1d.
- Flush panel sockets (nickel and nuts) 1d.
- Rheostats, special ... 9d.
- Vernier condensers ... 1/9
- Tumbler switches ... 10d.
- Shorting plug ... 3d.
- Eqg. Insulators, 4 for 3d.
- Variometer, 250, 450 ... 1/6
- Anticlipitto ... 4d.
- Good rod standard ... 1/-
- Slide rule ditto ... 8d.
- Hank 1/10 sq. Bus Bar, 6d.
- Lead in 16 yards ... 1/3
- Ebonite dials ... 8d.
- Unbreakable knobs ... 3d.
- Adhesive tape ... 10d.
- TWIN Aerial 100 ft. ... 1/10
- Phone Boards 4 pairs ... 1/3
- 6 pairs 1/11

- IMPOSSIBLE ADVERTISING ALL LINES STOCKED. PLEASE MAKE OUT LIST of goods required; will quote lowest possible prices by return. Immediate delivery.**
- "Wonder" Aerial** Phosphor Bronze 100 ft. ... 3/3
- Indoor, outdoor or fame, 49 strands.

- "UTILITY"**
- | | |
|-------------------|-----|
| 2 Pole c/o Knob. | 4/- |
| 1 Pole c/o Knob. | 6/- |
| 2 Pole c/o Lever. | 5/- |
| 1 Pole c/o Lever. | 7/- |
- Nickel 6d. each extra
- Special.**
- | | |
|---------------------------|------|
| Wates Microstat. | 2/9 |
| Watmel Grid Leak 2.6 | |
| Bretwood Grid Leak | 3/- |
| Bretwood Anode Resistance | 3/- |
| Resistors, 30 ohms | 2/6 |
| "Michrom" Vernier | 2/6 |
| "Polar" UNIT 15- | |
| Polar 0005 | 10/6 |
| Polar 0003 | 10/6 |

- Ebonite Coil Plugs.**
- | | |
|--------------|---------|
| Fitted Fibre | 7d |
| Plain | 4d |
| Shaped | 6d. 8d. |
| Edison Bell | 11d |
- Loud Speakers ... 15/9
- 4,000 ohm phones ... 6/6
- 2-way coil stands ... 3/6
- Special Rheostats ... 1/-
- Crystals, best ... 6d.
- Enclosed detectors ... 8d.
- Extra large do. ... 1/-
- 2-v. 40 accumulator ... 7/-

7, GRAPE STREET Shaftesbury Avenue, W.C.2
27, LISLE STREET Leicester Square, W.C.2
New Oxford Street end (Post Orders this address) (Back of Daly's Theatre)
NOTE:—Grape Street is between Prince's Theatre and Mudie's Library. Open 9 to 8. Sundays 11 to 1. Lisle St. Only.
Be Sure IT'S RAYMOND'S
Nearest Tube: Tottenham Court Rd. OPEN: Daily, 9 a.m. to 8 p.m.; Sundays, 11 a.m. to 1 p.m.

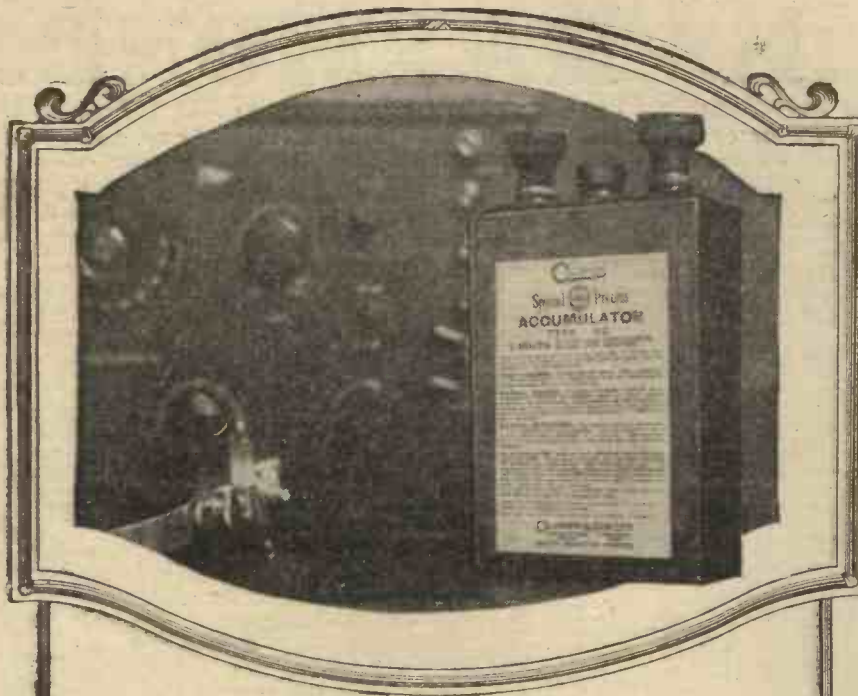

To the Beginner— a word of advice

YOU use an Accumulator to give you a lighting service for your Valves. The total cost of your Accumulator, therefore, is not what you pay for it when you buy it in the shop. Its real price to you is the purchase price plus the number of chargings per annum. For instance, it is obviously cheaper to buy an Oldham Accumulator at 38/- which will run a 3-Valve Set for 18 days on one charge than to buy one of any other make for 35/- which will be exhausted in 13 days. The extra five days use you get from the Oldham will more than repay you for the very slight extra initial cost.

Oldham Accumulators cost more to make because only the finest material is used in their construction. The Oldham Plate—the heart of the Oldham Accumulator—is manufactured under the exclusive *special activation process*. This process is responsible for a plate of remarkable strength. One that resists buckling and sulphation. One that yields up the greatest amount of electrical energy. One that will stand idle over lengthy periods without suffering harm. No Oldham Accumulator has ever been built down to a price. Obviously there are cheaper accumulators to be bought, but it is foolish economy to choose a cheap one that costs considerably more to keep in a charged condition. Discriminating purchasers, therefore, whose purchasing wisdom extends beyond first cost, invariably select the Oldham as Britain's best Accumulator.

OLDHAM & SON, LTD., Denton, Manchester.
London: Hazlitt House, Southampton Bldgs., W.C.1.
Glasgow: 120, Wellington Street.

OLDHAM

ACCUMULATORS

Gilbert Ad. 3033.

LISENIN

Positive Grip Plugs and Sockets
Pat. Appd. for 248.5.1.25.



THERE can be few amateurs who have not been troubled with broken leads or stiff hard things about faulty connections. Of the whole set there is probably no part which is so often abused as the connections. Lisenin Positive Grip Plugs alleviate this evil. They are designed to take sheath and flex up to 5 mm cable. 'A' shows insulated sleeve, cone and bare cable. 'B' cone in position. 'C' cable ends turned back. Pur is recessed and sleeve clamps ensuring positive grip. Red and black. Price, plug and socket complete with die and nut, 6d. each. Spare ends same price. As used in Double Purpose set described July issue 'Wireless Constructor'.
THE LISENIN WIRELESS CO.,
1a, Edgware Rd., London, W.2

"F.A.R." L.F. Transformer (SHROUDED)

RATIO 5 to 1. 15/-

OF ALL DEALERS OR

M. BOBIN, 21 Warwick Lane, London, E.C.
Telephone: Central 4872.

The Home for Your Wireless Set!

MORRIS SOLID OAK STANDARD CABINET WITH LOCKS,

to lock up any set and batteries with panel up to 36" x 18"

Sent on approval
Trade supplied

Price carriage paid and packing free:
22" wide inside £4 15
25" " " £5 0
36" " " £8 0

MAKERIMPORT CO.
(Dept. 20)
56, Lord Street
L'VERPOOL

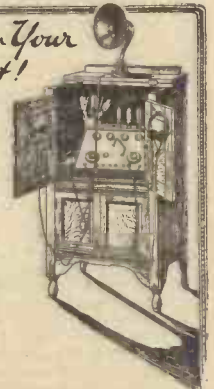

POWERQUIP
R. TRANSFORMERS
MEAN MELLOW MUSIC
The Power Equipment Co Ltd, The Hyde, Hendon, N.W.9.

COUPON
QUESTIONS AND ANSWERS
This Coupon must be accompanied with a 2/6 P.O. and stamped addressed envelope
"WIRELESS CONSTRUCTOR," Aug. 1925

will show the cause of this: though the metal disc provides protection for the fixed plates against the capacity of any earthed body immediately over the dial, the protective area is confined to the circular space whose diameter is indicated by the lines A and B. The arrows C and D show how the arm of the operator, acting as an earthed "plate," may affect the fixed plates; this effect is less than before, owing to the greater distance between the arm and the fixed plates; but when the set is

in the sensitive condition immediately preceding oscillation, it may be quite enough to upset the tuning of the receiver.

The obvious way of overcoming this difficulty is to increase the area of the metal screen; in practice, it will be found most satisfactory to cover the whole of the back of the panel with a sheet of metal foil connected to the earth terminal. Perforated metal, such as zinc, is sometimes recommended, in order to reduce to a minimum the eddy-current losses due to the presence

of this large area of metal. The use of earthed screens of any kind should be regarded rather as a cure, albeit in some cases a necessary cure when preventive means of dealing with hand capacity troubles prove unsuccessful. The soundest solution of the problem, at any rate in receivers to be used for the reception of broadcasting, lies in the careful design of the set and layout of the components, additional protective devices being employed only when such a design fails to produce the desired result.

□

Where are the Losses ?

By G. P. KENDALL, B.Sc., Staff Editor

(Concluded from page 887)

namely, in reducing the dielectric losses in the insulating material of which the socket is composed. This again, however, although worthy of a reasonable amount of consideration, should not be regarded as one of the really large sources of loss, assuming always that we are speaking only of a reasonably good component, and not taking into account the sockets made of really poor material.

Fixed Condensers

Fixed condensers do not as a rule enter into our calculations when considering possible losses in a receiving set, since their location is mostly confined to the low-frequency circuits, where all that is demanded of them is that their insulation resistance shall be reasonably high, and this feature is to be found in every fixed condenser of good make. One or two fixed condensers, however, are usually associated with the tuned circuits, and have to carry high-frequency impulses, and they are worthy of some consideration from the point of view of the losses which they may cause. Two principal positions in which fixed condensers are used in association with the tuned circuits are the first grid condenser of the rectifying valve, and secondly the fixed condenser used in series with the aerial in constant aerial tuning. In both these cases something more than perfect insulation resistance is demanded—namely, that the dielectric losses in the mica or other insulating material between the plates shall be reasonably low, and so far manufacturers of fixed condensers have contented themselves with a choice of a good grade of mica for the purpose, and it may safely

be assumed that the losses in such a component are reasonably low.

A fixed condenser specially designed with the idea of the reduction of the present accepted amount of loss has yet to appear upon the market, if we except certain fixed condensers of very small capacity which have appeared and which use air as a dielectric.

Wiring

When square wire first became popular for the wiring up of sets, several people that I know rewired sets which had been functioning perfectly when connected up with the ordinary tinned copper wire and Systoflex sleeving, and expressed themselves considerably disappointed that they did not notice a marked improvement when the new wiring was completed with stiff square wire. This brings out an important point—namely, that the wiring of a set if properly carried out need not be taken very seriously into our calculations regarding losses. Bad wiring—that is to say, wiring in which the connections are sleeved with Systoflex and bunched together, so that the capacity from wire to wire is considerable and dielectric losses possible in the sleeving—may be quite a serious source of loss; but when properly carried out, as no doubt it is done in the majority of cases, with well spaced wire, it can be assumed that the losses are negligible.

The actual gauge of wire used is not of great importance, and it must be remembered that connecting wires a few inches long have a very low high-frequency resistance, when compared with that of the other components in the circuit, such as tuning coils.

Panel Losses

The object of this article is chiefly to deal with those points at which losses of energy (in the sense of the received energy from the passing waves) may occur, and not to deal with such matters of inefficiency in functioning as may be concerned, for example, with telephone receivers, which only give out as sound a rather small proportion of the electrical energy communicated to them. With this limitation in mind, it will be seen that the other principal point in addition to those already considered at which energy may be lost is to be found in the panel material, which may cause losses of energy by actual direct leakage through the material or over its surface, or by dielectric losses between points which are at a different electrical potential. Here, again, it is fairly safe to say that so long as good material is used the losses are not among the more serious ones of the receiving installation, with the further proviso that such terminals as the aerial and earth, which are separated by considerable differences of potential, shall be fairly well separated upon the panel.

The July issue of "Modern Wireless"

contains instructions to
build an
"ALL-ENCLOSED
SUPER-HETERODYNE RECEIVER"
By G. P. Kendall, B.Sc.

Other items of interest include:

How to Obtain Better Reception.

A Skeleton Coil Crystal Set.

Faults in Tuning Coils.

&c., &c.

On Sale Everywhere.

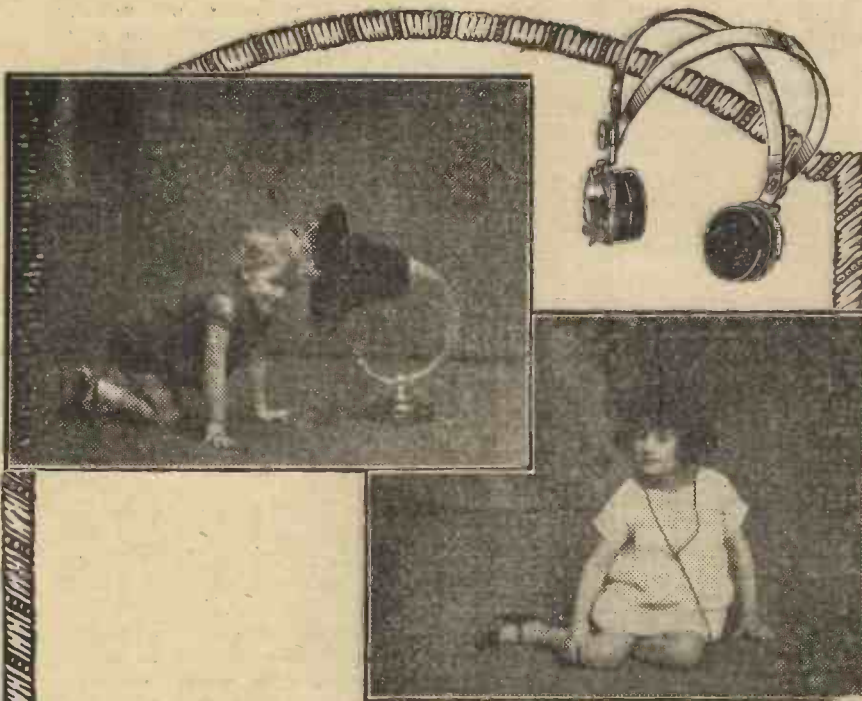

The incomparable Brown

IN every branch of industry there is inevitably some product which—by design, appearance or efficiency—is recognised as being beyond the range of competition. Radio proves to be no exception to the rule. You cannot compare other 'phones to Brown A-type. True, there may be some degree of external similarity—cords, headbands, and even cases can be produced to look very much alike. But the real essence of Brown superiority lies in its exclusive and fully patented tuned reed mechanism—a scientifically designed movement which permits the exact reproduction of even the faintest signals.

These same proved principles, which are also incorporated in every Brown Loud Speaker, are readily acknowledged by technical authorities as being one of the most brilliant contributions to the science of sound reproduction within recent years. Choose your Loud Speaker in no haphazard manner—do not consider it on external appearance alone—it is a serious investment worthy of your most careful attention. Your Dealer can demonstrate a Brown to you in one of its three sizes—hear it and then hear the others. We are confident that you'll agree that the incomparable Brown has no competitors.

LOUD SPEAKERS

Type H.1, 21 in. High
 120 ohms £5 5 0
 2000 " £5 8 0
 4000 " £5 10 0

Type H.2, 12 in. High
 120 ohms £2 5 0
 2000 " £2 8 0
 4000 " £2 10 0

Type Q
 All resistances £15 15 0

CRYSTAVOX

The Crystal Set Loud Speaker, requiring no valves or accumulators £6 0 0

HEADPHONES

A-Type
 120 ohms 50/- per pair
 2000 & 4000 ohms 50/- "
 8000 ohms 60/- "

F Type
 120 ohms 20/- "
 4000 ohms

S. G. Brown, Ltd.,
 Victoria Rd., N. Acton, W.3.

Showrooms:

19, Mortimer Street, W.1.
 15, Moorfields, Liverpool.
 67, High St., Southampton.
 13, Bushy Park Bristol.
 5, Wilson's Ct., Newcastle-on-Tyne.



Gilbert Ad 3021.

"BREAK-NOT" BATTERY TESTER THE IDEAL HYDROMETER FOR ALL WIRELESS ACCUMULATORS.

716

The "BREAK-NOT" HYDROMETER is the recognised standard of quality in battery testers and should be in the hands of every user of an accumulator. Being packed in unbreakable carton the Break-Not is the only practical instrument to keep in the tool box without fear of damage.

Liberal Terms to the trade.

S. GUITERMAN & CO., LTD.

35/6, Aldermanbury, London, E.C.2

Just out of reach—
 Because your phone leads are too short.
A PHONEREEL
 will allow you to move freely about the room and take your seat wherever is most pleasant, no matter where the set is placed.
 If you possess a Loudspeaker this is a convenient method of transporting it into the garden or any room in the house that you desire, the wire being run out as you walk along, free from knots and tangles.
 Each Phonereel carries four pairs of terminals and twelve yards of good quality flexible twin wire.
 Price complete 15/- Trade enquiries solicited
"Fit a Phonereel and listen in Comfort"
J. MERRETT & Co.
 Trowbridge, Wilts.

ELECTRADIX RADIOS
 The increasing scope of wireless apparatus has necessitated a wide increase in our already large and comprehensive stock in London.
 Our new July edition of our famous Catalogue of Radio Bargains now contains 500 illustrations of radio sets, components, and electrical instruments of great interest. Many of these are unobtainable elsewhere and our prices are the very lowest.
 The experimenter on short waves, the expert transmitter or the crystal novice will all find it advantage us to have a copy of
"THE CATALOGUE THAT SAVES YOU POUNDS"
 Its scope ranges from a 6s. pair of British Headphones or a 12s. 6d. Milliammeter to a 20,000 volt Generator, and covers all requirements.
 If you cannot call and inspect goods in our showrooms between 9 a.m. and 6 p.m. it will say you to send 4d. for our Catalogue at once. Goods promptly despatched all over the world.
LESLIE DIXON & COMPANY,
 9, Colonial Avenue, Minories, E.1.
 Phone: Avenue 4106 Teley: (Electradix Ltd.)
 Colonial Avenue is the first on left down the Minories from Fenchurch Street or Aldgate Underground Station

Illustration Adv.

Take your Wireless into the Garden with

300 FEET 5/-
ELECTRON WIRE
 Extension
 The New London Electron Works Ltd London, E.6.

Do You Know—?

By C. P. ALLINSON

THAT fair long-distance reception can be obtained without an aerial, by connecting the earth lead to the grid of the first valve

That dry cells are not really dry. The liquid electrolyte necessary to produce the chemical action that gives rise to electric current is contained in the cell in jelly form.

That dry cells generally run down because of the evaporation of the electrolyte, and not because the active elements of the cell have become used up.

That fibre will absorb up to 20 per cent. of its weight of moisture. That is why it is quite unsuitable material for wireless instruments as an insulator.

That the losses in an inductance may be twenty times those of even a poor variable condenser. In such cases little or no advantage is gained by the use of a low-loss condenser.

That Wood's metal which melts at a temperature about that of boiling water, is an alloy of two metals, both of which have a much higher melting point than that of the alloy.

That amalgams containing mercury, which therefore melt at a low temperature, are quite unsuitable for fixing crystals used in wireless reception.

That the windings of a low-frequency transformer may contain quite three miles of wire. That is why it is called wireless.

That the use of reaction may result in great amplification being obtained from the detector valve.

That interference from an oscillating receiver may be heard up to ten miles away. The moral is "don't."

That the finest wire ever made was produced recently in America. It is so fine that it is almost invisible to the naked eye.

That the ancient Greeks and Romans knew how to draw wire through dies. The dies used generally consisted of precious or semi-precious stones with holes bored through them. The wire produced was chiefly used for making ornaments.

That the energy from a single flash of lightning would be sufficient

varying between 20 minutes to two or three hours with the H.T. battery disconnected.

That not only does the use of a grid battery in a low frequency amplifier improve the quality of reproduction when a high value of H.T. is used, but it also cuts down the plate current, and therefore lengthens the life of the H.T. battery.

That the .06 type of valve has often a much lower internal capacity than other types. This makes it specially suited to H.F. amplification, and promotes stability.

That a fully charged accumulator, if left standing, will gradually discharge itself. If therefore you have an accumulator that is very



That some of the great liners carry a large number of operators? Above are seen the operators on board the S.S. Leviathan.

to light the whole of London for about a quarter of an hour.

That the insulating properties of ebonite deteriorate if it is left exposed to sunlight. The surface acquires a greenish tinge, and this needs to be removed by rubbing it with glass paper to restore the full insulating properties of the panel.

That a dull emitter valve that has lost its sensitivity through being run at too high a voltage may be restored by running it at the correct voltage for a period

little used, you should see that it is charged regularly, so as to keep it in good condition.

That rain, hail or snow, especially the last two, may produce a very loud rushing noise in a wireless receiver. In some cases hail and snow have been known to charge up an aerial sufficiently to produce sparking between condenser plates in the aerial circuit of the receiver.

That there will be some further highly interesting notes next month, when the transmitter will also receive attention.

C.P.A.



AN EASILY-CONTROLLED TWO-VALVE RECEIVER.

SIR,—*Re* "An Easily Controlled Two-valve Receiver," described by Mr. John W. Barber, in the May number of THE WIRELESS CONSTRUCTOR, I wish to inform you that I have made up this set, and am delighted with it. I do not use a Sterling anode reaction unit, but two coils in a two-way coil holder. Also a variable grid leak, also only one connection to +H.T., and a .0005 μ F. ordinary type variable condenser to tune the anode with; a .0005 μ F. square law for aerial coil. I have also joined -H.T. to -L.T. and to E.

It is marvellously pure, and I am very pleased with the circuit, which I have got on a 9 in. by 8 in. panel, with a two-way coil-holder on stand on top above sloping panel.

Yours faithfully,

G. L. F. SHEWELL,
Lieut.-Colonel.

Cheltenham.

AN APPRECIATION.

SIR,—May I encroach upon your time to voice my very great appreciation of your splendid magazine?

It is usual upon the appearance of a new publication for some people to rush for their pen, ink and paper, in order to write and tell the editor how good his paper is. I always wait until about half-a-dozen numbers have been published before passing an opinion, and I usually find a gradual falling off after the first number, both in quality of reading matter and number of pages. THE WIRELESS CONSTRUCTOR, however, has improved with each issue, and you are to be congratulated upon maintaining such a high standard of excellence. For sixpence the magazine is far and away the best value yet in the wireless literary world. Please keep it up.

Regarding the various sets described since the first number, I have made them all by means of hook-ups, and have found them all O.K. The best of them so far, in

my opinion, is the Twin-valve Set of January's issue. I was so pleased with the results obtained with a hook-up of this set that I made it up into permanent form, which now has an honoured place in our home, being known as THE wireless set. With it, on a poor aerial, I can get all B.B.C. main stations, and also many French and German ones, including Breslau, over 800 miles from here. I have not yet tried for America.

I can give it no higher praise than to say that it is worthy of being included in your envelope series.

Yours faithfully,

"SIGNALS."

Salisbury.

FOR THE SHORT-WAVE EXPERIMENTER.

SIR,—With reference to the article by Mr. C. P. Allinson, in the April issue of THE WIRELESS CONSTRUCTOR, on the construction of a single-valve Hartley receiver for 40 metres, &c., I wish to bring the following results obtained with this set to your notice. I have made the set exactly as detailed with the exception that I have wound the coils with 12's and 14 gauge wire.

Using a primary of five turns of 12 S.W.G. self-supporting, 3 in. in diameter, a secondary of 10 turns of 14 S.W.G. wire, coupling $3\frac{1}{2}$ in., I have got the set to oscillate from 19.3 metres upwards to 180 metres. Higher wavelengths are not required, as the broadcast programmes are catered for in another set. On 43.02 metres I heard "WIZ," the station of the Radio Corporation of America. He was using 10 kw., tremendous power for a frequency of approximately 6,300 kilocycles. Later on I heard—with a different coil, of course—NKF on 21 metres—12,000 k.c. approx. "WIZ" was calling "ABC," and NKF calling CQ. I used a repaired Cossor valve (repaired by Radions, Macclesfield) with a six-volt accumulator, H.T. was 86 volts on 20 metre band, and 58 on 50 metres

and upwards. There are no hand-capacity effects, so no long handles are necessary. Both my aerial and reaction condensers are of the "Fullstop" pattern, made by Naylor's, of Wigan, and I can recommend them. I do *not* work for Naylor's, by the way. I have also heard "8 ALG" three nights in succession, and "1 UR" (both on 20 metres) twice, besides "PCUU." The latter was working last night on 80 odd metres, and I sent him a "QSL" card this morning. I am at present trying to get down to 10 metres and below to include the "Yanks" on 8.3 metres. Allow me to thank Mr. Allinson most sincerely for the circuit, which will do far more than he modestly claims for it. I wrote to PCUU this morning, and gave them a sketch of circuit and also told them who was the author of the article in which the circuit appeared. I don't know whether I was quite in the right or not in doing this. Of any further results I get I shall be pleased to let you know.

Yours faithfully,

JAMES EDWARD NEEDHAM.

Blackley, Manchester.

RADIO PRESS ENVELOPE NO. 10.

SIR,—I have completed the "Twin-Valve" receiver described by Mr. John Scott-Taggart in No. 3 of THE WIRELESS CONSTRUCTOR. I made a few alterations in the laying-out of the components, using two small panels with the valves and coils on top and at right angles to the variable condensers, all the terminals at the back, and a Pye No. 1 transformer on the base board.

With two French '06 valves I heard four German stations very clearly, while Bournemouth was sufficiently loud to be audible quite pleasantly on a loud-speaking attachment fixed to the horn of a gramophone.

Yours faithfully,

JOHN LEONARD.

Stamullin,

Co. Meath.



Practical Workshop Hints

A Useful Soldering Hint—Accurate Centre-Punching—Preserving the Panel Surface—Wiring with Square Rod

A Soldering Tip

THERE is no doubt that one of the most important things in soldering, if neat and solid work is to be done, is that the iron should always be absolutely clean. If it is at all dirty, or if it is not quite properly tinned, the solder never flows on to the bit as it should, and one has considerable difficulty in getting joints to stick. Often they *look* all right when they are made, but when they are tested it is found that the adhesion is actually so poor that the two parts can be pulled asunder even though very little force is exercised. A really clean iron is a pleasure to work with.

Solder flows on to it, not in little blobs, but so evenly that it seems to be almost as liquid as water. When one comes to make a joint with the iron in this condition it is the work of a moment, and a sound job results. The ebonite is not heated up if one is soldering a wire to a terminal, since the iron is applied for only a brief instant. Even the most delicate jobs, such as soldering wires of the finest gauge or connecting leads to tin-foil condensers, can be accomplished with an iron in this state. Once tinned, a soldering iron will, as a rule, last for some time in good condition, provided that a clean flame is used for heating it.

When, however, one is engaged in making a good number of soldered joints one has to keep the iron constantly hot by means of a Bunsen burner, a blow lamp or a spirit lamp; the tinned point of the bit becomes dirty in time, and the quality of one's work deteriorates towards the end of a job unless precautions are taken. Here is a tip which the writer has found extremely useful when engaged in doing lengthy pieces of soldering work.

Keeping the Iron Clean

A short piece of square tinned rod is thrust into a cork, as shown in Fig. 1; the cork acts as a handle and protects the

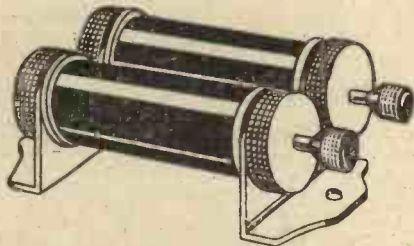

DETECTIKON

(Registered Design. Patent pending.)

THE ONLY ALWAYS PERMANENT DETECTOR

2 Perikon Crystals in Parallel

The circuit is NEVER broken even during adjustment. The ideal detector, Indispensable for Reflex circuits. Price **4/6**

Trads supplied through Wholesale Houses only

THE DETECTIKON COMPANY
17, LITTLE PORTLAND ST., LONDON, W.1 :: 'Phone: LANGHAM 1913

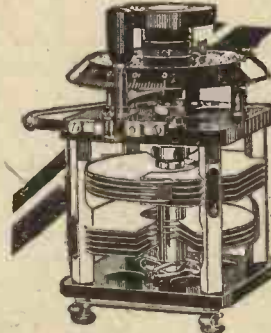

FOUR Ball Bearing Low Loss Condensers IN ONE

This condenser will revolutionize wireless tuning. Balanced vanes moving on ball bearings give vernier control with finger and thumb. Soldered brass plates, and absence of spacing washers yield freedom from loss as perfect as science can achieve. Each condenser has four available capacities, three single and one double, any one of which can be used at the will of the experimenter.

Square law tuning gives selectivity throughout the scale. A micrometer attachment gives additional precision by moving the rotor through five degrees with a gear reduction of 33 to 1 without backlash. Write to-day for free brochure giving full information about this wonderful instrument that will give you a degree of control over your set greater than you have known.

THE BOWYER-LOWE FOUR-SQUARE SQUARE LAW CONDENSER

Bowyer-Lowe Co., Ltd., Letchworth

Fletcher Ad.

ULTRA LOUD SPEAKER
REGISTERED TRADE MARK



2,000 ohms
27/6

ASK YOUR DEALER FOR THEM

Should you have any difficulty in obtaining same, write direct to

EDWARD E. ROSEN & CO.
158-160, CITY ROAD, LONDON, E.C.

with the name of your Dealer.

STRONG CONTACTS EVERYWHERE

Faulty electrical contacts mar many otherwise good wireless sets. Collett Terminal Tags give you good joints inside and outside your receiver. They simplify your soldering, they bend but will not break. Always ask for them by name. Every good dealer sells them and will show you the ten types made. In case of difficulty write to us for samples.

COLLETT'S EXCEL TERMINAL TAGS

52/9 1, HAMPSTEAD RD., N.W.1



Made by S. H. Collett Mfg. Co., London.

fingers against the rod, which becomes very hot at times. Every now and then the point of the rod is dipped into whatever flux is in use and rubbed over each face of the point of the iron in turn. This has the effect of removing all traces of dirt and restoring the tinning in a moment to its original freshness. If there is dirt upon the iron it will float upon the surface of the solder,

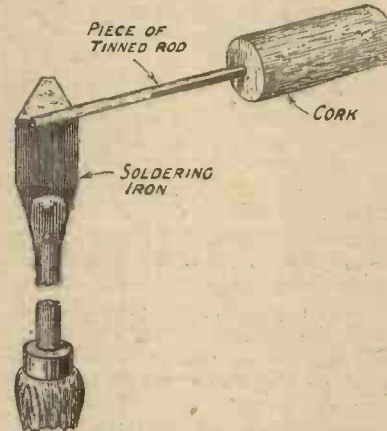

Fig. 1.—Showing an easily made soldering iron cleaner.

which liquefies under the influence of the flux, and it can be removed without any trouble by wiping with a cloth or a piece of paper. For wiring work the writer generally uses soldering irons of very small size, owing to their handiness. These in the ordinary way are very apt to become burnt or pitted. With the help of the little device mentioned it is quite simple to keep them always in perfect condition from one end to the other of the longest soldering job.

Accurate Centre-Punching

The wireless constructor is frequently called upon to do a certain amount of quite accurate marking out when he is engaged in the construction either of a complete set or of a small piece of apparatus. Though the actual marking out may be satisfactorily accomplished with the help of a setsquare, a good steel footrule and a scribe, it is surprisingly easy when using the ordinary type of centre-punch to make slight errors in the position of the drilling centres, even though the marking itself has been without fault. For really accurate work which demands accurate centring the writer has discarded the use of the centre-punch altogether. He employs instead the little tool which is

seen in Fig. 2. This consists of a jeweller's screwdriver of the type made to take detachable bits. These can be purchased quite cheaply from almost any tool shop. In place of the screwdriver bit, a diamond pointed drill is mounted in the chuck of the tool. The marking of centres is done in the following way: Cross lines having been made, the point of a scriber is used to make a prick at their point of intersection. There is in this way not the least difficulty in finding the exact point at which the lines cross one another. This having been done, the point of the diamond drill is inserted into the tiny hole made. The forefinger of the right hand rests in the cup at the top of the screwdriver handle, which is free to revolve. The thumb and second finger grasp the shaft and give it a backwards and forwards motion. By this means a small clean hollow is cut at precisely the point required, which forms a far better guide when the drilling proper comes to be done than any centre-punch mark.

Drilling Large Panels

Those who make up one of the sets described from time to time

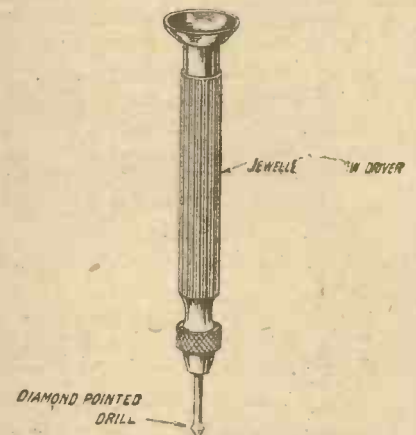

Fig. 2.—The instrument shown above facilitates accurate centre-punching.

in THE WIRELESS CONSTRUCTOR may find themselves faced with the problem of drilling a large ebonite panel without in any way spoiling the appearance of its beautifully polished surface. Until fairly recently one did not in the least mind spoiling the surface of the ebonite panel; in fact, it was desirable to rub it down, since it was difficult to obtain glossy ebonite with satisfactory qualities so far as

resistance is concerned. To-day, however, it is possible to purchase panels of guaranteed ebonite whose mirror-like surface, if carefully preserved, adds greatly to the appearance of the set, and does not in any way detract from its performance. How is one to accomplish the process of marking out and drilling without scratching or defacing its surface? In the first place, marking out should be done, not on the front, but on the back of the panel. This may present a little difficulty at first sight, since nearly all lay-out diagrams are given for the front. They can, however, be reversed by the simple process of laying them upon a sheet of carbon paper turned face uppermost and tracing over the lines with a hard pencil. On removing the lay-out from the carbon and turning it over it will be found that it appears in reversed form on the underside of the sheet.

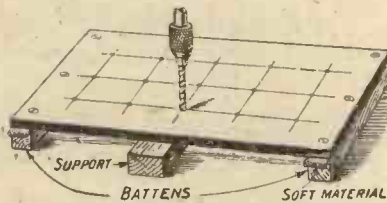

Fig. 3.—With the panel mounted as in the diagram, the lower surface is protected while drilling.

To protect the panel during marking out place a folded cloth or dust-sheet between it and the top of the table upon which the work is done. For drilling the precaution shown in Fig. 3 may be taken. Make first of all in the short edges of the panel such holes as will be required for the screws which will eventually fix it in position. Now obtain two wooden battens of the same width as the panel and deep enough to raise it when it is placed upon them, about 1/2 in. above the surface of the bench. Cover the top of each of the pieces with a piece of soft material, and screw the panel to them, as shown in the drawing, with the polished side downwards. Provide a third batten of the same thickness as the others, but rather wider. Do not fix this but push it under the panel at the point at which drilling is being done, so as to act as a support. Even the largest panels can be dealt with in this way without making a scratch upon them, if one is careful. The writer has often drilled fifty or more holes, many

of them being subsequently tapped, in a large panel whose surface at the end of the operation was every bit as good as it was originally. Another quite satisfactory method is to obtain a soft wood plank of the same dimensions as the panel, and about 1/2 in. in thickness. This is covered with a piece cut from a worn-out sheet, and the panel is screwed to it as before.

Wiring with Square Rod

There can be no doubt that the neatest of all wiring is that which is accomplished by means of square tinned rod, though it must be admitted that this material is not quite so easy to work with as ordinary round wire. To begin with, if one wishes to make all leads run either parallel with one of the edges of the baseboard or panel, or at right angles to it, each connection must be accurately fitted before soldering is done. With round wire it is quite possible to solder one end in place and then to do the necessary bending before fixing the other. But this cannot be done with square rod, which must be properly shaped before soldering is begun. A tip which the writer finds useful for shaping is as follows: When wiring is in progress a number of pieces of soft copper wire of No. 20 S.W.G. are kept handy on the bench. In the case of leads which require several bends, patterns are made first of all with the help of these wire lengths. It is then quite easy to shape the square rod in the required way, and to cut it off to the necessary length, using the wire pattern as a guide. Despite this, it will nearly always be found that a certain number of mistakes are made in bending the square rod. It is difficult to rectify such errors by straightening out the rod and then rebending, unless special precautions are taken, for the metal is hard and breaks easily once it has been turned at right angles. If a bend has been made in the wrong place proceed as follows: Place the bend in the flame used for heating your soldering iron, holding the rod in a pair of pliers so as not to burn your fingers as it heats up. Let it become fairly hot, and then plunge it into a saucer of water. This will "anneal," or soften, the metal, and will enable you to straighten it out without cracking it. It can then be rebent without risk. You can harden the metal again quite easily. This process is a useful one to know, since in many batches of length of square rod you will find a certain number which are rather too soft to enable first-rate work to be done. Heat

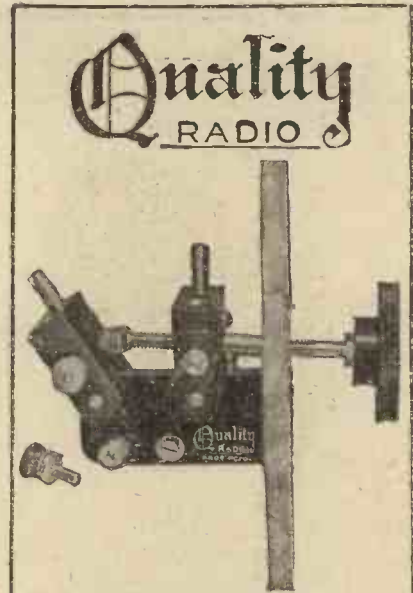

Quality RADIO BACK OF PANEL VERNIER COIL HOLDER with detachable coloured terminals for reversing reaction. Price 10/6. Post, 3d.

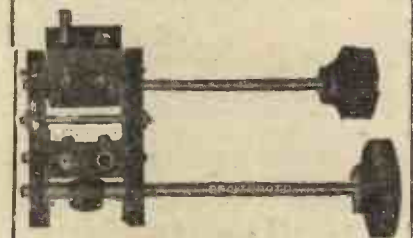

Pat. No. 231251
CAM-VERNIER COIL HOLDER
Price 9/-, on base 1/- extra. With Reaction Reverse and Shorting Switch incorporated 12/6, postage 4d.

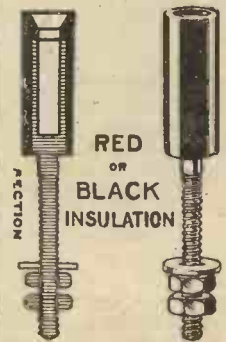

INSULATED VALVE SOCKETS
Set of 4, one red for plate, 1/-, Postage 2d.

If your dealer has not got them we send post free if you mention his name and address.
GOSWELL ENGINEERING Co., Ltd.
12a, Pentonville Rd., London, N.1
Liberal Trade Terms. Phone: North 3061.

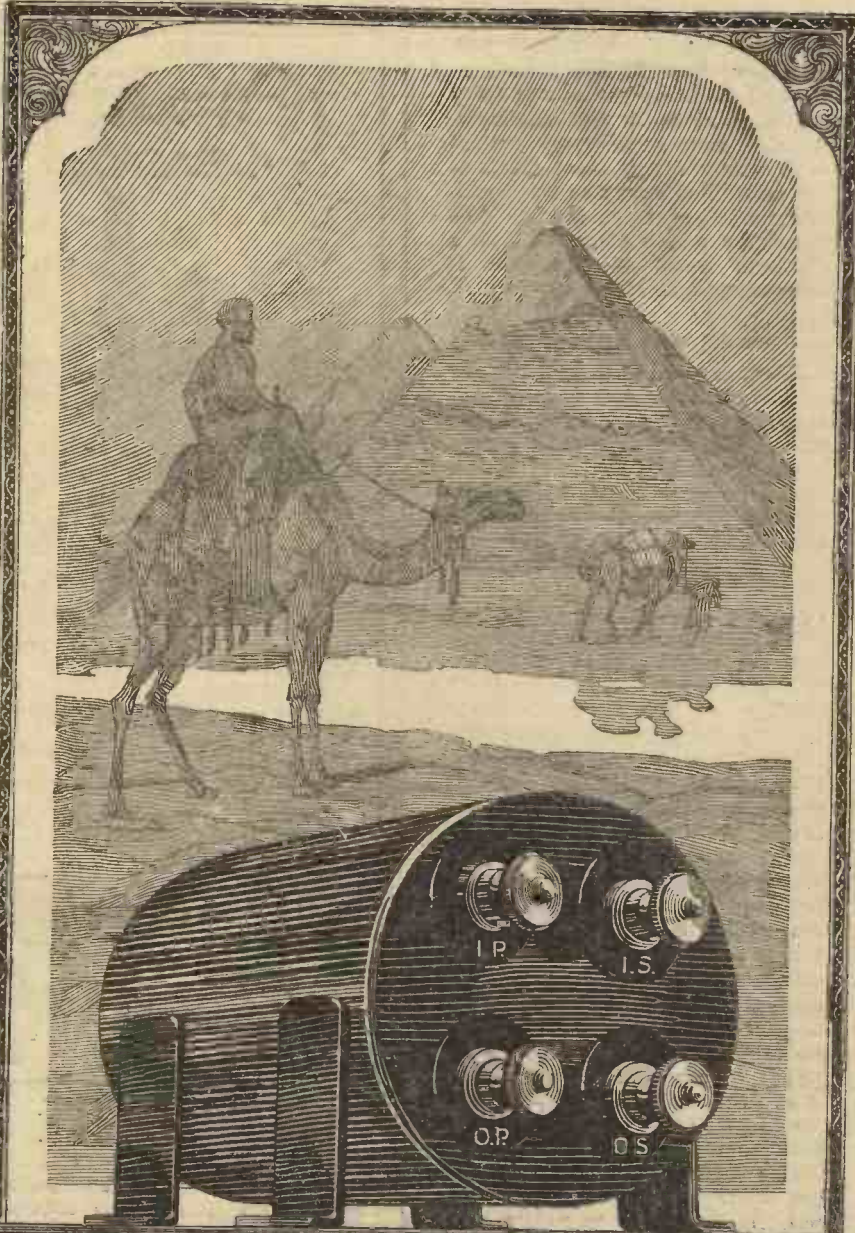

Age-proof!

TO produce a masterpiece that would readily resist the ravages of Time has also been the purpose of the designers of the Eureka. Hermetically sealed within a massive steel case, the Eureka is everywhere recognised as the *long-life* Transformer. Discerning wireless enthusiasts are finding that it is cheaper to pay 30s. for a Eureka Concert Grand, giving years of service, than to experiment with an inferior instrument liable to break down after a few months' use.

Concert Grand, 30/-

Eureka No. 2, 22/6

EUREKA

"A Switch in time"

A THREATENING rumble outside and the flash of distant lightning, causes you, for safety's sake, to disconnect the aerial "lead in" and join it to the earth-wire. But how? Usually a fumbling with flex ends and unscrewing of terminals characterises this procedure.

Of course, the danger of holding the wire is minute. The possibility of lightning striking the aerial during the operation is very remote. Yet one feels none too safe and the job is carried out in record quick time.

How much more satisfactory a switch would be to perform this duty; just one slight movement, and "click," you are safe from disaster.

This is but one use that a switch can be put to in wireless circuits. There are many others, loud-speaker to 'phones, cutting out or adding valve stages, to mention a few.

In "Switches in Wireless Circuits," by Oswald J. Rankin, you will find numerous methods of embodying switches in wireless circuits; all are illustrated in pictorial form.

SWITCHES IN WIRELESS CIRCUITS

BY
Oswald J. Rankin

Price 1/6 Post Free 1/8

Obtainable from all Bookstalls and Wireless Dealers, or direct from Dept. W., Radio Press, Ltd.



RADIO PRESS, LTD.

BUSH HOUSE, STRAND, LONDON, W.C.2

Barclays Ag.

Gilbert Ad. 3026.

the rod to redness, and allow it to cool slowly. If the tinning has burnt off it can easily be replaced by running a hot clean soldering iron

over the rod. In spite of all precautions it sometimes happens that a piece of rod cracks slightly at a right-angled bend. When

this occurs the point should be strengthened by the application of a little solder run on with a very hot iron.

Some Helpful Hints

Notes on improving the working and appearance of your receiver

Cleaning Variable Condensers

UNWANTED noises are frequently caused in a receiving set by dust collecting on the vanes of the variable condensers; the dust particles provide minute leakage paths between the fixed and moving vanes. The usual method of cleaning by inserting a feather between the vanes is not very satisfactory, especially if the condensers are built up into a set and are in inaccessible positions. A much simpler and more efficient way of cleaning out the dust is to blow it away with a strong blast of air. A pair of ordinary bellows may be used for this purpose, and indeed for cleaning any part of a set. The bellows should be "worked" a few times before applying the nozzle to the set, to ensure that any dust inside them is blown out. A. V. D. H.

Fixing Panel Transfers

MANY constructors of wireless sets do not mark their terminals by means of panel transfers, because they are under the impression that it is a troublesome process. This is by no means the case, as the transfers may be affixed very quickly with absolutely no trouble whatever. The following method has been used by the writer for several months, and has proved quite satisfactory and in every way equal to the hot-pad method. The transfer required is stripped off its thick paper backing, and held by one corner between forefinger and thumb. The transfer is then immersed in water, and carefully laid in position on the panel, taking care that it is perfectly straight. Pressure is then applied over the surface of the transfer with the forefinger for a second or two, when the thin paper is carefully stripped off, leaving the transfer in the desired position on the panel. The surplus water may be dried off the panel by means of a clean rag, but avoid touching the transfer for a few minutes after it is applied in order that it may take a firm hold upon the ebonite. J. W. B.

Oak for Wireless Cabinets

OAK is a very suitable wood for wireless-cabinet making, as it is hard enough to take an excellent polish, even without skilled treatment. But the constructor who chooses oak as his material should note that steel screws and nails should on no account be used for securing joints, since iron and steel are very soon rusted away by the gallic acid present in oak.

If it is not desired to take the cabinet apart at any future time, small tapered oak pegs should be used to secure the joints, suitable

off short in the wood before they have been driven right home.

A. V. D. H.

Make your own Crystals

TO make your own crystals at home is not so difficult as it seems, and it is cheaper than buying boxes of crystals at one shilling per box. The writer has made crystals for his set for some considerable time, and has found that the cost for crystals has decreased about fourpence per box. When making crystals a certain amount of care is required, but the process is a very simple one indeed. The materials required are one pound of galena, which costs about two and fourpence, about eight pennyworth of flowers of sulphur, and a small crucible, costing sixpence. Crush up the galena, and nearly fill the crucible with it, and then fill up



This small valve set, which hails from Peterborough, is only four inches square, but receives Paris regularly!

holes being drilled and the pegs driven home with a small mallet. If, however, one side or end of the cabinet is to be made detachable, with a view to possible alterations of the interior, brass woodscrews may be employed; in this case a hole should be drilled or punched to the full depth for every screw, and the holes should be made wide enough near the surface to clear the unscrewed part of the screws immediately under the head. If these precautions are neglected, the screws will be liable to break

with the sulphur. Now place the crucible in the oven, and see that you have a good, clear fire burning. Leave the crucible in the oven till the fire dies out, remembering that the slower the cooling, the better the crystals. When cold, the galena and sulphur will have solidified and you can then empty the crucible and break up the crystals into the required sizes. Crystals made in this manner are very sensitive and satisfactory, and the results obtained with them are very good.

D. McG.

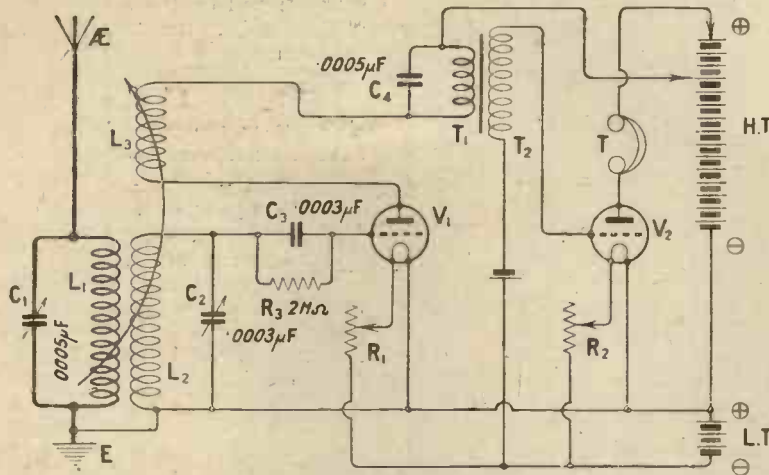

Fig. 1.—This circuit will be found more selective than the more usual detector and note-magnifier arrangement.

THE problem of selectivity is becoming more and more acute as the number of broadcasting stations on the existing broadcast band of wavelengths of from 300-500 metres increases. Apart from the separation of one broadcasting station from another in order that we may listen to the one we desire without the annoying interference of the unwanted station, there is the still greater problem of the elimination of that distressing sound which so often completely spoils a long awaited item in the evening programme, the spark transmitter of ship or shore station sending Morse signals.

Let us consider how we can improve our set in order to make it as selective as possible; in other words, endeavour to treat that desirable background of silence so that we reap the full benefit of the excellent and attractive broadcast programmes transmitted from the local station. That is the ideal of the man with the small set, and as to the owner of the multi-valve, his ideal is to tune in the desired station—if his receiver is capable of so doing—without so much as a whisper from the near-by station, and free from all interference. The ideal in each case is indeed difficult to achieve, but any step in the right direction is a step towards its attainment.

Aerial System

The first thing I would advise the listener to do is to inspect his aerial and earth system. What is the condition of the aerial? How many insulators are used? Are the connections to the lead-in tube making good electrical contact?

Let me give a few hints on aerials. Now, wherever possible an outside aerial should be erected; it need not be very high, for it has been observed that low aerials very often are more selective than high ones. A really high aerial tends to bring in so many unwanted stations on or about the same wavelength as



A handsome receiver made by Mr. J. W. Offley.

that of the station it is wished to receive that it is a good plan to strike the happy medium and to erect one with an average height of, say, 25 ft. A little volume will be sacrificed, but remember it is

Improving Your Selectivity

By
A. JOHNSON-RANDALL,
Staff Editor

selectivity we are discussing, and a signal of medium strength without interference is surely better than a much louder signal accompanied by a background of noise. Those who already possess an aerial must, of course, do their best to improve it in regard to the points I am about to mention. They should make sure that it is adequately insulated by using at least two good clean insulators at each end. The down lead should be kept well away from any pipes or other earthed objects, and if possible at a distance of about 6 ft. from the house. Finally, all joints should be well soldered, and each connection to the terminal of the lead-in tube must be scraped clean and kept in that condition, or, better still, soldered direct to a flat brass washer and gripped firmly between the terminal nut and brass collar.

The Earth Lead

The earth lead is the next point to consider, and this in all cases should be as short as is practicable, and where it has to travel for some distance before making contact with the earth proper it should be insulated with as much care as has been bestowed on the aerial. If the actual earth used is a water pipe, both the metal clip around this and the pipe should be cleaned and covered with insulating tape, after making the connection, in order to prevent any deleterious action due to the atmosphere.

The Receiving Set

So much for the aerial and earth systems. Now for the set itself. Listeners who possess crystal sets are not in such a fortunate position as the proud owners of valve receivers. On the other hand, the range of their set is not so great as that of the larger one, and will not bring in the interference that

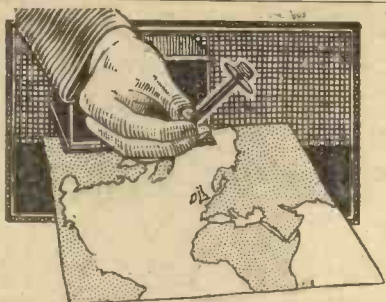

—that final adjustment—
perfects distant radio reception.

Listening to a distant station; receiver tuned to its highest efficiency; concert coming through fine—yet something is lacking; there is need of just that final adjustment to give perfect quality and maximum signal strength.

Those radio men who favour the use of variable grid leak appreciate how it gives the final touch—clearing reception to make it rich, pure and round in tonal quality.

The WATMEL is well known as the first variable grid leak which became available to the home constructor, and its consistent record for reliability to get the best out of the detector valve is unrivalled.

Send P.C. for Descriptive Folder.

5 to 5 Megohms ... 2/6
50,000 to 100,000 Ohms ... 3/6

WatMel

All goods of our manufacture bear this mark. It is your only guarantee.
FROM ALL DEALERS.

The
WATMEL WIRELESS CO. LTD.
33 a, GOSWELL RD., LONDON, E.C.1.

Always use a
variable grid leak;
but see you use a
WATMEL

Telephone: Clerkenwell 7090
Agent for Lancas hire & Cheshire:
Mr. J. B. LEVÉE,
23, Hartley Street, Levenshulme,
MANCHESTER

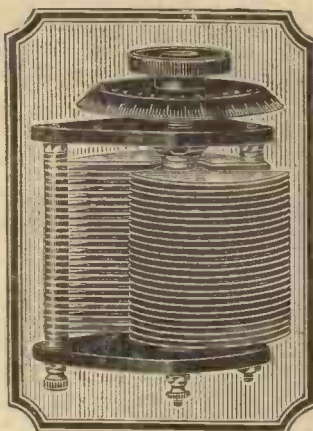

SQUARE LAW

'001	..	9 6
'0075	..	9
'0005	..	8
'0003	..	6 9
'0025	..	6 1
'0002	..	6 6
'0001	..	5 3
Vernier	..	4 6

STANDARD

'001	..	8 6
'00075	..	8
'0005	..	7
'0003	..	5 9
'0025	..	5 9
'0002	..	5
'0001	..	4 9
Vernier	..	4

SQUARE LAW with Vernier

'0005	..	12 6
'001	..	14
'0003	..	11 3
'00025	..	11 3

Post: One, 6d.
Two, 9d, Three, 1/-

A Significant Mark

WHEN you buy a condenser you first examine it for the name or mark of its manufacture. Every discriminating radio enthusiast knows the significance of the mark J. B. on an instrument, and has purchased it then and there, without further comparison with other condensers. The reason is—they know that the mark J. B. means Efficiency. Radio experimenters and constructors every where have put the J. B. instruments to the test and the proof is self-evident. News of a good thing soon

gets round in radio circles and so personal recommendation has been one of the greatest factors in the building up of the reputation of the J. B. condenser. Build them into your receiver. You will be surprised at the wonderful way in which they measure up to your expectations—what a really good condenser should be!

Remember to look for the mark J. B. when you go to purchase—the mark significant of the highest condenser efficiency.

JACKSON BROS.
8, POLAND ST-OXFORD ST
LONDON - W.1
(First Floor)
Telephone:-
GERRARD 7414

Barclays 1300

Genuine

Ripaults

BATTERIES and CELLS
for BETTER RECEPTION
and greater dependability

RIPAULTS LTD.,
King's Rd., St. Pancras
London, N.W.1
Phone: North 4372 (4 lines).

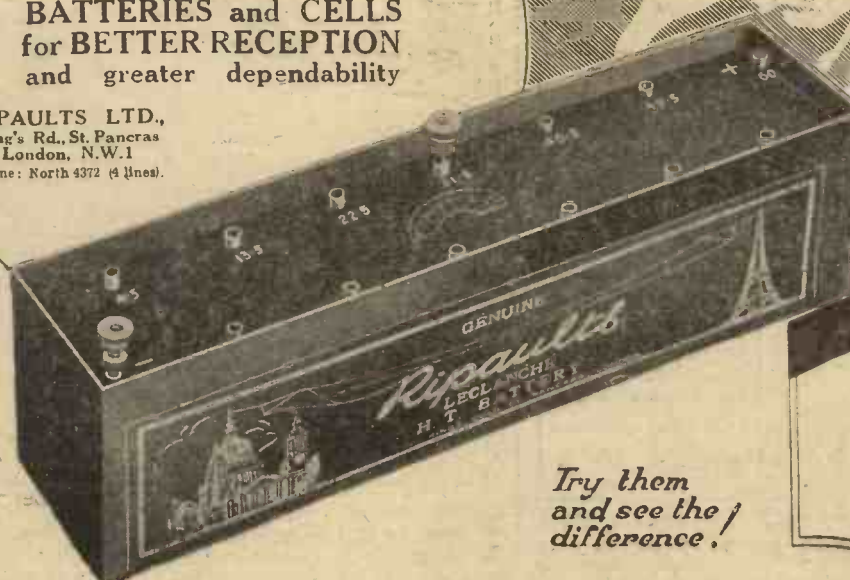

Try them
and see the
difference.

M. LECLANCHÉ
The
Genius
behind
our
Batteries

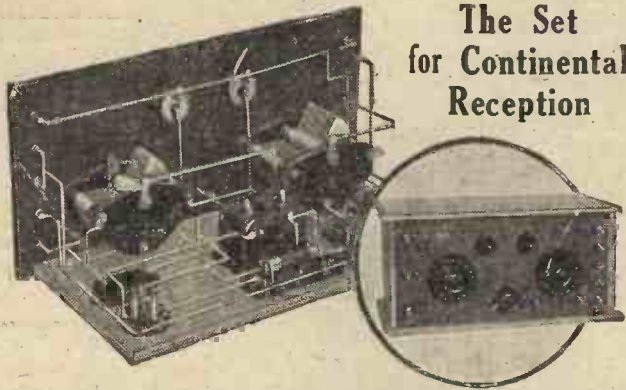

The Set for Continental Reception

64/- buys all the parts for this 2-Valve Set

NO need to spend a lot of money on a ready-built Receiver when you can build the splendid 2-valve Set shown above for just over £3. This is a wonderful Set for long distance reception. Now that valves have been reduced in price no one can say that a Valve Receiver is costly to build or expensive to run. Send for the parts you need to-day—wiring diagram, giving full instructions is supplied free of charge to all customers. Our 32-page Pilot Chart (post free 3d.) shows many other Receivers just as cheap and easy to build. Catalogue of Components, 48 pages; scores of illustrations, post free, 3d. Peto-Scott's Wireless Book, containing over 80 circuit diagrams, post free, 1/5.

	£ s. d.
1 Peto-Scott Square Law Condenser, 0005	8 0
1 Peto-Scott Square Law Condenser, 0003	6 9
2 Microstats	5 6
1 Two-Coil Holder, Board Mounting	5 6
2 Anti-capacity Valve-Holders	2 6
1 Board Mounting Coil-Holder	1 6
2-mez. 1 oak and Fixed Condenser (Peto-Scott)	3 6
1 002 Fixed Condenser (Peto-Scott)	1 6
10 Mark III Terminals	1 8
6 2-ft. Lengths 1/16 Bus Bar Nuts, Screws, etc.	1 1
1 Packet Panel Transfer	4
	£1 18 0
Plain Panel "Red Triangle," 13 in. x 6 1/2 in. x 4 1/4 in.	5 0
Panel drilled, extra	2 0
Panel engraved, extra	2 0
CABINET, 13 in. x 6 1/2 in. x 6 in. with Baseboard, Mahogany	1 1 0
Ditto, in Oak	19 6

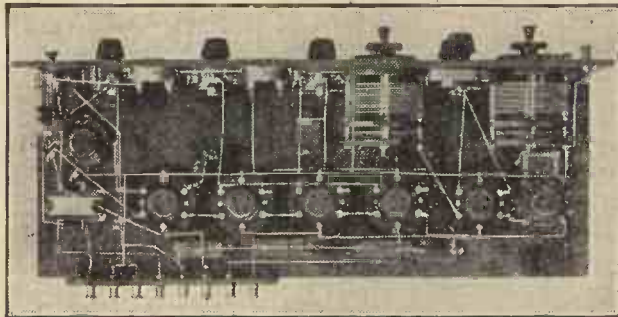

No previous experience needed to build this Keystone Super-Het

EVERYWHERE wireless enthusiasts are talking about the selectivity obtainable with Super-Heterodynes. Within the sight of 2LO's aerial, 2LO can be tuned out and either Cardiff or Manchester received on an absolutely silent background. Stations separated by only three or four metres can be eliminated with ease. The Super-Heterodyne shown here is made up from Keystone parts and is wonderfully efficient. It uses 7 valves yet requires only a frame aerial. Its range is limited only by atmospheric conditions. Owing to its simplified internal design it can be built by anyone without any special wireless knowledge and the cost will be no more than you would pay for a ready-built three valve set. Full details will be forwarded to anyone sending 2 penny stamps to cover postage. Write to-day and make up your mind to build a really good set at a moderate price.

Keystone Kit:

Three Intermediate Transformers carefully matched and fully tested. Each one contained in handsome oxidised metal case.
 One Tuned Filter complete with fixed condenser for tuning the primary winding (As all these units are carefully matched a variable condenser is unnecessary).
 One Oscillator Coupler designed to cover all wavelengths between 300 and 600 metres.

£5 the Set

PETO-SCOTT CO., Limited,

Registered Offices and Mail Order—77, City Road, London, E.C.1
 Branches:—LONDON—62, High Holborn, W.C.1. WALTHAMSTOW—230, Wood Street. PLYMOUTH—4, Bank of England Place. LIVERPOOL—4, Manchester Street. CARDIFF—94, Queen Street.

P.S. 3030

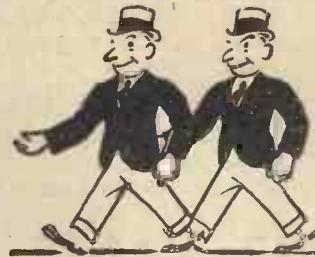

DOUBLES

Every single one of us (as they do say) has somewhere in this world a double. And yet how rarely do we meet these doubles—even in the world of things material and mechanical! There are two sockets that look alike—and have all the difference of a thousandth of an inch hugely yawning between them; two exactly similar plugs, of which one's a fit and the other's a miss! But how simply can you ensure having exact counterparts—in the Plugsocket CLIX! The Plug of one CLIX smoothly slips into the socket of the next CLIX or CLIX Adapter—and there is firmly held with full surface contact. That's the CLIX secret. Simple? But it's withheld from every kind of switch, plug or terminal but CLIX.

Retail Prices:

- CLIX with Locknut 3d.
- CLIX Adapter with Locknut 2d.
- CLIX Insulators (6 colours) 1d. each.
- CLIX Bushes (6 colours) 1d. pair.



The Electro-Link with 159 Uses

AUTOVEYORS LTD., 84 VICTORIA STREET, LONDON, S.W.1

"UTILITY" COMPONENTS

CONDENSERS

Scientifically designed, with Close Spacing. Large adjustable Bearings and Perfect Insulation.

Square Law or Ordinary	PRICES.	each
No. 123 '001	12 6
No. 144 '0075	11 9
No. 124 '0035	10 6
No. 125 '0003	8 9
No. 145 '0002	7 9
No. 146 '0001	7 6
Vernier 2 6 extra.	Fitted with Radlon Dials.	

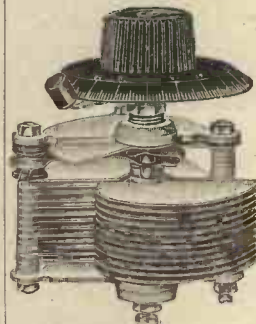

"UTILITY" COIL-CHANGING UNIT

Provides an instant means of changing from one Broadcasting Station to another, or from one inductance coil to another. It is attached to the inside of the panel by our usual method of one-hole fixing. As the illustration shows, it is only necessary to plug in coils in the ordinary way. W.135. Price 7/6 each



Manufactured by WILKINS & WRIGHT, LTD. UTILITY WORKS, KENYON STREET, BIRMINGHAM, England
 AGENTS:—Australia, A. E. Auckland, 216 Royal Arcade, Sydney; Malta, Muscat's General Stores.

the latter does. The effect of the crystal itself is to render real selectivity more difficult to obtain, but it is always worth while to pay attention to the tuning arrangements. The use of low-loss coils, such as those which have been described upon many occasions in THE WIRELESS CONSTRUCTOR and other Radio Press journals is a big step in the right direction, and it is as well to point out here that selectivity is decreased if the tuning coil is of such a nature that it is not immune to the effects of damp. Drying out a coil by baking may often increase selectivity enormously. Turning now to the valve

may be a No. 50 or 75 for the B.B.C. stations between 300 and 500 metres, while for Chelmsford a No. 250 should suffice. A smaller reaction coil than that usually necessary with direct-coupling will be needed, and the listener should experiment with sizes in the neighbourhood of a No. 25 or 35.

Loose-Coupling

Loose-coupled tuners require a little practice in manipulation before satisfactory results are obtained, but, as in most things, "practice makes perfect." The best plan is to tune in the desired station in the first instance with the coupling

ventional pattern to one of the neutrodyne type, as the only difference, apart from the necessity for a three-coil holder of good design, will be in the use of a neutrodyne transformer L_3L_4 , and a small neutrodyne condenser marked C_3 in Fig. 2. Descriptions of neutrodyne receivers have appeared from time to time in Radio Press journals, and for particulars of their operation I would refer listeners to these articles. Apart from the actual setting of the neutrodyne condenser, the tuning is very similar to that which I have just given in regard to loose-coupled circuits without H.F.

Wave Traps

Finally, we come to the use of wave-traps. The Fig. 3 circuit shows an efficient form, which was described by the Editor in the March issue of this journal. A suitable low-loss coil, together with a $.0005\mu\text{F}$. variable condenser are the chief components required, and it is easily possible to eliminate the unwanted station, provided a little care is taken in tuning. A wave-trap can be employed in conjunction with any existing receiver, and no alteration is necessary, the wave trap being coupled direct to the aerial and earth terminals, which are also joined to those marked A and E on the set. This, of course, applies in particular to the type shown, and readers, I am sure, will realise that it is not possible in a short article of this nature for me to describe every form of wave-

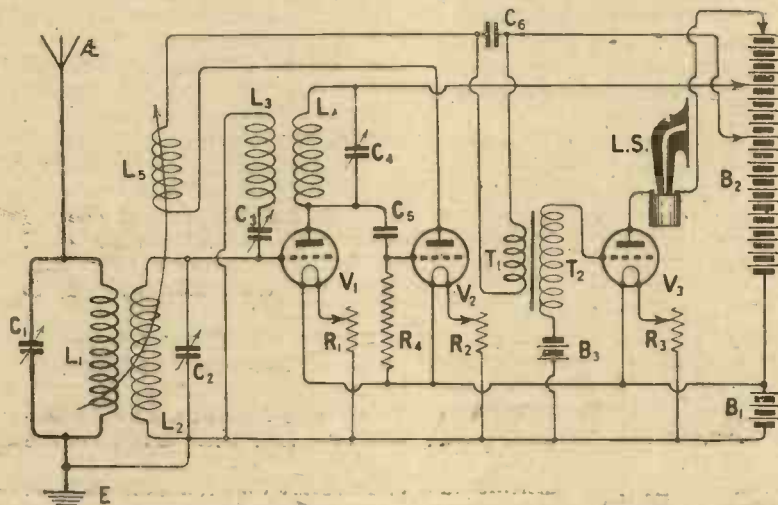

Fig. 2.—The particular form of aerial coupling, combined with neutrodyne arrangements, results in a very selective circuit.

enthusiast, I would say that all that has been said previously will apply in his case equally as much as in the case of the crystal set owner. He, however, has an advantage not possessed by the latter, in that by learning to manipulate his reaction in a skilful manner a powerful aid to selectivity is obtained. I have used the word skilful because I think all true listeners will agree that it is the unskilful rather than the deliberate abuse of reaction that causes the distressing interference from oscillation, which is so prevalent in the more widely populated areas at the present time. Those who remain faithful to the simple detector valve, or a detector followed by one or two stages of low-frequency amplification, would be well advised to try a loose-coupled circuit similar to that shown in Fig. 1. The aerial tuning inductance which is marked L_1 may be a No. 35 or 50 coil for the broadcast band of wavelengths, and for Chelmsford a No. 150 is correct. The secondary coil L_2

fairly tight; that is, with the aerial and secondary coils close together. Keeping the reaction coil well away from the other coils loosen the coupling between them, re-tuning on the aerial and secondary condensers. The final adjustment should be made with the two tuned coils widely separated, as in this position interference will be at a minimum. For users of high-frequency amplification, I would recommend a neutrodyne circuit of the type shown in Fig. 2, as an ordinary conventional circuit employing H.F. amplification will oscillate strongly when loose coupling is used. The oscillation can, of course, be controlled by the use of positive bias on the grid of the H.F. valve applied by means of a potentiometer, but unfortunately a decrease in both sensitivity and selectivity will result and the advantages of loose-coupling will be partly nullified.

Converting the Set

It should not be difficult to convert a receiver of the more con-

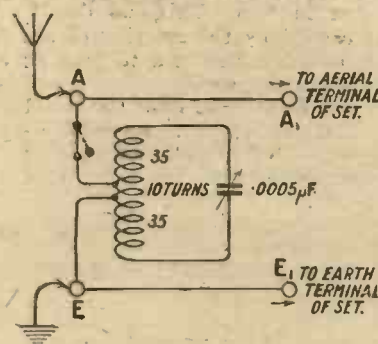

Fig. 3.—A useful form of wave-trap described by Mr. Percy W. Harris.

trap. The listener, however, by improving his set on the lines suggested, will do much towards obtaining that clean, silent background so desirable but so often unattained. It is only by attention to essential details, by the elimination of losses and by experimenting with various forms of tuning that progress towards the ideal is made.

An Improved Tree Aerial

By EDWARD P. FARR

Many wireless enthusiasts have a tree at the end of their garden which they wish to use to support the aerial. Below will be found an interesting method of securing a mast in a tree.

RECENTLY in THE WIRELESS CONSTRUCTOR Dr. E. H. Chapman described how an aerial was erected under very difficult conditions. His experience was that improved results repaid the trouble taken.

This, too, has been my experience, although my aerial was erected under somewhat different conditions, and readers may be interested to hear about it.

The Original Aerial

When I first became interested in wireless (originally through *Modern Wireless*) I erected my aerial in the first convenient spot I came across. The first sketch shows that this aerial was rather shielded, but I suppose it might be termed "an average P.M.G. aerial."

It will be seen that one end was attached to a tree. One morning last December, during a high wind the aerial collapsed! I started to re-erect immediately, but found that the aerial wire had actually broken in two. This, no doubt, was caused by the swaying of the tree, and I determined to prevent this happening again.

I also decided to raise the aerial so that it cleared surrounding objects. To do this I had to erect a mast in the tree, but there were no convenient boughs to fix the mast in an upright position. This trouble was overcome by making use of the two nearest boughs. The manner of fixing is shown in Fig. 2.

The House End

Next I tackled the house end. This meant another mast on the roof. The mast which I decided to use was about 10 ft. long and 6 in. in diameter. Two cushion blocks were cut and placed between the chimney and the mast, which was then secured by two pieces of stranded galvanised wire tightened up with two "strainers."

I had now to devise some means of preventing movement of the tree from breaking the aerial wire. A method I have seen employed is to keep the wire taut by placing

a suitable weight on the pulley cord. In my case, this method would mean that the weight would foul the branches of the tree.

Eventually I came across an old spring which I used for the purpose, mounting it between two of the insulators.

Having completed the work, I was very anxious to test the new aerial, and as the various operations had taken some little time and patience I hoped for ample repayment.

Results

To say I received a surprise would be to put it mildly. At that time I was using "The Home 3-valve Set," described by Mr. Redpath in December *Modern Wireless*. On my original aerial I generally received London, Bournemouth

and Newcastle at moderate I.S. strength, whilst the other main B.B.C. Stations came in at quite good strength on 'phones. With the new aerial within an hour of connecting up I had received all B.B.C. stations at good loudspeaker strength! This alone was enough to surprise me.

As a further test I connected up an ordinary crystal receiver, using a standard plug-in coil with .0005 μ F condenser. I found that 5XX came in with considerably increased strength; the same applied to Radio-Paris.

I might add that I have never regretted the accident which caused me to undertake these improvements, and I think almost anyone will find that their aerial can be improved with a little patience, and results amply repay any trouble.

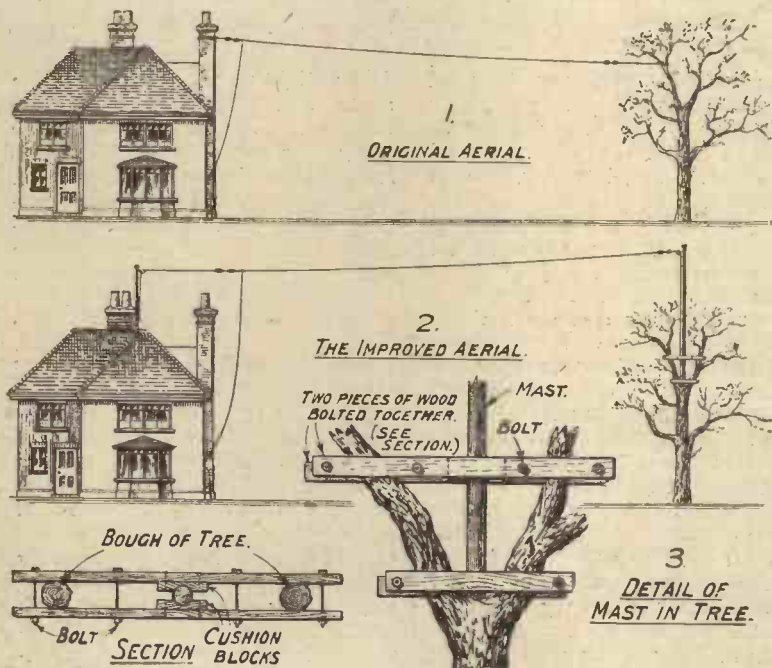

Showing how the original aerial, seen in the top picture, was improved by fixing masts both in the tree and on the roof. The smaller sketches show the method of securing the mast in the tree.

ROTHERMEL AMERICAN RADIO

REMLER PRODUCTS for the Popular Mechanics 8-Valve Super Het.

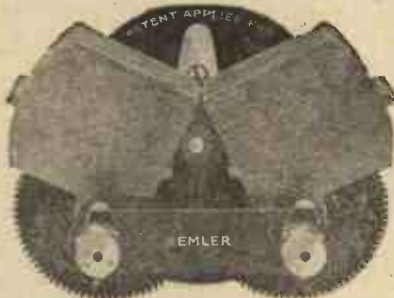

"REMLER" CAPACITY UNIT

The "REMLER" CAPACITY UNIT consists of two sets of Rotary Plates, each set moving through an angle of 90°. Both sets are insulated and are operated by silent anti-backlash Bakelite gears, which give fine vernier adjustment.

There is no metallic connection between plates and operating knob. Pigtail connections throughout. Paper char. on dial provides ready means of logging stations. Price (including dial and knob) 31/9

"REMLER" TRANSFORMERS

Every Remler Interfrequency Transformer receives individual tests of frequency characteristic and voltage amplification. Designed with air core to give maximum selectivity and maximum valve output.

- Type 600, Intermediate ... £1 15 0
- Type 610, Tuned Stage ... £1 15 0
- Type 620, Oscillator Coupler £0 18 0



FREE:

A 15-page booklet describing the building of "Popular Mechanics" Super 8 sent free on request, together with full list of American Radio apparatus, upon receipt of 3d. in stamps to cover postage.

Wholesale only—

R. A. ROTHERMEL LTD., Manufacturers and Suppliers of all kinds of Radio Apparatus

24 & 26, MADDOX STREET, LONDON, W.1 Telephone: MAYFAIR 578 and 579

Barclays 1270



20 Years ago

TWENTY years spent in the manufacture and development of one particular product is a long time. Yet this is just how long we have been making T.C.C. Condensers. Obviously we must have grown exceedingly wise in this business of condenser manufacturing—in fact, there are not many difficulties that we have not come up against and successfully surmounted.

Even a simple little component like a wireless condenser plays a most important part in the working of your Set. It may be badly insulated—its value may be incorrectly stated—it may not stand up to high voltages—these are but three of the many requirements. If you choose a T.C.C. Condenser you'll know that it will have passed a complete series of the most rigorous tests that it is possible to devise. You'll know, too, that it is as near perfection as any fixed condenser can be. So next time you want a genuine Mansbridge Condenser be sure to ask for a T.C.C. in a green metal case.

None genuine without **T.C.C.** the mark

Supplied in all values from .0001 mfd. to .2 mfd.



Sold by all Wireless Dealers.

Sole Manufacturers: Telegraph Condenser Co., Ltd. Mortlake Road, Kew.

G.A. 3041

Your radio reception, however satisfactory in itself, will only "sound" as good as the Loud Speaker you use.

Therefore it must be an

THE WORLD'S STANDARD **AMPLION** WIRELESS LOUD SPEAKER

Patentees and Manufacturers: **ALFRED GRAHAM & CO.** (E. A. GRAHAM) St. Andrew's Works, Crofton Park, S.E.4.

Showrooms: 25/26, Savile Row, London, W.1. 82, High Street, Clapham, S.W.4.

Obtainable from **AMPLION STOCKISTS**, Wireless Dealers and Stores.

A full range of Models at Prices from 25/- to £8 10s. 0d.

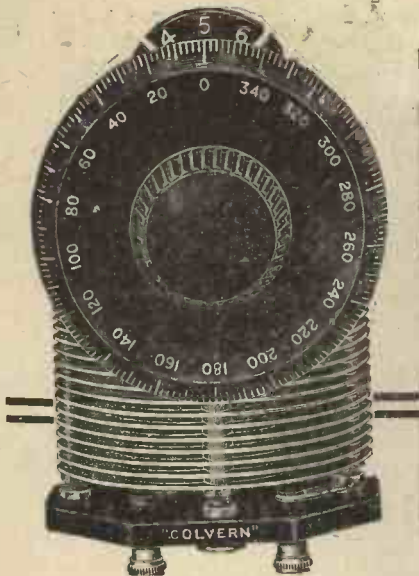

Imagine an analytical chemist without his scientific balances or an engineer without his micrometer!

Similarly, you will never tune a receiver with a direct drive condenser once having experienced the accurate tuning of the Colvern Selector Low Loss Precision Condenser.

Obtaining Hairbreadth Tuning

THE Colvern Selector Low Loss Precision Condenser is an instrument which gives the precise adjustment so essential to obtain perfect reception, whether on loud signals, such as the local broadcast, or on transmissions from low-powered distant stations. The mechanical method employed ensures accuracy to 1/200th of a degree; and, a further consideration, the eye is not called upon to supplement imagination. The scale interval is readily readable to that small difference in capacity—1/360th part of the total capacity available.

It is when working upon weak distant transmissions that the necessity for such critical and accurate adjustment is vital. Many excellent circuits have been discarded because they required a more critical tuning adjustment than available apparatus afforded. Equally efficient circuits were condemned as uncontrollable, since existing apparatus could not give the essential final adjustment.

Capacity reaction circuits such as the Reinartz, CR-17 Grebe, any Ultra Short Wave

Receivers, and the short-wave stages of Super Heterodyne Receivers, require hairbreadth tuning, obtainable only by such mechanical means as the Colvern Selector provides.

The dial of the Colvern Selector is divided over the full circle, and provides 360 degrees value for each rotation of the index. This enables 1/20th of a degree to be actually located: AND ANY PREDETERMINED CALIBRATION CAN BE RE-LOCATED TO THIS ACCURACY AT WILL.

- The Colvern Selector Low Loss—
 Reading to 1/3,800th of capacity
 Capacity 0005 mfd. £1 1 0
 " " 0003 mfd. £1 0 0
 Type F, without gear attachment—
 Capacity 0005 mfd. 15 0
 " " 0003 mfd. 14 0
 One hole fixing.
 Other capacities if required.
 Descriptive Folder upon request.

The Colvern Independent Vernier provides a very useful means of securing fine tuning adjustment. For balancing up H. F. Stages, taking up variations in capacity when H. F. Stages are controlled by dual or triple condensers, and for balancing up the Long Wave Intermediate Amplifier in Super Hets, when Matched Transformers are used.
 Price 2/6.

**COLVERN
 SELECTOR
 LOW LOSS**

From your Dealer

COLLINSON PRECISION SCREW CO. Ltd.
 Provost Works, Macdonald Road, Walthamstow, E.17.
 Telephone: Walthamstow 532.

Barclay Ads.

**SPECIALISTS IN
 SUPER HETERODYNE
 British and American Components and Kits.**

VAST STOCKS. 24 HOUR SERVICE.

The very nature of the Supersonic Heterodyne circuit demands **SKILLED ASSISTANCE BY EXPERTS** for successful results, and we place our resources at your disposal.

**THE BRIGHTON RADIO STORES,
 163, Western Road, BRIGHTON**

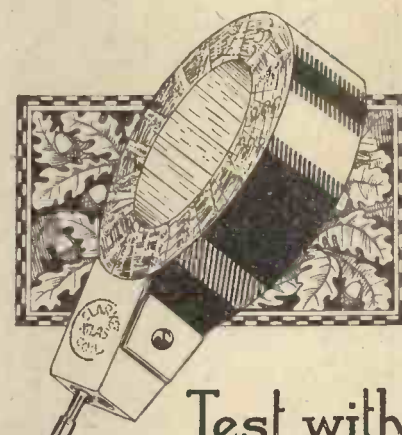
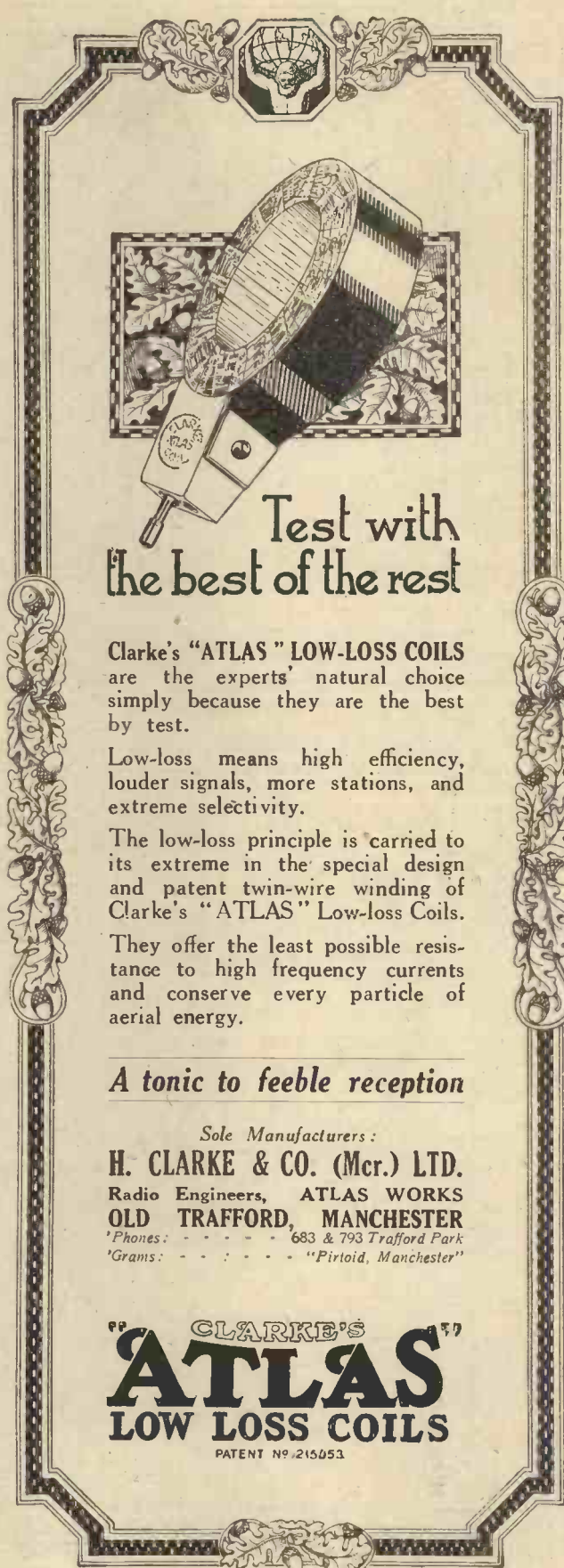

Test with
 the best of the rest

Clarke's "ATLAS" LOW-LOSS COILS are the experts' natural choice simply because they are the best by test.

Low-loss means high efficiency, louder signals, more stations, and extreme selectivity.

The low-loss principle is carried to its extreme in the special design and patent twin-wire winding of Clarke's "ATLAS" Low-loss Coils.

They offer the least possible resistance to high frequency currents and conserve every particle of aerial energy.

A tonic to feeble reception

Sole Manufacturers:
H. CLARKE & CO. (Mc.) LTD.
 Radio Engineers, ATLAS WORKS
 OLD TRAFFORD, MANCHESTER
 'Phones: 683 & 793 Trafford Park
 'Grams: "Pirtoid, Manchester"

**CLARKE'S
 ATLAS
 LOW LOSS COILS**
 PATENT NO. 215053

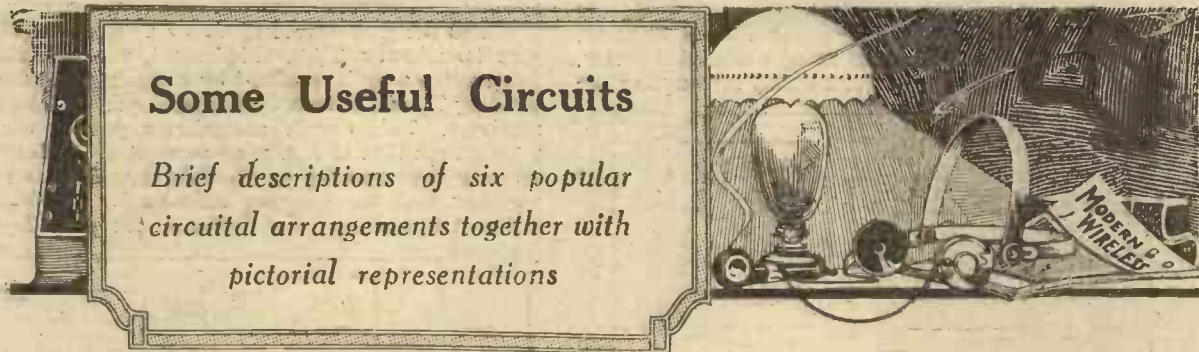

THE majority of listeners to the broadcast programmes live within a ten or fifteen-mile radius of a station, for the simple reason that such stations have been erected in towns, where people are more thickly congregated, and, this being the case, many thousands of listeners employ a crystal for rectification purposes. In a very large number of cases, headphone reception only is required, and the simple crystal set amply satisfies the requirements, but in cases where it is desired to work a loud-speaker, some form of amplifier must be added.

of up to, say, 80 volts on the anodes. When using dull emitter valves, or anode voltages of 100 volts or more with bright emitters, a grid bias battery of $4\frac{1}{2}$ volts will be required, with tapings at $1\frac{1}{2}$, 3, and $4\frac{1}{2}$ volts. The positive of this battery is joined to the

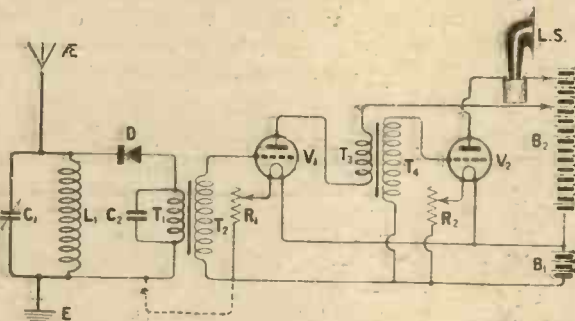

Fig. 1.—A useful loud-speaker circuit for the local station.

Fig. 1 shows how two stages of amplification may be used after a simple crystal receiver. Low frequency transformers are used and connected as shown in the diagram. For the benefit of those who are unable to read a circuit diagram (learn how as soon as possible!) a pictorial diagram is given in Fig. 1a, where the parts are drawn out instead of being represented by symbols, and are shown connected up in the correct manner. It will be noticed that the I.S. connection of both transformers is joined to the negative of the accumulator, and this will be found quite satisfactory with general purpose bright emitter valves with voltages

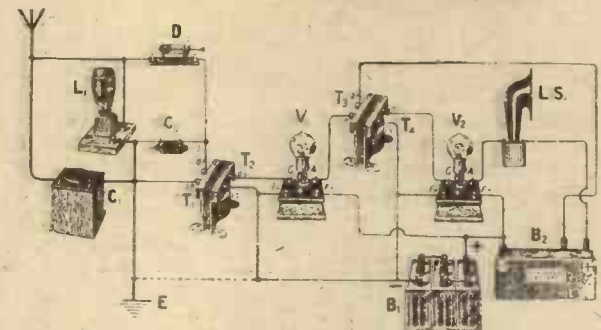

Fig. 1a.—Pictorial form of Fig. 1: In some cases it may be advantageous to earth the valve filament by making the extra connection shown dotted.

negative of the accumulator, and the I.S. connections are taken, by means of wander plugs, to suitable tapings on the battery. For the sake of example, the I.S. lead from the first transformer may go to the $1\frac{1}{2}$ volt tapping and that from the second transformer to the 3 volt tapping.

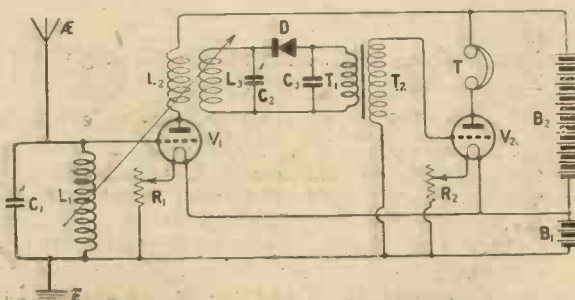

Fig. 2.—A useful tri-coil circuit comprising an H.F. valve, crystal detector, and one note magnifier.

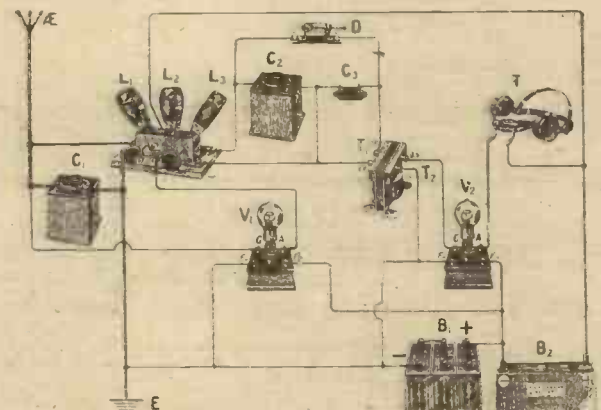

Fig. 2a.—The components of the Fig. 2 circuit and how they are connected.

Some Values

For broadcast reception the coil L_1 may be a No. 35 or 50, C_1 having a value of $0.005\mu F$. The condenser C_2 may have almost any small value from $0.005\mu F$ to $0.01\mu F$. For Chelmsford the coil L_1 may be a No. 150, the other values remaining the same.

Adding an H.F. Valve

In cases where it is desired to receive more distant stations, a high-frequency amplifier should be used, and if we are still desirous of using a crystal detector, we have to consider the best method of coupling the

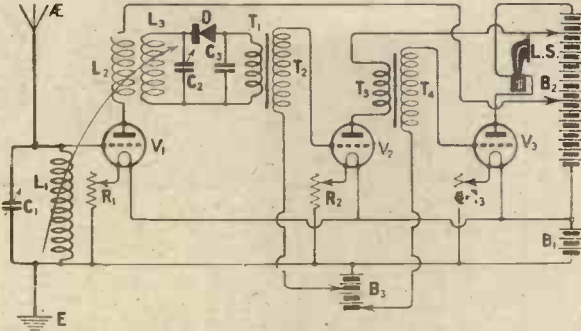

Fig. 3.—The addition of another note magnifier to the Fig. 2 circuit gives a powerful loud-speaker circuit.

crystal to the H.F. valve. If the coil L₃ in Fig. 2 be omitted and the connections from the condenser C₂ be taken to the respective ends of the coil L₂, the circuit L₂C₂ will not be capable of very sharp tuning owing to a factor which will be present, called damping, which we need not discuss here. It will be found better, however, to join the crystal across

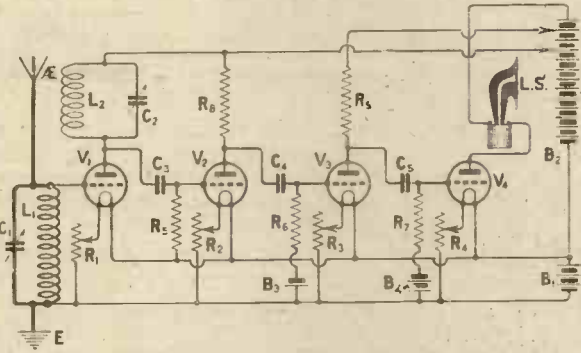

Fig. 4.—For the more advanced experimenter—a useful four-valve circuit.

a separate coil L₃ as shown in Fig. 2, and couple this coil to that in the plate or anode circuit of V₁. The three coils L₁, L₂ and L₃ are all mounted in a three-way coil-holder, the method being known as "Tri-coil" tuning, described by Mr. John Scott-Taggart in the September, 1924, issue of *Modern Wireless*. The circuit shown incorporates a stage of low-frequency

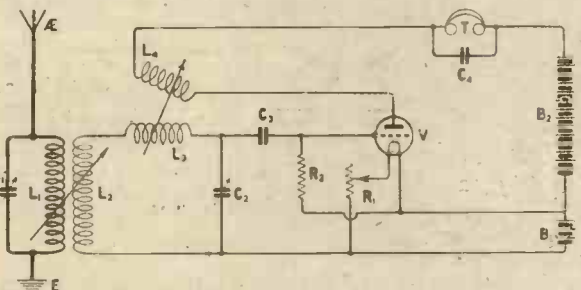

Fig. 5.—A selective circuit employing "split-secondary" tuning.

amplification, the second valve serving to amplify the rectified current from the crystal detector, which is fed to the grid circuit of V₂ by means of the iron-core transformer T₁T₂. If desired, the note-magnifying valve may be omitted by replacing the primary winding T₁ of the transformer by a pair of telephone receivers. This circuit necessitates greater care in tuning than that of Fig. 1, on account of the fact that we now have two tuning controls, namely, C₁ and C₂, together with the coupling between L₁ and L₂, and between I₃ and L₂. For broadcast reception L₁ may

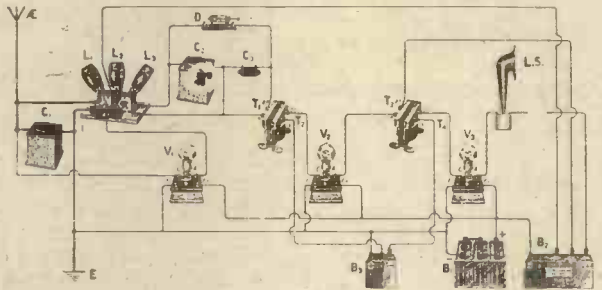

Fig. 3a.—This diagram makes clear the method of wiring up the circuit of Fig. 3.

be either a No. 35 or 50, L₂ a No. 75, while a No. 50 will in all probability be found correct for L₃. C₁ may again have a maximum capacity of 0005μF, C₂ being 0003μF, and C₃ about 001μF as before.

A More Powerful Circuit

The addition of a further stage of low-frequency amplification to the Fig. 2 circuit gives a powerful loud speaker circuit, and will appeal to those who

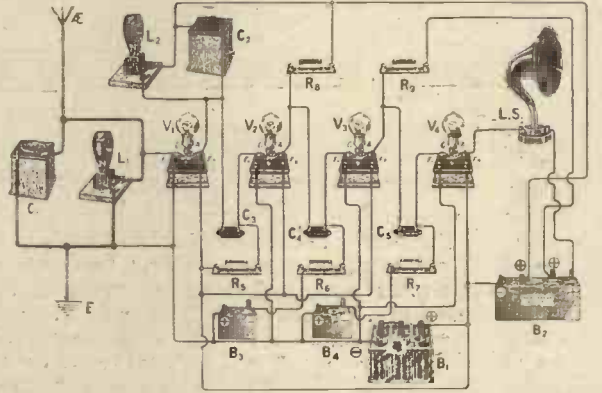

Fig. 4a.—All the components and connections necessary for the Fig. 4 circuit are given in this diagram.

want to get some of the more distant stations on the loud speaker. This circuit is shown in Fig. 3, and pictorially in Fig. 3a. The coil and condenser values for this circuit will be the same as those given for the Fig. 2 circuit.

A Good General-purpose Four-valve Circuit

The more ambitious experimenter may desire to try a four-valve circuit, comprising one high-frequency valve, detector, and two note magnifiers. Many favour the resistance-capacity method of low-frequency amplification as giving greater purity of reproduction than some makes of iron-core transformer, and this type of coupling is shown in Fig. 4. The aerial tuning circuit comprises the coil L₁ and

A FINISH TO FIDDLING

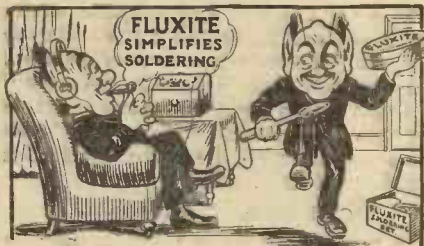

There's no tinkering about with joints once the wiring of your set is soldered.

A soldered circuit is one unbroken piece of metal. It will never need another moment's thought.

Soldering is simple with **FLUXITE**. It becomes a job anyone can

do without a chance of failure. Men who are soldering all day long don't attempt to work without it.

Ask your Ironmonger or Hardware Dealer to show you the neat little

FLUXITE SOLDERING SET

It is perfectly simple to use, and will last for years in constant use. It contains a special "small space" Soldering Iron with non-heating metal handle, a Pocket Blow-lamp, **FLUXITE** solder, etc., and full instructions. Price 7/6. Write to us should you be unable to obtain it.

Price 7/6



FLUXITE SIMPLIFIES SOLDERING

All Hardware and Ironmongery Stores sell **FLUXITE** in tins, price 8d., 1/4 & 2 8.

Buy a Tin To-day!

FLUXITE, LTD. (Dept. 330), West Lane Works, Botherhithe, S.E.10

ANOTHER USE FOR **FLUXITE**
Hardening Tools & Case Hardening
ASK FOR LEAFLET on improved methods



**SUCCESS
OSCILLATOR
UNIT
PRICE 21/-**

The "SUCCESS" Superforma

An Intermediate Frequency Transformer for Super-Heterodynes

The outstanding feature of the "Success" Superforma is the incorporation of a .0008 Variable Condenser as an integral part of the unit. The fact that it is tunable is a consideration which enables the experimenter to balance up the stages for himself, after the set is built, and to tune out interference. That the "Success" Superforma is tunable considerably increases the selectivity of the receiver, gives greater amplification and generally improves the efficiency of any Super Heterodyne Receiver. By turning the small knob, the tuning condenser may be locked in position.

"SUCCESS" SUPERFORMA. Price 30/-

If your dealer cannot supply, send direct to

BEARD & FITCH, LTD., 34, AYLESBURY ST., LONDON, E.C.1
Telephone: Clerkenwell 8941.
North of England Branch: 1, DEAN STREET, PICCADILLY, MANCHESTER.
Telephone: Central 8240.

Barclays 1318



Read the report of the test recently made by the National Physical Laboratory—impartial evidence of **ATLAS** efficiency.

"The effective series resistance of the condenser was measured at a frequency of 1,000 kilocycles per second with the condenser set at its maximum capacity. The effective series resistance was found to be less than 0.1 ohm."

PRICES:

•001	13/6	•0003	11/-
•00075	12/3	•00025	10/9
•0005	11/6	•0002	10/6

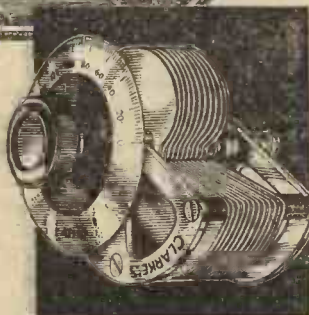

PROMISE! The latest addition to the famous "ATLAS" Range is the new **SQUARE LAW LOW LOSS VARIABLE CONDENSER**, and once again promise is even excelled by actual performance. A few of its outstanding features are:

The fixed vanes are insulated from the moving vanes by means of ebonite tubes outside the electrostatic field, and losses are still further reduced by the end plaques, which instead of being "fl" are cut away.

It gives straight line tuning—of course.
Has low phase angle difference and power factor

There are dozens of sound reasons why the man who wants the finest condenser will eventually choose:

"CLARKE'S" **ATLAS** SQUARE LAW LOW LOSS CONDENSER

Type A. Prov. Pat. No. 5030/25.

H. CLARKE & CO. (Mcr.) Ltd, Radio Engineers, Atlas Works, Old Trafford, MANCHESTER

condenser C_1 , the incoming oscillations (or signals) being passed on to the grid and filament of the first valve, which acts as a high-frequency amplifier on the tuned-anode principle, the coil L_2 and condenser C_2 forming the tuned circuit. The amplified oscillations

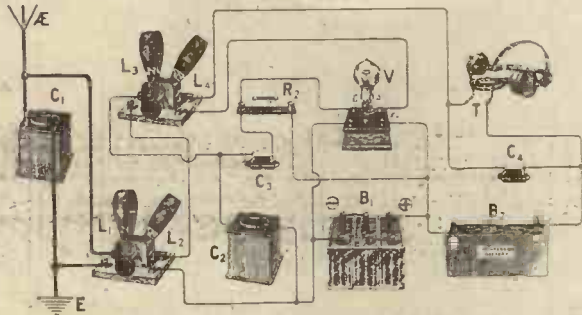

Fig. 5a.—A practical form of the Fig. 5 circuit. Two 2-way coil holders are required.

tions are then passed to the grid of the valve V_2 , through the grid condenser C_3 , a grid leak being provided and joined across grid and positive filament as shown. The oscillations are rectified by the valve V_2 and passed through successive stages of magnification by the valves V_3 and V_4 , the loud speaker being included in the plate circuit of the last valve.

Coils and Condensers

For broadcast reception L_1 may be a No. 35 or 50 plug-in coil, L_2 being a No. 50, or 75 for the upper band. C_1 is a variable condenser of $.0005\mu F$ maximum capacity, that of C_2 being $.0003\mu F$.

Other values are: C_3 , $.0003\mu F$; C_4 , C_5 , $.015\mu F$ not critical, almost any capacity between $.007\mu F$ and $.2\mu F$ being suitable. R_5 , 2 megohms; R_6 , R_7 , $\frac{1}{2}$ to $1\frac{1}{2}$ megohms. For Chelmsford and Radio-Paris, L_1 may be a No. 150 coil, while a No. 200 or No. 250 will be required in the socket of L_2 , other values remaining as before.

A Selective Circuit

Many listeners are greatly troubled by interference, and are willing to sacrifice something in simplicity for the required selectivity. The same state of affairs exists where it is desired to eliminate the local station and receive others whose wavelengths differ but little from that of the local station.

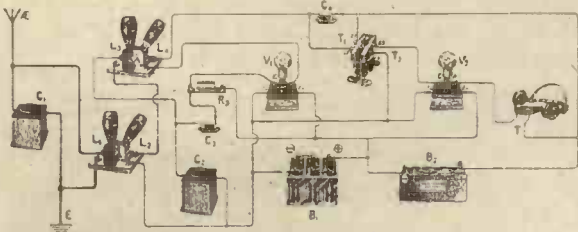

Fig. 6a.—A practical representation of the Fig. 6 circuit, which may be compared with Fig. 5a.

A method of obtaining the desired selectivity is that illustrated in Fig. 5, and is known as the "split-secondary" method of tuning. As will be seen, the aerial circuit comprises the coil L_1 and condenser C_1 , the coil being variably coupled with the coil L_2 , which latter coil constitutes one portion of the secondary circuit. The remaining portion of the secondary

circuit is L_3 , to which is variably coupled the reaction coil L_4 . Each pair of coils is mounted in a separate two-way coil holder, and the whole of the secondary circuit is tuned by the condenser C_2 . It is possible by this means to vary the coupling between aerial and secondary coils (L_1 and L_2) without necessitating a resetting of the reaction coupling, as is the case when the reaction coil is coupled directly with the secondary circuit coil L_2 . Great selectivity is obtainable by this method, it being possible to work with a very loose coupling between aerial and secondary circuits without upsetting the stability of the receiver.

Coil Sizes

For reception between 300-500 metres, L_1 may be a No. 35 or 50 coil, C_1 having a maximum capacity of $.0005\mu F$. L_2 may be a No. 50 coil, and L_3 a No. 25, while C_2 will also have a capacity of $.0005\mu F$. The size of the reaction coil will depend on various factors, but in all probability a No. 50 will suffice. C_3 is the usual grid condenser, of $.0003\mu F$ capacity, R_2 being a grid-leak of 2 megohms. For the long-wave station and Radio-Paris, L_1 may be a No. 150, L_2 a No. 200, L_3 a No. 50, while the reaction coil may be chosen to suit the reader's own circumstances.

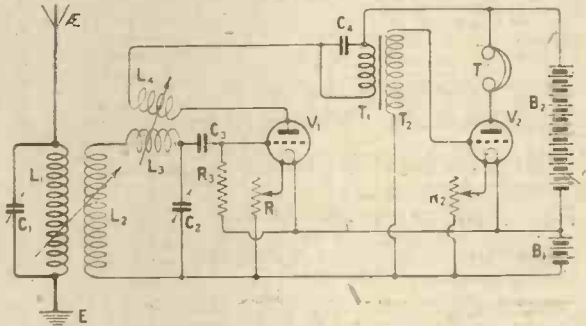

Fig. 6.—The addition of a note magnifier to the Fig. 5 circuit results in a useful long range circuit.

Smooth Control

In order to obtain smooth reaction control, a small fixed condenser of, say, $.0005\mu F$ capacity, may be required across the telephone receivers, and this is shown in Fig. 5.

Adding a Note Magnifier

A stage of low frequency amplification may very easily be added to the Fig. 5 circuit, as shown in Fig. 6, where the telephone receivers have been replaced by the primary winding of a low-frequency transformer, the secondary winding of which is joined across the grid and filament of the valve V_2 as shown. The values of coils and condensers will remain as given for the Fig. 5 circuit, and the two valve circuit will form a useful and selective receiver for telephone reception of distant stations.

The method of joining up the several pieces of apparatus for this last circuit is seen pictorially in Fig. 6a, the lettering of which corresponds with that of the theoretical diagram, Fig. 6.

The Coil Holders

Although not so shown in Fig. 6a, it will in all probability be found best to so dispose the two two-way coil holders that the coils in one are at right angles to those in the other holder, thus tending to reduce any coupling between aerial and reaction coils. Should such coupling exist, alteration in aerial coupling may necessitate a readjustment of reaction setting, thus nullifying the object of splitting the secondary inductance.

J.W.B.

THE PANEL DE LUXE



THE real wireless enthusiast goes over his Set inch by inch. Shortening a connection here—replacing an inefficient component there, he knows that success depends on the most careful attention to seemingly insignificant details. Such men are now standardising on Radion as the panel material de luxe.

Q Radion is available in 21 different sizes in black and mahogany. Radion can also be supplied in any special size. Black 1d. per square inch, mahogany 1½d. per square inch.

RADION

American Hard Rubber Company (Britain) Ltd

Head Office: 13a Fore Street, London, E.C.2 Depots: 220 Wellington Street, Glasgow, 116 Snow Hill, Birmingham. Irish Agents: 8 Corporation Street, Belfast

G.A. 3036.

L.F. TRANSFORMER

ALL RATIOS

PURITY

GUARANTEE

NONMAGNETIC SHROUD

500,000 IN USE

USED ALL THE WORLD OVER

RATIO 5% & 3%

9'6 PRICE



FROM ALL WIRELESS DEALERS.

SOLE DISTRIBUTORS, United Kingdom:

THE WHOLESALE WIRELESS CO.,
103, FARRINGTON ROAD, LONDON, E.C.

Colonies and Dominions:

A. VANDAM, CAXTON HOUSE,
WESTMINSTER, LONDON, S.W.

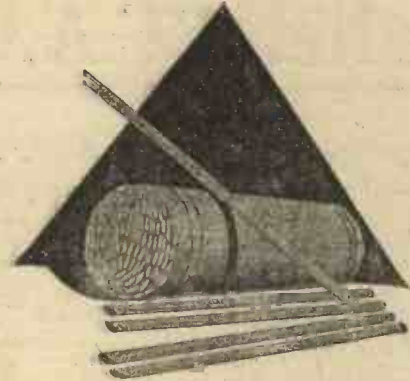

GLAZITE

REGD.

now packed in
2-foot lengths

YOU can now obtain GLAZITE in two-foot lengths, four pieces (one each red, blue, yellow and black) in a sealed envelope for 1/-. Each envelope contains enough wire for the construction of a one or two-valve set. The different colours facilitate "back-of-panel" wiring.

"Glazite" eliminates the old insulating sleeving. It consists of tinned copper wire covered first with cotton then with heavy insulating material. "Glazite" is flame-proof and damp-proof, and will not deteriorate in any way.

It possesses high dielectric strength and is easily flexible. See that the LEW Seal is intact.

Send a post card for the Glazite leaflet and name of nearest stockist
20% REDUCTION IN PRICE OF 10-FT. COILS

The retail price of GLAZITE in 10-ft. (1/18 S.W.G.) coils has been reduced from 1/6 to 1/2 per coil GLAZITE is now actually cheaper than the old method employing insulating sleeving.

Our mark is a



guarantee of quality

**The LONDON ELECTRIC WIRE CO.
AND SMITHS LTD.**

(Makers of Electric Wire for over forty years)

Playhouse Yard, Golden Lane, London, E.C.1

Telegrams: Electric, London. Telephones: Clerkenwell, 1388, 1389, 1390, 1391

The New "C.A.C." Valves

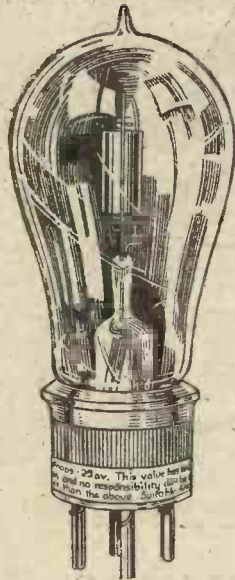

STUPENDOUS ADVERTISING CAMPAIGN

Test these new Valves at a reduced price

The "Broadcaster" says:

Best filament voltage—4. Filament consumption rather over-rated, for no valve took more than .55 amps.

On trial, using three of these valves in a set comprising one H.F., Detector, and one L.F., excellent results were obtained.

Anode voltage—60 on the high frequency, 55 on the detector, and 100 on the low frequency. The latter needed a negative grid potential of 5 volts, and there were no signs of "softening" when the anode voltage was increased to 150 volts. There were no noticeable microphonic or parasitic noises.

These valves are certainly to be included in the list of first-class British general purpose valves, for their performance on test was highly satisfactory and pleasing in every respect.

A noticeable feature was the smooth reaction effect which could be obtained when any of them were used as detectors. This greatly facilitated the reception of distant stations.

WE ASK YOU TO CONFIRM THIS REPORT YOURSELF!

As a result of months of research work, we are now in a position to place upon the market the first of our series of Wireless Valves, and we do so confident in the fact that they are unequalled by any other of their class yet placed before the Public.

This claim has still to be confirmed by the Wireless Public, whose verdict alone will prove or disprove our statement.

We realize that no amount of advertising can be half so convincing as an actual practical test, and it is for this reason that we are prepared to sacrifice a considerable amount in order to afford the valve user an opportunity personally to test this new valve on his own set.

To this end we have made arrangements with the Trade generally to dis-

tribute samples of our new Valves to the public, for a limited period only, at the nominal price of 6/- each for the Bright Emitter and 9/- each for the Dull Emitter, as against the usual price of 7/6 and 12/- each respectively. All we ask in return for this concession is that the purchaser shall put the valve through the most stringent tests at his disposal and more particularly compare the results obtained with those of other valves in his possession.

It will be apparent to everyone that such a concession cannot be afforded for an indefinite period, and as soon as the first 20,000 valves have been disposed of as samples, we shall be compelled to withdraw the offer and revert to our original price of 7/6 and 12/- per valve respectively.

THREE MONTHS' GUARANTEE

Inside each box will be found a stamped addressed postcard, addressed to our Head Office. Immediately upon sale to a customer, the retailer will fill in and return this postcard to us. From that date the valve will be guaranteed by us, in accordance with the terms printed on the postcard, for three months, and any valve found to be defective during that period for any reason other than over-volting or breakage of the bulb, will be instantly replaced by us without question or charge.

If your Dealer cannot supply, send to us at once together with your Dealer's name and address, and you will receive a valve by return of post

AGENTS WANTED IN EVERY LOCALITY

Type G.P. BRIGHT EMITTER, 7/6 each. Sample price, 6/- each

4 volts. 6 amps.

Type D.E. 2 DULL EMITTER, 12/- each. Sample price, 9/- each

1.5—2 volts. .25 amps.

C.A.C. RADIO LIMITED

Branches:
79, Old Christchurch Road,
BOURNEMOUTH
Central Street, LEEDS
10, Rupert Street, London
W. 1
79, Mark Lane, London,
E.C.3

10, RANGOON ST.,
CRUTCHED FRIARS
LONDON, E.C.3

Telephones:
Rangoon Street—Royal 4300
(2 lines)
Mark Lane—Royal 4301
Rupert Street—Gerrard 3063
Bournemouth—
Lords—Le-d
Bournemouth 3546

These are the Best Books on Radio!

and when we say best we do not use the word as an empty self-laudatory term; we state an indisputable fact. Every Radio Press publication is the work of an expert and is absolutely authoritative and reliable in its contents.

No.	Title	Price	Post Free
1	Wireless for All By John Scott-Taggart, F.Inst.P., A.M.I.E.E.	9d.	11d.
2	Simplified Wireless By John Scott-Taggart, F.Inst.P., A.M.I.E.E.	1/-	1/2
3	How to Make Your Own Broadcast Receiver By John Scott-Taggart, F.Inst.P., A.M.I.E.E.	1/6	1/8
4	How to Erect your Wireless Aerial By B. Mitchell, A.M.I.E.E.	1/-	1/2
5	The Construction of Wireless Receiving Apparatus By P. D. Tyers.	1/6	1/8
6	The Construction of Crystal Receivers By Alan L. M. Douglas.	1/6	1/8
7	How to Make a "Unit" Wireless Receiver By E. Redpath.	2/6	2/8
8	Pictorial Wireless Circuits By Oswald J. Rankin.	1/6	1/8
9	Wireless Valves Simply Ex- plained By John Scott-Taggart, F.Inst.P., A.M.I.E.E.	2/6	2/8
10	Practical Wireless Valve Cir- cuits By John Scott-Taggart, F.Inst.P., A.M.I.E.E.	2/6	2/8
12	Radio Valves and How to Use Them By John Scott-Taggart, F.Inst.P., A.M.I.E.E.	2/6	2/8
13	500 Wireless Questions Answered By G. P. Kendall, B.Sc., and E. Redpath.	2/6	2/8
14	12 Tested Wireless Sets By Percy W. Harris, M.I.R.E.	2/6	2/8
15	More Practical Valve Cir- cuits By John Scott-Taggart, F.Inst.P., A.M.I.E.E.	3/6	3/10
16	Home-Built Wireless Com- ponents By E. Redpath.	2/6	2/8
17	Wireless Sets for Home Constructors By E. Redpath.	2/6	2/8
18	Tuning Coils and How to Wind Them By G. P. Kendall, B.Sc.	1/6	1/8
21	Six Simple Sets By Stanley G. Rattee, M.I.R.E.	1/6	1/8
22	Switches in Wireless Cir- cuits By Oswald J. Rankin.	1/6	1/8
24	Wireless Faults and How to Find Them By R. W. Hallows, M.A. Elementary Text-Book on Wireless Vacuum Tubes	10/-	10/6
	By John Scott-Taggart, F.Inst.P., A.M.I.E.E.		

All the above can be obtained from
Wireless Dealers, Newsagents, Book-
stalls—or direct from Dept. W.

RADIO PRESS, LTD.
BUSH HOUSE, STRAND,
LONDON, W.C.2

Barclays Ad.

Send No Money!



We are so confident that our wonderful "Tonyphone" Super Two-Valve Set will more than please you that we offer to send same without payment of any kind until you have had an opportunity of testing it. If you are satisfied, you will remit 20/- within 4 days and pay the balance of 20/- monthly until completed.

"TONYPHO" 2" SUPER 2 VALVES

Complete with Accumulator, H.T. Battery, Aerial, 1 pair 4,000 ohms Headphones and two Valves - one High Frequency and one Detector. All Royalties Paid.

Send to-day and enjoy broadcasting NOW

BRITISH ENGINEERING PRODUCTS CO.
(Battery Dept.), WINDSOR HOUSE, VICTORIA STREET, LONDON, S.W.

S.S.A.

TUNING

Keen as a Razor!

Successful reception of distant radio demands the utmost tuning accuracy. Every radio enthusiast of experience appreciates this fact which accounts for so many having incorporated the Microhm Vernier Condenser into their receivers. They have proved it to be an instrument capable of sharp and accurate tuning always, with the greatest ease of adjustment. Until you have fitted the Microhm into your set, you cannot know what fine tuning really is. For a negligible outlay you can greatly improve upon present results. Remember it must be the—

MICROHM VERNIER CONDENSER

For use in parallel with aerial and a.c. tuning condensers.

Indispensable for "Neutrodynes."

24 turns of tuning adjustment. Single 1/4 in. hole fixing. Maximum capacity 1,000,015 m.f. Minimum capacity Negligible. Price 2/6 postage 3 d.

MICROHM ENGINEERING CO., VARSITY WORKS, COLLEGE ST., LONDON, E.9
Phone 2887
Scottish Agents: KEITH & IRWIN, 35, Robertson Street, Glasgow, C.2

Barelays 1316

SOLDERED JOINTS SUPERSEDED!

You can easily connect up the most complicated set entirely without use of solder, with the

PATENT "KRISCROS" CONNECTORS

Strong and perfect joints. Used by Mr. Percy W. Harris and other leading experts. A "Kriseros" for every standard thread. No Solder. Prices: 1/6 to 3/- per doz.

Send for List.

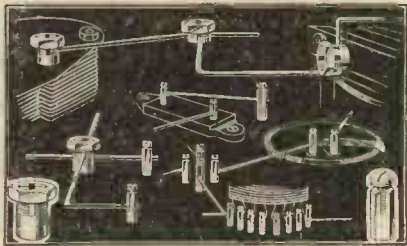

Kriseros Co., 50, Gray's Inn Road, W.C.1

FAMA & FAIRY VALVES FURTHER REDUCTION IN PRICE

Guaranteed to be the Cheapest, most Reliable and most efficient Valves on the Market.

Type.	Filament Volts.	Anode Volts.	Amps	New PRICE	
POWER [Double Grid]	6.0	100-250	0.6	8/6	POST FREE
Detector ..	3.8 to 4.0	20-60	0.5	4/5	
Amplifier ..	3.8 to 4.0	30-100	0.5	4/6	
0.06 DE ..	1.8 to 3.0	20-100	0.06	9/6	

EXTRA LIBERAL TRADE DISCOUNTS.

Keene & Quotations to the Trade for all Wireless Components. Write for Price List.

H. D. ZEALANDER & CO.,
St. John's House, 124-127, Minories, London, E.1.
Phone: Avenue 1182

3 volt D.E. 10/6
2V. D.E. 10/6
6V. Power Valve. 22/6
4 volt Bright 7/-

Send for Booklets to—

RADIONS LIMITED, BOLLINGTON, NEAR MACCLESFIELD

"BETTER RECEPTION"

is the unanimous opinion of Thousands of Satisfied Users of the

"LOTUS" Cut Geared Vernier COIL HOLDER

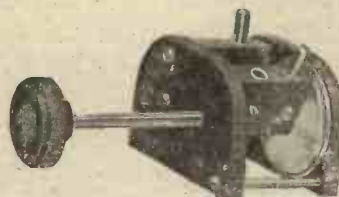

Vernier Movement, actuated by Three Sets of Encased Precision Cut Gears, representing a Reduction of 8 to 1.

Moving Block Cannot Fall.

"LOTUS" COIL HOLDERS are made from BAKELITE MOULDINGS, with Nickel-Plated Brass Parts.

Retail Selling Price Two-way, 7/-
Three-way, 10/6



Garnett, Whiteley & Co., Ltd.
Lotus Works, Broadgreen Road, Liverpool

The WIRELESS DEALER

Edited by

JOHN SCOTT-TAGGART, F.Inst.P., A.M.I.E.E.

THE First Number of this new trade periodical will be issued on September 12th, and the Publishers, Messrs. Radio Press, Ltd., have been pleased to appoint Messrs. Barclays Advertising, Ltd., as Advertisement Managers.

We wish to announce that the following exceptionally generous offer is made to all those firms whose advertisements appear in No. 1 issue of "The Wireless Dealer," viz. :-

HALF RATES FOR THE FIRST THREE ISSUES

Example :- 12 Full pages at series rate £11 11 0 = £138 12 0
 less 50% on first three issues ... 17 6 6
 Net Cost for a full page each issue for
 12 consecutive issues £121 5 6

ADDITIONAL FULL PAGES ARE SUBJECT TO A SPECIAL 20% REDUCTION

To all advertisers contracting for full pages we offer additional pages at scale rates less 20%.

ADVERTISEMENT RATES

Number of Insertions.	Page	Half	Third	Quarter	Sixth	Eighth	1" s/c.
1	£15 15 0	£8 8 0	£6 6 0	£5 5 0	£3 10 6	£3 3 0	£1 1 0
6	13 13 0	7 10 6	5 5 0	4 10 6	3 3 0	2 17 6	19 0
12	11 11 0	6 10 6	4 10 0	4 2 6	2 17 6	2 12 6	18 0

Trade and Miscellaneous Prepaid Paragraph Advertisements.—Three shillings for first twelve words and threepence for every additional word.

Situations Vacant and Wanted.—Two shillings for first twelve words and one penny for every additional word.

Special position and two-colour pages—rates on application.

ALL COMMUNICATIONS TO BE ADDRESSED TO

Barclays Advertising, Ltd.
 BUSH HOUSE, STRAND, LONDON, W.C.2



NOW READY Price 5s. 6d.
A Textbook of WIRELESS
Telegraphy and Telephony

By **W. GREENWOOD, B.Sc. (Eng.), A.M.I.E.E., A.C.G.I.,**
 Wireless Engineer, His Majesty's Signal School, Portsmouth.

In this book the subject of wireless telegraphy and telephony has been dealt with simply and concisely, yet scientifically and adequately. The instruments, apparatus and circuits in amateur sets, in radio-stations, in aeroplanes, and on ships receive full treatment, and at the same time the essential theory underlying the whole subject is thoroughly investigated and explained.

A Descriptive Prospectus of the above and Complete Catalogue of Educational Books post free on application

UNIVERSITY TUTORIAL PRESS, LD.,
 25, High Street, New Oxford Street, London, W.C.2

WIRELESS CONSTRUCTORS—
Construct your own Loudspeaker

There is nothing more simple—a good ear-piece and a "scientific" **NON-METALLIC SPEAKER HORN** gives you an extraordinarily efficient loud-speaking instrument.

These Horns, finished with an attractive dull bronze surface, are absolutely **NON-RESONANT and DISTORTIONLESS** and render voice and music with a degree of mellow sweetness hitherto unobtainable. (When ordering please state size of Ferrule required.)



	Approximate Price
	Ht. Flare
SMALL SWAN-NECK	16 in. 8 in. 5/9
with Petal Flare	16 " 10 " 7/9
SMALL WESTERN pattern	19 " 10 " 7/9
MEDIUM WESTERN pattern	21 " 11 " 8/9
with Petal Flare	21 " 12 " 9/9
LARGE WESTERN pattern (as illus.)	24 " 14 " 11/9
CURVED HORN, for Amplion Janios	— " 12 " 11/9
with Petal Flare	— " 13 " 12/9
LARGE SWAN-NECK	24 " 13 " 14/9
with Petal Flare	25 " 15 " 15/9

Post, Packing and Crave 1/9 ex ra.

SCIENTIFIC SUPPLY STORES.

80, NEWINGTON CAUSEWAY, LONDON, S.E.7. Phone: Hop 4177
 Branches: 126, Newington Causeway, S.E.1; 7, St. George's Circus, S.E.1
 16, Manette St., Charing Cross Road, W.1; 207, Edgware Road, W.2;
 84, Church Road, Upper Norwood S.E.23.



THE

DARGO NEW PROCESS Guaranteed Grid Leak

Has been well received by the technical press, and can be relied upon for highest efficiency. As mentioned in this issue and as used in the Short Wave Set described by Mr. Rattee in "Wireless Weekly," June 24th issue.

PRICE 2/- EACH

Dargo Leaks are provided with terminals, soldering tags and caps to fit any clip, and are made in sizes from 5 to 1/2 Megohms.

Purchase through your local dealer or, if he cannot supply, send P.O. direct with dealer's name and address.

DARGO LTD. 77, HIGH ST. WATFORD
 Phones: 1432, 336.

The BRONEL PERMANENT DETECTOR

THE BRONEL PERMANENT DETECTOR IS ABSOLUTELY & DEFINITELY PERMANENT

THERE IS NOTHING TO ADJUST AND IT IS ALWAYS SET

5 YEARS Solid GUARANTEE

From all Wireless Dealers or post free from—

Wm. R. BOWMAN LTD.

47, MARK LANE LONDON, E.C.3



5/- Get one! to-day!

FITTED with adjustable screw which gives 1/2 extension, thus allowing it to be fitted to existing clips.

AS used in the Crystal valve Set described in July issue of The Wireless Constructor.

Barclays 1306

His Friends are

"Charmed as well as Entertained"

So says every user of



He doesn't have to apologise for his set

The Fitments include—

- "Tangent" Tuning Coils
- "Tangent" LF Transformers
- "Tangent" Loud Speakers
- "Tangent" Discos
- "Tangent" Filament Rheostats
- Transformers

Catalogue TU and name of nearest dealer sent on request

GENT & CO., Ltd. (1872) Faraday Works, Leices'er

CONTINUOUS RECEPTION

in any position at all times, owing to the special design of both crystal and catwhisker, being always in contact. **GUARANTEED TONE—VOLUME—PURITY.**

Some Notable Features:

1. Nickel-plated, detachable, dust-proof cover.
 2. Special "Harlie" super-sensitive crystal.
 3. Ebonite wheel for rotating crystal. No fumbling about adjusting, just turn the wheel—simplicity itself.
 4. Catwhisker on slider for covering whole surface of crystal. Shock-proof.
- Obtainable from all dealers or direct from patentees and manufacturers. **PRICE COMPLETE 5/6**
 Don't tickle the crystal—use



Patented Patent 26791/24
 Generous Trade Terms. Telephone: Chisold 5061.
HARLIE BROS., 36, WILTON ROAD, DALSTON, LONDON, E.8

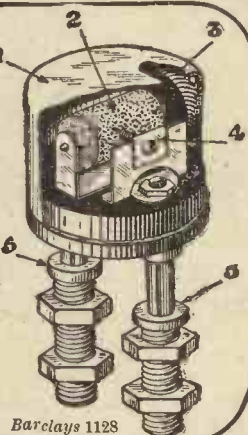

Barclays 1128

The New MAXEL Accumulator

Specially designed for Wireless GUARANTEED TWELVE MONTHS.

If you live too far away to call and see the Battery Mail your Order to us for the size you want. We will willingly return your money if you are disappointed.

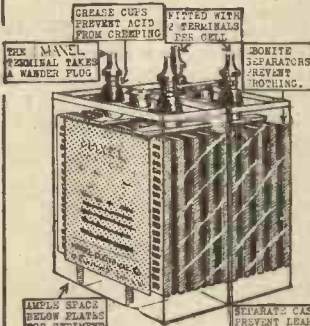

	AMPS.			
	40	60	80	110
2 VOLT ..	7/6	9/6	11/6	14.-
4 VOLT ..	15/-	18/6	22/-	25/6
6 VOLT ..	22/6	27/-	32/6	37/6

Packing 1/- extra per battery.

H.T. Batteries 60 volt 7/6 post free

MAXEL ELECTRICAL CO. 28, Clipstone Street, Great Portland Street, W.1
 Telephone: MUSEUM 708.

Patent Applied For.

The WL COIL HOLDER

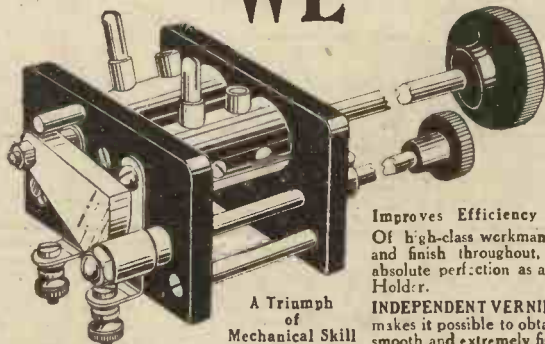

PRICES.

2-Way	9/6
3-Way	13/6

Improves Efficiency of Any S.t. Of high-class workmanship, material and finish throughout, it represents absolute perfection as a Vernier Coil Holder.

A Triumph of Mechanical Skill

INDEPENDENT VERNIER CONTROL makes it possible to obtain a perfectly smooth and extremely fine adjustment.

WESTERN LABORATORIES LTD., 11, Hanbury Rd., Acton, LONDON, W.3

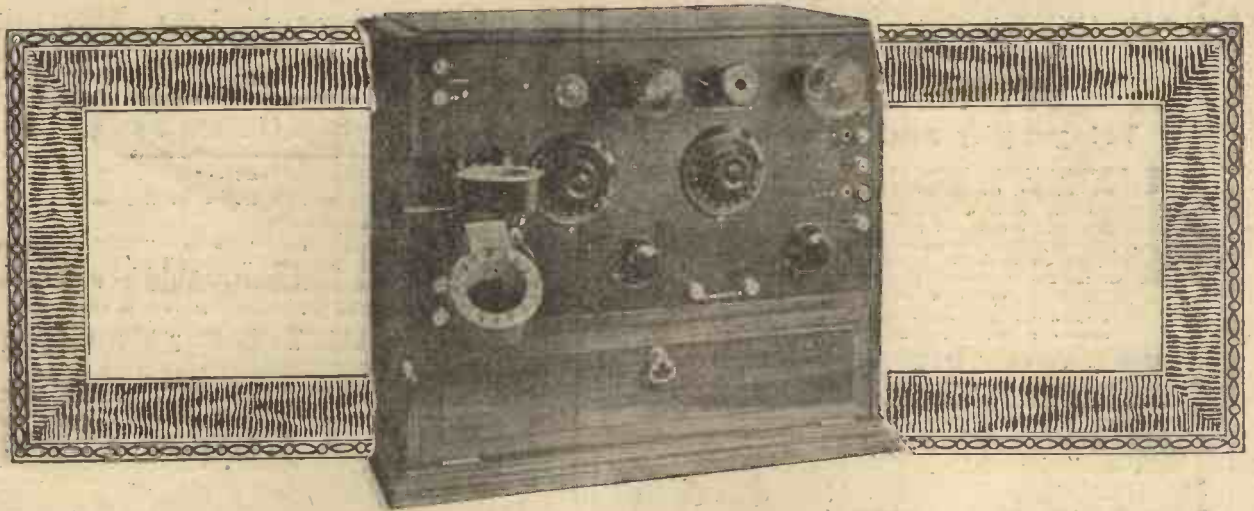

A Reflex Loud-speaker Set

REFLEX Receivers enjoy great popularity amongst listeners because of their ease of control and the very high quality of the results obtained. Yet they have their disadvantages, especially in circuits incorporating a crystal as a detector. Unless it is of the permanent type and thoroughly reliable, the adjustment of the crystal is always indefinite, and the set therefore lacks stability.

A Reflex Receiver that is designed to maintain the desired ease of control and perfect results, whilst not employing the rather unsatisfactory crystal detector will certainly be of great interest to reflex enthusiasts.

Such a receiver is the "Twin Valve" Loud-speaker Receiver, designed by John Scott-Taggart, M.C., F.Inst.P., A.M.I.E.E., Editor of WIRELESS WEEKLY and of MODERN WIRELESS, and the originator of the ST100 circuit.

Here are a few of the striking features of the "Twin Valve" Loud-speaker Receiver:

1. Will operate a Loud-speaker at distances up to 25 miles from the local station with an aerial system of average efficiency.

2. Only two valves are utilised. Either Bright Emitters or Dull Emitters can be used.

3. No crystal is employed. Perfect stability under all conditions is thereby assured.

With the assistance of Radio Press Envelope No. 10 you will find it an easy matter to construct this wonderful receiver. The Envelope contains, as usual, every possible detail.

It contains—

Two full-size blueprints.

Three sheets of reproductions of photographs on art paper.

Three sheets of working drawings.

Five sheets of instructions.

You cannot go wrong, even if you have never built a set before, so explicit and full are the instructions, and so helpful are the special progressive wiring diagrams

Radio Press
ENVELOPE No. 10



Radio Press Envelope No. 10

Obtainable from any Bookstall, Newsagent, your local Wireless Dealer, or direct from Dept. W, Radio Press, Ltd., Bush House, Strand, London, W.C.2

The "Twin Valve" Loud-speaker Receiver

Radio Press, Ltd.

BUSH HOUSE, STRAND, LONDON, W.C.2

CUT A BIG EXPENSE OUT OF WIRELESS BY WINNING YOUR OWN COILS ON THE

"WESTMINSTER"

Adjustable Coil Winder
PRICE 4/- post free



With the **WESTMINSTER** 600 ohms POTENTIOMETER you can secure that last degree of fine adjustment which makes all the difference in the efficiency of your set. Single hole fixing. Wound with enamelled wire on ebonite former.

Price 4/- post free

If your local retailer cannot supply you, order direct and send his name and address to

WATSON, JONES & Co.
6, ST. STEPHEN'S HOUSE,
Victoria Embankment, London, S.W.1
Trade Enquiries Solicited. Phone: VICTORIA 7571

A SILENT BACKGROUND

is essential if long distance reception is desired. The use of a grid leak containing carbon is bound to produce a noisy background. In a variable grid leak, especially, the resistance material used must be constant in use. Such a variable grid leak is the

"BRETWOOD" GRID LEAK

Successfully used and recommended everywhere.

BRETWOOD GUARANTEED

SPECIALITIES are obtainable from most Wireless Dealers.

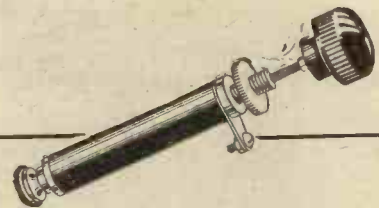

Changeable as a Weathercock

is a well-known expression. It is peculiarly applicable to the carbon compression type of variable grid leak.

A carbon leak examined under a powerful microscope shows minute arcing between adjacent particles when a current is flowing. Thus, slowly, portions of the leak may be consumed, while its use is bound to result in noisy operation of the receiver, and atmospheric conditions change its effective resistance.

The only variable grid leak which is so constant in action as to admit of its being actually calibrated is the "Bretwood."

The substance used is silent in action and constant in use. For better reception fit a "Bretwood."

PRICE 3/- POSTAGE 3d.

BRETWOOD LIMITED
12-18, LONDON MEWS, MAPLE STREET - LONDON, W.

Barclays Ad.



BALL ROTOR
2 1/2" diameter
Beautifully finished, with all holes accurately milled in.
Price 2/6



TAPPED ANODE COIL
for "Simplicity" Receiver.
Wound with silk cov red resistance wire on ebonite former.
Price 7/6



MICROPHONE TRANSFORMER
Very efficient.
10 ohms primary
2,000 ohms secondary
Price 17/6



WANDER PLUG H.T. BATTERY LAMPFUSE
Protects ANY type of valve, IN CLUDING DULL EMITTERS
Price complete and with Spare Lamp 2/6



NEON TUBE LIGHTNING ARRESTER
Safeguards your set at all times from heavy static or lightning discharges.
Price complete, 7/6
SPARE NEON TUBES 2/6



Well finished **SERIES PARALLEL SWITCH**
Rotary commutator type, ebonite insulation. Price 2/6
44-page RADIO CATALOGUE FREE, if you mention this advertisement.

ECONOMIC ELECTRIC, LTD., Patentees & Manufacturers
Head Office: 10, FITZROY SQUARE, LONDON, W.1
Showrooms: 303, EUSTON RD. N.W.1
Branch and Work: TWICKENHAM

RADIAX (H.E.) LOW LOSS COILS

Are streets ahead of ordinary coils in efficiency. Users write us to this effect continually. *THEY know; they have tried them against the others.*

If you desire improved tuning, volume and selectivity, insist on Radiax Coils. Each one is engraved with trade mark and size. They are strong, all the turns are bonded together, and they are of reasonable size. Packed in individual containers.

No. 25	1/6	No. 75	2/3	No. 200	4/3
" 35	1/9	" 100	2/9	" 250	4/9
" 50	2/-	" 150	3/-	" 300	5/3

Unmounted coils 9d. each less. Set of nine mounted, 27s.



RADIAX, LTD.,
44, RADIO HOUSE,
Tottenham Ct Rd., London, W.1.
Tel: MUSEUM 490



New Catalogue of all components Super Heterodyne material, as well as all types of sets complete and for constructors. Enclose 3d. Stamps.

Barclays 1312

Prov. Pat. No. 1101624.

EVERYBODY NEEDS the RADIO BEAD

Every radio enthusiast is troubled by the twisting and kinking of the flex leads of his headphones, loudspeaker, or batteries, and the consequent damage resulting in inferior reception. But now there is a remedy—

THE RADIO BEAD

is a simple accessory which clamps on to your flex leads (no disconnecting necessary) and enables you to instantly remove kinks and prevent their recurrence. Light in weight and small in cost, it prevents that frequent and often unknown cause of loss of signal strength which is so difficult to trace.

Approved by leading radio experts. Satisfaction guaranteed. **ESSENTIAL TO YOU. GET ONE NOW.**

Obtainable from all dealers. Trade enquiries invited.
WIN PATENTS, Bridgeway House, Hammersmith, London, W.6. Tel.: RIVERSIDE 3463.

1/- EACH

Barclays Ad.



“An All-Enclosed Super-Heterodyne”

By

G. P. KENDALL, B.Sc.

Selection from Contents

HOW TO MAKE A THREE-VALVE LOUD-SPEAKER RECEIVER

By A. Johnson-Randall

AN EFFICIENT CRYSTAL SET

By D. J. S. Hartt, B.Sc.

A SELECTIVE TWO-VALVE RECEIVER

By John W. Barber

A COMBINED FILTER AND TONE CONTROL UNIT.

By C. P. Allinson

THE HAMBURG BROADCASTING STATION

By Capt. L. F. Plugge, B.Sc., F.R.Ae.S., F.R.Met.S.

SOME SUGGESTIONS FOR BETTER RECEPTION

By John Underdown

COMMON FAULTS IN TUNING COILS

By G. P. Kendall, B.Sc.

Useful Four-Valve Circuits
Continental Transmissions

MODERN WIRELESS is always up to the times in set designs, and specially appeals to all enthusiasts whose interests are centred around that alluring hobby.

Foresight, enterprise and initiative are but three of its many qualities. Pure logical reasoning says that it is only a radio magazine edited by such competent wireless men, and published by Radio Press, Ltd. that could succeed in its endeavours.

The July issue fully maintains its undeniable prestige. Seasonable and descriptive is the article entitled “An All-Enclosed Super-Heterodyne” by G. P. Kendall, B.Sc. Here we find the Rolls-Royce of Radio circuits in a different rôle—in a semi-portable form.

To car owners this set will open up a new vista of delights. The flat period which usually follows the picnic tea will gain added charms by its presence. Buy a copy of MODERN WIRELESS and read all about it.

from all /
newsagents
and bookstalls

Buy Your Copy To-day

Modern Wireless

Edited by John Scott-Taggart, F.Inst.P.

Barclays Advt.

An ANNOUNCEMENT

Vacancy for DEPUTY CHIEF ENGINEER £1,700 per annum (minimum)

RADIO PRESS LIMITED desire to announce that there is a further vacancy on their new research staff for a Deputy Chief Engineer. A minimum salary of £1,700 is offered (which is exclusive of certain remunerations which may increase the amount to nearer £2,250). An agreement covering five years would be entered into.

The Engineer shall rank next to the Chief Engineer, the vacancy for which post was recently advertised, and must fulfil the following requirements:—

- 1 Possess a degree not lower than M.Sc.
- 2 Have had not less than 10 years' experience of research work in radio reception and transmission.
- 3 Must have held for not less than five years an executive position involving the originating of radio inventions and their development to a final practical stage.
- 4 Must possess extensive engineering experience and a thorough knowledge of the mechanical and electrical design of radio instruments.
- 5 Must be intimately familiar with all modern radio developments, and must at present be engaged commercially or in one of the services on work similar to that to be carried out at the Elstree Laboratories of Radio Press, Limited.

Applications (which will be treated in the strictest confidence) should be addressed to:

JOHN SCOTT-TAGGART, F.Inst.P., A.M.I.E.E.,
Technical and Managing Director,
RADIO PRESS, LIMITED,
Bush House, Strand, London, W.C.2.

Radio Press, Ltd.,



Bush House, Strand, W.C.2.

Barclays Ad.

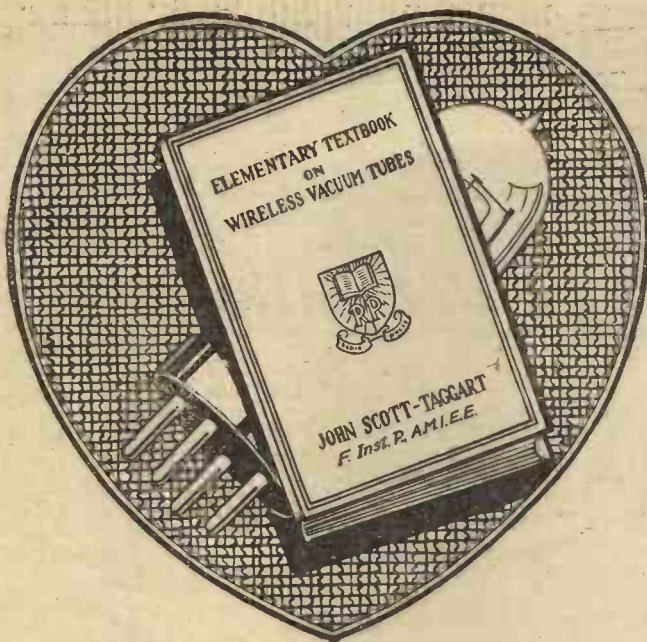

The Valve is the Heart of your Set—

*How much do you
know about it?*

COMPLETE satisfaction from any radio receiver is, as a rule, based upon the operator's knowledge of its fundamentals. In just the same way as a motorist, keen upon maximum efficiency, needs to be conversant with his machine, so must the radio enthusiast know and understand the component parts of his receiver if best possible results are his ideal.

There is the valve, for example. The whole working efficiency of valve receivers centres around the valve more than any other component. It is in fact almost what the heart is to the human body—a life giver.

It would be impossible to detect or to amplify weak long distance radio signals except for the valve. Yet how many radio experimenters and constructors know more than the very barest of facts about the valve? It is patent, however, that a good working knowledge of this vital component should be acquired by every radio man intent upon maximum efficiency. Indeed, it is essential to the experimenter and constructor!

Such a knowledge of the valve as meets the needs of the present day radio enthusiast is contained in "Elementary Textbook on Wireless Vacuum Tubes," by John Scott-Taggart, F.Inst.P., A.M.I.E.E. This book, which is one of the foremost treatises on the radio valve, is in its fourth edition, which testifies to the success it has already met with in the radio world. It is written in Mr. Scott-Taggart's usual lucid manner, thus making highly technical matters clear to the man who knows little of the subject.

The fundamental principles of the radio valve and its practical uses are dealt with fully and the text profusely illustrated with charts and circuit diagrams which makes the subject a pleasant and simple study. No serious experimenter or constructor can afford to do without the book.

Well bound and printed on good paper, it is eminently suitable to stand on the experimenter's shelf, and to be constantly thumbed over for reference.

ELEMENTARY TEXTBOOK ON WIRELESS VACUUM TUBES.

By John Scott-Taggart, F.Inst.P., A.M.I.E.E.

Obtainable from all Bookstalls,
Newsagents and Wireless Dealers, or
Direct from the Publishers, Dept. W.

PRICE
10/-
Post free 10/6.



Radio Press, Ltd.
BUSH HOUSE, STRAND, LONDON, W.C.2.



Barclays Ad.



*For the enthusiast
who wants
to know more!*

THERE comes a time to every radio enthusiast, when, having mastered a set or two, he is imbued with a desire to do more—to reach out into unexplored fields.

This is a critical time—a time when misplaced and incorrect advice would severely damp his enthusiasm. If you have reached this stage take no chances. Buy **WIRELESS WEEKLY** every Wednesday and you will gain added impetus in radio.

WIRELESS WEEKLY is for the man who wants to know more. It does not stop at essentials, but goes deeper into that alluring subject, radio. It shows you how to prove things for yourself. It gives the results and data from experiments by experts. In short, it is the ideal magazine for the experimenter.

Buy a Copy from
your Newsagent
or any Bookstall

PRICE

6^{D.}

Every Wednesday

Wireless Weekly

ADVERTISEMENT OF RADIO PRESS, LTD., BUSH HOUSE, STRAND, LONDON, W.C.2

Barclays Ad.

In replying to advertisers, please mention THE WIRELESS CONSTRUCTOR.

955



Sure it's Atmospherics?

When your Set suddenly develops violent symptoms of internal disorder, emitting noises which are not at all in keeping with good reception, you are apt to dismiss this inconvenience with one word, "atmospherics," and then look out of the window for a sultry sky.

But as the days wear on and the "atmospherics" appear to have made your Set a permanent residence, you begin to suspect other things. Finally you take down the Set and thoroughly scrutinize the interior for visible faults. Of course, there is nothing to be seen; everything is wired up O.K.

It is probably one of those faults which make themselves more exasperating by their habit of leaving no clues. Don't despair, get a copy of "Wireless Faults and how to find them," by R. W. Hallows, M.A., Staff Editor.

This useful book will show you just how to track obscure faults down. No expensive apparatus is needed, and the application of numerous simple tests is thoroughly described.

Price 1/6

You can obtain "Wireless Faults and how to find them" from all Bookstalls, Newsagents and Wireless Dealers, or post free, 1/8, from Dept. W.



Radio Press, Ltd.
BUSH HOUSE - STRAND - LONDON - W.C.2

Barclays Ad.

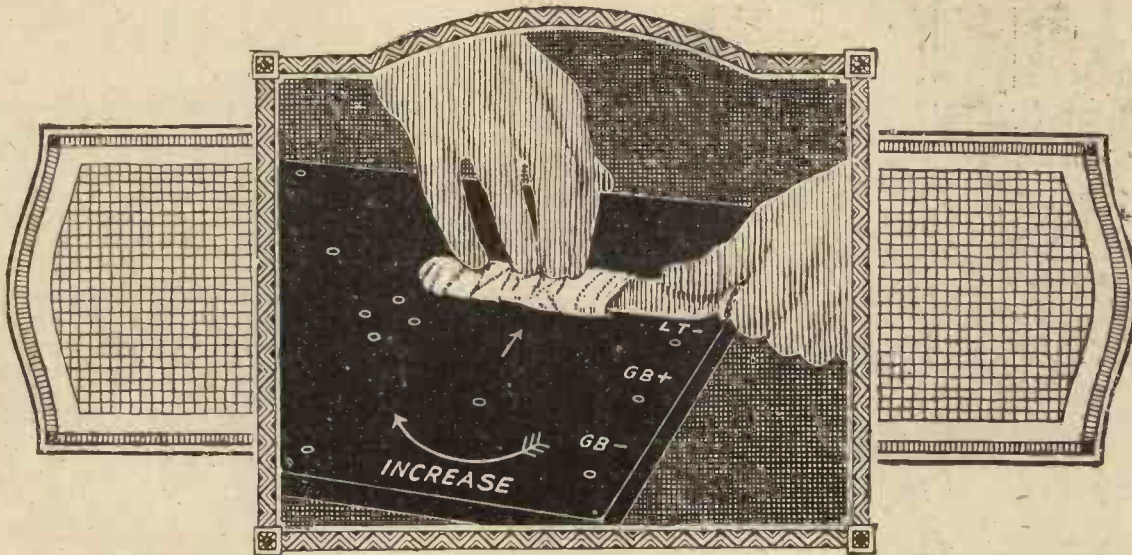

Protect your Set

A GOOD set deserves protection, and there is no better method of securing this than by using Radio Press Panel Transfers. Every packet contains over 80 transfers, for marking every control knob, valve holder, or terminal, on your panel. The method of applying them is most simple.

Accurate markings will ensure accurate connections. Remember this before you connect the H.T. leads to the L.T. terminals, resulting in the loss of one or more expensive valves. Buy a packet of Radio Press Panel Transfers and protect your set, at the same time give it—

*“That finishing touch—
which means so much!”*

Radio Press Panel Transfers are obtainable from all Bookstalls, Newsagents, your local Wireless Dealer, or direct from Dept. W., Radio Press, Ltd. 8d. post free.

A simple method of applying Radio Press Panel Transfers

Cut out the required transfer and place it in the desired position, covering it with a piece of cloth. Heat an ordinary table knife to a moderate temperature and apply to the cloth for a few seconds. The cloth and film can then be pulled away, leaving the panel clearly and neatly marked.

6d. PER PACKET
(8d. Post Free.)



Radio Press, Ltd.,
Bush House, Strand, London, W.C.2.

Barclays Ad.



You can build this Trap to cut out local interference.

Selectivity

WHEN a main or relay station is situated in close proximity to you and on a similar wavelength to those of the other stations you wish to receive, the question of interference becomes a serious nuisance.

It is not generally known that the addition of a wave-trap to your set will obviate this "bugbear" and give you clear reception from any station within the powers of your receiver.

But the wave-trap must be of good design, since it must be able to cut out unwanted stations without sacrifice of signal strength.

The A.B.C. Wave-Trap is the result of extensive experimenting in the question of elimination of undesired signals by G. P. Kendall, B.Sc., and is very near to perfection.

The A.B.C. Wave-Trap will completely eliminate your local station and bring you in unmolested signals from stations on quite nearby wavelengths, provided your aerial and earth are of average efficiency. In actual test, within 3 miles of 2LO, the A.B.C. Wave-Trap has eliminated that station and made it quite possible to receive Bournemouth without any trace of interference, and without any appreciable loss of signal strength.

Radio Press Envelope No. 6 contains full instructions for the building of the A.B.C. Wave-Trap, with three different arrangements which can be brought into operation at will.

The envelope includes instruction sheets, photographic reproductions, blue prints, and working drawings, which explain with extreme thoroughness the building and methods of using this Wave-Trap.

The A.B.C. Wave-Trap is an inexpensive instrument to build, inclusive of handsome cabinet and integral coils. This Wave-Trap is normally constructed to operate on the 300-600 metre band.

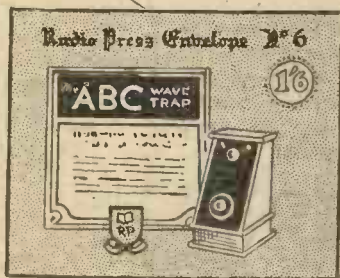

Anyone can build a wireless set from instructions contained in the Radio Press Envelopes. Build yourself the wave-trap described in Envelope No. 6.

These Envelopes may be obtained from your regular wireless dealer, newsagent or direct from Dept. W, Radio Press, Ltd., Bush House, Strand, London, W.C.2.



Cut out your local station

Radio Press, Ltd.,
Bush House, Strand, London, W.C.2.



Barclays Ad.

A NEW CRYSTAL SET

—adaptable to varying aerial and earth conditions

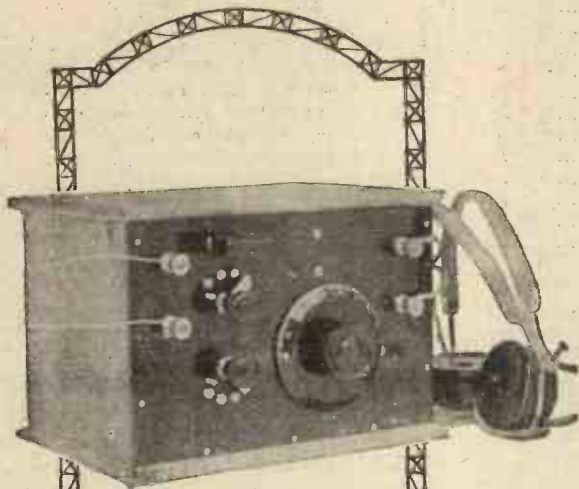

The Latest
Radio Press
ENVELOPE
No. 11

“An Adaptable
Crystal Set.”

PRICE
1/6

Post Free 1/9

Even in these days of the supersonic heterodyne, there is still a very large section of the radio public interested in the development of the Crystal Receiver.

To these people, the subject of the new R.P. Envelope No. 11 will make a special appeal.

It is descriptive of the “Adaptable Crystal Set,” designed by Percy W. Harris, M.I.R.E., Editor of *The Wireless Constructor*.

The special feature of this receiver is the adaptability to varying aerial and earth conditions. By means of a specially tapped inductance it is possible to make the set suitable for any aerial in a few moments. This, in the case of the auto-coupled circuit used in this set, results in appreciably louder signals, and the set is capable of receiving 5XX, with the aid of a loading coil, within reasonable range, in addition to your local station, provided your aerial and earth systems are of average efficiency.

Full instructions for the building of this unique receiver are contained in Radio Press Envelope No. 11.

Radio Press Envelope No. 11 contains complete instructions for building the set, with blue prints of the wiring and panel layout, reproductions of photographs and working drawings.

You can purchase Radio Press Envelope No. 11 from all Newsagents, Booksellers, your local Wireless Dealer or, for 1/9 post free, direct from Dept. W.

Radio Press, Ltd.
BUSH HOUSE, STRAND
LONDON, W.C. 2

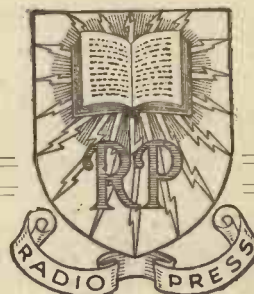

Barclay & Co.

Index to Advertisers

	PAGE		PAGE		PAGE
American Hard Rubber Co.	945	Economic Elec., Ltd.	951	Ormond Engineering Co.	909
Autoveyors, Ltd.	936	Edison Swan Elec. Co., Ltd.	921	Peto-Scott Co.	936
Beard and Fitch, Ltd.	943	Fluxite	943	Portable Utilities Co., Ltd.	932
Bobin (M.)	924	Formo Co.	917	Power Equipment Co., Ltd.	924
Bowman (Wm.), Ltd.	949	Gambrell Bros.	877	Radiax, Ltd.	951
Bowyer and Co.	960	Garnett, Whiteley and Co.	947	Radio Instruments, Ltd.	Cover iv
Bowyer-Lowe Co.	929	General Radio Co.	919	Radians, Ltd.	947
Brandes, Ltd.	894	Gent and Co.	949	Raymond (K.)	923
Bretwood, Ltd.	951	Goswell Engineering Co.	931	Ripaults	935
Brighton Radio Stores	940	Graham (A.) and Co.	939	Rosen (Ed.) and Co.	930
British and Colonial Industries Assn., Ltd.	920	Guiterman (S.) and Co.	926	Rothermel (R. A.)	939
British Engineering Products Co.	947	Harlie Bros.	949	Scientific Supply Stores	949
B.T.-H. Co., Ltd.	918	Igranic Electric Co.	905	"Sel-Ezi" Wireless Co.	917
Brown (S. G.), Ltd.	926	Jackson Brothers	935	Shipton (E.) and Co., Ltd.	920
Burndept, Ltd.	906	Kriseros Co.	947	Sterling Telephone and Elec. Co., Ltd.	878
Burne-Jones and Co.	960	Lisenin Wireless Co.	924	Telegraph Condenser Co.	939
C.A.C. Radio, Ltd.	946	Lissen, Ltd.	893	University Tutorial Press, Ltd.	949
Clarke (H.) and Co.	940, 943	London Elec. Wire Co.	945	Vandam (H.)	945
Collett (S. H.)	930	McMichael (L.), Ltd.	897, 914	Vandervell (C. A.) and Co.	920
Collinson's Precision Screw Co., Ltd.	940	Makerimport Co.	924	Watmel Wireless Co.	935
Cossor (A. C.), Ltd.	910	Maxel Electrical Co.	949	Watson, Jones and Co.	951
Curtis (Peter), Ltd.	917	Merrett (J.)	926	Western Laboratories, Ltd.	949
Darco., Ltd.	949	Michrom Engineering Co.	947	Wilkins and Wright, Ltd.	936
Detectikon Company, The	929	M. O. Valve Co.	902	Williams, Ellis and Co.	920
Dixon (L.) and Co.	926	Mullard Radio Valve Co., Ltd.	Cover ii	Win Patents	951
Dubilier Condenser Co., Ltd.	901	New London Electron Works	926	Zealander (H. D.)	947
		Oldham Accumulators	924		



The Latest development in "Super-Hets"

Magnum "VIBRO" Valve Holder

Specially designed for "Super-Hets" and all Portable and Multi-Valve sets. The valve legs which are all spaced are mounted on a channelled base, thus rendering the "VIBRO" holder Anti-Capacity in addition to being Non-Microphonic. Price 5/-

Build a "Super-Het." with MAGNAFORMERS. Price £5 per outfit (as illustrated), including instructions and Blue Print diagrams. (7 days approval against cash.) Carriage and Packing FREE on Retail Orders value £2 and over. Send stamp for illustrated list and set of leaflets dealing with "Radio Press" Circuits, also the MAGNADYNE "Super-Het."

BURNE-JONES & CO., LTD.
Magnum House,
296, Borough High Street, London, S.E. 1
Trade Enquiries Invited

Telephones HOP 6257
Telegrams "BURJOMAG, Sedist, London"
Cables "BURJOMAG, London"



Dorwood Precision Condensers

As used in this issue by Mr. PERCY W. HARRIS, M.I.R.E., Assistant Editor "Modern Wireless," Editor "Wireless Constructor."



THE ONLY GRID CONDENSER HAVING 3-POINT CONNECTION FOR SERIES OR PARALLEL COUPLING.

No extra unit needed for this purpose.

PRICES.

Capacities .0001 to .0009 MF. with or without Grid Leak Clip	2/6
" .001 to .006	3/-
" above .006 to .01	4/6

Please note .01 can be supplied with G.L. Clip if desired without extra charge. Other Capacities on application.

To be obtained through usual Wholesalers and Retailers, or direct from the Sole Manufacturers Post Free at List Prices.
HERBERT BOWYER & Co., 1a, Railey Mews, Leverton St., London, N.W.5

Notice to Radio Dealers

The first number of a new Radio Press, Ltd., monthly Periodical, "THE WIRELESS DEALER," will appear on September 12th. Advertising space is now being booked. For Rates apply to:—

Advertisement Managers,

Barclays Advertising Ltd.
Bush House, Strand, London, W.C.2.



Hieroglyphics.

WHY miss a great deal of the joy in radio because of your restricted knowledge in theoretical symbols?

Many enthusiasts often wish that they could wire up a set to a theoretical diagram, but their knowledge of theoretical symbols is so incomplete as to make it a hazardous undertaking. If, however, you possess that useful book, "PICTORIAL WIRELESS

CIRCUITS," by OSWALD J. RANKIN, you will find the way plain sailing. Here the orthodox symbols are replaced by actual representations of the components used. Provided you know what the components actually look like, you will find it an easy matter to wire up all the 34 circuits which the book contains. All working values are given, and every circuit is a good one, capable of giving efficient results.

"Pictorial Wireless Circuits," by Oswald J. Rankin, is obtainable from all Bookstalls, Newsagents, and Wireless Dealers, or direct from Radio Press, Ltd.



"Pictorial Wireless Circuits"
By OSWALD J. RANKIN.



Radio Press, Ltd.,

BUSH HOUSE, STRAND, LONDON, W.C.2.



VIBRATIONS

What do vibrations mean where music is concerned? A tuning fork, when struck, vibrates a definite number of times every second, thereby producing a note of definite pitch.

Is the same true of a piano? In a sense—yes, but in another sense, no; because the vibrations so set up induce further vibrations of very much smaller intensity which beautify the structure of the original note. Now the R.I. Transformer is designed to reproduce each note with all those delicate vibrations and overtones which add light and shade, and leave the music with all its original beauty.

It is essential that no note of any frequency, however small, should be omitted, and that the amplification of these overtones and harmonics should be of the same degree as the fundamental frequencies. This is what takes place in the R.I. Transformer due to the low self-capacity of only 18 *micro-microfarads*.

This low self-capacity is not merely a question of the ratio of the number of turns of wire to the area of the iron core. The results of a large number of tests have proved that in the R.I. Transformer the secret of the extremely low self-capacity is the sectionalising of the windings, and the fact that the primary is wound outside the secondary.



25/-



Write for R.I. Catalogue
free on application

12 HYDE ST! NEW OXFORD ST! LONDON W.C.1.

Contractors to the Admiralty and all Government Departments