

The

WIRELESS AGE

Number 10

UNIVERSITY OF MICHIGAN
JUL 2-1920
VOLUME 7

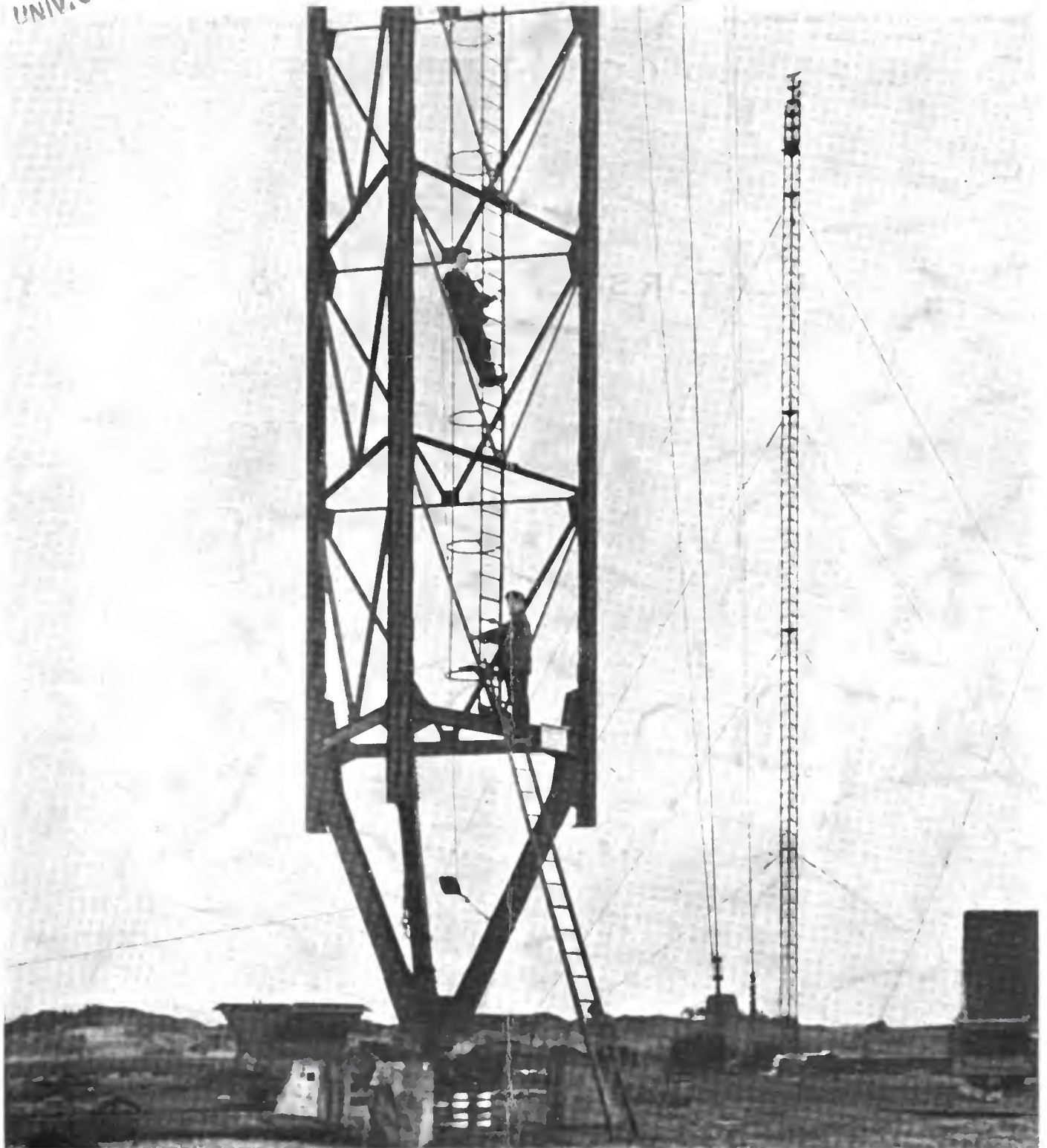

Base of the Towers of the new Wireless Station being erected near the Veluwa in Holland

WII—NEW BRUNSWICK

First Description of the Famous Alexanderson System

THE WORLD'S ONLY MANUFACTURER Of Moulded High Frequency, High Tension Insulators and Insulating Parts



Medal and Diploma
received at World's Columbian Exposition,
Chicago, 1893

INSULATION
"MADE IN AMERICA"
LOUIS STEINBERGER'S PATENTS

Medal and Diploma
received at World's Fair, St. Louis,
1904

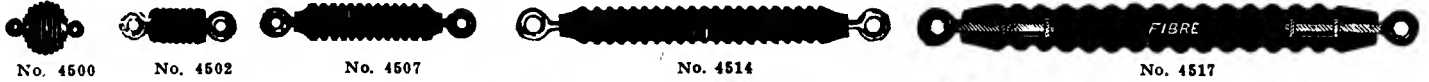

INSULATORS 1,000 TO 1,000,000 VOLTS

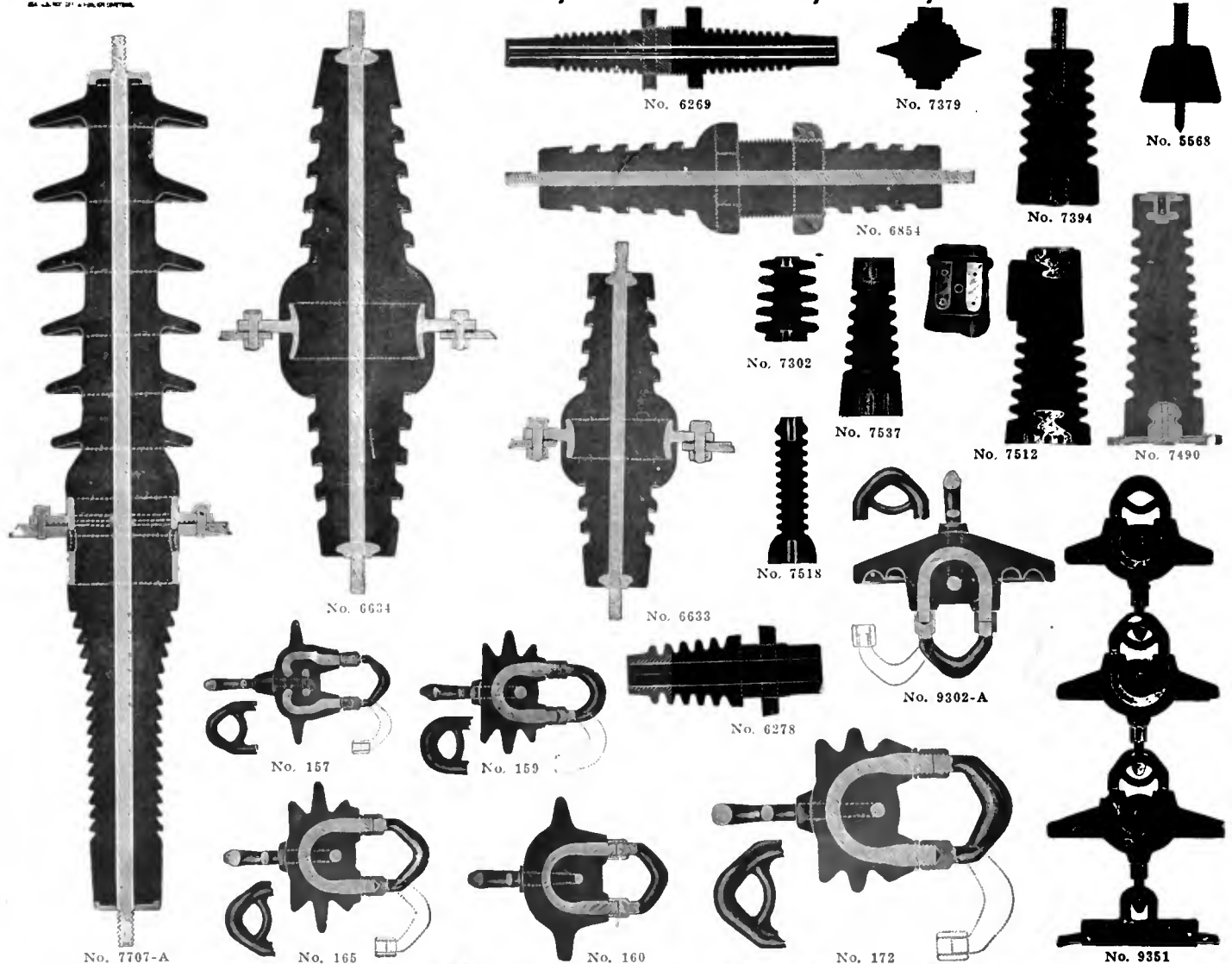

"ELECTROSE" Insulators are standard with UNITED STATES NAVY and ARMY and Wireless Telegraph and Telephone Companies, "Electrose" is made in a number of grades for various requirements, each grade possessing special characteristics "Electrose" Insulators—Best in the World for High Frequency Currents, Power and Transmission Circuits

SOLE MANUFACTURERS



66-82 Washington Street
66-76 Front Street

27-37 York Street
1-23 Flint Street

BROOKLYN, N. Y., AMERICA

Thermo-Ammeters, Milliammeters and Current-Squared Meters For Radio Service



Weston

Model 425 Instruments

(3¼ inches flange diameter)

are particularly adapted for use on small-size Radio panels where space is an important factor.

These Instruments are unaffected by temperature changes; have 50% safe overload capacity; are low in power consumption.

They are for use on Audio and Radio frequencies.

The Current Squared Meter is ideal for use on wave meters and wherever decrement measurements are to be made.



Write for information

Weston Electrical Instrument Company, 27 Weston Ave., Newark, N.J.

New York
Chicago
Philadelphia
Boston

Cleveland
Detroit
St. Louis
San Francisco

Denver
Cincinnati
Pittsburgh
Richmond

Buffalo
Minneapolis
New Orleans
Jacksonville

Rochester
Seattle
Toronto
Montreal

Halifax
Winnipeg
Vancouver
Calgary, Alta.

And in Principal Cities Throughout the World

Vol. 7 Contents of **The Wireless Age** for July, 1920 No. 10

Edited by J. ANDREW WHITE

FEATURE ARTICLES

"WII"—New Brunswick. By Elmer E. Bucher	10
The New Marconi Distress Calling Device	18
Transmission of High Frequency Waves Over Bare Wires in Water. By Major General George O. Squier	20
Universal Honeycomb and Lattice Coils in General. By Oscar C. Roos, Fellow I.R.E.	22

WORLD WIDE WIRELESS	7
EXPERIMENTERS' WORLD	
A Loop Transmitter for Local Work. By Albert F. Murray	25
A Sensitive Portable Receiver. By Francis R. Pray. First Prize, \$10.00	26
Portable Receiver. By Norman A. Nyquist. Second Prize, \$5.00	27
Second District Call Letters of Amateur Stations	30

A Universal Range Portable Receiver. By Chas. T. Jacobs. Third Prize, \$3.00	21
A Simple Wavemeter. By E. P. Hurley	36
N. A. W. A. BULLETIN	39
QUERIES	42

AUTOMATIC TRANSMITTERS

Omnigramp Mfg. Co.	2
--------------------	---

BLUE PRINT PAPER

New York Blue Print Paper Co.	35
-------------------------------	----

BOOKS

Audel & Co., Theo.	35
Radio Review, The	32
Wireless Press, Inc.	35, 37, 39

ELECTRICAL EQUIPMENT

American Electro Technical Appliance Co.	38
American Radio and Research Corporation	Fourth Cover
Atlantic Radio Co., The	48
Bates, Lee A.	39
Brandes, C.	39
Bunnell & Co., J. H.	48
Briggs Battery Co.	34
Chambers & Co., F. B.	48
Clapp-Eastham Co.	42
Cole & Morgan	38
Continental Fibre Co., The	Third Cover

ADVERTISEMENTS

Continental Radio and Electric Co.	4
Cornin & Co., A. H.	44
Duck Co., The William B.	38
Electric Storage Battery Co., The	43
Electro Mfg. Co.	Second Cover
Federal Telegraph & Telephone Co.	47
Firth & Co., John	47
General Radio Company	40
Grebe & Co., A. H.	42
Hovey, A. T.	45
International Electric Co., The	40
International Radio Telegraph Co.	89
Johnston, Chas. H.	44
Jones Radio Co., The	45
K. & G. Wireless Supply Co.	34
Magnavox, The	3
Manhattan Electrical Supply Co.	33
Mercury Radio Appliance Co.	44
Mignon Mfg. Corp.	36
Mutual Purchasers Association	45
National Radio Supply Co.	45
Newman-Stern Co., The	45
Pacent Electric Co.	43

Pitts Co., F. D.	44
Precision Equipment Co.	35
Radio Distributing Co.	5
Radio Electric Co., The	45
Stromberg-Carlson Telephone Mfg. Co.	21
Tresco	3
Winn Radio & Electric Mfg. Co.	43
Wireless Improvement Co.	6

ELECTRICAL INDICATING INSTRUMENTS

Weeton Electric Instrument Co.	1
--------------------------------	---

INSTRUCTION

Dodge's Institute	28
Eastern Radio Institute	41
Liederman, Earl E.	32
Marconi Institute	43
Service Radio School	38
Utmark's Nautical Academy	38
Y. M. C. A. Radio School	34

MOTORS

Crocker-Wheeler Co.	41
---------------------	----

SMALL ADS OF BIG INTEREST

RENEWALS—When subscription expires you will find a renewal blank enclosed. Return with remittance promptly.

Published Monthly at

GREAT BRITAIN, 12-13 Henrietta St., London

Yearly Subscriptions in U. S., \$2.00



CHANGE OF ADDRESS—Notify us of any change in your address, giving both the old and new location.

326 Broadway, New York

AUSTRALIA, 97 Clarence St., Sydney, N. S. W.

Outside U. S., \$2.48; Single Copies, 20 cents

Entered as second class matter Oct. 9, 1913, Post Office at New York, N. Y., under the Act of March 3, 1879. Copyright, 1920, Wireless Press, Inc. Edward J. Nally, Pres. Lee Lemon, Vice-Pres. David Sarnoff, Secy. George S. De Sousa, Treas. J. D. Conmee, Business Mgr.

Owing to the fact that certain statements and expressions of opinion from correspondents and others appearing in these columns from time to time may be found to be the subject of controversy in scientific circles and in the courts, either now or in the future, and to sometimes involve questions of priority of invention and the comparative merits of apparatus employed in wireless signaling, the owners and publishers of this magazine positively and emphatically disclaim any privity or responsibility for any statements of opinion or partisan expressions if such should at any time appear herein.

Learn The Code With The **OMNIGRAPH**

The Omnigraph Automatic Transmitter will teach you the Code—at home—in the shortest possible time and at the least possible expense. Connected with Buzzer or Buzzer and Phone, the Omnigraph will send you unlimited Continental messages, by the hour, at any speed you desire. It will bring an expert Operator—right into your home—and will quickly qualify you to pass the examination for a first grade license.

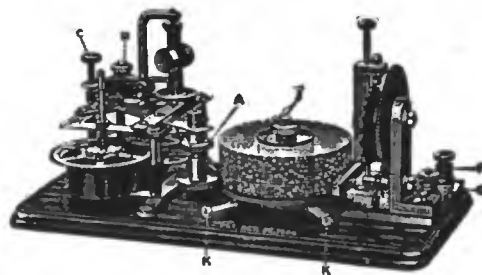

THE OMNIGRAPH MFG. CO.
Cortlandt Street, New York.

Gentlemen:—I wish briefly to commend your very excellent Automatic Transmitter. Recently I was successful in obtaining a first-class Commercial Radio License and I believe that the Omnigraph was my principal aid.

I took a four weeks course at a Resident Radio School in Theory only. I relied on the Omnigraph to get my Code to the proper speed, and the Omnigraph did it.

I was one of two in a class of eighteen to obtain a first-class License. The stumbling block for the others was CODE. And I know that a short time receiving Omnigraph messages daily would have enabled them to pass the examination as easily as I did.

I believe the Omnigraph to be the easiest, quickest and cheapest method to learn the International Morse Code.

Cordially yours,
(Signed) GEO. E. SELLERS.

4341 Richardson Ave.,
New York City.
Jan. 21, 1920.

The Omnigraph is used by several departments of the U. S. Government and by a large number of the leading Universities, Colleges, Technical and Telegraph Schools throughout the U. S. and Canada.

The Omnigraph is also used by the Bureau of Navigation in testing applicants applying for a Radio License. Thousands have learned both the Morse and Wireless Codes with the Omnigraph.

Send for free catalog describing three models—\$12 to \$28. Do it to-day. The Omnigraph is sold under the strongest of guarantees—if not as represented, your money back for the asking.

THE OMNIGRAPH MFG. CO., 26 Cortlandt St., N. Y.



CONNECT "AA"
to your detector or
amplifier, and "BB"
to a 6-volt battery

MAGNAVOX

RADIO TELEMEGAFONE

When used with one or more stages of amplification will reproduce signals with great volume. For the small fraction of a watt output of your receiver that is available for the production of signals, the MAGNAVOX TELEMEGAFONE will produce the greatest volume of sound

With Small Horn, as Illustrated \$75.00
With Large Music Master Horn 93.00

WRITE FOR BULLETIN No. 2102



THE MAGNAVOX CO.

PATENTED IN U.S.A. AND FOREIGN COUNTRIES

2701-2765 EAST 14TH STREET
OAKLAND, CALIFORNIA

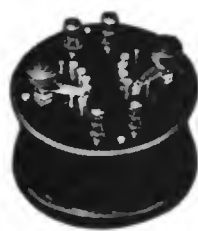

HOOK 'ER TO YER BULB

The most wonderful tuner in the world for only \$15.00. Last month this tuner beat in a test one of the NAVY STANDARDS at Ketchikan, Alaska.

10 Captains of Ocean-going ships have had their wireless operators install one of our tuners in the captain's cabin so the exact time by wireless can be had without using either tube, bell, or hand.

"GREAT!" says one old sea dog. "WHAT IN SAM HILL WILL YOU SMART ALECS GET UP NEXT?" European stations copied in day time and no fancy aerial is needed. A single wire about 40 long by 25 high will do the trick. London amateur W. R. Wade, Clifton, Bristol, promises report for the magazines to publish showing how the amateurs there read our "sigs" in England. Junk your funny wound coils and get a regular two pound tuner that you can use during the static season. 20,000 meters maximum wave length. Hook up on bottom of tuner.

KNOCKED DOWN AND ASSEMBLED CONDENSERS

Which kind do you want? Made for panel mounting and are complete with scale, pointer and knob. Used all over the world now and still going strong. No C. O. D. orders. Add parcel post. Buy from your dealers and send us his name if he cannot supply you. Canadian amateurs buy from local dealers or write us for nearest dealer. Formica tops and bases. Movable plates are screwed on and not clamped.

11 plate knocked down - \$1.80	11 plate assembled - \$2.75
21 " " " - 2.25	21 " " " - 3.25
41 " " " - 3.20	41 " " " - 4.25

SOLD BY YOUR DEALER :: OR



T R E S C O



Davenport, Iowa.

New Radio Products and Personal Service

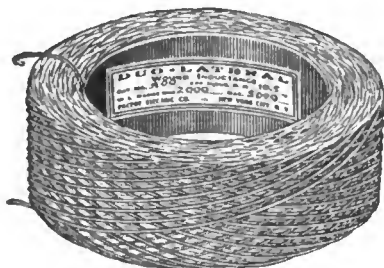

In endeavoring to give personal service to our ever growing clientele, we realize that new and more modern products make for the betterment and improvement of radio work and to this end we offer you the latest scientific achievement in radio

DUO LATERAL WOUND COILS

made in several different sizes covering every wavelength. These coils have staggered winding and a lower natural period, lower high frequency resistance, very low distributed capacity, lower D. C. resistance and higher self inductance, which makes it an ideal part of any set and superior to all other coils for amateur work.

Radio Engineers have made extensive tests of these coils and give them their highest recommendations.

ORDER BY CATALOGUE NUMBER AS LISTED.

CATALOG NUMBER	WORKING WAVELENGTH RANGE IN METERS	INDUCTANCE IN MILLI-HENRIES		LIST PRICE EACH UNMOUNTED
25	130 to 250	.045	.045	\$.90
35	180 to 450	.075	.073	1.00
50	250 to 700	.156	.15	1.10
75	400 to 900	.36	.34	1.20
100	500 to 1400	.66	.57	1.30
150	600 to 2000	1.40	1.35	1.40
200	1000 to 2500	2.50	2.30	1.50
250	1200 to 3500	4.2	4.	1.60
300	1500 to 4500	6.25	6.1	1.80
400	2000 to 5000	10.62	10.2	2.00
500	3000 to 6000	17.6	17.3	2.20
600	4000 to 10000	25.0	22.0	2.50
750	5000 to 12000	38.0	35.3	2.70
1000	8000 to 15000	72.8	68.3	2.90
1250	10000 to 20000	116.6	112.3	3.50
1500	15000 to 25000	171.5	162.2	4.00

We also carry a large stock of high grade electrical apparatus, including a very complete line of heating appliances.

You have our most courteous invitation to spend a few moments in our spacious show rooms and look over our complete stock. We will gladly show you any instrument or part you may desire to examine. It will be a revelation to you, besides it is part of our service.

OUR WORD OF HONOR TO YOU IS
OUR GUARANTEE. LET US PROVE IT.

Write Dept. E5 for literature and price lists.

CONTINENTAL RADIO AND ELECTRIC CORP.

J. DiBlasi, Secy.

J. Stantley, Treas.

6 Warren Street

New York.

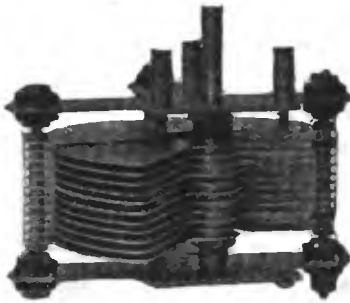

The New Arco Variable Condenser

We offer Radio Men something out of the ordinary in variable condensers. This new model is a step ahead of its rivals in that the plates are made of aluminum and heavier than those found in the average condensers. The rotary plates are rounded at one end, not the usual semi-circular type, thus affording a straight line capacity, which is a very valuable feature in Wave Meter work. The zero capacity in an instrument of this type is considerably lower than that of usual condensers. Shaft on which rotary plates are mounted is carefully machined from tool steel.

Instrument can be quickly mounted in case or behind panel.

Made in two capacities, furnished unmounted only, with or without dial of fine black moulded composition and bakelite knob.

Backed up by Radisco guaranteed quality of workmanship and low price.

Capacity	Unmounted	With Dial and Knob
.0005 mf.	\$5.00	\$6.00
.001 mf.	6.25	7.25

Shipping weight 2 pounds.

Prices quoted do not include carrying charges to Pacific Coast or duty paid for Canadian use.

RADISCO AGENTS carry only apparatus of proven merit. Look for the Radisco trade mark on all parts you buy and be sure of getting efficient apparatus.

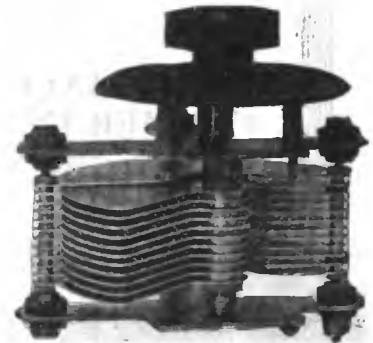

Below are listed a few of the reliable firms who carry the RADISCO COILS, Better "B" Batteries and are our Agents for all other standard apparatus of merit.

COMMUNICATE YOUR WANTS TO THEM.

- | | | |
|--|---|---|
| ALBANY, N. Y.
E. L. Long,
21 Magnolia Terrace | KANSAS CITY, MO.
McCreary Radio Supply,
4th & Delaware Sts. | PROVIDENCE, R. I.
Rhode Island Elec. Equip. Co.,
45 Washington Street. |
| ATLANTIC CITY, N. J.
Independent Radio Supply Co.
118 So. New Jersey Ave. | LOS ANGELES, CALIF.
The Wireless Shop,
511 W. Washington St. | PITTSBURG, PA.
Radio Electric Co.,
3807 5th Ave. |
| BALTIMORE, MD.
Radio Engineering Co.,
614 No. Calvert St. | MONTREAL, CAN.
J. B. Miller,
1600 Hutchinson St. | SEATTLE, WASH.
Northwest Radio Service Co.,
1801 Sixth Ave. |
| BEINVILLE, QUEBEC, CAN.
Canadian Radio Mfg. Co. | McKEESPORT, PA.
K. & L. Electric Co.,
427 Olive Street. | SCRANTON, PA.
Shotton Radio Mfg. Co.,
P. O. Box 3
Branch 8 Kingsbury St.,
Jamestown, N. Y. |
| BOSTON, MASS.
Atlantic Radio Co.,
88 Broad Street | NEW ORLEANS, LA.
L. A. Rose,
121 Camp Street | SPRINGFIELD, MASS.
Electric Service Co.,
585 Armory Street. |
| BROOKLYN, N. Y.
Kelly & Phillips Electric Co.,
312 Flatbush Ave. | NEWARK, N. J.
A. H. Corwin & Co.,
4 West Park Street. | TORONTO, ONT., CAN.
The Vimy Supply Co.,
585 College Street. |
| BRONX, NEW YORK
Amateur Wireless Equipment
Co.,
1390 Prospect Ave. | NEWCASTLE, PA.
Pennsylvania Wireless Mfg. Co.,
507 Florence Ave. "8HA" | WASHINGTON, D. C.
National Radio Supply Co.,
808 9th St., N. W. |
| CHICAGO, ILL.
Chicago Radio Laboratories,
1316 Carmen Ave. | PHILADELPHIA, PA.
Philadelphia School of Wireless
Telegraphy,
Broad and Cherry Streets. | WICHITA, KAN.
The Cosradio Co.,
1725 Fairmount Ave. |
| EUREKA, PEORIA,
ILLINOIS
Klaus Radio Co. | | |

If none of the above agencies are in your vicinity, communicate with

RADIO DISTRIBUTING COMPANY : : Newark, New Jersey

WICONY APPARATUS is designed by super-engineers. It received the Government's highest classification.



WICONY APPARATUS is made by master mechanics. It is a guaranteed product.

YOUR HOLIDAYS

Are you going to spend your holidays improving your Radio station, or will you lose that opportunity.

You can do more for your station during your holidays than during all the evenings you have worked in the past months—and it will be *genuine recreation*—you will finish your vacation with a feeling of "*something accomplished.*"

THE SMALLEST TRANSFORMER IN THE WORLD

How would you like to have "The smallest transformer in the world" if you were convinced that it was also the most efficient?

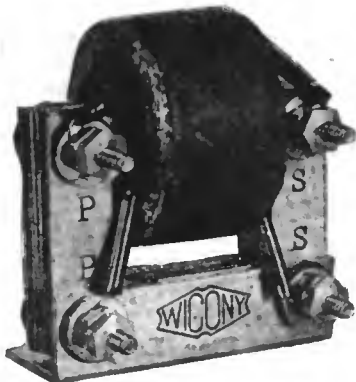

AUDIO FREQUENCY AMPLIFIER TRANSFORMER; Type WI-110 C.
Dimensions
2½" x 2" x 1½"
Shipping weight 10 oz.
Price \$7.00. Code "Wictra."

Order now if you want immediate shipment.

After all, there is no need for a bulky affair in handling audio-frequency currents, if the design is correct. This transformer was designed especially for the operating characteristics of the Moore-head-Marconi-de Forest audion tubes. It has a closed core of the best grade laminated iron, with the primary and secondary windings of several thousand turns of extremely fine enameled wire. The design is such that the distributed capacity and current losses are extremely low.

DO YOU USE AUDIONS?

Suppose you wanted to change the leads to your audion socket base—must you rustle 'round for a screw driver, or pair of pliers, mar the screws, or scratch the bakelite base with an everyday slip of the tool? Would it not be much better to have neat bindings posts, with plenty of room to work without fear of shorting thru the metal socket?

Look at the photograph—those terminals are of the best Bakelite type. The base is also of bakelite, while the socket is of finely machined, dull aluminum, another WICONY innovation. Notice the manner of support;—those legs are drilled and tapped and nicked—heavily nicked—thus giving you an ideal method of fastening to your panel or table.

We have bases with one, two, or three sockets especially mounted for interior of audion cabinets. They are most reasonable in price.



AUDION TUBE SOCKET. Type WI-111 A.
Dimensions
2½" x 2¼" x 2" height.
Shipping weight 6 oz.
Price \$1.90. Code "Wicbaa."

WE ARE AT YOUR SERVICE

Whether you want an audion bulb or a complete audion cabinet—a coil, or a complete receiver, write us your needs. State specifically what you are interested in and we shall give you every possible item of information and assistance. Drop us a line now.

WICONY BULLETINS, handsomely illustrated and instructive, describing audion amplifiers, audion control boxes, batteries and complete receiving and transmitting sets or accessories, are yours for ten cents. (We charge this small fee to insure that they go to serious, reliable experimenters).

Write for yours today.

Dealers—It will pay you to write us NOW.

WIRELESS IMPROVEMENT COMPANY

INCORPORATED

Radio Engineers, Manufacturers and Distributors

47A West Street

New York, N. Y.

If this page is cut out and appended to the same page cut from the editions to follow, a complete file of very interesting information will soon be available. (No. 7)

WORLD WIDE WIRELESS

Thousand-Word-a-Minute World-Wide Radio Station

THE world's biggest wireless plant, to be built at Rocky Point, L. I., by the Radio Corporation of America, will handle 500 words in and 500 words out a minute, simultaneously, the land wire relay of seventy miles from Rocky Point to the company's office in Broad Street, New York City, being controlled mechanically, the human element entering into the process only at the point of actual transmission.

Mr. Edward J. Nally, President of the Radio Corporation, announces that the company plans a \$10,000,000 plant on a 6,000-acre tract about seven miles from Port Jefferson.

"We are going to erect," he said, "five units, with another one to be held in reserve for use in the emergency of severe storm or other trouble. Each of the units will have a minimum capacity of sending 100 words a minute and of receiving the same number. This is, of course, the minimum capacity. We are hopeful, however, of doing better than this when the plant is fully geared up.

"To get an idea of the projected plant you might fancy it laid out as a wheel. The big power house represents the hub, while the spokes or wings, twelve in all, radiate out in all directions from the power house. Each wing will have six antennae strung to 400-foot steel towers.

"It is our plan to transfer the wireless signals directly from the wireless apparatus to land wires and send them right along into New York City, to headquarters, without calling manual labor into the process at any time. We are going to have a radio receiving station about seven miles from the transmitting station, and we plan to operate both simultaneously.

"It is the design to control relays entirely from our city office. All of the operating work will be done there, although the machinery of transmission will be, of course, out at Rocky Point.

"Each of the five units of the plant will serve a separate field. One will be in touch continuously with South America, another will talk to Germany, a third will serve France, another goes to Italy and the fifth will serve Poland."

The third transoceanic wireless circuit, linking America with the rest of the world, has been opened by the Radio Corporation. Opened principally for commercial messages, the new wireless route connects this country with the Scandinavian countries—Norway, Sweden, Denmark and Finland. The American stations, at Marion and Chatham, Mass., with their complementary stations at Stavanger and Naerobe, Norway, are of the duplex type, sending and receiving simultaneously at high speed.

It was announced that the rates for the new service, from New York City to any point in the countries named, would be, per word, Norway, 24 cents; Sweden, 26 cents; Denmark, 28 cents, and Finland, 29 cents. It was stated that these rates were from 30 to 50 per cent. lower than existing cable tolls. The other commercial circuits

in operation by the Radio Corporation are from San Francisco to Japan, via Hawaii, and from New York to Great Britain.



London Daily Mail Has Radiophone News Service

WIRELESS telephone receiving set has been installed in Northcliffe's Daily Mail. The paper hopes to have its American news dictated by 'phone from New York in the very near future.



Keystone

Danish wireless commission to U. S. Left to right—Capt. H. Faber, Prof. P. C. Pederson, Commander H. J. Schledermann, Hon. T. F. Krarup and W. G. Thomson

Marconi Has 500-Mile 3 K. W. Radiophone

WIRELESS telephone communication over a distance of 500 miles, with apparatus of a strength of only three kilowatts, has been achieved by William Marconi, the Italian inventor. This was announced upon his return to Rome from a cruise in the Atlantic and Mediterranean on board the yacht Electra.



Albany Firm to Use Radiophone

THE Esco Electrical Company, of Albany, N. Y., has erected a powerful wireless telephone set in its Broadway store. It will use the radiophone method of communication with its agents in New York and other places as soon as the operation of the instruments is perfected to a point where such points can be reached. Carl Hoffman, employed by the company, is conducting tests in an effort to increase the working distances of the instruments. Already he has established communication with wireless operators at Troy and Schenectady. The firm especially wishes to be able to talk with New York.

Marconi Explains Radio to Spanish Workers

SENATOR GUGLIELMO MARCONI, who is known for his amiable qualities almost as much as for his great invention, has just given another proof of his urbanity. Despatches from Seville, Spain, where he stopped with his yacht *Electra*, state that a large party of laborers approached the yacht and requested permission to see the wireless apparatus on board. In the absence of the owner the officer in charge refused to grant the permission.

Just as the men were leaving Marconi returned to the vessel and, having been informed of their desire, he invited them aboard and personally explained to them in all its details the working of the wireless apparatus.



Keystone

Dr. Frederick Millener (standing), scientist of Omaha, trying to catch Mars wireless signals by means of special apparatus

Radiophone Talk Recorded on Phonograph

EXPERIMENTS which have been carried out in London have resulted in the making of a talking machine record on wax of a voice transmitted by wireless telephone forty miles away.

While the voice was speaking at Chelmsford, in the County of Essex, where there is a high-power instrument capable of transmitting the voice many hundreds of miles, the equipment at the receiving plant in the Strand, London, was attached to a recorder, which engraved the messages in soft wax in the same way as an ordinary talking machine disk is manufactured.

The record when produced was perfectly audible.

Commercial Application of Radiophone

THE Public Service Company of northern Illinois is installing wireless telephones at its Blue Island and Joliet stations, the intervening distance as the crow flies being only about 25 miles. The two stations tie-in together and also are interconnected with the Fisk and Quarry Street stations of the Commonwealth Edison Company in Chicago. The wireless system will have a radial power of about 100 miles, and will be used primarily during such times as the metallic telephone lines are out of service, due to weather or high-voltage system trouble.

Radio Service Between Germany and Spain

PRESS dispatches may be sent between Germany and Spain by wireless, according to an announcement made lately. Most German correspondents, however, have left Spain and consequently the service will be used principally for German propaganda, it is asserted.

Danes Seek Direct Wireless Connection With U. S.

THREE officials of the Danish Government arrived lately to confer with Washington officials regarding the establishment of a direct wireless communication between the United States and Denmark, to facilitate commercial communication between the two countries. A great trans-Atlantic wireless station has been established in Denmark of sufficient range to transmit messages direct across the Atlantic.

When this channel of communication is firmly established, commercial messages will no longer be routed via Great Britain.

Commercial Company to Use Private Radiophone

THE new Winchester stores in the New England States may be connected by wireless and all their business so transacted. Officials have consulted W. J. Butterworth of Boston, assistant federal radio inspector for New England, in regard to the proposed enterprise.

The Winchester company is considering the use of the wireless stations largely on account of the delays caused by wire troubles. This situation was particularly noticeable during the last winter. Often in very severe weather, when the telegraph and telephone lines are out of commission, the weather conditions are especially favorable for wireless. Moreover, the increasing improvement of the radiophone has added greatly to the possibilities of wireless, and radio communication would also be advantageous in that messages are simultaneously heard in all directions and hence at one time the headquarters of a company could transmit orders and information to all branch offices within a radius of one hundred miles.

Whole World to Get Wireless Time Signals

WIRELESS telegraphy may yet prove to be the means of preventing many railway and sea catastrophes. To this end in fact an International Time Bureau is being formed in Brussels, which intends to develop methods of transmitting throughout the world the time signals of the greatest precision.

The bureau is in charge of M. Bigourdin, member of the French Academy of Sciences, who for many years has been attached to the Paris Observatory. Discussing the aims of this new organization M. Bigourdin has called attention to the fact that all through the war the Eiffel Tower sent daily signals that were picked up in the most remote quarters of the globe.

"It is most essential that navigators know at every instant the precise time," says M. Bigourdin. "Extensive experiments have been carried out in the last year and we have reason to believe that the efforts will lead to unexpected discoveries concerning the variations in actual longitude similar to those known to exist with respect to latitude. With precise knowledge of the time, the sun's location and the consequent geographical position ships will more easily avoid dangerous areas."

M. Bigourdin is confident that many sea accidents have been due to the impossibility of ships picking up accurate time signals. He points out also the necessity for the most reliable records for despatching trains in all countries. Further experiments will be conducted with intermittent Hertian waves approximately 2,600 metres long to replace those of shorter length now used.

M. Bigourdin, whose investigations are receiving support in all allied countries, hopes to create a system whereby the expenses will be distributed among all nations, for it is obvious that once the signals begin to work there is nothing to prevent any mariner from taking advantage of an organization in which French scientists are taking an important part in putting into operation.

Transpacific Steamship Lines Plan Radio Charts

STEAMSHIP lines operating in the transpacific trade are planning to take advantage of the chain of powerful wireless stations, which extend along the Alaskan Coast from Juneau to Dutch Harbor and to St. Paul Island, making possible permanent wireless communication with the Orient from Seattle and other North Pacific ports.

The importance of taking advantage of these radio stations in communicating with ships at sea and in transmitting messages from Seattle to China and Japan, has been emphasized by the serious delay to cable messages, now ranging from 150 to 160 hours.

Representatives of the Nippon Yusen Kaisha are preparing maps for use aboard the vessels of the N. Y. K. transpacific fleet and in the company's offices both in the Orient and America, showing the position of the stations and the possibility of constant communication with a vessel of the fleet from the time she sails from Seattle until she berths in Yokohama. This is made possible by the radio stations in Juneau, Sitka, Cordova, Kodiak, Dutch Harbor and on St. Paul Island.

The most powerful of the stations is the one in Cordova, which has a radius of 2,000 miles in the daytime and 4,000 miles at night. The distances the other stations can work follow: St. Paul station, 1,000 miles in daytime and 2,500 miles at night; Dutch Harbor, 300 miles in daytime and 600 miles at night; Kodiak, on Kodiak Island, 1,000 miles in daytime and 2,000 miles at night; Sitka, 1,000 miles in daytime and 2,500 miles at night; Juneau, 500 miles in daytime and 1,000 miles at night.

With the present wireless arrangements of the transpacific steamship lines, the first communication with a ship at sea bound from the Orient for this coast is had when the vessel arrives within 1,000 miles of Victoria, B. C.



Radio Masts Snapped Passing Under Brooklyn Bridge

THE radio masts of the U. S. collier Nereus were snapped off as the ship passed under the middle span of the Brooklyn Bridge on her way to the navy yard recently. The fragments of the masts fell to the deck of the ship, where they narrowly missed hitting some of the crew.

The Nereus arrived from France with the bodies of sailors and marines who had died overseas.



Jap Navy to Use Wireless 'Phone

THE Japanese Navy will no longer depend on radio telegraphy for communication as a result of the perfection of the wireless telephone, which hereafter will take the place of all other forms of signaling.

An official of the Ministry of the Navy said that the new wireless telephone apparatus had been installed on the vessels of a unit of the First Squadron and was being installed on the rest of the Japanese war ships.



Radio Rates to Japan Reduced

TO offset the rising price of necessities, comes the announcement that the high cost of sending wireless messages from Seattle to points in Japan has dropped. The rate now from San Francisco to Tokio is 72 cents a word instead of 80 cents. W. F. McAuliffe, local manager of the Radio Corporation of America, gave this information and declared that within a short time messages destined for the Orient from Seattle will be accepted by messenger boys in the same manner as ordinary telegrams are delivered.

Many will give three rousing cheers, it is said, when they learn that a night letter to the Emperor of Japan, say of fifty words, instead of costing \$40 as formerly, will now cost but \$36.

The cut in the rate of wirelessness Japan, says Mr. McAuliffe, is made possible by the opening of a new 400-kilowatt station at Haro-no-machi, in the vicinity of Sendai, on the Northern Japanese mainland. This sta-



Keystone
Erecting the receiving loop on the N. Y. Times Bldg., with which it was hoped to receive radiophone messages from warships entering the harbor

tion, with high frequency alternator type equipment, will work directly with the Pacific Coast stations of the Radio Corporation.

"Traffic schedules are being worked out so that Seattle firms will shortly be able to file their business locally, the same as any other ordinary telegraph message," said Mr. McAuliffe. "For the immediate present, however, messages are accepted only in San Francisco, Seattle messages to Japan going through San Francisco by the wiring of messages from Seattle to San Francisco."



U. S. Radio Examinations

THE United States Civil Service Commission announces open competitive examinations for radio engineer (aeronautics), \$3,600 to \$5,000 a year; assistant radio engineer (aeronautics), \$2,500 to \$3,600 a year, on July 6, 1920. Vacancies in the Air Service at Large at the salaries indicated, and in positions requiring similar qualifications, at these or higher or lower salaries, will be filled from these examinations, unless it is found in the interest of the service to fill any vacancy by reinstatement, transfer, or promotion.

Competitors will not be required to report for examination at any place, but will be rated on the following subjects, which will have the relative weights indicated:

Subjects—Physical ability, 10 weights; education, experience, and fitness, 90 weights. Total, 100 weights.

Competitors will be rated upon the sworn statements in their applications and upon corroborative evidence. For the position of radio engineer, applicants must have graduated with a B. S. degree, with major courses in physics or electrical engineering, from a college or university of recognized standing; and, in addition, have had at least three year's experience in the design, manufacture, or installation of radio apparatus for the Government or for a contractor who has supplied satisfactory apparatus of this class to the Government.

For the position of assistant radio engineer, applicants must have had the education and one year of the experience prescribed for radio engineer.

"WII"—New Brunswick

The Alexanderson Continuous Wave System—Description of the High Power Radio Apparatus for Radio-Telegraph and Radio-Telephone Transmission

By Elmer E. Bucher

Commercial Dept., Radio Corporation of America

RADIO engineers early foresaw that the ultimate generator of oscillations for radio-telegraphy and telephony would be one of a type providing more efficient and reliable operation than the systems utilizing the "arc" and "spark." In fact the literature of the past makes frequent references to the desirability of an oscillation generator constructed along the lines of an ordinary power-house alternator; but because such alternators were required to provide frequencies a thousand times or more in excess of those used in power engineering, new problems of design were encountered which were declared by many to be well-nigh insurmountable.

For a time the development of the art seemed to follow the line of least resistance, and it resulted in the evolution of several systems utilizing the "arc," the "spark gap," and the type of radio frequency alternator which generates at a comparatively low frequency, the necessary increase of frequency being obtained either by groups of mono-inductive transformers external to the alternator, or by tuned "reflector" circuits associated with the alternator. None of these systems, however, can be said to have satisfied fully the exacting requirements of commercial operation.

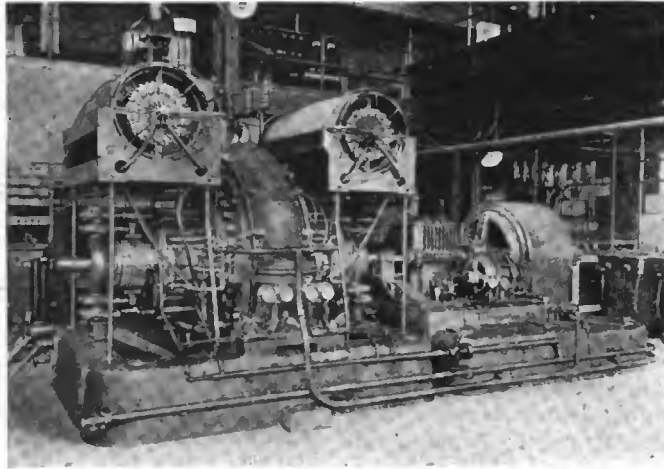

Figure 1-2—200 kw. Alexanderson radio frequency alternator installed in the New Brunswick transoceanic station

a fundamental wave in which the radiation incurred by super-imposed harmonics is negligible.

3. It should provide a performance as reliable as the ordinary power dynamo.

4. It should operate economically and efficiently.

5. It should permit manufacture of units in any desired power.

6. The design of the whole system should be such as to permit telegraphic signaling at very high speeds.

These specifications are met fully and fairly in the Alexanderson system.

As is well known, the design of radio frequency alternators has occupied the attention of Ernst F. W. Alexanderson of the General Electric Company and his staff for a number of years, and the pioneer work of these men in that branch of radio research is now a matter of common knowledge. Starting with the development of several experimental types of alternators, they have steadily progressed toward the designs of more powerful machines which are now available for commercial use. Standardized alternator sets for transmission at wave lengths between 6,000 and 10,000 meters and between 10,500 and 25,000 meters, are now in production. This description is devoted principally to the discussion of a 200-kilowatt

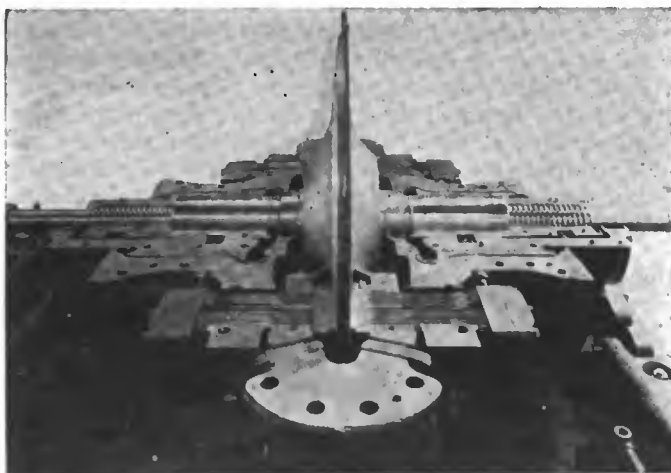

Figure 3—Alexanderson alternator with top half removed

An oscillation generator suitable for commercial radio service over great distances, should possess the following qualifications:

1. It should generate a steady stream of oscillations of constant amplitude.
2. It should generate a so-called "pure" wave; that is,

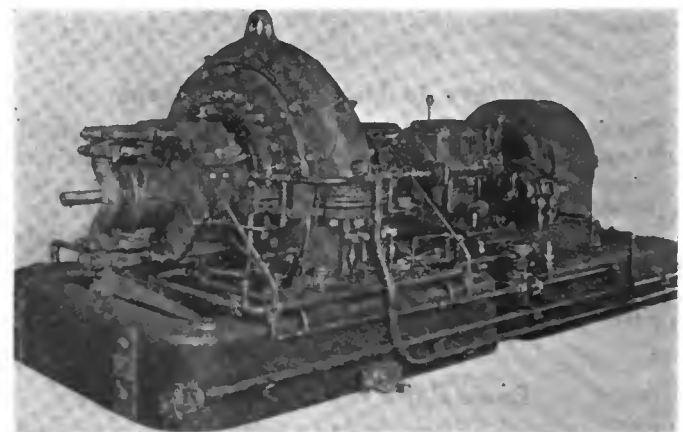

Figure 4—Alexanderson alternator with high frequency transformer removed

set, although sets of other powers are now under construction.

The typical Alexanderson high-power station may be said to represent a radical departure from current ideas regarding radio design. In fact, at first glance, it seems to possess little in common with the apparatus of other

systems. These features will presently be described in greater detail.

The Radio Corporation, after an extensive test of the Alexanderson system at its high power station at New Brunswick, N. J., has acquired the rights to the Alexanderson system, and it will be employed at all its stations devoted to long-distance signaling. A 200-kilowatt alternator set was installed at New Brunswick in September, 1918, and from that time it has provided continuous and most satisfactory service in continent-to-continent communication. Normal transmission is at present conducted at the wave length of 13,600 meters, with antenna current of 400 amperes corresponding to an alternator output of approximately 80 kilowatts. With this fractional value of the available output of the al-

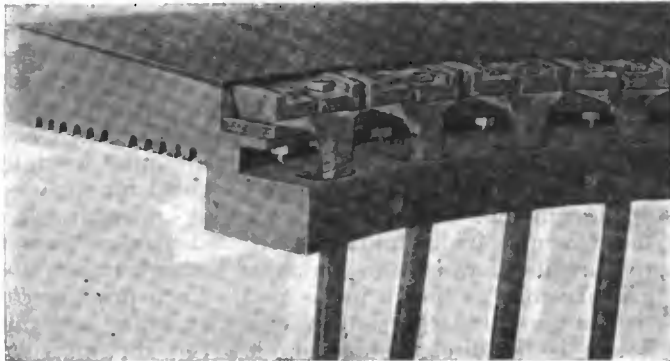

Figure 6—Detailed view of section of armature

ternator, trans-oceanic communication has been maintained with European stations throughout the twenty-four hours of the day. The alternator is capable of supplying 600 amperes to the New Brunswick antenna, but its full output of 200 kilowatts is not at present utilized, due to the lack of adequate power supply at that point. The alternator, as installed at the New Brunswick station, is shown in figure 1-2.

The following explanation of the basic principles of the Alexanderson System and the fundamental circuits of a typical station may be accepted as indicative of a standard 200-kilowatt installation, although largely based upon the apparatus at the New Brunswick station.

A high power radio station of the Alexanderson type contains three important developments:

(1) An alternator—which generates currents directly at the frequencies which are required for the radio circuits with which it is associated. The frequency of these currents is solely dependent upon the number of field poles on the machine, and upon the speed at which the rotating member is driven. This is in distinct contrast to certain other systems in which the radio frequency currents are obtained indirectly by means of "reflector circuits" or frequency raising transformers electrically associated with the alternator.

(2) A magnetic amplifier—which provides a non-arcing control of the alternator output for radio telegraphy, and is equally applicable to radio telephony.

(3) A multiple tuned antenna—a development which has markedly reduced the wasteful resistance of the flat-top antenna, and has therefore increased the transmitter overall efficiency many fold.

To date the development in radio alternators has included the following types:

2-kw., 100,000 cycle; 50-kw., 50,000 cycles; 200-kw., 25,000 cycle.

The characteristics of several alternators of other power outputs have been investigated from time to time. A standard 25-k.w. and a 5-k.w. alternator are now under construction and will be shortly put into commercial production.

With the object of providing a distinct range of frequencies, both the 25-k.w. and the 200-k.w. alternators are manufactured with armatures and rotors with different numbers of poles; also with gears of different ratio for different driving motor speeds. Thus the 25-k.w. machine can be assembled for any wave length from 6,000 to 10,000 meters, and the 200-k.w. machine for any wave length from 10,500 to 25,000 meters. Frequencies lower than these for which the machine has been assembled can be obtained by running the alternator at a reduced speed.

The standard drive for the 200-kw. Alexanderson alternator is two-phase, 60-cycles, 2,300-volt alternating current. By the use of suitable transformers, the voltage of the power supply can readily be transformed to the value for which the motor was designed. Special driving motors and control equipment can be supplied for frequencies other than 60/50 cycles.

The Alexanderson alternator is an inductor type of generator with a solid steel rotor having several hundred slots milled radially on each side of the rim. The slots are filled in with non-magnetic material, with the object of reducing wind friction to a minimum. The fillers are brazed into the disc in order that they may withstand the centrifugal strain of rotation. The rotor is designed for maximum mechanical strength by providing it with a thin rim and a much thicker hub. With this construction the strain on the material due to centrifugal force is the same from the shaft to the outer rim.

The rotor of the 200-k.w. alternator—with half of the field frame removed—is shown in figure 3. This also shows the collars of the thrust bearings and a partial sectional view of the main bearing housings.

An assembled 200-k.w. alternator with its driving motor is shown in figure 4. The alternator is driven by a 600

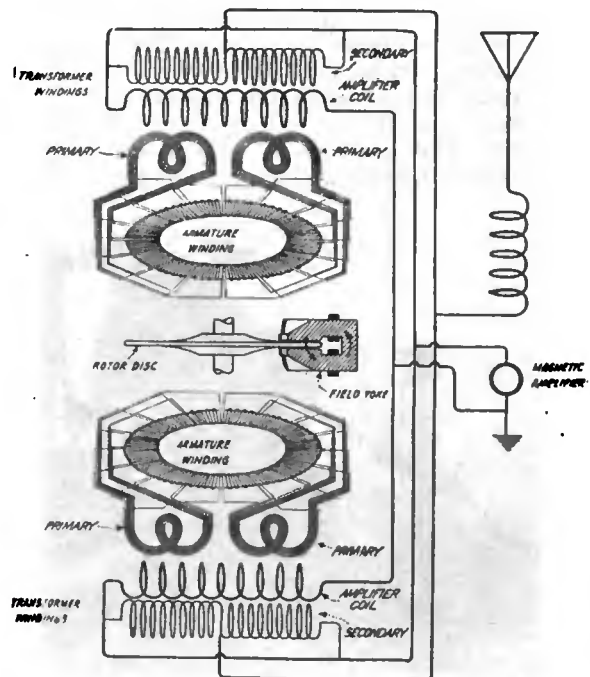

Figure 5—Schematic diagram of Alexanderson alternator circuits

h.p. induction motor of the wound-rotor type, which is operated from a 60-cycle, 2,300 volt, quarter-phase source of supply. The motor is connected to the alternator through a double helical gear—with a speed step-up ratio of 1 : 2.97—which operates in a container partially filled with oil.

The main bearings and the thrust bearings of the alternator are oil-lubricated by force feed at pressures varying from 5 to 15 pounds according to the demand on the bearing. During the periods of stopping and starting,

and in possible emergencies, oil is supplied by a special motor-driven pump mounted on the alternator base. When the alternator is working under normal operating conditions, a separate pump geared to the main driving shaft feeds the bearings, and the motor-driven pump is automatically cut out of service. The oil-supply tank is located in the base of the alternator, to which the oil returns after being pumped through the bearings. The oil gauge on the main feed pipe is fitted with a signaling



Figure 7—A section of the armature

circuit to call the attention of the operator in case the oil supply fails. The main bearings of the alternator, which are self-aligning, are also water-cooled by a series of copper pipes which run through the bearings near to the friction surface. The armatures of the alternator are also water-cooled from the same pumping source by a series of parallel copper tubes cemented in the frame alongside the laminations.

In order to avoid large losses through magnetic leakage, the air gap between the rotor and the stator frame is maintained at a spacing of 1 millimeter. It is important that the rotor be kept accurately centered, for otherwise the armature coils on one side of the rotor will become overloaded. This is accomplished by the use of specially designed thrust bearings which are inter-connected by a

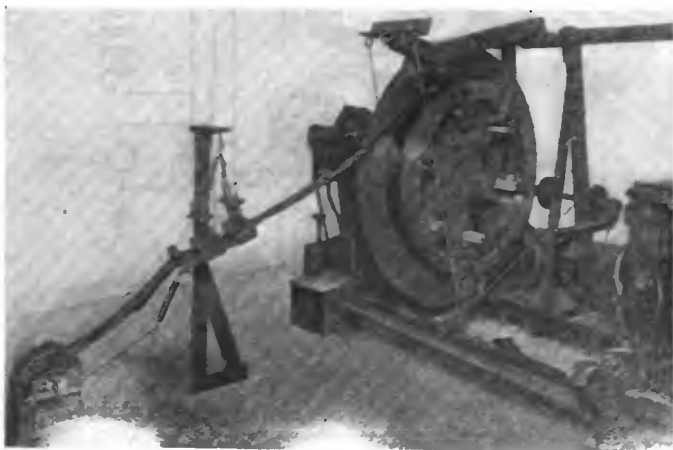

Figure 8—Method of assembling the armature

set of equalizing levers with an adjustable controlling leaf between them. These prevent the possibility of binding between the thrusts, due to expansion of the shaft from heating, and they also take up automatically all slack in the bearings as they become worn. Any tendency towards a change in the air gap is thus counteracted by the action of the levers. The equalizers are in part, the heavy vertical column shown at the end of the alternator in figure 4. Should the air gap on either side tend to get smaller, the pull of the field on that side would cause an excessive strain on the thrust at the end and cause

heating. This, however, is prevented by the leverage system, which automatically corrects this and holds the rotor in a central position at all times.

In regard to some of the electrical features of the alternator, it will be noted from figure 5 that the armature and field coils are stationary, the requisite flux variations for the generation of radio frequency currents being obtained from the slots cut in the rotor. The diagram points out the fundamental construction of the alternator and the general mode of winding the armature. The rotor disc revolves between the two faces of the field yokes. The direct current supplied to the field coils produces a magnetic field flux which passes between the field yoke faces and through the rotor as shown by the arrows.

The armature coils, which are placed in slots cut in the two faces of the field frames, are shown in the drawing as tipped away from the rotor, although in the actual machine the spacing between the rotor and the frame is but 1 millimeter. Two distinct armature windings are thus provided, one on each side of the rotor. There is but one conductor in each slot and two of these slots make a complete loop, and comprise a pole in the armature windings. One slot in the rotor is therefore provided for each loop in the winding. The armature windings on each side of the rotor are divided into thirty-two independent sections, the circuits of which are completed through transformer primary coils as shown in figure 5. Each primary consists of two turns with sixteen separate wires in each turn. There is no direct connection between the individual



Figure 9—Completed armature ready for sawing into two sections

armature sections, but, through the two-turn primaries, they combine to act upon the secondary coils of the transformers. It is obvious that with this division of armature circuits the potential on any armature coil—or on the corresponding transformer primary—is very low, and as such, it permits a grounded or open-circuit armature coil to be cut out of the circuit and the operation of the alternator to be continued with but a slight decrease in its output—an obvious advantage.

A detailed view of a portion of the alternator armature windings is given in figure 6, and of the preliminary stages of assembly in figure 7.

Figure 8 shows the laminated armature under assembly, which is wound with 0.037 millimeter steel ribbon and afterward machined into the shape of figure 9.

The completed rotor and its shaft appears in figure 10, while figure 11 is an end view of the alternator with the equalizing column removed. Figure 12 shows the alternator during one stage of the assembly—the driving motor, the alternator transformer and the thrust-bearing equalizing system not having been placed in position.

It is to be noted that a transformer is provided for the armature coils on either side of the rotor. There are therefore two transformers, and they each contain the three coils P_1 , S_1 , S_2 and P_2 , S_1 , S_2 , shown in the fundamental station diagram figure 19. The primary of each transformer contains two turns of sixteen wires each, as mentioned above. The intermediate coils S_1 have twelve turns on each transformer. The two intermediate coils are connected in parallel, and are shunted by the magnetic amplifier. The coils S_2 are also connected in series with the secondary proper, and the antenna system.

The secondary coils, which consist of seventy-four turns on each transformer, are wound so that their high potential ends are at the center, in order to provide a uniform potential gradient. The two secondaries are connected in parallel and their final terminals are in series with the antenna circuit. More in detail, the low potential terminals of the intermediate coils are connected to the ground, the other terminals of the intermediate coils are connected to the low potential terminals of the secondary coils, and the high potential terminals of the secondary coils to the antenna loading coil. The intermediate coils S_2 are placed between the primary and secondary of each transformer in order to obtain a close coupling with the alternator. One unit of the high frequency transformer is shown in figure 13.

The voltage at the terminals of the secondary winding of the transformer when the alternator is operated at normal speed is about 2,000. The normal output current is 100 amperes. It is thus seen that the alternator is designed for a load resistance of 20 ohms.

Since the antenna circuit is directly associated with the alternator circuit, any change in the rotative speed of this machine would throw the alternator circuit out of resonance with the antenna circuit; consequently it is easily seen that the speed variation of a radio frequency alter-

crease the received current. A change of wave length or frequency is likewise detrimental when reception is obtained by the heterodyne or beat principle, for should the speed of the alternator vary markedly while signaling, the beat note may vary to the degree that will render it objectionable for ear reception. A variation, for instance,

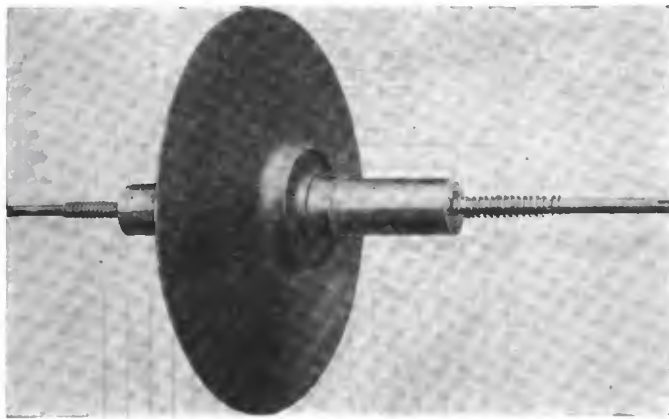

Figure 10—Typical rotor construction of the Alexanderson alternator

nator for substantially constant output must be held within very close limits. The variable load imposed by telegraphic signaling has a tendency to cause a variation of speed that must be compensated for by some device which operates more critically than any of the mechanical and electrical methods of speed control devised for ordinary power use. The characteristics of any satisfactory governor must be such that a small variation of speed will effect a maximum change in power input to the device under control. To accomplish this, some mechanism must come into such a critical state at the speed to be maintained, that a low percentage of change in speed causes a high percentage of change in itself.

It can be shown that a change in speed of one-quarter of one per cent. from that necessary to maintain resonance will reduce the antenna current in a station utilizing the wave length of New Brunswick—13,600 meters—to one-half its full value. This clearly infers that the speed variation must be much less than one-fourth of one per cent. to maintain a constant output at the alternator. As a matter of fact, a regulation within one-tenth of one per cent. is obtained by the Alexanderson speed regulator.

The necessity for close speed regulation becomes equally important when considered from the standpoint of the receiving station. With a modern receiving apparatus of low decrement, a very slight change in the wave length of the incoming signal will materially de-

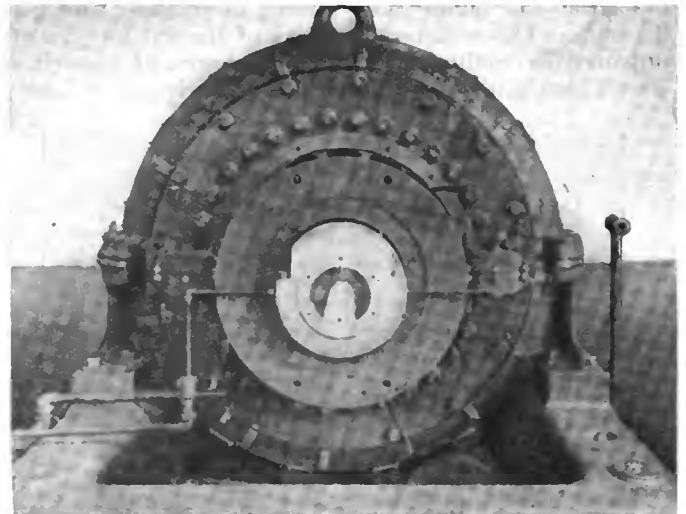

Figure 11—End view with air-gap equalizing mechanism removed

crease the received current. A change of wave length or frequency is likewise detrimental when reception is obtained by the heterodyne or beat principle, for should the speed of the alternator vary markedly while signaling, the beat note may vary to the degree that will render it objectionable for ear reception. A variation, for instance, of 50 cycles in the alternator will cause the beat note at the receiver to vary by 50 cycles, which is the equivalent of a speed variation of 0.23 per cent. at the wave length of 13,600 meters.

A solution of the problem of speed regulation with alternating current motor drive was found by Mr. Alexanderson in the use of a resonance circuit, which is tuned to a frequency slightly above the frequency to be maintained at the alternator. This circuit is supplied with current from one of the armature coils on the alternator. The current in this circuit increases with alternator speed and, through the agency of a rectifier, a direct current component operates on a voltage regulator connected in the circuit of the dynamo which supplies the saturation current for a set of variable

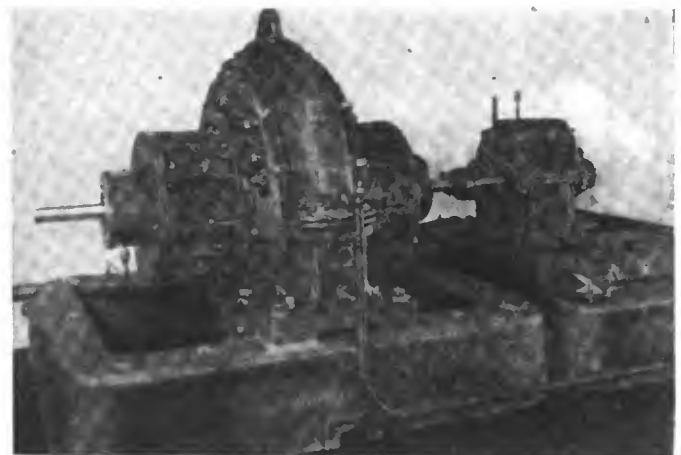

Figure 12—Alternator partially assembled

impedances in the two phases of the motor supply circuit. The function of the regulator is to prevent, within established limits, either an increase or decrease of alternator speed. Additional compensation for the load imposed when signaling is provided by a relay which also operates through the direct current control circuits to vary the line impedances.

The panel board of the voltage regulator system is shown in figure 14.

The multiple tuned antenna may be said to establish a

radical departure from the types of antennae formerly used for high-power radio transmission. The immediate object of the multiple antenna is to reduce the wasteful resistance of the long, low, flat-top aerials formerly used and to permit the length of such aerials to be increased indefinitely for the use of greater powers. In the case of the New Brunswick antenna, its resistance as a flat-top aerial—3.7 ohms—was reduced by multiple tuning to 0.5 ohm. The radiation qualities of the flat top are not impaired by multiple tuning, as a series of tests have shown that with an equal number of amperes in either

six times the capacitive reactance at a given frequency. The multiple antenna is thus the equivalent of six independent radiators, all in parallel and resonant to the same wave length. Their joint wasteful resistance obviously is much less than that of an antenna with a single ground, and herein lies the saving of power which the Alexanderson antenna brings about.

The relative power inputs required by both types of antennae for the same value of antenna current will be seen from the following illustration: To maintain 600 amperes in the multiple-tuned antenna at New Brunswick, at a resistance of $\frac{1}{2}$ ohm, the power required is $600^2 \times 0.5$, or 180-k.w. To maintain the same antenna current in a flat-top antenna with resistance of 3.7 ohms requires $600^2 \times 3.7$, or 1330-k.w. The economy of power secured in the case of the multiple-tuned antenna is an important consideration from the standpoint of the cost of daily operation.

Prior to the advent of the Alexanderson antenna, theory and practice pointed to the desirability of a very high antenna structure for long distance communication at high powers, but as is well known, the cost of erecting an antenna increases very rapidly with the effective height. The multiple-tuned antenna, however, permits the use of a less expensive antenna structure, and gives

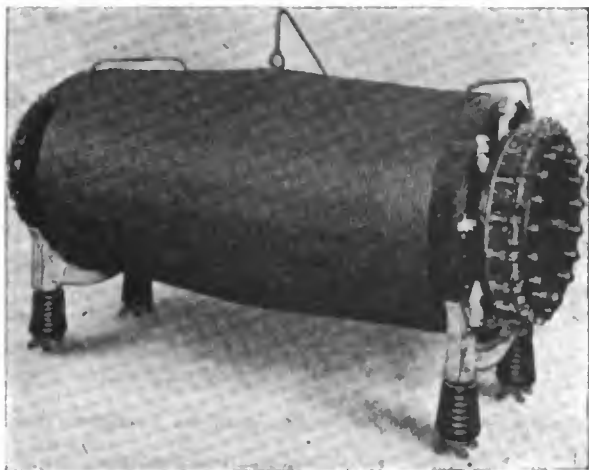

Figure 13—High frequency transformer

types, the same signal audibility is obtained at a receiving station, but there is an enormous saving of power in the case of the multiple antenna, as will be presently pointed out.

As shown in the station diagram, figure 19, the multiple antenna has, instead of the single ground wire usually employed, a number of ground leads which are brought

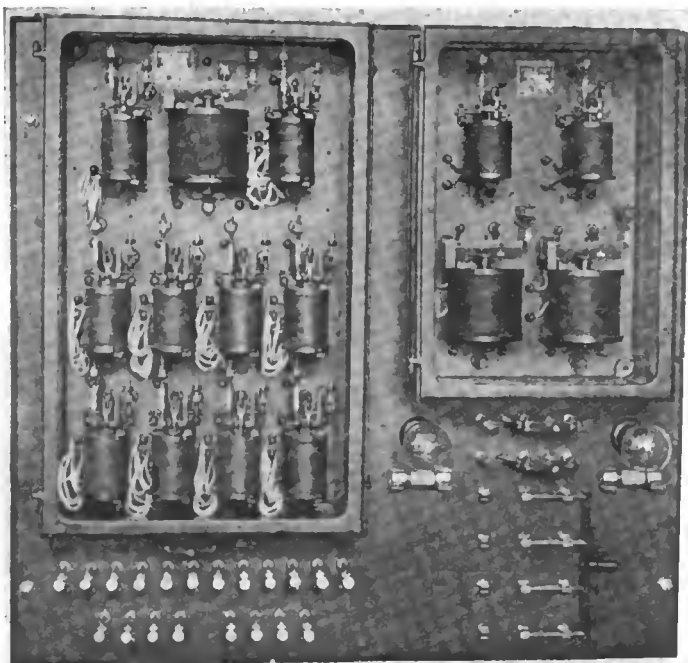

Figure 14—Control panel of current and voltage regulator

down from the flat top at equally spaced intervals, and connected to earth through appropriate tuning coils.

The capacitive reactance of the flat top is thus neutralized by inductive reactance at six points to earth, instead of but one point as in the ordinary system. The inductive reactance in each down lead is therefore made

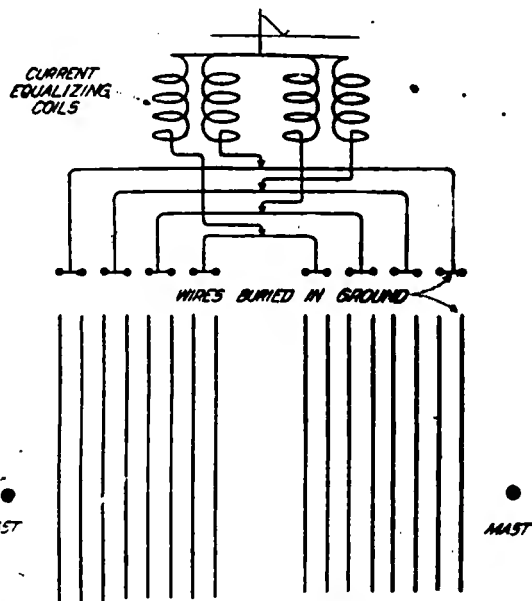

Figure 15—Schematic diagram of earth-wire system at the New Brunswick station

the same signal audibility at a given receiving station as a high antenna of the old type with less power. The example given demonstrates quite conclusively that the multiple antenna will provide the same antenna current as the flat-top type antenna, but with only one-seventh of the power. The multiple-tuned antenna will be treated more comprehensively in a later article.

The earth-wire system at the New Brunswick station is a combination of a buried metallic and a capacitive ground. Sixteen parallel copper conductors are laid underneath the antenna and buried one foot in the ground. They extend the entire length of the antenna and are spaced between towers somewhat as shown in figure 15. A network of wires and zinc plates are also buried in the ground around the station. At each of the five tuning points outside the station, connection is made from the antenna flat top to the sixteen underground wires.

In order to secure equal distribution of current through the buried ground conductors, equalizing coils are inserted between the tap on the down lead coil and the earth wires at each of the five tuning points outside the station, as shown in detail, figure 15. The function of

the equalizing coils is to increase the impedance of the wires near the center and hence force current in the outside wires. Since the coils are wound in opposite directions they add no appreciable inductive reactance to the tuning circuits. In one instance, the use of these coils reduced the multiple resistance of the antenna system from 0.9 to 0.7 ohm.

A still better distribution of the earth currents at New Brunswick was obtained by using a capacitive ground commonly known as a counterpoise, which is erected underneath the antenna and a few feet above the earth. A plan view of the counterpoise is shown in figure 16.

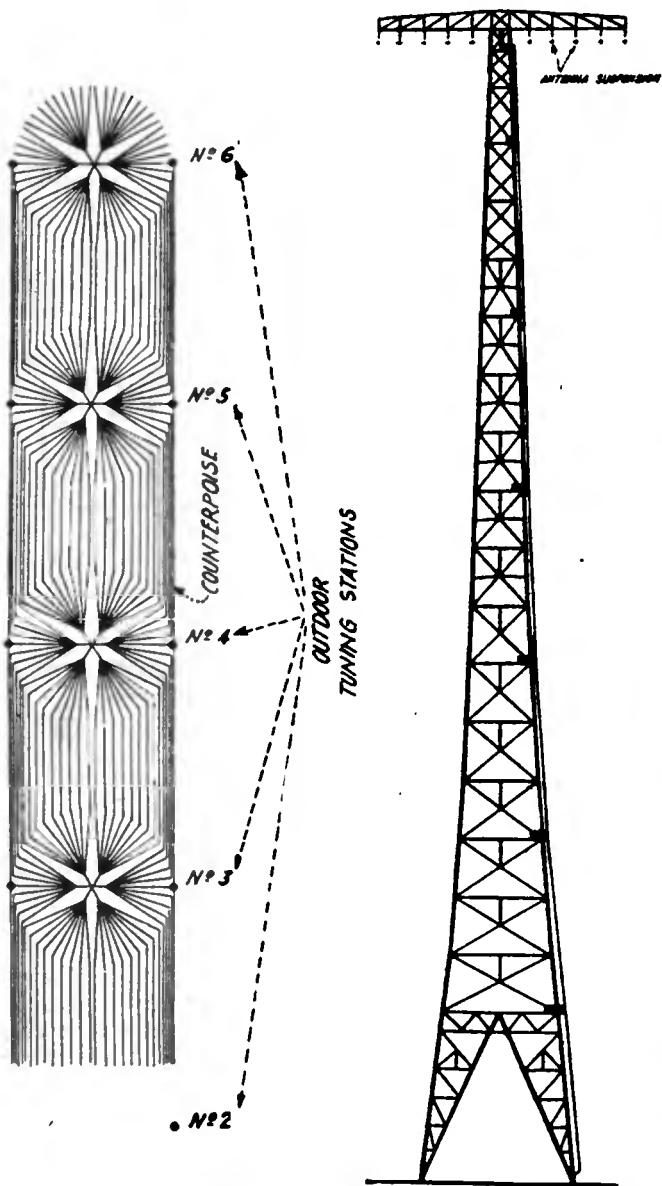

Figure 16—Plan view of counterpoise at New Brunswick Station

Figure 20—Design of standard tower used

The capacitive ground may be considered as a combination of a tuned and a forced oscillation circuit, and it has the effect of drawing the current from the ground circuit more uniformly than with wires lying on the ground or buried beneath the surface. In practice the total current in the down lead may be distributed between the capacitive ground and the wire ground in any desired ratio. The effect of adding this unit to the system at New Brunswick was to decrease the multiple antenna resistance from 0.7 to 0.5 ohm. The capacitive ground may be divided into separate units for each tuning down lead or the units may be connected together as shown. A schematic diagram of the connections between the flat top and the capacitive and earth-wire grounds is shown

in figure 16a. The equivalent circuit is given at the right of the drawing. The construction of the outdoor inductances for multiple tuning is shown in figure 17.

Telegraphic control of the large antenna currents involved in high-power radio transmitters has ever presented a difficult problem. Particularly has this been

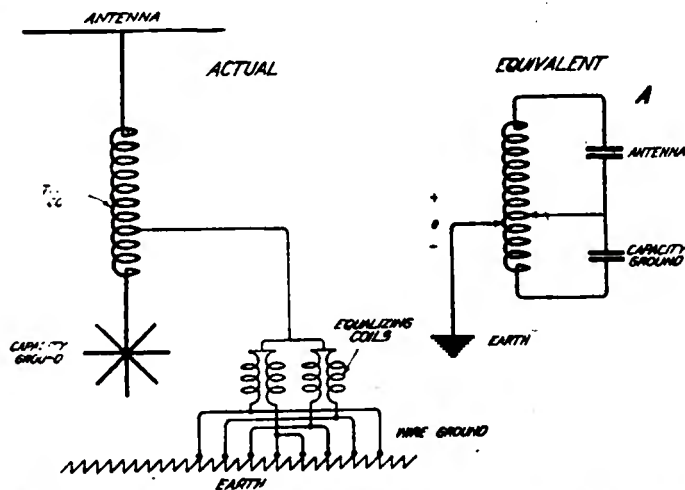

Figure 16A—Schematic diagram of antenna to earth connections of the multiple tuned antenna

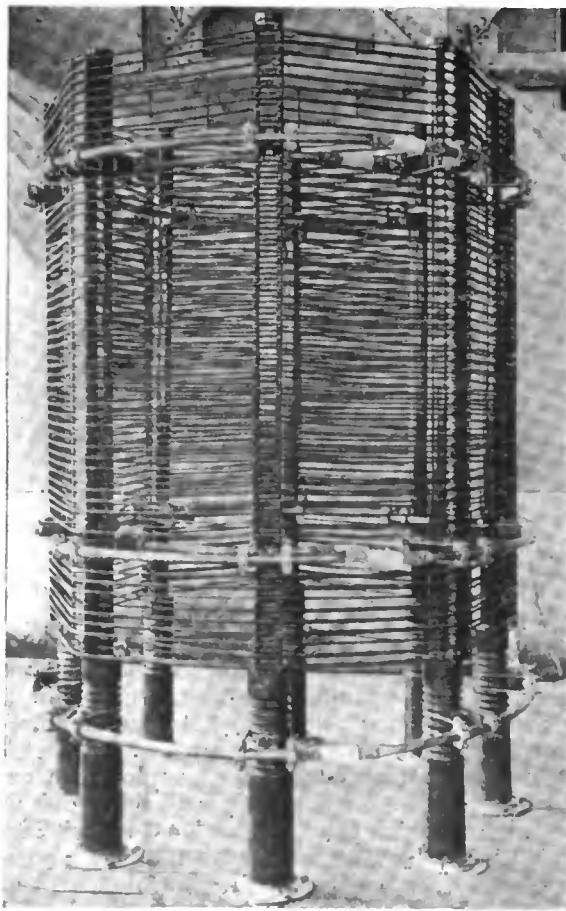

Figure 17—Tuning inductance for multiple tuned antenna

true when signaling at high speeds. Rapid signaling obviously requires some device that will not cause destructive arcs and will provide the desired modulation of antenna power without taking upon itself the burden of carrying the full power of the system, during the intervals between signaling.

The magnetic amplifier is a device which meets these exacting requirements, for it provides a non-arcing con-

trol with a minimum current in the key circuit, and it takes within itself only a small proportion of the total alternator output. A photograph of the amplifier, removed from its container, is shown in figure 18.

The magnetic amplifier in general may be described as a variable impedance which is connected in shunt with the external circuit of the radio frequency alternator. Its function is to reduce the voltage of the alternator and to detune the antenna system when the sending key proper is open, and to perform the opposite functions when it is closed. Thus when the sending key is open the amplifier short-circuits the alternator and detunes the antenna system, thereby reducing the antenna current to a negligible figure. When it is closed the output of the alternator is fed to the antenna system.

A general idea of the operation of the amplifier can be obtained from the fundamental circuit, figure 19, where it will be noted that the radio frequency coils A and a control coil B are mounted on a common iron structure, and are so disposed that the effect of the control coil upon the radio frequency coils is obtained solely through the agency of flux variations within the core. The impedance



Figure 18—Magnetic amplifier removed from case

of the amplifier is dependent upon the degree to which the iron core is saturated by the control winding. The saturation in turn varies as the current fed into the control circuit. When the control circuit is closed the alternator is short circuited; when it is open, the alternator assumes normal voltage and its output flows into the antenna system.

The magnetic amplifier has been employed in experimental telegraphic signaling at speeds above 500 words per minute, at which rates it functions without lag. It is equally applicable as a modulator of antenna power in radio telephony, in which case the control current of the amplifier is modulated at speech frequencies by a bank of Pliotron (vacuum tube) amplifiers, which in turn are controlled by an ordinary speech microphone.

The characteristics of the amplifier will be treated in greater detail in a later article.

The fundamental circuits of a typical Alexanderson alternator station are shown in figure 19. Beginning at the left of the drawing, it is to be noted that a source of two-phase, 60-cycle alternating current drives an induction motor M, having a wound rotor, the circuits of which include a liquid rheostat R_3 . The motor is connected to

the radio frequency alternator through a helical step-up gear.

The alternator armature coils are indicated at A_1, A_2 , the field coils at F_1 , and the rotor at A_3 . There are two sets of armature coils one on each side of the rotor, which as already mentioned, are divided into 32 sections on each side. The windings on each side connect to the primaries of two transformers shown at P_1, P_2 . The primary of each transformer (see figure 5) contains two complete turns of 16 wires in each turn, which carry the current developed in the 32 sections of the armature coils on each side of the rotor. As can be seen from the diagram, there is no direct electrical connection between the armature circuits leading to the transformer primary, but the individual primary circuits are disposed so that their magnetic fields at any instant are in the same direction; that is, their fields combine to operate on the secondaries S_1, S_2 . In addition to the primary and secondary coils, the two transformers have intermediate coils S_3 which are connected in parallel and shunted by the magnetic amplifier coils A. The coils S_3 are connected in series with the antenna system, and are also closely coupled to the primary and secondary.

The multiple tuned antenna, shown in the upper right hand part of figure 19, is a long, low, horizontal aerial of

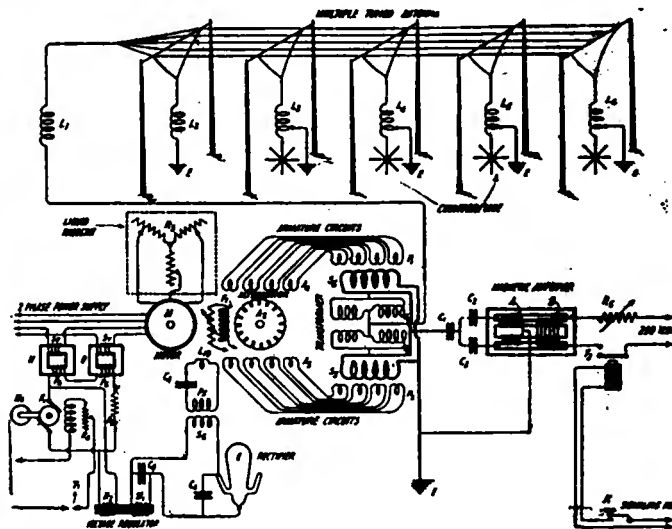

Figure 19—Fundamental station diagram

the Marconi type, from which are brought down leads to earth, which include the tuning inductances $L_1, L_2, L_3, L_4, L_5, L_6$. For any given wave length the joint inductive reactance of the down lead circuits $L_1 \dots L_6$ is made equal to the capacitive reactance of the entire flat top at the operating frequency or wave length. The multiple antenna is therefore the equivalent of six independent radiating systems resonant to the same wave length, and for all practical purposes, the oscillating currents in them flow in phase.

The magnetic amplifier, shown to the right of the diagram, comprises the parallel-connected impedance coils A, which are connected in series with the condenser C_1 and the transformer amplifier coils S_3 . B is the control coil, wound to include both branches of the windings A, which is fed with direct current, regulated by the rheostat R_4 . When the control circuit is closed the impedance of the amplifier coils A become a minimum; when it is open the impedance is a maximum. In the former case the alternator is placed on short circuit and the antenna is detuned; in the latter case the alternator assumes normal voltage and its output flows into the antenna system. In practice the capacity of C_1 is selected to neutralize the inductance of windings A for some value of current in the control coil.

The circuits of the speed regulator appear in the lower left hand part of the drawing. Note is to be made first of the variable impedances N and O in the motor supply line with their direct current control coils P_6 and the variable impedance coils S_7 .

The extremely close speed regulation essential to alternator operation is obtained from the resonance circuit L_{10}, C_4, P_6 , the coil L_{10} being one of the alternator armature coils. This circuit is made resonant to a frequency slightly above the normal frequency at which the alternator is to be operated and the current developed therein acts inductively on the circuit S_6, E, M_1 —E being a rectifier. The latter rectifies the radio frequency current and sends a D. C. component through M_1 , which acts with an increase of speed to decrease the voltage held by the voltage regulator M_2, T_1 on the generator K_1 . This increases the impedance of the coils S_7 and therefore

in M_1 . This keeps the speed variation within exceedingly close limits.

The trend of future development is of interest. In event that a larger output than that provided by a single alternator, of 200-k.w. is desired, parallel operation is contemplated. Such operation is entirely practicable and will be employed in the Radio Corporation's high-power stations, when great distances are to be covered.

A standard tower for high-power stations is shown in figure 20. This is of the self-supporting type erected on a suitable concrete base. The antenna wires are suspended from the steel cross arm at the top. This method of antenna suspension lends itself admirably to the long narrow antenna which has been found most suitable for the Alexanderson system.

The antenna layout for a two-alternator unit high-power station using these towers is shown in figure 21,

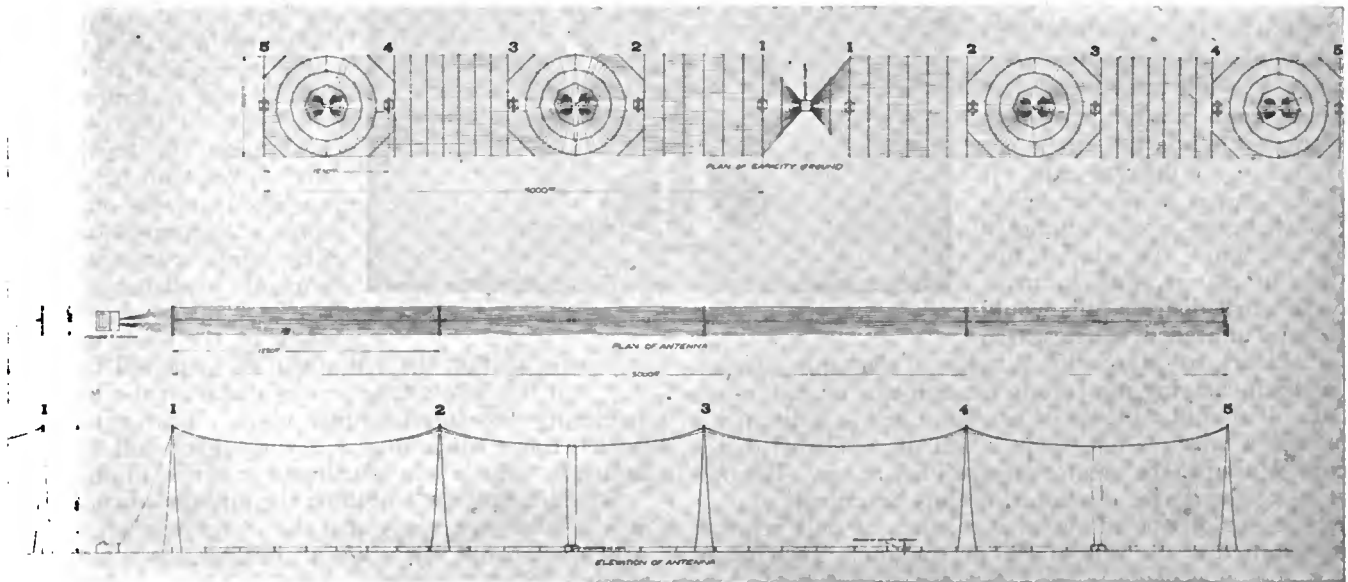

Figure 21—Typical antenna and counterpoise construction

tends to reduce the speed of the driving motor. As the speed now falls the current in the resonant circuit falls off and likewise that in the coil M_1 . This permits the voltage held by the voltage regulator to increase, and therefore acts to reduce the motor supply line impedance and thus increase the speed. A given mean voltage is thus maintained in the control circuit by generator K_1 , which depends upon the magnitude of the control current

where two antenna wings of any desired length extend in opposite directions from the station house which is located at the center. With this construction the wings may be tuned to different wave lengths and each energized by a single alternator, thus permitting simultaneous transmission at two different wave lengths; or the two alternators may be joined in parallel to energize both wings at some selected wave length.

Performance and Operation of the New Brunswick Station

and the Alexanderson System will be described in detail in the August issue.

The New Marconi Distress Calling Device

IN THE February issue announcement was made of a demonstration conducted in England between Chelmsford and Shelford (Cambridge), in which the station at Shelford rang an ordinary electric bell and exploded small mines at Chelmsford, by means of special wireless signals. The purpose of the tests and a description of the apparatus are now available.

A recent article in "The Wireless World" directs attention to the problem arising through the fact that some ships carry only one operator, who cannot spend anything like twenty-four hours per diem "listening in" on the off-chance of hearing a distress call. If such a call is made during his "watch below" it goes unheard by his ship. To amend this state of affairs, and to make certain that distress calls would not pass unheeded, the Research Laboratory of Marconi's Wireless Telegraph Company has been carrying out certain experiments on distant control. It sought a means of ringing a bell at a distance by means of wireless telegraphy, with the object of thereby contributing to the greater safety of life at sea. The operation of the device developed is thus described:

The predetermined signal is a series of dots regularly transmitted at the rate of 180 per minute. This number was chosen as being not too fast for the operator to count and time, and too slow to be interfered with by ordinary transmissions.

The first thing was to make a relay which would respond only to the predetermined signal, and which could be operated by the change in current produced by the reception of such a signal. The change in current with the vacuum tubes in use in the receiver was never more than half a milliampere.

Many relays were made, and tried out, and for various

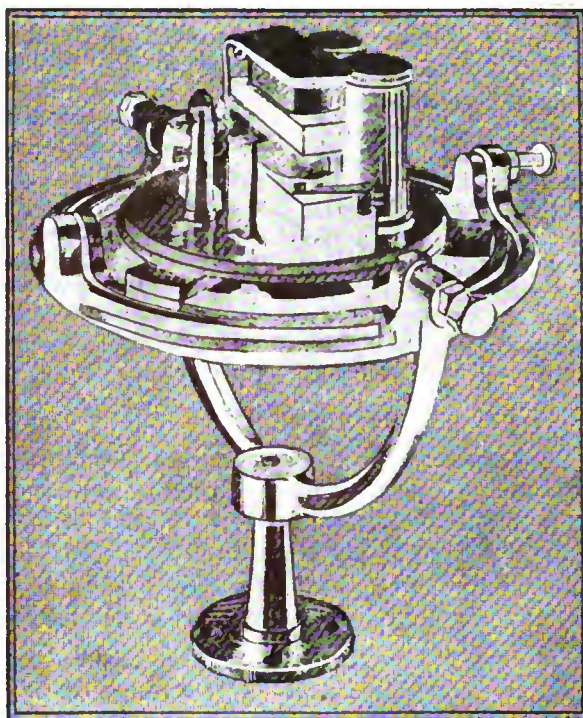

Figure 1—Final design of the Marconi distress calling device

spring, one end of which is attached to a brass collet on the pivot, the other end being soldered to a tongued brass washer clamped to one of the brass pillars. This tongued washer serves the same purpose as the zero adjustment on an indicating instrument. By twisting it about its center the position of the magnet can be altered and the best working position obtained. Besides these two details the pivot has fixed at right angles to itself a fine platinum-tipped steel arm. This arm is one pole of a switch and is connected by way of the brass pillar, spring and pivot, to the base of the instrument. The other pole of the switch is a small piece of hard carbon, fixed to one end of a strip of flexible copper, the other end of which is supported on a small pillar and connected to a terminal insulated from the base. A glass front is provided in the case of the instrument,

so that the action can be inspected from without, and the whole case screws down on the brass base, rendering the interior dust-proof. Two gauze-capped leaden tubes containing a drying agent will be seen in figure 1. The whole instrument is swung in gimbals.

By adjusting the length of the phosphor-bronze spring it is possible to arrange that the wheel magnet, pivot, and arm oscillate at the rate of 180 complete periods per minute.

The resistance of the coils and the current available are sufficient to prevent a single dash, or series of mixed dots and dashes, such as are received in an ordinary telegraphic communication from swinging the moving system far enough to cause the two contacts of the tiny switch to

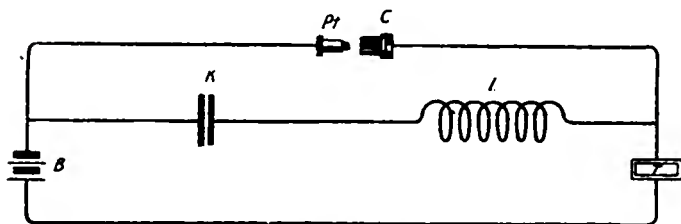

Figure 2—Circuit showing the modified connections

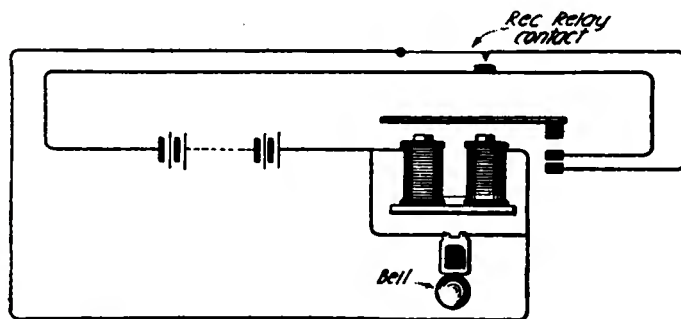

Figure 4—Circuit of instrument that operates alarm circuit

reasons were rejected. The final design is shown in figure 1, and in construction is not unlike the ordinary moving needle galvanometer. In brief the description is as follows: Two rectangular hollow forms each wound with many hundreds of turns of very fine wire are placed one above the other on a brass base, the windings being connected in series, and the free ends being taken to two insulated terminals in the base. In the rectangular orifice of the coils swings a small ring magnet, pivoted at its centre and supported in jewelled bearings which are carried by two vertical brass pillars screwed to the base. The pivot also carries a small circular phosphor-bronze

touch. It is only by the regularly delivered impulses arriving at the right moment that the swing can be built up from zero to full, and contact established.

Some trouble was experienced with this tiny switch. In the original model both contacts were made of platinum and sometimes they did not strike with sufficient force to make good contact at the first time. To overcome this fault Dr. Fleming's Patent No. 112544 of 1918 was employed. The modified connections of this patent are as shown in figure 2. In figure 2, Pt is a contact of platinum or other noble metal, C is a hard carbon contact, K a condenser, L an inductance, T an instrument which it is de-

sired to operate by the battery B on closing the switch Pt C. The battery charges the condenser, and when the switch closes the condenser discharges through the inductance and oscillations pass across the points Pt C and improves the contact at those points.

The point next to be considered was an arrangement for permanently closing the alarm circuit once the contact had been struck, and the instrument shown in figure 3 was designed.

This instrument consists of two coils with soft iron cores mounted on a soft iron plate, forming an electromagnet. Above these coils is placed a soft iron armature connected with a flat steel spring at one end to a brass standard, the other end being free. At the free end is carried a small insulator, which, when the electromagnet is energized, will depress a short platinum-tipped steel spring on to a similar one; also at a little distance from the free end is fixed a manipulating key contact which can strike a similar one situated immediately beneath it.

The action is as follows: The platinum-carbon switch of the receiving relay is connected in series with a 24-volt battery and the coils of this electromagnet; the two platinum-tipped steel springs are connected in parallel with the platinum-carbon switch. When this switch makes contact the electromagnet is energized and the armature is drawn down and closes the switch formed by

For transmission, a series circuit is made comprising a 24-volt battery, the coils and contacts of the transmitter, and the coils of the instrument shown in figure 3; a small tapping key is connected in parallel with the transmitter contacts. To start the instrument this key is pressed and immediately released. By thus closing the circuit the electromagnets of both instruments are energized and

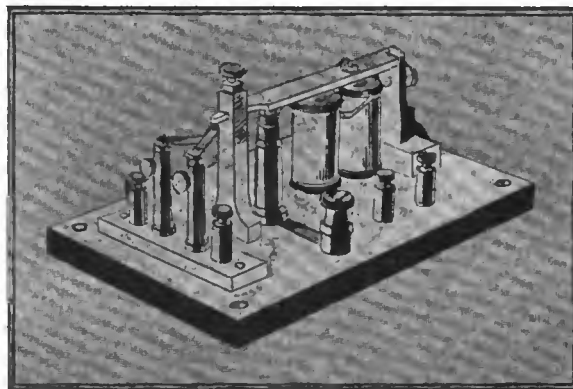

Figure 3—Instrument for permanently closing the alarm circuit

the iron bar of the wheel swings towards the magnet. The circuit being broken and the magnet demagnetised the wheel is urged by the clock spring past its position of rest, and on until the contacts of the transmitter touch; attraction starts again and the circuit is again broken, and so the cycle of events is repeated as long as the battery is switched on. Each time the wheel transmitter is energized the electromagnet shown in figure 3 is energized, the armature is drawn down, and the heavy key contacts meet. These contacts are in parallel with those of the manipulating key of the ship set, so provided that the generator is running, sparking occurs at every striking of the contacts. By means of a watch and the worm gear previously referred to, the operator can adjust the fre-

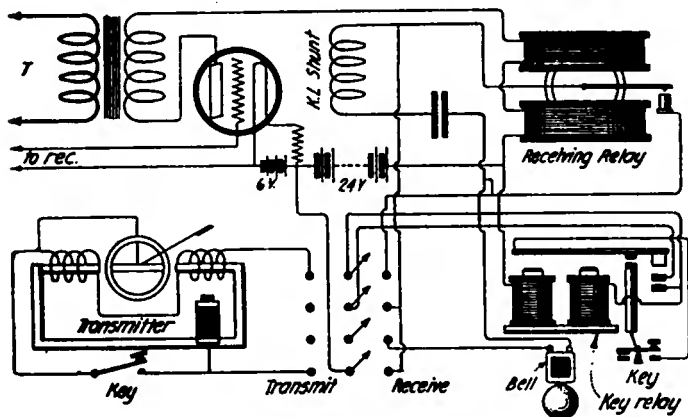

Figure 6—Complete diagram of connections from the receiver to manipulating key

the two steel springs. This switch being closed and in parallel with the first switch the magnet will remain energized, and the armature depressed, until the battery is switched off. Figure 4 shows these connections. Neglecting the resistance of the connections, it will be seen that as long as the electromagnet is energized there will be a P.D. of about 24 volts at its terminals. The alarm bell, which is an ordinary high-power bell working off 24 volts is connected in parallel with the electromagnet, and so long as the latter is energized the bell will ring.

The adopted automatic transmitter is as shown in figure 5. The instrument consists of two iron-cored coils mounted on a yoke, the whole forming an electromagnet. Between the poles of this magnet swings a heavy brass ring with a soft iron diametric bar. To the shaft carrying the ring are attached a spiral steel spring, like a clock spring, and a light flexible steel arm tipped with platinum. Below this arm is a small platinum contact, supported by a helical spring contained in a tube. The free end of the clock spring is clamped to a projection on the wheel of a worm gear, and a handle is provided on the screw of this gear, so that the distance of travel between the moving contact on the shaft, and the spring-supported contact, can be varied. The variation of this travel controls the period of the transmitter, and it is found that the shorter the travel the shorter the period. Three terminals are brought through the base and the whole instrument is mounted in gimbals.

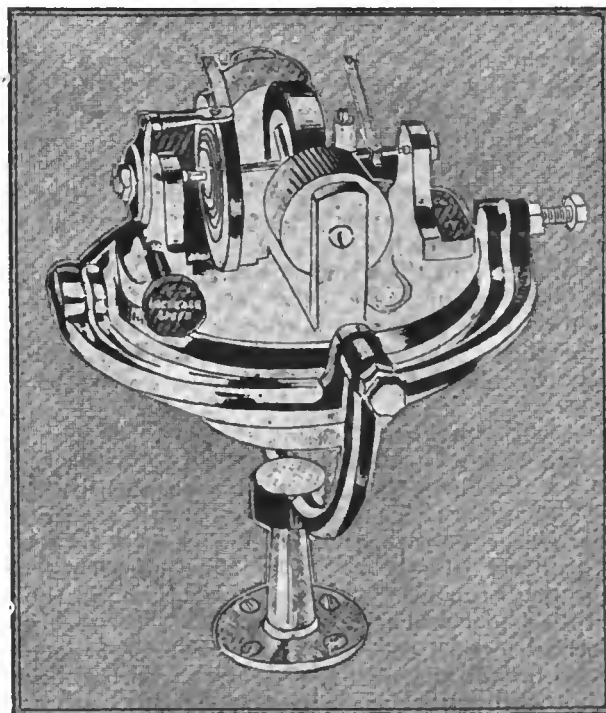

Figure 5—The automatic transmitter

quency of his signal to a nicety, and when once this is adjusted it is unlikely to vary.

Figure 6 shows the complete diagram of connections from the last vacuum tube of the receiver to the contacts of the manipulating key.

Transmission of High Frequency Waves Over Bare Wires in Water

By Major General George O. Squier
Chief Signal Officer, United States Army

(Abstract of a paper presented to the National Academy of Sciences)

THE following reasoning led to the carrying out of the experiments to be described:

Since we can already communicate by radio means between one submarine and another submarine, both completely submerged, it was considered that connecting two such stations by a submerged copper wire could have no other effect than to facilitate the propagation of the electric waves between the stations.

It was considered possible that the behavior of earth

clean and entirely free from any grease or other insulating material.

The success of this simple experiment immediately led to more thorough consideration of the entire subject.

One of the questions to be investigated was the general efficiency of the electron tube when used as a potentially operated instrument. The following experiment was made:

A strip of wire netting was buried in the snow outside the office of the Chief Signal Officer in Washington and a wire attached thereto leading to the second story of the building. The upper end of this wire was connected directly to the grid of an electron tube. The reason for connecting the grid to the upper end of the antenna is of course obvious if we are to use the tube as a potentially operated device. It was necessary for maximum sensitiveness to connect it to the point of maximum potential of the antenna which in the case of a linear oscillator occurs at the open end. By this arrangement, messages were readily received from distant points in the United States.

These two simple experiments demonstrated the possibility of transmitting electromagnetic waves along bare wires submerged in water and the use of an electron tube as a potentially operated device for the reception of signals.



Receiving apparatus used in telephoning and telegraphing by means of bare wire laid in water

or water under the action of high frequency currents might exhibit greatly different properties from those with which we are familiar at direct or low frequency currents.

It was realized that whatever high frequency energy losses might occur in the case of bare wires laid in earth or water, yet the over-all efficiency would be higher than in the case of radio space transmission where the plant efficiency is so very low.

It was noted by the writer in September, 1910, and discussed by him in April, 1912, that the three electrode audion could be used as a potentially operated device on open circuits. This arrangement was considered suitable for the reception of the signals over bare wires in earth or water.

The first experiment was an extremely simple one as follows: A bare No. 18 phosphor bronze wire, such as is used for the Signal Corps field antenna, was laid across the Washington Channel of the Potomac River from the War College to the opposite shore in Potomac Park. It was paid out from a small boat with sufficient slack to lay on the bottom of the river. A standard Signal Corps radio telephone and telegraph set, SCR 76, was directly connected to each end of the wire, one set serving as a transmitter and the other as a receiver. At the receiving end of the line the bare wire was directly connected to the grid of the receiving set and the usual ground connection left open. A frequency of about 600,000 cycles a second was used and the line tuned at each end by the usual methods. Excellent telegraphy and telephony were obtained. Care was taken to make this preliminary experiment as simple and basic as possible and precaution taken to insure that the wire itself should be bright and



Exterior view of the U. S. Gov. research laboratory where experiments were carried out

For military reasons, if for no other, the Signal Corps has recently undertaken certain investigations in the phenomena connected with the transmission of high frequency electromagnetic waves over bare wires in earth and in water.

In carrying out these investigations and in attacking the problems from various angles, the research staff of the Signal Corps laboratory at Camp Alfred Vail, Little Silver, New Jersey, was directed to carry out experiments on bare wires laid on the surface of moist ground and also buried in earth. The staff at the Signal Corps research laboratory at the Bureau of Standards was directed to investigate fundamentally the transmission of electromagnetic waves over bare wires in fresh water. In addition to this, the engineering staff of the Office of the Chief

Signal Officer has carried out from time to time certain experiments of a more or less crucial character which have come up for solution in the prosecution of this work at the other laboratories.

Telephone and telegraph communication has been established between Fort Washington, Maryland, and Fort Hunt, Virginia, across the Potomac River, below the City

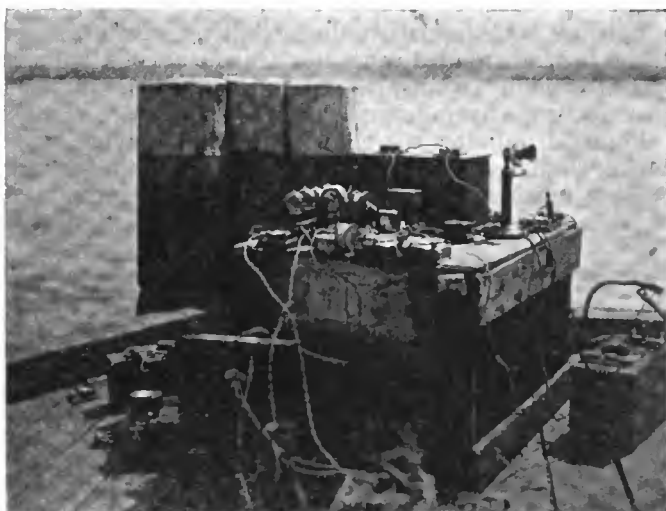

The transmitting apparatus containing an electron tube oscillator

of Washington, over a distance of about three-quarters of a mile, by the use of a bare No. 12 phosphor bronze wire laid in the water to connect the stations. The transmitter consisted of an electron tube oscillator which delivered a current of about 270 milliamperes to the line at a frequency of about 600,000 cycles a second. At the receiving end of the line an electron tube and a 6-stage amplifier were used without any ground connection. With this arrangement good tuning was obtained at both ends of the line, and telegraphic and telephonic transmission secured over the bare wires immersed in fresh water.

A resonance wave coil has been developed. The coil is in the form of a long helix wound with a large number of turns on which stationary waves are produced by the incoming radio signals. An electron tube is used as the detector, the grid being connected to the point of maximum potential on the coil. The wave coil may be used either as a part of the usual antenna system or a part of a line wire, or it may act itself as the antenna for picking up the energy of the signals. In the latter case the coil may be either free at both ends or grounded at one end. Good results have been obtained in either case. It has been also found that the open coil has directional proper-

ties and can be used as a goniometer not only for horizontal measurements but for vertical measurements as well. This form of radio goniometer has the great advantage that it permits not only of determining the plane where the signals are strongest but also the direction from which such signals proceed.

Telegraph and telephone communication has been also established between two stations at the Signal Corps Research Laboratories at Camp Alfred Vail, Little Silver, New Jersey, using a bare No. 16 copper wire buried in the earth to a depth of about eight inches to connect the stations. The distance between the two stations was three-quarters of a mile. Frequencies as high as one million cycles a second were used. Similar communication has been carried on over a bare wire one and three-quarter miles long laid on the surface of moist earth. The current at the transmitting station in these installations was about 100 milliamperes. It has been shown that a bare wire buried in moist earth with the distant end open can



Members of the engineering staff at the research laboratory observing the effects of the transmission of electro-magnetic waves over bare wires laid in fresh water

be tuned both at the transmitting end and at the receiving end.

The development of types of resonance wave coils, both open at one end and at both ends, for general radio work offers an interesting field for investigation. This involves the study of the electron tube as a potentially operated device. The application of such coils properly designed for specific purposes may lead to the practical solution of a number of radio problems such as directional effects, and wave coils antennae of very small dimensions.

IN THE AUGUST WIRELESS AGE

Second instalment of "WII—New Brunswick" containing a description of the performance and operation of the Alexanderson system.

An Impedance Curio.

Operating suggestions for the radio amateur.

Universal, Honeycomb and Lattice Coils In General

By Oscar C. Roos
Fellow I. R. E.

THE sudden wide adoption of the universal winding by radio engineers as standard for inductances, has produced conflict and confusion in the names used in the trade to designate various makes. Technical facts have been ignored in the emphasis laid on "selling points."

There are the following names in use to denote varieties of universally wound coils—"Honeycomb," "uni-lateral," "duo-lateral," "uni-lattice," "mono-lattice," "bi-

lattice, with special winding relations, insure a large decrease of distributed capacity. Universal coils, without special winding layouts, do not do this. Bank windings have about the average capacity of the above two classes.

Figure 1 indicates the general method of laying out a lattice winding, and shows the special features which cause a universal coil to have the additional properties of a lattice coil. The general features in figure 1,

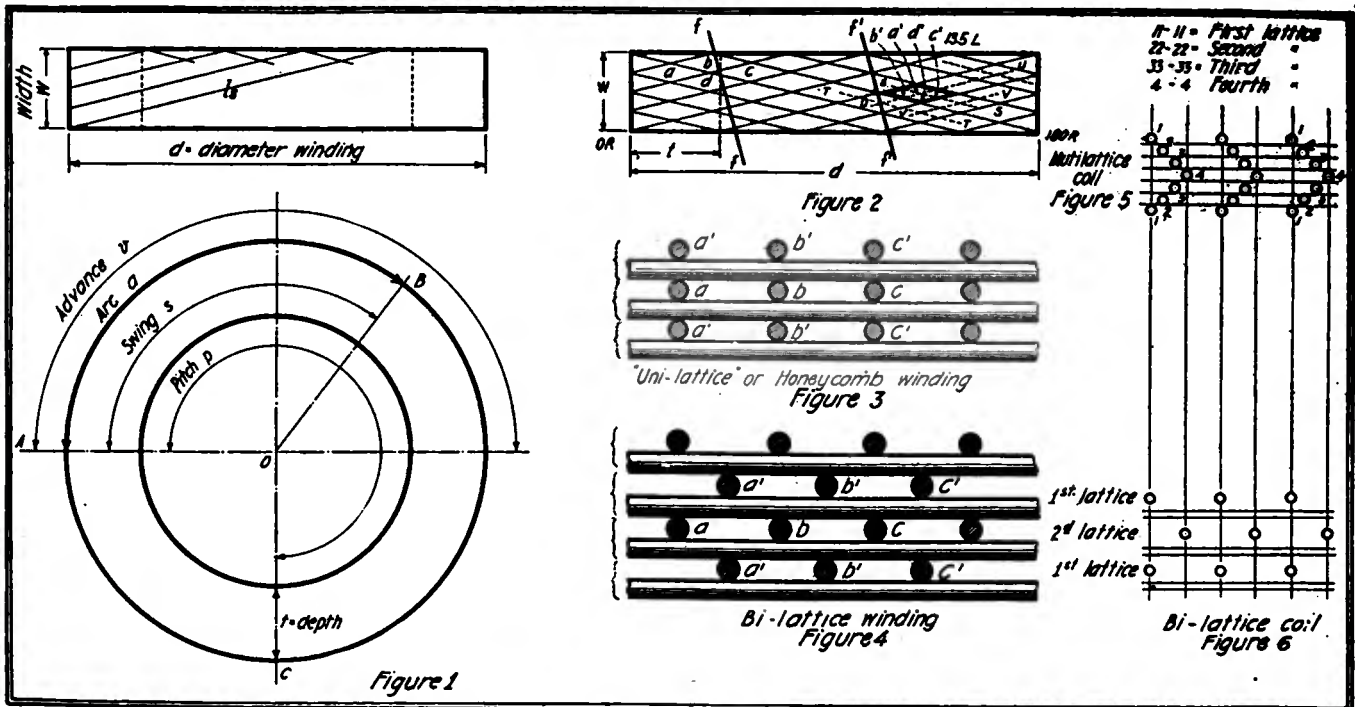

Figures 1 to 6—Details showing method of laying out winding and views at various stages of the winding

lattice," and "multi-lattice." Why all these "names?" Are they necessary? Cannot engineers adopt a "non-partisan" classification of the universally wound coils which are really different in winding layout and electrical properties?

This paper is an attempt to "clear the air." It touches the subject quite fully on the winding and general properties of universal coils. It adopts the terms, "uni-lattice" for "honeycomb" coil, and "bi-lattice" for "duo-lateral" coil. They are both different from "multi-lattice" coils.

These technical names have an advantage over trade names in that they prevent the physical properties of the different forms from being confused. This has prevented, in several investigations, a great deal of misunderstanding, regarding the differences in their winding schemes.

The following definitions have been tried out by several engineers and have run the gauntlet of general discussion.

All coils wound after the methods used in the machines of the Coto Coil Co. are "universal wound." The average experimenter will not produce a real "honeycomb" coil, and still less, a "bi-lattice" coil (these are defined below) by just sticking on a coil frame and winding it up "bobbin-fashion," the way our mothers used to do their sewing machine bobbins. The very thing the experimenter wants—low capacity—will not be obtained to any extent, even at the cost of the extra wire which is needed in all universal windings to obtain a given inductance.

peculiar to a merely universally wound coil are—first, the "angular swing, S," or simply the "swing" of the wire. This is the angle, AOB between the elements of the cylinder, between which the "swing" takes place. Second—the length of the swing or the "linear swing, ls" is the actual length of wire in the swing. Third, the "swing arc" or the "arc," which is the length of the arc denoted by the letter "a." Fourth—the "angular pitch" or the "pitch" which is always twice the swing, e.g. the swing in figure 1 is 135 degrees, and the pitch is therefore 270 degrees. Fifth—the "advance, v," which is the angular distance which some multiple of the pitch first reaches, beyond 360 degrees. The advance in figure 1 is 180 degrees, or the difference between twice 270 degrees and 360 degrees. Sixth—a separation of wire of h inches.

Now the lattice has two additional features, an advance which is an exact submultiple of the pitch and 360 degrees also and a width such that, if m is the above submultiple, hm the width of the coil w, is $\frac{hm}{2}$ if m is even and $\frac{h(m+1)}{2}$ if m is odd. Hence figure 1 does not represent a lattice coil, strictly speaking.

A swing of $82 \frac{2}{7}$ degrees, or other odd fraction of a degree is the kind of swing necessary to get a true lattice, in actual computations. A good short rule is this. The advance must divide 360, and the pitch also. If

we adopt 1.5 degrees as the advance $v = 1.5$, we can get along with a pitch of 183 degrees, 186 degrees, etc., since 1.5 goes into 183 degrees, 186 degrees, etc., and 360 degrees exactly.

We now define lattice coils as those universal coils in which the advance is a submultiple of the circumference and the swing. This is limited only by the condition that the advance must be less than one-half the pitch.

The result of this definition is that all lattice coils end at the same angular point on the circumference at which they start. There is no "creeping" forward of the turns, "stopping up" the radial view through the cells and increasing coil capacity. When the lattice winding has come back to the starting point just once, we have one "layer." This gives us the pattern of a rhombus, or lozenge, which

as in the honeycomb coil. Their average self capacity is smaller. In both forms, in fact in all lattice coils, the cells get "flatter" as the coil gets larger, as will be shown later.

Figure 3 shows the cross-section of three wires and three layers of the "uni-lattice" winding taken at $f f$ and figure 4 shows a cross section of three wires and three layers of the "bi-lattice" winding taken at $f'f'$. The latter is easily seen to possess less distributed capacity than the former—about 15 per cent. less on the average.

It is understood that the second lattice when finished, constitutes a complete separate system of honeycomb cells, whose walls are "staggered" half-way between the cell walls of the first lattice. Since a honeycomb coil is a "uni-lattice" or "mono-lattice" coil, the name "bi-lattice"

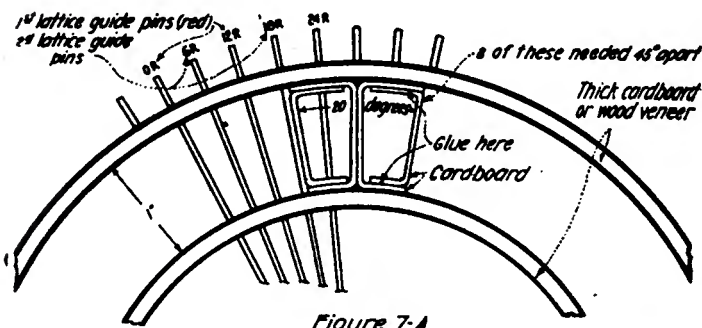

Figure 7-A

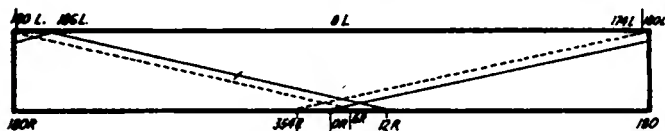

Figure 7-B

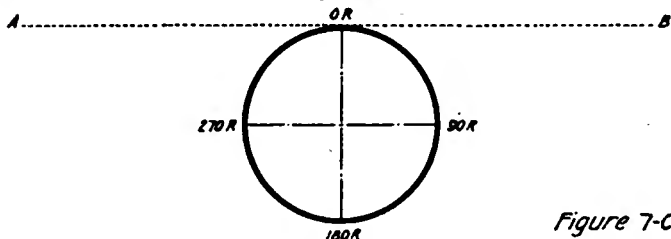

Figure 7-C

Figures 7A, B, C—Constructional details and method of winding bi-lattice coils

resembles a honeycomb cell and suggested the trade name used by many.

All honeycomb coils are lattice coils, but all lattice coils are not honeycomb coils. The bi-lattice coil described below is not a honeycomb coil, but a uni-lattice coil is.

Figure 2 is a lattice coil of external diameter a , and width w . It shows the honeycomb structure at the left and illustrates the "bi-lattice" differences in structure at the right. If we had repeated the first single "layer" of the lattice winding above specified, until a depth t , was reached, we could look down into the four "cells," $a, b, c,$ and d in figure 2, without finding anything to obstruct the vision. The wires forming the walls of the cells are arranged substantially one over the other. They spread slightly as they recede radially from the axis of the coil.

The bi-lattice coil is so wound that every cell of the original four, a, b, c and d , is broken up into four smaller cells a', b', c' and d' by the new wires of the second lattice. These are shown in dotted lines of which four are lettered SS, TT, UU, VV . It is true that we have smaller cells here—honeycomb cells, if you insist—as far as the mere question of looking down through the coil is concerned, but the successive cell wires are not "over" each other,

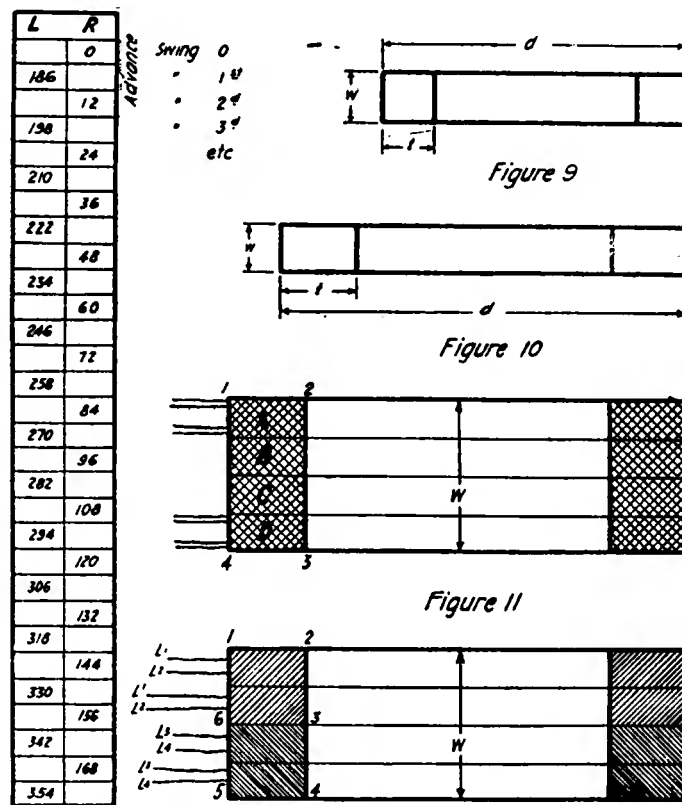

Figure 8

Figure 12

Figures 8 to 12—Chart and method of winding multi-lattice coils

has been given to this other form of winding. Only the alternate layers are started at the same circumferential point.

It was suggested in 1918 to engineers investigating the possibilities of further reducing the self capacity of the honeycomb coil, that by gradually shifting the starting point of the layers forward and then backward, as in figure 5, this self capacity would be reduced. This might be called a "quadri-lattice" coil or "multi-lattice" coil, as the series of lattices is repeated regularly.

However, it is not as good a reducer of capacity for given inductance as the bi-lattice winding, drawn to same scale in figure 6. This has a better selectivity at a given wave length.

STUDY OF COIL LATTICES

There are two distinct but related problems to be considered in making a lattice coil:

First, how shall we make the winding repeat every "layer" regularly? The solution of all electrical requirements is based on this purely arithmetical problem, in addition to determining the size and kind of wire and the diameter and width of winding.

Second, what is the best angular pitch to use in a coil of given lattice separation? This is determined by the number of turns and the coil width.

There is no exact analytical or even experimental engineering formula, it may be said, for the inductance of lattice coils. It is safe to recommend Professor Hazeltine's practical coil formula, presented at a meeting of the R. C. A. It is as follows:

This formula, based on Stephan's formula, is accurate to about 3 per cent.

$$L = \frac{.0008 a^2 N^2}{6a + 9t + 10w} \text{ in milhenries.}$$

where a = mean radius of winding in inches
 t = depth of winding in inches
 w = width of winding in inches
 N = total number of turns

In winding bi-lattice coils, it is not necessary to finish the first layer on one lattice, before starting the first layer of the other. This is especially evident in winding lattice coils by hand.

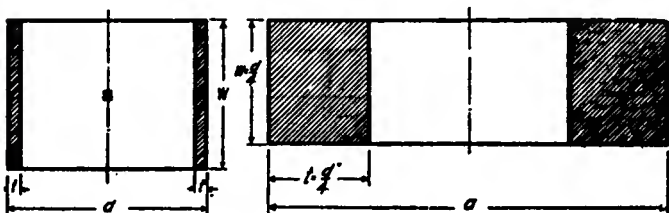

Figure 13

Figure 14

Figures 13, 14—Extreme and best ratios

To illustrate, place a double set of, say, red metal pins, No. 50 drill and about 2 inches long—equal in length to twice the coil winding depth—every 12 degrees around the circumference of a cylindrical coil frame, of say, 4 inches diameter and $3\frac{1}{2}$ inches width. Place the holes within $\frac{1}{8}$ inch of the faces of the frame. Then arrange another identical set of pins of different surface appearance 6 degrees away circumferentially from the first. Here we have the elements of a bi-lattice coil. We start one coil at OR on red pins only with 186 degrees swing, and another at 6 R, with the other pins only, with 186 degrees swing. Neither of these lattices will conflict, if wound by hand.

The finished coil is a bi-lattice coupler, and in large sizes cannot be surpassed for radio frequency work when used with proper "iron-dust-dielectric" in the lattices of the transformer. Transformers on this principle were tested as early as 1906. Figure 7a gives a sketch of the method. A wooden disk $\frac{1}{4}$ the width of the coil is used to support the inner cylinder of the winding frame.

In figures 7b and 7c we have a single lattice. In figure 7b it is shown in the form of a single layer, rolled out on the transparent imaginary surface A-OR-B, after being "cut" at 180 in figure 7c. The best way to gain an insight into the law giving the layout of the winding is to examine an actual winding chart to see whether it is practical or not.

Assume a "swing" of 186 degrees; make the "pitch"—which is 372 degrees—always twice the "swing." It happens that this first "pitch" is greater than 360 degrees, and the excess, which is called the "advance" is 12 degrees. The chart shows two things immediately.

First—There is room on this coil for a complete second lattice of the same description starting from the left at OL instead of the right at OR. This can be "hooked up" in series with the previous winding if a coupler is not desired, then we have a regular bi-lattice coil.

Second—The dotted lines in figure 7b are impossible

under the above scheme, as winding swings. They cannot be covered by the chart-layout.

The winding chart shown in figure 8 indicates that several separate uni-lattice windings may be wound without in the least interfering with one another. The smaller the wire, the wider the coil and the smaller the "spacing" as shown in figure 4, the greater the number of separate "lattices" which can be wound. It is readily seen how windings started on 2R, 4R, 6R, 8R and 10R will give separate lattices. Thus by using six different double sets of colored pins as winding supports along the "right" and "left" faces of the coil frame, the experimenter may wind a sextuple lattice coil, by winding each lattice only on its own colored pins. The possibilities of various spacings and other winding factors will be treated in the next section.

COIL DIMENSIONS AND WINDING FACTORS

We need to establish general limits within which lattice coil dimensions may be considered to conform to practical experience from mechanical considerations. If a coil form is satisfactory from the above standpoint, it may be left unsupported; as it should be mechanically rigid.

It may keep this rigidity through a large variety of windings, of very different electrical efficiencies, without appreciable mechanical change. In figure 9 we have sketched the kind of coil shown in figure 2 without indicating the lattices formed by the windings. This form gives a ratio

$$\frac{d}{w} = 6 \text{ and } \frac{t}{w} = 1, \text{ changing the ratio } \frac{t}{w} \text{ to } 2 \text{ and } \frac{d}{w} \text{ to } 10 \text{ we obtain figure 10.}$$

Four of these coils, placed close together, coaxially, have a very good time constant if connected in series. We may put this in other words by saying that in this

$$\text{case } \frac{d}{w} = 5, \frac{t}{w} = \frac{1}{2}. \text{ Such an equivalent coil is shown}$$

in figure 11.

In the light of the "multi-lattice" windings indicated by figure 8, it is interesting to consider the four coils A, B, C and D as wound in a single coil "quadri-lattice" coupler. Every lattice has its pair of separate terminals. By various combinations a range of inductance of 1 to about 36 may be obtained.

A smaller range is obtained by winding the four "coils" of figure 11 as two "bi-lattice" couplers, as shown in figure 12. Each "coupler" with the same area of winding cross-section, 1, 2, 3, 6 or 6, 3, 4, 5 has two sets of terminals, and starts with a lower inductance than figure 11. The first lattice terminals are indicated by L_1L_1 , the second lattice by L_2L_2 etc. These changes are really of no effect in determining a change of "swing," "pitch," or "advance," when changing the coil of figure 10 into the multi-lattice coupler coil of figure 11 or the two "bi-lattice" couplers of figure 12. The chart in figure 8 would do for any of them, as the "swing" is independent of the width, within wide limits.

The extreme case is shown in figure 13, where $\frac{d}{w} = 1$.

This is about the limit of $\frac{d}{w}$. The depth of winding is that due to two "layers," and figure 13 could only by courtesy be called a lattice coil.

The best ratios to secure a high time constant are about $\frac{d}{w} = 4, \frac{t}{w} = 1$ shown in figure 14.

(To be continued)

EXPERIMENTERS' WORLD

Views of readers on subjects and specific problems they would like to have discussed in this department will be appreciated by the Editor

A Loop Transmitter for Local Work

By Albert F. Murray

THE amateur of to-day is familiar with the characteristics of loop antennae, and is perhaps using or has used, some form of loop for receiving. Very few have tried transmitting on loops and up to the present, little has been written about this subject in radio journals. The reason for this, undoubtedly, is the shortened range of transmission when using a loop, although it will prove of great value to the amateur for short-distance or local work. The advantages, construction and operation of such a set follow.

A station desiring a short-range set would be of the more advanced type, possessing a non-synchronous spark transmitter of from $\frac{1}{4}$ to 1 kw. The short range work would be among amateurs using vacuum tube detectors, located in the same city or within 15 to 25 miles. The features desired are: sharp tuning, reduction of interference to or from other stations; a good spark note; a fool-proof break-in system with no contacts or moving parts; freedom from complication or duplication of parts. The necessity of two keys, two antenna switches, two sources of power, etc., is naturally to be avoided. All of these advantages are obtained by use of the loop for transmission and at the expense of one item, that is, low radiation efficiency. The power input is large compared to the distance covered. From the amateur viewpoint this is not a great disadvantage.

The wiring diagram of the station is shown in figure 1. To change from "long distance" to "local," throw switch SW from "antenna" to "loop." The additional apparatus required is the loop (described later); a high voltage condenser C, of any type whose capacity is approximately equal to that of your antenna, say .0003 mfd. or larger (it should be roughly adjustable in steps); and the inductance L, which is provided for fine tuning. If you do not mind moving the clip on the secondary of your oscillation transformer when changing from loop to antenna, you can tune in that way and omit inductance L, which is a helix of 4 turns, 12 inches in diameter.

In tuning proceed as follows:

With the transmitter in adjustment for maximum radiation on antenna, switch to loop and vary C until the

H.W. ammeter reads highest. Shunt H.W. ammeter with a loop of copper wire, unless it will stand four times the ordinary current. Now vary L until a maximum antenna current is obtained. The settings for radiation on the antenna have not been disturbed and either aerial or loop can be used by throwing one switch. However, if maximum range on loop is desired by the experimenter, C should be increased, the secondary inductance of

repeating parts of messages lost due to QRM. Unless one has used such a system it is difficult to appreciate the advantages of being able to listen and talk at practically the same time. The grounding of one side of the loop decreases its directive properties somewhat, but experiments show that when the loop is pointing as much as 10 degrees away from a nearby station your signals at that station are inaudible. Of course, many factors, such as

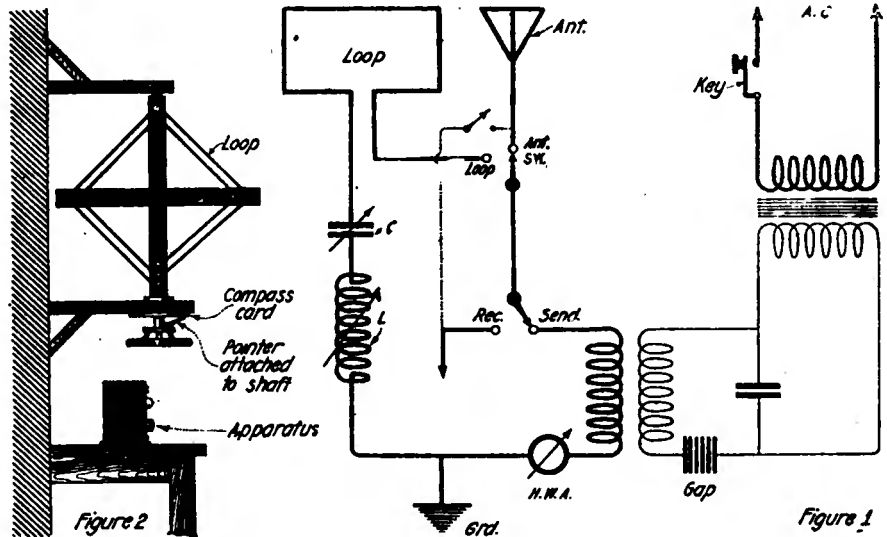

Figures 1 and 2—Circuit and construction of the loop transmitter

the oscillation transformer decreased, then retune and vary coupling for greatest current in loop. The tuning of the loop is much sharper than that of any antenna circuit because of the low resistance of the former. The coupling should be such that a wavemeter coupled to the loop should show but one "hump."

To operate swing loop so that the coil points in the direction of the station you wish to work. Receive on antenna and leave receiving set connected while sending. It is assumed that an audion is used as detector. Unless the loop and antenna lead are within a few feet of each other, it will be possible to wear the phones while transmitting and be able to hear other stations in the pauses between words. Not only can another station "break in" but you can hear when some loud interfering station starts up and send only during the times when he is not working, thus saving much time in

sensitiveness of receiver, etc., enter into the directional properties of the loop which, however, were found to be fairly pronounced and yet not too sharp. By using a receiving loop in a horizontal position it is said to be a "pick-up" loop receiving from all directions. Whether this is true of a transmitting loop and whether the range is decreased when in this position has not yet been experimentally determined.

It was found that work could be carried on through considerable interference when using the loop for reception. Low power amateur stations 10 miles away could be heard on a single tube, but a one step amplifier is necessary for satisfactory local work.

The loop used by the writer is 5 feet square, this being the largest size that could be handled easily in the operating room. It is mounted above

(Continued on page 41)

A Sensitive Portable Receptor

By Francis R. Pray

FIRST PRIZE, \$10.00

IN the past, amateurs generally depended on a crystal rectifier for the operation of their portable receiver due to the instability of the early types of gas filled audion tubes. Although they saved in space and weight, the results obtained with the crystal equipped set were not encouraging.

Now that a rugged vacuum tube has been developed for amateur use which can be used with comparatively small plate potentials and low filament current consumption, the practicability of

fit. As a Marconi-Moorhead VT requires about .65 amps. to light the filament to full brilliancy, it can be estimated that the battery will last about twenty operating hours before becoming useless. The inherent recuperative powers of the No. 6 cell may extend this time limit, depending on how the battery is treated.

Many VT's will operate with the 22-volt potential derived from a Signal Corps size "en bloc" B battery but it would be advisable to include a couple

the condenser scale by variation of the grid condenser. This makes a fairly good regenerative circuit, also, when the condenser values are set at a point just previous to that where oscillations begin.

The most practical form of inductance to use is unquestionably the universal wound coil, which is sold with a plug mounting by the De Forest establishment. Of course the amateur may buy the Radisco coils at a slight saving and equip them with a self-con-

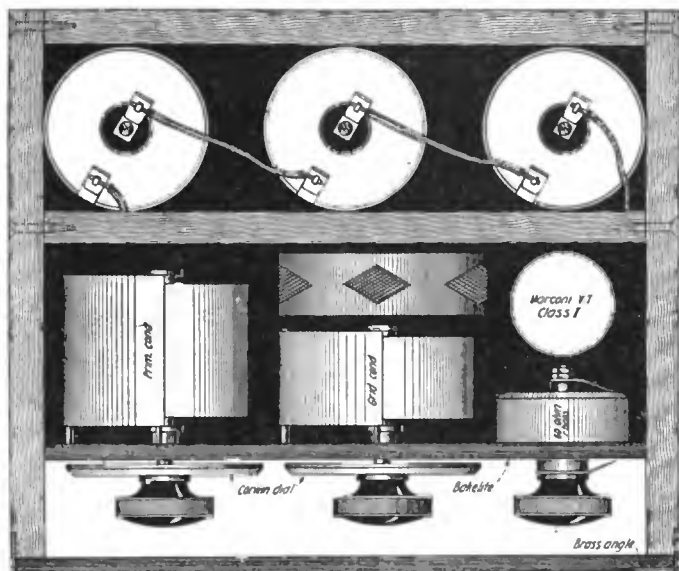

Figure 1—Top view of panel showing arrangement of instruments

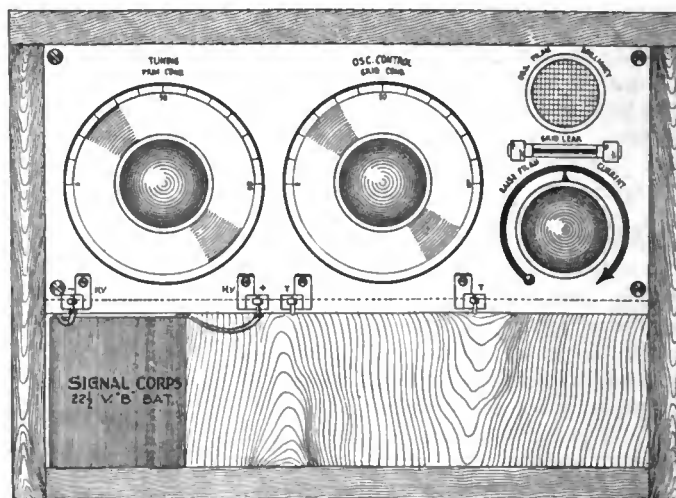

Figure 2—Front view showing controls and lower compartment for storing extra coils, phones, etc.

including an audion detector in the portable outfit is an accepted fact, and with it goes the following advantages:

(1) Maximum efficiency at the detector.

(2) Elimination of the buzzer test and battery.

(3) Constancy of operation.

(4) By employing the oscillating characteristics of the tube, regeneration or amplification is obtained on spark signals and continuous wave signals may be received.

The one primary obstacle in the use of a VT, is the "A" and "B" battery problem. Most portable sets are taken to destinations which make impossible the use of a storage battery and even if charging facilities are at hand, storage batteries are a bad proposition for field use, as any Signal Corps man will affirm.

Really the only solution possible is the use of ordinary No. 6 dry cells. It would be impracticable to carry along more than a single series—3, to give 4½ volts—as six, in series multiple, although having longer life, would add too much weight to the out-

of small flashlight batteries with Fahnestock clips for terminals, as many tubes require increased plate potential with continued use.

Fahnestock terminals are ideal for binding posts on portable outfits as the wires cannot jar loose, connections are easily made, and there are no thumbscrews to lose.

The next most important consideration is the selection of the circuit. It is at once apparent that an inductively coupled circuit is not required, as a broadly tuned circuit allows the reception of "everything in the air." More and more radio men are conceding that the single coil circuit is the most efficient for all-around reception, except perhaps in 200-meter reception and in long wave continuous wave reception.

In the circuit shown herewith, all that is necessary is one coil in the tuning circuit, which need not be variable if interchangeable coils such as the De Forest plug inductances are used. All the tuning variation is done with the .001 mfd. condenser and the circuit can be made to oscillate at any point on

constructed plug with a little ingenuity. The separate brass plugs and sockets used on these plugs can now be obtained separately from the Somerville Radio Laboratory, enabling the radio constructor to devise all sorts of original honeycomb coil mountings at a very low comparative cost.

Reference to the drawings will show the best form of arranging the apparatus. These are drawn to scale, to conform with the dimensions of standard apparatus, but exact dimensions are not given as the constructor can use material already on hand, in many cases, thereby making necessary the enlarging of the cabinet. Roughly speaking, the entire outfit may be placed in a cabinet of half inch oak, 8 x 8 x 8 inches.

The front can be a sheet of 3/16 inch Bakelite or Micarta held in by brass angle strips. The sheet when removed, makes an excellent writing surface for copying messages, and also cuts down weight. The use of Bakelite as constructional material in the instrument compartment also cuts down weight, and makes the mount-

ing of same much easier. The material may be drilled and tapped and held together with machine screws. 4-36 thread screws are the proper size to use on 3/16 inch stock.

2-megohm Marconi grid leak may be purchased without the base, and held on the panel by two spring metal clips. Fahnestock binding posts should be used and the No. 6 dry cells should

or lost in a forest fire, etc. Signal Corps P-11 phones are very good for field use, but don't take anything to camp which you prize highly. When going into unknown territory,

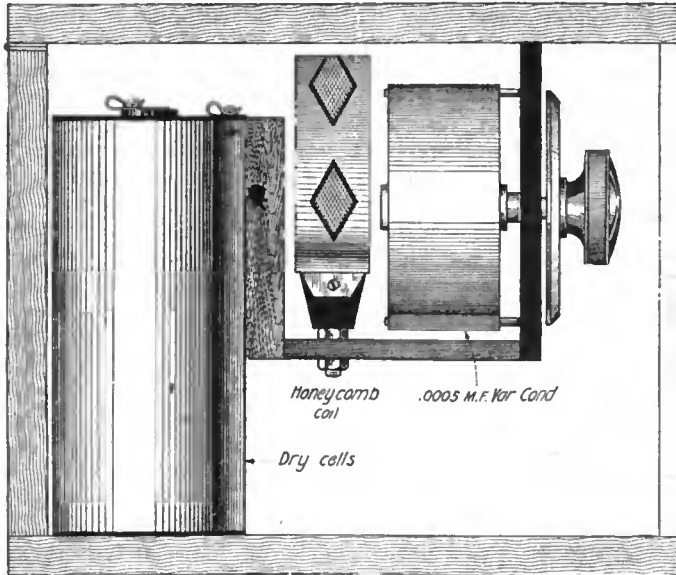

Figure 3—Side view showing mounting of coil direct to bakelite housing

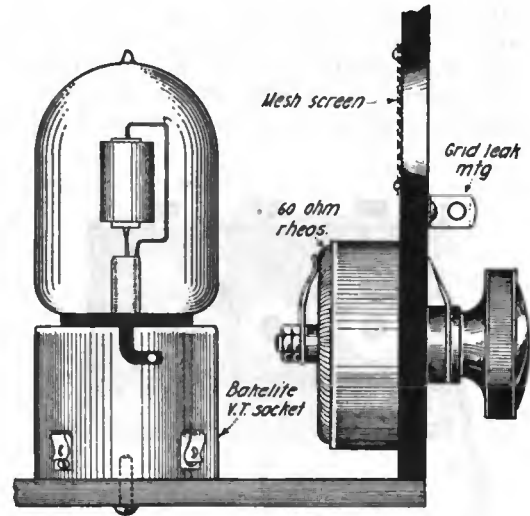

Figure 4—View of "VT" mounting, rheostat and grid leak

The neatest and most compact condenser arrangement is the Radio Equipment condenser equipped with a Radisco dial. The most compact VT socket is one made of Bakelite by a Massachusetts radio company, advertising in WIRELESS AGE. It is equipped with Fahnestock terminals and contacts of phosphor bronze.

The most desirable rheostat for the VT filament regulation is unquestionably the Paragon as it is only 2 1/8 inches in diameter and very easily and neatly back-mounted. Its "off" position obviates the need of the usual "on-off" filament circuit switch. A number of fine holes may be symmetrically bored to observe filament brilliancy or a large 1-inch hole may be cut and covered with a metal gauze screen. The

also be purchased equipped with them. Although Murdock No. 55 phones are

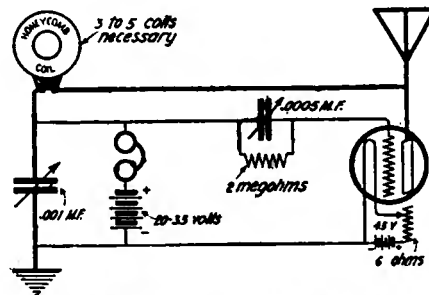

Figure 5—Single coil arc, regular spark circuit used

not necessarily the best, they can be packed very compactly, are light in weight, and their small cost discounts worry, if the set is dropped in the lake

the best antenna proposition is a couple of 100-200 feet coils of common annunciator wire, one for the antenna and the other for the counterpoise, to serve in lieu of a ground. Don't forget to include plenty of pencils and writing paper, which may be wrapped in oiled paper and stowed away between the dry cells.

While there are many other practical suggestions which might be made, in closing, let me suggest that you commission some obliging friend or radio company to send by parcel post to the nearest mail destination another set of dry cells, and perhaps a fresh B battery, after a few weeks, as they may come in mighty handy if something should go wrong with the first set.

Portable Receiver

By Norman A. Nyquist
SECOND PRIZE, \$5.00

DURING the summer, most amateurs leave their stations to go on vacations or to other towns to work for the season and consequently have no apparatus to experiment with, as the transportation and erection of their existing equipment would be difficult. In these warm months, the ideal receiver would be one that could be set up in the open and used to receive wave-lengths from 150 to 3000 meters and which could also be installed indoors as well, in a few moments.

The following described receiver was designed for portable work, and by removing the cover, a perfectly satisfactory instrument for permanent

station work is available. The design of an efficient receiver to cover a wide range of wavelengths is very difficult unless sufficient space and complicated

mechanical movements are permitted; that is, if it is to be automatically operated. It is believed that manual operation to secure changes to the upper

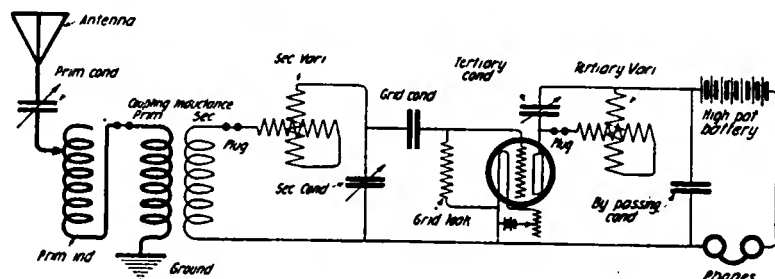

Figure 4—Schematic wiring diagram of the portable receiver

range of wavelengths will be satisfactory for amateur purposes.

Referring to figure 4, a schematic wiring diagram of the proposed receiver is shown. Starting at the antenna, we come to the primary variable condenser. This condenser is mounted by itself and should have one of the rotor plates bent over at the corner so that it will short-circuit itself in the 180 degree position, as it will not be used for some wavelengths. This con-

denser is controlled by the handle with pointer shown in figure 2, marked coupling.

From the coupling inductance we come to the secondary variometer, which construction will be described in detail later on. The secondary variable condenser which is of .005 mfd. capacity is mounted directly on the front panel and the secondary variometer is mounted on the same shaft directly in back. The secondary con-

denser is controlled by the handle with pointer shown in figure 2, marked coupling.

After another wire is run from the other terminal of the coupling inductance to the other terminal of the secondary condenser to the filament lighting battery, the secondary circuit is complete.

The tertiary circuit is now considered, and starts by a wire running from the plate to one terminal of the tertiary variable condenser which is the same size as the secondary condenser. This wire also runs to one terminal of the tertiary variometer. The remaining terminals of the tertiary variometer and condenser are connected together and are also connected to the positive side of the high potential battery. From the high potential battery a wire runs to the telephones. In this case the telephone terminals are two jacks for the telephone cord plugs and are mounted on the front of the panel as shown in the drawing. From the other telephone terminal a wire runs to the filament battery and completes the tertiary circuit, with the exceptions of the by-passing condenser for battery. This is a small condenser to allow the high frequency oscillations to pass around the high resistance offered by the telephones and high potential battery and is exactly the same as the grid condenser except

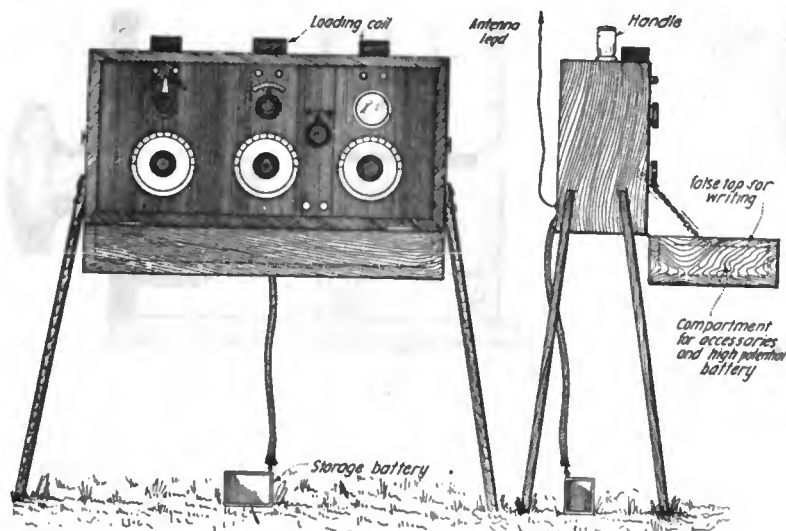

Figure 1—Front and side view of assembly

denser should have a capacity of about .0008 mfd. and work through a 180-degree scale. It is preferable to buy a standard condenser and arrange for mounting it on the front panel.

Next we come to the primary loading inductance. This is a small cardboard or dilecto tube two inches in diameter and three inches long, wound with 120 turns of 27-38 Litzendraht or No. 22 d.c.c. copper wire, bank wound, two layers. Taps should be taken every twelve turns and brought out to a 10-point switch on the front panel. When finished, the winding should be baked dry and given two coats of a good insulating varnish.

Following the primary loading inductance, is the primary coupling inductance, which is a fixed winding with no taps. A small tube three inches in diameter and two inches long, is wound with 20 turns of the same size wire, single layer, which will leave sufficient room at the other end of the tube, for fastening a bracket to mount the tube to the panel. One end of the primary coupling inductance runs to the ground and completes the primary tuning circuit.

The secondary circuit is now to be considered. The secondary coupling inductance consists of ten turns of the same wire wound on a small disc $\frac{5}{8}$ inch wide and $2\frac{1}{4}$ inches in diameter. It should be baked and varnished. This is the movable coil shown in the sketches and swings through 90 de-

grees and is in shunt to the secondary coupling and variometer inductance, which are in series.

One lead of the variometer runs to the grid condenser. This condenser consists of four copper discs one inch in diameter, two connected to one side and two to the other, insulated from each other by $\frac{1}{2}$ -inch discs of mica .005 inch thick. This condenser should be dipped in a good insulating varnish and dried. A small bolt insulated from the plates can be passed through the center and fastened to a bracket for mounting to the front panel from the rear. The other lead of the grid condenser runs to the grid of the VT audion and also the one terminal of the grid lead, which should be 2 megohms for ordinary VT tubes. As shown, the other lead of the grid lead

that there are four discs of copper on each side, eight in all.

On the filament lighting circuit a variable resistance is in circuit, to properly adjust the filament to the proper temperature for best operation and long life. The Adams-Morgan Co., Montclair, N. J., is putting out an excellent rheostat suitable for this purpose and comes ready to mount on the panel, from either the front or rear. The resistance is suitable for VT tubes on operation from 4 to 6-volt batteries.

The most difficult part of the receiver to build will be the variometer, and well spent skill on this portion of the construction will be repaid in results. Referring to figure 5, it will be noted that the variometer is extended directly on the secondary and tertiary variable condensers, and that there is no

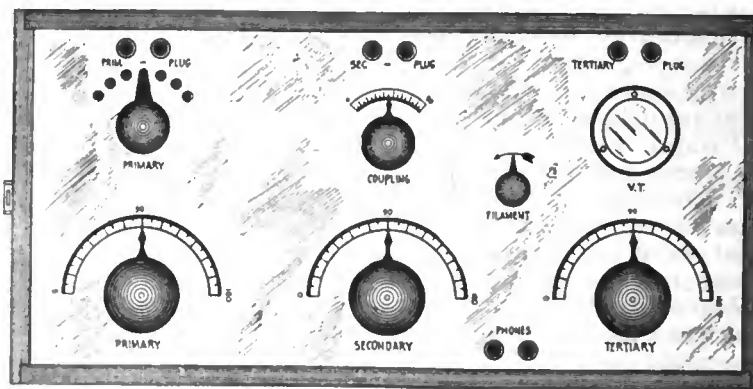

Figure 2—Front view showing location of instrument controls

variometer on the primary condenser (figure 3).

Either a new extended shaft will have to be put through the rotor plates of the variable condensers, or the end of the shaft can be tapped and an extension threaded in and sweated with solder which will be satisfactory. A frame of dilecto is then made to hold the stator windings. This is simply two pieces spaced with brass rods and fastened to the rear end dilecto piece of the condenser. The windings are held in place by small aluminum

clips at the extreme lower right. The primary inductance is at the upper right end of the receiver and is perpendicular to the panel. The primary coupling inductance is at right angles to the primary load and has no coupling to it. The secondary coupling inductance has no permanent coupling to the primary load in any position.

The VT tube, rheostat and fixed condensers may be mounted as shown or in any position convenient to the individual requirements. It will be

provided to insert loading inductances in the primary, secondary and tertiary circuit and the receiver may be loaded up to 2500 meters, and used for both damped and undamped reception.

In regard to its operation: Assuming that we did not know the wavelength that was to be received, first, we would tighten the coupling by setting the dial at 75 degrees on the scale, then short circuit the primary condenser by moving it into the 180 degree position. Of course, telephones are now plugged into the jack. Loading coils are short circuited, valve lit and the high potential battery connected and filament adjusted to normal temperature. The tertiary circuit control is set at 0 degrees on the scale. By simultaneously moving the primary inductance switch and secondary circuit control we will cover the range of 175 and 875 meters. It is best to hover around 600 meters as most stations work on that wavelength. When signals are heard, first adjust the primary inductance to the exact point; if this cannot be done directly with the inductance, increase the inductance and throw the primary condenser in series

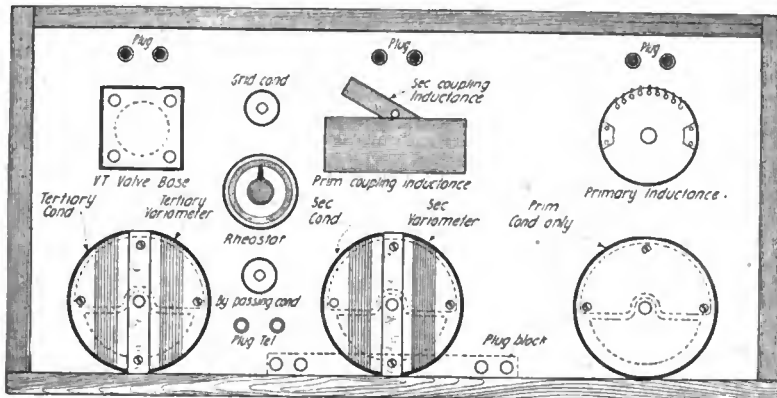

Figure 3.—Diagram of panel arrangement

brackets that are screwed to the dilecto frame pieces. The windings are then tied in place with strong linen thread and waxed. The rotor windings are held in a similar manner. The shaft runs through a dilecto rectangular block and is split in the middle and then the shaft continues through the other half of the dilecto block out the rear end. This shaft is split so that each of the two rotor winding ends can be brought out through one half of the shaft. The middle two connections of the rotor winding are connected together so that the winding is in a continuous direction.

Variometer winding is shown in the small sketch in figure 5. Preferably wooden forms are turned in a lathe the exact groove being cut as per sketch. The form should be made in such a manner that it can be taken apart to remove the winding. Before the windings are removed, the wires are firmly waxed together with a medium hard wax. It will be found that the windings will keep their form and a very substantial variometer can be constructed.

Now as to the assembly. A possible arrangement is shown in the assembly drawings. The front panel is dilecto which is the best material for this purpose and well worth the money it costs. Looking from the rear the tertiary condenser and variometer are at the extreme lower left end, and the secondary condenser and variometer at the lower center. True, there is some permanent coupling between these circuits, but it will not be detrimental to their operation. The primary con-

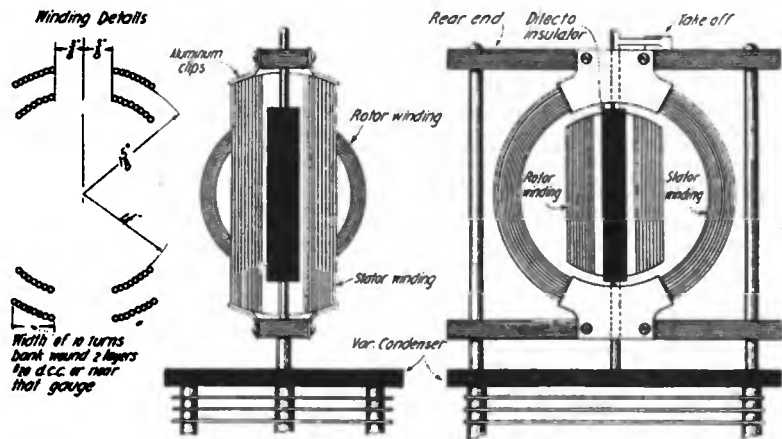

Figure 5.—Variometer and winding details and secondary and tertiary condensers

noted that the telephone plugs in from a jack on the front of the panel. The antenna, ground, high potential battery and storage battery are connected to the receiver through a small terminal block on the rear of the receiver which is not covered when the case is on. The case may be of oak.

Three leg fastenings are to be made of sheet metal and fastened on the case to hold the legs. The legs should be of oak, about eighteen inches long. It is figured that the legs will hold the receiver sufficiently above the ground to allow an operator to sit at the receiver with his legs straight out under the receiver, while sitting on the ground.

As designed the receiver will cover a range of 175 meters to 875 meters which is best for experimental purposes. However, as shown in the schematic wiring diagram, plugs are pro-

vided to insert loading inductances in the primary, secondary and tertiary circuit and the receiver may be loaded up to 2500 meters, and used for both damped and undamped reception. In regard to its operation: Assuming that we did not know the wavelength that was to be received, first, we would tighten the coupling by setting the dial at 75 degrees on the scale, then short circuit the primary condenser by moving it into the 180 degree position. Of course, telephones are now plugged into the jack. Loading coils are short circuited, valve lit and the high potential battery connected and filament adjusted to normal temperature. The tertiary circuit control is set at 0 degrees on the scale. By simultaneously moving the primary inductance switch and secondary circuit control we will cover the range of 175 and 875 meters. It is best to hover around 600 meters as most stations work on that wavelength. When signals are heard, first adjust the primary inductance to the exact point; if this cannot be done directly with the inductance, increase the inductance and throw the primary condenser in series

and tune with that. The secondary circuit and coupling should then be adjusted, the coupling being reduced to a point where signals are the best and still readable, and still further if interference is prevailing. Now by moving the tertiary circuit control slowly toward the 180 degree position, we start to tune the plate circuit and the valve regenerates and the signal strength is increased. This increase will continue until the valve starts to oscillate. Of course, then the spark resembles a hiss. If we are to tune to undamped stations, the valve must be oscillating all the time, and tuning done by the heterodyne method. Indications of oscillations are noted in many ways, but a sure indication is a dull thud as the tertiary is moved from the 0 position to the 180-degree position. After the thud, the static has a different tone.

(Continued on page 41)

Second District Call Letters of Amateur Stations

(Continued from June WIRELESS AGE)

Table with columns: Call Letters, Power, Name and address. Lists amateur stations from 2IO to 2MY, including names and addresses across various New York locations like Orange, Jersey City, and Brooklyn.

(To be continued)

A Universal Range Portable Receiver

By Chas. T. Jacobs
THIRD PRIZE, \$3.00

WITH the coming of the various multilayer coils into general use, the problem of the construction of a portable receiver to cover the complete range of wavelengths has been greatly simplified. Believing that there is now no obstacle to the construction of a truly universal receiver that would be truly portable, the writer has designed and is now constructing for his own use the receiver described.

The receiver is completely enclosed in a covered cabinet or case 6 x 12 x 13 $\frac{3}{4}$ inches, with bakelite panel for controls. It is designed primarily for use with the vacuum valve, either regenerative or simple rectifying action being obtainable at will. Binding posts are provided, however, for a crystal detector, which may be used when desired. The receiver accommodates multilayer coils of present-day design. These are to be obtained or made unmounted and a small block of wood, with a hole therein, glued firmly to the inside of each coil, as shown in figure 1. These blocks are made of wood about the same thickness as the coil, and are laid out, drilled and cut on the heavy lines, making six blocks at once.

A rod onto which the coils needed for a certain range of wavelength are slipped, is then set in notches provided for it. Flexible leads from the coils are then connected to the proper binding posts. Coupling is varied by sliding the coils along the rod, there being no tendency for the coils to revolve on the rod, as the hole in the block is

above the centre of the coil. The coils are still essentially air-core coils—a great advantage over solid cores. The advantages and ease of operation of this mounting will be readily appreciated.

The secondary circuit is tuned on a novel principle which the writer picked as being most satisfactory in every way. Bearing in mind that the vacuum valve requires a low maximum secondary capacity—an almost zero minimum—and a fine adjustment of capacity for best results, and that the portable set requires a small weight and bulk, the reader will realize the tremendous advantages of this method. A home-made variable condenser having one rotary and two stationary plates, and a six-step adjustable fixed condenser are used, connected in parallel. The variable is calculated to have a maximum capacity of approximately .000065 mfd., and each step of the fixed condenser about .00005 mfd., so that the variable laps well over on each step. The step condenser is controlled by an ordinary seven point instrument switch, one of which is left unconnected. By joint use of this switch and the handle of the variable, a continuous range—very finely adjustable—from almost absolute zero to approximately .000365 mfd. is obtained, which is ample for valve use.

Details for the construction of the variable condenser are given in figure 2. The stationary plates are made from 1/32 inch aluminum as shown, a



Stromberg-Carlson Radio Head Sets

Strong, Durable Construction, Yet Extremely Sensitive

This Stromberg-Carlson Radio Head Set is very simple and efficient. All operating parts are housed in dust-proof, moisture-proof aluminum case. The diaphragm is mounted metal-to-metal in a way that the variation in temperatures cannot disturb the air-gap adjustments. Non-conducting spool heads and slotted pole tips decrease the eddy current losses and make the set more efficient.

Each set wound to a resistance of 2,000 ohms with pure copper wire, furnished complete with a 6-foot moisture-proof cord attached.

All sets thoroughly tested in actual service before shipment. For \$12.00 we will ship sample set for trial in your own station. If not satisfied, return equipment and money will be refunded.

Bulletin 1206 will give full particulars. Write today.

Stromberg-Carlson Telephone Mfg. Co. Rochester, N. Y.



Small Ads of Big Interest

A Meeting Place for Buyers and Sellers

Space in this department costs only 25c a line. Minimum space 8 lines. Payable in advance.

"Silverplate" Without Electricity

Modern, efficient radio apparatus is silverplated, giving higher conductivity to high frequency currents, and giving a finer and more substantial appearance. "SILVERPLATE" needs only to be rubbed or brushed on any metal, and will produce a fine permanent silver plating. One bottle will plate a whole set. 50c prepaid.

ROBERTS LABORATORY,

11716 Detroit Ave., Cleveland, Ohio.

"WHAT YOU WANT TO SAY AND HOW TO SAY IT." By W. J. Hernan, in French, Spanish, Italian and German, 25c each; Russian (cloth bound), 50c.

The best little books in the world for the traveler or student. They contain the phrases and sentences most used and give the phonetic spelling that enables you to get the correct pronunciation at the first try. Satisfaction or money refunded. WIRELESS PRESS, Inc., 326 Broadway, New York City.

Special Summer Sale of Ground Wire No. 4 Triple Braid Rubber Covered 8c per ft. plus postage. \$7.00 buys the 100 ft. wt. 17 lbs. 100 ft. 100 Amp. 600 Volt Lightning Switches, \$4. We stock everything worth while in wireless. Have you written us lately? RADIO EQUIPMENT CO., 630 WASHINGTON ST., BOSTON, 11, MASS.—LET US QUOTE YOU.

Wireless supplies especially for the amateur. Magnet wire, brass and zinc rod, inductance tubes. Standard wireless knob and lever 35c. Switch points and screws 35c dozen. One piece switch point with screw stud and nut 40c dozen. NOVOTOY RADIO SHOP, 20 West 5th St., Charlotte, N. C.

TELEGRAPHY (both Morse and Wireless) and Railway Accounting taught quickly. Tremendous demand. Big salaries. Great opportunities. Oldest and largest school; established 46 years. All expenses low—can earn large part. Catalog free. DODGE'S INSTITUTE, N St., Valparaiso, Indiana.

A HUMAN DYNAMO

I WILL MAKE YOU LOOK LIKE ONE
ACT LIKE ONE
BE ONE

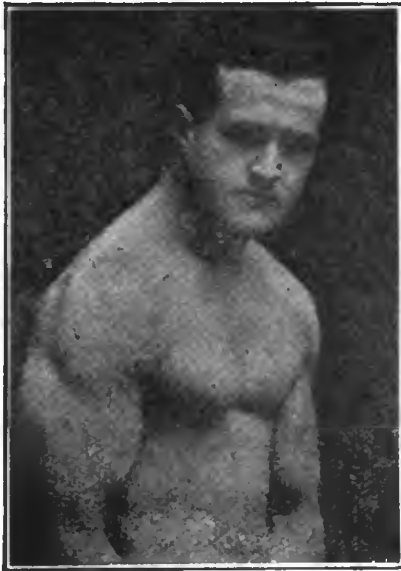

EARLE LIEDERMAN
The Acme of Physical Perfection

Today this world is calling for the man of pep, ginger and action. The man who is on his toes every minute—ready to jump in and do things. The big man of powerful physique and untiring energy. The man who is bubbling over with life, having the keen, alert brain, the bright, flashing eyes and the spring and step of youth. This is a day of critical events coming in rapid succession.

ARE YOU FIT?

How do you measure up to these requirements? Can you feel the fire of youth surging through your body? Do you have the deep full chest and the huge square shoulders, the large muscular arms that mean you are 100% efficient? Can you go through a good, hard physical tussle and come out feeling fresher and better than when you started? If not, you are unfit. Get busy—steam up at once before you are thrown aside as a failure.

I Will Give You

**HEALTH
STRENGTH
DEVELOPMENT**

I will make a new man of you in a remarkably short time. I will fill out your chest so that every breath means increased life, purifying your blood and filling you with vim and vitality. I will develop your whole body so that you will be admired and sought after in both the business and social world. I will give you the strength and power to do things that others would not even attempt to do. And I will do all this in so short a time that you will say, "I did not think it possible." I have already done this for thousands of others and my records are unchallenged. What I have done for them I will do for you. Come, then, for time flies and every day counts. Let this very day mean the beginning of new life for you.

Send for My New Book

"MUSCULAR DEVELOPMENT"

It tells the secret, and is handsomely illustrated with 25 full-page photographs of myself and some of the world's best athletes whom I have trained, also full particulars of my splendid offer to you. The valuable book and special offer will be sent you on receipt of only 10 cents, to cover cost of wrapping and mailing.

Sit right down now and fill in the coupon. The sooner you get started on the road to health and strength the easier it will be to reach perfect manhood. Don't drag along one day longer—mail the coupon today.

EARLE E. LIEDERMAN

Dept. 2007 203 Broadway, New York City

EARLE E. LIEDERMAN,

Dept. 2007, 203 Broadway, New York City.

Dear Sir: I enclose herewith 10 cents, for which you are to send me, without any obligation on my part whatever, a copy of your latest book, "Muscular Development." (Please write or print plainly.)

Name

Address

City State

When writing to advertisers please mention THE WIRELESS AGE

small semi-circle being cut out of the lower edge. The same layout suffices for the rear support of the shaft—a piece of 1/8 inch bakelite—except that instead of a cut in the bottom, a projection is left there, and the center of it drilled 1/4 inch, as shown. The stationary plates and bakelite support are mounted directly on the back of the main panel of the set. The spacers shown are 3/8 inch in diameter, and exactly 5/32 inch thick. They are drilled in the center to pass an 8-32 machine screw. They had best be made by a machinist, together with two 1/4-20 nuts accurately faced to an exact 1/4 inch thickness, and a 2 1/2 inch length of 1/4 inch brass rod, turned down for

ed rod up to it, and clamped firmly in place with the second accurate nut. The turned down end of the rod is now placed in its hole in the panel. Now slip the bakelite support over the threaded rod and connecting screws, and place nuts on the latter. The distance from the panel to the bakelite is now 17/32 inches, and since the thickness of the two nuts and rotary plate is the same, these should just fit between the panel and bakelite block. A spring washer is now placed behind the block, and an ordinary 1/4-20 nut screwed against it till a slight tension is obtained. This nut is tightened gradually till the rotary plate will stay in any position in which it may be

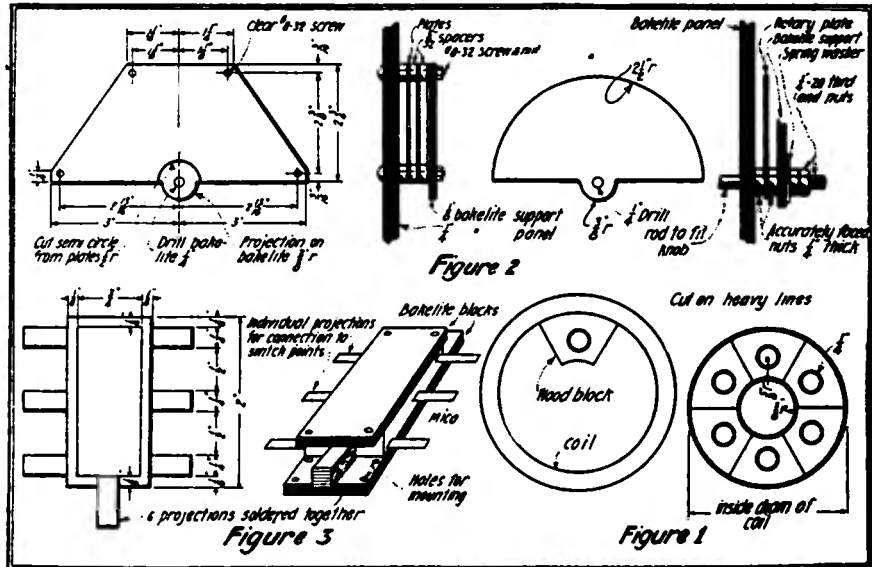

Figures 1, 2, 3.—Constructional details of the portable receiver

a distance of one inch to fit the knob to be used on the condenser and threaded for the remainder of its length with an accurate 1/4-20 thread. Figure 2 shows the rotary plate of 1/32 inch aluminum, drilled to fit over the threaded rod, and also a vertical cross section of the shaft and rotary plate as mounted between the panel and the rear bakelite support, all but a small portion of the latter, together with the stationary plates, spacers and screws, being removed for the sake of clarity.

In addition to making the parts, it will be necessary to drill the main panel of the set to pass the turned down end of the rod, and also for the 8-32 screws which support the stationary plates. These screws are slipped into place, and a spacer placed over each. Then one of the stationary plates is slipped on, next another set of spacers, then the second plate, and again a third set of spacers. Now take one of the accurately faced nuts and screw it onto the threaded rod so that it just overlaps the turned down portion by a tiny fraction of an inch. The rotary plate is slipped over the thread-

placed, and then a second nut is screwed on behind the first to lock it. The entire assembly as seen from the top is shown in figure 2. The 1/16 inch separation of rotary and stationary plates assures great ruggedness even under hard usage such as a portable set might undergo.

The six-step condenser for the secondary is constructed of mica dielectric, a micrometer being necessary to measure the various thicknesses required. Mica 1 x 2 inches is used, together with a dozen very thin copper plates 3/4 x 1 3/4 inches with projections for connection to switch points, etc. Alternate plates are connected together by soldering the projections, and form one terminal of the condenser, while the intermediate sheets are connected to individual switch points for variation of capacity. It should be understood that only one plate is connected at any one time, it being unnecessary to connect in parallel.

This admits of an ordinary instrument switch being used instead of a fan switch. To this end the copper plates are spaced as shown, the numbers between them indicating the

thickness of the mica in thousandths of an inch, and the numbers at the switch points, the capacity available in microfarads:

10	
10	.0003
12	
12	.00025
15	
15	.0002
20	
20	.00015
30	
30	.0001
30	
30	.00005

This is a six-step condenser made of mica plates $1\frac{1}{2} \times 2$ inches and twelve copper plates $1\frac{1}{4} \times 1\frac{3}{4}$ inches with projections for connections, spaced as follows:

$1\frac{2}{3}$	
$1\frac{2}{3}$.003
3	
3	.0018
5	
5	.001
9	
9	.0006
15	
15	.00035
$12\frac{1}{2}$	
	.0002

Two views of the condenser are shown in figure 3. One is a top view

While it may be difficult to measure

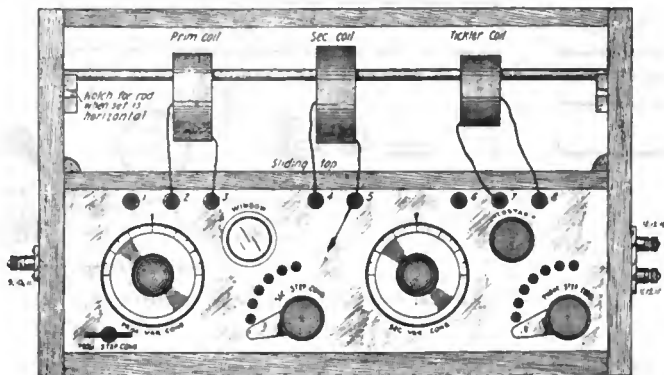

Figure 4.—Front view of receiver with cover removed and three coils in position

of the mica and copper sheets, showing dimensions, and the other is a perspective view showing the assembly placed between two $\frac{1}{8}$ inch bakelite blocks 1 inch wide which are to be clamped together by screws and nuts through the holes shown. The bottom block should be made longer than the top, and extra holes drilled therein for screwing to the bottom of the cabinet. The entire unit had best be baked at about 250 degrees F. for several hours to dispel all moisture, and immediately impregnated with insulating compound, which may afterwards be scraped off where connections are necessary.

The primary is tuned by a purchased balanced-type condenser, capacity .0006 mfd., shunted by a two-step condenser having capacities of .0005 and .001 mfd. This is controlled by an anti-capacity, single-pole, double-throw switch, having a neutral position. The capacity obtainable is therefore continuously variable from the minimum value of the variable condenser to .0016 mfd. The two-step condenser is made of the same size mica and copper and is mounted in the same way as the six-step for the secondary, but only four copper plates are needed spaced as follows:

3	
3	.001
3	
3	.0005

A third condenser of this type is required to shunt the head telephones.

accurately $1\frac{2}{3}$ thousandths of an inch, extreme accuracy is not required in this condenser, owing to its use. The assembly is mounted as before. An eight-point switch is used here, one of the extra points being unconnected, and the other connected so as to short-circuit the "tickler" coil as explained below. The mica for these three condensers should be purchased in sheets 2×3 inches, from $1\frac{1}{2}$ to $3\frac{1}{2}$ thousandths of an inch thick, an eighth of a pound of which will be more than sufficient. For the primary and secondary step condensers the mica sheets may be cut in thirds along the three-inch dimension, and for the phone condenser it may be cut in half.

Having described the separate parts which have to be made, attention to the assembly of the instruments is now in order. Figure 4 is a sketch of the front of the receiver, cover removed, and three coils in position. The $\frac{1}{4}$ inch bakelite panel, $5\frac{1}{2} \times 13$ inches, is mounted flush in the cabinet. The sliding top, 4×13 inches, is made to slide in grooves, so that it may be removed for access to the bulb, etc. Dimensions are not given here, but the various parts are marked. The binding posts on the outside of the set will probably be noticed. While they do not appear so well here, this arrangement conserves panel space and permits closing of the cabinet without disconnecting aerial, ground, battery and phone connections. These posts are mounted on

ORDER TODAY Robison's Manual of Radio Telegraphy and Telephony

"The Navy Book"

New Edition
Price, Postpaid, \$1.75

With one year's subscription to
THE WIRELESS AGE
(New or Renewal)

Total Value **\$3.75** Special Price **\$3.25**

Dept. N
THE WIRELESS PRESS, Inc.
326 Broadway New York

CONQUEST New English Publication
Devoted to Science, In-
vention and Industry. You will like it. Send 30c
for specimen copy.
Wireless Press, Inc., 326 Broadway - New York

Get Bigger Pay through ELECTRICITY



You will find in HAWKINS GUIDES just what you need to know about electricity. In simple everyday language—complete, concise, to the point. In questions and answers. A complete standard course in Electrical Engineering. Send for your set today to look over.

**HAWKINS
ELECTRICAL
GUIDES**

3500 PAGES
4700 PICTURES
POCKET SIZE
FLEXIBLE COVERS
\$1 A NUMBER
\$1 A MONTH

Magnetism—Induction—
Experiments—Dynamics—
Electric Machinery—Motors
—Armatures—Armature Windings—Installing of Dynamos—
Electrical Instrument Testing—Practical Management of Dynamos and Motors—Distribution Systems—
Wiring—Wiring Diagrams—Sign Flashers—Storage Batteries—
Principles of Alternating Currents and Alternators—
Alternating Current Motors—Transformers—Converters—
Rectifiers—Alternating Current Systems—Circuit Breakers—
Measuring Instruments—Switch Boards—Power Stations—
Installing—Telephone—Telegraph—Wireless—Bells—
Lighting—Railways. Also many modern Practical Applications of Electricity and Ready Reference Index of the 10 numbers.

Shipped to you FREE. Not a cent to pay until you see the books. No obligation to buy unless you are satisfied. Send coupon now—today—and get this great help library and see if it is not worth \$100 to you—you pay \$1.00 a month for 10 months or return it.

**SEND
NO MONEY**

THEO. AUDEL & CO., 73
Fifth Ave., N. Y. Please
submit for examination Hawkins
Electrical Guides (Price \$1 each).
Ship at once, prepaid, the 10 numbers,
satisfactory. I agree to send you \$1 within
seven days and to further mail you \$1 each
month until paid.

Signature _____
Occupation _____
Employed by _____
Residence _____
Reference _____ W. A.

BURGESS "B" BATTERIES

SEVERAL SIZES FOR SPECIAL WORK



SEND FOR CATALOGUE
BURGESS BATTERY COMPANY
HARRIS TRUST BLDG. - CHICAGO, ILL.

$\frac{1}{8}$ inch bakelite, which is screwed over the cut-outs in the side of the cabinet. On the left there are three posts mounted on bakelite $1\frac{1}{4} \times 3\frac{1}{4}$ inch for connection to aerial and ground. On the right are six binding posts mounted on bakelite $2\frac{1}{4} \times 3\frac{1}{4}$ inches, for connection, to "A" and "B" batteries and telephones.

The hole marked "window" is an aperture of $1\frac{1}{4}$ inch diameter in the panel, through which the vacuum tube is observed. The tube is mounted vertically in a socket which may have to be raised by a block or two of wood, so as to bring the filament opposite the

tionary plates of the secondary variable, and since they can be placed in just the position of the upper two screws supporting the stationary and bakelite block, the shanks of the binding posts can themselves be used as the supporting screws, saving extra screws and wiring. The writer places the center of his variable $2\frac{9}{16}$ inches above the bottom of the panel, and since the holes in the plates are $2\frac{5}{8}$ inches above the center of the variable, the center of the binding posts is brought $5/16$ inch from the top of the panel, which is sufficient.

The wiring of the set will be found

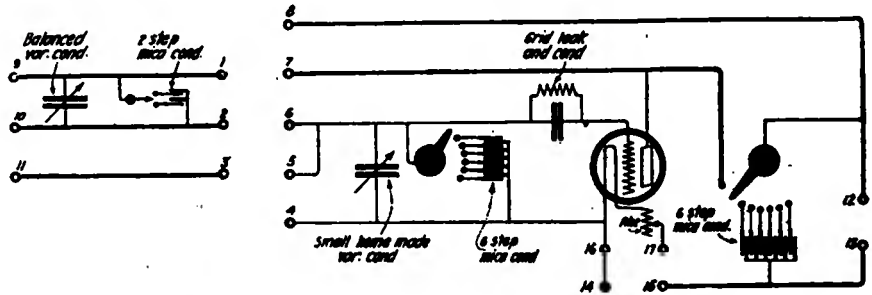

Figure 5.—Theoretical wiring diagram of the receiving set

BUILD YOUR OWN WIRELESS RECEIVING SET

YOU CAN SAVE AT LEAST \$25.00
By buying parts and assembling yourself

Think of the pleasure and practical experience you will gain in making your own set, size 16"x8"x6", with wave-length range from 170 to 2,500 meters. Send \$1.00 and we will send you the blue-print and instruction sheets—also prices of all parts. When you order at one time \$5.00 or more worth of parts, you may deduct this \$1.00 from the total. Since the blue-print and instructions alone are worth \$1.00, and since we can save you money on wireless material, you cannot possibly lose. So send \$1.00 today before this slips your mind and start making your set as soon as possible.

Write to-day and get started
K. & G. WIRELESS SUPPLY CO.
152 Chambers St. Dept. 17C New York City

window in the panel. The socket should be mounted as far back as possible so as to leave room for the secondary step condenser in front of it. This condenser, as well as the other two of similar construction, should be screwed to the bottom of the panel through the holes provided. The rheostat, the handle of which is shown on the panel, is a six-ohm instrument of small diameter, and is front mounted on a wooden upright in the back of the cabinet. An extension shaft enables it to be controlled from the front of the panel.

It is here appropriate to mention that since binding posts No. 5 and No. 6 are both to be connected to the sta-

very simple, owing to the logical placement of the apparatus. Bare copper wire, over which varnished cambric tubing has been slipped, is best for wiring, although a flexible lead will be required to the shaft of the home-made variable. All connections should be soldered.

The theoretical circuit is shown in figure 5. The aerial is connected to binding post No. 9, and the ground to No. 11. The primary coil is connected between No. 2 and No. 3. The primary condenser is now in series with the coil. A shunt connection may be obtained by connecting No. 10 to the ground without disconnecting No. 11.

The secondary coil is connected be-

BRUSH UP
on **THEORY and CODE**
Get a COMMERCIAL LICENSE
Jobs are always waiting for good operators

Study where you get the close personal attention of the finest and most experienced men in the Radio field. We placed approximately three hundred men last year.

Y. M. C. A. RADIO SCHOOL
149 East 86th Street, New York, N. Y.
"The Best Radio School in the East"

NOTE:—We have on hand a select list of Radio text books and blueprint diagram of complete commercial ship set, which we recommend for home study.

tween No. 4 and No. 5, the "tickler" between No. 7 and No. 8, the telephones to the front two posts on the right—No. 12 and No. 13, the "B" battery to the middle two—No. 14 and 15, and the "A" battery to the back two—No. 16 and 17. To secure regenerative action in the valve, keep the phone condenser switch on any of the first seven points. To secure simple rectification, place the switch on the eighth

ments. The cabinet may be joined in any way desired, but the back must be screwed on only, so as to be readily removable for better access to the interior than can be obtained through the sliding top. The cover is fastened to the cabinet with separable hinges so that it may be removed by opening and sliding to one side. A lock should be fastened on the side of the cabinet near the bottom. A handle should be fas-

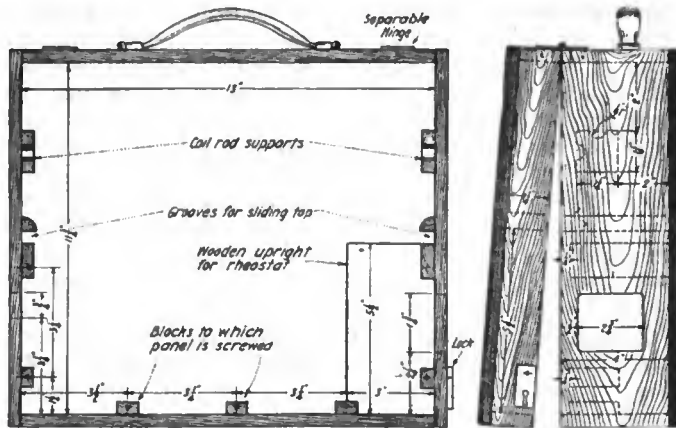

Figure 6.—Details of the cabinet with panel and instruments removed

point, which not only removes capacity from in shunt to the phones, but also short-circuits the "tickler" coil. To use a crystal detector, remove the "tickler" coil, set the detector on the sliding top above the posts No. 6 and No. 8, to which it should be connected, and short circuit posts No. 14 and No. 15. The remarkable flexibility of the set can be appreciated from the foregoing.

Figure 6 shows details of the cabinet, panel and instruments removed. This can be made of any wood desired, preferably 3/8 inch. For this reason only the important dimensions are given, and these are inside measure-

ments. The cabinet may be joined in any way desired, but the back must be screwed on only, so as to be readily removable for better access to the interior than can be obtained through the sliding top. The cover is fastened to the cabinet with separable hinges so that it may be removed by opening and sliding to one side. A lock should be fastened on the side of the cabinet near the bottom. A handle should be fas-

tened to the top of the cabinet. The cabinet may be used in the upright or in a horizontal position, two sets of notches being provided for the coil rod as shown. A front view with cover removed, a side view with cover in place, and a top view with cover separate is shown. When completed this receiver will be found extremely compact. The space in which the coils slide when the receiver is in use forms an excellent storage place for all needed coils, phones, rod, small batteries, etc., when the instrument is being carried, crumpled newspaper being stuffed around

Drafting Supplies

We manufacture a full line of high grade supplies made under our own supervision. We know they are right.

Quality Plus
and at prices that appeal.



A Specialty—
Our

MONROE Drawing Table

A table of general utility made after our own ideas. Stands rigid and lasts a lifetime.

Let us quote on your needs
Ask for catalogue W

New York Blue Print Paper Co.

102 Reade Street
New York City



O, What a Pal

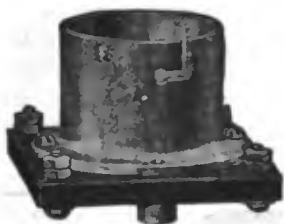

was Mary, but say boy, do you know an up-to-the minute radio installation is SOME pal too?

We manufacture high grade apparatus only. Here is a good value—The Ace V. T. Socket—with grid leak at \$1.50 each. Better buy Ace equipment than be sorry you did not. Ask your dealer.

The Precision Equipment Company
2437 Gilbert Avenue, Dept. C, Cincinnati, Ohio

Mesco RadioBuzzer

With Shunt Resistance —
U. S. Navy and U. S. Army
Standard.

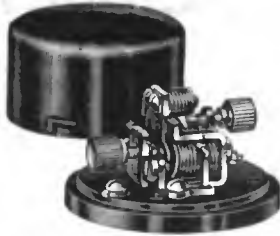

The Radio Officers of the NC planes, after testing all other buzzers, decided to use the "Mesco" on their radio equipment. The R-34 was equipped with two of them.

Why? Because of its reliability and constancy in operation; greater output efficiency; ease of adjustment; unaffected by extreme variations in weather conditions; exposed wires eliminated. Sparking is almost entirely eliminated, so that the energy lost in light and heat in the operation of other buzzers is here conserved and radiated in the form of oscillating energy.

This buzzer maintains a constant note and is recommended as an exciter for checking wave-meters where pure note and ample energy are required.

List No. Price
55. Mesco Radio Buzzer..... \$2.05

Send for Our Manual N 12

WIRELESS TELEGRAPHY

You should have it even if only superficially interested. Around about you every day you read of some marvelous occurrence in which wireless played a distinguished part. It may not be entirely clear to you. The Manual will explain it. To the student of Wireless Telegraphy, the Manual contains much that is indispensable to a proper understanding of the art. The Manual will contain about 200 pages, fully illustrated on high-grade paper stock with a two-color cover, and will be ready for mailing about May 1.

We ask twenty-five cents (\$0.25) for it—give you a coupon receipt which can be applied on any order amounting to Five Dollars (\$5.00) or more.

Do not wait until some other time, but sit down now and send your name and address, and get one of the most complete, comprehensive and reliable wireless pamphlets published.

Manhattan Electrical Supply Company, Inc.
New York, 17 Park Place St. Louis, 1106 Pine St.
Chicago, 114 So. Wells St. San Francisco, 604 Mission St.

NO Loose Couplers Mignon "RW4"
Loading Coils Undamped Wave
Variometers Receptors
Amplifiers Write for literature.
Mignon Mig. Corp.
Newark, N. J.
Dept. W
Strongest, Most Distinct Signals

Have You Any Copies of
WIRELESS AGE
Dated May, June, August,
September, 1919 and
January, 1920?
Send them to us and we will extend your
subscription one month for each copy you
send.
Circulation Manager
Wireless Press Inc., 326 Broadway
New York City

the articles to prevent them from being shaken around. Thus no space is wasted. In conclusion, the writer would unhesitatingly say that, were he planning a set for stationary use only,

it would not differ in any essential particular from this portable one—which shows that he believes the efficiency of the set to be as great as it is possible to attain.

A Simple Wavemeter

By E. P. Hurley

THE majority of radio amateurs and experimenters unfortunately are under the impression that a wavemeter is more or less a luxury rather than a desirable addition to the equipment of a modern radio station. This idea is refuted the moment they have installed and used it, for this instrument makes it possible to accurately determine the wavelength of their transmitting apparatus.

In the construction of the wavemeter, the feature that should appeal strongly to the amateur is that the condenser can be used in other circuits when not used in conjunction with the inductance as a wavemeter. The first

two 1/8 inch discs with a center 1 inch in diameter. Hard rubber or formica can be used to advantage, instead of bakelite. The coil is now wound with 22 feet of 23/38 litz. Solid wire can be used if litz is not available. Two small holes are drilled in the coil and the ends of the wire brought through to connection marked "B." The detector support "C" is made from 1/8 inch bakelite. Two supports are made from spring brass and slotted at each end for coil connections and condenser binding posts. Binding posts are mounted on support and cup with rod and detector wire added. Figure 1 shows the arrangement as used by the

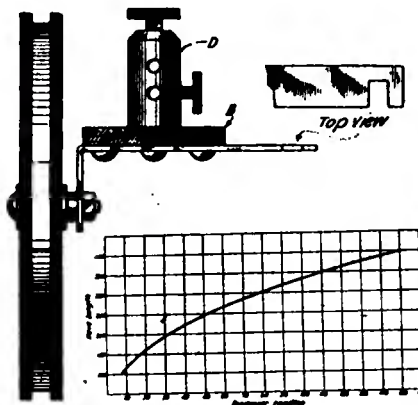

Figures 1, 2.—Construction and graph showing calibration of wavemeter

requisite is a variable condenser which should be of standard type, having a capacity of approximately .001 mfd. The mounting with the inductance is the only part of the instrument that requires specific description from the builder's standpoint. It is made as shown in figure 1.

The coil is made from a solid piece of 1/4 inch bakelite and slotted to the depth of one-half inch to receive the wire. If the amateur does not have the facilities for making a coil of this type, one can easily be made by using

author. Phone connections are made at "D."

The wavemeter is now ready for calibration. This can easily be done by comparison with a known wavemeter or for precision work the amateur can send the inductance and condenser, prepaid, to the Bureau of Standards, Washington, D. C., accompanied by a written request for the test, enumerating the articles and advising definitely of the test desired. Fees must accompany all

<p>American Electro Technical Appliance Company Dept. A. - 235 Fulton Street New York City Fresh Stock "B" Batteries, 25-Volt, 14-Amp., \$2.25. Switch Points 3/16 x 3/16, 20c per doz. The Kind with Threaded Shank, 3c each. Marconi Type Crystal De- tector, \$1.75. DeForest Type Crystal De- tector, \$2.60. Spark Gaps, 75c, 90c, \$2.00 and up. Murdock Oscillation Trans- former, \$5.00. Oscillation Helix, to As- semble, \$3.00.</p>		<p>Loose Couplers, 800 meters, \$5.00. 3600 Meters, \$15.00; Arnold Type, \$19.00. Slider Type, 4000 Meters, \$10.50. Doron Tuning Coil, \$4.75. Western Electric Head Sets, \$12.00. Brandes Superior Head Sets, \$7.00. Honeycomb Coils, all sizes, as per list. Paragon Rheostats, \$1.75. Parkin Rheostat, \$1.00; DeForest Type, \$1.00. Two Step Amplifiers with- out Bulb, \$50.00. A full stock of DeForest, Grebe, Murdock, and other best manufactures on hand. Illustrated Cabinet, \$20.00.</p>
---	--	---

Operating as a Career

What
gnified,

Marconi on the Future of Wireless

GUGLIELMO MARCONI, in a signed article in the Nuvo Giornale of Florence on the predicted revolution in wireless communication, says: "Eventually science will find a way of directing electrical energy without wires in an absolutely straight line. The result will be less expenditure of energy for short distances and hence less expense for messages. Once directive control has been established we shall undoubtedly be able by means of powerful machines to girdle the whole world with waves of electric energy without wires."

Marconi describes a radio telegraphic receiver no bigger than a gramophone by means of which, without any other communication with the atmosphere, he receives all day in his study every scrap of wireless news sent to the European press. He says that very soon with an instrument of this kind "bankers, politicians and business men in general will be able from minute to minute to keep themselves in contact with both hemispheres." He continues:

"Very soon, too, that miserable ticking machine on which all newspaper offices depend will yield place to this mighty invention, which is suitable for news sending, news receiving and simultaneous communication with any number of receiving stations."

"With that installment of radio telegraphic receivers throughout the civilized globe in every public school, university and library, the prevailing languid interest of the public in international happenings will be immensely stimulated."

...at a resident school requires, roughly, two to four months of study.

Bigger Jobs Are Yet To Come

← says the World's Authority on Wireless.

Many new names will be indelibly written on the Wireless Roll of Fame that are now entirely unknown.

These will be the names of men who are preparing

NOW

When the problem of making wireless available for every-day communication between individuals is solved the names on everybody's lips will be those of men who are studying now, getting ready to do their share.

Will YOUR name be one?

Do you take Wireless Seriously?

You need these Laboratory-tested books

They contain the facts that will help you go ahead fast.

Profit by the summed-up knowledge of the men who have made wireless what it is today. Build on what you learn from them.

THE WIRELESS EXPERIMENTERS' MANUAL
By Elmer E. Bucher



The only book published that comprehensively covers the theory and design of amateur wireless transmitters and receivers. Construction of transformers, high voltage condensers, spark gaps, aerials, masts, receiving sets for long and short wave length reception. Construction and operation of a 50-mile buzzer transmitter, regenerative receivers, cascade amplifiers, preferred circuits for long and short wave receivers, quench-gap transmitters, methods of measuring the internal impedance, and amplification of constant of vacuum tubes are explained. Direction finders, underground aerials and the use of Weagant's static eliminator for amateurs are the subjects of special chapters. The most complete textbook on the subject yet published. Cloth bound. 351 pages. Fully illustrated. Price..... **\$2.25**

VACUUM TUBES IN WIRELESS COMMUNICATION
By Elmer E. Bucher



An elementary textbook for students, operators, experimenters and engineers. Navy wireless men find this book especially helpful. Tells in understandable language the fundamental operating principle of the vacuum tube. Shows over 100 different circuits for the practical use of the Vacuum Tube as a Detector, Radio or Audio Frequency Amplifier, Regenerative Receiver, Beat Receiver and Generator of Radio Frequency Currents. One hundred and thirty diagrams reveal, step by step, in simple and direct form, the uses of the vacuum tube. Cloth. Size 6 x 9 inches. 184 pages. **\$2.25** Price.....

PRACTICAL WIRELESS TELEGRAPHY
By Elmer E. Bucher

More than 65,000 copies of this book have been sold to date. It is used in practically every school, college, and library in this country. It is the recognized standard wireless text book. It is the first wireless text book to treat each topic separately and completely, furnishing a progressive study from first principles to expert practice. Starting with elementary data, it progresses, chapter by chapter, over the entire field of wireless—fundamentals, construction and practical operation. Size 6 x 9 inches, 352 pages, 340 illustrations, handsomely bound in fall cloth. **\$2.25** Price.....



RADIO INSTRUMENTS AND MEASUREMENTS

Here is a book that should be in the hands of every wireless worker. Under the general heads that follow it treats simply and concisely of all phases of the subjects indicated. Fundamentals of electromagnetism. Principles of alternating currents, Radio circuits, Damping, Wave meters, Condensers, Coils, Current measurements. Instruments and methods of radio measurements. Resistance measurement, Sources of high frequency current, Calculation of capacity and inductance. Design of inductance coils, High frequency resistance. Miscellaneous formulas and data. Cloth bound. 332 pages. Fully illustrated. **\$1.75** Price.....



RADIO TELEPHONY
By Alfred N. Goldsmith, Ph. D.



This complete text on radio telephony is intended for radio engineers, operators and experimenters, also radio electricians in the Navy, men in the Signal Corps and especially men in the Aviation Service who handle radio equipments. Students and others who desire to be clearly informed concerning this newest and most interesting branch of electric communication need this book. It is written in clear style, and presupposes very little knowledge of radio. Size 6 x 9 inches. 256 pages, 226 illustrations. Full cloth, stamped in gold. Price..... **\$2.50**

HOW TO PASS U. S. GOVERNMENT WIRELESS LICENSE EXAMINATIONS

By Elmer E. Bucher
New Edition Revised and Extended. 142 Questions and Answers.
An ideal review quiz book when used with PRACTICAL WIRELESS TELEGRAPHY CONTENTS
Explanation of Electrical Symbols—Definitions of Electrical Terms—Part I. Transmitting Apparatus—Part II. Motor Generators—Part III. Storage Batteries and the Auxiliary Set—Part IV. Antennae or Aerials—Part V. Receiving Apparatus—Part VI. Radio Laws and Regulations—Part VII. General Information Concerning Operator's License Examinations—Practical Equations for Radio Telegraphy—Equations for Ordinary Power Work. Size 6 x 9 inches. Fully illustrated. Price..... **75c**



A 7-20

QUALIFICATION COUPON—Mail Today

Wireless Press, Inc.,
326-28 Broadway, New York.

Enclosed please find \$.....for which send me the books checked below.

Title	Author	Price
Wireless Experimenters' Manual	Bucher	\$2.25
Vacuum Tubes	Bucher	\$2.25
Radio Telephony	Goldsmith	\$2.50
Radio Instruments and Measurements		\$1.75
Practical Wireless Telegraphy	Bucher	\$2.25
How to Pass U. S. Govt. Wireless License Examinations	Bucher	.75
* The Wireless Age (one year)	With Book Order	\$1.50
* The Wireless Age (two years)	With Book Order	\$3.00
* The Wireless Age (one year)	Without Books	\$2.00

Name

Street

CityState

* Include 50 cents additional for postage on AGE outside of U. S.

P. S.—Include a Subscription to THE WIRELESS AGE in Your Order.
WIRELESS PRESS, Inc. 326-28 BROADWAY
NEW YORK



DUCK'S
No. 14 Big 200 Page
Wireless and 100
Page Electrical
CATALOG

JUST OFF THE PRESS

Any radio amateur will tell you there is no catalog to take the place of Duck's, and that it is a *Beacon Light* to guide you in the selection of your apparatus.

Send 12c for the *Wireless Catalog* and 6c for the *Electrical Catalog*. This amount may be deducted on first dollar purchase.

Great cost of catalogs and low prices prohibit distribution otherwise

THE WILLIAM B. DUCK CO.
239-241 Superior St., Toledo, Ohio

Prize Contest Announcement

The subject for the new prize contest of our year-round series is:

"SOME POINTERS ON RECONSTRUCTION"

Closing date, August 1, 1920.

Contestants are requested to submit articles at the earliest practicable date.

Prize Winning Articles Will Appear in the October Issue.

No one would care to venture that American amateurs are not observing. Each one of us, during the radio year just gone by, has learned many new applications of this wonderful art which has enabled us to increase the efficiency and the range of our installations. What are these things we have learned and how have they enabled us to increase our range and why? Each of us would like to hear of the other fellow's troubles and how he remedied them. It is in this way that amateur stations as a class will increase in efficiency, and we should all welcome this opportunity to do our bit toward forwarding our mutual interest.

PRIZE CONTEST CONDITIONS—Manuscripts on the subject announced above are judged by the Editors of THE WIRELESS AGE from the viewpoint of the ingenuity of the idea presented, its practicability and general utility, originality, and clearness in the description. Literary ability is not needed, but neatness in manuscript and drawing is taken into account. Finished drawings are not required, sketches will do. The contest is open to everybody. The closing date is given in the above announcement. THE WIRELESS AGE will award the following prizes: First Prize, \$10.00; Second Prize, \$5.00; Third Prize, \$3.00, in addition to the regular space rates paid for technical articles.

All manuscripts should be addressed to the Contest Editor of THE WIRELESS AGE

TELEGRAPHY

(Both Morse and Wireless) and RAILWAY ACCOUNTING taught thoroughly and quickly. Big salaries now paid. Great opportunities for advancement. Oldest and largest school; established 46 years. Endorsed by Telegraph, Railway, Radio, and Government officials. Expenses low—opportunities to earn large portion. Catalog free.

ROGGE'S INSTITUTE 8 Street, Valparaiso, Ind.

apparatus and remittances made by money order drawn to the order of the Bureau of Standards. The authority for a specially reduced fee for amateurs is set forth under paragraph No. 7, testing schedule No. 90, and reference should be made to this paragraph when forwarding the wavemeter. The fee is 50 cents per point.

With the condenser used as described above, figure 2 shows the curve for inductance. After the wavemeter has been properly calibrated it can be used for calibration of a receiving circuit by connecting a buzzer battery

and switch in series to "D." By coupling the wavemeter coil to the coil to be calibrated, a current will be set up at the point of resonance which can be heard in the telephone of the receiving circuit. By referring to the curve the wavelength can be easily ascertained.

For the calibration of the transmitting circuit, the wavemeter is placed near the transmitter and the condenser handle rotated until the signals are the loudest at which point the condenser reading should be taken and reference made to the curve for wavelength.

Recognized as the largest and best.



Send ten cents for descriptive catalogue to Dept. D
900-902 Penna. Ave., N. W. Washington, D. C.

Make Your Own
WIRELESS APPARATUS
with the help of our
Reliable Books
—Send for Price List No. 139—
COLE & MORGAN, Inc., Publishers
188-190 Greenwich Street. New York

Advanced Radio Students
read
The Radio Review
The new British Publication devoted to
Radio Science.
A Monthly Record of Scientific Progress
in Radio Telegraphy and Telephony.
Subscription price \$7.15 per year in
U. S. and Canada.
Send all orders to
WIRELESS PRESS, Inc., 326 Broadway,
New York.



UTTMARK'S
NAUTICAL ACADEMY
RADIO SCHOOL

NEW YORK **BOSTON**

THIS school offers a thorough course in all branches of Radio Telegraphy. Prepares you thoroughly for Government examinations. Merchant Marine, Commercial Land Radio, Radio for railroads, Radio for Aerial Mail Service, Etc. Elementary and Advanced Classes, day and evening sessions.

Nautical Academy established 1804 Radio School, 1920
CAPTAIN F. E. UTTMARK, PRINCIPAL
Write, call or phone for illustrated booklet.

8 STATE STREET NEW YORK, N. Y.
Facing Battery Park. N. Y. Telephone, Bowling Green 8079

For Radio UTTMARK'S For Navigation

The Monthly Service Bulletin of the
National Amateur Wireless Association
 Founded to promote the best interests of radio communication among wireless amateurs in America

Guglielmo Marconi *President* J. Andrew White *Acting President* H. L. Welker *Secretary*

NATIONAL ADVISORY BOARD OF VICE-PRESIDENTS

Prof. A. E. Kennelly, <i>Harvard University.</i> Maj. Gen. George O. Squier, <i>Chief Signal Officer, U. S. Army.</i> Captain D. W. Todd, <i>U. S. N., Director Naval Communications.</i> Rear Admiral W. H. G. Bullard, <i>U. S. N.</i> Prof. Alfred N. Goldsmith, <i>College of the City of New York.</i>	Major William H. Elliott, <i>American Guard.</i> E. E. Bucher, <i>Instructing Engineer.</i> Prof. Samuel Sheldon, <i>Brooklyn Polytechnic Institute.</i> Colonel Samuel Reber, <i>Signal Corps, U. S. Army.</i> Prof. Charles R. Cross, <i>Massachusetts Institute of Technology.</i> William H. Kirwin, <i>Chief of Relay Communications.</i>
--	---

Headquarters, 64 Broad Street, New York

Club to Time Races

THE Radio Club of Burlington (Iowa), organized three months ago, announces that on July 2nd, 3rd, 4th and 5th there is to be a Regatta held at Burlington under the auspices of the Mississippi Valley Power Boat Association. The Radio Club of Burlington has been given the task of timing the races which are to be held on a one mile course between two bridges. The fact that some of the fastest racing boats in the world, such as the Miss Detroit III and others capable of making a speed of almost seventy miles an hour, and because the officials know the speed and accuracy of Radio, the club has been given this important task.

The following is the secretary's brief description of the method which will be employed in timing the races: "We are to have two 1/2 kw. transmitting stations, together with receiving sets, one at the starting and one at the finishing points of the one-mile course.

In order to avoid a possible mistake and to insure accuracy there will be three official timers and two operators at each station, the operators being members of the club. When the fast boats near the starting line a dash will be transmitted from the station located at this line. The ending of this dash will be a signal that the boats have crossed the starting line, and exactly at the ending of this dash the three official timers at both stations will set their stop watches. When the boats cross the finishing line the order of things will just be reversed."

Secretary H. H. Waugh says: "We realize that our task is to be a tedious and painstaking one but nevertheless we intend to put it across in the right manner and we believe that we have the honor of being the first club to try a stunt of this kind. We will also relay friendly messages, announce the winners of the various races, send re-

(Continued on page 42)

"Ask Anyone Who Has Used It."

What Our Patrons Say
 "You manufacture a brand of phones that surpass all of equal price and most of higher price."
 (Name on Request)

BRANDES Wireless Headset



"Superior," 2000 ohms, \$7

TRIAL OFFER Buy a Brandes Superior Headset and use it critically for ten days. Then, if it does not come up to our claims or your expectations, return it and your money will be cheerfully refunded. Test it—compare with others—for sensitiveness, clearness, distance. Prove for yourself the fine quality, the "matched tone." The two diaphragms, toned exactly alike, strengthen the signals and prevent blurring. Used by many U. S. Government experts, and experts abroad; by colleges and technical schools; and by professionals and amateurs everywhere.

Send 4c for Catalog "W."



C. BRANDES, 32 Union Square, INC.
 Room 818 New York
WIRELESS RECEIVER SPECIALISTS

**"JUPITER" STRANDED
AERIAL WIRE**

1 1/2c. PER FT.—\$12.00 PER M.

7 strands No. 22 solid copper. The ideal radiator. Strong. Low resistance. Shipping wt. 15 lbs. per 1,000 ft. Send postage.

Lee A. Bates Sole Agent
 8 Moan St.
 Worcester, Mass.



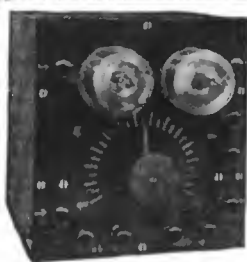

INTERNATIONAL RADIO

Vacuum Tube Detector and Amplifier and Two Stage Audio Frequency Amplifier

This detector and amplifier unit is one of the series of interchangeable panel units for receiving, which the International Radio Telegraph Company is manufacturing as part of its new line of experimental and laboratory apparatus. The two-stage amplifier will multiply signal strength about 350 times. The units are all of the same size, having 6" x 6 1/2" panels, and are all fitted to standard well finished cases, so that they may be combined and connected in any way desired. These instruments include detectors, condensers, inductances, amplifiers, etc., as described in our various Experimental Apparatus Bulletins.

The detector amplifier is priced at \$36.00, without tubes, and the two-stage amplifier at \$42.50, without tubes. Terms—cash with order, F.O.B. New York City.
 Write to Department 24 for our new, completely illustrated six-page bulletin index.

INTERNATIONAL RADIO TELEGRAPH COMPANY
 326 BROADWAY NEW YORK CITY

1920 YEAR BOOK

OF
**Wireless TELEGRAPHY
and TELEPHONY**

NOW READY TO SHIP
Price \$3.50 Postage 25c Extra
Over 1200 Pages

CONTENTS:
 CALENDARS.—Wireless Summary for 1919.—Record of Development.—National and International Laws and Regulations, revised to date and reset in handy form with map indicating Wireless Stations of each country.—Call Letters of Land and Ship Stations.—Definitions.—Directory of Technical Terms, &c.—Also a large number of exclusive contributions by eminent scientists on the following subjects: Direction Finding, Wireless Telegraphy, Continuous Waves, Aircraft Control, Valves, &c., &c.

Order Today—Supply Limited

WIRELESS PRESS, Inc.
 326-328 BROADWAY, NEW YORK

"Sparks" says:



"Lasting Satisfaction"

is measured to a great extent by the initial quality of the radio apparatus you purchase."

Our high grade line of Standard-make Commercial and Amateur Radio equipment embodies the latest ideas in design and workmanship, which assures you of lasting satisfaction under all operating conditions.

Our Specialty

is rendering you such Service that you may always know your interests will be looked after as to Quality and price.

Call on us when in town. Your wants will be quickly and Satisfactorily looked after.

Our latest catalog is yours for 10 cents to cover postage. Write for it today.

International Electric Co.

Eugene Dynner, President

226-E Fulton Street, New York, N. Y., U. S. A.

- Keys
- Audions
- Detectors
- Transformers
- Loose Couplers
- Binding Posts
- Spark Gaps
- Switches
- Contacts
- Buzzers
- Sockets
- Tubes
- Etc. Etc.

Fifty members of the Irvington Radio Club, Newark, N. J., met at Achtel-Stetter's for the first annual dinner of the organization. The club is nine years old and is said to be the pioneer among societies of its kind.

The speakers were L. M. Clement, of the Western Electric Company, and R. F. Gowan. Both praised the club for its interest in wireless telephony and telegraphy and explained intricate points in apparatus mechanism. Albert Mills, president of the club, was toastmaster. De Witt Paxton entertained with recitations. The club meets regularly Thursday nights at 55 Union avenue, Irvington.

The New Jersey Radio Club was formed at a meeting held in the New Jersey School of Radio-Telegraphy, Elizabeth. There were present about thirty wireless students, from this section of the State, who attend the evening class at the Radio School. It is expected that about ten students of the day class will also join the club. A. V. Hill, of Elizabeth, was elected president, and C. J. Frank, also of Elizabeth, secretary and treasurer.

Meetings will be held every Thursday evening at the school, 218 Broad street, Elizabeth, which is the club's headquarters. A large 1/8 KW Marconi transmitting set with a radius of 350 miles; also a receiving set with a radius 3,000 miles has just been installed in the school.

In the near future a trip to the Fleet Supply Base and Bush Terminal, Brooklyn, will be made under the supervision of Lieut. H. Armerding, U. S. N. R. F., who is the principal at the Radio School. Other trips of this sort are in prospect for the members of the club.

The Camden, N. J., Radio Club was organized about a month ago to assist the amateur in the fascinating study of wireless. It has been decided to erect an antenna on the roof of the Y. M. C. A., and install a set for the members' use. The technical committee has been elected to help any amateur who has difficulty with his set. There is to be a wavemeter for the use of the members, which all amateurs will appreciate. There is to be in connection with the club an apparatus exchange where members may buy or sell any wireless apparatus.

The club has for its president and guide Mr. Knierman, who is at the head of the League Island Radio Testing Laboratory. He is qualified and willing to help the members, so the best thing an amateur can do is to get his friend and go to the Y. M. C. A., room F.

AMPLIFYING TRANSFORMER

Type 166A



This instrument is so designed that it combines all of the essentials necessary in the really satisfactory amplifying transformer. The ratio between the coils is such that it is especially adapted to use with tubes having high impedance.

Price—complete - - - \$7.00
unmounted - - - 4.50
mounting supports .75

Have you received Bulletin No. 901?

GENERAL RADIO CO.

General Radio Building
Cambridge 39 Massachusetts

A Loop Transmitter for Local Work

(Continued from page 25)

the instrument table as shown in figure 2. The loop should be either of solenoidal or pancake form, the latter being easier to build. It is wound with two turns, spaced 2 inches apart with a conductor whose cross-section is approximately equal to that of the closed circuit conductor. This can be of litzendraht, of lamp cord in parallel, a cable of magnet wire, or of copper strip. Flexible leads connect the loop to the apparatus.

Those interested in the experimental side of loop antennae for transmission should read Scientific Paper No. 354, Bureau of Standards, by J. H. Dellinger, where there is given valuable formulae for calculating distance, received current, etc., using coil antennae. The writer, when working a 1/2 kw., 500-cycle transmitter of a well-known make, put 8 amps. into the loop described above, when using a .0007 mfd. condenser and optimum coupling. The wavelength was 300 meters. Using a crystal detector, signals were loud at 10 miles. Amateurs within a radius of 15 miles have been worked. The maximum range has not, as yet, been determined.

It is suggested that experimenters should try the loop in a horizontal plane, try to make it uni-directional by combining it with a straight antenna, try enlarging the inductance of the closed circuit, into a loop; in fact, there is no end of experiments one can try when your entire antenna is just above the operating table!

Portable Receiver

(Continued from page 29)

Now after the summer season, if the amateur wishes to use this receiver in his home station, the leg fastenings, front cover and handle can be removed and it is ready for station use. The front cover was designed to hold a portable single wire antenna, telephones, high potential battery and tools.

The World's Largest Wireless Station

"At Honolulu, H. I. is located the largest wireless station in the world. This station is equipped with a 300 K. W. Crocker-Wheeler radio generator."

"Radio generators were specially designed by the Crocker-Wheeler Co. for the Marconi around-the-world service in sending messages from Funabashi, Japan, to Bolinas, California, 6512 nautical miles."

C.W. Motor Generator Sets for Wireless Telegraphy and Wireless Telephony are made for a wide variety of purposes including land stations, ships, portable stations, aeroplanes, dirigibles, submarine chasers and train signaling.

Works and Laboratories of the
CROCKER-WHEELER COMPANY
 New York Chicago AMPERE, NEW JERSEY Pittsburgh Philadelphia
 Boston Cleveland Newark Baltimore
 Syracuse Birmingham New Haven San Francisco

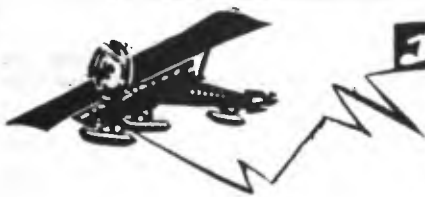

**EASTERN
 RADIO**

INSTITUTE

**899 Boylston St.
 Boston - Mass.**



**TEL.
 BACK BAY
 5 9 6 4**

Learn Wireless under men who have spent YEARS in the SUCCESSFUL training of THOUSANDS of Wireless operators. Graduates now in all parts of the world. When you realize that our Day or Evening School prepares you quickly and efficiently for positions paying from \$100 to \$150 per month, food and quarters besides, does this not appeal to you? REMEMBER: We are the OLDEST, LARGEST and BEST EQUIPPED school of its kind in New England. Have always placed every graduate in a good position and kept them employed. Last year alone we gave instruction to more students than all other schools in New England combined! If these facts mean anything to you send in your enrolment today. Start any Monday. Special Summer classes. Our prospectus for the asking.

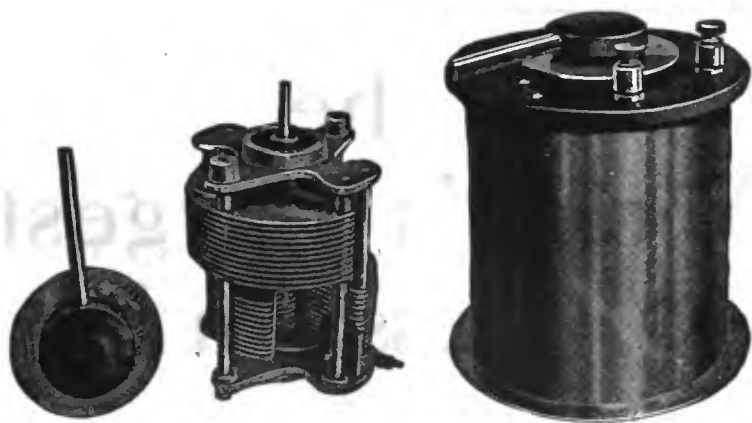

TYPE 800

Balanced Condenser

Mounted or unmounted. Made in three capacities. Carried by most good dealers; price \$7.50 and up. Bulletins F and Z, sent for 4c stamps, show our complete line of high grade moderately priced apparatus for the modern Radio Laboratory.

CLAPP EASTHAM CO.

161 Main Street

Cambridge, Mass.

1920 DIARIES

THE WIRELESS OPERATOR'S
DIARY & NOTE BOOK

THE WIRELESS AMATEUR'S
DIARY & NOTE BOOK

Special price\$1.25 Special price\$1.25
BEST LEATHER CASE, WITH TWO POCKETS, CARD AND STAMP DIVISIONS. These Diaries represent different interests, and have been prepared, with different Sections to meet varying requirements. In addition to Charles Letts & Co.'s Standard Diary, each Diary contains 32 pages of squared paper for curves, &c. The Special Sections cover:

CONTENTS.

Call Letters of Chief High-Power Stations. Gauges and Types of Wire used in Winding Receiver Coils. Conversion Factors and Data. Typical Valve Circuits. Amateur Station Directory. Receiver Notes. Long Distance Communications, &c., &c. &c.

CONTENTS.

Principal Wireless Stations on Ocean Routes. Table for Calculating Tolls on Messages. Some Typical Valve Circuits. Freak and Long Distance Communications. Best Adjustments of Receiver for Various Wavelengths. &c., &c., &c.

The Wireless Press, Inc.

326 BROADWAY,
New York

Tresco Tuners Deliver the Goods

A TESTIMONIAL

TRESCO, Davenport, Iowa, Point Pleasant, N. J.
Gentlemen:—

Some time back you will remember that I bought a 20,000 meter coupler from you and now I wish to tell you of the wonderful results that I have had from it. I was very timid about buying this coupler, as I got stuck with a set of honeycombs, but now I am glad I got that coupler, as I would not part with it for anything.

I could get results with it just as you show the hook-up, but with a little altering I got it to working so that I have heard NPL, BZR, NAR, NFF, NDD, NSS, POZ, OUI, IDO, FL, YN, LCM, and many others that I do not call to mind just at this writing. This is no bull, either; all straight stuff. I am using one bulb—a VT, 3 variables, Baldwin phones, and your Tresco coupler.

Anybody that contemplates buying one of these couplers should not hesitate, as they are the greatest thing out, take it from me. Hoping you are selling lots of these couplers and thanking you for such a wonderful instrument, I am,

Yours very truly,

R. VAN CAMP, Radio Station 2VC.



(Continued from page 39)
ports and conduct amateur transmission and reception in general with a powerful 1 kw. transmitting station (Call 9 ACZ) together with a short wave regenerating receiver, long wave set, and a couple steps of amplification."

Queries Answered

Answers will be given in this department to questions of subscribers, covering the full range of wireless subjects, but only those which relate to the technical phases of the art and which are of general interest to readers will be published here. The subscriber's name and address must be given in all letters and only one side of the paper written on; where diagrams are necessary they must be on a separate sheet and drawn with India ink. Not more than five questions of one reader can be answered in the same issue. To receive attention these rules must be rigidly observed. Positively no questions answered by mail.

J. F. T., Kingsbridge, N. Y. C.:

In order to get the 25-mile radius with the radiophone outfit which you mention, it would be necessary for you to use a 400-volt generator. A 60-volt B battery would probably reduce your radius to something like 3 or 4 miles. * * *

W. F., Troy, Ala.:

We gather from your letter that you are unable to receive signals on either of your two aerials and blame this to lack of a good ground connection. If you have a connection soldered to the city water system and the rest of your apparatus is in the proper shape, you should get some indication of signals. A connection to the water system is, however, not always the best ground possible. If you are so located as to be in a position to erect a counterpoise, we would suggest that you do this. A counterpoise provides an antenna system of high efficiency, regardless of local terrain conditions. * * *

E. N. W., New York City:

We print herewith your corrected diagram covering connections for three vacuum tubes and a radio telephone outfit.

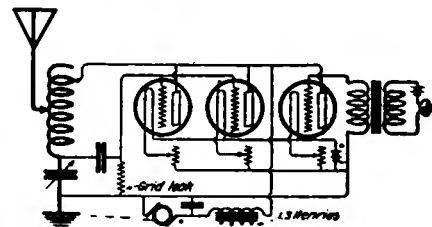

You will probably be able to buy a 2,000 volt D.C. generator from the Electric Specialty Company, Stamford, Conn.

The fundamental wavelength of your antenna is approximately 243 meters. * * *

F. H. M., Albany N. Y.:

The following formula will enable you to find the required condenser capacity for a radio transformer:

$$C = \frac{2W}{E^2 N \times 10^{-6}}$$

where C is in farads
W in watts
and N the spark frequency * * *

J. J. A., Washington, D. C.:

It would be impossible for us to give you instructions covering the construction of a wavemeter having a range of 150 to 12,000 meters in these columns. Various articles have been printed from time to time within the last few months covering wavemeter construction. You should be able to get sufficient information from these to enable you to build such an instrument.

J. G., Tranquille, British Columbia:

Although the use of 110 volts D.C. is not to be recommended in case you are expecting to use an amolifier in conjunction with your detector, it can be done. A circuit of this sort was published in a recent issue.

In case you have only two tubes, it would be better for you to use the second as an audio frequency amplifier, rather than a radio frequency amplifier.

Marconi "Q" and "V24" valves are manufactured by the British Marconi Company. "VT1" and "VT2" valves are marketed by the Marconi Company and are identical with the Audions sold by the De Forest Company. The amplification factor of the "VT's" is about 7 to 1. We regret that we have no data available, giving the characteristics of the tubes manufactured by the British Company, but we presume that they are at least equal to the product of the American Company.

* * *

F. A. W., Woodhaven, N. Y.:

In a recent issue we published a correction covering the circuit diagram shown on page 15 of the April issue. The penciled corrections which you have made on enclosed drawing are O. K.

* * *

J. C., Jr., San Jose, Cal.:

The fundamental wavelength of your antenna is approximately 225 meters. In case your antenna terminates on one end at the house in which your radio set is located, it would be impracticable to attempt the conversion of your L antenna into a T antenna. The lead-in from the T antenna should be as nearly vertical as possible. We suggest that you cut off twenty (20) feet of the end of your antenna.

In the June issue of WIRELESS AGE, several wavemeters were described, together with information which will enable you to construct one for short waves.

* * *

W. S., Port Williams, Nova Scotia:

In the construction of your two-stage audio frequency amplifier, you will find that the best and most convenient method for securing the correct negative grid potential will be by bringing the filament side of the transformer secondary to the slider of your rheostat and connecting the rheostat slider to the negative terminal of the six-volt filament lighting battery. Under these circumstances, in case Marconi "VT's" are used, a resistance of about two ohms will always be in circuit between the filament connection of the transformer and the filament itself.

If we have two oscillatory circuits inductively coupled, any change of coupling between the two circuits will change the wavelength of both circuits, due to their mutual inductance. The fact that the note of a received undamped signal changes when you vary the coupling in your receiving transformer is due to this effect and only in a minor degree to a variation of capacity in either of the two circuits.

We very much regret that we are unable to tell you at the present time what stations have been assigned the calls PTA, NSN, VAV, and WBF. We will endeavor to secure this information for print at a later date.

* * *

H. M., Newport News, Va.:

We regret that we have no actual construction of details covering the uni-control receiver invented by Roy E. Thompson. It is to be presumed, however, that the size of wire and the insulation is of slight import. If you are considering the construction of such an instrument, we suggest the use of No. 24 double cotton covered, or a No. 20/38 Litzendraht double silk covered.

No Seals - No Secrets - But Service!

There is only one Relay Receiver the



TYPE CR-3
**Relay
Receiver**



Inspection of the interior of this Receiver reveals design and workmanship fully in keeping with its outward appearance.

The circuits used are thoroughly explained in the instructions and blue prints which accompany each Receiver.

The use of this Receiver is licensed under the original Armstrong and Marconi patents.

The GREBE RADIO guarantee is absolute and unconditional. Each instrument manufactured by us must give satisfactory service. Our interest in the purchaser does not terminate with the sale.

The CR-3 Receiver may be inspected at any of the following progressive dealers:

- | | |
|---|---|
| Barber-Fowler Electric Co., Lansing, Mich. | Kelly and Phillips, Brooklyn, N. Y. |
| Continental Radio and Electric Corp., New York | Manhattan Electrical Supply Co., New York, Chicago, St. Louis |
| Dougladay-Hill Electric Co., Pittsburgh, Pa. | Pacent Electric Co., Inc., New York City |
| Holt Electric Utilities Co., Jacksonville, Fla. | Geo. W. Parsons & Co., Washington, D. C. |
| Hurlbert-Stell Electrical Co., Houston, Texas | F. D. Pitts Co., Inc., Boston, Mass. |
| | School of Wireless Telegraphy, Philadelphia, Pa. |

A. H. GREBE & CO., Inc., 78 Van Wyck Blvd., Richmond Hill, N. Y.

SOMETHING NEW!

DUO-LATERAL WOUND COILS

THE DUO-LATERAL COIL now being offered for the first time is not to be confused with any other type of machine wound inductances which have been on the market for some time.

The Duo-Lateral Coil, made in various sizes for general and specific application, has the following distinct advantages which make it superior to any other coil for amateur and commercial work alike.

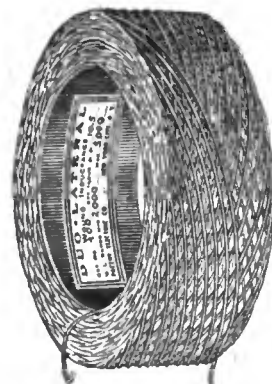

1. Lower natural period.
2. Lower high frequency resistance.
3. Very low distributed capacity.
4. Lower direct current resistance.
5. Higher self inductance.
6. Mechanically stronger.

Bulletin PIW, containing valuable engineering data, constants and prices of numerous sizes of Duo-Lateral Coils covering practically every wavelength used, is yours for the asking. MANUFACTURERS, DEALERS, JOBBERS and DISTRIBUTORS—write for our proposition. SALES AGENTS for Electrical Products Mfg. Co., A. H. Grebe & Co., Dubilier Condenser Co.,

Richter & Byrne, Rawson Electrical Instrument Co., The Magnavox Company and others.

PACENT ELECTRIC COMPANY, Inc.

Builders & Specialists of Radio, Electrical & Laboratory Equipment

150 Nassau Street Telephone Beckman 5810 New York City



A More Improved INDICATING DIAL

This new dial made of same quality and workmanship as our famous smaller one, is marketed to fulfill the demand for a dial to fit the standard 1/4 inch Shaft. Made of black polished composition with radial lines and figures accurately engraved and filled with brilliant white. Diameter is 3 7/8 inches; and 3/16 inches thick. Bevelled edge. Knob has set screw to clamp shaft of instrument.

3 inch dial only 75c. With knob \$1.30
Postpaid
3 7/8 inch dial only \$1.00. With knob \$1.70
Postpaid

OUR NEW CATALOG now ready for distribution contains 24 snappy pages of news and descriptions of all standard Radio parts, including the above indicating dial.

Sent anywhere upon receipt of 10c.

For sale at all Radisco Agencies and by

A. H. CORWIN & CO.

4 West Park Street

Newark, N. J.

Here they are Meraco Perfect "B" Batteries

Standard BA-2 TYPE The same type of a battery as used by the U. S. ARMY AND NAVY SIGNAL CORPS. Fully guaranteed on a money back basis. Once you use these batteries you will use no other. Meraco Perfect "B" Batteries are made in three sizes and should be ordered by catalog number.

Cat. No.	Cells	Volts	Sizes	Shelf Life	Price
BA-2XPR-1K	15	22.5	3 1/2 x 2 1/2	4 months	\$1.20 Postpaid
BA-2XPR 2	15	22.5	6 1/2 x 3 x 4	8 months	\$2.20 "
BA-2-XPR	30	45	14 x 6 x 8	1 year	\$4.50 "

Watch this magazine for future advertisements containing our big offers.

MERCURY RADIO APPLIANCE CO.

DEP. D-T1

672 Broadway

Brooklyn, N. Y.

NEW MOTORS

FACTORY GUARANTEED - ALL SIZES - IN ORIGINAL BOXES

Your Opportunity

To Buy New Guaranteed Electrical Apparatus of Standard Manufacturers.

Single Phase Motors	Charging Generators	Polyphase Motors	Battery Charging Outfits
110-220 volts, A. C., 60 cycle, 1800 R. P. M. with pulley	Suitable for all lighting. Battery Charging and Power Requirements.	2 and 3 phase, A. C., 220 v. 60c., 1750 R.P.M., complete with base and pulley.	To operate on A. C., 60 cycle, single phase. Voltage as specified.
1/4 H. P., 110-220 volts, induction, full load start - -	6 volts, 10 amp. - \$19.50	1/2 H. P. - \$46.50	110-220 v., A.C., 150 watts, 18 v., with switchboard - \$68.50
1/2 H. P., 110-220 volts, induction, full load start - -	15 volts, 10 amp. - \$24.50	1 H. P. - \$64.00	110-220 v., A.C., 150 watts, 20 v., with switchboard - \$68.50
1/2 H. P., 110-220 volts, repulsion, for compressor	40 volts, 8 amp. - \$31.50	2 H. P. - \$81.00	110-220 v., A.C., 175 watts, 24 volts, with switchboard - \$68.50
1 H. P., 110-220 volts, repulsion, with sliding base - -	110 v., 3 1/2 amp. - \$31.50	3 H. P. - \$96.00	110-220 v., A.C., 250 watts, 48 volts, with switchboard - \$88.50
2 H. P., 110-220 volts, repulsion, sliding base	110 volts, 6 amp. - \$46.50	5 H. P. - \$112.00	220 volts, 2 phase, 600 watts, 20 v., without switchboard - \$75.00
3 H. P., 110-220 volts, repulsion, sliding base	110 volts, 20 amp. - \$78.50	1 H. P., high speed, 3000 R.P.M., 220 v. 2 phase only - \$36.50	
5 H. P., 110-220 volts, repulsion, sliding base	110 volts, 10 amp. - \$106.50		
	40 volts, 30 amp. - \$146.50		
	110 volts, 10 amp. - \$106.50		
	Moving Picture Arc Generator 60 v., 35 a. - \$106.50		

WRITE FOR CATALOG. BARGAINING IN MOTORS AND GENERATORS

1/4 SPECIAL 110 volts A.C., 60 c. S. P., 1750 R.P.M. Complete, cord, plug and pulley. **\$22.75** Each. Reg. Val. \$22.50

WASHING MACHINE MOTORS Suitable for operating Small Compressors, Coffee Grinders, Bottle Washers, Etc. **\$22.75** Each. Reg. Val. \$22.50

SHIPPING TERMS: 15% deposit required on all orders. Balance O. O. D. by Express. Slight draft with Bill of Lading attached by freight.

MANUFACTURERS' DISTRIBUTOR
CHAS. H. JOHNSTON, Box 18, West End, Pittsburgh, Pa.

RADIO APPARATUS

Distributors of reliable Radio apparatus for Experimenters in every branch of the Radio field.

'PITTS CO'
The sign of Service. All we ask is a trial.



'REMEMBER'
We carry an immense stock and can make immediate delivery.

AMPLIFIERS

- No. P-200 Dc Forest 2 step with "B" Battery but without tubes.....\$69.50
 - No. RORJ Grebe (new type) 2 atcp, with cam switch control.....\$45.00
 - No. RORE Grebe single step audio frequency amplifier.....\$23.00
- F. D. PITTS CO., BOSTON, MASS.

AMPLIFYING TRANSFORMERS

- No. A-2 Acme mounted.....\$7.00
 - Acme unmounted.....\$4.50
 - No. 226-W Federal.....\$7.10
 - No. Y-739 Clapp Eastham mounted...\$7.50
 - No. Y-739-A Clapp Eastham unmounted.....\$5.00
- F. D. PITTS CO., BOSTON, MASS.

ANTENNA CHANGE-OVER SWITCHES

- No. 463 Murdock, capacity 1 K W... \$4.50
 - No. Y-658 Clapp Eastham, new type bakelite base, three poles.....\$12.00
- F. D. PITTS CO., BOSTON, MASS.

AUDION CONTROL PANELS

- No. P-400 De Forcast audion panel without cabinet.....\$12.00
 - No. P-401 De Forcast audion panel, same as above with oak cabinet...\$14.25
 - No. P-402 De Forest audion panel with 40 volt "B" battery in oak cabinet.....\$19.95
 - No. P-500 Dc Forest audion-ultraudion panel with 20-40 volt "B" battery with oak cabinet...\$25.00
 - No. RORA Grebe vacuum tube control panel.....\$11.00
 - No. RORH Grebe vacuum tube control panel with 40 volt "B" battery.....\$17.00
- F. D. PITTS CO., BOSTON, MASS.

BUZZERS

- No. 178 General Radio pure tone...\$1.95
 - No. 77 Mesco High frequency.....\$2.05
 - No. 5 Century High frequency.....\$1.95
 - No. 9010 High pitch, watch case, brass.....\$0.75
 - No. 9011 High pitch, nickel plated...\$0.75
- F. D. PITTS CO., BOSTON, MASS.

CONDENSERS

- No. CV-500 De Forest .0005 MF. unmounted suitable for panels...\$6.25
 - No. B-1 Bowman .001 MF. unmounted suitable for panels.....\$3.95
 - No. B-2 Bowman .0005 MF. unmounted.....\$2.95
 - No. 366 Murdock .001 MF. in solid case mounted.....\$4.75
 - No. 368 Murdock .0005 MF. mounted.....\$3.75
 - No. Y-800 Clapp Eastham balanced unmounted .0006 MF.....\$7.50
 - No. Y-800A Clapp Eastham balanced unmounted .001 MF.....\$9.50
 - No. Y-800B Clapp Eastham balanced unmounted .0015 MF.....\$11.50
- F. D. PITTS CO., BOSTON, MASS.

HOT WIRE METERS

- No. 128 Roller-Smith, range 2.5 amps. \$7.00
 - No. 128A Shunt to enable same meter to read 5 amperes.....\$0.75
 - No. GR-100 General Radio, range 1 amp.....\$5.00
 - No. GR-200 General Radio, range 2.5 amps.....\$5.00
- Note.—These meters are splendid values.
F. D. PITTS CO., BOSTON, MASS.
Important! Every article listed sent to any part of the U. S. A. postage prepaid. We want your business!

Send 6 cents for new catalog.

F. D. PITTS CO., Inc.

12 Park Square Dept. B. Boston, Mass. U. S. A.

ARLINGTON TESTED CRYSTALS

Why buy minerals on a gamble? Be SURE when you put a crystal in your detector that it is EXQUISITELY SENSITIVE. Buy Arlington individually tested Minerals, Galena or Silicon, post paid on receipt of price.

35¢

THE NEWMAN-STERN CO., Dept. W. A. Cleveland, O.

FREE **POCKET HANDBOOK CATALOGUE**

Radio Handbook & Catalogue

Contains much valuable radio information, tables and data. Describes a remarkable line of wireless instruments including "Red Head" Phones, Arlington Tested Minerals, DeForest, Murdock and Signal Apparatus. Write for this book today

The Newman-Stern Co. Dept. W.A. Cleveland, O.

Red Head Radio Phone

The accepted standard in wireless receivers. If they are not BETTER than anything you've ever seen return them for full cash refund. Our Radio Hand Book and Catalogue, free on request, describes them, and many other instruments.

\$7.00

The Newman-Stern Co. Dept. W.A. Cleveland, O.

RADIO MEN

The Mutual Purchasers Association will save you money on all **WIRELESS APPARATUS**

Write Dept. W.A. for details.

Mutual Purchasers Association
24 STONE STREET, NEW YORK

AT LAST

Our new catalogue is here showing the most complete line of wireless apparatus ever displayed in catalogue form before. 24 hour shipments in most all goods shipped from our own stock. This catalogue consists of 100 pages of well displayed apparatus, wireless hookups, radio symbols and other interesting reading matter. 15 cents in stamps will bring this book to your door.

NOTICE

Wireless Associations, Colleges, Vocational Training Schools and Wireless Clubs.—A number of our new catalogues will be sent to those having the proper authority to write in for same.

NATIONAL RADIO SUPPLY CO.,
Dept. 156
806 Ninth St., N. W. Washington, D. C.

WESTERN ELECTRIC RECEIVERS

These are the same type of receivers furnished to the United States Signal Corps and Navy Department and were known in Army circles as the "P-11." The Navy knew them as the "CW-834." They are without exception the best receivers on the American market today. Price \$13.00 per pair.

In addition to these receivers we carry one of the most complete lines of high grade radio apparatus in America.

"We make or sell Everything Radio"

3807 Fifth Ave. THE RADIO ELECTRIC COMPANY Pittsburgh, Pa.

NEW SHORT WAVE COUPLER No. 747

Comes up to the CHAMBERS' usual High Standard. Especially adapted to long distance Amateur work. Tunes to 800 meters. Does away with the dead-end effect so common when large couplers are used for short wave reception.

Mahogany finished woodwork. Brass metal parts. Has new slider feature. Secondary has six taps. Wound with Red Enamelled Wire, or, secondary with Green Silk if so ordered. Measurements over all, length 12 inches, width 4 1/2 inches, height 5 inches.

PRICE - - \$10.00

F. B. CHAMBERS & CO.,
2046 ARCH STREET - - PHILA., PA.

The B & H Mounting for Radisco, DeForest and other coils

The single support allows easy change of coils with ample length of rod to allow very loose coupling. The square rod prevents coils from turning. Special Stands and Centers Made to Order.

THE MOST EFFICIENT STAND ON THE MARKET

Pat. Applied For	Radisco	DeForest	Special
No. 1R Complete with 6 Binding posts, flexible leads and 3 Coil centers.	\$6.00	\$6.50	\$7.00
No. 2R Complete with 3 Coil centers, but without flexible leads or Binding posts	4.00	4.50	5.00
No. 3R Extra Coil Centers, (give size)	.35	.40	.50

Parcel Post Charges on 2 lbs. FINISHED IN WEATHERED OAK

HIGH FREQUENCY CABLE (LITZ) 10-35 20-35 16-2-35 16-3-35
DSC, Enamelled—any other size and covering to Order. Send stamp for further particulars.

WIRELESS SUPPLIES
A. T. HOVEY
Dept. B
61 BELVIDERE STREET
BOSTON-17-MASS.

THE JONES VACUUM TUBE CABINET RECEIVING TRANSFORMER

The Ideal Set for the Experimenter

Extracts from unsolicited Testimonials: Originals on file.

"The set seems very well adapted to Radio Telephone work, and has given satisfaction in all ways."

"Regarding my JONES Cabinet set, which I received about a month ago. It works fine. My set works as good as any set around Detroit."

"Permit us to express our deepest satisfaction in reference to your receiving set recently purchased. From exacting tests, we find it meets all requirements. It certainly is an ideal set."

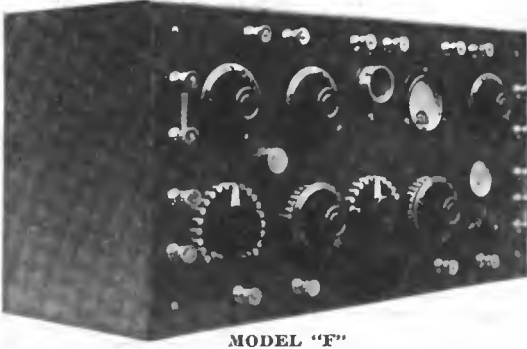

MODEL "F"

Model "D"	\$ 60.00
Model "E"	85.00
Model "E-1"	95.00
Model "F"	150.00

No dead wire in any circuit. Minimum and maximum wave length. Simplicity of tuning method. Damped and undamped waves.

Our Receiving sets employ a highly perfected Loose Coupler method of wave reception, in conjunction with latest and most approved Vacuum Tube Circuit, all assembled within a metal frame that can be instantly removed from its cabinet. Fitted with modern "DEAD END" switches that balance both circuits perfectly, practically eliminating loss of energy, and greatly increasing signal strength and selectivity. Gets all stations, instantly, from the smallest Amateur spark, to the Long undamped musical note of the High Power Government Stations. Unexcelled for Wireless Telephone reception. No complicated tuning arrangements, simply vary the coupling and hear them all come singing in. Read the above testimonials: They tell you plainer than we can, what our sets are doing. Bulletins describing them upon request.

THE JONES RADIO COMPANY, Laboratory, 384 Monroe Street, BROOKLYN, N. Y.



MARCONI INSTITUTE

326 Broadway, New York City

Telephone, Barclay 7610

More than 200 young men are enrolled in our classes preparing for employment in the Merchant Marine.

The demand for EXPERT WIRELESS OPERATORS is enormous. The position is most remunerative and the work is unusually pleasant.

The junior ship operator receives \$100 per month, the senior \$125 per month, to which is added \$3.00 per day subsistence pay when the ship is in port.

You may enjoy the life of a globe-trotter and receive

this salary by studying from three to four months at the Institute.

Prospective applicants are urged to investigate our course before enrolling elsewhere. Remember that by far the greatest number of assignments to the ship service are made in New York City.

The Trans-oceanic Division of the Marconi Company is in need of expert Continental Morse operators.

Write us for facts regarding the present radio situation.

We have more than 6,000 graduates to our credit.

AMERICA'S FOREMOST SCHOOL FOR INSTRUCTION IN WIRELESS TELEGRAPHY

Afternoon and Evening Classes throughout the year.

Branch School: New Call Building, New Montgomery St., San Francisco, Cal.

Address all inquiries to Director of Instruction

"WINN" PORTABLE WIRELESS SET No. 149



WINN Hi-Quality WIRELESS APPARATUS

"WINN" PORTABLE WIRELESS SET

This SET represents the very highest type of construction throughout, made complete in our own factory, of excellent materials, by expert workmen, under the direct supervision of R. E. Winn. Each part carefully tested to insure absolute reliability and dependability under all conditions of service in home station or field. Size of box 8 x 9 x 11, handsome mahogany finish, all metal parts heavily nickel plated, weight 16 lbs., handy carrying strap of heavy ribbed duck.

SENDING RANGE 10 TO 12 MILES

Receiving range 200 to 300 miles under favorable conditions. Lightest portable set made of equal high-quality. Offers amateurs and professionals a well made, beautifully finished, compact, and efficient Wireless Set, which anyone would be proud to own and use. Particularly well adapted to Boy Scout organizations. Scouts in camp, on the hike or at home, could keep in touch with other camps as well as the outside world. No special aerials required. Complete instructions with binding guarantee enclosed in each box, the guarantee an insurance of satisfaction. Price complete with phones, \$50.



"WINN" RECEIVING TRANSFORMER No. 504. \$13.50

"WINN" RECEIVING TRANSFORMER

This instrument gives good results, receiving wave lengths up to twenty-five hundred meters. To simplify the use of Transformer for beginners, this one is to be used in place of tuning coil and tuning inductances, where distances and sharper tuning is required. The aerials in ground are connected with the two binding posts below the primary. The secondary terminals connect with the two remaining binding posts. Contact is made by means of a slider mounted conveniently on top of the primary. All metal parts heavily nickled. Base and end pieces of birch highly polished.

"WINN" TRANSMITTER COIL

This coil is especially designed for wireless and high frequency work. Produces heavy, energetic spark. Capable of transmitting up to 25 miles under favorable conditions. Contact points on interrupter extra large, of heavy platinum iridium. Interrupter is our own "Winn" design, and the most sensitive vibrator made. Transmitter complete with exception of Spark Gap and Key. Normal voltage required, 10 to 12 volts, although higher voltage may be used. Mounted in mahogany finished cabinet, with nickel plated mountings.

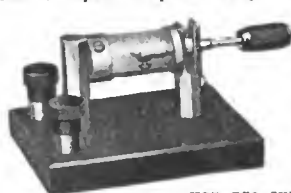

"WINN" DETECTOR No. 400, \$5

Our Detector is in a class by itself and is the outcome of long and careful experiments to produce an article which does away with all the objections of the ordinary Detector. Enclosed in glass, dust-proof cylinder, which keeps the mineral clean and free from vibrations. This feature alone bears out our claim for general excellence of any and all "WINN" apparatus, all HI-GRADE.

Your dealer will supply you with any "WINN" HI-QUALITY Wireless Apparatus. If not send his name and we will see you are supplied promptly. Write for our "Supplement A" advance catalog, which contains complete information about the entire "WINN" HI-QUALITY Radio goods. It's FREE.

"WINN" TRANSMITTER COIL, No. 201 \$7.50



WINN RADIO & ELECTRIC MFG. CO., 537 So. Dearborn St., (Dept. 12) Chicago, Ill.

JOHN FIRTH & COMPANY, Inc.

81 NEW STREET, NEW YORK

SOLE DISTRIBUTORS OF THE BALDWIN MICA DIAPHRAGM TELEPHONES, BALANCED ARMATURE TYPE. THE MOST SENSITIVE TELEPHONE ON THE MARKET, STANDARDIZED BY THE NAVIES OF THE WORLD. SCIENTIFIC INVESTIGATORS PRONOUNCE THE BALDWIN "TYPE E" THE ONLY PHONE SUITABLE FOR USE WITH THE MARCONI VACUUM TUBE.

Type C—Navy Standard Type E—Newest Type
Type F—Smaller Type

Write for Catalogue

MANUFACTURERS OF U. S. NAVY STANDARD LEYDEN JARS, SILVER AND COPPER DEPOSIT, KOLSTER PORTABLE DECREMETERS, WAVE METERS, AND ALL HIGH CLASS MEASURING INSTRUMENTS.

Federal Radio Accessories and Parts



No. 226-W Type A

AUDIO FREQUENCY
Transformer
\$7.10 each

Are Distinguished for Their
Reliability, Quality and Efficiency
WRITE FOR BULLETIN 101 AND 102

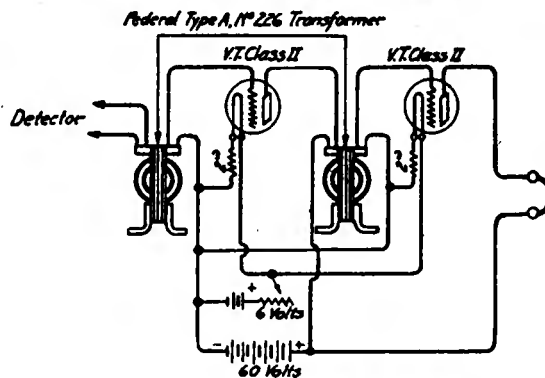

CIRCUIT WITH TWO STAGE AMPLIFIER



No. 52-W 2200 Ohms

LIBERTY HEAD SET
\$12.50 per set

One 226-W Transformer with one Marconi V. T. gives an energy amplification of 400 times.
(Audibility amplification of 20 times.)

Two 226-W Transformers with two Marconi V. T.'s give an energy amplification of 160,000 times.
(Audibility amplification of 400 times.)

Federal Telegraph and Telephone Co.
Buffalo, New York

The "Exide" Battery for Wireless Service

In Wireless Service as well as in many other fields where the application of storage battery power is an important factor the "Exide" has successfully and dependably met the most exacting demands made upon it. They have conclusively proved their right to first consideration for Wireless Service and Emergency Lighting.



Thirty-two years of storage battery building experience is back of the "Exide"—that experience alone is proof positive that the Exide is as nearly 100% right as it is possible to make it.

THE ELECTRIC STORAGE BATTERY CO.

The largest manufacturer of storage batteries in the world

1888

PHILADELPHIA, PA.

1920

New York
Minneapolis

Boston
Cleveland

Chicago
Atlanta

Washington
Kansas City

Denver
Pittsburgh

San Francisco
Detroit

St. Louis
Rochester

Special Canadian Representative—Chas. E. Goad Engineering Co., Limited, Toronto and Montreal

Batteries are made by this Company for every storage battery purpose

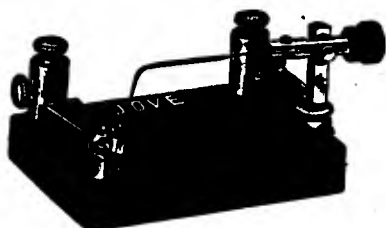

Ghegan Patent

Bunnell Instruments Always Satisfy

Our Jove Detectors Simplest and Best

Beware of Infringing Imitations

Sample mailed for \$2.00 Tested and Guaranteed Galena 25 cents
Our Keys, Spark Gaps, Condensers, Transformers, etc., are high grade but inexpensive
Distributors of Standard Electric Novelty Company Type B "Cyclone" Audion
Batteries. Also De Forest, and all other makes of High Class Wireless Apparatus.
Send stamp for our No. 42-W Catalog.

J. H. BUNNELL & CO. - - - 32 Park Place, New York City, N. Y.

The Atlantic Radio Company Variable Condenser

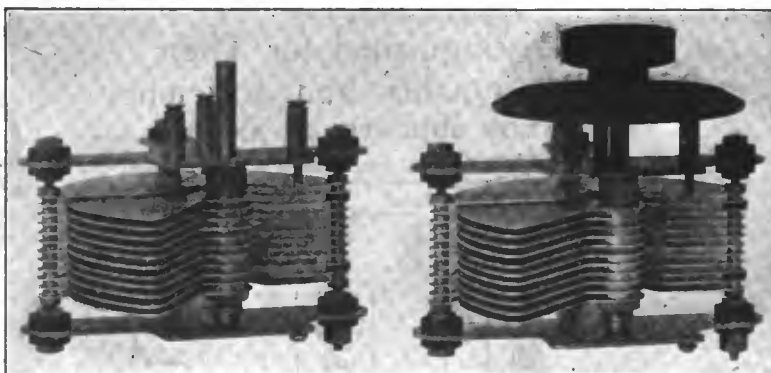

THE ATLANTIC RADIO COMPANY VARIABLE CONDENSER, illustrated above, is made in two capacities—.0005 Mfd, and .001 Mfd. The rotary plates are rounded on one end, affording a straight-line capacity—a valuable feature in wave meter work. The condenser is furnished unmounted only, but with the addition of Dial and Knob, if desired. Dial is moulded composition, scale in white—0-100 reading. Bakelite Knob. We can guarantee this condenser in every way as to quality, reliability and satisfaction. The low price is decidedly an innovation.

Capacity	Unmounted	With Dial and Knob
.0005 Mfd.	\$5.00	\$6.00
.001 Mfd.	6.25	7.25

"BULLETIN 14"—describing and illustrating the best in RADIO EQUIPMENT will be mailed upon receipt of 10 cents in stamps—this amount may be deducted on first order of \$1.00 or over.

ATLANTIC RADIO CO., Inc.

NEW ENGLAND DISTRIBUTORS "RADISCO" PRODUCTS

88 BROAD STREET,

BOSTON 9, MASS.

BAKELITE - DILECTO

Manufacturers!

Wireless apparatus for commercial, experimental and amateur use has recently moved a considerable number of notches ahead.

Yesterday's Construction Don't Go Today

Handsome appearance must be combined with efficient working. The true enthusiast looks for both in the apparatus he buys nowadays.

This is particularly true of the insulation used. And the engineers and amateurs of widest experience have learned that when genuine

BAKELITE - DILECTO

is used, SATISFACTION is SURE.

Combine the popularity of this wonderful insulation with the best work you can do. Tell your customers that you use the genuine BAKELITE-DILECTO—and watch your sales grow.

BAKELITE-DILECTO WILL CUT YOUR MANUFACTURING COSTS—

because it comes in sheets, rods and tubes. This means the minimum of fitting work. It is waterproof, permanent and strong.

We also manufacture Vulcanized Fibre and Conite for special insulating purposes.

Write us about your requirements. Our engineers will gladly show you how our products will solve your insulating problems.

THE CONTINENTAL FIBRE CO.

NEWARK, DELAWARE

233 Broadway, New York City.
525 Market St., San Francisco, Cal.
Cor. King and Yonge Sts., Toronto, Ontario, Canada.

332 S. Michigan Ave., Chicago, Ill.
411 S. Main St., Los Angeles, Cal
301 Fifth Ave., Pittsburgh, Pa



The Recognized Symbol of Superior Performance

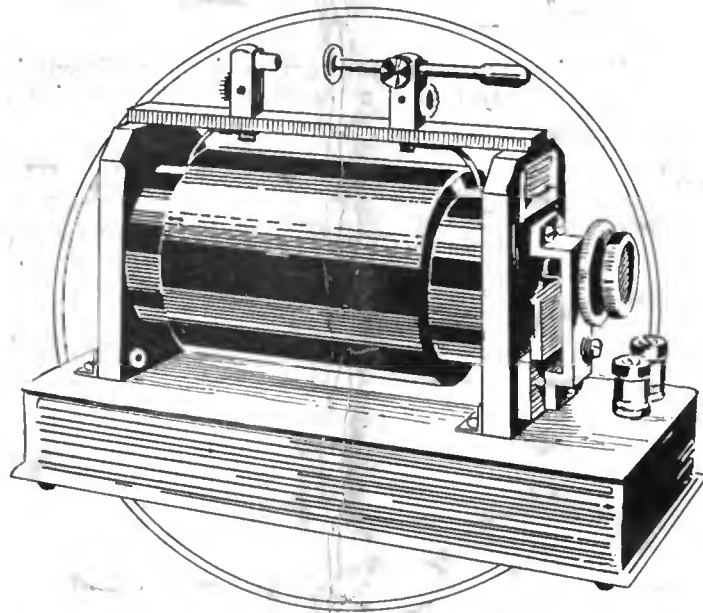

G RIM necessities of war required the development of a Standard Induction Coil, powerful enough to propagate signals of great intensity over short distances, rugged enough to outlive the hazards of everyday trench service, dependable enough to entirely preclude the possibility of failure at the critical moment. The Amrad Induction Coil—a product of American engineering, met the supreme test of the hour in characteristic American fashion. Honorably discharged from the battlefields of France, it is now available in a new form best adapted to meet the peace-time demand for a *standard* induction coil capable of maintaining reliable communication over moderate distances. As the Amrad Induction Coil is the only available coil especially designed for short wave radiotelegraphy it is unquestionably *the* standard and as such merits no comparison. Bulletin P containing full description sent upon request. Prices: 6 volt, \$35.75; 32 volt, \$38.50.

Dealers: Become the recognized Amrad Retailer in your locality. Write for our new terms made effective June 15th.

Radio Operators. Send us your station call letters and name of nearest radio retailer and we will place you on our mailing list for one year, forwarding our latest bulletins as issued.

AMERICAN RADIO AND RESEARCH CORPORATION

15 Park Row
New York

Address all Communications to New York

Factory and Laboratory
Medford Hillside, Mass.