

**WIN! A YAMAHA A3000 SAMPLER**

# THE MIX

THE **MUSIC PRODUCTION** MAGAZINE

**PLUS**

## Size matters!

Behind the scenes with the big guns of mixer design – SSL and AMS Neve

# PCI WARS

New Korg 1212 and Emagic Audiowerk 8 herald new wave of high-performance PCI audio cards **EXCLUSIVE!**

## ALSO

Yamaha 03D  
New Sony DATs  
Sonic enhancers  
DIY synth project

also in this issue



MIKE HEDGES



MARTYN WARE



FUTURE LOOP FOUNDATION

**Future**  
PUBLISHING

Your guarantee of value

£3.99 WITH CD

ISSUE 37 • JUNE 1997



9 771354 428024

07

# LIVE ON STAGE

... as it should be!

## The Roland Band with the very latest gear.

- Grand Tour Prize: V-Xpanded VS-880 Digital Studio Workstation
- Nightly Equipment Prize Draw
- Lots more FREE goodies
- Meet the guys in the know
- Check out the gear for yourself in the 'hands on' area



The tour will take place in June, and the dates and venues are as follows:

Swansea Taliesin Theatre	3 <sup>rd</sup>	10 <sup>th</sup>	Bristol University Victoria Rooms
Dublin Temple Bar Music Centre	4 <sup>th</sup>	11 <sup>th</sup>	Guilford Civic Hall
Belfast Lyric Theatre	5 <sup>th</sup>	12 <sup>th</sup>	Sheffield Memorial Hall
Glasgow Tramway	6 <sup>th</sup>	13 <sup>th</sup>	Midlands Arts Centre (The MAC), Birmingham
Newcastle Eldon Leisure	7 <sup>th</sup>	14 <sup>th</sup>	The Playhouse Theatre, Norwich
Manchester University Students Union	8 <sup>th</sup>		

**Tickets: £2.50**  
Credit cards welcome

**Hotline: 0800 765263**  
**or 0800 ROLAND**  
calls free within UK

# PICK A CARD...

If there's one thing that we've waited far too long to see, it's quality audio cards at a reasonable price. While audio recording software has raced ahead in features and functionality, its usability has been hampered by the physical limitations of accompanying hardware. Now, a new generation of PCI-based audio cards look set to take computer-based audio to the next level...

These new cards offer enhanced multi-channel capabilities, offering eight or more inputs and outputs, as opposed to the normal two or four channels on existing 'affordable' hardware. This means that you can now retrieve your mixer from the cupboard under the stairs and integrate it into your computer set-up.

Those connectors on the back of the Korg and Emagic PCI cards reviewed in this issue make look inconsequential, but in computer audio terms they represent a real step forward. No longer will you have to stuff your signals into a stereo minijack socket to get audio into your PowerMac. No longer, too, will your painstakingly-produced music be outputted



## Is the new wave of PCI cards the final piece in the computer audio jigsaw?

to the world via a similarly-inadequate minijack. It seems insane that the amazing capabilities of Logic, VST, Studio Vision and

the like have had to live with the design restrictions of their chosen platforms – designs that may be fine for multi-media, but fall well short for serious recording applications.

But fear not, at the eleventh hour the cavalry has arrived, and it looks like the two PCI cards in this issue may well be the first of many to appear in the coming months. Offering two different approaches, the Korg relies on the ADAT digital interface to get its signals in and out, while the Emagic has a set of leads to plug straight into your mixer – but both offer serious advantages for users of VST, Logic and other applications.

And from here it's only going to get better; newer cards will offer more audio channels, more interfacing options, and DSP effects – all at a price that'll make them viable for most musicians and producers. If you hadn't thought seriously about the computer audio option before, now's as good a time as any to reappraise the situation...

*Chris Kempster*

### ALSO AVAILABLE FROM FUTURE PUBLISHING



**KEYBOARD REVIEW**  
Essential reading for practising keyboard players



**FUTURE MUSIC**  
Making music with modern technology

## CONTRIBUTORS TO THIS ISSUE...



**Alan Branch**  
Alan is one of London's most in-demand freelance engineers, with

credits that include Eternal, M People, D:Ream, Michelle Gayle, Boy George, Damage, Jamiroquai, Depeche Mode, Primal Scream, Living Colour and On U Sound. Alan studied music at Goldsmiths College and worked through studios from Engineer to Chief Engineer, and now freelances, his musical and technical skills making him one of today's top professionals.



**Ian Waugh**  
A professional freelance musician and writer, Ian is one

of *The Mix's* longest-established and most prolific contributors. Highly regarded as one of the UK's leading hi tech computer and music experts, Ian has written over 1200 articles, authored several books, scripted videos, written software and hardware manuals, released several albums and composed music for computer games.



**Peter Forrest**  
Analogue synth addict Peter is most well-known for his epic guide

to keyboards, the *A-Z of Analogue*, which finishes its serialisation in *The Mix* this issue. Peter's next project is the *A-Z of Analogue Effects*, which will also be available in book form. In between his collecting and writing, he also runs the VEMA vintage instrument auctions, a net-based format that brings buyers and sellers around the world together.



**THE MIX** Future Publishing, 30 Monmouth St, Bath BA1 2BW Tel: 01225 442244 Fax: 01225 732353 **EDITORIAL:** Editor Chris Kempster **Art Editor** Kev Lowery **Technical Editor** Paul Mac **CD Editor** Nick Serre **Additional Design** Paul Kingett **Contributors** Bob Dorman, Nigel Lord, Danny McAleer, Ian Waugh, Simon Trask, Peter Forrest, Phil Strongman, Pat Reid, Tim Barr, Alan Branch, Nick Smith, Rob Green, Trevor Curwen **Senior Art Editor** Ian Miller **Art Director** Trevor Gilham **PHOTOGRAPHY Chief Photographer** Rob Scott **Studio** Rick Buettner, Gavin Roberts **Location** James Cumpsty, Luke Shepherd **ADVERTISING:** Ad Manager Tony Halliday Tel/Fax: 01353 666332 email: tony@epgroup.co.uk **Classified Sales** Mark Durham **PRODUCTION:** Product Manager Pete Stothard **Production Manager** Nicola Lucas **Deputy Production Manager** Lou Reffell **Production Co-ordinator** Carolyn Tandy **Production Co-ordinator** Matt Gregory **Ad Design** Claire Watkins **Circulation Director** Sue Hartley **Publisher** Andy Marshall **Publishing Director** Steve Carey **Managing Director** Greg Ingham **Chairman** Nick Alexander **Printed by** Heron Print, Heybridge, Maldon, Essex **Licensing enquiries:** Mark Williams Tel +44 171 331 3920 **UK and world news-stand distribution:** Future Publishing Ltd, +44 1225 442244 **Circulation Director:** Sue Hartley **PR and publicity:** Liz Ramsey, Jenny Press Tel +44 171 331 3920 **FutureNet URL:** http://www.futurenet.co.uk **Subscriptions/backissues:** +44 1225 822511, Future Publishing, FREEPOST (BS4900), Somerton, Somerset TA11 6BR



© Future Publishing 1997. No part of this magazine may be reproduced, stored in a retrieval system or resold without the prior written consent of the publisher. Unless otherwise specified, prices quoted on the editorial pages are recommended retail prices and include VAT. The Mix makes every effort to check all information, but can accept no responsibility for any errors or omissions. The Mix recommends that all your purchases from our advertisers are made with a credit card, so in the unlikely event of a problem, redress may be sought from the credit card company. The Mix recognises all copyrights contained in this issue. Where possible we acknowledge the copyright holder. All contributions to *The Mix* are submitted and published on the basis of full assignment of copyright, unless otherwise agreed in advance and in writing.

# CONTENTS

## FEATURES

- 18** **STUDIO FILE: MANOR MOBILES**  
Can a studio in the back of a lorry be any good? Nick Smith reports on a company challenging old preconceptions
- 72** **SSL & NEVE**  
They're the two biggest names in mixer design, but what's the story behind their success? Paul Mac looks for the answers
- 78** **FUTURE LOOP FOUNDATION**  
Drum'n'bass hits the airwaves with the first live broadcast on Radio 1. Rob Green meets Mark Barratt at Maida Vale
- 82** **MIKE HEDGES**  
Nick Smith talks vintage gear, French chateau and the Manic Street Preachers to indie-pop producer Hedges
- 122** **PRODUCER Q&A: MARTYN WARE**  
He's back with Heaven 17 after seven years, but as a producer he's never been away. Nick Serre asks the questions



## REGULARS

- 7** **CD CONTENTS**  
Gear demos, tutorials, samples, MIDI files, synth patches and shareware music software – all on the CD, and all listed here
- 8** **NEWS**  
If it's new and it's music production, it's here. New products, courses, net news, competition winners and industry gossip
- 64** **SAMPLE CDs**  
All the latest sample CD releases reviewed and rated, plus a full listing of the free samples on this month's cover CD
- 66** **HELP FILE**  
Problems in the studio? This is where our team of experts turn agony aunt to find solutions to your technical hitches
- 70** **ALBUMS**  
Read about all the major album releases this month, plus who's in the studio doing what with whom and why!
- 88** **TOOLBOX**  
News, tips and new software for your computer of choice – PC, Mac and not forgetting the good ol' Atari ST
- 104** **TOTAL RECALL**  
Tune into the last ever instalment of the *A-Z of Analogue*, the most complete guide to analogue synths ever compiled
- 110** **A&R DEPT.**  
This is your chance to show us what you've got. Send in your tapes and CDs and we'll give our honest opinion
- 112** **READERS' ADS**  
Advertise your music and recording gear for free. This month, over 4 pages-worth, stuffed with 100's of secondhand bargains!

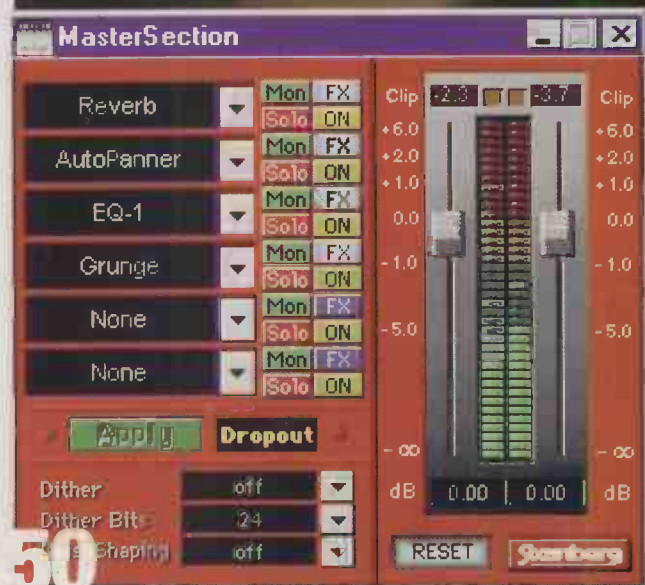

REVIEWS

- 20** **AUDIO TOYS 8MX2**  
The perfect partner to an 8-track digital recorder, Bob Dormon checks out this rackmounted mixer/limiter
- 22** **KENTON PRO 2000**  
Peter Forrest tests Kenton's new two-channel MIDI-CV convertor which promises to work with 95% of old synths
- 24** **CLM DB400S**  
A four-channel mic pre-amp with a difference; Trevor Curwen meets a unit with Middle + Side recording capabilities
- 27** **KORG 1211I/O & EMAGIC AUDIOWERK 8**  
A new wave of high performance PCI audio cards promise to turn your computer into a serious recording tool. Nigel Lord reports exclusively on the first two out of the block
- 34** **YAMAHA O3D**  
In the second part of his review, Bob Dormon reports on how this latest digital mixer fared in real-life situations
- 41** **OPCODE GALAXY PLUS**  
A synth editor/librarian that can deal with almost any synth you own. Ian Waugh details the new features of this latest update
- 44** **SONY DTC A6/A8/A9**  
A new range of affordable DAT recorders that comes with a warranty covering studio use. Paul Mac puts them to the test
- 48** **FAIRMAN TRC**  
An EQ/compressor that has more valves than a pig's arteries, Trevor Curwen tries the Luxurious Tube Recording Channel
- 50** **STEINBERG WAVELAB 1.6**  
Ian Waugh loads up the latest version of this popular PC audio editor, which comes with a bundle of plug-ins
- 54** **ROLAND SC88 PRO**  
Roland's Sound Canvas series has become a standard in the GM world. Simon Trask auditions the most well-specified model yet
- 58** **XPRESSION DPM1 & MS1**  
Harbeth's first foray into studio monitor design, a near-field and sub-bass combination, is SSL studio-tested by Alan Branch
- 60** **ROLAND V-XPANDED VS880**  
A powerful effects board and some nifty modelling features are added to Roland's digital multitracker. Paul Mac reports

SOUND ADVICE

- 96** **SONIC ENHANCERS: PART 3**  
In the last part of this series, Bob Dormon looks at cleaning your recordings up with both software plug-ins and discrete hardware
- 100** **DIY SYNTH PROJECT: PART 4**  
Synth guru Geoff Waterston shows you how to build a state-variable filter – circuit diagrams and parts list included

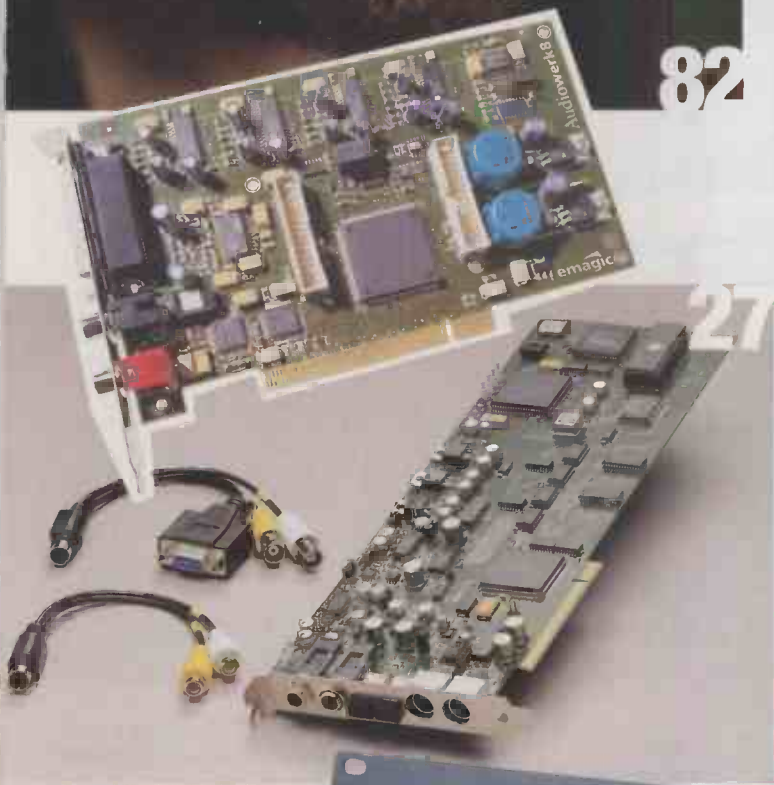
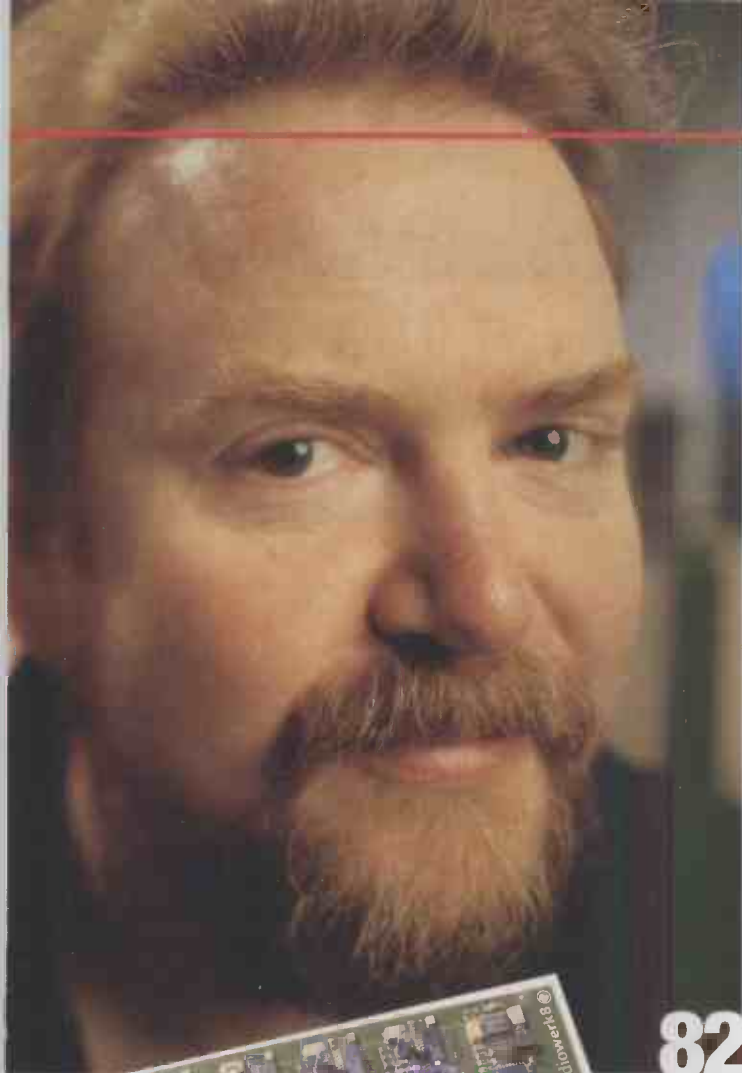

86

Win

a Yamaha A3000 sampler worth £1300!



# WAY OUT WEST

## MUSIC COMPANY

0181 744 1040

Worldwide  
Mail order

0181 744 1050

Professional Service

We buy used gear & P/X

FREE Parking

1 Minute from Twickenham station

Express Nationwide & overseas Delivery

W.O.W Mobile nationwide installation service

Educational Discount - £

### BARGAIN BASMENT

### ANALOGUE RECORDING

WAY OUT £BEST PRICES

**TASCAM**



Porta 03 £199  
414 £CALL  
New 424 II £449

**WOW**

WAY OUT £BEST PRICES

**FOSTEX**



X18 £299  
XR3 £249  
XR5 £335  
XR7 £449

R8, G16S, G24S  
OPEN REEL MACHINE SALE

**WOW**

WAY OUT £BEST PRICES

**YAMAHA**



MT 50 £299  
MT4X £399  
MT 8X £899

**WOW**

- Allen & Heath CMC 24 Mixing Desk .....£699
- Allen & Heath SR 24-4-2 Mixing Desk .....£199
- Apple Macintosh Mac II CX complete.....£299
- Alesis Microverb III.....£139
- Alesis QS6 Synth .....£265
- ART Multiverb LT .....£165
- Audio Logic PA 88A .....£145
- Akai DR4 .....£750
- Behringer Eurodesk 24:8:2.....£999
- Boss DR55 .....£179
- Boss DR550 .....£150
- Boss TR606 .....£99
- Digitech VHM5 .....£350
- E-MU Proteus 1 .....£285
- E-MU Proteus 1XR .....£299
- E-MU Proteus FX .....£325
- Fostex 4050 Sync/Autolocator .....£275
- Fostex 812 Desk 12:8:2 .....£475
- Fostex G24S with 8330 sync board (as new).....£6399
- Fostex M80 8 Track 1/4" Recorder .....£599
- Fostex 450 Mixing Desk .....£350
- Korg Prophecy .....£649
- Korg Wavestation .....£499
- Korg KEC 42 compander .....£139
- Lexicon LXP5 .....£375
- NEM 24:2 Rack mount line mixer .....£125
- Novation Bass Station Keyboard .....£199
- Roland JD800 Synth.....£995
- Roland D110 Synth module .....£199
- Roland DEP 3 .....£175
- Roland MDC-1 Dance Module .....£345
- Roland Rhodes MK80 .....£750
- Roland VS 880 with hard drive.....£1299
- Soundcraft Ghost 24 + M/Bridge .....£3999
- Steinberg Syn্থworks M1 .....£39
- Steinberg Cubasis(PC) .....£69
- Studiomaster Mixdown classic 8 with M/Bridge .....£1199
- Studiomaster Traxmix 24-8-2 with M/Bridge.....£1699
- Studiomaster Mixdown Gold 16-8-2.....£799
- Tascam DA88 .....£2799
- Tascam 688 MIDI Studio .....£1199
- Tascam MM20 MINI Mixer .....£99
- Tascam TSR 8 1/2" 8 track .....£1199
- Tascam DAP 1 Porta DAT .....£999
- Technics SY-MQ8 8 track sequencer with disc drive..£199
- Yamaha SPX90 .....£250
- Yamaha MDF 2 Midi data filer .....£250
- Yamaha TQ-5 synth Mod .....£79
- Yamaha EMP 700 F/X Multi.....£299
- Yamaha CMCS-2 .....£50
- Yamaha NS10 M Monitors .....£275
- Yamaha PF 85 Stage Piano.....£799

### DIGITAL RECORDING

**TASCAM**



NEW TASCAM 564 DIGITAL PORTASTUDIO

**YAMAHA**

YAMAHA MDA

**£BEST**

**Roland**



VS880

ANY SPEC

**£BEST**

**FOSTEX**



NEW DMT8 VL

DIGITAL MULTITRACKER

**£BEST**

**TASCAM**



DA38 & DA88

**£BEST**

**ALESIS**



ADAT XT

**£BEST**

**FOSTEX**



D89

MODULAR 8 TRACK HARD DISK RECORDER

**£BEST**

### OUTBOARD

### MIXING DESKS

<b>BEHRINGER</b>	Nanoverb.....£159	<b>WOW</b>
	Microverb IV...£199	
	Midiverb IV...£299	
	Q2 .....£599	
	3630 Comp...£199	
MEQ 230.....£229	<b>£BEST</b>	
Dualfex..... £119		
Ultrafex..... £189		
Autocom ... £169		
Composer...£219		
Multicom ....£219	<b>WOW</b>	
Intelligate...£219		
Multigate....£219		
TSR 24.....£699		
Studio Quad....£499		
Vocalist II.....£549	<b>£BEST</b>	
Studio Vocalist..£879		
Vortex.....£429		
Jamman.....£359		
Alex.....£349		
Reflex.....£429	<b>WOW</b>	
LXP 15 II.....£879		
PCM 80.....£1799		
REV 100.....£229		
SPX 990.....£729		
SPX 1000...£1199	<b>£BEST</b>	
Aphex C2		
Exciter .....£239		
BBE Sonic	<b>WOW</b>	
Maximiser ...£209		

Best Demos Best Prices



YAMAHA PRO MIXER

BEHRINGER EURODESK & EURODESK MIXER

NEW SOUNDTRAC 800S

SOUNDTRAC TOPAZ

MINI 24:8:2 BOSS

TASCAM M2500 II

### PACKAGES

**ALESIS**



A-DAT XT + TOPAZ II 24:8:2

**SOUNDTRAC**

**WOW**

**£4350**

**TASCAM**



NEW DA-38 + EURODESK

**BEHRINGER**

**WOW**

**£4195**

### MICS & MONITORS

- MICS**
- Audix OCTAVIA Sennheiser AKG beyerdynamic Neumann Rode SHURE

- MONITORS**
- ALESIS GENELEC TANTOY JBL  
Soundcraft Event Monitors  
dynamiaacoustics PMC YAMAHA

### DCC/DAT

**TASCAM**



NEW D20 & DA30 II

**PHILIPS**

**FOSTEX**

D5, D10 & D20

**WOW**



47 London Road, Twickenham, Middlesex TW1 3SA  
Tel: 0181 744 1040/1050 Fax : 0181 744 1095



# CD CONTENTS



**TRACK** **Future Loop Foundation**  
 'Shake The Ghost (Musicology Mix)' Live drum'n'bass at its best with this exclusive Mark Barratt track (Interview, page 78)

**A&R DEPT.**

**TRACK** **Close 'Hide'**  
 Contemporary pop with classic influences (A&R Dept, page 110)

**TRACK** **Raze 'Resistance'**  
 European techno grooves (A&R Dept, page 110)

**TRACK** **Critical Adjustment**  
 'At-Most-Fear (Remix '97)' Dreamy head-state drum'n' bass (A&R Dept, page 110)

**TRACK** **Justin Owen 'One People'**  
 Blunted beats and spiralling acid (A&R Dept, page 110)

**COMPETITION**

**TRACK** **Mirrormaker**  
 Win this revolutionary software (Review, page 9)



**GEAR DEMOS**

**TRACK** **Fairman VRC**  
 EQ and compression from the Valve Recording Channel (Review, page 48)

**TRACK** **Roland V-Xpanded VS-880**  
 A selection of effects and treatments from this add-on board (Review, page 60)



**TRACK** **Roland SC88 Pro**  
 The ultimate incarnation of Sound Canvas? Decide for yourself... (Review, page 54)

**SAMPLES**

**Time+Space Showcase**  
 (Sample CDs, page 64)

**TRACK** **X-FX**  
 All manne of weird and wonderful FX



**12. Jam Box Musical**  
 toolkit for house, jungle and trip hop

**13. Fields of Motion**  
 More wacky sound FX

**14. F.A.S.T Animation**  
 Spatially enhanced sound effects

**15. LF010S**  
 Bass loops, acid style

**16. Sample City 1+2**  
 Vocal compilations

**17. Steve Levine**  
 Toms and cymbals From Steve's 'Pro-Series' of samples

**18. Roland TR 606 samples**  
 Classic beatbox one-shots and loops

**TUTORIALS**

**TRACK** **DIY Synth Project**  
 Hear Geoff Waterstons synth filter in action (Sound Advice, page 100)

**TRACK** **Sonic enhancers part III**  
 How to clean up your recordings (Sound Advice, page 96)

**TRACK** **Software**

- APPLICATIONS/PROGRAMS
- MIDI FILES
- SAMPLES
- SYNTH PATCHES

**MAC SECTION**

- MidiKit2.1.1**  
 A useful MIDI file utility (Toolbox, page 94)
- Steve Levine toms and cymbals**  
 More samples from Steve's 'Pro-Series'
- Yamaha VL70-m voices**  
 New patches for the virtual synth module
- Peter Lockett drum patterns**  
 New! MIDI files played on an electronic kit
- The Mix samples**  
 A selection of samples in AIF format
- Roland TR606 samples**  
 Loops and one-shots from classic beatbox

**PC SECTION**

- BankEdit**  
 Text here text here text here
- The Mix samples**  
 A selection of samples in WAV format
- Roland TR606 samples**  
 Loops and one-shots from classic beatbox
- Steve Levine toms and cymbals**  
 More samples from Steve's 'Pro-Series'
- Peter Lockett drum patterns**  
 New! MIDI files played on an electronic kit
- Yamaha VL70-m voices**  
 A selection of new sounds for this virtual synth

**ATARI SECTION**

- MIDIMover**  
 MIDI file converter
- MUSICDB2**  
 Database for your music
- PLAYBACK**  
 Standard MIDI file player/editor
- SNIPPIT**  
 Demo version of granular synth
- STELLO**  
 Othello-type game
- SYNC-SWTOIY**  
 sync-switch project
- Peter Lockett drum patterns**  
 New! MIDI files played on an electronic kit
- The Mix samples**  
 A selection of samples in AVR format
- Yamaha VL70-m voices**  
 New virtual synth patches

**ABOUT THE CD:** The Mix CD combines normal CD audio with software readable by a computer's or sampler's CD-ROM drive. The software will not harm your CD player, but it may make an unpleasant sound. So if you value your speakers, don't play track 1! Most modern CD-ROM drives can also play audio CDs, so computer users get the best of both worlds. And don't worry about compatibility. Your CD-ROM drive - Mac, PC or Atari will simply recognise compatible files and allow you to open only those files.

# NEWS

The latest products and gossip from the world of music production...

## 8 BUSSES AT ONCE

**A**llen & Heath have returned to making recording mixers in impressive style, with the launch of their WZ20:8:2 'Wizard'. An 8-buss design, it offers a total of 28 inputs at mixdown, 4-band 2-sweep EQ, 6 stereo line inputs and 6 auxiliaries. Build quality is 'bulletproof', as A&H put it, and that means vertically-mounted circuit boards and nutted pots.

The WZ20:8:2 is clearly aimed at the 8-track mixer market, being the perfect partner to ADAT, DA88, Fostex D80 and similar machines. The big surprise, though, is the price: you can expect to see it on sale for 'significantly less than a thousand pounds', which makes it extremely competitive on the current 8-buss market. Its compact dimensions should also endear it to the space-conscious musician.

Features that you might not expect on a mixer at this price include 1kHz line-up oscillator, talkback facility, and an EQ in/out button. The

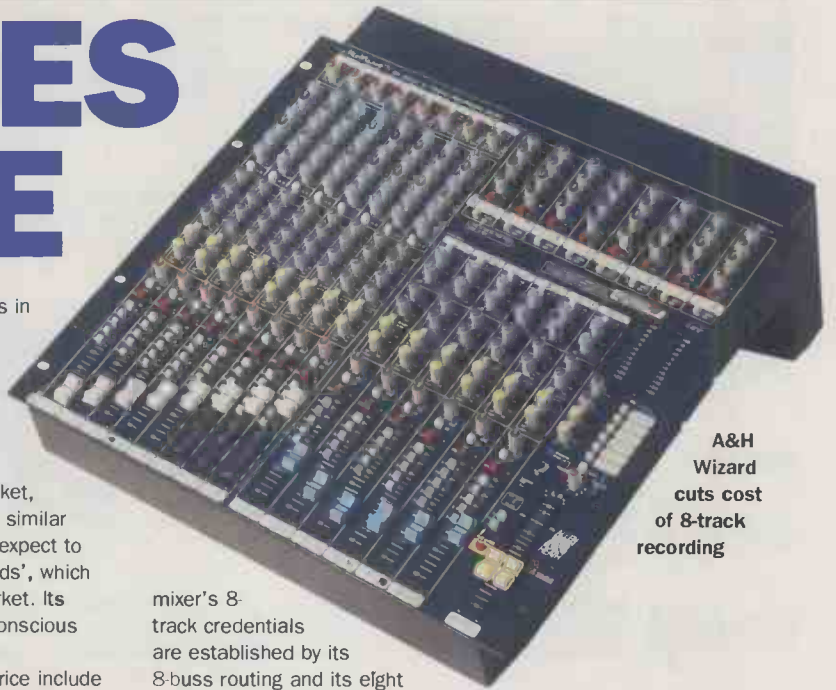

A&H Wizard cuts cost of 8-track recording

mixer's 8-track credentials are established by its 8-buss routing and its eight tape returns with stereo cue and FX routing.

Clearly, the WZ20:8:2 has been tailor-made for 8-track recording situations, and cuts the cost of such a set-up considerably. Watch out for a review soon!

More from: Allen & Heath Tel: 01326 372070

## PINO GETS PALLY WITH ADAT



Pino Palladino chooses ADAT XTs for his home studio

**P**ino Palladino, bassist to luminaries such as Paul Young, Jeff Beck and Tom Jones, has invested in a brace of Alesis ADAT XTs for his ever-expanding home studio, installed by Way Out West Music. Pino comments, "I have often used ADATs, and many of the people I work with, both in Europe and the States use them.

They sound good so it made perfect sense to stick with a tried format. Also, the units are really simple to use and sync effortlessly."

More from: Sound Technology Tel: 01462 480000

## TAKE ME TO YOUR TASCAM...

**T**he relationship between hard house dance mixes and the underworld of Dr Who cult worship may not seem immediately obvious, but they are two major contributing factors in the existence of STD, a hard core dance production house, who have just equipped their studio with a brand new Tascam M1600 24-channel mixing console.

With the installation, STD have remixed a number of tracks to take advantage of the Tascam's superior signal to noise performance, EQ, and greater number of effects sends.

"It's a huge leap forward for us, we've never produced tracks using a real mixer like the Tascam before", says Alistair Lock, programmer,

arranger and engineer at STD, "so we were discovering a lot more that we could do when finally mastering to DAT."

More from: Teac Tel: 01923 819630



M1600 interfaces perfectly with Dalek at STD



# SPL ADD TO DIGITAL RANGE

**D**esigned to complement the digital 'Red' products in SPL's Electronics range, the Machinehead is a new digital sound processor that simulates tape saturation effects of analogue tape machines. The algorithm of the Machinehead computes tape saturation effects that are difficult to achieve in the digital domain. The sonic effect increases loudness, and better

penetration of the mix at an identical peak level, with the resultant sound becoming warmer and more powerful, whilst taking away the harshness associated with digital recording. The Machinehead joins the Spectralizer and Loudness Maximizer digital products, which were launched earlier this year.  
*More from: Beyerdynamic Tel: 01444 258258*

## IN BRIEF

Electro-pop stars **ERASURE** are using the 40-input Yamaha 02R fully automated digital console for all their live performances. FOH engineer Andy Whittle, comments, "It's amazing, the Yamaha is so consistent. Having preset the values of the mix, together with the built in delays and effects, I only ever have to make minor adjustments. I can literally set it up in minutes, even at new venues, which because of their unknown acoustics, always need 'ringing out!'".

**SPICE GIRLS** were among a host of stars using AKG radio microphones at the recent Brit awards TV spectacular broadcast from London's Earls Court. Sound equipment for the event was supplied by Britannia Row and Dimension Audio. Skunk Anansie, and Jamiroquai with Diana Ross also sang into AKG's TRI-Power C5900 mic working with the WMS 900 wireless system.

**WEMBLEY CONFERENCE CENTRE** has chosen the Soundcraft K3 Theatre 40-channel console for their front of house desk in the 3000 seater Grand Hall. The console was provided by LMC Audio Systems, and forms part of a refit that includes equipment from Turbosound and BSS Audio.

**TIME + SPACE** have added to their armoury of sample CDs with a multimedia sampling CD-ROM. AXE is an eight track digital percussion machine focusing on Brazilian sounds based on 817 sound phrases separated by Instrument and bpm at a sampling rate of 44.1kHz at 16 bit.

If you like weird and wonderful electronic gadgets, check out the next issue of our sister magazine **FUTURE MUSIC**. MIDI controllers, wacky synths and weird light things are all featured in this celebration of the unconventional. FM is due to make a supernatural appearance in your newsagents on the 10th June.

PA specialists **TURBOSOUND** have expanded their marketing department, with the appointment of Allyson Dias as marketing assistant, who'll be involved in organising trade shows, exhibitions and ads.

# WIN! THE AMAZING MIRROR MAKER

**H**ere's your chance to win a copy of RTPS Systems' Mirrmaker software. In case you missed our earlier issues, the Mirrmaker is a device which reverses the scalar step sequence of a piece of music to produce a 'mirror image' which sounds completely different to the original, but still musical (see our review in the April '97 issue of *The Mix*).

All you have to do is listen to the mirrored piece of music on this month's CD (track 7) and tell us which of the following was the original tune...

1. Amazing Grace
2. Virtual Insanity
3. Pretty Vacant

Send your entries back by 30th June to: **Mirrmaker Competition, The Mix, 30 Monmouth Street, Bath BA1 2BW.**

By the way, the latest version of The Mirrmaker comes with an extended help file and a selection of MIDI files to help demonstrate the process. Further information can be obtained from RTPS Systems (Tel/fax: 01869 277884), or check out the regular column on mirror music in our sister publication *Keyboard Review*.



Double your repertoire with this ingenious new software

# REVERB AND CROSSOVER FROM RDL

**R**DL Audio, UK-based mixer, amplifier and speaker manufacturers have introduced a stereo 2-way crossover and a digital reverb unit. The 16-bit RDL 1600 reverb comes equipped with 16 pre-programmed effects, 10 reverbs, two echos and four gated reverbs. The crossover unit, the RDL GLXE has a crossover point of 180Hz, and a 18dB/octave slope separates treble and bass signals and delivers mid cut enhancement to the frequency response, giving an overall tighter sound. Further additions to RDL's line-up is a new range of their Pro Mix consoles; now available in both 8/2 and 12/2 formats, and with 3-band EQ, four auxiliaries, phantom power, and bargraph metering.

**More from: RDL Audio Tel: 01353 698589**

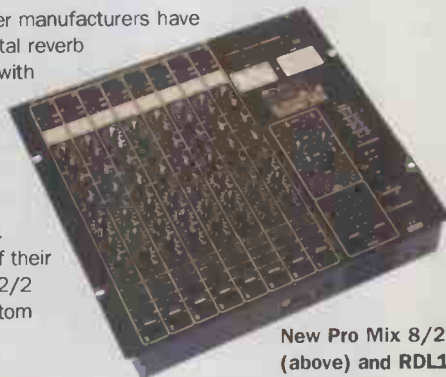

New Pro Mix 8/2 mixer (above) and RDL1600 reverb (below)



# DTRS GROWS AND GROWS

Following the success of the Tascam DA-88 digital modular multitrack, the new DA-98 boasts a number of new operational features, and is fully compatible with both the DA-38 and DA-88.

New features include full onboard synchronisation capabilities, including the generation and support of all SMPTE/EBU timecode formats, MIDI Machine Control and Sony P2 protocols. Also new is 20-bit resolution, 64x oversampling A to D converters, with switchable dither.

Also new from Tascam is

Tascam double-up with the DA-302 tape deck



their DA-302 Dual DAT recorder. Housed in a 3U rackmount chassis, the two R-DAT recorders feature a full complement of professional features as well as the obvious advantages derived from housing two independent DAT



DA-98: DTRS for grown-ups

drives in a single unit. Individual and common ins and outs are provided on the decks, with phono unbalanced analogue inputs and S/PDIF inputs and outputs for digital recording or simultaneous transfer of different program material.

Digital output is selectable between AES/EBU and S/PDIF formats, with normal and high speed dubbing available, for production of safety copies, and playback rates of 32/44.1 and 48kHz.

More from: Teac UK  
Tel: 01923 819630

## Net News

Purveyors of fine solid-state and valve processors, **TLAUDIO**, have now got their site up and running. This classy-looking site is well worth visiting, with product information, reviews, a directory of distributors, and all the latest TLAudio news. There's direct email access to technical support, and you can also send brochure requests and general feedback this way, too.

The address is: <http://www.tludio.co.uk>

Computer music suppliers **SOUND SOLUTIONS** have secure ordering in their 'Virtual Shop', which allows you to browse their products, read the reviews, and check out their prices. There's music playing on every page, and regular competitions to tempt you to visit. Two addresses for this one: <http://www.soundsol.com> or <http://www.com>

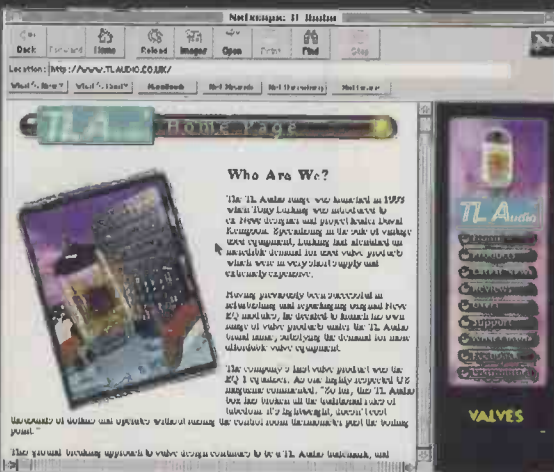

TLAudio's site is a mecca for valve lovers

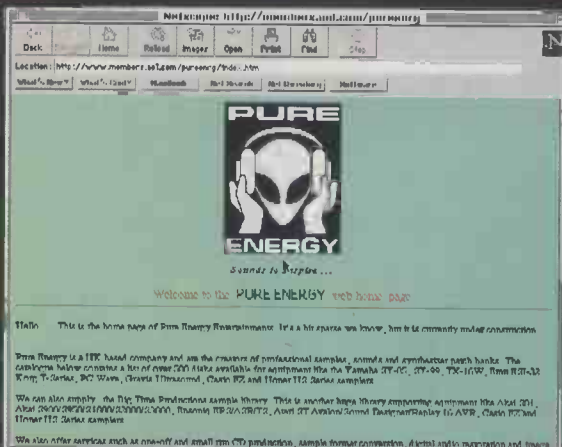

Still under construction: Pure Energy's PC music site

A new name in music retail is **PURE ENERGY ENTERTAINMENTS**, who specialise in PC software and soundcards, samples, and synth patches. Their site is currently under construction, but should soon have free samples and demos to download, as well as the usual product information and news. Point your browser at: <http://members.aol.com/pureeng/index.htm>

Also on the horizon is **TIME+SPACE'S** new net-based sample delivery system, which will make their massive sample library available to anyone hooked up to the web. This could be a great way of auditioning and buying samples, since the process can be very selective. We await to see what form the site takes...

Finally, we have a new net magazine from Future Publishing to tell you about. **CONNECT**

aims to review and rate over 250 new net sites every month, it has an exclusive Net Events Diary, and an Innovative CD-ROM that gives you instant access to the latest movie clips, music videos and game demos knocking about in cyberspace. The debut issue of *Connect* is out on Thursday May 29th and costs £4.99.

## STOP, OR I'LL IONIZE!

**A**rboretum Systems, developers of the Hyperprism audio processing software reviewed last month, have announced the release of their Ionizer software for Power Macs. With up to 512 bands of equalization, combined with simultaneous multi-band compression, expansion, limiting, and side-chain processing, Ionizer is a powerful software tool for professional sound engineers. It is ideal for a wide range of critical audio situations, including broad-band noise reduction, audio restoration, mastering, multimedia, broadcasting, sound design, special effects – anywhere powerful EQ and dynamics control are needed.

Due to its extremely efficient coding, Ionizer provides superb real-time performance. For example, the package can simultaneously perform EQ, compression and expansion on different parts of the frequency spectrum in a single pass, without any specialized third-party audio hardware. Ionizer can work as an Adobe Premiere-compatible plug-in, or run stand-alone. The Premiere plug-in version can be used within popular applications such as BIAS Peak, Macromedia Deck and Opcode Vision and Studio Vision.

More from: Unity Audio  
Tel: 01920-822890



# NEW MICS FROM



EV's new drum mic, the N/D868, has been well-received by live engineers



Low handling noise is one of the features EV's RE500 vocal mic

# EV

Two new mics have been announced by ElectroVoice – the RE500 vocal mic, and the N/D868 kick drum mic. The RE500 is intended for both stage and studio use, and combines the same condenser technology as EV's flagship RE2000 with the company's renowned noise-resistant mounting systems.

The RE500's superior sound is due to its externally-biased, true-condenser element: "The element is less susceptible to temperature variations than electret designs, and gives a much better signal-to-noise ratio, as well as a warm, tailored frequency response," explained EV's Peter Igel.

Also new is the N/D 868 high-end kick drum mic, which has been enthusiastically received by live engineers touring with major acts, who like its large-diaphragm sound and sturdy design.

More from: *Shuttlesound*  
Tel: 0181-646 7114

## Course News

SAE Technology College, formerly known as the School of Audio Engineering, is continuing its quest to become one of the most comprehensive audio and multimedia education institutions with a major refurbishment. With the acquisition and development of property adjacent to the existing premises in Islington, SAE has added an SSL-based studio, an D2R digital studio/teaching room, and a multimedia facility. There are currently 25 SAE colleges worldwide, and the developments in the UK mean that the London school now boasts more than 30 workstations and studios, filled with state of the art equipment. SAE now has the ability to train students on Neve and SSL consoles, two of the top names in the console industry. Along with the physical expansion comes a review of the curriculum; the Audio Engineering Diploma is now available as a full or part time option, and in October SAE London will be offering a degree course in conjunction with a local university.

More from: *SAE Technology College* Tel: 0171 609 2653

Manchester MIDI School is open for business, providing an array of courses in MIDI-related music production. Courses range from the one week Dance Music Production, to the Studio Recording Diploma, which lasts seven months. Hands on experience is very much the ethos of MMS, with opportunities for students on the DJ courses to put their experience into practice at the Hacienda club in Manchester. The MMS team cover a broad range of professional experience, including production, performance, promotions, management and media – spanning work with artists such as Bjork, Oasis and New Order. More from: *Manchester MIDI School* Tel: 0161 4072

# TLAUDIO WORKSHOPS



Producer Billy Sherwood is well-pleased with his Classic EQ-1 Valve Equalisers

TLAudio have announced more in-store workshops during May and June, during which their Classic, Indigo and Crimson ranges of processors will be demonstrated, along with the Spondor SA active monitors.

If you'd like to go along, make sure to ring the store before to find out the start times.

Meanwhile, another TLAudio convert has been recruited in the form of US engineer/producer Billy Sherwood. Billy's credits include Yes, Toto, and Paul Rodgers, and has been using Classic EQ-1 Valve Equalisers for a while now, with great results.

More from: *TLAudio*  
Tel: 01462-490600

The dates for your diary are as follows:

Wednesday 14th May - *Sound Control, Glasgow* (0141-204 0322)

Thursday 15th May - *Sound Control, Edinburgh* (0131-557 3986)

Wednesday 21st May - *Axis Audio, Stockport* (0161-474 7626)

Thursday 22nd May - *Sound Control, Newcastle* (0191-232 4175)

Thursday 12th June - *M Corporation, Nottingham* (0115-947 4070)

## NOW IN STEREO...

Beyerdynamic have introduced a new stereo microphone to their range, the MCE 82. Designed for X-Y recording in reporting, film and video applications, the mic has two condenser capsules with cardioid polar patterns which are mounted at an angle of  $\pm 45$  degrees of the microphone axis. The rugged metal casing makes the MCE 82 ideal for mobile recording, as the elasticated suspension of the capsules suppresses handling and mechanical noise. The microphone can be phantom powered, or from an internal battery, and a switchable bass filter eliminates wind noise and rumble.

More from: *Beyerdynamic* Tel: 01444 258258

# Absolute Power

**SPIRIT**  
THERMAL POWER PROTECT

**Absolute 4P**  
Active

SPIRIT

## They said it, not us...

Since its launch, the Absolute Monitor Series has won praise from reviewers and users alike. Here are just a few examples:

"This (Absolute 2) is a very good monitor, and simply has to be auditioned"

The Mix

"They're astonishing!... Beg, borrow or busk ... grab a pair" 92%

Absolute 4P, Platinum Award, Future Music 1997

"The power handling is spectacular and they sound great at high volumes"

Absolute Zero, Future Music

"These are by far the most cost effective speakers I have ever come across. 'Absolutely Superb'. I want a pair!!"

Absolute Zero, DMC

"Lovely transparent sound and a great bass response" (Absolute 2)

James Reynolds, Engineer

"The Absolute 2s are really good to work with - they let me hear what I want to - they have an excellent, transparent sound and a great bass response"

Tony Taverner  
Producer/Engineer

"The Absolute 2s combine a neat bottom end with an attractive, curvaceous top"

John Leckie, Producer

At just £799 a pair\*, Spirit's first powered monitor, Absolute 4P, has no peers.

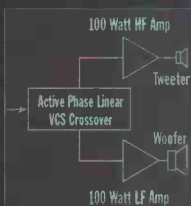

At the heart of Absolute 4P is a true phase linear active VCS crossover that completely eliminates phase delay so there's no low frequency lag, even when you're listening off-axis.

The name 4P is derived from its four 100 Watt power amplifiers. Each is precisely tuned to the tweeters and bass drivers which means smooth recreation of source signals with almost nil distortion, even at high SPLs. The drivers are actively monitored by a "music friendly" protection circuit that progressively limits very high signal levels but allows transients through, so you can drive Absolute 4P to the limit.

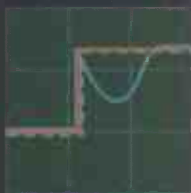

--- Input Waveform  
— Non Phase Linear System (low frequencies lag behind)  
— Absolute 4P Phase Linear System

Words won't tell you just how good Absolute speakers sound - only your ears can. Visit your Spirit stockist today and experience Absolute Power for yourself.

PROFESSIONAL ACTIVE MONITOR SYSTEM

Integral HF and LF 100W amplifiers  
40Hz - 22kHz [-3dB points]  
True Phase Linear System



Absolute 4P

£799\*

PROFESSIONAL MONITOR SYSTEM

100 Watts RMS/8Ω  
50Hz - 20kHz [+2dB/-3dB]  
High Definition Design  
Full Magnetic Compensation  
Bi-Wirable



Absolute 2

£272\*

COMPACT MONITOR SYSTEM

95 Watts RMS/8Ω  
60Hz - 18kHz [+1dB/-3dB]  
High Definition Design



Absolute Zero

£206\*

\* UK RRP per pair including VAT



**SPIRIT**

By Soundcraft

H A Harman International Company

Spirit by Soundcraft™, Harman International Industries Ltd., Cranborne House, Cranborne Industrial Estate, Cranborne Rd, Potters Bar, Herts EN6 3JN, England. Tel: +44 (0)1707 665000. Fax: +44 (0)1707 665461.

I'm power hungry.

Please send me more information on:

Absolute 4P  Absolute 2  Absolute Zero  The Range

Name: .....

Address: .....

What will you use your speakers for? .....

What magazines do you read? .....

<http://www.spirit-by-soundcraft.co.uk>

# GONGS FOR DISCS



"Fists like concrete, me" – Shell UK representative hands over a cheque and award to Platinum Discs boss Jason Allen

A 25 year old entrepreneur who set up his own record company has won a top business award – the LiveWIRE Business Start Up Awards, supported by Shell UK. Jason Allen received a check for £750 for his business, Platinum Disc Records, at a recent ceremony in Gatwick. The independent label specialises in producing drum'n'bass and jungle, and draws on Jason's experience from DJing up and down the country. The label's first single has just been released, and has already received airplay on both Radio 1 and Kiss FM. Listen out for more Platinum releases coming your way soon...

## HEAVENLY MIDI SEMINARS

Heavenly Music are to host a number of all day MIDI/Music seminars, aimed at users from beginners through intermediate to advanced. The seminars are to be presented in several parts, covering the use of MIDI sequencers, computers, sound sampling and manipulation, hard disk recording and editing, CD authoring and much more.

Each part will end with a lengthy Q&A discussion. Lunch and refreshments will also be included. The first seminar will be held in the quiet village surroundings of the scenic Lake View Bar, near Clacton in Essex, which sports a bar as well as water ski and motorboat activities – so be sure to take your wet suits along!

Tickets should be booked in advance, and don't delay since places are strictly limited and are likely to be filled quickly.

More from: Heavenly Music  
Tel: 01255 821039  
E-mail :  
heavenly@ortiz.demon.co.uk

## SX IN ADVERTS?



Grand Central Studios, specialists in sound recording for TV and cinema advertising, have been using Spirit Folio SXs for foldback and talkback in their four studios. Recent clients of the studio include BMW, Budweiser and The Disney Channel. Problems with foldback caused technical director Ivor Taylor to look for a solution:

"We initially spent a fortune on a custom-designed foldback system that simply wasn't performing up to scratch – the SXs solved the problem effectively and economically." And in a complex that has AMS Neve Logic II desks and Synclaviers in each studio, that's a high compliment.

Another AV facility, Essential Pictures, has also been making use of Spirit's compact mixers. Used in conjunction with Avid Media Composers, the Spirit Notepad has been used on a wide range of programme material, from documentaries, sports magazines, training videos and in-flight entertainment packages.

More from: Spirit Tel: 01707 665000



Spirit at the movies: Grand Central Studios (above) and Essential Pictures (top)

# ROLAND TOUR DATES

The most spectacular MI demonstration tour ever has been announced by Roland. The 'Roland 25 and Live Tour 1997' celebrates a quarter of a century of manufacturing musical instruments and sound



THE DATES ARE AS FOLLOWS:

- June 3rd  
Swansea Taliesin Theatre
- June 5th  
Dublin Temple Bar Music Centre
- June 6th  
Belfast Lyric Theatre
- June 7th  
Glasgow Tramway
- June 8th  
Newcastle Eldon Leisure
- June 9th  
Manchester University Students Union
- June 10th  
Bristol University Victoria Rooms
- June 11th  
Guildford Civic Hall
- June 12th  
Sheffield Memorial Hall
- June 13th  
**NEW VENUE!** Midlands Art Centre, Edgbaston, Birmingham
- June 14th  
**NEW VENUE!** Playhouse Theatre, Norwich

## BIRMINGHAM SHOW CANCELLED

Future Publishing has decided to cancel its planned Birmingham National Music Show, to have been held at the NEC on June 15-16th. With the London-based MIA trade show just a week after Birmingham, it was decided not to put cost-conscious exhibitors in a position of having to choose between the two shows.

Instead, Future will be concentrating on making their National Music Show in London the biggest and best show of the year. To be held at Wembley on 28-30th November, this promises to be even more successful than last year's superb event.

Roland's '25 and Live Tour' was due to finish at the Birmingham Show, and now alternative dates have been confirmed - check the full list on the right...

equipment, and features all their latest exciting products. The JP-8000 synth, V-Drums, VK-7 organ and VS-880 digital recorder will all be demonstrated by their top team of musicians, and there's chances to win some great prizes too.

It's not just demos, though: visitors can get to play with the gear themselves in special 'hands on' areas, set up at each venue.

Tickets for the 'Roland 25 and Live Tour' cost £2.50 each, and can be booked from Roland's free-call ticket hotline: 0800 765263

**PRO  
2000  
SHIPPING  
NOW**

**KENTON** electronics

ONE FOOT IN THE PAST.....  
BOTH EYES ON THE FUTURE

### MIDI-CV CONVERTERS

Our MIDI-CV converters are recognised the world over, as the finest that money can buy. From the Pro-Solo to the Pro-Four, via the brand new PRO-2000, all of them are packed with features, including built in LFO's, Portamento, and enough Auxiliary connections to drive parameters such as Slide and Accent on your TB303. But whichever synth you own, our converters are the best that money can buy.

### RETROFIT'S

If you are unable to connect up your synth via one of our many MIDI-CV converters, the chances are that we can supply a Retrofit for it. From Junos to Jupiters, Arps to Oberheims, we supply a range of over 50 retrofits for drum machines and synthesizers. We can supply these in kit form, or if you would rather, we can fit them for you.

### PLUS OF COURSE...

In addition to our PRO-SOLO, 2000 and FOUR, there are now the PRO-DCB for controlling Junos and Jupiters, and the PRO-KADI for the control of Roland drum machines. Plus our range of socket kits, which give CV and gate sockets to an ever expanding range of monophonic analogue synthesizers. And of course we supply all the leads, plugs and accessories to complete your set-up.

PRO-2000 MIDI - CV CONVERTER ONLY £229.95



PRO-FOUR MULTI-CHANNEL MIDI - CV CONVERTER £499.96



PRO-SOLO SINGLE CHANNEL MIDI-CV CONVERTER JUST £124.90 INCLUDING VAT

ALSO AVAILABLE:  
PRO-DCB / PRO-KADI @ £24.90

CALL US TODAY

**KENTON** electronics

12 Tolworth Rise South  
Surbifon

Surrey KT5 9NN (UK)

tel: +44(0)181-337 0333

fax: +44(0)181-330 1060

WORLDWIDE TRADE AND RETAIL ENQUIRIES WELCOME  
web - <http://www.kenton.co.uk/> mail - [sales@kenton.co.uk](mailto:sales@kenton.co.uk)

MOST OF OUR PRODUCTS ARE AVAILABLE FROM STOCK FOR DELIVERY THE NEXT WORKING DAY  
ALL KENTON EQUIPMENT IS FULLY GUARANTEED

# ACTIVE SOUND

# ...creative technology

**CALL NOW ON:**  
**01923 246282**  
1 2 L I N E S  
**OR FAX ON:**  
**01923 246669**

THIS IS JUST A SMALL SELECTION OF THE MANY OTHER PRODUCTS HELD IN STOCK!!!

## SAMPLERS AND HARD DISK RECORDING

AKAI S2000 INC 16 MEG.....£49.45 per month  
 AKAI S3000XL INC 16 MEG .....£88.79 per month  
 AKAI S3200XL INC 32 MEG .....£172.79 per month  
 ALESIS ADAT XT INC 2 TAPES AND LEADS ETC  
 .....£114.54 per month



**ROLAND VS880 INC F/X  
 AND HARD DRIVE ETC**  
 £106.09 per month  
 (VS880 M2 UPGRADES  
 AVAILABLE NOW)

EMU ESI 32 (INC SCSI AND 32 MEG) £46.58 per month  
 EMU 6400 INC 32 MEG .....£108.94 per month  
 EMU 4X (CAN'T BE BEATEN ON PRICE, LOOK).....  
 .....£136.44 per month  
 EMU 4K (AGAIN, WE CAN'T BE BEAT ON PRICE)  
 EMU 4X TURBO ..... £159.95 per month

**SOUNDSCAPE VERSION 2, ON DEMO NOW.**  
**THE ONLY SERIOUS SYSTEM THAT WORKS.**  
**DEFERRED FINANCE AVAILABLE**  
 YAMAHA'S LATEST MEGA SAMPLER A3000 ..£PHONE

**GIVE US A CALL AND VISIT OUR NEW HI-TECH STORE**  
**WHERE WE CAN ADVISE YOU WHILST WE**  
**DEMONSTRATE. PLEASE NOTE WE ARE THE UK'S**  
**ONLY PRO-MAIL ORDER TRACKING COMPANY**  
**CAPABLE WITH THE AID OF THE LATEST COMPUTER**  
**TECHNOLOGY TO ORGANISE YOUR MAIL ORDER**  
**TRANSACTION WITHOUT FAULT.**

## MIXERS/MICROPHONES AND PA

SAMSON MIXPAD 9 .....£159  
 SAMSON MIXPAD 12 .....£249  
 SAMSON MPL1502 (INC FREE S11 MIC WORTH £89).....£299  
 SAMSON MPL1640 (INC FREE S12 MIC WORTH £129) .....£499  
 SAMSON MPL2242 .....£LOW PRICE  
 KORG 168RC DESK .....£1799

**YAMAHA 02R, ON DEMO NOW, VISIT US SOON,**  
**COST SHOULD BE DISCUSSED WHILST HERE.**  
**YAMAHA PROMIX0!**

.....£PAY SMALL DEPOSIT NOW, NOTHING FOR 6 MONTHS  
 YAMAHA 03 (INTEREST FREE AVAILABLE AS IS DEFERRED) ..£2999  
 TC FINALIZER.....£DISCUSS THIS PRODUCT WITH OUR SPECIALIST  
 TC WIZARD ..£AS ABOVE, ALL TOO SERIOUS TO SIMPLY MORDER  
 SPIRIT FOLIO NOTEPAD .....£199  
 SPIRIT FOLIO 12:2 (INC 10 JACK TO JACK LEADS).....£449  
 SPIRIT FOLIO F1 14:2 (INC 10 JACK TO JACK LEADS).....£379  
 SPIRIT FOLIO FQ 16:2 (INC 10 JACK TO JACK LEADS) .....£449  
 SPIRIT FOLIO SX (INC 20 JACK TO JACK LEADS) .....£619  
 STUDIOMASTER DIAMOND CLUB .....£299  
 ALESIS X2 24:8:2 MIDI CONTROL RRP WAS £10,000.....£3995  
 EV SX200 PA PER PAIR.....£WILL NOT BE UNDERCUT, CALL US  
**JBL TURBO SOUND, TOA, DYNAMIX, ETC ALL IN STOCK AND**  
**AVAILABLE NOW. GENELEC 1029A, 1091A AVAILABLE NOW.**  
**AKG, SHURE, AUDIO TECHNICA, RODE. AGAIN WE SUPPLY**  
**EVERY MODEL OF MIC, CALL FOR INDIVIDUAL LOW PRICES**

## HOME STUDIO AND PRO AUDIO AND F/X

ALESIS MEQ 230 .....£249  
 ALESIS 3630.....£209  
 ALESIS NANOPIANO .....£329  
 ALESIS NANOBASS .....£229  
 ALESIS NANOVERB .....£159  
 ALESIS NANOCOMP.....£159  
 ALESIS MICROVERB .....£219  
 ALESIS WEDGE .....£429

**ALL ALESIS PRODUCTS WILL BE SUPPLIED  
 WITH A FREE MIC WORTH £89.00**

BOSS SX700 .....£399  
 BOSS GX700.....£419  
 BOSS VT1 .....£259  
 DIGITECH STUDIO 400.....£37.45 PER MONTH  
 DIGITECH GSP 2101 ARTIST .....£UK LOWEST  
 DIGITECH VTP1 .....£UK LOWEST  
 DIGITECH XPI00 AND 200.....BOTH £179  
 ROLAND VG8 INC EVERY OPTION

ROLAND GR30  
 £31.45 PER MONTH



ROLAND SRV330 .....£35.94 PER MONTH (UK LOWEST)  
 ROLAND AF70 (COMES WITH 5 FREE MIDI LEADS).....£299  
 ROLAND AD5 (COMES WITH FREE MIC WORTH £89).....£299  
 ROLAND G110P .....£27.45 PER MONTH  
 ROLAND GP100 .....£37.45 PER MONTH

**WE STOCK MOST BOSS EQUIPMENT  
 (TOO MUCH TO LIST)**

BOSS GT5 (INC FREE HOME HI-FI SYSTEM WORTH £299) .....  
 .....£32.95 PER MONTH  
 TASCAM DA20 (INC 10 JACK TO JACK LEADS .....  
 .....£34.95 PER MONTH  
 TASCAM DA30 .....£59.95 PER MONTH  
 TASCAM DA38 .....£126.69 PER MONTH  
 (GIVE UP SMOKING AND IT'S FREE. UK LOWEST)

TASCAM 564  
**WE STOCK THE WHOLE RANGE OF  
 TASCAM MULTITRACKS PLEASE CALL**

YAMAHA SPX1000 .....£1199  
 YAMAHA D5000 .....£1249  
 YAMAHA SPX990 .....£749  
 YAMAHA REV 100 .....£CALL FOR SPECIAL PRICE  
 YAMAHA MD4.....£39.95 PER MONTH

**FULL RANGE OF YAMAHA MULTITRACKS  
 IN STOCK NOW**

SPIRIT ABSOLUTE 0'S .....£189  
 SPIRIT ABSOLUTE 2'S .....£249  
 SPIRIT ABSOLUTE 4P'S .....£CALL URGENTLY  
 ALESIS MONITOR 1'S .....£299  
 ALESIS MONITOR 2'S .....£549  
 ALESIS POINT 7'S .....£239  
 YAMAHA NS10 M'S .....£359  
 GENELEC (THE RANGE) .....  
 £SORRY, NO PRICE. PLEASE CALL, WE'LL MAKE YOUR DAY.



**ALL PRICES  
 INCLUDE VAT  
 AND  
 DELIVERY**

TEL: (01923) 246282 / (01923) 444599 FAX: (01923) 246669 WEBSITE: HTTP://WWW.ACTIVE SOUND.CO.UK  
 OPEN MONDAY TO FRIDAY 10AM-6:00PM (SATURDAY 11AM-5:30PM).



CALL NOW ON:

01923 444599

1 2 L I N E S

OR FAX ON:

01923 246669

ALWAYS COMPETITIVE IN PRICE. NEVER BEATEN IN SERVICE

...creative technology

ACTIVE SOUND

MAIL ORDER SPECIALIST

WHY YOU SHOULD BUY

FROM US:

CASIO

We offer same day next day delivery service

YAMAHA

Payment on delivery (selected areas)

ROLAND

Tailor designing systems to suit your requirements

Authorized service centre

Educational discounts

Installation and

training

Part exchange welcome

Demo suite try before you buy

Viewing by appointment only

Account customers welcome

Payment by Access/Visa/Switch Amex/Cash/Postal Order/Transfer

Instant Cheque Clearing

0% INTEREST FREE FINANCE OVER £500

TASCAM

9-12 MONTH DEFERRED PAYMENTS

KEYBOARDS, SYNTHS AND PIANOS

ROLAND RD500 (88 NOTE WEIGHTED)	£67.45 PER MONTH
ROLAND XP50 (INC ONE EXPANSION CARD)	£59.95 PER MONTH
ROLAND XP80	£86.59
ROLAND XP10	WELL UNDER £499, BETTER CALL US
ROLAND A90EX	£94.95 PER MONTH
ROLAND A33	£365
ROLAND VK7	£84.95 PER MONTH

ROLAND JP8000  
£70 PER MONTH



KORG TRINITY	£76.34 PER MONTH
KORG TRINITY PRO	£102.69 PER MONTH
KORG PROPHECY	£42 PER MONTH
KORG X5D	...EVERY LIKELY TO HAVE SOLD OUT, TRY CALLING
YAMAHA QS300	£999
YAMAHA CS1X	£549

ANIX, WILL EAT ITS OPPONENTS

INTEREST FREE FINANCE AVAILABLE

ENSONIQ TS10 .....MEGA LOW PRICE OF £999

ALESIS QS6 .....£699

ALESIS QS7 .....£949

ALESIS QS8 .....£1599

FULL RANGE OF STUDIO LOGIC (FATAR) MASTER KEYBOARDS AND CONTROLLERS IN STOCK FROM.....£279

FREE, ANY PURCHASE TOTALLING OVER £1000 WILL BE SUPPLIED WITH A COMPLETE HOME HI-FI SYSTEM WORTH £299

SOUND MODULES/DRUM MACHINES AND TONE GENERATORS

ALESIS S4PLUS	£PAY IN 6 MONTHS
EMU DRUM KAT (EXCELLENT PRODUCT, PHONE FOR INFO)	
EMU ORBIT V2	£699 (PLUS LAUNCH PAD) .....£999
EMU CARNIVAL	£869
EMU PLANET PHAT	£849
EMU PROTEUS FX	£399
NOVATION BASS STATION RACK	£349
NOVATION DRUM STATION	£329
ENSONIQ MR RACK (CAN'T BE BEATEN ON PRICE)	£999

LATEST NOVATION UNITS AVAILABLE SOON

ROLAND JV1080	£49.95 PER MONTH
ROLAND JV2080 (INC CARD OF YOUR CHOICE)	£65.50 PER MONTH
ROLAND MGS64	£549
ROLAND MBD1	£399
ROLAND PMA5	£429
ROLAND SC88 PRO	£649
ROLAND SD35	£619
ROLAND MDC1	£329
ROLAND MC303	£26.45 PER MONTH



WALDORF PULSE PLUS.....

.....£UK LOWEST

YAMAHA MU5 .....£229

YAMAHA MU50 .....£419

YAMAHA MU80 .....£529

YAMAHA P50M .....£339

YAMAHA RY20 .....£369

YAMAHA RY8 .....£229

YAMAHA QY700 £99.99 NOW

BALANCE IN SIX MONTHS

YAMAHA SU10 (POCKET

SAMPLER) .....£279

ROLAND MSI (PORTABLE

SAMPLER) .....£299

MUTRONICS MUTATOR

.....£COME DOWN FOR A DEMO, PAY DEPOSIT NOW, BALANCE 6 MTHS

HD RECORDING & MULTI-MEDIA SYSTEMS

**Pentium P133** • 16Mb System Ram - 256K Cache • 3.5" Floppy - 1.2Gb Fast IDE Hard Disk • 8 Speed CD Rom • 14" Monitor - 1Mb Video Adaptor • MaxiSound 64 Full Duplex Sound Card • Win/95 Keyboard - Mouse - Win/95 • Desktop or Mini Tower Case - Active Speakers • 49 key Master Keyboard inc Notation & Sequencing Software  
**£54.00 per month**

**Pentium P133** • 16Mb System Ram - 256K Cache • 3.5" Floppy - 1.2Gb Fast IDE Hard Disk • 8 Speed CD Rom • 15" OSD Digital Monitor - 1Mb Video Adaptor • Turtle Beach Fiji Hard Disk Recording Card • Win/95 Keyboard - Mouse - Win/95 • Desktop or Mini Tower Case - Active Speakers  
**£58.33 per month**

**Pentium P200** • 32Mb System RAM - 512K Cache • 3.5" Floppy - 2.0Gb Fast IDE HD • 4 x 6 Writeable CD ROM Drive • 15" OSD Digital Monitor - 1Mb Video Adaptor • Turtle Beach Pinnacle Hard Disk Recording Card • Win/95 Keyboard - Mouse - Win/95 • Desktop or Mini Tower Case  
**£106.82 per month**

AUDIO-DIGITAL SOUND CARDS

Audiowerks 8 2in/8out PCI	£499
AWE 64	£169
DMan Digital Audio Card	£239
CardD Plus	£575
Digital only CardD	£297
Maixound 64 (Full Duplex)	£189
MultiWav Digital I/O	£439
MultiWav Pro 18 I/O	£539
Roland ATW-10 (RAP-10)	£99
TripleDac V2 Card inc Software	£1220
Turtle Beach TBS2000	£148
Turtle Beach Tropez Plus	£259
Turtle Beach Fiji	£349
Turtle Beach Pinnacle	£459
Yamaha DBS0XG	£115
Yamaha SW60XG	£139
Yamaha MU10XG	£195

MIDI-ADAPTOR CONNECTORS & INTERFACES

Winman Internal 1x1	£45
Winman Internal 2x2	£69
Winman 4x4 SMPTE	£199
Winman Syncman	£99
Winman Syncman Pro	£69
Winman Smartsync	£79
Winman Parallel or Serial 1x1	£79
Opcode Studio 64X	£256
Mark of the Unicorn Midi Express	£362
Mark of the Unicorn Midi Time Pc	£639
MidiQuest 2 Port SE	£182
MidiQuest 8 Port SE	£389
MidiQuest Midi Engine	£95
Mac Midi Adaptors 1x1	£32
Mac Midi Adaptors 1x3	£41
Midi Edge 1x1 inc Wave Conn	£56
Midi Edge 1x4 inc Wave Conn	£119
Sound Card Midi Adaptor	£25
Full selection of Midi Adaptors, Lds, Conns	

SOFTWARE

Autoscore (Mac)	£129
Band In A Box (PC, Mac, Atari)	£89
Cakewalk Home Studio	£99
Cakewalk Professional V5	£189
Cakewalk Pro-Audio V5	£289
Cakewalk Pro-Audio Delux V5	£369
Coda Finale	£490
Musicator - Musicator Audio	£299
Musicware Piano Course 1, 2 or 3	£69
Piano Discovery	£189
Musicware Piano System	£95
Sound2Midi	£139
Soundtrek Jammer Pro V2.0	£125
Steinberg Cubasis PC	£238
Steinberg Cubase V3.0	£319
Steinberg Cubase Score	£489
Steinberg Cubase Audio	£649
Steinberg Wave Lab V1.5	£389
Sion Software Quickscore Elite V5.1	£69
Sion Software Quickscore Elite Level 11	£149
Nightingale Notation (Mac)	£385

Call for further selection of software titles

STUDIO PACKAGES

Folio F1 16/2	£452	Yam ProMix1	£1999
Alesis RA100	£349	AT4033	£499
Monitor Ones	£325	Alesis RA100	£349
AT4033	£499	Alesis Mon 15	£349
Alesis 3630	£225	Quadraverb 2	£699
Midiverb 4	£329	Joe Meek VCI	£599
Tascam DA20	£799	Tascam DA20	£799
£111.66 per month		£198.33 per month	
Folio F1 16/2	£452		
Samson S12	£150		
Alesis RA100	£349		
Alesis Monitor Ones	£325		
Alesis Nanoverb	£169		
Alesis Nanocomp	£149		
£59.91 per month			
Yamaha O3D	£2999		
Alesis Adat	£2100		
£191.25 per month			

GEAR TO CLEAR

Casio HT3000 Keyboard	£299
Yamaha Y5212 Speakers	£199 (pair)
Mojo Pic22	£1.99
Mojo MH4	£249
Mojo MQ302	£309

Samson Model E30 EQ Unit	£179
Alesis SR16 Drum Machine	£179
Art MR1 Reverb	£80
Eon Power 10 Spkrs	£50 low, can't print
Kurzweil PC88 Weighted Piano	£1599

IMPORTANT NOTE: We happen to have opened our new hi-tech/pro-audio store next door to **GUITARLAND** who keep in stock over 100 gtrs and carry in stock the range of Marshall, Peavey, Fender PA etc. Let Guitarland look after you whilst we do the same all in one go.

If you happen to notice another retailer attempting to undercut our prices simply let us know, we will (not at the cost of sacrificing after sales support) do all we can to furnish you with your equipment and expected high standards of service to at least a matched price.

# MANOR MOBILES

The history of mobile recording is littered with valiant attempts and inevitable failures, but one company seems to have got the balance right and is expanding into the European market. Nick Smith reports on Manor Mobiles

**T**he mere thought of mobile recording studios can conjure up some evocative images: you start to think of '70s rock bands with long hair, hanging around in quaint ramshackle caravans crammed with dodgy gear. These images probably spring from your first ever encounter with the concept of the studio-on-wheels, and that is the strange reference to "the Rolling-truck-Stones thing just outside" in Deep Purple's perennial 'Smoke on the Water'. And if that's an image that won't go away, then it's the fault of the song, because – like the rest of us – mobile recording and broadcasting has come a long way since then. These days it's a big and serious business.

## On the Manor

It's beyond dispute that the most influential player in the field is the now EMI-owned Manor Mobiles, who with the recent acquisition of a fourth unit specifically to service the Spanish market, boast the largest fleet around, and consequently the most versatile and comprehensive range of facilities for its clients.

Popular mythology has it that when EMI bought Virgin records about three years ago

## RECENT CLIENTS

The Brits (Audio Logistics & Initial Television), Ocean Colour Scene, MTV, Björk, MCA, No Doubt, Fun Lovin' Criminals

they didn't even realise that they were getting The Manor recording studio, let alone a mobile. Sadly for our industry, when the stuffed suits got together for a calculator-fest they decided to close down The Manor to cries of 'off-side' all round. Somehow, though, the mobile avoided getting the chop, and over the next few years it expanded to its current, enviably healthy position – largely due to the business acumen of Sales and Marketing director Mike Oliver. It was under his stewardship (and with £400,000 investment from their new owners) that Manor Mobiles was able to increase their fleet and open up additional offices in both Paris and Barcelona.

There's no black art behind running a successful mobile operation, as the requirements are pretty obvious and straightforward. Firstly, and most importantly, you've got to be able to deliver

a state-of-the-art control and machine room with sufficient recording channels and communications, in one piece, to wherever and whenever your client requires. This basically means that the gear you rig out the truck with has to be robust enough to stand up to days on the road without falling apart. Secondly, it helps if you can man the truck with engineers who can also double-up as drivers - there's no flying out to meet the truck once it's on location. And that can mean an incredibly long time on the road.

Thirdly, you need patience, and a lot of it. This is not so much on account of the technical difficulties associated with the recording or the broadcast, but more to do with the fact that when you arrive at the gig, no one has given the slightest thought to where you're going to be able to park the truck or how they're going to route enough power to it to keep both the recording gear and the air-conditioning working at the same time. And you've got to be patient enough to keep your head in urban battle-zones; a couple of years ago Manor Mobile engineer Dave Porter found himself parked up behind the Brixton Academy for a live transmission of a Pulp gig, just a day after the riot. It's not always so stressful, as Will Shapland explains: "Tonight's gig is a comparatively sedate affair – Depeche Mode at Adrenalin

Village, where the biggest problem was that the band wanted to soundcheck a six-song set for four hours."

### The kit

Horror stories aside, there's a serious job to do, and that requires serious equipment. A quick look at the equipment inventory of Manor 1, the flag-ship of the fleet, confirms this. There's an adapted 48-channel 32 bus Solid State Logic E series with G series computer, a 24-channel 16 bus API as well as 72 channels of API remote mic pre-amps. When it comes to tape machines there's the choice of either an Otari MTR 90 MkII 24-track analogue unit, two Mitsubishi X880 32-track digitals, two Sony 24-track digitals, four DA88 digital 8-track machines or any combination you like, up to a possible 192 tracks. Monitoring is in the form of ATC 150s (main) or Yamaha NS10s (near), with a vast array of outboard and mics. But it's not until you get into the communications that you really get the picture: for the multi-ways there's 2 X 54 pair (75m), 2 X 27 pair (150m), 1 X 27 pair (80m), 1 X 15 pair (150m). There are also 72 isolated mic splits (plus 132 additional tie lines) and six video inputs.

As Will Shapland says: "The real sign of a good mobile, apart from it being well maintained, is the availability of masses of channels and comms." And if you think that the figures quoted here are a bit of a belt and braces job – when you consider that for the TFI Friday show (which Manor Mobiles handle) there are at least four bands going out live – it's easy to see how these numbers can get eaten up really quickly. That's when, according to Will "things can start to get pretty hairy."

A common misconception about mobile recording studios is that their main revenue comes from record company and live bands, especially during the festival season. Though there are still a few of the more mature guitar acts out there (such as Eric Clapton or AC/DC) who may – every now and then – want to cut a live album and the ubiquitous Radio 1 simultaneous broadcasts (from the Phoenix festival for

<h2>Equipment List</h2>	
<p style="text-align: center;"><b>Console</b></p> <p>48-channel SSL E series with G series computer 24-channel API 72 channels of API remote mic pre-amps</p> <p style="text-align: center;"><b>Tape machines</b></p> <p>Otari MTR 90 MkII 24-track analogue 2 X Mitsubishi X880 32-track digital 2 X Sony 24-track digital 4 X DA88 digital 8-track digital Studer A810 stereo Sony PCM7019 time code DAT Tascam DA30 DAT Sony and Technics cassette decks</p> <p style="text-align: center;"><b>Monitors</b></p> <p>Main monitors: ATC 150A Nearfield: Yamaha NS10M</p> <p style="text-align: center;"><b>Outboard</b></p> <p>Eventide H3000 D/SE, H3000 Yamaha Rev 7, SPX90, SPX1000 Roland SDE3000</p>	<p>BEL AD80S Lexicon PCM70 Lexicon 480L AMS 15/80 de-glitching/sampling Tubetech CL 1A compressor Tubetech CL1B dual/stereo compressor Focusrite Red 3 dual compressor/limiter Summit Audio DCL200 Urei 1176 X 3 Urei LA4 X 2 JoeMeek stereo compressor JoeMeek voice channel Audio &amp; Design ADF760 dual compressor X 2 DBX 160 compressor X2 DBX 166 dual compressor plus 163 X2 BSS 402 compressor X2 Drawmer DS201 dual gate Ear EQ</p> <p style="text-align: center;"><b>Microphones</b></p> <p>Neumann, AKG, Sennheiser, Shure, B &amp; K, Beyer, Sanken, Electrovoice</p>

example) but the real business comes in from TV and video. For example, recently Manor Mobiles were responsible for the outside broadcast sound at this year's Brit Awards. This incredibly complex event meant that Manor had to draw on the resources of all four of its trucks. One was assigned the task of comms links between teams of camera crews, sound crews, producers, directors and stage personnel, one was dedicated to mixing tracks as soon as they were recorded, while the other two were used for playback and recording. Given that the finished soundtrack was finally mixed and laid back to picture at the post-production suite in Manor 1 and delivered on time, a justifiably relieved Mike Oliver said: "The perennial problem with the Brits is the delivery schedule, with eight bands needing to be mixed in such a short time. Having four trucks on the job meant that we could save time as well as having backup in

the event of any major problems."

Not surprisingly, then, the efforts of the Manor crew were roundly praised by the programme's musical supervisor, Toby Allington, who called them "without doubt the most professional outfit in the UK". This sentiment is echoed by the fact that Will Shapland is currently up for a BAFTA award for his work on TFI Friday.

### Competitive streak

Despite these accolades and a comfortable market position, Mike Oliver is phlegmatic about the door now being well and truly opened for competition: "With the arrival of digital TV and its explosion of channels, I see music playing a huge part in programming schedules. Music television is pretty cheap to produce, and what may happen is you'll get a lot more of the smaller trucks springing up to service the demand."

Is the message, then, that the mobile is simply a control room on wheels? "The only real difference is that you have to make things a little more bullet-proof, and the design has to be flexible enough to deal with a wide range of situations. On TV work like TFI Friday where you've got an awful lot of signals coming in and out of the truck. In principle, the SSL truck [Manor 1] is just like any other SSL studio but with wheels on it. To be honest I've heard a lot worse set-ups in terrestrial studios." ■



**A range of tape machines is provided to suit the client's preference**

## RATES

No fixed rate available, but Mike Oliver says: "Our policy is to name a price for the job and stick to it. There are no hidden extras and you get two tape machines running to avoid tape changes."

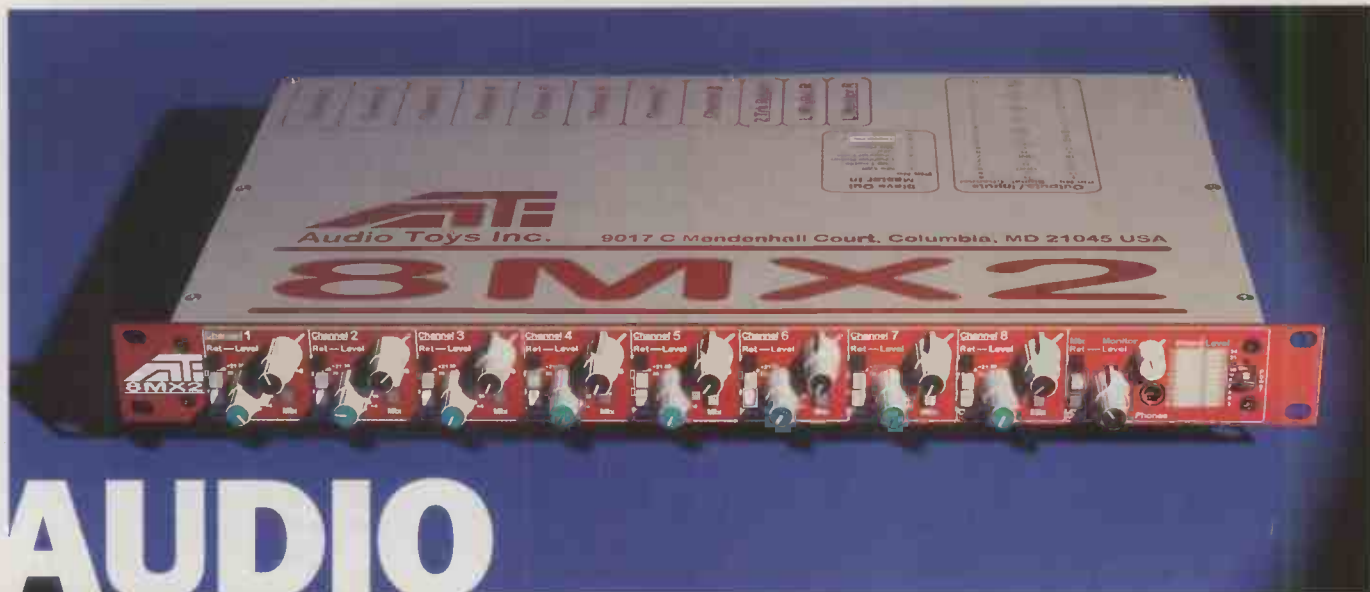

# AUDIO TOYS 8MX2

**Bob Dormon meets a perfect recording partner for his Tascam DA38...**

**T**he 8MX2 has been optimised for digital recording, providing a limiter on each of its eight channels to keep potentially disruptive transients in check. A 25 way D-sub connector on the back panel provides easy access to send and return signals. Custom leads are available for models such as Alesis ADAT and Roland DM-800, and Tascam DA-88/38 owners will be pleased to learn that the pin configurations match those on their machines. So what you have in effect is an eight channel mixer, with no aux sends, no EQ, but independent limiting and phase reversal plus a 2-track return.

But there's more, and a glance at the back panel helps to make more sense of the flexibility of the 8MX2. All eight input channels are balanced XLRs clearly marked as pin 2 hot, and have a gain range that can handle anything from minute microphonics to loaded line levels, with 65dB of boost to hand. Above each input are two switches: phantom power on/off and an earth lift. Along from there you have three pairs jacks for 2-track return, Mix Out and Monitor Out. Things get more intriguing with the pair of 9-pin D-sub connectors marked Master In and Slave out. These provide the means to connect up to three 8MX2s for 24-track recording and mixing, by daisy-chaining their respective mix outputs that also appear within each connector.

## 8-Channel Mixer/Limiter £1757

Adjacent to them are the larger 25-pin D-types that accommodate balanced 8-channel sends and returns for one-to-one channel interfacing with a multi-track.

### Up front

The front panel looks more like what you'd expect to see on a compressor or noise gate than a mixer. Two dual concentric pots take on most of the work. The upper arrangement controls level and pan, with the lower pots dealing input gain and limiter threshold. The knobs themselves were far too wiggly for my liking, but I'm told that this has been rectified. Each channel has four switches, a solitary grey one on the right of each channel puts the signal in or out of the mix bus. On the left row of three, the top black one toggles between the input and the tape return, the grey one is for phase reversal and the white one is called Cue (solo), its actual function being governed by the Cue/Pre switch in the Master section on the right.

The Cue master status will allow you to hear the channel post limiter or pre-fader. The corresponding levels appear on the single 10-segment Level meter. It's not a stereo display, as the other meter adjacent to it shows the limiter's attenuation for the channel(s) currently in Cue mode. Apart from the Cue status switches, the master section has 2T return, Monitor level, Mix Level Master, an overall pan control, and the pleasing inclusion of a headphone socket. As the 8MX2 is suited for 'field' work this will prove very handy when monitoring through speakers is not an option.

### Verdict

Recording now and EQ'ing later has always been an option in sound engineering, and has grown in appeal with accessible digital audio systems. The 8MX2 is perfect for this; the limiters are fast and effective – even overloading channels produces a distortion that on DI'd guitars and basses was quite pleasing. Erroneous blips that typically accompany hard limiting were rarely heard, proving the 8MX2 to be an audio toy that'll be more than a three day wonder. **MM**

More from: The UK Office  
Tel: 01442-870 103 Fax: 01442 870 148

## AUDIO TOYS 8MX2



### WHAT WE LIKE

- Fast limiters
- Compactness
- Audio quality

### WHAT WE DON'T LIKE

- Wobbly knobs
- Unsophisticated metering

### OVERALL

Perfect 8-track partner and/or submixer, but quality (as ever) comes with a price on it.

The new Behringer EURODESK MX 3282 Live/Recording 8-Bus Console

... Ready to go ...

**NOW  
Available  
!!!!**

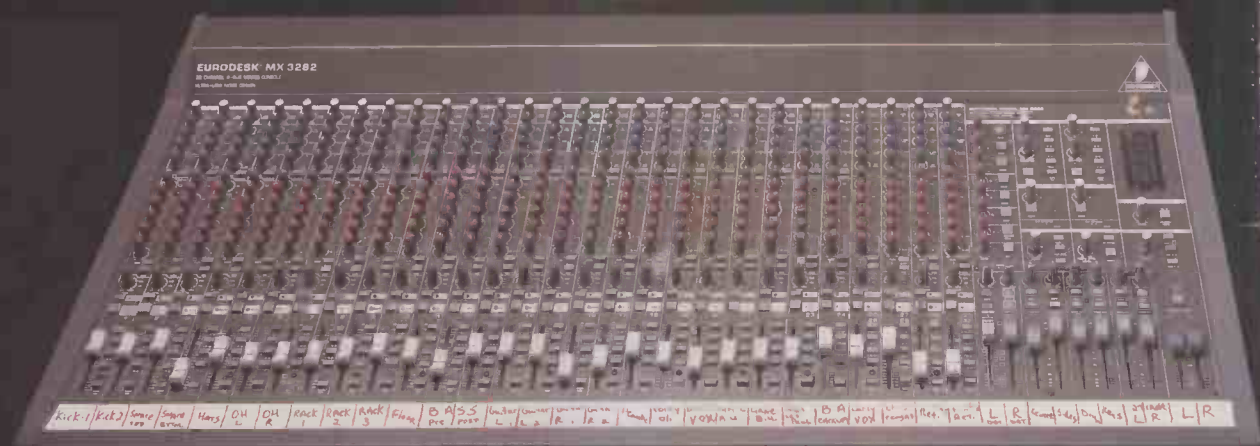

... the show begins! You've spent endless nights rehearsing with the band, gone through every step of the stage performance again and again in your mind's eye and done everything to achieve perfect sound. The mixing console has become the heart of your equipment. For your stage and studio work you've got high expectations about sound, flexibility and reliability - there's no room for compromise.

We listened to you.

The EURODESK MX 3282 is a true 8-bus console using one of the best low-noise\* technologies in the world. Our exclusive "Ultra-Low Impedance Design" based on the ICs NJM 4580 guarantees exceptional audio performance. The MX 3282 gives you 24 channels with discrete microphone pre-amps, 3-band EQs with parametric mids and low-cut

filters, as well as 4 stereo channels with 4-band EQs. All channels feature 8 aux sends (pre/post switchable), -20dB/ peak LEDs, SOLO/PFL and mute functions plus full routing facilities to 8 sub-groups. 4 stereo returns, a 2-track input, an onboard talkback section and a robust 100 W external power supply complete the MX 3282's catalogue of professional features.

As with all Behringer products, the MX 3282 is manufactured in compliance with the stringent ISO 9000 standard. Naturally, we use nothing but best quality components, such as those made by Panasonic etc.

Easy sound check, standing ovations, crystal-clear recordings, perfect mixdown, bestselling CDs.

All you need is just one console - the MX 3282.

It's been hard work. And now the success is yours!



Your Ear Is Our Judge

\*Behringer mixers are equipped with the superior type NJM 4580 operational amplifiers, for an ultra-high level of quiet musical audio performance.

Get more information about the EURODESKS and the Interactive World of Behringer! Hotline: +49(0)2154-920666, Internet <http://www.behringer.de>



© BEHRINGER Spezielle Studioteknik GmbH Tel. +49 (0)2154-92 06 0, Fax - 42 85 23

© BEHRINGER UK Ltd. Tel. +44 1483 - 45 8877, Fax - 45 8822

© BEHRINGER France S.A.R.L. Tel. +33 4 - 7804 4416, Fax - 7804 4429

© BEHRINGER Espana S.L. Tel. +34 (9) 1 766 1398, Fax 1 383 5052

© BEHRINGER AG Tel.+41 (0)56 - 210 9555, Fax - 210 9556

© BEHRINGER Austria Ges.mbh Tel.+43 (0)7752 - 85181, Fax -7752 86707

© BEHRINGER Benelux b.v. Tel. +31 (0) 73 - 513 0000, Fax - 513 0778

© SAMSON Technologies Corp. Tel.+1 516 364 2244, Fax 516 364 3888



# KENTON PRO-2000

**Peter Forrest tries the latest addition to Kenton's range of MIDI-to-CV convertors**

**K**enton's new mid-range unit has been eagerly awaited, and boasts two basic MIDI/CV channels, individually switchable between the Moog, Roland or SCI 1V/octave standard and the early Korg or Yamaha Hz/Volt (making it compatible with 95% of old monosynths) and caters for a comprehensive range of gate and trigger controllers.

It's in the area of extras that the Pro-2000 really scores. For each of the two instruments it's capable of controlling, an independent MIDI channel can be set, note priority can be switched between lowest, highest and newest, single or multiple triggering selected, transpose, pitchbend and portamento rate values can be set, a MIDI controller assigned to switch on portamento, and much more – providing more control over most monophonic synths than you'd get by playing them from their own keyboards.

### In use

The Pro-2000 was tested with an SH-101, Pro-One, MS-10, and Doepfer modular, and the results were impossible to fault. It was especially nice to have one box controlling the MS-10 and an SH-101 at the same time – something that I'd never managed before.

## MIDI-CV Converter £229.95

As well as the CV/gate channels, there are two more control possibilities. One that comes as standard is a MIDI filter/re-channel system, which can take any OMNI output from a synth and convert it to one chosen channel, or take a specific channel output from a synth with primitive MIDI (like the early DX7) and change it to any other channel. These are a nice bonus for anyone with early MIDI synths (Jupiter 6, Poly 800 and so on) which need them.

The other is optional, but is even more worthwhile if you own bits of quaint old tech that you want to run via MIDI. It's a digital output, either dedicated to DCB (Roland's pre-MIDI Juno-60 and JP-8A interface), or dual-purpose: KADI/Wasp. KADI, Kenton's proprietary interface, is designed either for possible future expansion, or to speak to Kenton-modified Roland drum machines. The best bit for me, though, was the Wasp output. Although there are severe limitations on what the old EDP synth can ever respond to, it makes such a good sound that MIDling it is a real treat.

There's more, too. A 5-pin DIN Sync 24 output socket is included, so that some old Roland machines can be run from a MIDI sequencer. There's also a clock pulse output, for syncing arpeggiators or other drum machines with a Trigger/Clock In socket. This can be set to send a pulse at various MIDI clock rates, from 1 to 24. Even better, a clock polarity switch is enabled in software, so that something like a Korg Polysix or MonoPoly arpeggiator can be clocked without a problem. There's also the option of treating 'continue' messages as 'start', or ignoring them.

### Verdict

This is an excellent MIDI/CV box, and there really isn't anything more you could reasonably expect from it. Although the business of programming it does take you a little way from the immediacy of analogue synths, the interface is well-designed and easy to use – and you can always store your seven most usual configurations in the Pro-2000's memory. If anyone else comes along with a rival box that represents better value, it'll be a remarkable achievement. **TM**

More from: Kenton Electronics  
Tel: 0181 337 0333 Fax: 0181 330 1060

## KENTON PRO 2000



**WHAT WE LIKE**

- Versatility
- Ease of use
- Inbuilt LFOs

**WHAT WE DON'T LIKE**

- Sketchy manual

**OVERALL**

A superb unit that should be high on your check-list if you're looking for a MIDI/CV converter



# 4.0

## POWER UP!

### NEW Pro Tools 4.0 from Digidesign®

#### More professionals use Pro Tools than all other workstations combined. Why?

Because Pro Tools provides powerful features for recording, editing, mixing, and mastering. With up to 48 tracks of record and 64 channels of digital and analog I/O, Pro Tools has become an industry standard with unsurpassed price performance.

Patch in your favorite gear from Apogee, dbx, Dolby, Drawmer, Focusrite, Lexicon, and t.c. electronic, — or expand Pro Tools' capabilities with software Plug-Ins from these companies and 100 others.

And now Pro Tools 4.0 has arrived. Among the dozens of new features are:

- THE MOST POWERFUL MIX AUTOMATION IN THE WORLD AT ANY PRICE
- PROFESSIONAL DIGITAL VIDEO
- MULTIMEDIA AUTHORING TOOLS
- EDITING DURING PLAYBACK
- LOOP RECORDING
- SPEED, SPEED, SPEED — POWERMAC NATIVE!

Whether you're using Pro Tools III, Project, Audiomedia, or PowerMix systems, you can rest assured that Digidesign's new Pro Tools 4.0 software will take you to new heights in creativity and productivity.

To remodel your studio with Pro Tools 4.0 or any of Digidesign's audio solutions for music, post, multimedia, and radio broadcast, call **0800 898 331**. And ask about our free Pro Tools video.



[www.digidesign.com](http://www.digidesign.com)

**Pro Tools.  
The Perfect Fit for  
Your Audio Needs.**

#### U.K. & Eire Pro Tools PCI Preferred Dealers:

ASHFIELD CTS Pro 01623 720 777	DUBLIN Audio Engineering +353 1 671 7600	GLASGOW MediaSpec 01355 272 500	LONDON Music Lab 0171 388 5392	LONDON TSC 0171 258 3454	N.LONDON Natural Audio 0181 207 1717	
BARNET Digital Village 0181 440 3440	GATWICK AudioTech 01293 821 610	LIVERPOOL Studio Care 0151 236 7800	LONDON Sycos 0171 625 6070	LONDON Turnkey Pro 0171 240 4036	RINGWOOD M Corporation 01425 470 007	WARRINGTON Dawsons 01925 632 591

**digidesign®**



**UK & European HQ** Westside Complex Pinewood Studios, Iver Heath, Pinewood, Bucks, SL0 0NH

A Division of Avid Technology, Inc. Tel: +44 1753 653322 Fax: +44 1753 654999

©1997 Digidesign, a division of Avid Technology, Inc. All features and specifications subject to change without notice. Audiomedia, Digidesign, Pro Tools, Pro Tools Project and Pro Tools PowerMix are trademarks or registered trademarks of Digidesign or Avid Technology, Inc. Apogee, dbx®, Dolby®, Drawmer, Focusrite®, Lexicon, and t.c. electronic® are trademarks or registered trademarks of their respective owners.

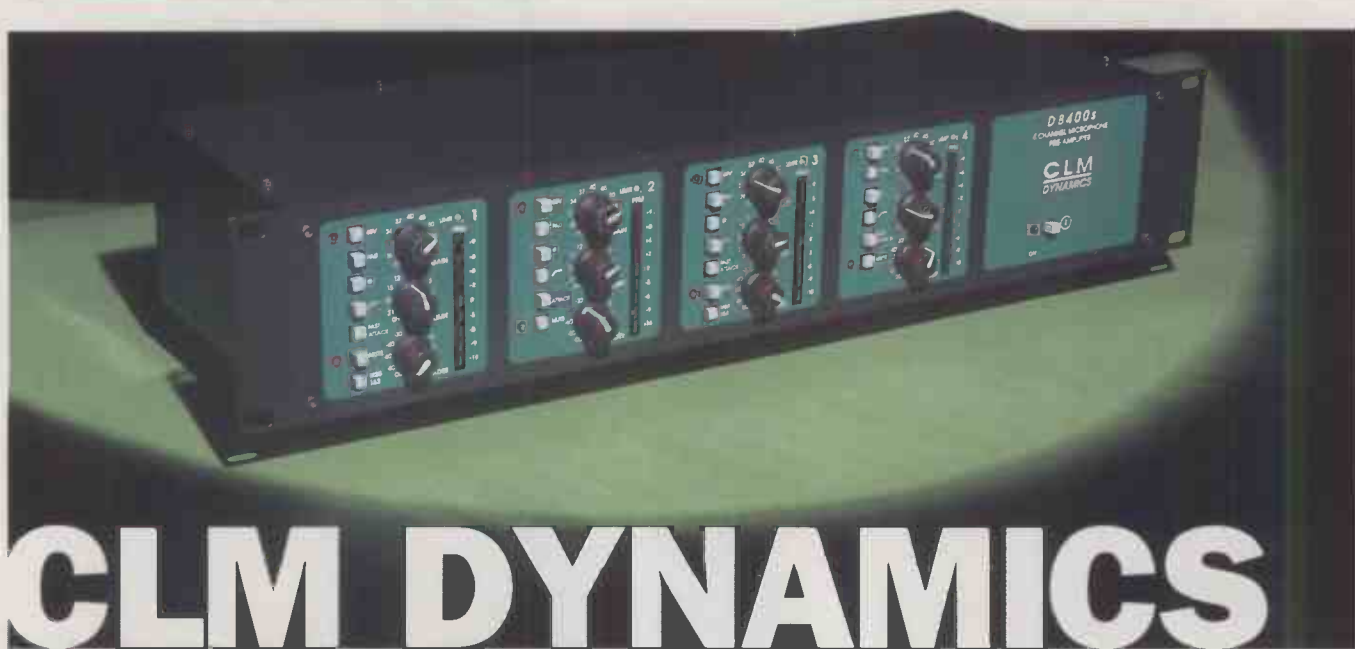

# CLM DYNAMICS DB400S

Mic Pre-Amp £1380

**Trevor Curwen tries a mic-amp with more features than first meets the eye**

**L**ately we have seen the arrival in the marketplace of several one and two channel mic pre-amplifiers, many of which incorporate some form of EQ and dynamics processing. The basic premise behind these units is to create a high quality signal path direct from the microphone to the recording medium, often completely bypassing a mixing desk. CLM Dynamics have put a new slant on this idea with their DB400s, providing four independent pre-amplifiers in one 2U box, each with their own limiter and the capacity to use pairs of channels for middle and side (M+S) recording.

**Layout**

The DB 400s is a solidly-built, well engineered unit with a classy feel to it. The four channels sit next to each other on the front panel, each with identical vertical arrays of three rotary knobs and six switches. In addition, channels 1 and 3 have an extra M+S switch which we will come to later.

Looking at an individual channel, the mic pre-amps input gain is controlled by a rotary knob and is variable from 25db to 70 db. 48V phantom power is provided on a switch with its own LED indicator and a pad switch can provide 20 db of attenuation when presented with loud sound sources. Also

present are a phase reverse switch and a high pass filter which rolls off 24db per octave below 80 Hz, perfect for reducing low frequency rumble and microphone handling noise.

A Limiter is built into each channel to prevent the output signals exceeding a set level, particularly useful when recording to a digital medium. Ratio is set at 10 to 1 and release time is automatic, varying between 0.3 and 3 seconds depending on the type of source material. Attack time in the default position is set fairly slow at 1 millisecond to avoid sudden level shifts but this can be switched to a much faster 10 microseconds using the fast attack switch giving a virtually instantaneous response which may be required for percussive instruments. When Limiting is taking place a yellow LED, directly above the bargraph, lights up.

**Middle and side**

Using this unit as four separate mono pre-amps would be just fine, but its versatility is increased by the previously mentioned M+S switched on channels 1 and 3.

Middle and side recording is a method of recording in stereo which allows adjustment of the width of the stereo image and is always mono compatible. Unlike setting up conventional left and right microphones, the M+S method uses two coincident microphones – a directional type (cardioid) pointing to the front (middle) and a bi-directional type (figure of eight pattern) at right angles (side). The middle mic sees the centre image while the side mic sees the left and right ambience, and to obtain a true stereo image the outputs from these two microphones must be summed.

With this unit, one mic is plugged into

channel 1, the other into channel 2, the M+S switch on channel 1 is engaged doing the summing, and a decoded stereo signal is now output by the two channels and can be recorded on two tracks of a recorder. The same process can be carried out with channels 3 and 4.

**Verdict**

In use, the mic amps seemed to be of very high quality – quiet and clean – and the limiters did their job properly, keeping signals to tape well under check. If you need several channels of good quality mic pre-amps this could be the model for you, while for location recording with multiple mics it's an excellent choice, the M+S capability being a great bonus. **TM**

More from: CLM Tel: 01382-534868

**CLM DYNAMICS DB400S**



**WHAT WE LIKE**

- Very quiet operation
- M+S facility
- High pass filter

---

**WHAT WE DON'T LIKE**

- Not much in practice

---

**OVERALL**

Quality mic pre-amp with added advantage of its M+S capability, great for location work



# Retro-synthesis:

Imagine the classic analogue synthesiser... where the oscillators have infinite waveforms.

## The Prologue:

The most powerful MIDI-CV converter for its price!



## The Prologue Plus:

Gives almost any synth the most obese analogue sound you've ever heard !!!

The complete MIDI-analogue INTERFACE

The Prologue Plus combines a powerful eight-output MIDI-CV processor with RETRO-SYNTH.

The RETRO-SYNTH is a MIDI-controlled analogue synthesiser with all the essential elements you would traditionally expect, but where the oscillators are substituted by any other audio input you may care to use.

The Design Laboratories' "RETRO-SYNTH" concept enables you to take the main audio output of any synthesiser and give it that REAL analogue feel.

The Prologue Range:  
From only £249 inc VAT

Please call and discover the other features that are available.

THE  
DESIGN  
LABORATORIES

Unit 3, 6 Erskine Road, London, NW3 3AJ, UK

Tel: +44 (0) 171 586 0357 Fax: +44 (0) 171 586 7651

# Sample City

CHECK OUT OUR SAMPLER  
POWER PACKAGES

AKAI AKAI AKAI AKAI

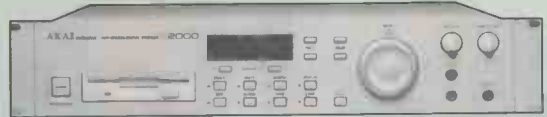

Give it to me .....from £875.00  
With megs 6, 10, 18, 32 .....£Call me  
S2000 Special, 6mb ram & cd rom drive & Akai cd rom disk, .....£999.00  
NEW AKAI MPC2000 sampler/32 voices/excellent graphic display/built in sequencer/SCSI port/expandable upto 32 meg and a full on price of only .....£1199.00  
NEW! S20 16 bit stereo sampler upgradeable to 17mb .....£499.00



UK's top dog .....from £1575.00  
As above with 32megs .....£1699.00  
S3200 xl 16mb & fx board .....£3069.00  
CD3000xl 8mb 8cd roms .....£1999.00  
ANY OF THE ABOVE WITH A SCSI ZIP DRIVE PLUS 2 100 MEG CARTRIDGES .....£169.00

EMU EMU EMU EMU EMU EMU

New pricing on Esi 32 packages all inc 3 free cd roms.....now don't be shy  
ESI 32 with SCSI .....£899.00  
ESI 32 with SCSI 32mb ram zip drive cd rom player.....£1399.00  
NEW E6400 expandable to 128 meg ram 128 voice 16 outs need we say more  
- prices start from .....£2500.00  
NEW E4X & E4X TURBO serious power pricing starts from.....£3000.00

YAMAHA YAMAHA YAMAHA YAMAHA

Samplers from .....£269.00  
NEW A3000 64 voice expandable to 128mb ram real time time stretch, SCSI option it's going to be hot, hot, hot. Prices start from .....£1299.00



SU 10 Sampler plus CS1X inc next day delivery .....£739.00

WE ALSO STOCK

Mackie, Mass, Roland, Kurzweil, Korg, Alesis, Behringer, Novation, Samson, La Audio, Fostex, Digitech, Time and Space, and much much more!!!

BUY ANY SAMPLER AND  
HAVE FREE ACCESS TO OUR  
SAMPLE LIBRARY.....

CALL US FREE ON  
0500 821795

INSTANT CREDIT FACILITIES AVAILABLE  
CALL FOR A QUOTE  
ALL MAJOR CREDIT CARDS ACCEPTED

# the MOST comprehensive LIST of midi files

MIDI-FILES FOR  
MUSIC LOVERS  
EVERYWHERE.

Simply put, you just won't find a wider range of midi-files than ours. From the latest chart hits to the classical greats, our catalogue contains over 1500 individual files, and our list grows daily.

Professional tracks for gigging bands, compilation midi disks, tuition packs for beginners or midi software. We can provide you with what you want at the most competitive prices available and with the fastest despatch around.

So when you want to make music, make for Promusic's Midi Catalogue.

\* Over 1500 midi-files starting at just £3.95 each covering every musical style imaginable.

\* New titles every day - call us for details of latest releases.

\* No minimum order quantity - just try one file to put our quality, service and value to the test. You won't be disappointed.

Stop Press

THE INTERNET MUSIC SHOP  
the online music sales of UK

Interactive Music  
Packs

Exceptional arrangements of eight chart busting hits with printed music and lyrics at just £12.99 each.

Coming soon: Eric Clapton 2, Classics 1, Classics 2, Elton John, Bob Marley, Pop.

The Midi Keyboard  
Library

A superb new series of midi packs. Eight fully orchestrated midi-files with printed music and lyrics for just £9.99. Latest titles include: Beatles 1 & Beatles 2.

Steinberg Software

Cubasis - PC - £129.00  
Cubase Score - Atari - £399.00  
Cubase 2.5 - Mac - £379.00  
& full range of Steinberg Software.

PROMUSIC

Midi-files for  
musicians  
by musicians

ORDER YOUR BIG NEW  
CATALOGUE NOW

This is just a selection from our vast range of products and titles. For the full story, our comprehensive catalogue is an absolute must.

Order yours right now!

Song Song Blue Neil Diamond  
Cracklin' Rosie Neil Diamond  
Only One Road Celine Dion  
That's The Way KC & The  
I Like It Sunshine Band  
Scatman's World Scatman  
Medley Everly Brothers  
Tragedy Bee Gees  
A Whiter Shade Annie Lennox  
Of Pale

And More

PROMUSIC, Newmarket Rd, Bury St Edmunds, Suffolk IP33 3YB

01284 702592 Fax: 01284 702592 / 768301 Internet: http://www.musicsales.co.uk

# Keyboard review

for every keyboard player

# Dudley Moore

## his unique piano style revealed!

**TWO NEW  
TUITION  
SERIES FOR  
BEGINNERS!**



**CASIO CTK-601 - UNDER £200!**  
is this the best value home keyboard ever?



## REALPIANO EXPANDER

GEM's new budget  
'piano in a box'



**ATC-1**  
meaty Moogy sounds!



## STRANGLERS

**EXCLUSIVE** interview with  
keysman Dave Greenfield

**ROLAND VK-7**  
the latest combo organ

**OUT  
NOW!**

**Future  
PUBLISHING**  
Your guarantee of value

**PLUS:** MUSIC: PLAY THE STRANGLERS' 'GOLDEN BROWN'  
AND: JOHN MAYALL, SYNTH SECRETS, RETRO, BUYERS' GUIDE

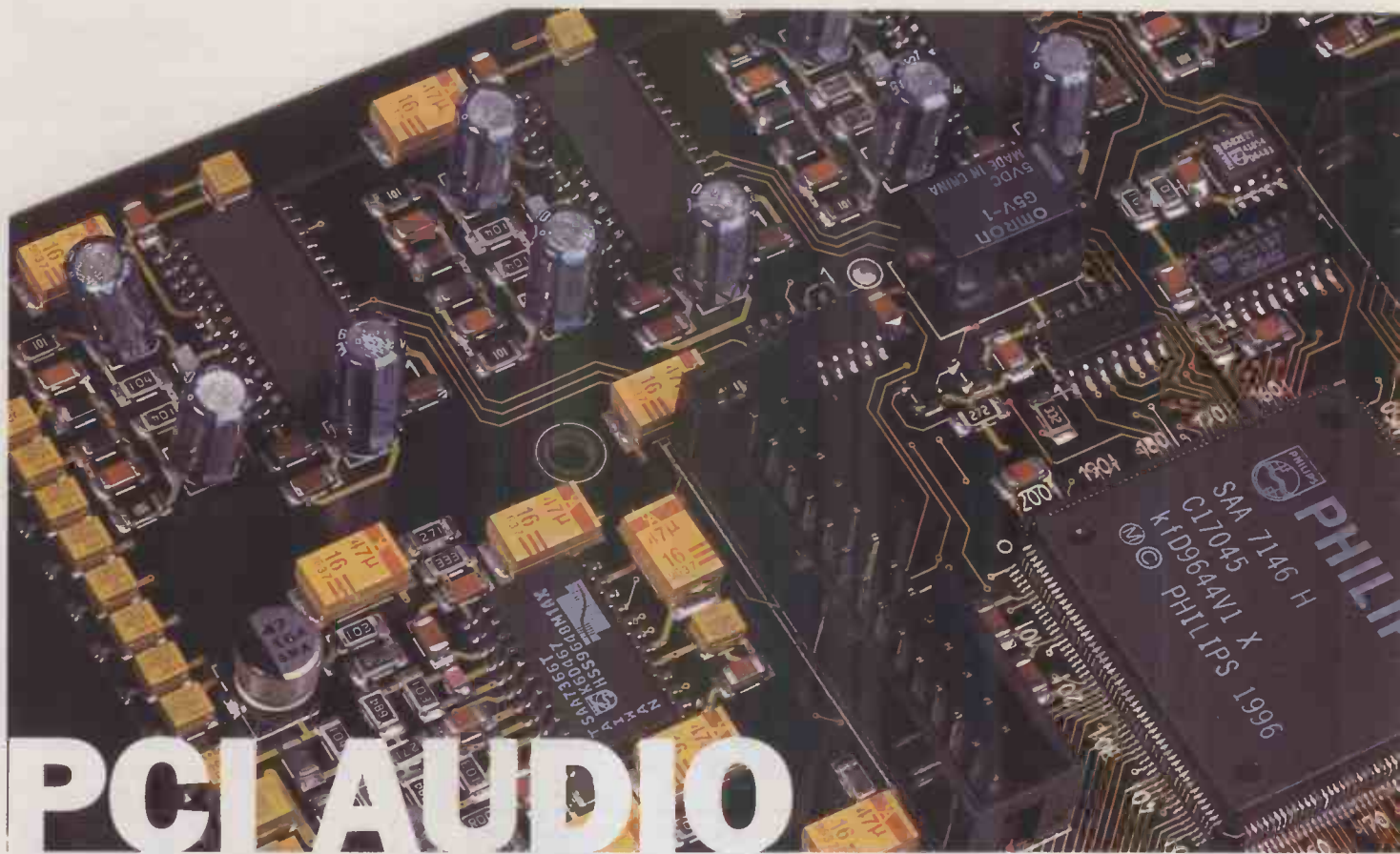

# PCI AUDIO CARDS

**Korg 1212 I/O £599 / Emagic Audiowerk8 £499**

**Audio cards for Mac have traditionally been both pricey and scarce. All that is about to change with the launch of PCI-based cards from Korg and Emagic that offer more performance for less money. Nigel Lord tests the first of the new generation**

**M**ac users have always paid dearly for their independence. Though the price of Macs and third-party clones has fallen rapidly over the past twelve months, it's still some way short of the cost dividend enjoyed by PC users who share economies of scale with countless millions of offices and homes around the globe. Generally speaking, Mac owners accept this with good grace and a sense of resignation, knowing that their machines are at least easier to use and configure and remain more adaptable to their way of working.

One of the few areas in which discontent has been known to stir, however, is in the cost of audio cards, which has remained frighteningly high for some years now. It's a bitter pill for all Mac digital audiophiles, made more difficult to swallow by the thought of their counterparts in the PC world taking advantage of broadly similar technology at a fraction of the price.

The problem has often been put down to Digidesign's virtual monopoly of the market. But while it may be true that Digidesign have maintained almost total domination in

this area, the lack of any serious competition has more to do with the reluctance of other manufacturers to get involved, rather than any monopolistic tendencies on Digidesign's part. Even so, it's hard to read the company's price list without a certain amount of incredulity – especially when it comes to systems based on older, NuBus technology. At a shade under £1000, the Audiomedia II card, for example, would set you back rather more than a complete Apple Performa system – monitor included.

## What's going on

As expected, the recent change from NuBus to PCI slots in all Apple machines has prompted a fall in the price of most types of cards. PCI technology is standard on all PC machines, so manufacturers only needed to develop different software drivers to give them access to both markets. To their credit, Digidesign weren't slow in producing a PCI version of their Audiomedia card (at a dramatically reduced price), but more significantly, the way has now been cleared for other manufacturers to develop for the Mac as well as the PC.

The word is that Yamaha have a PCI-



## Virtual Multi-track Recorder

Emagic's Virtual Multi-track Recorder – or VMR – comes as part of the Audiowerk8 package and as its name suggests, provides a 'virtual' representation of the sort of control panel you'd expect to find on a typical hardware multi-track recorder or tape machine. At its heart is a large scrolling display with eight tracks of audio information, linked to eight input channels featuring bar-graph metering, solo, mute and record buttons and indicator LEDs. Standard cut, copy and paste editing techniques are possible using a system locators which may be defined to provide gapless recording and playback cycles, with up to 24 positions stored in memory and recallable individually or in pairs.



You can start multi-tracking out-of-the-box using VMR

VMR allows you to play back up to eight tracks whilst recording a further two, and it's possible to record multiple takes and select the best version subsequently. Drop-ins can also be carried out, again using the locators, and may be combined with the cycle function to provide repeated passes until you get the new recording right. Entire tracks may be copied, leaving the original intact – and restorable, should you be unhappy with any editing you've carried out on the copied version.

In the attempt to emulate an analogue multi-track tape machine, VMR has clearly been made as simple to use as possible, so it's perhaps churlish to complain about the absence of any sophisticated editing functions. Even so, beyond recording of basic tracks and a limited amount of editing, this isn't a program which provides an awful lot of creative potential. Certainly, it could be improved in a number of key areas without impinging on Logic Audio's territory. Nice to have as a freebie, but there's some way to go in terms of its development. Addressing some of the inconsistencies in the manual would be a starting place.

based system scheduled for imminent release, and a British company, Lucid Technology, will shortly be announcing a PCI version of their existing NuBus card. In the meantime, two other major manufacturers – Korg and Emagic – already have new systems up and running, each reflecting something of its manufacturer's background in digital audio.

In fact, so different has been the approach of the two companies, it would make little sense to assess the new systems as part of a conventional 'head-to-head' review. Though users will undoubtedly find themselves choosing between them (and of course, the existing Digidesign alternatives) the radically different design concepts make it impossible to pick a clear winner on the grounds of performance and/or value for money.

### Emagic Audiowerk8

Audiowerk8 is largely a vehicle for Emagic's software sequencers – Logic Audio and Logic Audio Discovery – both now available for the Mac and PC. Though a free-standing application (Virtual Multitrack Recorder) has been developed to accompany the card, it seems clear that the appeal of Audiowerk8 will be greatest among existing Logic users – who currently rank second only to Cubase users in terms of numbers.

Offering eight physical analogue outputs

(as opposed to the 'virtual' outputs we've come to expect on most stereo sound cards), the Audiowerk8 also provides two analogue inputs and a pair of S/PDIF digital in/outs – though it's not possible to use the analogue and digital inputs at the same time.

The Audiowerk8 is designed around 32-bit PCI 'Busmaster' technology which

guarantees uninterrupted data transfer to and from the card, independent of CPU load. The onboard bitstream (18-bit equivalent) A/D and D/A converters offer an impressive 20 - 20kHz frequency response (+/- 0.5dB) and a 92dB dynamic range.

Using Logic Audio v2.6.5 or Logic Audio Discovery v1.1 (both supplied as updates with Audiowerk8), PC users will need to provide a Pentium 60 host machine with at least 16MB RAM. The requirement for Apple users is any Performa or Power Macintosh machine, again with 16MB RAM. With the forthcoming upgrade to version 3.0 of Logic Audio, however, the minimum requirement is a Pentium 166 or high-end Mac (presumably with level-2 cache). This is because like Steinberg's Cubase VST, Logic Audio 3.0 will include processor-based DSP functions such as EQ, chorus, flanging, reverb etc. Version 3.0 of Logic Audio will also support a second Audiowerk8 card for a total of 24 audio tracks and 16 physical outputs.

Installation is quite straightforward, providing you observe the obligatory earthing procedure and hold the card only by its edges. At 7-inches long, you should find Audiowerk8 will fit in any machine without difficulty – even in the slots located behind the CPU fan. Connection to the analogue ins and outs is provided through a standard 25-pin SUB-D socket, though an adapter is included with trailing phono connectors. These are labelled with small paper tags and are of identical length, so with everything connected you end up with a rather heavy (and unprofessional) bunch of plugs and cables hanging out of the back of your computer.

Incidentally, like any direct-to-disk recording system, demands on your hard drive are considerable: a sustained data transfer rate of 1.5MB/s is essential, together with an average access time below 15ms. This doesn't rule out the use of an

Audiowerk8 lets you take multiple signals straight into your mixer

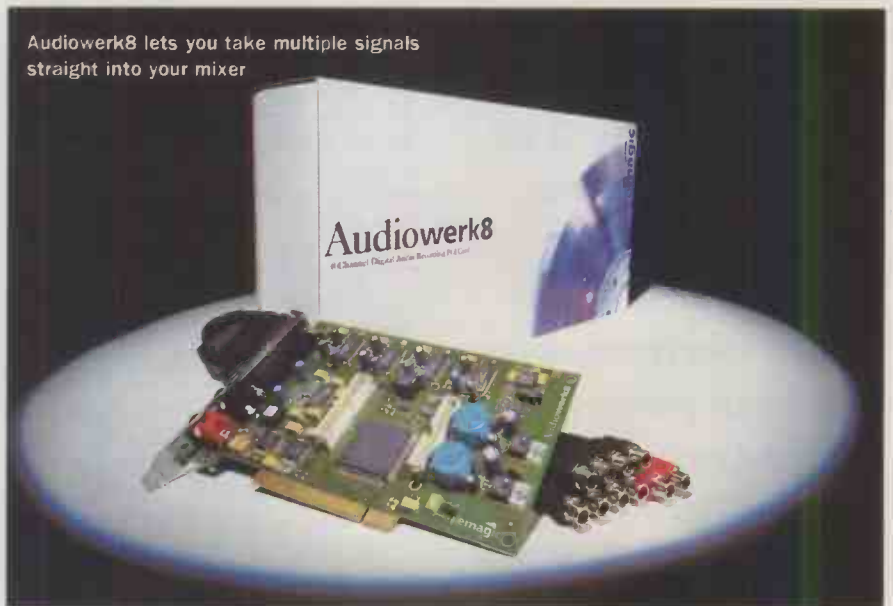

IDE drive for PC systems, providing it's a pretty recent model (check the specifications), and most current Mac (SCSI) drives should also measure up - but remember the 5MB per track/minute rule of thumb when assessing your needs.

### Synchronisation

Using the S/PDIF input, the Audiowerk8 can be digitally sync'd to incoming word clock from external sources, and the relationship can be reversed, so that word clock from the S/PDIF output may be used to slave external devices. Audiowerk8 may also be slaved to MTC or SMPTE time code. Used in conjunction with the Mac version of Logic Audio 3.0 (which supports continuous MTC synchronisation of Audiowerk8), no additional digital word clock is necessary.

Logic Audio is also able to choose between Audiowerk8 and any other digital audio systems you may have installed in your machine. Providing your CPU (and hard drive) can take the pressure, the Macintosh Logic Audio extension allows simultaneous use of Audiowerk8, Digidesign hardware, Yamaha CBX, and the computer's own AV circuitry.

Where Emagic aren't so accommodating - at least according to distributors, Sound Technology - is in allowing Audiowerk8 to be used with software applications other than their own. I raised the point with them after reading in the manual that installation of the VMR software (under the Mac OS) places an extension in your system folder containing the Sound Manager driver for Audiowerk8. This, it goes on to say, allows use of Audiowerk8 from within any application program that complies with Mac OS conventions.

Not so, say Sound Technology, and the absence of said extension from my system folder seemed to confirm it. This is a card which Emagic want to reserve for use with only their sequencers. Of course, there

would be nothing to prevent other software companies from developing their own drivers for use with the card - and I can certainly see this happening - but it seems that Audiowerk8 is not destined for the kind of ubiquity enjoyed by Digidesign hardware.

Given the competition which exists between Emagic and the other software companies, it's clear what has prompted this re-think (...if that's what it was), but I have to say, it seems rather short-sighted to me. Quite apart from the potential sales lost to existing software users who cannot access the card, this kind of isolationist approach is the last thing we need in a world already beset by uncommunicative hardware. Frankly, software companies should have enough faith in their own products to allow them to compete in an open environment. I can only hope Emagic will reconsider their position on this.

On a rather more optimistic note, plans have already been announced for the release of two 'daughter boards' for Audiowerk8 - the first offering an additional three stereo outputs to bring the card's digital capacity up to eight, available in parallel with the analogue outs. The second board will provide an optical link between Audiowerk8 and ADAT interfaces (in place of the analogue outputs). As you may know, the ADAT interface is already the de facto standard for digital audio systems, and this link will provide a bridge from Audiowerk8 to the increasingly wide family of hardware on which it is included.

### Overall

As one might have predicted from the impressive specifications, the performance of Audiowerk8 is generally excellent. Basing my comparison on Digidesign's Audiomedia II NuBus card (...not to mention the thoroughly acceptable built-in sound of my 9500 PowerMac), Audiowerk8 acquits itself very well indeed. Firing on all eight outputs,

## Spec Sheet

Emagic Audiowerk8	
<b>Card type:</b>	32-bit PCI Busmaster
<b>Card length:</b>	7"
<b>System compat:</b>	Windows 95 or Mac OS
<b>Input channels:</b>	2
<b>Output channels:</b>	8
<b>Nominal level:</b>	-10 dBV
<b>Maximum level:</b>	1.5 Vrms
<b>Dynamic range:</b>	> 92 dB (f to 0, A-weighted)
<b>THD:</b>	< 0,006% (1 kHz @ 0 dBfs)
<b>Freq response:</b>	20 Hz to 20 kHz +/-0.5 dB
<b>A/D converters:</b>	1-bit bitstream, 18-bit equivalent
<b>D/A converters:</b>	18-bit, continuous calibration
<b>Oversampling:</b>	128x
<b>Digital I/O:</b>	S/PDIF (parallel to channels 1 / 2)
<b>Digital audio format:</b>	16-bit linear
<b>Sampling rates:</b>	38.5 - 50 kHz, Resolution 1 Hz

it's a formidable system which blows away any lingering doubts anyone might have about the superiority of digital multi-tracking. Frankly, no analogue tape system comes near to it, particularly when you consider that no amount of editing or bouncing down is going to have the slightest affect on quality.

After the obligatory stereo mixdown of recordings made through my Audiomedia II card, working with eight outputs was quite a revelation, especially from within Logic Audio. I've had plenty of experience of using ▶

## Bondage.

## A subject close to our hearts.

A specially developed formulation bonds the ultra-fine magnetic particles of HHB DAT Tape to the base film, ensuring that block error rates stay consistently low - even after 100 passes. It's just one of the reasons why HHB is independently proven to be the most dependable DAT tape that money can buy.

**HHB Advanced Media Products. Don't record on anything less. Tel: +44 181 962 5000**

HHB Communications Ltd - 73-75 Scrubs Lane, London NW10 6QU, UK - Fax: +44 181 962 5050 - HHB on-line: <http://www.hhb.co.uk>



**HHB**

ADVANCED MEDIA PRODUCTS

COMING SOON IN

TOTAL  
FILM

# THE FIFTH ELEMENT



**Bruce Willis, Luc Besson, and the brainiest sci-fi blockbuster since Blade Runner...**

**PLUS!**

*Con Air*: this year's all-action answer to *The Rock*.

*Gridlock'd*: Tim Roth and Tupac in the Yankee *Trainspotting*.

So you wanna be a stuntman? Our man learns the ropes...

**It's all in Total Film 6. On sale Thursday 5 June.**

## EMAGIC AUDIOWERK8

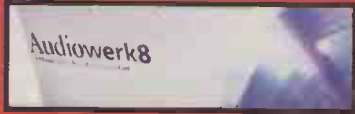

### WHAT WE LIKE

- Good cost/performance ratio
- Ease of installation
- Use with a sequencer or supplied software

### WHAT WE DON'T LIKE

- Restricted to use with Emagic software
- VMR software is limited

### OVERALL

A welcome addition to the limited range of Mac audio cards; well-priced but ultimately let down by Emagic's refusal to acknowledge the existence of other sequencers.

other software, I wouldn't be able to use my preferred sequencer, but even so, it was a sobering thought.

I have to say, I wasn't quite so impressed with the VMR software included with the package. Frankly, I've seen shareware applications with more to offer. But it's there if you need it, and it does at least allow you to work independently of any sequencer, if you prefer.

And they have a point. We produce sound digitally from synths and samplers, output it in analogue form, convert it back to digital for recording onto hard disk, reconvert it to analogue for sending to the mixing desk, then record it digitally again on a mastering machine. Finally, we transfer the finished product to digital CD and play it back in analogue form through an amp and speakers.

Korg 1212 I/O uses the popular ADAT digital interface

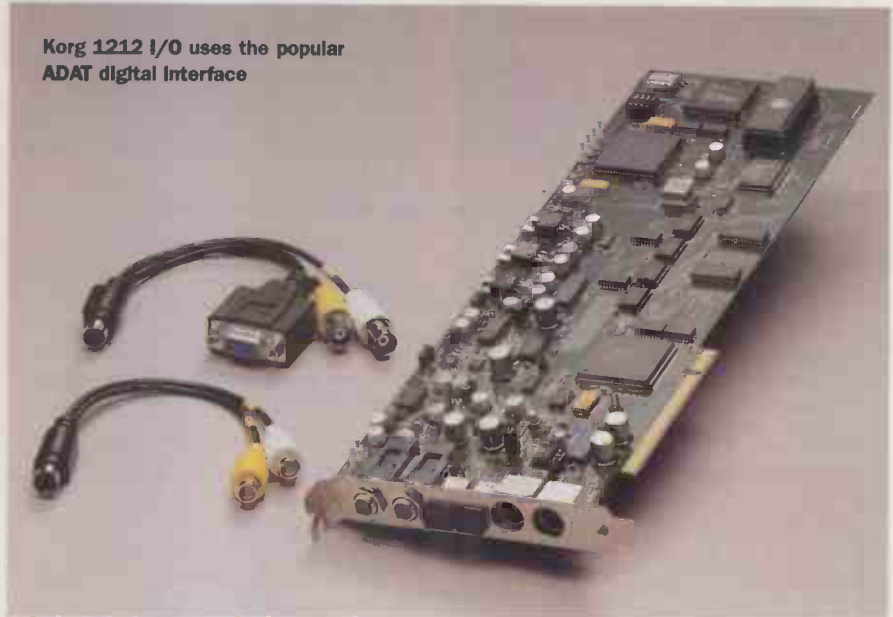

### Korg 1212i/o

To understand the design ethos behind the 1212i/o digital audio card, you have to share Korg's belief that our approach to digital multi-tracking is rather anachronistic. They see a fundamental contradiction in the way in which we move in and out of the digital domain simply to mimic the action of older analogue equipment such as multi-track tape machines.

How close this comes to describing your way of working will depend on the type of equipment you own. With a digital mixing desk, for example, you can obviate at least one stage in the multi-conversion process. As far as multi-track digital recording is concerned, it is Korg's contention that we don't actually need a set of outputs returning us to the analogue domain, providing we have the necessary equipment ▶

▶ Pro Tools, but have always preferred working within a sequencing environment. Piecing together a true multi-track audio recording and having it sat there alongside your MIDI tracks is a thoroughly liberating experience which I can recommend to anyone.

With eight outputs at your disposal, it becomes much easier to record the audio from one or more of your MIDI tracks to free up keyboards and sound modules, and still be able to process and mix levels independently. Other possibilities also begin to present themselves once you get used to working with the eight separate outputs - though I couldn't help being distracted by the thought that what I paid for a single stereo NuBus card would now buy me two Audiowerk8 cards offering no fewer than 16 outs.

I could console myself with the knowledge that until Emagic reverse their decision to deny access to Audiowerk8 for users of

Consumers.  
Take their formats (but let them keep their error rates).

Block error rates on HHB professional MiniDiscs are 10 times lower than those of some consumer media.

HHB Advanced Media Products. Don't record on anything less. Tel: +44 181 962 5000

HHB Communications Ltd · 73-75 Scrubs Lane, London NW10 6QU, UK · Fax: +44 181 962 5050 · HHB on-line: <http://www.hhb.co.uk>



ADVANCED MEDIA PRODUCTS

## 12121/O Utility

Included with the software supplied with the 12121/O, this utility application is designed to provide quick and easy access to the card's channel routing and Sound Manager settings. It's a rather prosaic piece of software, but surprisingly useful when you're transferring audio between the S/PDIF and ADAT formats or routing tracks in an ADAT system.

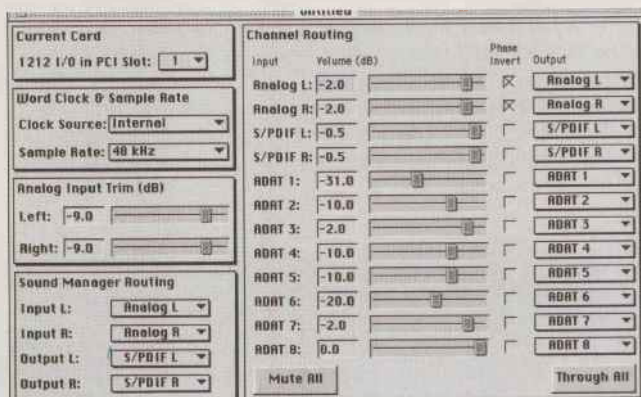

The Korg utility makes routing signals a piece of cake

As you'll see from the screen shot, it may be used to set the word clock source and sample rate, trim the analogue input levels and determine the input and output routings for the Apple Sound Manager. In the main routing area, you can adjust the volume, phase and output routing for all twelve inputs, globally mute them or bypass all settings by sending each input directly to its corresponding output. As it's possible to use multiple 12121/O cards in your computer, there's also a selection field where you can call up the card you wish to set up. All settings may be saved as standard Mac documents.

## Spec Sheet

Korg 12121/O	
<b>Card type:</b>	PCI (revision 2.1 compliant)
<b>Card length:</b>	Full length
<b>Systems compat:</b>	Mac OS (currently)
<b>Input channels:</b>	10 digital 2 analogue
<b>Output channels:</b>	10 digital 2 analogue
<b>Analogue inputs:</b>	20-bit Delta-Sigma
<b>Analogue outputs:</b>	18-bit linear
<b>Analogue levels:</b>	-10 dBV or +4dBu
<b>Dynamic range:</b>	> 94 dB (I to O)
<b>THD:</b>	< 0.009% (@1 kHz)
<b>Freq response:</b>	20 Hz to 20 kHz +/-0.6 dB
<b>Digital I/O:</b>	S/PDIF
<b>Sampling rates:</b>	44.1kHz and 48kHz, external clock

▷ and interfacing to stay digital.

To this end, they have produced the SoundLink series of products, the major component of which – the 168RC mixer – we looked at in our December '96/January '97 issues.

### Interface

Central to operation of SoundLink is the ADAT interface – the optical digital communication system developed by Alesis for their two ADAT machines, but currently taking on a life of its own as the standard interface for semi-pro digital audio

equipment. It is this interface which lies at the heart of the 12121/O and its one-to-one relationship with the 168RC (or any other suitably equipped digital device).

The card has been designed to integrate the entire digital recording process by providing not only twelve outputs (ten digital, two analogue), but also twelve inputs (again, ten digital, two analogue). In this central position in the chain, the 12121/O becomes more like a multi-track recording matrix than a conventional sound card and can quickly change your whole perception of direct-to-disk recording.

This would be impressive enough, but it also transpires that Korg have already involved the major music software houses in developing for the project and we'll soon see versions of the more popular sequencers able to address the 12121/O directly.

The most enthusiastic company is undoubtedly Steinberg, who claim the Korg hardware is exactly what has been needed to release the full potential of Cubase VST. Version 3.5, currently at the beta testing stage, will be the first software from Steinberg to address the card, although Macromedia's (much-underrated) Deck program (v2.6) is likely to beat them to the post.

Interestingly, it was OSC, the company originally responsible for Deck who completed most of the design work on the 12121/O. With their demise last year, however, the card ended up in the hands of Korg who saw its tremendous potential and wanted to develop it as part of its SoundLink technology. Deck itself was taken over by Macromedia, the US company responsible for Director and Sound Edit 16.

### Installation

As a PCI card, there should be no barrier to installing the 12121/O in either Macs or PCs, but at the present time drivers have only been developed for the Macintosh (a rare example of Mac users actually getting the jump on their PC counterparts). The software provided includes a system extension which allows Cubase or other software to talk to the card and an additional extension to provide compatibility with Apple's Sound Manager.

The 12121/O is a full-length card, which might restrict installation in some machines, but it's often possible to change positions, with other, smaller cards to create the necessary space. Earthing (of you) is advised before installation takes place, and as usual you need to hold the card only by its edges. Care also needs to be taken if you elect to move the miniature jumper connectors on the 12121/O. These are used to set analogue input and output levels to either -10dBV or +4dBu.

In addition to the pair of optical ADAT interface connectors, rear panel hardware comprises 1/4-inch stereo jacks for the analogue input/output connections together with S/PDIF breakout connectors for the digital stereo input/output signals and word clock/ADAT sync. The latter should take care of most of your syncing problems whether you're using the 12121/O with an ADAT machine, Alesis' BRC controller or any other compatible device.

But let's assume for a moment you've opted for a system comprising 12121/O card and 168RC desk; what sort of configuration could be set up? Well, as it's an 8-buss desk, all eight groups may be sent to the digital inputs on the card through the ADAT optical interface. In addition, you could route the stereo master signals to the digital stereo input via the S/PDIF connectors. Analogue signals from the mixer's Auxiliary Sends might then be sent (via standard jack connection) to the analogue inputs on the 12121/O.

With its twelve input channels, the 168RC can be fed from up to eight line-level inputs and four mics with full EQ plus insert points for external processors. It's up to you to determine which signals stay in the digital domain: on mixdown you can elect for these to be re-routed through the digital channels of the desk.

As Korg point out, even with Cubase VST to perform your main automated mix, the 168RC can always be used as a sub-mixer for external processors or to bring in audio from your MIDI instruments. Apart from any other advantages, this would give you access to the mixer's built-in effects processors which eclipse anything the standard VST plug-ins are capable of.

### Configuration

I almost didn't include these examples of how the 12121/O could be configured, as it may seem like this is the 'prescribed' connection method. In fact, the range of



Korg's 1212 I/O is just one part of their innovative SoundLink system

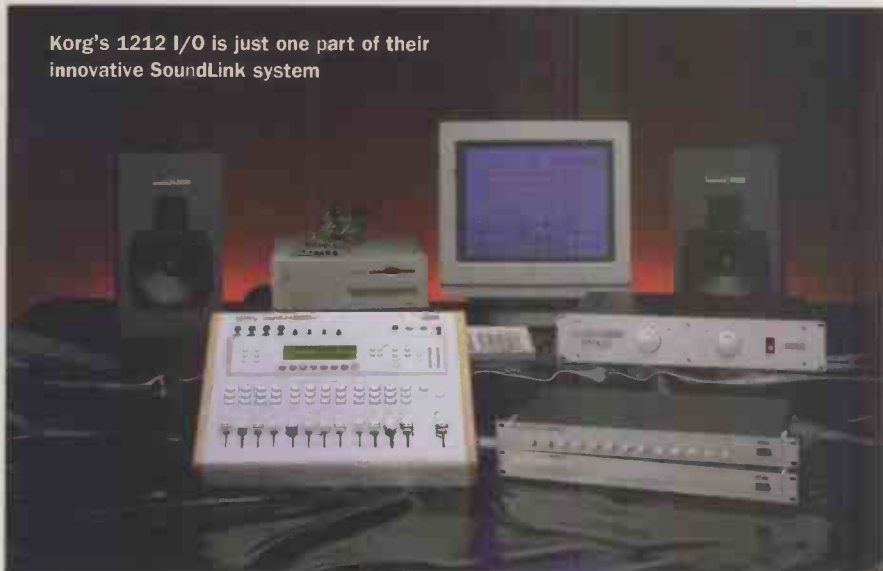

possibilities is amazingly broad – even without the companion 168RC desk. Frankly, until I was faced with the prospect of actually having 12 inputs to work with, I wouldn't have even included them on my list of priorities. Like many people, it was

separate outputs I craved. I know better now.

For some, not having the twelve analogue inputs and outputs physically hanging out of the back of the computer is going to be rather off-putting, but it doesn't

## Speaking ADAT

References to ADAT throughout this review might well lead you to conclude that the 1212I/O is designed expressly for use with the Alesis machines. Not so. The ADAT interface has appeared on a variety of recent devices and looks like doing for digital audio what MIDI has done for synths and sequencers. Users of Yamaha's digital desks, the D2R and D3D, will be pleased to hear that both can be fitted with optional ADAT interface cards. And there's good news, too, for the legions of ProMix 01 users who should be able to take advantage of a third-party upgrade for their machines from the Italian company, SoundLab. The new Mackie digital 8-bus mixer is also ADAT compatible. Not unreasonably, Korg themselves would prefer it if you opted for their 168RC 8-bus recording desk, but have obligingly produced a pair of ADAT-compatible 8-channel converters - the 880A/D and 880D/A - through which the 1212I/O can address the none-ADAT speaking world. Needless to say, this involves exactly the kind of analogue-digital-analogue conversion process you'd be better to avoid, but at least it allows the card to be used by owners of existing analogue desks. That said, at current prices, the 168RC will only set you back another £400 over the combined cost of the two 880 converters.

## KORG 1212 I/O



### WHAT WE LIKE

- A great idea, well implemented
- Good number of inputs (12)
- Software utility makes routing easy

### WHAT WE DON'T LIKE

- Slightly expensive
- Its physical length may be a problem

### OVERALL

A visionary approach to digital multi-tracking that deserves to be successful. Used with a program like Cubase VST, its potential is vast.

take long before you see the sense of Korg's approach, and indeed, the madness of moving in and out of the digital domain – as if all that A/D and D/A circuitry was actually doing your music any good.

The quality of recordings which have remained in the digital domain all the way through to your monitoring system is actually quite astonishing, and makes a nonsense of the 'semi-pro' tag which seems to attach itself to this type of equipment. It certainly left me pondering exactly what I'd need to sell to get my hands on a 1212I/O and 168RC system.™

#### More from...

Emagic Audiowerk8: Sound Technology, Letchworth Point, Letchworth, Hertfordshire SG6 1ND Tel: 01462 480000 Fax: 01462 480800

Korg 1212I/O: Korg UK, 9 Newmarket Court, Kingston, Milton Keynes MK10 0AU Tel: 01908 857150 Fax: 01908 857199

## Warning.

Too much slack in your pack can hit you where it hurts.

Slack windings can result in tape snapping. HHB ADAT tapes use precision engineered cases and hubs to minimise tape pack slack and ensure accurate tape handling.

**HHB Advanced Media Products. Don't record on anything less. Tel: +44 181 962 5000**

HHB Communications Ltd · 73-75 Scrubs Lane, London NW10 6QU, UK · Fax: +44 181 962 5050 · HHB on-line: <http://www.hhb.co.uk>



ADVANCED MEDIA PRODUCTS



# YAMAHA O3D

**Yamaha's long-awaited O3D digital console has arrived to fill the gap between the ProMix 01 and the 02R. Bob Dormon uses it anger in the second instalment of our two-part review**

**Digital Recording Console £2999**

**P**eople will always make space for analogue consoles, but these days people are inclined to make room for digital ones too. And generally, you have to make less room for the digital versions! A factor behind this is that you can flick through LCD menu pages to uncover hidden depths in the machine (which can be both the console's saviour and its downfall). You only have to glance at a typical analogue console and you know what's what. Like other digital desks, the O3D can relay a vast amount of information, but not all of it at once. So when you're routing something, sending effects from channels or simply panning a signal you'll have to get used to the idea of a bit of manic prodding or mouse clicking (yes, that is a built-in option), to achieve digitally, what

is taken for granted in the analogue world. The question is, 'Can you adapt?' or moreover 'Can you be bothered to adapt?'. Yamaha would like to think that with the features included in their range of digital consoles you'll want to adapt.

### Overview

In last month's preview the features of O3D were covered, but here's a brief outline of the main points again...

More like the 02R than the ProMix 01, the O3D has a YGDAI interface card slot that allows it to communicate digitally with a variety of other digital formats – among them, the Alesis ADAT, Tascam's TDIF (DA-88/38 protocol), AES/EBU and Yamaha's own Y2 and digital cascade system. This is perhaps the most significant aspect since the cards used are the same specification as the 02R. This compatibility opens a

*The voiceover on track 20 of this month's cover-mounted CD was recorded using the O3D*



number of possibilities for example, an O3D can be used for field work and an O2R can take the strain in the studio. The main difference being that the O3D has only one card slot whereas the O2R has four.

So in essence, the O3D is the perfect companion for an 8-track digital recorder, with the AES/EBU (CD8-AE-S) card providing the means to interface with hard disk recording systems. This card is actually different to the original AES/EBU interface card (CD8-AE which took up two O2R slots), since it has a 25-pin D-sub connector to accommodate the four balanced stereo pairs (I/O) that usually appear on (as you'd expect) XLR connectors.

As a mixer, the O3D has 26 input channels (16 analogue, 8 digital plus stereo input configurable for either analogue or digital sources). Besides the choice of input card (which can be analogue too if preferred), there are both AES/EBU and S/PDIF digital stereo I/Os, word clock I/O plus MIDI In, Out and Thru together with RS-422 video editor and 8-pin mini DIN (Mac) interfacing. You also get a four-channel buss and four aux sends. The O3D has only four groups so you can't really use Auxes 1-4 and Busses 1-4 to create an 8-buss matrix. What you can do though, is set the input channels to Direct mode found in the DIO (digital in/out) or Pan/Routing menu. That way, any of the sixteen input channels can be sent directly to the eight digital outputs. Incidentally, channel 9 will go directly to track one, channel 10 to track two etc. The Auxes and Busses also have analogue outputs so there are no sacrifices in this domain either.

One area where the analogue scores is with the inserts available on the first two input channels. Favoured valve compressors or EQ can be introduced into the signal chain to add the character that digital systems are reputed to lack.

### Dub and effection

When it comes to character, then the selection of Yamaha effects built-in to the O3D are not to be overlooked. The 64 presets (and 32 user memories) contain some of the same algorithms as the ProR3 and Rev500. You get two effects engines that are independent of the Aux sends (though the high quality pitch change and freeze effects are only available in Effect 2). I'm delighted to see the Freeze program in there because I suggested it in my preview of the ProMix 01 back in the July 1994 issue of *The Mix*. They got there in the end. Those familiar with Freeze on the SPX series of effects processors will know that it's a cheap and cheerful sampler that can be triggered manually, via MIDI or from and audio source. The O3D offers all of these features plus 2.73 seconds of sampling time (2.972 at 44.1kHz) with pitching, looping and editing facilities.

Besides the usual reverb and chorus effects (SPX fans will literally be pleased to hear the classic Symphonic chorus program



Power and beauty: the Yamaha O3D

is in there), there is a comprehensive guitar distortion algorithm set. For the full blown treatment it's best to feed these effects pre-fader, which is easy to select by repeatedly pressing the relevant Effect button to scroll through the pages. Just remember to revert to channel fader mode and pull down the level of the input channel. There are ten different amp types and five distortion choices all with obscure abbreviations which the manual doesn't explain, together with familiar amp drive settings and EQ. The distortion effects aren't bad at all, offering instant gratification and – in my experience – a lengthy distraction from writing this review!



Motorised faders in action

Needless to say these amp simulations can certainly spice up a DI'd sound.

So you've only got two built-in effects (plus their respective returns) and one stereo return if you want to use the Auxes for an external device. What would you say to a delay on every channel? Yes please, I imagine. Well it's all yours under the grey Delay/Ø (phase) button with up to 200ms of delay to hand (217ms @44.1kHz). There are even three delay types:-

- i. Delay. A basic track delay which can be helpful when compensating timing with the digital cascade option.
- ii. Slap. A single slapback echo that has its own Mix level
- iii. Echo. A multiple repeat echo with Mix level and positive and negative Feedback settings too.

Interestingly, the delay follows the panning of the track so you can't create stereo effects by panning the delay to one side and the signal to the other. You'll need to use the one of the effects algorithms to achieve that or clone the track and pan it accordingly with the delay you want on it.

### Digital dynamics

So if I were to ask the same question about getting a dynamics processor on every channel the answer would be... well no, because, not only do you get a choice of a compressor, gate, expander or compander on every channel, you get them on the Auxes and Busses, Effects Returns Stereo ▸



Moving faders, scene memories, the list goes on...

▷ inputs and outputs too! They can also be triggered from other sources and ganged in stereo pairs. Favourite settings can be named and stored in a separate Dynamics effects library too. Within the Dynamics edit screen are the relevant meters for gain reduction and output volume. For compression, the usual Threshold, Attack, Release, Ratio and gain controls are there plus a choice of 'knee' settings, the combination of which are reflected in the compression curve graph on-screen.

I found the response to be excellent in both the compressor and the gate, with the digital processing offering very fast attack and release times. You soon find that having so much to play with results in some very anal tweaking. I started gating shakers and adjusted their sound length with the gate hold parameter and limiting a vibraslap so that its sound was full throughout. Congas were treated more gently, bringing out their resonance with a fast release time. The list goes on. Needless to say these are yet more creative tools and also safety devices. For example, some protective limiting wouldn't go amiss on the higher thresholds when recording live musos... if they still exist.

### In use

It's easy to take for granted many of the O3D's features such as moving faders, scene memories (that store all the current settings), and the on-board automation that utilises MIDI time code as a reference but retains all the information in the O3D's memory. Plus new functions such as mouse

control and surround sound panning which are welcome additions. While it's not in the scope of this review to go through all these features in detail, together they expand the versatility and the creativity of the O3D. But enough of this adulation, what's wrong with the O3D?

Sometimes you only find things out when you try and do the simple stuff like recording. So, track by track, I'll take you through some of the operational considerations and a particular omission within the O3D. Rather taken by the Freeze sampler facility I simply fed a conga track into it from the track's Effect send 2 and sampled it. Incidentally, the track was coming from tape and was being treated to a healthy dose of compression and EQ before even getting to the Freeze program. Editing the start and end points and looping it was a breeze. Pitching it downwards by an octave while it played was smooth and certainly a lot less grungy than many samplers I've encountered. Hence the congas became a djembe. At this point, having slowed the tempo, I wished I could fathom out a way of feeding Effect 2 into Effect 1 so I could have a go at pitching it up in realtime. But it seemed the only way to do that was to record the Freeze output and bring it back in again. I didn't bother.

What I did do was record it on two tracks and pan them hard left and right applying a track delay on the right one to broaden the stereo image. It worked a treat. So then I paired up these two tracks so that one fader would move both and in doing so the delay disappeared. To work around it you

## Interface Intimacies

To install an interface card into the O3D you simply remove four screws from the back panel. This reveals a neat slot with more than enough space to fit the card and a reasonably excessive stash, a thoughtful consideration for touring musicians. The guides at the front are followed by another lot inside which prevent you from hogging the connection. Slide it in and with a firm push the installation is complete once you've screwed it in.

If you've an ADAT then you'll need the usual complement of two optical cables for audio in and out. The Tascam DA-88/38 requires a 25-pin D-sub connector for all its digital duties. Don't just use any old cable or you'll fry the Tascam's DSP. The pin connections are very specific which – just before a Bank Holiday weekend – meant I had to trudge round town to find a lead and have to offer my thanks to Music Lab for being the only outfit in Central London who could oblige me at short notice. Making a lead isn't big deal, but buying 25-way cable involved exactly the same effort as borrowing a lead.

Having tried both the ADAT XT and DA-38 with the O3D I'm impressed with the console's intelligence. Under the DIO (digital in/out) switch you'll find the main interfacing set-up page which has an Auto Navigate facility. This simply scans the digital interface busses for a wordclock source and each time with both machines set for a digital input it found them, no sweat.

Being a four buss system, the default is that groups 1-4 also feed track 5-8. As mentioned earlier, this can be changed for direct access from the channels to give eight independent record tracks which is useful.

What both the Tascam and the ADAT XT offer are ways to re-route the incoming audio to other tracks. The Tascam does it with the Track Copy facility which, so long as it's turned off, won't do anything weird. The ADAT XT is weird though and unless you know about it you'll be scratching your head for quite some time.

I've mentioned this before in the O2R review (see the Steve Levine interview, *The Mix* June '96), because I was caught out briefly and anyone using a hired or used ADAT XT may well come to grief. This information was certainly news to the chaps at Yamaha when I told them about it.

What you have to do is press and hold down the XT's digital input button so that the metering scale disappears. If there are any tracks highlighted in blue at the bottom of the meters then extinguish them by pressing the relevant track record button.

If a track is highlighted and you don't do this then the digital audio being bussed to the ADAT XT will not function properly. This digital audio input facility is there so that you can receive audio on just one input but use the record buttons to select the track you want it to go on.

For example, if track one is highlighted, you send out on group/buss 1 from the O3D and then select any of the eight tracks to record, as the signal will be routed to all of them. You may well be able to see the other groups sent to the ADAT while it is input mode, but they will disappear when the tracks are selected for record.

Yamaha's O2R responded to this situation by disabling all the groups that weren't selected on the XT's, which is maddening when you don't know why. You just get the one that's selected on the XT's digital input.

The O3D doesn't let on in this way, so it's best if you can, to check out the ADAT XT first for trouble-free multi-tracking.

# We didn't reach No.1 by being out of stock, slow or expensive



Virtually, any item you could need; recording, live sound, broadcast, post production and audio for video is in our catalogue and can be in your hands today or tomorrow!

Whether it be a simple jack plug, cables, a reel of 456, a rack tray, multi track recorder or acoustic treatment, Studiospares has it and everything else you could need, in stock at the trade counter at the **UK's lowest prices**. Next day delivery, nationwide.

- |                |                     |                        |                    |
|----------------|---------------------|------------------------|--------------------|
| 3M             | TASCAM              | Gates                  | Power Supplies     |
| AGFA           | TDK                 | Glands                 | Pre Amps           |
| AKG            | TEAC                | Goosenecks             | Quickrack          |
| AMPEX          | TECHNICS            | Graphic Equalisers     | Racks Lights       |
| ARBITER        | TRANTEC             | Guitar Stands          | Racks Strip        |
| BASF           | TURBOSOUND          | Headphone Amps         | Racks Trays        |
| BEHRINGER      | YAMAHA              | Headphones/Headsets    | Radiomics          |
| BEYER          | Acoustic Analysers  | Heatshrink             | R-DAT Tapes        |
| BOSE           | Acoustic Treatment  | Humfrees               | Reverbs            |
| BSS            | A.DAT Tapes         | Infra Red Headphones   | RIAA Preamps       |
| CONNECTRONICS  | Aerosols            | Isopropyl Alcohol      | RFI Filters        |
| CP CASES       | Amalgamating Tape   | Littlelites            | Roadcases          |
| DBX            | Amplifiers          | Leads                  | Rockwool           |
| DENON          | Attache Case        | Looms                  | Scart Leads        |
| DRAWMER        | Bantam Plugs        | Loudspeakers           | Sleeving           |
| DURACELL       | Batteries +Chargers | Mains Transformers     | Snakes             |
| EDAC           | Books               | Meters (Volt-Amps etc) | Solder and Irons   |
| EDITALL        | Cable               | Microphones            | Speakers           |
| E.M.O.         | Caged Nuts          | Microphone Stands      | Spike Filters      |
| FOSTEX         | Cassettes           | MIDI Accessories       | Stack Rack         |
| HARTING        | CCTV                | MiniDiscs              | Stage Boxes        |
| H+H AMPLIFIERS | CD Players          | MiniDisc Recorders     | Stools             |
| ISOTRACK       | CD-R                | Mixers                 | Strato Rack        |
| JBL            | Compressors         | Music Stands           | Syquest            |
| KLOTZ          | Connectors          | Noise Gates            | Tape               |
| KOSS           | DAT                 | Patch Cords            | Tape Recorders     |
| LA AUDIO       | Demagnetisers       | Patch Panels           | Tools              |
| MACKIE         | DI Boxes            | Phantom Power Supply   | Transformers       |
| MARANTZ        | Effects Units       | Phono Preamps          | Turntables         |
| NEUTRIK        | Empty Spools        | Plastic Spools         | Ventilation Panels |
| P & R AUDIO    | Equipment Stands    | Plugs                  | Wall Boxes         |
| PHILIP REES    | Fibre Optical Leads | Pop Screens            | Windshields        |
| REVOX          | Fish Poles          | Porta Studios          | Workstations       |
| ROCKWOOL       | Floppy Discs        | Power Amps             | Zimmer Rack        |
| SENNHEISER     | Fuses               |                        |                    |
| SHURE          |                     |                        |                    |
| SONY           |                     |                        |                    |
| SOUNDCRAFT     |                     |                        |                    |
| SWITCHCRAFT    |                     |                        |                    |
| SYQUEST        |                     |                        |                    |
| TANNOY         |                     |                        |                    |

# Studiospares

*No waiting, no fuss,  
just service with speed!*

Studiospares UK Ltd  
61-63 Rochester Place, London NW1 9JU  
tel 0171 482 1692 fax 0171 485 4168



Studiospares Deutschland GmbH  
Köln Strasse 195-197  
D-50226 Frechen, Köln, Germany  
tel 0049 2234 922 710



Please send me a free copy of the new  
Studiospares 140 page catalogue

Name .....

Company (If relevant) .....

Address .....

.....

.....

Post Code .....

THE MIX JUNE '97



The large, user-friendly display acts as a set of input meters, as well as the expected editing functions.

**Verdict**

Well it must be said the benefits of the O3D outweigh the disadvantages. If I had to grumble, then I'd like to be able to change the effects algorithms when I'm in Effect Edit mode and scroll through the effects programs with the Up/Down keys, since the way the data entry wheel scrolls through them takes some getting used to. I'd also like to be able to feed the 2-track return so that it can be heard with the main mix. For many musos this is important for arranging and transcribing work. It would also be a good idea to be able to see the Stereo Bus routing for the Effects and Stereo input in the Pan/Routing menu as this is where you'd expect to find it, even if it does appear under Views.

That aside, just adding together all the features of the O3D and considering what they'd cost to buy separately, brings to mind the scale of this achievement. Whether or

▶ need to group the tracks to retain the delay. That's easy enough, there are four separate fader groups found under the Groups/Pair button, plus four mute groups. Your grouping choices are made by simply selecting the tracks. Anyway, now I had two faders tied together with the delay I wanted.

The next thing to do was add a bassline. A quick wander through effects bought up my old favourite, Symphonic. Instant fretless bass. Setting up to record the effect failed to show a way of taking the Effect Return out of the Stereo Bus so that I could hear just the tape return.

All the others under the Pan/Routing menu, showed their four groups and stereo out choices. The Stereo In and both Effects Returns had no Stereo Buss choice to disable. So the next thing to do was to look in the manual – the first time, I might add – and there was a nice picture showing the Stereo Buss option for these particular channels. "Aha," I thought, "they do exist, but not on this baby!"

Anyway, by chance I prodded the View switch that shows an overview of the parameters relating to any selected channel and there it was plain as day; the stereo routing option. It works too, which is just as well after all that.

**Of mice and men**

Having done a considerable amount of prodding I thought I'd try the mouse option using an old Atari mouse. Unfortunately, it didn't work and as an Apple Macintosh evangelist, I refuse to have a PC in the house other than an ancient DOS laptop that I use as a doorstop. So the prodding continued, by which time I thought "why don't they have hot keys to turn EQ on and off etc?"

It then occurred to me to check out the User Define keys which had so far confused me by changing scene memories when I



You can slot in a digital interface of your choice at the back

was least expecting it. Under the Utility button you'll find just the place to do exactly what I was after.

Four banks of preset controls appear that you can customise. So you can choose to turn EQ or Dynamics on or off for any channel you select. MMC messages, automation controls and of course, preferred scene memories can also be set up here.

Taking the control aspect a stage further, the same User Define keys can be used with the MIDI Remote function which provides preset templates for a number of products including XG compliant synths, the Rev 500 and ProTools.

In the latter, the keys are used for transport control while the O3D's faders and panpots control the output of the software mixer within ProTools.

This is a natural evolution from the ProMix 01 (also included as a template) which has a local off mode so that the fader movements don't affect the mixer's audio, but do transmit MIDI messages.

With MIDI Remote, a stereo digital output from ProTools can be fed directly into the O3D and the audio tracks controlled from it together with other sources connected to the mixer.

You can also make up your own templates which will certainly appeal to those who are more at home with a fader than a mouse.

not you need one – once you've encountered an O3D – you'll probably want to buy one just to vent your approval of what Yamaha have done here. Overall, the O3D is a wonderful example of fairytale functions at an absolutely groundbreaking price... **TM**

More from: Yamaha Kemble  
Tel: 01908 366700 Fax: 01908 368872

YAMAHA O3D

WHAT WE LIKE

- Built-in effects
- Dynamics on every channel
- Moving faders and automation
- Digital throughout, interface cards compatible with 02R

WHAT WE DON'T LIKE

- Can't change algorithms in effects menus
- No instant overview of all channels and sends (as on an analogue desk)
- Analogue 2-track return can't be heard with the main mix

OVERALL

A complete and compact mixing solution for new-age digital dudes

# PHONIC BOOM!



Introducing the New Phonic professional range - setting new standards in mixing desks, disco mixers, amplifiers, graphic equalizers and speakers. Superb quality, excellent reliability and unbeatable value. New Phonic... phantastic!

**NEW**  
**PHONIC®**

New Phonic is here. Call or send off the coupon for full details.  
HW International, 167-171 Willoughby Lane, London N17 0SB Tel: 0181-808 2222

I am interested in:-

- New Phonic Mixers
- New Phonic Amplifiers
- New Phonic Speakers
- New Phonic Graphic Equalizers

Please send me details on the New Phonic Pro Audio range

Name \_\_\_\_\_

Address \_\_\_\_\_

Postcode \_\_\_\_\_

Tel: \_\_\_\_\_



# Fostex

## DMT-8v1 Digital Multitracker

It's finally here - the affordable digital multitracker which offers 8 true tracks of non-compressed CD quality recording and mixing.

Introducing the new great value Fostex DMT-8v1.

While the competition expects you to join the 'digital recording revolution' with less than 8 tracks and compromise the integrity of your audio with cost-cutting compression techniques, Fostex know better.

After all, it was Fostex who invented the first digital multitracker and have been innovators of ground-breaking recording products for the past 15 years.

The DMT-8v1 is quite simply the best value package with which to enter the exciting world of digital audio.

Quality, easy expansion, instant integration and a great sound.

It's everything you need.

Only 8 tracks  
of non-compressed  
CD-quality audio  
can cut it.

So why settle for  
anything less?



### FOSTEX DMT-8v1 FEATURES

- 8 true tracks of 16-bit 44.1kHz recording direct to supplied 540Mb hard disk.
- Easy Copy & Paste editing with Undo
- Easy recording time expansion via removable panel - up to 60mins with 2.55GB drive!
- Full-function 8 channel mixer. 2-band EQ and 2 Aux sends per channel. 20 inputs in remix.
- In-built MIDI and MTC synchronisation without track loss
- Future-Proof. Side mounted 3.5" expansion bay for soon-to-be-released E-IDE & SCSI interface options



Exclusively distributed  
by SCV London

For further information contact SCV London, 6-24 Southgate Road London N1 3JJ, Tel: 017 923 1892, Fax: 0171 241 3644



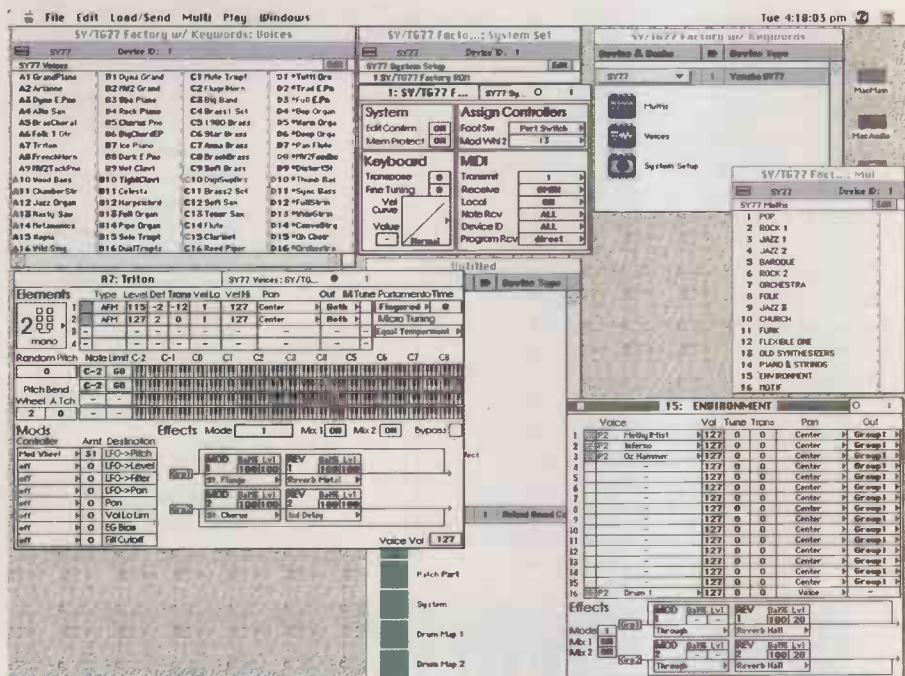

# OPCODE GALAXY PLUS

Synth Editor/Librarian £349

**A**fter a sequencer, the next most important piece of software on many people's list is a librarian. Although many musicians seem to be content to use an instrument's presets, there are often dozens, if not hundreds, of additional sounds available for most programmable instruments, and to ignore them is to severely under-use an instrument's potential. But organising and cataloguing the sounds, especially if you have two or more instruments, is not the most fun thing on the planet - which is where a librarian can help.

If you like to create your own sounds, then you may want the convenience of an editor to save you wading through lists of sub-menus on the instrument itself. Software editors give you the convenience of being able to see lots of parameters on screen at once and often include useful functions for organising and sorting the sounds. If you already use Opcode software, you probably have a copy of the Galaxy Librarian as it's bundled with Vision and Studio Vision. To get the editors, however, you have to buy the Galaxy Plus Editors pack.

## How it works

Galaxy stores patches and sounds in several ways. The most obvious way of storing

sounds is in banks, and this is usually how synthesizers and sound modules store their sounds. And, if you want to work in this way, you can store instrument banks in a Galaxy Bank.

However, Galaxy has a more flexible storage system called Bundles. These group any or all related patch banks into one big file and allow you to transfer all related patches between Galaxy and the MIDI devices in a single action. They could include single patches, multi patches, effect banks and so on. You can create Bundles of patches for multiple devices, which is particularly useful for live use and for setting up all your instruments for a particular song or project.

A multi patch usually consists of several single patches and perhaps an effects patch. It's a common arrangement on multi-timbral instruments. Galaxy calls the main patch a parent patch and the other patches children patches. You can 'attach' children to parents so if you copy a parent, the children are also copied, and if you transmit a parent patch, the children are transmitted, too. Jolly useful, though the manual makes the point that not all devices support this.

Then there are Libraries, which can store an unlimited number of patches of the same type. You can only send patches from a Library to a MIDI device one at a time. The Librarian has lots of neat functions. You can organise libraries with cut, copy, paste and ▶

**Once you have more than a couple of synths and modules, a software editor/librarian starts to make a lot of sense. Ian Waugh checks out one of the best...**

**OMS**

The (OMS) Open Music System Is Opcode's alternative to the Apple MIDI Manger and a lot more (see last month's Sound Advice feature). Virtually all major applications - and many smaller ones - are OMS-compatible, and many include a copy of the OMS in the pack. In fact, you can download a free copy of OMS plus lots of associated documentation from Opcode's Web site: <http://www.opcode.com>. The version of OMS Included with Galaxy Is 2.31.

OMS acts as a central MIDI driver to allow communication between MIDI devices and all OMS-compatible applications. It also provides a central location for defining and storing a description of your MIDI studio. This includes Instrument names, the MIDI channels they are assigned to and how they are connected. All OMS-software references this information so if you change your set up, you only need make the changes in the OMS Studio Setup and all OMS-compatible software will be aware of it. Using the Studio Setup is not terribly complicated but you will have to read through the manual carefully and go through all the steps if you don't want to end up in a mess.

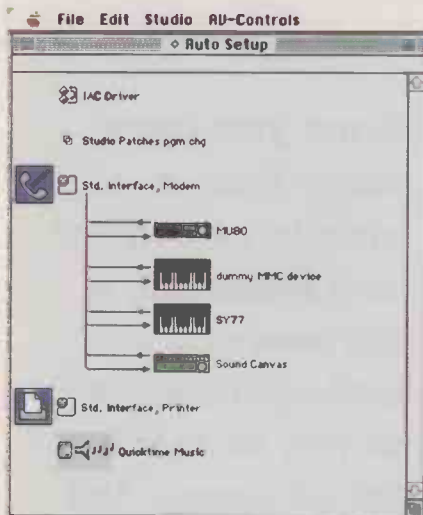

The OMS Set Up uses graphics to show which instruments are in your system

▶ drag functions. You can audition sounds using the on-screen MouseKeys keyboard, from a MIDI keyboard, from the Mac's keyboard or the program can play a sequence you've recorded. It can also check for duplicate patches.

One of the best features of the Librarian is the cataloguing system which allow you to add keywords to patches along with your own comments. The program includes 28 categories each with many keywords and you can add your own. You can search for keywords in several ways including using logical operators such as 'and' and 'or'.

**Modular editing**

The Editor's modules are used to edit voices, effects, system parameters and so on, and they use a range of standard tools as far as possible including flip menus, sliders, toggles, draggable nodes and the like. As each instrument has different parameters, it's impossible for all the editors to be the same, although many do have similar characteristics. In fact, Galaxy's approach is quite crafty and common in universal editors - the editable sections of an instrument are broken down into smaller modules.

Instead of having one humongous module containing all the parameters for a voice, for example, you're more likely to find an edit module for the voice architecture, one for the pan settings, one for the effects, one for tuning and so on. As well as making the modules easier to write, it also help you



You can audition the sounds by clicking on the MouseKeys keyboard

concentrate on a specific set of parameters at a time and you can work with several open windows at once. Some of the latest modules are in colour, and while this probably makes no difference to their functionality, they certainly look more the business than the black and white editors which smack of the old days of mono Mac displays.

The manual doesn't include a lot of information about the Editors, other than the common control features which is, doubtless, due to the differences between the instruments and editors. The pack includes information about creating custom modules but it's in an on-line document called PatchTalk. It has to be installed by performing a Custom Install, but full marks for including the info, anyway.

**Verdict**

If you have ever hunted through a mountain of floppy disks or RAM cards looking for a particular sound or type of sound, you need a librarian. It simplifies the search process beyond belief, and even makes the process enjoyable. The downside is that you have to put the sounds into the Librarian in the first place and spend a little time categorising them. Personally, I think it's time well spent, since during the writing stage you're not side-tracked by hunting for sounds.

A universal editor is worth considering if you program your own sounds and use several instruments. If you're happy to go into some of the instruments' edit pages and tweak a few parameters you may not see much advantage, but on-screen graphic editing may encourage you to greater editing feats. The program is very flexible, although the flipside is relative complexity, at least until you've grasped the basics of the

**Spec Sheet**

<b>Editors:</b>	Supports 11 companies', including full colour editors for the Roland JV-1080/XP-50/XP-80 and the Yamaha MU50/80
<b>Librarians:</b>	Supports 29 companies, including Alesis, Clavia, Korg, Kurzweil, Lexicon, Novation and Roland
<b>New features:</b>	15 new editors 50 new librarians MIDlex librarian that reads and writes WWW sysex format
<b>Platform:</b>	Mac with a 68020 processor, System 7.01 or later, and 8Mb of RAM

system.

Galaxy Plus Editors is not without its idiosyncrasies, but trying to be all things to all MIDI devices is not an easy task. At the risk of being picky, I wonder how difficult it would have been to convert all the program and editors to colour. On a subject closer to all musicians' hearts, the program costs a not inconsiderable amount. On an editor-per-pound basis it's jolly good VFM, but if you only have a few instruments then it's obviously less so.

If you need librarian and editor facilities, Galaxy Plus Editors is certainly worth considering, and if you're already using Opcode software and the OMS you'll find it integrates rather nicely.™

More from: MCMXCIX, 9 Hatton Street, London, NW8 8PR Tel: 0171 7237221

**OPCODE GALAXY PLUS**



**WHAT WE LIKE**

- Sophistication
- Being able to add keywords
- Integrates nicely with Opcode software

**WHAT WE DON'T LIKE**

- Not all editors are colour
- A little pricey

**OVERALL**

A top contender in the editor/librarian stakes, and a logical choice for existing Opcode users.

# A.K.A. Innovation.



Akai's products are market leaders and there's a very good reason why; first we make them better than everyone else then we make them more affordable.

The Akai S20 is a MIDI compatible digital sampler that will let you enter Akai S-Series sampling with change from £500. It has 8 voice polyphony, gives 16 bit stereo sampling at 32kHz and the standard 1MB memory is expandable to 17MB using SIMMS modules. The 16 large bank keys allow you to select and edit samples, customise the beat with the manual tap-tempo feature, playback looped samples in matched tempos using the beat-loop function - all in real time. Then there's a 4 track sequencer to record your performances and access to almost all the massive S-Series sample library.

The MPC2000 MIDI Production Centre is a no-compromise sampling drum machine and MIDI sequencer using the S3000XL technology at a stunning price that puts the MPC concept within reach of every serious rhythm programmer.

A superb new graphic interface with waveform display provides extensive cut-and-paste sample editing which, together with a powerful 64 track/100,000 note capacity sequencer and dedicated buttons for most-used functions, makes negotiating the complexities of the MPC a simple and friendly business.

Words and pretty pictures don't do them justice.  
Try the S20 and MPC2000 at your nearest  
Akai dealer.

**AKAI**  
professional

Akai (UK) Ltd  
EMI Division, Haslemere Heathrow Estate  
Parkway, Hounslow Middlesex TW4 6NQ  
Tel 0181 897 6388 Fax 0181 759 8268  
<http://www.akai.com/akaipro>



# SONY DTC A6, A8 & A9

Sony have added three new DAT machines to their DTC range. *The Mix* Technical Editor Paul Mac puts them through their paces

**DAT Recorders £799/£949/£1169**

**U**ndoubtedly the holder of the most popular mastering format award, DAT emerged from a rocky start to become a world-wide standard, and continues to be developed due to demand from studios. Whether that's because DAT really is the best way, or because there's no other way, is a matter for ambitious R&D departments and philosophical audiophile discussions, rather than the introduction to a gear review. One thing's for sure though: Sony's contribution to Digital Audio Tape is usually one worth listening to; they invented it, after all. But does their claim to the first word on DAT mean they get the

last word as well? That's what we're here to find out.

The three machines on test here are the DTC-A6, DTC-A8, and DTC-A9, though we have included some general information on the PCM2600 and PCM2800 machines though, as the manual for the A9 also covers those machines.

### Overview

In simple terms, the higher the model number of these machines, the better the features specification. The only exception is in the electrical spec: THD (total harmonic distortion) gets turned on its head, being quoted as less than 0.005% for the DTC models, and less than 0.5% for the PCM

models.

While the DTC-A6 does have all of the features that are common to the series, it doesn't do the posh bits. For example, it does convert analogue at 44.1kHz, which is what 90% of the DAT using population want anyway, but it doesn't convert at 48 or 32kHz. Playback and digital I/O at all frequencies are fine. The only functional difference between the A8 and the A9 is the balanced analogue I/O (XLR); that is, the A9 does, but the A8 doesn't.

As you can see, there are no giant feature leaps across the DTC range. Each level adds one or two extras over the last one; three shades of Sony, if you like. Between DTC and PCM ranges, though, a couple of prominent differences show up. First, SCMS (serial copy management system), a standard developed for the consumer market, is implemented on the DTC range but not on the PCMs. If you don't already know, SCMS is a digital coding standard that prevents digital copies being made of second generation, digitally-recorded tapes. In other words, if you transfer from DAT, CD, or MD to tape B via the digital I/O, you cannot do a digital transfer using tape B as the source (unless you strip the SCMS code from the bit-stream with an external stripper unit, or use a second machine that ignores SCMS). On most non timecode, coaxial digital I/O DAT machines, SCMS is optional, normally switched off with dip switches, or in a set-up menu. Unfortunately, this cannot be done with the DTC series.

The second difference is in record monitoring. The PCM2800's head drum allows monitoring from tape during record, which none of the others do. Other than these two, the PCM range support AES/EBU digital I/O, and provide for a hard-wired remote (as opposed to the foot switch functions on the DTCs). This is about as far as we will delve into the PCM range; as mentioned above, these were not sent for review, and the information we have on them is derived from a manual.

## Transports

The DTC-A8 and A9 use the same transport, while the A6 has a slightly different one. Both versions take the DAT in at an angle, so the operator can look through the window in the transport cover at the rotating tape spindles. The two visible differences are in the method used for securing the DAT as the transport assembly pulls it in, and two of the tape guides posts (furthest from head and pinch wheel).

As far as cassette in-take is concerned, both trays have plastic guides so the tape cannot be put in at an awkward angle, minimising the strain on the tape restraining assembly. The A8 and A9 use a fairly common method for non-draw type mechanisms; a slim piece of aluminium, shaped and stressed so that it fits in the small, top recess that all DAT cassettes have. In the A6, a metal bar closes in on the rear of the cassette, as if it is clamping the cassette into the transport. The plastic guides are the A8/A9's saviours; in transports where inadequate guides are provided, machines spent at least some of their life back in the service department having a re-bend.

The A8 and A9 advertise their 4DD (direct drive) motor mechanism, while the younger brother relies on a rubber belt. No, this doesn't refer to the drive for the rotating head or cassette spindles (error control would be impossible), it actually refers to the loading mechanism, which on the A6 has a belt linkage.

Overall, both transports seem solid and positive, with the added benefit of being able to see the tape moving during playback (an underestimated 'safety blanket'). The point of highlighting the differences between the transports is just that: If you buy an A8 over an A6, you are not just paying extra for a different front panel, and a bit of extra software.

## Subcodes

All three machines reviewed implement subcodes. These are lumps of non-audio data recorded on the tape as supplemental information, such as the start position of a track, or cue (start ID), the program number associated with it, the end of a track or cue (stop ID), an instruction to skip the next cue (skip ID), or even a character string (Character pack).

The DTC-A6 supports start IDs and program numbers, complete with the usual renumbering function, which automatically writes consecutive program numbers to every start ID on a tape. In addition, an auto numbering function will write start IDs on any decent level that occurs after 3 seconds of silence, or copy a master's subcodes during digital recording from a CD, or DAT source. Write, Erase, and Rehearse buttons provide the necessary ID placement tools (see below). The DTC-A8 and A9 models support skip IDs. These are ignored by the machine unless you select 'Skip Play' mode. In that case, whenever a skip ID is encountered, the tape fast forwards to the

## Spec Sheet

<b>Sampling rates:</b>	<b>48, 44.1 and 32kHz</b>
<b>D/A conversion:</b>	<b>Standard: 16-bit linear Long-play: 12-bit non-linear</b>
<b>Dynamic range:</b>	<b>90dB or more</b>
<b>THD:</b>	<b>Standard: 0.005% Long play: 0.008%</b>
<b>Analogue sockets:</b>	<b>Phonos in, phonos out, XLR in, XLR out (A9)</b>
<b>Digital sockets:</b>	<b>Optical, coax phono</b>
<b>Accessories:</b>	<b>Remote control (supplied)</b>
<b>Weight:</b>	<b>5kg (A6), 6kg (A8, A9)</b>
<b>Dimensions:</b>	<b>430mm (w) x 122 (h) x 325 (d) (350 for A8/A9)</b>

next start ID. Again, write, rehearse, and erase tools are provided.

The rehearse function is the only accurate cuing method that the DTC series provides. It allows you to adjust an ID's position once it is written, or place a new ID manually (rather than 'on the fly'). You only get 8 rehearse passes (repeated segment of tape) to position your ID, after which the unit presses its own stop button and you have to start again. Putting a rough ID in first lets you start a rehearsal with an ID search, rather than nimble use of the REW button.

The FF and REW buttons move the rehearse segment backwards and forwards in 0.3sec increments, and pressing Write places the ID at the beginning of the rehearse segment. Placing an ID can be awkward, as adjusting the rehearse position doesn't always have the effect expected; at one stage a single step forwards left the rehearse pass three steps behind the first position. The current rehearse position is reliable, though.

If you are in either stop or play mode, a click of the previous or next buttons whizzes you to the next Start ID and plays from there automatically. If you want to stop before you play from that ID, you have to use pause mode. Unfortunately, an ID locate in pause mode seems to stop a fraction before the equivalent locate in stop or play mode.

In a lot of applications, these fractional discrepancies are unimportant. A DAT machine used for mastering normally uses subcodes only as an index system, marking each track. For cued audio, however, more accurate positioning is required, such as those provided by RAM start DAT machines, and machines with jog/shuttle cuing. Mid ▶

## Consumer correction

Sony's previous DTC range did cause some confusion when it came to warranty and free modification claims. It turned out that popular machines such as the DTC55es and the DTC750 originated in the Sony consumer division, and as such were not, under some circumstances, covered for the rigours of professional use. This time around, both Sony and HNB assure us that the DTC-A6, A8, and A9, are professional machines, intended for professional use. There are some machines with the DTC prefix that are still classified as consumer, so check before you buy.

▷ song or dialogue cues with ID s are not recommended.

Another two uses of subcodes in the DTC range are AMS and RMS (Automatic Music Sensor, and Random Music Sensor, respectively). Using start IDs and program numbers, the user can pre-program tracks to be played, scan through tracks playing 8 seconds at a time, jump to previous and next tracks, and repeat play.

All of the machines come with a remote control that repeats most front panel controls. The only exceptions are the subcode tools, SBM on/off selection, and foot switch mode. The foot switch facility, is a welcomed, if slightly unusual, one. You get two foot switch sockets: REC/PAUSE, and MODE. The former sets you off into a loop of record and record-pause modes, while the latter has three function loop variations,

Sit back and listen with the remote supplied with all the test models



selected with the front panel mode switch: Stop and Play; Stop, Play, and Rew; or Stop, Play, and backwards search (by AMS). In addition, the RMS settings (basically pre-programming start IDs for a track playing order) is also applicable to mode 3: Play, search, and stop.

### Super Bit Mapping

SBM, or Super Bit mapping, is a noise shaping function on the A to D side of the new Sony DAT machines. If you don't know already, noise shaping is an ingenious use of a low-pass integration filter, and negative feedback in the A to D conversion, that pushes quantisation noise up to the high end of the spectrum. By doing this, you reduce the noise in the sensitive bandwidths, though lose out in the higher frequencies. Sony reckon that their system reduces noise in the low spectrum by more than 10dB, offset against a noise increase that starts around 15kHz. Actually, the noise level starts to increase at about 3kHz, but is still way below the noise floor that would have been in place if SBM didn't exist. At 10kHz, the noise is still about 4dB below the pre-SBM noise floor.

In practise, accurately normalised mastering processes gain only subtle clarification from SBM, though dynamic



For the full works, opt for the A9 at £1169



A8 adds more features for its £949 price-tag



A6: the entry point into the DTC range at £799

material does reap the benefits more explicitly. While not tried in the review, high harmonic enhancement processes might lose some of their psycho-acoustic value to SBM, so top marks to the SBM on/off switch; giving the choice to the user is always a good plan.

### Time machine

There's more good news for archivists: A8 and A9 machines date and time stamp recordings with the internal clock settings (supported by an internal battery). Even the year gets printed, which is useful for validating disclaimers on older, more embarrassing tracks, or helping out those of us who hardly ever have a pen handy when we should be writing notes on the cassette shell.

All three machines implement the main timing information now expected of any self respecting DAT machine: Absolute time, playing time of the track, remaining tape time, and tape running time. All of these are selected by cycling through the counter modes with buttons directly below the display.

There are two aspects to the metering sections of the displays; the first is the stereo bargraph meter, which covers much of the width of the display and is of the peak level type with a reasonable peak hold time and bright red 'Over' indications past the all important 0dB level. The second metering aid is the margin display. This gives a numerical reading of remaining headroom, updated only when the headroom decreases, or when the margin display is reset. A definite plus for digital recording, the margin display allows easy level optimization of material to be recorded, minimising quantisation noise.

### Verdict

A clear, useful display, and effective noise shaping are the highlights of these DAT machines. It is good to see the reappearance of a margin read-out to

compliment the peak hold metering, and the transports seem to be a big improvement on the older DTC models. The biggest disappointment is the non-optional SCMS, a throwback to the consumer machines that is now all but abandoned.

The record/playback quality does just pip at least a couple of other machines in the same price range, probably due to the SBM function, and a healthy dose of high end and lower level clarity, but it was close.

Without the special '97 offer of ten free HHB DAT tapes, the DTC-A6 would be only slightly overpriced, and it does have some stiff competition. The A8 is positioned about right, with the special offer being a bonus. The DTC-A9? You might want to try a bit of negotiation with your dealer, using the old "£220 for balanced I/O?" line - you never know... **DM**

More from: HHB Communications Ltd, 73-75 Scrubs Lane, London, NW10 6QU Tel: 0181 962 5000

Fax: 0181 962 5050 Email: sales@hbb.co.uk

## DTC A6/A8/A9

**WHAT WE LIKE**

- Numeric margin display
- Time/date stamping on recordings
- SBM, especially with on/off option

**WHAT WE DON'T LIKE**

- No SCMS defeat
- No dedicated cueing (rehearse ID only)
- No error rate display

**OVERALL**

Price conscious people will want to check out the DTC-A6 and the HHB DAT tape offer, but for feature frills, the DTC-A8 and A9 are a little more comprehensive.

# Audiowerk8



**E**magic's Audiowerk8 is a two input, eight output audio card for Power Macs and PCs with PCI slots. The board also has a stereo digital S/PDIF output. Audiowerk8 can also be bundled with VMR, which can turn your computer into a true eight track digital recorder

**Audiowerk8 £499**

**T**he Pioneer PDR-05 CD-R makes CDs at the push of a button. It can also record one track at a time, for programme editing. The price of the Pioneer PDR-05 is just £1,299



**1402vz  
£475**  
RRP £549

**Follo SX  
£Call**  
RRP £623



**03D  
£Call**



**SM58  
£99**  
RRP £125



**C3000  
£239**  
RRP £378



**M149  
£2799**  
RRP £3798



**C414ULS  
£799**  
RRP £1173

**PRO  
TOOLS**



## Digidesign Pro Tools 4 and Apple 7300/166 CD

- Apple Power Mac 7300CD/166 16/1.2Gb CD (Total RAM 32 MB)
- Mac 1705 display
- Mac keyboard
- Digidesign PCI ProTools 4 Core System
- Digidesign 882 PCI
- Kingston RAM DIMM 16Mb
- Seagate Ultra Barracuda 2Gb ex HD

**Pro Tools 4 System £12,150**

**A**standalone unit the Marantz CDR615 at £2291, supports all main CD formats with automatic indexing from CD, DAT DCC and MD sources and uses standard CDR blanks.



**MPC2000 £1199** Inc 16Mb



**DMT8-VL £Call** RRP £999



**DA-38 £1999** RRP £2999



**D160 £Call**



**ADAT XT £2150** RRP £2699

# MUSIC LAB

The UK's leading professional audio supplier

**SAVE  
£200  
ON NEW  
SONY DAT**

## DTC-ZE700

- 44.1kHz Analogue In
- Optical In and Out
- Coaxial input
- Super Bit Mapping
- Full Remote Control
- Rehearsal Function
- 48kHz, 44.1kHz, 32kHz
- Time Display
- Re-number Function
- Absolute Time Display
- AMS



**DTC-ZE700 £499 inc vat** RRP £699



**DA-20 £649** RRP £799



**DA-30 Mk2 £975** RRP £1299



**MINI DISC JE500 £299**



**Composer £199** RRP £299



**Studioquad £425** RRP £699



**SDE330 £849** RRP £699



**TLA Comp 2021 £468** RRP £703

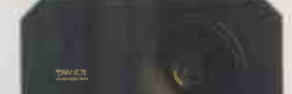

**TLA EQ 2012 £350** RRP £703



**System 600 £299** RRP £446

## TCD-D8



- Mic Input
- Digi In/Out
- 1 Bit A/D & D/A
- 44.1kHz Analogue In

**TCD-D8 £549** RRP £599



**MINI DISC MZ-R30 £299**



**VC1 £588**



**Midiverb 4 £299** RRP £329

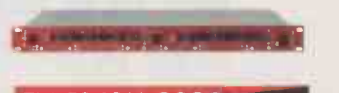

**TLA EQ 3011 £233** RRP £468



**TLA EQ 2012 £350** RRP £703

## Tannoy System 600

- 52Hz - 20kHz
- Dual Concentric
- 160w

All prices include VAT. Add £12 for next day delivery.

**PHONE: 0171 388 5392 FAX: 0171 388 1953 INTERNET: WWW.musiclab.co.uk  
72/74 Eversholt Street, London, NW1 1BY**



# FAIRMAN TRC

**Tube Recording Channel £4582**

**Fairman's latest offering is based on two acknowledged classics, the Fairchild 670/650 and the Pultec EQ. But is it worth its high price-tag? Trevor Curwen investigates**

**T**he Danes have got it sussed when it comes to exports. We have them to thank for three of the little luxuries of life: bacon, porn and quality pro-audio equipment. Following in the footsteps of Tubetech and TC Electronic we now have Fairman who have just presented us with their all-valve TRC or Tube Recording Channel, whose design is based very solidly on vintage gear, notably Fairchild and Pultec.

Look at any old photographs of studios taken in the sixties and you will probably see Pultec EQ's and Fairchild limiters alongside the old Neumann, AKG and RCA microphones. The Fairchild, now a very highly regarded piece of gear, is becoming increasingly hard to find and rarely comes up for sale. The studio where I work most of the time sold its stereo Fairchild 670 about four years ago for about £4,500 – the same Fairchild is now on the market again for ▲ £12,000 and I'm reliably informed that the mono versions can sell for around £6,000. Now, people still want to buy this gear to get the classic sound found on old records, so it's obvious that if someone could build new equipment, copying the old designs and getting close to the sound, then there would be a ready market for it.

The Fairman, I presume, is supposed to be a grown-up Fairchild (although maybe it ought to be called Fairperson in these politically correct times). The concept behind this unit is to incorporate one Fairchild type compressor/limiter and two Pultec EQ's (Pultecs come generally as either mid-range or high/low units) in one perfectly-formed package. Two Pultecs and a Fairchild in one box ought to be a truly wonderful thing and I'd been wanting to try one out ever since I first found out about it.

The TRC is a very imposing piece of gear. It's a large (6U) black box, with large black knobs and one large VU meter. In fact, it looks like the sort of thing you'd see in an old black and white war film, with a crippled Lancaster bomber's radio operator frantically using it to send out a distress call as he goes down in flames. Construction of much of the metal casing is of perforated metal to allow air circulation around the seven valves which run quite hot when working; in fact the unit should not be used until the valves have warmed up, which takes about an hour from switch on.

Components used in the construction are of very high quality; polypropylene capacitors are used, the valves are all stringently selected and there are no potentiometers but ELMA hard gold

Hear the processing power of the Fairman in action on this month's cover CD





switches which are made to military standards.

There are three basic sections to the TRC – the mic/line pre-amp, the equalizer and the compressor. The pre-amp section utilises three knobs, an input selector chooses between mic, mic with 48V phantom power and line signal. Gain is set by a 10-step rotary knob. On the back panel is a balanced XLR input for both mic and line use and an XLR output. There is also an unbalanced jack input on the front panel which is optimised for use with electric guitar and bass output levels (use of this socket overrides the rear XLR socket). The large VU meter can be switched, using the third knob, to show either input level or gain reduction when the compressor is active.

The Equalizer section, like using a mid-range and a high/low Pultec together, is very comprehensive having both low and high cut filters and low, mid and high EQ bands. The low filter has an attenuation control which ranges from off to -18db in 2db steps. Attenuation begins at a frequency set by the LO Hz control which has four settings, 20 Hz, 30Hz, 60 Hz and 100 Hz. Selecting the frequency and turning up the attenuation control removes signal at and below the selected frequency. The high filter is a similar set up with selectable frequencies of 8, 10, 16 and 20 khz, the attenuation control removing signal at and above the selected frequency.

## Compressor

Five knobs on the TRC's front panel relate to compressor functions. Threshold is variable from off to 9. There is no ratio control on this compressor since the ratio at which it works is controlled through a combination of the gain and threshold settings. A low gain coupled with a high threshold will result in soft compression with a ratio of around 1:2, and high gain and a low threshold will give a higher ratio of around 1:15.

Attack and release both have their own knobs but these are not continuously variable. Instead, both Attack and Release are each switchable between four preset times – fast, medium, long and slow. The actual corresponding attack times are 0.12 ms, 8ms, 30 ms and 120 ms. The release settings are 40, 80, and 160 ms and an auto setting which can vary between 40 and 320 ms depending on the characteristics of the source material.

The position of the compressor in the signal chain can be selected with the three position comp-EQ knob. It can be placed either PRE or POST the EQ section or with the third position of the knob. The EQ can be switched into the compressor's detector circuit, allowing some form of frequency-conscious compression and allowing the TRC to be used for de-essing. The final knob on the front panel is the output gain control which can be used to make up any gain lost in compression and to optimise the level sent to tape.

## In Use

The Fairman was tested with a wide variety of sound sources and the mic amp presented no problems, giving overall a warm and smooth sound. The High and Low filters worked very accurately and allowed a great deal of control over the nasties at both ends of the frequency spectrum. The EQ section sounded very good and gave a lot of scope in tailoring sounds. The idea of just boost controls for Low and Top and cut for the midrange might put some people off, but the idea is perfectly logical and has worked for years on original Pultec units.

The Low control worked very well in adding a certain thump to kick drums and thickening up the Low range of some quite thin-sounding vocals. The high band gave vocals some sparkling presence while the mid cut came into its own, taking character and presence that one would expect from a high quality valve EQ, and I had no problems whatsoever with it.

The compressor section, however, did give me some problems. It did sound good and worked well particularly on milder settings – the problem was one of choosing the correct settings for the attack and release controls when heavier amounts of compression were applied. The whole thing was just a bit tricky and time-consuming to set up. It was all too easy to get some vicious gain pumping and strange effects going on when I didn't want them. Perhaps living with the machine for awhile and getting to know its quirks would allow someone to familiarise themselves with the best combinations of settings but in a quick and busy studio session I could imagine engineers getting quickly frustrated and moving back to more familiar equipment.

The omission of a bypass control on the EQ section is unfortunate. To do an A/B test of the original signal against the EQ'd one involves turning off all the boost and dip controls and if both filters and all three EQ bands are in use, then that's five knobs to turn off and then move back to their desired positions. Why a simple in/out switch (which incidentally Pultecs do have) isn't fitted, I just don't know.

Other minor quibbles (while I'm at it) are that the inputs and outputs are on plastic sockets. For a price in excess of £4,000 I would have expected top quality metal connectors. Also the large plastic knobs felt cheap and flimsy. Call me a pedantic git but the Bakelite knobs on Pultecs feel solid, classy and reassuring.

One last ergonomic point is the position of the Q controls on the front panel. While there is really no other position for them, it's not immediately apparent which knobs relate to each other. I know that extra white lines forming a panel around the relevant sections of the front panel would spoil the matte black designer look of the unit, but in everyday practical use the thing's soon going to be covered in white chinagraph markings anyway. It's these kind of practical details which niggle after a while.

## Spec Sheet

<b>Processors:</b>	Mic/Line Preamp, Equaliser, Compressor,
<b>Mic Input:</b>	XLR, Balanced only
<b>Sensitivity:</b>	5mV (-4.4dB) to 575mV (-2.6dB)
<b>Impedance:</b>	1200 ohm
<b>Line input:</b>	XLR, Balanced/unbalanced
<b>Freq response:</b>	20Hz - 100kHz
<b>Distortion:</b>	0.06% @ 1kHz unity gain
<b>Noise:</b>	-92dB @ Line, unity gain
<b>Headroom:</b>	20dB above +4dB output
<b>EQ:</b>	Low, Mid & High Bands
<b>Filters:</b>	Lo Hz attenuation (20, 30, 60, 100Hz) to -18dB, Hi KHz attenuation (8, 10, 16, 20kHz) to -18dB
<b>Compressor:</b>	Make up (-6dB to +6dB), Attack (0.12ms to 120ms), Release (40ms to 320ms)

## Verdict

I really can't fault this unit on sonic grounds – it does sound great. Criticisms really apply to the ergonomic details of the unit. If someone was really familiar with it, I'm sure they would get optimum use out of the Fairman, but in a busy pro studio where it's most likely to end up (I don't suppose many of us can afford it for our home studios), ease of setting up counts for a lot. The concept of this unit is a great one, the execution of that concept not quite as great. 

More from: Fairman UK, Stockport  
Tel: 01663 764 900 Fax: 01663 762 328

## FAIRMAN TRC



### WHAT WE LIKE

- Excellent EQ
- Good overall sound
- Great concept

### WHAT WE DON'T LIKE

- Compressor fiddly to set up
- No bypass switch

### OVERALL

An excellent concept but in practice the unit which needs a few modifications to become a real world-beater



# STEINBERG WAVELAB 1.6

**Steinberg's PC waveform editor has just had a face-lift, with new features and extra plug-in effects. Ian Waugh tests the results...**

**PC AUDIO EDITOR £399**

**Y**ou can't keep a good waveform editor down. We originally looked at Steinberg's WaveLab program last June. The company promised updates and here they are - two of them, in fact, hard on each others' heels. Version 1.5 appeared a little into the year but it was known that a version 1.6 was already under development to take advantage of Microsoft's ActiveMovie technology (more of which in a moment) and now it's here. Leading edge technology, eh? You just can't keep up with it.

So let's run through the basics and then look at the new goodies. WaveLab is a digital audio recorder, editor and sound processor. It handles mono and stereo

recordings - it's not a multi-track recorder - and it has a wealth of edit options and processing functions. It was one of the first 32-bit editors designed specifically to run under Windows 95 and Windows NT, and it uses internal 64-bit processing to maximise the sound quality. You can edit on the fly, making changes while the file plays back in a loop. It also supports an unlimited number of Undos which you can Redo and Undo without halting playback.

Installation is dead easy, as it should be under Windows 95. For copy-protection, the program uses a registration key and prompts you to insert the CD ROM. This is a one-thousand percent improvement on hard disk install copy-protection systems which ought to be stuffed up the behind of the companies which use them. Dongles are

better but try hanging a couple off the back of your PC and see how well they work. The fact that music software is one of the few areas of application which uses copy-protection says something about music software developers - or musicians...

### Here's a nice wave

The program works with .WAV files, as most PC digital audio programs do, but it supports other formats including AIF and it can save files in a format compatible with Digidesign's Session 8. It can also handle Dual Mono files which some audio programs use. You can open and work with several files at once - very useful for cutting and pasting. The waveforms appear in a window in traditional waveform format with an overview display above them. A play line moves through both displays during playback so you know exactly where in a file you are.

Sections of a waveform are selected by clicking and dragging. Move the mouse over the edge of a selected area and it turns into a double arrow allowing you to adjust the selection points. Activate Loop playback and the program automatically loops the selected area even as you change it and you don't have to release the mouse. Dead easy and intuitive. Why don't all editors work the same way?

Edits and processes are performed on the selection and you can zoom in and out using zoom buttons on the waveform



Many of the new effects modules look and work like hardware effects units.

window, not totally unlike Cubase. The user interface is excellent and you can point and click your way through most of the program without referring to the manual. There is on-line Help if you get stuck and you may need to check on the settings for some of the effects.

There are nine Toolboxes which can float anywhere on the screen. You can change their shape from a horizontal strip to a vertical strip or to a square, and drag them into a toolbox area at the top of the screen - I find this the most useful. One Toolbox lets you take up to eight snapshots which store window positions and parameters.

The main processing functions include normalise, change gain, invert phase, eliminate DC offset, fade in and out, crossfade, reverse, time stretch, pitch correction, harmoniser, chorus, EQ and dynamic processing. Several use Wizard-like tabs for ease of use, and the dynamic and EQ windows have graphic displays. You can create your own settings by dragging nodes in the dynamics windows and as you adjust parameters in the EQ window, the filter curve changes. Most processes include several presets which are good starting points for your own creations.

Time-stretch doesn't yet include a formant control, which is a little odd considering several developers are making much of this in their software. Formants are what give vocals their gender characteristics, and lack of formant control makes pitch shifted voices sound like Mickey Mouse.

Other features include a FFT (Fast Fourier Transform) display, batch processing and a rather nice Audio Database which help you organise large numbers of files by category and search for them. It will scan disks for audio files and keep track of files on removable media such as CD ROMs - great if you use a lot of sample CDs.

### New on the block

That's basically what WaveLab does. Versions 1.5 and 1.6 add many new features. The main ones include support for 20-bit and 24-bit files, CD burning and the RealTime Engine which comprises a MasterSection window and programmable effects.

The MasterSection has faders for the left and right channels, and clip indicators with peak hold values. On the left are six slots into which you can load Plug-in effects. Any effect can be assigned to any of the slots. Ten are currently supplied with the program and more are expected to appear from Steinberg and third-party programmers.

## Spec Sheet

<b>Processing:</b>	8, 16, 20 and 24-bit
<b>Plug-Ins supplied:</b>	Autopanner, Chorus, EQ, Echo, Grunge, Leveler, Resampler, Reverb, Stereomager, Tools One
<b>Other processing:</b>	Time-stretch, pitch correction, harmoniser, chorus, parametric EQ, dynamics processor, fades and crossfades, 3D spectrum analyser
<b>Formats supported:</b>	.WAV, .AIF, .AU, .SND, .RAW and .PCM file
<b>Additional features:</b>	FFT (Fast Fourier Transform) display, batch processing, Audio Database, CD-R support
<b>Requirements:</b>	To use the real-time features, a Pentium 90 (133 or faster recommended), 16Mb RAM (32Mb recommended) and 256 colours. A Pentium Pro is recommended for a high-end system.

The program also supports ActiveMovie effects. This is an open standard for audio and video Plug-ins and you can use any ActiveMovie Plug-in with any ActiveMovie-compatible program. It should encourage developers to create Plug-ins and, hopefully, we'll start to see them appear before long. Just one point to note - ActiveMovie Plug-ins may require a little more processing power than dedicated WaveLab Plug-ins.

Many of the effect modules look like a hardware FX unit with 'left/right buttons' for selecting parameters and a rotary dial for changing values. You can create, save and load presets and there are mute and bypass buttons on the modules. You can switch effects on and off from the MasterSection. ▶



The Grungelizer Plug-In - now the high quality recording you slaved over can be made to sound like cracked 78 vinyl!

## Plug-in and see

### THE 10 WAVELAB PLUG-INS

**AUTOPANNER:** Moves signals around the stereo image. You can control the speed, width and levels of the two channels.

**CHORUS:** A full-featured, real-time chorus effect. Parameters include delay, width, frequency, feedback, Fb balance, glimmer (how the effect moves around the stereo image), stereo spread, mix and output level.

**ECHO:** Includes delay, feedback and delay balance parameters with the option to link the two delay settings. The decay dies naturally even if applied to a short sample.

**EQ-1:** Hi, Mid and Lo sections can be switched on or off. You can set the frequency of each band along with the cut or boost level.

**LEVELLER:** Reduces or boosts the level. Patch it in between two effects to match signals, say after the EQ-1 module.

**RESAMPLER:** Lets you play back the file at a different sample rate.

**REVERB:** Has several parameters including five relating to early reflections. Lots of scope for creative reverbing.

**TOOLS ONE:** Functions for adjusting overall level, switching the phase, swapping stereo channels and changing the perceived microphone recording method to add ambience.

**STEREOMAGER:** Converts a mono image into a stereo one and enlarges the width of a stereo signal.

**GRUNGELIZER:** Adds distortion, clicks and noise to simulate old recordings.

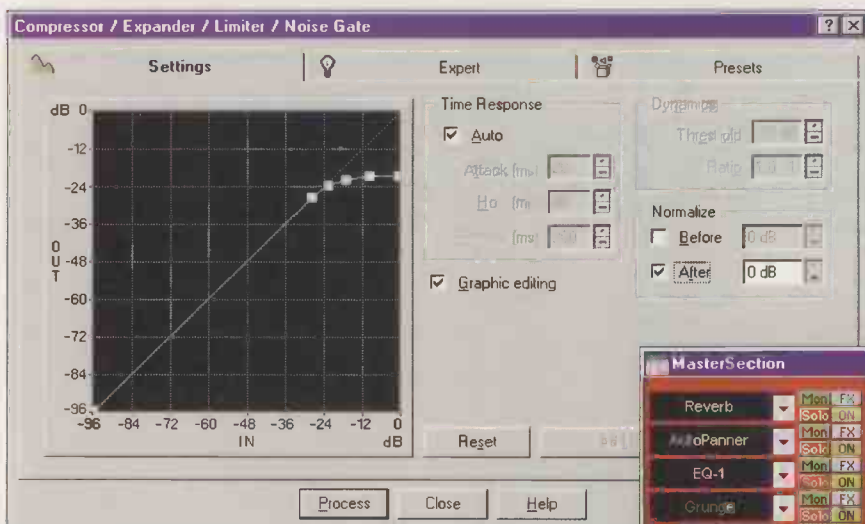

The Dynamics window is one of the most powerful and useful features of WaveLab

► The effects are applied to the waveform on playback in real-time. This is where a pretty nippy PC comes in useful. A less-than-nippy job will struggle if you apply too many effects at once. However, once you've got the effect (sorry!) that you want, you can write it to the file in which case lack of real-time processing power is not a problem.

There's also a dropout indicator which lights up if the program fails to play back correctly. This happens when you assign or remove an effect, which is fair enough, or if you're running too many effects and the processor can't cope. You can also cause a dropout by running other programs at the same time although WaveLab didn't pick up all dropouts caused this way, even though some were very severe.

The MasterSection also has two Dither settings, three Noise Shapes and you can set the output to 8, 16, 20 or 24 bits. These settings govern the quality of the sound if you need to reduce the bits - reducing a 20-bit file to 16 bits for CD mastering or reducing a 16-bit file to 8 bits for multimedia work, for example. Always remember, though, that the final quality of the output depends on the sound card you are using.

**Fast extraction**

Other goodies include support for .AU and .RAW file formats. There's a new Windows Controller Toolbar which makes it a little

easier to select the tools you want to use, though it's hardly a major enhancement.

The program can extract audio from an audio CD and transfer it to your hard disk. It should work with most SCSI CD ROM drives. There's also a Trim Silence option to remove the gaps between tracks and a speed selection choice so if you have an 8-speed drive, for example, you can extract audio at 8 x speed.

A major new feature in 1.6 is support for CD burning, for which you need a SCSI-based CD-R unit. The program includes the code for creating Red Book CDs based on the CeQuadrat software engine. The drivers can be updated, of course, but the program seems to support most of the common recorders. The main requirement for the CD-R is support for the 'Disk-at-once' mode. I ran WaveLab with Plasmon's CDR4240 and it worked a treat. It's an excellent CD-R unit, well worth checking out.

The CD-R facility makes it a practical proposition to master directly to CD. You could copy a DAT master to your hard disk and create a CD or, if you already have a master CD, you could use the audio transfer facility to copy it to the hard disk and create other CD. Used this way,



The MasterSection controls the selection and application of effects.

WaveLab is an ideal mastering system and perfect for short runs of promotional CDs, for example.

The infamous FFT display impresses the hell out of the neighbours.

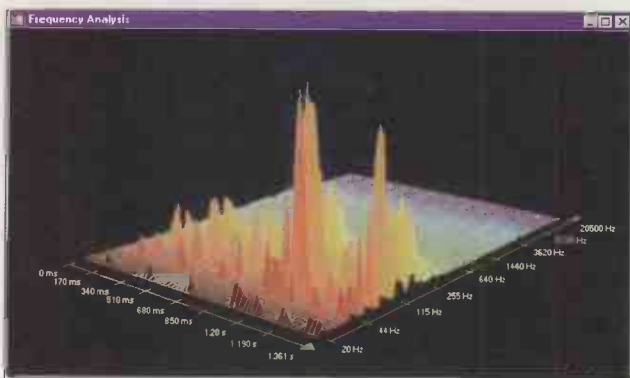

**Verdict**

What WaveLab 1.0 needed was more effects, particularly reverb and ambient effects - and now it's got them! The FX are reminiscent of those in Cubase VST on the Mac (and coming to a PC near you later in the year) - a neat and flexible arrangement, programmable and highly usable.

Spiffy features apart, it's the user-interface which really impresses. The ability to call up several sub windows, alter parameters in any of them and still control playback is superb. Technically, this is known as 'non-modal dialogs' - it's what you always wanted to do but never could in other programs. And most functions are intuitive, even beyond the level the Windows interface ought to inspire but rarely does. Add the ability to write CDs and WaveLab is a superb all-round editor, processor and digital audio mastering system. It's a shame it isn't a little less expensive and

then everyone could have one - and I find it hard to believe that once you've tried it you won't want one!

Doing production work on a PC has not, perhaps, caught on as quickly as it might have done. But with tools like WaveLab there's no reason why any musician should not be able to process and master their material to professional standards. It's simply a superb piece of software.

**More from: Harman Audio, Unit 2, Borehamwood Industrial Park, Rowley Lane, Borehamwood, Hertfordshire, WD6 5PZ  
Tel: 0181 2075050  
Fax: 0181 2074572**

WAVELAB 1.6

WHAT WE LIKE

- Superb and intuitive user interface
- RealTime Engine
- Support for 20/24-bit files
- Lots of programmable effects
- CD copy-protection system

---

WHAT WE DON'T LIKE

- Needs wads of computer power for real-time processing
- A tad expensive for those who would most like to use it

---

OVERALL

A high quality audio editor, processor and CD writer with lots of effects, expandable via Plug-ins and intuitive to use.

AKG Alesis Allen & Heath Aphex Audio Technica Behringer Beyer BSS C-Audio



We believe in giving our customers the very best in service, good advice, competitive pricing & excellent backup service!

**RENTALS**

We probably have the best rental system in the UK using world-class products from EAW, Midas & Crown

**RECENT CLIENTS INCLUDE**

Alanis Morissette • Beautiful South • Black Grape • Bluetones • Cream • Hootie & the Blowfish  
Lemonheads • NME Brats Tour • Placebo • Super Furry Animals • The Prodigy • Van Halen  
Wembley Stadium (FA Cup Final)

**INSTALLATIONS**

We can provide sound systems from background music in a wine bar to a full-blown 100kw rave rig!

**SALES**

We will only sell products that we feel confident will give years of trouble-free service!

**HOT SALES ITEMS**

- |  |  |
|--|--|
| <i>Amps</i>  | <i>Loudspeakers (in pairs)</i>                           |
| C-Audio RA3001 625 w/ch .....£749                        | Peavey Impulse 200 300w 12" • Horn. Same As The          |
| C-Audio RA4001 1000 w/ch .....£999                       | EV Sx200 But Only Half The Price .....£CALL              |
| Crown PT3 765 w/ch .....£849                             | JBL EON 15s A Few Left At This Crazy Price ... £699      |
| Crown K2 1250 w/ch .....£1499                            | Concert Systems CS152 700w 15" + 2" Comp 4Q Full         |
| Studiomaster 1200D 600 w/ch .....£549                    | Range cabs, the absolute business! .....£1649            |
| Studiomaster 700D 350 w/ch .....£399                     | Concert Systems SB215 800w 2x15" 4Q Push Pull            |
| Samson Servo 500 250 w/ch .....£359                      | compact sub .....£1499                                   |
| Peavey Amps GREAT PRICES .....£CALL                      | Concert Systems SB600 600w 1x15" 4Q lightweight          |
| <i>Effects</i>   | compact 15" subs .....only £849                          |
| Alesis All In Stock .....£CALL                           | Celestion Road All In Stock BEST PRICE .....£CALL        |
| Lexicon BEST PRICE .....£CALL                            | DAS Cabinets Now Available. Check Out The                |
| DBX Full Range In Stock .....£CALL                       | Stunning Sound and at only 17kg each                     |
| <i>Radio Mics</i>  | DS12.300w List £938 Promotional Price .....£749          |
| Shure T Series Diversity SMS8 Systems .....£395          | <i>Decks</i>   |
| RCF Twin Diversity Systems .....only £259                | Studiomaster 166 Trilogy 12-4-2 6 aux 2 st .....£599     |
| Audio Technica Liberator Limited Quantity At Only...£159 | Spirit Folios and Live Desks All Great Prices .....£CALL |
| <i>Mics</i>  | Mackie VLZ and SR All On Show BEST PRICE .....£CALL      |
| Shure SM58s For A Limited Period Still Only .....£89     | Allen & Heath GL2000 16/4/2 .....only £1249              |
| Shure Beta 58a Limited Special Offer .....£169           | Allen & Heath GL2 14-4-2 10 mic 2 st & 6 aux ...£749     |
| AKG D3700 Excellent All Rounder Voc/Inst .....£65        | <b>WHY NOT GO ON THE MAILING LIST AND</b>                |
| AKG D3900 Top Quality Vocal Mic List £259 Only £129      | <b>GET FIRST SHOT AT THE SALES SPECIALS</b>              |
| Audio Technica MB4000 Affordable Voc Condenser £79       | <b>AND BRILLIANT SECONDHAND DEALS!!!</b>                 |
| Audio Technica MB1000 Voc/Inst 3 For Only.....£99        | <b>CALL CARLA NOW.</b>                                   |
| Audio Technica Studio Condensers,                        |  |
| AT4033/AT4050 in stock .....£CALL                        |  |

**Excellent Part Exchange Deals**

**Finance Available, written details on request**

Unit 4D, Stag Ind. Est., Atlantic Street, Altrincham WA14 5DW  
Tel: 0161 927 7700 Fax: 0161 927 7722

Yamaha Tascam Tascam Spirit Studiomaster TAC Tascam Trantec Yamaha

Celestion CP Cases Crest Crown Denon Digitech DOD EAW Fostex Furman Garwood HH JBL Klark

Don't flatter yourself...

Xpression!



**XPRESSION! DPM1**

From Harbeth, the people who build the BBC's own speakers: studio monitors that are 100% about accuracy (and 0% about flattery)



turnkey

In stock + on demo!



Xpression!™  
Made in England

For information please ask your dealer or contact:  
Harbeth Acoustics Ltd., Unit 1 Bridge Road, Haywards Heath, W. Sx. RH16 1UA, UK.  
Tel: + 1444 440955 Fax: 440688 www.harbeth.com

gateway

in partnership with  
Kingston University



APPLY NOW FOR  
HIGHER DIPLOMA COURSE  
commencing September 1997

Call for our latest brochure or Visit us on the WWW

Options include  
Service and Maintenance  
Broadcast and Live Sound  
Post Production and Multimedia

Gateway, The School of Music, Kingston University,  
Kingston Hill Centre, Surrey, KT2 7LB Tel 0181 549 0014  
[http://www.king.ac.uk/~xe\\_s516/gateway.html](http://www.king.ac.uk/~xe_s516/gateway.html)



# ROLAND SC88 PRO

**Roland's new flagship Sound Canvas module includes a new, expanded sound set, hundreds more patches, and a new insertion effects processor with 64 effects.**

**But can it compete with the recent offerings from Korg and Yamaha? Simon Trask probes the SC88 Pro...**

**GM Sound Module £699**

It's now been over two years since Roland released their SC88 Sound Canvas GM/GS module, which at the time represented a significant advance for the Sound Canvas line. Roland followed up the SC88 with two 'spin-off' models: the marginally scaled down SC88VL desktop model at a significantly reduced price, and the MGS64, a 1U 19" rackmount repackaging job aimed at studio owners.

Today, the SC88VL has mutated into the SC88VLWH, whose white casing and reduced price (£499 to the original's £575) positions it in the computer add-on market. The MGS64 is still available, unchanged in colour and at its original price of £599; as such it competes more directly with Yamaha's £549 MU90R than the SC88 Pro does. The original SC88 cost £799 to the MU80's £699, and the price differential has been preserved with the latest round of modules, although the prices are creeping down, with Korg's NS5R at £599, the MU90R at £549, and now the SC88 Pro at £699.

The name of this new Sound Canvas module suggests that it's an enhancement of the SC88 rather than a 'next generation' GM/GS instrument. At the same time, the Pro designation is intriguing for a GM/GS module, hinting that there might be more to the new SC than meets the eye.

## Overview

In appearance, the SC88 Pro emphasises continuity and similarity with its

predecessor, giving the impression that anyone familiar with the original SC88 will have no trouble getting to grips with the Pro version. Front-panel differences are minimal: along with its Pro label, the Key Shift buttons now have the word 'Delay' beneath them, the EQ button has become SC88 Map, and the bottom row of buttons are labelled to indicate that they can be used for effect editing (in fact, EFX, the new Insertion effects).

On the rear panel, Roland have added a second pair of audio outs and provided a switchable Out/Thru MIDI socket. The in and out audio connections are still on phonos while the front-panel headphones socket is still a mini-jack. Studio owners might question the Pro tag of the new Sound Canvas, but there's a growing number of professional MIDI file developers for music and multimedia who might think otherwise. What counts most, after all, is whether the SC88 Pro is a professional instrument on the inside.

## The sounds

Several things struck me on first playing and listening to the SC88 Pro. To begin with, the grand piano sound (always a good starting point) has a new richer, smoother, more rounded quality to it (very similar to the grand piano on Roland's new E500 keyboard). Listening to the demo songfiles that come on a floppy disk, I was struck by the freshness, vitality and richness of the ensemble sound, and by the presence of effects not previously heard on a Sound

Is the SC88 a real Pro or not? Hear it in action with Roland's own demo





Two sets of outputs at the back, but only on phono plug

Canvas instrument – there's some funky wah wah guitar, for instance, and what sounds like a vocal part going through a voicebox à la Peter Dinklage.

The new effects are down to the addition of an Insertion Effect processor which provides an impressive array of 64 effect types/configurations, including not just single effects but two effects in parallel and up to five effects in series. The variety of effects and effects configurations here is very impressive (see Spec Sheet for full list). The vocal sound is produced by an Insertion effect called the Humanizer, which allows a range of vowel sounds to be 'superimposed' on any instrumental sound – and, as I say, the result is quite striking.

All the effects are programmable, with multiple parameters, and it's also possible to control selected parameters dynamically during performance. You can use one of the 64 Insertion effect types at a time, and route any number of the 32 available parts through it. This is in addition to the familiar System effects, namely reverb, chorus and delay (send level per part) and two-band EQ (on/off per part). Roland are so proud of their Insertion effects, it seems, that they've included a bank of 128 Patches which feature preset combinations of instrumental sound and Insertion effect;

these are played using parts A01 and A02. Including guitars, basses, electric pianos, leads, ensemble strings, pads and sfx, the Presets are generally very impressive, and are far removed from the 'General MIDI standardisation' normally associated with this type of module.

As I've already hinted, Roland have done more than add a few new capabilities to their latest module. They've actually given it a completely new sound set, and in the process bumped up the size of the sample ROM considerably, to an amazing 20Mb of samples and waveforms (the original SC88 has 8Mb). This results in improvements to many sounds and, of course, many additional sounds as reflected in the much greater number of preset sounds. The Pro has 1117 presets in all, and includes new drum and percussion sounds and additional kits which among other things help to give it a more contemporary feel.

The SC88 Pro's sounds have been designed and organised on the 'GM plus variation' principle, with each GM sound having a number of alternative sounds in different sound banks but using the same patch number. These additional sounds can be called up via MIDI using MIDI Bank Select commands followed by the appropriate patch number. So, for instance, the Synth Bass 1 GM preset (patch 39) is augmented by 18 additional synth bass sounds which you can call up by sending the SC88 Pro the relevant bank numbers plus program change number 39. Saw Wave (patch 82) has the most number of alternative sounds, with 31, but the average is around six or seven.

While the quality and variety of instrumental sounds on offer are impressive, the SC88 Pro doesn't sound dramatically different from its predecessor. It hasn't suddenly morphed into a JV2080, for instance, but remains recognisably a Sound Canvas module, although the Insertion effects do allow you to create a greater variety of sounds, and even a richer, more 'synthy' sound. But the SC88 Pro is first and foremost an ensemble instrument, and it has the characteristic bright, crisp, transparent yet well-rounded ensemble sound so characteristic of the Sound Canvas range.

## Spec Sheet

<b>Polyphony:</b>	64 voices
<b>Multi-timbrality:</b>	32 parts via MIDI In A and B or computer serial port
<b>Sound memories:</b>	Instruments: 1117 preset, 25 user; Patches: 128 preset, 16 user; Drum Sets: SC88 Pro (native) mode: 25, SC88 mode: 14, SC55 mode: 10
<b>Display:</b>	70.6 x 24.5mm graphical backlit LCD
<b>Effects:</b>	Reverb (8 types), Chorus (8), Delay (10), Insertion effects (64), 2-band EQ; delay and EQ are unavailable in Double Module mode
<b>Connections:</b>	Audio Output 1 L & R phonos, Audio Output 2 L & R phonos, Audio Input L & R phonos, MIDI In A, MIDI In B (duplicated on front and rear panels), MIDI Out/Thru (software switchable), headphones mini-jack, computer serial port with Mac/PC/MIDI switch

## Verdict

The SC88 Pro sees Roland bringing the Sound Canvas range up to date, with its new and additional sounds, Insert effects and extra set of audio outputs. Whether this qualifies it as a pro instrument probably depends on what area of the increasingly diverse music market you're working in. Roland have presumably stuck to the desktop format, phono connections and familiar interface for good reason – not least to encourage SC88 owners to upgrade to the Pro, something well worth doing.

By today's standards the SC88 Pro is pricey for a GM-based module, however, and it may not do enough to tempt people away from the significantly cheaper NS5R and MU90R. At the same time, if you're looking for a more synth-type all-rounder module with full programmability and sonic expandability, Alesis' new QSR may be the way to go, for around £50 more. **M**

More from: Roland, Atlantic Close, Swansea Enterprise Park, Swansea, West Glamorgan SA7 9FJ Tel: 01792 515020 Fax: 01792 799644/700130

## ROLAND SC88 PRO



### WHAT WE LIKE

- Sound quality
- Huge collection of sounds
- Insertion effects
- 32-part multi-timbrality

### WHAT WE DON'T LIKE

- Limited sample editing facilities
- Limited processing functions
- Cramped display and front-panel layout

### OVERALL

A powerful and versatile GM/MS module which brings the Sound Canvas range up to date.

# WORLD CLASS INSPIRATION

JUST A FEW OF THE WORLD'S BEST QUALITY SAMPLED SOUNDS FROM THE WORLD'S LARGEST DISTRIBUTOR - SEE 100'S MORE CDS IN OUR FREE CATALOGUE

## Best Service (Germany)

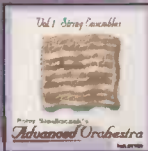

**ADVANCED ORCHESTRA**  
Produced by PETER SIEDLACZEK. A complex yet compact and user-friendly sound library setting new standards for symphonic samples. • 5 CD-ROMs or audio CDs • 5455 samples of all instrument groups.

Numerous characteristics distinguish this library from others (too many details to mention here - read the full story in our new free catalogue). Vol 1 - String Ensembles. Vol 2 - Solo Strings. Vol 3 - Woodwinds. Vol 4 - Brass & Effects. Vol 5 - Percussion & Harp. Each Volume: Audio: £59.95 / ROM: £149.00. Or purchase the whole ROM set for only £599. (Choose AKAI or ROLAND for the CD-ROM version).

## Spectrasonics (USA)



**LIQUID GROOVES**  
Grooves that have existed only in your imagination.

Fluid rhythms forged by a synthesis of propelling live drum grooves and unusual, organic percussion loops performed by some of L.A.'s most creative session players. Unique sonic textures! State-of-the-art instruments such as Korg Wavedrum™. The full-blown CD-ROM version (organised to make mixing & matching effortless) includes a wider selection of grooves & killer Wavedrum™ single hits. The liquid concept is two-fold: Sparse "hand-played" grooves that feel great, combined with focus on uncharted sonic territory. Another inspiring & unique library from Eric Persing to reinforce Spectrasonics' reputation as second to none. Audio CD: £59.95. CD-ROM: £149

## A.M.G. (England)



**BLACK II BLACK KILLER VOCALS VOLUME 3!**

AVAILABLE NOW!  
Yet another 2-CD package of almost 2000 vocals from McIntosh & Charles - this is the third and final part of this five-star international smash hit series. CD 1 features hooks in a similar vein to volumes 1 and 2. CD 2 runs for almost an hour, and features 'Percussion vocals', Vocal Fills, a DJ section, Ragga section, and a section of advanced chords. SO DON'T MISS THE THIRD AND FINAL PART OF THE BIGGEST AND BEST VOCAL COLLECTION EVER RELEASED! Audio CD: £59.95

## Ilio Entertainments (USA)



**DOUBLE PLATINUM DRUMS**  
Multi-Platinum record winners, producer John Boylan and drummer Michael Botts have put together one of the smartest, most tightly assembled collections of live drum loops to date.

Phenomenally well-recorded and mixed in true stereo with the same high quality you expect from platinum records. These acoustic kits are played with raw, rockin' energy and plenty of feel. Loops & hits. Dry & Room. Intros, fills & ends for assembling complete tracks! Audio CD 2-disc set: £79.95. CD-ROM 2-disc set formatted for Akai, Roland or SampleCell: £199.00



**XX-LARGE THE KILLER VOLUME 2**

This is the sequel to the triple-5-star-rated XX-LARGE THE KILLER, and it includes over 1000 accurately tuned new drumloops from 120 to 165 BPM and many more hot killer samples.

XX-LARGE THE KILLER has been one of our best sellers and rightly so - now Best Service have pulled out all the stops to bring you a sequel that once again truly deserves the title KILLER. All we can say is: miss it at your peril. Audio 2-CD Set: only £59.95. Akai/EMU, Roland or SampleCell CD-ROM (500Mb): Only £99.00



**HEART OF AFRICA VOLUME 2**

Following the success of Heart of Asia, the equally unique sequel is a smash hit.

The library comes in two parts. Volume 2 (shown) features all-new tribal phrases, vocals, performances and effects, mostly recorded at a huge tribal competition in Kenya. This material is very primitive & really enhances the volume 1 samples. "Heart of Africa" is heartily recommended to anyone seeking beautifully recorded authentic ethnic sounds & rhythms, and complements "Heart of Asia" perfectly. Volume 2 audio CD: £59.95 CD-ROM: £149. [Volume 1 audio 2-CD set: £79.95. CD-ROM: £199.00]

## Sounds Good (Sweden)



**METHODS OF MAYHEM**

Brutal & sweet sampling for Industrial/Intelligent Techno. Goth Techno or anything in need of an Experimental Edge. Uniquely twisted, bizarre and savage stuff. Drum-, Bass-, Synth-, FX-,

Vocoder-, Feedback- & Noise-loops. Grinding Guitar Riffs & Feedback. An Analog Heaven with Synth FXs, Sweeps, Zaps, Basses, Drum & Perc Sounds etc. All programmed on vintage equipment and treated without any mercy. Creepy & Cheesy Sound FX, Music FX & Voices. Over 1000 samples. A unique collection. Loops are in set tempos that match other Sounds Good titles. Audio CD: £59.95



**SYNCLAVIER LIBRARY (AUDIO)**

The five-CD-ROM Synclavier Library from Ilio (USA) has been compiled into two audio CDs containing over 2000 samples. VOLUME 1: "ESSENTIAL" covers Electric and Acoustic Guitars, Electric Pianos, Synths, and Drums & Percussion. VOLUME 2: "ORCHESTRAL" covers Strings, Harp, Brass and Woodwinds, Grand Piano, Orchestral Percussion including Timpani, Bells, Chimes, Gongs and more! Accompanying manual gives loop points for every sample so it's extremely easy to loop samples quickly and effectively. Each CD: £69.95



**DANCE MEGA SERIES HOUSE & DANCE**

Each title in the new DANCE MEGA series from BEST SERVICE (Germany) includes an audio CD AND AN AKAI CD-ROM for only £59.95!

"House/Dance" features 1300 new drum loops (120-140 BPM) PLUS 350 house and dance sounds including house synths, house organs, pads, basses, multisamples, drums etc etc. Another hot new dance resource, coming to a jukebox near you soon! TWO OTHER VOLUMES ARE ALSO AVAILABLE NOW in this great new series: "HipHop/Electro" and "Jungle/Rave". Each title: £59.95 (Audio CD plus CD-ROM 2-disc pack).



**SUPREME BEATS**

The most comprehensive library of percussion grooves & instruments ever developed, featuring percussionists from all over the world. This highly acclaimed library is now available on 2 CD-ROMs.

1: AFRICAN/CONTEMPORARY, & 2: WORLD/DANCE. "A feast of human folk-energy & emotion... a knockout... Supreme Beats is a winner, 20 stars out of 20." (Keyboard, USA). African/Contemporary CD-ROM: £149.00. World/Gance CD-ROM: £149.00. Audio CDs 1 to 4 (boxed set): £199.00. Audio CD 5 (NEW!): £59.95. (CD-ROM versions include all the sounds from Vols 1-5 audio CDs).



**ON A JAZZ TIP**

This is Hip Hop In Full Swing! This superb release from Swedish developer Sounds Good features stomping grooves, licks and loops, played in pre-determined keys and tempos to be used inter-actively.

Includes Bass, Guitar, Keys, Horns, Drums and Percussion, Jazz pads, riffs and chords. Perfect for all HipHop, Rap, Soul, TripHop, Acid Jazz and Funky flavors.

"On a Jazz Tip" is ideal for any music project that needs a sting, swing or that Jazz Thing. Produced and played by musicians who love and respect music. Audio CD: £59.95



**D-DAY**

2CDs/145 minutes of all-new construction kits, drum loops and hits, synth & percussion effects and more. This is the second release in the Megalon Bomb series. Styles include: jungle, electro, west coast breaks, trip-hop, hard-hop, gabber- and of course, House & Trance (goa, hard trance, melodic trance, etc). Several of the contributors are internationally recognized and have toured and/or released records all over the world. The quality really shows. Also features drum machines, Junk yard and industrial clanks and scrapes, individual hits, loops and layers, vocoder sounds, west coast breaks, live drummers, Synth loops (TB-303's, MC-202-controlled synths, Nord Lead and lots more). Audio 2-CD set: £69.95

## Big Fish Audio (USA)

## A.M.G. (England)



**PASCAL'S BONGO MASSIVE**

Rhythm of Life Vol. 4 is a 2-CD set from Pascal Benadjoud, the top percussionist whose credits include Stereo MCs, Bob Marley, Lisa B, Gypsy Kings etc. Also well known on the UK club scene, he's

worked with top UK DJs like Paul Oakenfold & Ganny Rampling, often adding live percussion to their mixes. Features longish) grooves with various mixes accompanied by solo patterns and hits. Lots of tight, inspirational performances to explore. All in all this is another high quality and useful collection from AMG that's sure to become another classic. This CD has received truly FANTASTIC reviews in all the music press. Audio CD: £59.95



**DISTORTED REALITY**

Cutting Edge Textures, FX and Loops from the labs of top Hollywood sound designers and techno-heads. From 3D atmos transformed via Harmonic Morphing, to incendiary fuzz mutations, Trance-inducing ambiences, loops, enormous modular drones and astonishing

timbral contortions - an essential resource for the producer, composer, or sound designer in search of the magic noise. "If you're making any kind of edge music, this is a library YOU MUST HEAR... gorgeous curtains of sound... will get your listeners' blood pumping... For the progressively minded this disc is a feast-5 stars out of 5 in every category" (Keyboard, USA). A spine-tingling-sample collection. Audio CD: £59.95. CD-ROM: £149.00

## Best Service (Germany)



**JAM BOX**

This new cracker from ueberschall is a complete work-tool for jungle, house & trip hop, produced by DJ & remix workaholic Mousse T (eg Quincy Jones, Ann Nesby, Ruffneck, Bootsy Collins).

It contains over 1600 samples including: 320 Drum and Percussion loops, 370 Vocals, Adlibs, Shouts, Bass, Guitar, Brass, Sax-Licks, Pianos, Organs, Rhodes, Synthesizers, Jazz-Chords, Strings, Effects, Breaks, Special 3D Vocals, 3D Percussion Loops+Samples, 250 Drum-Percussion Samples. Midi-files for drumloops+chords for Mac/PC are included in a mixed-mode section. Audio CD: £59.95. Akai CD-ROM: £99



**FREAKY JAZZY FUNKY**

From Rich Mendelson, the five-star producer of Phat & Phunky and Dance Industrial, comes the new standard in construction kits. Rich assembled the East Coast's premiere session talent and contributed his own amazing production and programming skills to make this set his best yet. With the included midi-file disk, it's a breeze for the producer to customize the loops and swap sample elements. Exploring the funky side of dance music, Freaky Jazzy Funky is the set to beat for 1997 and with three CDs and a Midi file floppy disk, this collection has to be one of the industry's best value products! Audio CD: £59.95

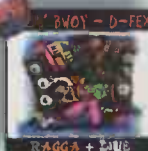

**KRITICAL MASSIVE**

"KRITICAL MASSIVE" by SOUN BWOY is a brand new dance sample CD featuring grungy, dirty Ragga and Dub samples. It features loops, Vocals, Bass, FX and loads more.

If you're looking for dirty dub sound and rhythm, with tons of feel to sit under your next music project, you should check this out this resource of fresh new material.

AVAILABLE NOW!  
"Soun' Bwoy" will be featured in our jukebox listening stations at over 50 UK dealers from 1 March onwards, if not before! Audio CD: £59.95

## Zero-G (England)



**CUCKOOLAND VOL 2 GHOST IN THE MACHINE**

"Ghost in the Machine" is the second title by the Cuckooland team, & delivers everything you'd expect and more from this innovative and highly-acclaimed production team! Dark & menacing mind-altering ambiences, heavenly pads, extraordinary arpeggiations..... this CD is packed full of some of the most amazing textures & effects ever created. Lie back, shut your eyes, and let the ghost take control....

"Very bizarre... a multitude of creative possibilities... you can't get much scarier than this monster" (The Mix). Audio CD: £59.95

## Zero-G (England)



**THAT JUNGLE FLAVOUR VOL 2**

Just arrived - the latest in the Zero-G line-up of jungle CDs! Rinsing out the drum 'n' bass flavour, 'That Jungle Flavour Vol 2' is a superb addition to extremely popular Vol 1 & must for the serious junglist producer. Featuring 350 rough & ready breaks, an enormous selection of pads, stabs and fx, plus vocals and scratches to step up the dancefloor pressure. Rollin', rough, hard-steppin' and firing on all cylinders!

Audio CD: £59.95



**LOOPALICIOUS**

NEW! Another sonic smash from Big Fish Audio (USA). Crammed with drum loops - all the beats are 2 bars long and each is unique - lots of variety which means value for money. Also features loops that leave out the snares or the kicks. This enables you to get that authentic turntable sound, but add the character of your private collection kicks & snares. To top it off, they've included scratches and transforms, 4 bars long and with precise tempos. From the smoothest hiphop soul to the deepest bass, some of your best jams will start with Loopalicious! Runs 74 minutes. Audio CD: £69.95

## Q-Up Arts (USA)

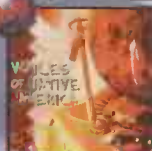

**VOICES OF NATIVE AMERICA**

NEW FROM Q-UP ARTS in the USA. This is a truly unique sample collection. An evocative and inspiring journey into the heart and soul of North American indigenous music. "Voices of Native America" features a wide variety of sounds including: Flute passages, multi-track shaker and percussion loops, group and solo vocals, and lots of huge low drums. Features performances from tribes such as Lokotah, Navajo, and Apache. Audio CD: £59.95. CD-ROM: £199



**Promotion FREE WHEN YOU BUY AN A.M.G. CD\***

The brand new AMG demo CD "Promotion" - a riveting collection of samples from many AMG products, including: Black II Black Killer Vocals, Keith Le Blanc II, Karma Chopra, Tony Mason Smokin, Abracatabra, Pascal's Bongo Massive, Tim Farriss, DJ Papa Large (Hot & Sweaty House Cuts), and Blackbeat. Plus! - lots of exclusive samples that don't appear anywhere else from: Black II Black, Terminalhead, Sample & Hold, David Ruff's Drums II, and others. This is a huge and valuable collection of pro samples and it's FREE when you buy an AMG sample CD. (\*Offer limited to one per household, while stocks last)



**JUNGLE WARFARE**

For Jungle this is the one that EVERYONE says is the best of the bunch • Loops • Rolls & fills • Perc Kits • Pads & Chords • Bass • FX • Vocals. "Excellent fidelity, balance & punch, & variation in feel & sound... there's no serious competition. Rated 5 stars out of 5" (Sound on Sound, UK). "Kicking grooves... a wide range of styles... highly useful... AS UP-FRONT AS YOU CAN GET." (The Mix, UK). "Jungle Warfare gives you just about everything you need to survive in the remix rain forest." (KEYBOARD USA) Audio CD: £59.95



**CUCKOOLAND VOL 1 'UNHINGED'**

The incredible rhythms, textures & FX on 'Unhinged' will blow your mind! Grooves from 67 to 170 bpm provide rhythmical backing unlike anything else available, & the textures & FX are not of this world... This collection is ideal for all - from Trip Hop to Film. "Rhythm & sound simply acting to be sampled & used in new & exciting ways... this is no ordinary CD" (Sound On Sound, UK, Sept '96). "Loops wonderfully diverse in style... Production is exemplary throughout... musicianship is of a high standard" (The Mix, UK, October '96). "The off-beat, rhythmic nature of the loops make them extremely useful as inspirational tools" (Future Music, UK, February '97) Audio CD £59.95







# XPRESSION DPM1 & MS1

Nearfield Monitors/Sub-Bass Units £379/£349

**Alan Branch  
checks out a  
monitoring system  
from a company  
new to the project  
studio market**

**N**ear-field monitoring can be such an opinionated subject. The speakers that you think are the best in the world are probably hated by someone else working next door. Many engineers will be familiar with the scenario of arriving at a studio, and the producer or artist saying "Right, let's get rid of those NS10s because I can't work with them," and hiring some alternate speakers. This kind of thing happens all the time because people in the industry like working with equipment they know.

Ideally, a set of monitors for mixing and mastering should be uncoloured, so you get

a good idea of the frequencies you are dealing with, and don't find them tiring when working for long periods of time. Monitors that are very 'bright' or 'flattering' can be nice to listen to, but are generally not a good idea for judging your material in the recording studio.

Some time ago when Yamaha's NS10s came out, people decided not only did they look good but they sounded great in the studio, and this has led them to become an industry standard of sorts. Speaker manufacturers have tried over the years to capture this kind of market, and many good alternate studio monitors now exist, whether you are paying £200 or £2,000.

**Overview**

Harbeth Acoustics, a specialist loudspeaker manufacturer located in the south of England have, for twenty years, been monitor manufacturers for the broadcasting industry – clients include the BBC, ITV, Channel 4 and NBC, in addition to many post-production studios around the world. For mastering and project studios, Harbeth have developed a new range of speakers, called the Xpression. The first in this series is a ported two-way monitor, the DPM1.

The speakers themselves seem well-constructed from seamless 15mm MDF, with a grey suede-finish NEXTEL paint which gives a very nice look and feel. The DPM1 uses a custom 28mm ferro-cooled soft dome with rear damping chamber for the HF driver, and a 200mm injection-moulded polymer cone for the LF driver. This has what's described by Harbeth as a "distinctive colour-coded bass driver" (in this case pink). There's also a pro version available which includes HF power monitoring/limiting with an internal auto-resetting microchip overdrive switch and a peak power LED.

The DPM1's come fully AV-ready, with a controlled magnetic field making them suitable for close proximity to TV and computer screens. This is great if you have a large screen like I do in the studio; normally I'd need to keep the screen a good distance from the speakers which can be impractical if I want the screen mounted above the middle of the desk.

**MS1 Subwoofers**

The additional matching subwoofers, MS1, are designed to passively filter sub-bass at around 140Hz, so removing LF from the signal being fed to the DPM1s. The MS1 has just an external port, using the same drive unit as the DPM1's inside the cabinet in a front venting band pass enclosure. This forms a natural low pass filter, and ensures they deliver a powerful bottom end. MS1's are similar in size and weight and come as

a pair, which is unusual since most manufacturers provide only one sub-bass for a pair of speakers. However, this does mean that each signal being fed to the left and right is dealt with separately, and provides the opportunity for experimenting with placement of the subs.

Connection is made via a four-pole 20A lockable connector, using a Neutrik Speakon NLF4C plug, a connection normally associated more with PA use than studio. However, it does give a nice airtight lockable connection, and when used with a good quality speaker cable provides a professional and reliable signal flow. This is quite a nice feature, since you often find wires only half in, or strands of wire pulled out of the speaker connections. Connection using Speakons is a simple case of inserting the plug and twisting to lock it. On the back of the MS1 you'll find two sockets, one to receive power from the amplifier, the other to feed the DPM1.

**In use**

The specially-made polymer cones are firm to the touch, unlike conventional soft-drape cones, and transfer the dynamics well. This tough material seems to give the speakers a nice lasting feel to them. I installed the DPM1's with the MS1's as additional speakers in Adrian Sherwood's (On-U Sound) studio and also used them whilst mixing in two different SSL rooms, placing the DPM1's about 1.5 metres apart with the MS1's below the desk in the same relative position. Using them for both recording and mixing, I also listened to various mixes that I know well, and was very impressed by the uncoloured nature of the sound, with good detail at the top end.

The stereo imaging seemed exceptional, with a very clear mid-range. The sub-bass units deliver the goods, but give a little too much for my liking. It is, as ever, down to personal listening preference – mine being that as a studio monitor, I would prefer slightly less bass. This set-up may be off-putting for someone new to them, and certainly take a while to get used to which, whilst okay in a private studio, may be unacceptable in a commercial one.

However, it's a simple matter to disconnect the MS1 sub-bass units and just use the DPM1's on their own, if this does prove to be a problem.

Speakers generally operate more efficiently when used with sub-bass units, as the LF is being filtered out, leaving the speaker to produce the rest of the frequency range. In practice, this is quite nice for mixing, as your near-field monitors can show what is happening at the bottom end. So if you're in a studio and the main monitors are not to your liking (which is more often than not), you can use your near-fields and still be able to hear the bass you would only usually hear on main monitors.

Another nice thing about buying speakers from Harbeth is that they offer several custom options, which include

**Spec Sheet**

<b>Frequency Response:</b>	48Hz - 20kHz
<b>Drive Units:</b>	LF: custom 200mm polymer cone, 25mm aluminium voice coil and antimagnet HF: 28mm soft cone with rear damping chamber
<b>Sensitivity:</b>	87db 1W/1m
<b>Power Handling:</b>	120W programme
<b>Impedance:</b>	8 Ohms
<b>Dimensions:</b>	420mm(H) x 255mm (W) x 285mm (D)



The DPM1 has attractive looks and quality sound

powered/active versions, cloth grille covers and accessories such as a twin channel power amp, studio stands, and so on.

**Verdict**

I compared these speakers to various other types and powered them with different amplifiers, and the results were always positive. There is a good all-round frequency response,

giving an unflattering and clear sound at all volumes, with the added bonus of the controlled magnetic field (being ever more important in today's growing multimedia). For the money, whilst not being the cheapest, the DPM1's certainly offer very high quality, with both the sound and design that you may normally expect in a much higher-priced range of monitors.

Remembering that all your judgement, whether recording or mixing, comes via what you hear, the importance of good monitors cannot be overstated. They can either help you achieve the sound you are looking for, or they can hinder you and keep you guessing all the time. I would recommend both these Xpression models – with, and without, the sub-bass units – whether you're pumping bass on dance material, cranking up a guitar or recording your string quartet. If you are an engineer, producer or a home studio user, these would definitely be worth considering when looking for new monitors. Think pink!™

More from: Harbeth Acoustics Ltd, Unit 1, Bridge Road, Haywards Heath, West Sussex RH16 1UA  
Tel: 01444 440955 Fax: 01444 440688

XPRESSION  
DPM1/MS1

WHAT WE LIKE

- Controlled magnetic field
- Excellent stereo imaging
- Custom options
- Uncoloured response

---

WHAT WE DON'T LIKE

- A tad bass-heavy with subwoofers

---

OVERALL

Quality studio monitors whose honest sound won't lead you astray.



# ROLAND V-XPANDED VS-880

Expanded Digital Recorder £2238

Roland have added a powerful effects generator, system upgrades and some 'virtual processing' functions to their VS-880 digital recorder. Paul Mac plugs it in...

**W**hen it was reviewed, back in April '96, Bob Dormon had this to say about the Roland VS-880: "I'm impressed. If I could be disparaging then believe me I would be... this is one of the best performances Roland have ever made." High praise indeed. The VS-880, complete with VS8F-1 effects expansion board is truly a recording workstation. To summarise: 8-track (64 virtual tracks) hard disk recording and editing with no mouse, 99 levels of undo, scene recall, and an internal effects processor with a staggering array of algorithms.

Just in case you aren't satisfied with that, Roland have added a few bits and pieces in the form of some new software, and called any VS-880 with that new software 'V-Xpanded'. First we'll take a

short cut though the basics of the VS-880, and then explore the new features, but for a quick scan of what's new, you could take a look at the 'In Brief' sidebar. We have dedicated a large portion of the article to the effects expansion. This was an option for the VS-880, and with the new features, it's time we had a look at it in detail.

### New tricks

One big improvement is the auto mix system. Previously, the VS-880 had only scenes to store mixer settings (snapshots of the system's controls and levels), and one song supported a maximum of eight scenes. These are still retained, but the V-Xpansion adds some automation to its existing mark points system.

The VS-880 has various recording modes that allow the user to offset hard disk time, compression, and sample rate. The highest quality mode is Mas (Master), though in

Hear a selection of the Xpanded VS-880's effects processors in action on this month's cover CD



version 1 it was restricted to 4-track playback. This has been V-Xpanded to 6-track playback, which will be an important improvement for some people, though we suspect most VS-880 owners will be using Multi-track 1, or Multi-track 2 modes and so won't be affected by this.

EQ is one thing that the V-Xpanded VS-880 has in generous amounts. Many of the algorithms in the effect processors incorporate EQ into the chain, and even without the VS8F-1 board, the VS-880 has a modicum of EQ available. In the V-Xpanded model, eight channels of EQ are available, independent of the effects processors. Each EQ is 3-band, with semi-parametric low and high bands, and a fully parametric mid band, all with  $\pm 12$ dB gain. Maximum Q setting is an impressive 16.

Apart from the effects, the addition of a stereo input for input-track mode, and a peak hold function for channel metering, round off the main V-Xpanded features. If anything, the metering side of things could do with a bit more. For example, overload alerts, and metering through the signal path would be useful. One display could be used to show the signal levels throughout one channel's route, using the Ch Edit buttons to switch between channel displays.

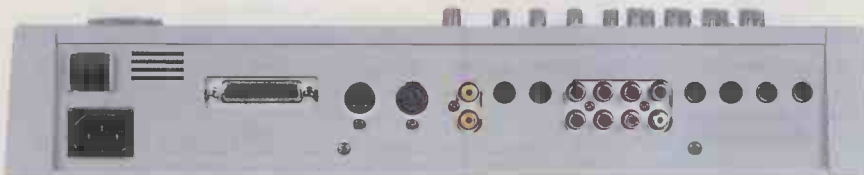

Phonos, jacks, DINs and SCSI share the Roland's back panel

## The effects

The VS8F-1 is a small circuit board that fits inside any VS-880, behind a screw-down plate on the underside of the main unit. Once in, all the new options become available, already catered for by front panel legending and buttons.

You get two stereo effects processor that can either be inserted into a channel of your choice, or stuck on the internal auxiliary busses (fed either pre- or post-fade from the channels). If you insert an effect, it is not available to any other channel, though left and right channels can be inserted on different channels. As per normal, auxiliaries are open to any channels. The Effect edit condition button displays either effect 1 or effect 2 on screen, where preset select, user patch save, and all the editing options are scrolled using the parameter keys. Stepping through the editing parameters of a complicated algorithm is a minor pain, but the shift button eases this by letting you skip several parameters at a time.

That's about it, operation-wise. The effects can be slotted in during recording, bouncing, or mixing, or can be routed back out without going to disk, for monitoring. The real excitement starts when you consider the algorithms, not just the quality,

but the quantity. The VS8F-1 is swamped with every effect under the sun, adding an enormous chunk of power to the VS-880.

## The reverb

The VS8F-1 has three reverb algorithms (reverb 1, reverb 2, and Gate reverb), and a selection of 42 presets based on those three. Reverb 2 replaces damping functions in Reverb 1 with a gate/ducking select option and appropriate controls. The only other difference is an operational one: Reverb 1 and the gated reverb can only run on Effect 1, while Reverb 2 can run in either effect slot.

Reverb 1 is definitely smoother than Reverb 2. Switching between them and listening to the tails tells us that much. Overall, reverb is not the VS8F-1's forte. While the presets are plentiful, some of them suffer from a slightly grainy quality, most obvious in the face of low frequency transients. However, much of a reverb's impact is in the high-frequency reflections, and in the VS8F-1, subtle doses can be quite pleasing. The ambient reverbs are the best of the reverb presets, especially Soft Amb, a pleasantly percussive, complimentary reverb with warm tonality.

The larger rooms fall short of most

outboard reverbs, even when levels are tempered. These are best reserved for individual tracks where a covert spacial sense is required and where the final mix provides a bit of camouflage. One plus point is that the reverb defaults stay admirably true to the direct source, so low reverb levels sound natural. This attribute is a useful marker while preset editing is actually in progress.

You get 200ms for the pre-delay, and a refreshingly effective density adjustment. While there are plenty more fiddly bits, a mention of the damping parameters will finish off the reverb assessment. These are high and low frequency modifiers that actually have meaning and do add bit physical dimension to the proceedings.

## The vocal FX

When Roland say Multi-effect algorithm, they mean it. The Vocal Multi algorithm is a string of seven processes: Noise suppressor, limiter/De-esser, Enhancer, Equaliser, Pitch Shifter, Delay, and chorus. The Noise suppressor is actually a noise gate; the limiter/de-esser can do one or the other (not both); the enhancer works in the time domain, taking a bandwidth defined by a high pass shelving filter and adding a phase-shifted version to itself. Unless intended, overdoing this process can be

## Spec Sheet

<b>AD conversion:</b>	18-bit, 256 times oversampling
<b>DA conversion:</b>	18-bit, 8 times oversampling
<b>Internal processing:</b>	24bit (mixer section)
<b>Frequency response:</b>	10Hz – 22.6KHz $\pm 0/-3$ dB (48kHz)
<b>Total Harmonic Distortion:</b>	<0.08% (input sens= $-10$ dB, 1kHz at nominal output level, recording mode: Mas.)
<b>Residual noise level:</b>	$\leq -91$ dB (aux send/master out, input terminated with 1K $\Omega$ , input sens= $+4$ dBm, IHF-A, typ.)
<b>Dimensions:</b>	434 x 317 x 88mm
<b>Weight:</b>	4kg (excluding internal hard disk).

tragic, producing a thinner replica of its victim. As in most of the other equalisers, Roland have gone to town with the EQ: three band, fully parametric, with the choice of shelving and peaking shapes for low and high. Next is the pitch shift process, which has a range of  $\pm 12$  semitones with  $\pm 100$  cents fine tune. The chain is finished with delay (up 1 second in 1ms increments) and a chorus with pre-delay (rate 0.1 to 10Hz).

The reason we've gone into this algorithm in so much detail is that many of its component parts are found in other algorithms. In some cases, spare processing power allows the addition of a couple of controls (feedback in the pitch shifter, for example). The Vocal Multi algorithm is Roland showing off. The price you pay for this many processes is stereo. Left and right inputs are summed at the input and only get open out again for the stereo chorus. All of the algorithms in the VS8F-1 trade processing power for size and configuration of algorithms, nothing new for 99% of the worlds FX processors, and you should agree that seven processes for a stereo feed is a bargain.

## The Mic Simulator

We'll stay with the vocal theme for a moment, as there are some interesting, and unexpected algorithms just around the bend. First is the Mic Simulator algorithm, one of the algorithms described in the main manual, but not in the VS8F-1 user manual. For a specified mic source (Roland DR-20, small dynamic (SM57), Head-set dynamic, miniature condenser, or flat/line input), the mic simulator claims to convert these to an expensive studio mic of your choice, including small condenser (C451), large condenser (U87), and small dynamic (SM58).

The rest of the parameters are just as intriguing: phase inversion, bass cut (found ▶

▷ on posh mics and mixer inputs), proximity effect, time (distance from source), and a limiter with filtered sidechain, threshold, attack, and release. We didn't have enough mics to test every aspect, but in general it did help open up the sound of dense vocals, the SM58 did its 3kHz hump thing very well, and even the proximity effect, which one might expect to be a little over the top, was very realistic.

The mic simulator algorithm is loaded as a stereo process, but can be operated as two mono channels or two linked channels for stereo mic work. Even using a stereo feed, keeping the channels independent can be lucrative, as some interesting effects can be had by mixing and matching mic type and time domain settings.

Also in the vocal arena is a stereo pitch shifter/delay algorithm; a Voice Transformer algorithm for changing the gender of the vocalist (unfortunately quite grainy compared to ordinary pitch shift); a very cool, ten-band Vocoder (instrument in the left channel, mic in right; and exceptional 19 band Vocoder (we had loads of fun with this one); and a vocal canceller.

### Guitar hero

The VS8F-1 has three Guitar Multi FX algorithms, and an amp/speaker simulator algorithm. The Guitar Multi algorithms, like the Vocal Multi, sum left and right inputs, stick the result through seven processes, and release a stereo output. Only one process differs between the three versions (the fuzz box), so all three can be summarised as follows: Compressor, Metal/Distortion/Overdrive, Noise suppressor, Auto Wah, Guitar Amp simulator, Flanger, and Delay. Strangely, Roland have only provided fourteen presets based on these algorithms, and that includes three basic templates. So anybody with an inkling for tinkling will be in heaven.

Nobody could be disappointed by the Guitar Multi algorithms. Roland's experience in spectral simulation shows its colours here. The three fuzz box variations alone will get any guitarist over to the VS-880's screen – just don't let him put it on the floor. The acoustic preset is deep and warm in a metal string kind of way, and the Guitar Multi 3 presets make conservative, but effective use of the overdrive process. The list goes on: the flanger can go all the way to a dirty sweep oscillator, the Auto Wah has a tonal abilities beyond the call of duty, and the guitar amp simulator adds an all-important live feel.

The dedicated amp/speaker simulator is far more comprehensive than the one embedded in the Guitar Multi algorithms, offering a choice of fourteen pre-amps, and

## In Brief

### NEW FEATURES OF V-XPANDED VS-880

- 1) Effects:** With the VS8F-1 board you now get two stereo FX processors, 100 new presets, and nine new algorithms. Two effects can be inserted into one channel.
- 2) Auto mix/mark points:** 100 mark points per song. Settings for level and pan information for channels, master, auxiliary sends and effects sends can be recorded during playback.
- 3) More Tracks:** In MAS recording mode, the maximum track playback capability has been increased from four to six tracks.
- 4) EQ expansion:** Up to eight, three-band EQs can be used in input-mix/track-mix modes on any of the fourteen signal paths.
- 5) Stereo source mix:** The VS-880 can now mix in an external stereo source, as well as the eight tracks, in input-track mode.
- 6) Track tweak:** Track levels can be set in channel menus, independently of – and in addition to – fader levels.
- 7) Metering:** The level meters display now features optional peak hold, reset with the display button.
- 8) Copy Protect:** When you master via the digital outs, you can opt to set copy protect on the master, preventing second generation digital copying.
- 9) FaderMatch:** When fader levels do not match actual levels (when modes have switched, for example), you can choose to match levels as soon as a fader is moved or when a fader passes the actual level.
- 10) Space remaining:** There are now four options for the RemainDisp: Time, Capacity (MB), Capacity (%), and events.

twelve speakers. Roland's COSM technology, made famous with the VG-8 guitar processor, is the engine behind this; just think of it as a room full of classic gear, waiting to be explored.

The VS8F-1 also has more single algorithms, such as a stereo flanger or a phaser. If you don't need an all-singing Multi, you can opt for a single effect, get a little more control, and wallow in separated stereo inputs. Many of the so-called guitar effects sound great on vocals, percussion, and synth noises that need to sound a bit rough at the edges.

### Another dimension

For the experimentalists, and sweet spot listeners among you, the RSS (Roland Sound Space) 3D encoding system is included. This splits into three algorithms: 2ch RSS (the most famous version – Azimuth and elevation controls), Delay RSS (90° left and 90° right three tap delay), and chorus RSS (panned as above, chorus effect – mad). A full investigation into this process is beyond the remit of this review, but we've said plenty about it before (see Bob Dorman's review of the RSS10 in our November '95 issue). Suffice to say it's a stereo experience you won't forget. This is one effect where control over more than one parameter at a time would be an

advantage. So what about mapping the controls to faders Roland?

We've tried to focus on the effects most likely to be used in run-of-the-mill recording. There are a staggering number of algorithms in the VS8F-1, and many are combinations of dynamic and frequency based 'blocks'. If you can think of a process, it's probably there. To finish off our look at the algorithms, we'll canter through some you may not have thought of: Space Chorus (Roland SDD-320 simulator), four-band parametric EQ, ten-band graphic EQ, Chorus, Flanger, Phaser, Pitch shifter, Rotary speaker simulator, Lo-Fi processor (audio degradation on purpose), and Hum canceller. Most of these are also available in Multi-FX algorithms.

### Verdict

Here's the bottom line – for just over £2000 you get a fully featured 8-track hard disk recorder, with automation, high sound quality, and a hands-on operational method. With the effects you get a no-frills result. All of the algorithms are practical at reasonable levels and reasonable parameter settings. There is no mystery fatness or warmth, just the predictable attributes of well-defined processes. Anybody doing a bit of analogue squidding, or attempting to squeeze a record number of strange harmonics out of a guitar, might find some of the extremes a bonus, but – on the whole – the best results come with a tweak, rather than a heavy-handed approach. You don't get a Lexicon, you get a reverb; you don't get an Eventide, you get a pitch shifter, but the V-Expanded VS-880 deserves a thumbs up for being all things in one box, and a gold star for the quality that comes with it. 

**More from: Roland UK, Atlantic Close, Swansea Enterprise Park, Swansea, W. Glamorgan SA7 9FJ. Tel: 01792 515020 Fax: 01792 799644**

## V-XPANDED VS-880



### WHAT WE LIKE

- New auto mix feature
- Sheer number of FX algorithms
- Quality of guitar FX

### WHAT WE DON'T LIKE

- Long effect parameter menus
- Glitching in voice transformer effect
- Display readability

### OVERALL

It was a great studio workstation already; now it's even better. The V-Expanded VS-880 is a unique product with many features to be proud of, at a stunning price.



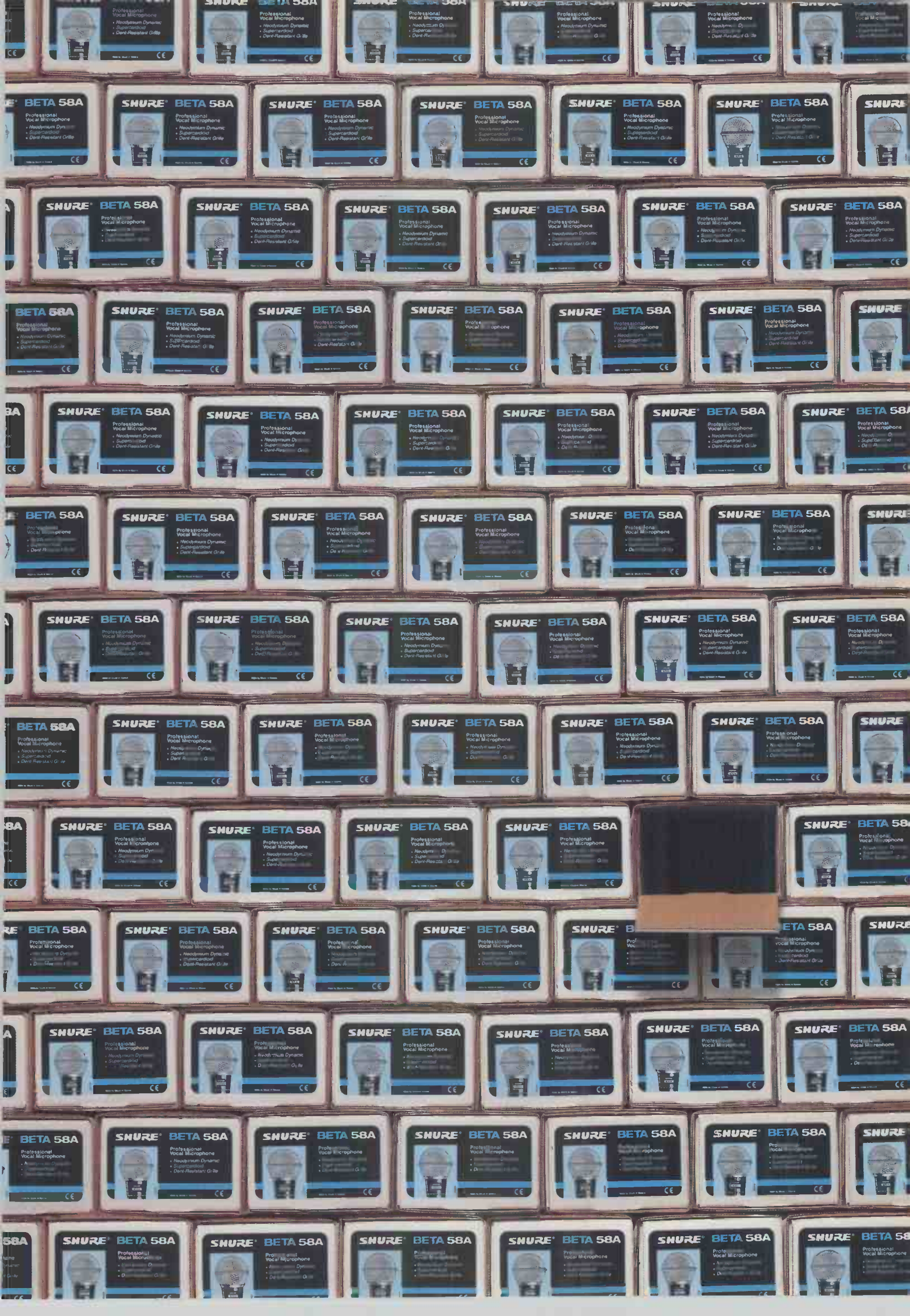

# SAMPLES

Audio and CD-ROM sample CD reviews, plus what's on the CD

**X-FX**  
(Best Service)



Not the most in demand set of sample material, perhaps, but sound effects are increasingly found in all sorts of unexpected places. X-FX is crammed to CD limit with all manner of weird and wonderful effects, from guns to air conditioning units. The sounds are logically split into fairly self explanatory sections: Sound elements, categorised; Interior atmos - machines, rooms and environments; Subsonic tracks; Engines, and engine construction kits. The 'Battle Radio Communication' track instantly recalls the eerie Intro to The The's 'Sweet Bird of Truth', and the various shots and explosions could easily find their way into a number of musical styles, be they comedic or deadly serious. For ravey-type stabs, you could do a lot worse than the 'Pneumatic doors' and 'Electric doors' timbres. The Interior atmos section provides a range of atmospheric textures which could find a perfect niche nestling under a track to add a slightly sinister edge, as well as being perfectly suited to film soundtrack composition and experimental music productions. Least impressive, yet still useable in a range of scenarios, are the subsonic tracks; they don't really have much depth and clarity. In all, though, X-FX is an interesting, if slightly limiting sample CD, but if you're looking for film scoring capabilities, you can't go far wrong with this offering. ● *Nick Serre*  
**Price: £59.95**  
**More from: Time + Space**  
**Tel: 01442 870681 Fax: 01442 877266**  
**email: sales@timespace.com**

**DEFINITIVE GROOVES**  
(The Digital Kitchen)



Put together by west coast DJ Pimp D, this release is a treasure trove of authentic hip-hop beats and sounds. Paying homage to the masterful grooves and programming of the likes of Public Enemy and Paris, the extensive breakbeat section forms the meat of this CD. All well-programmed and excellent audio quality, these give you the most classic of hip-hop beats - and some new takes, too - but because they are specially recorded for this CD, there's no legal headaches in using them. A good selection of individual bass drum, snare, and hi-hats is followed by a variety of other rap-orientated audio matter, including scratches, horn hits, vocoded voices, and synth sounds. The scratches section is superb, with some great bass and snare scratches in particular - DJ Pimp's turntable expertise is certainly not wasted here. Also worth checking out is the 'Sexual Female Moans' group, if only to hear "get your foot off my hair" amongst all the "ooohs" and "aaahs". Overall this release is well worth checking out, and at under 45 quid, represents good value for money. ● *Chris Kempster*  
**Price: £44.95**  
**More from: Sounds OK**  
**Tel: 01276-682313 Fax: 01276-682717**

**JAM BOX**  
(UEBERSCHALL)



Over 1600 samples are provided on this CD, which fall loosely under the umbrella of house, jungle and trip hop. From loops to basses, effects to vocals, there is enough here to pen your very own club anthem. The 320 drum and percussion loops are split into the genres, and then by BPMs; ranging from a liting 73 BPM in the trip hop section, to a frantic 160 BPM in the jungle break section. It's great to see such a variation in tempos and styles on one CD; many sample CDs can prove limiting given their non diversity - which is fine if you're a jungle or funk aficionado - but if you're looking to spend sixty quid on such a CD, you may well be looking for that little extra bit of versatility. The majority of the sounds on Jam Box are culled from the library of DJ/remixer Mousse T, whose credits include Quincy Jones and Bootsy Collins, so, unsurprisingly, the production and general quality of the samples is formidable. The loops are provided effected and non-effected, making Jam Box truly versatile. The bass and guitar sounds are equally impressive, especially the real bass licks and wah wah guitar, all of which helpfully provide the key of the sequence or note provided. Thrown in for good measure are brass, keys, strings, and effects sections, and with most if not all of the samples recorded with Roland's RSS surround sound system, this CD comes heartily recommended. Hey, Tommy, go get your Jam Box. ● *Nick Serre*  
**Price: £59.95**  
**More from: Time + Space**  
**Tel: 01442 870681**

## On the CD

**TIME + SPACE SAMPLE SHOWCASE**

**TRACK 1** **X-FX**  
A selection of samples from this impressive sound effects CD. *Reviewed on this page*

**TRACK 12** **JAM BOX**  
A selection of samples from an inspiringly diverse house, jungle and trip hop CD. *Reviewed on this page*

**TRACK 13** **FIELDS OF MOTION**  
See next month for a review of this CD

**TRACK 14** **FAST ANIMATION**  
Spatially-enhanced effects. *Reviewed on this page*

**TRACK 15** **LFOIDS**  
Acid style bassline loops from the archives

**TRACK 16** **SAMPLE CITY 1+2**  
Classic vocal sample CD from the archives

**F.A.S.T. ANIMATION**  
Ueberschall/Time + Space



A new dimension in stereo listening," is how the team behind f.a.s.t animation (it stands for future audio sampling technology, apparently) describe this latest addition to the Time + Space catalogue. It's perhaps a slight exaggeration, though there's no doubt that this CD does include some exceptional spatial and dimensional sound effects. Grouped together under the sub-heading of 'Dimension E' are a collection of stereo samples which seem to circle the sound-field - imagine a kind of 3-D doppler effect and you'll be in the same ballpark. The tones themselves range from dreamily ambient to heavy sci-fi but there are a good number which would be useful for a range of music styles from, say, softcore drum'n'bass to experimental ambience. The rest of the collection is sub-divided into ten sections; 'The Dread' is, as you'd expect full of horror movie synth sounds and effects while the 'Science Fiction' and 'Comic' sections deliver exactly what they promise. The most useful of these are 'Zpin Zounds' and 'Special Loops' which offer some unusual but pretty inspiring sounds including a few Eno-ish 3-D pads and some weird, sucking tones. Less appealing is the section entitled 'Please Turn Over' which contains a recording of someone shuffling a sheaf of papers. Pointless? You bet. Overall though, this is worth checking for those spatially-enhanced effects and not much else. ● *Tim Barr*  
**Price: £59.95**  
**More from: Time + Space**  
**Tel: 01442 870681 Fax: 01442 877266**

**'BIG FAT BEATS & LOOPS VOL.1'**  
Voice Crystal/Sounds OK



As the cutting edge of dance music shifts towards jazz, funk and fusion, the kind of sampling tools which draw on these areas are going to be the ones to have. The latest release from Voice Crystal (distributed by the Surrey-based Sounds OK team) is a perfect mix of superbly-produced drum loops, basses, guitars and single-shot drum hits which draw on the west coast jazz scene, '70s rare groove and even some electro influences to create an essential addition to your sampling armoury. Compiled by Larry Washington - one of LA's most in-demand session drummers - *Big Fat Beats & Loops* focuses on the kind of grooves that will appeal to everyone who's looking to freshen up the rhythmic structures of their music. In particular it's likely to go down exceptionally well with house, techno and breakbeat producers who are looking for something more challenging than a regular 4/4 drum pattern. With sections devoted to '70s loops, jazz, '80s drum grooves (of the fusion and electro variety) and percussion FX, there's plenty to work with. The bass and guitar sections aren't huge, but what's on offer is top quality and extremely useful. The sounds themselves are beautifully recorded too. All of which makes this one of the most desirable sample collections around. ● *Tim Barr*  
**Price: £44.95**  
**More from: Sounds OK**  
**Tel: 01276-682313 Fax: 01276-682717**



# JOMOX

GLOBAL  
DISTRIBUTION

Brand

new: Analogous Drum Module

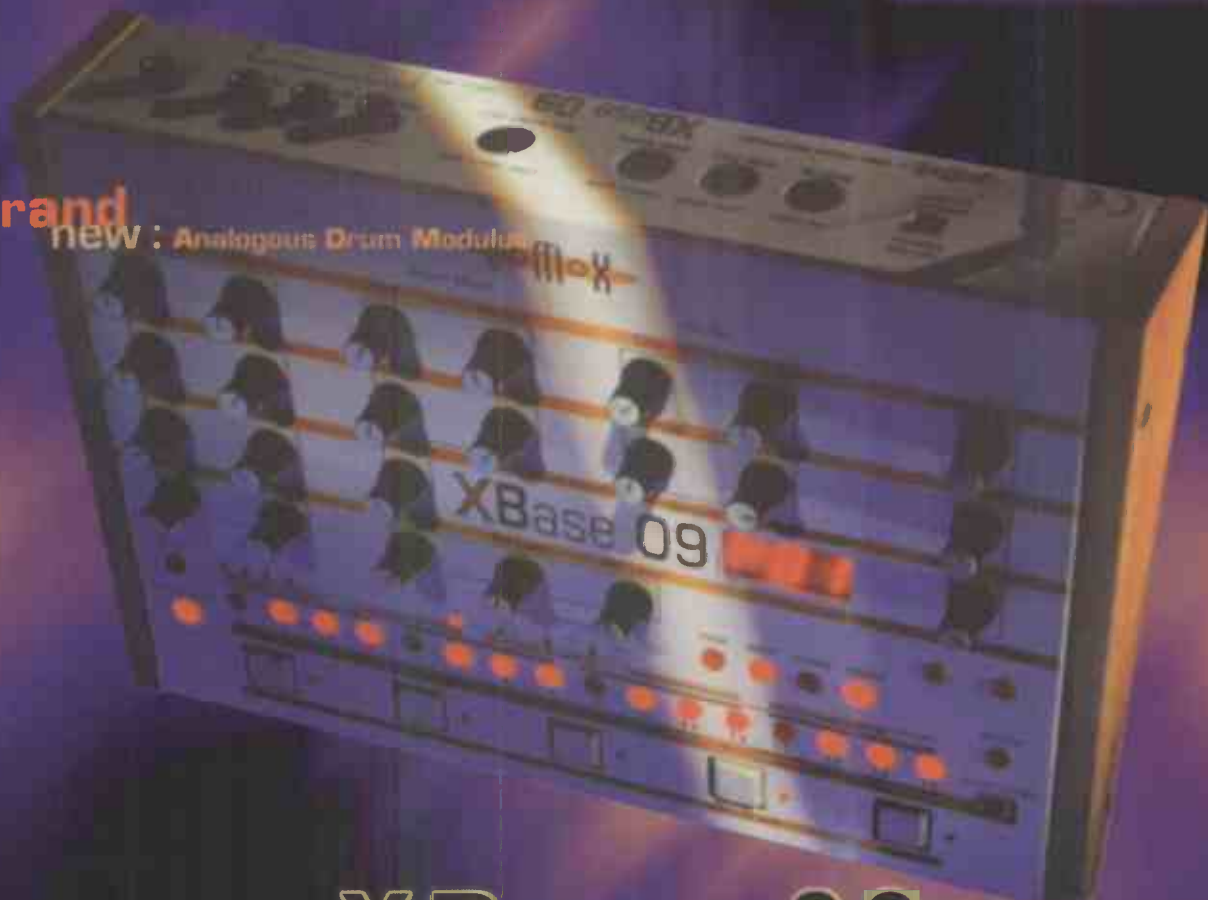

## XBase 09

Drum 'n' Bass...

...just got better!

Where others copied, Jomox modified.  
It's more than 'just' a drum machine.  
3 Instruments, Bass, Snare, HiHat each with  
greatly improved sound generation parameters.  
Crazy bass sounds, twangy nasal snares and HiHat  
forms (including reverse play).  
Real time MIDI control.  
100 perform memory's (kits),  
64 pattern memorys, 10 song memorys.  
The unique sound generation of the XBase09 has  
never been possible before with the original TR909.

Distributed in the U.K by:  
The Global Distribution Group  
PO Box 39, ASHDON  
Saffron Walden  
Essex CB10 2FT  
Tel: +44 (0) 1799 584925  
Fax: +44 (0) 1799 584094  
Email: Sales@Globaldistribution.com  
Http://www.Globaldistribution.com

# HELP FILE

**Nervous? Anxious? Can't sleep? Then you need the new, improved *Help File*, offering free advice to the tech problems that are making life in your studio unbearable. Just drop us a line by letter or email and our team of audio agony aunts will do their best to ease your suffering.**

**The Help File,  
The Mix,  
Future Publishing,  
30 Monmouth St,  
Bath BA1 2BW  
email: themix@futurenet.co.uk**

## Bird Watching

**Q** After reading Danny McAleer's review of the *Bird of Prey Falcon* CD-ROM, I decided to buy it, mainly for the Cubase Audio Utilities. I was impressed. The mixer maps are a revelation; a stereo EQ is what Cubase Audio has been crying out for; and the MROS update has helped synchronisation with my Macintosh 'slave' machines. The real reason for the purchase though was the driver for a Mac MIDI interface on the LAN port, which was mentioned in the article, and is something I've been hoping for.

Now to the reason for the letter: As I also use Macs in my studio, I had a Mac interface lying around. When I examined the readme file for the driver file, it said that the interface must only be connected after Cubase Audio had booted: Not a great solution, and a state of affairs I'd only just got out of with dongles (thanks to the Cart-Master Lite, from System Solutions!). Luckily for me, the Mac interface I had spare was the excellent Macman, by Midiman. This lin-3 out gem has a printer thru switch. Using this, the LAN port option in Cubase is great and perfectly usable. Just hit the interface 'on' button when Cubase has booted and there you go, an extra in and out. Well three actually, but they're all sending on the same channel. Still, it saves needing a MIDI THRU box when daisy chaining is not ideal, or possible.

I've read about people trying to use the 'Export' driver, and having problems. I feel this is a much better solution. Could you please let the readers know about this, because I know it's been a bind for Falcon owners for a while.

Thanks for a great column and for not being so downbeat as everyone else about

the Atari. Like I said. I do use Macs, but for sequencing and the main guts of my music, I wouldn't swap my Falcon for anything.  
**Alan Bailey, Cheshire.**

**A** Thanks for your contribution Alan, the comments and compliments have been passed to Danny McAleer, who was both interested and flattered. This kind of unsolicited wisdom is always a welcome addition to the Help File. That goes for any aspect of music technology; if anybody else has sorted out their own solution or technique, please take the time to tell us about it; you'd be surprised how many people will have your baby in exchange for a top tip.

For anybody who missed the *Bird of Prey Review*, it was in the May issue, page 94.

The CD costs £24.95, is sold by System Solutions (Tel: 01753 832212), and has a big fish on the front.

The Macman, by Midiman costs £45 inc.VAT, and Midiman's phone number is 01205 290680.

It's interesting to note that you slave Macs to an Atari, in opposition to the commonly touted hierarchy. There might be a message in there somewhere. **PM**



## Modus Operandi

**Q** I desperately need help. Before I decided to write to you guys, I've been through hell, first of all with my computer, then with my computer again, and an audio board that didn't work at all with my set-up.

My real problems started after I got myself a Korg N-364. While figuring out how to insert its Banks into Cakewalk Pro Audio (this is past, thank God), something else came up.

The N-364 has something called Global MIDI Channel, that by default is MIDI channel 1, and prevents Cakewalk from

## Five... four... three...

Can someone please tell me what has happened to Intermanual Rescue. I sent a keyboard to them for repair last year, but since December have been totally unable to get through by phone or letter to them. I hope someone out there knows what is going on as I don't want to lose this keyboard. The *Help File* is probably my last hope.

**Bob Shave, Somerset.**

*This is an all-readers bulletin. Bob needs to find his keyboard, so we need to find Intermanual Rescue, or their personnel. The last known phone numbers go nowhere, so if you've heard anything, or suspect a member of your family, please give us a call. You could get 'The Mix Community Action Award'. **PM***



**Korg a la mode:** put the N364 in Sequencer mode to use multi-timbrally

recording and playing back on any other channel. As well as that, I live in Rio de Janeiro, Brazil, which makes it hard to get any information.

On top of all that, I have never subscribed to *The Mix* or *Future Music*, because it comes with a CD, which attracts too much attention in the mail, so I buy straight from a news-stand and pay twice the price. I've received e-mails from three different continents from people with exactly the same problems I went through. Thanking you in advance.

**Marcos Pinto (e-mail supplied)**

**A** This is probably a simple matter of mode madness. The N-364 uses a Global (or generic, or base) channel in program mode, where only one channel is available. You need to run the Korg in either sequencer mode (all 16 channels will be available), or combination mode (eight parts, eight channels). In the former case, you don't need to run the internal sequencer, just treat it as a multi-timbral mode. Check the manual for the gory details on these modes, and how to change the MIDI channels once there. Thanks to Korg UK's tech department for their words of wisdom. **PM**

**Special theory of sample CDs**

**Q** Could you give me some information on the Time + Space CDs advertised and reviewed in your magazine. I have just purchased an MC303 and was thinking of buying an MS1, but I don't know that much about digital samplers and what they do. I mean, what's their main function and how do they work? Do you need a sampler to use Time + Space CDs? I've noticed some titles come in audio CD and CD-ROM. How are they used, and what's the difference between them and the sampler ones?

PS. Is an MS1 any good? Could you recommend any good rough-edged dance/jungle Time and Space titles?

**Mann Chu Man Keung (e-mail supplied)**

**A** A sampler's main function is a take a sound, store it as data (1s and 0s) and let you play it back, on command, at different pitches, via MIDI. They do this by chopping an analogue

(continuous) waveform up into small chunks (samples) and giving the level of each chunk a number (D to A). Any sound can then be represented by a long list of numbers, which is ideal for storage and manipulation (editing) by a microprocessor. They are played back by simply reversing the process (D to A).

To use sample CDs (of the kind that Time + Space distribute) you need either a computer with audio capability, a sampler, a compatible instrument, or a reel to reel tape machine and a razor blade. The latter option is not recommended.

Audio CDs are exactly like the CDs you buy at a record shop. All samples can be played with a CD player and passed to a sampler through its analogue inputs. Computers with CD drives can normally take audio straight off of an audio CD, as long as you have appropriate software.

The term CD-ROM is used when the samples are stored as data (computer files). The complication here is that different computers/instruments like to see different forms of data (formats). Akai samplers, Kurzweils and even computers have their own specified file format. This is becoming less of a problem with computers, as most will deal with different file formats (.WAV, AIFF, SDII, AVR, and so on), and the Macintosh computers will read PC format disks. Lastly, we have mixed mode CDs (like The Mix CD). These combine audio and data. While virtually anybody can read

these, you do lose storage space through putting three variations of the same stuff on one CD (not the case with The Mix CD, except with samples). If you are considering the MS1, you should buy audio



sample CDs. For the last word on the MS1, you should consult our back issues department and ask for the March '95 issue of *The Mix*. If you are looking to go into sample CDs in a big way, you should consider spending a bit more, further up the market.

As for jungle sounds, we would heartily recommend five outstanding sample CDs, all produced by Time and Space: *Jungle Warfare*, audio, £59.95; *Creative Essentials - Jungle Frenzy*, £19.95 (mixed mode:

**Run to the sun**

In your January 1997 issue, in the A-Z of Analogue, you referred to a US magazine called *Electronic Musician*. Is this magazine still being published, and if so, do you know how I can get in touch with them? I have enquired at WH Smith's, but they have no record of this magazine in their index (which covers the entire known universe, allegedly). **Stephen Withers, Leeds.**

Is California in the entire known universe? Sometimes. Anyway, *Electronic Musician* is based over the water, as you say. The phone number is (+1) 510 653 3307, if you really want it, but don't be surprised if they say, "We don't know, ask *The Mix*." Oh, and the fax number is 510 653 5142. **PM**



audio, PC, MAC); *That Jungle Flavour Volumes 1 & 2*, audio, £59.95 each; and *Jam Box*, audio CD £59.95 (Akai ROM £99). **PM**

**Sample starter**

**Q** I am very interested in setting up a small home studio, for the composition and production of dance music. The studio will be based around a Pentium PC, running Cubase 3.0 (Windows version), a sampler, and a mastering unit (DAT or MiniDisc). My questions are as follows:

1. Can you recommend any reading material to help me to understand the theory of sampling, and does the sampler use MIDI to communicate with the sequencer?
2. Can you recommend an entry level sampler that has enough features to enable me to do serious production work? For example will the Akai S20 do the job?
3. Can you tell me whether a Zip drive will be compatible with the Akai, and if not, which removable storage system will work?
4. Can you import samples from the sampler and from CDs directly into Cubase 3.0?

**Neil Hobbs**

**A** 1. Most general music technology books give a good grounding in digital audio (we recommend *Sound and Recording – An Introduction*, ISBN 02405 513835, Focal Press), but for sampling proper there doesn't seem to be much out there. Take a look at *Introducing Digital Audio* (ISBN 18707 775228, PC Publishing). PC Publishing's entire book list can be found on their Web site: <http://www.pc-pubs.demon.co.uk>. And, yes, the sampler will use MIDI to communicate with the computer.

2. The S20 is an entry level sampler and will be able to sample, loop and do a bit of time-stretching (tempo-matching in S20-speak), but you wouldn't describe it as a tool for serious production work. Its place is in the DJ and integral sequencer markets.

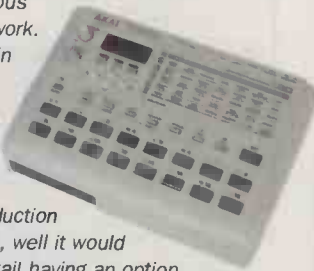

What is serious production work? Mmm, well it would probably entail having an option on more than 17Mb of RAM, being able to sample at 44.1kHz (the S20's limit is 32kHz), and being able to stick a SCSI drive on the back of it. For these kind of facilities you should start with something like an S2000. Unfortunately, it's a case of pounds for prizes; the S20 will make noises and give you an easy way into sampling, but it probably falls short of 'serious production.'

3. The S20 has two removable storage systems: A floppy drive, and a MIDI lead. The former has limited capacity and the latter has limited convenience (MIDI sample dump is slow, and needs a librarian at the other end). There is no SCSI, so the Zip drive idea is out.

4. Yes, but this is mainly of use when you're

## The continuing 101 saga

Regarding the letter from Mr Gold Coast in the April edition: The sequencer of the SH101 needs quite a hefty pulse, and some drum machine click outputs don't quite make it. The answer is to slightly amplify the click by, for example, running the click through the line in of an amp, cassette player etc, and taking the signal from the headphone output into the SH101. Short percussive sounds such as bass-drums will sometimes trigger the SH101 but then again they may need to be amplified.

Mr. Sync, West Sussex.

Suggestions for the next instalment to the usual address please. PM



using a sample editor on the PC rather than the audio tracks of Cubase 3. However, and you might want to consider this before you buy a sampler: Steinberg have announced the imminent release of Cubase VST for the PC. More from Harman Audio (0181 207 5050). PM

### All that Jaz

**Q** I would like to find out whether it is possible to use an lomega Jaz drive (1G) for hard disk recording. I use PowerMac 7200/120 and Cubase VST for making my music. I want to expand the hard disk for more music recording. I would like advice on the Jaz drive, especially the reliability, stability, and whether it can perform real time record and play back like internal hard disk.

Unknown, Unknown.

**A** First, apologies for losing the original letter with your name on it; you know who you are, don't you? Anyway, the real issue is Jaz drives and hard disk recording. Steinberg say don't do it. Although many people have had a certain amount of success with removable media, there's no way of knowing that you will. Additionally, you will certainly be limited to a small number of tracks. Removable

media has not yet achieved speeds high enough for this kind of application, though is particularly useful for file back up.

Drives certified as 'AV' are the most suitable, as they do not recalibrate during the write process, so their high speeds are consistent. Ideally, you should contact either your dealer or Steinberg directly and ask what drives are 'qualified' for use with VST and your system. For UK enquiries, phone Harman Audio on 0181 207 5050 and ask for Steinberg technical support. PM

### Hangman

**Q** Can you help? I run a Roland XP-10 using Cubase Lite on a PC. I frequently get 'hanging notes', which come about quite randomly. Sometimes they are triggered if I'm adjusting controls, but they also happen quite spontaneously with no obvious cause. I always have Local turned off on the keyboard, so that's not the problem. Any suggestions?

Brian Taylor, Email supplied.

**A** Hung MIDI notes and random triggers are normally caused by a disconnection or fault that causes a note off message to get lost in the ether, or a random message to materialise. All the receiving device knows is that the note it has turned on should keep going until it is told to turn that note off. You should check the integrity of your interconnections: swap out all MIDI leads, re-seat your sound card, and re-plug the D connector that is most likely feeding your MIDI set-up.

If you can cause the fault to occur by wiggling something, you have found the problem. If not, you will have to eliminate system components until the fault no longer appears. The last box taken out of the equation is most likely at fault. If you suspect internal connections of the XP-10, PC, or sound card circuit board, the offending item should be returned to you dealer, or a qualified technician. Leave no stone unturned; once an intermittent fault is turned to a service department, the cost will spiral. PM

Don't use a Jaz drive with Cubase VST; 'cos it just ain't fast enough...





# SOUND SOLUTIONS

COMPUTER MUSIC SUPPLIES

### Yamaha Soundcards!

Yamaha MU10	XG Edit Registration	£199.00
Yamaha SW60	XG Edit Registration	£149.00
Yamaha DB50	XG Edit Registration	£129.00

### Turtle Beach Soundcards

TBS2000	£159.00
Tropez Plus	£249.00
Pinnacle	£409.00
Pinnacle Digital I/O	£489.00
Fiji	£319.00
Fiji Digital I/O	£359.00

### Software

Wavelab	£380	Terratec EWS64	£449	S/C Cable	£19.95
Cake Pro Audio	£299	Audiowerk 8	£499	MK161	£165.00
Koan Pro	£159	Triple DAT	£1099	Creative Ess	£19.95
XG Edit Reg	£ 25	D Man Dig Audio	£229	AWE CDs	£29.00
Sound 2 Midi	£ 99	EQ Man	£89	YSTM20DSP	£75.00
Home Studio	£ 89	Maxi Sound 64	£149	MK149	£109.95
Cakewalk Pro	£179	Card D Plus	£569	<b>More Software</b>	
Fast Edit	£179	Digital Only Card D	£339	Logic Audio PC/Mac	
Personal Comp	£ 69	Multi Wav	£449	Discovery	£269.00
Piano Discovery	£ 69	Master Port	£729	Logic AudioMac	£649.00
ReSample Pro	£ 99				
Cubase	£299				
Logic Audio PC	£399				

### Soundcards

### Bits 'n' Bobs!

### Special Offer

Twiddly Bits and Newtronic Midi files, Creative Essentials sample CDs all in stock at incredible prices!

We supply Master Keyboards, Software and all other Computer Music Supplies, inc. Newtronic Midi Files, Sample CDs etc. Please phone for further offers. Systems now available! e.g. Pentium 150, 32 meg, Tropez Plus & Cakewalk Pro Audio only £1770! Other configurations available, phone for details.

The above is a small selection from our range. Please phone for items not listed. Prices include VAT. No Credit Card Surcharges!

TEL: 01403 732606 FAX: 01403 732607

Web: <http://www.soundsol.com>

Email: [sales@soundsol.com](mailto:sales@soundsol.com) or [info@soundsol.com](mailto:info@soundsol.com)

Secure Online Ordering! Virtual Shop, News & Reviews, Music and more!!!

## Hip-Hop Connection



## BEAT'S, RHYMES & LIFE

## JULY 72 PAGE SPECIAL!

## ON SALE NOW

# INDIGO SERIES

## PRICES SLASHED!

Special Offer Prices from **£299** +VAT  
Usual Prices from **£599** +VAT

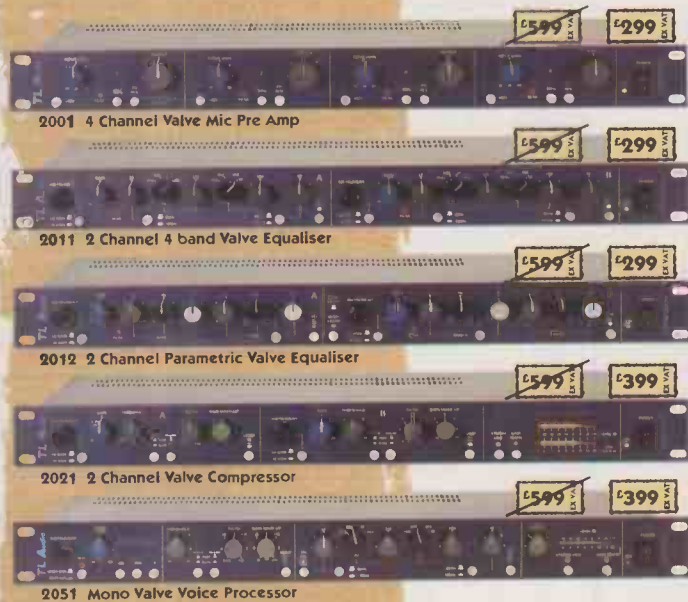

Special offer subject to availability.

Available from participating TL Audio stockists:

Audio Toy Shop.....01225 447222	M Corporation.....01425 470007
Axis Audio.....0161 474 7626	Music Connections.....0171 731 5993
Blue Systems.....01799 584095	Music Lab.....0171 388 5392
Digital Village.....0181 440 3440	Sound Control
Funky Junk.....0171 609 5479	Glasgow.....0141 204 0322
HHB.....0181 962 5000	Turnkey.....0171 379 5148
Larking Audio.....01234 772244	



Worldwide distribution:  
Tony Larking Professional Sales Ltd.  
Letchworth, SG6 - 1AN (UK)  
Tel: +44 (0)1462 490600  
Fax: +44 (0)1462 490700  
WEB: <http://www.tludio.co.uk>

### SASCOM MARKETING GROUP

Canada & USA:  
Sascom Marketing Group  
Tel: +1 905 - 469 8080  
Fax: +1 905 - 469 1129  
WEB: [www.sascom.com](http://www.sascom.com)

Fax us on +44 (0)1462 490700 or send for your FREE 16 page full range colour brochure

Name: \_\_\_\_\_  
Address: \_\_\_\_\_  
Post/Zip Code \_\_\_\_\_

# NEW RELEASES

**CAST**  
**MOTHER NATURE CALLS**  
**(POLYDOR)**

**Producer:** John Leckie  
**Engineer:** Mark 'Spike' Stent  
**Studio:** Olympic Studios



In the continuing trend to move subtly out from under the Britpop umbrella, the likes of Blur, Supergrass and Cast have emerged with a hard, dark edge. Certainly, it's a healthy shift in direction. For some. Cast, however, seem to have missed the point a bit; the single 'Free Me', despite its reasonably catchy melody, is simply too formulaic to excite the ears. Perhaps it was just not the wisest choice for release, as there are sweeping moments of inspired originality here; 'She Sun Shines' and 'Mirror Me' are lyrically evocative and well-arranged in a Paul Weller-esque style, with intricate, weaving guitar lines and intense drumming. 'I'm So Lonely' prompts the response 'I think I know why'; a drivelling self-indulgent rant with about as much soul as my boots. That said, in terms of production, John Leckie does a fine job of creating an intriguing sonic myriad – tight, rocking guitar textures and creative use of effects (particularly delays) nearly make up for the weakness of many of the tracks. Perhaps, as a first step, Cast mainman John Power should draft in a singer with a more suitable voice; his is nasal and whining, and does little justice to this album's (admittedly rare) glimpses of a sometimes gifted songwriter. ● *Nick Serre*

**VERDICT:** If Mother Nature Calls, keep the chain on the door .....5/10

**GLENN UNDERGROUND**  
**THE JERUSALEM EP'S**  
**(PEACEFROG)**

**Producer:** Glenn Underground  
**Engineer:** Glenn Underground  
**Studio:** Strictly Jaz Unit



Along with label-mates Boo Williams and Tim Harper, Glenn Underground played a significant part in Chicago's house music renaissance a few years back, largely thanks to some essential 12" on Cajmere's Relief imprint. The *Jerusalem EP's* is his second long-player for Peacefrog, and it's simply too good for words. Pulling percussion from a killer combination of TR-909 and TR-808, the man with the coolest name in dance music crafts a drop-dead-gorgeous fusion of mellow jazz stylings, deep house grooves and pristine techno angles. On tracks like the blissed-out 'H-Dance' or the inspired 'Sun, Moon & 12 Stars' (which sounds like a tribute to Larry Heard), he floats delicate digital spikes and fluid solo playing over a warm, embracing backdrop of fat synth bass and, of course, brilliantly sewn-together rhythms. This is house music drawn from the original jack blueprint – loaded with funk, soul and on-the-edge vibes. Defiantly new and 100% original. What cuts such as 'Negro Cry' or the exceptional 'Trance 0 Israel' prove is that house music is still capable of breaking new ground. Like Paul Johnson's masterful *Bump Talkin'* from 1995, this is a house album that everyone should own. ● *Tim Barr*

**VERDICT:** Essential for house-heads – and everyone else .....9/10

**BRAND NEW HEAVIES**  
**SHELTER**  
**(LONDON)**

**Producer:** Brand New Heavies  
**Engineer:** YoYo  
**Studio:** Various



1994's *Brother Sister* was a huge success for the Heavies, but instead of following it up with more of the same, the band have bravely moved their sound on with *Shelter*. Admittedly, it was almost inevitable with the departure of singer N'Dea Davenport, and arrival of Siedha Garrett, who has brought her own formidable writing talents with her. Garrett has worked with some big names as a singer, including Michael Jackson, Quincy Jones, Aretha Franklin, and Madonna, and the list of those who have recorded her songs is no less impressive. The Heavies sound for '97 is moving ever further away from their acid jazz roots, and towards the soul/pop side of funk. The singles 'Sometimes' and 'You Are The Universe' are the most openly pop songs on the album, but there's also a rougher side to this release if you look hard enough. 'Shelter', Carole King's 'You've Got A Friend' and the Sly Stone-like 'Once Is Twice Enough' are highlights of an album filled with a tad too many throwaway tracks. Production is excellent, with a tightly-engineered sound from YoYo, engineer on *Brother Sister*. If you can handle some of the oh-too-sweet pop tracks here, you'll find some gems worth digging out. ● *Chris Kempster*

**VERDICT:** Straying ever further from their funk roots, but still a good listen .....7/10

## MILESTONES

**THE TORNADOS**  
**TELSTAR**  
**(DECCA – NOW AVAILABLE ON MUSIC CLUB)**

**FIRST RELEASE 1974, NO. RE-ISSUES 4**

**Studio:** 304 Holloway Road **Producer:** Joe Meek **Engineer:** Joe Meek



'Telstar' entered the UK charts in August '62 and was still up there 6 months later, having become the first ever British hit to top the US charts. The million-selling instrumental's unique sound was cooked up by RGM – Roger George 'Joe' Meek – the UK's first real rock producer. Former RAF radar operator Meek had opened his tiny studio after engineering for the majors. In an age when two tracks and two takes was the norm, a pioneering Meek put real effort into recording pop, experimenting with multi-tracking, close-miking and his own hand-built reverb and compression machines. Named after that summer's famed communications satellite, 'Telstar' was conceived as a dynamic opener for an EP-cum-album, but its Intro seemed weak. With the band away gigging, Meek took the liberty of book-ending the track with 30 seconds of FX; what sounds like roadworks from a Sci-Fi movie give way to rippling, cascading keyboards before a galloping beat lifts it into a ridiculously catchy tune played on a kazoo-like organ. 'Jungle Fever', inspired by the Everly's 'Wake Up Little Susie' was similarly arranged, with an Intro of an electric animals growls and a pounding, compressed drum kit – shaped to sound more like a bass guitar – leading to an ethereal organ melody. 'Globetrotter' also hit the Top 10 on single; this was a trifle more mainstream, but still had surprising depth and a background of subtlety shifting backing vocals. After these early singles, more success followed for Meek with John Leyton and The Honeycombs, but 30 years ago last February, a combination of business problems, ouija boards and a messy private life drove the short tempered genius into one of rock 'n' roll's first scandals; he killed a complaining neighbour before blowing his own brains out with a shotgun. So Meek didn't quite inherit the earth, but his reputation for shaping sound has endured. Those who'd like to further investigate the Meek legend will find more gems and curiosities on *The Joe Meek Story – The Early Years* (Sequel NEMCD 882). ● *Phil Strongman*

**CARL CRAIG**  
**MORE SONGS ABOUT FOOD & REVOLUTIONARY ART (PLANET E)**

**Producer:** Carl Craig  
**Engineer:** Carl Craig  
**Studio:** Planet E

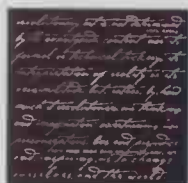

Ten years ago, Carl Craig knocked on Derrick May's door, armed with only a self-produced demo tape. Since then, he has gone on to become one of the most respected electronic musicians of his generation. "I don't make techno or jazz," he says. "If my music is going to be typecast as anything, it should be 'urban' or 'soul'." *More Songs About Food & Revolutionary Art* is either Carl Craig's second album or his fifth, depending on how you count them. As you'd expect, it's a ground-breaking masterpiece of dreamy synthetics and future grooves, which pushes a minimal selection of electronics (Kurzweil K-2000, Akai S1100, Roland SH-101) into the kind of territories originally signalled by Keith Jarrett, Kraftwerk and James Brown. What astonishing tracks such as 'Dreamland' (with its beautiful Roland JX-8P strings) and 'At Les' prove is that Craig has created an index of possibilities that stretches far beyond those original conceptions. Funk, romanticism, abrasive experimentation and sheer dancefloor know-how collide on this album in a fusion that's every bit as exciting as you'd imagine. And it's appropriate that, a decade on from their first fateful meeting, this album features a rare collaboration between May and Craig on 'Frustration'. Simply perfect. ● *Tim Barr*

**VERDICT:** Is it too early to use the word 'genius'?..9/10

# All the major album releases of the month reviewed and rated, our new classic sessions spot *Milestones*, plus who's in the studio doing what with whom and why in *Recording In Progress*

## VARIOUS BREAKBEAT SCIENCE 2 (VOLUME)

Producer: Various  
Engineer: Various  
Studio: Various



Volume's first *Breakbeat Science* collection was one of the most comprehensive drum'n'bass releases of last year. This follow-up approaches things from the same angle; combining acts and producers

on the cutting edge of the scene with some less well-known but equally-compelling talents. Opening with the breathless ambient jungle of Kid Loops, *Breakbeat Science 2* quickly establishes a darker mood than its predecessor with T. Power's 'Thirteen Over For', a sharp, wheezing workout with heavily filtered and stretched percussives and a deeply abstract bassline. Elsewhere, Endemic Void's jazz-spiked 'Zen' plays wild games with a string-bass sample and shimmering atmospherics. Though there are still the elegantly-jazzed excursions which made *Breakbeat Science* such an essential purchase, the new compilation reflects the scene's shift towards a tougher, more deliberately experimental direction, with tracks from Cybernet, Elementz of Nolze and Sureshot all pulling shapes from oppressive samples and claustrophobic riffs. Each of the exclusive tracks was specially written for this release, making *Breakbeat Science 2* a definitive guide to the latest developments in drum'n'bass. ● *Tim Barr*

**VERDICT:** Your guide to the cutting-edge of the breakbeat scene and beyond.....7/10

## APOLLO 440 ELECTRO GLIDE IN BLUE (SONY)

Producer: Apollo 440  
Engineer: Will D'Donovan  
Studio: Apollo Control



It's no mean feat to categorise Apollo 440; their eclectic fusion of dance beats, hell-for-leather guitars, and orchestras (yep, orchestras) make for a truly diverse and intriguing collection of sonic wizardry. From the intoxicating

reworking of Van Halen's 'Ain't Talkin' 'Bout Love' (re-christened as 'Ain't Talkin' 'Bout Dub'), to the brooding atmospheric textures of the title track (complete with menacing vocals from Ewan MacFarlane), Apollo Four Forty prove there is room for a multitude of influences on one album. The production of *Electro Glide...* is highly inventive, utilising sampling and orchestration in a way that begs the question, how did they do that? 'Tears Of The Gods' is simply one of the most enduringly funky tracks I've heard in ages, while 'Pain In Any Language' is a tear-jerkingly emotive ballad of the first degree, featuring silky, sultry vocals from the late Billy MacKenzie. The ethos of this album is so diverse and instantly accessible that, despite the obvious range of influences, Apollo 440 have carved a distinctive niche that is entirely their own. They deserve to take off in a big way. ● *Nick Serre*

**VERDICT:** A truly eclectic and original offering.....8/10

## REPUBLICA REPUBLICA (DECONSTRUCTION)

Producer: Various  
Engineer: Various  
Studio: Various



There's been a recent upsurge in the number of bands fronted by talented women with so-called 'manly' attitudes. Whatever, the wave of bands like Garbage, No Doubt, Raissa and so on has been refreshing for those of

us tortured by Celine Dion and Gina G. Republica are a recent addition to this breed. The ugly bloke/talented musicians are intact, as is one attractive singer with attitude in the form of the pouting Saffron. The rest of the band comprise one-time Bow Wow Wow drummer Dave Barborossa, ex-Flowered Up keyboardist Tim Dorney, guitarist Jonny Male and remixer Toddy on keys and bass. Sadly their mixture of riffy rock, coy punk and huge amounts of dance sits uneasily with Saffron's talents, and tend to sound like a dance act that is reluctantly including a few extra selling points. Saffron herself can certainly sing, but you only get rare glimpses of this as she concentrates on the bratty delivery of some of the most inane lyrics since Bonnie Langford. Songs like 'Bloke', 'Drop Dead Gorgeous' and 'Get Off' (as in with someone) start well enough but the presumably humorous lyrics sound like they were overheard in the Grange Hill common room. ● *Dominic Hilton*

**VERDICT:** A bandwagon act, perhaps, but well-executed.....6/10

## THE CHARLATANS TELLIN' STORIES (BEGGARS BANQUET)

Producer: Dave Charles/Charlatans  
Engineer: Dave Charles  
Studio: Monnow Valley



The baggy pioneers are back with a new album of swaggering, pout-laden rock. Their record company describes *Tellin' Stories* as 'uplifting and optimistic', but it still includes the bitter-sweet

aftertaste endemic to the current British indie scene. However, this could have been a much darker album – It was during the recording sessions for *Tellin' Stories* that keyboard player Rob Collins was tragically killed. On a happier note, the rest of the album lives up to the expectations of the vibrant single, 'North Country Boy'. The trademark drawl of Tim Burgess is delivered over loose, roaring guitars and a gurgling Hammond. Backed up with crashing drums and tight basslines, the whole effect is captivatingly infectious. This may not be the most original music – the retro flavours sounding just too commonplace right now – but it's still quality songwriting. The band have considerably upped the content of other styles, such as psychedelic and country rock, to keep your attention from wandering. The fab instrumental 'Area 51' gets pretty out there, and songs like 'Get It On' have fantastic arrangements that slide between Dylan and Zeppelin before strutting off with a Stones-style swagger. ● *Dominic Hilton*

**VERDICT:** Not wildly original but worth checking out.....7/10

## RECORDING IN PROGRESS...

Paul Weller is working on mixes at Whitfield Street in London with producer Brendan Lynch.

Mayfair Studios is host to **The Orb**, who are working on mixes with producer Trevor Jones.

**Imogen Heap** are at Battery studios recording an album which features Nik Kershaw in the production seat.

**The Dust Junkies** are recording their debut album with producer Al Stone at Great Linford Manor Studios.

**Dragstripper**, whose numbers include ex-Echobelly bassist, Alex, are recording tracks for their first album at Livingston Studios with producer Tot Taylor.

Tot Taylor is also producing tracks for **Jenifer Jenifer** at Livingston.

**Babylon Zoo** are recording tracks at Sarm West and are being produced by Arthur Baker.

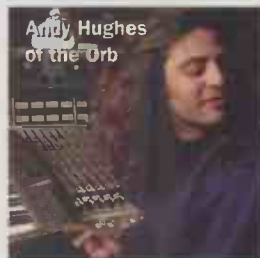

Steve Harris is co-producing tracks with **Kula Shaker** at Whitfield Street Studios.

Whitfield Street is also playing host to **UB40**, who are working on album mixes, produced by Dave Bascombe.

Pete Smith is producing tracks for **The Pocket Devils** at Trident.

Simon Climie is at Metropolis, producing tracks for **Eric Clapton**.

**Urban Species** are working on tracks at London's Battery Studios, with producer Jimbo.

Chris Potter is busy at Metropolis producing tracks for **The Verve**.

**Mungo Jerry** are at London's Red Bus recording tracks with producer Ray Dorset.

Sawmill Studios is host to **Cassius**, who are working on their album, co-produced by John Cornfield and Pat Moran.

**Warm Jets** are working on self-produced tracks at Battery in London.

Andy Partridge is producing tracks for **Stephen Duffy** at the Townhouse.

**Orlando** are working on a self-produced album at **RG Jones Studios** in London.

**Chaka Demus** is at Swanyard with producer Robbie, working on mixes.

Gavin Monaghan is producing mixes for **Gold Blade** at Battery Studios.

# SIZE MATTERS

PHOTOGRAPHY: JAMES CUMPSTY

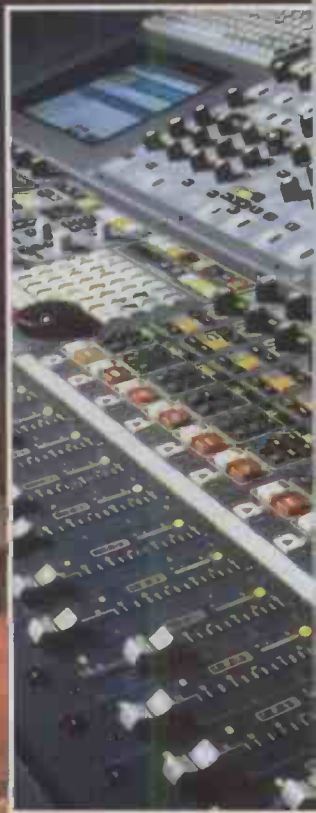

SSL Omnimix

SSL's awesome SL9000J, installed at Mega Studios in Paris

**In the world of the recording studio, two names are synonymous with the very best in quality consoles. And they're both British. Paul Mac investigates the up-market institutions of AMS Neve and SSL**





**I**s your biggest purchasing decision a choice between 8-buss and 4-buss, or whether to buy a second-hand Atari or wait a few months and buy a PPC on interest free credit? There's a section of the music industry that most of us are insanely jealous of, that has the power afforded by big budgets, and big control rooms. You've probably seen the seemingly infinite stretches of knobs, faders and buttons in the professional audio magazines, almost always accompanied by a small white box (also known as a LARC; the remote control unit for a Lexicon 480L). The chances are, you're looking at mixing consoles from one of two manufacturers: SSL (Solid State Logic), or AMS-Neve. Well, it's time we put on bibs and drooled at a few of those pictures (we've even managed to find some without a LARC). Yes, it's *The Mix's* answer to *Country Life*; when you've finished reading, donate your copy to a dentist's waiting room.

We're going to have a look at some of SSL and Neve's studio consoles, and the companies themselves. They both have big stakes in post production, but (1) we haven't got enough room for that, and (2) post-production consoles generally don't have as many knobs (excepting dubbing theatres). Both companies have wholly embraced the digital studio, but they have both kept an analogue console for the sizeable body of customers who rely on the sound that made both companies what they are today.

Before we get down to the details, we should acknowledge the contribution of one man: Rupert Neve, who put console technology, and the console market into gear, so to speak, and who continues to develop products for AMEK. Anybody with AMEK Supertrue automation can listen to Rupert telling you where to put your Aux send, since he does the voice for the recall. We did try to contact him for an interview, but with no luck – so if you're reading Rupert, give us a call; the only quote we've got so far is "Mix gain down – slowly."

### AMS Neve

It's no coincidence that AMS Neve shares its second name with Rupert. He started making consoles back in 1961 and by 1966 Rupert Neve & Co. Incorporated was on the map. Between these dates he built his first transistor console for Philips Recording Studios. Ten years later, things went digital, with a digitally controlled audio routing system sold to the South African Broadcasting association. AMS (Advanced Music Systems) got up and running in 1977. DSP started becoming important in the early '80s, culminating in a digital console from Neve and a hard disk recording system from AMS, both in 1984.

By the start of the '90s, both Neve and AMS were owned by Siemens, Austria. To cut a long story short, soon after the launch of the Neve Capricorn and the AMS AudioFile Spectra in 1992, the two companies rolled themselves into one and became AMS Neve PLC. Capricorn, AudioFile (which became a 24 bit system in 1993) and Logic consoles sold all over the world, a new automation system (Encore) went on line in 1995, and the VX music console was born in 1996. Their latest entry into the music market is the Libra music console.

*The Mix* spoke to Colin Pringle, Marketing Director at AMS Neve, to find out a bit more about SSL, their products, and their market:

**AMS Neve have matured the digital domain: All-digital consoles, automation, and digital recording and editing. What comes next?**

Future development largely depends on the demands made by our client base and, ultimately, our clients are driven by the consumer. You have to remember that the whole entertainment industry is in a period of change and expansion. At the moment Hollywood seems set to embrace digital mixing for feature films, taking us into a scale of digital operation previously not contemplated. In addition to that, now that we have embraced stereo TV, broadcasters are thinking about surround and planning for that. DVD and the 5.1 format also presents an opportunity, and there is certainly a great deal of activity mixing for DVD at the present time... We're all chasing some kind of audio Holy Grail - fortunately!

**If I were putting together a large music recording facility, what would be the top five reasons for me to choose an AMS Neve console?**

At the risk of sounding like a politician – sound quality, sound quality, sound quality, sound quality, and sound quality. Of course, there are other issues. Automation, format flexibility, the number of artists and engineers who like the system. Also, different consoles are popular for slightly varying reasons. Capricorn and Libra naturally provide a greater level of automation capability to the analogue VX and VXS, but for many engineers analogue has sonic nuances which they prefer.

**What is the maximum configuration of a Capricorn. What would this cost?**

We're always crossing new frontiers as far as configurations go! Lucasfilm have recently installed a three-operator Capricorn at the Skywalker Ranch for mixing features like *Jurassic Park 2: The Lost World*. The cost of these desks is really determined by the number and type of inputs and outputs you require, so a ball park is difficult. Consoles are normally built to order, to precisely meet a client's spec.

**Of your main three markets (film, post production, and music studios), which has traditionally been AMS Neve's biggest? How has this changed over AMS Neve's life, and what is the current trend?**

For analogue technology, music has undoubtedly been the biggest area. Neve largely defined the modern multi-track console and so there are hundreds of desks around the world, with more regularly going in. The fact that we have now started manufacturing the classic 1081 modules again shows that there is no sign of the demand for analogue technology diminishing. In the digital world, post-production has been the area to embrace this technology first. This is because post-production facilities need both speed (because of tight deadlines) and throughput. It's also because they have house engineers who can learn a new system and stick with it.

**In the past, people have associated AMS Neve consoles with huge picture spreads, full of faders, knobs and buttons. As consoles get smaller, how do you maintain an 'open' user interface?**

The area of user interface is naturally a very important one. As engineers may sit behind a console for 12 hours a day, any slight niggles will quickly become major problems. We work very closely with engineers to ensure that we achieve a clarity of control information, together with bringing the most frequently used controls within easiest reach. AMS Neve's patented Logicator controls, for example, have certainly contributed to the wide success of the Logic range of desks. Size, of course, isn't everything. ▶

AMS Neve Libra

AMS Neve AudioFile

## AMS Neve Capricorn



The first Capricorn, with its futuristic, grey scale went into Abbey Road Studios in 1992. The internals are entirely digital, with almost every aspect under the eye of a huge automation system. Outboard racks house all the audio electronics, while the control surface acts as a giant, intelligent, remote control.

The controls on the desk are touch sensitive, so the desk knows where your hands are and can respond accordingly. For instance, touching the channel's EQ brings up a display showing the EQ's settings. In addition, circular bargraphs surround the knobs, showing the actual setting. On these consoles, the number of faders does not necessarily represent the number of channels available. The Capricorn can have 24 and 120 faders, but these can be assigned to any channel.

Assigning and switching is an important issue in digital desks, and this one allows a lot of leeway. A set of user-definable controls come with each channel, faders can control auxiliary and cue send levels, every signal path can implement full processing, helped by the ability to patch processing 'blocks' into virtually any stage of any path and move them without losing the settings. What about the split/in line issue? Just choose one and press a button; the desk will re-configure itself. The processing racks are built up from several different cards: EQ (4 band parametric 'blocks'), dynamics (compressor, limiter, expander/gate in each block), 20 bit converters, multi-channel digital I/O, plus optional delay 'pool' and varispeed options.

Just about every control on the Capricorn can be automated, from the motorised faders to the EQ in/out buttons. Every automation pass is saved as a separate mix for unlimited undo, and every path and control setting in the desk (over 10,000 controls) can be recalled in 20 seconds. 24 custom 'element' (I/O, grouping, channel assignments and so on) combinations (banks) can be stored for instant recall, giving the operator settings for the job at hand, with the touch of a button. You can lift your jaw off the floor now.

sought after, together with the world's most extensive experience of designing and manufacturing digital consoles. I'm sure that because of this, different clients will see us in different ways. Overall I hope our image is 'the company that knows how to make great consoles'.

### How do AMS Neve invest or take an interest in new blood in the recording industry (such as students, work experience and so on)?

AMS Neve regularly host visits from various recording schools and college groups. We also make presentations about technology and design when the opportunity arises. Many of these organisations are also our clients: SAE, Full Sail, Musician's Institute all have AMS Neve consoles which they use to train their students.

### Solid State Logic

Founded in 1969, SSL is the younger of our two manufacturers. The HQ is a large site in Oxfordshire (housing R&D, manufacturing, and training operations) which was purpose-built in 1987. The company's first big break was with the SL 4000 B console in 1977, combining an analogue signal path with digital control and winning a Design Council Award into the bargain. The famous Total Recall automation and integration system was launched in 1981, followed by the fader automation system: Ultimatum (1991). SSL had also been busy in the '80s developing its video and post production product line, culminating in ScreenSound (1989), which prompted the development of a digital networking system.

The SL 8000 G console was launched in 1991, closely followed by Scenaria (digital post production) in 1992, and OmniMix in 1993. The latest additions to the SSL range, more relevant to musical applications, are the SL 9000 J (analogue), the Axiom (digital), and a 96 channel hard disk recording system, called DiskTrack.

The Mix spoke to Hazel Simpson, Group Commercial

▷ Once engineers have used an assignable control surface they find that it can make a great deal of sense. Often music mixers are forced to sit way off centre when balancing a track, which is crazy really. On the other hand, in film work, where three mixers work side by side, the aircraft carrier desk remains both desirable and sensible for what they need to achieve.

### Does AMS Neve see a prosperous future ahead for their large 'mothership' consoles, or will they move towards the high end project studio market?

There may well prove to be an optimum control surface size for an application like music mixing. The key is to allow the client to decide. As our desks are built to order, the scale of assignability is to some extent an option. The growth of the project studio is certainly an interesting area and one that commercial studios have been addressing to some extent by building 'satellite' project rooms. At the end of the day, professional projects typically end up with lots of tape tracks looking for a desk big enough to cope with them. I therefore see project rooms and commercial studios co-existing quite happily.

### From the 'inside', what do Neve see as their company 'image'?

AMS Neve really stands for two things. The classic analogue sound and feel which remains so highly

## AMS Neve VX music console

It's wrong to think that the digital revolution signals a dead end in the analogue world as both SSL and AMS Neve remain committed to analogue console development. The VX music console stands at AMS Neve's analogue frontier, together with its post-production companion, the VXS, which has extras for multi-format sound (surround formats etc).

In configuration options, automation, and sound quality, the VX calls on all of AMS Neve's experience and reputation. Frame sizes start at 24 channels and go to 96, or more if you want it (in AMS Neve's words "96+"). There are a staggering 48 multi-track busses, which can be turned into 48 effects sends at mixdown. Global configuration can be either split or in line, with an additional three routing configurations: track laying, mix down, and broadcast. Every channel has a dynamics section (limiter/compressor, expander/gate), with the option of using the channel's four-band parametric EQ as a side-chain filter. Metering for channel ins, group outs, and monitor outs, is taken care of by 200-segment bargraphs, and the dynamics sections use nine-segment, local metering. The Encore system takes care of dynamic automation (successor to Flying Faders), with motorised faders and various automated buttons (no VCAs), plus extensive fader grouping and linking facilities. The ability to recall all switches and rotary controls is an option.

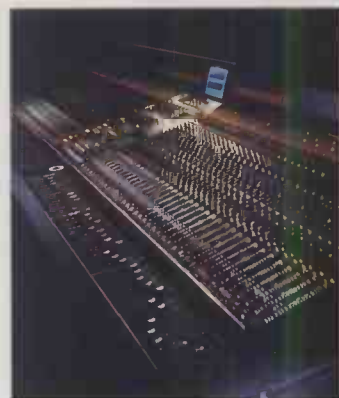

# ULTIMATE SUPPORT FOR MIC STANDS

## FEATURING UNIQUE ONE-HAND OPERATION

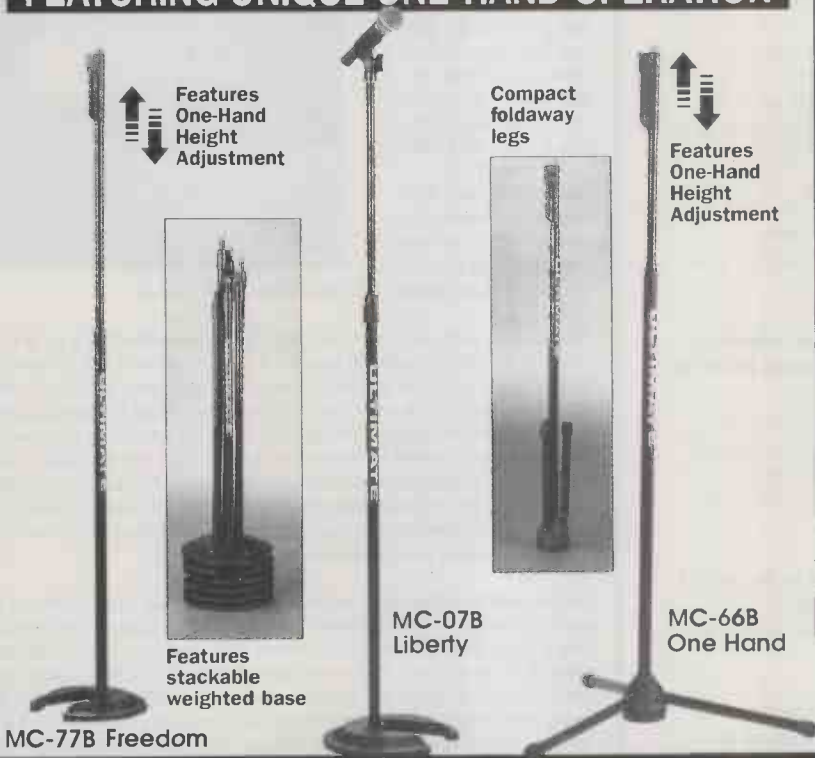

Take hold of the most innovative mic stands on the market today.

### FREEDOM (MC-77B)

The Freedom Mic Stand combines the unique features of the Liberty and One-Hand Stands...the convenience of single hand height adjustment with the space-saving stackable weighted base

Height ..... 39"-64"  
Weight ..... 8lbs

### LIBERTY (MC-07B)

The Liberty, weighted base mic stand features a stackable base that allows up to six stands to be stacked in the footprint of one. Quick response on-off clutch.

Height ..... 34"-3/4"-64"  
Weight ..... 9lbs

### ONE HAND (MC-66B)

The One-Hand Stand has a unique clutch that lets you adjust the height with just a squeeze. The legs fold up along the shaft making the One Hand Stand extraordinarily compact.

Height ..... 40"-1/2"-66"  
Weight ..... 3lbs

The Ultimate range of innovative support systems are lightweight, strong and virtually indestructible. Contact us for a full colour brochure.

## ULTIMATE™

Distributed by HW International  
167-171 Willoughby Lane  
Brantwood Indust. Area, London N17 0SB  
Tel: 0181-808 2222

# Global Proudly Presents... the Syntecno TEEBEE.....

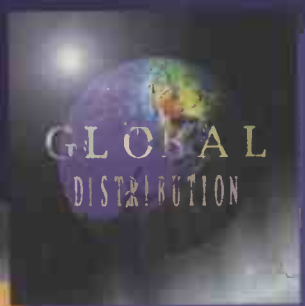

The Syntecno TeeBee - Now available in BRIGHT YELLOW.

- Not only that but incorporating the KORG Ring modulator, enhanced electronics & mixable analogue input.
- Sounds & Feels like the original TB303
- Monophonic bass synthesizer
- 4 Channel MIDI - CV converter
- 5 Rotary controllers are MIDI controllers
- MTC to Roland Sync24 converter
- Simple 16 Ch real time sequencer
- Auto-Wah filter
- Pitch wheel & velocity sensitive
- Selectable MIDI control on each knob
- Polyphony to monophonic algorithm

## Mutator



The Mutator is a stereo analogue effects unit based on technology for synthesis in the late sixties. Quite unlike your standard reverb, delay chorus and flanger type effects the effects achievable with the Mutator are unique and simply defy description

.. the thing about the Mutator is that it is actually ALIVE!

Distributed in the UK by:  
The Global Distribution Group  
PO Box 39  
Ashdon  
Saffron Walden CB10 2FT  
Tel: +44 (0) 1799 584925  
Fax: +44 (0) 1799 584094

▷ Director, to find out a bit more about SSL, their products, and their market.

**Axiom is, "...entirely digital, totally automated, and tapeless."** (Web site company profile). How can SSL top that? What comes next?

The total digital solution offered by SSL today is certainly one which will last many years; in many respects it's ahead of its time. Predicting what will come next is purely hypothesis and largely dependent on client requirements combined with new core technologies becoming available. What is certain is that the digital platform currently being provided by SSL will benefit from continuous evolutionary advancement, as did the 4000 console and all other SSL products.

**If I were putting together a large music recording facility, what would be the top five reasons for me to choose an SSL console?**

Fabulous sound quality; Optimum ergonomics for creativity; International client demand; Unsurpassed service and training; SSL studios command the highest studio rates; Proven return on investment; Great music is produced on SSLs!

**What is the maximum configuration of an SL 9000 J and an Axiom. What would these cost?**

120 channels - SL 9000 J, 96 channels - Axiom (with banking) providing 192 channels total.

**Of your main three markets (film, post production, and music studios), which has traditionally been SSL's biggest? How has this changed over SSL's life, and what is the current trend?**

## SSL Axiom

Axiom is SSL's flagship all-digital console. Not only have they integrated one studio in a console, they have given it the facilities to act with multiple control rooms, under the Intelligent Digital Routing Hub. Looking very much like a conventional console, the Axiom uses the now familiar outboard digital audio rack, and dumb console approach to deal with its huge abilities.



The routing system can address over 2000 inputs and outputs, and up to 192 audio channels. The actual number of channels in a frame amounts half the number of addressable channels, as a system known as 'banking' uses shift keys to switch either channels, groups, or the whole console between two banks of channels. All console controls can be dynamically automated, or saved and recalled as snapshots. Snapshot recall also covers routing and processing presets. Talking of processing...uniquely, the Axiom has the wonderful luxury of 24 Internal Reverb processors and 24 delay processors, all assignable across the console. The dynamics processors are made up of 3-band processing, with compression, expansion, limiting, and gating, and to top the lot off, EQ is 4-band, complete with no less than eight contour types.

The Hub routing mentioned earlier takes advantage of the large number of ins and outs available through the Axiom system. The idea is that multiple control rooms can be fed from a single routing hub and share remote inputs and outputs via HiWay links (95 channels of digital audio, plus control data). Is this the new face of high end recording? Add the DiskTrack 96 channel hard disk recording and editing system, and the Audio Preparation Station (project management, waveform editing, file import, and back up), and you have a networked and complete multiple studio system. 'Workstation' that, guys.

## SSL SL 9000 J



As with AMS Neve, the digital invasion doesn't spell the end of analogue progress; on the contrary, SSL pride themselves on their continuing success and their persistent good name in analogue consoles. The standard bearer is the SL 9000 J, a stylish design concealing an awesome machine. Routing for all 48 multi-track busses is included on every channel. Internally, add four stereo busses, the main stereo buss, and eight cue/FX busses. As with the VX (global configuration), console wide status switching for quick set up is available.

Every channel incorporates a dynamics section with compression and gating, plus dedicated side-chain filtering. These

are fed from one of two points: monitor input, or channel insert. The EQ is 4-band parametric with a total range of 15Hz to 50kHz, far wider than is normally expected of most audio equipment. Gain of  $\pm 20$ dB, and a choice of E and G series curves add the 9000 EQ to a legendary list. The automation system (as is mandatory) has a name: Ultimatum. The unusual bit is that it uses both VCA and moving fader systems, to give the best of both worlds. All faders are dynamically automated, as are the cue sends, 6 mono FX sends, and LR or FB panning, plus quite a few other important buttons. The rest of the console's controls are covered by Total Recall, the famous snapshot system. Dedicated group faders and macro switches round the whole thing off nicely.

You'll find the SL 9000 J literature stuffed with endorsements from important studio personnel all over the world, all citing sound quality as the reason they purchased this desk. As with all the consoles in this article, you'll find that the amazing electronic achievements and sheer magnitude of the engineering, are always overshadowed by the importance of high quality audio.

SSL was founded on the popular music market. In the last 10+ years the percentage of sales to Post Production and Broadcast Houses has increased dramatically. However, these sales have been additional business, and the Music sales, whilst representing approximately 50% of the total turnover now, are still growing.

**In the past, people have associated SSL consoles with large, double page spreads, full of faders, knobs and buttons. As consoles get smaller (eg Aysis), how do you maintain an 'open' user interface?**

Aysis and Axiom still retain the philosophy of "one knob per function": it is merely a question of what functions the client, in his application, needs to have immediate, 'always' control over. For example, the prime purchasers of Aysis are broadcasters who have no need for effects facilities on an immediate basis.

**Does SSL see a prosperous future ahead for their large 'motherhip' consoles, or will they move towards the high-end project studio market?**

There is no sign that the demand for truly top-end facilities requiring truly optimum mixing console solutions will decrease.

**From the 'inside', what do SSL see as their company 'image'?**

We believe we represent quality in sonic performance, manufacturing, robustness, service, and training.

More from: AMS NEVE Tel: 01282 457011 Fax: 01282 417282 SSL Tel: 01865 842300 Fax: 01865 842118

# FREE

One of these  
three  
fantastic  
footballer  
inflatables

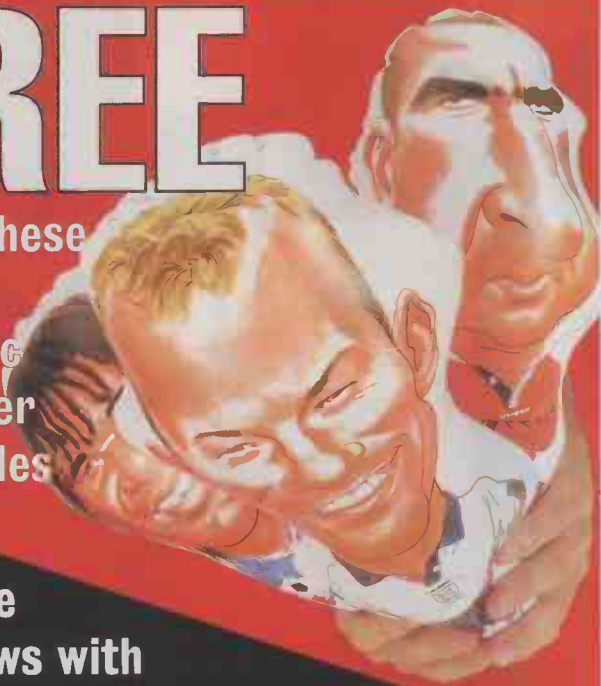

Exclusive  
Interviews with  
Alan Shearer and Les  
Ferdinand • How the title was won  
• The greatest Brazilians EVER  
• Ferenc Puskas • Ref bribe scandal  
• Trevor Brooking • Jorg Albertz  
and much more

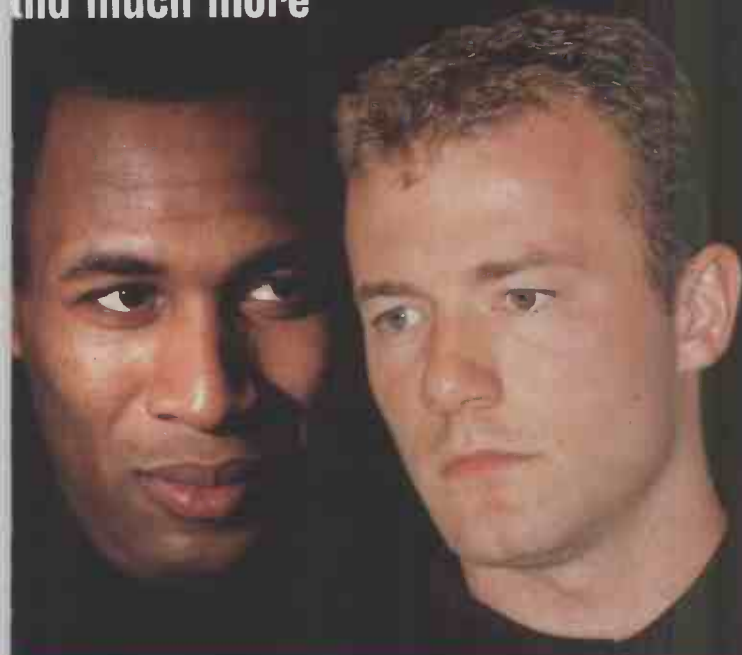

# TOTAL FOOTBALL

## NEW ISSUE ON SALE NOW!

## great vocals



**Q: How can I record vocals which really cut through the mix?**

**A:** Record Direct, bypass the mixing console and go direct to tape through a Focusrite Mic Pre, Eq and Compressor. We know most people haven't the budget for all that high quality outboard so Focusrite designed a box that can do it all.

The Focusrite Voicebox contains the 5 essential elements to record vocals direct.

### 1. Pre-Amp

Superb Mic Pre Amp designed to accurately reproduce the subtle detail of a vocal performance.

### 3. De-Esser

An essential second stage of dynamic control to remove sibilance.

### 5. Fader

Output Fader guarantees accurate level matching without affecting previous mic gain, and EQ settings. A quieter & lower distortion route to tape than your console.

### 2. Compressor

High quality Compressor that seamlessly controls vocal dynamic variations without adding distortion.

### 4. EQ

A voice optimised and extremely musical 3 Band EQ section powerful enough to bring out the character in any voice.

At **£849.00** (+VAT)

The Voicebox truly represents Affordable Excellence through Revolutionary Engineering.

Focusrite  
GREEN RANGE

## the VOICEBOX

Brochure & further Information:

Focusrite Audio Engineering Ltd. Tel: (0)1494 462246 Fax: (0)1494 459920  
Home Page: <http://www.focusrite.com>

# LOOPS

# ON AIR

**He's made a name for himself for playing live drum'n'bass, and now he's done the first live broadcast of the genre for Radio 1. His name is Mark Barratt, alias the Future Loop Foundation. Rob Green tracked him down at BBC's Maida Vale studios...**

It's 8.30 on a Friday night, and one intrepid journalist and his trusty photographer have touched down at the BBC's Maida Vale radio studios. A chance meeting with Mr. Future Loop himself, Mark Barratt, speeded our entry into the intriguing war-tme building, and after the obligatory 'no photographs' routine from a less-than-content security guard, we passed go, collected 500 pounds, and made our merry way to Park Lane... well, Studio 5 to be precise!

The Maida Vale facility is a massive maze of rooms with strange names, and even stranger equipment lurking within. Walking down one of the deserted, eerie corridors, we passed the massive hall that is devoted to the BBC Philharmonic Orchestra. It's almost like being in the Tardis, because the building looks so much smaller from the outside. We passed scores of recital rooms, and even the old (and soon to be defunct) BBC Radiophonic Workshop with its weird and wonderful vintage synths, and tumbleweed-esque bundles of wire. This was the nearest I'd ever been to a ghost town.

When we'd finally negotiated our way around the labyrinth, Mark and his crew set about the task of setting up the equipment. It all happened remarkably quickly, and Mark's set-up has obviously been specifically designed for an ease-of-assembly club situation. Before we knew it, soundchecks were being done, and looking at the equipment, it was hard to believe that these sounds were actually live. Mark was due on at half past ten for the first ever live drum'n'bass set on radio, so I set about asking him some questions...

I wondered if this fun-sized meccano-like kit was responsible for the Future Loop recordings: "Yeah. Everything here is used at home. The other stuff for recording is a Mac, which is an old Ilici, with Recycle! for chopping and changing, Logic Audio, and SoundTools, a JV-1080 with a Dance and Vintage board - I use that a lot for pads and stock sounds, even if I end up effecting stuff and sampling it - there's a 1 Gig Micropolis drive, an Apple CD-ROM drive, and an SH-09."

I don't hear of many acts who are using the SH-09, so what does Mark use it for? "When I was 13 or 14, the first ever synth I got was an SH-09, so I recently swapped my Bass Station for an SH-09 again - A for the filtering, and B for twiddly effects and for filtering loops, it's ideal. All that's what I made the album on, and people are like, 'where's the rest of your kit?' I don't think you need a lot."

Many producers these days extol the virtues of a more minimal set-up, and Mark is no stranger to this ▶

**R**

Live on air: Mark Barratt at Radio 1

▷ concept: "It's kind of got back from gear excess to 'do you really need it?'. I had a lot before, because I was lucky enough to have a fair bit of gear – SH-101, 303, Korg MS-20 – all rigged up, and I don't really think you need it. You need a sampler, and a synth - I find the 1080 easy to program. I've really only used the Korg Prophecy live yet, and I only really use the arpeggiator for 303-type stuff. I don't really know what else you would need.

"I went to Carlisboro in Sheffield, and I thought I would spend some money while I could. What would I buy? I thought 'well, there's a Roland JP-8000', so I fiddled around with it, and thought 'yeah, that's alright.' Then there was Nord Lead, and a new Yamaha one... but what do you need it for?

"Buying musical equipment is like buying a car - it

## Mark's Kit

Roland JV-1080  
 Roland SH-09  
 Mac IIci  
 Steinberg ReCycle!  
 Emagic Logic Audio  
 Digidesign  
 SoundTools  
 Korg Prophecy  
 Akai S1000  
 Yamaha ProMix 01  
 Alesis MMT8

trusty old workhorse, the Akai S1000. With an extra 16 Megabytes of RAM, there is more than enough scope for long loops and vocals. Mark discusses the pros and cons of more modern samplers: "The E-mu ones look great, the S3000 XL looks great, but what am I getting? I'm getting a resonant filter. I've got the SH-09, and I can chop sounds to DAT, filter them and re-sample them. The thing that worries me about the S1000 is that the screen's going to go soon. Sometimes those two boxes seem to go when I'm loading from the SyQuest, but I don't feel the need for any more. The only thing I feel the need for is inspiration to make tracks, and that doesn't come from gear, and it never did do."

As mentioned earlier, Mark has a wonderfully compact set-up which is geared for live use. I wondered, however, if Mark's album had been recorded in a big studio, but apparently not – it was done on an Allen & Heath GS3, which he loves. So why didn't he choose the commercial studio route? "Waste of money. This set-up this year, it's the first time I've used it for recording, and this year I've done the new single, which is out in June. I think it's going to be called 'Sonic Drift'. I've got to think of a title in the next hour, because I've got to announce it at about half eleven!

"One thing I could use is a valve compressor, just to warm it up a bit. I really miss a real EQ, rather than the parametric on the ProMix 01, because I don't come from an engineering background. If someone says 'roll off the bass at 80Hz' or something, I don't know what they're talking about. I'm basically EQ'ing to sound. But on the other hand, I do find the ProMix a Godsend for live, because for every song I can recall different EQ and level settings."

Mark may make it look like child's play, but live drum'n'bass is no simple matter: "Basically, everything's live apart from in between each song when the SyQuest takes 40 seconds to load up, so there are 40 second interludes on DAT, in-between each song, which are kind of relevant to the next track. It's virtually a seamless mix.

"I don't really see the need of going into a studio. If you want to hear how good something sounds, just leave it for two or three days, listen to it in the car. One thing I find a bit difficult in the studio at home, which is basically a bedroom, is the level of the bass, and what I tend to end up doing is use a test DAT at home, and run down to the car. It's just a volume balancing trick. Even for live, you'll see me madly pulling one thing off, and pulling another thing off."

The live sets aren't sequenced as such, and revolve around Mark triggering loops from the Alesis MMT-8. It would appear that some people can't even grasp the concept that Mark isn't a DJ... "I did a three-month tour at the end of last year, and I'm just embarking on virtually a year's touring. I'm off to the States in June and again in August, and then Europe, and the festivals. I don't think anyone else is doing live drum'n'bass. This is the first live drum'n'bass set on national radio. I remember playing in Ireland and this pissed-up kid asked me to play BBE or something. He couldn't get it into his head that I wasn't a DJ. And he even started getting pretty aggressive about it!" ■



Mark's Korg Prophecy is reserved mainly for live use

never makes money, so if you buy it, you're always going to lose money. When you're working every day, you get into working habits which could be good or bad, but if you find the right way of working for you, and I've got the gear that I need to do that now, then you need very little else. Alright, there's a sample CD that comes on the market every now and again that you go for - quite often you're disappointed by them, but there's odd bits that you can get on with."

Satori's *Classic Breaks* CD is a valuable source for drum & bass and jungle loops, and I wondered if Mark had found any use for it: "That is the best jungle CD, and I saw it advertised and rang the guy up. He sent me some free loops on a DAT. That and *Jungle Warfare* are the best ones, but by the time you've chopped loops up, does it matter where they originally came from?

"I would never sample a chunk of music. That's not really where I'm coming from, but if I buy a bit of gear now, it's going to have to be revolutionary in that it will alter my working practise and inspire me to different things, or I'm buying for the sake of it. What I hate is when you buy some gear for one sound, and you use it again and again, then you sell the gear and lose your money. I thought about getting the Emu Orbit, but why buy an Orbit when I could hire it from FX [Rentals], pay 50 quid for a couple of days' rental, and sample all your favourite bits?"

The majority of Mark's music comes from that



'Shake the Ghost (Musicology Mix)' demonstrates FLF's unique blend of beats and textures



# EVERY PICTURE TELLS A STORY

**ULTRA-CURVE A 24-Bit Dual-DSP Processor Mainframe With Auto Graphic EQ, Real Time Analyzer, Parametric EQ/Notch Filter, Feedback Destroyer, Limiter, Gate, Input/Output Level Meter, MIDI Implementation, Delay Option And More.**

	FB-D	FREQUENCY	BW/OCT	G[dB]
+	OFF	20.000 Hz	1/60	+0.0
+	OFF	20.000 Hz	1/60	+0.0
-	OFF	20.000 Hz	1/60	+0.0
-	OFF	20.000 Hz	1/60	+0.0
-	OFF	20.000 Hz	1/60	+0.0
-	OFF	20.000 Hz	1/60	+0.0

**PARAMETRIC EQ/NOTCH FILTER**  
3 bands per channel of parametric equalization with +16 to -48 dB of gain range. fine-tunable between 2 octaves and 1/60th of an octave.

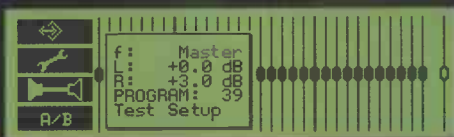

**DIGITAL STEREO 31-BAND, TRUE RESPONSE, AUTO-Q GRAPHIC EQUALIZER**  
Up to 100 EQ curves can be named, stored, copied, inverted, added and subtracted. True response ensures that **WHAT YOU SEE IS WHAT YOU GET!**

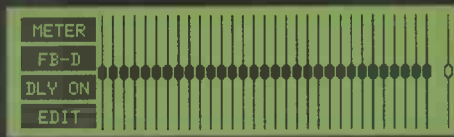

**FEEDBACK DESTROYER**  
Any of 6 parametric EQ bands can "seek and destroy" unwanted feedback frequencies dynamically. A perfect solution for all live applications.

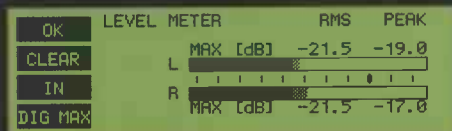

**INPUT/OUTPUT METERING**  
The ULTRA-CURVE offers full input/output high precision metering capability. Permanent RMS and Peak reading as well as various reference levels are a matter of course.

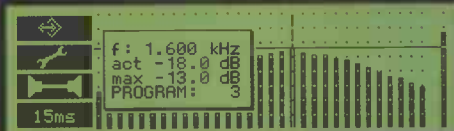

**REAL TIME ANALYZER**  
High-resolution RTA with Peak, Hold. Variable integration time and 10 user memories. A noise & sinewave generator enables for automatic room-equalization.

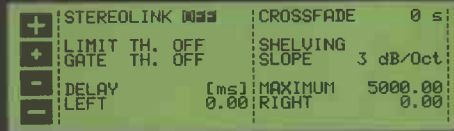

**LIMITER, NOISE GATE**  
Limiter with variable threshold and IGC protects against overload without distortion. Digital Noise Gate with IRC provides a level-dependent expansion ratio for "jitter-free" performance.

These pictures only tell part of the story. If you're involved in sound installation, touring sound or simply looking for an ultimate digital signal processing "tool kit" for your musical suite, audition the ULTRA-CURVE.

**UPDATE V2.0, NOW ON THE WEB! „WWW.BEHRINGER.DE“ ▲ MIDI-SYSEX-CONTROL & DATA DUMPS  
▲ TOTAL-REMOTE VIA PC ▲ EQ-DESIGN ▲ FASTER GATE & LIMITER ▲ NEW 20-BIT CONVERTERS**



- ☎ BEHRINGER Spezielle Studioteknik GmbH Tel. +49 (0)2154-92 06 0. Fax - 42 85 23
- ☎ BEHRINGER UK Ltd. Tel. +44 1483 - 45 8877. Fax - 45 8822
- ☎ BEHRINGER France S.A.R.L. Tel. +33 4 - 7804 4416. Fax - 7804 4429
- ☎ BEHRINGER Espana S.L. Tel. +34 (9) 1 766 1398. Fax 1 383 5052
- ☎ BEHRINGER AG Tel.+41 (0)56 - 210 9555. Fax - 210 9556
- ☎ BEHRINGER Austria Ges. mbH Tel.+43 7752 85181.
- ☎ BEHRINGER Benelux b.v. Tel. +31 (0) 73 - 513 0000. Fax - 513 0778
- ☎ SAMSON Technologies Corp. +1 516 364 2244, Fax 516 364 3888



**Your Ear Is Our Judge** <http://www.behringer.de>



**BEHRINGER**



# INTERVIEW

PHOTOGRAPHY: JAMES CUMPOSTY

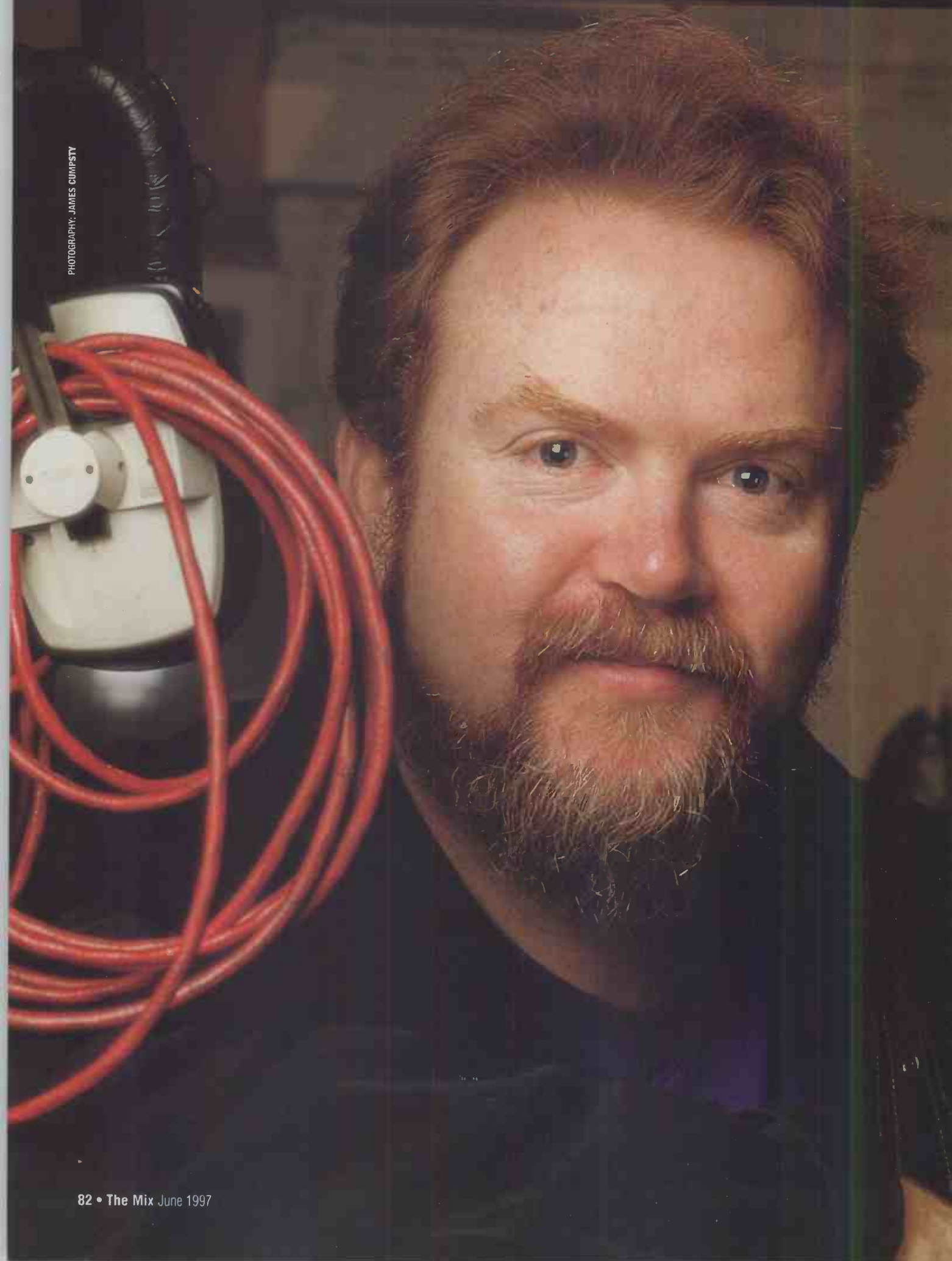

# EVERYTHING MUST GLOW

**Fresh from critical and commercial success with the Manic Street Preachers' *Everything Must Go* album, producer Mike Hedges reputation has been cemented as one of the top producers of 'indie-lite'. Nick Smith caught up with the vintage gear fan at Abbey Road recently.**

**S**omething strange happened at this year's Brit awards – something which no-one, least of all Mike Hedges, could have predicted. The powers that be finally got round to the realisation that there is more to British pop music than Oasis and the Spice Girls, and for once, dished out the gongs to the originators of the best music, rather than the generators of the most high powered marketing campaigns. For once, we witnessed, albeit open-mouthed, the industry's acceptance of what has been for two decades one of the most essential organs in the body of pop: sensible, intelligent, guitar-driven, organic, no-nonsense three-chord trickery with a few socially aware lyrics thrown into the bargain.

John Leckie picked up something for his mantelpiece as Producer Of The Year, for his work with Radiohead and Kula Shaker, while Mike Hedges, for his production work with the Manic Street Preachers now finds his name on the Album Of The Year (*Everything Must Go*) and the Single of the Year ('A Design For Life'). But even if we can't be sure what brought about this change of heart in the industry, we can be sure that it was a Good Thing, as for many of us the emotionally charged guitars and the lush string orchestrations of the Manics simply was the sound of last year.

This won't come as a surprise to anyone familiar with Hedges' back catalogue. He's been the man behind the mixing desk (usually a lovely old EMI valve monster he rescued from the scrapheap) of some of the best indie sounds out there for the last twenty years. His career reads like a guided tour of that slightly off-beam, distinctly British sound that refuses to go away. And whilst it sells in prodigious quantities both here and overseas, it has been largely, until now,



ignored by the establishment.

Starting his career in the late '70s at Morgan Studios, Hedges' first major break came when producer Chris Parry asked him to work with his new signing, The Cure, on their legendary debut album *Three Imaginary Boys*. He produced their next album, *Seventeen Seconds* before leaving Morgan to set up his own Playground Studio, where he produced the cream of British leftfield pop, creating massive hits for The Associates, The Cure, Siouxsie and the Banshees, Wah!, Bauhaus and the Creatures. Again he was to move on, creating a different, more chart-friendly sound, lending his distinctively melodic sound qualities to hits with Marc Almond, *Everything But The Girl* and The Beautiful South, whose *Carry On Up The Charts* is now, last time of checking, at least six times platinum in the UK alone.

More recently, Hedges has produced hits for McAlmont and Butler (including the sumptuous 'Yes'), Geneva, Northern Uproar, Texas and, of course the Manics, who apart from cleaning up the Brits, won Best Album awards from *Q*, *Select* and *Music Week* magazines. Which brings us neatly back to where we started – the Manics, the Brits and Mike Hedges, the man credited with re-inventing the sound of the band after the disappearance of guitarist Richie Edwards.

For Mike it was an extremely emotional experience, and certainly not one he expected to win any awards for. After twenty years in the business, he has a slightly jaundiced outlook on accolades and what they mean: 'It was unexpected, mainly because we didn't think that the album would do so well. We thought it was a good album while we were recording it, but we didn't realise that people would take it so much to heart. But as for the awards, it's difficult to describe, but there's only a very small percentage of people who ever seem to win them. It seems to me that there's a clique of people who tend to win them, and you don't really think that you're ever going to be included. Of course, I'm delighted, but I was still very surprised to win.'

One of the real achievements of *Everything Must Go* is that it is so emotionally explorative, an accusation you could hardly level at its three predecessor albums with any real attitude of authority. In a sense, the Manics were under the gun to come up with the goods this time. After all, they'd been quoted and misquoted in the press as saying that they wouldn't record again without Edwards, the vibe wasn't right, the energy wasn't there. True or not, what was crystal clear was that, as a live outfit, they were missing his presence and dynamism in a way that threw doubt back in the face of the cynics who had always slated him off as a passenger – little ▶

Q, *Select* and *The Brits* voted *Everything Must Go* (produced by Mike Hedges) their Album of The Year

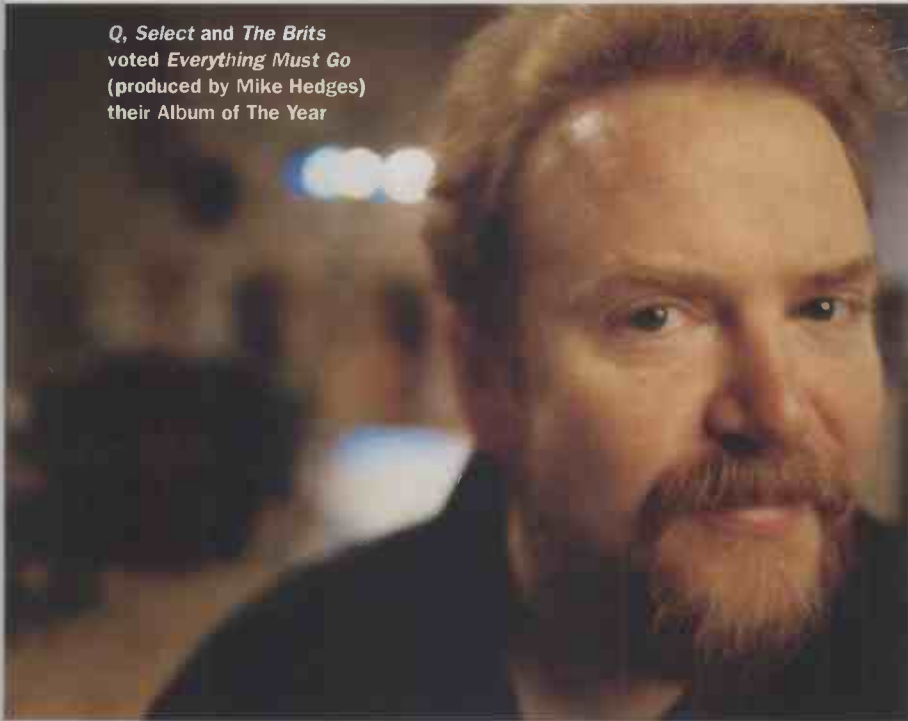

**"If I'm not in the studio working with bands, I turn into a computer nut..."**

▷ more than, say, *Bez* in the *Happy Mondays*. The band was in deep shock, and it seemed likely that it would be difficult for them to maintain their ironic posturing and total sincerity with the media without Edwards.

That they were a band in a transitional phase left a deep impression on Hedges: "It's a very, very emotional album. It was quite intense doing it. Everyone realised how important it was and applied themselves to it. It wasn't something to be taken lightly – they were a very intense band, and getting that on tape was extremely difficult. But I think that we succeeded in what we were trying to do. On its release *Everything Must Go* immediately outsold the band's previous three albums put together, which was somewhat inevitable, given the maturity of the work. But had there been a conscious decision to make the *Manics* more radio friendly?"

"Put it this way, I wasn't the one to say 'right guys, you've got to get more radio friendly'. It was the band really, coming up to me with ideas, saying 'we'd like to try some strings on this track' or 'we imagine this one to be Burt Baccharach crossed with whatever'. No one decided to go more commercial – we just wanted to do something different, to get away from what they'd done before. They wanted to re-invent themselves, and I guess that's why they chose me to do it, rather than someone who would have continued in the same vein."

With the exception of the string overdubs, which were recorded at Abbey Road, the entire album was recorded at Hedges' own residential studio complex, Chateau Rouge, in Normandy. Essentially a project suite, the studio has its origins in Abbey Road, where Hedges had been working "for years", and collecting a good deal of unwanted vintage gear in the process:

"I started off with a mobile EMI TG mixer, but I wasn't really using it at all – it was more a collection.

Most of the stuff I was using then was Akai. I had a 12-track mixer/recorder and a couple of samplers, which I was using mostly for B-sides rather than serious projects.

"At the time, I was approached to do a professional album recording, but when I looked at the budget it occurred to me that I might be better off not going into the studio but buying some new equipment instead, doing up some of the vintage equipment, and recording that way. The project could be done cheaper than in the studio, and I'd end up with a working environment of my own. I was still in London, but by now I'd got the EMI desk working, and had converted two of the 8-tracks into a two-inch, 16-track, which we used as our mastering machine, and still use to this day."

Hedges is slightly misleading here when he talks about his EMI desk. In fact, he's got two of these phenomenally rare beasts (to give you an idea how rare they are, George Martin and Geoff Emerick had to borrow one of the six remaining in the world to work on the *Beatles Anthology*). Apart from the mobile, he has an EMI Mark IV in Chateau Rouge, which is genuinely unique on account of it being the only one in the world: "I knew how good this old equipment sounded. I'd used it all before and loved it, but it came as a bit of a surprise to others when they heard it. I mean, these old desks aren't like modern ones. For a start, there's very little on them."

The move to France happened in 1989 when, unable to find suitable premises in the UK, Hedges cast his net further afield: "Everywhere in England was prohibitively expensive, so we went to France where it's actually a lot cheaper, even when you consider the cost of shipping all the equipment out there. It was a risk, but we wanted to put together something that was affordable."

The control room at the Chateau is a delight for lovers of vintage gear but it's not, he stresses, a museum but a real project studio. When it comes to monitoring, he uses only near-fields, and then almost exclusively Dynaudio Acoustics M1s, with secondary monitoring in the form of B&W 1200s. His avoidance of big monitoring systems is based on a fairly straightforward assumption that since most playback systems he's mixing for are small home hi-fis, bigger monitoring systems simply lose their relevance.

For tracking he uses the 16-track 2-inch, which can be linked to a 24-track. On top of that, there's a 32-track Pro Tools system, just in case anyone wishes to run away with the idea that Hedges is exclusively a retro nut. He sees that system as more than a hard disk recorder, noting that it can come in especially handy when there's a difficult backing track needing sorted out. Digital is something that Hedges accepts, though he states that he wouldn't use it for its sonic qualities alone – it's the flexibility that holds the appeal here. Vocals and guitars are nearly always tracked to the 16-track, he says, because "it sounds better than anything else."

The concern for quality means that when it comes to outboard processors he aims high, using a battery of Focusrite Reds. Interestingly, the Focusrites are just about the only equipment he buys from new – it's a big investment, but he happily states that it's "worth it". Pretty clear, then, that Hedges is a fan of the analogue sound? "Yes I am, but I don't see it as retro. Everyone's been through the retro stage when people were using the equipment, because it gave them the Sixties sound, but that's not the reason we use it at all. We use it because it gives us a better sound than modern equipment. Simple as that." ■

### Mike Hedges: Fact File

#### CREDITS

The Associates, The Cure, Siouxsie and the Banshees, Wah!, Bauhaus and the Creatures, Marc Almond, *Everything but The Girl*, The Beautiful South, McAlmont and Butler, Geneva, Northern Uproar, Texas, Manic Street Preachers

#### GEAR

EMI Mark IV mixer, Dynaudio Acoustics M1s monitors, 32-track Pro Tools system, 2-inch 16-track multitrack recorder, Akai samplers, Focusrite outboard

# FOUNDATIONS

## COMING UP FROM THE STREETS

A UNIQUE DOUBLE ALBUM FEATURING UNRELEASED, EXCLUSIVE AND RARE TRACKS BY THE UK'S MOST INFLUENTIAL ELECTRONIC ARTISTS

RADIOHEAD — TALK SHOW HOST (THE BLACK DOG REMIX)  
ORBITAL — THE TRANQUILISER BUSY TRANQUILISING  
A GUY CALLED GERALD/GK — MELLOW MADNESS  
UNDERWORLD — SPIKEE  
808 STATE — MONDAYS  
FLUKE — STUNT BUBBLE  
BOMB THE BASS — HANGING IN MIDAIR  
ULTRAMARINE — RUSSIAN ROULETTE  
FUN-DA-MENTAL — MOTHER INDIA (MOODY BOYZ REMIX)  
THE BLACK DOG — FOUR FRIENDS AND A MICROPHONE  
SCANNER — JAT SCHEELAN

DJ EVOLUTION FEATURING MC TEABAG — ESCAPE FROM TOKYO  
BANDULU — BIL'LET  
SYSTEM 7 — BIG SKY CITY (JACOB'S OPTICAL STAIRWAY REMIX)  
LEFTFIELD — SPACE SHANTY (TRIBAL REMIX)  
MENNI — DISTANT LANDS  
FUTURE LOOP FOUNDATION — STRANGE FEVER  
EGEBAMYASI — BAMBIENT  
MASSIVE ATTACK — SUCK ME UP DUB  
HEALING ARTS FEATURING JANE WALKER — ONLY LOVE (WILL LIFT US UP)  
DJ CRYSTL — LET IT ROLL (REMIX)  
THE ALOOF — BITTER SWEET (LEMON IN THE HONEY REMIX)  
ATLAS — SAYNAHA  
MOODY BOYZ — MARCH 19TH

PROFITS FROM THE SALE OF FOUNDATIONS, INCLUDING ROYALTIES, ARE PAID DIRECTLY TO THE BIG ISSUE FOUNDATION, FUNDING THEIR INITIATIVES FOR THE 365,000 HOMELESS IN THE U.K.

A FEEDBACK COMMUNICATIONS PRODUCTION FOR THE BIG ISSUE FOUNDATION  
UK FACSIMILE: +44 (0) 1256 862182 E-MAIL: [internet@feedback.com](mailto:internet@feedback.com) WEBSITE: <http://www.feedback.com>

DISTRIBUTED BY RTM THE BIG ISSUE FOUNDATION — REGISTERED CHARITY NO. 1049077

THE  
BIG  
ISSUE  
FOUNDATION



# WIN

## YAMAHA'S STUNNING NEW SAMPLER

It's safe to say that the world of audio sampling, perhaps more than any other field in music, has reflected the fast pace of advancing technology. From units such as the Fairlight CMI and the Synclavier

which were out of reach of all but the most affluent musicians and studios to 'affordable' classics like the Akai S900 and the Ensoniq Mirage, samplers have changed the face of modern music. But – until now – Yamaha haven't had a serious contender in this sector, an exclusive club headed up by Akai and E-mu, who have set the industry standards over the past decade. All that looks likely to change with the arrival of the sensational A3000.

Featuring a massive 64-note

polyphony, the A3000 has 2Meg of RAM (expandable to 128Meg), SCSI interface, EQ, filters, and powerful effects processing section that marks it out from the crowd.

So what is all this sampling power going to cost you when it finally arrives on these shores? Well, from your friendly music store, the A3000 will lighten your wallet to the tune of £1,299 (if you want the optional expansion board which adds three more pairs of outputs and digital i/o connectors

you'll need to pay just £149 extra). But in our exclusive competition, you have the chance to get your very own A3000 for nothing. Just answer the question below, and let fate decide the rest. So, do you feel lucky?

YAMAHA

MASTER VOL. REC VOL.

PHONES INPUT

PROGRAM 001 "PERS" "SAVE" "ALL"

### Competition Rules

1. All entries must be received by 30th August 1997
2. Employees of Korg and Future Publishing may not enter
3. No correspondence will be entered into
4. The editor's decision is final

# AN

Yamaha's entry into the professional sampling market with the stunning A3000 looks likely to shake up the whole sector. It's already been described as "the best-sounding sampler out there" and boasts a wealth of functions including on-board effects, EQ and filtering. Now – thanks to *The Mix* and Yamaha – you've got the chance to win one of the very first units in the UK



The question is:  
What is the A3000's polyphony?

- A. 50 Plus      B. Just 17  
C. 64-note      D. Four-Four-Two

Send your answers on a postcard to: Yamaha Competition, *The Mix*, Future Publishing, 30 Monmouth St, Bath BA1 2BW

### What to expect from the Yamaha A3000

- 16-bit linear sample format
- 64 note polyphony
- 44.1, 22.05, 11.025kHz sampling (analogue in)
- 48, 44.1, 32kHz sampling (digital in)
- 2Mb memory (expandable up to 128Mb)
- 4-band EQ
- Three independent effects blocks
- MIDI recorder for song sketching
- L & R stereo outputs, L & R assignable outputs (AIEB1 option adds another six assignable outputs)
- Direct sample audition via SCSI or CD-ROM
- Internal 2HD/2DD floppy drive, external SCSI

# A3000

# PC News, advice, and new software for PC users, compiled by Ian Waugh

## Windows 95... and a bit

While existing Windows 95 users wait for its next release, Microsoft has already released an updated version known as OSR2 (OEM Service Release 2). It's intended to support new hardware and to include updates to Windows 95 that were formerly available separately. Because most of the new features will only apply to new hardware, OSR2 is currently only strictly available if you buy a new PC, although some dealers have been known to part with copies in exchange for a bunch of tenners...or six.

Here are some of the new features; enhancements to the Windows 95 FAT file system to support large hard disks; the DriveSpace compression utility supports volumes up to 2Gb (but don't use this - buy a larger hard disk); support for third-party software which exploits the Intel MMX (Multimedia eXtensions) for fast audio and video; and increased support for changing the screen resolution and colour depth.

The following enhancements are also available for download on the Net: Internet Explorer 3; an Internet Connection Wizard; DirectX 2 for high performance 2D and 3D graphics and sound; and ActiveMovie for high quality playback of QuickTime and MPEG movies.

If you bought a new PC this year, certainly during the past few months, with a version of Windows 95, it ought to have been OSR2. If you have an older machine it's probably not worth trying to find an upgrade, but the web will furnish you with some of the new and useful enhancements and new or upgraded utilities.

## All the way from Memphis

Memphis is the codename for the next generation of Windows 95 software. A beta version was due to be released in April, but that has slipped. One of its much touted key features is the integration of Internet Explorer with the desktop, so you can access any file wherever it may be and, coincidentally, help Microsoft see off Netscape, its main rival in the Web browser war. However, the integration is apparently slowing down the OS...

It was thought that Memphis would be shipping by the end of 1997, but if it has

## Slow start

So you've got a whizzy Pentium, organised all your applications and sorted them into groups, but when you click on the Start button it takes an age for the sub menus to appear. Annoying, isn't it? That's because the appearance of the sub menus is delayed but, fortunately, you can change the delay period by editing the Registry.

Now one of Windows 95's 'good points' is the way it shields us users from most of its complex bits. Settings which were once found in INI files and the like have been assembled into one humongous mass called the Registry. The Tab sheets in Windows 95 let you make changes to the Registry in a friendly way but they don't cover every setting.

You are advised by everyone not to mess with the Registry unless you know what you're doing, and

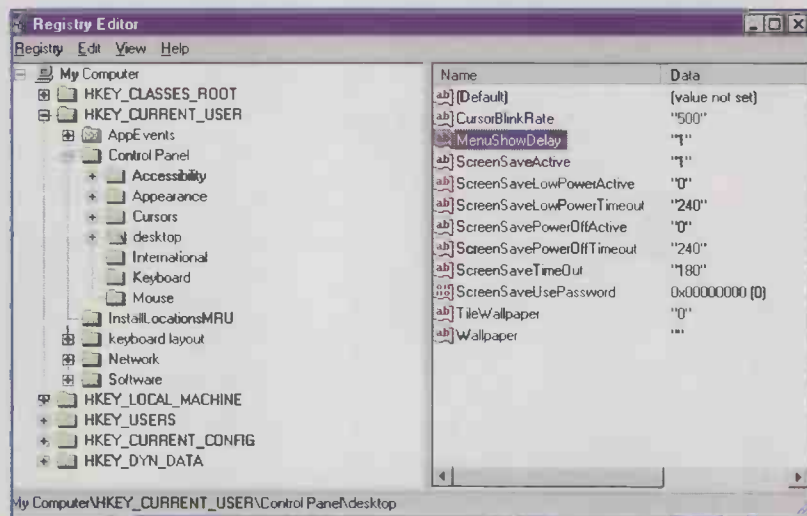

You can edit the Registry to make the sub menus on the Start menu appear more quickly.

you should make a backup of it before changing it. The Registry details are stored in two files - SYSTEM.DAT and USER.DAT - in the Windows folder. The easiest way to back them up is to start the computer in Safe mode (so Windows doesn't load the Registry) by pressing F8 when Windows 95 starts to load. Copy the files to another directory and then reboot.

There's also a program on the Windows 95 CD called CfgBack which can make up to nine different backups. It's not installed by default with the Windows 95 installation, so you'll need to copy it to your hard disk. However, this runs under Windows 95 and if there are serious problems with your computer, you may not be able to use CfgBack to restore the Registry.

Once that's sorted you need to access the Registry Editor. It's called RegEdit and it's in the Windows folder. You may want to add it to one of the Accessories/System Tools program group.

It works much like the Explorer. Without going into too many details, open the Editor and select HKEY\_CURRENT\_USER/Control Panel/desktop in the left pane. Look for an entry in the right pane which says MenuShowDelay. Right-click and select Modify in the menu. Enter a value between 1 and 100. That's it!

I did this on a friend's machine and there was no MenuShowDelay entry. No problem. Right click in the right pane and select New>String Value. Name it MenuShowDelay then modify it as described. If you set a value of 1, the sub menus appear instantly!

to go through a beta test stage that may be an optimistic estimate. Of course, Microsoft could release it anyway and let the buyers do the beta testing. But they wouldn't do that, would they?

## Catch the bus

Microsoft and Intel has released design guidelines for 1998's computer. An entry-level system is likely to be based on around a 200MHz MMX processor with 32Mb of RAM and a USB (Universal Serial

Bus). Although the USB is undoubtedly more efficient than the rather old ISA bus, it does mean card manufacturers will have to decide when, or if, they will start producing USB boards, and consumers could be faced with a price hike. Of course, manufacturers could ignore the guidelines.

In any case, the introduction of a new standard always causes some problems for someone; let's just hope it's not us. Watch this space...

WAV samples and MIDI files are on the ROM this month - check page 7 for details





## MicroWave It

One of the nice things about Creative's range of AWE sound cards is the ability to create, edit and load samples into the cards' on-board RAM. Software editing is much more flexible than that offered by dedicated standalone, rackmount samplers, and while you would expect the hardware samplers to have superior sound output, the AWE64 Gold card, for example, has improved output quality which will delight semi-pros.

But, of course, you need some samples to load into the card and although you can make your own, a few off-the-shelf samples never did anyone any harm. Sample CD supremo Time + Space is taking the computer-based musician to its bosom and released several CDs containing samples which can be readily accessed by a PC. MicroWave It contains samples in both SoundFont and SoundFont 2 formats. The CD also contains all the samples in the .WAV format.

There are about 100 SoundFonts divided into 14 categories: bass, brass, choir, chromatic percussion, drums,

### The real thing

You'll probably know that many sound cards claim to be Sound Blaster compatible. Well Cyrix, the chip manufacturer, has been claiming that its Media GX chipset was just this. Creative Labs disagreed and obtained a temporary restraining order in the US preventing Cyrix from selling Media GX or Media GX-based motherboards. Creative claims that the Media GX-based systems are missing a number of functions found in genuine Sound Blaster and Sound Blaster AWE products. Creative further asserts the Cyrix has violated Creative copyrights through its Web distribution of Creative drivers and software.

So, when a card says it's Sound Blaster compatible, what exactly does it mean? In most cases, the compatibility is required for games use but musically it may not make a lot of difference. However, that's not to say that all cards will work as you expect. Cards running under Windows 95, for example, need a set of Win95 drivers which tell the system how to control it. Any program wanting to access the card does so through the system. A program may issue instructions to play some notes, for example. The drivers work as a half-way house collecting the program's messages and translating them into the format the card requires.

This means developers don't need to write special drivers for every sound card on the market, and it enables anyone to develop a card which can be used with any software - providing it has suitable drivers. So, if you're having trouble with a device, check with the manufacturer that you have the latest drivers.

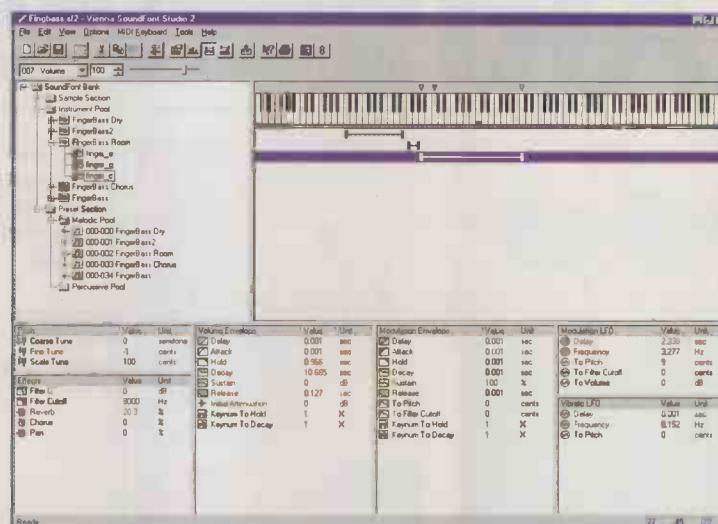

In Vienna, you can see how the MicroWave It sounds have been constructed - and edit them if you wish.

ethnic, guitar, key, loops, Synth, strings, synth bass, synth pad and wind. There are around 600 instruments in total. The sounds are accessed from the AWE Control program from the User page. You can load up to 127 banks here, assuming there is enough RAM. Each SoundFont is less than 512K and will load into an unexpanded AWE card. Once loaded, you can play the sounds by clicking on the on-screen keyboard in the Playback page.

### Banking on it

The sounds are arranged in banks so to access them from a sequencer you would send a Bank Select message and a Program Change message. Bank Select is MIDI Controller 0 so to select a sound which was in Bank 6 in the User page, you would enter Controller 0 with a value of 6 into the sequencer's editor. You then send a Program Change message corresponding to the sound's position in the bank. Many sequencers now such as Cubase, Logic, and Evolution's Sound Studio Gold have Bank which make it easy to enter Bank changes.

There are several text files on the CD and one includes a list of GM sounds with suggested MicroWave It alternatives. The CD includes an audio demo comparing the standard AWE sounds to the MicroWave It sounds, and even the Spice Girls could tell the difference (*what are you insinuating?* - Ed).

Most sounds are instrumental in nature and ideal for band and ensemble pieces although there are a few synthy sounds and pads here, too. One of the best things about the CD is the price - £24.95 - which is less than 6 new pennies per sound. Well worth investigating if you want to add to your SoundFont collection.

The CD was produced by Music Mind Interactive and you can find out more



You can get more information about MicroWave It from the Wave It Web site.



Each MicroWave It SoundFont contains several sets of instruments.

about MicroWave It from the Web site: <http://www.wave-it.com>.

MicroWave It costs a nominal £24.95 and it's being distributed by Time + Space on 01442 870681. ■

# ATARI

News, advice, and new software for Atari users, compiled by Danny McAleer

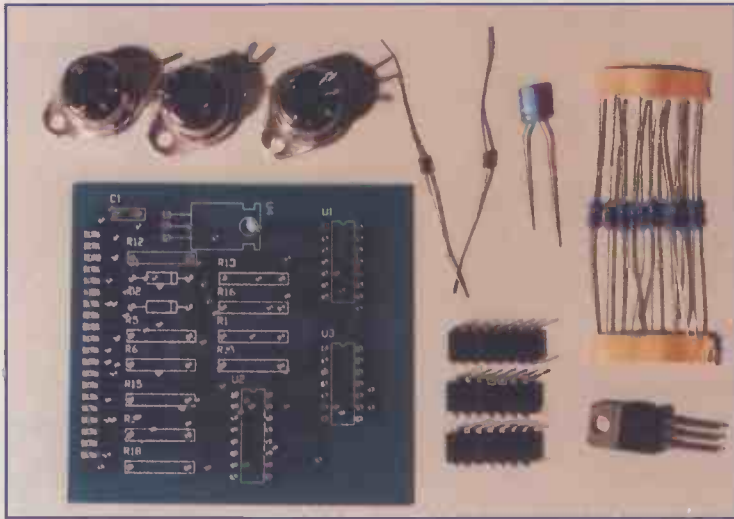

All the bits you need to make a 48 channel MIDI interface, less asoldering iron and a steady hand



Power Up racing; don't drive angry



Take a break from making music; overtake with Power Up.

## A grand day out

Another Atari show has come and gone, and for those who missed it, or walked around the venues with their eyes closed (so as to avoid spending money, or talking to some of the stranger members of the Atari community), here's an appraisal of the best bits...

Over the last year or so, there have been quite a few interesting hardware developments on the Atari platform, and one of the most fascinating is the Upgrade Shop's new 2.5" internal IDE hard drive kit for the STE. Since most of the cost of hard drives on the ST comes from the host adaptor and the external power supply/case, it makes getting a hard disk for the ST far less prohibitive. Prices start from £59 for just the interface, or £99 including a 65Mb or 80Mb hard disk.

The Upgrade Shop also have a replacement rack-mount casing that happily accommodates any Atari computer. The basic case costs £129 (plus a standard £15 fitting charge), and has two 5.25" bays for front-mounting CD-ROMs, disk drives, and so on, and is apparently sturdy enough to stand on. Other peripherals, including mono monitors, modems, and other internal hardware upgrades like the TOS2.06 switcher, real-time clock (that doesn't use the cartridge port), high-density drive module and disk

drive, and a serial port modification (to improve the baud rate to a maximum of 38,400 on a standard ST), were also demonstrated on the stand, all at bargain prices.

Intrinsic Technology's Noboxe is a do-it-yourself MIDI expander for the ST (not Falcon compatible) that incites a MIDI riot of forty-eight channels (three separate outputs) in the usually docile modem port. As its name implies,



System Solutions, obviously.

Noboxe has er, no box, and is

Intrinsic Technology's Noboxe

designed to fit into a custom PC box or rack-mount (or

possibly adapted to fit inside a standard ST case). A disk is supplied with MROS drivers for Cubase, but it will also work with Notator or Creator using the built-in Export driver. In its composite bits, Noboxe costs £39 plus £2 p&p, but since soldering for some people is more foreign than a trip abroad, a ready-assembled version is available for £10 extra.

Although there was certainly a lot of Atari paraphernalia on the System Solutions stand, it all seemed rather secondary to the large intrusion from the TripleDAT PC hard disk recording system (at an Atari show!). More interesting, but no less insanely priced, is the new VME plug-in audio card and software, Star Track. Although

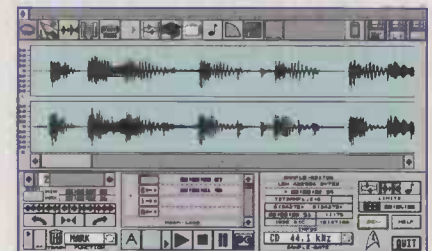

System Solution's Star Track. Get this one on expenses

designed to work on System Solution's all-powerful Hades TOS-based clone (68040 versions start from £1,995), this direct-to-disk recording system will also run on a TT or Mega STE. The VME card has stereo analogue inputs and outputs, SPDIF coaxial and optical connections, and up to four can be used in the Hades (the 060 version is recommended for this) for simultaneous 8-track recording. The software has support for up to 99 virtual tracks, MIDI play-listing, and DSP effects. Unfortunately, each card costs £799 (with software), so it's hardly a viable alternative to a Falcon set-up, or even a fairly good Digidesign set-up on a Power PC for that matter.

## Stratos-phere

As well as the usual stampede of updates for the indomitable software titles NVDI, MagiC, Ease, and HD Driver, C-Lab's Stratos ST-on-a-PC card finally made a working appearance, and CAB too, received quite a major update, giving it commercial software status. Stratos costs £299, and theoretically should run any Atari software on the PC (since it's just an ▶

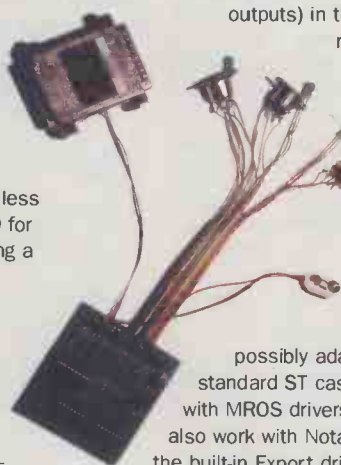

Complimentary software and samples for the Atari can be found on this month's CD



# ADDICTIVE AUDIO QUALITY

(just ask anyone who's listened)!

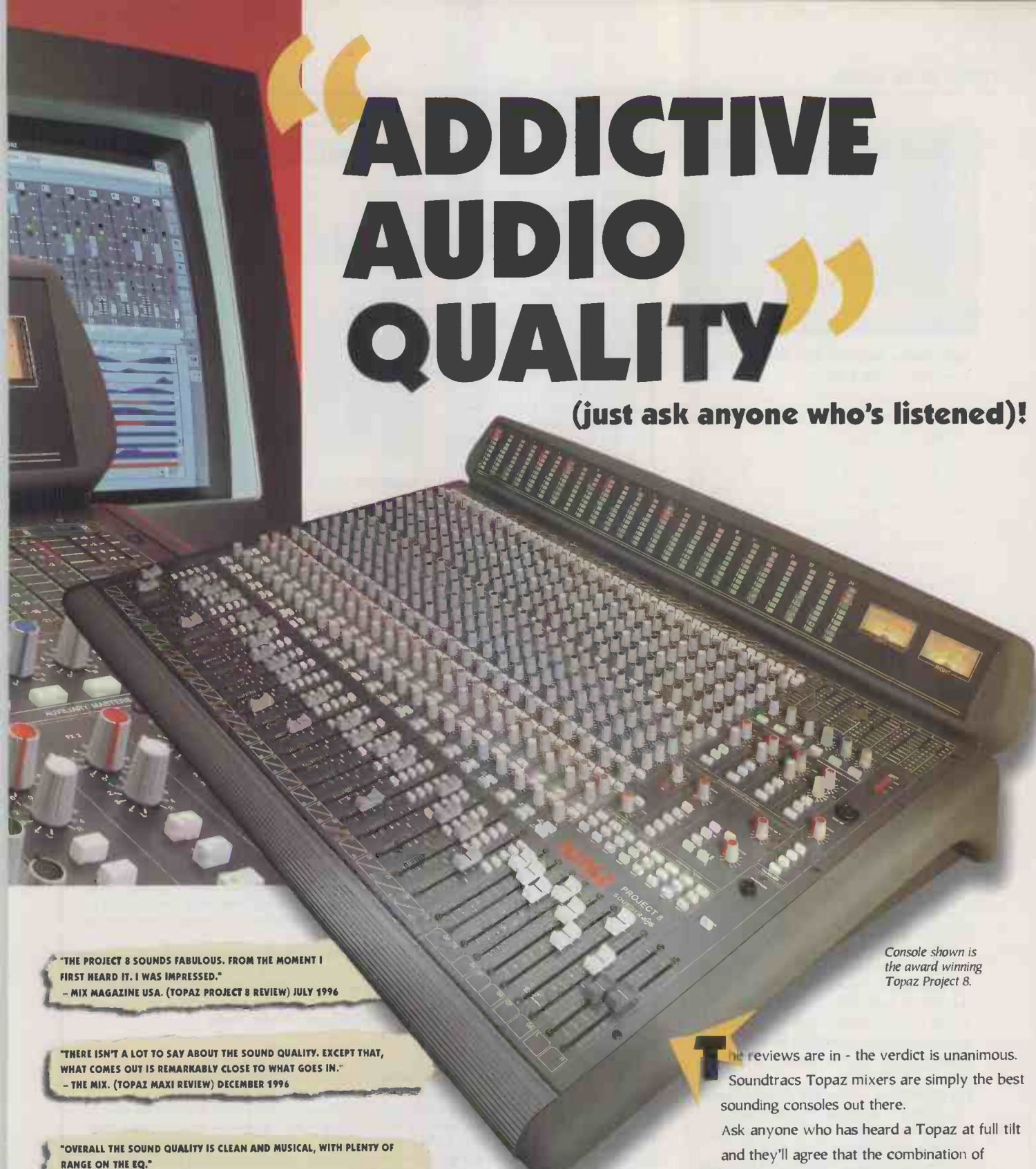

"THE PROJECT 8 SOUNDS FABULOUS. FROM THE MOMENT I FIRST HEARD IT, I WAS IMPRESSED."  
- MIX MAGAZINE USA. (TOPAZ PROJECT 8 REVIEW) JULY 1996

"THERE ISN'T A LOT TO SAY ABOUT THE SOUND QUALITY. EXCEPT THAT, WHAT COMES OUT IS REMARKABLY CLOSE TO WHAT GOES IN."  
- THE MIX. (TOPAZ MAXI REVIEW) DECEMBER 1996

"OVERALL THE SOUND QUALITY IS CLEAN AND MUSICAL, WITH PLENTY OF RANGE ON THE EQ."  
- SOUND ON SOUND. (TOPAZ PROJECT 8 REVIEW) MAY 1996

"I CAN'T SAY ENOUGH GOOD THINGS ABOUT IT. THE EQ IS A STANDOUT IN THIS FINE SOUNDING MIXER."  
- MIX MAGAZINE USA. (TOPAZ PROJECT 8 REVIEW) JULY 1996

"IT HAS A CLEAN AND TRANSPARENT SOUND QUALITY TO IT. MANY APPLICATIONS IN LIVE, HARD DISK RECORDING AND GENERAL STUDIO APPLICATIONS."  
- SOUND ON SOUND. (TOPAZ MINI REVIEW) NOVEMBER 1995

"THE OVERALL SOUND QUALITY WAS IMMENSELY BOUNCY, CAPTIVATING AND ENORMOUSLY WELL-LIKED. ADDICTIVE SOUND QUALITY"  
- THE MIX. (TOPAZ PROJECT 8 REVIEW) JANUARY 1997

Console shown is the award winning Topaz Project 8.

**T**he reviews are in - the verdict is unanimous. Soundtracs Topaz mixers are simply the best sounding consoles out there. Ask anyone who has heard a Topaz at full tilt and they'll agree that the combination of superior audio quality, incredible ease of use and massive feature set is just unbeatable. In fact, completely addictive. So why degrade your sound with an inferior mixer.

Choose the best.  
Choose a Soundtracs Topaz.



by SOUNDTRACS

# TOPAZ

PROJECT 8 CONSOLE

For further information call Freephone 0800 374994.

Distributed in the UK by **beyerdynamic** 17 Albert Drive, Burgess Hill, West Sussex RH15 9TN

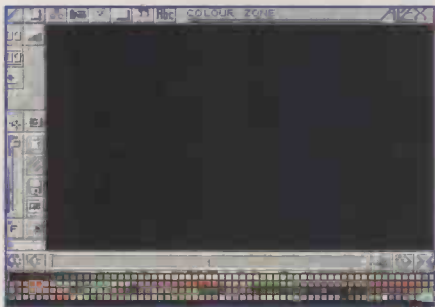

**Apex Media upgrade: You've got to draw something first**

▶ ST built onto a PC card), and was cheerily running Notator SL at the show.

On the more frivolous side of the computing coin, Floppyshop took the opportunity of the show to demonstrate two new Atari games: Tetris II Strikes Back (£8 plus £1 P&P in the UK), and PowerUp (£12 plus £1 P&P). Both games work on any Atari with 1Mb of memory (although there are different versions for the ST and TT/Falcon with the Tetris II game).

PowerUp is a racing car game for one or two players, and features sixty preset tracks, and a track editor with which to design your own. It also has support for the Jaguar control pad, as well as standard joystick or keyboard control. Floppyshop's public domain software catalogue has also been updated, and includes quite a few MIDI and audio additions. For a full catalogue, send two blank disks to Floppyshop at the address below (don't forget to specify ST or Falcon version).

Other exhibitors included Sunrise Audio (tel: 01925 815828), who demonstrated their CD-workstation rack-mount Falcon, and Titan Designs (tel: 0121 693 6669) who brought along Nemesis, Afterburner, and Expose hardware options for the Falcon. ■ **For more information on the Hades, Stratos PC card, CAB v2.0, and Star Track, contact: System Solutions, Windsor Business Centre, Vansittart Road, Windsor, SL4 7SE. Tel: 01753 832212. Fax: 01753 830344.**

**For information on the 2.5" IDE interface and other ST upgrades (including an accelerator currently under development), contact: The Upgrade Shop, Unit F6, Venture house, Cross Street, Macclesfield, Cheshire, SK11 7PG. Tel: 01625 503448. For the latest PD and shareware, contact: Floppyshop, PO Box 273, Aberdeen, AB15 8GJ. Tel: 01224 312756.**

**Email: delaney@steil.wintermute.co.uk**  
**Or: Goodman's, 16 Conrad Close, Meir Hay Estate, Longton, Stoke-on-Trent, ST3 1SW. Tel: 01782 335650. Fax: 01782 316132 (printed PD guide costs £2.95 plus £1.25 p&p). Email: fd18@dial.pipex.com**  
**Noboxe is available from: Intrinsic Technology, PO Box 907, London, SE27 9NZ. Tel/fax: 0181 761 0178. Email: phud@cix.compulink.co.uk**

## The BIG picture

Unlike the ST, the Falcon's video system is completely user-configurable, although you do need a particularly inventive piece of code to begin poking around with it. Vidality is one of many resolution enhancers for the Falcon, enabling you to enjoy huge screen displays that most GEM-based applications will love you for. Installing the software is simple enough: Copy the driver to the Auto folder (after NVDI) and re-boot. Once installed, the configuration program can be loaded, and twiddling can begin. Unless you're familiar with all the jargon attributed to screen displays, some of the

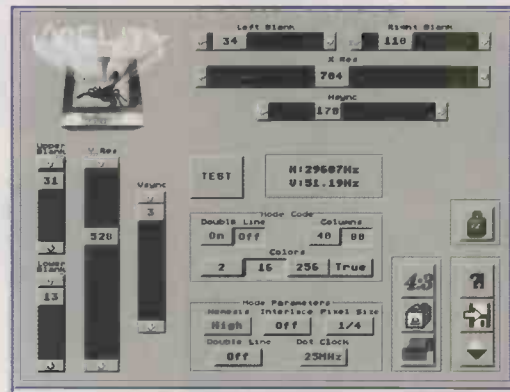

**Gambling with a monitor's life, in Vidality**

configuration controls will at first seem completely bizarre. Experimentation is more often than not a good idea to begin with. In the preferences, a helpful lock button is included, to prevent setting the resolution beyond that supported by the monitor (a very sensible addition when you consider how easy it can be to damage a screen display). Amongst the other settings, there are options for configuring Vidality with Nemesis or an external video clock (like the one supplied with Blow Up), and for changing the scan rate boundaries of the monitor.

### Configure it out

A library of standard configurations is supplied with Vidality. They include non-interlaced resolutions up to 1024 x 768 and are suitable for most monitors. Otherwise, you can modify the library configurations to suit your own particular hardware. You can add modified configurations to the list, and also remove redundant entries, which is a good idea; if some of the presets aren't going to work on the monitor being used, there's little point in having them clutter up the place. One setting is stored for each of the Falcon's standard screen modes (as set in the GEM desktop menu), and swapping resolutions from boot-up or at the desktop allows you to switch between them.

The easiest way to configure a screen from scratch is to follow the example in the manual: start with the screen width, and then press the 4:3 aspect ratio button. Vidality will then automatically calculate the screen height (using a 4:3 ratio) to produce a display that looks neither squashed or stretched. Afterwards, you can adjust the upper and lower, and left and right, blanking (where the X and Y borders start), to squeeze a few more pixels out of either axis.

By clicking on the test button and holding down the mouse, resolutions can be 'auditioned' to see if they work on the display. If all goes well, a pattern is drawn on screen; if not, either something awful-looking happens (blank, dlm, or rolling screens happen a lot), or the image is distorted. In these cases, all that's usually required is a little less zeal on the resolution settings. Some visual anomalies can be fixed by changing just the blanking settings, and these can be adjusted using the cursor keys with the test pattern still on-screen.

All the following resolution settings were obtained during the review period (no flickering, or interlaced modes were used, and all were 1/4 pixel size), with a slightly dire VGA monitor (multisync and SVGA monitors should be even better): 640 x 400 in true colour, 800 x 608 in 256 and 16 colours, and 864 x 688 in 2 colours. Trying to eek out any more on a standard VGA monitor will probably result in crazed screen flicker and all the physical illnesses inherent with using a horrid display.

### Blown it

Some of the things that Blow Up couldn't manage very well were swapping between resolutions, booting in two colour mode, and high resolution true colour. Vidality does all of these, and in the case of the latter, rather well. On a standard VGA monitor, an acceptable picture can be displayed in 640 x 400 true colour; better monitors and fitting Nemesis (Titan Design's system-wide accelerator), produce even higher results. In fact, 720 x 536 in true colour is very possible, given the right environment, which could be of particular use to users of DTP and graphics applications (such as Calamus SL).. Obviously, the higher the screen resolution, and the more colours used, the greater the burden on memory and processor speed. At 800 x 608 it's barely noticeable, especially if the computer has NVDI installed, but huge resolutions do suffer a little. (This is by no means the fault of the software, but to do with the way the Falcon uses the normal ST RAM for the display, unlike PC graphics cards, which have their own, much faster RAM.)

There are other screen enhancers available for the Falcon (Blow Up, Screen Blaster, and Videli Inside for example), but Vidality is the choicest of them all. The only thing it doesn't have that was useful in Blow Up is a virtual screen resolution (allowing you to scroll around an area up to four times that of the visible display. However, in use, it seems far less sulky than Blow Up, plus it does have high resolution true colour support, and even better capabilities when used with Nemesis. So, spend a few pounds and see so much more of you Falcon.

Available for £14.95 from: Titan Designs, 6 Witherford Way, Selly Oak, Birmingham, B29 4AX. Tel: 0121 693 6669. Fax: 0121 414 1630. Email: 100345.2350@compuserve.com

**ALCHEMEA NOW OFFERS ALL GRADUATES AN EXTRA 12 WEEKS OF PRACTICAL STUDIO TIME AND GUARANTEED JOB INTERVIEWS**

OUR STUDIES AT ALCHEMEA

**CAN YOU HANDLE**

**DAILY LECTURES PRESENTED BY DEDICATED AND COMMITTED PROFESSIONALS**

**MINIMUM OF 30 HRS PER WEEK OF HANDS-ON INDIVIDUAL PRACTICAL TIME**



**CAN YOU COMMIT YOURSELF TO**

**CAN YOU KEEP UP WITH TIGHT DEADLINES FOR THEORY ASSIGNMENTS AND PRACTICAL PROJECT**

**ABOVE ALL THIS, DO YOU HAVE IT IN YOU TO STUDY HARD TO PASS ALL EXAMS THROUGHOUT**

# FEAR

**ALCHEMEA**  
The London College of Professional  
Audio Engineering and Production  
2-18 Britannia Row  
The Angel  
Islington  
London N1 8QH

FOR A FREE PROSPECTUS AND A PERSONAL TOUR OF THE COLLEGE TELEPHONE THE ALCHEMEA INFORMATION LINE (24 HRS) ON 0171 3594035, FAX ON 0171 3594027. E-MAIL ON 101645.1103 @ COMPUSERVE.COM OR WRITE YOUR NAME, ADDRESS AND TELEPHONE NUMBER ANYWHERE ON THIS PAGE, TEAR IT OUT, FOLD IT AND SEND IT TO US.

# MAC

News, advice, and new software for Macintosh users, compiled by Ian Waugh

## Apple turnover

Apple's fortunes continue to flounder. Its shares reached a ten year low and the company posted a Q2 \$708 million loss, although that's still better than the \$740 million loss it posted twelve months ago. The Chief Financial Officer said the results would have been better if the company had been able to fulfil \$400m in back orders! So demand is there, pity Apple can't get its act together to supply it.

CEO Gil Amelio, who makes a packet whichever way Apple flips, tried to brush it aside and predicts profitability by Q4. Industry rumours, however, are suggesting that a buyout may be on the cards, and there are two eager investors waiting in the wings. Oracle's CEO Larry Ellison is fond of rattling Bill Gates' cage and could be ready to step in. The other contender is Prince Alwaleed, a nephew of King Fahd of Saudi Arabia, who has already bought \$115m of Apple shares. His reputation is one of buying companies with strong international brand recognition but which are failing.

## Wanna new Mac?

But Apple still has wads of money to spend on promotional items such as the limited edition Twentieth Anniversary Mac. Created to celebrate Apple's twentieth anniversary (obviously), the Mac consists of a computer, a built-in TV/Tuner, a full complement of video inputs and customised Bose Acoustimass speaker technology designed to handle low frequencies.

The main processor is a 603e running at 250MHz, the machine has 32Mb of RAM, 256K Level 2 cache, 2Mb of video RAM, a 2Gb hard disk and a 33.6Kbps GeoPort modem. The screen is a slimline 12.1" active matrix screen with a resolution of 800 x 600. The CD ROM is mounted vertically and the R&D boys, apparently, scoured the world for a mechanism that would withstand the rigours of vertical operation. What's wrong with horizontal operation, you may wonder.

Only 12,000 machines are being made and one can be yours - if you hurry - for £4900. But if you're prepared to spend that amount of £of£y on a Mac, read on...

## 604e or bust

The two processors you'll find in PowerMacs are the 603e and the 604e. Essentially, the 604e is about 50 percent

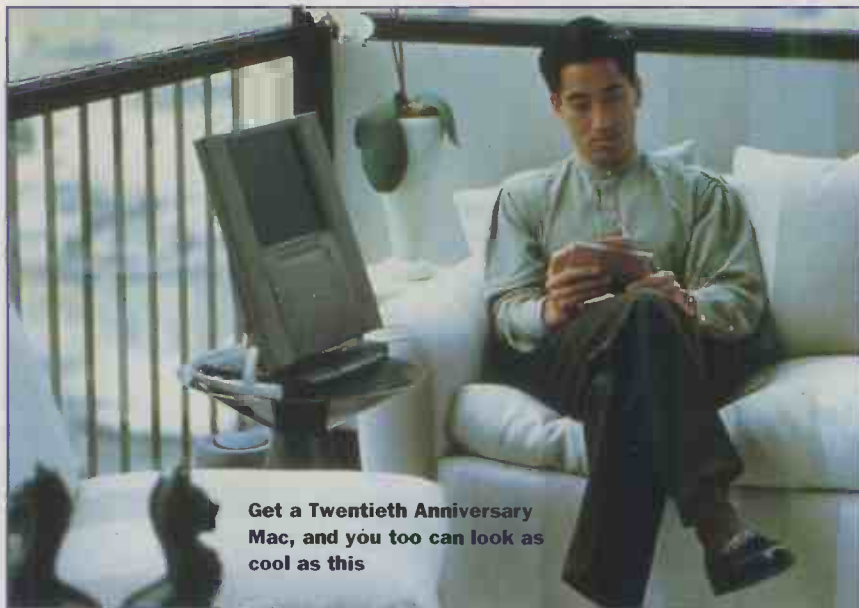

Get a Twentieth Anniversary Mac, and you too can look as cool as this

faster than a 603e running at the same speed. It has a larger cache than the 603e and handles instructions more efficiently. Although, as far as I am aware, no music software developer has come out and said that their software

won't run on a 603 machine, it is widely believed that most prefer you to have a 604 machine. For the relative difference in price, it would seem to make sense to go for the faster chip. If anyone is happily using a machine with a 603 chip for

## MIDI Kit

Here's a useful utility for anyone who messes around with MIDI files, especially if you collect them from the Net or need to convert files which have been created on a PC or ST. MIDIKit has five main functions: It can modify the file type and creator, copy the tempo to track 0, convert files between format 0 and 1, rename files based on the sequence name, and embed a copyright message in the file. A few explanations...

As a Mac user, you probably know that applications

recognise files by looking at the file and creator types - these are what allow you to open an application by clicking on one of its files, and it's what gives the files their distinctive icons. Many music programs can load any MIDI file - even if it hasn't been stamped with a MIDI file type - because they check the header, but some music programs can't. MIDIKit lets you stamp MIDI files with the type and create of your choice.

Some programs can't correctly read the Set Tempo message contained in MIDI files. It probably means that these messages are recorded in tracks other than track 0 (Master/Conductor Track), while the program expects to find them in track 0. MIDIKit can put tempo details in track 0. Files transferred from a PC will likely have an 8-character name.

MIDIKit can read the name of the first sequence in the file and change the filename to it. This is obviously only useful if the first sequence contains the name of the piece. In a format 1 file it probably won't but in format 0 file, many MIDI file producers do give the track the name of the piece. The ability to insert a copyright message into a file is obviously useful and it's odd that not all sequencers actually display this information.

MIDIKit is shareware (\$12 registration fee to the author in Italy) and registration unlocks the ability to process up to 400 files at once. It's on the CD.

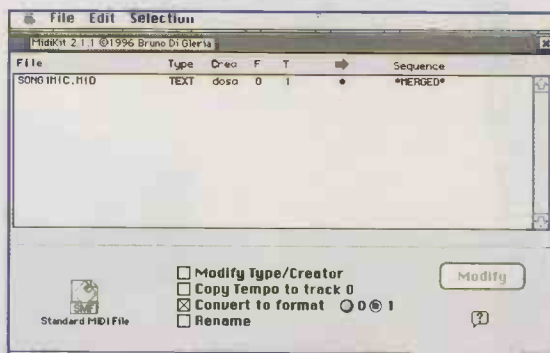

MIDIKit - a bag of MIDI file utilities in one box.

Complimentary software and samples for the Mac can be found on this month's CD



## 7 tricks to speed up your Mac

Never fast enough, are they, computers? There are, however, several things you can do to speed them up. Some cost money but lots don't. Here's a few tips for squeezing a few more horsepower out of your Mac:

1. If you're using Virtual Memory, switch it off in the Memory Control Panel. VM uses the hard disk as a temporary storage area when the RAM fills up but hard disks are incredibly slow compared with RAM. VM will make your Mac crawl. If you desperately need more RAM, buy the real stuff.
2. Connectix RAM Doubler also works on a virtual memory basis so to speed up your Mac, turn it off.
3. If you have a PowerMac without a Level 2 cache, add one. It acts as a buffer which stores information which is required regularly, making access and operation much faster. It will increase the general speed of the machine by up to 30 percent.
4. Does your monitor support millions of colours? If you're not running a QuickTime movie or working with graphics, you probably don't need them all, so reduce the colours using the Monitor Control Panel.

Speed up your Mac by switching off Virtual Memory.

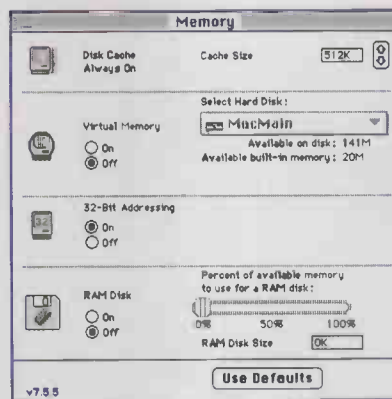
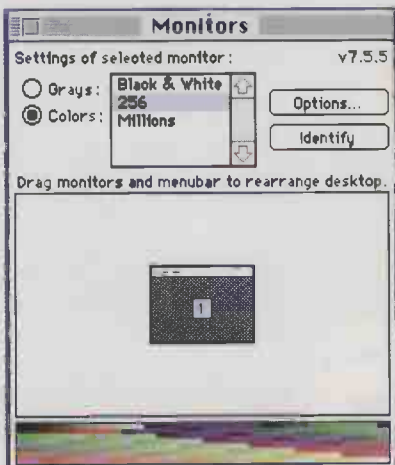

Do you really need millions of colours? Reducing the bit depth could speed up your Mac.

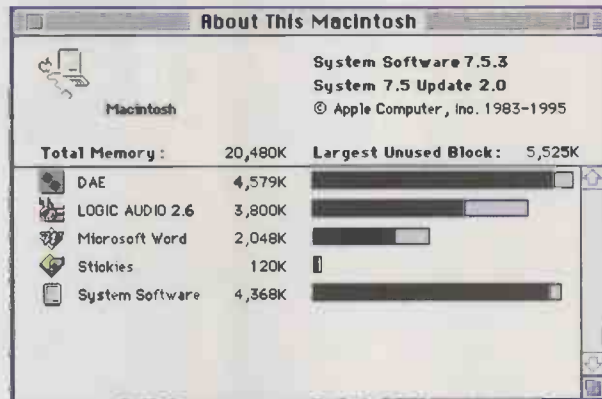

You can see which OS software version you are running by selecting About This Macintosh from the Apple menu.

4. If you have a PowerMac, upgrade to Native software if it's available. It has been written to take advantage of the superior processing power of the PowerPC chip. Virtually all major applications are now available in a Native version and many companies ship Native and non-Native versions together.

5. To ensure backwards compatibility, PowerMacs have a built-in emulator which translates older programs into a Native format. In early PowerMacs such as the 6100, 7100 or 8100, this emulation was rather slow (it was greatly improved on later models).

6. System 7.6 was not designed with older Macs in mind. If you have one, especially with a limited amount of RAM, you'll probably find the latest OS version slow it down.

7. Notwithstanding the remarks made earlier, if you have a new PowerMac then System 7.6/7.6.1 should improve performance in several departments.

direct-to-disk recording and would like to sing its praises (or otherwise) let me know.

Apple's latest round of computer releases is heavily based on the 603e processor. Power Computing has announced a new PowerCentre Pro range that is around 30 percent faster than Apple's latest machines. They are based on 604e chips and run at speeds from 180-210MHz which still outperform Apple's 603e-based computers, even though they are clocked at 300MHz.

The PowerCentre Pros also use a faster 60MHz bus (Apple's machines are busied at 40-50MHz), have 1Mb of Level 2 cache, built-in 3D hardware graphics acceleration, 16Mb RAM, a 2Gb hard disk and a 16-speed CD ROM drive. The only thing to take issue with is the RAM which is not enough to run any half-way serious application but that can easily be upgraded. For direct-to-disk recording you may want to add more drive space but

you can easily hang another drive off the SCSI bus. The PowerCentre Pros should be available now.

### OS blues

As we await delivery of OS 8 and the next generation of OS software – code-named Rhapsody – Apple keeps us up to date with new additions to System 7. Barely had OS 7.6 appeared on this side of the pond than OS 7.6.1 has been announced and released, albeit in the USA. I'm sure there will be many Mac users over here who have been using US releases - I've done so myself in the past - but it has been said that they are not suited to UK machines (so where does that leave users who have bought grey imports from UK suppliers?) and some Mac mags will not put OS updates on their cover CD until an official UK version have been released. Seems to be a message there somewhere.

I've noticed several messages on the

Net from users who have had problems with 7.6, and from users who saw an improvement in performance when they installed it! Some users also reported problems with music software which, apparently, vanished when they reverted to an earlier OS release. The moral of the story is to keep the early release hand when you upgrade, just in case...And a case in point concerns Macs running System 7.5.5. Apparently this has caused problems with MIDI timing and at least one tech help-line has suggested users revert to System 7.5.3. The problems are rumoured to be fixed in System 7.6.1

If you want the update (which fills four floppy disks), it can be downloaded from Apple's Net site at: <http://support.info.apple.com/ftp/7.6.1.html/>. If you've had good or bad experiences of using a US OS, let me know. By the way, if you haven't been there yet, the apple.com site is worth your connection fee alone; check it out. ■



# SONIC ENHANCERS PART 3

**In the last of the series on Sonic Enhancers, Bob Dormon looks at the big noises in audio restoration and discovers there's more to extracting the hiss than meets the ear...**

**C**ambridge is home to England's most prestigious scientific university. Consequently, it's also home to CEDAR Audio Limited (CAL). The acronym stands for Computer Enhanced Digital Audio Restoration, a project that began with an initiative from the National Sound Archive and funds from the British Library back in the early '80s. The motivation for this work was to preserve the aging recordings within the National Sound Archive (see *The Mix*, February 1997). It soon became apparent that the restoration process - achieved through the university's painstaking research and development supervised by Dr. Peter Rayner - had commercial value too.

The original procedures involved taking a noise fingerprint from the source material which would be analysed and extracted leaving the music behind. Due to the

## On The CD



Hear the Denoise and Decrackle treatments from CEDAR and Steinberg on this month's cover CD as they switch in to rescue two of Bob Dormon's exclusive recordings which are in desperate need of restoration and refurbishment

processing power available at the time, applying the de-noise algorithms to the audio would be an overnight number-crunching affair. Fortunately, the computing power available today means that these algorithms can be applied in real-time without the need for a noise fingerprint.

### Noise Reduction

Although many other systems are available it's CEDAR's pioneering research that has shown others the way. This is evident in the type of processors available. All those involved in this particular aspect of audio restoration recognise the need to divide up



**"The block diagram shows the processing sections for the CEDAR CR-1. How the algorithms actually achieve this complex processing is still one of the best kept secrets in the industry."**

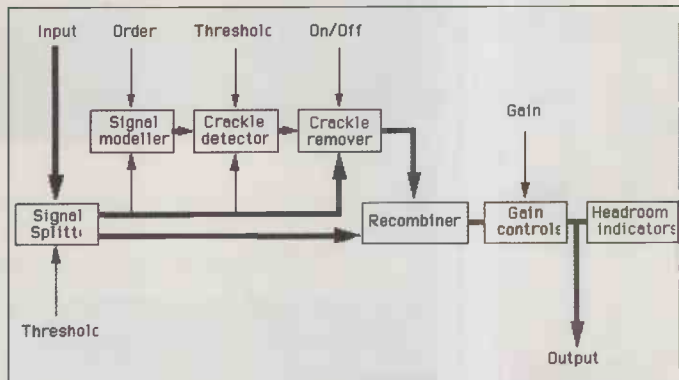

the noise removal tasks into distinct sections. Noise isn't just noise, it has a variety of forms generally described as:-

- i. Clicks – Typically scratches of short duration, generally spread out through the recording. Common in recordings needing a stylus for playback or short-lived electrical disturbances and overloaded digital recordings.
- ii. Crackle – Repeated clicks of low amplitude heard throughout the recording. Common in early 78RPM and cylinder recordings and beer-drenched Spandau Ballet albums that have survived a bad taste party.
- iii. Hiss – Broadband noise, constant in level. Generally heard on poor quality tape recordings. We've all got them tucked away somewhere.

With these types of noise defined, the task of removing them becomes easier since the engineering involved is more specific; designing "horses-for-courses" so to speak with each processing stage being available to treat the source material. It's still a massive undertaking which the staff at CEDAR are very tight-lipped about.

However, as I discovered during a recent visit there, one thing you will hear them say is that CEDAR is the best in the world. This is quite a claim. Then again their processors aren't cheap, but they certainly are taken seriously. Hundreds of CDs of renovated recordings appear with the CEDAR marque on the cover and perhaps the biggest coup of all, is that the revitalised *Star Wars* trilogy had all its audio tracks cleaned up with two DH-2 Dehissers.

### Process Prerequisites

As you can hear on the CD there are a couple of tracks that have treatment from both CEDAR equipment and Steinberg VST plug-ins. CEDAR Audio Ltd also provide a renovation service and in-house engineer Josie Carman (probably the only audio technician alive who works from nine to five), had the privilege of working on a track I'd created which had the crackle from an original George Formby film deliberately applied to the music I'd written and performed especially for the CD demo.

There is a strict order to the processing of this type of material which is to declick first, decrackle and then dehiss. One of the problems Josie encounters is the "help" she

gets from clients. Many of them think that if they roll off some of the top from the original audio (to make it sound less hissy), it will assist in the restoration process. In fact, the reverse is true. In order for the DC-1 declicker to interpolate the scratches accurately, an untreated/unequalised signal is needed, otherwise the magnitude of the click itself maybe diminished by the EQ so that detection becomes harder.

It was only when I later saw the spectral analysis of the audio on the CEDAR for Windows system that I remembered that I had also EQ'd the background crackle to remove a high frequency spike I'd noticed in the recording. That made the job a little harder for the DC-1 and so the next stage was to try decrackling with the CR-1. This proved very effective, but again I hadn't made things easy. The nature of the kazoo



**CEDAR for ProTools offers Macintosh users plug-ins that integrate into the high-end ProTools TDM system**

tracks bear a similarity to the kind of distortion artefacts that the decrackler is so good at removing. You can hear how their presence is softened by the treatment on the CD. And this is yet another example of where certain compromises have to be made with audio restoration procedures. The decrackling process is often targeted at distorted audio, as the frequent clipping found in these recordings can be interpreted as crackle. Even in extreme cases the harshness of distortion can be reduced substantially.

The DH-2 dehisser is a significant improvement on the DH-1 since the algorithms have been remodelled to enhance the noise reduction still further. On this month's cover-mounted CD you can hear how it copes with a very old four-track recording that has been bounced around a few too many times resulting in an extremely unhealthy amount of tape hiss. I've since tried the same recording on a DH-1 and have to admit that the DH-2 is very much better.

## Jobs for the Noise

Even if you can't muster up the many thousands required for a CEDAR processor or three, you can hire them or take advantage of the restoration service CAL offer. Because some customers expect miracles, prospective clients receive a demo tape with audio examples of before and after CEDAR restoration processes. This helps to clarify the possibilities for their own recordings. The prices start at £5 per minute of material for one process (£7.50 two and £10 three processes) with a minimum charge of £50. Discounts apply on volume work and you can attend the studio sessions for £100 an hour. **More from: CEDAR Audio Ltd.**  
**Tel: 01223 414 117 Fax: 01223 414 118**  
**e-mail: 101367,315@compuserve.com**

### Take Your Pick

Despite the complexity of the processing involved, both hardware and software modules are extremely simple to operate. For example the DH-1 and DH-2 dehissers have only three treatment parameters: Level, Attenuation and Ambience (now called Brightness on the DH-2). Note the function similarity with Steinberg's DeNoiser. All rackmount units have AES and S/PDIF digital interfacing and balanced XLR analogue inputs and outputs. The front

panels are identical too having input and output rotary controls with their respective metering above. Five function keys reside below the large LCD screen, to the right are six LEDs that relay the digital interfacing and processing status. The four buttons to the left of the large data entry wheel toggle Bypass, Pre/Post processing, menu Pages and Enter which also locks out accidental adjustment from the front panel.

The Page button scrolls through three set-ups; main control, In/Out interfacing and Remote (MIDI/RS232) menus. Surprisingly, there are no memory locations. You can store a default interfacing set-up, but since there are typically only three noise parameters to adjust, the thinking is 'what's wrong with writing them down on paper?' Hence there are no program changes as MIDI control is restricted to parameter changes only. As you can no doubt surmise simplicity is fundamental to the CEDAR philosophy and although the parameters differ with other models the approach is much the same. The only real work involved

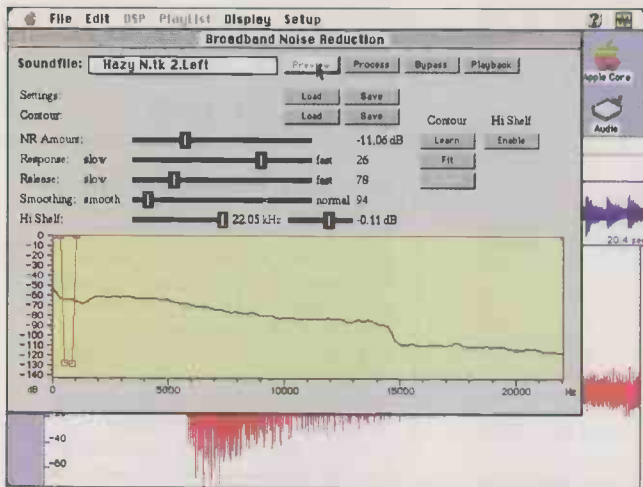

Old Macs fitted with an Audiomeidia card can use DINR with Sound Designer II. You can apply drastic noise-shaping to focus on particular instruments.

is with your ears which is where the front panel headphone output and separate volume control come in handy.

### Sound Investments

There is a variety of choice for anyone wishing to undertake audio restoration work, each with their own merits with regard to performance or price. There are always products available that attempt to do things cheaper, but there are also those that strive to do things better. As usual you'll have to let your ears be the judge of what is acceptable to you. Plug-ins for Steinberg's Cubase VST are appearing quicker than spots on a pubescent teenager. No sooner have one lot been perused and prodded than another fresh batch arrive. Among the latest to emerge are the DeNoiser and DeClicker. At £300 apiece they seem a cheap and cheerful alternative to dedicated restoration tools such as CEDAR. But appearances can be deceptive as you will, of course, need a pretty hot Macintosh with at least 24MB RAM and a 90MHz processor to run these plug-ins. The £300 asking price soon turns into thousands when all these hardware requirements have been met. A situation that begs the phrase 'There's no such thing as a free lunch'.

Installation is easy, just drag the necessary files from the floppies to Cubase VST's Plug-ins folder and they're ready for use. As we've come to expect these days, both are real-time effects which is extremely handy since you don't have to record your audio to hard disk. For example, applying the plug-in effect across VST's main stereo output allows you to play suspect recordings into the Mac with VST tracks set to monitor and listen to the treated output which can then be recorded to DAT or what have you.

### Click Tracks

The DeClicker offers three modes: Old, Standard and Modern which adapt the processing algorithm to suit the source material. Old is optimised for a limited frequency range typical in early recordings.

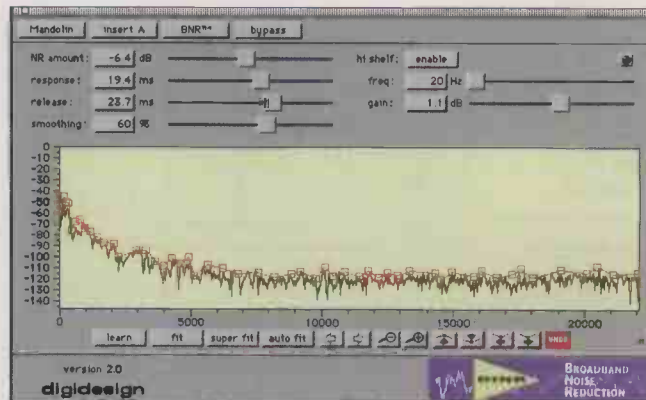

"DINR version 2 has many new features and works in realtime on a ProTools TDM system."

Standard is the general purpose option with Modern being mindful of the

wide frequency range of contemporary recordings. Switch between these and the four options below that span between the Quantity and Quality of click interpolation to fit the character of your click tracks.

Of the two slider controls the Threshold control plays a critical role in the DeClicker's performance. Bearing in mind that clicks and crackle are considered as different noise entities, clicks themselves are generally of high amplitude and so adjusting the threshold correctly can produce significant results without overtaxing the DSP engine. A green waveform display above this control assists in establishing the effected audio, with treated signal areas superimposed in red, while a DSP Performance window draws a real-time graph representing how well the DeClicker is coping with the programme material. If the graph overshoots then you'll probably hear about it first as the DeClicker will almost certainly mute the output and you'll need to concentrate your adjustments around the offending area until it can cope. This is where the Deplop control can come in extremely handy. This special high pass filter only works on signals below 150Hz and can counteract the 'plop' noise that can result from the DeClicker.

### In Use

Above the DeClicker's metering is the Audition button, this acts as a processing sidechain listen allowing you to hear the audio that is actually being treated. This proves very useful for setting up the Deplop control. As Deplop filters off the low frequency audio you can use Audition to check that it's not doing anything too drastic to your bottom end. Deplop works quite well on mechanical noise too, such as rumble, but I found that it wasn't sensitive enough in the lower settings. Levels may well vary, but if the material is very crackly then it may be necessary for it to be recorded at a low level to avoid creating larger clicks through input level clipping. Hence, Deplop should have more adjustment in the lower ranges so that you don't end up consuming a track with a low pass filter, when all you wanted to do was take out the whirring of an old recording. I noticed this when using the DeClicker on a cracked vinyl single. Using Audition I could hear the clicks that had been accepted for treatment, but moving up the Deplop range gradually didn't bring in the bottom end slowly, as you might have expected, but brought it in very suddenly at a setting of nine. This bass will, of course, be removed as listening in Audition mode tells you what's being treated. Use Deplop with care or you might find your bottom has been wiped!

As for the clicks themselves, well there

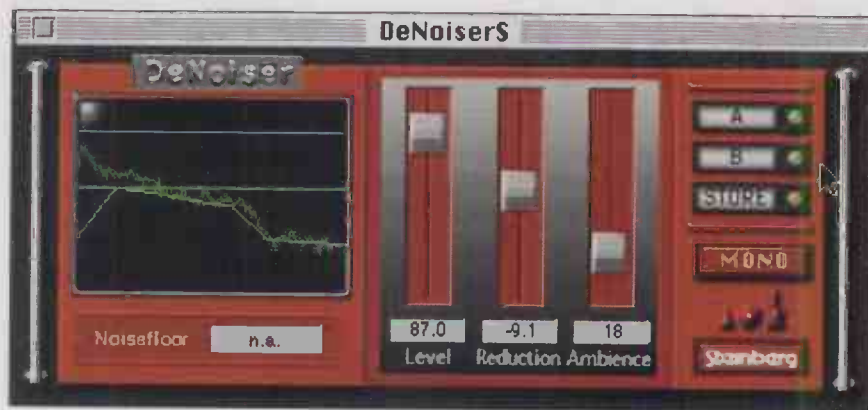

You can use the DeNoiser and DeClicker without recording audio to hard disk. However, you'll also need to upgrade to Cubase VST v3.02 or Steinberg's WaveLab PC system to use them.

were quite a few, but the main culprit (the actual split in the record), was dealt with extremely well. The threshold had to be adjusted to accommodate this big click beastie so that the processor graph didn't go through the roof and mute the audio. Consequently, smaller clicks got through the net, but there's nothing to suggest you shouldn't try the DeClicker a second or third time with new settings for clicks at different levels.

### What's DeNoise All About?

Steinberg's minimalist approach to denoising is similar to the CEDAR DH-1 system with just three controls: Level, Reduction and Ambience. These parameters can also be stored as A or B which makes life easier when checking the effectiveness of your tweakings. A large display relays a spectral analysis of the incoming audio in green. A yellow line tracks an estimate of the noise floor and a light green one shows the relative setting of the Level parameter. The Level control serves as a threshold setting, determining the point at which denoising takes place in the dynamic range of the audio. The Reduction control simply attenuates the noise present in the audio by the amount you set. The Ambience control acts to remedy the stifling effects of the DeNoiser by re-introducing elements of the sound's ambience that may have been smothered by the processing. Too much ambience can be counterproductive as more noise reappears. Too little can bring about a lacklustre sound.

### In Use

No matter what advice may be offered about de-noising, you really have to try it for yourself because the severity of the effect applied is down to personal taste. To get to grips with the DeNoiser's effectiveness you can exaggerate the Reduction parameter and then move the Level control, which quickly gives you an idea of the area that cuts the crap. Wind up the Ambience control and get familiar with how it sounds. Back off the Reduction to say -10dB, adjust the Level carefully and a more subtle treatment can be realised with or without Ambience.

On the CD, you can hear how it sounds



Watch your Mac take the strain in the DSP Performance window and deplop with care or your bottom end will suffer.

## Noisy Neighbours

**CEDAR IS EXPENSIVE, WITH NO SINGLE SYSTEM COSTING LESS THAN £9,000 (INC VAT), SO IT SHOULD COME AS NO SURPRISE THAT THERE ARE MANY CHEAPER IMITATIONS OUT THERE. VIRTUALLY ALL OF THEM ARE SOFTWARE BASED USING A MAC OR PC.**

**DINR - Digidesign:** The Digidesign Intelligent Noise Reduction (DINR) software plug-in works with both Sound Designer II and ProTools. The initial advantages are that the Sound Designer version (2.8 or higher) will run on the old Mac 68030 processor. At the very least you'll need an Audiomeia card and a sizeable hard drive, but together with the software and a secondhand Mac, you can have a complete hard disk denoise/plug-in system for around £2,000 if you shop around. However, with the SDII set-up you can't work in real-time, you have to set up the treatments first and then apply them to the audio file(s).

First you select the audio - preferably a noise-only section to derive a noise fingerprint, click on the Learn contour and then Fit contour. Press Preview and a short piece of audio will cycle round to let you hear the adjustments you make with the other parameters. While it's tempting to try extreme settings with the NR Amount (noise attenuator), you'll get some weird tinkling and bubbling noises if you overdo it. These side effects are common with all de-noise systems and with DINR you can reduce their prominence by getting familiar with the Response, Release and Smoothing parameters. Thankfully, you can store your settings so that you can while away the hours refining and comparing these parameter positions.

DINR can also be used creatively. The graphical squares that track the noise contour can be moved or even removed. Repositioning a square to zero will remove that frequency entirely. So you could take out hum or even remove a wide spectrum of audio bringing only a certain frequency band to the fore. Drum loops can be manipulated so that intrusive instruments disappear or so that individual drum sounds are effectively isolated. With version 2 for ProTools TDM systems, DINR can work in realtime and can be applied in record as well as playback modes.

More from: **Digidesign Tel: 01753 653 322 Fax: 01753 654 999**

Web-site - <http://www.digidesign.com>

**SONICWORX STUDIO - PROSONIQ:** Another Mac system comes from German company Prosoniq. Utilising the PowerMac's powerful RISC processor the sonicWORX Studio software can work without additional hardware on a system with as little as 8MB of free RAM. Besides hard disk recording, the main features are a suite of audio tools which are bundled with the system. Added together, plug-in costs can reach dizzying heights, but with sonicWORX Studio you get quite a selection including, Oenoiser, declicker/decrackler, plus realtime Multiband Compressor/Maximizer, 7 band EQ, Exciter, Spatial Expander and Spectrum analyser plus all the usual timestretch features.

You can save your sound files as AIFF or Sound Designer II so that the resulting treatments can be used on other popular platforms such as Logic Audio, Cubase Audio and Digidesign software.

While Prosoniq may not have the highest profile in the audio marketplace their work can be found integrated into Emagic's Logic Audio 3.0. The timbre correction found in the new Time and Pitch Machine II plus realtime EQ, flanger and reverb effects are the result of Prosoniq's Neural Network processing and PowerMac native code.

More from <http://www.prosoniq.com>

**TRIPLEOAT - CREAMWARE:** Even the much hyped MMX range of PCs don't necessarily include on-board sound processing (those that do have it on a daughterboard) so additional hardware is always going to be a factor when choosing and using a PC platform for audio. Creamware's minimal tripleDAT system will cost around £1,300 for the hardware and software bundle.

With a variety of interfaces available, tripleDAT is among the better-featured, better value PC hard disk recording systems. It can run their Declicker, Denoiser, Exciter, Sub-bass Enhancer and EQ simultaneously on a Pentium 166 with 16MB RAM. These new real-time treatments are part of the Osiris plug-in package which should be available now. Watch this space for a full review in *The Mix* in the near future.

on a hissy tape recording and a more demanding crackly piece. I had tried the DeClicker on the latter, but crackle is distinct from hiss and clicks and hence under these conditions it didn't perform as well as the DeNoiser. Although using a DeNoiser on crackle isn't ideal either, you'll hear that there is sufficient noise in the audio to make it worth a try. In fact, it did succeed in suppressing a lot of the noise but also a fair amount of music too!

When it comes to hiss-removal, the DeNoiser is very impressive. The Level control may need to be higher than you'd expect in some circumstances, even though the manual suggests that it should be only slightly higher than the noise floor level

shown in yellow. Even with the aid of graphics, as usual, it's always going to be your ears that are the best judge here. Notably, the tonality of the Ambience control being the grungiest aspect, producing sweeping resonances if overdone, yet this parameter is a necessary evil with extreme DeNoiser settings. While it's always tempting to try and eliminate noise completely with large Reduction factors, the art of noise reduction appears to be found in the subtlety of use.

More on CEDAR from: **HBB Communication Tel: 0181 962 5000 Fax: 0181 962 5050**  
More on Steinberg DeNoiser and DeClicker plug-ins from: **Harman Audio UK Ltd., Tel: 0181 207 5050 Fax: 0181 207 4572**

# DIY SYNTH PROJECT PART 4

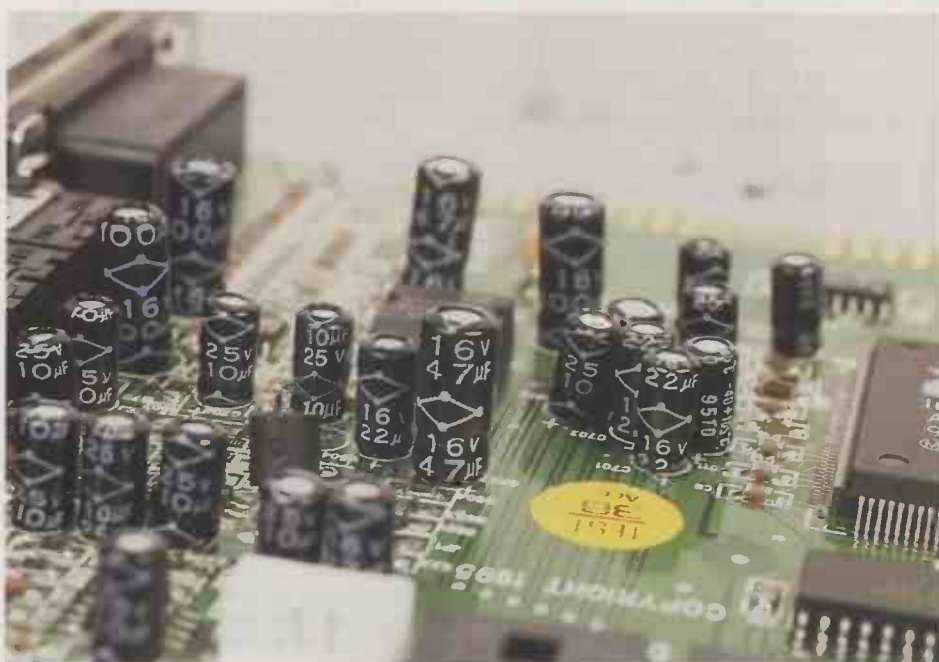

**In the fourth part of our series, synth designer Geoff Waterston takes a practical look at building a state variable filter to emulate the sound of some vintage analogue keyboards**

**T**he classic state variable filter was utilised by many synths manufactured during the late '70s and '80s – you'll find it in a lot of Yamaha and Oberheim analogues, for example. The main feature of this type of filter is its ability to produce a low pass, high pass and band pass response simultaneously. It's also possible to mix the low pass and high pass response to create a notch response. This provides a filter with lots of responses, each of which sound radically different and have a characteristically fat, open tone.

This type of filter won't object too much to being slightly overdriven, so if you're after dirty filter sounds this could be the one to go for. You could also use it to make drum sounds by turning the resonance control up to the point just before oscillation and then, by applying a pulse to the signal input,

you'll make the filter 'ping' every time a pulse is applied. This pinging sound is remarkably similar to a classic analogue bass drum (if the cut-off frequency is turned up a little, you'll get congas, turn it up a bit more and you'll get clave sounds.

## Question time

Before we get going with the construction, I'd like to answer some of the questions I've been asked recently.

**Q: Will it harm the filter if I overdrive it?**

**A:** A mild amount of overdrive will do the filter no harm. However putting very large amounts of signal through the circuit could do some permanent damage.

**Q: Do I have to use 9 volt batteries to power the circuit?**

**A:** Batteries are the safest option for the beginner as mains PSUs can be potentially deadly if they're not built properly. More experienced constructors may prefer to use one of the many commercially-available power supply kits which suppliers such as Maplin provide. Almost any of them will work, as long as the voltage output is positive and negative, 12 volts at 50 mA or more. But be very careful.

**Q: What gate voltage does the envelope circuit use and will it work off S trigger?**

**A:** The envelope uses a positive trigger voltage between 5 and 10 volts. It will not work off S trigger.

**Q: How many filters can I chain together in series?**

**A:** If you chain more than four filters together noise could become a problem. ▶

## On The CD

The demo on the CD is a state variable filter with an SCI Pro 1 playing a sequence through it. The drums are a filtered Roland TR606. Everything that you hear on the CD track is filtered with the circuit I've just shown you how to construct.



You'd normally pay £60 for a sample CD...

...not in this case



**FUTURE  
MUSIC**

**XP2**

**FREE SAMPLE CD WITH *FUTURE MUSIC***

**OUT NOW!**

▷ If the resonance is turned up high on all the filters, you may find the signal will clip every time the cut-off frequencies cross or get close to each other.

**Q: Will you be making a Moog-style ladder filter?**

A: Yes, I'll be showing you how to construct a simple ladder filter over the next few issues.

**Q: Can I make the LFO circuit work at audio frequencies?**

A: Yes, if you substitute the timing capacitor for a smaller value e.g. 1nF, the circuit will then work at audio frequencies.

**Q: Where can I get other schematic diagrams for synth modules?**

A: I have found lots of good circuits on the Internet. Try searching for 'oscillator filter' – you'll be amazed at what turns up. You could also try Penfold Books; they do a range of synth and electronic music construction titles.

If you'd like any further information or

have more questions please drop a line to the address at the end of this article and I'll do my best to answer them in next month's issue.

More from: Geoff Waterston, Orgon Systems, PO Box 76, Whitley Bay NE26 2YT



## Let's build it...

Anyway, lets get on with constructing the filter. This is a little more complex than the projects we've constructed recently, but If you take your time and keep checking for mistakes you should have a filter up and running in no time. You may notice that the control voltage is missing. This is because I will be continuing with this filter in next month's issue. For now, the cut-off frequency is controlled with the 100k pot at the top of the circuit. The pot at the bottom of the circuit controls the resonance.

**PARTS YOU WILL NEED**

**RESISTORS**

- 1x 47R
- 4x 220R
- 3x 1k
- 4x 15k
- 2x 27k
- 5x 100k
- 3x 100k linear pot

**CAPACITORS**

- 2x 150pF poly

**TRANSISTORS**

- 2x 2N3819

**ICs**

- 2x CA3080
- 1x TL072

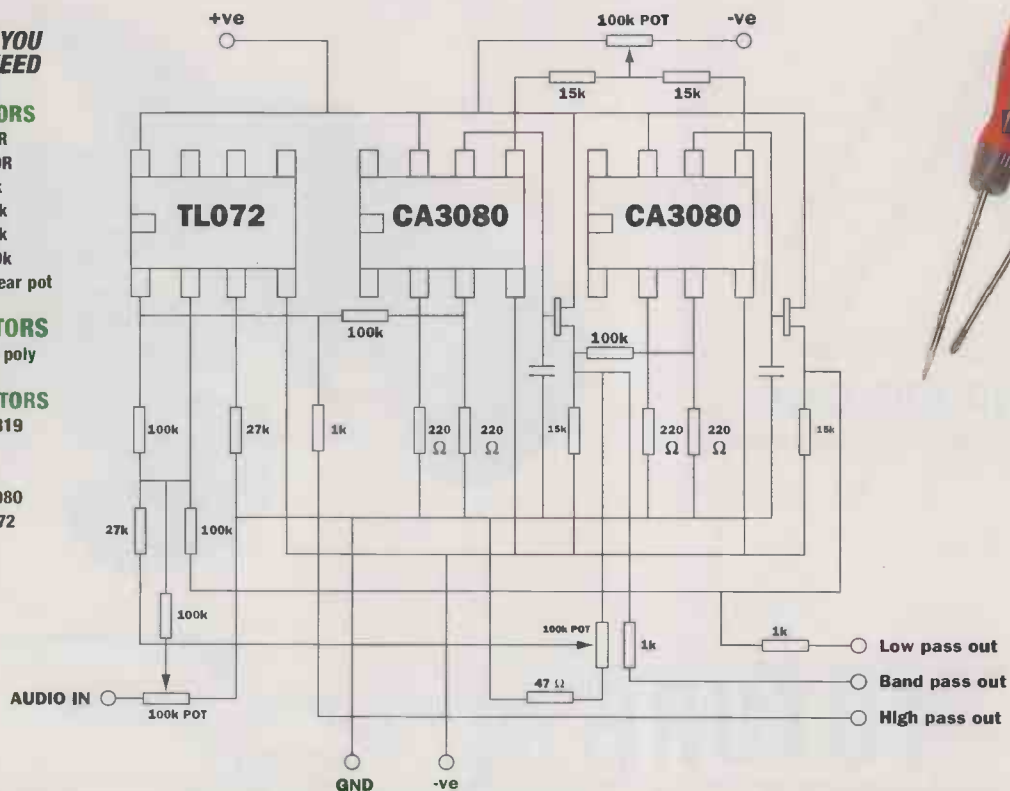

**TESTING**

1. Connect the low-pass output to an appropriate amplifier.
2. Set the resonance and cut-off frequency pots to half way.
3. Connect the batteries up to the circuit.
4. Turn the audio input pot to half way, and connect the signal source to the audio input.
5. You should hear a low pass filtered sound, and when you turn the cut-off frequency pot up and down the filter should also sweep up and down.
6. Check the band-pass and high-pass responses work correctly by connecting the amp into the appropriate sockets.
7. Try turning up the resonance and when you get towards maximum it should start to oscillate.
8. If none of the above happens, go back and check the power supply and circuit layout.

**CONSTRUCTION**

1. Solder into the circuit board 3 appropriate sockets for the ICs, (don't insert the ICs until you have finished soldering).
2. Solder in the resistors.
3. Solder in the 2 capacitors.
4. Connect up all the wiring for the power supplies and IC connections.
5. Connect up the three 100k pots.
6. Solder in both of the FET transistors. Be careful not to heat these for too long.
7. Solder all the outputs and inputs to 1/4 inch jack sockets.
8. Insert the ICs into the sockets.
9. Check for any shorts or solder splills.

In next month's issue, I'll continue on this theme and install the control voltage circuit together with an audio mixer so you can mix the three responses. See you then..

# Subscribe NOW and save nearly

# £9!



Subscribe to The Mix by direct debit and you will save nearly £9 on the price you would pay in the shops.

The Mix is the essential magazine for music production fanatics everywhere. Each month The Mix is full of advice on how to get the best out of your equipment, reviews of the latest gear, news, interviews with the big names, readers letters, technical advice and much, much more...



We want happy customers which is why we guarantee that if you are not completely satisfied with your subscription to The Mix. For whatever reason. We will refund you in full for any unmailed issues. No questions asked.

More reasons for taking out a subscription to your favourite music production magazine...

- Save nearly £9 when you subscribe by direct debit. (You'll get 13 issues for the price of 12 **PLUS** a saving of £4.88)
- Each month your favourite music production magazine will be delivered to your door. Postage free.
- Every month you'll get our free CD packed with tests of the latest gear, readers demos and samples
- If the cover price of the magazine increases during your subscription you won't have to pay a penny more

**Yes, I want to subscribe to The Mix, and save nearly £9**

- UK direct debit.....13 issues £43 **Save £8.87**
- UK credit/cheque.....12 issues £45
- Europe/Eire (airmail) .....12 issues £68
- Rest of World .....12 issues £86

Name \_\_\_\_\_

Address \_\_\_\_\_

Postcode \_\_\_\_\_ Telephone (STD) \_\_\_\_\_

### Method of payment

- Direct Debit (fill in the form opposite)
- Cheques (make cheques payable to Future Publishing Ltd)
- Access  Visa  Expiry date  /
- Credit card No
- Signature \_\_\_\_\_ Date \_\_\_\_\_

Send form to (No need for a stamp if mailed in the UK)

**The Mix Subscriptions, Future Publishing,  
FREEPOST (BS4900), Somerton, Somerset TA11 6BR**

Tick here if you do not wish to receive direct mail from other companies.

Code: MIX797P



Please send this form to address shown.

Instruction to your Bank or Building Society to pay Direct Debits. We cannot accept photocopied or faxed direct debit forms.

**Originator's Identification Number 930763**

1. Name and full postal address of your Bank or Building Society branch

To: The Manager

Bank/Building Society

Address \_\_\_\_\_

Postcode \_\_\_\_\_

2. Name(s) of account holder(s)

3. Branch sort code (from the top right hand corner of your cheque)

4. Bank or Building Society account number

5. Instruction to your Bank or Building Society

Please pay Future Publishing Direct Debits from the account detailed on this instruction subject to the safeguards assured by the Direct Debit Guarantee

Signature(s) \_\_\_\_\_ Date \_\_\_\_\_

Banks and Building Societies may not accept Direct Debit Instructions for some types of account.

Ref No (Office use only) \_\_\_\_\_

# the A-Z

## OF ANALOGUE PART 40

**All good things come to an end, and after four years the end is nigh for Peter Forrest's A-Z Of Analogue.**

**It's the most complete record of analogue synths and keyboards ever compiled, and if you missed any of the previous 39 episodes, you can now get it in concentrated book form...**

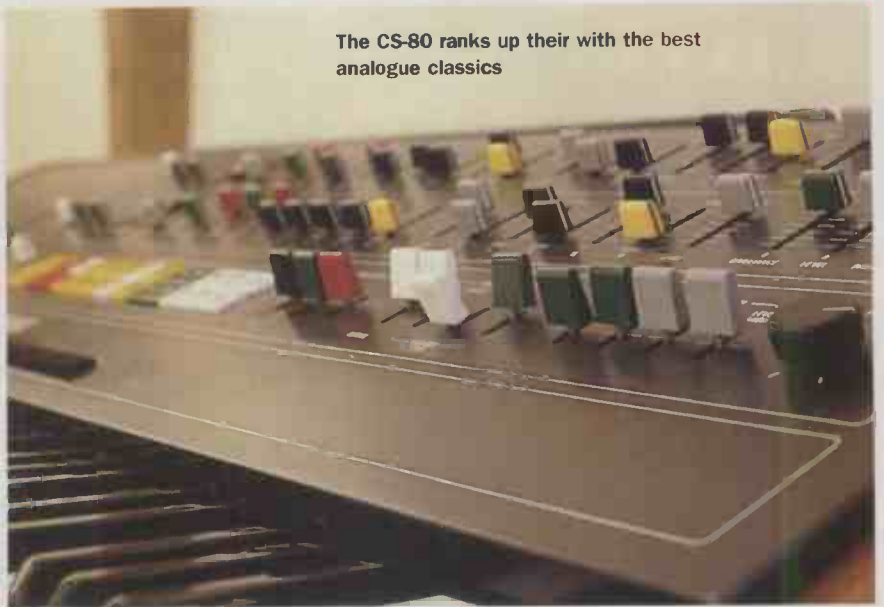

The CS-80 ranks up there with the best analogue classics

### Yamaha CS80 (continued)

- The biggest single improvement on the CS-80, which made it stand out from any synth of the era (and most since) was its touch sensitivity: this time, Yamaha introduced velocity sensitivity, and, just as important, made the aftertouch polyphonic: press down harder on one key, and just that note gets brighter, or louder, or more modulated, or whatever. This added a level of expression to keyboard playing that it had never had before, and still makes the CS-80 one of the most pleasing and powerful synths ever produced. Each 8-voice bank has four sliders to control its response to velocity and to aftertouch, either or both of which can affect the VCF and/or the VCA. That's in addition to the global touch response controls as on the CS-60.
- It came with a very chunky chrome stand - which is just as well, considering the CS-80 weighs 100kg. A semi-flightcase top protected the control panel, so that you often get CS polyphonics which are very tatty all around their tolex-covered case, but in far better condition once you take the lid off. The same pedals as with the CS-60. There were also casters permanently attached to the case. Useful for moving it across a very smooth surface, but not recommended on cobbles.
- Another improvement on the 60: as well as having the unusual but effective keyboard brilliance sliders, it has two others which set the relative volume of each end of the keyboard.
- The controls to the left of the keyboard are also changed and enhanced: there is now a switchable tremolo and chorus unit, with speed and depth knobs; and two buttons to switch the footpedal response from Exp (volume) to Exp Wah - volume and filter cutoff.
- Yamaha were certainly in a hurry to get the CS-80 out there to dominate the

potentially huge pro polysynth market: the first edition of the service manual has a lot of hand-drawn pages, including the main panel layout. Interestingly, there was a third button originally planned underneath the Exp / Exp Wah buttons: the legend has been scribbled out, but it was probably Wah. Wonder why they didn't implement something that would have been logical and useful.

- Instead of the four octave select switches, there are two click-stopped sliders, so that each set of voices can be set to 2', 2 2/3', 4', 5 1/3', 8' and 16'. Very effective with some layered sounds.
- The CS-80 puts out a lot of heat (which certainly didn't help its tuning). When you see that it uses 180 watts, it's not surprising. Compare that with, say, a JX-10 (28 watts).
- The back panel has Left, General and Right outputs (all, surprisingly, unbalanced jacks) switchable high/low; sockets for the foot pedal and switch; and the External input, with a level control. In an ideal world, stereo external audio ins and some sort of CV interfacing would have been great.
- Such a shame Yamaha didn't include unison switching (Ken Freeman modified his to go into unison, and to have two layered eight-oscillator sounds of this power must be stunning. While he was at it, he also managed to phase-shift the LFO feed to the oscillators, for an extra-rich vibrato).
- The other surprise is that it's not a wooden keyboard. It's still very high quality, though: very long keys, quiet and smooth, well-balanced, and an absolute pleasure to play.
- When it comes to trying to decide which of the top-flight synths is the best ever, it's not easy. From almost any practical viewpoint, and in terms of versatility of sound, there are a lot of instruments which wipe the floor with the CS-80. But if you're looking at richness of sound



coupled with performance power, and sheer overkill, maybe nothing can touch it.

- Typical serial number: 1014 (fourteenth in the production run, and not a happy bunny)
- E&MM Jun 86, MT retrospective: Sep 90

<b>SOUNDS</b>	●●●●●●●●●●
<b>KEYBOARD</b>	●●●●●●●●●●
<b>INTERFACE</b>	●
<b>CONTROLS</b>	●●●●●●●●●●
<b>MEMORIES</b>	●●●●
<b>EASE OF USE</b>	●●●
<b>CHARACTER</b>	●●●●●●●●●●
<b>POWER:SPACE</b>	●●●●●●●●
<b>MAINTENANCE</b>	●
<b>COLLECTABILITY</b>	●●●●●●●●●●

**GX-1**

Treble-manual (2x61-note 8-voice, 1x37 mini-key mono) megasynth / organ with 25-note pedalboard.

1975 - late 70s

**Original price:** £30 000 - £50 000

**Typical price:** £1000 - £12 000

**Users include:** Benny Andersson / Abba ("It has no limits, that machine"), Chess (the musical, London), Keith Emerson ('Works', esp. 'Fanfare for the Common Man'), George Fleury, Hans Juergen Fritz / Triumvirat, John Paul Jones / Led Zeppelin (later sold to Keith Emerson), Mickie Most / Rak Studios / Hot Chocolate, Rick van der Linden, Stevie Wonder ('Songs in the Key of Life' and 'Journey Through the Secret Life of Plants'), Rick Wright, Hans Zimmer.

- The most impressive synthesiser of its time, both visually and sonically. Demonstrated at Frankfurt in early 1975, it was like nothing else that had ever gone before. Although the styling was similar to the top-end Electone organs (the EX-42 is a dead ringer as far as casing and keyboard size go, and the GX-1 was even labelled Electone, and treated as the top of their organ range) the concept was unique - and available way before the Prophet-5 or Polymoog were ready to go public.
- A giant white fibreglass pod sits on two wide mirror-chrome legs, which in turn sit on a white fibreglass island, containing the pedalboard, and the adjustable bench, again on similar legs. You could imagine it floating off after an ocean liner shipwreck - if it didn't weigh something over 380kg (the equivalent of three CS-80s, or two B3s, or 170 Wasps).
- It also had a reasonably powerful (120W RMS) matching amplification system, too, with giant multi-speaker cabs.
- Each of the four playing surfaces - solo (S), upper (U) and lower (L) keyboards and pedals (P) - has ten presets, selected by nice illuminated buttons at the top centre of the console. There are also controls for Pitchbend (a preset auto-bend type of effect), Sustain, Overtone, Volume, Brilliance, Resonance, and Mixing for U, L, and P. Overtone is unusual: each

section has two sliders, one each for voice channels I and II, to select octaves, as on the later CS-80. There's also a Reverb control for UL together, and S, and a 'coupler' system, derived from church organs, but just as useful in something like this.

- All the presets' electronics are in racks underneath these controls, and can be programmed with the separate shiny little programmer. Apparently, the presets could also be transferred from machine to machine: each was contained in a removable match-box-sized module, like a miniature version of the CS-80's presets, but with pots you turned with a mini-screwdriver.
- The next layer down is dedicated to the monosynth. It may have mini-keys, but it's an interesting little beast. As well as a ring modulator like on the CS-80, there's a good LFO, noise, and, most important of all, very impressive touch-sensitivity. As well as two levels of pressure sensitivity, it has the rare ability to sense side-to-side movement, and turn it into modulation. Directly above it is the long pitch ribbon. To the right are twelve switches to route the various modulation voltages to various locations.
- The next layer houses the upper keyboard and its modulation and touch controls. Each of the eight voices has two oscillators, and there are loads of modulations available, three destinations for Noise, portamento, and even a knee controller.
- The bottom layer of the keyboard is similar, but instead of the noise controls, has a neat little drum machine. 16 preset rhythms in two banks, with a good shuffle / swing facility. You can start it by hand, or by clicking on the switch to the top left of the footpedal. The banks can play counter-rhythms against each other. ("...its silly little drum machine, which seems very home-organish now but was quite revolutionary at the time." Keith Emerson, E&MM Apr 85.)
- Underneath the left of the bottom keyboard, there's a pull-out tray with tuning controls, and sliders with which to set octave combinations which can then be accessed with the organ-like but still effective buttons under the middle of the upper manual. Buttons 1, 2 and 3 select these octave combinations, button 4 switches everything full on (what Yamaha call a full organ setting) and button C cancels the presets, and puts control over to the panel. (More switches to the right hand side decide what effect the expression pedal has on the various parts of the synth.)
- A mixture of dream and nightmare? Stevie Wonder called it his "dream machine", but there was such a lot to go wrong, and the technology was so early - and in many cases independently invented and developed for it by Yamaha - that there must have been many times when players were desperate to get back to something

less grandiose but more reliable.

- Keith Emerson's original GX-1 - later customised by Nick Rose with sequencer, knee and foot levers, and a CV/gate out to control a Minimoog for that bass sound that Emerson felt the GX just couldn't provide - proved to be fairly unreliable. Even moving it across the studio caused parts of it to break down - but as late as 1985, in that E&MM interview, Emerson could still say "when it's working as it should do, it's still unbeatable."
- If you already own one of these unwieldy giants, and you go out and buy another - as Emerson did - it says something for how highly you rate them.
- Emerson also had the portamento control moved from the right to the left of the keyboards - a much more usable position for a right-handed player.
- In what looks like a bizarre bit of cost-cutting, the monosynth S&H rate is derived from the drum machine, and, according to Riccardo Grotto, is completely unusable: "Can you imagine a fast tempo Bossa Nova sample and hold note?" To which the answer is no, but I reckon I'd like to hear it - if only once.
- The technology was used in the CS-50, 60 and 80, in a less programmable, but relatively much more affordable and reliable format. Still those same Rolls-Royce sliders, though.
- Featured on the UK TV programme Tomorrow's World in 1975.

<b>SOUNDS</b>	●●●●●●●●●●
<b>KEYBOARD</b>	●●●●●●●●●●
<b>INTERFACE</b>	●
<b>CONTROLS</b>	●●●●●●●●●●
<b>MEMORIES</b>	●●●●
<b>EASE OF USE</b>	●●●
<b>CHARACTER</b>	●●●●●●●●●●
<b>POWER:SPACE</b>	●●●●●●●●
<b>MAINTENANCE</b>	●
<b>COLLECTABILITY</b>	●●●●●●●●●●

**SK-10**

49-note (C-C) 'symphonic ensemble keyboard'. c. 79 - c. early/mid 80s

**Original price:** £385

**Typical price:** £20 - £40

- Organ 8' / 4' / 2', String 8' / 4', Brass 8' / 4'. Vibrato speed and depth, switchable slow attack and two types of sustain. Churchy organ; average strings (helped by the ensemble switch); poor brass. The cheapo model in the SK range - at less than a quarter of the cost. Even so, it wasn't a bargain. By everyone's admission, this was a turkey - and actually used a different sound generation system from the bigger of the SKs.

<b>SOUNDS</b>	●
<b>KEYBOARD</b>	●
<b>INTERFACE</b>	●
<b>CONTROLS</b>	●●
<b>MEMORIES</b>	●
<b>EASE OF USE</b>	●●●●



▷ CHARACTER  
POWER:SPACE  
MAINTENANCE ●●●●●●  
COLLECTABILITY

### SK-15

49-note (C-C) 'symphonic ensemble keyboard'.

c.81 - c.84

Original price: £789

Typical price: £30 - £70

- A slimmed-down version of the SK-20, losing some harmonics from the organ, some waveforms or footages from the polysynth, and generally carrying on the tradition of not being half as nice as it ought by rights to have been.

### SK-20

61-note (C-C) 'symphonic ensemble keyboard'.

Aug 80 - c. 84

Original price: £870

Typical price: £50 - £80

Users include: Mainframe.

- Despite a heap of features - the Leslie-type speeding-up effect on the tremolo, band-pass filter on the polysynth, keyboard split, and various chorus, ensemble and de-tuning effects - the net result is fairly unmemorable.

### SK-30

61-note (C-C) 'symphonic ensemble keyboard'.

c. 79 - c. mid 80s

Original price: £1650

Typical price: £140 - £180

Combination of organ, polyphonic synthesizer, solo synthesizer and strings in one keyboard.

- Lots of controls - 46 of those distinctive but not very nice square faders, 31 of the square push-buttons with integral LED, and a few knobs and other sundries as well. The back panel is pretty impressive, too: CV and gate in and out for the solo synth (Hertz/octave, of course), sustain and portamento footswitch sockets, footpedal sockets for string and overall volume, and polysynth filter, individual outs for the polysynth, solo and organ, and a mix out; key code interface; headphone socket; and, most impressive and useful of all, an 11-pin Leslie socket.
- The solo synth seems the most promising section, with a good degree of control, including PWM, a full ADSR, and aftertouch - a very good idea, mimicking polyphonic aftertouch in a very cost-effective way.
- In principle this should be wonderful, but I'm not sure it is. You can build up a reasonably full ensemble sound, and have quite a good time doing it, but each of the elements is really not that strong. You obviously shouldn't expect too much of 'polyphonic synth' - brass section of a string synth is more like it - but the



SK-50D was the two-manual model in Yamaha's symphonic keyboard range

strings are a bit weedy too, the organ doesn't really stand out, and the solo synth somehow isn't that exciting, despite the aftertouch. It just doesn't have the soul (or funk?) of the much earlier ARP Omni or even some of the Crumar variations on the same sort of theme.

- Admittedly, a contemporary IM review says "An uninventive player is likely to use it without getting the best from it, and probably never knowing it." So.. what am I missing?

### SK-50D

2-manual (61-note, C-C) 'symphonic ensemble keyboard'. c. late 1980 - mid 80s

Original price: £2799

Typical price: £170 - £220

If there was one model in the SK range that I had been looking forward to having for a few weeks to explore, it was this monster. First impressions were very good: it's massive, very nicely put together, and just bristling with controls. The semi-flightcase stores the legs (sufficient to cope with the 48kg the thing weighs) and pedal - though the optional bass pedals have to travel separately.

- Shown at Frankfurt in Feb 81.
- It really is a slightly improved SK-30 with two keyboards. One of its improvements involves having a dedicated bass organ section, played either on pedals or on the bottom 1.5 octaves of the lower manual. One of the bass voices is quite aggressive, too, and cuts through well. Switchable sustain maintains continuity on the bass without your having to be a brilliant player.
- But.... it actually doesn't have a great deal more in it than the SK-30, except for the two keyboards and optional bass pedals. And that, in my opinion, is disappointingly bad news.

SOUNDS ●●●  
KEYBOARD ●●●●●  
INTERFACE ●●●●  
CONTROLS ●●●●●  
MEMORIES ●  
EASE OF USE ●●●●●  
CHARACTER ●●●●  
POWER:SPACE ●  
MAINTENANCE ●●●●●●  
COLLECTABILITY ●

### SS-30

49-note (C-C) string synth.

Early 78 - c. early 80s

Original price: £760 / £635 (79)

Typical price: £50 - £160

Users include: Billy Currie, Mick McNeil, Rick Wakeman.

- After slagging off all the SK range, it's bizarre to come across a slightly earlier Yamaha which does a quarter of any of the SK range - at twice the cost of the SK-10 - and have to say that it's a real gem.
- This is a rich, powerful and effective string synth, which seems to use quite a lot of discrete circuitry, and two (divide-down) oscillators per note, to produce its high quality sounds.
- Style-wise, it's more of the same fake rosewood as the SKs, but somehow it seems more appealing - if easily damaged. Controls (rocker switches and knobs) are good quality, and a rather smart black. The tuning knob is dual concentric.
- Vibrato depth and delay; sustain for cello and violin/viola; variable range for the cello - one, one and a half, or two octaves; cello volume, slow attack, and two cello sounds to choose from - both, or either. Higher up the register, there are selectors for Viola, Violin 1, and Violin 2, and another Slow Attack control and separate Brilliance controls for cello and violin/viola. To the left of the keyboard is the chorus/ensemble section, called Orchestra: a depth knob, two switches for speeds, and two more for cello and violin/viola.
- The whole thing, played in a realistic manner, sounds very good. Even without the Orchestra modulation on at all, it sounds very good. And through a good hall or large room reverb setting, it sounds very very good.
- It just goes to show that it's better to do one thing well than three things to a so-so standard.

SOUNDS ●●●●●●●●  
KEYBOARD ●●●●  
INTERFACE ●  
CONTROLS ●●●●●  
MEMORIES ●  
EASE OF USE ●●●●●●●●  
CHARACTER ●●●●●●●●  
POWER:SPACE ●●●●  
MAINTENANCE ●●●●●  
COLLECTABILITY ●●●●●

## SY-1

37-note (C-C) preset/controllable pressure-sensitive monmsynth. Early/mid 70s - late 70s

**Original price:** £475 (Jan 76) £550 (1976)

**Typical price:** £70 - £160

**Users include:** David Vorhaus/Kaleidophon studio

- Not common outside Japan, this is in many ways just another of those classic (and/or classically awful) 70s preset synths like the SH-2000 or Pro-Soloist. The presets are fairly predictable, but are at least reasonably individual - Flute, Trombone, Trumpet, Saxophone, Oboe, Bow Violin, Piano, Harpsichord, Contrabass, Tuba, Bass Guitar, Funny, Trumute, Double, Clarinet, Bassoon, French Horn, Bass Clarinet, English Horn, Pizzicato Violin, Guitar, Hawaiian Guitar, Pizzicato Bass, Sousaphone, Wah Guitar, Pulsar, Growlpet, and Reed. Nice to see Growlpet included. I can't understand why Roland didn't put it on the SH2000. As usual, 14 switches (self-cancelling, in this case) with a further switch to select between banks (or what Yamaha call Side 1 and Side 2). There seems to be some colour-coding of the switches going on, which without a manual is completely unfathomable - but not anyway important. 'Double' definitely seems to have two oscillators going
- There's a fair bit more than just these presets, as well. You can take an ordinary preset, and switch to manual control of filter, envelope, vibrato or pulse width. To the left of the keyboard are knobs for Vibrato Speed and Depth, and high-quality, GX-1-like sliders for the other functions - though only Attack and Sustain parameters for the envelope. This is an instant and effective way of producing some genuinely interesting sounds.
- There are more sliders for Attack Bend Tone - intensity and time of a simple attack envelope on the VCO and/or VCF; and knobs for Tune, Portamento, and Touch Control Sensitivity. This controls the amount of effect pressure has on Vibrato Depth, Wah Wah, or Volume.
- Transposition switches - down one (often the best setting), or one or two octaves up.
- Very smart - the wood effect is actually rather good (if not roadworthy), the keyboard is pleasant, and the fittings are high quality, too - far superior in finish to, say, an ARP Pro Soloist. The lower control surfaces (very CS-80-like) seem to float above the case.
- If only it had CV/gate and a few other CV control inputs, it would be excellent. But just as it is, it's great fun - a very good source of early 70s sounds, and a bit more than that as well.
- In the mid 70s, Yamaha also put out a £1053 / £1347 home organ, the CSY-1, which incorporated a synthesiser triggered by its upper manual - presumably the guts

of an SY-1.

SOUNDS	●●●●●●
KEYBOARD	●●●
INTERFACE	
CONTROLS	●●●●●
MEMORIES	●●
EASE OF USE	●●●●●●●●
CHARACTER	●●●●●●●
POWER:SPACE	●●●●●
MAINTENANCE	●●●●
COLLECTABILITY	●●●●

## SY-2

An expanded, semi-flightcased version of the SY-1.

Mid 70s - late 70s

**Original price:** £518 (Jan 76), £600 (1976)

**Typical price:** £70 - £200

**Users include:** BBC Radiophonic Workshop, Joe Sample.

- Basically the sensible version of the SY-1: the Growlpet preset has been changed to Growl. On the other hand, the only other significant change of presets is from Pulsar to Drake....
- This has practically all of the attributes of the SY-1, but is substantially re-designed.
- Attack Bend Tone now becomes Bend Tone, with an added Decay slider, and is a very effective filter envelope. It can no longer control pitch, but there's now a pitchbend switch, which gives a usable preset little swoop to the beginnings of notes.
- There's also an extra amount of performance control: a Foot Control Sensitivity knob links to a rear panel socket, and can be switched to filter cut-off or volume. It could presumably be voltage controlled from any source.
- The other major change is the best of the lot: the introduction of sliders for HPF and resonance. Although both filters are designed to stop short of self-oscillation - and were never Yamaha's strongest point - there's still a lot of potential.
- The case has to be a little bigger to accommodate the extra controls, and is re-designed with black metal control panels and black Tolex.
- As with the SY-1, Yamaha marketed a CSY-2, presumably incorporating the controls and innards of an SY-2, for about £1560.

SOUNDS	●●●●●●●●
KEYBOARD	●●●
INTERFACE	●
CONTROLS	●●●●●●
MEMORIES	●●
EASE OF USE	●●●●●●●●
CHARACTER	●●●●●●●●
POWER:SPACE	●●●●●●
MAINTENANCE	●●●●
COLLECTABILITY	●●●●●

## YC-25D

Portable organ. Mid 70s - late 70s

**Original price:** £623 (Apr 75) / £703 (Jan



SY-2 was essentially an SY-1 in a flightcase, but with added HPF and Resonance sliders

76) £889 (Aug 77)

**Typical price:** £50 - £200

- A slimmed down sibling of the much more famous 45, this came in some interesting colours: I know of at least one red version.

## YC-45D

Portable double-manual touch-sensitive organ with pitch ribbon.

c. mid 70s - early 80s

**Original price:** £1166

**Typical price:** £150 - £600

- Users include:** Gerard Bikialo / Magma, Dave Formula, Philip Glass Ensemble, Madness, Donny Osmond (pictured, curiously, in a Marshall amp catalogue), Sun Ra, Terry Riley ('Shri Camel'), Chris Stainton / Eric Clapton band, ?Mick Talbot / Merton Parkas, Dave Wright / The Beat.
- Any instrument that numbers Sun Ra and Donny Osmond in its list of users can't be all bad. In fact, this is a fairly extraordinary instrument, for two main reasons:-
  - One, it has a pitch bend ribbon. The only disappointment is that it only affects a few monophonic 'special effect' sounds, which have their own switches near the ribbon: Slide Trombone, Squawk, Birds, or Astro. They're not awe-inspiring, partly because you have to stop playing with one hand to play the ribbon, and partly because they tend to produce a sort of off-the-wall craziness which doesn't fit in with most of the rest of the sounds in the instrument. They're also pitched far too

Monster YC-45D had unusual features for an organ, including a pitch ribbon and touch sensitivity



▷ high on the only instrument I've ever played, but that may well be a servicing problem.

- Two, it has touch-sensitivity on the top keyboard. Nothing particularly amazing about that - many fairly nasty organs have touch sensitivity on a solo synth voice; but in this case, there's actual velocity sensitivity on the 4' and 8' voices on the upper manual, and also (supposedly) .... touch vibrato: by waggling your finger on the key, vibrato can be introduced. This ought to have huge expressive potential - like a Clavinet but much more so - but sadly on my YC-45D, no amount of waggling produces any discernible change in the sound. When working, it should also be able to introduce VCF modulation as well.

There are also all the things you definitely would expect a top-end pro portable organ to have:-

- Enough footage selectors (sadly not drawbars) to be able to copy most organs, Hammond and Vox Continental included (both of which it does quite well). Good percussion selection, too, though the percussion length settings don't seem very Hammond-like.
- A connector for optional bass-pedals, or the ability to use the bottom section of the lower manual instead. (The keys from bottom C to Fsharp an octave up are reverse colour, to match the range of the pedals. That does make it initially confusing, because the first normal colour keys can look like C-E in the heat of the moment, though they're actually G-B. There's an effective bass guitar sound which does the job well.)
- Standard vibrato with switchable speed - but not selectable for each manual separately.
- It comes in a solid case, with elaborate chrome legs which enable you to set the organ up at any angle from the horizontal to the vertical and beyond. Quite why you'd want it vertical is beyond me.
- All controls are beautifully made. Like the

CS-60/80, there are some mini-slider/switches (14 and 20 switches respectively) for two programmable presets, this time not under a flap, but just at the back of the control panel.

- As well as standard organ tones, more sounds are provided on the upper keyboard: Marimba (speed switchable but not totally variable), and Piano, Harpsichord and Vibraphone, each of which cuts the other sounds on the manual. All of the sounds except vibes can be put through an inbuilt Fuzz. There's also multiple triggering of the percussive organ sounds if you want it.
- Other upper manual sounds include Trumpet (which sounds more like Electric Piano on mine, but is quite pleasant like that) and Kinura, which is a great, buzzy sustained harpsichord. (The lower keyboard is much more basic - standard organ footages, the bass section, and nothing else fancy at all.)
- Further weirdness from Attack Mute and Auto Mute (variations on auto-wah) and Attack Glide - like Roland's autobend. There are also Bright and Sustain controls. You can't complain that Yamaha didn't put enough in to this machine. The only trouble is most of the extra facets seem to involve a fair bit of complicated circuitry, with loads of point-to-point wiring. That's why the YC-45D is so big, and heavy... and probably unreliable.
- It's not very often that just one electric instrument is used for the whole of an LP, but Terry Riley did so on the whole of Shri Camel, with a modified YC-45D and a few delay units. The organ was fitted with extra tuning pots, so that it could be tuned to just temperament (where all of the intervals in just one key are mathematically perfect - but if you change key are often further out than in standard equal temperament). The result is distinctive.

SOUNDS ●●●●●●  
KEYBOARD ●●●●●●

INTERFACE  
CONTROLS ●●●●●●  
MEMORIES ●●  
EASE OF USE ●●●  
CHARACTER ●●●●●  
POWER:SPACE ●●●  
MAINTENANCE ●●  
COLLECTABILITY ●●●●●●

## YINXIANGHECHENGQI

The first synthesiser produced in China, according to the book J-M Jarre by Jean-Louis Remilleux.

- The photo in the book shows a master keyboard, with what looks suspiciously like Roland System 100M modules perched behind it. This suspicion is increased fractionally by the text: J-M J is asked for the "recipe" for a synthesizer, and "sends them precise working drawings - originally from Japan". Let's be honest, the modules look practically identical.
- The upside of this plagiarism is that synthesis started to be taught at Beijing Conservatory.

## ZAPI!

A UK-based business that put out an impressive spec sheet in the winter of '91/2, but couldn't turn it into reality. They promised ADSRs with a 0.5ms attack, a dual custom-designed ring mod, audio mixer VCAs with controllable distortion, VCF with simultaneous 12dB and 24dB responses and VC resonance, noise which included a 'deep and heavy rumble output', and stereo outs.

## NOW AVAILABLE

The *A-Z Of Analogue Part 2* is now available for £16 (inc P&P), the companion to the first book which costs £14. A special deal of £27 gets you both parts.

Send a cheque to: Susurreal, Star House, Sandford, Crediton, Devon EX17 4LR



# The A-Z of Analogue Synthesisers Part Two: N-Z

Peter Forrest

**new!**

Want to get a  
band together?

**WANT TO  
GET GIGGING?**

Want to get a  
record deal?

Want to be a  
**real** success?

**we'll show you how  
in**

**the**

**gigging, recording, making it**

**band**

**issue one – out soon**

**Future**  
PUBLISHING

**Don't miss the launch issue!**

Send us your name and address and we'll make sure you don't miss out!

The Band, 30 Monmouth Street, Bath BA1 2BW, UK

# A&R dept

Welcome to the dingy depths of the A&R Department. Down here your CD, cassette and vinyl demos are scrutinised for signs of musical, engineering and production talent. We're still looking for new, unsigned music which we think is genuinely going places – but now we want your finished products...

## RAZE RESISTANCE

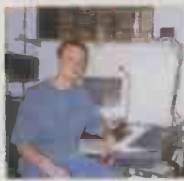

Thumping kick drums, racing sequences and some fairly appealing melodies combine to create an exceptionally good three-track demo from 16 year old Mark Butler who cites a range of influences including classic Detroit techno (Model 500, Rhythm Is Rhythm) and some more commercial contemporary dance (Underworld, The Prodigy). It's the European side of things that Mark's own tracks like 'The Darkside' and 'Resistance' seem to be drawn to most; 'The Darkside' leans towards CJ Bolland, while 'Resistance' (included on this month's cover CD) flirts with a very continental softcore techno sound. Mark's put these tracks together on a 486 PC running a Soundblaster 16 soundcard and, though the overall constructions are necessarily simple (he's used Impulse Tracker 2.11 for composition and Cool Edit, Waveworks and Wave 2 for sampling) they're a very competent reminder of how often talent and determination can overcome the limitations of even the most basic equipment. Mark's tracks tend to be quite straight-ahead and they'd certainly benefit from the injection of a little funk into the rather rigid rhythms. Take a listen to either the recent Ian O'Brien album Desert Scores or Carl Craig's stunning Landcruising for an insight into how the experts do it.

**VERDICT:** A superb beginning but, sadly, not the original 1986 line-up who did 'Jack The Groove'.....7/10  
More from: Mark Butler Tel: 01792 885190

## ENTWINE RUNNING SCARED



Entwine are Simon Davies and Mark Millins, a pair of keyboardist/programmers who've been musical collaborators for over a decade. Here they use a Yamaha SY 35, Roland SC-7 and Alesis SR-16 along with the Evolution Midi program. Their stated aim? "To create pieces of music which reflect an interest in film soundtracks". The sensitive 'Running Scared' is a melodic piece of mood music with a nice touch of percussion. Sadly it's marred by some bog standard drum programming and a sinister reverberating bass sound that doesn't really work. The next arrow from Entwine's sonic quiver is entitled 'Western', which shimmers with a crystalline frailty, but that's about it. 'Doom Town' at least has a bit of oomph about it, being somewhat slow and moody, with the same spoon-on-tinfoil drum sound that Yangelis patented on the soundtrack to Chariots Of Fire. Finally, 'Empathy' is a pretty enough confection, but, as with all the imaginary soundtracks included here, it suffers from its own politeness. No hooks, no swagger – Goldfinger it ain't.

**VERDICT:** Don't retire yet, Ennio Morricone.....4/10  
More from: Simon Davies Tel: 01707 321255

## JON BON TEMPO SECRET ADMIRER



Twenty year-old Jonathan Gardiner (AKA Jon Bon Tempo) is a Nottingham University student who, in his previous incarnation as Probe, featured on this page a couple of years back. The title track here is a hauntingly melodic instrumental which nicks the shambling beat from White Town's 'Your Woman'. Track two, 'Blue', sounds disturbingly similar to 'Big In Japan' by '80s Euro-hitsters Alphaville - it drags on a bit too. Next up, 'Wish' resembles a house mix of any of Visage or Heaven 17's early '80s output. By this stage, a definite theme is emerging...The atmospheric 'Last Chance' is enlivened by imaginative use of percussive effects along with tuned percussion. Secret Admirer was recorded using a Roland JV880 and D110, a Peavey QFX 4/4 effects unit, various home made filters and mixers and a "trusty" Amiga 500 running a combination of Octamed with some custom written software. Jonathan is currently on the lookout for a female vocalist to warble on his tracks, something which could provide the catalyst he needs to jolt him out of 1981 and into the present day. For the time being, despite some contemporary-sounding beats, this is clearly the work of a frustrated New Romantic.

**VERDICT:** Now that's what I call retro-futurism.....5/10  
More from: Jonathan Gardiner Tel: 01756 752859/0115 9480952

## SERATONE DEMO 2



Bass Cowboy's pumping house with ever multiplying layers of sound all held in check by a gloriously insistent bassline. In the quiet bit you can practically hear the whistle-puffing hordes, and when the tune bulds, it's a real headrush. Add a few cheesy samples for commercial appeal, and this could easily follow 'Encore Une Fois' into the charts. 'Hydrant' is similarly urgently-paced, but this time various keyboard motifs provide the hooks. Just when you think it's getting predictable the track miraculously reanimates itself with a shot of verve. 'Walt' has a bassline that sounds like it came from an early '80s jazz-funk cut. Add the string section from Massive Attack's 'Unfinished Symphony', weld it to a breakneck house beat, and you're pretty much onto a winner. It's at this point that some long-awaited vocals finally appear. They're suitably indecipherable and blended into the track with a supremely skilled deftness. Possibly a little too scratchy for daytime radio, they'd definitely hit the spot in a crowded club. The final track, 'Nosebleed' is, as the title suggests, Seratone's excursion into the world of techno. As such, it's more than competent. However, after the sensual touches of the preceding three tracks, 'Nosebleed' is just too remorseless in its Teutonic thumping to reinvigorate our by now drooping tootsies.

**VERDICT:** At last! Leicester justifies its existence.....7/10  
More from: Lewis Hunt Tel: 0116 2913995

**CRITICAL ADJUSTMENT  
AT-MOST-FEAR**



**"A**ll the electrical secrets of heaven... promises Critical Adjustment's 'At-Most-Fear' and the track itself has a pretty good attempt at delivering. Fragile breaks, a sweet dub bassline

and some serious atmospherics add up to an excellent drum'n'bass workout. Lloyd Morgan (who's behind it all) has been a breakbeat DJ for the last four years and began producing music just a couple of years ago on a small, but good quality, set-up which includes an E-mu ESI-32 sampler, a Studiomaster 12:2 mixer, a Novation Bass Station and a Quasar tone module. Effects are provided by a Quadverb and a Midverb. Lloyd prefers tunes which reflect "a deep, serious, emotional state of mind" and, listening to superb tracks like 'Time Slip 2' on his demo, it's not hard to see where he's coming from. The overall sound is very good - it's what you'll hear described as "floaty business" around the scene; a dreamy, head-state kind of thing which is neatly counterpointed at times by Lloyd's tech-step bass sounds. Overall it's reminiscent of the Shogun/Renegade/Trouble On Vinyl sound of a few years back. And the sugar-coated softcore of 'Deep Sea' should have labels queuing up to sign Lloyd's music.

**VERDICT:** Beautifully put-together dream-state drum'n'bass.....8/10  
More from: Lloyd Morgan Tel: 01222 252 156

**A&R DEMO OF THE MONTH**



**JUSTIN  
ONE PEOPLE**

**J**ustin Owen cites a diverse range of influences stretching from old-skool East Coast hip hop acts like EPMD and Run DMC to more up-to-date outfits (The Chemical Brothers provide one obvious point of reference) and even the New York/CBGBs hardcore guitar scene of the mid-eighties. It's a diversity which Justin has reinterpreted and funneled into his unique blend of fat beats, spiralling acid and low-slung bass. Recorded onto ADAT at home, using a Macintosh running Cubase, an Akai S-2000 sampler, a Yamaha TG-100 tone module and a beautiful-sounding MKS-20, Justin's tracks were mixed down in a friendly multi-media studio with the addition of a borrowed Novation Bass Station to provide the twisting acid lines. The effect is stunning. Tracks like 'Two Beats And A Bell' or the deeply jazzual 'Think' merit a record deal immediately, flirting with a downbeat trip-hop vibe that's easily the equal of the aforementioned Chemicals. Other cuts like 'One People' and 'Jupiter' veer towards a kind of trance/hop fusion which is hugely club-friendly. Record labels looking for the next stoned beat phenomenon need look no further.

**VERDICT:** A smoker's delight. This deeply-blunted fusion deserves to be signed immediately.....9/10  
More from: Justin Owen Tel: 0171 580 2263

**ASSEMBLER  
ARTIFICIAL LIFE**



**"S**ynthetic heaven in ninety-seven" is the battle cry of Al Ferrier, writer and producer of all the tracks on offer here, under the name Assembler. 'Nineties' is a doom-laden soundscape, not unlike Orbital at their most pessimistic. After this promising start, however, the next track, 'This Other Blue' is more along new age ambient lines. It meanders along peaceably enough, but it's final destination is a fairly aimless melange of electronic doodles. 'Michael Collins' is presumably intended as either a tribute to or a comment on the Irish Republican leader of the '20s (recently the subject of a film starring Liam Neeson, movie fans). Stately and elegiac, with a somewhat funereal tone, the piece putts along like Michael Nyman at his most downbeat.

**VERDICT:** Synthetic heaven can wait.....4/10  
More from: No further details available

**CLOSE  
DEMO**



**A** London-based quartet with a strong grasp on contemporary pop, allied with a respect for classic influences, Close are highly prolific, and the three songs on this demo are representative of their eclectic writing and playing prowess. Italian chanteuse Daniela Bove's dulcet tones are a tad reminiscent of Keli of Sneaker Pimps, and the volcanic redhead's sultry intonations are intoxicatingly seductive. 'Mean Streets' has a slick drum'n' bass edge coupled with manic guitars and atmospheric arrangement techniques. An admirable talent of Close is their wonderful ability to build songs subtly, and not rush them; always leaving the listener intrigued as to the next sonic surprise. Bassist, and all round writer and producer Richard Robson has a definite vision, and with the drumming and programming skills of Tim Land and guitar antics of Jona Warbey, make Close a force to be reckoned with. Lyrically, Close's material is emotional and introspective to the point of being tortured, but remains uplifting and intense. I've been fortunate enough to catch one of Close's live shows recently, and they can certainly cut the mustard on the stage, too. This is a well played and produced demo with a fair number of genuinely original sparks; what more can I say?

**VERDICT:** An inspiring, original, and well-conceived demo.....8/10  
More from: Will Tipper Tel: 0171 686 9264

**ON THE CD**

**A&R DEPARTMENT**

**TRACK**  **BLUEBERRY SANDS 'SILVER MONKEY'**  
Funk breakbeats loaded with cool, ethereal chord stabs and some very tasty summer-time vibes.

**TRACK**  **HEADJAM "HORNS"**  
South Wales gets it together on the dance-floor - with interest already from Paul Oakenfold among others, this lot could go far.

**TRACK**  **TUMULT "POINT BLANK"**  
Gritty, industrial breaks and dark atmospherics from producer James Saunders. File under Chemicals-meet-Nine Inch Nails...

Unsolicited packages might be accepted at the following address:  
**A&R Dept,  
The Mix,  
Future Publishing,  
30 Monmouth St,  
Bath BA1 2BW**



# FREE ADS

There are three ways you can advertise your equipment in *The Mix*:

1. Post – cut out and fill in the coupon and send to: Readers Ads, *The Mix*, Future Publishing, 30 Monmouth St, Bath BA1 2BW
2. Fax – Fax us your ad on 01225 462986
3. Email – Mail us at themix@futurenet.co.uk

When sending an advert please remember to state which Equipment Category you wish the ad to appear in and include full contact details.

## KEYBOARDS

**Absolute Bargains.** DX-7 and RAMs £175. S700 separate outs, 70 quick disks £175. ESQ1 needs sounds £175. D-110 £175. Tel Pip on 0181 998 8628

**Absolute bargains DX7** £175 ESQ1 needs sounds £175, D110 £175 S700 separate outs plus 70 quick disks £175 phone pip on 0181 998 8628

**Akal MG1212** £850 ono good condition incl. 40+ tapes Eusonique EPS Sampler, 10 outs 2 meg 50+ discs library £500 XR1300 SMPTE SYNC £90 Vesta Kozo enhancer £70 V Katt 01983 297110.

**Alesis QuadraSynth** + piano, 500 sounds, 104-note poly, 16-part multitimbral, excellent analogue and string sounds, built-in Quadraverb II effects unit, amazing editability + Mac sampling software £649 ex P&P. Tel Paul on 0191 410 7471 after 6pm please

**Alesis Micro Enhancer** (restores top end) stereo ins and outs. Good condition with manual, PSU £50 plus postage (if required) Tel 01933 678608.

**Alesis QuadraSynth**, great condition £500. Tel L Luck on 0115 944 1973  
**Casio CZ1000** with memory cartridge and manuals £100. Tel 01452 380159 evenings  
**Casio CZ5000 + ST editor** £300. Atari 1040 + monitor + Notator software £200 ono. Roland TR-505 £75. Tel 0114 288 3901 (Sheffield)

**Crumar DS2** analogue, flight-cased £175 or swap drum machine Alesis SR16. Wanted Cubase for Atari 520 STEM V2. Tel Tony on 01582 865262

**Does anyone want** to give a home to a Korg Poly 800? I've got big fat sounds, MIDI, resonance, etc. Going for a song £140 ono. Tel Paul on 01952 582719 answerphone

**Eika Synthex** (midi) £1,000 EMU SP-12 £350 Roland Juno 60 £350, SH-09 £325, TR-808 £400. Automatic fax 0039 41 631540 (Venice).

**E-mu Morphous** + dance card £625. Korg M1 keyboard + three cards £550. JX-8P mint £340. Korg CX3 + case £550. SH-101 £250. Plus some effects and more. Tel 0181 455 7677

**Ensoniq VFX** multitimbral built-in effects, big sound, powerful editing functions, instruction book £450 ono. SC-7 Roland

GM sound module Multi 16, FX, interface PC/Mac £100. REX50 Yamaha 90 effects, MIDI £95. Tel Laurent on 0181 888 2167

**Gem S2 turbo**, brand new, never played. Still in original wrapping and box. Anybody with a Technics WSA1 consider some form of swap deal? Tel Alan on 01633 663718

**Gem S2** with turbo kit. 16-track sequencer keyboard inc all manuals, sample disks and stand £650. Tel Andy on 01782 714824 (North Staffs area)

**Gem S3 turbo** keyboard 76-note sampling loading, separate outs, loads of Gem and Akai disks, studio use only £850. Bruno 0171 485 8689 (home), 0410 388110 (mobile), Bruno Newman, 46 Mansfield Road, London, NW3 2HT

**Home studio clearout!** Boss DR-550 DMC £700. Roland JS-30 sampling Wavestation 2Mb + Mac editing software £450. Yamaha CS5 classic mono synth, external filters input. Bargain at £175. Tel Charlie on 01703 813057

**Jen SX1000** analogue monosynth filter sounds. Envelope on VCA and filter, white and pink noise, inc patch sheets and stand, excellent condition £80. Analogue Polysynth, Crumar Multiman S, bass, string piano and synth sections. Five octaves, built-in, flight case, good condition £70 ono. Tel 01782 717009 (Stoke area)

**Korg 01/WFD** Two PCM cards, 1,000s of sounds on card/disk £799. Roland XP-80, two additional boards, never used guaranteed £999. Yamaha RM800 16:8:2 mixer, new, six aux sends £499. Tel 01226 724095

**Korg 01/WFD**, six PCM sound cards, Atari manager plus 5,000 sounds on disk, immaculate, as new, consider p/ex Akai sampler, BassStation, Boss DR660 £1,050. If answer phone will call back. Tel 01202 392198

**Korg 01/WFD**, immaculate condition, home use only, boxed with manuals and two patch disks £900 ono. Akai S950 £700. Roland U-220 £200. Tel Laurence on 01934 415441

**Korg 01W/FD**, 16-track sequencer, four outs, 2FX disk drive £850 ono. Roland W-30 sampler, sequencer Workstation, eight outs, loads of samples £750 ono. Tel Mike 0141 332 7240

**Korg dance card** for 01/W and Wavestation £80. Serious 909 style kicks

and snares. Wicked new combis and programs. Tel Rick Loopzone on 01442 870597

**Korg Delta**, analogue polysynth with strings, four octaves, joystick, VCF, MG, SG with white noise, ADSR envelope generator, eight inputs/outputs, trigger, all working with manual £160. Tel Michael on 01268 555319 after 6pm (Basildon)

**Korg i3 WMH** £379. Memory upgrade, immaculate condition, never gigged £100. Flight case, manuals, style disks £1,100 or swap for N264. Tel Ross on 01903 770376 or 01482 494261

**Korg M1** in good condition, home use only, 1,000s of sounds on ROM and disk £550. Tel 01895 835749 (Denham)

**Korg M1** sounds 200 in your face dance techno sounds filter controlled monsters analog synths basses kits organs £35 on Atari and PC Format tel 0121 443 1922 don't miss out.

**Korg M1 sounds**, 200 killer dance, techno sounds, filter sweeps, analogue synths basses kits, put your M1 back in the mix, supplied on Atari format £35. Tel 0121 443 1922

**Korg M1** with manual £525. Roland U-110 sound module with sound card and manual £225. Atari ST1040 and SM124 monitor, both boxed with manual £225. Tel Richard on 01943 462722 (Leeds)

**Korg M1** in excellent condition, manuals, boxed, some MIDI sound disks, all for £600. Aphex Compellor signal processor, unboxed, leads hence £200. Can deliver. Tel 0831 238874 anytime (Reading area)

**Korg M1** Sounds 200 Killer in your face dance techno sounds analog synths filter sweeps FX's supplied on Atari Format £35 put your M1 back in the mix tele 0121 443 1922.

**Korg N364 Workstation**, excellent condition, home use only, over 900 sounds, arpeggiator 16-track sequencer £850 for quick sale, can deliver. Tel Alan on 01443 205629 (South Wales)

**Korg Polysix**, sounds and manuals Inc. Any offer considered. Tel 01383 820618 after 6pm

**Korg Prophecy** with new sounds, mint condition £725. Atari 520STE 2Mb with Cubase V2 £60. Tel John on 01482 322049

**Korg Prophecy**. One owner, home use only with extra sounds £675 no offers. Tel

0171 738 6515

**Korg T3EX Workstation**, loads of sounds on disk, takes M1 sound cards £850. Korg Wavestation SR £490. Roland D-110 1,000+ sounds with Synthworks and DRT's Atari Editors £295. Tel Chris on 01494 523096 (Bucks)

**Korg Trinity Plus**, boxed, manuals, disks, Prophecy card, first-class condition £1,750. Tel 01436 676164

**Korg Trinity Plus Workstation** 16-track seq, Prophecy sound card, too many sounds to list, excellent condition, in box £1,450. E-mu Orbit, excellent condition in box £375. Serious enquiries only, no offers. Tel 01527 68704 (Redditch)

**Korg Wavestation EX keyboard** with RAM cards and manuals. Absolutely mint condition £750 ono. Tel 01332 205832 after 6pm

**Korg Wavestation EX** with three cards, excellent condition £640 ono. Ensoniq EPS 16-bit sampler, full memory, 10 outputs, library £520 ono. Both boxed with manuals. JD-800, first class £1,350. Tel 01337 828496

**Korg X2 76-key Workstation**, 11 months old. X2 user video, manuals, disks Inc MIDI Magic SMF, home use only £750. Tel Matt on 01493 731834 evenings

**Korg X3 quality Workstation** £650. Philips colour monitor with leads £85. C-Lab polyframe, Universal editor and librarian £45. Tel Robert on 01903 693435 (Worthing)

**Korg X3** in excellent condition. Solid flight case, disks, manuals, stand £650 ono. Tel Matt on 01792 473158 (Wales)

**Korg X5**, boxed with manual, vgc, £450. Would consider part exchange for Yamaha CSIX, Vintage Keys, Waldorf Pulse or similar style synth. Tel Chris on 01733 759045 or 01733 312929

**Kurzweil K2000 V3.16 4Mb Ram** very large library of sounds and samples £1195 Roland MCS0011 sequencer £325 16u Rack on Wheels £150 01256 350259.

**Looking for patches/editors** for your synths/modules, all the best sounds and editors for Juno 1+2, Korg M1, D50 and many more, just £25 for two jam-packed disks. Tel 0151 630 0898 any time

**Moog Minimoog**, vgc, perfect working order, inc owner's manual, reluctant sale, accept £1,000. Tel 01274 620004 (Bradford)

**Moog Opus 3 synth**, mint condition with maker's box £350. Sequential Toms drum machine, nice condition, very user-friendly, brilliant sounds, techno, jungle, etc £140. Tel 0181 881 5330

**Nord lead rack** unused £1100 Roland JP 8000 £1250 MC303 £460 unused Roland V5880 Plus hard drive, effects board and zip drive unused cost £2200 accept £1700 0114 248 4440 Craig Evenings.

**Nord Lead Rack** £1,100. Unused Roland JP-8000 £1,250. Unused MC-303 £460. Unused Roland VS-880 digital recorder hard drive effects and zip drive cost £2,200, accept £1,700. Tel 0114 248 4440

**Novation BassStation rack** £250. Alesis Micro Unit £70. Tel Mark on 01246 570781

**Oberheim Expander** + MIDI and manual, perfect condition £1,350. Tel Nicolas on 00 32 3 2367454. Fax 00 32 3 2358766 (Belgium)

**Oberheim OBXA** eight-voice £775. Roland E-86 £850. MKS70 £550. ARP 1623 sequencer £475. Juno 106 £475. Yamaha DX7, two ROM one RAM cartridges £275. CS50 £299. Wanted Vintage Keys. Tel 0116 283 5455

**Prophet TB** £1,650. Juno 2 £295. Minimoog £950. CR78 £250. Oberheim DX

£195. CR68, Model 103, 800DV, MC-202, SH-101, Multi Klone. Tel 01372 745494  
**Proteus MPS**, 200 realistic sounds, manual and leads inc. Very good condition



£430 ono. Tel Alex on 01865 240458 (Oxford) or e-mail a.dennis@elsevier.co.uk  
**Quasimidi Raven** virtual interactive synth, 21-voice polyphonic, 16-part multitimbral, 512 single sounds, 250 performances, built-in sequencer, mint condition, home use only £920 ono. Tel Andrew on 0161 427 5423

**Quasimidi Technox** £450 ono. Novation BassStation rack £325 ono. Ensoniq ESQ1 £150 ono. Roland S-10 sampler £200 ono. Roland E-5 £225 ono. Oberheim DSX sequencer £100 ono. Alesis MMT8 £110 ono. Tel Chris on 0116 236 6057, 0850 740962 (mobile)

**Roland Alpha Juno 1** MIDI analogue synth, mint condition, flight case, manual £270. Yamaha TG300 GM module. Huge editing screen, resonant filters etc. Mint, boxed, manuals £250. Tel Martin on 01244 376446 evenings

**Roland AX-1** round your neck remote keyboard. Very expressive, red, with flight case and manuals. Excellent condition £290 ono. Tel Sam on 0171 607 6889

**Roland CMU-810**, very rare SH-101 without a keyboard, excellent condition with manual and PSU. Phat sound, fat price offers over £500. Tel Mark on 0171 226 8836

**Roland D-10 synth**, excellent condition, good techno sounds £280. Roland MC-303 Groovebox, six months old, excellent condition, you know what it does! £480. Tel Dan on 01725 552351 (Wiltshire)

**Roland D-20** with flight case, manuals and sustain pedal £275. Roland SD-35 sound module with manuals £325. Tel 0191 427 5802 (Tyneside)

**Roland D-20** with hard case, home use only £400. Tel David on 01483 727837 evening

**Roland D-20 Workstation**, eight melody tracks plus one rhythm in its sequencer, plus disk drive and effects. Great synth for older sounds too. Comes in original box with manuals and recently serviced by Roland. Only £400 and will deliver. Call 01225 732368 or 01225 442244 ex 2368

**Roland JD-800**, mint, boxed with manuals, offers over £1,100. Roland Jupiter 6, mint with flight case £800. Tel Alex on 0161 283 9494 (Manchester)  
**Roland JD800** boxed manuals ten extra sound banks library cubase 2 x 3 positive condition £1250 ono, Akai 5900 & library £450 SH101 £250 all in mint condition Alan evenings 01942 749868 see ya!

**Roland Juno 106**, excellent condition, recently serviced, manual £420. Korg MS20, as used by Aphex Twin, excellent condition with patch leads and original manual £420. Tel Ben on 01280 814385  
**Roland Juno 60** £275. JSQ 60 sequencer for Juno 60 din sync £35. JX-8P £295. TX802 £295. EMT10 95 PS1000 programmer £110. Korg 700 monosynth £150. Yamaha CS80 manual £15.  
**Oberheim DPX1** £275. Tel 01726 66715  
 Roland Juno 60 analogue poly synth, excellent dance/techno sounds, excellent condition £285 ono. Tel Rob on 0117 955 8521

**Roland Jupiter 4** analogue, good condition, recently serviced £250. Tel Graeme for details on 01273 699065

**Roland JV-1080** £750. Mackie 12-2 mixer £150. Sony M2-3 MiniDisc Walkman and 10 MiniDiscs free £200. Cubasis Audio £60. Kaon Pro £30. No offers. Tel Mr Singh on 0121 356 8626 after 9pm

**Roland JV-35** synth plus VE-JVI expansion card and stand. Excellent condition, home use only £400. Tel 01223 360502

**Roland JV-90 Pro** synth, four months old, immaculate, only used at home + Alesis MMT8 sequencer £1,100 ono. Tel Andy 01332 773950 or 0410 427202 mobile.

**Roland MC-202** analogue squelch machine, boxed, manuals, PSU, excellent

condition, reluctant sale £250. Korg Micropreset MKII with internal speaker £100 ono. Tel Nick on 01372 456146/0117 927 6725

**Roland MC-303 Groovebox**, as new, boxed £500 ono. Roland vintage synth £200. Korg M1 Workstation £575. Atari/monitor/Cubase £190. Wanted TB303, TR909, Akai sampler or similar. Tel 01252 372940

**Roland MC-303**, the ultimate dance music production tool, as new £400. Roland Bass 'n' Drums expansion board, unused, fits XP80/50 etc £165. Tel Steve on 01732 872101 days (Kent)

**Roland MKS-70** analogue rackmount polysynth, bitimbral, excellent MIDI spec 12-note poly, vgc with manual £550 ono. Wanted scrap analogue synths, Moog, ARP, Yamaha, Roland, Sequential, Oberheim, Korg, etc. for project. Tel 01352 712937  
**Roland MPU401 MIDI adaptor** + MT32 soundcard for PC (Model No LAPC1), one in, two outs + sync £80. Tel Matt on 01705 523309

**Roland MV51** 'Vintage Synth' Sound module 256 excellent sounds plus Drums, Reverb, Chorus etc. £195. Roland SC33 'Sound Canvas' 226 Sounds, Drumkits FX £150 Both as new Tel 01933 678608

**Roland RS-202** string synth £100. Yamaha MT2X six-channel, four-track £250. Digitech ESP21 Pro, floor controller, hard case £300. Washburn EA30 electro acoustic black, gig bag, stand £300. Tel Ross on 0191 226 0337 (Newcastle)

**Roland SH-101** with manual £225. Tel Derek on 01902 887017 (Wolverhampton)  
**Roland Space Echo's RE-201, RE-301, RE-501**, also Watkins Copycat with four inputs, all in good condition. EMS Vocoder 1000 circa 1976, very rare piece of analogue equipment, as used by Herbie Hancock. In good condition with manual. Serious offers only. Tel 01942 814818

**Roland TB303** all manuals etc excellent condition. Quick sale wanted £650.00. 0181 695 5939  
**Roland TB-303** £600. Alesis SR16 drum machine, vgc £130. Casio CZ3000, two RAM cards, manuals £175. Evolution EVS1 sound module, boxed, manual £150. Cubasis PC, boxed, manual £70. Tel Nell 0161 366 1079

**Roland W-30** £545. Kawai K4 £325. Juno 106 £370. Korg M1 £495. MS20 £315. Kawai K4R £195. E-mu Classic Keys £360. Roland D-550 £295. Yamaha TG55 £185, will post anywhere. Tel 01261 815707  
**Roland W-30 Workstation** £700. Yamaha SY55 Workstation + dance soundcard, 909s, 808s £425. Ensoniq Mirage sampler £250. Yamaha EMEI multi effects £60. Atari STFM £70. No monitor. Tel Paul on 01604 471566 after 4pm

**Roland W-30 Workstation** with 150-disk sample library and owner's manual, as new condition, home use only, offers around £700. Tel 0181 886 6709 (North London)  
**Roland W-30 Workstation**, full MIDI 16-channel sequencer/sampling keyboard/synth, inc manual. Boxed as new, factory disks and many others £550. Tel 01255 821211

**Roland XP-10**, 338 sounds inc 303, 101, JP-8 + 808 and 909 kits. Arpeggiator + real-time filter control £375 ono or your Casio VZ1 plus £150. Phonic 6:2 mini mixer £60. Tel 01509 267926  
**Roland XP-50**, plus hard case, excellent condition only £799. Tel Bernie on 01634 240551

**Sequential Circuits Prophet 5 Rev 2** recently serviced £700. Roland MKS-70 Super JX rack with PG-800 programmer and one RAM card £650. Emagic Diver/suffer ed/lib Atari £75. Tel Brian on 01752 550199

**Sequential Circuits** six-track polyphonic analogue synth. Full MIDI implementation, four-octave keyboard. Excellent condition, flight case, manual £300. Tel 01242 693007 (Cheltenham)

**Siel DK600** programmable analogue polysynth. Needs internal and external attention. A dream of a machine (if you can get it going), £50 or will swap. Tel Dave on 0161 792 8557 (Salford)

**Siel DK80** bitimbral synth, 49-note, RAM card, PSU, wooden hard case, onboard 300-note sequencer. Analogue sounds with digital control, good filters, rare £200 ono. Tel John on 0113 282 2269 day, 0113 257 4170 evening.

**Steinberg Mixex + SMPTE/Midi Expander** £180. Tascam TSR8 1/2"8TK with DBX £950. Soundcraft Spirit absolute 25 new/boxed £200. 21/2 meg ram upgrade for Atarist £50 external floppy for Atari £25.

**Swap SH-101 with PSU** for sampler, any condition considered. Tel Pat on 01995 640623 (Preston) or e-mail on project.x@dial.pipex.com

**SY85 workstation** and sound disks manuals a doddle to programme sounds and a free pack of jammie dogers or cookies a bargain at £700 call Gavin on 01633 664162

**Technics KN1000** home keyboard. 127 preset sounds + 30 editable, 127 rhythms + 10 editable. MIDI compatible, vgc, £600 ono. Tel 01279 831676 after 6pm

**Yamaha CS1X** with dead hard carry case and manuals. You've seen the review in Future Music, now hear it in action. Will deliver. Only £430. Call 01225 334753. Leave a message and return number

**Yamaha CS1X**, control synth, 16-part multitimbral, great arpeggiator, real-time editing, killer dance synth, two months old, boxed, manuals, bargain at £450 ovno. Tel John on 01875 615640 or e-mail j.campbell@btinternet.com

**Yamaha DX7 sounds**, 2000 £65, sequential prophet VS sounds, 300 £15 per hundred, Yamaha SY35 sounds, 128 £20. All dance orientated supplied on Atari disk. Don't miss out. Duncan 0121 444 2681.

**Yamaha DX21** with manuals, good condition £150. Tel Marcus on 0370 778183

**Yamaha DX7S** £350, Yamaha SY55 £395, Alesis SR16 £170 ono. All excellent condition. Tel Mark on 01204 593060 or Paul on 01706 824739

**Yamaha PPF100** digital piano, superb stereo grand and Rhodes/DX sounds with effects and internal monitor speakers serve as good controller keyboard £950 ovno. Tel Steve on 01703 550913

**Yamaha SY35** Vector synth MIDI, excellent sounds, mint condition, home studio use only, boxed with manuals £280 ono. Tel Paul on 01902 352497

**Yamaha SY77 Workstation** synth. 1000 sounds + cards £650 ono. Wavelength 15" Bass Lab, 200W £70 ono. Two Yamaha four-track recorders £150 each. Sanyo 24-disc CD player £220 ono. Tel Mark/Andy on 01429 866401/222609

**Yamaha SY77 Workstation**, effects disk drive £650. Yamaha TG33 Vector synth £230. Yamaha RY10 drum machine £120. All boxed, excellent condition. Tel 01788 574889 weekends, 0370 591089 weekdays (Midlands area)

**Yamaha SY85** £600. Kawai K1R £125 inc Steinberg editor. Alesis SR16 £125. Roland PAD5 drum unit £50. All boxed with manuals, home use only, mint. Tel Andy on 01484 647131

**Yamaha SY85**, excellent condition complete with extra disks, boxed with all manuals £550. No offers. Tel Nick Bradshaw on 01343 812121 ex 3132 days or 0370 975558 any time

**Yamaha SY85**, hard case, 2.5Mb RAM, 20

sample disks £620. Roland D-110, sound disks £165. Yamaha FB-01 £60. Atari Replay 16 sampler + sequencer £60. All with manuals. Tel 01302 310641 any time (Doncaster)

**Yamaha SY85**. 61 keys, 30-note polyphony, nine-track sequencer, 90 effects, 0.5Mb sample memory £700. Novation BassStation analogue synth, great fat bass sounds, emulates Roland TB-303, MIDI controllable £250. Home use only. Tel 0116 267 7872

## SAMPLING

**Akai S01** boxed, mint, 85 Akai disks plus manual £400. Tel Nige on 01298 26025 (Buxton)

**Akai S01** plus memory expansion £400. Roland JV-880 synth module £350. Both with manuals and in good condition. Tel Oliver on 0171 263 4933 or e-mail oliver@theoffice.net

**Akai S1000**, 8Mb, digital I/O, SCSI port, 11 outputs, V4.3 software, manual £1,200. Tel James on 01978 362910

**Akai S2000** 10Mb, brand new, boxed £850. Tel 01386 584054

**Akai S2000** upgraded with eight outputs £800. Quazimidi Quazar multitimbral analogue sound module £700. Both perfect condition with manuals and disks, etc. Tel 01253 796486

**Akai S2000**. 2Mb sample memory, eight outputs plus stereo input/output board fitted £800. Home use only. 0116 267 7872

**Akai S2800** 10Mb mint condition, manuals and library £895. Tel Richard on 01488 686496 (Hungerford)

**Akai S2800**, immaculate condition. Mackie CR1604. Both boxed and in mint condition. Atari 2Mb with monitor and Cubase. The lot for £1,500. No offers. Tel 01455 238028

**Akai S3000** 2Mb, two months old. Mint condition, bargain at £850. Original box, manuals and sound disks. Tel Mark on 0113 268 9068

**Akai S3000**, 10 outs, SCSI, internal FX, as new, boxed, inc library and sample CD, bargain £1,000. Tel Andy on 01482 448674

**Akai S3000XL** 16Mb, used twice, boxed with manual + disks £1200. Samson M9 nine-channel mixing desk, as new, boxed with manual £100. Tel Martin on 01203 455268 (Midlands)

**Akai S3000XL** with 32Mb £1,500. Roland JD-800 with flight case £1,200. Alesis Micro 3 £100. Steinberg Mixex £150.

Yamaha TG500 with two RAM cards £550. Tel David on 0151 709 8811

**Akai S900** good condition £450. Tascam 488 eight-track Portastudio, hardly used £600. Tel David on 01483 727837 evening (Surrey)

**Akai S900** rackmount, 11 outputs, absolutely spotless condition, 30 sample filled disks and manual inc £400. Tel 0161 295 8661

**Akai S950** fully expanded, eight outputs, vgc, manual, comes with massive library (200+ disks) £625. Fostex X28H 4-track inc manual and foot switch, mint £250 ono. Tel Mark on 01422 320147 (Halifax)

**Casio FZ-1** keyboard, eight outs cutoff + resonance filters, eight stage envelope generators, large LCD for displaying waveforms when looping, splicing, truncating, etc £550. Tel 01592 644471 (Fife)

**Cheetah SX16**, boxed, manual, disks £300 ono. Tel Antony on 01323 730233 (Eastbourne)

**Controller keyboard Goldstar GMK 49**. Careful owner £95 ono. Tel Sam on 01225 483808

**E-mu E64** 34Mb RAM, 1Gb hard drive, CD-ROM, SCSI, ext drive, 14+ CD-ROMs, professional sampling station, a steal at £2,200. No offers. Tel 01527 68704

(Reddit)

**E-mu E64** 64-note polyphony, SCSI, 10Mb, Audition, etc, as new £1,500. Tel 01902 657223

**E-mu ES1-32**, home use only with £200 worth of sample CDs, loads of disks, excellent machine, genuine reason for sale £700 ono. Will deliver in UK. Tel Stewart on 01326 378050

**E-mu ES1-32**, V2.1 operating system, 18 disks, three sample CDs, home use only, £750 ono. Tel Jason on 01642 894362 after 6pm

**E-mu ES132**, 8Mb, V2 software, upgrade plus E-mu disk library and 60 sample CDs (audio) inc. Immaculate condition, home studio use only, boxed with manuals £1,100 ono. Tel Paul on 01902 352497

**Ensoniq ASR10** rack sampler, 10Mb SCSI hard disk, eight outputs, CD-ROM drive, as new £1,150. Waldorf Pulse analogue rack module £375. Tropez sound card 8Mb sample memory £100. Tel Steve on 01273 776273 (Brighton)

**Ensoniq EPS** sampling keyboard, large library, case, manual £400. Phonic BKX8800, eight-channel mixer, two effects sends, MIDI splitter £100. Alesis Microverb II power supply £50. Tel Robin on 0181 979 9950 (West London)

**ESI-32** new sounds available on floppy or zip. Classic Roland, Korg and Yamaha Waveforms inc Prophecy, JV-1080, 303 etc. No GM sound sets here! Tel Roy for prices on 01843 845057

**ESI-32 sounds**, two 8Mb banks on floppy disks. Contain classic Roland, Korg and Yamaha sounds. £25 per bank or both for £40. Tel Roy on 01843 845057

**Kurzweil K2500** rack sampler, 32Mb, 1GB Jaz drive, the ultimate sampler £2,300, no offers please. Serious enquiries only please for this mint condition machine. Tel 0402 302321 2-7pm

**Roland colour monitor**, 14" display with special RGB cable, suitable for samplers S-770, S-760, S-750, S-550 and S-330 etc. Good condition, can despatch if required £85. Tel 0181 668 6077

**Roland DJ-70** 4Mb Workstation. Built-in filters, graphic editing, stereo/mono recording, CD quality. Original box, manual, Time+Space house construction £850. (Keyboard version) Tel Scott on 01474 362594/324410

**Roland Juno 106** analogue MIDI synth £400. Yamaha stereo chorus pedal £30. Boss turbo overdrive pedal £40. Tel Mike Redditch on 0378 437804

**Roland MS-1**, as new, boxed with manual, leads and sample CDs. Ideal for DJ £250 ono. Tel 01767 680067 (Beds)

**Roland MS-1** digital sampler expanded to 2Mb £170. Tel Chris on 0121 444 8774 (Birmingham)

**Roland S-550** £500. Soundcraft 700 series 16-channel desk £750 ono. Tel Alex on 01608 737951

**Roland S-550** with monitor, mouse and disks £600. Tel Nathan on 0117 944 1205

**Roland S-550** with mouse, eight outputs + sequencer package £650. Tel 01246 207554

**Roland S-750**, 18Mb RAM, 100Mb hard disk, colour monitor, mouse, eight outputs, excellent condition, boxed with manual £1,150. Tel Phil Roberts 01923 236502

**Roland S-760**, 10Mb sampler £1,100! Novation BassStation keyboard £250. Both with manuals and bought from new. Reluctant sale but must sell quickly. Tel Ben on 01736 331202 (Cornwall)

**Roland S-30** sampling Workstation. Sequencer, eight outputs, filters, loads of disks inc Roland sample library, home use only £695. Novation BassStation keyboard £210. Tel Tom on 0117 904 6016 (Bristol)

**Roland W-30** Workstation 16-track sequencer, manual, disks, stand, vgc.

Moving abroad, must sell! £575 ono. Tel Simon on 0468 405038 day, 0181 514 5153 evening (Ilford, Essex)

**S2000** 8 outputs digital in/out + SCSI + 6Mb, boxed with manual £1,050 ono. Wanted Matrix 1000, will pay £180. Pro One also wanted, will pay £200. Tel Harry/Woody on 0161 248 0507

**S3200XL** fully expanded, six months old £2,500. S3000XL 32Mb, one month old £1,500. S1000 PB 8Mb £600. Above, all Akai Sampson £62. Siband EQ £150. Roland TR-505 £100. Behringer Ultrafex 2 £100. Tel Steve on 01273 413766

**Yamaha QS300** Workstation, only 12 months old, main features inc disk drive, 16-track sequencer, large LCD screen and over 1,000 sounds + software £750 ovno. Tel Andrew on 01509 813474 (Leics)

**Yamaha SU10** with two sample CDs, boxed, new £225. Casio CZ-101 synth £95. Tel 01202 530140

**Yamaha SU10**, boxed as new, only two months old £200 ono. Amiga 500 £60. Will sell both for £230. Tel Georgio on 01342 323459 evening

### SEQUENCERS

**Atari ST** sequencing set-up, complete, ST 1Mb, hi-res monitor, leads, accessories, excellent condition, was used with Cubase, editors, sampler etc, ready to plug in to keyboard or module £190 ono. Tel 01884 257487

**Casio S21** digital four-track sequencer £30. Tel 01452 380159 evening

**Spider offers**. Tel Jamie on 0113 253 9269 (Leeds)

### DRUM MACHINES

**Alesis HR16B**, as new £150. Tel Steve on 01293 887502 after 6pm

**Alesis SR16** immaculate condition, boxed as new with manual and video manual £150 no offers. Will post. Tel Paul on 0113 232 0537

**Analogue drums**: SR88 £95. ST305 £125. Multiklone £195. CR68 £125. TR-606 £155. Oberheim DX with MIDI £195. Tel Tom on 01372 745494

**Casio RZ-1** digital sampling drum machine, boxed with manuals £100. Tel 01452 380159 evening

**Cheetah MD16**, superb editing, built-in MIDI tape sync, eight outs, boxed, manual £100. Eko new rhythm box analogue preset drum machine, good for sampling £15. Will post. Tel 01782 717009 (Stoke area)

**Korg Rhythm 55** analogue drum machine, mint condition £60. Casio CZ-2305 with manual £75. Tel 01202 631267 (Poole)

**Korg S3 Rhythm** Workstation with dance card, multi-FX, eight-track sequencer, two MIDI outs, vgc £200. Wanted - ARP Odyssey (Mark II), SCI Pro One, Yamaha CS15. Tel 01243 830697

**Roland MC-303** groovebox, unwanted gift, as new, boxed with manuals £450. Tel Tim on 01634 364423 (Medway, Kent)

**Roland MC-303**, one month old, as new £450. Tel Roger on 01753 856915

**Roland TR-707**, good condition £110. Tel Karl on 01769 550697 (Devon)

**Roland TR-909** MC cartridge NR mint £1,200. Tel 01902 657223

**Roland TR-909** with manual £965. R8M rack with four cards, electronic dry kit sound effect power drums with manual, vgc £385. Korg DW6000 with stand £200. TR-808 with manual £525. Tel 0151 727 7161 (Liverpool)

**Roland TR-909**, excellent condition with manual £990 ono. Tel Jan on 01752 667044 or e-mail jmonsen@plymouth.ac.uk

**Yamaha DD9**, hardly used, excellent

condition £50. Boxed with instructions. Tel Mike on 01904 763837.

**Yamaha RY20**, superb drum sounds, good FX, mint condition with box, manual and power £275. Tel Mark on 0114 267 8109

### COMPUTERS

**Amiga 1200** with MIDI interface, Stereo Master Sampler, Octamed, Music X, joysticks, leads and loads of games + disks, vgc £220 ono. Tel George on 01295 730372 after 4pm

**Amiga 1Mb**, colour hi-res monitor, MIDI interface, sampler, Music-X, DR.Ts KCS 3.5, games, joystick £200. Tel Chris on 01970 832737 (mid Wales)

**Amiga 600** 4Mb upgrade, mint condition £100 or will swap for Atari 1040ST with hi-res monitor. Will also consider swap for Casio CZ-1000 or similar. Tel Mike on 01952 406570 (Telford)

**Amiga 600HD** 20Mb hard drive, 2Mb RAM, MIDI interface, Music-X software, extra floppy drive, mouse, two joysticks, loads of software, all boxed with manuals, excellent condition £185 ono. Tel Colin on 0151 201 5249

**Apple Mac Performa 600/8/80** CD Monitor, mouse, keyboard, Claris Works, Cubase V2/5 Audiomediam 11 sound designer 11 £800 ono phone Chris 01296 386043

**Apple Powermac 7200/90** 16/700 CD. Apple monitor and extended keyboard, software. Tel Dave on 01922 445635

**Atari 1040ST** and SM124 monitor plus Cubase. Mouse, sequencing set up £195 ono. Tel 0171 419 4285 (W1)

**Atari 1040ST** plus hi-res monitor, manuals, leads, software, vgc £200. Tel 0114 222 2809 days

**Atari 1040ST** with 1Mb RAM, SM124 monitor, Cubase plus blank disks, good condition £160. Tel Lee on 0161 295 8661

**Atari 1040STE** with very good monitor + Epson printer, Cubase V2, Steinberg Pro 2411, loads and loads of software inc sample programs. All mint, boxed as new with manuals, hardly used £200. Tel Mark on 01702 715951/0802 368627 (Southend-on-Sea)

**Atari 1040STE**, monitor, Breakthru V2 sequencer, Replay 16 sampler. Dream GMX1 GM module. On stage MIDI file player plus lots more software, hardware, external floppy, printer, joysticks, games etc £400 the lot. Tel Winston on 01473 710912 day, 01284 768317 evening/weekend

**Atari 1040STE**, monitor, Cubase 3.1, leads, 2Mb genuine software £250. Fostex 812 mixer £450. Boss CE2 chorus pedal £40. All excellent condition. Tel Renie on 0171 252 4326

**Atari 1040STFM** + SM124, inc Cubase, Cubase and Steinberg editors for Kawai K1 and Korg Wavestation, only £200. Tel Andy on 01484 647131

**Atari 2.5Mb STE**, hi-res monitor, Cubase V2, manual, twiddly bits, MIDI files Vols 3, 4 & 7 £300. Roland M-VS1 vintage synth £250. All items boxed as new, P&P extra. Tel Steve on 01553 674076 (Norfolk)

**Atari 520 2Mb upgrade**, hi-res monitor, complete MIDI setup. Replaying CD quality sampler software inc Cubase, Breakthru, KCS Omega, X-OR editor/librarian and more. Two MIDI leads, external drive, mouse, two joysticks, 100 disks/mags + more £300. Tel Tony on 0121 236 6616

**Atari hi-res monitor** suitable for Cubase/Notator/WP software. Latest 14" model with sound, as new condition with

carton so can despatch. Two monitors at £90 each. Tel 0181 668 6077

**Atari ST** upgraded to 2.5Mb hi-res monitor. All manuals with Steinberg Pro 2411, sequencer and leads £150 ono. Tel Roger on 01753 856915

**Atari STE** 1Mb, SM124 mono monitor, mouse, lots of disks, full copy of Steinberg's Cubase £150. Tel 01452 380159 evening

**Atari STE** 2Mb with SM24 hi-res monitor, manuals, mouse, disk, boxed, standard for music £250 ono. Tel Ivor on 0181 965 7119

**Atari STE** 2Mb, VGA hi-res monitor plus manuals, Cubase V2, 30 Atari Format mags and cover disks, over 60 games £250. Tel Nige on 01298 26025 (Buxton)

**Atari STE** 4Mb, Atari HD music software, mono monitor, lots of music disks, utls all GW0 £200 ono. FM back issues with CDs, offers. Tel 01522 881814 (Lincoln)

**Atari STM 520**, mouse, external disk, power unit, no monitor £65. Tentrax music software for Atari £20. Comber 270MB 1DE hard drive £65.00 cash required, also PS/2 keyboard and surplus 3.5" floppy drive both £30.00 each and also Elone 14" svcp monitor £160 also M/Board 1MB Video card 256K cache tel Chris 01621 815162

**C-Lab unitor 2**: SMP2 synchroniser with extra ins/outs + human touch (sync with live drummer and old analog gear) For Notator and Emagic software #200 - will separate. phone Richard 01782 213226

**Cubase for Mac SE30**. Urgent. Tel 0181 549 7611 anytime. (any version)

**Roland MT32** sound module used with Tentrax £145. Tel Dave on 01306 743597

**Drumkat 3.5**, five pole pads dual zone FSR trigger pads, over 60 games £250. Alesis DMS inc all wiring, bought June 96, original cost £3,780, accept £2,200 ovno. No time wasters. Tel 0161 232 0023

**Friend-chip K.AT** remote control for the Atari ST or Falcon, five-metre cable for joystick port, 14 functions, 35 configurations, stop, start, etc. New boxed £45. Tel David 01307 850393

**Novation Drum Station**, still under warranty 808/909 in one box and extra editing £370 ono. Tel Sam on 01225 483808

**Turtle Beach Tahiti PC Sound Card** and MIDI adapter leads and manual £150 ono Tel 0181 772 0063

**Wanted urgently** creative labs sound blaster 16 original software would monolede for windows and latest program, also add on ADSP chip for above must be cheap Chris Disks 01621 815162

**7100/180 CPU (Mac)** TVST & Recycle & Hyperprism on disk £850 Audiomediam 1 £95 660 A/V 12/500/CD Audio/video In/out CUP £550 Mackie 1604 with Ottomix automation £950 Yamaha CVS10-Mid £160 Rocktron Hux HXC £110 Mick 6pm 0113 246 9254

### SOFTWARE

**Coda Finale for Windows**. The most powerful music notation software available for the PC. As new, boxed £240 ono. Tel 01734 417295

**Emagic Sound Super Sound Driver** for Atari ST. Universal editor and librarian for dozens of synths, etc. Latest version £60. Roland Juno 106 mint with case £450. Tel Brian on 01752 550199 day

**Hard disk recording** and editing software for Atari Falcon. 4TFX/D2D £75. Tel Chris on 01509 507188 (East Midlands)

**Logic Audio V2.5 (PC)**, brand new, unwanted present £250 only. This is the full version. Tel Steve on 0181 6850998

**PC Cakewalk Pro Audio** with upgrade disk software and sound-to-MIDI software with manual. Tel Mark on 0973 873271

(SW London)

**Phillips CM8833** colour monitor with software to run Cubase on Atari going cheap at £85 ono. Tel Sam on 01225 483808

**Pro Tools!!! Quadra 800, 17" monitor,** keyboard, studio 3, 882 Audio Interface, Various bits of software in perfect condition, £6,000 Tel Steve 0181 239 1712

## RECORDING

**A&H GS3** 24/8 mixer £950. Korg O3R/W module £450. Yamaha QY20 £225. Tel Andy on 0121 712 4393 or 0121 449 2035 after 6pm

**Akai S950** Sampler, expanded, immaculate hardly used, with sound library, manual, 8 outputs £750 Tel 01482 448767.

**Alesis SR16** Drum machine 233 great sounds (some with stereo reverb). Tons of Kits, preset patterns etc. Fully programmable. £120. Tel 01933 678608.

**Alesis 1622** rackmount mixer with eight mic ins and eight direct outs, sub outs, inserts on every channel plus six effects sends. Great stereo studio mixer. Comes in original box. Cost £550, will sell for £330 and deliver. Call 01225 732368 or 01225 442244 ex 2368

**Alesis ADAT XT** latest model, unused, immaculate, boxed, under guarantee until May. Two free S VHS tapes. Was £2,300, bargain price £1,650. Tel Richie on 0151 643 9996

**Alesis QuadraVerb, MidiVerb II,** Quadrasynth **Fostex R8** multitrack, Studiomaster 16:4:16:2 Proline mixer, Yamaha SY35 and TG300, Quasimidi Quasar dance module (expanded), **Fostex MC102** tape/mixer plus odds and sods. All offers! Tel Andy on 01869 347167

Atari STE with Hi Res monitor, mouse and cubase. Sequencing set up £195 ono Tel 0171 419 4285. W1.

**Atari ST 2** meg high res monitor 50 disks of software mouse joystick £215 Roland D110 £170 Korg DW6000 £180 casio £1000 £100 0115 9382468

**EMU orbit** boxed £595 Yamaha CS1X boxed £420 NWC Pc Pentium 133 MHZ 2.5gb HD 32mb Ram plus logic Audio 2.5 £995 Tel 0958 438486.

**Ensoniq EPS16+R** SCSI, Four CD's Syquest Drive & Carts, 8-outs, waveboy software, boxed, manuals, mint £800. Ensoniq 50-80 analogue workstation brilliant resonant sounds case, cart disks mint £450 ono.

**Folio Lite Soundcraft** £150. SDD8 drum pads Roland £120. Yamaha MT3X, 4-track £150. Atari STE 1040 plus monitor and software £160. Reddi mixer rack 8-2 £60. Tel Chris on 0181 894 7306

**FOSTEX X26** 4 track multitracker. Only had max of 12Hrs use. Bought to record group project that never happened. £125. TEL: 01869 249995 after 6.30pm.

**Fostex D80** digital multitrack recorder, as new, boxed with instructions £950. Tel 0191 285 0818 (Newcastle)

**Fostex DCM100** + MIXTAB 8:2 MIDI mixer. RRP £729. Mint, boxed for £275. Tel 01432 342343 (Hereford)

**Fostex E16**, immaculate condition, fully flight cased with patchbay looms and six reels of 456 tape £1,800. Loads of other recording gear. Tel Trevor for details on 01670 829227

**Fostex G16S** 0.5" multitrack recorder. Excellent condition. JBL 4208 studio monitors, excellent condition tape machine £2,200 ovno. Monitors £250 ovno. Or £2,300 for both. Tel Liz on 0181 365 0800

**Fostex Highspeed Multitracker X28-H**, as new, boxed, power supply, tapes, manual etc £275 ono. Tel 01727 861006

**Fostex Mixtab** MIDI mixer and DCM100

mixer tablet, eight months warranty at Turnkey still left, manual and power supply £150. Tel Chris for full spec on 01245 328736

**Fostex R8** + MTC1 + remote cable and tapes - no mileage! Studiomaster Mixdown Gold 16:8:16 + looms. Both like new! Manuals and hard flight cases £1,895. Tel Mike on 0161 740 9438

**Fostex R8**, inc MTC-1, Remote extension and manuals. Seven looms (one unused) still boxed. All in excellent condition £650. Tel 01386 832391

**Fostex XR-7** Multi Tracker, Mint Condition, Hardly used, only £300. Tel Matt 01483 33778.

**Fostex X28H** four-track with eight inputs. As new, boxed, manual, less than one hour's use £250. Tel Iain on 0141 772 7594 (Glasgow)

**Fostex XR-5** multitrack recorder £325. Hardly used, excellent condition, four months old. Tel 01704 29470

**Fostex XR3** Multitracker, hardly used £125. Tel Roger on 01753 856915

**GPO Patch bays** 20 Row £19 10 Row £9 Bos 6.2 Audio mixer £149 Mics Shure SM57 £75 (as new) AKG 0190 (2) £47.50 each 01865 776587 (Oxford).

**Home studio sale!!** E-mu Emax II 16-bit stereo sampling keyboard, disks, leads, manual £850. Atari 1040STE monitor, keyboard, mouse, Cubase £275. Spirit Folio 12-channel mixer, leads £275. £1,200 the lot!! Ono. Tel Tony on 01245 324137/01245 323130/0410 576533

**Lexicon DCM80** professional effects processor, pitch FX card over £2,000 new, £850. **Fostex D5 DAT** rackmount both used little £450. EC in box. Tel 01527 68704

**Mackie 1202VLZ** mixer £250. Akai DR4D 500Mb hard disk MIDI board £700. Both excellent condition. Tel 01484 646242 (Huddersfield)

**Marantz PMD720** four-track cassette recorder, excellent condition, only used as mixer since I switched to hard-disk recording £250 ono. Tel Steve on 0181 685 0998

**Midimation** mixer automation unit, 16 VCAs + mutes £250. Alesis 1622 £300. Micro EQ £50. Atari Mega 1 + monitor £200. DX7 Mkl £200. LXP5 £250. Squire Strat £150. Isopatch £45. Tel 01268 559284

**Newly formed label/agency/** require talent from any musical genre. Bands/producers/DJ's almost anything! Techno/Indie/House/Brit pop guaranteed replies. Contact Matt or Pete on 01902 682877 or 0973 273988

**Otari MX5050** 0.5" eight-track with remote and manual etc £995 ono. Tel Mike on 0171 722 8138

**Peavey SP Sample** playback module requires Peavey SX/SX2 (or Yamaha SU10 etc) To make own samples. As New. 4MB 4 outputs, filter manual etc. £270. Tel 01933 678608

**Philips DCC300** digital recorder, remote, manual, tapes, boxed £160. Roland S-10 sampler/keyboard with disks £250. ADC stereo 12-band equaliser £20. Tel 01203 394737 (Mid ands)

**Pro Tools III**, Nubus with 888 1/0 and DSP Farms. Expansion chassis + sample Cell II, 32Mb + TDM. All new, never used, new price £12,000, best bid. Tel 0171 630 9403

**Roland R8M** drum module, immaculate. c/w 4 cards - 808, contemporary percussion, jazz brush, dry. As new, c/w box and manuals. 420 pounds. Jon 0121 449 6603.

**Roland VS-880** eight-track hard-disk recorder/digital automated mixer with 1Gb drive. Great MIDI spec, six months old, good as new £1,400 ono. Tel 0161 295 8661

**Roland VS-880** digital recorder plus hard

drive, effects board and zip drive, boxed, unused, cost £2,200, accept £1,700.

MC303, unused £460, Roland JP-8000 unused £1,250. Tel Craig on 0114 248 4440 evening

**Roland VS880** 8 track hard disc recorder/digital automated mixer with 1 gig H/D great midi spec 6 months old, good as new £1400 ono. Tel 0161 295 8661.

**Roland VS-880 plus effects** and 1Gb hard drive. Unused. Yamaha DX7S, immaculate £250. Tel 01926 817877

**Samick SM820p** eight-channel mixing desk. three-band E/Q, pan, monitor and effect controls. four phono channels, eight line, insert and mic channels. Home studio use only £130. Tel Paul on 01902 352497

**Samson 2242** desk offers? Signed Dance artist: Hopscotch (essential platinum) requires female vocalist for forth coming hardcore/4-beat projects. (West Midlands area preferably). Demo tapes to Dan, 15 Castle Street, Bishops Castle, Shrops, SY9 5BU.

**Super JV-1080** with dance board £850. Tel Paul on 0141 556 2267 or 01698 826454

**Seck 18:8:2** mixing desk, vgc, home use only, with stand. Phantom power supply. £500. Tel 01708 763994.

**Soundcraft 1"** eight-track recorder and series 400B 16-8-2 mixing desk £1500. Tel 0976 274499

**Spirit Folio 12.2** Rack mount mixer graphic AHX's mint condition. Boxed PSU etc £200 Yamaha CS70M analogue Beastie £500 call Dan 01276 682075.

**Spirit Folio 12:2** rackmount, sweepable mids au sends, boxed, home use only £200. Crumar Performer analogue poly £75. CS70M analogue Daddy £500. Sound Man. Tel Dan on 01276 682075

**Spirit Folio SI** mixer 18:2, semi parametric EQ, lovely clean Soundcraft sound rackmount version £260. Tel Mark on 0171 585 1814 (London)

**Steinberg Mixex** + SMPTE/Midi Expander £180. Tascam TSR8 1/2"8TK with DBX £950. Soundcraft Spirit absolute 25 new/boxed £200. 21/2 meg ram upgrade for Atari £25 external floppy for Atari £25.

**Tascam 38** eight-track recorder, Behringer eight-channel denoiser, 16-way loom. 10 used tapes £575. Seck 18:8:2 mixer £525. Both for £1,000, no offers. Tel Clive on 01243 514567

**Tascam 488** eight-track recorder, hardly used £600. Roland D-20 with hard case £400. Home use. Tel David on 01483 727837 evening

**Tascam Porta 7**, four-track mini studio. Excellent condition, boxed with instructions, six months old £225. Tel Mike on 01904 763837

**Vocalist/Frontman** seeks dedicated Programmer keyboardist for visible in your face punk rap dance band Prodigy, Senser, Chemical brothers etc. 0181 889 7536.

**Yamaha MT3X** four-track, six-channel, two-band equaliser, two auxs, stereo returns, DBX, two tape speeds, auto punch in/out, vgc £270. Midiman sync, unused, boxed, £65, £325 for both. Akai EX80E, professional half-rack enhancer £40. Tel 0973 122572 (Leeds)

**Yamaha MT8X** eight-track cassette recorder £600. PPS 2 SMPTE/smart FSK sync £60. Both as new, hardly used and boxed with manuals. Tel David on 01483 893365 (Guildford)

**Yamaha MT8X** eight-track, hardly used, boxed, manual, easy to use, great quality, extensive features £465 ovno. Oberheim DX digital drum machine (with MIDI) bargain at £85. Tel Dean on 01924 452408 after 5pm (West Yorks)

**YAMAHA TG500**. Basically the rack mount of the SY85 but with the filters of the SY99 (very nice v). 64 note poly. 16 part

multi-timb. Boxed, manules 440 pounds ono. Contact James or Rob on 01332 381159. **Yamaha TXBIZ** Multi Timbral sound module classic equipment superb FM sounds absolutely immaculate and as new hardly used, manual and original box £170 Tel 01482 448767.

**Zoom 9120 FX** £150. Roland R-8 drum machine £280. 16U rack £30. Roland U-220 rack £150. Roland D-5 keyboard £200. Tel John on 01438 310139

## AMPS & PA

**6000W acoustic sound systems** PA + amps + over graphic multicore racks and trunk £10,000 no offers. Tel Chinn on 01480 470179 (St Neots Cambs)

**Acoustic studio monitors** 3311 12" polywoofer and liquid-cooled 5" miorange + 3" tweeter. Two frequency controls + instant circuit protector. Superb sound quality, max power 125W. Home or professional use, as new, boxed £400 ono (RRP £900). Tel Tim on 0958 502571

**Carlisbro keyboard** 150W amp, 5 channels, graphic, reverb £220. Tel 01234 400246

**Fostex 6301B** self powered monitors £50 **Jamo 400 Pro** speakers, 1,000W of music power, 15 in bass, six tweeters and large mids. Cost £1,000, will sell for £500 pair ovno. Tel Darren on 0958 415872 or 0181 855 6309

**JBL EON 15** never used, in their boxes, excellent speakers £600 ono. Samson S8 mixer amp, never used, all leads, 300W output £400 ono. Tel Gary on 01634 364948 or 0410 446252

**QSC USA850** power amp 425 W RMS £440. 4U rack bag £60. Korg Poly 800 keyboard £110. NJD Butzer light effect £110. Tel Carl on 01507 606956

## EFFECTS

**ART Multiverb** with 256 presets (some multis). Great reverbs and plates plus loads of flanges and delays. Cost £200, will sell for £95. Digitech 256 programmable multi effects box. 256 presets (128 user) with remote control. Cost £350, will sell for £160. Will deliver both. Call 01225 732368 or 01225 442244 ex 2368

**Korg A1** top quality £600. Electro Harmonix frequency analyser £250. EH Talkbox £150. Art Xtreme £160. TLA C1 £850. Joemeek Voice channel £375. Soundiver Atari £150. Turbosynth £190. E-mail storm@redestb.es

**Yamaha TX81Z** eight-part multitimbral module, mint condition £125. Tel Sam on 01225 483808

## SOUND MODULES

**Akai SG01V** vintage sound module with PSU and manual, mint condition £199. Tel 0113 286 6848 (Leeds)

**Akai SG01V** Sound Box. Boxed as new £220 ono. Yamaha RX7 drum machine £125 ono. Tel Paul on 01229 812153

**D-110** as new, boxed and manual £185 ono. Sound Brush Roland MIDI data recorder, as new, manual £250 ono. Casio FZ library 100 disks £140. Will split. Tel Declan on 01706 58625

**JV-1080**, the best sound module around, never used, still in box £850 ono. IU rack offers. Tel Gary on 01634 364948 or 0410 446252

**Korg Wavestation A/D** + E-mu Classic Keys, both good condition with manuals. 10-unit rack case. Offers? Swap Wavestation for your Korg BX-3 dual organ? Tel Henry on 0181 840 3249 (West London)

**MC-303** Groovebox with manuals, excellent for fast sequencing and for





# CLASSIFIEDS

Future Publishing,  
30 Monmouth Street, Beauford Court,  
Bath, BA1 2BW

Call Martin Sreeves on  
**01225 442244**  
or fax 01225 462986

## FOR HIRE

### Audiohire

Hire of:  
Virtually any recording and  
backline equipment  
**Tel: 0181-960 4466**

### ATLANTIC HIRE

RECORDING EQUIPMENT HIRE

Discounts - Best Rates

**TEL: 0181-209-1384/0025 (24hrs)**

### tickle music hire

0181-964-3399

Best Rates  
Best Service  
Best call us

The Best in pro-audio hire and sales

### ADVANCED SOUNDS LTD (Hire & Sales)

- Musical & Studio Equipment Hire
- Home Recording Packages Hire
- New & used equipment Sales, part/Ex
- Delivery/Collection - Nationwide

**LOW RATES GOOD SERVICE**

**0181 462 6261 (OR 8621)**

## COURSES



### Live Audio Courses

**LIVE AUDIO ENGINEERING** Under real concert  
environment with bands  
playing warm-up gigs every day of the course.  
Lectures cover all aspects of setting up a  
concert/mixing/EQ/production techniques.  
Tutorials take place at The Garage and Forum.  
For a Prospectus call: 0171-700 3271  
or fax your details on: 0171-700 4600

## FOR SALE

### ADVANCED SOUNDS LTD

#### New & Used Equipment Sales

Selection of current used stock  
(Telephone for new equipment prices)

Akai S3000XL (5 months).....£1379	Lexicon PCM80 (9 months).....£1619
Akai C03000XL + CDs (4 months) ..£1659	Lexicon MPX1 (5 months).....£899
AKG 414ULS (new - special offer).....£749	Mackie 24/8/2 (5 months).....£2259
AKG 414ULS (18 months).....£639	Mackie 1202 VLZ (4 months).....£269
AKG C3000 (2 months).....£215	Mackie CR1604 VLZ (3 months).....£709
Alesis Midiverb 4 (2 months).....£249	Peavey KB300 K/board Amp (3 mths).....£349
Alesis ADAT XT (215 hours).....£1899	Roland 1080 (3 months).....£799
Behringer Ultralex 2 (2 months).....£176	Roland XP50 (4 months).....£899
Behringer Intelligate (2 months).....£189	Roland 2080 (3 months).....£1229
Fostex 3045 (16 ch dol c for G16S) ..£499	Tascam DA20 (4 months).....£589
Fostex DM78VL (3 months).....£819	Tascam DA38 (4 months).....£2199
Fostex D80 (4 months).....£999	TL Audio Valve Comp (2 months).....£949
Fostex D5 DAT (4 months).....£659	TL Audio 2012 Valve Para EQ.....£499
Korg Trinily Plus (4 months).....£1439	Yamaha MS202 Pow Mths (pair).....£329

\*Part exchange and equipment purchased for cash \* Licensed  
credit broker \* Multitrack and Keyboard Repairs \* Well  
established co formed in 1983 \* We can despatch by courier  
overnight \* Studio and Musical equipment hire dept including  
home recording packages. Prices include VAT.

**TEL: 0181 462 6261 (OR 8621)**

### MULTITRACK SALES CENTRE

TASCAM TSR 8.....£899	TECHNICS WSA 1 (mint).....£779
FALCON 14mb-65 c audio:500hd mon £699	ROLAND DM80 (mint + mac int) . . . £499
MACKIE SR32/4/2 (mint) . . . . .£1099	ROLAND JD800/JD990 . . . . .£999/£799
KORG M1 . . . . .£499	ALESIS 3630 Compressor . . . . .£129
S/MASTER proline gold 16/8/16 . . . . .£550	ROLAND SUPER JX10 (+flight case) £599
LOGIC AUDIO PC 2.5 . . . . .£225	YAMAHA MT8X (as new) . . . . .£599
ENSONIQ SQR PLUS (module) . . . . .£299	ROLAND MC303 . . . . .£399
LEXICON REFLEX . . . . .£250	EMU PROTEUS 3 . . . . .£250
YAMAHA MV 1602 (rack 4 aux+eq) . . . . .£399	MACKIE 1604 (v.g.c.) . . . . .£450
ROLAND TR909 . . . . .£899	KAWAI Q80 Sequencer (boxed) . . . . .£150
ROLAND JUPITOR 8 (midi) . . . . .£995	YAMAHA R100/REX 50 . . . . .(each) £125

**WANTED**  
ALL STUDIO & MUSIC EQUIPMENT  
ASCOT 01344 891110 or 0831 882666

## AD Rates:-

£22 per single column centimetre  
spot or full colour available  
discounts for series bookings.

### DJK MIDIFILES & MUSIC SOFTWARE

A small selection of what we stock:-

- DJK Midi Songfiles:- Our own extensive range of over 800 titles/medleys from the 50's to current chart hits in any key with lyrics. Used by live performers worldwide. Songs programmed to order. Also available on cassette, DAT, MiniDisc & CD.
- Roland/Labyrinth/Classical/Backbeat & Vintage Midifile Albums:- If you gig, you need these disks! - £14.99 per album.
- Tune 1000 Midifile Albums:- With vocal harmony data. Ideal for use with the Digitech Midi Vocalist Harmony Processor - £14.99 per album.
- Midifile Albums + Matching Songbooks containing melody lines, lyrics and chord symbols of all the songs - from £12.99 per album.
- Midifiles On CD-ROM inc. '50 No. 1 Hits for only £24.95.
- Educational Midipacks:- Learn how to improvise over melodies, riffs and chord sequences - from £13.99 per pack.

Telephone or write for our free midifile demo and catalogue:- DJK Music, Malgrat, Thorpe Road, Tendring, Essex CO16 0HW  
Phone: 01255 830185 (9-5); 861949 (eves/weekends); fax: 861190; E-mail: djk.music@dial.pipex.com  
Fast efficient service. Most major credit cards accepted. Mail order only.

- Creative Essentials Audio/WAV/AIFF Sound Sample Collections on CD - only £19.95 per disk.
- Four oct. mother keyboard + Cakewalk Home Studio only £119.99.
- Books:- Fast Guide To Cubase - £10.95, Handbook of Midi Sequencing - £13.95, Cubase Power Users Guide - £11.95, PC Music Handbook - £10.95 + many more.
- Best Prices for Cakewalk/Cubase Sequencers, Yamaha/Turtle Beach/Soundblaster Soundcards, Zip/Jaz Drives etc.
- Piano/Vocal Songbooks.
- Twidly Bits:- Hundreds of dazzling riffs, runs, patterns, grooves and licks as standard midifiles from £12.99 per disk.
- Style Disks for Roland, Korg, Technics and Yamaha keyboards - only £14.99 per disk.
- Keybags:- Strong, well padded bags for keyboards and modules. Dustcovers/Leads & Cables also in stock.

## R.O.W. AUDIO SALES

### WANTED

ALL RECORDING EQUIPMENT  
NATIONWIDE COLLECTION  
ABSOLUTE BEST PRICES PAID FOR SAMPLERS,  
ADATS,  
OUTBOARD KEYBOARDS,  
CONSOLES,  
8/16/24 TRACK MACHINES ETC.  
SAME DAY SERVICE.  
SO PHONE US NOW,  
PIX WELCOME!  
TEL 0161 483 8551  
MOBILE 0468 946450  
7 DAYS 24 HOURS  
(HIRE SERVICE ALSO AVAILABLE)

## NEW - USED - EX-DEMO

Alesis Adat XT (ex demo) very low hours	£1600	Yamaha DX7 MK1 with x/tra Rom Sounds	£200
Dennon DTR2000, Dat machine, inc remote	£400	Roland D50, plus sound cards	£400
Yamaha MT8X, Portastudio	£550	Korg Wavestation	£600
Tascam 488, Portastudio	£475	Yamaha CS01 Polysynth	£100
Alesis Midiverb 4, ex demo	£250	Yamaha QY10 Music Sequencer	£100
Soundtracs Topaz 24/8/2	£1300	Yamaha EMT10, piano module	£75
Soundcraft Spirit Studio 24/8/2	£1200	Novation Bass Station Keyboard	£250
Fostex B12	£450	Atari 1040 + 144 Mon	£250
LA Audio CX8 Compressor	£400	AKG C3000	£250
Alesis Quadraverb+	£240	AKG D3700	£80
Alesis 3630 Compressor	£170	Sennheiser MD431	£120
Behringer Auto Quad	£225	Alesis Monitor 2's, boxed ex demo, powerful, mid field	£450
Behringer Composer, ex demo	£200	Alesis SR16 drum	£140
Fostex Patchbay	£40	Yamaha RY30, drum machine	£250
Frontline X4 Chrs/Del/Flinger	£100	Roland MC303, boxed ex demo	£450
Accessit Reverb	£80	Roland Super SC88 sound canvas	£475
BBE Sonic Maximiser, 362	£150	Korg Wavestation	£600
Sessionmaster award pre amp	£120	Roland MSQ700	£100
D & R Compressor	£80	Art.DRX, FX, Multi FX	£200
Behringer Exciter Type F	£150	Casio FZ10M Sampler + Lib Manuals	£460
Korg DVPI Vocoder/		Kawa K1R, sound module	£170
Harmoniser	£250	Alesis Midiverb 4, ex hire	£240
Digitech Studio Vocalist	£725		
Korg M1	£500	All prices inc. VAT	

PLEASE MENTION THE MIX WHEN REPLYING TO THESE ADVERTS

# THE MIX CLASSIFIED

## COURSES



### AUDIO VISUAL TRAINING

Bon Marche, Ferndale Road, London SW9 8EJ

The following courses are available.

One year full-time Diploma course in:

#### Advanced Sound Recording and Production.

Practical based tuition from internationally recognised specialists, supplemented with new technology from leading manufacturers. Starting: 22nd September '97.

Three months full-time Certificate courses in:

#### Analogue Sound Recording and Production.

Starting: 22nd September '97.

One week full-time course in:

#### Introduction to Sound Recording and Mixing.

An entirely practical foundation course. Starting: 8th & 15th September '97.

Tel: 0171 737 7152 Fax: 0171 738 5428

### POINT BLANK TRAINING

Intensive weekend courses and 6 week practical courses in latest studio technology including:

#### SAMPLING, SEQUENCING, DIGITAL RECORDING AND MIXING

Maximum 4 people per group

Based in London • Parking available

FOR MORE INFO CALL: 0181 293 4909



To Advertise Call:  
01225 442244

## SERVICES

**AKAI**  
AUTHORISED  
SERVICE  
CENTRE

**Roland**  
**Oberheim**

**YAMAHA**  
**ART**

**KORG**  
**ZOOM**

**TASCAM**  
**PEAVEY**

**JL COOPER**  
**OPCODE**  
SYSTEMS INC

**CIMPLE**  
**SOLUTIONS**  
Professional Ltd

Tel • 0181 904 4141

Mobile • 0973 723033

Fax • 0181 904 1200

Unit 2-17 Wembley Commercial Centre  
80 East Lane • North Wembley  
Middlesex • HA9 7UR

<http://www.cimplesolutions.demon.co.uk>  
email [service@cimplesolutions.demon.co.uk](mailto:service@cimplesolutions.demon.co.uk)

**WHILE-U-WAIT & PRIORITY SERVICE**  
@ **NO Extra Charge**

FOR ALL OPERATING SYSTEM SOFTWARE  
UPGRADES, DRIVE REPLACEMENTS  
and any minor repairs - please ask!



Many other brands also repaired, please call

We don't just fix gear we can also fit MIDI Retros and much much more.....

**HARD DISKS AND MEMORY** SUPPLIED FOR ANYTHING THAT CAN TAKE IT  
**EMU PROTEUS 1, 2 or 3 OWNERS** UPGRADE TO AN XR VERSION FOR ONLY £47  
**Need more MIDI channels?** "EXTRAPORTS" A TOTAL OF 64 MIDI CHANNELS FOR  
YOUR ATARI ST (Cubase, Notator, DIT, Mastertracks Pro) FOR ONLY £70

Please add £4.00 P&P to all orders. All prices include VAT.

We've got **ESP @ CSP**  
or so we're told!

Specialists  
in the service and repair of  
**ALESIS & FOSTEX**  
**adat**

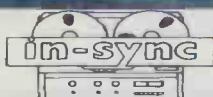

**in-sync service limited**  
Unit 6, 43 Carol Street,  
Camden Town, London, NW1 0HT  
Specialists in servicing  
Fostex / Tascam / Teac / Revox  
tape machines  
Fully re-conditioned and immaculate  
2nd hand equipment for sale  
**0171 485 3447**

### KEYBOARDS/PROGRAMMER

Reasonable rates. Totally mobile.

Kit includes:

- Pro Tools editing and recording • Logic Audio
- Loads of analogue and digital keyboards
- Akai and EMU samplers • Huge sound library

Pro  
Tools

Hit list includes:

- Vanessa Mae • Donna Summer • Giant City • Eternity
- Take That • Channel 4 • Pasadenas
- Charles and Eddie • New Bob Marley Mixes

Call Phil

**0171 736 7182**

Service, Repairs, Modifications

**The Stage**  
**Keyboard**  
**Company**

Keyboards, Amplifiers, Mixers, Effects

Ampeg - ARP - Crumer - Elka - Farfisa - Fender  
Gem - Hammond - Jennings - Laney - Leslie  
Marshall - Mellotron - Mesa Boogie - Moog  
Selmer - Vox - Watkins - Wurliizer  
(plus many others - please call!)

**Making it all sound**

Valve amps a speciality

**Rates from £25.00/hour**

25 River Street, Islington, London EC1R 1XN

**0171 837 2070**

**G'N'T PRO-AUDIO**  
All cables & looms made to order, any spec or length! • Fast turn  
around, next day available. • Edac looms for ADATs, Soundcraft  
desks & sync cables. 25w D for DA-88, RD8. • Credit cards accepted.  
• Free studio accessories catalogue, trade & retail • Also including  
patchbays, mains accessories, stage boxes, connectors & much more  
• Everything for your studio or band.  
CALL THE FRIENDLY COMPANY 01933 411200



Smallest ads  
Greatest expertise  
Best value  
Need we say more?

**0171 586 0357**

Unit 3, 6 Erskine Road, London NW3 3AJ

**AD RATES:-**  
622 PER SINGLE  
COLUMN CENTIMETRE  
SPOT OR FULL COLOUR AVAILABLE  
DISCOUNTS FOR  
SERIES BOOKINGS.

TO ADVERTISE CALL MARTIN SREEVES ON 01225 442244 EXT 2668

# THE MIX CLASSIFIED

## DUPLICATION

**Get it properly mastered!**  
 We've been mastering for over ten years and we guarantee to improve the sound of your recording. In fact we're so confident that you'll love what you hear, we won't charge you if you prefer the original! Call us now or visit our web site. You can't lose out!

**RPM**  
**Repeat Performance Mastering**  
 6 Grand Union Centre  
 West Row  
 London W10 5AS  
 Tel: 0181 960 7222  
 Fax: 0181 968 1378  
 www.repeat-performance.co.uk

**No charge if you don't like it!**

**CD Mastering**  
**CDRs from just £7.50**  
**Real Time Cassette Copying**  
**Copy Masters and Editing**  
**CD Manufacturing**  
**Laser printed labels & inlays**  
**Every copy individually checked**  
**Excellent quality & presentation**  
**Best prices, ultra fast turnaround**

**RPM**  
**Repeat Performance Mastering**  
 6 Grand Union Centre  
 West Row  
 London W10 5AS  
 Tel: 0181 960 7222  
 Fax: 0181 968 1378  
 www.repeat-performance.co.uk

**ELITE CD'S and CASSETTES**

500 CD Singles - £725  
 1,000 CD Singles - £915  
 500 CD Albums - £795

**1,000 CD Albums - £995**

\*Realtime cassette duplication on Nakamichi decks  
 \*Blank tapes wound  
 \*One off CD's  
 \*D mastering & Digital Editing

15 mins from Victoria Station  
**0181-466-7435**

ESTABLISHED 1979

**WE'VE BROKEN THE £1,000 BARRIER FOR 1,000 CD ALBUMS! COMPLETE PACKAGE FROM SUPPLIED DAT & FILMS!**

All CD prices are plus VAT

Compact Discs Pro-Mastering Digibin Cassettes Reprographics Print  
 32 Bit Technology ISDN Lines MD2 3 Band DSP One-off CDs

**HILTONGROVE**  
 Where sound advice counts...  
 http://www.knowledge.co.uk/xxx/hiltongrove  
 0181 521 2424 / 0181 503 6360  
 Facsimile: 0181 521 4343  
 Alpha Business Centre, 60 South Grove, Walthamstow, London E17 7NX  
 4 mins walk from Walthamstow Central (Victoria, BR), 12 mins M25, 8am-8pm 7 days

**Compact Disc Manufacture**

One off CDs up to 74 mins £23.50 inc VAT

500 CD Singles complete only £763.75  
 1000 CD Singles complete only £1086.88

500CD Albums complete only £869.50  
 1000CD Albums complete only £1292.50

Digital/Post Mastering  
 Sadie - Focusrite - GML - Neve  
 Lexicon - TC Electronics - MD2  
 20 Bit A to D - 32 bit DSP

Tel **C.R.S.**  
 01424 444141  
 All prices inc VAT

Artwork Design & Layout  
 Drum Scanning - Typesetting  
 Fine art - Imagesetting  
 to Film & Bromide.

**COMPACT DIGITAL MEDIA**

**CD MASTERING & PRODUCTION**

**1 OFF CD'S & DUPLICATION**

**ARTWORK LABELS & DESIGN**

TEL 01793 770025 - 0410 189419

PO BOX 1046 WEST SWINDON SN5 0AR  
 e.mail CD.MEDIA@dial.pipex.com



**Keynote CASSETTES**

REAL-TIME CASSETTE DUPLICATING  
 LABEL & INLAY PRINTING, BLANK CASSETTE SALES  
 DAT & AMPEX REEL TAPES  
 FRIENDLY PROFESSIONAL SERVICE

**01252 794253**  
 Fax: 01252 792642



**ONE-OFF CD'S**  
**CD MASTERING**  
**DIGITAL EDITING**

SONIC SOLUTIONS NO-NOISE  
 SOUND RESTORATION

SOUND CUTS LTD  
**0181 964 4091**

Reference CDs from £10<sup>vat</sup>  
 Want One?

- Reference CDs
- Digital Editing
- CD Mastering
- Compilation
- Dat Duplication
- Data Backup
- Freepost Mail-Order
- Sample conversion
- On Disc Printing
- 22 Hours Storage
- Fast Turnaround
- Professional Service

0181 960 1088 / 0958 311484  
 \*Quality comes as standard\*

**REAL CHEAP**  
**REAL TIME**  
**AND ONE-OFF CD'S**

Realtime from DAT or cassette  
 Small quantity specialist  
 Excellent side label designs available and more.

**JB AUDIO/VIDEO 01621 783518**

**ONE-OFF CDS**  
 VINYL  
 CD  
 CASSETTE  
 DIGITAL EDITING

**TEL/FAX 0171 713 1303**



Look! 1000 cds + booklet  
**Only £1185 COMPLETE**  
 0181-845-4979 'nuff said!  
 Champagne Lake Productions

PLEASE MENTION THE MIX WHEN REPLYING TO THESE ADVERTS

# THE MIX CLASSIFIED

## DUPLICATION

**TapeLine**  
Ltd

**CASSETTES & CDs**

- ★ BLANKS
- ★ LOOP BIN DUPLICATION
- ★ APEX DIRECT PRINT
- ★ COMPACT DISCS
- ★ ACCESSORIES
- ★ NATIONWIDE DELIVERY

0161 406 8608

**WHY PAY MORE FOR DATS?**  
ALL DATS ARE NOT THE SAME - SOME COST TWICE AS MUCH!

DAT R30 - FROM £2.89+VAT!	DAT R61 - FROM £3.35+VAT!
DAT R46 - FROM £3.09+VAT!	DAT R92 - FROM £3.85+VAT!
DAT R122 - FROM £4.35+VAT!	

MAXELL TAPE - RATED FIRST IN A TOP SURVEY (COPIES AVAILABLE)

<b>COMPACT 1U PATCHBAYS</b> £37.99 +VAT	<b>DAT STORAGE RACK</b> £3.50+VAT!
32-WAY JACK/JACK 24-WAY JACK/8-WAY HIGH EASILY REVERSIBLE NORMAL SING	• HOLDS 10 DATS & LOCKS TOGETHER & • FREE STANDING OR WALL MOUNTED &
	<b>PLASMA GLOBES</b> ONLY £37.99+VAT

CALL FOR FULL PRICE LIST

**CRYSTAL**

TEL: 01223 208937 FAX: 01223 207021

NORTH ROAD WENDY ROYSTON HERTS SG8 0AB

... **ONE-OFF CDs** ...

Add that professional touch & have your music put onto CD. We can transfer your recordings from DAT or cassette onto CD.

- 1 CD = £20
- 3 CDs = £45
- 5 CDs = £70
- 10 CDs = £102

Price includes VAT, PQ encoding, printed inlays & labels. Small order specialists! Mail order welcomed. Call Paul for a CD info brochure on 01923-253133

## ARTISTS WANTED

### WANT A RECORD DEAL?

WE ARE CURRENTLY SEEKING BANDS AND SOLO ARTISTS WHO WOULD LIKE THE OPPORTUNITY TO APPEAR ON OUR COMPILATION CD. THIS CD IS CURRENTLY CIRCULATED TO OVER 75 RECORD AND MANAGEMENT COMPANIES IN THE UK. IF YOU ARE AN UNSIGNED ACT, SIMPLY PHONE OR SEND AN S.A.E. TO RECEIVE INFORMATION ON THIS, AND OTHER SERVICES WE PROVIDE.

**dayglo Black**

PO Box 363 Bristol BS99 5UR

0117 975 4776

## UNSIGNED Ltd

Get your music on one of our compilation CDs for as little as **£130**

For details phone now on

**0181 518 3358**

## SOUND ASYLUM RECORDS

Require new talent for 1997 house, techno, drum & bass, others. Please send demo & info guaranteed replies. Sound Asylum Records, Unit 19, Bassetts Manor, Hartfield, Sussex TN7 4ZA Fax: 01892 770013

## TRAINING

### SOUND PRODUCTION & RECORDING TECHNIQUES

These 1 week courses have been especially designed to give students extensive 'hands on' experience, maximum subjects and the flexibility to study 1 or 2 in depth or more (up to 8) in lesser detail. The courses consist of up to 40 hours of total studio time and group sizes are strictly limited to 3 per course. Courses are run monthly throughout the year. Course fees inc. B&B £200 exc B&B £160. Course summary available on

**01482 342773**

### The Recording Workshop

Comprehensive range of exclusive 2 month part-time courses, on latest recording and production techniques in small groups. Working 16 track studio in West London. Hands-on experience from the start. Beginners welcome, all aspects covered, from MIDI, CUBASE, SAMPLING to EQ, EFFECTS USE, MULTI TRACKING and MIXING. Established since 1989.

For Prospectus:  
**0181 743 2645**



### ISLINGTON MUSIC WORKSHOP DIPLOMA COURSES

in SSL G+/24 track engineering and MIDI programming



For free brochure  
CALL 0171 608 0231

Big concessions for unwaged



**July '97 Issue**  
Copy deadline: 29th May '97  
On sale: 26th June '97

## COMPUTERS

### OAKWOOD AUDIO

studio computer support

dedicated computer music specialist leading supplier of 19" rack mountable computer systems

large selection of second user apple systems from powermacs to powerbooks

audio pc systems built & configured to your exact specifications

minimise your studio downtime-efficient repairs & upgrades of pc's & apple mac's

**0345 023 530**

### MAKE MUSIC! - SAVE MONEY!

#### YAMAHA

DB50XG/SW60XG/MU10  
TURTLE BEACH

Pinnacle/Fiji/TBS2000/Tropez  
Creamw@re

TripleDAT/Masterport  
UBISOFT

Maxi Sound 64 Home Studio  
CREATIVE LABS

AWE 64 GOLD  
SOFTWARE AND MORE!

CAKEWALK, CUBASE, EVOLUTION  
AND REBIRTH

Use Windows PC Power For Powerful Music

#### CUSTOM PC SYSTEMS

Example: Pentium 150 / 32mb EDO RAM  
2.5gb EIDE Hard Disk / 15" Colour Monitor  
Yamaha SW60XG Soundcard / 8XCD-ROM  
2mb Video Accelerator / Windows 95  
PRICED AT JUST £1350

ring  
**SNS**  
M.U.S.I.C

Telephone (01782) 263999  
Fax (01782) 260690

TO ADVERTISE CALL MARTIN SREEVES ON 01225 442244 EXT 2668



# THE MIX CLASSIFIED

## ADVERTISERS INDEX

<b>Active Sound</b>	<b>16, 17</b>	<b>Music Lab</b>	<b>47</b>
<b>Akai</b>	<b>43</b>	<b>Music Sales</b>	<b>25</b>
<b>Alchemea</b>	<b>93</b>	<b>Project Music</b>	<b>25</b>
<b>Avid</b>	<b>23</b>	<b>Raper &amp; Wayman</b>	<b>11</b>
<b>Behringer</b>	<b>21</b>	<b>Roland</b>	<b>IFC</b>
<b>Beyer</b>	<b>91</b>	<b>SCV</b>	<b>IBC, 40</b>
<b>Concert Systems</b>	<b>53</b>	<b>Sound Solutions</b>	<b>69</b>
<b>Design Labs</b>	<b>25</b>	<b>Soundcraft</b>	<b>OBC, 13</b>
<b>Digidesign</b>	<b>23</b>	<b>Studio Spares</b>	<b>37</b>
<b>Gateway School of Music</b>	<b>53</b>	<b>TEAC</b>	<b>85</b>
<b>Global Distribution</b>	<b>65, 75</b>	<b>Time &amp; Space</b>	<b>56, 57</b>
<b>HHB Communications</b>	<b>29, 31, 33</b>	<b>Tony Larking</b>	<b>69</b>
<b>HW International</b>	<b>39, 63, 75</b>	<b>Way Out West</b>	<b>6</b>
<b>Kenton</b>	<b>15</b>	<b>Xpression!</b>	<b>53</b>

### STUDIOS

#### Shot in the Dark Recording Studio

16 track 1" tape  
Soundcraft 2400 desk  
Cubase  
Live room  
Excellent quality + tea & sympathy  
£11 per hour or £75 per day  
0171 928 1889 Fax 0171 928 1889

### INTERNET

imagen.co.uk  
Internet Services

http://www.imagen.co.uk

#### DATABASE OF MUSIC AND RELATED SERVICES

Check out our site for:

- Used equipment (FREE ads and classified)
- Listings of music companies and services
  - Bands, Artists and Musicians
  - Employment in the music industry

PROMOTE YOUR SERVICES ON THE INTERNET WITH US FROM  
AS LITTLE AS £25 +VAT PER YEAR

Web design  
& hosting  
available

Visit our website  
or telephone (01784) 850021  
email: sales@IMAGEN.CO.UK

### The Mix

Copy deadline: 29th May '97  
On sale: 26th June '97



Ad  
Rates:-

£22 per single  
column  
centimetre

spot or full  
colour  
available

discounts for  
series  
bookings

Contact:-

Martin Sreeves  
on  
01225 442244  
ext 2668

### MIDI FILES

#### TranTracks™ MIDIFILES (USA) ARE BACK IN TOWN!!

Imported from the USA TranTracks are an absolute MUST for any performer requiring quality. The name "TranTracks" is well known throughout the music industry and to many regarded as the world's leading source of high quality midfiles. Programmed in the USA and exclusively available through:  
Dolphin Music UK - The ONLY authorised dealer in Europe \*\*

#### Arranger Series™ MIDIFILES (USA)

Produced with Performance in mind. Richly orchestrated enhancements for incredible musical feel gives these tracks that BIG BALLSY feel!!

#### Real Tracks™ MIDIFILES (Canada)

Stylish and Masterful arrangements are just two of the words used to describe these sequences. Powerful feeling and depth required by the professional, oozes through every song.

<b>WHAT PRICE ARE THEY?</b>	: Midfiles from £4.95 each (incl. VAT)
<b>HOW SOON CAN I GET THEM?</b>	: Same day dispatch/courier & selected E-mail services available
<b>WHAT PLATFORMS ARE THERE?</b>	: PC/Mac/Atari/Korg/Roland/Yamaha/Technics/Solan
<b>WHAT FORMATS HAVE YOU?</b>	: You choose ... Mhidisc; CD; Floppy disk; Dat; Audio cassette
<b>WILL YOU GIVE DISCOUNTS?</b>	: Yes. See our catalogue for details
<b>WHAT HELP IS THERE?</b>	: If you need assistance we are only a phone call away
<b>WHAT'S THE CATCH?</b>	: Just call for a catalogue ... It's that simple
<b>HOW CAN I PAY?</b>	: Cheque; Mastercard; VISAcard; Switch
<b>WHO DO I CALL?</b>	: Dolphin Music UK

\*\* WE are the only authorised dealer in 13 European countries to stock and distribute all of the above company's midfiles. \*\* (unavailable in Norway)

#### DOLPHIN MUSIC UK

Call for your **Free Catalogue** : 01573 440559  
Fax for your **Free Catalogue** : 01573 440515  
Please E-Mail us at : ps-dolphinmusic@msn.com  
or E-Mail us at : DM UK82685  
Or snail mail us at : Dolphin Music UK  
Samieston House, Jedburgh  
Roxburghshire TD8 6RK  
Great Britain  
Outside Great Britain call : 0044 1573 440559

PLEASE MENTION THE MIX WHEN REPLYING TO THESE ADVERTS

# MARTYN WARE

**M**artyn Ware was a founder member of the Human League and Heaven 17. In the 1980's he enjoyed worldwide acclaim as an artist and went on to gain a string of production credits

Including Tina Turner's 'Let's Stay Together', Terence Trent D'Arby's *Introducing The Hardline According To...* and an enviable number of Top 20 hits for various pop luminaries. Recent projects with Erasure, Marc Almond, Alison Moyet and Pauline Henry have cemented his reputation as one of the UK's top producers. Recently, Martyn has reformed Heaven 17 with original members Glenn Gregory and Ian Craig-Marsh after a seven year break. The band's new album, *Bigger Than America* saw him back in the production chair again. We caught up with him at his home studio, The Institute of Sonology, just before Heaven 17 set off on tour.

**TM:** Was the seven year gap in Heaven 17's career to do with priority being given to external production projects, or was there a feeling that the band had reached the end of its natural shelf life?

**MW:** Well, as we know, pop music is very cyclical. Things come and go. We had gone down the path of incorporating more and more real instruments into what we were doing live and using more session musicians. As sales declined, musical integrity became less prioritised, and we were virtually doing things for the wrong reasons. We also, subconsciously, lost confidence in our own abilities.

**TM:** So has the spark returned with the newly-reformed Heaven 17?

**MW:** Totally, and it's not to do with money – I was earning more money doing production anyway. I wanted to reform because I find it a lot more enjoyable than dealing with a lot of the incompetence in some record companies nowadays, to put it politely.

**TM:** Production-wise, do you have a fixed way of working, or is each project unique?

**MW:** Production-wise they are all different, I've done everything from 70-piece orchestras and full orchestral brass ensembles (which demands a great deal of understanding of how the sounds are put together) and – at the other end of the scale – completely electronic projects as well. The latest Heaven 17 album is 95% analogue, with 5% samples.

**TM:** Have you tried out any of the new pseudo-analogue synths and what do you think of them?

**MW:** I've tried some. They're alright but really they're built for people who didn't have the original models. But they do have MIDI implementation. When it comes down to it you want as much flexibility as possible and you want as much cross-patchability as possible and what the Japanese have succeeded in doing is taking all that cross-patchability and putting it in a chip.

**TM:** Is that why you use quite a minimal and, synthesis-wise, analogue studio set up for your productions?

**MW:** Yeah, absolutely. I mean, I was doing the Vince Clarke album, and I went down to his studio where he's



Martyn Ware in  
The Institute Of  
Sonology

## Producer and founding member of Heaven 17 talks samplers, synths and taking tea with White Town

got virtually every analogue synth in existence, plus duplicates of most of them. Basically, we were doing these demos onto ADAT, and we decided to add some stuff to the first track, and Vince said 'just give me a few hours...', and he completely restructured the track. He did the same on some more tracks – just tweaking a few filters or whatever – which demonstrates just how easy and quick it is to change things with analogue. And it's a lot more fun than trawling through gigabytes of samples or using presets.

**TM:** You're using just a couple of ADATs at your studio. Does this limit you in any way?

**MW:** No, I don't think so. We used to record to one-inch 8-track. What's interesting is the methodology of recording to eight tracks. It's the discipline of mixing down to a small number of tracks; it means you make decisions earlier in the recording process, and I find that much more stimulating.

**TM:** You're quite a fan of Roland samplers, as opposed to the 'industry standard' Akais. Why is that?

**MW:** I've never liked Akais. I don't like the filters, especially the low end; they're no comparison to Roland's. There's no problem with compatibility, because we do all the recording here (at his home studio, The Institute of Sonology) and I have a gigantic library of samples. Also, Ian [Marsh, Heaven 17 member] has always had an ongoing love affair with Emulator stuff. He's just got an E-64, which reads Roland and Akai stuff. So we've got everything we need.

**TM:** Do you use any hard disk recording systems?

**MW:** Yeah, I've got a Session 8 ProTools system. I'd held

on for quite a while but it's so flexible it's silly not to have it. They sound a lot better now than they used to and the plug ins are obviously the way things are going. I think we've reached the point where it will become cheap enough for everyone to do it and I think everyone, however attached they are to their Akais or whatever, will have this in three or four years time.

**TM:** What have been the highlights of your production career?

**MW:** I thought the Terence Trent D'Arby album was very good. It didn't sound like anybody else – the combination of sounds that we used, with the R&B influence, and his unique voice. I'm very proud of productions I do that give you that sense of atmosphere, like a film soundtrack. I think there's far too much production nowadays which is, firstly, too formulaic, and secondly doesn't pay any attention to the kind of imagery you can create.

**TM:** You recently remixed the White Town single. How did that come about?

**MW:** They used a sample of one of our tracks on the single, and I e-mailed them to say how flattered I was and how much I liked the song, and they e-mailed back and said would I like to go round and have a cup of tea (laughs). So we had a chat, and I ended up doing the remix for the next single. He's really good; he's thoroughly absorbed hip hop breakbeat knowledge, but then looking for a different way to use it.

**TM:** What do you make of the current dance scene?

**MW:** There are some people in the dance scene who are truly innovative, and it's a massive part of the music scene, if not in sales, then in terms of the number of people doing it. Some of the trancy stuff and trip hop is great, and even some of the drum & bass stuff. Well, that was innovative until you got a million imitators... I think there is as much creativity as there's always been, I just think it's sad that people feel the need to imitate so strongly, and not to look very far for their influences. If it's economically based, like remixes, when it has to be done quickly, they're not going to spend hours finding some interesting loop and messing around with it. That's what I think is wrong with the dance scene; there's too much laziness, and many record companies are not interested in creativity.

**TM:** How are the plans for the tour shaping up?

**MW:** We've done new versions of all the tracks, with a view to probably putting out a live album. We've been working non-stop for five weeks, and we've basically got about three quarters of the stuff on ADAT. I mean, when you've got a band that is fundamentally electronic, unless you've got millions of synthesizers, all MIDI'd up running from computer... would you risk that? I certainly wouldn't. So we are going to be blatantly honest, we've worked exceptionally hard; it's not going to sound like a record. The three of us will be playing live, and we've got two female backing vocalists, too.

**TM:** Best of luck with the tour then.

**MW:** Cheers!

● Nick Serre

**Fostex**

8 tracks,  
no compression,  
SCSI back-up,  
seamless studio  
integration.

And all from less  
than £1,500 inc vat.\*



**S**o what do you want from an 8 track digital multitrack? Non-compressed CD quality audio with 18/20bit converters? Simultaneous 8 track recording? Non-linear cut, copy, paste and move editing? Varipitch? Removable expandable recording media with up to 2 hours recording time? Analogue & Digital I/O? Versatile Chase mode?



With the new D-90 you get all of that. And then some. Standard equipment also runs to an ADAT™ Digital Interface for simultaneous 8 channel input and output via optical data I/O - making it easy to transfer existing recordings to and from our non-linear format and connect directly to the new wave digital mixers. Optional balanced inputs and outputs are via a plug-in card. And there's a SCSI option for the ultra-fast back-up and restore of sessions to removable drives such as SyQuest, MO, Jaz, external hard drive, etc.

**SCSI INTERFACE**  
For ultra-fast back-up & restore to removable media



Flexible, expandable, easy to interface and loaded with the features you want. It has to be the new Fostex D-90.

**MULTIPLE 16 AND 24 TRACK MACHINE SET-UP**  
Use a D-90 to control further D-90s and/or D-80s (backwards compatible) all from one remote control, locked to sample accuracy.

# Fostex D-90

## Non-Compressed Digital Multitrack



Exclusively distributed in the UK by SCV London, 6-24 Southgate Road London N1 3JJ. Tel: 0171 923 1892. Fax: 0171 241 3644  
email: [fostex@scvlondon.co.uk](mailto:fostex@scvlondon.co.uk) web: <http://www.scvlondon.co.uk>

Also from Fostex...

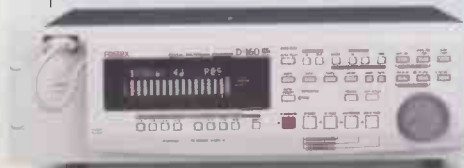

- 16 track digital multitrack with no compression
- 8 further 'ghost tracks' for additional takes
- ADAT™ Digital Interface (simultaneous 16 channel)
- ±6% pitch control with no loss in audio quality
- Optional LTC Timecode board with Word & Video sync
- SCSI interface as standard for fast back-up of sessions
- Balanced I/O option

## D-160

16 Track Digital Multitrack

\* All trademarks acknowledged. Prices are approximate and subject to change without notice.

