

electronic engineering

January 1977

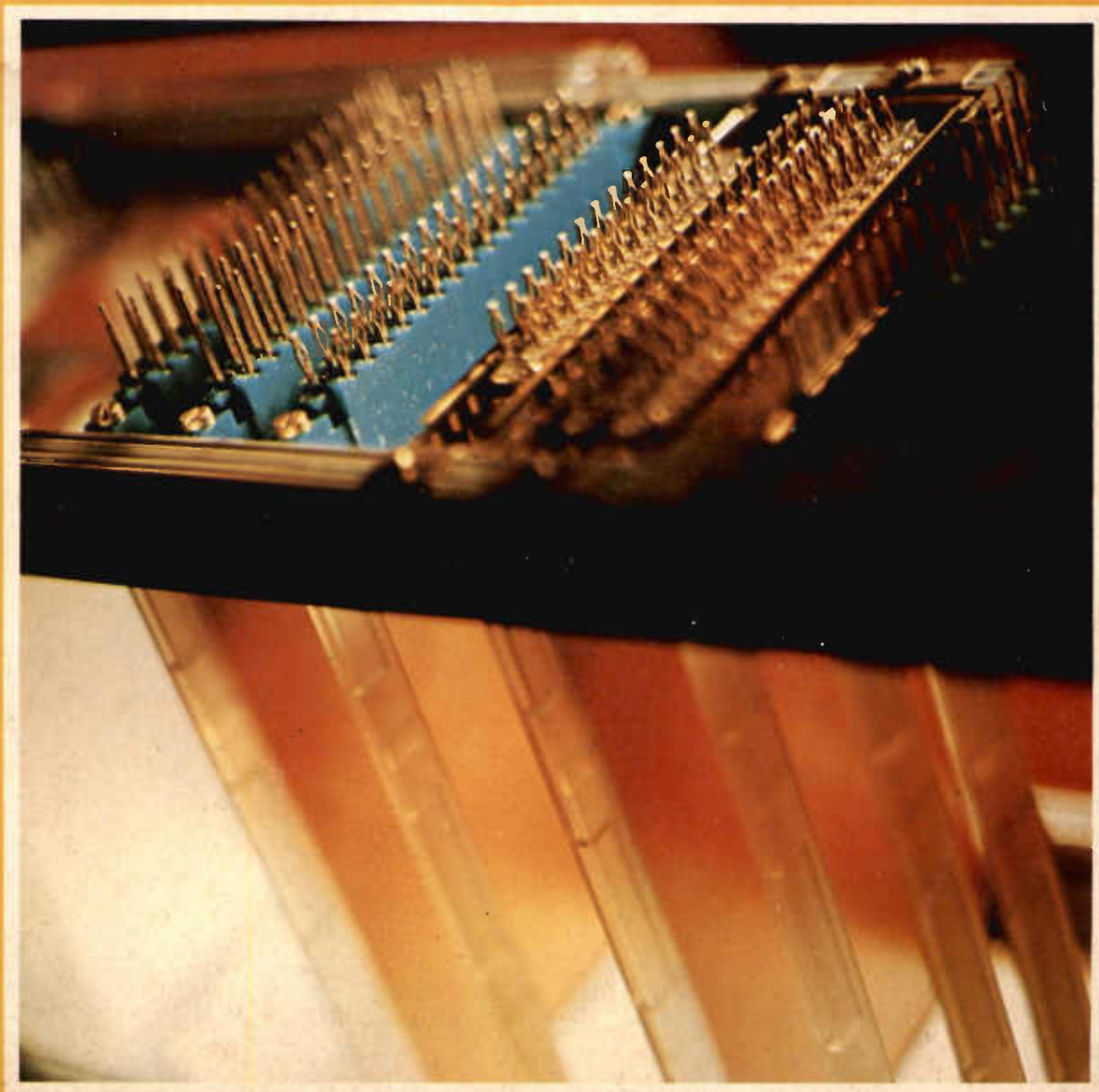

Exploiting pyroelectric effects for thermal imaging

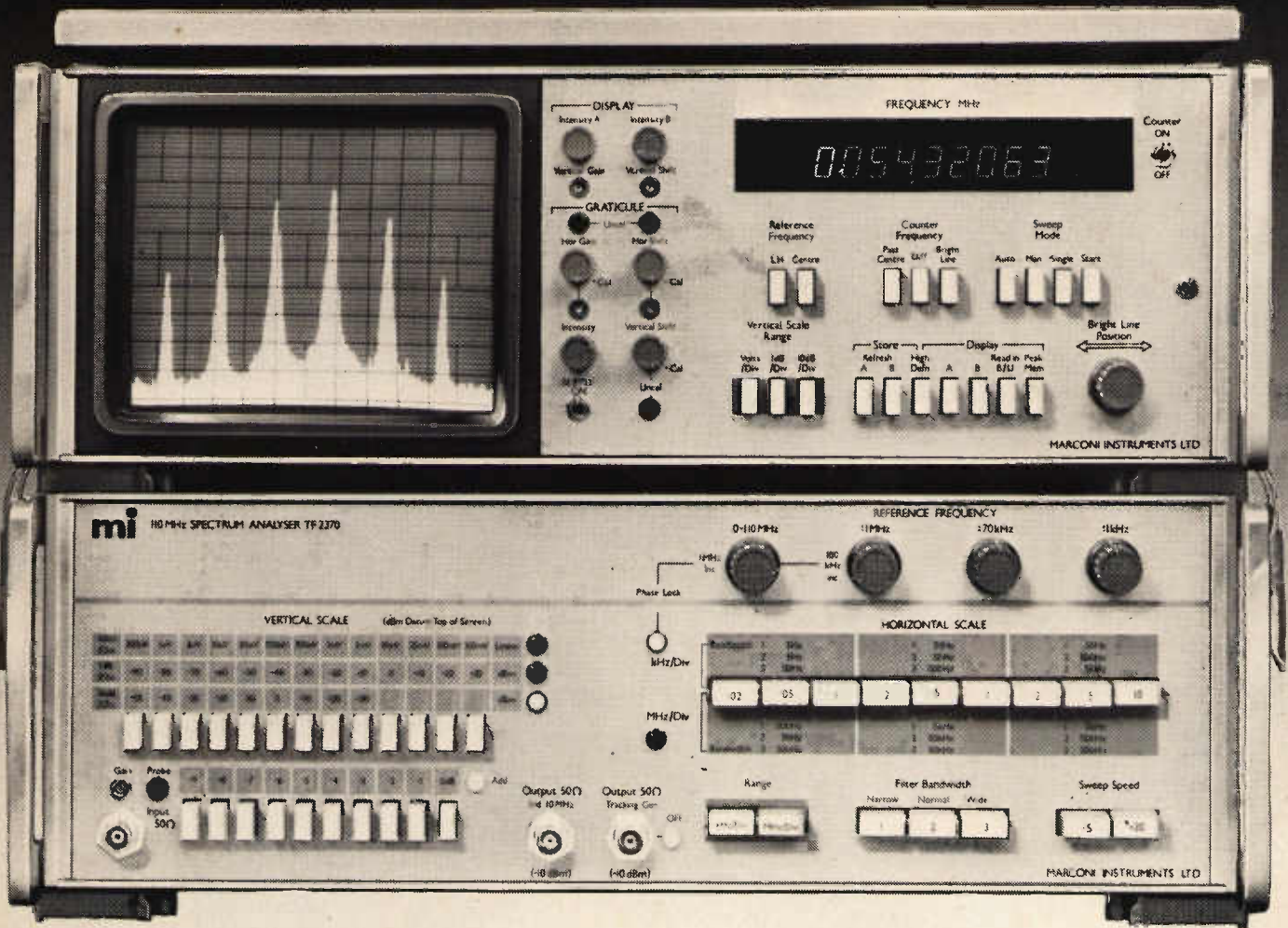

The Most Advanced Spectrum Analyser

You've never seen a faster, more accurate way
of measuring frequency response from 30Hz to 110MHz

The TF 2370 Spectrum Analyser employs advanced technology to provide a complete system for measuring response, level, frequency, signal purity, modulation and much more, with a speed and degree of accuracy previously unobtainable. A digital memory permits the use of a standard monitor tube and internal logic selects gain ratios and sweep speeds for optimum performance. The specification speaks for itself:

- * Flicker-free 100 dB display of frequency response from 30 Hz to 110 MHz on a high brightness c.r.t.
- * Electronic graticule, with a $\pm 15\%$ variation of horizontal divisions for pin-point positioning against waveform display.
- * Three amplitude scales: one linear and two logarithmic with expansion to 1 dB/div. with an accuracy of ± 0.1 dB/dB.
- * 9-digit electronic counter automatically gives centre frequency, reads any other frequency corresponding to manually-adjusted 'bright line' position on display, or the difference frequency between the two, at the press of a

button. All to an accuracy of $\pm 2\text{Hz} \pm$ reference frequency accuracy on high resolution and manual. Internal reference frequency provided with setting accuracy of 1 in 10^7 .

- * Internal generator supplies synchronous signal source for measuring such items as networks and filters.
- * For comparative measurements, unique memory storage system will retain one display indefinitely as required, for simultaneous display with response produced by items under test.
- * Automatic adjustment of amplifier gains to give optimum lowest-noise performance with full protection against input overloading.
- * Automatic selection of optimum sweep speed.
- * With the 5 Hz filter, signals 100 Hz from a response at 0 dB can be measured to -70 dB.

Please send for full information or ask for a demonstration – seeing is believing!

mi: THE INNOVATORS

MARCONI INSTRUMENTS LIMITED,

1 on enquiry card

Longacres, St. Albans, Hertfordshire, England, AL4 0JN. Telephone: St. Albans 59292 Telex: 23350.

Editor

Brian J. Jennings

Technical EditorsPeter Gebler *BA*Elaine Williams *BSc***Group Editorial****Consultant**Lord Avebury *BA CEng**MIMechE MIMC***Art Editor**

Adrian C. Day

Circulation Manager

H. S. Gibbs

Reader Service Manager

Grace Wall

Advertisement Manager

Patrick Flynn

Northern Area Manager

Peter T. Westhead

061-928 9801

Publisher

Peter Jago

Electronic Engineering is published monthly and is distributed free of charge in the United Kingdom to designers, engineers, researchers, technical management, and approved authorities, in industrial and scientific establishments manufacturing and using electronic components and equipment. It is also available to others in the U.K. and overseas at an annual subscription rate of £12.50 (or \$37.50 in North and South America). Single copy price is £1.50.

Notice to overseas readers

A number of advertisers, at their own request, do not appear in the world-wide edition. This unavoidably interrupts the page sequence, but does not affect the editorial content.

ME © 1977

Morgan-Grampian (Publishers) Limited

Morgan-Grampian House

30 Calderwood Street

London SE18 6QH

Telephone 01-855 7777

Telex 896238 (Industpres Ldn)



This month's cover illustrates ISEP2000, produced by ITT's Equipment Practice Division. The system is available in sub-rack heights suitable for 100 x 160 and 233, 4 x 160 mm Eurocards. Photograph courtesy of Paul Brierley.

electronic engineering

Vol 49, no 587

January 1977

-
- 4** **Comment and Readout:** *Resolution; Sybex to hold μ P seminars; microprocessor goes down mine; fast cmos with plasma-etch; car safety device hopes; hybrid plant in South Wales; Norwegian agreement; Lascar launches modules; liquid crystal production; Vero sets up new company; telecomms report for NEDC; AES up date.*
-
- 17** **Applied Ideas:** *Integral cycle control using a multiplier; constant amplitude triangular waveform generation; seven segment to bcd converter uses standard ttl; triggered switch makes sweep generator highly linear; a universal sequential element provides flexibility; simple selective amplifier uses one 709 timer for low frequency oscilloscope; pulse subtractor for frequency synthesis; auto-positioning of main tap for cyclic equaliser; a voltage to frequency converter with one ttl-chip; only one line is true detector for digital parallel lines; temperature compensation via current generators.*
-
- 36** **Magnetic bubbles memory systems:** *Magnetic bubble technology has reached the point of exploitation, writes A T Gibson. This article describes a bubble memory system developed in the United Kingdom.*
-
- 38** **Pyro-electric technology in modern thermal imaging systems:** *This article by J R Forman discusses recent developments in thermal imaging techniques based on the exploitation of the pyro-electric effect.*
-
- 42** **Software approach to computer displays:** *The complexity and cost of the hardware for a computer visual display unit can be greatly reduced by using a software approach, writes J E M Tyler.*
-
- 46** **Digital logic board design with test needs in mind:** *Part 1 of this article dealt with hardware design considerations and this concluding article by David Tose, discusses testability and the impact of ate in a production environment.*
-
- 51** **Linking microprocessors to increase system throughput:** *Linking several μ P can improve system performance and is not as difficult as is commonly believed. writes Peter Gebler.*
-
- 60** **Developments in pulse code modulation transmission:** *The appeal of pcm techniques is greatly enhanced by the availability of monolithic companders. writes Brian Jennings, who reports on a recent development in this field.*
-
- 67** **Product Focus: Enclosures and Packaging:** *Elaine Williams reviews the developments and trends in this industry.*
-
- 77** **New Products**
-
- 90** **New Data**
-
- 95** **Classified Advertisements**
-
- 95** **Advertisers Index**



p



BICC-BURNDY

Parr, St Helens, Merseyside WA9 1PR
Telephone: St Helens 24000

Limitation of design flexibility was a common connector problem. Until TRIM-TRIO.

TRIM-TRIO is a unique system that reduces these kind of complications in design. And in production. Once employed, it is a lasting design decision. Once evaluated it gives you practically all the flexibility you need.

It's simple. Choose any from the three crimp contact families and your choice can be used in a multitude of connector styles and sizes. You can interface with wrapped and soldered techniques without deviating from your original contact choice.

There's an expanding range of connectors which include circular plastic types with metal coupling rings. Low profile styles. Rectangular multipins for many applications. And low cost self mounting types. All constructed for outstanding performance and reliability.



Production becomes more efficient and more economical with TRIM-TRIO. Fewer contact types speed production with less tooling, longer runs and fewer special skills. And there's a comprehensive range of production tooling for low to high volume needs.

Stock control is simplified too. And the reduced number of TRIM-TRIO components cuts inventory costs.

So get the freedom of connector design that only the TRIM-TRIO system can give you. And get all the U.K. based know-how behind you. Plus the international resources associated with BICC-BURNDY.

**TRIM
TRIO** SYSTEMATICALLY YOURS

for three
pins we'll
give
you our
system

Resolution

With Britain making her new year's resolution to adhere to the conditions laid down by the International Monetary Fund we can see some signs at last that the world believes that we will keep our promises in this respect. The pound, for example, has been showing some signs of improvement with our agreement to face up to the realities of economic life.

However we would only be fooling ourselves if we thought that tightening our belts and waiting for a few months would be all that was needed. The loan from the IMF will only cushion the effects of pressures on sterling. It cannot provide the stable platform which we need to build for the future.

This is where the electronics industry can help not only itself but also the more antiquated of our industries, by enabling them to become more competitive at home and abroad. The expertise required to do this is here and even the USA manufacturers have acknowledged that. GIM has about three quarters of its products designed in Britain, though production is mainly in America or Asia. Another large semi-conductor company's European head recently suggested that British component designers were without equal in the world.

We used to be a nation noted for its inventiveness and vision but, although the inventiveness remains, our vision has become a little blurred by the lack of commitment to profit. We have seen individual motivation stifled and corporate ambitions have come to be regarded with some suspicion.

We have been placing too much emphasis recently on the unacceptable face of capitalism so much so, that we are not sure, as a nation, whether it has an acceptable face at all.

Our most important resolution must be to recapture our drive and success but, this time, it must be based on vigorous enterprise coupled with a firm self-belief. If our economic splint is to rise from the ashes we need more than a faint spark of optimism.

We cannot expect the world to have any confidence in our abilities to win through if, we have no belief in ourselves.

This is Jubilee year and the eyes of the world will be upon us. It is vital that we do not let the celebrations become yet another excuse for nostalgia. Rather, let them be an expression of the hope we have for the future.

The electronics industry could lead Britain along the road to recovery and, instead of drowning our sorrows, we could raise our glasses and drink not only to a Happy New Year but also the recovering health of the nation.

READOUT

Sybex to hold μ P seminars

Three microprocessor seminars will be held in Stockholm next month. Organised by Sybex of Paris, the seminars will cover microprocessors and micro-computers (Feb 7-8), bit-slice systems (Feb 10) and a comparative evaluation of micro-processors (Feb 9).

The first seminar is intended to cover all aspects of micro-processors, from technology to project management, and stresses case studies. All the major microprocessor families and their design aids will be reviewed and selection criteria will be discussed.

The seminar devoted to bit-slice systems will cover techniques for designing micro-programmed systems, analyse currently available devices and examine typical applications.

The seminar to be held on February 9 is likely to be of particular interest to designers who have not yet decided which microprocessor to use. Today's microprocessors are the result of historical evolution and, in some cases, of incorrect predictions by the manufacturer, according to Sybex. This has resulted in devices with inefficient features or architectures poorly adapted to intended applications. The speakers will therefore attempt to identify the types of application best suited to each individual microprocessor family. All major 8-bit and 16-bit micro-processor families will be analysed and compared. The conference will be followed by a discussion between manufacturers which will attempt to define the ideal microprocessor.

Fast cmos with μ processor plasma etching for mines

A complete dry plasma etching process developed by Bell Northern in Canada under a US Army contract is claimed to have produced cmos integrated circuits with gate delay times of typically 600 picoseconds. The company maintains that nominal gate widths of two microns have been achieved by this method with ion implanted, plasma etched cmos using either bulk silicon or silicon on sapphire substrates.

Bell Northern Research is the r and d subsidiary of Northern Telecom and sees the applications of these devices in low power voice communications. Plasma etching removes material by the action of decomposed gas molecules in weak vacuum under the influence of an rf field at wafer temperatures below 100°C.

To eliminate all wet etching, a technique of etching aluminium had also to be devised.

The first microprocessor has been installed in a mine as part of a safety protection system for a mine winder. The unit was designed and built by Transmitton and the NCB has announced that half of the mines in South Wales will be equipped with the devices in the next eighteen months and, it is intended that every pit shaft in the country will have them within the next few years.

The equipment which costs £3000 has only one mechanical element which is a toothed wheel, keyed to the winder drum shaft, with a tooth pitch corresponding to 0.15 m of rope movement. As the wheel turns at the rotational speed of the drum, pairs of teeth activate inductively two pairs of sensors which feed information into the microprocessor. The microprocessor then determines the direction of travel and the distance of travel of the rope.

Hybrid plant in South Wales

This month sample and prototypes of chip and wire micro-circuits will be produced at AB Microelectronics South Wales plant. The company has decided to extend its hybrid microelectronics business and has commissioned new clean room facilities there. Full produc-

tion is expected in the second quarter of this year.

The chip and wire process itself will use both ultrasonic and thermocompression bonding with aluminium and gold wire. All the devices will be hermetically sealed.

Car safety device hopes

A British firm may have an export winner on their hands with its 'econocruise' device for cars. The device which provides electronic speed control and is a fuel economy and safety device was developed by the Associated Engineering Group.

So much interest has been generated that a new company has been set up by the group to manufacture and market the system.

The managing director Tim Blee, believes that this British invention will be received favourably overseas especially in European countries such as West Germany, France and Italy. Blee claims that independent tests conducted by motoring associations and leading motoring correspondents have proven that the system is both safe and efficient.

The system incorporates a small minicomputer which is installed by qualified mechanics which have been trained by Econocruise.

Norwegian agreement

Three of Norway's leading electronics companies have announced a major cooperation agreement. The companies involved are Tanbergs Radiofabrikk, Elektrisk and Kongsberg Vapenfabrikk. Under the terms of the agreement, Tandberg and KV will acquire two fifths of the 43.25 per cent stake held in Elektrisk Beraas by LM Ericsson.

Also the three companies have bought a majority interest in a small firm Noratom/Norcontrol which specialises in the production of marine data systems.

The main purpose behind the agreement is to create an international group with the facilities of research, product development and marketing. Until now such agreements had been impractical for small Norwegian firms since their chances of success in international markets had been impaired by high costs in relation to earnings.

This is seen as a much needed boost to the electronics industry in Norway, and has been encouraged by the Norwegian government.

Lascar launches modules

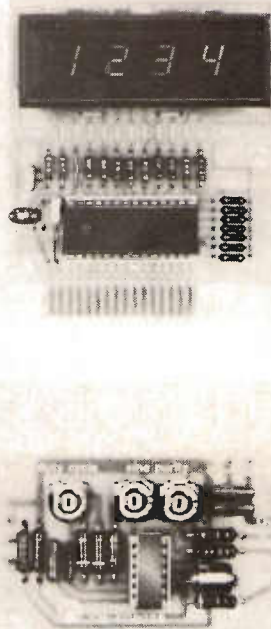

A new company, Lascar Electronics, has been formed to manufacture and distribute electronic circuit modules. Lascar is the brainchild of Brian Currie, formerly with RS Components.

Lascar's circuit modules will be marketed under the name 'Circblocc' and the range includes amplifiers, timers, power supplies, waveform generators, led displays and several other basic building blocks.

The modules are available fully assembled on small printed circuit boards or with certain components omitted so that users can program the modules by adding resistors. These additional components are inserted into pre-drilled holes in the board according to the diagram printed on the component side of the pcb.

The modules are intended, says Currie, to allow the assembly of complex systems in the shortest possible time. For example, a four-digit digital frequency meter can be constructed from three of the modules.

Liquid crystal production

This year's display's 76 exhibition had its venue as the Royal Mount Hotel once more. Although the exhibition seemed to be smaller than last year's effort the organisers claimed that there were in fact nearly the same number of stands.

The main news of the event was the imminent opening of two liquid crystal production plants one by ITT and one by Rank. The latter company will be manufacturing the twisted nematic type display which has a biphenyl structure and is a very stable type of display. Production of the liquid crystal elements will be at Leeds which is currently concerned with the manufacture of fibre optics components.

The manager of the new facility is Bill Freer who was in charge of the development of the crystal at the research facility in Brentford where the r and d will continue to be carried out. Customers had been pressing Rank for a long time to increase its output of liquid crystals to avoid having to obtain displays from America which incurred delays and inconvenience.

Telecomms report for NEDC

With the current cutbacks of the PO's ordering having an effect on the entire telecommunication industry it is no surprise to anyone that the government is getting worried. STC, GEC and Plessey have already had to undergo the agonies of reducing staff but with the further belt tightening of the PO these companies have to undertake further amputations.

Overseas trading too has been going downhill for some time and a report has been prepared by Sir Raymond Brown for the National Economic Development Council (NEDC) on exports of British telecommunications equipment. The report will not be considered until the next NEDC meeting early this month, but it does make some strong recommendations to boost Britain's telecomms industry.

Within the last ten years Britain has been toppled from its first place in the world market in telecommunications to fifth. Although system X is still in its infancy it could help to put Britain back at the top of the tree. It needs to be designed with exports in mind and to be ready as soon as possible to catch the markets of the developing countries whose telecommunication standards have not yet been established.

Sir Raymond, in the report, sees three major issues which have to be faced if Britain has any chance of winning significant contracts. They are, to produce an export marketing strategy which will guide the development; improve the relationship between the PO and the supplier and to investigate the structure of the supplying industry.

He also made three recommendations related to improving exports. The first was to set up a Telecommunications Export Corporation which would be similar to the Defence Sales Agency. The second recommendation was the rationalisation of the three publicly owned telecommunication consultancies—Cable & Wireless, International Airadio and Millbank Technical Service. Finally the implications of these developments on the supply of equipment to the PO should be considered.

Vero sets up new company

Vero has set up another company within its group called Vero Systems (Electronic) Ltd. The company is intended to bring together the equipment division and the assembly and wiring division from two of Vero's other companies.

The new company will be installed in a modernised factory in Southampton and will distribute wire wrapping tools and equipment on behalf of OK Machine and Tool Corporation, together with other production aids such as automatic test equipment.

The company will also be responsible for the marketing of numerically controlled printed circuit board drilling and routing machines.

Also another company trying to lift itself out of the economic gloom is Computer Instrumentation which is embarking on what it calls a programme of enlarging its own system capability. In order to achieve the increased business the company is looking for, restructuring of the marketing organisation at senior level has occurred in the computer systems division.

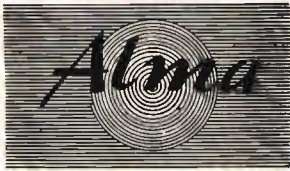

HIGH CURRENT REFERENCE RESISTORS

NEW HCRR range

To supplement low value wirewound precision resistors utilised as current shunts or for current monitor/control applications.

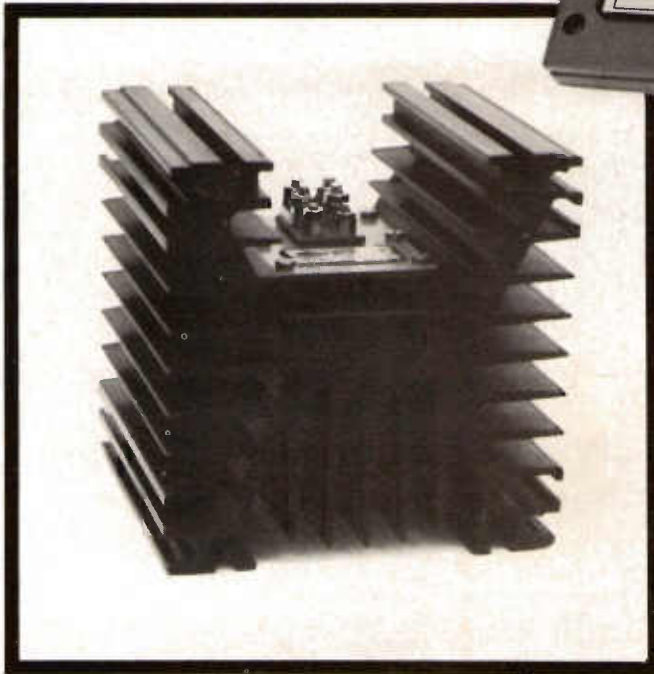

Manufactured in a sandwich for mounting on heat sink together with solid state power devices, or permanently laminated to a self-contained heat sink section.

Designed to meet special low value/high current requirements having small overall variations arising from self-heating and ambient temperature changes. Combines the low temperature coefficient resistive alloys especially selected for each requirement, with low internal thermal resistance to minimise the effective temperature gradient within the construction.

TYPICAL DESIGN CONSTRUCTION

TCR	40ppm/C°	10ppm/C°
Dissipation	1 Watt/100(mm) ²	1 Watt/25(mm) ²
Range of Values	29100 milliohms	
Tolerance	±2% to 0.5%	
Stability	Better than 0.1% per annum	
Insulation	100V test between resistive element and heat sink	
Inductance	Low inductance and pick up from external fields	

Please send for further details and data sheet

ALMA COMPONENTS LIMITED
Park Road, Diss, Norfolk Telephone Diss 2287
Telex 98162



05-29 and C.A.A. Approved
Inspection

The All-Electronics Show

19~21
April
1977

Already The All-Electronics Show invites you to put your stamp on the event.

The All-Electronics Show opens its doors for its second year on 19th April 1977. An annual exhibition held at London's Grosvenor House hotel in Park Lane, it is open to visitors from 10.00—6.00 daily for three days and is sponsored by *Electronic Engineering*.

Already the organisers have received many requests from people for tickets to visit the exhibition.

Said Samantha Clarke, Administrative Director, "Part of our success last time can be attributed to the fact that we invited the industry to attend free of charge—so long as they registered in advance.

"The same applies this year. In return for a postage stamp and a completed coupon we will send applicants a free season ticket... as well as an extra one for a colleague.

"Without a ticket admission on the door will be 50p.

The exhibition attracts both large and small companies alike with its philosophy that no exhibitor may overshadow another—no matter how big a name it is. All exhibiting companies have the same style of shell stand and floor area allowed to each company is strictly limited. With this system it is easy for visitors to see everyone and everything in one day without a route march, and without becoming absorbed into the background of large stand building.



The view exhibitors received from the Great Room Balcony just before the exhibition was opened.

STOP PRESS: The most recent companies to take stands are: Thomson CSF, Wavetek and Farnell.

One criticism levelled at the show last year was that exhibitors in the Ballroom were not easily found by visitors. This has been remedied for the 1977 event by altering the main entrance to the exhibition to make it directly opposite the Ballroom, thus ensuring a much smoother flow of traffic around the exhibition areas. There will also be greatly improved signposting and lighting in connecting corridors between the two exhibition halls.

As the name implies, The All-Electronics Show has exhibitors from all fields of the electronics industry and really does offer something for everyone. But bearing in mind the fact that it is the only major showcase for instrument companies in London in 1977 there will be a large representation from the instrumentation sector of the industry, including Fluke, Farnell, Tektro nix, Pye Unicam and J J Lloyd.

It is never easy to know whether or not a new exhibition will be successful, but the fact that the majority of the exhibitors at the first event have re-booked puts it well on the road to a successful future.

There are still a few stands available, and if you are interested in taking one for your company, telephone Samantha Clarke on Saffron Walden (0799) 22612 and she will give you full details.

I enclose a 6½p stamp to cover second class postage and I look forward to receiving my ticket to The All-Electronics Show.

NAME

Attach stamp by its corner here. "Please: no stamp, no ticket."

POSITION

COMPANY

ADDRESS



Have you booked your

intel

microprocessors workshop

INTEL SBC SYSTEMS WORKSHOP

The Intel range of single board computer products offer tremendous cost and time advantages to the Original Equipment Manufacturer; this course covers the selection of level of integration i.e. single board, crated boards or fully packaged, system configuration, I/O and power supply requirements, standard and custom software design. Demonstrations and student exercises feature the SBC80/10, SBC80/20, crated systems, PROMPT 80 and SYSTEM 80/10. Supporting development and maintenance hardware (MDS, ICE etc.) will be discussed, and available software packages including CORAL 66 may be demonstrated.

Intel SBC Systems Workshop (2 days £80+VAT)	January	12/13
	July	6/7
	November/December	30/1

and your Coral 66 Compiler Workshop

GEC SEMICONDUCTORS WORKSHOP DATES FOR 1977

RCC 80 (3 days £110+VAT)	March	8/9/10
	June	7/8/9
	November	22/23/24
Intel 8085/8080A (3 days £110+VAT)	February	22/23/24
	May	10/11/12
	October	11/12/13



GEC
SEMICONDUCTORS

GEC Semiconductors Limited
East Lane Wembley Middlesex HA9 7PP
Telephone: 01-904 9303 Telex 923429

7 on enquiry card

(The Meaning of Sprague Leadership; a series)

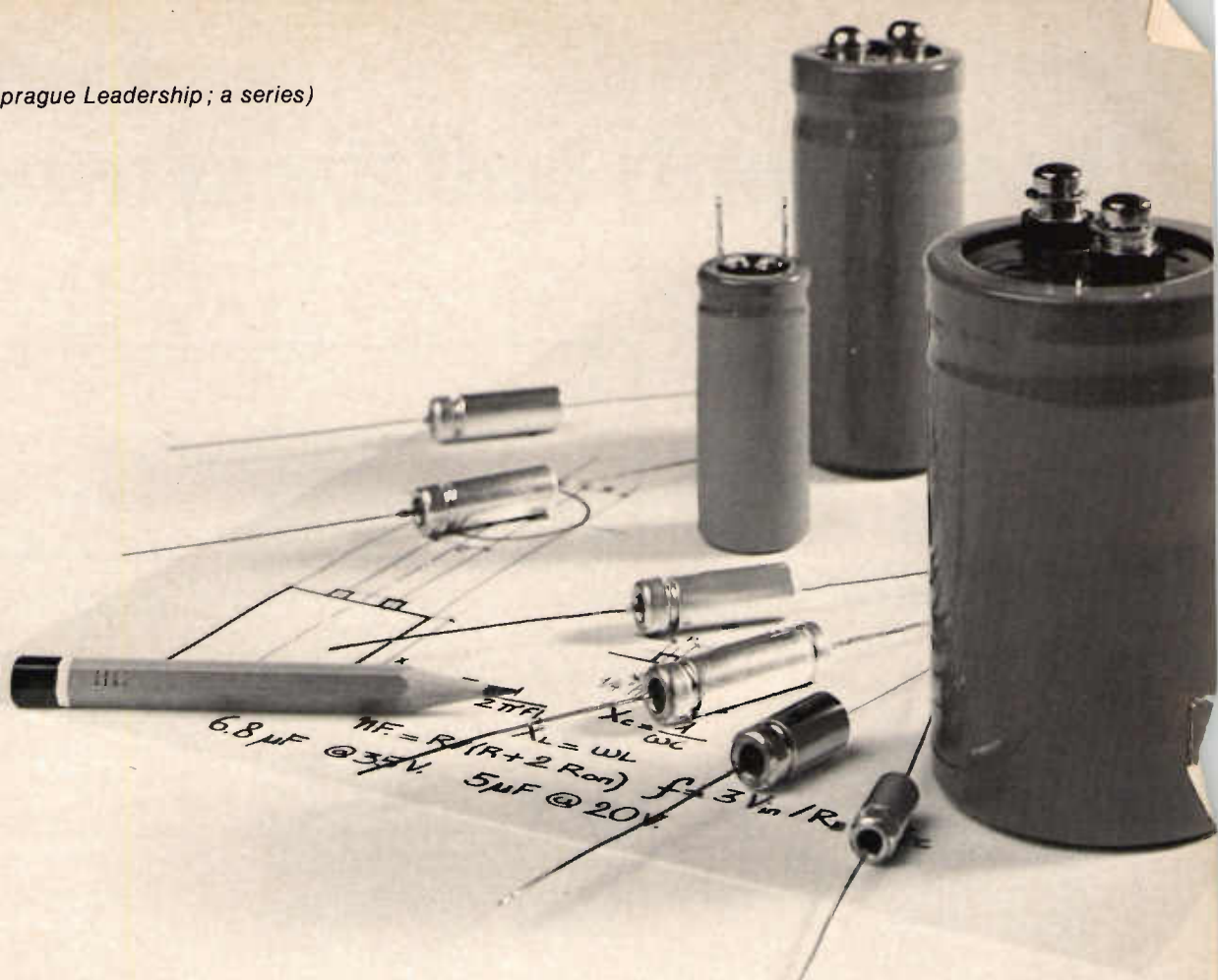

SPRAGUE LEADERSHIP: COMPONENTS ADAPTED TO CUSTOMER REQUIREMENTS

On the surface ... no more than you'd expect of any serious component manufacturer. Yet, there is decidedly more to this statement than meets the eye.

That's because, although many manufacturers are willing to go to the wall these days to meet customer specifications, non-standard components – especially when ordered in small quantities – can still cost the earth.

On the other hand, SPRAGUE's broad line capability in Electrolytics, Ceramics, and Semiconductors usually allows us to supply one of our catalogue items.

Or, we may be able to suggest a slight design modification which will also permit utilisation of a standard component – without sacrifice to customer production or performance requirements.

Exceptionally, certain applications call for a customised product. In these instances, our engineering specialists, drawing upon their in-depth knowhow and SPRAGUE's advanced State-of-the-Art, can be relied upon for a practical solution.

This combination ... the right people – the right product ... means leadership. SPRAGUE LEADERSHIP in service to our customers.

All inquiries, on any aspect of this advertisement, should be addressed to: Mike Jones, Sales Manager, Sprague Electric (UK) Limited, 159 High Street, Yiewsley West Drayton, Middlesex. Telephone W. Drayton 44627, telex 261524.



Until now, bought only half the synthesized

Now Racal Instruments bring you a new concept in signal generation—the 9081. Take a good look at its features and see why this Synthesized Signal Generator will become the standard by which others will be judged.

The 9081. Synthesized precision and analogue tuning from 5-520 MHz

You set the output frequency by means of conventional analogue tuning controls. Once you've selected the appropriate frequency range you simply spin the main tuning control and stop it when the display shows the desired frequency. No longer is it necessary to adjust a formidable array of decade switches.

When tuning has been completed the output is automatically locked to an ovened crystal oscillator which



control that gives the 9081 a continuous tuning capability—something quite new in a synthesized instrument. And even when using this facility the output signal is still locked to a crystal oscillator and has a stability at least one order better than any analogue generator.

You don't need a frequency meter to check the output, because we've built in an l.s.i. counter that continuously monitors the output frequency and updates the eight digit l.e.d. display. So you are always

The 9081. Channelised tuning

In channelised radio communications the need is to generate precise spot frequencies separated by internationally agreed channel spacings. With the 9081 this couldn't be easier. In fact, it takes just the flick of a switch. Simply select the channel spacing you require, tune to the first channel frequency and press the step switch for the next channel. You can then step up or down through the entire frequency band one channel space at a time. Very fast, very simple, and with guaranteed synthesized precision all the time. We've provided all ten channel spacings between 5 and 60kHz so you can use the 9081 wherever you're based.

The 9081. Automatic Output Levelling.

As you'd expect in a top quality signal generator, the 9081 includes automatic voltage levelling to maintain the output amplitude substantially flat over the whole frequency range—typically within $\pm 0.5\text{dB}$ in fact. There's an accurate switched attenuator and a vernier control which provide an output range from -130dBm to $+3\text{dBm}$. So you can vary the output amplitude from $0.7\mu\text{V}$ up to 316mV into 50Ω .

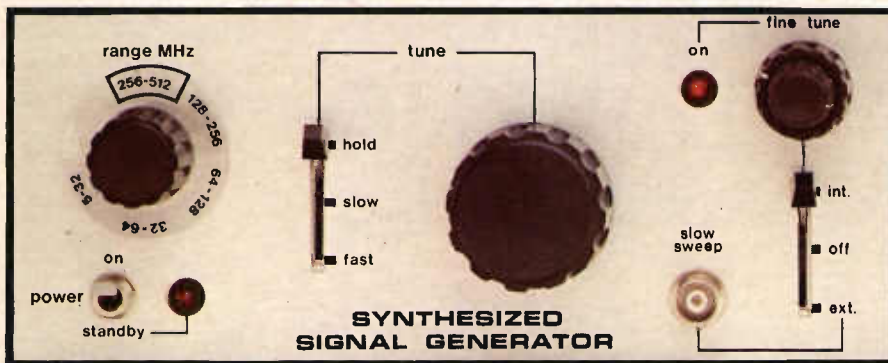

has a very fast warm-up and a stability of better than ± 3 parts in 10^9 per day. You can forget about the usual add-on extras such as synchronizers or lock boxes—they're just not required.

There's also a fine tune vernier

to let you select exactly what frequency the 9081 is generating. The counter has a maximum resolution of 10Hz at all frequencies and derives its high accuracy and stability from the same internal frequency standard used for the synthesizer.

- 5 to 520 MHz
- Synthesized Performance—Analogue Tuning
- Channelised or continuous operation
- Stability ± 3 parts in 10^9 per day
- AM, FM and Phase Modulation
- Output automatically levelled

£1995 Signal Generator you wanted.

The 9081. Comprehensive modulation facilities

Full a.m., f.m. and phase modulation facilities are provided to enable you to check most types of radio communications systems. The r.f. output can be modulated either at the fixed 400Hz, 1kHz and 5kHz frequencies provided by the internal oscillator or at other frequencies up to 100kHz if you use an external source of your own. In both cases the front panel meter gives a clear indication of modulation depth, frequency deviation or phase deviation according to the type of modulation being used.

9081 has a simultaneous modulation capability. That means you can modulate with a.m. in combination with either f.m. or phase modulation. And you can use internal or external oscillators to do it.

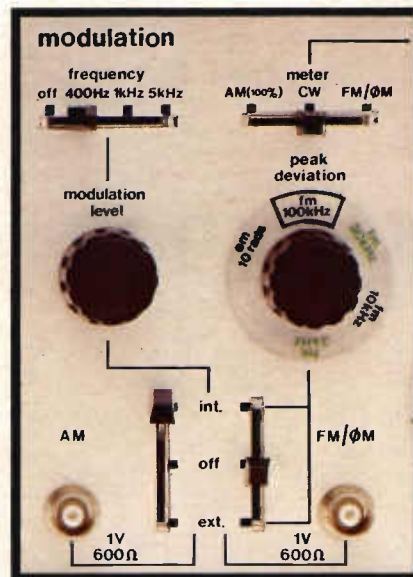

The 9081 is ruggedly constructed for high performance in both field and laboratory roles. It doesn't just look good. Designed to meet recommended European safety standards and built to satisfy military environmental specifications, the 9081 measures only 133mm x 408mm x 445mm, weighs a mere 13 kg and is readily portable. It's an easy to use, fast to tune, high precision synthesized signal generator and is unique. In fact, the 9081 is unbeatable.

Still need convincing? Why not write today for a copy of our brochure which will give you all the technical details?

Racal Instruments Limited,
Duke Street, Windsor, Berkshire,
SL4 1SB, England.
Telephone: Windsor 69811
Telex: 847013

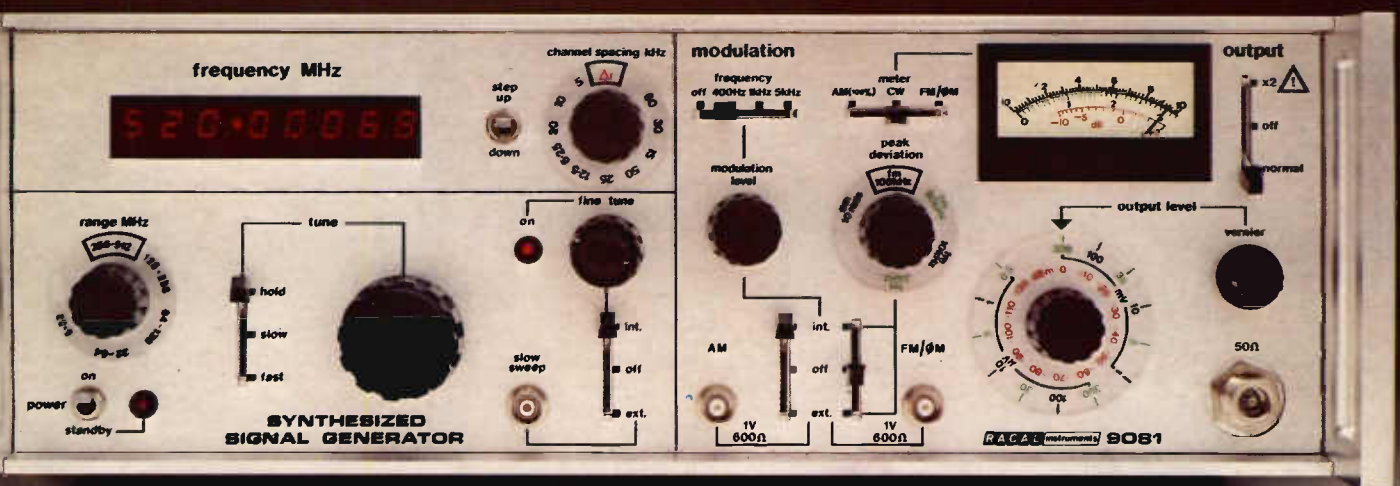

9081 The complete synthesized signal generator from Racal Instruments

You can't integrate POWER! (better than I.R.can!)

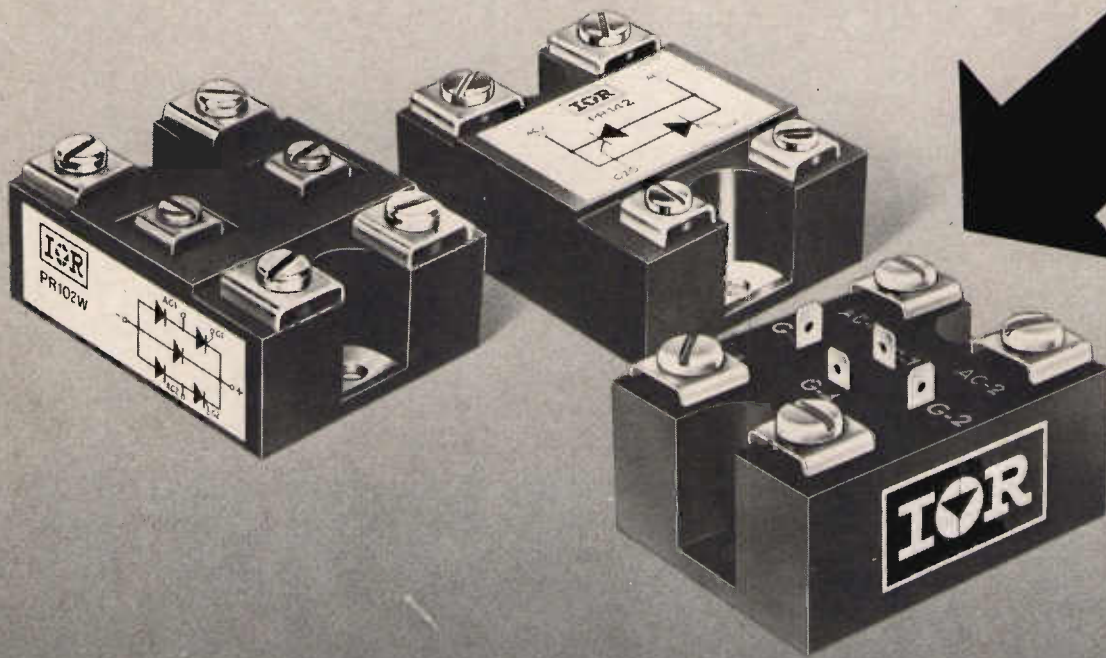

The trouble with all power semiconductors is that they dissipate heat. Lots of it. This severely limits the amount of integration achievable on one semi-conductor chip. We managed it with our ACE gate thyristors, with our triple diffused power darlington, and with our range of triacs, but we compromised when it came to the power circuit. I.R.'s 'PACE/pak' power circuits consist of power semiconductor chips mounted on metallised alumina or beryllia substrates and aluminium sub-heatsinks, totally encapsulated to form a rugged, compact, isolated, ready built power module.

You'd be surprised at the variety of standard circuits available, (anti parallel, half controlled or full controlled thyristor bridges up to 100 Amps rms), and even more surprised at the "specials" we can tackle.

While we're on the subject, don't solid state relays, encapsulated bridges and h.v. rectifier modules all count as integrated circuits.

Who said you can't integrate power? I.R. CAN!

INTERNATIONAL RECTIFIER

HURST GREEN OXTED SURREY RH8 9BB TELEX RECTIFIER OXTED 95219 TELEPHONE OXTED 3215/4231



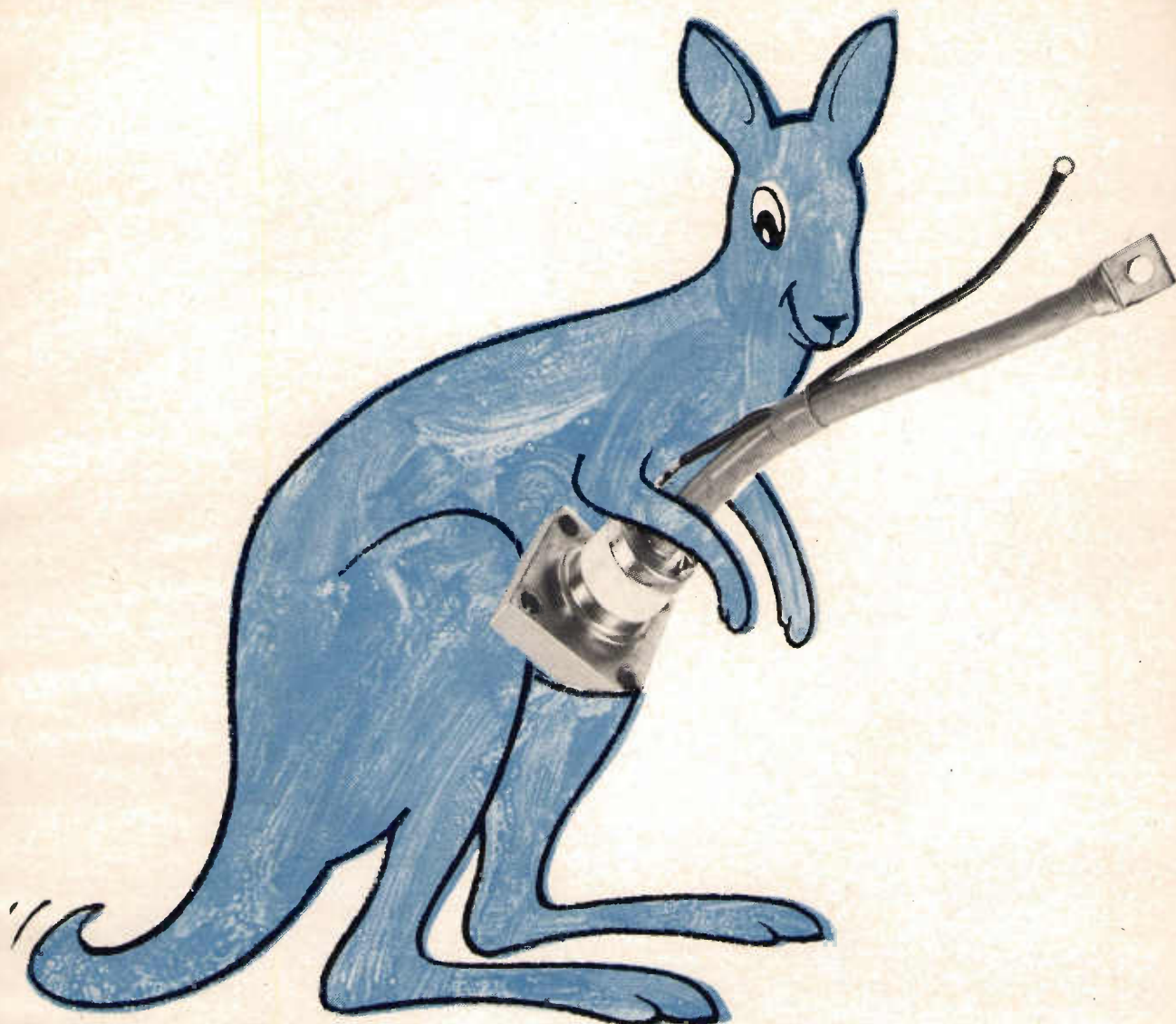

The future in our pocket.

We've always had good products. Now we've got our service in step too – with processing of orders, stock availability and delivery all one jump ahead.

That leaves us the precious time to spot new trends and new problems in circuit requirements... and do something constructive about satisfying new demands with new approaches and new devices.

Keep an eye on Westcode. We've got the future in our pocket.

Semiconductor Division, Westinghouse Brake & Signal Co. Ltd. Chippenham, Wilts. SN15 1JD.
Tel: Chippenham (0249) 4141. Telex: 44751.

WESTCODE

Westcode is a registered trademark of Westinghouse Brake & Signal Co. Ltd



—ONE JUMP AHEAD

VITAL STATISTICS OF THE WT4300 TRANSISTOR

Look at them closely enough and you'll begin to get ideas... design ideas that will put the future in your pocket. For example, just think what you could do with an $I_{c(\text{peak})}$ of 375A combined with a V_{CE} of 100 V in a single diffused transistor – and these are not calculated values, they result from tests in our own labs under worst case conditions. There's a low $V_{CE(\text{sat})}$ which is useful when switching at low frequencies. It's very tough, with excellent resistance to thermal fatigue. And its high current rating means that it is more economic to use than multiple transistors in parallel. Which means greater reliability and easier maintenance... it's time you wrote off for the data sheet.

UK STOCKIST DISTRIBUTORS: Consort Power Sales Ltd., Rosebank Parade, Yateley, Surrey. (0252) 874075. Telex: 858809; Semicomps Northern Ltd., Kelso, Scotland. Kelso 2366. Telex: 72692; G.D.S. (Sales) Ltd., Slough, Berks. (0753) 30211. Telex: 847571; Harmsworth Townley & Co. Ltd., Todmorden, Lancs. 070-681 2601.

Ferranti transformers.

Ferranti Professional Components Department have the capability of producing a wide range of precision transformers and inductors to meet the most demanding specifications.

We have the top people in design and development, the most modern production facilities and a total

commitment

to quality.

So it's not surprising that

Ferranti signal, power and pulse transformers are specified for advanced military projects such as the Tornado (MRCA), maritime Harrier



where the action is.



and Sea King helicopter, as well as the Type 21 frigate and Chieftain battle tank. In addition, we supply transformers for Concorde, microwave communication links and computers.

Our capability meets the requirements of the Ministry of Defence, and



we are a defence registered contractor to DEF STAN 05.21. We also meet the requirements of British Standard 9000. Why not send for our new transformer brochure, which tells you quite a lot more about our capability and our wide range of quality transformers.

Contact Transformer Sales, Ferranti Limited, Professional Components Department, Dunsinane Avenue, Dundee DD2 3PN, Scotland. Telephone: 0382 89321 Telex: 76166.

FERRANTI

Professional Components Department

11 on enquiry card



Hewlett-Packard's new Model 436A combines three important advantages: low VSWR thermocouple sensors; high instrumentation accuracy; and simplicity of operation.

A significant advance in Microwave Power Measurement

Model 436A is a general purpose power meter with a frequency range of 100kHz to 18GHz, and a power range of -70dBm to +35dBm depending on the sensor used.

The low VSWR of the HP8480 family of sensors with which this meter works (8481A - less than 1.1 from 50MHz to 2GHz, and less than 1.28 to 18GHz), and its 0.5% instrumentation accuracy, lead to RF and microwave power measurements of very high precision.

Read power in the units you choose

Push-button operation and digital display make the 436A easy to interpret and easy to use in any application. Mode switches allow you to read absolute power in either watts or dBm, and relative power in dB. Its auto-ranging capability allows for hands-off operation.

Automatic sensor recognition

The 436A automatically recognises which sensor is connected to it, displays the correct power units, directly and accurately.

Remote programming

Two programming interfaces are available as options on the 436A: the Hewlett-Packard Interface Bus (HP-IB) and a BCD interface, both of which allow full remote control of the meter's functions.

With the new 436A mismatch uncertainty is minimised while accuracy and simplicity are greatly increased - a significant advance in microwave power measurement.

You ought to get the details

Just write to Hewlett-Packard Ltd., Enquiry Department, Winnersh, Wokingham, Berks. RG11 5AR.



HEWLETT  PACKARD

Sales and service from 172 offices in 65 countries.

Integral cycle thyristor control using a multiplier

Integral cycle firing of thyristors is now an established method of heater power control. The advantages of the method proposed here are that the control signal is digital and the conducting cycles are evenly distributed in time.

Since each half-cycle of the supply corresponds to a fixed discrete pulse of energy, the number of such pulses per second represents the power. The mean power is proportional to the mean pulse frequency, i.e., a form of pulse frequency modulation of the power occurs. The binary rate multiplier (brm) provides a very simple method of achieving this. A train of pulses co-incident with the zero-crossings of the ac supply is generated and fed into the brm. The output from the brm is a

series of pulses (also co-incident with the supply zero-crossings), the average frequency of which is proportional to the digital input to the brm.

Figure 1 shows how the brm clock frequency, f_i ($= 100$ Hz), is generated using simple squaring and pulse conditioning circuits. Separate pulse trains are obtained for the positive-going and negative-going zero-crossings and then *ored* to produce f_i . The pulse width is determined by the capacitors C. The value used here was $1 \mu\text{F}$, giving a pulse width of 0.6 ms. The control input to the brm is a 6-bit parallel binary signal (x), the decimal equivalent (x) of

$$\sum_{n=0}^5 x_n 2^n \text{ where } x_n$$

= zero or one. This signal was generated using toggle switches. The brm output feeds directly into a conventional thyristor firing circuit, having two isolated outputs. The average frequency of the brm output is given by

$$f_o = \frac{x}{2^6} f_i$$

The average power in the load can be varied in steps of $\frac{P_m}{64}$ from zero to $\frac{63 P_m}{64}$, where

$P_m =$ full power. Figure 2 shows the brm output pulse train and the load voltage waveforms for values of $x = 28$ and 48 .

The circuit was used to control the power in a 3-kW heater element in a temperature control system and was found to be satisfactory in every respect. However, for purposes of evaluating the system more fully, a

simulation was used. Here it was assumed that each energy pulse was square, having an amplitude $= P_m$ and a duration $= \frac{1}{2}$ of supply period (10 ms). This waveform was readily obtainable. The thermal system was simulated by a simple RC low-pass filter, the time constant of which could be varied readily. It was found that, for a given time constant, the peak-to-peak ripple in the filter output was substantially constant over a wide range of x . This differs from other systems where a large variation in the level of ripple occurs as the power demand signal is varied. Compared with a burst firing system having the same control resolution, the maximum level of ripple is reduced by a factor of 7 approximately. *E P McCarthy, Salford.*

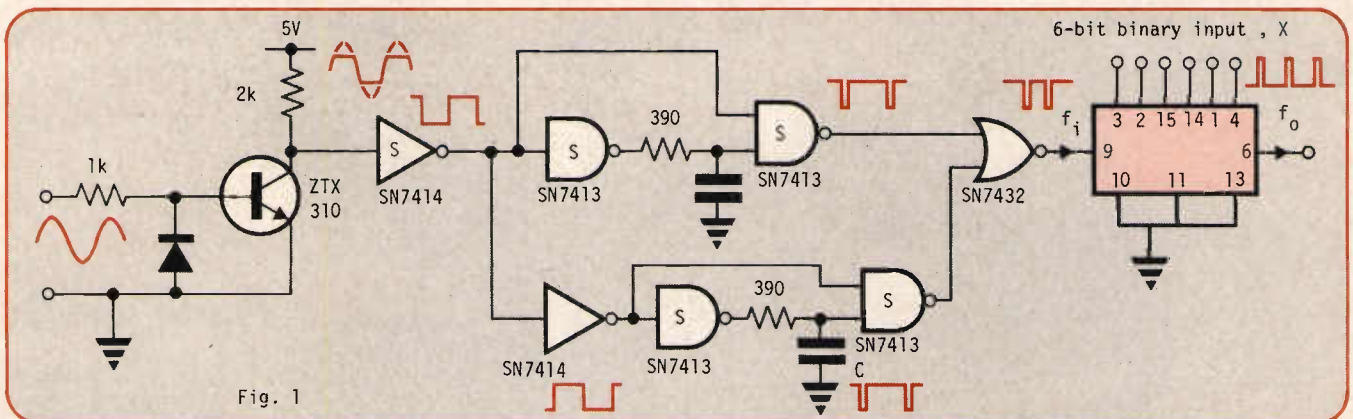

Fig. 1

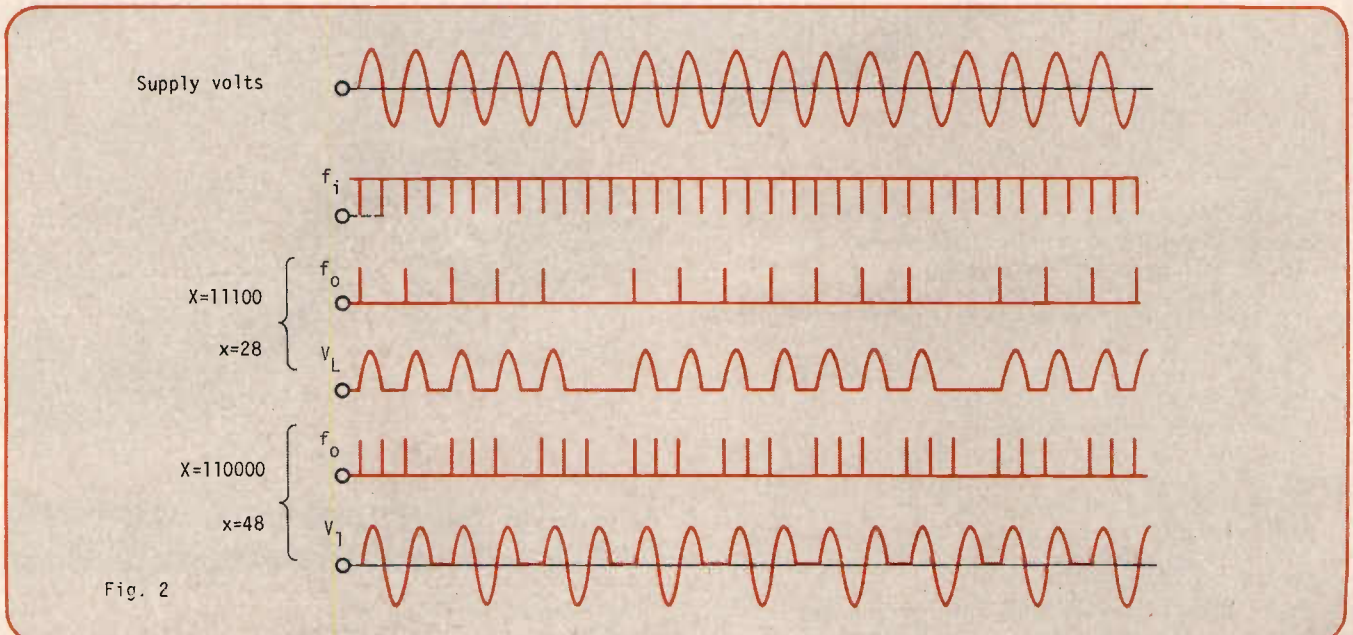

Fig. 2

The new Fluke multimeter.



Actual size.

Actual weight.

See how small the new Fluke 8030A digital multimeter really is.

It's that size because that's the way field service engineers wanted it. Handy to fit into a tool kit or brief case. And light, too, at just over 1½ lbs.

But, although small is beautiful, it isn't everything. At least, not in the case of the 8030A.

Packed into its sparse dimensions are five ranges of a.c. and d.c. voltage and current, and resistance. And a bright, 3½-digit LED display. Plus features normally confined to its bench-bound cousins.

True r.m.s. readings on all a.c. ranges, for example. So, power supply circuits and distorted waveforms hold no secrets from the field service engineer.

And the 8030A's unique 'diode test' capability, as well, which allows him to check the state of a semiconductor junction. In situ. On site.

We have a saying at Fluke: big instrument — big performance; little instrument — all performance.

And that, appropriately condensed, is the new 8030A. Which is surely what a field service instrument should be all about.

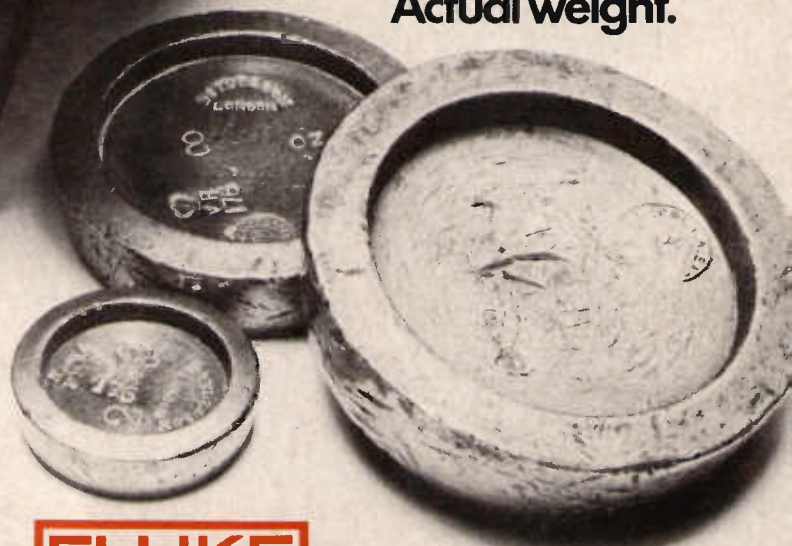

FLUKE

ITT instrument services

Exclusively available from:
ITT Instrument Services, Edinburgh Way, Harlow,
Essex CM20 2DE. Tel: Harlow (0792) 29522. Telex: 81146.
Fluke International Corporation, Garnett Close, Watford
WD2 4TT. Tel: Watford (0923) 33066. Telex: 934583.

Constant amplitude triangular wave generation

Voltage to frequency converters generally have square waves as their output wave shape. For transmission (as in outputs from underwater sensors) the square waves are usually converted to sine waves.

The use of fets to convert triangular to sine waves requires the triangular waveforms (derived from the square wave) to be biased at zero volts and with variable amplitude.

The simple circuit shown in Figure 1 produces constant amplitude triangular waves from a square wave. The basic integrator circuit has already been published¹ and is adopted here.

The closed loop circuit has a common integrator circuit whilst the peak rectifier, difference amplifier and switch are duplicated, one set each for the positive and negative ramps.

Assuming that the operational amplifier has high input impedance and large open loop gain, the positive peak voltage output from the integrator, V_R , will be equal to the set point voltage to difference amplifier. The same is true for the peak negative voltage.

The timing diagrams for the circuit at points A, B and C are shown in Fig. 2. The input square wave is applied to

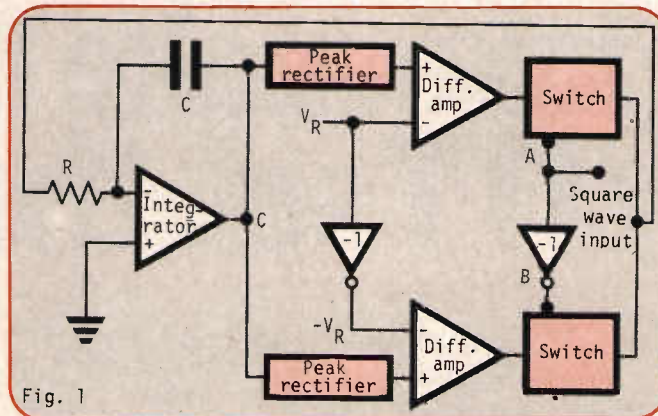

Fig. 1

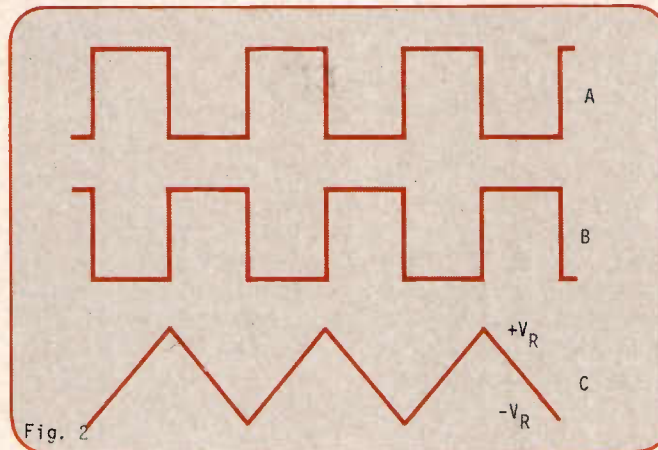

Fig. 2

switch 1 controlling the positive ramp. This ensures that the path to the integrator is closed during the first half cycle and opened during the second half. The inverted input is applied to switch 2 to work in a similar but phase reversed manner.

The peak rectifiers can be replaced by sample and hold circuits if a higher dynamic response to varying frequencies is required. The set point voltages, V_R , and $-V_R$, are obtained from the same voltage source using an inverting amplifier or they may be set independently for different peak levels. The switches could be both n-channel fets or an n-channel and a p-channel. In the latter case the inverting circuit is not required.

To compensate for different values of $R_{ds(on)}$ of the switches a small resistor may be placed in series with either switch to ensure that the positive and negative ramps have identical slopes.

Ehrlich Desa and P E Sankaranarayanan, Dona Paula, PO, Goa, India.

Reference

1. Sankaranarayanan, P E, Constant Amplitude ramp generation with op-amps, *Electronic Engineering*; p.19; September, 1974.

Seven segment to bcd converter uses standard ttl

This solution to the conversion of seven segment to bcd uses only five standard ttl chips and is a cheap solution. In the circuit of Fig. 1, a three or four bit unique term is formed from the seven bit code corresponding to each decimal number zero to nine. The bcd code is then encoded using unique terms. These terms and the relevant output equations are in table 1. *V T Chandrasekar and R Ramadurai, Bangalore, India.*

UNIQUE TERMS	OUTPUT EQUATIONS
0 = EFG	$P = BEFG + AB EF$
1 = AFG	$Q = BF + AEF + AFG$
2 = EFG	$R = EG + BEF + AFG$
3 = EFG	$S = E + AEF$
4 = AEF	
5 = BEF	
6 = BEF	
7 = AFG	
8 = BEFG	
9 = AB EF	

Decimal No.	SEVEN SEGMENT CODE							BCD CODE			
	A	B	C	D	E	F	G	P	Q	R	S
0	1	1	1	1	1	1	0	0	0	0	0
1	0	1	1	0	0	0	0	0	0	0	1
2	1	1	0	1	1	0	1	0	0	1	0
3	1	1	1	1	0	0	1	0	0	1	1
4	0	1	1	0	0	1	1	0	1	0	0
5	1	0	1	1	0	1	1	0	1	0	1
6	1	0	1	1	1	1	1	0	1	1	0
7	1	1	1	0	0	0	0	0	1	1	1
8	1	1	1	1	1	1	1	1	0	0	0
9	1	1	1	1	0	1	1	1	0	0	1

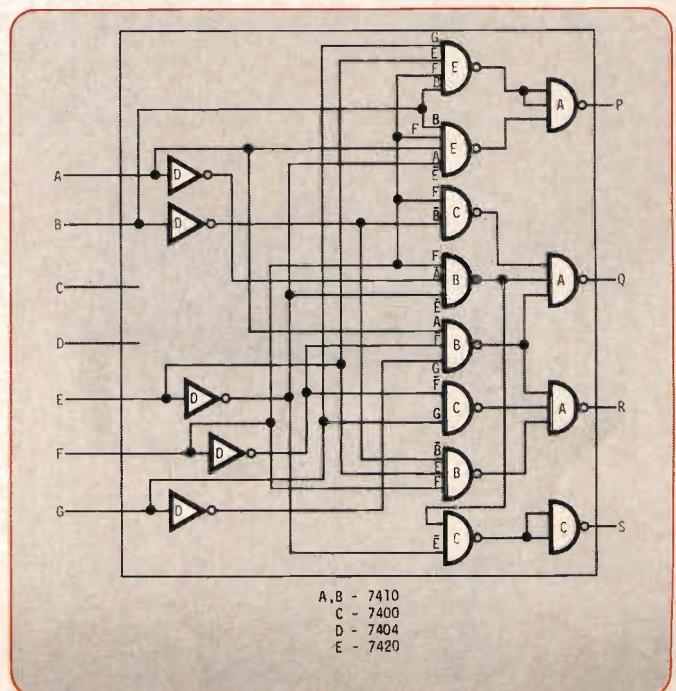

A, B - 7410
C - 7400
D - 7404
E - 7420

New portable DMMs.

Only Fluke make them- only ITT sell them.

New Fluke DMMs Fluke have introduced two new digital multimeters. That is big news in itself, because when you are already producing the best selling instruments on the market, how do you bring off another success? The answer has been to take an outstanding specification and shrink it into a truly portable instrument.

True RMS a.c. This is the most important feature – especially when you realise that it is incorporated in a battery operated instrument that measures less than 6 x 5 x 2½ in. and weighs only 2½ lb. It means that you can take lab. quality measurement out in the field, free from the shackles of size, weight and power points.

Two versions – 8030 & 8040 Both models offer five ranges over

five measurement functions and include autozero. The 8030 is a 3½ digit instrument with a useful diode test facility. The 8040 has 4½ digits and incorporates autoranging.

The only way to buy Both these briefcase sized DMMs are available from ITT Instrument Services; and from nobody else, not even from Fluke. Which brings together the best sellers among portable DMMs and the biggest name in the instrument distribution business. That means no-delay telephone ordering, streamlined internal processing, and delivery from stock.

Ask for a spec. sheet now. Or better still, get ITT to arrange a demo. You will be more amazed by the performance than the price!

Fill in this coupon for your copy of the data sheet on the 8030 and 8040 and send it to:
ITT Instrument Services,
Edinburgh Way, Harlow, Essex.

Name _____

Company _____

Address _____

Tel No _____

ITT instrument services

The only way to buy.
Harlow (0279) 29522.



APPLIED IDEAS

Triggered switch makes sweep generator highly linear

The general method for generating linear sweep voltages is charging a capacitor with a constant current. A switch connected across the capacitor provides a discharge path at specified intervals of time or levels of the ramp. For sweeps of very large time periods the changing current is extremely small. For example, to achieve a ramp of 15 V in 3 seconds across a capacitor of 10 μ F, the current has to be only 50 μ A. In such cases a good constant current source is not sufficient, but the switch across the capacitor should have negligible leakage. In the example, to obtain a linearity of 0.1 per cent the maximum current drawn by the switch while it is *open* should not be more than 50 nA. When the sweeps are of larger periods this requirement becomes more stringent. Fig. 1 illustrates a method of generating highly linear sweeps.

R_1 is valued so that only a negligible fraction of the current is drawn by it. R_2 is of low value compared to R_1 to avoid pick-up voltages appearing at the input of the next state. R_2 is adjusted so that V_1 equals V_{ref} at the sweep maximum.

The comparator output is at negative saturation except at the instant the sweep voltages reaches the desired maximum. A fraction of the comparator output (selected by the potential

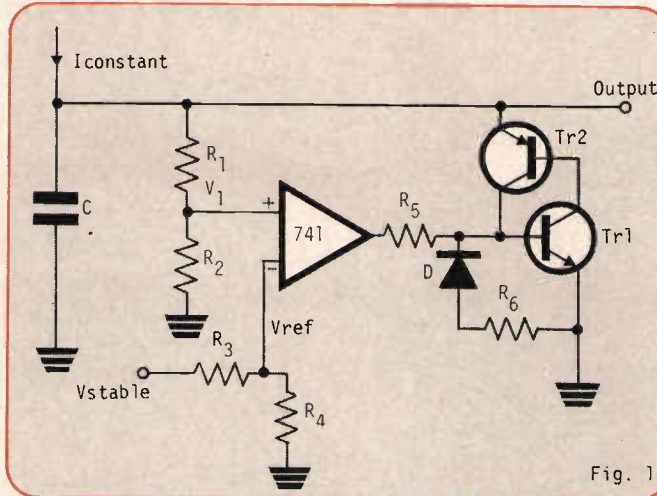

Fig. 1

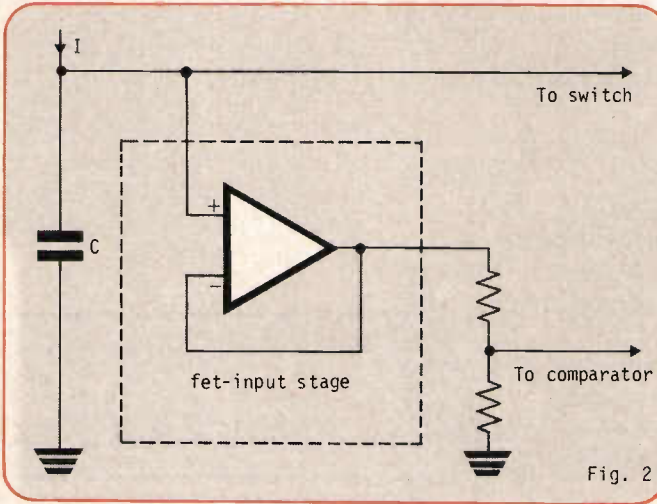

Fig. 2

divider arrangement formed by R_5 , R_6 , and the diode D) less than the BV_{BEO} of the transistor Tr1, reverse biases the npn switch *off*, allowing it to draw only few nano amps. At the instant the sweep voltages reaches the maximum, the comparator output switches to positive saturation, triggering the npn switch and offering only a few ohms across the capacitor. The capacitor quickly discharges through it. The diode D does not allow the positive output of the comparator to be divided and ensures the perfect switching *on* of the switch. As soon as the capacitor is discharged, the comparator output switches back to negative saturation. This type of perfect reverse biasing has the added advantage of eliminating the initial steep rise of the ramp.

With $C = 25 \mu$ F, $I = 125 \mu$ A, $R_1 = 15$ Meg.ohm, a linearity of better than one per cent could be obtained.

For sweeps of very large periods, extending over minutes, it is necessary to operate at still lower currents, when the selection of R_1 becomes impractical. In such cases R_1 - R_2 combination can be replaced by an fet-input stage of very high input impedance as shown in Figure 2.

K O Rose and P R M Panicker, Trivandrum-695 022, India.

A universal sequential element provides flexibility

The SN74150 sixteen-input multiplexer can be used in conjunction with SN74S175 quadruple D-type flip-flops to implement a universal sequential element—*use*, shown in block form in Fig. 1. The *use* is a four-stage shift register with feedback via the multiplexer to the first stage. The multiplexer serves as a five variable Boolean function generator. Three data select inputs A, B and C of the multiplexer are connected to outputs X1, X2 and X3 of the shift register, while the fourth input, D, is controlled by a variable P.

The general state diagram for the *use* is shown in Fig. 2. The purpose of the diagram is to show all possible state sequences. Each state is represented by a four bit word which

is the contents (X1, X2, X3, X4) of the register. Each *next state* in the diagram can be found by shifting the *present state* one stage to the right, and letting the first stage, X1, equal *one* if the feedback is *one* and *zero* if the feedback is *zero*. The logic power of the *use* becomes evident when one realizes that

Fig. 1: Block diagram of the universal sequential element—*USE*.

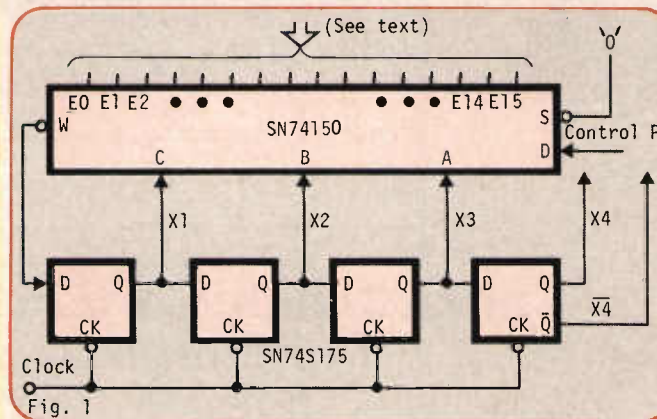
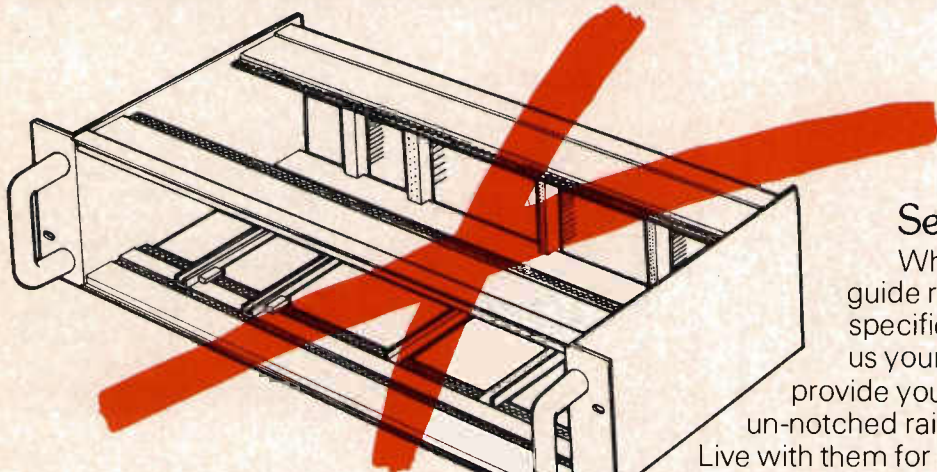

Fig. 1

two arbitrary state sequences of Fig. 2 can be produced with no additional control logic. The sequence of states and the number of states per cycle is determined by the feedback function. In order to implement desired feedback, each data input E0 to E15 of the multiplexer is connected to one of the following four signals: a logical *zero*, a logical *one*, the assertion, or negation of the X4 variable. An actually used sequence of states—one of the two prescribed—is then selected by letting the control variable, P, equal *one* or *zero*.

The input connection configuration is determined with the aid of the multiplexer input map, shown in Fig. 3. In fact it is a next-state map for the first stage of the shift register. It is

Most card frames are a waste of money.



The picture above shows a traditional card frame guide rail with location holes pre-set at the standard 0.2in pitch.

Manufacturing these guide rails is an exacting and expensive process and ironically most of the money is spent making holes or notches that you pay for but never use, which is quite clearly a waste of *your* money. This is why we have developed the guide locating system shown below.

It's the end of the line for the old 0.2in pitch and its limited increments. Now you can position your cards exactly where *you* want them without being restricted to pre-set pitches.

Send for free samples.

What we do is notch the guide rail to suit precisely *your* specified requirements. Send us your problems and we'll provide you with free samples of un-notched rails and snap-on guides.

Live with them for a few days.

When you've established the module or card position that suits *you* send us a working drawing and we'll supply rails, accurately notched to $\pm 0.2\text{mm}$, with *no* accumulation of error, at a price that's bound to please. Or, if you prefer stock items - with off the shelf delivery - we've got rails notched to standard pitches of 0.4, 0.5, 0.6, 0.625, 0.7, 0.75, 0.8, 0.9 and 1.00in.

To find out more, fill in the coupon.

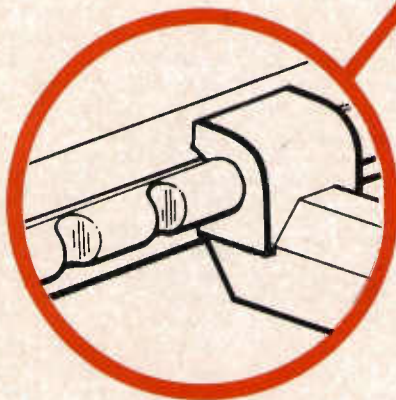
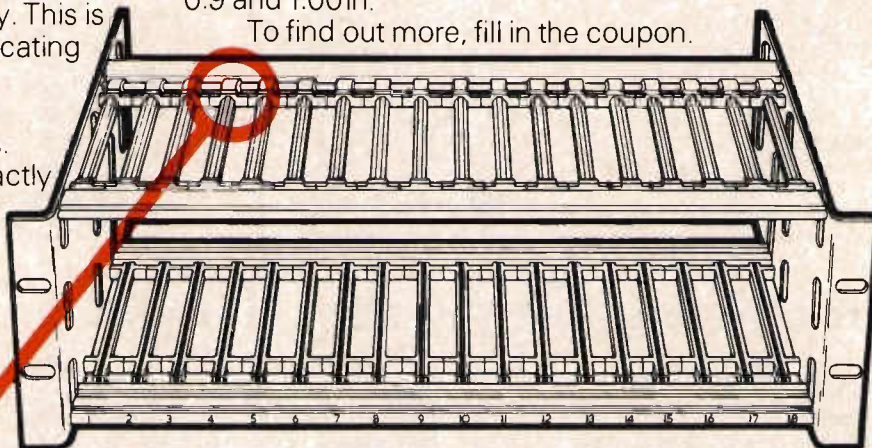

I want to know more about the unique Critchley card frame System.

Name _____

Position _____

Company _____

Address _____

CRITCHLEY
EE

Delivery ex-stock

The Critchley Card Frame System. Designed better to cost less.

Critchley Bros. Ltd., Brimscombe, Stroud, Gloucestershire GL5 2TH, England
Telephone Brimscombe (045 388) 2451 Telex 43194

convenient to label the map so that $P = 0$ identifies the first desired sequence, and $P = 1$ identifies the second. The next-state map is generated from required state sequences by finding the value of $X1$ for the next state. This value is entered in the cell under consideration in the map. When this procedure is completed, the contents of the two circled cells associated with a given input of the multiplexer determine which connection must be made to that input. Since only the inverted output of the multiplexer is available, one should comply with the following procedure. If both cells contain a zero, a logical one should be connected to the input; if both cells contain a one, the input should be connected to the logical zero. If the two cells contain a one and a zero then either the assertion or negation of $X4$ will be required. If the single one

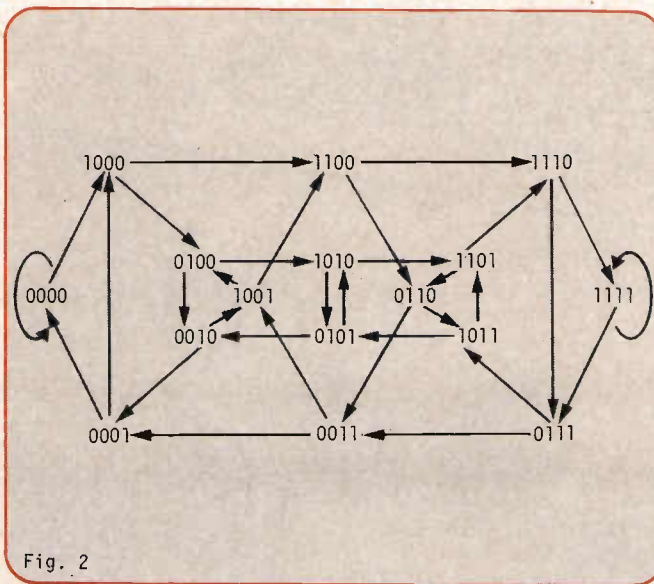

Fig. 2

Fig. 2: General state diagram for a four-stage shift register.

Fig. 3: Multiplexer input map for $A=X3$, $B=X2$, $C=X1$ and $D=P$.

Fig. 4: Logic design of the use generating two sequences.

(or zero) is located in the cell associated with the assertion of $X4$ then $\overline{X4}$ (or $X4$) is connected to that input. It should be noted that this technique can make all unused states lead to the cycle of states that is being used, so that self-starting operation is obtained.

An example of the logic design of the use is illustrated in Fig. 4. A 12-state sequence (for $P = 0$) and a 10-state sequence (for $P = 1$), e.g. such as may be required for variable modulo counters and dividers, are selected. The required state sequences are shown along with the resulting next-state map and input connection configuration.

High speed (at 50 MHz, approximately) operation of the use may be achieved with the Schottky SN74S151 multiplexer, but only one arbitrary state sequence can be generated.

WJ Szajnowski, Warsaw, Poland.

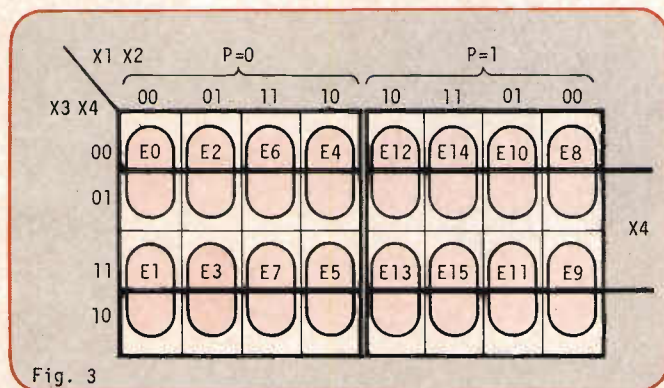

Fig. 3

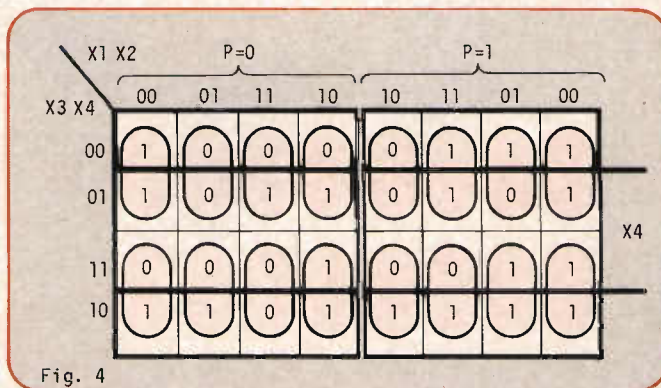

Fig. 4

Simple selective amplifier uses one 709

Most selective amplifiers with RC networks are required with high Q on a specific frequency and need critical components values as well as being complicated.

A simple circuit is shown in Fig. 1. This amplifier uses only one $\mu A709$. Frequency and Q are easy adjustable with trimms, without using exact components. The fundamental system comprises an astable multivibrator, with a negative feedback loop which determines the frequency $R_1 C_2$, and a positive feedback loop oscillation formed by $R_2 R_3$.

When the input signal is presented to either the inverting, or non-inverting input it would not fit the circuit function. That is why the input signal via C_3 is presented to pin 8 for external frequency compensation. The

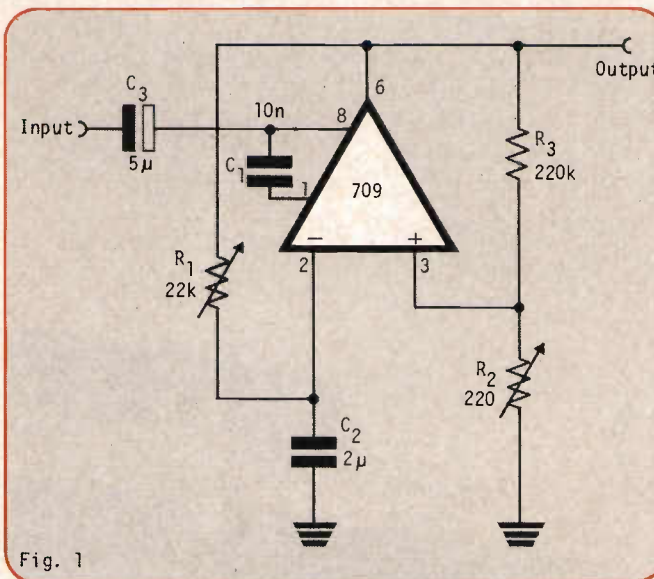

Fig. 1

compensation capacitor C_1 also determines resonance frequency. If the resistance of the signal source is sufficiently low (under about 1 k-ohm), free oscillations depending on the alignment R_2 occur and the circuit is now as a selective amplifier, whose resonant frequency is controlled by resistor R_1 and the Q-factor by R_3 . Frequency is defined as

$$f = 2,1,10^{-2} \frac{1}{\sqrt{R_1 C_1 C_2}}$$

The high cut-off frequency is defined by the properties of the ic, and is minimally 60 kHz for $C_1 = 470p$, $C_2 = 2n2$, $R_1 = 120$. Stable oscillations is only for low values resistance of R_1 , and C_1 more than 1 nF.

Vlastimil Novotny, Vokovicè, Czechoslovakia.

SPECIAL MESSAGE FOR THUMBS...

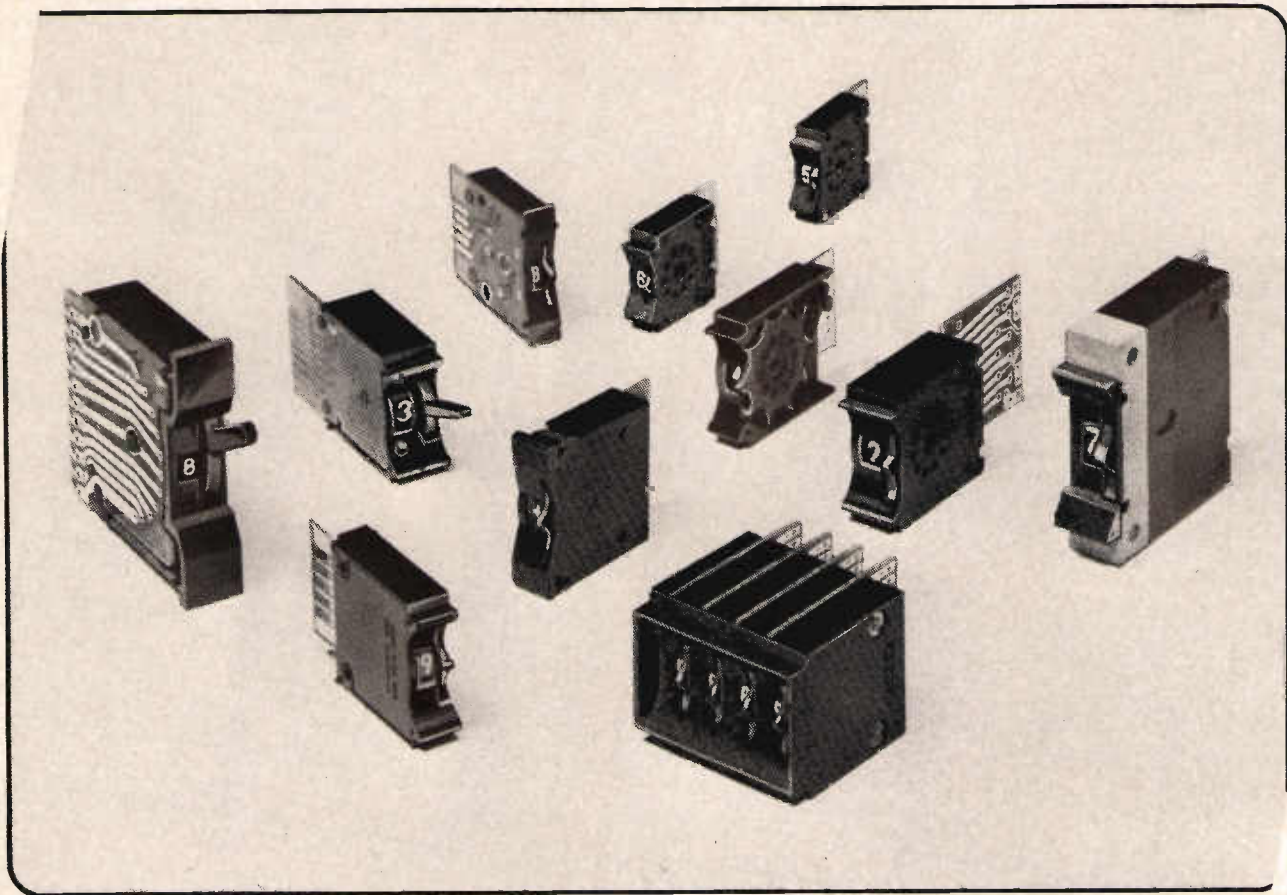

Thumbs who are not using Cherry thumbwheel and leverwheel switches are being deprived. Because Cherry give thumbs more choice. Not only in the way-out sizes, but in the popular sizes that are in everyday use. Cherry also give more quality. With top grade circuit boards, gold alloy contacts, 'clean' in-house mouldings, large digits and reliable action. You can choose between gloss finish, or a mat finish that is moulded in. There are a big selection of end caps and spacers so you can customize your control unit to suit your panel. Or we can do it for you. An additional bonus is that many of our switches are available in thumbwheel or leverwheel versions. Some of our latest refinements include sealed windows or totally sealed units, illuminated digits, R.F. screening and back mounting facility. For all the facts get in touch. *Got the message?*

CHERRY



CHERRY ELECTRICAL PRODUCTS LTD., ST. ALBANS INDUSTRIAL ESTATE,
ST. ALBANS ROAD, SANDRIDGE, HERTS. AL4 9BP
Tel: ST. ALBANS (STD 0727) 68231. TELEX: 28894

APPLIED IDEAS

Timer for low frequency oscilloscope

When extremely short duration pulses occur among low frequency signals it often becomes necessary to make them visible on the oscilloscope.

By using the circuit of Figure 1 these pulses can be seen on low frequency oscilloscopes and at low frequency measuring. This is achieved by increasing the

pulse-length.

During the *one* state of the JK latch, the master acts as a T latch, and its information appears at the latch output when the level of the clock-pulse goes *low*. The Schmitt-trigger oscillator and the RC circuit gives negative clock-pulses. The extremely short duration pulses

which appear between the two clock-pulses inverts the master which, for the duration of a clock-pulse will be written over to the slave. In this way it creates a 2 μ sec wide pulse which is easily seen on the oscilloscope. Otherwise the JK follows the incoming signal.

The frequency of the oscilla-

tor is chosen so as not to cause significant time-delay on the oscilloscope screen. This type only imposes one load for the measured circuit, and because it is only a few cms away from the point to be measured, it is suitable for the detection of extremely short duration pulses.

Deáki Tibor, Budapest, Hungary

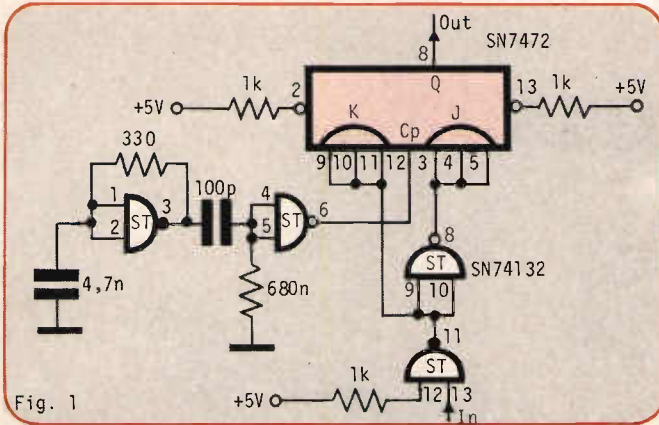

Fig. 1

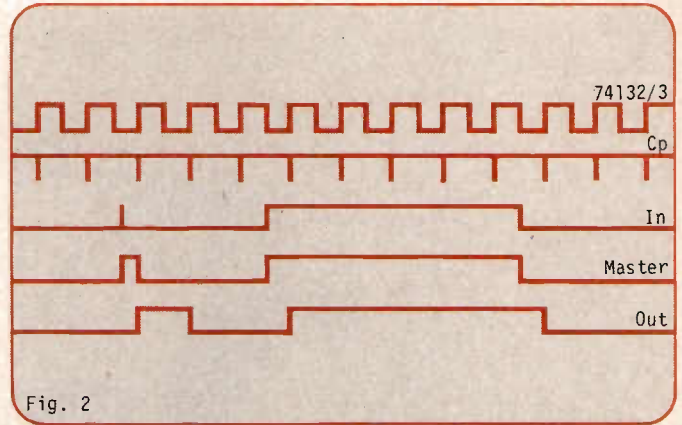

Fig. 2

Pulse subtractor for frequency synthesis

In some systems of frequency synthesis [1,2,3] we face the problem of removing pulses from a pulse train. The difficulty with coincident gate circuits is the proper timing of the suppression process, particularly, if larger propagation delays have to be taken into account.

This problem is solved by the introduction of a memory circuit, consisting of two flip flops and 6 two-input gates, which are activated by a *remove a pulse command* but are otherwise directed by leading and

trailing edges of the original pulse train (A). This pulse subtractor finds wide applications and is illustrated in Fig. 1 with the time diagram shown in Fig. 2.

The *remove a pulse* command is supplied to the clock input of the first flip-flop (B input) which is activated by the positive edge. The Q_1 output goes *high* and enables activation of the second flip-flop by the next positive going edge of the sequence \bar{A} . Thus Q_2 goes *high* when A is *low*; after nearly a half period later A goes also *high*,

the output of the gate G_2 *low*, and that of G_3 , *high*. The following change of the state of A activates G_1 , G_2 and also gate G_4 because, due to the delay in the interconnecting RC circuit, both its inputs are simultaneously *high* for a very short time. The negative pulse at its output *clears* both flip-flops and prepares them for the next subtracting operation which is performed while Q_2 is *high*. At the same time Q_2 is *low* and blocks the passage of the sequence A through the gate G_5 .

The following inversion by gate G_6 supplies the original pulse train with one pulse missing—as shown by Fig. 2.

Venceslav Kroupa, Prague 8, Czechoslovakia.

References

1. Kroupa, V. F., Frequency Synthesis, Theory, Design, and Applications. New York, Halsted, a div. of Wiley, 1973.
2. Becker, G., Quasiperiodic frequency synthesis. Proc. of the 26th Annual Frequency Control Symposium, p. 279, Atlantic City, June 1972.
3. Small, G. W., A Frequency Synthesizer for $10/2\pi$ kHz. IEEE Trans. on Instrumentation and Measurement, Vol. IM-22, No. 1, pp. 34-37, March 1973.

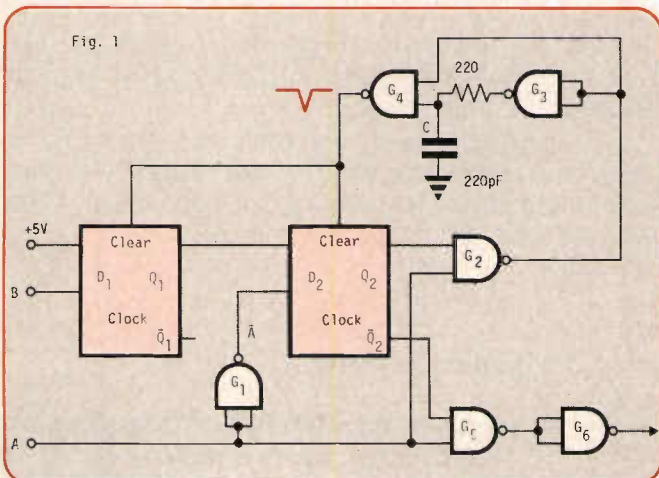

Fig. 1

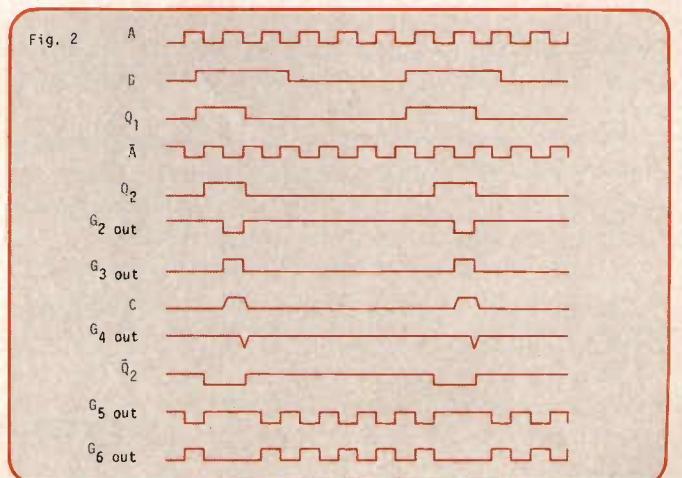

Fig. 2

One button dialling.



The busy person is constantly dialling telephone numbers. Locally. Through-out the country. Even internationally.

But let's face it. Dialling is one of the biggest time wasters in a busy day.

Think of the number of digits you dial. And have to remember. If you forget a telephone number and your secretary is unavailable, you lose valuable time looking it up. If the line's busy, you have to re-dial.

But General Instrument Microelectronics is changing all that. Our MOS/LSI circuits are making the telephone easier to use and a whole lot more human. They're making possible today's third generation solid-state 'phone. And tomorrow's "super phone."

With one-button dialling, the sky is the limit. You program your phone's memory with the numbers you call most frequently. Then, instead of dialling, you simply push a button. The phone dials for you. Instantly. Automatically.

You can set up your own identification system, too. If you like surnames, list your telephone numbers by surnames. Or by locations. Or by digits in sequential order.

It's up to you.

That's not all. If you get a busy signal, the phone will re-dial until you hang up. You can see the number you're dialling with a digital read-out display. And you can even convert your phone into a data transmission centre.

GI circuits are opening the way to advanced phone technology. You can select our AY-5-9200 that stores telephone numbers in multiples of ten. Or our AY-5-9100 that converts push button input to rotary dial pulses. Or our AY-3-9400 and AY-3-9410 that generate MF/tone telephone frequencies. Or our AY-5-9800 that decodes them.

Making engineering more human is our real job at GI Microelectronics. One-button dialling is a good example. Another is TV games. And hand-held calculators that print. And microwave ovens that practically nudge you when the food is cooked. And lots more.

True, GI makes standard and custom circuits. By the millions. Whole families of them. In depth. But we're really in business to help you make products that do things people want them to do. **If you'd like to make your products more human, write or call General Instrument Microelectronics Ltd., 57/61 Mortimer Street, London W1N 7TD, England, Tel: 01-636 2022.**

We help you compete.

**GENERAL INSTRUMENT CORPORATION
MICROELECTRONICS**



Autopositioning of main tap for cyclic equaliser

For high speed data transmission over voice frequency telephone channels, it is necessary to perform cancellation of inter-symbol interference so as to maintain the quality of data transfer. This is best carried out in the sampled baseband domain using an adaptive digital filter known as the automatic equaliser. However, the equaliser requires training-up and this increases system turn-round time. For multipoint polling applications, it is important to keep this period to a minimum.

A scheme (see reference) proposed by Mueller and Spaulding, which utilises the cyclic property of a training sequence, enables good channel equalisation to be achieved within a very short period of time, typically one or two symbol

periods. It is called cyclic equalisation. The principle involves setting the length of the equaliser such that it is the same as the length of the training sequence. Once the steady state has been reached, the input to the equaliser is disconnected and the information contained in the delay line of the equaliser cyclically shifted. Now, adaptive equalisation can be carried out at a much faster rate. A local reference store which contains the transmitted training sequence is used to detect the equalised output, hence forcing the signal eye to open up quickly. Once equalisation has been achieved, the equaliser is reconnected and detection takes place using estimated reference.

One drawback with this

method is that synchronisation between the received signal and the local reference is hard to achieve. Any cyclic shift between these two, yields a cyclic displacement of the tap position. In this situation if all the taps are in use, the system will be less than optimum.

Implementation is straight forward (Fig. 1). When search begins, the equaliser clock is increased by a factor which equals to the number of taps (N). This enables N detections to be carried out for the N different tap positions, all within one symbol period. Each detection provides a corresponding error value which is then subtracted from the previous one to give the first derivative. This is compared to the last minimum Error. If the present value is

less, this is loaded into the store as the minimum. At the same time, a counter is used to keep a count of the number of cyclic shifts that have taken place. The count corresponding to the minimum Error is also loaded into a count store. At the end of the search, the number which is in this store determines the number of cyclic shifts required to appropriately place the tap coefficients.

This method is message dependent, but the first order filtering is designed to smooth out most of this.

Martin N Y Shum, Harefield Road, Rickmansworth, Herts.

Reference
Cyclic equalisation—A new rapidly converging equalisation technique for synchronous data communication. BSTJ February 1975.

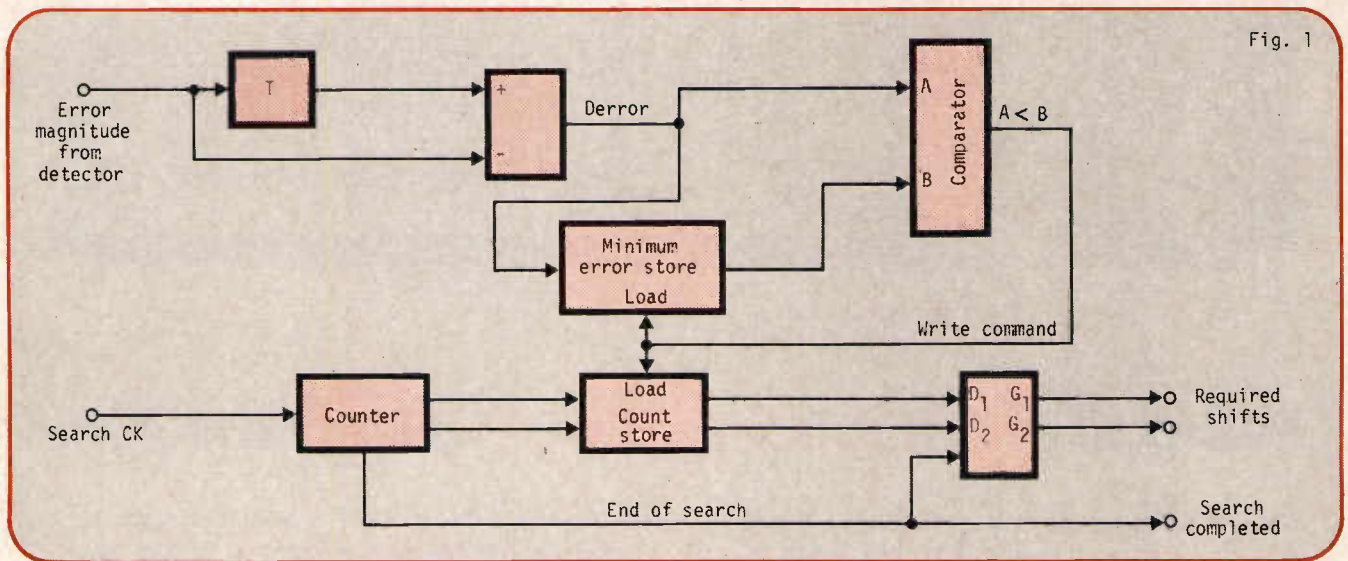

A voltage to frequency converter with one ttl chip

A voltage to frequency converter which employs only one inexpensive ttl chip and a jfet n-type transistor can be constructed quickly and cheaply.

The basic circuit, illustrated in Fig. 1, consists of a free-running adjustable generator which consists of three open-collector 2-input nand gates (7403) and a jfet. The frequency of the adjustable generator depends upon the values of its RC elements.

Under certain conditions the channel of the jfet behaves almost as an ohmic resistor. In

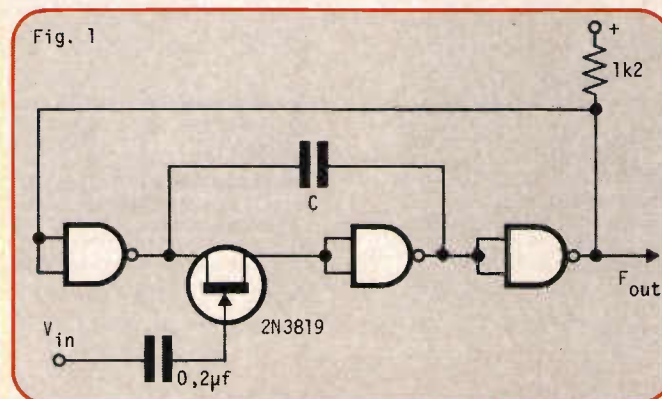

addition, when the jfet is operated near the origin, then the channel resistance r_{DS} is almost linear and depends only on V_{GS} .

When the resistor of the square-wave generator is replaced by an n-type jfet, then variations to the input voltage V_{in} will result in variations to V_{GS} and consequently to the channel resistance of the jfet. This will result in variations to the frequency (F_{out}) of the square-wave elements.

In Figures 2a and 2b the input voltage versus frequency in semi-logarithmic and linear

Fluke's 2240A datalogger:

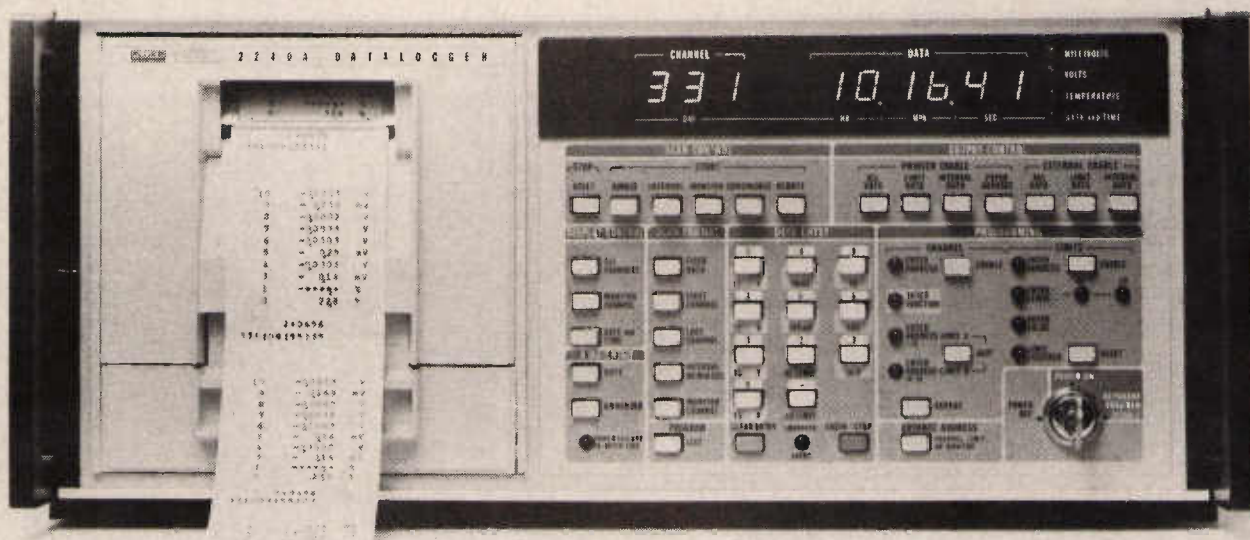

we call it **general purpose** on purpose.

The 2240A datalogger, from Fluke, is one of our new Summa II series. And that makes it something extra special.

For example, it has a 60-channel capability in the mainframe. Plus the possibility of up to 1000 channels, using our optional scanner extender.

The 2240A offers full programming too. This means that range, alarms, function and channel skip can be pre-programmed by the user for individual channels.

It also has microprocessor control. So, in addition to extreme flexibility and simplicity of operation, the 2240A ensures greater accuracy; increased reliability; and less power consumption — all at a sensible price.

Voltages, thermocouples and thermocouple types can be mixed in adjacent channels. And up to four thermocouples can be used per system.

That's quite a lot from *any* datalogger.

But no less than you've come to expect from Fluke.



Fluke International Corporation,
Garnett Close, Watford WD2 4TT.
Tel: Watford (0923) 33066. Telex: 934583. 6641

APPLIED IDEAS

scales are illustrated, respectively. From the linear scale it is seen that for input voltages from 0 V to -0,7 V the non-linear relationship between input voltage and frequency can be approximated by the linear relationship

$$f = K V_{in} \quad (1)$$

In equation 1, the constant K provides the resolution of this voltage to frequency converter and for the above mentioned range and for the particular jfet used (2N3819) is estimated to be

$$K = 4,5 \times 10^3 \text{ (kHz/Volt)}, \quad n = 1, 2, \dots \quad (2)$$

where n denotes the order of the decade of the working frequency (or carrier frequency) in kHz. For example, for carrier frequencies between 1 kHz and 10 kHz (first decade), n = 1,

therefore a resolution of 45 Hz/mV is obtained; for carrier frequencies between 10 kHz and 100 kHz (second decade), n = 2, therefore a resolution of 450 Hz/mV is obtained, etc.
S V Kartalopoulos, University of Toledo, Ohio, USA

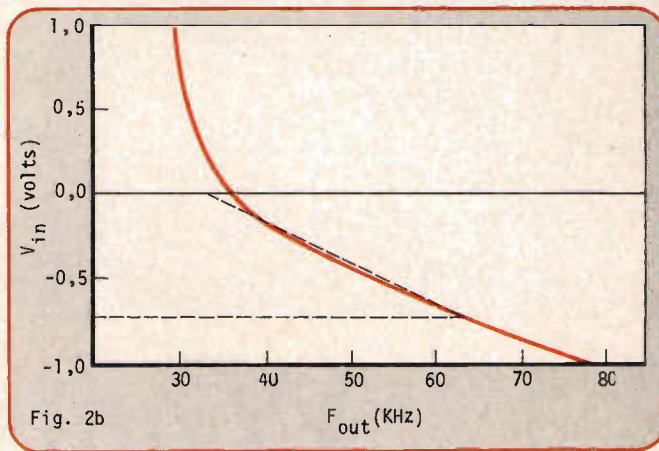
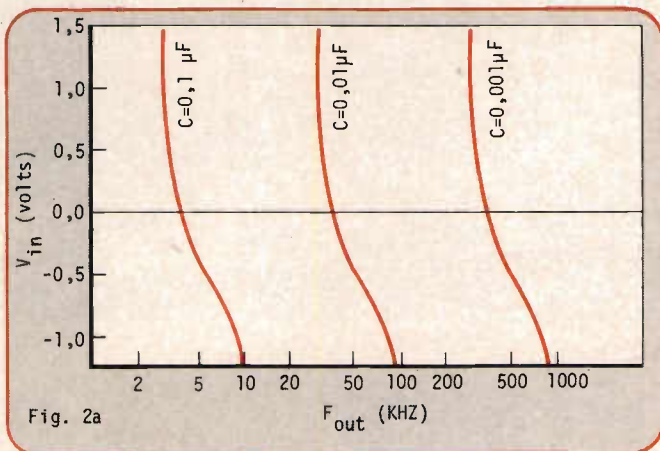

Only one line is true detector for digital parallel lines

The problem is a method of selecting those ones of digital data being on m parallel lines that are composed from m-1 logical zeros and only one logical one. The logical or Boolean function is:

$$F_{1-m} = Q_1 + Q_2 + Q_3 + \dots + Q_m \quad (1)$$

where

$$Q_i = \bar{A}_1 \bar{A}_2 \dots \bar{A}_i \dots \bar{A}_m \quad (2)$$

The F_{1-m} function is the exclusive or connection of two logical variables.

For $m > 2$ cases an interesting solution is offered by using SN7442 decoders. Let us rewrite the notation of SN7442: $A \rightarrow A_1$; $B \rightarrow A_2$; $C \rightarrow A_3$; $D \rightarrow A_4$; $\bar{1} \rightarrow \bar{Q}_1$; $\bar{2} \rightarrow \bar{Q}_2$; $\bar{4} \rightarrow \bar{Q}_3$; $\bar{8} \rightarrow \bar{Q}_4$; $\bar{0} \rightarrow \bar{O}_{1-4}$

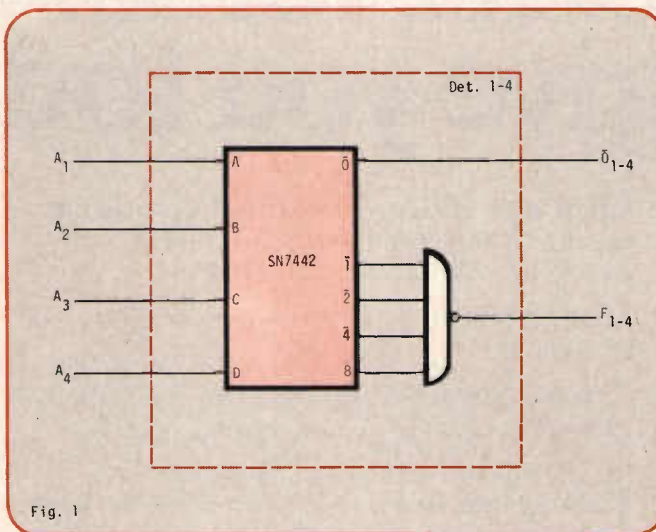

where O_{1-4} comes from:

$$\bar{O}_{1-m} = \bar{A}_1 \bar{A}_2 \bar{A}_3 \dots \bar{A}_m \quad (4)$$

Fig. 1 shows the use of SN7442 to realize the F_{1-m} function at $m \leq 4$ cases. O_{1-4} output is used is $m > 4$ cases.

In Fig. 2 we can see the realization of the F_{1-m} functions at $m \leq 8$ cases. For example at $m = 8$ the F_{1-8} may be written into the following form:

$$F_{1-8} = \bar{A}_1 \bar{A}_2 \bar{A}_3 \bar{A}_4 F_{5-8} + \bar{A}_5 \bar{A}_6 \bar{A}_7 \bar{A}_8 F_{1-4} \quad (5)$$

The extension of equation 18 to $m \leq 16$ cases may be done by the principle used in equation 5

$$F_{1-16} = \bar{A}_1 \bar{A}_2 \bar{A}_3 \dots \bar{A}_8 F_{9-16} + \bar{A}_9 \bar{A}_{10} \bar{A}_{11} \dots \bar{A}_{16} F_{1-8} \quad (6)$$

The scheme to realize equation 6 can be seen in Figure 3.
Sándor Lökös, Hungary.

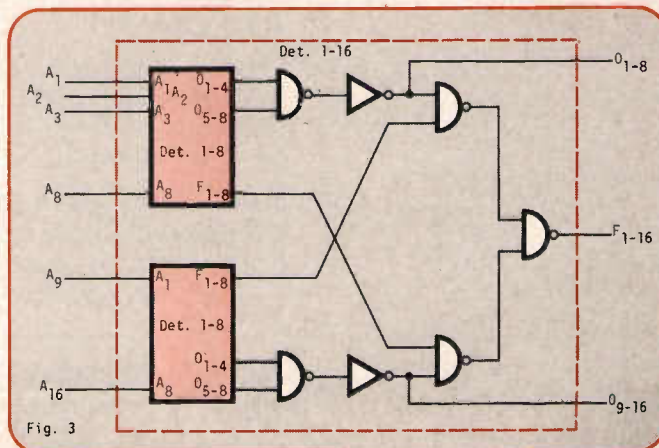
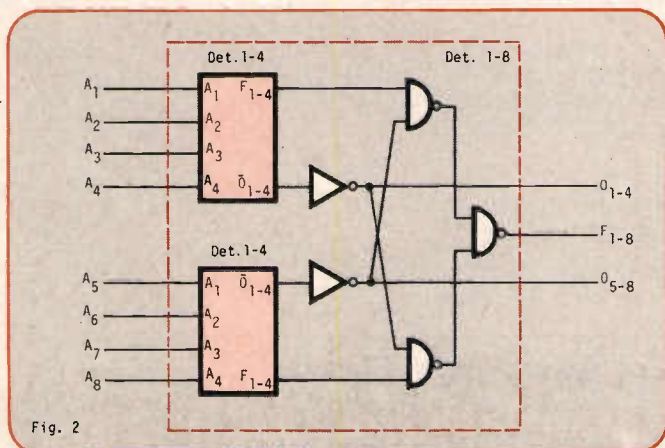

Newmarket thick film custom microcircuits.

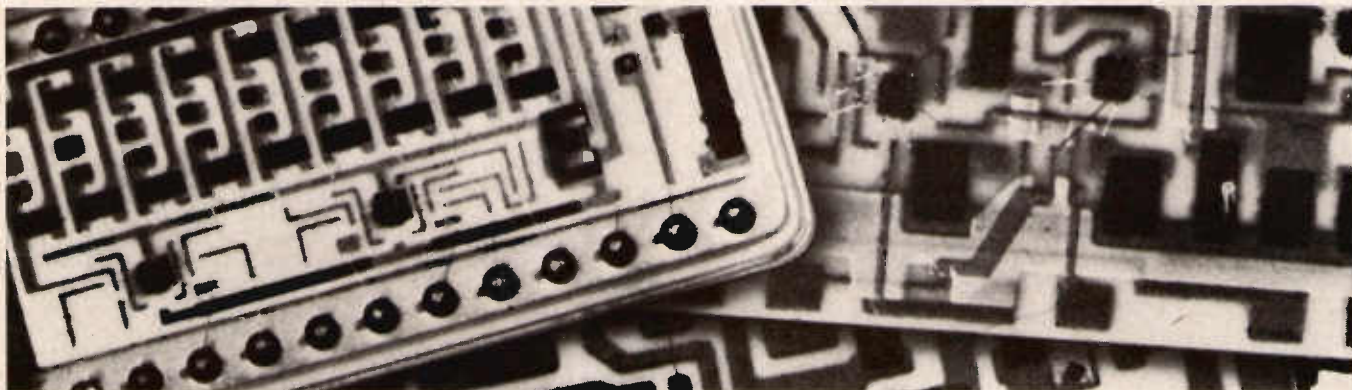

What others may offer tomorrow—we give you today.

- ▷ **Chip and Wire Bonding Techniques** obviate the need for discrete and i.c. semiconductor packaging – true microminiaturisation.
- ▷ **Laser Trimming** of all resistive values, ready by computer-controlled laser.
- ▷ **Circuit Sophistication.** From straightforward passive networks to high technology hybrids, including r.f. and power types.
- ▷ **Packaging.** From simple resin-dip to the latest projection welding technique meeting the highest defence standards.
- ▷ **Quality.** 100% on-line testing. Comprehensive Q.A. facilities. Manufacturing to Government and P.O. specifications. Full involvement in BS9450 capability approval.
- ▷ **No Delay.** Speedy prototypes – production quantities scheduled to meet your needs.
For unrivalled experience and proven capability *today*, consult NEWMARKET – the thick film experts.

NKT

Newmarket Transistors Ltd

Exning Road, Newmarket, Suffolk, England CB8 0AU
Tel: Newmarket 3381 Telex: 81358 Semicon Newmkt

A member of the Pye of Cambridge Group

Temperature compensation via current generators

By tailoring the current generator characteristic to offset an undesired signal variation, significant compensation can be obtained. Figure 1 shows the circuitry employed for this.

The circuit equations are

$$I_G R_G + N V_D + I_D R_D = V_{EE} \quad (1)$$

$$I_G R_G + V_{BE} + M V_D + I_E R_E = V_{EE} \quad (2)$$

$$I_G - I_D = (1 - \alpha) I_E \quad (3)$$

Solving these equations for I_E :

$$I_E \approx \left[\frac{V_{EE}/V_{BE}}{1 + R_G/R_D} + \frac{N}{1 + R_D/R_G} - M - 1 \right] \frac{V_{BE}}{R_E} \quad \dots(4)$$

Since $(1 - \alpha)$ is very small in most practical cases and the diode voltage drops V_D are approximately equal to the transistors emitter-base voltage drop.

Differentiating the equation for I_E with respect to temperature we obtain the temperature coefficient:

$$\frac{\delta(I_E R_E)}{\delta T} = \left[\frac{N}{1 + R_D/R_G} - M - 1 \right] \frac{\delta V_{BE}}{\delta T} \quad \dots(5)$$

In an integrated circuit know-

ing the temperature dependence of the emitter-base voltage (typically $-0,3\%/^{\circ}\text{C}$) and the temperature dependence of integrated resistors (typically $+0,09\%/^{\circ}\text{C}$), it is possible to design the circuit parameters

(R_E , R_D , R_G , N and M) for the required current level and nominal temperature coefficient.

These equations are plotted in Figures 2(a) and (b) to show the typical degree of control that can be achieved.

Figure 3 shows the temperature dependence of the output of a sensor before and after compensation with this circuit. The uncompensated characteristic shows a negative temperature coefficient in the region of $0,06\%/^{\circ}\text{C}$ at current of 1 mA.

From the design charts (Fig. 2), one of the following combinations of the circuit parameter values is required:

- (a) $M = 0$, $R_E = 1 \text{ k}\Omega$,
 $N = 1$, $R_D/R_G = 2,40$,
 $V_{EE}/V_{BE} \approx 3,0$
- (b) $M = 1$, $R_E = 1 \text{ k}\Omega$,
 $N = 3$, $R_D/R_G = 1,28$,
 $V_{EE}/V_{BE} \approx 3,8$
- (c) $M = 1$, $R_E = 1 \text{ k}\Omega$,
 $N = 4$, $R_D/R_G = 2,06$,
 $V_{EE}/V_{BE} \approx 3,2$

In practice, better compensation over the full working range may often be obtained with non-minimal combinations such as (b) and (c) above. This arises through second order effects causing curvature in the compensating characteristic matching curvature in the output characteristic.

J E L Hollis, Portsmouth.

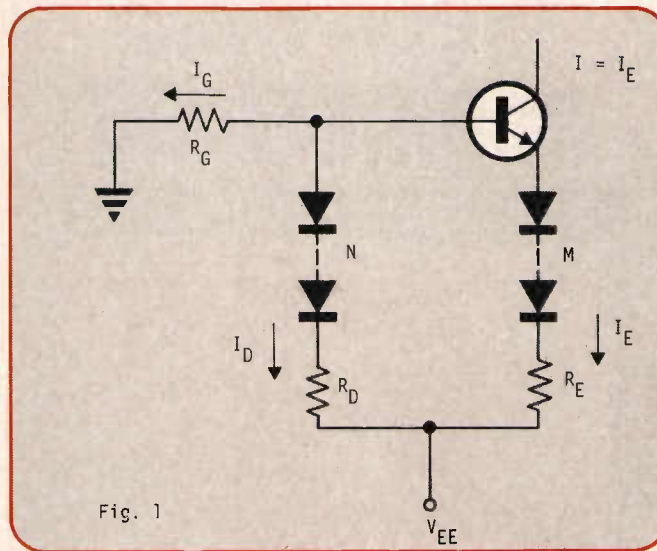

Fig. 1

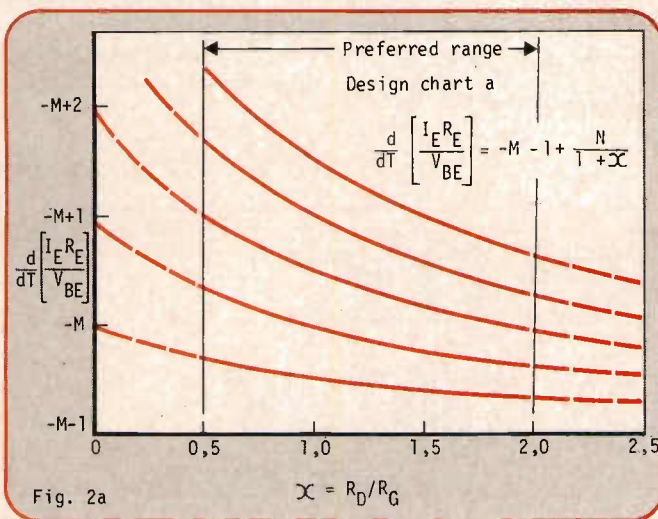

Fig. 2a

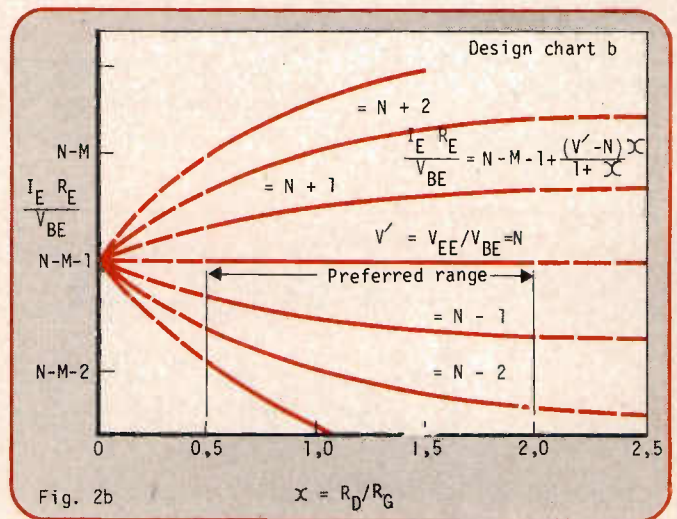
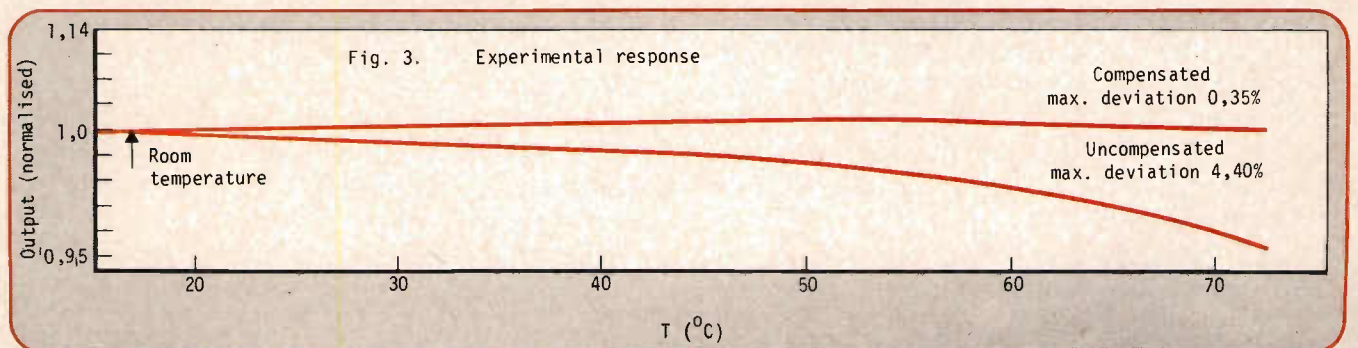

Fig. 2b



Applied Ideas Competition 1977

Once again *Electronic Engineering* will be running the Applied Ideas competition and will be giving away prizes which have a total value of £1000. Jubilee Year marks the fourth appearance of the competition and the co-sponsors this year will be Siliconix, the semiconductor company which is based in Newbury.

Prizes will again be awarded for the best Applied Ideas published in *Electronic Engineering* during the year. Originality, suitability, elegance, adaptability and general usefulness are some of the factors which will be taken into account.

Contributions should give a concise account of the application of the submitted Applied Idea along with design criteria and an indication of performance of the design.



Entries must be from named individuals and must not have appeared previously outside the originating establishment. A contributor's fee of £10 will be paid on publication.

Applied Ideas must be typed, using only one side of the paper, with double spacing and wide margins. Illustrations must be drawn clearly on separate sheets. They should be captioned, show component values and type numbers, and indicate test voltages and waveforms where appropriate. Entries should conform to the usual style of the journal.

Please send entries to the Applied Ideas Editor, *Electronic Engineering*, Morgan Grampian House, 30 Calderwood Street, London SE18 6QH.

The Editor's decision in all matters is final.

Award for the best Vmos circuit

Siliconix are running a second competition in 1977. Prizes will be awarded to the best practical applications of circuits using vmos devices.

The design ideas will not only be judged by Siliconix but will be eligible for consideration as an Applied Idea. This means that any vmos circuits published as an Applied Idea will automatically be entered for the 1977 Applied Ideas competition.

The standards and format required for the vmos circuit ideas should be the same as those

specified in the rules of the Applied Ideas competition, explained above.

Entries must be accompanied by an application form which will be supplied by Siliconix, but requests for forms through *Electronic Engineering* will be answered. Full details of the competition ie the rules and conditions Siliconix have laid down will be given in the next issue of *Electronic Engineering*.

Again the Editor's decision in all matters is considered final.

Are you getting the best buy in general purpose transistors?

Mullard
Semi
Conductors
for
industry

Next time you order TO-92 plastic general purpose transistors make sure you don't lose out. Have a look at the Mullard range. Mullard TO-92s are made by the million and you can get them off-the-shelf at really keen prices.

And when you get Mullard TO-92 you get quality as well. Chip bonding onto precision-flat lead frames is only one of their finer points. And there are literally millions of component-hours of life tests behind them . . . so you can expect a long operating life.

The great majority of TO-92 circuit requirements can be met by the Mullard range. Reader enquiry service no. 150 will bring you a list of types.



Mullard

Check our whiskerless diode prices

You could well cut your bills for silicon whiskerless diodes by checking the prices of Mullard types. We produce these diodes in a BIG way. And we have a wide standard range . . . all rugged and in DO-35 glass encapsulations. Reader enquiry service no. 151 for a type list.

The pick of the bunch

For a particularly good buy in silicon whiskerless check the BA316, 317, 318 and BAW62. These four star types satisfy most applications . . . and prices are very competitive.

A better deal with Zeners?

When you're shopping for 400mW planar zeners get a quote for the Mullard BZX79. Prices are what you'd expect from automated large volume production. And performance is first class . . . excellent knee characteristics and particularly good voltage stability, even at zener currents down to a few microamps.

Remember, BZX79. It's the low cost planar companion to our alloy junction BZY88. Reader enquiry service no. 142 for data on BZX79.



FOR INFRARED DETECTORS

contact the leaders

For semiconductor infra-red detectors get in touch with Europe's leading manufacturer and supplier - Mullard. There's no other company with the same scale of production and depth of technology in solid-state IR this side of the Atlantic.

From Mullard you can get single elements and arrays.

Materials are across the board and include mercury cadmium telluride, triglycine sulphate, indium antimonide and lead sulphide. Reader enquiry service no. **153** for further information.



If it moves

detect it with this mini-radar module

You can hold the Mullard CL8960 doppler radar module complete with its antenna in the palm of your hand. And you only need a 7-volt supply and an audio amplifier to make up an inexpensive movement system.

Modules like the CL8960 from the Mullard range of microwave semiconductors and modules are an excellent proposition for intruder alarms, portable traffic lights and a host of other movement sensing and industrial control applications. Reader enquiry service no. **154** for further information.



POWER rectifiers strong on

BS 9300



Mullard standard power rectifiers are designed to give you the ratings needed for the bulk of industrial applications - both present and future. Types for single and three phase voltages are available with ratings up to 47A, and most can be supplied to BS9300. Reader enquiry service no. **155** for data.

Mullard





**down
down
down
down
down in size**



You go right down in size when you use Mullard microminiature semiconductors. Down to devices no larger than a grain of rice. Down to the size that's ideal for thick and thin film circuits.

These micromins have the same basic characteristics as full-sized devices except for the power ratings. Even so, some are rated as high as one watt.

There are plenty of different types to choose from: general purpose, switching and high voltage transistors; v.h.f., u.h.f. and microwave transistors; signal diodes and zeners. Reader enquiry service no. 156

POWER DARLINGTONS Up to 150W and complementary

When it's high gain and watts you're after check Mullard's range of Darlington power transistors. There are twenty of them with power dissipation ratings from 5 to 150 watts - all available in NPN and PNP polarities. They are an excellent choice for amplifier, switching, voltage regulator and many other industrial applications.

Reader enquiry service no. 157 for a summary of these and other Mullard power transistors.



**Free
Wallchart**



**Semiconductors,
Capacitors, Resistors,
ICs, Magnetic devices,
Valves . . .**

**For fast delivery of
Mullard standard ranges
of components contact
your Mullard distributor**

Mullard

Mullard Limited, Mullard House, Torrington Place,
London WC1E 7JP. Tel: 01-253 4811

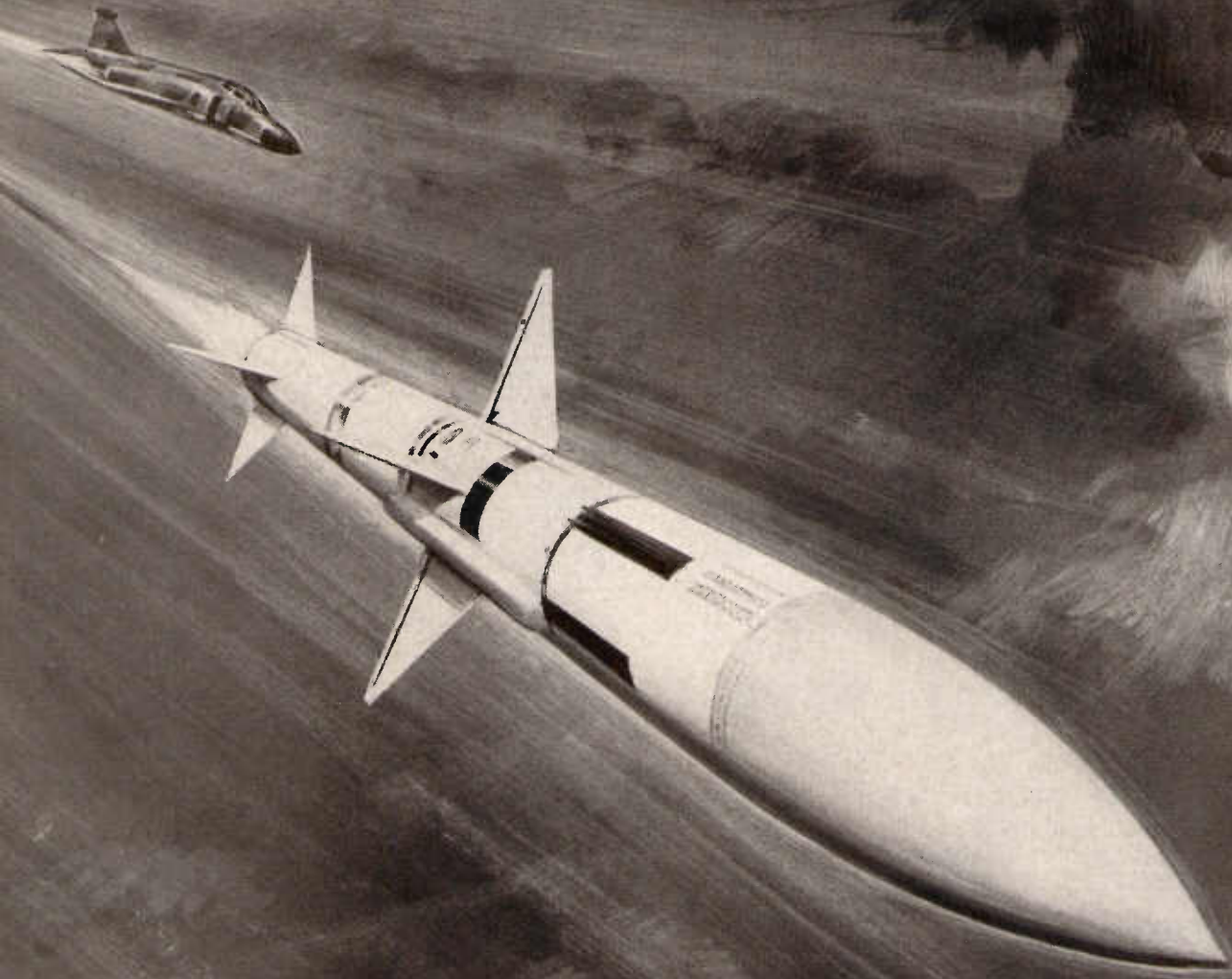

Wima[®] MKB-3 & MKB-5 metallised polycarbonate capacitors

Wima MKB-3 and MKB-5 are the first choice for applications demanding capacitors with very high reliability and excellent electrical characteristics.

These two Wima ranges have proved themselves above all others over the past nine years in such tough and exacting applications as Sky Flash, Red Top, Martel, Nimrod, Rapier, Jaguar, Harrier and Concorde.

Professional and industrial applications include computers, communication equipment, medical electronics, instruments

and wherever good and stable electrical parameters are of importance.

The range extends from 0.01 to 10mfd with voltage ratings of 63V. and 100V.d.c. The MKB-3 is available in 20% and 10% and the MKB-5 down to 1%.

Wima capacitors are manufactured by Wilhelm Westermann, W. Germany and comprehensive data sheets covering 24 Wima ranges are included in the Waycom handbook.

Contact Waycom for the latest Wima information.

Waycom-reliable in so many ways

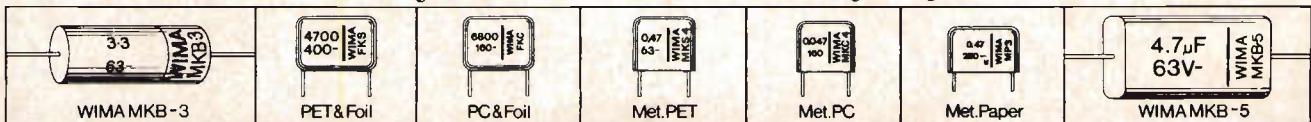

WAYCOM LIMITED

Wokingham Road, Bracknell, Berks RG12 1ND
Tel: Bracknell 22751 Telex: 848402

Sanwa precision circuit testers – Big on features. Bigger on selection.



1



2



3



4



5



6



7

Sole Importers in U.K.

Quality Electronics Limited

24 High Street, Lydd, Kent, TN29 9AJ

Telephone: LYDD 20252 Telex: 965265

sanwa
MULTITESTERS

1. BX-505

- Fast-response, $24\mu\text{A}$ movement – fuse & diode protected with high resolution factor ($0.4\mu\text{A}/\text{scale division}$)
- Revised scale marking – intermediate readings readily determined

2. U-60D

- $44\mu\text{A}$ movement – quality performance, diode protected
- Stable ACV measurement – solid-state rectifier & enlarged frequency coverage

3. SP-10D

- Easy operation – multiposition rotary selector switch & well-lighted scale
- Stable ACV measurement – durable diode rectifier

4. N-501

- $2\mu\text{A}$ suspension movement – $0.05\text{mA}/1\text{mV}$ resolution
- Double protection – fuse & Si diode

5. CX-505

- $16.5\mu\text{A}$ movement – varistor protected & $50\text{k}\Omega/\text{V}$ for DC
- Capacitor tester – push-button operation with solid-state oscillator built in

6. PDM-500 (Insulation Tester)

- Battery operated – 3 small-size 1.5V batteries built in
- Push-button operation – pointer calibration & insulation test

7. CAM-300D (Clamp Meter)

- Two scales, front and bottom, for reading convenience
- Specially-designed, scissor-action core arms

New
from Micro
Networks

Two low-cost alternatives to Monolithic converters

Just introduced to the UK by Tranchant Electronics, the MN3013 and MN3014 hybrid digital to analogue converters are complete 8-bit D/A's in hermetically sealed, 18 pin, dual-in-line packages.

Ready to use without any adjustment, these new hybrid devices need no external reference, output amplifier, or trim pots - components that must be added to, and significantly increase the cost of monolithic devices. Also eliminated are testing, assembly and calibration which further increase the price of monolithics.

One of the industry's largest producers of thin-film hybrid D/A and A/D converters, Micro Networks MN3103 and MN3104 offer:

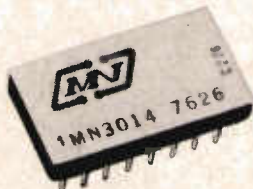

- ★ guaranteed linearity $\pm 1/2$ LSB over full operating range 0°C to 70°C .
- ★ full scale output settling time to $\pm 1/2$ LSB = 23 micro sec. MN3013 and 1.5 micro sec MN3014
- ★ four selectable output ranges: 0 to +10v, 0 to -10v, $\pm 5\text{v}$ and $\pm 10\text{v}$ are standard.

To get the full facts on these low-cost answers to digitizing in automatic test equipment, environmental control, programming of temperature, pressure, speed controllers and other similar specifications, send for our free data sheets today.

 **Micro Networks Corporation**

tranchant electronics (uk) limited

Tranchant House 100a High Street
Hampton Middlesex TW1 2ST
Tel: 01-979 0123.

Tomorrow's Electronics Today

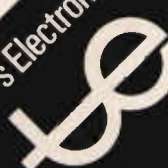

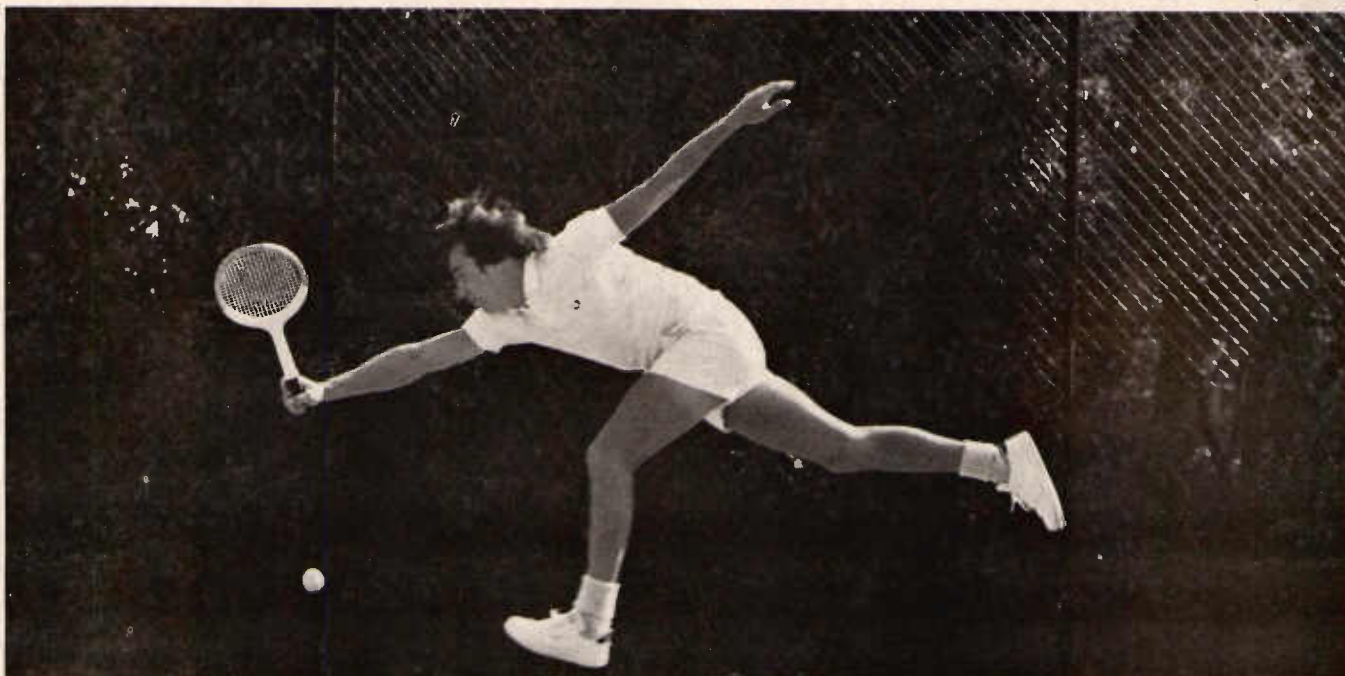

In this game you're only as good as your last service

It's the same with electronic measuring equipment.

Repairing and calibrating modern test gear is a demanding and exacting business – a professional business. That's why you need the backing of Labservice when a fault is called.

From three locations in the UK, all equipped with the finest traceable calibration facilities and manned by experienced engineers, Labservice provides maintenance and calibration to BCS or DEF STAN 05-26 over a wide range of measuring instruments.

And with Labservice, instrument downtime is dead. Because Labservice is a division of the Labhire organisation – which means you can hire instant replacements while your own equipment undergoes repair.

So don't get called out. For service, calibration, and replacement hire on demand, give us a call, It's the only way to win in this game.

LABSERVICE

Lab House, Horton Road,
West Drayton, Middlesex. Telephone: 01-897 2434

I would like more information about Labservice

EE 1

NAME

DEPT.

COMPANY

ADDRESS

Magnetic bubble memory systems

Magnetic bubble technology has reached the point of exploitation, writes *A T Gibson*. This article describes a bubble memory system developed in the United Kingdom.

The advent of cheap bulk memory, having a cost/bit approaching that of existing rotating disc memory (i.e. 0,005 c/bit by 1980) even for moderate capacity, will significantly affect the move towards distributed intelligence in systems and will enhance the impact of the microprocessor. Magnetic Bubble memories will also be able to replace electro-mechanical storage in many applications, and give the possibility of improving the cost/performance of memory hierarchies in many mainframe computers.

Numerous articles have been written on the basic technology and method of operation. Briefly, 4-6 micron diameter bubbles are contained in a thin single crystal film of Yttrium Iron Garnet (YIG) which is doped with certain rare earths to give optimum properties. This magnetic film which is grown onto a non-magnetic substrate of Gadolinium Gallium Garnet (GGG) is processed as a multi-chip wafer to include, in a simple two mask process, gold interconnectors for the *write* and *read* functions and the permalloy pattern for bubble propagation and detection. Storage cell size is typically between 16 and 26

microns square giving a storage density 1500-4000 bits per mm².

Bubble memory operation

A magnetic bubble memory chip consists essentially of one or more non-volatile, recirculating, static shift registers which operate at a typical clock rate of 100 kHz. Data is represented by the presence or absence of a bubble. Initially production devices will have capacities of between 64 k bits and 128 k bits per chip for a chip size of 5-7 mm².

To obtain fast access time, a major/minor loop organisation (Fig. 1) is used. To access data, bubbles in the minor loops are first shifted to the position closest to the major loop. Corresponding bubbles (or absence of bubbles) are then transferred simultaneously from all minor loops to the major loop. Then they are shifted around the major loop, read, annihilated or replicated as required, and transferred back to the minor loops. Access time for this organisation is $\frac{1}{2}\sqrt{N}$ times less than the simple shift register type, where N is the total number of bits per chip,

For simple single register devices, the basic functions required to operate a magnetic bubble memory are propagation, generation, detection and anni-

hilation.

Propagation is accomplished by driving the two clock waveforms, each clock cycle shifting the bubbles one position in the register. A current pulse in conjunction with the clock waveform generates a bubble (i.e. writes a *one*) and the absence of a current pulse generates a *zero*. The pulse amplitude is typically 300 mA with duration of 0,2 μ s.

A 'chevron detector' stretches a bubble into a wide strip which causes a change in magneto-resistance of the Permalloy pattern. The resultant change of voltage amounting to several millivolts is compared with a signal from a dummy detector to provide a noise-free signal.

A current pulse in conjunction with the clock waveform is also used to erase a bubble if present. Typical pulse amplitude and width for annihilation are 50 mA and 3 μ s. Additional functions for a block organisation. A current pulse in conjunction with the clock waveform transfers a bubble from each minor loop to the major loop, typical pulse amplitude and width being 50 mA and 1,5 μ s and for replication another current pulse in conjunction with the clock waveform duplicates information in two divergent paths. Typical pulse amplitude and width for this function

A T Gibson is with Plessey Memories, Towcester

Fig. 2: Single chip package assembly.

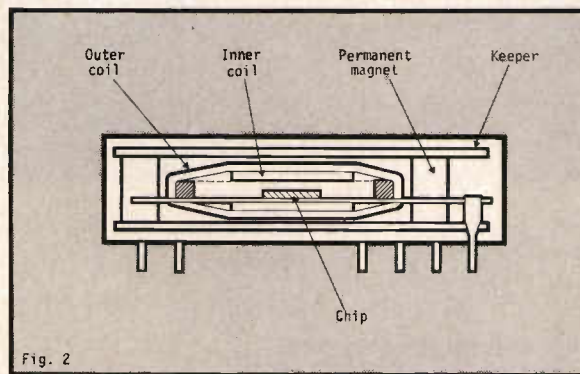

Fig. 2

Table 1: Comparison of performance.

	800 BPI Cassette	Floppy Disc	Bubble Memory
Capacity	2,4	2,0	1,024 Mbits
Bit Rate	10	250	800 kHz
Access Time (Average)	20	0,46	0,08 Seconds
Weight	1,4	4,5	0,5 Kg
Power	35	150	15 W
Volume	2048	8194	410 cm ³
Solid State	No	No	Yes
Removable Media	Yes	Yes	Possible
Asynchronous	Yes	No	Yes
Incremental Facility	Yes	No	Yes

Fig. 1: Major/minor loop organisation.

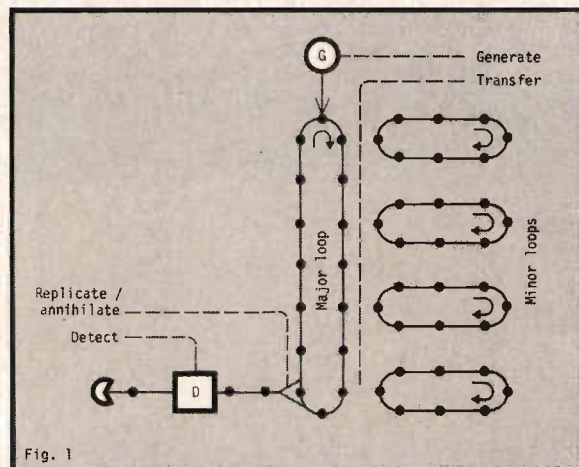

Fig. 1

Table 2: Multiloop designs are competitive.

	Fixed Head Discs	Bubble Memory
Capacity	16	16 Mbit
Data Rate	4,4	7,7 MHz
Access Time	10	1 ms
Weight	32	9
Volume	0,06	0,03 kgm ³

are 100 mA and 0.25 μ s.

The clock waveforms are typically 500 mA amplitude sinewave functions, one clock being 90° out of phase with the other. Stop/Start operation is a very advantageous feature. Stopping the shifting process completely, or restarting it from a standstill, takes only 10-20 μ s. This allows access to a single bit at a time, groups of bits or continuous operation. Approximations to a sinewave function, such as triangular waveforms, can be used for the clocks.

Up to the stage of wire bonding a chip to a lead frame, the magnetic bubble technology is similar to semiconductor technology, except that the structure of the bubble chip is simpler and therefore provides relatively high yield. However, the package must incorporate two orthogonal coils for the two clock waveforms and also a permanent magnet assembly to provide a steady bias field. Fig. 2 shows a single chip package assembly in cross-section. The assemblies are encapsulated to form finished packages.

Some companies are using multi-chip packages, thus sharing the cost of coils and magnets over 8 or 16 chips. Disadvantages of this approach are lack of user flexibility, lower chip yield inherent in hybrid production, and module rework is difficult at best. However this could be a useful approach where low volume is required.

Memory system

For a single chip package, the clock input impedance consists of an inductance of typically 30 μ H in series with a small resistance less than 1 Ω . A coil

driver can drive eight of these inputs in series from a 20 V rail. The power dissipation of such an arrangement is predominantly in coil resistance, which amounts to approximately 250 mW per package for both clocks operating at maximum speed.

Sense amplification requires a differential pre-amplifier which can be shared between two packages and multiplexed when used in a large array. The final amplifying stage incorporates ac coupling, dc restoration and a strobing circuit. Resulting superimposed zero and one signals are shown in Fig. 3 together with a strobe pulse. In future, integrated support chips will certainly be available.

A block diagram of a 32 kbyte bubble memory system card is shown in Fig. 4. One 'X' or 'Y' coil driver will drive eight interconnected coils which, together with tuning capacitors, form a tuned circuit. The natural frequency of the tuned circuit provides the clock for the system and the 'Y' and 'X' circuits are interconnected so that the phases are locked accurately at 90°. Two output synchronising signals are derived from the 'clock' as timing waveforms for the user.

Each coil driver supplies only the incremental current required to replace the resistance losses in the coils during continuous operation and also provides the high energy, short duration pulses needed for start/stop operations. Thus, power requirements are minimised under continuous operation.

Detectors of each pair of bubble chips are connected in a bridge arrangement

and the resulting sense signal (≈ 5 mV) is amplified before being strobed into an 8-bit data register.

The write function is performed on eight of the sixteen bubble chips, as determined by the address register. One erase driver is pulsed and eight write drivers are pulsed, or not, depending on the state of the data register during the cycle.

The control organises the various pulse timings from the basic clock waveform to complete a particular function. By controlling the run input, single cycles or blocks of cycles can be performed with the memory being left in a static state ready to perform a function on the next consecutive bit.

Magnetic bubble technology is just at the beginning of its life cycle and advances will be made rapidly over the next few years. The major trend will be towards smaller bubbles, and further advances are predicted to yield 1 Mbit chips by 1980, with no major change in technology.

In spite of the relatively long access time which is a feature of the simple single loop chip organisation, the performance compares favourably with tape cassette and floppy disc memories as shown in Table 1. Multi-loop 64 kbit chip designs will enable the design of bubble memories competitive with fixed head discs (Table 2). Improved materials used in chip fabrication will lead to a wider temperature range and higher operating speed. A 120°C temperature range and 300 kHz operating rate have been demonstrated in the laboratories but this is only the beginning.

Fig. 4: Block diagram of 32 Kbyte system.

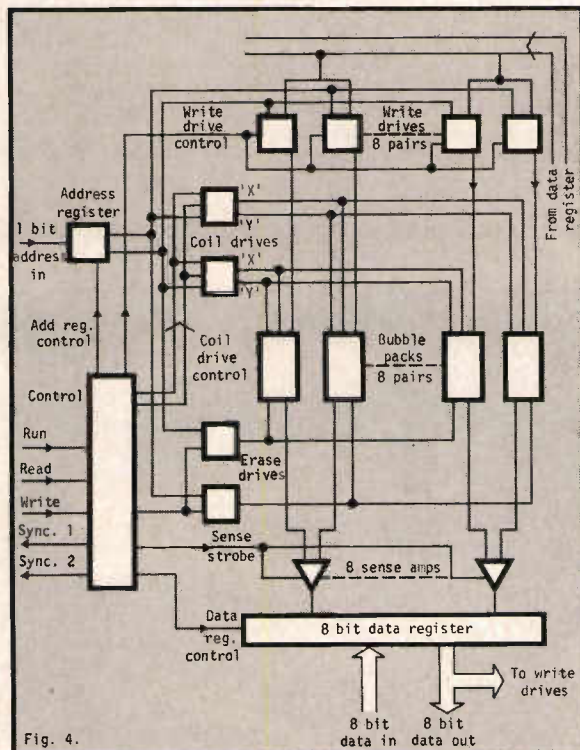
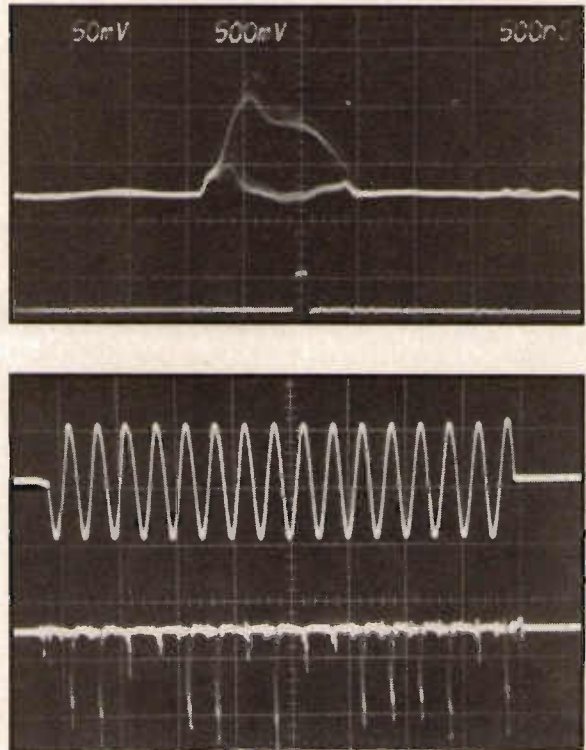

Fig. 4.

Fig. 3: Superimposed zero and one signals.



Pyroelectric technology in modern thermal imaging systems

In this article *J R Foreman* discusses recent developments in thermal imaging techniques based on the exploitation of the pyro-electric effect.

Objects at temperatures other than absolute zero are known to radiate within the electromagnetic spectrum. In the case of the familiar blackbody (an object whose absorptive power is equal to unity), the total emitted radiation is proportional to the fourth power of absolute temperature, a rule known as Stefan's law. This relationship was inherent in the celebrated Displacement Law due to Wien (1893) and the Planck relation (Fig. 1.) which defines spectral distribution of radiant energy as a function of temperature and frequency within the electromagnetic spectrum.

These ideas are applicable to most graybody objects even though they diverge from black body criteria and form the basis of a remote means of detecting hot bodies. If a 'two-dimensional' detector or a single detection with 'third-party' scanning can be produced with response in a region corresponding to the inherent radiation emitted by an object at a particular temperature and if the detector information can be eventually presented to the eye, thermal imaging will result.

It is generally taken that thermal imaging concerns the viewing of objects at or near room temperature and, in this case, we are dealing with radiation in the common middle infra-red ranges 3-5 or 8-14 microns as dictated by atmospheric absorption (Fig. 2.). Before discussing this, however, it can be added that as bodies heat up, the radiant

energy spectrum spreads closer and closer to the familiar visible spectrum to the point where 'thermal' pictures may be taken with conventional suitably filtered silicon vidicon cameras.

Thermal imaging methods in the regions 3 to 5 or 8 to 14 microns are varied. There is the single detector approach whereby the incident radiation is deflected by means of prisms or the like to fall onto the detector which is usually liquid nitrogen cooled. Cooling is generally necessary as detectors, such as indium antimonide, rely on the ionization of deep-seated donor levels within the forbidden band by incident radiation to give rise to photo-conductivity. Without cooling, these levels would be fully ionized at normal room temperatures alone. This prism approach yields good results and reasonable quality pictures to a spatial resolution of about 0,0025 rad at 50% contrast are obtainable. Good temperature resolution down to 0,1°K/300°K ambient is achieved as might be expected of a cooled system. The disadvantages include flicker presentation to the viewer (as the unit can only be scanned below the limit of minimum eye refresh rate), mechanical size and fragility, the need to supply liquid nitrogen in field applications and, perhaps the main limitation, high cost.

Systems employing electronically scanned (on-chip) liquid nitrogen cooled detectors are under consideration and it seems likely that they will have their day. In this case, an array of detectors

replace the prisms but with technology at its present level, the physical size necessary and the difficulty in producing uniform response makes the yield and hence price uneconomic. The advent of sophisticated electronics in the ccd area could hasten progress, but, as most of the development in this area is for the military, it could be some years before this approach is viable.

Pyro-electric effect

The pyro-electric vidicon and its related camera present themselves in recent developments in the thermal imaging field. Certain types of crystals can be spontaneously polarised in a single well-defined direction called the polar axis. As this polarisation is temperature dependent, heating such a crystal creates charges on the faces normal to the polar axis. This is known as the pyro-electric effect. The magnitude of the effect (the quantity of charge produced for a given temperature change) depends on the material and always reaches a maximum at a temperature specific to the material. Triglycine sulphate (TGS) is commonly used as the target material in vidicons of this type and simply replaces the antimony trisulphide deposited layer in conventional vidicons.

TGS targets have a maximum useful pyro-electric effect at about 35°C, the spontaneous polarisation disappearing above a certain temperature known as the Curie Point (49°C). The pyro-electric effect results from electric dipoles inside the crystal lining up along the polar axis and it is a maximum when

J R Foreman is with Thomson CSF

Below: Examples of thermal pictures taken with silicon vidicon cameras.

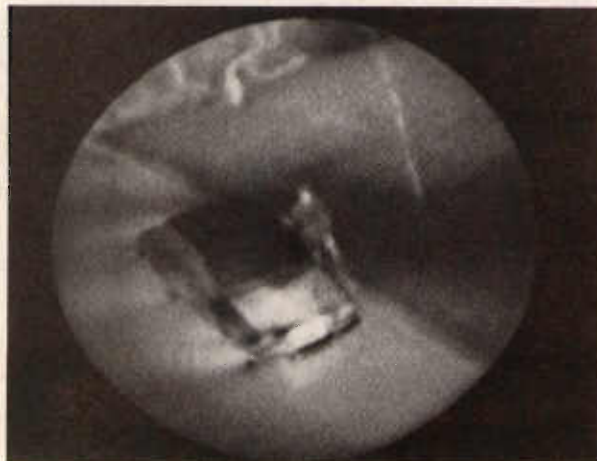

all of the dipoles are orientated in the same sense. This situation can be obtained by a process known as 'poling' which consists of applying a strong dc electric field across the crystal faces.

Electric charges are only produced when the temperature of the pyro-electric material changes. It is for this reason that pyro-electric vidicons cannot produce an image output from an unchanging image. If part of the scene is mobile (for example, a man walking across the field of view) then only the mobile part will be seen. If the whole scene is to be observed then the incoming radiation must be chopped, or the camera panned, in order to produce target temperature variations.

Tube operation

The thermal vidicon (Fig. 3.) consists of a glass envelope, fitted with a germanium faceplate (matching the $8\ \mu\text{m}$ to $14\ \mu\text{m}$ atmospheric window), a pyro-electric target mounted on a metal backing plate that also acts as the video output electrode, an electron gun and beam shaping electrodes like those of a standard vidicon and a gas reservoir headed by a tungsten filament may be incorporated. The tube is surrounded by focusing and deflection coils that are identical to those used with a standard vidicon. When an infra-red image is focused onto the tube, heat energy is absorbed by the target. This creates a temperature distribution which in turn causes charges to appear on the surface of the pyro-electric material. The resulting potential distribution, which faithfully reproduces the thermal image, can then be read by means of an electron beam.

The actual mechanics of the reading depends on the tube operating mode. Stable operation can be obtained in two ways, known as the cathode potential stabilised (cps) mode, which is the more common, and the anode potential stabilised (aps) mode. Unlike a normal vidicon, temperature variations in TGS create positive and negative charges on the target surface. In the cps mode, the electron beam cannot neutralise negative charges once the target has reached equilibrium potential. This problem is overcome by charging the target surface between scans to a pedestal potential which is greater than the potential variations caused by increases or decreases in temperature, so the beam has access to the target at all times. The pedestal potential (which must be constant over the whole target surface) is generated by positive gaseous ions deposited on the surface of the target. The ions are created by the electron beam striking gaseous molecules within the tube which can come from a gas reservoir in the tube or from gas introduced in bulk in the envelope during fabrication. A reservoir is generally preferred as it allows complete control over the tube in all operation modes. The entire active surface of the target

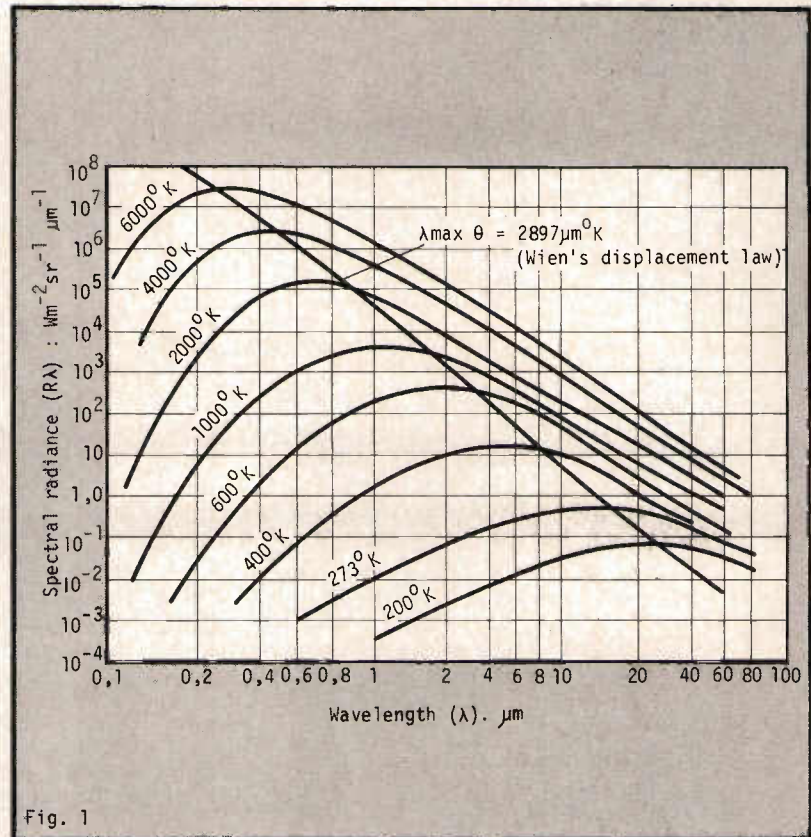

Fig. 1

Fig. 1: The total emitted radiation obeys Stefan's Law.

Fig. 2: Radiation in the common middle infra-red ranges.

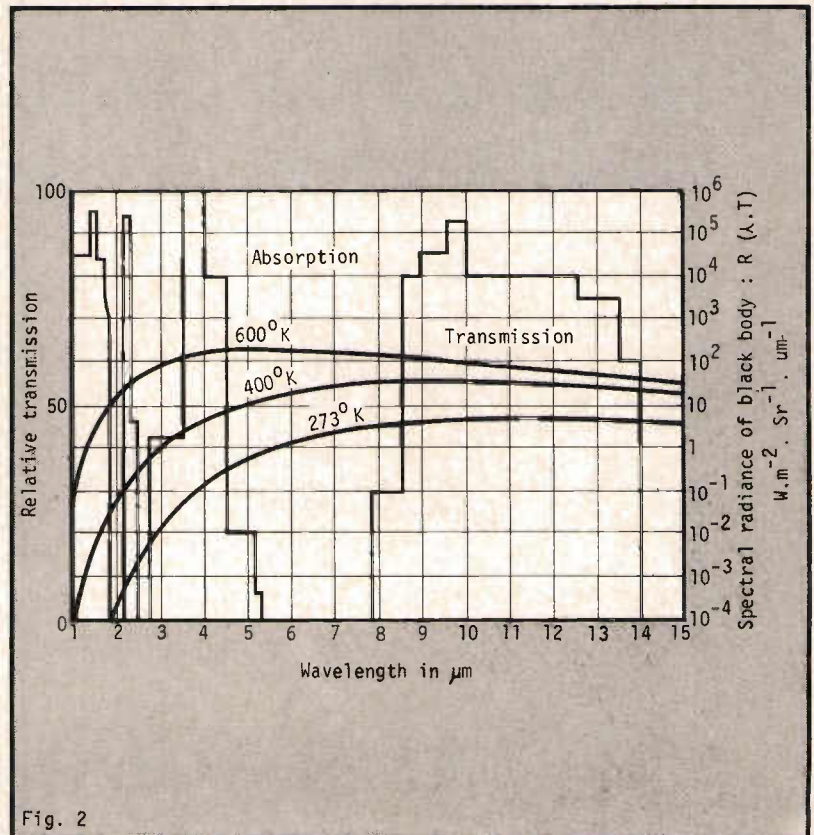
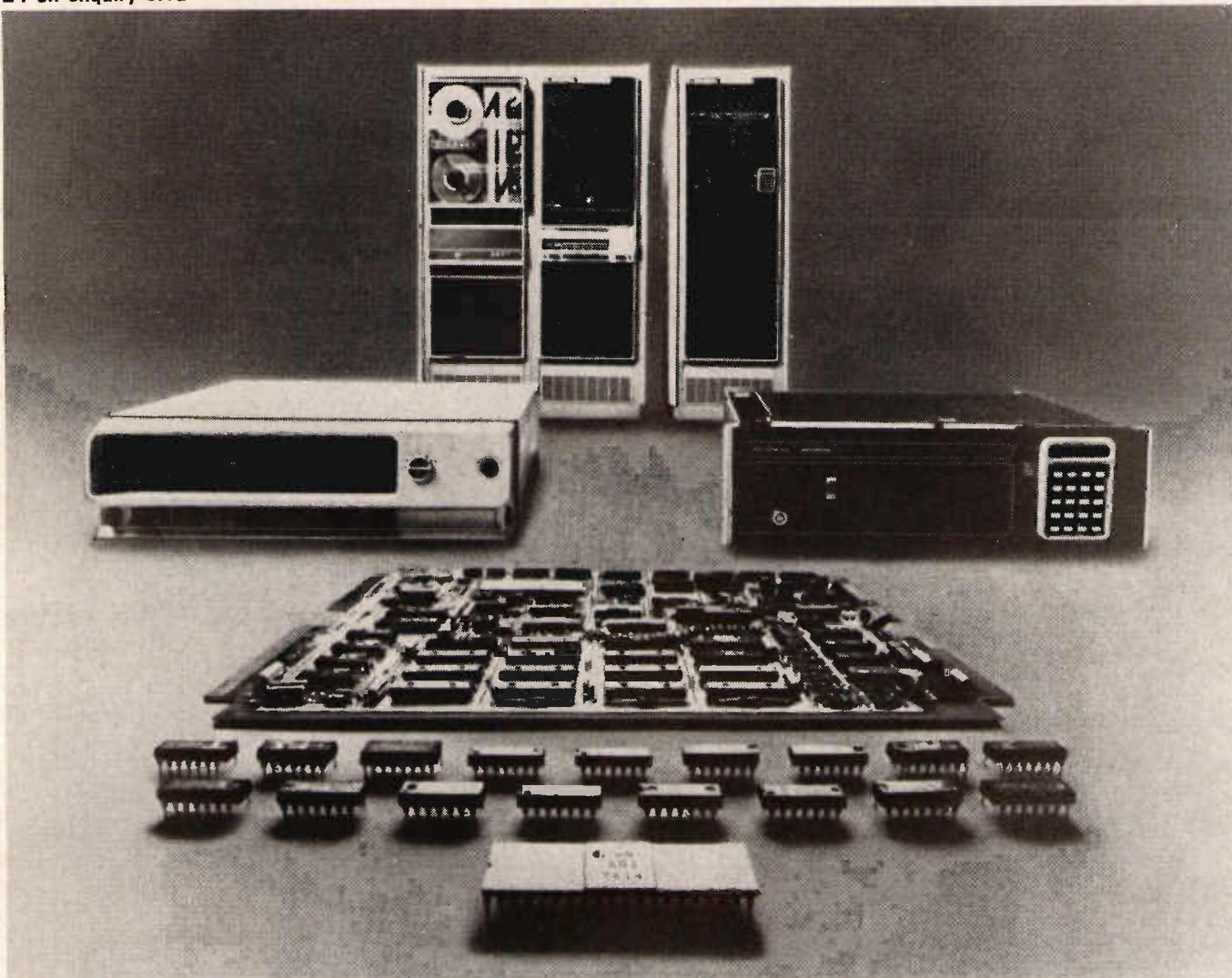

Fig. 2



With a line of minis and micros like ours, we don't have to push any one of them.

With other companies, you might set out to buy a micro-processor chip and end up with the whole chassis. Or get a box when all you need is a board.

But Data General doesn't work that way. We don't have to push you into buying something you weren't really looking for. Because we can let you choose from microprocessor chip sets, microcomputer boards, completely packaged MOS minis and full-blown NOVA 3 systems. All four are compatible. And they give you a range of performance with a range of prices.

So, if you're a component user, there are both high-performance microNOVA chip sets and microcomputer boards that feature Data General's mN601 microprocessor. The mN601 is a full 16-bit NOVA-on-a-chip. And the microcomputer is a full 4K-word computer-on-a-board. You package them yourself, for greatest economy.

And if you're not ready for components yet, there's our fully-packaged microNOVA MOS minicomputer. It's available

with up to 32K words of MOS memory and peripherals like our diskette subsystem. And it's supported by our Real-Time Operating System and diskette-based Disc Operating System. You can get our mini with 4K words of MOS memory or as a complete development system with the diskette.

If you need bigger systems capabilities, take a look at our NOVA 3 computer. It's compatible with our microNOVA family. And it runs with high-performance peripherals, sophisticated software like Real-Time Disc Operating System, high-level languages like FORTRAN 5 and BASIC, and memory expansion to a full 128K words.

We've got it all. But we won't try to sell it all. Unless it's what you really need. If you don't believe that line write to Marketing Communications, Greenford, for our microNOVA or NOVA 3 brochures.

And see for yourself.

Data General

Data General Limited, Westway House, 320 Ruislip Road East, Greenford, Middlesex, UB6 9BH. Tel: 01-678 9231

Offices also in Birmingham, Manchester and Glasgow.

Nova is a registered trademark of Data General Corporation.

must be scanned by the electron beam or else the continuous flow of positive ions would raise the unscanned areas to an excessively high potential causing tube instability. Best results are obtained if the target is overscanned and this accounts for the circular image normally associated with pyro-electric vidicon camera pictures.

Much development effort has been devoted to designing suitable cameras to overcome one of the weaknesses of the pyro-electric vidicon, namely the ability to see only temperature changes and not temperature differences. Two techniques—panning and chopping—have been particularly successful.

The panning mode camera needs only minor circuit modifications to standard cameras. These are concerned with bandwidth reduction and improved pre-amplifier gain and no changes to deflection circuitry are really necessary. The drawback is obviously the need to have a constantly moving camera. Cameras are also available that use specially shaped choppers to modulate the flow of incident radiation to the tube and thereby remove the need for panning. Of particular importance in this type is the need to make best use of the relatively low signal current by combining intricate amplifier circuitry with considerable video image enhancement networks. Performance is such that the image definition is comparable to panning mode cameras but is free of flicker.

The performance of a pyro-electric vidicon in 625 TV line use with 25 Hz interlace is summarised in Table 1. The temperature resolution is always an important parameter and Fig. 4 shows a typical relation between this and spatial resolution.

Target useful diameter	16mm
Signal current - ($E = 10Wm^{-2}$)	15nA
Resolution (20ms after irradiation)	2 line pairs per mm
Limiting resolution 20ms after irradiation	5 line pairs per mm
Average gamma	1
Responsivity (scanned area, $A = 4,3cm^2$)	$15\mu AW^{-1}cm^2$
Intrinsic responsivity ($8 < \lambda < 13$ microns)	$3,5\mu AW^{-1}$

Table 1: Performance of vidicon in 625 TV line use.

These parameters were measured with the camera used in panning mode (image moved over target at $0,4cms^{-1}$). The scanned area of target was 18×24 mm and the objective was a good quality, coated infra-red lens opened up to F/1. The object was an infra-red test chart consisting of an approximately $300^{\circ}K$ background with slightly warmer bars superimposed on it. The assembly has near blackbody characteristics. The minimum resolvable temperature (mrt) was considered as being the temperature difference for which the test chart was just visible on the TV monitor screen. The overload characteristic is good for a pyro-electric vidicon as signal saturation will only occur for object temperatures causing an irradiance exceeding $40W cm^{-2}$. This corresponds, for example to a lens aperture of F1 and an object temperature of $85^{\circ}C$.

In an assessment of performance, specific detectivity is a parameter which permits a comparison of photodetectors of different areas measured in different bandwidths. It is defined by the relationship

$$D^* = \frac{A^{\frac{1}{2}} \Delta F^{\frac{1}{2}}}{(NEP)}$$

Fig. 3: Structure of the thermal vidicon.
Fig. 4: Relationship between temperature and spatial resolution.

where A is the area of the photodetector, (NEP) is its noise equivalent power and F is the bandwidth of the measuring system. Its units are $cmHz^{\frac{1}{2}}W^{-1}$.

The concept of D^* is not truly applicable to a pyro-electric vidicon as it is an imaging system, not a simple photodetector. However, for convenience and comparison, an artificial value can be calculated by considering the target as being a whole series of image elements that are sequentially read out.

Specific detectivity is wavelength and frequency dependent for most photodetectors. However, it is wavelength independent over the 8 to 14 micron range for a pyroelectric vidicon a value of $3 \times 10^8 cmHz^{\frac{1}{2}}W^{-1}$ is typically achieved with a 1MHz bandwidth. In real applications, this level of performance gives useful spatial/temperature resolution relationships. For example, with a good chopper camera giving a completely still picture with a F0,7/50mm germanium lens looking at a nominal blackbody at room temperature, with full aperture, resolutions of 36, 145 and 180TV lines has been obtained at mrt of 0,2, 1,0 and $3,0^{\circ}C$ respectively. Dynamic range was 0,2° to $20^{\circ}C$. For the same lens at F2 aperture, with 2° to $100^{\circ}C$ dynamic range, 36, 145 and 180 TV lines resolutions can be obtained at 2° , 10° $30^{\circ}C$ mrt.

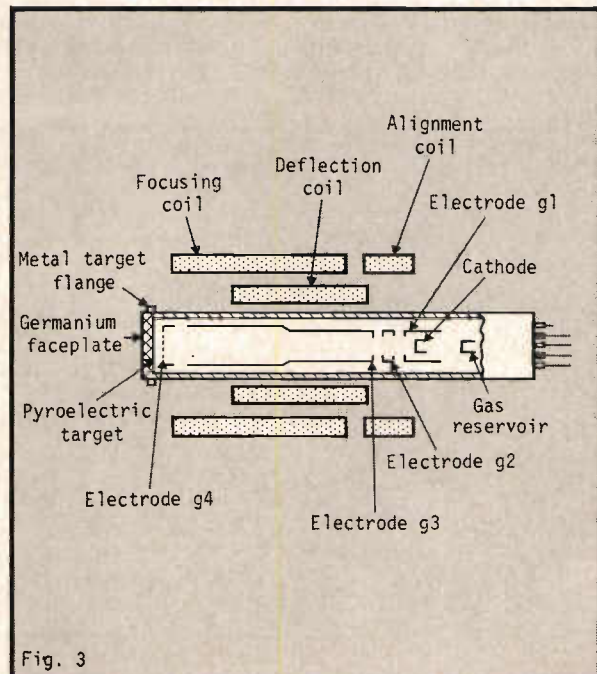

Fig. 3

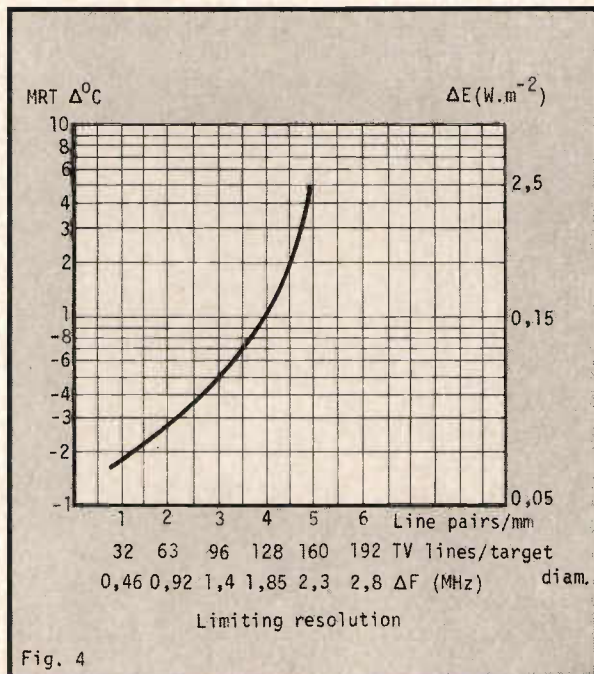

Fig. 4

Software approach to computer displays

The complexity and cost of the hardware for a computer vdu can be greatly reduced by using a software approach, writes *J E M Tyler*.

The usual method of driving a computer visual display unit involves storing the required characters in a coded form (normally ASCII) and to output this code via interfacing to the peripheral. Logic circuits within the peripheral then decode the characters and assemble the data in a format suitable for the display device. The most readily available display is a television monitor. However, owing to its inherent speed of operation, a large character store is normally required, together with decoding and character generating circuitry. In addition, it is necessary to convert the data to serial format and to assemble the horizontally divided sections of each character of a line of text to form the modulation information for the display. The complexity and cost of the hardware can be considerably reduced by using a software approach. In particular, it is possible to store the data for each frame of the display in non-coded format. Thus, using a television display, the data stored represents a series of bits each of which controls the level of modulation at a particular location on the screen. The data is output continuously under program control, with frame synchronisation being incorporated. It would then be possible to write a program to accept characters from an input device or another program, convert the character data to serial form, and store it in the correct sequence for the data output routine.

J E M Tyler is with Leicester Polytechnic.

To minimise display costs, an unmodified uhf television was used, with the output of the display system driving a commercially available uhf modulator designed for use in domestic cctv systems. The standard uhf 625-line broadcast signal consists of 4.7 μ s line synchronisation pulses with 64 μ s period, with approximately 52 μ s of modulation signal between them. The frame synchronisation is achieved with 500 μ s of synchronising pulses with a period of 20 ms.

These pulses are simply generated using SN74121 monostables with appropriate timing networks (see Fig. 3). The line and frame synchronising pulses are inverted and added to the modulation signal using an AM301 operational amplifier, the output of which is taken to the uhf modulator.

The modulation pulse demands are derived from the output of what is effectively a 64-bit shift register. The register is clocked continuously during the period between each frame pulse, putting out the data for each line of the display as the data arrives from the output bus of the computer. Because of the difficulty of precisely synchronising the programmed output instructions and the shifting of the register, the four

16-bit words of data are each loaded into a separate register. The outputs of the registers are then gated together to provide a continuous 64-bit data stream. Thus, only one register is being shifted at any instant, allowing the next data word to be safely loaded into another register. This is carried out in a cyclic manner, each register being loaded with new data while the next is being shifted.

The output bus of the computer consists of sixteen lines and data is put on to this bus under program control using the OTA instruction. Clearly the rate at which the modulation monostable can be triggered depends on the time taken for the computer to execute a programmed data transfer loop.

For the Honeywell 316, the number of machine cycles required for the transfer of one data word is eight, assuming the peripheral is ready. This gives a word transfer rate of approximately 78 kHz. (One machine cycle = 1.6 μ s). This is equivalent to a bit rate of 1.25 MHz. To allow sufficient time for initialisation and loop count checking of the program loop, a rate of 1 MHz was used. Since the video line frequency is 15,625 kHz, four words of data can be transferred for each line of the display. Thus each line of picture is made up of 64 bits of data.

Software

A flowchart for the subroutine to output the four data words for each video line incorporating four of the data output sequence previously described is shown in Fig. 2. The hardware

Fig. 1: Shows the flowchart for a subroutine to demonstrate the data display program (Fig. 2). The routine produces a chequered pattern on the screen and also indicates any lack of synchronisation.

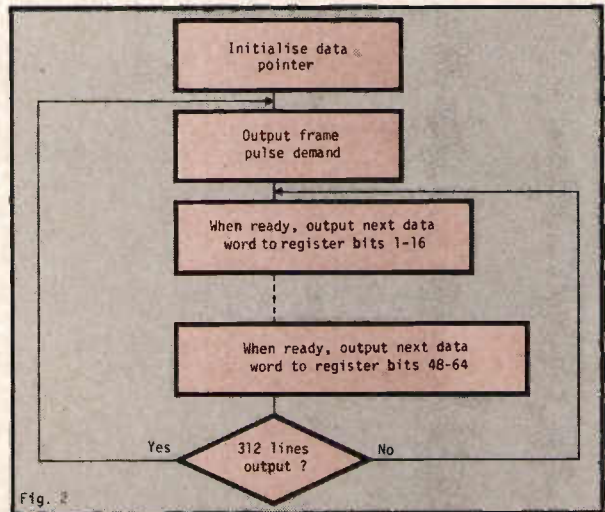
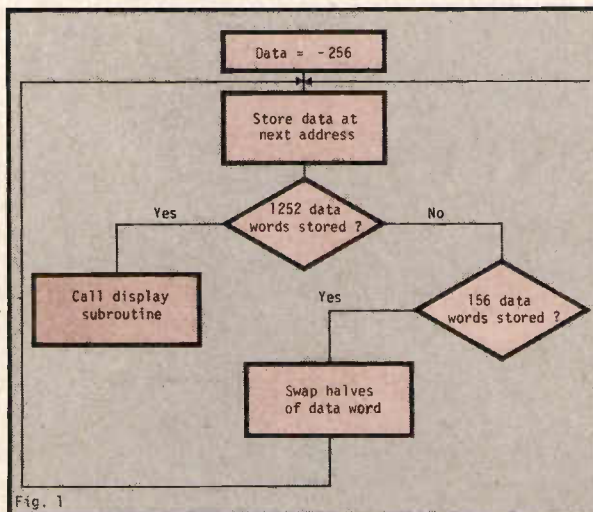

indicates its readiness to receive data by setting the Device Ready Line (DRLIN) low. If it is not ready, the computer goes into a waiting loop until the DRLIN changes state.

For the display of alpha-numeric characters or graphics, it was not considered necessary to use 625 lines and therefore the system does not use interlacing, and the subroutine puts out data for 313 lines per frame. The subroutine continuously refreshes the display using the same data sequence of 1252 words until the front panel sense switch is set, when control is returned to the calling program.

Hardware

The circuit diagram is shown in Fig. 3. The system was designed around eight SN74165 8-bit parallel-in, serial-out shift registers. These are arranged as four 16-bit registers, the serial data being taken from each of the four outputs in turn during the respective 16 μ s period. The system is synchronised by a 1 MHz crystal controlled clock, the counter-decoder supplying the enabling signals to load or shift the registers.

The output of the decoder is also used

to drive the DRLIN logic, which ensures that the data is loaded into the four shift registers at the correct point in the sequence. When an OTA instruction is executed, and the DRLIN indicates that the system is ready to accept the data word, the computer sends a pulse on the Reset Ready Line (RRLIN) which is used to clock the data into the particular register.

At the beginning of each 64 μ s decoded cycle, the system generates a line pulse. This is independent of the program so that the output of data from the registers is synchronised with the start of each line. However, as already mentioned, the frame pulse command is generated under program control at the start of each frame, since the synchronisation of this pulse is not so critical. During the frame pulse, the frame pulse flip-flop is reset, and the output is gated to the clock inhibit of the registers. The \bar{Q} output of the frame pulse monostable is used to prevent line pulses being generated for the duration of this pulse.

The end of the frame pulse is detected by the sensing of address line '161. The

External hardware required for the data display routine.

decoded address is gated with the output of the frame flip-flop so that the DRLIN changes state only if the flip-flop is set, denoting the end of the pulse.

The system as described, has low horizontal resolution but acceptable vertical resolution. It would therefore be suitable for applications where large characters only, or a combination of graphics and characters, are to be displayed. Suitable applications may be the display of data to a large number of viewers.

However, with certain improvements, such as the increase in speed of data transfer, and the reduced cycle time of the more recent microprocessors, a viable system for conventional-sized characters may be possible using the principles described. The required number of bits per line for the representation of, say, 40 characters would be 240, using a 6x7 dot matrix.

This would require a system which transferred the data words at about 5 MHz bit rate or 312 kHz word transfer rate. If this were achieved, the system could be expanded to 16 shift registers, there being 16 words of data for each line of the display. The system could then be used as a conventional vdu.

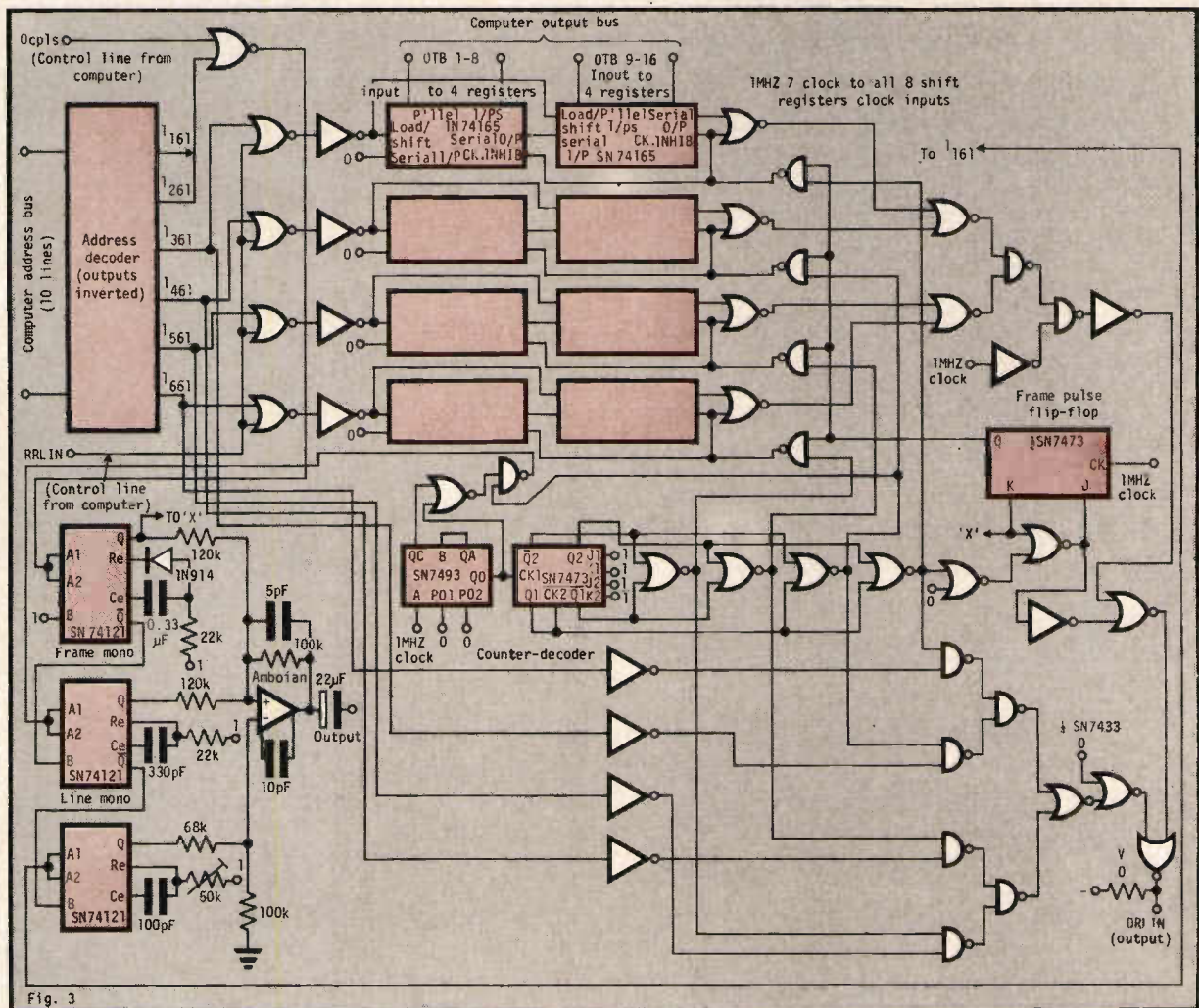

Fig. 3

Some things just can't be take

An oil rig in the Arabian Gulf for instance.

To be more specific the three alternators that power it.

The problem was simple. Each alternator had to be completely rewound. On site and with the test equipment usually used for such a task unavailable - conventional test equipment being notoriously cumbersome.

To get it there would have cost a small fortune in shipping costs and lost time. (Figure out how much it costs to have an oil rig idle.)

The alternative was to send out a Hunting Hivolt IT30 Insulation Tester.

It's small enough to be carried over the shoulder.

And it's sensitive in virtually any conditions.

(Which is why, incidentally, it's been adopted by all three British services as part of their common test equipment and has been allocated the number CT 587 as well as the NATO stock number 6625/99/620/4858.)

The end of our story is a happy one.

The oil rig was back in action fast.

It's also interesting to note that once the electrician on the rig saw the IT30 in action he asked if he could buy it.

It was sold to him and is still providing consistently reliable service.

Hunting Hivolt make a wide range of high voltage electrical test equipment catering for most d.c. testing situations.

Our d.c. voltmeters range from 10kV to 180kV.

And our insulation testers range from a few volts to 30kV d.c. Also our range of d.c. power supplies extend this capability to over 200kV, from a few watts to over 5kV.

For further information, please use the coupon now.

Please send me further details of the HUNTING HIVOLT RANGE OF TEST EQUIPMENT.

Name _____

Position _____

Company _____

Address _____

Telephone _____



**HUNTING
HIVOLT LIMITED**

Riverbank Works, Old Shoreham Rd., Shoreham-by-Sea, Sussex, BN4 5FL. Telephone: 07917 4511.

EE



back to the factory for testing.

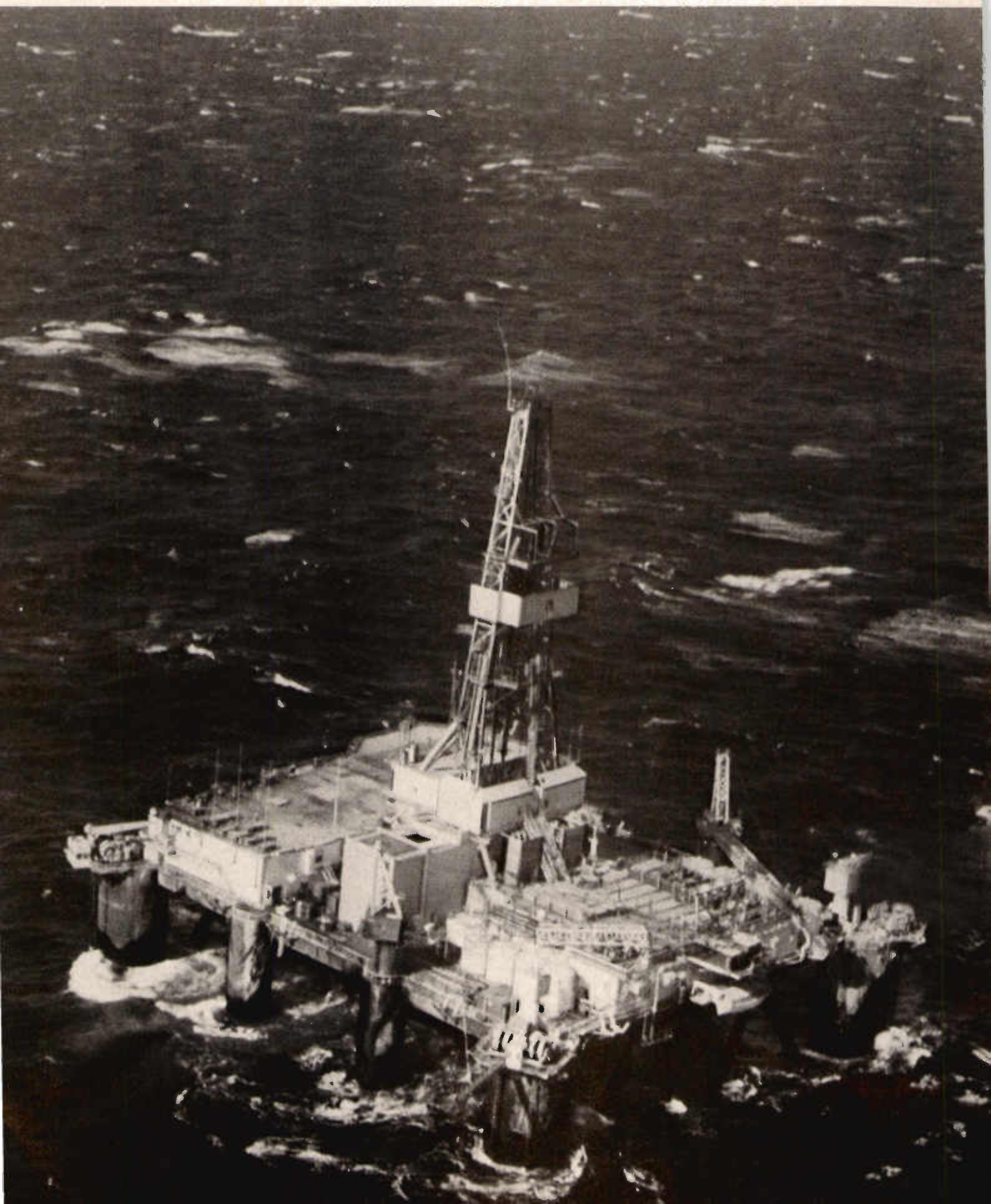

Digital logic board design with test needs in mind

Part 1 of this article dealt with hardware design considerations.
In part 2, David Tose discusses testability and the impact of ate in a
production environment.

The programs for automatic testing normally comprise two types: functional test (go/no-go), and fault isolation files. The functional test program is the basic test program of each pcb assembly and provides an indication as to whether the board is good or bad. It is generated directly from the uut circuit diagram and/or test specification, sometimes with the assistance of a logic simulator. The functional test program can be used in isolation or with the fault isolation tables.

One type of fault isolation (fi) method is the 'footprint' or 'fault signature' technique, in which the fi file contains the effects of all faults on the board as seen at the edge connector. This method of automatic fault isolation (afi) is satisfactory when the logic depth of the board is shallow, and it has the advantage that no operator intervention is required; as a result, test throughput is high. It identifies one or more probable causes of board failure and prints them or displays them on a vdu.

For higher fi resolution on more complex or larger boards, the guided fault isolation (gfi) method is preferable. This method requires that the system stores the inter-nodal connections of the board together with the response of those nodes to the test program—sometimes referred to as the structure and status files. Armed with this information, the ate system can instruct the operator to back track down the circuit path that leads to the source of the fault.

When using this method of fi, the more data about the response of each node that can be sorted, the better will be the accuracy of fault isolation. The seven most common logic states on a board are listed in Table 1. The tester should be capable of differentiating between all these distinct states; in addition, it should have the capability of selectively ignoring the status of those nodes whose condition may be unknown or impossible to determine for part of the test program (e.g. uninitialised circuits).

A test program used in conjunction with afi, gfi or both provides a standard of test performance and fault isolation that is far more reliable than human test engineers, and at the same time allows a much higher board throughput. Furthermore, the quality of the automatic testing remains consistent for as long as the programs and test equipment

are maintained. This last point is particularly significant in the application of long-term service testing, because test engineers come and go, but the proven test package is always available.

Test philosophy

The aim of total fault isolation for every board being tested is not always a practical one. Various conditions can interfere with this ideal, not the least of which is circuit design. However, given good circuit design, the user has to decide which application is best for his environment. Due to exceptional production demands, it may sometimes be necessary to operate the ate as go-no/go tester to keep throughput high, and then to fault isolate the failed assemblies later.

If no off-line program generation facility—for example a logic simulation system—is available, then the same tester will have to be employed for program production as well as its normal board testing role. Because operator intervention slows down board throughput and can introduce false errors, it should be kept to an absolute minimum. This can be achieved by good programming and intelligent board design. For example, where messages are required, they should be kept short and concise, since the experienced operator will not take kindly to having to read long unwieldy text.

Simulation

The use of a computer-based logic simulator during the generation of test and fault isolation programs can greatly reduce test program generation and execution times, improve fault isolation and detection capabilities, help pcb layout and design practice, verify logic design, eliminate logic state confusion and produce prototype pcb wire lists.

A logic simulator takes in circuit diagram data as provided by the design

engineer, and with the use of a device library creates a circuit model. This model can be exercised in just the same way as the real circuit, thus enabling a test program to be generated and its efficiency verified prior to the availability of a known good board.

The simulator reduces test execution time by omitting non-productive tests since it can study the effect on each element within the circuit model as the test is executed. It generates automatic and guided fault isolation tables without any increase in effective timescales and can assess the capability of the test program to find any fault on any ic. To do this, the simulator subjects each node to a series of fault conditions, and then monitors the output pins to study the effects of the fault.

Some simulators check that lines are correctly terminated with the right loads and will allow the logic to be laid out more efficiently on the pcb. If the simulator is one that can produce 'all iteration' outputs on demand, it will provide timing analysis data and thus enable the user to check the logic for race conditions and evaluate circuit performance. Since the circuit is only modelled in the computer, it can be readily updated as a result of this analysis and so enable design improvements to be made before the hardware prototype stage is even reached. When the circuit designer is satisfied with the operation of the simulated model, the simulator can then output a wire list for the production of prototype pcbs.

To produce a good test program it is necessary to run the simulation a number of times in order to optimise its fault detection capability. Since each simulation run takes a specific period of time, the benefits to be gained from a high-speed simulator are considerable; for example, if a one-hour run can be reduced to ten minutes (i.e. a reduction ratio of 6:1), then if 20 runs are needed to optimise the final programme, a one-week programming exercise can be reduced to one day.

It is important to have a fast simulator and preferably to have a simulator operating in an off-line mode so that it does not interfere with production testing. Simulation employed in this way can complement the operation of logic testers and produce all the programs required to keep the unit price of each ate down to a minimum.

Another item for consideration in automatic testing is the connection to

Table 1: Common logic states

1. Floating (between logic 0 and logic 1 thresholds)
2. Low (below logic 0 threshold)
3. Positive pulse
4. High to low transition
5. Low to high transition
6. Negative pulse
7. High (above logic 1 threshold)

David Tose is with the Industrial Products Division of Computer Automation.

Our case has five sides

Our GRS and GRD (single and dual) linear power supplies offer some outstanding features.

Firstly, they can be mounted on any one of five sides—fitting standard rack systems or, when required, plug in card frame mounting.

Secondly, these high power density linear regulators also offer a high degree of versatility and compatibility. Which means that you can start with any one unit, and build up an entire system from the same family.

Thirdly, there are three case sizes available in both the GRS and GRD ranges and all incorporate built-in overload protection.

Fourthly, both the GRS and GRD offer ripple and noise of just 0.02% p-p.

And fifth, they are made by Gresham Lion, which is

more than just an assurance of quality, it's an assurance of getting the best power supplies money can buy.

We 100% test all incoming active components. We evaluate every product in our Quality Assurance Department. We wind every transformer ourselves. If you'd like further specific information about the 24 units in these two ranges. Or, if you'd like more general information, send for our Standard Product Catalogue.

It may well be that our case has more than five sides!

Gresham Lion Limited

Gresham House, Twickenham Road, Feltham, Middx. TW13 6HA. Tel: 01-894 5511 Telex: 27419.

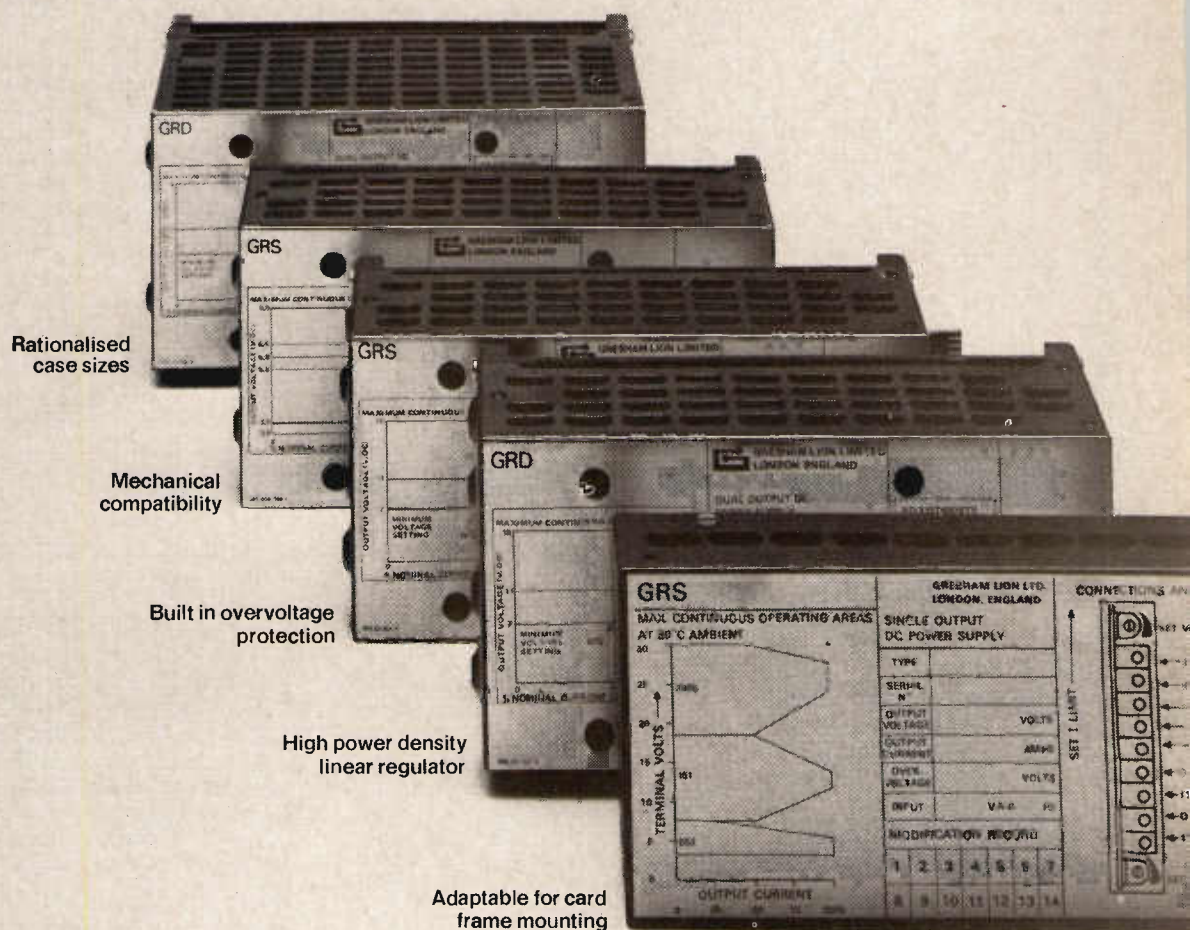

The people in power



SE 6150 — not just an oscillograph — an innovation

Our new SE 6150 12-channel UV Oscillograph is unique — its low price is unique, its built-in signal conditioning is unique.

For the first time, the researcher can move from one experiment to another without changing or adjusting galvanometers. Fit one standard set of galvos and six channels are conditioned to record up to 2 kHz fsd from high impedance voltage sources between 500 mV and 500 V at the turn of one control. And a *further* six unconditioned channels are available for less demanding parameters.

In addition, SE 6150 combines portability with an accurate, easy-to-read display, reliability and simple operation — qualities which combine to make it the most cost-effective oscillograph of its kind. If built-in conditioning is not required, the SE 6150 can

be supplied without it — at a price significantly lower than its nearest competitor.

Backing up SE 6150 is the SE family of oscillographs offering a cost effective instrument to meet every requirement. The range includes six light-beam recorders, from a 6-channel battery portable to the SE 6012 with 12" chart width and up to 50 channels, as well as compatible signal conditioning equipment and transducers.

SE has a wealth of applications know-how at your disposal — expertise difficult to find elsewhere — and because of this, we are able to provide a higher level of back-up service with fast response whenever you need it, world-wide.

When you're in the market for oscillographs, SE will provide the answers — from experience. Talk to us now.

EMI SE Labs

SE LABS (EMI) LIMITED,
Spur Road, Feltham, Middlesex TW14 0TD, England.
Telephone: 01-890 1477. Telex: 23995.

A member of the EMI Group of companies. International leaders in music, electronics and leisure.

the unit to be tested. Careful thought needs to be applied to this connection if reliable testing and diagnosis is to take place. For example, consideration of correct earth termination for the unit is one that is often overlooked: it should be located as near to the unit as possible, be as solid as possible, and be the one point where the unit power supply OV line, the OV sense line and the signal-return line all terminate together. The signal harness should employ twisted pair signal lines and its length should be kept to a minimum, unit power supplies should always be remotely sensed at the unit and adequate fast decoupling should be located at the unit interface.

ATE organisation

When an ate system is purchased, it should be borne in mind that for the user to maximise the benefits obtainable from the installation some prior thought should be given to the overall system integration and organisation. First to be decided must be which department should be responsible for the system—Production Test or QA?—since each will have its own particular requirements of an ate system. Production test will wish to supply the system test and/or commissioning department good working boards. QA, on the other hand,

will be interested in the quality performance data that is obtainable from the system.

Another aspect of the overall installation will be the physical position of the ate system: for optimum operator comfort and minimum system downtime, the system should be kept in a normal working environment. It is often advantageous, too, to have a small re-work area close to the ate, for quick interactive turnaround of faulty boards. A localised store area may also be required (for programme listings, disc files, test harnesses etc) and its size will naturally depend on the number of different types of board in production and being tested on the system.

An equally important decision to make concerns what should be done with faulty boards in the field. Should they be returned to production test for checking on its ate, or should the servicing department have its own ate facility in the field? If the latter course is adopted, then it must be decided whether or not the field tester should have the same performance as the production tester, or whether it should have only limited testing capabilities. Clearly, a field tester which exercises boards as thoroughly as the production tester, and which uses the same test programs, will

be more desirable and economical than any other solution.

The digital ate of the type described here will operate at test rates of up to 100,000 tests per second, and will normally find all but the 'real time' or dynamic faults; these will still require a system test and a commissioning engineer to locate them. On a production unit, faults of this nature tend to be only 1% or 2% of the total, and it can sometimes be more cost effective to discard pcbs exhibiting faults of this nature rather than try to isolate them.

From a well organised ate department, valuable data can be generated and returned to the test programmer to provide him with a means of improving fit techniques. It can also provide invaluable data for the design department, isolating the most common faults and suggesting where tracking could be improved. There is no doubt that ate used correctly in a test environment can reduce the test bottleneck, enable increased production and provide a guarantee of consistent quality that will increase product life, improve service and reduce cost. If ate is introduced properly, the capital investment involved can reap large rewards; but like any change, it requires a disciplined approach to its use.

28 on enquiry card

AC Voltage Stabilisers

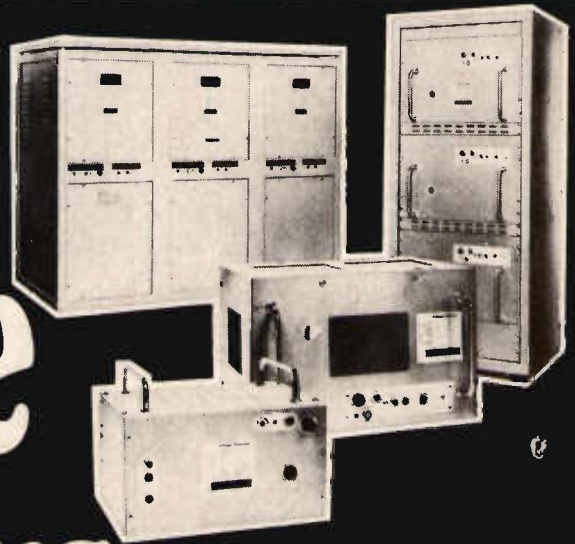

■ Range 1.7kVA to 430kVA, single or three phase. ■ All models cater for voltage fluctuations of -20% +10% or $\pm 16.5\%$ ■ Output voltage stability $\pm 0.5\%$ ■ Improved correction rate up to 36% per second. ■ Manufactured to DEF STANDARD 05 - 24 ■ Most models Ex stock

Ling Dynamic Systems Limited., Voltage Stabiliser Division, Baldock Road, Royston, Herts. SG8 5BQ. Telephone: 0763 42424 Telex: 81174.

A Subsidiary of British Electronic Controls Ltd.

We measure up to your standards

B900
Automatic Digital Bridge 1kHz 0.1%



B224
Wide-range Audio Bridge 1592Hz
(200Hz–20kHz external)



B331
Self-balancing 0.01% Precision Bridge

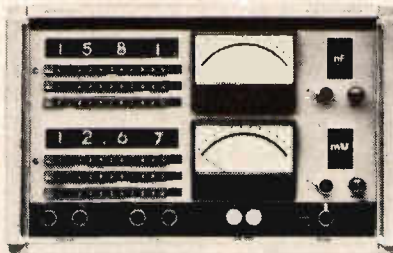

B642
Autobalance Universal Bridge 0.1%

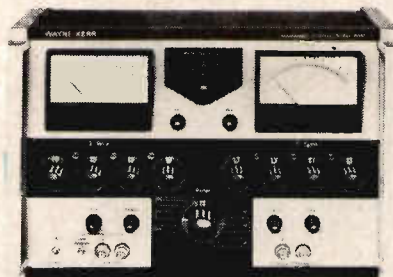

B421
Direct-reading Component Meter 0.25%

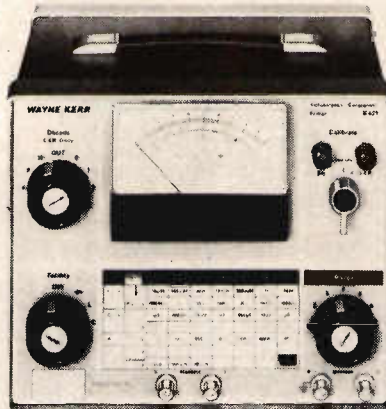

Whether you check components at Goods Inwards, during production or on Final Test, Wayne Kerr has the bridge you need. For fast measurements of resistance, capacitance and inductance, or for continuous monitoring of changing values, you can select the ideal instrument from our comprehensive range.

All models—AF, RF and VHF—have a wide measurement range and are easy to use. Many have automatic readout and automatic lead compensation; most will measure components *in situ*.

Only part of our range is illustrated. Send in the coupon for further information.



Wilmot Breeden Electronics
Ferrograph Rendar Wayne Kerr

Wilmot Breeden Electronics Limited,
442 Bath Road, Slough,
SL1 6BB, England.
Telephone: Burnham (06286) 62511
Telex: 847297

Please send me the Wayne Kerr short form catalogue.

Name _____

Position _____

Company _____

Address _____

Telephone _____

EE 1/77



Wilmot Breeden Electronics Limited,
442 Bath Road,
Slough, SL1 6BB,
England.

WAYNE KERR BRIDGES

**Gould Advance
instruments.
Our latest, most
revolutionary
feature is tied on
with string.**



Signal Generators & Test Oscillators

J3A and J4A, Test Oscillators—10Hz to 100kHz of accurate, high resolution, sine and squarewaves. Versatile and reliable offering a wide range of general and exacting applications.

Multiple impedance outputs including 600 ohms balanced. Up to 30V of metered output or 7W power with precise attenuation. Flat response and high stability with less than 0.02% distortion. Can be used as a power amplifier or for signal mixing.

SG200 RF Signal Generator—160kHz to 230MHz in 7 ranges with convenient band break points offering C.W., int. or Ext. modulation.

200mV EMF from 50 ohms with 0-100dB attenuator, flat amplitude response with level indicator and fine level adjust.

Excellent frequency stability with fine setting to within 1kHz. Low cost, solid state, compact and portable with mains or int. battery operation.



J3A



SG 200

Pulse Generators

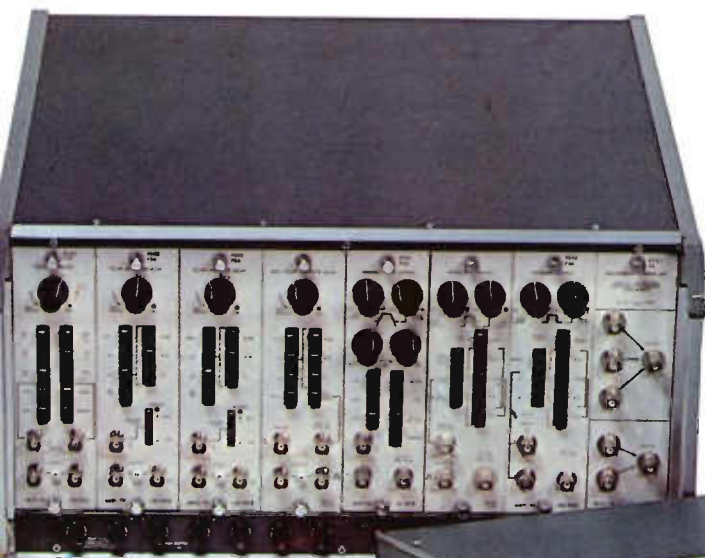

PG52B

PG 58A—A compact, reliable, low cost pulse generator offering a wide range of applications. 0.1Hz to 5MHz. Single and Double pulse. True simultaneous positive, negative or inverted output plus square wave. Width and delay, 100nsec. to 500msec. Up to 10V of protected output from 50 ohms. Rise and fall times less than 10nsec. External trigger and gating plus manual and pre-pulse facility.

PG 52B—A sophisticated and versatile modular pulse generator, with the capability of generating most pulses and pulse patterns within the parameters, 0.1Hz to 30MHz and 0V to 50V, including Word generation, Waveform synthesis and VCO Sweep. Combinations can include the Main frame and power supplies plus Clock generator Width generators, Delay generators, Standard output units, Variable slope unit, Passive summing unit, High power unit, Fast output module, Word generator, Gate unit and a Summing coupler all of which are protected, well established and in current use with armed forces and throughout industry.



PG58A

Everybody offers reliability—Gould Advance guarantee it for 2 full years.

Gould Advance Limited,
Roebuck Road, Hainault, Essex IG6 3UE, England.
Tel: 01-500 1000 Telex: 263785.

 **GOULD ADVANCE**

TIB 6281 12/75

Printed in England.

Linking microprocessors to increase system throughput

Linking several microprocessors can improve system performance and is not as difficult as is commonly believed, writes Peter Gebler.

A common reason for using several microprocessors in a system is to improve system throughput. In a single processor system, throughput can only be increased by the use of a more powerful processor. If, for example, a system requires some fast peripherals such as floppy discs, several slower peripherals such as line printers, card readers or adcs and perhaps an interface to a larger computer, the throughput requirements may exceed the capabilities of any single microprocessor. Instead of using a minicomputer, which, two years ago, would have been the only economically viable course, the multiprocessor system shown in Fig. 2 can be used. Apart from the considerations of chip cost, there are other factors which may favour this approach. A designer who has previously used the two types of microprocessor will not have to familiarise himself with a new architecture and instruction set, nor will he have to buy new development tools. The capital investment required to start working with a new microprocessor and the time needed to become familiar with the device's characteristics provide strong incentives for choosing the same microprocessor for different applications. The system shown in Fig. 2 was developed by National Semiconductor to illustrate how the 8080 can be used in an application which demands a greater throughput than the 8080 can by itself deliver.

In the system shown, three or more SC/MP microprocessors are used to control the input/output operations of

low-speed peripherals (teletype-writer, crt, line printer etc.) and low-speed interfaces (adcs, sensors). The 8080 controls the I/O operations of high-speed peripherals (floppy discs, communications circuits etc.) and may also function as a 'slave' for a remotely located large computer. The basic multiprocessor configuration can be used in two distinct ways. Each SC/MP can perform its own task and use the 8080 as a data reference or as a source of increased execution power or, each SC/MP microprocessor (slave) can perform its own task under the control of the 8080 (master).

In the second scheme, the tasks performed by the slave microprocessors can be regarded as extensions of the master's instruction set and the master will normally execute its own program in addition to controlling the slaves. In the first scheme, the slower microprocessors can 'borrow' the 8080 whenever they are called upon to perform tasks beyond their capabilities.

The multiprocessor system of Fig. 2 features separate address, data and control bus systems for the two types of microprocessor. The master part of the system is straightforward; the 8080 program memory, local ram and peripherals are connected to the buses as if they were part of a single processor system. In the slave part of the system, the program memory, common ram and peripherals are connected to three (or more) slave microprocessors but in

this part of the system some memory locations are reserved as data buffers, 'mailboxes' and temporary storage for the individual slaves. Peripherals and memory are treated identically by SC/MPs so that all of the peripherals connected to the slave bus system can be shared by any of the slave microprocessors in the system. However, slave No. 1 is used as a controlling device (responsible for controlling communication between the microprocessors and between the system and the operator) and the operator's peripheral (usually a tele-typewriter) is always connected to this device. By dedicating a slave to the supervision of the interprocessor communication, the software is greatly simplified.

Bus control

At this point, one might ask why SC/MPs have been used instead of additional 8080s. In fact, there is no reason why a multiprocessor system should not use only one type of microprocessor and schemes for a network of interconnected 8080s have been proposed in the USA. The difference in cpu cost between an all-8080 system and a mixed system will normally be unimportant. The use of the SC/MP microprocessors does have other advantages, however, which simplify the system's hardware aspects. The main reason for this is the bus-access logic built into the devices—three pins provide signals specifically designed to simplify multiprocessor system hardware. Before a device can take part in any data transfer it must

Fig. 1: A typical format for a Select, Character word.

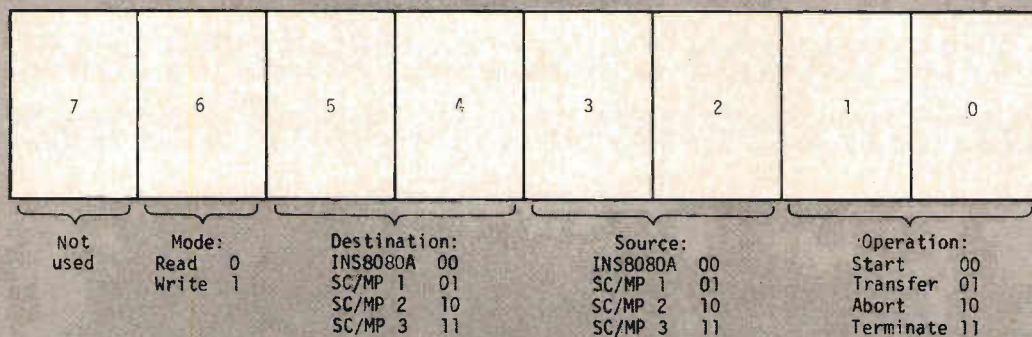
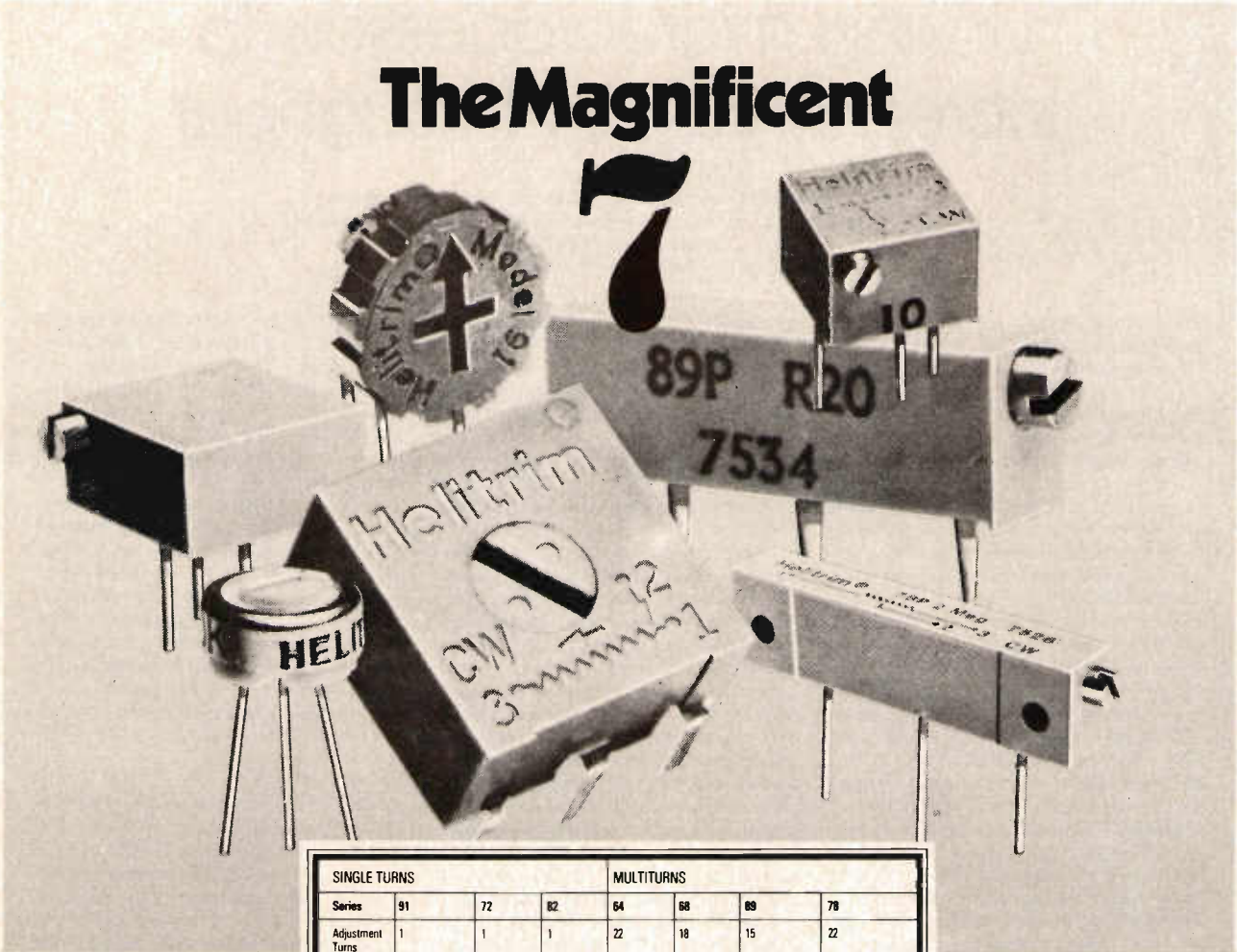

Fig. 1

The Magnificent



The Beckman 7 offer you a one source trimmer supply—available off the shelf—for 95% of your applications, and there are more Beckman trimmers to deal with the other 5%. These cermet trimmers, offer you essentially infinite resolution, show superior environmental stability and excellent voltage setting ability, giving you longer, trouble free life at reasonable cost. Thanks to Beckman's development research and quality control

	SINGLE TURNS			MULTITURNS			
Series	91	72	82	64	66	69	78
Adjustment Turns	1	1	1	22	18	15	22
Resistance Range (ohms)	10-2 meg	10-2 meg	10-1 meg	10-1 meg	10-2 meg	10-2 meg	10-2 meg
Power Rating (Watts)	0.5 at 40°C	0.5 at 70°C	0.5 at 70°C	0.25 at 85°C	0.5 at 70°C	0.75 at 25°C	0.75 watt at 70°C
Unit Size	3/4" (19.53mm) dia.	3/4" (19.53mm) square	3/4" (19.53mm) dia by 0.50" max. ht. (13.81mm)	3/4" (19.53mm) square	3/4" (19.53mm) square	3/4" (19.1mm) rectangular 0.250" (6.35mm) high	1 1/4" (31.75mm) rectangular 0.195" (4.95mm) high
Maximum Operating Temperature	125°C	125°C (Flame retardant housing)	125°C	150°C	125°C	105°C	125°C
Sealed/Unsealed	Protective dust cover, board washing permitted	Sealed for board washing	Sealed	Sealed	Sealed for board washing	Sealed for board washing	Sealed.

programme, all trimmers conform to stringent standards designed to assure maximum reliability of the products in use.

For free Evaluation Samples or technical information contact:—
Sales Department,
Beckman Instruments Limited,
Queensgate, Glenrothes,
Fife, Scotland.

Tel: 0592 753811
or your local Beckman Helipot Distributor.

The world's most efficient and comprehensive range of cermet Trimmers.

Beckman U.K. Distributors
Atlantic Components Limited, 143 Loughborough Road, Leicester LE4 5LR. Tel. No. Leicester 65931
Comway Electronics Limited, Market Street, Bracknell, Berks. RG12 1JU. Tel. No. Bracknell 24765
REL Equipment & Components Limited, Croft House, Bancroft, Hitchin, Herts. SG5 1BU. Tel. No. Hitchin 56576
T.I. Supply Co. Limited, Manton Lane, Bedford MK41 7PA. Tel. No. 0234 67466

BECKMAN® 

have access to the address, data and control buses. Bus access is controlled by Bus Request (BREQ), Enable Input (ENIN) and Enable Output (ENOUT). The microprocessor requests control of the buses by forcing BREQ high. If the request is granted, this is signified by ENIN going high. With BREQ and ENIN both high, SC/MP can use the buses and sets ENOUT low. The ENIN and ENOUT pins therefore allow simple 'daisy-chaining' of processors so that simultaneous requests for bus access are resolved on a priority basis. In the system shown in Fig. 2, slave No. 1 has its ENIN input tied to the wire-anded BREQ pins of all slaves. Thus, whenever slave No. 1 requests bus access by setting its BREQ output high, ENIN goes high. This device, therefore, can access the buses on demand. When access to the buses is no longer required, BREQ is taken low again. ENOUT is low whenever ENIN is low, or when the processor is using the buses. Because the ENOUT pin of slave No 1 is connected to the ENIN pin of slave No. 2 and slave No. 2's ENOUT is connected to slave No. 3's ENIN, slave No. 1 has priority over No. 2 which, in turn, has a higher priority than No. 3.

Bidirectional communication between the master and slave No. 1 is effected on an interrupt basis, using a

pair of 8212 I/O ports. In the diagram, the upper port is used to transfer data from the master to the slaves while the lower port allows the slaves to pass data to the master. In both cases, the sending microprocessor loads the appropriate I/O port with the required data character and the I/O port activates its Interrupt output line to the receiving microprocessor. If slave No. 1 is the receiving device, it receives the interrupt signal on its sense B line and reads the transmitted data under software control. If the master is in the receiving device, it will also respond to the interrupt request if it has been enabled to do so. Assuming that the master's interrupt line is enabled, the device reads the transmitted data from the lower port. In each case, the I/O ports deactivate the interrupt lines once data is read.

Data transfer

When a particular microprocessor wants to initiate a transfer, it does so by means of a Select Character word. This is an 8-bit word which carries, in encoded form, a description of the nature of the required transfer. A typical format for the select character word is shown in Fig. 1 and it can be seen by inspection that it encompasses all of the

possible interprocessor transfers. When the master wants to initiate a transfer it places its Select Character in the upper I/O buffer which activates its interrupt line connected to the sense B input of the controlling slave (No. 1). If, for example, the master needed to pass data to slave No. 2, the Select Character sent to the I/O port would be 01100000. The procedure when a slave wants to initiate a transfer is a little different, because both sense inputs of the controlling slave have been used (sense A is connected to the user input peripheral allowing the operator immediate access to the system). When a slave wants to start a transfer, it places its Select Character word in a pre-assigned memory location known as a 'mailbox'. The controlling slave continuously polls this memory location in order to detect transfer initiation requests from the other slaves.

Slave No. 1 has the task of detecting and interpreting Select Character words and this arrangement places a minimum burden on the remaining microprocessors, allowing them to spend as much as possible of their time carrying out other tasks. The controlling slave must be provided with a data transfer routine such as that shown in Fig. 3. This routine causes the controller to continuously poll the 'mailbox' and sense line until either a slave Select

Fig. 2 Basic interconnection scheme for multiprocessor system.

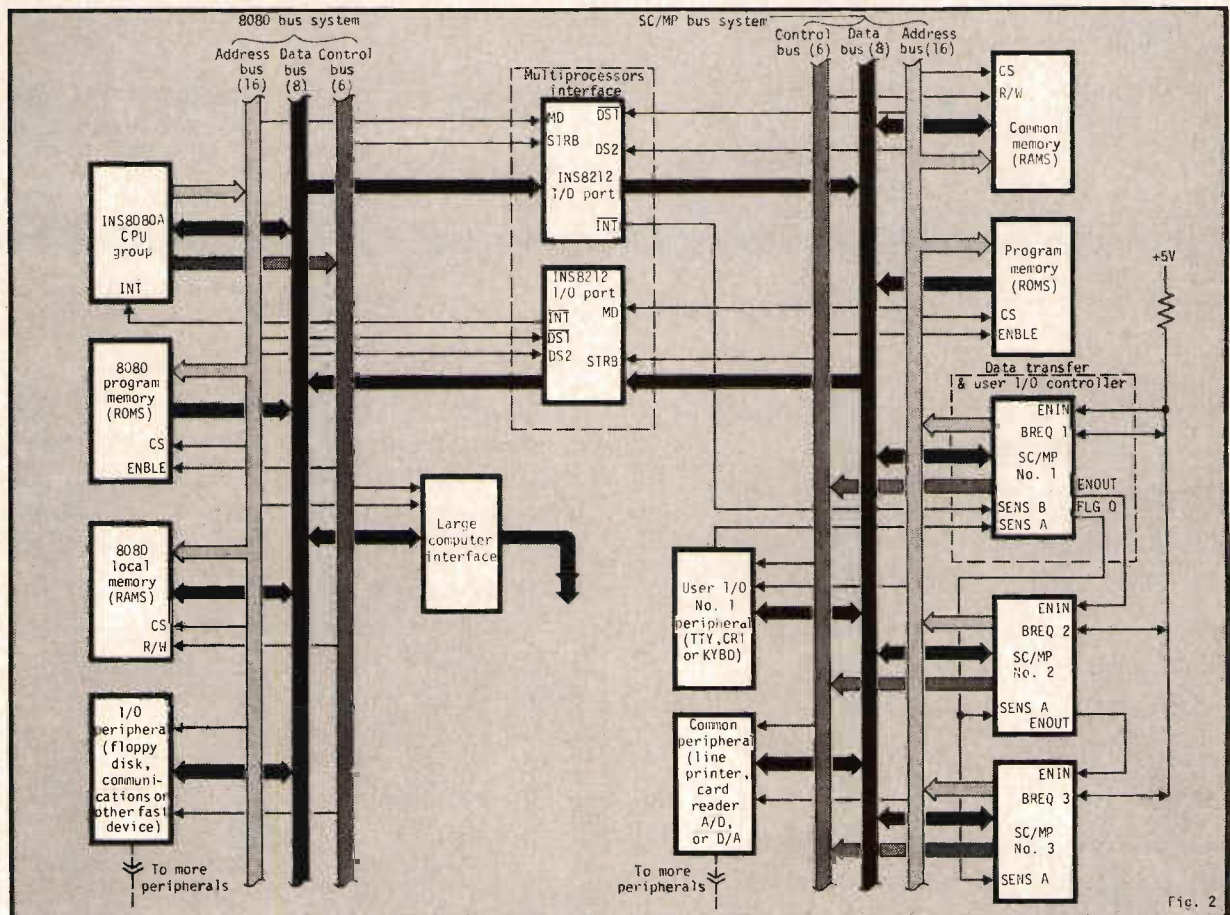
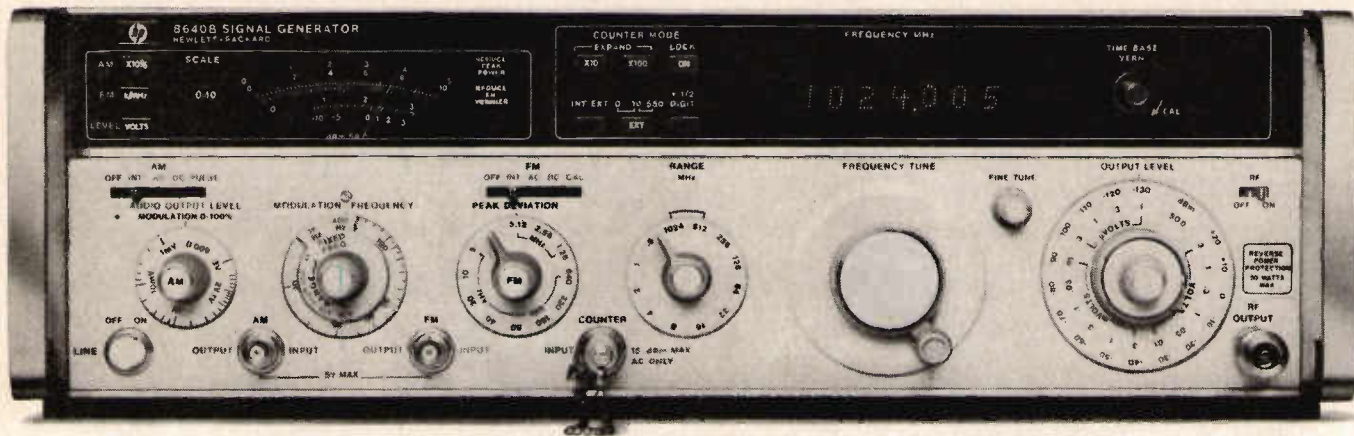

Fig. 2

For high performance receiver testing, you need high performance signals.



HP 8640B w/Opt. 001,002, 003 - 0.5 to 1024 MHz.

When HP introduced the 8640B, its product concept brought together the superior characteristics needed for high performance receiver testing:

- Spectral purity <130 dB/Hz, 20 kHz offset
- Wide dynamic range; +19 to -145 dBm
- Phase lock stability/external count capability

Since then we've continued to add to the original capabilities:

- Opt. 001 - Variable modulation
- Opt. 002 - Extended frequency, 0.5 to 1024 MHz
- Opt. 003 - Reverse power protection to 50 watts
- Opt. 004 - Avionics version for NAV/COM tests
- 8640M - Ruggedized/military version

Now with the 8640B you get $\frac{1}{2}$ digit phase-lock resolution (500 Hz, 100 to 1000 MHz), improved modulation and power settability. You can also use the new Model 11710A Down Converter to extend output frequency down to 5 kHz and test standard IF amplifiers at 262 kHz and 455 kHz.

So for your high performance receiver testing, you'll still choose the performance leader in RF signal generators. For more information, contact your local HP sales office.

HEWLETT  PACKARD

Sales and service from 172 offices in 65 countries.
Wokingham, Wokingham, Berks RG11 5AR. Tel: Wokingham 784774

Character word is found or a sense B transition occurs, indicating that the master has placed a Select Character word in the appropriate I/O port. The rest of the routine decodes the Select Character word and controls the transfer. The poll routine tests the sense B line (which is connected directly to bit 5 of the SC/MP status register) and compares the contents of the 'mailbox' to zero. When the poll routine detects an active input on the sense B line, it exits to the '8080 Select Character Decode' routine and when it detects a non-zero 'mailbox' entry it exits to the 'SC/MP Select Character Decode' routine. In the polling routine, it would normally be more efficient to poll the master Select Character more frequently than those of the slaves; polling sense B before each 'mailbox' polling, for example, enables the master's requests for data transfer to be granted with minimum delay.

In addition to the data transfer routine, the controlling slave is provided with an interrupt service routine which allows the operator to communicate with the system. The user peripheral would normally be a teletypewriter or similar keyboard-driven peripheral but could be as simple as a bank of input switches. The user peripheral is connected to the sense A line of slave No. 1 which, unlike the sense B line, is a true interrupt request

line. Provided that slave No. 1 has enabled its interrupt facility, the operator has ready access to the system. The interrupt service routine will then depend on the operator's requirements. These might include writing to a specified location in the SC/MP memory, reading from memory or placing a Select Character word in the 'mailbox'.

The system described can be used as the basis of a wide range of multiprocessor systems, not necessarily employing the devices shown. If other microprocessors are used, the details of both hardware and software will need to be changed, but the conceptual basis remains unaltered. Almost any microprocessor can be used in a multiprocessor configuration and the arrangement of Fig. 1 can be adapted for use with any microprocessor that has bus-isolation capabilities (microprocessors with no bus-isolation facilities can also be used in multiprocessor configuration but an entirely different approach is required). Although the bus-access prioritising logic featured by SC/MP is not usually incorporated, most of the popular microprocessors allow bus isolation. Usually a single input is used to force the microprocessor to relinquish control of the

buses by placing its bus output circuits in a high-impedance state and a single output line is provided to indicate when this has been done—the 6800, 8080, CP1600, Z80 and 9900 are examples of microprocessors of this type and the 2650 has similar provisions except that separate bus enable inputs are provided for the data and address buses. It is not necessary for the microprocessors to have interrupt facilities, although these usually simplify the implementation of the system.

Although the technique is rarely employed by microprocessor users today, distributed processing is well established in the minicomputer world and its acceptance by microprocessor users is inevitable. Recent studies by the US Air Force Avionics Laboratory have shown that most avionic processing requirements can be met by this approach. Many of the multi-microprocessor systems developed to date have been military applications, but the technique is well suited to applications such as traffic control, electronic fund transfer and process control in large plants. Previously, the cost of processors precluded the use of distributed processing in all but a small number of applications. With the sharp drop in the cost of microprocessors and their support circuits that has taken place over the past year, this barrier has been removed.

Fig. 3 Flowchart for the interprocessor data transfer routine.

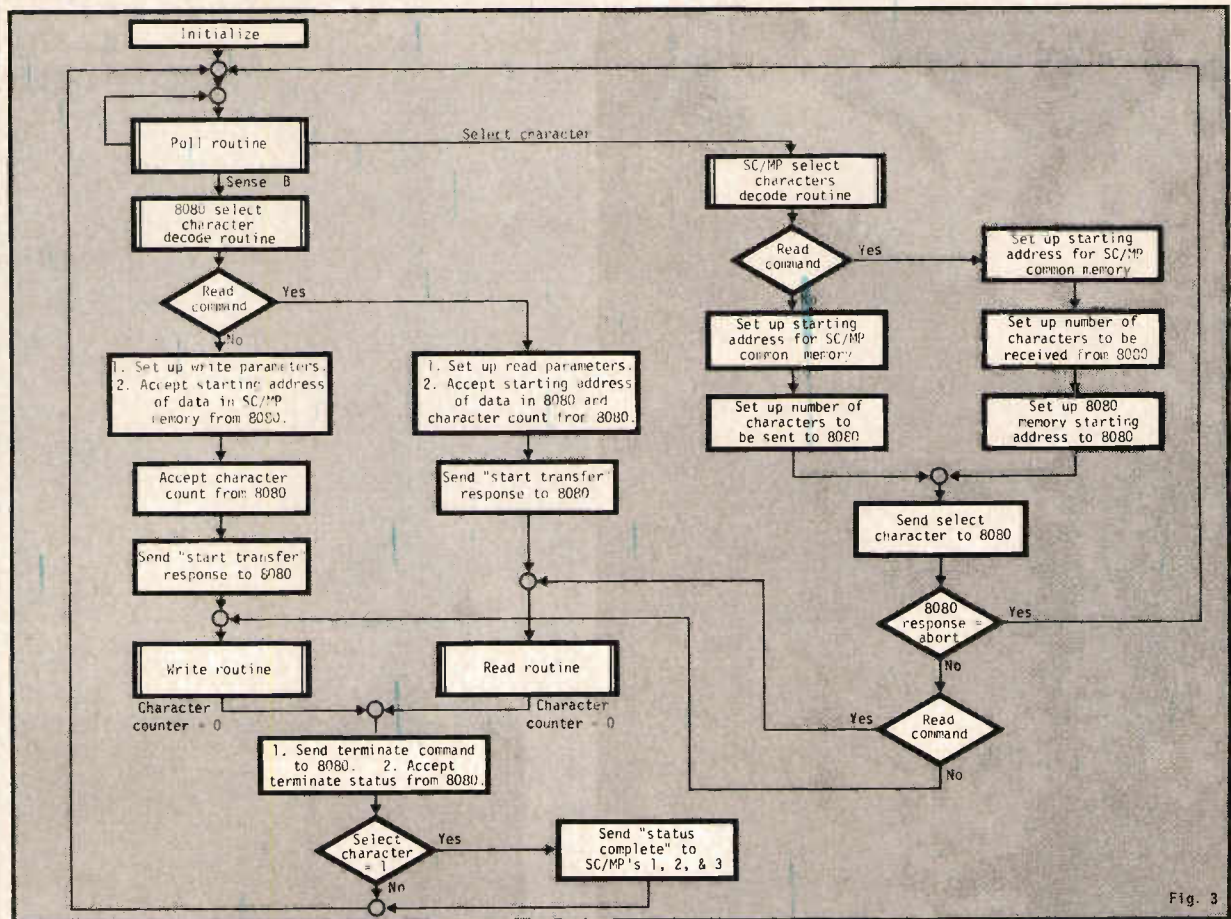

Fig. 3

conductive plastics capability

no 7: potentiometers
 Penny & Giles range of conductive plastics potentiometers are precisely suited to industry's needs, with the performance features you'd expect from a precision potentiometer.
 virtually infinite resolution
 absolute conformity to $\pm 0.025\%$
 exceptionally long life in severe environments
 low electrical noise
 chemically inert tracks



Precision rotary potentiometers synchro sizes 05 to 30 with absolute linearity from 0.025%. Non-linear functions to close conformity.
Sine/cosine potentiometers built in synchro sizes 11 to 30.
Rectilinear potentiometers up to 250mm stroke length, single or dual electrical output & a comprehensive environmental spec.
Tracks and wipers manufactured to suit your requirements, accuracy to $\pm 0.1\%$ and a high frequency response.
Torque motor potentiometers compact module, high torque, special products built to customers own requirements.
 Use the enquiry number to obtain a full spec.

Penny & Giles Conductive Plastics Limited
 Newbridge Road Industrial Estate
 Pontllanfraith Blackwood (0495) 223771 Telex 49135
 a member of the Penny & Giles group of companies.



New heads...

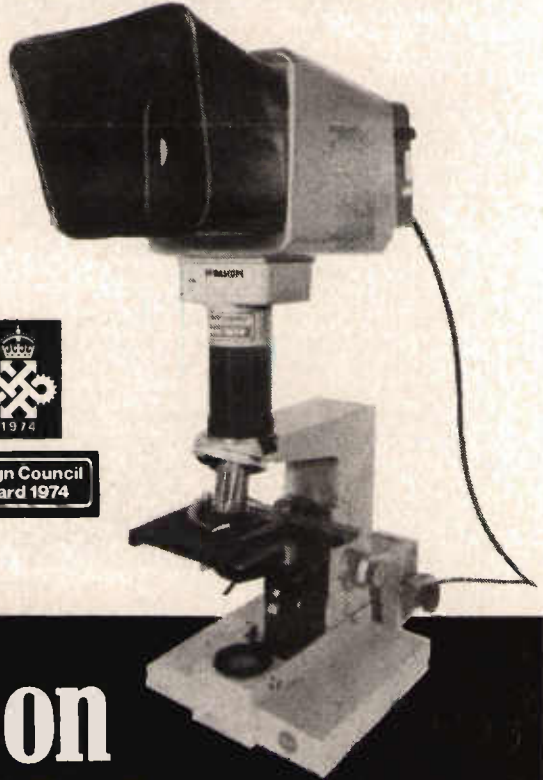

Design Council Award 1974

...on old shoulders

The Vision 4A Dynascope Head is specially designed to fit on compound microscopes in place of the existing binocular head. Results? Comfortable, fatigue-free viewing with eyepiece-quality resolution.

This Queen's and Design Council Award winning viewing system is available in a number of models to suit most individual requirements.

For further information on the Vision 4A Dynascope Head, or to arrange for a demonstration, please telephone or fill in the coupon and send it to us.

'LOOK AT THINGS A BETTER WAY'



Vision Engineering Ltd.

SEND ROAD, SEND, WOKING, SURREY GU23 7ER, ENGLAND

Tel: Guildford 223417 Cables: 'Vision' Woking Telex: 859301

To: Vision Engineering Limited
 Send Road, Send, Woking, Surrey GU23 7ER England
 Please send more information on the Vision 4A Dynascope Head
 Please ring me to arrange a time for a demonstration
 (Tick as appropriate)

Name _____
 Position _____
 Organisation _____
 Address _____

Tel: _____ EE13

Assessing polyimide film in flexible printed circuit boards

Various types of material have been used in flexible pcb manufacture
Brian Jennings takes a detailed look at one type and compares it against other available materials.

Flexible circuits proved themselves so well in 'space age' applications that they are now being incorporated into high volume, mass produced products with increasing frequency. These circuits can often solve space and weight problems at lower cost than conventional point-to-point wiring or printed boards.

Flexibles can take many shapes, including coils, bends and twists, conforming to available space and allowing shorter runs to be made. Wiring costs in electronic and electrical equipment can be reduced by as much as 50%. Space savings can be as high as 75% over conventional high density wiring, with weight savings as high as 50%. The high surface area to volume ratio of flexible circuits allows high heat dissipation and higher current ratings than possible with normal round wire. Further, all solder pads are in one plane, making flexible circuits adaptable to automated manufacturing procedures. Also, the etched copper conductors bonded between layers of flexible insulation are completely encapsulated against moisture, gases and foreign materials for increased reliability.

Flexible printed circuits were designed to deliver many positive benefits, but, the flexible circuit design cannot deliver all of these benefits if the insulation used in bonding has serious limitations. Also if the insulation can be soldered only once—the circuit is not repairable. Should the insulation flow during processing, the conductors may become misaligned, affecting circuit quality and if the insulation tends to crack when creased, circuit integrity is compromised.

To this end DuPont developed Kapton. The all-aromatic ring structure polyimide film, offers an interesting combination of physical, chemical and electrical properties, previously not available in plastics film materials. The film can be used in applications with temperatures as high as +400°C, or conversely as low as -269°C,

without losing its inherent properties. The film will not support combustion, or melt and has no known organic solvent. It is resistant to high energy radiation, has high dielectric strength and it can be used in thinner sections than several other materials.

Circuits with Kapton insulation display properties conforming to hand or wave soldering techniques, without damage to the insulation. They can be soldered by unskilled personnel, unlike some circuits using polyester which requires skilled labour for safe soldering. This feature alone helps to reduce the manufacturing reject rate, as well as cost. It also means that there is no waste in starting up a new line of newly designed circuits. Further, the film can be repeatedly soldered, unlike polyester; it can take heat from temporary circuit overloads without damage or risk of circuit breakdown and accepts heat from sources outside the finished assembly, again without damage.

It is the accepted rule that any flexible circuit design will cater for the minimal amount of shrinkage, despite high processing temperatures, and this is true of Kapton. Conductors stay in place during processing, unlike those of thermo-plastics FEP film, where processing heat may cause film flowing and some displacement of the conductors, either increasing the reject rate (and manufacturing

costs), or producing circuits of uneven quality. Kapton insulation insures that design distances between conductors are maintained and that all circuits in a production series are identical.

Circuits produced from this insulation film can be bent and flexed repeatedly without breaking, unlike materials such as glass epoxy, where the glass fibre core is inherently susceptible to cracking when creased, giving a subsequently low tear resistance.

Many users have been living with the inherent limitation of polyester, because of its low cost in the raw material state. However, in many cases, this can be rightly considered to be doubtful economics. As a raw material, polyester costs considerably less than Kapton. However, in the laminated state, the cost for Kapton has dropped to a level only two and one half times that of polyester. And, incorporated in the printed circuit itself Kapton costs about one third more.

Three types of the material are available, type H, an uncoated, all purpose film; type V, an uncoated film with high dimensional stability and type F, a base film coated with Teflon FEP fluoro-carbon resin permitting heat sealing and an enhancement to chemical resistance. Applications for flexible circuits include, electronic digital watches and car radio cassette players,

Fig 1. In this instance the circuit connects external push-button controls to all internal working parts. The circuit construction consists of 25 µm of soft rolled copper laminated to 25 µm film; end connectors are hand soldered to the circuit.

It would be unfair to dismiss all other flexible circuit materials without discussing their relative merits and disadvantages. *Polyester*: Although polyester has excellent electrical and mechanical properties, its upper temperature limit restricts its use to mechanical connections rather than soldered joints. Soldering always causes some delamination and flow soldering may cause serious problems. Polyester can seldom be soldered more than once and some success has been achieved using welding techniques. In common with all thermoplastics materials, polyester can be used for all manufacture of retractiles and other heat-set applications, but it is unsuitable for flexible multilayer applications. *Glass epoxy*: In this material, the good electrical properties of epoxy are combined with the mechanical strength of glass fibre. The material has an upper temperature limitation of 150°C and can be hand or wave soldered. It is readily adapted to multilayer processing using conventional techniques. Although the material possesses good flexural properties, the glass fibre core is inherently susceptible to cracking when creased, giving a subsequent low tear resistance. *Fluorinated Ethylene Propylene Systems*: The FEP film may be unsupported or combined with glass fibre or Kapton to give systems with excellent moisture resistance coupled with good electrical properties. However, because FEP is a true thermoplastics material, it tends to flow. This makes it extremely difficult to prevent movement of the conductors during processing. FEP systems are stable up to 250°C and have an operating temperature of 200°C maximum.

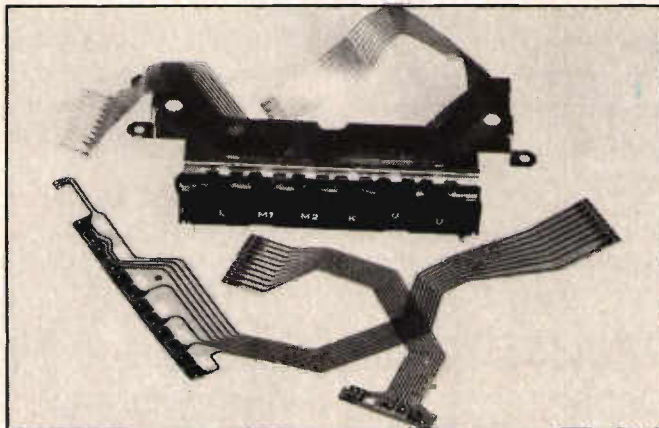

NEW digital testers from ESI

Tranchant, UK sole agent for Electro-Scientific Industries bring you two brand new high accuracy, digital readout measuring instruments:-



Model 475

A simple and flexible tester, the 475 displays Capacitance value and Dissipation factor simultaneously which speeds up production testing.

Features:

- ★ simultaneous C and D display
- ★ high resolution, 4½ digit displays
- ★ basic C accuracy 0.1% + 2 digits
- ★ basic D accuracy 1% + 0.0005
- ★ guarded four-terminal connections for accurate measurement
- ★ 1 kHz test frequency
- ★ low test voltage on all ranges
- ★ BCD outputs available as option

ESI, a world leader in test and calibration instruments, offers a range of models covering a variety of production, pre-production and research applications.

Send for data sheets on the ESI range today.

esi®

tranchant electronics (uk) limited

Tranchant House 100a High Street
Hampton Middlesex TW1 2ST
Tel: 01-979 0123.



Model 506

Designed primarily for production testing, the 506 can be joined with an optional sorting fixture and/or comparator for rapid sorting or checking.

Features:

- ★ 4½ digit display
- ★ basic accuracy 50 ppm (20 ppm available)
- ★ diagnostic overload indicators
- ★ high ac noise rejection
- ★ thermal emf cancellation
- ★ appreciable lead resistance allowable
- ★ rear panel BCD outputs

Tomorrow's Electronics Today

The detectors

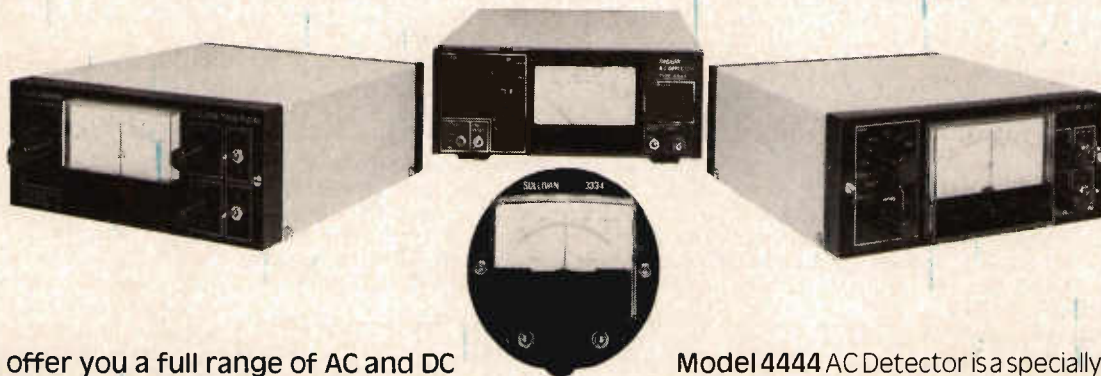

Sullivan offer you a full range of AC and DC Null Detectors. There is a wide span of ranges available, with battery operation, portability and high quality being common to all.

NEW Model 3336 DC Detector is a versatile production and laboratory instrument offering discrimination of $1\mu\text{V}$ in $10\text{k}\Omega$ and sensitivity of $10\mu\text{V}$. This instrument offers low zero drift, linear or logarithmic response and high stability.

NEW Model 3337 Microvolt Detector has 9 centre zero ranges from 10V to $1\mu\text{V}$. It has a resolution of $0.1\mu\text{V}$ into $10\text{k}\Omega$. Battery operation eliminates mains voltage interference. There are many other features, too, not least of which is a surprisingly competitive price.

Model 4444 AC Detector is a specially designed, battery operated solid state AC detector for the detection of very low level imbalance signals from modern AC bridge and potentiometric measuring systems.

Model 3334 DC Null Detector is a compact unit specially designed for null point measurement. It is small in size, low cost and rugged and these are just three of the features that make it ideal when replacing pot galvanometers in potentiometers and bridges. For fuller facts about Sullivan Detectors, simply contact:

Sullivan

H.W. Sullivan Limited, Archcliffe Road,
Dover, Kent CT17 9EN
Tel: 0304 202620 Telex: 96283

↓ Thorn Measurement Control and Automation Division



9 out of 10 manufacturers recommend Insuloid for new washing machines

No weekday washer is really complete without an Insuloid product. They keep their wiring neat, safe and tidy—a very important factor in product design.

And you'll find Hellermann Insuloid products at work wherever there are cables and wires to be fixed, clamped, hung, protected or identified.

Hellermann Insuloid manufacture an extensive range of cable tie harnessing products. The Insulok cable ties—easily the best and safest cable tie in the world. Adjustable

cable saddles to secure cables of every size and every combination. Bridge saddles, cradle clips, flexible cable trunking, terminal insulating shrouds, bus bar insulation systems, harness board breakouts and aids, cable identification systems of every type and every size to meet

the needs of manufacturers and contractors everywhere.

The products meet US military, MOA, ARB and Government specifications and are backed by the research, advice and development resources of the Bowthorpe-Hellermann Group.

If you have a cable tie or wiring problem like washing machine manufacture, a Bowthorpe-Hellermann product could well be your secret ingredient for success. Contact Bowthorpe-Hellermann today.

insuloid

Hellermann Insuloid

Wythenshawe, Manchester M22 4RH
Tel: 061-998 5415/6/7. Telex: 667657



THE BOWTHORPE-HELLERMANN GROUP CONNECTIONS THROUGHOUT THE WORLD

Hellermann Deutsch · Hellermann Electronic Components · Hellermann Electric · Hellermann Insuloid · Bowthorpe-EMP · Bowthorpe-Hellermann Distributors
Power Development Ltd · Hellermann Cassettes Ltd · Hiatt & Co. Ltd □ The Bowthorpe-Hellermann Group, Gatwick Road, Crawley, West Sussex.

Developments in pulse code modulation transmission

The appeal of pcm techniques is greatly enhanced by the availability of monolithic comparators, writes *Brian Jennings*, who reports on a recent development in this field.

Without question, the technological advancement in cost effective, fast digital switching devices has led to the reality of pulse code modulation (pcm) for telecommunications transmission systems.

Technological achievement in recent months has included the development of the first monolithic integrated circuit containing a complete pcm decoder. This circuit forms the basis for a pcm encoder, making possible an integrated coder and decoder—or *codec*, as it has become known.

The device replaces in excess of two hundred discrete components or the equivalent of two pcb's in the manufacture of pcm terminals.

Precision Monolithics Inc, represented in Europe by Bourns, have not been slow to capitalise on the vast new avenues available for these products, (see p47, New Products, Electronic Engineering, ref:340, August). The standard Comdac (DAC-76) has been upgraded by two military versions, DAC-86 and 96, both adhering to Bell Labs. μ 255.

The Comdac or companding d-a converter, provides the telephone in-

dustry with a standard off the shelf component, simplifying pcm equipment design, increasing reliability through component count reductions and reducing costs.

Manufacturers, until quite recently, designed and assembled *codec* circuits from discrete devices, but due to the economic considerations involved in this type of equipment it generally prohibited the use of pcm for less than twenty-four channel systems. This restriction has now been removed and this system can be considered for four, eight and even single channel applications. It is possible to apply the pcm advantages to any level of transmission, which is particularly important in the development of pbx and subscriber carrier systems.

Basically, pcm involves the conversion of analogue voice communication into digital pulses for transmission and the re-establishment of that transmission into analogue signals by the *Fig. 1: The functions of quantising and coding are accomplished at the same time. This process includes companding to reduce the number of quantising steps required.*

equipment at the receiving end.

Coding of signals

To code the analogue amplitude in binary, the axis is divided into a discrete number of equal intervals; 32 levels for a 5-bit number, 64 levels for a 6-bit number etc. At each sampling point the amplitude is measured and the level nearest that value taken as the approximation of the amplitude. Figure 1 shows the stages in obtaining a binary output at the pcm with eight levels. Therefore there will always be an error, the maximum value of which is 0,5 multiplied by the separation in levels (see Fig 2). Most current techniques transmit the binary number serially as indicated in Fig. 1. The bit rate on the line must be much higher than the rate at which the analogue signal is being sampled. For example, sampling an analogue signal eight thousand times per second, coding each sample as a ten bit number and transmitting it serially, results in a bit rate of $10 \times 8000 = 80\,000/s$. For this reason most techniques incorporating pcm are used on high speed (wide bandwidth) lines. There is a

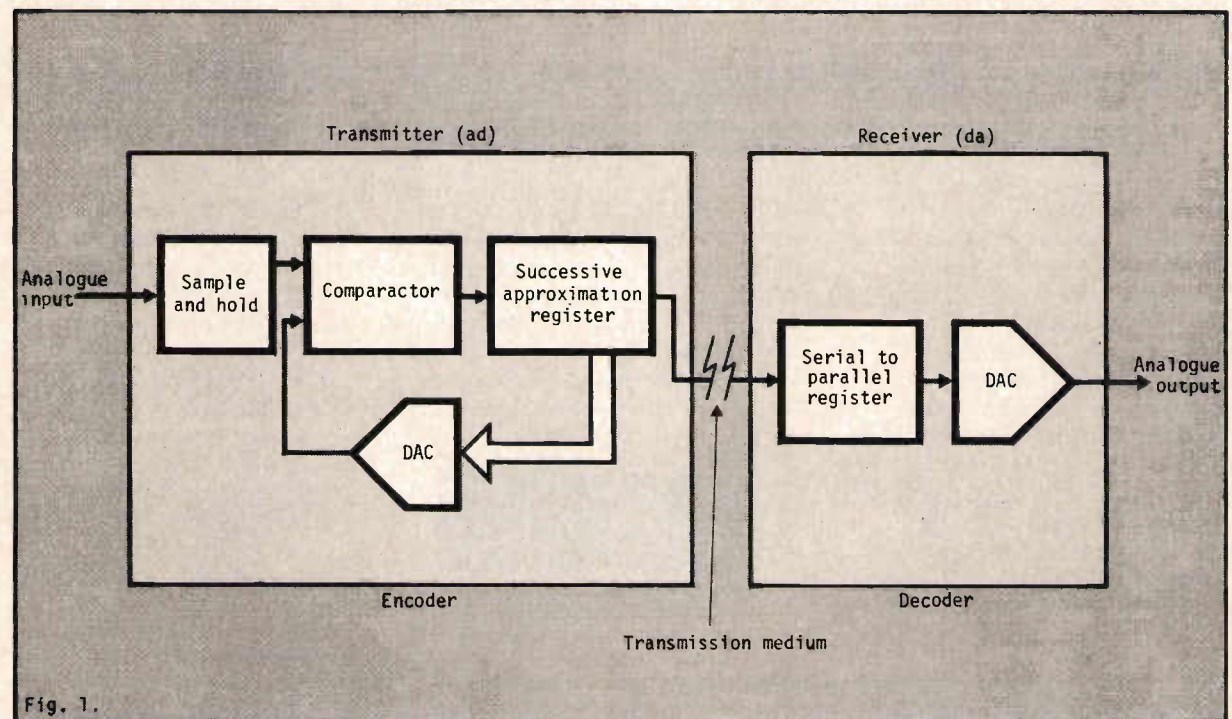

Fig. 1.

STEP SIZE SUMMARY TABLE DECODE OUTPUT (SIGN BIT EXCLUDED)

Chord	Step size normalised to full scale	Step size in μA with 2007.75 μA F.S.	Step size as a % of full scale	Step size in dB at chord endpoints	Step size as a % of reading at chord endpoints	Resolution and accuracy of equivalent binary DAC
0	2	0.5	0.025%	0.60	6.67%	Sign + 12 bits
1	4	1.0	0.05%	0.38	4.30%	Sign + 11 bits
2	8	2.0	0.1%	0.32	3.65%	Sign + 10 bits
3	16	4.0	0.2%	0.31	3.40%	Sign + 9 bits
4	32	8.0	0.4%	0.29	3.28%	Sign + 8 bits
5	64	16	0.8%	0.28	3.23%	Sign + 7 bits
6	128	32	1.6%	0.28	3.20%	Sign + 6 bits
7	256	64	3.2%	0.28	3.19%	Sign + 5 bits

trend, however, towards multilevel transmission; for example, a data transmission system working in ternary, ie a three level system, to increase the data rate. The number of levels refer to the permissible line signal states. The manner in which transmitter and receiver use these states is a first-stage design choice.

The next major step forward will probably be towards a true multilevel transmission system combining the advantages of both binary and analogue transmission.

The sampled amplitude can be coded in many different ways, eg, as a decimal number. One method divides the amplitude axis into a discrete number of unequal intervals, the steps chosen to be on a logarithmic scale. The idea here is that analogue noise which is usually at a fairly low level is then, when on its own, always sampled and coded as zero (or near zero), whilst higher levels of more meaningful signal have correspondingly more weighting.

PCM is a form of quantising in two dimensions; one is the time axis (by

sampling), the second by only permitting a finite number of amplitude levels. PCM never allows the analogue signal to be exactly recovered, since the coding allocates a finite number of codes (eg, binary numbers) for an infinite variation in analogue signal level. For example, seven bits could be allocated for a signal level which may be anything in the range zero to 6V. In this case each sample is accurate to 0.5 parts in 2^7 , (or 1 in 256). Reforming the analogue signal from this digitised and coded signal reproduces this accuracy of noise, called quantisation noise, discussed in a later paragraph.

Fig. 2: A complete pcm codec comprises a comdac device, an sar, an s/p circuit and associated components. The complete unit will operate as either an encoder or decoder depending on the functional control signals.

Fig. 3: The comdac transfer characteristic is logarithmic in nature resulting in a larger number of divisions or steps around the low amplitude points. The curve actually is made up of sixteen straight segments or chords each containing 16 individual steps.

Without question digital transmission equipment manufacturers have profited by developments in semiconductor componentry, ie reduction in component and assembly costs, faster testing and a significant improvement in reliability. The implementation of a digital pcm transmission system using comdac devices offers the advantages of increased signal to noise ratio, lower system distortion and the facility for computerised switching.

The transformation from analogue to digital signals takes place in three operations; sampling, quantising and coding. An inspection of these functions illustrates how modern ic's will affect performance and cost.

Conversion

The conversion from analogue signals to digital pcm commences with the sampling of speech signals at a suitable rate, following the Nyquist sampling theorem, (which states that for a given bandwidth or frequency limitation f_0 , the sampling interval needed to determine the waveform is $(1/2f_0)$). It gives two samples for each cycle of the

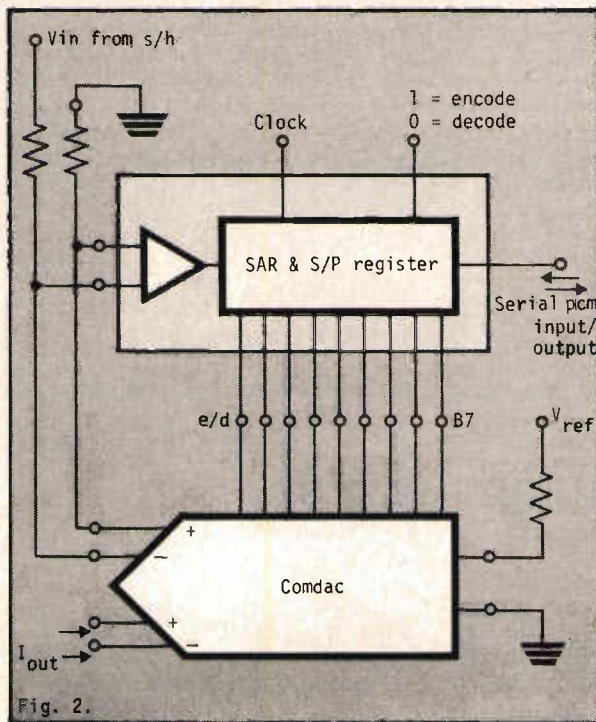

Fig. 2.

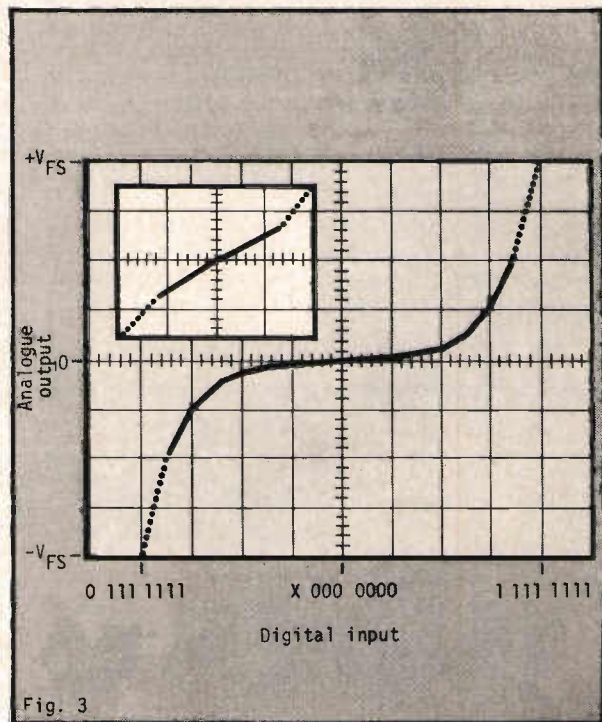

Fig. 3.

Chemically treated water
Softened water
Demineralized water
pH Neutral water
British Pharmacopoeia quality
Ultra-filtered pure water
Micro-biologically pure water
Intrinsic water

Houseman Hegro is the largest combine in Europe supplying complete water treatment systems for every conceivable application, totally from its own resources.

We've collected the experience you need already. And we've probably designed the system that suits you best—to produce and store water in *exactly* the right condition and in *exactly* the right quantity. No more, no less.

For us, it's almost a matter of taking the right parts 'off the shelf.' For you, the speed and accuracy with which we work can save a great deal of time, trouble and money.

For details about the system that suits you best, just draw the line—anywhere between raw water and intrinsic water—and then send this page back to us.

Name _____

Company _____

Address _____



Portals Water Treatment

Houseman Hegro

"The water people"

Houseman Hegro Limited
Permutit Standard Plant Division,
The Priory, Burnham, Slough SL1 7LS
Telephone: Burnham (062 86) 4488 Telex: 848252

37 on enquiry card

EE1

Show us where to draw the line

See us at Labex
Stand No 5112



cut-off frequency f_0). For a voice channel where the upper limit is no more than 4 kHz, the minimum sampling rate is 8000/s.

The amplitude of each sample is compared to a scale of discrete values and takes on the value to which it is the closest. This operation, as previously stated, is termed quantising.

Finally the amplitude value of the sample must be coded into binary form, represented by a series of digital pulses symbolising the speech information that can be transmitted. It is necessary that this process captures all the levels within the speech range, but since the dynamic range—the variation between the lowest and the loudest signals—is quite large, it would take more than eight thousand consistently spaced steps to sufficiently transmit human speech. To reduce the quantity of operation but maintain quality, non-uniform steps are used to condense the speech information. Very small steps are assigned to lower amplitude levels where the majority of speech information is concentrated. Proportionately larger steps are used as the signal level increases.

A similar result is obtainable by adopting linear, evenly spaced quantising steps and a digital compression process. This method of compression and later expansion of the values, denoted by the terminology companding, is used to identify the non-uniform process whether linear or digital.

Using a companding characteristic variable logarithmically, the number of quantum steps is reduced from in excess of eight thousand to two hundred and fifty six. This subsequently

amounts to a reduction in bandwidth required to transmit the information on a pcm system. The non-linear encoding characteristic allows linear 12-bit to be presented in 8-bits (7-bits + sign). Assuming the same transmission channel characteristics, this means you can increase the transmission speed by a factor of 3:2. This method of companding is currently in wide use in pcm systems on both sides of the Atlantic.

Of the three basic functions within the pcm terminal—sampling, quantising and coding—the comdac converter contains most of the required circuits necessary to perform the latter two functions in a single function. All that is required is external digital logic, supplied by another circuit designated a Successive Approximation Register (SAR) and a comparator.

Versatility

In conjunction with the comdac unit, the SAR circuit, an analogue comparator and a series-to-parallel register can perform the complete coding and decoding functions. Depending upon the method of interconnection, the combination can operate as either an encoder or decoder, or since functions can be externally controlled by other logic signals within the terminal, a complete *codec* can be achieved with the same components plus a sample/hold circuit. In this configuration, the unit may be thought of as a two-way trans-

Fig. 4. Functional elements of a pcm encoder consist of sampling, quantising and encoding. The resulting digital pulses is then transmitted over a repeated line or microwave radio system:

ceiver that can either code a voice into pcm pulses or the reverse. Hence, only a single set of componentry is required to establish pcm transmissions in both directions. In twenty four or thirty two channel terminals, however, the functions will remain separate due to the necessary switching times.

In the encoder, the comdac device operates in a feedback loop with the SAR and comparator. Sample signals are quantised through a series of approximations. The Comdac converter and the support circuits when working simultaneously quickly find where the sample is located in the characteristic curve.

Through this process, the binary pcm code is generated for transmission. After serial-to-parallel conversion, the Comdac is used to change received pcm signals back from a digital to an analogue state.

The use of integrated circuits drastically reduces the count in discrete components, some claim by a factor of four, and reduction in the noise figure is also possible. Power savings are significant; the Comdac for instance requires 150 mW for operation, compared to 1.5W for comparable discrettes.

Away from the telecommunications industry, the Comdac finds use in a number of instrumentation applications, ie data acquisition, process control, data recording and in audio presentations. A current example would be the 8-bit code working directly with 8-bit microprocessors, negating the necessity of store and shift functions. The code is also fully compatible with the 8-bit format of current semiconductor memories.

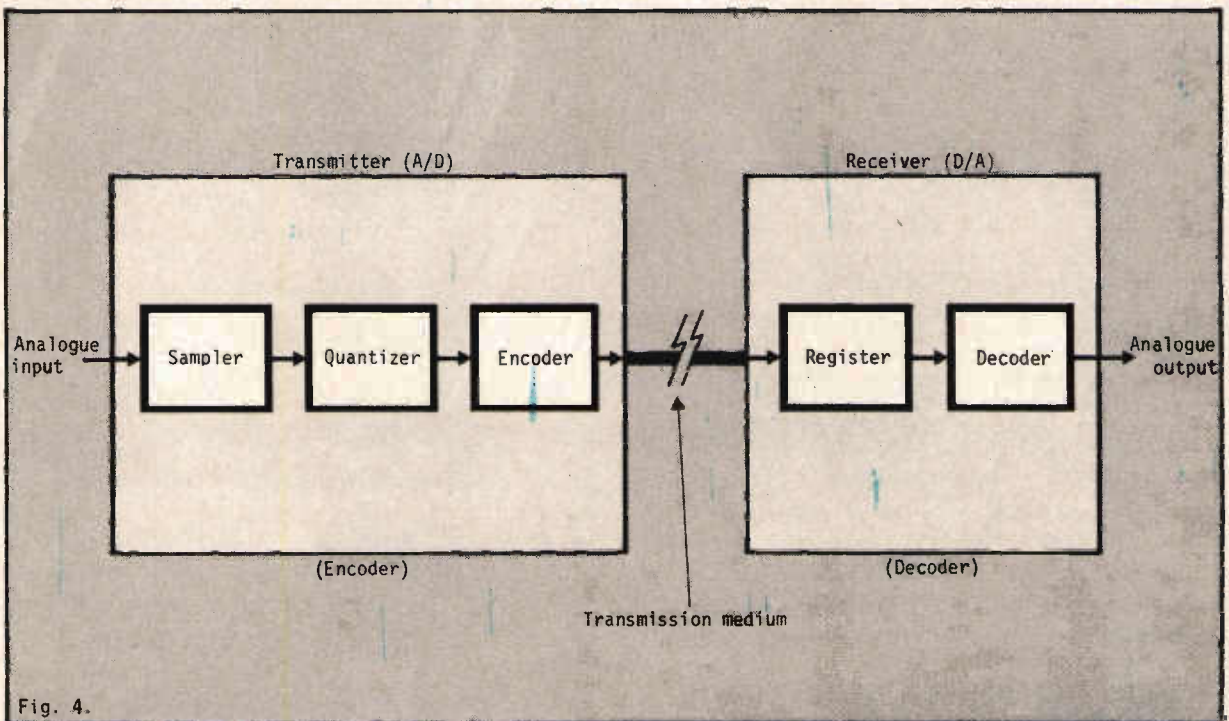

Fig. 4.

HIRST ELECTRIC

the most comprehensive range of British

MAGNETISING EQUIPMENT

Proved by continuous everyday work under widely varying conditions in both industry and research throughout the world, the Hirst range of Magnetic Equipment covers Magnetisers up to 11,300 watt/secs, Controlled De-magnetisers and Flux Measuring equipment. All magnetic systems can be magnetised to saturation and accurately calibrated either manually or on an automatic basis.

- CONSISTENT PERFORMANCE
- STANDARD AND CUSTOM-BUILT SYSTEMS
- EASE OF OPERATION
- FREE EVALUATION AND CONSULTANCY
- COMPREHENSIVE AFTER-SALES SERVICE
- WIDE RANGE OF EQUIPMENT AND ANCILLARIES USING LATEST 'STATE-OF-THE-ART' TECHNIQUES

THE NEW HIRST PERMEAMETER

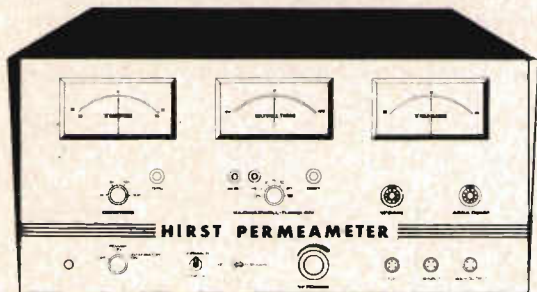

This latest edition to a comprehensive range of specialised magnet systems, the Hirst Permeameter plots complete hysteresis loops and minor loops, DC magnetisation curves and second quadrant demagnetisation curves of normal and intrinsic induction. Levels of magnetising force (H) and flux density (B) of the permanent magnet material are detected by the permeameter system comprising an electro-magnet, power supply, standard Hirst measuring instruments, search coils or probes and X - Y chart recorder.

Full technical consultancy service and laboratory facilities freely available.

Send for details of the complete range of Hirst Magnetising Equipment, including Chargers, Gaussmeters, Fluxmeters, Probes, Reference Magnets etc.

Hirst **HIRST ELECTRIC INDUSTRIES LTD**
 GATWICK RD., CRAWLEY, SUSSEX RH10 2SA
 Telephone: (0293) 25721 Telex: 87424

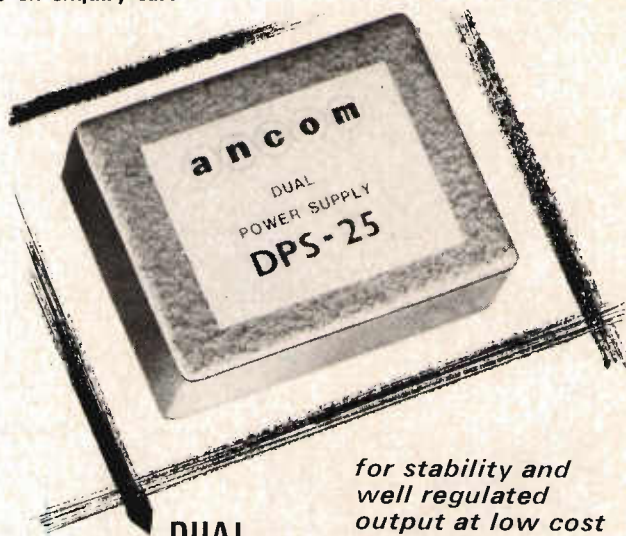

for stability and well regulated output at low cost

DUAL
ENCAPSULATED POWER SUPPLIES
FULLY SHIELDED MAINS OPERATED

- DPS-100 $\pm 15V$ @ 100mA output
- DPS-150 $\pm 15V$ @ 150mA output
- DPS-25 $\pm 15V$ @ 25mA output
- APS-30 Precision Source

ancom

DEVONSHIRE STREET · CHELTENHAM

Telephone 0242, 53861 or 24690

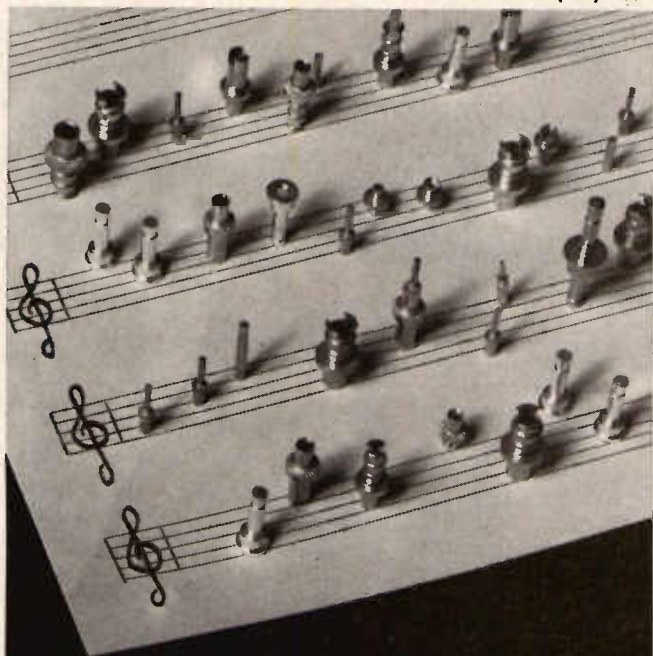

The Harwin range combines quality with quantity

Whatever the quantity, if you are looking for terminal lugs and pins, then we at Harwin can supply them ex-stock, at extremely low prices. If we don't have what you need in our high quality standard range, then we are only too happy to produce special lugs to meet your requirements.

We also produce terminal boards in a variety of materials (e.g. SRBP, SRBF, ERBG, Melamine), which can be shaped, drilled, and printed to suit your needs.

So, if you think no-one can give you quality with quantity, just ask us... after all, we are experts.

For full details of our superb quality terminals, send off this coupon today to:

Harwin terminal lugs

HARWIN ENGINEERS SA, Fitzherbert Road, Farlington, Portsmouth, PO6 1RT. Tel: Cosham 70451/6 Telex: 86125
Please send me the full facts about Harwin terminals :

NAME _____

POSITION _____

COMPANY _____

ADDRESS _____

EE 1/77

ERMA-BUCHANAN THE CRIMPING TOOLS THAT KEEP IN STEP WITH CONNECTOR MINIATURISATION!

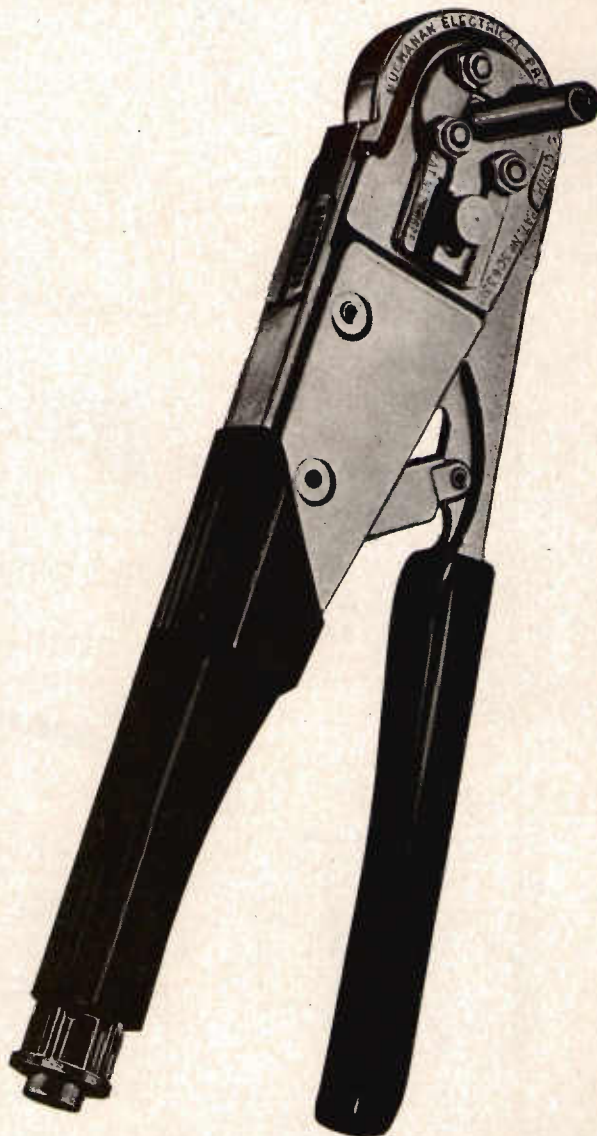

The Microcrimp Tool crimps even the smallest contacts

Deals with solid and stranded conductors

Infinitely adjustable crimping depth with direct reading indicator

Ratchet control

Can be locked after setting

For this and other tools to cover all your crimping needs write to



ERMA LIMITED

Mount Pleasant, Alperton, Wembley, Middlesex
Telephone: (01) 903-4561 Telex 264229

only from imhof-bedco

can you get such an extensive range of quality housings and accessories

INSTRUMENT CASES

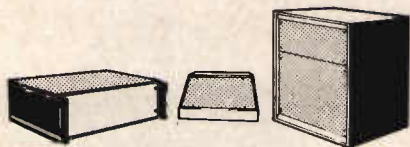

Who else can offer you a choice of over 130 different instrument cases from a standard range? Rectangular cases, sloping front cases, carrying cases, visor front cases, de-luxe cases, economy cases, pack-flat cases, miniboxes, die-cast boxes and, of course, the Series A and B IMcases with easily removable tops.

181 for further information

IMRAKS

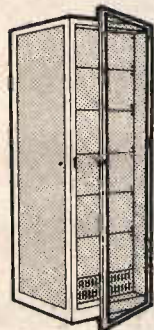

We offer three comprehensive racking systems - Series 80 IMraks, International Series IMraks and Datum Series IMraks. Over 100 standard models with a whole host of optional variations and accessories such as: deep recessed or adjustable panel mountings, doors, mobile bases, castors, lifting eyes, etc.

182 for further information

CONTROL CONSOLES

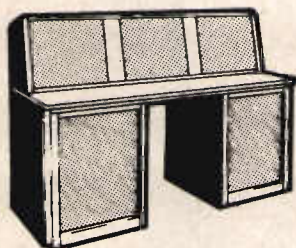

There are some 23 desks/control consoles in our standard range and these may have either single or double pedestals. Superstructures are available to suit all models and non-standard sizes can be built to order.

183 for further information

CHASSIS, SECTIONAL CHASSIS, ETC.

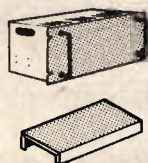

All types of chassis are available including both steel and aluminium chassis, bracket chassis and the versatile Datum Sectional Chassis System. A wide variety of chassis brackets and chassis runners are also offered.

184 for further information

MODULAR SYSTEMS

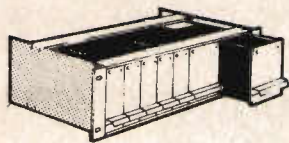

IMPS InLine is the most advanced of the five systems offered for housing sub-units, printed board units and circuit boards. Not only do these systems include an extensive variety of alternative arrangements, but also many optional accessories.

185 for further information

CIRCUIT BOARDS



IMcards are development boards available with two alternative configurations of pads and tracks. In addition, we are able to offer a comprehensive circuit board manufacturing service - including through-hole plating.

186 for further information

TELESCOPIC MOUNTINGS

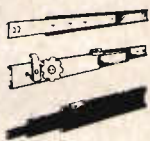

Accurides are steel slides of which there are 33 standard designs - each available in a choice of 17 different lengths.

The range of aluminium IMslides includes some 48 standard models to suit most usual applications.

187 for further information

FANS AND BLOWERS

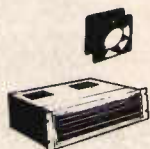

Powerful blowers to cool a whole rak, fan trays that can be positioned at any desired height within a rak or small fans for cooling local hot-spots - all will be found in our 12 page Fans and Blowers catalogue.

188 for further information

PANELS



Steel panels, aluminium panels, flat panels, flanged panels, formed panels, full-length panels, ventilation panels - all with a choice of finish.

189 for further information

CONSTRUCTION SYSTEMS

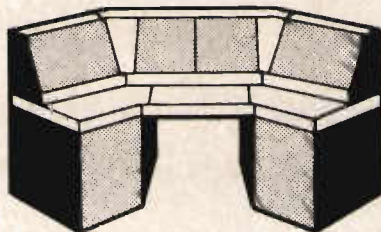

Choose from standard IMlok with radiused corners or 90° IMlok with "square" corners to build your own cases and cabinets - of virtually any shape or size. Ideal for prototypes and one-offs but equally suitable for production runs of non-standard size units.

190 for further information

HANDLES AND ACCESSORIES

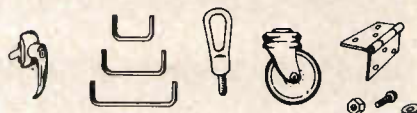

Our 125 standard handles include simple bar types, elegant die-cast models, lift-up handles, locking handles, etc. Then there are all those difficult-to-find items such as castors, hinges, locks, catches, feet, lifting-eyes, etc.

191 for further information

DESKS, DRAWERS, CABLE TRAYS, TAPPED RAK BARS, ETC. ETC.

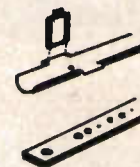

Our standard range is designed to cater for ALL your packaging requirements and space has only permitted mention of the principal items. So if your specific needs are not mentioned here, please ask - we are almost certain to be able to help.

192 for further information

CUSTOM SHEET METALWORK



We have three factories whose entire manufacturing facilities are devoted to batch production of custom sheet metalwork. Be it a small component or the complete housing for a computer, we will be delighted to discuss your next project with you.

193 for further information

imhof-bedco

Ashley Works Ashley Road
Uxbridge Middlesex UB8 2SQ
telephone Uxbridge 37123

also at London • Watford • Harpenden • Chapelhall • Carfin • Lanark

For further information on any of the above products, enter appropriate enquiry number on Reader Service Card.

W 58

PRODUCT FOCUS

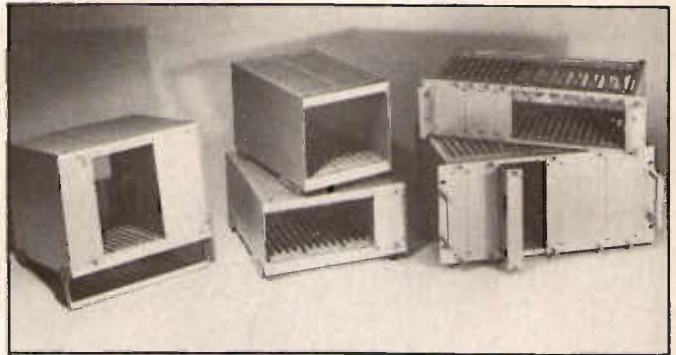
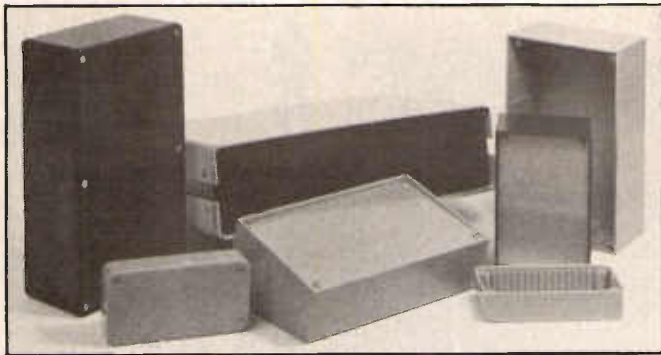

The importance of instrument enclosure is rarely considered at the design stage of an instrument or system. But it can have a considerable affect on the performance of the equipment it is intended to house and ultimately the success of the product. In some respects a design can fail because the designer has not been aware of the environment in which the instrument has to function or has not made adequate provision for the variety of conditions under which the equipment may be expected to operate. Also equipment must be easily accessible for repair.

Today electronic systems and instruments are being used in relatively hostile environments compared with the sanctity of the laboratory. Communications instrumentation for example, is expected to function equally well in the frozen wastes of Antarctica as in the humid conditions of the jungle. Even though much of the internal circuitry may be capable of versatile operation it has to be aided by good case design.

Portable design

With more and more demands being placed upon manufacturers to provide equipment which can move outside the confined area of the laboratory this requirement becomes even more important. Although portable instrumentation has been around for many years the word *portable* is hardly suitable to some of the cumbersome equipment many field engineers have to heave about. Most of the advances towards lighter instrumentation has come about mainly from contributions from the semiconductor industry such as the elimination of many discrete devices. LSI has undoubtedly removed the necessity for small instrumentation to be encased in heavy boxes just to be able to

ENCLOSURES AND PACKAGING

In this month's product focus *Elaine Williams* takes a look into the world of enclosures and packaging, and tries to find out how trends are changing in the design of instruments enclosures.

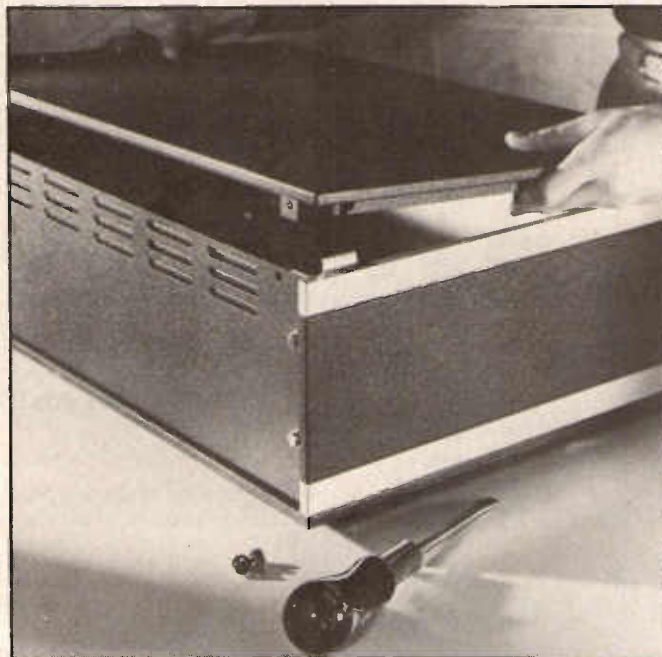

Some of the range of Boss Industrial Mouldings enclosures.

The IMS and NIMS card frame systems by Daturr.

Removing the top of Series B imcase from Imhof Bedco.

The IMS and NIMS card frame system by Daturr. Made in heights of 3U, 4U, and 5U the cassettes can be accommodated in bench cases or rack-mounting frames. Again there is a proliferation of extra features available.

support the weight of the more bulky components but, the enclosures industry still has an important role to play.

Plastics cases

Lighter instruments have evolved using plastics rather than metal cases. While that makes instruments more portable, provision has to be made for adequate earthing of the circuitry and they may not be so useful for conducting heat away from components which dissipate a large amount of energy such as the power supply. This means that plastics cases are generally confined to low power or battery operation in environments where there is little likelihood of extreme variation in temperature.

The use of plastics is best kept to areas where special consideration of environmental factors is not required such as in laboratory work, although there are plastics coming onto the market which are capable of more robust use. Many manufacturers produce ranges of plastics cases. Vero for example produce a range of polystyrene boxes which have a high impact capability but have a limited operating temperature range of 70°C which is typical of most plastics and is quite adequate for most laboratory activities. Some companies combine both metal and plastics, such as Daturr, so that provision can be made for a control panel and heat sinking.

For a long time the word 'plastics' has been associated with something rather cheap and nasty. The image of plastics has been severely tarnished by the early days when the plastic bucket brigade flooded the consumer market with poor types of plastics. Even though this situation has changed there is still a reluctance which can be observed when equipment manufacturers contemplate us-

Feast yer bins on this lot!

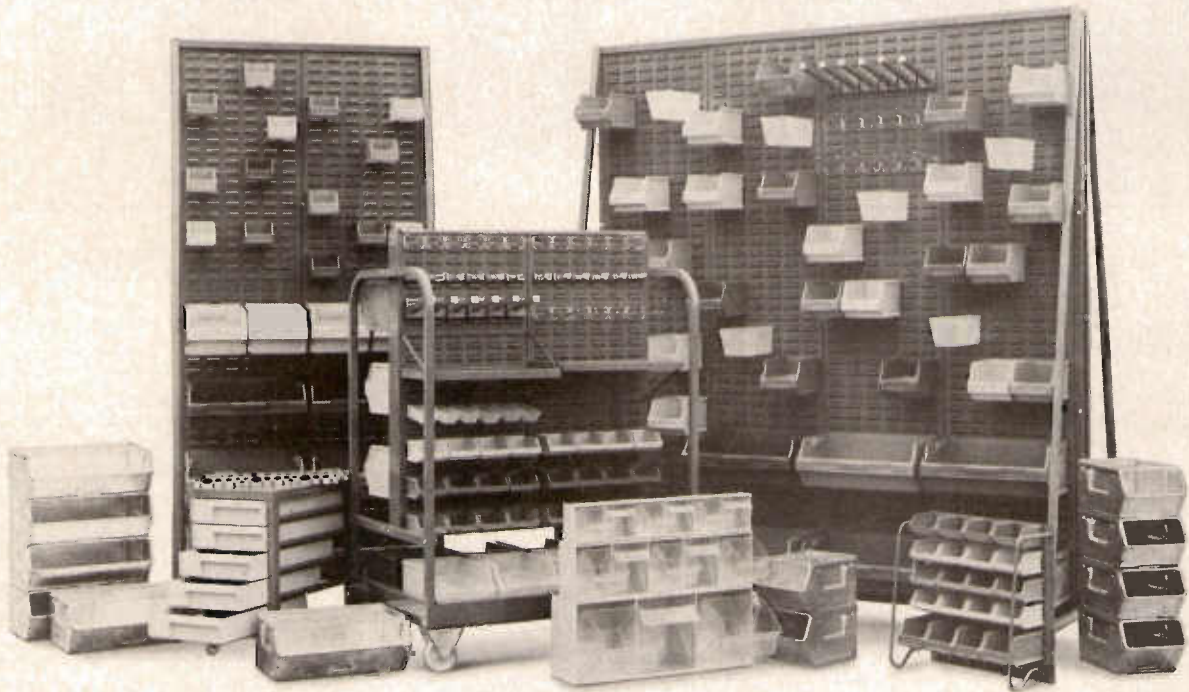

Take a look at the Dexion Maxi system for storing and handling small items.

What do you see?

Bins, of course. All sizes and colours, plastic and steel. And things to stack, carry and move bins (louvred panels and racks, trolleys, shelving . . .)

But some stock just won't fit neatly into bins.

It needs to be handled differently. What then? Maxi.

Because when Maxi isn't bins it's hooks, clips, drawers, tilt boxes, cabinets . . . a complete range of components to store and handle all shapes and sizes of items efficiently, smoothly.

Dexion Maxi — the system that has everything.

Be sure. Be sure it's Maxi.



Post the coupon and get a free sample Maxi bin!

Post the coupon to: Dexion Ltd enquiry service, Dexion House, Empire Way, Wembley, Middlesex HA9 0JW. Tel: (01) 902 1281.

- Please send me literature on Maxi.
- I would like a representative to call. Please telephone me to arrange an appointment.

Name

Position

Company

Address

.

. Tel

Type of business



Pallet storage and handling systems, shelving, conveyors, partitioning, small items storage, slotted angle and square tube construction systems.

B465JA

PRODUCT FOCUS

ing it for the first time.

The main advantages of plastics are that they are relatively cheap, readily available and is an easy material with which to work. Also it can be produced in a wide range of colours and shapes which make it an interesting medium in which to design unusual cases.

Ergonomics

Although, often the design engineer is not concerned with the appearance of the final product, the shape of the case should be considered at least. The apparent unconcern of ergonomic factors in case design was illustrated by Mr W R Cheston of Widney Dorlec whose company produces custom consoles. Mr Cheston noted that

can be built up from components.

Consoles and larger equipment housings need only to withstand the knocks and rough treatment of human mishandling or day to day use while smaller enclosures have to undergo a far more rough handling. Manufacturers abound in this area of the market. The most noted case producers are companies such as Foxall Instruments, Imhof Bedco and Boss Industrial Mouldings as well as Vero and Daturr. While Boss has concentrated on producing functional plastics aluminium boxes and cases in large quantities at what they claim as very competitive prices, Imhof Bedco have taken a slightly different approach to the problem. The company believes it is

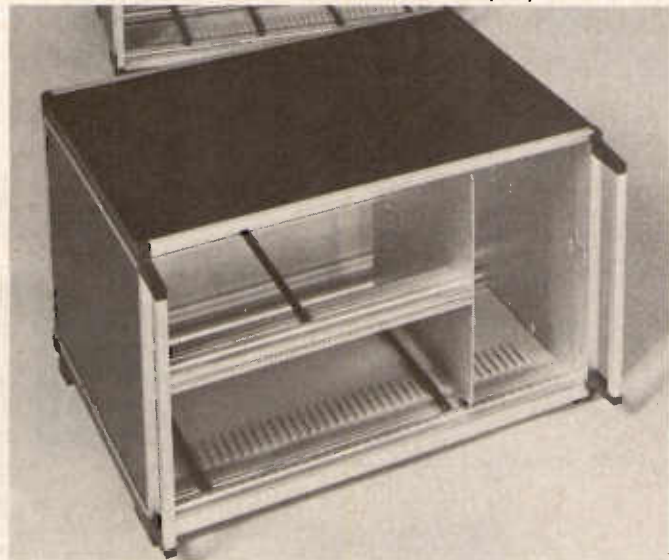

ITT's range of standard racking systems.

users did not specify very exciting consoles nor did they think up very exciting colour schemes. He explained "It is easy for people not in the know to think of our custom built consoles as a bit traditional. To combat this the company has arranged a service with leading industrial design consultants for those of our customers who are looking for something a little different".

Widney Dorlec try to consider the human element and some of the company's slimline range of consoles have been used by the Royal Navy for the bridge controls of a frigate. They found that the working surface of a desk should be as thin as possible to be comfortable for a wide range of operators. P and H Engineering also produce a range of desk consoles which

the largest organisation in the world whose production activities are solely devoted to the manufacture of sheet metal enclosures and allied accessories for packaging electronic instruments. The company has a large range of standard products such as the implan series. Where a standard solution does not suffice, the company will undertake custom design or standard products such as the imlok systems which may be suitably modified. Foxall's Hemex range of cases have overall dimension compatible with standard rack mounting equipment so that free standing equipment may be rack mounted by the addition of mounting angles. The cases are made of extruded aluminium while the top and base covers are pvc clad and offer easy accessibility to the instrumen-

Sealed Instrument Cases in Makrolon

Fully insulated, unbreakable, resistant to acid and alkali, self-extinguishing and hose-proof to 1P55—those are just some of the outstanding features of our new high quality range of sealed instrument cases—ideal for a host of electrical and electronic applications in severe environments. Some 16 sizes are offered,

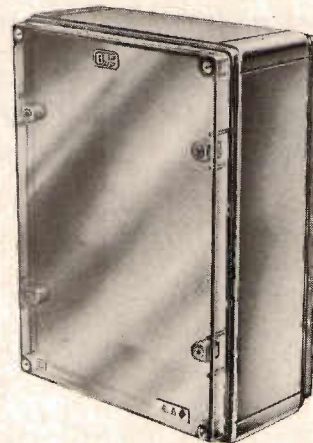
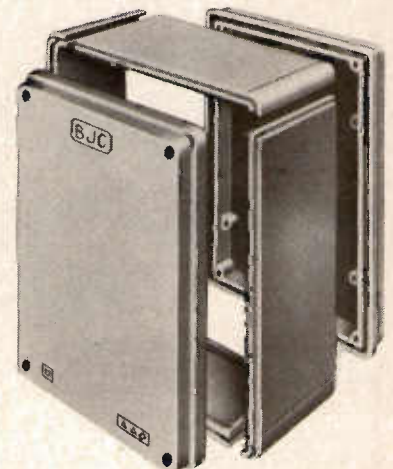

all moulded in Makrolon—from 200 x 200 x 160 mm up to 600 x 400 x 230 mm.

Each housing can be supplied with a transparent front panel or door and each can incorporate fittings for location to walls or plinths.

Groups of boxes may be 'ganged' together without loss of sealing. Removable sealed side and top panels can be specified to aid access to the enclosures.

For full details of any of these Radiatron Products, complete and return this coupon or circle the appropriate reply number.

NAME _____

POSITION _____

COMPANY _____

ADDRESS _____

 **Radiatron
Instruments Ltd**

Crown Road, Twickenham, Middlesex, TW1 3ET
Telephone 01-891 1221 Telex 267807

EE1/77

an enquiry card

Freedom of choice

That's what's important to us at Optima. And that's why Optima cabinets and cases come in more sizes and colours than any other kind you can buy. With Optima you get 11 different colours to choose from, in fact. And hundreds of different models and sizes. Not to mention a great long list of optional features like rack adapters and perforated panels and tiltstands and spring-loaded handles.

In other words, you can have any enclosure, the way you want it. That's what freedom of choice means.

And that's what Optima means, too.

OPTIMA

Optima® Enclosures, a division of Scientific-Atlanta, Inc.
Macmerry, East Lothian, EH33 1EX, Scotland
Telephone Tranent 610747
Telex 72623

46 on enquiry card

VERO 19" CASES

vero

Section  in our catalogue

A Series 4U height, P.V.C. clad aluminium. Pack flat construction to accept 19" panel or be 19" mountable.

B Series 18 SWG steel finished in Hammertone blue/grey, pack flat construction, 6U to 30U heights by 400mm. deep.

Easily assembled to provide attractive and rigid enclosure.

D Series Instrument Case, 20 SWG steel finished in acrylic blue/grey or moonstone. 1U to 6U heights 320 to 445mm. deep.

Attractive slim line appearance using anodised aluminium trim and integral front handles.

Retractable tilt feet are a standard fitting.

Compatible front panels and panel handles can be supplied for any of the above.

Available world wide through 3 subsidiary companies and 25 agents.

Vero Electronics Limited
Industrial Estate, Chandler's Ford,
Eastleigh, Hampshire SO5 3ZR
Telephone: Chandler's Ford 2956
Telex: 47551

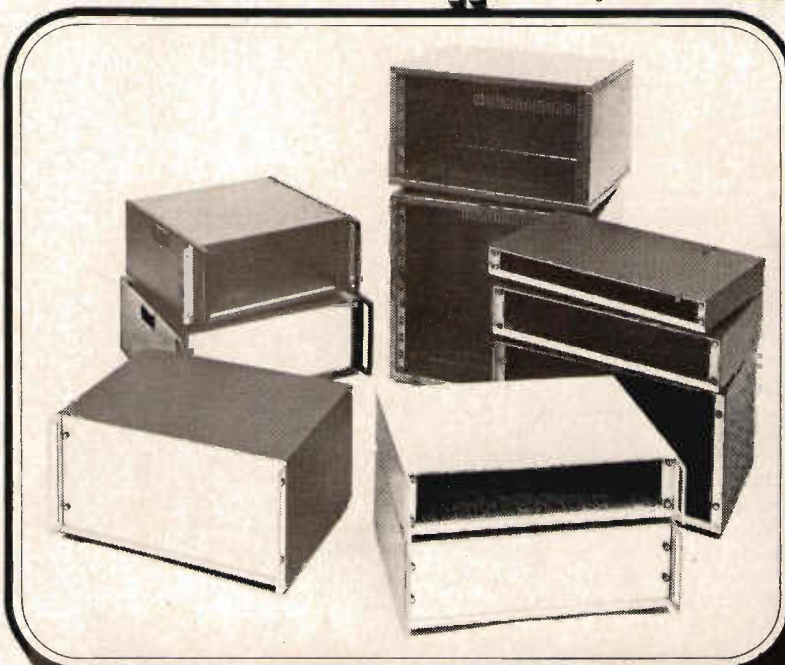

WORLD LEADERS IN PACKAGING TECHNOLOGY

PRODUCT FOCUS

tation inside.

Racking systems

Probably the most flexible type of enclosures are racking systems since while still providing modularity and equipment accessibility within a standard framework, there is still a degree of freedom in the way in which the systems are arranged. Instruments can be made to stand alone or be incorporated within large free-standing racks.

Racking systems have become very popular and most enclosure companies have realised the need to provide ranges of racking systems. ITT's standard product, for example, is based around the nominally 19 inch wide racking system, which was originally associated with Post Office specifications from Europe. David Hawkins of ITT explained that the subracks and enclosures the company manufactures and which make up the total packaging of the systems naturally conform to the basic ground rules of width, height

and depth, to be able to offer compatible systems. He could envisage this system becoming more standard especially if European export markets were to be exploited although, he did not think that Britain would lose its individuality.

More flexibility

CSM also realises the demand for more flexibility in enclosure and package design, and the initial problems the engineer has to face in his choice of enclosure design. The first considerations are the price of the enclosure and how quickly the enclosure company can deliver the product. If the engineer has opted for a custom design or special rack design he has to wait even longer for his product whereas if he decides to have one of the standard products he may have had to compromise with the cosmetics of the system he is designing.

CSM explained that additional costs have to be met with custom design for special tool-

ing, especially when section of extruded aluminium is being considered, apart from the expense of hiring the services of specialist consultants.

Compromises

When considering the use of standard enclosures, compromises must be made and the engineer must fit his requirements to the basic standards available. It is recognised that standard enclosures are usually supplied in four heights with a choice of three or four depths. However the international standard is the 19 inch panel width with 1.75 inch increment panel height.

CSM also noted how trends have affected stock standards in that two years ago no manufacturer stocked racks that would accommodate a 30 inch deep chassis depth. With the upsurge of computer peripheral requirements demanding deeper and deeper chassis depths, most leading manufacturers now offer the 30 inch chassis ex-stock.

CSM itself markets the 2000 series racking systems, which conforms to international standards, regarding panel size and unit heights. The range offers 38 standard formats, many variations combine with standard items so that the ex stock range contains over 100 types of enclosure. In addition CSM can modify or adapt the systems to fit specific requirement.

Vero is another company which has understood the trend towards the increasing use of the European standard frame. Its systems was based originally on a printed circuit size of 100 mm by 160 mm. The frame will accept the standard euro-card, the profiled international card, as well as modules in a variety of widths, screened or open, or plug in card units with individual front panels. The company stated that its newest housing systems was designed around the European standard to demonstrate the confidence it has, that this standard will be used increasingly in the future

47 on enquiry card

DATURRMAN HAS GOT THE LOT - ENCLOSURE-WISE

Regional Offices:

Brian Hickling
51 Fennels, Harlow, Essex.
0279 34652

John Fletcher
82 Cambridge Street,
Birmingham B21 2NP.
021-643 4595

Peter Colman
67 Penrith Crescent,
Maghull,
Liverpool L31 0BN.
051-526 5271

John Symington
103 Maplewell Road,
Woodhouse Eaves,
Loughborough, Leics.
0509-890674

Frank Parker
Hexham Road,
Swalwell,
Newcastle upon Tyne
885321/3

Bill McMillan
12 Campbell Road,
Hamilton ML3 6A5
Hamilton 29517

Eddie Corbett
163 University Street,
Belfast BY7 1HR
Belfast 31710

HEAD OFFICE

Daturr Limited
Market Road Richmond
Surrey TW9 9NE, England
Tel.: 01-876 0589
Telex: 929949

when is a box not a box?

Instrument boxes are often sold in standard sizes— not always the most practical sizes for your needs. When bought they take up a lot of storage space.

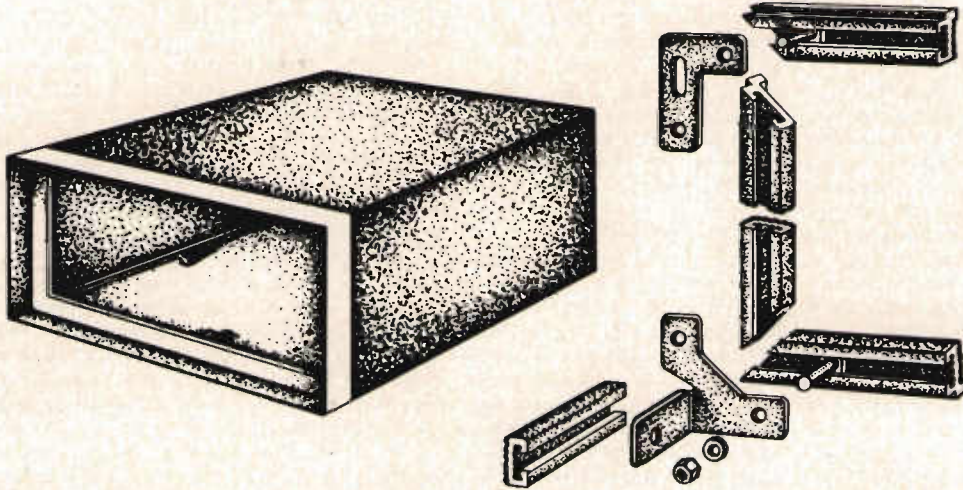

WIDNEY DORLEC Series 3 is a new, simple constructional system for building cases, boxes, chassis, frames, drawers etc. etc. Just 3 basic extrusions and 3 simple brackets— available as components for DIY, kits,

or fully finished products to your design.

Custom made cases at prices you pay for standards. Ideal for Laboratories, Universities, small workshops. Call Cyril Vaughan on 021-359 3044 for more details.

Northern Stockist:
Widney Dorlec (Northern) Ltd.
181a Bramhall Lane,
Stockport.
Telephone: 061-4801333.

widney dorlec

P.O. Box 133,
Birmingham B4 7BD.
Telephone: 021-359 3044
Telex: 338054.

COMPONENT HOUSINGS

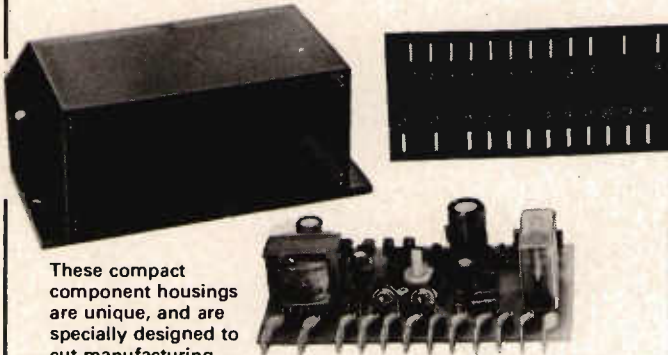

These compact component housings are unique, and are specially designed to cut manufacturing costs of electronic circuits. They have facility for 2 printed circuit boards on which miniature mains transformers and relays may be mounted. Printed circuit fast-on connectors and snap-fit lid eliminate the need for a special plug and socket.

Specification	LK8 & LK16	LK12 & LK24
Material	Polypropylene or Nylon	Polypropylene or Nylon
Size	90 x 50 x 37 mm	130 x 65 x 55 mm
Fixing centre	80 mm	120 mm
Internal volume	100 cc	315 cc
P.C. Board size	65 x 45 mm	105 x 60 mm
Terminals	8-16	12-24

AMP 250 Series fast-on tabs

PRINTED CIRCUIT BOARDS can be supplied to customers' design

logikontrol

Ltd.

17 Little Edward Street
London NW1 4AT
Telephone: 01-387 7555

Agency enquiries for European Mainland territories invited. Logikontrol component housings are purpose designed and protected under the Design Copyright Act 1968.

LA ALLOY TRANSIT CONTAINERS stand

up to anything

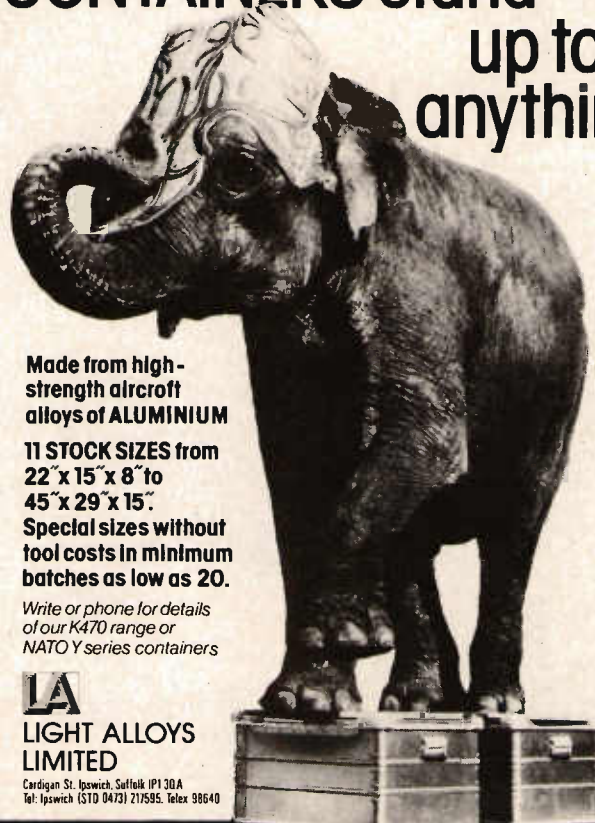

Made from high-strength aircraft alloys of ALUMINIUM

11 STOCK SIZES from 22" x 15" x 8" to 45" x 29" x 15". Special sizes without tool costs in minimum batches as low as 20.

Write or phone for details of our K470 range or NATO Y series containers

LA LIGHT ALLOYS LIMITED

Cardigan St. Ipswich, Suffolk IP1 3DA
Tel: Ipswich (STD 0473) 217595. Telex 98640

PRODUCT FOCUS

development of electronic equipment, not only in the United Kingdom, but also in export markets.

Packaging choice

Once the decision has been made on the method of enclosure the next problem to be encountered is the choice of packaging material for shipping and transportation. For certain specialist applications such as in the military area the transportation container has to be a very robust one such as those marketed by Tekdata and manu-

region of £47 million. Although the response to the questionnaires was only about 11 per cent it did reveal such information as the types of material used for both outer and inner packages (see Table 1). The report showed that the most popular type of packaging material was polystyrene (both moulded and loose fill) accounting for over 66 per cent of the market. The report stated that polyurethane foam is now the single material in greatest use and has proved itself (together with flexible polyethylene foam) to be the most satisfactory shock

Material	Percentage use	Material	Percentage use
Polyurethane foam pads	26	Cardboard liners	2
EPS moulded corners	20	Injected polyester foam	1
Polyethylene film encapsulated air bubbles	15	Shredded cellulose film	1
Loose EPS chips	12	Plywood liners	1
Foam laminated board	8	'Anything to hand'	1
Shredded paper	8	Woodchip	1
Wood wool	2	Straw	1
		Rubberised hair	1

Table 1: Survey of popular infill materials.

factured by Zero International. Among the housings they produce are a series of sealed housings which are made from deep drawn aluminium. These are both light in weight and corrosion resistant, also being water tight to a pressure of 0.1 bar.

However in the more common applications, other types of packaging is more suitable. The cost of providing adequate protective packaging for equipment whether it be small components or large systems is estimated to be about 1.77 per cent of the manufacturers selling price according to a survey which was undertaken by Information for Industry on protective/transit packaging in the electronics industry. The survey which was undertaken last year covered 600 companies with whose packaging costs were in the

cushioning packaging material available. While many companies could report a nil damage rate some had a ten per cent damage rate. In general it was found that those companies using loose fill or wrapping type of packaging suffered the highest damage rate although these materials are quite adequate if the packaging design had been considered correctly.

Inner and outer packs

Transit packaging can be considered to consist of outer packs and inner packs. Corrugated fibreboard boxes are by far the most popular outer packs accounting for over 40 per cent of the number of outer packs used. Solid board boxes appear to be the next on the list at around 25 per cent. According to the survey other outer cases had the following percentage of

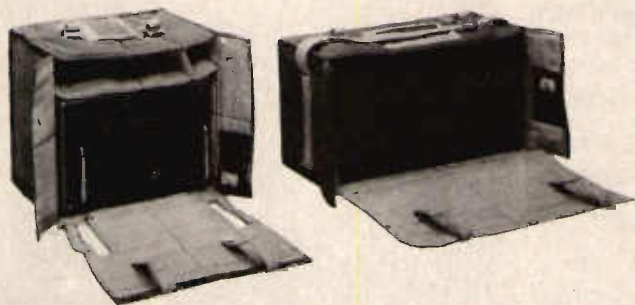

Benjamin Edginton specialises in protectomuffs, soft covers to protect instruments in transit.

Cabinets, Cases, Housings

Radiatron
Components
Product
Memo

Today's reminder of what you can get from Radiatron Components right now—the professional choice for cabinets, cases and housings.

Elmaset Floor Cabinets, Instruments Cases, Card Frames.

The well proven Elmaset range is being used in thousands of applications throughout the world. It's probably the most adaptable system of its type

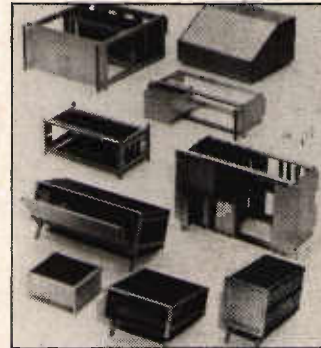

anywhere. Rugged construction in finished aluminum and extremely aesthetic with PVC clad Panels—wide choice of colours. Systems are available for 19in and more recent European Standards. Circle Reply No.

Rose Component Housings — Hoseproof to IP 65

Makrolon—with clear or opaque lids for light use up to 135°C. Circle Reply No.

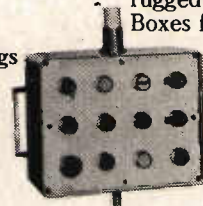

Enamelled Aluminium—ideal for RF screening, featuring thick walls for machining and rugged environments. Explosion proof and Marine versions available. Circle Reply No.

Polyester—for applications in aggressive or corrosive environments. Circle Reply No.

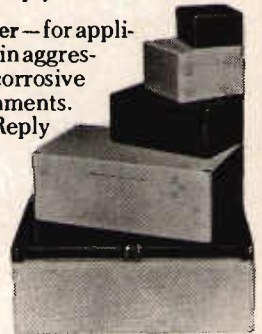

ABS—similar standards in strength and with the same high quality as Makrolon, but with significant cost advantages. Circle Reply No.

'Commando' Range—rugged aluminium control Boxes for machine tool and marine applications. Feature a protective rim and an anodised aluminium front panel. Circle Reply No.

For full details of any of these Radiatron Products, complete and return this coupon or circle the appropriate reply number.

NAME _____

POSITION _____

COMPANY _____

ADDRESS _____

**Radiatron
Components Ltd**

Crown Road, Twickenham, Middlesex, TW1 3ET
Telephone 01-891 1221 Telex 267807

CCH

EE1/77

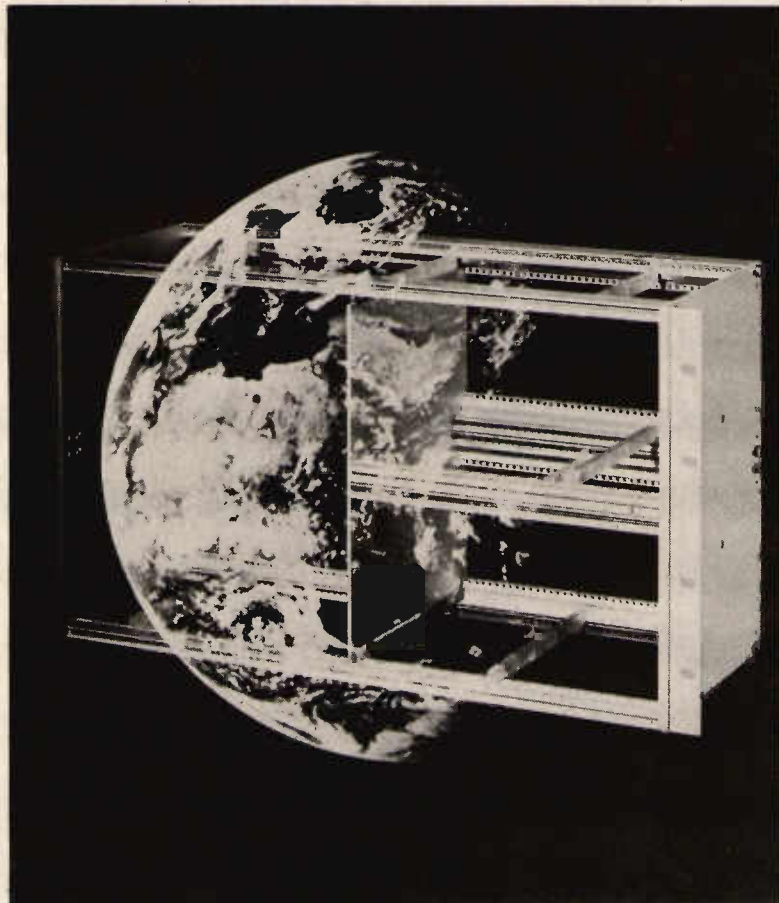

ISEP[®] 2000

ISEP 2000 for EUROCARD

- Sub Racks to DIN 41494
- 3 Unit height for 100 × 160 mm card sizes
- 6 Unit height for 233,4 × 160 mm card sizes
- 6 Unit height for 100 and 233,4 × 160 mm card sizes
- Plug-in Modules and Front Panels
- Hinged Front Panels
- Mounting Rails for DIN 41612 Connectors

For fuller information write, phone or telex to:-

ITT Components Group Europe

Standard Telephones and Cables Limited,
Equipment Practice Division,
Edinburgh Way,
Harlow, Essex CM20 2DE
Telephone: 0279 26811
Telex: 81146

Components **ITT**

ADAPTARACK

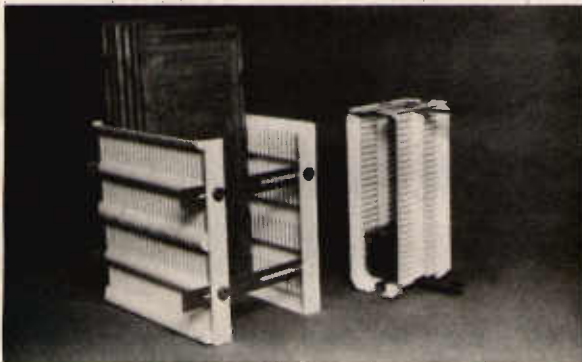

An infinitely adjustable rack designed to help the manufacturer and user of printed circuit boards in the factory and the store.

Holds up to 25 boards, vertically or horizontally. Available in two sizes, and there are three lengths of Adaptabar from 60 to 410 mm.



B & R Plastics

Details available on request.

TRINITY TRADING ESTATE
SITTINGBOURNE KENT ME10 2PG
TEL: SITTINGBOURNE (0795) 77341/2



Quality turned parts to 25mm. dia.

● Mechanical assemblies

● Instrument making

● Personal attention

circle no.194

SHERWOOD - INSTRUMENTS LIMITED

ACE WORKS
CUMBERLAND AVENUE
LONDON NW10 7RG
TEL: 01-965 4305

Electronic sheet metal work

● Cases

● Chassis

● Design co-operation

circle no.195

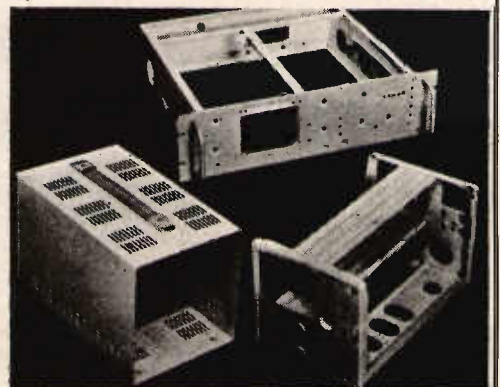

PRODUCT FOCUS

the packaging market, plywood boxes 18 per cent; corrugated paper wrappings seven per cent; padded bags three per cent and aluminium one per cent. Carton Industries, Abbots Packaging and Jiffy Packaging all produce various products from the above.

There was a far greater diversity in the use of the infill materials as Table 1 shows. Since this is one area where the choice of material is important in cushioning the effects of blows, companies seem to experiment with a number of materials. Flo-pak produces a free flow cushioning made of expanded polystyrene pieces in the shape of a figure eight which is used by GEC. Abbots Packaging and Jiffy Packaging both make the padded bags. The Sentinel range from Abbots have the inner surface coated with polythene which means that they can be heat sealed.

Transportation

The decision whether to commit your packaged instrument component to the various

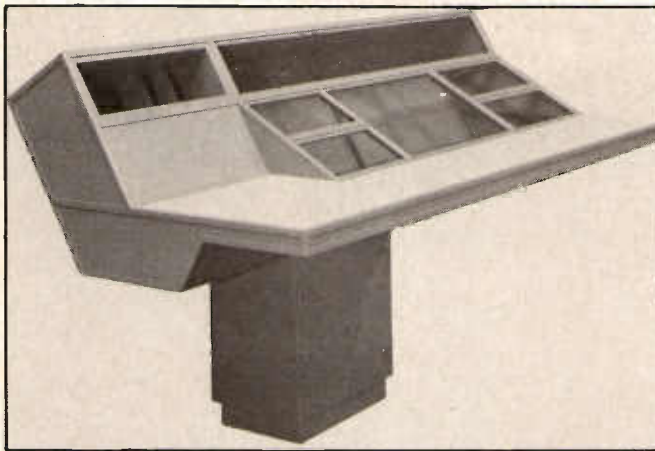

An example of the slimline Widney Dorlec consoles.

hazards of transportation or to provide one's own means of carriage is one which was encountered by Precision Equipment Transport Service. The company noted that there was a lack of specialist electronics transport service and decided to provide a nationwide, fast, highly insured handling service capable of carrying totally unpacked

equipment in safety covering the whole spectrum of the electronic equipment market. For this purpose the company acquired two types of vehicles; one type which was capable of carrying smaller items with padding and a safety belt system to protect from shock and chafing; the other type was similar in design but suitable for larger equipment

and racking systems. Roger Connel of PETS commented that "In this time of depression the need for a specialist transport service does exist provided it will take equipment of all sizes and shapes and cover the whole of the country rapidly and carefully."

Further information

Our reader enquiry service can provide information on the companies mentioned in this article upon request.

Abbott's Packaging	524
Benjamin Edginton	525
Boss Industrial Mouldings	526
Carton Industries	527
Daturr	528
Flo-pak	529
Foxall Instruments	530
Imhof-Bedco	531
ITT	532
Jiffy Packaging	534
PETS	535
Tekdata	536
Vero	537
Widney Dorlec	538

54 on enquiry card

ENCLOSURE and ELECTRONIC PACKAGING ACCESSORIES

The CSM standard range gives option on panel height from 2U to 46U in various chassis depths to 30". Where one of our standards does not match your requirements ask about our 'Specials' service. Send for details.

RACKS

CSM (ENGINEERING) LTD. CSM HOUSE, LISKEARD, Cornwall PL14 4AB
 PHONE LISKEARD (0579) 43043 & 43243 TELEX 45415

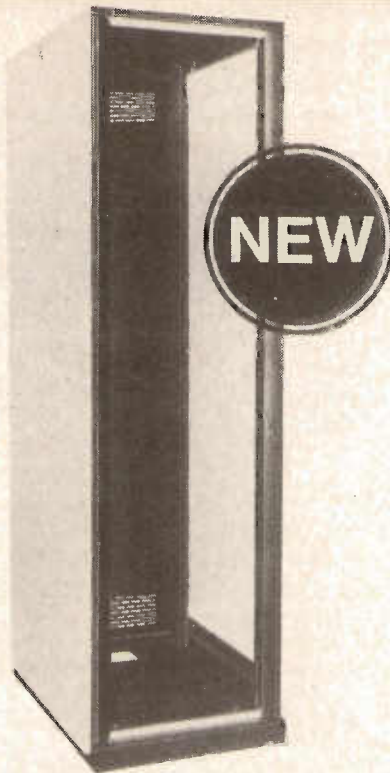

NEW SLIMLINE INSTRUMENT RACK

the latest in a long line of Langley racks for the electronics industry

Featuring fully-welded rigid construction, and a slimline design to prevent excessive build-up of unused space, the new STR rack is built to international standards and incorporates many features usually offered only as optional extras. Among these are panel screw concealment trims, lockable side panels, ventilated rear doors, and a static plinth support with jacking feet.

Standard and enclosed versions are available in 4ft, 5ft, 6ft, and 7ft heights. Overall rack width is 23" to accommodate the standard 19" instrument frame, and depth varies from 17" to 30". Custom-built units may also be supplied.

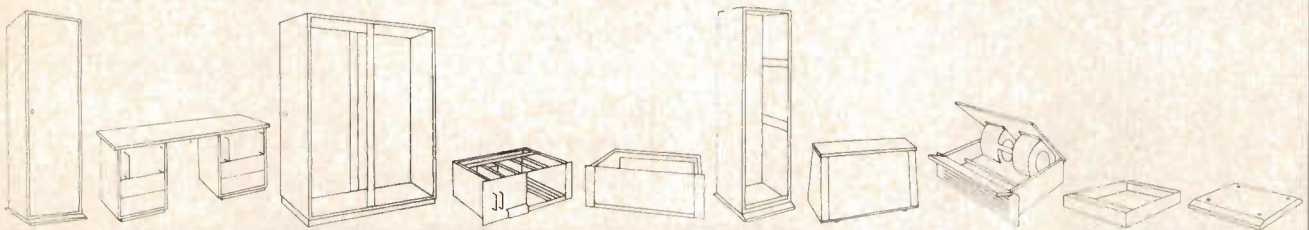

Please send me literature on the Langley Instrument Racks

Name

Position in Company

Company

Address

Langley Metal Products Ltd., Unit 4A, Lyon Industrial Estate,
Hartspring Lane, Watford WD2 8JU



LANGLEY METAL PRODUCTS LTD

Unit 4A, Lyon Industrial Estate,
Hartspring Lane, Watford WD2 8JU
Telephone Watford 48327 Telex 922189

NEW PRODUCTS

CMOS memories

A family of 256 × 4-bit cmos static rams offers low power, fully static operation, three state o/p and complete ttl compatibility. Access time is 450 or 650 ns, according to the type selected. The minimum current drawn by a deselected memory is 10 µA. Devices require a single 5 V supply and models are available with a guaranteed data retention for power sources down to 2 V. *AMI Microsystems, Swindon, Wilts.* **300**

Relays

The R series of medium power relays, rated at five or 10 A, can be supplied in panel-mount,

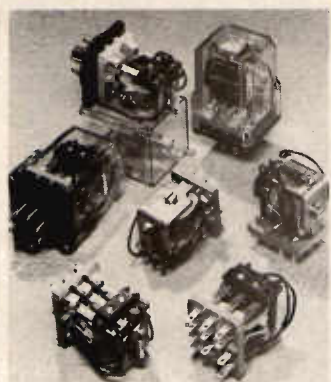

pcb or octal plug styles and are SEV approved. Relays are available with two or three c/o contacts of pure silver. Switching power, ac, is 1,25 KVA (5 A) and 2,5 KVA (10 A). Insulation resistance is 100 MΩ at 500 V dc. *ITT Comps., Essex.* **301**

UHF dividers

The SP8740 and -/45 are 300 MHz divide by 5/6 counters, with ac/dc coupled i/p respectively. The SP8741 and -/46 types are 300 MHz divide by 6/7 counters with ac/dc coupled i/p. The SP8743 and -/48 versions are 500 MHz divide by 8/9 counters with ac/dc i/p. The dc coupled devices require PECL III i/p and the ac devices have an i/p range of 400 to 800 mV. The specified supply is 5,2 V but the devices will operate from a 5 V source. *Plessey Semis., Swindon, Wilts.* **302**

Cable harness

A range of heat-shrinkable cable harnesses allow groups of cables to be routed without the need for cable trunking or other conduit systems. The harness is slipped over the cables and then shrunk into position. Shrinking occurs at between 125 and 130°C, allow-

ing the use of a hot air gun or naked flame. *Thomas Ness, Harrow, Middx.* **303**

Solar cells

A solar power module designed for remote power supply applications contains 18 silicon solar cells, each 50,8 mm in diameter, connected in series on a finned aluminium substrate and potted in a silicon compound. Designated MOD-2118, the modules can be connected into arrays to charge 6 V batteries. An optional built-in Schottky blocking diode is available. *Sensor Technology, Chatsworth, California.* **304**

Digital tachometer

The 1000 series of tachometers incorporate a latched digital display fitted with a polarised filter. Speeds of up to one million rpm can be displayed. The instrument is designed to give an accuracy of 0,01% and can be used in conjunction with magnetic, photoelectric or proximity sensors. It is available with bcd printout and analogue set-point trip controls. *Sapphire, Ferndale, Glams.* **305**

Battery charger

A constant current charger for 501 RS NiCd cells can hold up to four cells. Each cell, 1,2 V, is rated at 500 mAh. The charger has a built-in selector for the number of cells to be charged and is suitable for operation from a 220/240 V mains supply. *Varta (GB), Crewkerne, Somerset.* **306**

Ceramic filters

Type CFM 107S12C piezoelectric ceramic filter has a centre frequency range of 10,62 to 10,78 MHz in 0,04 MHz steps ±35 kHz on each frequency. The -3 dB bandwidth is 220 ±40 kHz and the -20 dB bandwidth is 60 kHz. Maximum insertion loss is 6 dB and minimum spurious response 38 dB (10,7 ±1,5 MHz). Input/output impedance is 470 Ω; ripple 1 dB max; and breakdown 50 V dc. *ITT Comps., Paignton, Devon.* **307**

Signal generators

Two additions to the TF2015 range of signal generators offer alternative deviation ranges. The 2015/1 is a narrow deviation unit with three ranges of 2,5, 5 and 25 kHz fs, whilst the 2015/2 is a wide deviation variant with ranges of 20, 100 and 500 kHz. *Marconi Insts., St Albans, Herts.* **308**

Rotary switches

The C range of rotary, multi-position switches, features up to 30 no/nc contacts for 5 A at 380 V or 10 A at 220 V. Each contact is activated by its own cam and a range of cams can be assembled on a shaft in eight varying positions, allowing a variety of switching sequences. *Entrelec, Felpham, Sussex.* **310**

Opto-isolator

The MCT210 isolator has a specified minimum current transfer ratio of 50% saturated, and 150% unsaturated, over a temperature range of zero to 70°C. The device incorporates a GaAs diode emitter, coupled to an npn silicon planar phototransistor. Isolation between i/p and o/p is 4 kV dc. *Monsanto, London.* **311**

BCD comparator

The 74L 40 comparator accepts up to four decades of bcd i/p information at ttl logic levels. Each o/p, 'high' and 'low', is in the form of a sp c/o contact. The o/p are activated when the i/p exceeds or drops below pre-settable high and low limits respectively. *Orbit Controls, Cheltenham, Glos.* **312**

Field strength meter

Model NM-67 is a programmable microwave receiver with spectrum analyser capability and tracking preselection. Frequency and amplitude o/p are provided for x/y plotting. A digital frequency readout is available simultaneously. Frequency coverage is from one to 18 GHz, expandable to 40 GHz. *REL Equip. & Comps., Hitchin, Herts.* **313**

Resistors

A range of precision resistors conforming to MIL and DIN specifications comprises metal film, carbon film and colloid film types. M/f types have tcr's from ±15 ppm with tolerances down to 0,1%. The c/f range includes high ohmic values up to 100 GΩ. Working voltages up to 30 kV are available in the colloid film range. *Colstar, London.* **314**

Resistance meter

A battery operated high megohm resistance meter provides direct measurement of resistance values from 0,1 MΩ to 10⁶ GΩ. Accuracy is ±5% of fs and the i/p impedance is >10¹⁴Ω. *Rofin, Egham Surrey.* **315**

Capacitance meter

The CP570 capacitance meter, includes overload protection and a battery test facility. Five ranges can be selected by means of a rotary switch, from 50 pF to 0,5 µF fs. The meter movement is a Class 1,5 moving coil (3 kΩ) with sprung jewel bearings. *Carlo Gavazzi, Newport Pagnell, Bucks.* **316**

Relays

A low profile, 30 W two-pole c/o relay, designated SC200, is fitted with a dust cover and designed for close space mounting of pcb's such as PO Type 62 EPS. Operate and release times are 20 and 15 ms respectively. The relay can operate over a temperature range spanning -10 to 40°C. *Plessey Aerospace, Titchfield, Hants.* **318**

D/A converters

DAC371-8-LV, is an 8-bit, current o/p model operating from 5 V supplies and drawing 20 mA. Two models are available, one featuring binary i/p, the other a two decade bcd i/p. The binary unit delivers a zero to +1,9 mA. Settling time to 0,2% is 1 µs for both types. *Hybrid Systems, Camberley, Surrey.* **319**

Multiplier/divider

The 4213 differential i/p multiplier/divider is a self-contained, laser trimmed circuit, with an

$$E_o = \frac{(X - X_2)(Y - Y_2)}{10} + Z_2$$

accuracy of 0,5% and a noise specification of 120 µV rms (10 Hz to 10 kHz). Four quadrant multiplication, division and square rooting can be performed without additional amplifiers. Zener regulated references are included to reduce sensitivity to power source variations. *Burr-Brown Int., Watford, Herts.* **309**

Enquiry Service

For rapid access to further information, use the reply paid card at the end of the commercial section. Our R.E.S. department provides same day turnaround on all enquiries.

continued ▶

TEXAS



The big, BIG range!

SDS Components now provide the biggest range of Texas products and services for the MPU user

- * MPUs, developments systems and support chips.
- * Comprehensive Data service
- * Rapid prom programming service
- * Full systems evaluation and development back-up
- * Full time field sales specialist
- * Prompt delivery by Securicor

SDS COMPONENTS LIMITED



Hilsea
Industrial Estate,
Portsmouth Tel: 0705 65311
Telex: 86114



SCOTTISH OFFICE

Room III, Alexander House, East Kilbride,
Glasgow G74 1LX.
Telephone: East Kilbride (035 52) 48617

Please send me full details.

Name.....

Position.....

Company

Address

ONLY THE BEST FROM SDS

nothing fixed about our resistors

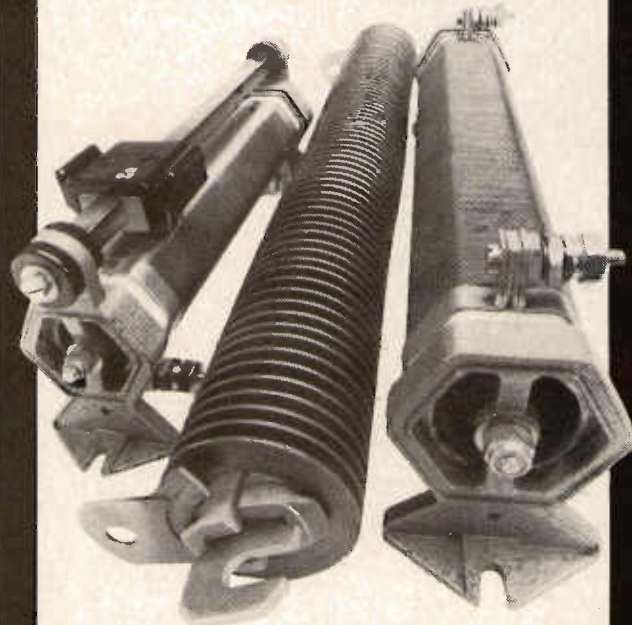

You can have them virtually any way you want them.

Spirals. Tubulars. Hexagonals.
Mica-cards. From 12W - 3kW.
Single or ganged.

You name it - we'll supply it.

Claude Lyons Controls Ltd
Ware Road, Hoddesdon, Herts. EN11 9DX.
Tel: Hoddesdon 67161 Telex: 22724

CLAUDE LYONS CONTROLS LTD

NEW PRODUCTS

A/D converter

ADC84 contains internal clock, comparator, reference and i/p buffer amplifier and features conversion times of 10 μ s for 12-bits and 6 μ s for 10-bits. Five analogue i/p ranges are available and gain and offset errors can be externally trimmed to zero. Several o/p codes are available and all digital i/p and o/p are ttl compatible. *Burr-Brown Int. Watford Herts.* 317

Crystal oscillator

A low profile, tempco: crystal oscillator, TCX08, features 8 mA current consumption, instantaneous turn-on and a frequency range of 4.1 to 20 MHz. The frequency stability depends on the operating temperature range required. Typical specifications are ± 1 ppm for zero to 60°C operation and ± 1.5 ppm for -10 to 70°C. *ITT Comps., Harlow, Essex.* 320

Multiplexers

MX series analogue multiplexers, available in four, eight and 16 channel configurations, are manufactured with a dielectrically isolated cmos process.

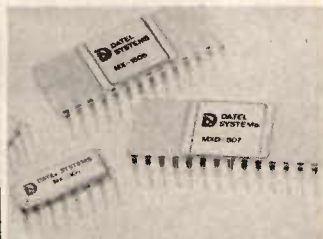

Break-before-make switching ensures that no two channels are ever momentarily shorted together and no damage results for analogue i/p over-voltages of

± 4 V or a loss of power with control and signal i/p applied. *Datel, Basingstoke, Hants.* 321

Microcomputer kit

The MCS-40 system B kit, comprises a 4040 cpu, a programmable I/O device (4269), providing simultaneous interface with a keyboard and display. An interface circuit provides 16 I/O lines, 256 words of static ram, a combined memory interface and I/O device, 256-bytes of e-prom and a system clock generator. *Intel, Oxford.* 322

Analogue switches

TL600 analogue switches are fully ttl compatible and will accept ± 10 V signals. Operating from five to 30 V supply voltages, these devices have an ON and OFF resistance of 100 Ω and $10^{11}\Omega$ respectively. Four versions are available providing sp/st sp/dt and dual sp/st configurations controlled by either a single strobe i/p or one, two or three logic i/p. *Mogul Electronics, Harlow, Essex.* 323

Prescalers

The SP8646 and -/47 are divide-by-10/11 counters identical in performance to the SP8640 and -/41, but with the addition of an open collector o/p stage. The o/p can drive three standard ttl loads. The -/46 is specified to 200 MHz and the -/47 to 250 MHz with dc-coupled i/p. *Plessey Semis., Swindon, Wilts.,* 324

Power supply

The Triple Powercard is provided with a third o/p line, whilst maintaining the basic Powercard specification. All rails

are short-circuited protect and both positive and negative o/p go low when either is short-circuited. The $\pm 12/15$ V o/p track together and the 5 V o/p has a fixed over-voltage trip. *ITT Comps., Harlow, Essex.* 325

Static rams

Three static n-mos rams, organised as 256×4 , operate from single 5 V supplies and are fully ttl compatible. Each is available in three speed ranges with access times of 1000, 650 or 450 ns. Versions are available with separate and common I/O lines and in plastics or ceramic dil packages. *Texas Insts., Bedford.* 326

Impedance converters

Model 304 impedance converter includes a fet, a high megohm resistor for biasing and a low value resistor in the power circuit. It effectively converts charge or other high impedance sensor o/p into low impedance voltage signals. Exhibiting near unity gain, the unit will accommodate i/p impedances up to 5×10^{11} Ω with an o/p impedance of 6.2 k Ω . *Rofin, Surrey.* 327

Power drivers

A series of cmos compatible dual peripheral power drivers, includes the DS1631/3631, 1632/3632, 1633/3633 and 1634/3634. These circuits feature pnp i/p which provide high impedance and thresholds that track as a function of V_{cc} . The V_{cc} operating range is 4.5 to 15 V. Output current capability is 300 mA and the o/p transistors are protected in the event of V_{cc} failure. *National Semis., Bedford.* 330

Orange displays

MAN6660 and -/80 are 15.24 mm high single digit displays in common anode or cathode configurations respectively. Both units emit orange light at a wave length of 630 nm and feature a minimum brightness specification of 510 μ cd/segment digit at a forward current of 10 mA. *Monsanto, London.* 328

RMS converter

A true rms to dc-converter, model 442, features an 8 MHz bandwidth and $\pm 0.5\%$ accuracy for crest factors up to 10, enabling true rms measurements on signals containing both dc and ac components. Power supplies of ± 6 to ± 18 V dc are required. Input range is zero to 2 V rms and response time to 1% accuracy is 5 ms. *Analog Devices, E. Molesey, Surrey.* 329

Multimeter

The 1057 is a $5\frac{1}{2}$ digit half-rack multimeter which measures dc-V, true rms ac-V and resistance. Ranges, in five steps, cover 1 μ V to 1 kV (dc), 10 μ V to 700 V (true rms ac) and 10 m Ω to 20 M Ω . An integration notch and three pole filter provide

Enquiry Service

For rapid access to further information, use the reply paid card at the start of the commercial section. Our R.E.S. department provides same day turn-round on all enquiries.

continued ▶

58 on enquiry card

POTENTIOMETERS

Because Intel carries extensive stocks of potentiometers. Ensuring a continuity of supply you don't find elsewhere. 24 hour service for stock items. Or phone a.m.— collect p.m. Complete with bonded store facilities, Intel is a fully approved supplier to BS9000 and other specifications.

Don't delay — let Intel solve your potentiometer problems.



Send now for the comprehensive catalogue.

 **INTEL ELECTRONICS LIMITED**
HENLOW TRADING ESTATE, HENLOW, BEDS, SG16 6DS
TELEPHONE: HITCHIN 812505. TELEX 825637

the fastest multipliers...

Semtech high voltage multipliers

Well established in the art of integrating their unique suprataxial high voltage rectifiers with the best in high voltage capacitors, Semtech bring to the U.K. the capability of building their full range of High Voltage Multipliers.

Applications such as VDU's, Oscilloscopes, Electrostatic systems, high voltage supplies for Magnetrons, TWT's and the modern high reliability colour TV set are amongst the many that Semtech have satisfied.

Engineering facilities now in Glenrothes, Scotland, provide on the spot assistance to get the specification right.

The U.K. manufacturing unit is already supplying rectifier assemblies to Europe. Prototype or production quantities are ready when you are.



Represented in the U.K. by



Bourns (Trimpot Limited)
Hodford House 17/27 High Street
Hounslow, Middlesex TW3 1TE
Telephone: 01-572 6531 Telex: 264485

...with a lot of breeding.

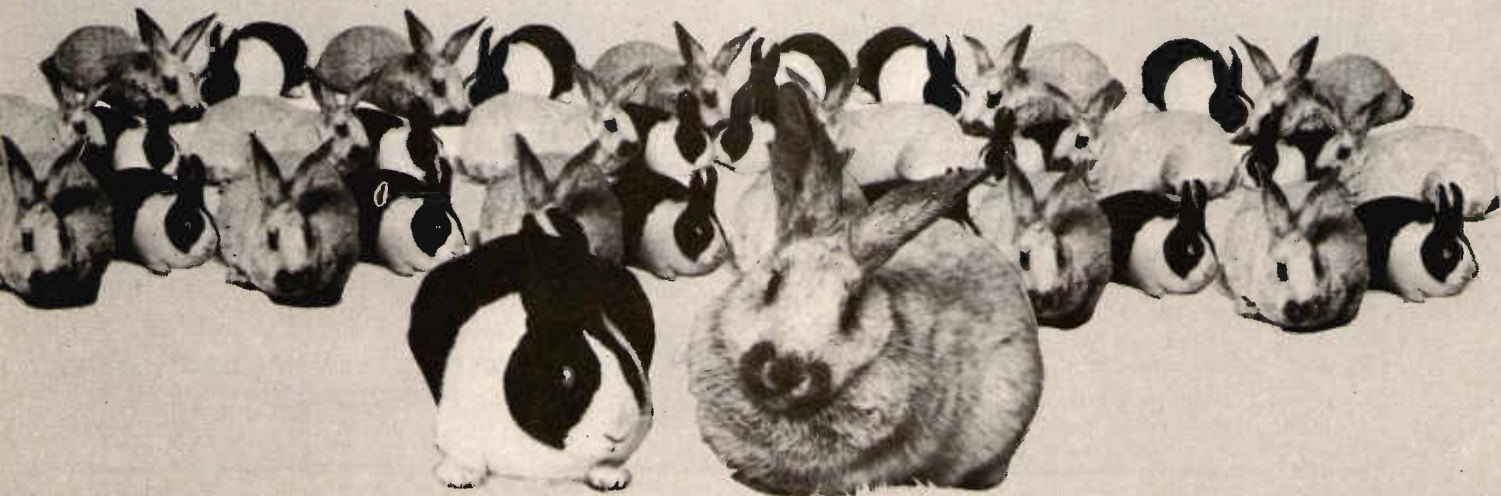

NEW PRODUCTS

more than 80 dB of series mode rejection at 50 Hz and a typical dc accuracy of 0,015% \pm 0,001% fs is claimed. *Datron Electronics, Norwich.* **331**

Diode holder

The TN diode holder, designed for use on pcb's, occupies 40 x 15 mm and offers space for the vertical installation of up to 80 diodes arranged on a 2,54 mm matrix. The diode panel can be enlarged by combining several holders. The holders are made of Ultramid plastics, resistant to temperatures of up to 220°C. *Colstar, London.* **332**

Dynamic ram

The 2104A is a 4k dynamic ram fabricated with an improved n-channel Si-gate process. Average drain current is 30 mA and access time is specified as 200 ns (read or write). The tolerance on the voltage on the power rails is \pm 10% and the maximum allowable logic low i/p voltage is 800 mV. *Intel, Cowley.* **333**

Power transistors

The BU500 power transistor is designed for colour tv horizontal deflection applications where 110° in-line gun crt's are used. The device, rated at 1,5 kV, 6 A, can withstand turn-off transients of up to 16 A at 500 V. The unit is designed to prevent the occurrence of failures due to eht flash-over. *Texas Insts., Bedford.* **335**

Function generator

Model 180 sweep function generator has a frequency capability of 0,1 Hz to 2 MHz with switched range selection and dial tuning. Output signals can be

selected as either sine, square, triangle or dc level and separate terminals are provided for ttl pulses and variable ramp o/p. The internal sweep facility allows variable sweep widths and rates to be set by the front panel controls. *Electroplan, Royston, Herts.* **336**

Oscilloscope

The OS3000A is a dual trace 40 MHz 'scope incorporating an 8 x 10 cm rectangular faced crt, running at 10 kV with an illuminated graticule. The sensi-

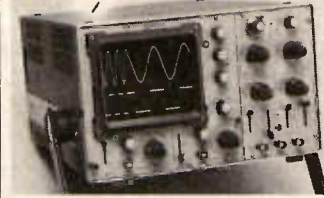

tivity can be adjusted from 5 mV/cm to 20 V/cm, with a x5 facility giving 1 mV/cm between dc and 10 MHz. Time-base speeds up to 20 ns/cm are provided with independent triggering for each time base. *Gould-Advance, Essex.* **334**

Converters

The 7103 digital processor is used with the 8052 signal conditioner to provide all the logic circuitry necessary for a \pm 1999 count a/d counter. The device includes auto-zero, auto-polarity switches, converter, latches, multiplexer and associated logic to provide a multiplexed bcd o/p format. *Intersil, Reading.* **340**

Detector

Series 1001 are broadband half-wave detectors claimed to feature a flat frequency response. The vswr is said to be typically

>1,1 at 1,2 GHz. The connectors are available with either bnc or n mating faces. *Suhner Electronics, High Wycombe, Bucks.* **342**

Voltmeter

The Ithaco Dynatrac 395 narrow-band voltmeter automatically locks its centre frequency to an external reference signal from 10 Hz to 10 kHz. The user need only set the sensitivity and bandwidth; maximum sensitivity is 100 μ V and bandwidth can be set between 0,03 and 300 Hz. A differential i/p is provided, allowing the instrument to be used as a null detector. *Techmation, London.* **337**

Edge connector

The 4338 edge connector incorporates crimp type contacts spaced at 3,97 mm. The Valox 94V-O polyester housing is said to feature dimensional stability, low moisture absorbancy and high dielectric resistance. The terminals are rated at 5 A and are of brass, tin or gold on nickel plate. Versions are available ranging from eight to 30 dual positions. *Molex Electronics, Aldershot, Hants.* **338**

Military fpla

The S82S100 and -/101 are Schottky ttl fpla's with three-state and open collector o/p respectively. Both employ nichrome fuse technology and operate over a temperature range of -55 to 125°C. Key specifications include 600 mW typical power dissipation and 80 ns max. access time. The devices are organised with 16 i/p and eight o/p. *Mullard, London.* **339**

Pressure transducer

The sensing element of the 8507 series of pressure transducers consists of a shaped silicon chip on which is diffused a four-arm piezo-resistive Wheatstone Bridge. The chip is 3 mm in diameter. Full-scale o/p is 300 mV and an integrated temperature compensation circuit keeps sensitivities within \pm 2% of fs. Four models are available, with pressure ranges up to 50 psi. *Endevco UK, Royston, Herts.* **341**

Connectors

A range of two-part connectors, designated the KS 1000 series incorporates conventional tuning fork contacts. The contacts are produced from beryllium copper with gold over nickel plating. The contacts are designed to handle currents up to 3 A with contact-to-contact voltages of up to 1 kV ac (rms) at 60 Hz. *Teradyne Comps., Cambs.* **343**

Insulation tester

A 10 kV insulation tester, measuring 203 x 139,7 x 76,2 mm can be operated from the mains or from internal batteries. Nominally rated at 7 kV the unit delivers o/p voltages up to a

Enquiry Service

For rapid access to further information, use the reply paid card at the end of the commercial section. Our R.E.S. department provides same day turn-round on all enquiries.

continued ▶

60 on enquiry card

CRYSTAL FILTERS

High quality HF, VHF and UHF units at competitive prices

Also: DISCRIMINATORS
LC FILTERS
CRYSTAL UNITS
OSCILLATORS AND OVENS
MONOLITHIC FILTERS including HF range by Piezo Technology Inc.

Call us today!

Cathodeon Crystals Ltd

Linton, Cambridge CB1 6JU England Tel: Cambridge 891501

**Burr-Brown's 8-bit ADC82 gives you
a 2.8 μ sec conversion speed,
adjustment free operation, low cost,
and much more...**

Our new ADC82 successive-approximation A/D converter offers both parallel and serial data outputs, output-status signals, and conversion speeds of 2.8 μ sec maximum. It's self-contained, with internal clock, comparator and reference.

No gain or offset adjustments are needed for 0 to +10V or ± 10 V signal range accuracies of better than $\pm 0.2\%$, ± 1 LSB.

All this means money saved in production and testing. And the ADC82 is packaged in a metal (ADC82AM) or ceramic (ADC82AG) 24-pin DIP that measures only 36mm by 20mm and is less than 7mm high.

ADC82

For details on this
or other conversion
products, contact

Burr-Brown
International, Ltd.,
Permanent House,
17 Exchange Road,
Watford WD17 8B,
Telephone
(0923) 33837



BURR-BROWN
BB

**Fifty-four
conversion choices**

A change is good for the best.



Deer occupy in the mammalian world, a similar ecological niche to the kangaroo of Australia – last stronghold of the once dominant order of marsupials.



In high voltage engineering also, the good always gives way to the better – hence the new generation Gamma HV power supplies.

Available with outputs up to 100kV at 1mA d.c., a major feature of the range is the system of polarity reversal.

With certain models, polarity is controlled from the front panel.

Others, have either a positive or negative polarity multiplier designed-in to meet customer's specification. And these multipliers are available separately, so polarity can be changed after purchase.

The Brandenburg range of solid state HV modules, are ruggedly built and economically priced for CRTs and other applications with outputs up to 15kV at up to 500 μ A.

Please request full details of the Gamma and modules ranges. You'll soon see why there're dominant.

brandenburg
Part of Britain's technological growth.

Brandenburg Limited,
939 London Road, Thornton Heath, Surrey CR4 6JE.
Tel: 01-689 0441. Telex: 946149.

NEW PRODUCTS

maximum of 10 kV at 250 μ A controlled by a 10-turn potentiometer. Push-button switches provide four metering modes. An auto-trip facility operates at 130% of the fs setting. *Hunting-Hivolt, Shoreham, Sussex.* 345

Photoconductive cells

The NSL312 and -/412 series of Cd-sulphide photoconductive cells operate over a temperature range of -60 to 65°C and 75°C respectively. Both types have a 50 mW power rating at 25°C a choice of seven photocell resistances and typical dark capacitance figures of between 1,2 and 4 pF. The devices have peak spectral response figures of 720 and 560 nm respectively. *National Semis., Altrincham, Cheshire.* 346

LED displays

Series 1775 and -/76 led displays are 7,62 mm high with deep red characters providing zero to nine and right-hand decimal point. Series 1775 is the

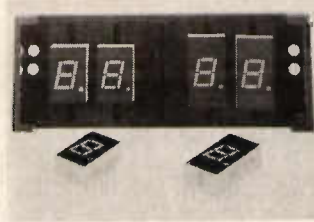

common cathode version, whilst the -/76 is common anode. Other features include single plane, wide angle (160°) viewing and 350 μ cd/segment luminous intensity at 20 mA drive current. *IEE, Van Nuys, California.* 344

Oscilloscope

The 45000 uv-oscilloscope recorder provides 18 fixed speeds from 10 mm/m to 5000 mm/m. An alpha-numeric indicator panel presents the status of the main controls. A variable speed vernier control is also provided and the display warns when this control is engaged. A choice of six, 12 or 25 channel magnet blocks are available and both heated and hv blocks can be provided as options. *Electroplan, Royston, Herts.* 347

Slide switch

Series 24 slide switches are designed to escape contamination during pcb assembly. Measuring 14,5 x 3,8 x 12,7 mm the switches can be supplied either fully assembled or in two-parts. The upper half contains the actuator button and sliding contacts, whilst the lower sec-

tion contains the fixed contacts and the pcb pin base. *Roxburgh Electronics, Rye, Sussex.* 348

Regulators

A pair of three terminal voltage regulators with preset o/p of +5 and -5 V have load driving capability of 3 A. The LM323 (+5 V) is a 3 A version of the LM309 with internal current and thermal limiting. Typical o/p impedance is 0,01 Ω and power dissipation is 30 W. The LM345, the -5 V device, can dissipate 25 W and requires one external component. Both devices come in hermetically sealed TO-3 cans. *Jermyn, Sevenoaks, Kent.* 349

Oscillators

Model CO-238A-2S-2 clock oscillator drives 10 ttl loads at any specified frequency in the four to 100 MHz range with a stability of ± 50 ppm over the -55 to 125°C temperature range. The device is sealed in a metal can and ruggedised for shock to 100 g and vibration of 20 g to 2 kHz. *Lyons Insts., Hoddeston, Herts.* 350

Rotary switches

A family of rotary switches provides eight positions within a TO-5 package. The switches have gold contacts and each contact is rated at 0,5 A at 125 V ac with a break-down voltage of 500 V at 60 Hz. Switches are available for direct pcb mounting or can be supplied for panel mounting. *Quiller Comps., Bournemouth, Dorset.* 351

Microwave amplifier

Models 600L and /P microwave amplifiers provide 24 dB of gain with an o/p of 150 mW (min) of linear Class A power, or 300 mW of saturated power over the frequency range of 0,8 to 1020 MHz. Model 600L is designed for use as a laboratory amplifier, whilst the 600P finds use as an oem product. *ENI Power Systems, Hitchin, Herts.* 352

Audio amplifier

The TDA2002 is a Class B audio amplifier with typical o/p powers of 5,2 W into 4 Ω load and 8 W into 2 Ω . The minimum guaranteed figures are 4,8 W and 7 W respectively. In addition to its intrinsic reliability it can withstand $> 7,5 \times 10^3$ thermal fatigue cycles with $\Delta T_{case} = 100^\circ\text{C}$. *SGS-Ates, Aylesbury, Bucks.* 353

Microprocessor system

Two new μ P systems forming complete 8-bit micro computers on two chips, claim to cut the cost of equipment systems. Designated the PPS-8/2 family, both systems provide two-chip micro computers with cpu, one auto-serial and 17 parallel I/O ports, 16-bit interval timer, three level interrupt, clock circuit, 64 x 8 ram and either 1024 x 8 or 2048 x 8 rom. Both use 109 instructions. *Pelco (Electronics), Hove, Sussex.* 354

Integrated drivers

This comprehensive family of integrated monolithic circuits has been designed to work as interfaces between logic circuits and inductive loads, ie, relays, motors, lamps, etc. The PBD3510 is a single driver for positive earth systems with a fast switch-off. Driving capability is 125 mA. The 3511 is identical, but for negative systems. The PBD3513 is a dual 12 V driver with two 3 i/p and gates plus dual expandable i/p. The 3520 is a driver with open collector/emitter o/p and the 3523 is a Darlington Septette, designed for 7-segment printers, 500 mA driving capability/channel. *Rifa, Sweden.* 355

16k cmos ram

The HMM1600 is the first of a series of static silicon gate hybrid ram's designed to optimise the capabilities of 1k cmos ram's. It is organised as 2k x 8-bit words, but can be optionally connected as 4k x 4-bit words by bussing relevant i/p and outputs. Access time is 150 ns typically with a standby current of 120 nA. It is ttl i/p and o/p compatible and includes on-chip registers. *National Semis., Bedford, Beds.* 356

Electrolytics

Aluminium electrolytic capacitors have now been designed for use in rc-timing circuits. The family consists of six devices, with capacitance ranges from 10 to 500 μ F at working voltages of 25 V dc. Capacitance tolerance of the type 603D is 10%. *Sprague Electric, W. Drayton, Middx.* 357

16k rom

The MCM68316E, 16384-bit static rom is organised as 2048 bytes of 8-bits and offers a maximum access time of 450 ns. The rom offers tri-state o/p and ttl compatible i/p. *Motorola Semis., Wembley, Middx.* 359

5 $\frac{1}{2}$ -digit dmm

Known as the 8500A this instrument is really a modular measuring system rather than a



dedicated instrument. Operation of the unit is based on a μ P, which controls all the unit's modules. All these modules reside on a computer-type bus structure and each module has a discrete address. The basic device incorporates five dc-V ranges as standard, additional modules permit true ac-V, average responding ac-V, dc/ac current and resistance measurements. *Flyke Int., Watford.* 358

Voltage regulators

With an o/p voltage adjustable between three and 30 V and o/p current adjustable from zero to $> 1,8$ A, the L200 has considerable advantages over existing regulators. The maximum reference voltage is 40 V, ripple rejection is (> 70 dB) and the adjusted current has low thermal drift (100 ppm/ $^\circ\text{C}$). Stability is $> 0,2\%$ of I_{out}/V during load variations. *SGS-Ates, Aylesbury, Bucks.* 360

Dual-gate mos/fet

The MFE140 dual-gate mos/fet is characterised for frequency modulation amplifiers and mixer applications. This n-channel device functions in the depletion mode and silicon nitride passivation has been utilised. Both gates have been diode protected. The device features a low reverse transfer capacitance of 0,05 pF, high gain of 20 dB and high conversion gain of 15 dB. *Motorola, Semis., Wembley, Middx.* 361

Opto-isolators

A uniquely designed internal shield for high common mode rejection guarantees common-

Enquiry Service

For rapid access to further information, use the reply paid card at the end of the commercial section. Our R.E.S. department provides same day turnaround on all enquiries.

continued ▶

Professionals with the edge

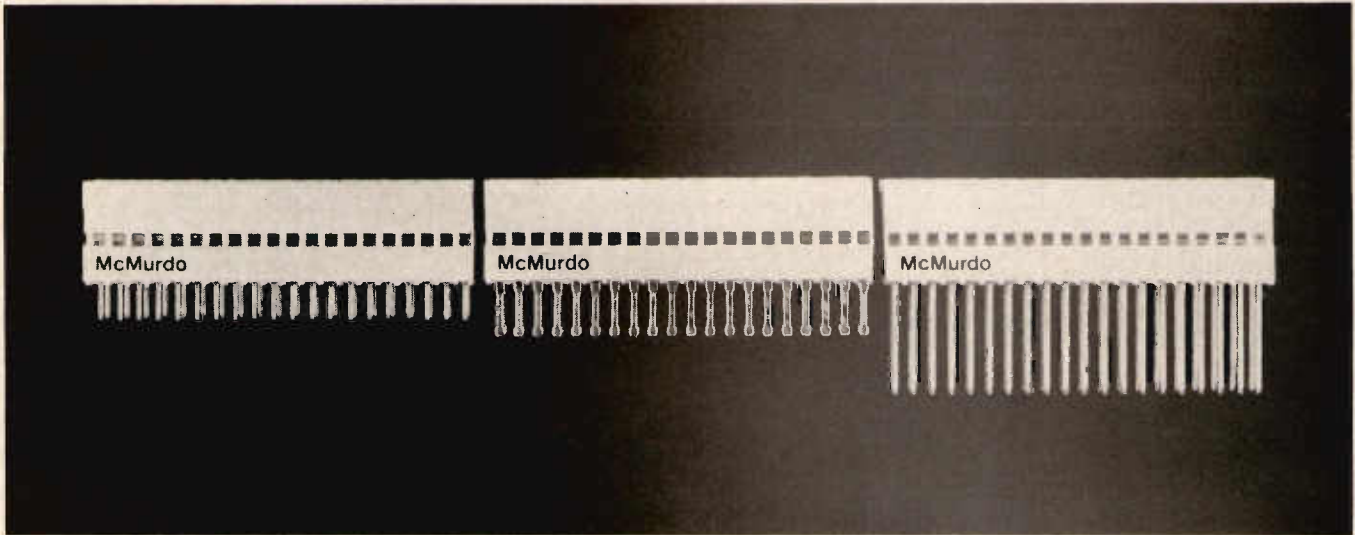

the McMurdo connection

KEYMEC is a high reliability professional modular edge connector with contacts at 2.54mm (0.1in) pitch. Any number of ways up to 90, single or double sided. Front removable cantilever contacts selectively plated. Selection of terminations — wire wrap, flow solder and solder spill. Designed to meet BS9526-N001, 2 and 3 (draft) and PO spec D2552. Plus the all important factors of cost effectiveness and availability.

The McMurdo Instrument Co Ltd
Rodney Road, Portsmouth, Hampshire PO4 8SG
Tel: Portsmouth 35361 (STD Code 0705). Telex 86112

***new sizes**
LOW COST
OPTICAL ENCODERS



To complement the existing range of the successful 7000 series of Optical incremental Shaft Encoders, Kenure Developments now introduce Encoders down to size 1100.

Full details are available upon request.

Kenure Developments Limited

Blackwater Station Estate, Blackwater, Camberley, Surrey. GU17 9AQ
Telephone 0276 32111. Telex 858719

LOW COST ID

Identification made on the spot

BRADY

Write-On
Self-Sticking LABELS

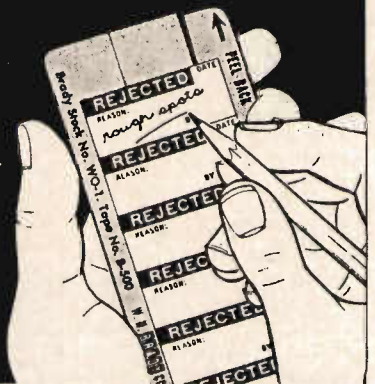

Self-Sticking Write-On Labels for inspection, Laboratory, maintenance, electrical, and safety marking. Mounted on handy portable dispenser cards for on-the-spot use. Just add specific data to preprinted label form with pencil, pen, rubber stamp or typewriter. Over 100 stock items. Three label materials: Removable Vinyl Cloth, oil-proof Aluminium Foil, self-destroying Paper. Specials to order.

BRADY

DAVENTRY ROAD INDUSTRIAL
ESTATE, BANBURY
OXON OX16 7JU

W. H. Brady Co., Ltd. TELEPHONE: 0295 56101

Manufacturers of Quality Pressure-Sensitive Industrial Tape Products, Self-Bonding Nameplates, Automatic Machines for Dispensing Labels, Nameplates, Masks and Tape.

NEW PRODUCTS

mode transient immunity of 1000 $\mu\text{V/s}$. Designated the 5082-4361, these isolators have the ability to reject an increase of 100 times more common-mode noise. Input current required is 5 mA with a propagation delay time to high or low o/p level is 35 ns. *Hewlett-Packard, Wincoburn, Berks.* **362**

Chart recorder

A new thermal writing multipoint recorder, type 816 can record up to eight channels of analogue information on fan-fold chart paper at sampling rates of up to 17 points/s. Three operating modes are available; multipoint, intensified and continuous. The maximum channel span of 11,4 cm provides high display resolution. *Gould-Advance, Bishop's Stortford, Herts.* **363**

Frequency synthesiser

The model 6595 frequency synthesiser module is designed for use in the range 962 to 1213 MHz. The device provides 10 mW o/p over the band and is tunable in 1 MHz steps with 250 μs switching time. Spurious o/p are 80 dB below the carrier. *Dale Electronics, Camberley, Surrey.* **364**

Differential amplifier

The 3627 unity-gain differential amplifier is a self contained amp. including resistor network and laser trimmed offset circuitry. Accuracy is $< \pm 0,015\%$ at 25°C. The cmr offered ranges from dc to 60 Hz of 80 dB and offset voltage drift of 40 $\mu\text{V}/^\circ\text{C}$. Offset voltage of $< 250 \mu\text{V}$; small signal ± 3 dB response $> 0,8$ MHz;

slew rate of 0,6 $\text{V}/\mu\text{s}$ and settling time of 20 μs are all major specifications. *Burr-Brown, Int. Watford, Herts.* **365**

Voltage reference

The REF-02 precision voltage reference provides a stable +5 V o/p adjustable over a $\pm 6\%$ range with minimal effect on temperature stability. Single supply operation over an i/p voltage range of seven to 40 V, low current drain of 1 mA and excellent temperature stability have been achieved with an improved bandgap design. Noise is low, typically 10 μV pk-pk and the load driving capability is 20 mA. *Bourns (Trimpot), Hounslow, Middx.* **366**

Solid state relay

The 613 series is claimed to be the industries first dc solid state relay with a current rating of 20 A at 50 V dc. Two versions are available with ttl or HiNIL compatible i/p, to cover a control range of four to 32 V dc. Transformer isolation provides 1,5 kV rms isolation together with a low 5 mA off-state leakage. Response time is $< 200 \mu\text{s}$. *Teledyne Relays, Hounslow, Middx.* **367**

Joysticks

The model 101-2, two axis miniature force joystick has been designed to meet stringent military and industrial environments. The overall size is 31,7 mm mounting flange with body diameter 25,4 x 50,8 mm long. Analogue voltage o/p is standard and infinite resolution is offered. *DACO Scientific, Basingstoke, Hants.* **368**

Isolators

These three ranges of optically coupled isolators utilise GaAs ir-led's, together with silicon phototransistors. Type 520 is available in a 14-pin dil and type 521 in a 24-pin package. Both types have minimum isolation voltages of 5 kV and insulation resistances of $> 10^{11} \Omega$. Type 525 offers a minimum isolation voltage of 10 kV and an insulation resistance of typically $10^{14} \Omega$. Operating temperature range is -40 to 85°C . *GE Electronics, London.* **369**

Receiver

The CM8824, single digit receiver is a high performance, low cost module for applications where single dtmf receivers are required. A low power requirement and excellent talk-off protection affords use in control systems, dial transfer applications or precise dial tone detection. *Mitel, Shannon, Eire.* **370**

Strip-switch

The 2500 series, is a low profile strip-switch, having a maximum height above the pcb of 7,62 mm. Operation may be either thumb-wheel or screw driver slot and the setting of the switch is clearly shown in a window. Six 10-way switching codes are available, including single pole decimal and the commonly used bcd codes. *Waycom, Bracknell.* **371**

Miniature meter

The Minipilot is a miniaturised moving coil meter designed for radios, tape recorders and other portable equipments. Its applications are as a battery checker, turning meter, sound level meter,

etc. The meter has an 11 mm barrel, 12,6 mm flange and is 16,3 mm deep. The range spans zero to 1 mA or 0,5-0-0,5 mA. *Europa Comps & Equip., Elstree, Herts.* **373**

Slider pots

The Seimart series C and F slider potentiometers, include single and tandem slider devices with both 40 and 58 mm travel.

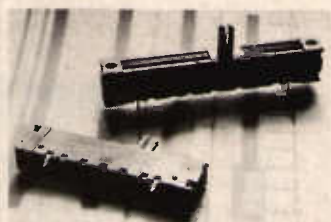

The resistive element consists of carbon composition film bonded, at high temperature, to a flat base made of paper impregnated with phenolic resin and housed in a moulded plastics case. Metal screened types are available where the elimination of external interference is important. *Distronic, Harlow.* **372**

W/W resistors

Five nprf radial tag series precision w/w resistors are available in resistance ranges covering 1 Ω

Enquiry Service

For rapid access to further information, use the reply paid card at the start of the commercial section. Our R.E.S. department provides same day turnaround on all enquiries.

continued ▶

66 on enquiry card

hypertac

Type HPD connector, designed to conform to the forthcoming British Standards specification.

Type HDD High Density connector is the answer to miniaturisation and densification of electronic packaging.

Type HMC Modular connector

solves the equipment designers problem of obtaining special connectors quickly and inexpensively.

HYPERTAC CONNECTORS

Chronos Works, North Circular Road, London NW2 7JT

Telephone 01-452 3333

Telex 25847

a registered business name of



SMITHS INDUSTRIES LIMITED

67 on enquiry card

Willsher & Quick Electronic Racks and Enclosures

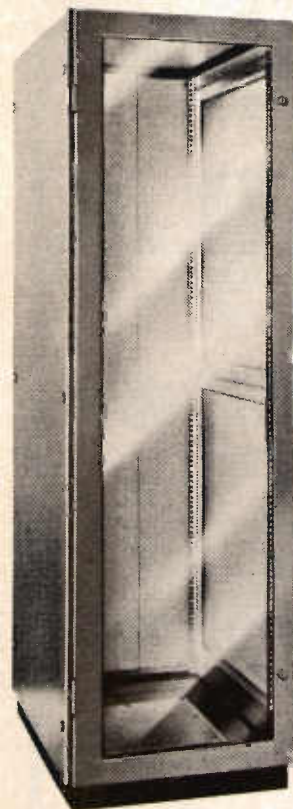

A comprehensive range of 19" racks, chassis and aluminium consoles for the electronics industry.

From our wide range of standard designs you can choose a Willsher & Quick electronic rack to suit most requirements. Because of our experience we can also make 'special' electronic racks to meet your particular specifications. But first put yourself in the picture with our information pack on electronic enclosures.



Willsher & Quick Limited
Walrow, Highbridge,
Somerset TA9 4AQ
Telephone: 0278-783371/5
Telex: 46145

69 on enquiry card

LEVELL

PORTABLE INSTRUMENTS

PERFORMANCE AT A PRICE YOU CAN AFFORD!

INSULATION TESTERS

OSCILLATORS

AMPLIFIERS



TRANSISTOR TESTERS

RESISTANCE BOXES

VOLTMETERS



Send for data covering our full range.

LEVELL ELECTRONICS LTD.

Moxon St., Barnet, Herts.

Tel: 01-449 5028/440 8686.

68 on enquiry card

The 5000 was a long time coming.



Twelve years ago, Comark produced their first temperature measuring instrument. Now, they've just introduced the new 5000 state-of-the-art range—to give you all you'd ever want from a digital thermometer.

Like custom MOS for reliability and accuracy from -200°C to $+1767^{\circ}\text{C}$.

A variable intensity 14mm orange display for clarity of readout at a brightness level of your choice.

And, in case you want to record your data, simply effected plug-in B.C.D. or digital to analogue output options.

5000 units come with single Pt100 sensor inputs, as well as with single or ten thermocouple inputs. Bench or panel models are readily available.

Please send for our brochure. You'll agree they've been worth waiting for.

Comark

Comark Electronics Limited,
Brookside Avenue, Rustington,
West Sussex BN16 3LF, England.
Tel: Rustington (090 62) 71911.
Telex: 877317.

5271

70 on enquiry card



SHEET METAL PUNCHES

for quick, clean holes

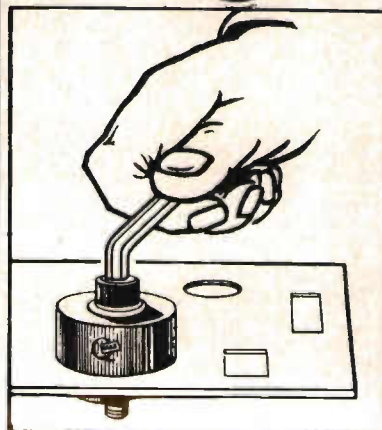

- * Easiest and quickest way of punching holes in sheet metal (up to 1.625mm)
- * Simple operation. **100% British.**
- * Burr-free holes—no jagged edges
- * **57 Metric and Linear sizes** (Lists on application)

Used all over the world by Government services

—Atomic, Military, Naval,

Air, G.P.O. and Ministry of Works; Radio, Motor and Industrial Manufacturers, Plumbing and Sheet Metal Trades, Garages, etc.

Wholesale & Export enquiries to:

"Q-MAX" (ELECTRONICS) LTD
44 PENTON STREET LONDON N19QA Tel: 01-278 2500

We Can Do More Together...

Professionals in the fields of optics, electro-optic, laser and photographic instrumentation are invited to become members of SPIE . . . a sure way to keep pace with rapidly advancing technology.

Here are just a few of the practical benefits you'll receive:

- Subscription to the official journal **Optical Engineering** and the bi-monthly **Bulletin**
- Reduced tuition rates for seminars and meetings
- Discounts on SPIE publications
- Professional Placement Service
- Member rates at cooperating society functions and more. . .

If you're not a member, write today for full details. See why SPIE is worth looking into!

Society of Photo-Optical
Instrumentation Engineers
P.O. Box 1146

Palos Verdes Estates, CA 90274
USA

Society of Photo-Optical
Instrumentation Engineers



338 Tejon Place, Box 1146, Palos Verdes
Estates, California 90274 213/378-1216
USA

Please send full details on
SPIE membership

Name

Address

City

State/Zip

SPIE is worth looking into!

Please, note on your diary ...

31st

march

1st

april

2nd

april

4th

april

5th

april

6th

april

*PARIS
closed on
Sunday 3*



salon international des

**composants
électroniques 77**

4 sections : Components - Measurement
Raw Materials & Products - Equipment & Methods

an ever increasing number of visitors :

1974 - 57.000

1975 - 61.000

1976 - 72.000

permanent entrance cards

You must come to Paris again this year !

**Further particulars
and free entrance
cards on request:**

FRENCH TRADE EXHIBITIONS

196 Sloane Street LONDON S.W. 1

☎ 235.32.34 - 235.32.35 ☒ 91 91 32 Francom Londres

NEW DATA

Physical properties of materials by Lovell Avery and Vernon, £5.95 paperback version, contains basic ideas of modern physics and concepts required by materials scientists. *Van Nostrand Reinhold Company, Wokingham, Berks.* 421

The series 050 flat cable connectors and jumpers are the subjects of a leaflet from Kings. The leaflet reference no. 47-755 can be obtained from *AWP, Horley, Surrey.* 422

A catalogue of optoelectronic devices has been produced by Telefunken listing their complete range of devices with technical data. Information on the handbook can be obtained from *AEG Telefunken, Manchester.* 423

The EVA brochure have details of the offerings of principal British manufacturers of electrical vehicles and trucks. *EVA, London.* 424

The Intronics Technical wallchart is available from REL and contains information for engineers who design analogue circuitry for computing, signal conditioning and function generation. *REL, Hitchin, Herts.* 425

Understanding microprocessors, £2.75 comprises 120 pages and 24 chapters taking the novice in ups up to a standard of being able to specify and use systems. *Motorola, Wembley, Middx.* 426

The 1977 Fluke Instrument catalogue contains data on the company's wide range of instrumentation from digital voltmeters, counters, signal sources to digital thermometers and data loggers. *Fluke, Watford, Herts.* 427

Electronics by Close and Yarwood, £4 (paperback) is aimed at students studying for a degree and the emphasis is on semiconductor devices, circuits

and systems. *University Tutorial Press, London.* 428

Data sheets are available which give details of the 50 secondary windings available in Avel-Lindberg's standard range of low noise, loss toroidal transformers. *Avel-Lindberg, Ocken-don, Essex.* 429

The 1976/77 condensed general catalogue is now available from Bourns giving details of components such as potentiometers, resistor networks, converters, comparators and silicon rectifiers. *Bourns, Hounslow, Middx.* 430

Designing surge suppression circuits to protect thyristors from load induced faults is the topic of a new application data sheet produced by the *Westinghouse, Le Mans, France.* 431

John Matthey Metals has just revised its

electrical engineering catalogue. Also included is a 20 page colour booklet illustrations of the products available. *John Matthey Metals, London.* 432

The SC/MP microprocessor applications handbook is now available from *National Semiconductors, Bedford.* 433

A six page brochure has been produced by Kistler on transducers and amplifiers which have been designed for the plastics injection moulding industry. *Kistler, Farnborough, Hants.* 434

Du Pont has information available on the Hytrel range of polyester elastomers which have electrical properties which are relatively insensitive to moisture. *Du Pont, Hemel Hempstead, Herts.* 435

The latest publication from Computer Automation discusses the various extra costs that an oem can incur when he buys a minicomputer. *CAI, Rickmansworth, Herts.* 436

Intel Electronics has published a combined pack of three leaflets containing information on relays, resistors and switches. *Intel Electronics, Henlow, Beds.* 437

The book Discrete Time Signal Processing by SA Tretter, £18.25, is intended as an introduction to discrete time signal processing. *John Wiley & Sons, Chichester, Sussex.* 438

A four page brochure is available from Radiatron which describes the latest version of the ptw diamentor, diagnostic dosimeter for measuring x ray exposure. *Radiatron, Twickenham, Middx.* 439

Worked examples in Engineering Field Theory £5.00, by A J Baden Fuller provides a summary of engineering field theory. *Pergamon Press, Oxford.* 440

The PEM International condensed catalogue contains information of the company's range of fasteners from standoff spacers to earth terminals for pcbs. *PEM International, Doncaster.* 441

A wallchart giving details of all the commonly used graphic symbols for electronic diagrams is available from *Belling Lee, Enfield, Middx.* 442

Handbook of Instruments and instrumentation £15, is intended to give the engineers a quick means of reference to the type of method and measurement required. *Trade and Technical Press, Morden, Surrey.* 443

The latest catalogue of information on broadband power amplifiers and power generators is now available from *ENI, Hitchin, Herts.* 444

The latest edition of the data book of discontinued integrated circuits is available from *London Information, Ascot, Berks.* 445

The fifth edition of the book Problems in Electronics with solutions by F A Benson £3.95 is intended for undergraduate engineers. *Chapman and Hall, London.* 446

A new brochure has been released by Advanced Water Services on its range of packaged modular design fully automatic pressure filters. *AWS, Penn, Bucks.* 447

73 on enquiry card

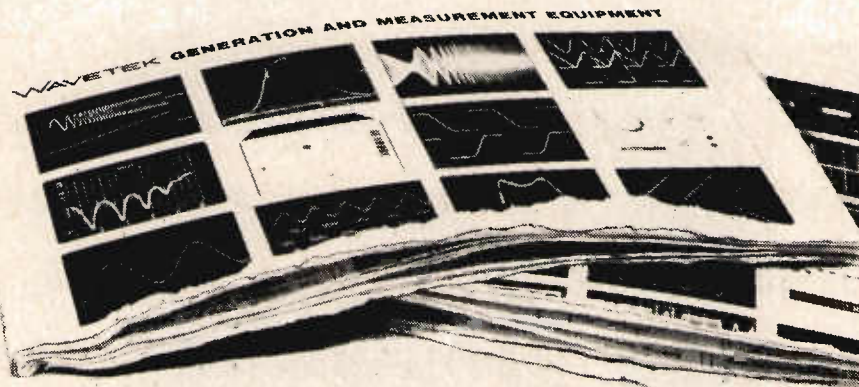

RIP-UP YOUR WAVETEK CATALOGUE

If your copy of the Wavetek catalogue looks like this - get rid of it! The new one is now ready and a copy is waiting for you. It's full of instruments that are not in the old one. Such as the 2101 wideband amplifier, 2002 sweep/signal generator, 180 series of function generators, 171 and 172 synthesizer/function generators, 164 function generator and 3001 signal generator and lots more. Further proof that if you want the very latest in function, sweep or signal generators you will find them in the Wavetek range.

For the biggest choice in generation and measurement equipment use the reader reply service or this coupon for your copy of the Wavetek catalogue.

To: Wavetek Electronics Ltd., 109 Crockhamwell Road, Woodley, Reading, Berks RG5 3JP.

Please send me the new Wavetek catalogue.

Name _____

Address _____

WAVETEK®

NEW DATA

The latest edition of the George Kent Review No 17, contains technical articles on the group's **measuring**, analytical and process control instrumentation. *George Kent, Luton, Beds.* 448

The Gould Advance OS3300B, a portable 50 MHz dual trace **oscilloscope**, is described in a new four page data sheet. *Gould Advance, Hainault, Essex.* 449

Morlock Industries has produced a two colour catalogue and specification list on its helical spring lock washers. *Morlock, Wolverhampton.* 450

ITT's Electron Device Division has recently issued a new data summary covering a wide range of **microwave tubes**. *ITT Paignton, Devon.* 451

The P/tel 700 a four page brochure introduces the Standard Grigsby programmable rotary encoded logic **switch**. *Standard Grigsby, USA.* 452

A new wallchart showing Sprague's range of **wirewound resistors** is now available. *Sprague, W. Drayton, Middx.* 453

A sonic tide and liquid level indicator is the subject of a brochure from *Vacuum Reflex, London.* 454

Power testing methods and reliability by A Simpson is intended for students £3.95. *Macmillan, London.* 455

A brochure is available from Rikadenki

detailing a range of 250 mm chart width **potentiometric recorders**, *Mitsui Machinery Sales, Chessington, Surrey.* 456

Penny and Giles has published a brochure describing its range of linear motion **faders** and joystick quadraphonic pan potentiometers. Full data and circuits are included. *Penny and Giles, Blackwood, Gwent.* 457

Information is available on Matthey silvered mica **capacitors** in the company's new catalogue, *Matthey, Stokeon Trent.* 458

A four page shortform catalogue from Nolton Communication describes the daneman range of **switching modules**, instrumentation and monitoring equipment for the control of data networks. *Nolton, Waltham Cross, Herts.* 459

A wallchart from Rayleigh describes the range of products the company produces from **paper tapes** of programme cards. *Rayleigh Instruments, Rayleigh, Essex.* 460

Fifteen pages of application notes are available in a brochure on media and disc **cartridge** requirements for Pertec D36XX disc drives. *Pertec, Reading.* 461

Digital Engineering, £19.45, by G K Kostopoulos presents techniques, methods and algorithms as well as practical information. *John Wiley & Sons, Chichester, Sussex.* 462

The Jordon Dataquest financial survey of 175 British component distributors has been published and contains details such as sales **pretax profits** and assets and liabilities. *Jordon Dataquest, London.* 463

A brochure has been produced on the range of **meters** such as the 900 and 440 series manufactured by *Ernest Turner, Northampton.* 464

Another London Information data book in the guise of **power semiconductors** can now be obtained at a price of £45.15 a subscription (two issues). *London Information, Ascot, Berks.* 465

The engineering properties of Viton **Fluoroelastomer** is described in a publication from Du Pont and has applications in many industries. *Du Pont, Hemel Hempstead, Herts.* 466

A new product summary booklet is available from Marler Haley **exposystems** illustrating the complete range of **portable display** and exhibition systems. *Marler Haley, Barnet, Herts.* 467

A 14 page short form catalogue covering the range of Toshiba semiconductors including **transistors**, diodes, thermistors and microwave devices can be obtained from *Eire Electronics, Gt Yarmouth, Norfolk.* 469

This 16 page periodical includes an introduction to **microprocessor** and technical articles on broadcasting and

personal call systems. *Telephone Rentals Milton Keynes.* 470

Three more DATA Books cover the subject matter, MSI/LSI **memories**, **transistors** and **thyristors**. The first of these covers some 4500 devices, broken down to subject area and costing £30.25 for two issues, 471. The second in the series is the 41st edition of the transistor book, priced at £39.85 for two issues and covers in excess of 20 000 devices 472. The last in the trio dealing with thyristors lists some 2950 new types and 1688 deleted products 473. *London Information, Ascot, Berks.*

REL has published some information on the latest of the company's products in the programmable switched mode **power supplies**. *REL Hitchin, Herts.* 474

A colour brochure on the cat 2 logic **tester** which has a low cost microprocessor controlled memory system has been produced by *Columbia Automation, Slough, Berks.* 475

The book, Instrumentation, measurement and feedback by BE Jones, £5.95 provides a degree level treatment of the basic principles of **measurement** and feedback. *McGraw Hill Maidenhead, Berks.* 476

The IBA technical review no 8 and 9 cover the fields of digital video **processing** and digital television developments. *IBA, London.* 477

74 on enquiry card

Power supplies up to 500 kV

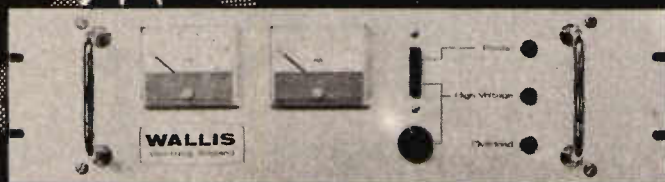

with overall stabilities of better than 10 ppm

High Voltage Specialists

We manufacture a comprehensive range of precision HV supplies for use, worldwide, in conjunction with scanning electron microscopes, X-Ray machines, precision visual displays (CRTs including colour tubes), photomultiplier tubes, insulation testing, research and industry.

Success in this field has led us to produce custom built power supplies for use in all sorts of applications. Reversible polarity, programming, high stability, short circuit and flashover proof, slow rise times, fast HV switching, safety features etc... all are no problem with these lightweight all-solid-state units.

So... contact us if you have HV supply problems... we are sure we can help.

WALLIS
Worthing UK
Europe

Wallis Electronics Limited,
Bedford Row, Worthing, Sussex
(0903) 208201/2. Telex: 877112

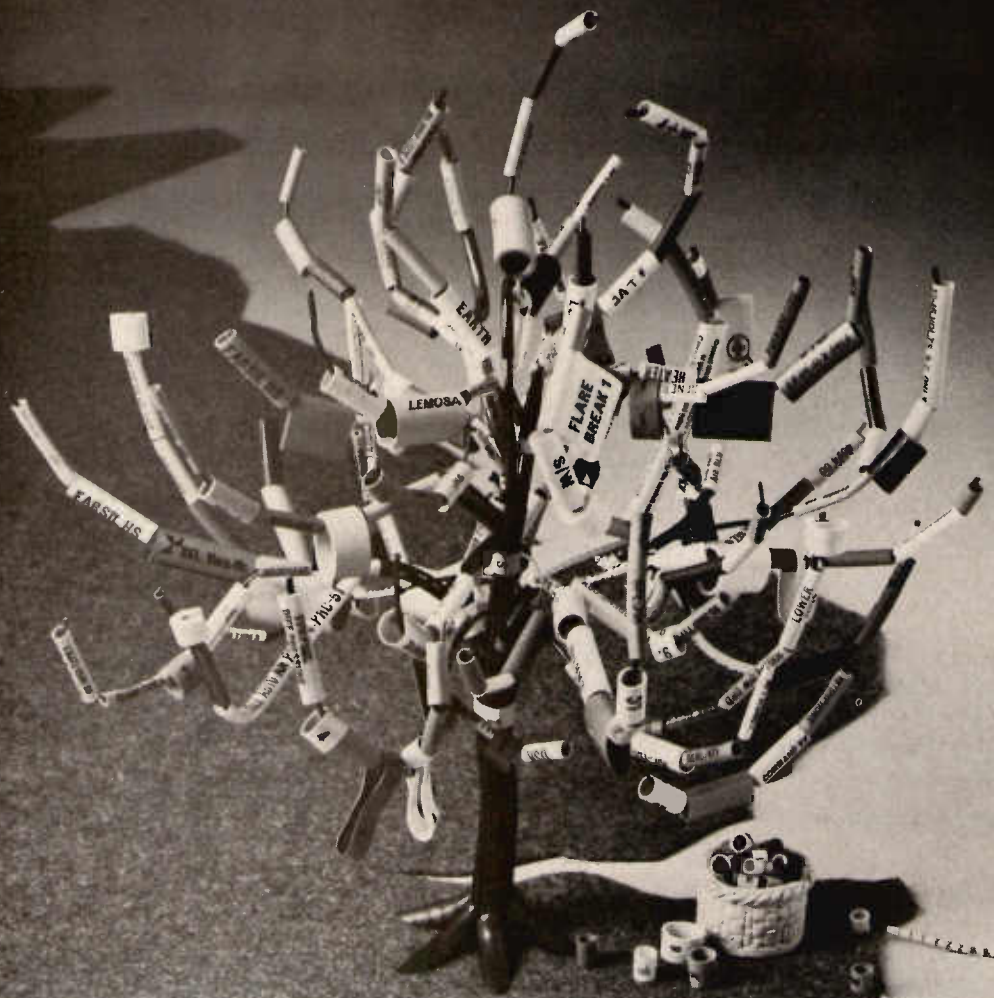

**There's many a good thing in Kent, the Garden of England!
Hops. Knott. Canterbury Cathedral - and Siegrist-Orel!**

Siegrist-Orel's sleeves and cable markers in Neoprene, P.V.C. and Silicone are renowned. Supplied -promptly-plain or printed. And in 11 colours. There is a range of expanding tools for application.

Add to this the Bar-Lok cable ties - now distributed by Siegrist-Orel - and made from Nylon 66 in lengths of 4, 6 and 10 inches - and you've got something else that's good from Kent!



Send for literature and samples

SIEGRIST-OREL Ltd

STAR LANE, MARGATE, KENT. Tel: Thanet 65241/4 Telex: 96266

MoD approved to
DEF Standard 05/24
DCL Registration
No 77680/1/01

NEW DATA

Information is available on courses and publications in the **microprocessor** and microcomputer field published by *Integrated Computer Systems, Brussels*. 478

Linear transducers are the subjects of a brochure from Penny and Giles and cover rectilinear transducers, and LVDTs for various applications. *Penny and Giles, Christchurch, Dorset*. 479

The annual report and accounts for the 75-76 period has now been released by the IBA, £1.50. *HMSO, London*. 480

Another annual report this time from Sira has also been recently prepared and is now available from *Sira Institute, Chislehurst, Kent*. 481

Details are available on the range of **multimeters** and panel meters which are marketed by *Carlo Gavissio, Newport Pagnel, Bucks*. 482

The services offered by BXL are described in a brochure entitled products and services and gives all the **plastics** products the company has. *BXL, London*. 483

Pluggable accessories and assemblies for packaging are contained in a catalogue from *Garry Manufacturing Co, New Jersey, USA*. 484

The MP range of regulated **static inverters**, which provides 110/220/240V ac at 50, 60 or 400 Hz from dc supplies of 24, 32, 48, 100 or 220V, is described in a leaflet. *Avel-Lindberg Ltd., South Ockendon, Essex*. 485

ITT Instrument Services has produced a supplement to its catalogue. The supplement describes the recently added Fluke 8030A and 8040A **dmms**. *ITT Instrument Services, Harlow, Essex*. 486

Enclosures and accessories for the electronics industry are described in a catalogue produced by *Datarr Ltd., Richmond, Surrey*. 487

Quality Assurance assessment by multiple purchasing agencies is the subject of a review published by the *Institute of Quality Assurance, London*. 488

The latest issue of Farnell News includes information about new **power supplies**

oscillators and computer peripherals. *Farnell Instruments, Wetherby, West Yorks*. 489

The papers presented at the sixth **International Broadcasting Convention** held in London in September, have been published by the *Institute of Electrical Engineers, Stevenage, Herts*. 490

Erie Electronics has produced a catalogue providing technical information on its range of **ceramic capacitors**. *Erie Electronics, Great Yarmouth, Norfolk*. 491

The basic requirements of **shielded facilities** are described in a leaflet produced by *REL Equipment and Components, Hitchin, Herts*. 492

A brochure summarising the company's range of **coaxial connectors** has been produced by *Plessey Connectors, Northampton*. 493

The latest edition of the **Landis and Gyr Review** is now available. *Landis and Gyr, London*. 494

Specification details of seventy-nine **fire resistant fluids** are included in a publication prepared by the *Association of Hydraulic Equipment Manufacturers London*. 495

The **Science Research Council's** report for the year 1975/1976 is available for £1.75 from *HMSO*. 496

Tri-Data Corporation has published a leaflet describing the CartriFile 10 **magnetic tape subsystem**. *Tri-Data Corporation, USA*. 497

NRDC has published its **report** for the year 1975-1976. *National Research Development Corporation, London*. 498

"**Incandescent readouts in Avionics**", a paper presented in October at the European Electro-Optics Conference, is now available from *Chicago Miniature Lamp, Bury St Edmunds, Suffolk*. 499

"**Multivariable control theory**" by JM Layton presents the theory of deterministic multivariable control systems. Part of the IEE Control Engineering series, the book is available at £11 from *Peter Peregrinus, Stevenage, Herts*. 500

Video instrumentation manufactured by Colorado Video, Inc. is described in a short form catalogue produced by *KGM Vidiaids, Isleworth, Middx*. 501

Bin units, conveyors and other production and storage aids are described in a catalogue available from *Kaiser and Kraft, Watford, Herts*. 502

A list of **unclassified documents** by the staff of the Materials Development Division, AERE Harwell, has been published by *HMSO*. 503

A 12-page applications guide to the HDSP-2000 **four-character display** includes drive and interface circuits, mounting techniques and contrast enhancement. *Hewlett-Packard, Winnersh, Berks*. 504

The latest **stock information** on the range of components and instruments handled by REL is now available. *REL, Hitchin, Herts*. 505

Electro-Optic deflection of laser beams is among the topics included in the latest issue of the Philips Technical Review. *Philips Research, Eindhoven, The Netherlands*. 506

A brochure describing the Acculin range of machine-tool **digital read-out systems** has been prepared by *Ferranti Dalkeith, Midlothian*. 507

A four-page application note describes how **optical isolators** can be used in a variety of linear applications. *Hewlett-Packard, Winnersh, Berks*. 508

Another Hewlett-Packard application note gives details of the design procedure for waveguide and coaxial amplifiers using **IMPATT diodes**. *Hewlett-Packard, Winnersh, Berks*. 509

A leaflet describing the Lyssy **multi-channel water vapour permeation test system** is available from *Richard R. Leader, Chertsey, Surrey*. 510

A 16-page brochure describing the RCA range of **memory products** gives basic parameters of six cmos memories, static and dynamic mos rams and three static 1k sos rams. *RCA Solid State-Europe, Sunbury-on-Thames, Middx*. 511

A range of **switched-mode power supplies** is the subject of a leaflet produced by *REL, Hitchin, Herts*. 512

The latest edition of "The World of Learning" contains more than 2000 pages and lists educational and scientific personnel and institutions throughout the world. *Europa Publications, London*. 513

A brochure describing the range of **design and production services** offered by the company is available from *Electronic Engineering, Ipswich*. 514

The latest **Heathkit catalogue** is available from *Heath (Gloucester), Gloucester*. 515

Service planning and propagation is the topic matter featured in the latest IBA Technical Review. *IBA, Winchester, Hants*. 516

A 36-page **distributor catalogue** and distributor list published by Elco Corporation lists all the interconnection products available directly from Elco distributors. *Elco Corporation, USA*. 517

A range of conversational mode **crt terminals** manufactured by the data systems division of Research Incorporated is described in a leaflet available from *Technitron, Camberley, Surrey*. 518

All forms of **joining and fastening processes** are the subject of the PERA Industrial Joining Digest available at an annual subscription of £25. *PERA Melton Mowbray, Leics*. 519

Model 7575 **smoke and heat detector** is described in a leaflet produced by *Nu-Swift International, Elland, Yorks*. 520

A **tone-to-pulse converter** for telephone equipment is described in a brochure available from *Mitel, Ontario Canada*. 521

Techniques for the measurement of mechanical, electrical and fluid parameters are described in "The **Handbook of Instruments and Instrumentation**", £15, available from *Trade and Technical Press, Morden Surrey*. 523

78 on enquiry card

The highs and lows of Gresham Lion transformers

High or low frequency—up to 30KHz or more. High or low power—from milliwatts to 25KVA. High or low voltage—up to 100KV. High or low quantities—from prototypes to large scale production runs. High or low specifications—to general commercial requirements, up to DEF 05/24 standard.

Over 40 years experience in transformer design and production backed by two production centres (one in the

South, one in the North East) has put Gresham Lion in the front of transformers. Get in touch for the full facts, you'll find our service is always high.

Gresham Lion Limited

Gresham House, Twickenham Road, Feltham, Middx TW13 6HA. Tel: 01-894 5511. Telex: 27419.



The people in power

CLASSIFIED

telephone:
01-855 7777

APPOINTMENTS

ZENITH CARBURETTER CO. LTD

require an

ELECTRONICS ENGINEER

To join a team engaged on projects utilising the latest Microprocessor technology. Work involves the development of the Company's calibration and test functions.

Ideally applicants should possess a H.N.C. but we would consider full technological Certificate. This should be backed up by 5 years experience in an electronics department concerned with the development of production equipment. Must be capable of the design, build and commissioning of production test equipment involving both digital and analogue systems. The ability to interface with mechanical design is essential, also to fault find and rectify in a production environment.

Please write giving brief career progression to date to:—

Miss M. B. Kelleher, Personnel Officer,
ZENITH CARBURETTER CO. LTD.,
Thurston Road, Lewisham SE13.
Telephone 01-852 9207

ENGINEERS WANTED:

CE, ME, AND EE with Ph.D or MS Arabic language required. Write to Royal Scientific Society P.O. Box 6945. Amman — Jordan.

FOR SALE

ENAMELLED COPPER WIRE

swg	1 lb	4oz	2oz
14-19	2.40	.69	.50
20-29	2.45	.82	.59
30-34	2.60	.89	.64
35-40	2.85	1.04	.75

inclusive of p&p and VAT
SAE brings Catalogue of copper & resistance wires in all coverings
THE SCIENTIFIC WIRE COMPANY
PO Box 30, London E4 9BW 6243

CAPACITY

SUB-CONTRACT CAPACITY

Our modern facilities are available under qualified engineering management for:—

- P.C.B. Assembly
 - Electronic Mechanical Assembly
 - Cableforming
 - Sheet metal and Press Work
 - Coil-Winding
- Production Engineering & Electricals (Southern) Ltd.,

Boden Street, Chard, Somerset TA20 2AH
Tel: Chard (046-06) 4211



LAMPS

SWITCH, TELEPHONE, MICRO-MIDGET, AND SMALL INDICATORS.

COMPONENT SERVICES LTD.,
South St., Hertford, Herts.
Tel: Hertford 57766



Department of Agriculture and Fisheries for Scotland, Marine Laboratory, Aberdeen

Electronics (Instrumentation)

■ Lead team providing instrumentation and technical support for experimental studies of fishing gear ■ Design electronic instrumentation for measuring dynamic characteristics of gear ■ Considerable scope for original thought ■ Short periods at sea on research vessels.

□ Degree, HNC or equivalent in Electronics Engineering or Physics □ Considerable post-qualifying experience in design of electronic circuitry or instrumentation □ Age normally under 30 □ Appointment as Higher Scientific Officer (£3560-£4760) □ Ref: SA/13/DLC.

■ Application forms (for return by 31 January 1977), from Scottish Office, Personnel Division, PM(PTS)3, Room 214, 22/25 Queen Street, Edinburgh, EH2 1LY, telephone 031-556 9222 ext. 761.

CAPACITY

COIL WINDING

Specialist Service and Design Pot-cores — small torroids — self-supporting — fixed inductors. Isolated switched mode transformers to B.S. 415.

Automatic Windings,
57, Copthorne Road,
Rickmansworth, Herts.
WD3 4AH

Tel: Rickmansworth 76010.

PRINTED CIRCUITS IN THE MIDLANDS

We have capacity for the manufacture of Printed Circuit Boards, single or double sided. Hard Gold Plate and machined to any shape required. We specialise in giving Good Fast Service for Short Runs. One off Prototype Service from receipt of 2X Artwork. Glass Fibre only. No through hole plating, please.

DIKTRON DEVELOPMENTS LTD.

5 Highgate Square,
Birmingham B12 0DR
Telephone: 021-440 1321-2

ERKO limited

SUBCONTRACTORS TO THE ELECTRONIC INDUSTRY

Capacity available for comprehensive production service under qualified engineering management.

For enquiries relating to PCB assemblies; cable forms; panel and switch wiring; testing; sheet metal work, contact:

ERKO LTD.

Thameside Industrial Estate,
Silvertown, London E16.
Tel: 01-511 0877 or
01-511 0725

EDUCATION

ELECTRONICS QUALIFICATIONS

An ICS home study course can give you the qualifications essential for career success in the electronics field. Courses include: City and Guilds Certificates; Radio, TV and Audio Engineering; Colour TV, Electronics. For free prospectus 'phone or write today stating subject to:—

ICS, Dept 732B, Intertext Hse,
London SW8 4UJ.
Tel: 01-622 9911.

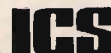

CAPACITY AVAILABLE

For electronic wiring, P.C.B. assembly, (Batch-work & Prototype) Test and light engineering if required.

**SWIFT AND ACCURATE SERVICE,
USING ONLY EXPERIENCED PERSONNEL
SUPERVISED BY SENIOR GRADE TECHNICIANS**

Contact:—

Appleton Audio Services Ltd.,
Electronic Engineers,
66 Silvester Road,
London SE22.
Tel: 01-693 5051.

**ELECTROCIRCUITS (P.C.) LTD.,
DELAMARE ROAD,
CHESHUNT,
HERTS, EN8 9UB**

Manufacturers of P.C.B.'s
Thro' hole plated
Conventional,
gold plating,
All or part service

Tel: Waltham Cross 38600
or 20344, for leaflet or
ask for quotation.

TENDERS

BOROUGH OF BOURNEMOUTH SELECT TENDER LIST — RANDOM NUMBER SELECTION EQUIPMENT

Applications are invited from firms wishing to be included in a select tender list for the provision of certain equipment required in connection with a Municipal Lottery.
Apply for further details, including the general specification, to the Borough Engineer, Town Hall, Bournemouth, by Friday, 24 December, 1976.

K. LOMAS,
CHIEF EXECUTIVE & TOWN CLERK

SERVICES



The ONLY truly specialised carriers of
packed/unpacked electronic & scientific
equipment. Specially equipped vans and
lorries throughout the U.K.

Precision Equipment Transport Services
Penfold House, Woodbridge Meadows,
Guildford, Surrey GU1 4RH
Telephone: Guildford (0483) 38888

PUBLIC NOTICE

METAL FASTENERS:

reference to the Monopolies and Mergers Commission

On 14 October 1976 the Director General of Fair Trading referred to the Monopolies and Mergers Commission for investigation the supply in, and export from, the United Kingdom of certain metal fasteners viz: nails, tacks and staples; nuts and bolts; rivets; screws; cotter and cotter pins. Any person or organisation wishing to offer evidence in relation to the reference should write to:

The Secretary,
THE MONOPOLIES AND MERGERS COMMISSION,
New Court, 48 Carey Street, London WC2A 2JT

STRIPPER FOR HIRE!

Your free issue wire cut and stripped from 75p per 1,000 leads, tinning facility also available.

Printed circuits assembled.
Cable looms and complete equipment manufactured to order. Wire supplied and cut, a quotation will cost you nothing from:—

Hamer & Emmins Ltd.,
Deeronto Wharf, St. Mary's
Road, Langley, Bucks.
Tel: Slough 75-46760 or
46769.

YOU CAN REACH OVER 100,000 READERS WITH AN ADVERTISEMENT ON THESE PAGES

INDEX TO ADVERTISERS

Alma Components Ltd	6	Labhire Ltd	35
Ancom Ltd	64	Langley Metals Ltd	76
B & R Plastics Ltd	74	Levell Electronics Ltd	88
Beckman Instruments Ltd	52	Light Alloy Ltd	72
Belix Ltd	96	Ling Dynamic Systems Ltd	49
BICC-Burndy Ltd	2/3	Logikontrol Ltd	72
Bourns Trimpot Ltd	80	Lyons, Claude Ltd	78
Brady, W. H. Ltd	84	Marconi Instruments Ltd	IFC
Brandenburg Ltd	82	McMurdo Ltd	84
Burr Brown Research Group	82	Mullard Ltd	Insert
CSM (Engineering) Ltd	75	Newmarket Transistors Ltd	30
Cathodeon Crystals Ltd	81	Optima Enclosures Ltd	70
Cherry Electrical Ltd	24	Penny and Giles Ltd	56
Cosmark Electronic Ltd	88	Q-Max Electronics Ltd	88
Cosmocord Ltd	64	Racal Instruments Ltd	10/11
Coutant Electronics Ltd	86	Radiatron Components Ltd	73
Critchley Bros Ltd	22	Radiatron Instruments Ltd	69
Data General Ltd	40	Rosemount Engineering Ltd	87
Data Precision Ltd	96	SDSA	89
Daturr Ltd	71	SDS Components Ltd	78
Dexion Ltd	68	Sanwa Electric Instrument Ltd	34
Du Pont de Memours	IBC	SE Labs (EMI) Ltd	48
Erma Ltd	65	Sherwood Instruments Ltd	74
Ferranti Ltd	14/15	Siegrist Orel Ltd	92
Fluke Ltd	18, 28	Smiths Industries Ltd	85
French Trade Exhibitions	89	Society of Optical Instrumentation Engineers	89
GEC Semiconductors Ltd	8	Sprague Electric (UK) Ltd	9
General Instruments Ltd	26	Sullivan, W. H. Ltd	58
Gould Advance Ltd	Insert	Tranchant Electronics (UK) Ltd	34, 58
Gresham Lion Ltd	47, 93	Vero Electronics Ltd	70
Harwin Engineering Ltd	65	Vision Engineering Ltd	56
Hellermann Insuloid Ltd	59	Wallis Electronics Ltd	91
Hewlett Packard Ltd	16, 54	Wavetek Ltd	90
Hirst Electric Ltd	64	Waycom Ltd	33
Houseman Hegro Ltd	62	Westinghouse Brake & Signal Ltd	13
Hunting Hivolt Ltd	44/45	Widney Dorlec Ltd	72
ITT Electronic Services Ltd	20	Willsher & Quick Ltd	88
ITT Equipment Services Ltd	74	Wilmot Breeden Electronics Ltd	50
Imhof Bedco Ltd	66		
Intel Group Ltd	79		
International Rectifier Ltd	12		
Intersil Inc	OBC		
Kenure Developments Ltd	84		

77 on enquiry card

Increase your standard of living

ARE YOU AWARE that the purchase of a retail business – i.e. a modern Foodstore with sub Post Office or a Newsagents & Confectioners – is an investment over which you have personal control and from which you can expect to receive not only a substantial income, but one where enterprise and personal effort will bring rewards far in excess of those attainable in the role of an employee?

ARE YOU AWARE that a house in itself is entirely unproductive, but by investing the proceeds, for example £15,000 in cash plus an easy payment loan you could obtain a business that would produce over £10,000 p.a. clear profit together with virtually cost free private accommodation. Within 2 or 3 years the purchase of a second business would be quite practicable during which time your assets would have at least doubled and once again, the purchase of a private house could be achieved out of the profits, if desired.

Your introduction to the many hundreds of businesses currently available can be found in Daltons Weekly, price 10p from newsagents.

Daltons Weekly

The Shopwindow for Shops and Businesses

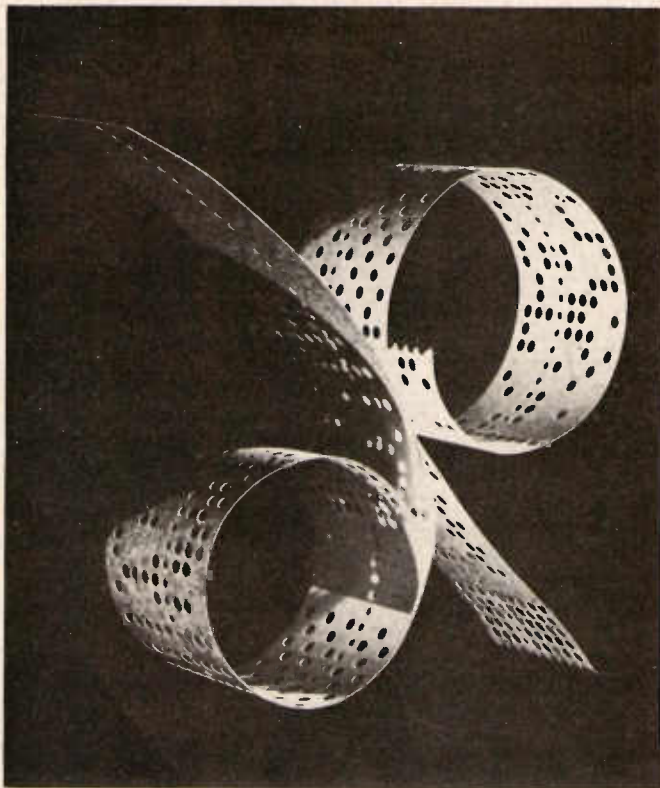

PAPER TAPE READER FER 150/350

photoelectric, infrared (GaAs)

150/350 characters/sec., bi-directional

This tape reader is precision made to a simple, robust design to give extremely reliable operation in a wide range of applications. It employs a stepping motor drive for "on character" positioning and silent operation. Input and output signals are DTL, TTL compatible.

The basic reader unit can be supplied for OEM use along with control and driver circuitry and connectors. It is also available with a fanfold cassette for 19" rack use.

The FER 350R is designed for a speed of 350 characters/sec. and is available in two different sizes.

A full range of spool sizes can be supplied on 19" width standard rack modules.

A table mounted version is also available.

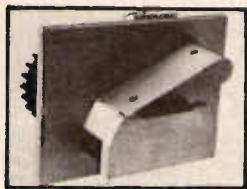
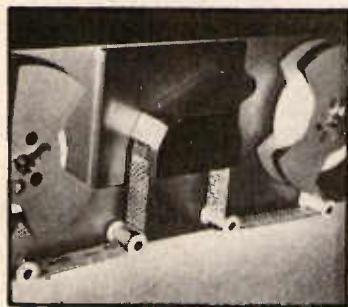

Data Precision (Equipment)Ltd

81 Goldsworth Road, Woking, Surrey.
Tel: Woking (048-62) 67420 & 64444. Telex: 859617
Northern Sales Office: 98 Kenworthy Lane, Manchester M22 4BE
Tel: 061-998 - 2612

BELIX

the powerful name
in reliable PSU's

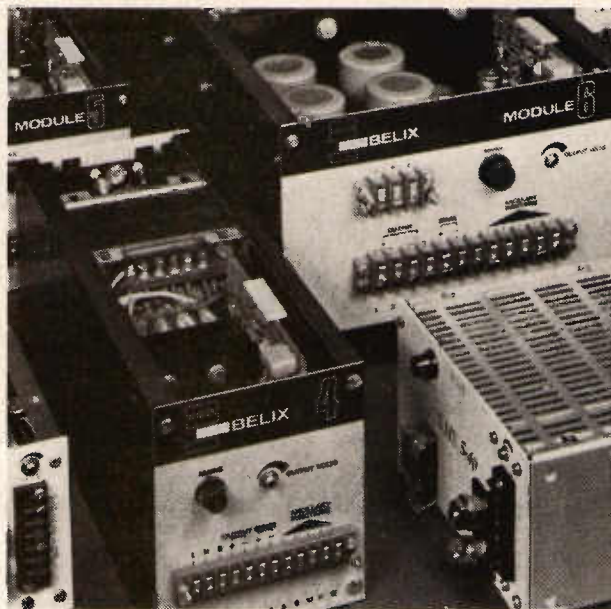

When you invest in power supplies, one of the most important features is reliability. That's why we take extra care at BELIX — from initial design right through to final test and inspection. And as we build all our own component modules throughout the entire BELIX range of linear and switching-mode supplies, we have total control at every stage of manufacture.

Standard range

Our standard linear PSUs start with the low-power BOA types for driving operational amplifiers, through to the well-proven BELIX high voltage types. Our switching-mode units have rated outputs from 50VA to 300VA, covering the range from 5 to 28 volts.

Custom-built

In addition to standard units, our extensive experience in the design and production of custom-built PSUs, enables us to offer a specialised service for the manufacture of units to individual specification. These include direct off-line switching-mode supplies, incorporating the latest PSU technology.

To find out more about our high performance power supplies, contact our Sales Department.

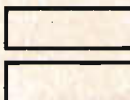

When thinking PSU's—
Think—

BELIX



The Belix Company Limited
175 Hook Road, Surbiton, Surrey
Telephone 01-397 0921

**Specify your
flexible printed circuits with
Du Pont Kapton* polyimide film.
You will save on assembly
and servicing and get
extra high temperature insurance.**

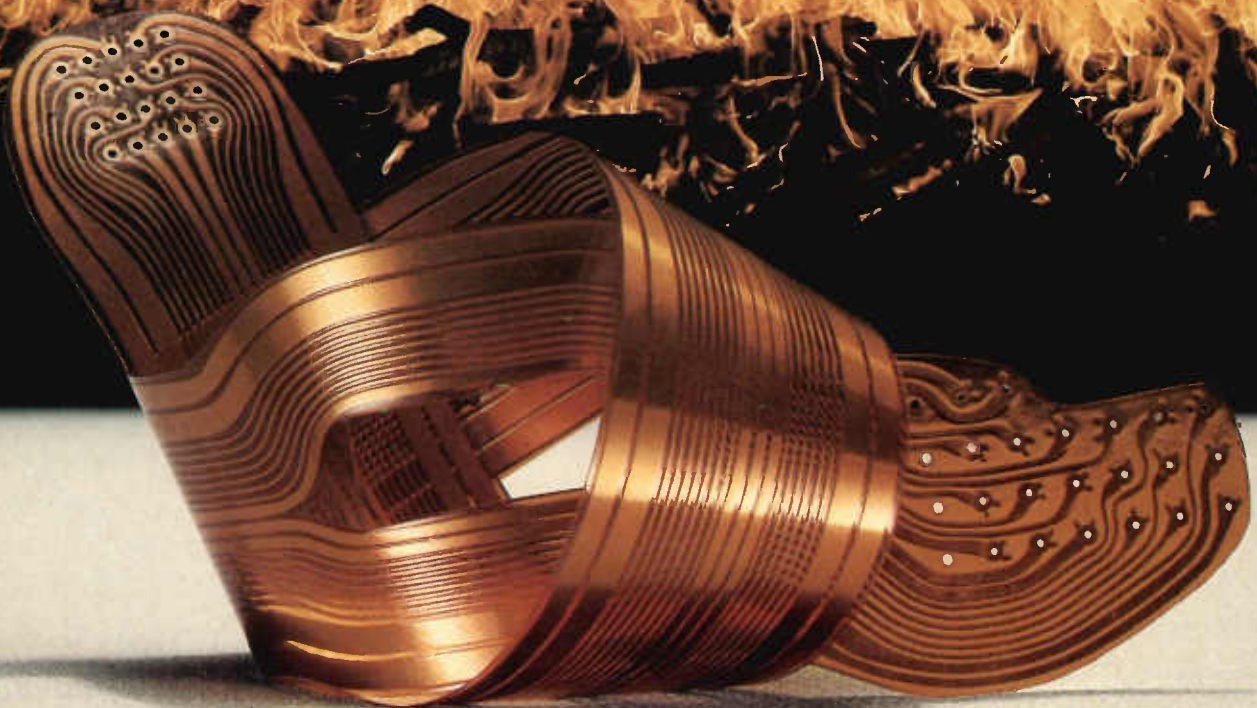

We can prove it!

Write to any of the following flexible circuit manufacturers for a detailed brochure giving proof of cost-saving and improved performance in high-volume applications.

Belling & Lee Ltd.
Great Cambridge Road
Enfield, Middlesex
Tel. (01) 3635393

Bribond Printed Circuits Ltd.
Terminus Road
Chichester
Tel. (0243) 84516

I.T.T. Canon Ltd.
Lister Road
Basingstoke
Tel. (0256) 3171

M. B. Metals Ltd.
Victoria Road
Portslade/Brighton
Tel. (0273) 413981

Welwyn Electric Ltd.
Bedlington,
Northumberland
Tel. (0670) 822181

Laminates based on 'Kapton'
are manufactured in U.K. by
Brittains-Riegel Ltd., Wrexham
and G.T. Sheldahl Ltd., Bracknell.

*Du Pont's registered trademark



Kapton

2 on enquiry card

Want zero input to read 0? Tired of fat 7s and skinny 6s?

Accuracy costs no more with our new 8052/7103 A/D pair.

Build 3½ digit DPMs without the zero-reading errors and rollover you're now getting; without fat and skinny numbers—some so skinny they're missing. Do it all with Intersil's new 7103 digital processor and 8052 signal conditioner, plus a few passive components, clock, BCD-to-7-segment decoder/driver, and display. And the 7103 can be easily wired for 4½ digit operation, to simplify stocking if you're building both 3½ and 4½ digit instruments.

The 8052/7103 guarantees zero reading for OV input, zero drift less than 2µV/°C, full scale drift less than 5ppm/°C, and accuracy to ±1 count in ±20,000. And more. MUXed BCD output, autopolarity, on-chip reference, over- and under-range signals, and 6 input/outputs for interfacing UARTs and microprocessors. Now off the shelf in plastic or ceramic DIPs.

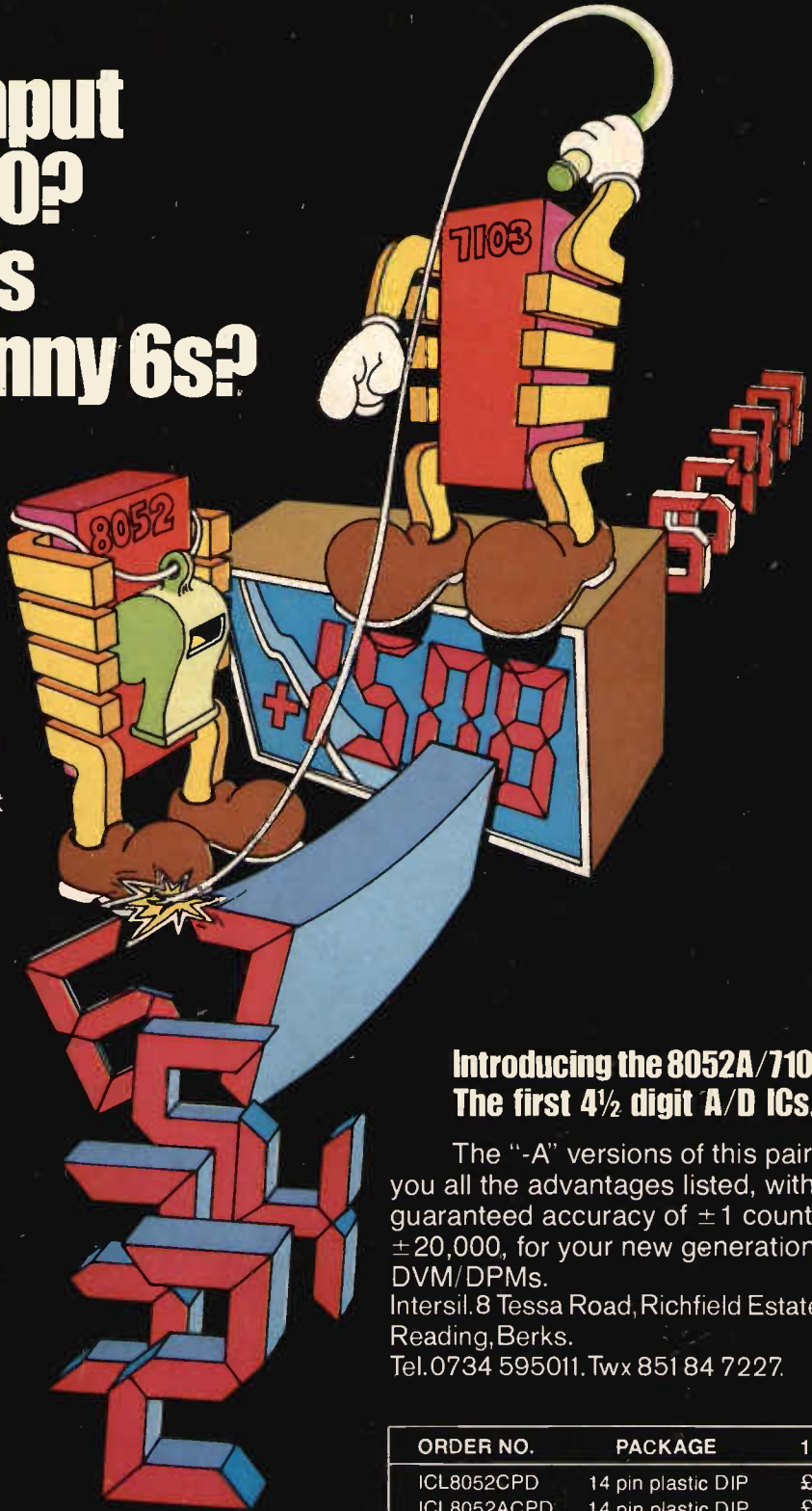

Introducing the 8052A/7103A. The first 4½ digit A/D ICs.

The "-A" versions of this pair give you all the advantages listed, with a guaranteed accuracy of ±1 count in ±20,000, for your new generation of DVM/DPMs.

Intersil, 8 Tessa Road, Richfield Estate,
Reading, Berks.
Tel. 0734 595011. Twx 851 84 7227.

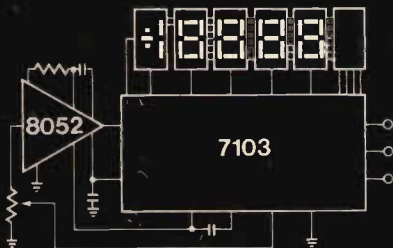

ORDER NO.	PACKAGE	100+
ICL8052CPD	14 pin plastic DIP	£3.75
ICL8052ACPD	14 pin plastic DIP	£4.50
ICL7103CPI	28 pin plastic DIP	£4.13
ICL7103ACPI	28 pin plastic DIP	£4.88

UK Stocking Distributors
Macro-Marketing Ltd.
396 Bath Road, Slough, Berks.
Tel. (06286) 63011

Rapid Recall London
Tel. 01-379 6741
Trenchant Electronics Ltd, Hampton, Middx.
Tel. 01-979 0123

**Netherlands
Stocking Representative**
Ad. Auriema-Europe
Vestijk 32, Eindhoven
Tel. 040-444470

Scandinavian Stocking Representatives
Denmark: E. V. Johanssen A/S Copenhagen
Tel. 451839022
Norway: Hans H. Schive A/S Oslo
Tel. 557692
Sweden: Teleimport AB
Tel. 08 7510475

Intersil European Sales Offices
UK: Intersil Inc Reading
Tel. Reading 595011
France: Intersil Inc Versailles
Tel. (1)953 4708

