

ELECTRONIC ENGINEERING

VOL. 28

No. 338

APRIL 1956

Commentary

EDUCATION, as a subject for discussion, has become a little wearisome in recent years. It has formed the subject for countless articles and editorials in the technical and lay press, while no presidential address to a learned society has been complete without some, and often extensive, reference to it. The Government has now shown its awareness of the problem by the publication of a White Paper and the announcement contained therein that £97m is to be expended in the next five years: £80m on buildings and £17m on equipment.

The White Paper is carefully prepared and gives evidence of extensive study of the problem. Nevertheless the Government action is late. This is evident from the acute shortage of technologists and technicians in this country and also from comparison with the efforts that are being made to educate technical personnel in other countries—countries which are competing with us for world markets. The White Paper states that last year Britain produced 57 graduate engineers per million of the population, for the U.S.A. the figure is 136, for West Germany 86, while for Russia it is 280. These figures cannot necessarily be used for direct comparison, since the standards in the various countries may vary considerably, as may also the value accorded to the arts and humanities. These figures, and the great efforts which are being made to improve them, cannot, however, be ignored. That the start on this project is late is not altogether the fault of the present Government, it is due in part to many years of, if not neglect, at least of no integrated plan or even awareness of the necessity for intensive technical education.

The amount of money now to be spent needs, too, to be kept in proper perspective. By personal standards £100m over five years is a very large sum, but governmentally it is not so great. For instance, the estimated expenditure on atomic energy in next year alone will be £68m, while the total spent on education by the Government and local authorities in the coming year will be some £485m. The present plan is a start only, it is nothing like sufficient to fulfil our needs for technical manpower in the coming years.

The White Paper states that the immediate objective is to increase from 9 500 to 15 000 a year the output of technologists from advanced courses at technical colleges and to double the number of students released for part-time day courses for technicians and craftsmen. In 1954-5 the number of the latter was 355 000. It also says that sandwich courses, that is alternate periods of three to six months in industry and technical college, will form one of the main avenues leading to the highest technological qualifications.

The main method envisaged to bring about this increase in scientific manpower is to build-up some 30 technical colleges to the level of university institutions; they will then be known as Colleges of Advanced Technology. The greater part of the £97m will be spent on doing this.

Technologists cannot, however, be created by government decree, and nor can successful technological institutions. The best of modern buildings and equipment are not enough; the right atmosphere must also be created, and this depends to a large extent on getting the right type of men as the heads of departments; men who can imbue others with their enthusiasm as did Thomson and Rutherford, and who can direct the institutions' activities with great foresight. Whether the creation of this type of institution is compatible with control by local authorities is, to say the least, contentious, and it may well be that the money could be more profitably spent on the foundation of one, or perhaps two, large centralized, and top rate technological institutions, on the lines maybe of the Massachusetts Institute of Technology.

The crux of the whole matter seems to be, however, recruitment of teachers of the right calibre, both in the advanced institutions and in the schools which feed them. The White Paper assertion that the present increase of 800 a year in the number of full-time technical college teachers is very satisfactory seems difficult to credit since, over a five-year period, it represents no more than a 45 per cent increase, whereas the yearly output of technologists is to be increased by 50 per cent and the number of part-time students is to be doubled. Further, the Government hopes that industry will be prepared to release yet more of its employees for part-time teaching during the day. Apart from the fact that it is asking a great deal of firms engaged in competitive business to release their key men for long periods, often at times when their work will be in a crucial stage, teaching is an art. The possession of high technical qualifications and knowledge does not necessarily mean that a man will make a good teacher. It is a vocation that needs to be backed up with sound training. It seems then that a prerequisite of producing more technical manpower is to build up the numbers of trained full-time teachers, and to do this teaching, as a profession, must be made attractive; by providing the right type of place in which to teach and by offering satisfactory financial inducements. To provide more teachers means, of course, less technologists for industry in the near future, but this seems the logical place to break into the circle and the best method of putting technical education on a sound footing.

Batching and Counting Using Gas-filled Decade Tubes

(A design for Laboratory and Industrial Use)

By W. Grimmond*, B.Sc., and W. H. P. Leslie†, B.Sc.

This article describes a range of units in the form of "building blocks" from which a variety of frequency meters, chronometers, frequency dividers and batching counters, etc., can be quickly assembled. The counting circuits use gas-filled decade tubes. Various applications of the units are described.

CONSIDERATION of the various counting frequency meters, chronometers and frequency dividers required in the new Mechanical Engineering Research Laboratory (East Kilbride) suggested the desirability of stocking "building blocks" suitable for quick assembly for specific purposes and, after their purpose had been served, easily returnable as units to central stock. For most applications in this field a maximum counting rate of 10kc/s was adequate; reliability was more important than smallness; simple fault finding and easy maintenance were necessary to allow the limited electronic engineering effort to be used for application and research.

A specialized requirement¹ for a batching counter capable of resetting without missing a count for input frequencies up to 10kc/s occurred at the time that the equipment was first considered. Cold cathode decade tubes were chosen in order to establish whether the promised increased reliability over hard valve counters would be realized. At the time the G10/241E (CV2223) was chosen for its high counting speed of 20kc/s, single pulse drive, and plug-in base with access to all cathodes for batching. The construction and operation of the tube having been described^{2,3} only a brief outline follows.

Basic Circuit

The tube is constructed with a single anode cup within which ten cathodes and ten transfer electrodes are arranged concentrically. Each cathode is brought out to a pin on the base, the transfer electrodes are joined and taken to a single base-pin. A shield is used to restrict the glow to discrete areas.

The anode is supplied through a resistor R_{13} (see Fig. 1), the voltage being sufficient to break down the anode-cathode gap. The cathodes are taken to earth through parallel RC circuits. The transfer electrode is taken to a positive bias voltage so that normally the glow prefers to rest on a cathode.

If the first anode-cathode gap is struck, the asymmetrical cathode primes the second transfer electrode in excess of any other gap. Also capacitor C_1 is at a potential of 45V. When a negative pulse is applied to the transfer electrode, T_2 fires, pulling down the anode voltage, and thus extinguishing cathode k_1 . The charge on C_1 starts to leak to earth through R_1 . At the end of the transfer pulse, the anode voltage rises and on reaching a suitable level the gap $A-k_2$ is struck, having been primed by T_2 . Any tendency to move back from T_2 to k_1 is discouraged by the voltage on k_1 . It is important to ensure that the pulse length is short enough for the pulse to have finished before the capacitor C_1 has discharged to below 25V.

* Formerly Atkins, Robertson & Whiteford Ltd.
† Mechanical Engineering Research Laboratory, D.S.I.R.

Decade Units

The decade units are made up in small boxes with the counter tube mounted on top as in Fig. 2. All supplies are taken to sockets on the back of the box. The decade unit is

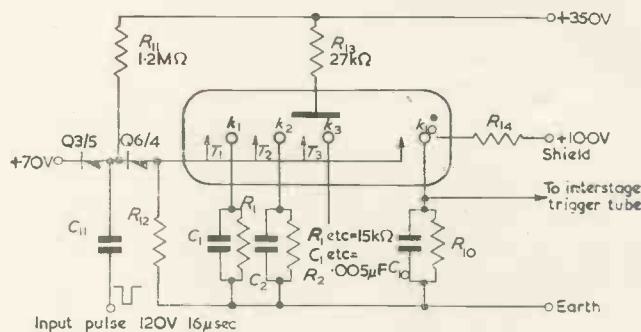

Fig. 1. Basic decade circuit

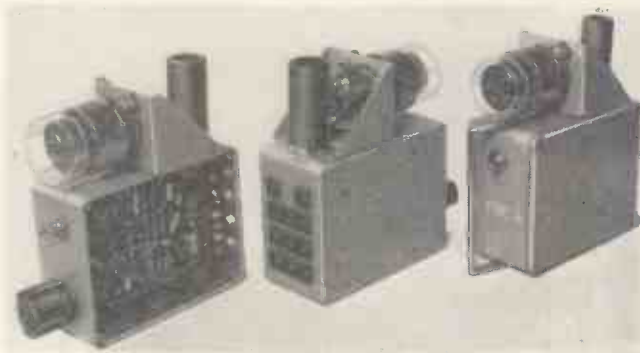

Fig. 2. Decade units

plugged into a connexion strip and the counter tube is visible from the front of the apparatus. By removing a cover plate the units can be withdrawn.

Two types are available. In type A, used for plain counting, the decade tube is connected as in the basic diagram with each cathode brought out to a separate circuit. At reduced speeds, below 5kc/s, every second cathode can be joined; by taking each cathode out to a separate circuit a counting speed of 20kc/s was achieved. A cold cathode trigger tube provides a negative pulse suitable for firing the next stage. The trigger tube fires when the zero cathode is struck; the voltage across the cathode load rises from zero to approximately 50V.

Type B decade is used for batch counting. Referring to the circuit, Fig. 3, it is seen that resistors R_6 etc. have been added in the cathode RC return to earth. These resistors are associated with the reset function, details of which are

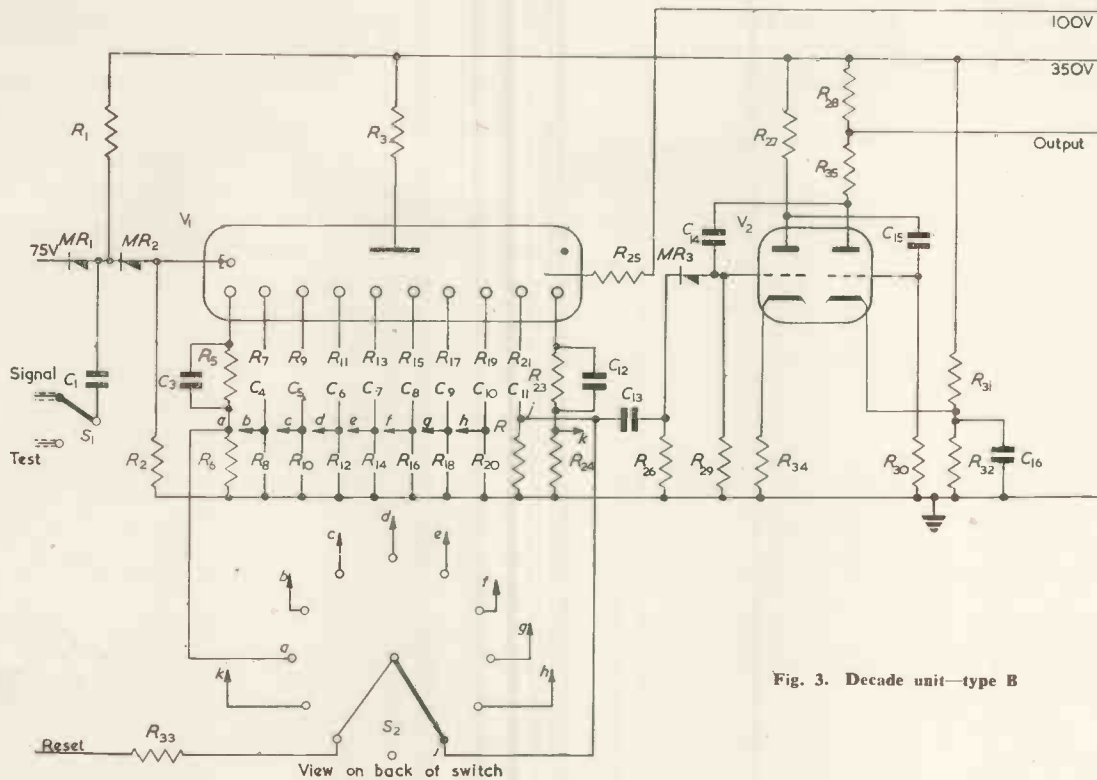

Fig. 3. Decade unit—type B

considered later. If it is required to strike the cathode gap 4, the selector switch is taken to position *d*. A large negative reset pulse, when applied across R_{12} , takes the cathode 4 negative and makes the glow prefer this cathode.

The unby-passed cathode resistors reduced the maximum speed of counting to 7.5kc/s. It was found that by reducing the h.t. voltage from 350 to 330V an acceptable counting speed of 10.5kc/s could be obtained.

The resistor in the ninth cathode, R_{22} , also serves to give the hand-on pulse, the drop in voltage as the ninth cathode glow extinguishes being applied to the trigger stage. This pulse is 8V negative and is applied to a hard valve flip-flop with two a.c. couplings. One half of V_2 is biased beyond cut-off by R_{31}, R_{32} and so maintains a stable state between periods of operation. The trigger pulse is applied through the CR circuit C_{13}, R_{26} , whose time-constant is small to ensure that the trigger circuit only fires once. An output 120V, 16 μ sec negative pulse is used to operate the next counter tube.

The reason for transferring the count as the glow leaves the ninth cathode is as follows.

If the ninth cathode is struck when a 20 μ sec pulse is applied to the transfer electrode, the ninth cathode extinguishes at the start of the pulse but the zero cathode does not conduct until the end of the pulse. If the hand-on pulse were taken from the zero cathodes, this delay would accumulate and after five decades the total delay would be 100 μ sec. To this time must be added the length of the resetting pulse and a safety margin of 40 μ sec, making about 200 μ sec. This would limit the maximum speed of count to 5kc/s.

By taking a hand-on pulse as the glow leaves the ninth cathode, the total delay over five decades is reduced to several microseconds. This gives an overall time, including the resetting pulse, of the order of 100 μ sec and permits a maximum speed of 10kc/s.

Gate Unit

There are two types of gate unit, Fig. 4, to deal with the

different requirements of counting with type A decades, and batching with type B units. The gates are mechanically interchangeable and are withdrawn from the front of the assembly, the front panel of the gate forming part of the assembly front panel.

The gate unit acts as a switch which can be opened and closed by electrical pulses. In type A provision is made for:—

- (1) Starting and stopping from pulses applied on a common line.
- (2) Starting and stopping with pulses applied on separate lines.
- (3) Starting on the first pulse arriving after pressing a push-button and stopping at next pulse if desired.
- (4) Manual starting and stopping by push-button.

With type B the requirements are:—

- (1) Start on pulse or with push-button;
 - (a) Stop manually when switched to stop.
 - (b) Stop at end of batch and generate an output pulse.

Fig. 4. Gate units and reset pulse stage



- (2) To initiate a resetting pulse when required.
- (3) To stop the count on receiving a pulse, reset the decade units and reset the gate, all in time to receive and register the next counting pulse.

Both gates are able to deliver an output pulse suitable for driving five decade stages in parallel, for test purposes. In this respect both units are identical, the gating circuits are also very similar and only type B is described, (see Fig. 5).

The reset pulse is negative going and is taken from the last decade unit. If selected by S_{1a} , this pulse is inverted by V_1 and applied to a cathode-follower, which uses the other half of V_1 . This output pulse, 90V positive, can be used to

are extinguished which will occur when the selector switch is moved to "reset".

As V_2 fires, lamp Lp_1 strikes and indicates that counting has finished.

In the auto-reset position stopping pulses are not applied to V_2 , so that the gate remains open all the time; a pulse indicating the end of each successive batch is sent to the resetting pulse generator.

Resetting Pulse Generator

This unit is required only for the batching counter and its operation is controlled by gate B. It is made up on a small chassis which is mounted at the rear of the main chassis.

To reset the decade units a negative pulse is required

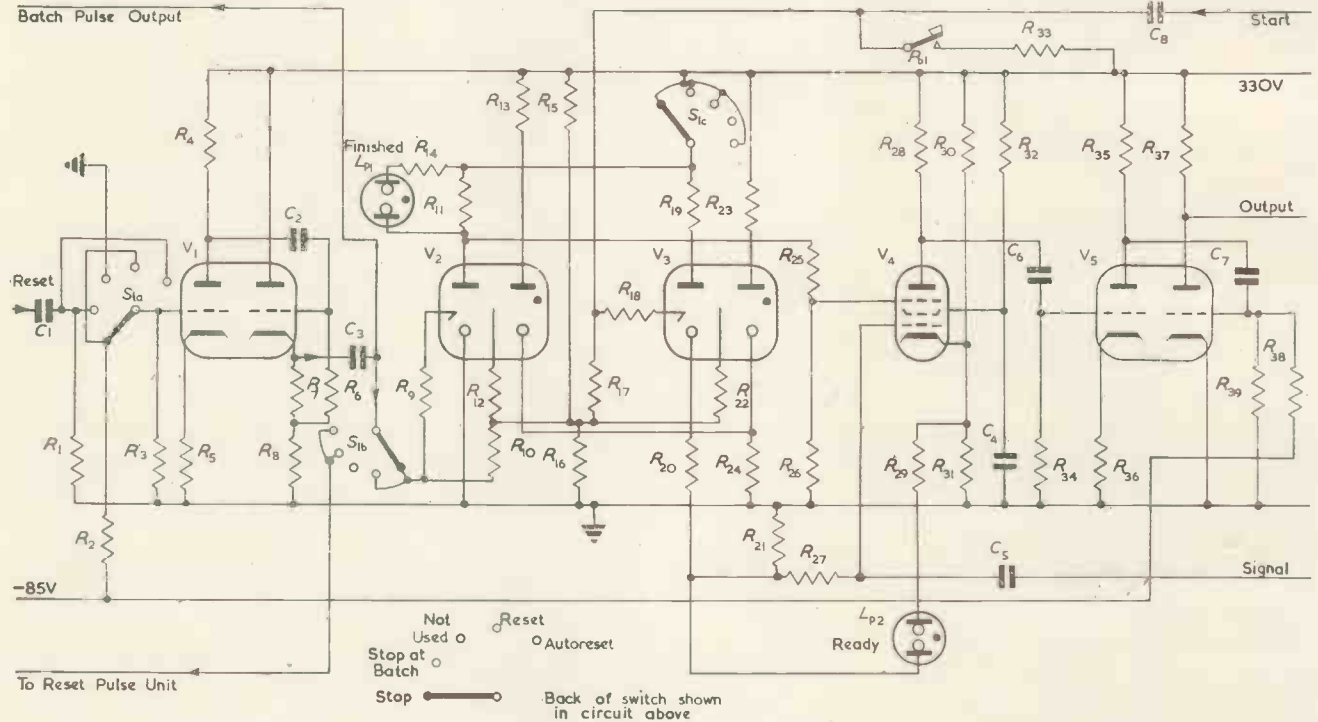

Fig. 5. Gate units—type B

operate a batching mechanism. It is also used to trigger the resetting pulse generator or the stop valve V_2 , depending upon the function selected by the switch S_1 .

V_4 is the gate valve, a 6F33 (CV2209) which has a sharp cut off g_3 . Grid g_3 is strapped internally by a diode to the cathode, so that the g_3 cannot exceed the cathode voltage. The cathode of V_4 stands at 100V; g_3 is also at this potential. The potential of g_1 is about 10V and, as the signals on g_1 are of the order of 50V, V_4 will not conduct.

Lamp Lp_2 is glowing, indicating that the gate is 'ready'. When a start pulse, 50V positive, is applied to V_3 trigger electrode, V_3 will fire and its cathode voltage rises to 140V. The signal bias level is raised to 70V and, if a signal is applied, V_4 will conduct. The resulting negative pulse at V_4 anode is inverted and applied to an output stage, both functions being performed by V_5 , a 12AT7. The output from this stage is a negative pulse suitable for driving five decade units connected in parallel. Lamp Lp_2 has only 30V across it and extinguishes.

The gate remains open until a "stop" pulse is applied and V_2 fires. The anode voltage of V_2 drops to 180V and g_3 of V_4 which is supplied from this point is reduced to 75V, i.e. 25V below cathode potential and beyond the g_3 cut-off point.

The gate is now closed and remains so until V_2 and V_3

which, when applied to a selected cathode, will transfer the glow to that cathode. The length of the pulse must exceed the counting-pulse length, i.e. $20\mu\text{sec}$, since, if the ninth cathode is selected, the application of the resetting pulse initiates a counting pulse to the next decade. The amplitude of the pulse developed across the cathode resistor is approximately 70V. This resistor must be small to give a high rate of count; for 10kc/s operation a value of $3.3\text{k}\Omega$ is used. Five decades are reset in parallel and with a hard valve circuit it is desirable to generate a higher voltage pulse and attenuate to 70V, the attenuator increasing the load impedance and reducing the interaction between cathodes of the five decades which are taken to a common resetting line.

A 3 to 1 attenuator, using $6.8\text{k}\Omega$ with the $3.3\text{k}\Omega$ cathode resistor, gives a total load of $2\text{k}\Omega$ across which a 210V pulse must be developed.

The circuit is shown in Fig. 6. The first stage associated with V_1 is a cathode coupled flip-flop, triggered by a positive pulse, which comes from gate B. It gives a positive pulse whose width can be varied from 30 to $60\mu\text{sec}$. This pulse is taken to V_2 , a beam tetrode valve which is biased beyond cut-off. The output is taken from the anode through a blocking capacitor and is a 240V, negative pulse delivered into a load of $2\text{k}\Omega$.

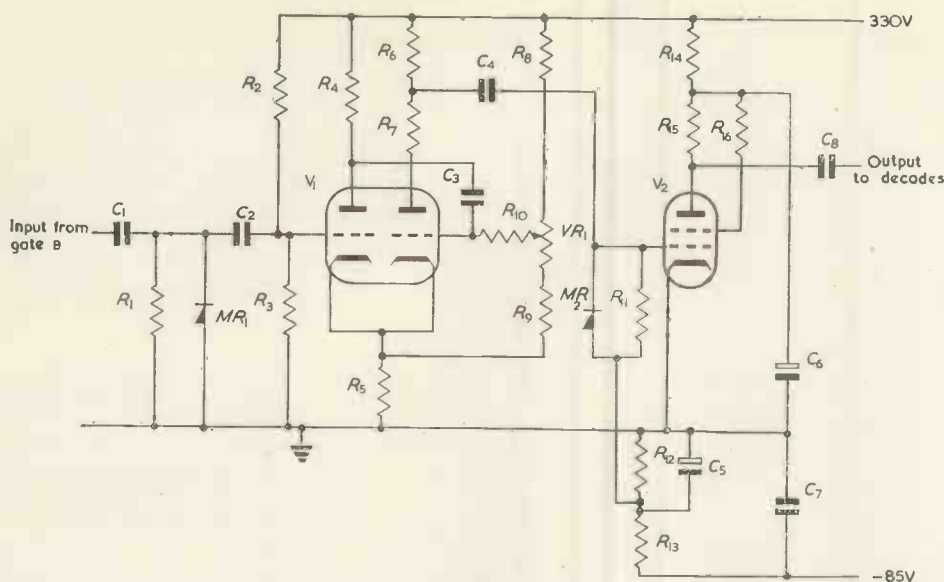

Fig. 6. Reset pulse unit



Fig. 7. Pulse shaping unit

Pulse Shaping Unit

This unit, shown in Fig. 7, is used with both types of counter. It is specified to work with inputs which may be sinusoidal, positive or negative pulse, of peak amplitude 1 to 150V and frequency 0.1c/s to 20kc/s. The output is a 45V positive pulse of 16 μ sec width.

Negative pulses and sinusoidal voltages are applied to the second half of V_1 , a d.c. amplifier in Fig. 8. The direct coupling to the amplifier permits the handling of the very low frequency sine wave pulses. Positive pulses are phase inverted by the first half of V_1 , before going to the amplifier.

The second stage, associated with V_2 , is a Schmitt circuit

which has the property of backlash, the firing and return potentials being at different levels. This ensures that a ripple superimposed on the main signal will not give rise to spurious counting pulses.

An input voltage of 1V will trigger V_2 , which remains in this state until the input is reduced to 0.45V. The firing of V_2 produces a positive trigger pulse which is applied to the pulse generator, V_2 , a cathode coupled flip-flop. The output pulse width is determined by C_5 and R_{23} , which are chosen to give 16 μ sec.

Power Supply Unit

The power supplies are housed in a unit having a standard 19in front panel 10 $\frac{1}{2}$ in high. It can supply two complete counting assemblies.

The load for a type A counter is 65mA and, for the type B counter, 80mA.

The requirement is therefore for 330V, 140mA stabilized supply for a mains fluctuation of 5 per cent.

A negative bias line is also required.

The circuit is quite conventional, a simple amplifier being adequate to give the required degree of stability. The reference voltage is used to provide the bias supply.

Fig. 8. Pulse shaping unit

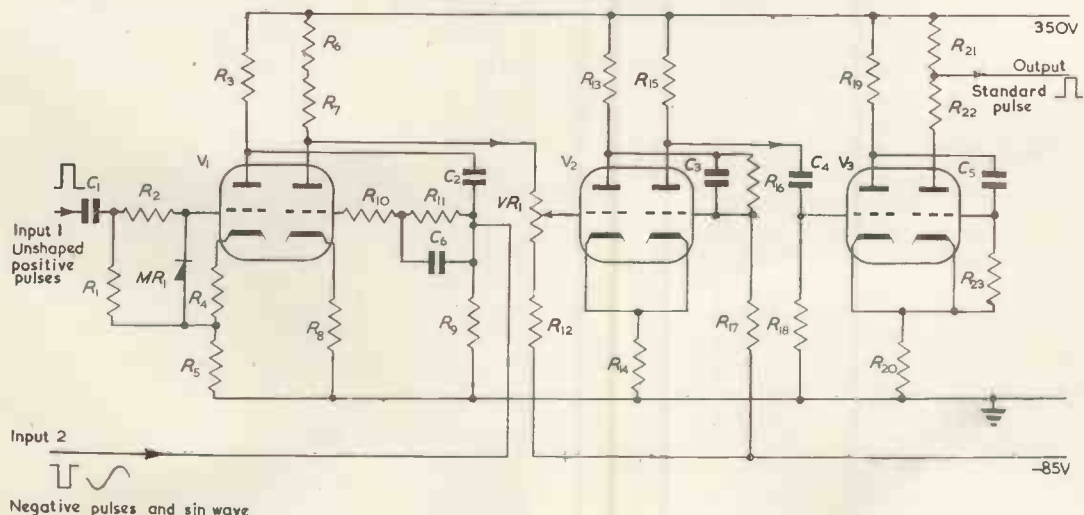

With the h.t. voltage set at 330V when a.c. supply = 240V and load = 140mA a change of supply from 220V to 250V producing a 3V change in h.t.

Mounting

Since reliability and simple maintenance were sought, no attempt was made to reduce unduly the size of the equipment. The various counting units are assembled on a chassis with 19in \times 10 $\frac{1}{2}$ in front

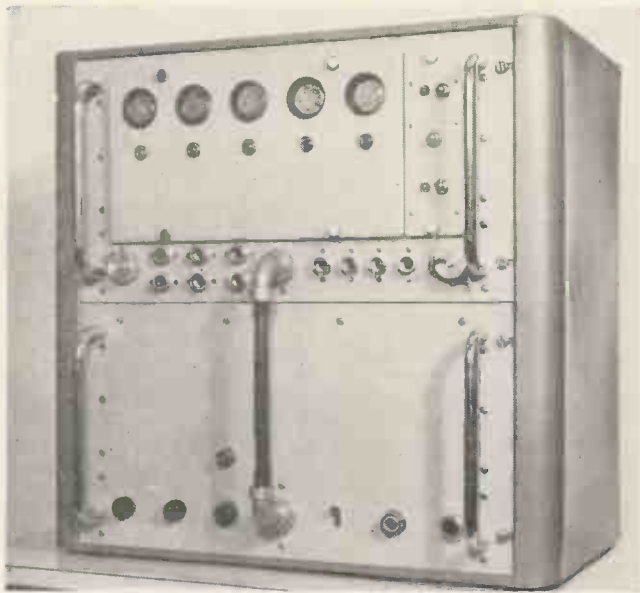

Fig. 9. 10kc/s frequency standard and dividers

panel, see Fig. 9. The decades plug into an interconnexion board; the gate unit and pulse shaping units also plug in and are held down to the main chassis by fixing bolts.

The input and output sockets and selector switches as required by the application are situated on the main front panel and connected to the various units. A tagboard is also mounted beneath the main chassis to take the components associated with the divider network providing the various bias voltages for the cold cathode tubes.

Applications

It will be seen that the counting equipment has been designed so that a number of basic units can be assembled as required to form a laboratory or industrial instrument. Servicing can then be carried out quickly by unit replacement followed by detailed examination under less pressing circumstances. When a special instrument has served its purpose it can be broken down into its useful components. Typical applications are detailed below.

DECADE FREQUENCY DIVIDER

The reliability and circuit simplicity of the cold cathode counter offer a compact laboratory frequency standard for continuous running. Fig. 9 shows an assembly which contains a 10kc/s quartz crystal oscillator and provides pulse repetition frequencies of 10 000; 1 000; 100; 10; 1; and 0.1c/s suitable for timing marks for oscillograph records, controlling counter type frequency meters, and for reference frequencies for counter chronometers.

The figure shows that each of the A decades contains a changeover switch immediately below the counting tube. The input pulses to the decade are selected by this switch—when the switch is to the right the decade counts the pulses from the previous decade—when to the left it counts the input pulses to the first decade (at the right). The cover plate is engraved to show this function which allows a simple check on the system. By switching all decades to the left, each counts the same input pulses. Manually starting and stopping the count (using the gate push buttons) allows a number of pulses at 10 000 per second to be fed to each decade. After this operation each decade should show the same number (i.e. the "units" column of the count fed in). Similarly, by suitable switching, the

counter can be split into two chains each of which should show the same "tens" and "units".

In addition to being available separately at coaxial sockets on the panel, the 6 pulse trains available from the divider are fed to a 6 pin socket at the left of the panel from which they can be linked to a counter as described below.

A divider of this type is used as a laboratory frequency standard; the various signals required throughout the building are combined as pairs of pulse trains of positive and negative polarity and passed through a set of cathode-follower stages and thence by coaxial cable to the sites in question.

DECADE COUNTER

Up to five type A decades (as required) can be assembled with pulse shaper and gate to form a counter. When reference timing pulses are available this counter becomes a frequency meter counting cycles or pulses per time interval.

Fig. 10 is a block diagram of a counter, similar in size to the divider in Fig. 9, which operates direct from a 60 pulse phonic wheel to be direct reading in rev/min when a 1 second interval is used or reading 10 times rev/min when a 10 second interval is used. In the latter case the speed can be read correct to 0.1 rev/min (viz 4789.7 rev/min). Timing pulses of 10kc/s and 10c/s are also available and can be used for checking.

Fig. 11 shows the combination of the frequency divider and the counter in one cabinet with a power unit. This is now a self-contained frequency meter and counter chronometer. The 6 pulse repetition frequencies from the continuously running divider are taken by the multicore screened lead on the left to the counter chassis. Switches can be seen on the latter which allow any of these frequencies or an external one to be counted and also to start and stop the counter. This combination is very convenient for self-checking, a feature which contributes to user confidence as well as simplifying fault finding. For example, it is now possible to parallel all the counter decades and feed in say 10, 100 or 100 000 pulses from the 10kc/s source by selecting 1kc/s, 100c/s or 0.1c/s as the timing interval. In each case all the counter tubes should complete whole numbers of turns and be back at zero. With the decades in their normal series arrangement counts of 10, 100, or 100 000 will be obtained. Alternatively, selection of a low frequency such as 10c/s and parallelling of the counters allows visual checking of the counting.

Fig. 10. Typical frequency meter

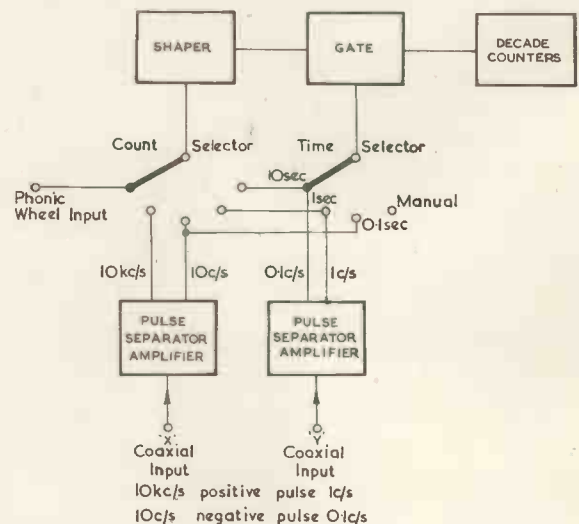

BATCHING COUNTER

The type B decades and associated gate were developed initially for a novel speed control application¹ but have other uses.

The assembled counter, as in Fig. 12, can divide an input frequency by any integral number from 3 to 99 999 at 10kc/s or less. Below 3kc/s it can also divide by 1 and 2; 3.5kc/s is the maximum resetting frequency.

The counter has two distinct methods of operation; that just described is its continuous repetition method where the last pulse of a chosen batch tries to change the count from 99 999 (if 5 decades are used) to 00 000. As the glow in the left-hand decade begins to leave 9 it causes the reset pulse which returns the glow in each decade to the complement of the batch number required. Thus, if 123 is required, the counter is reset to 99877. This operation is completed in 65 μ sec so that, even at the top frequency of 10kc/s the next counting pulse is properly counted. The alternative method is selected by putting the gate switch to "stop at count"; on leaving 99999 the gate is closed and an output pulse sent out. This method can be used to set a time interval (such as 97.785 seconds). To start again the switch is turned to "reset" when the complement of the batch is set up and then to "stop at count". The push-button can then be used to start the count or a pulse can be applied to the start terminal.

LOW FREQUENCY MEASUREMENT

The batching counter has been found a great convenience for the accurate measurement of frequencies in the awkward zone between 10 and 500c/s. Higher frequencies can be counted direct in reasonable time intervals (e.g. 5kc/s for 10sec gives a precision of 1 in 50 000). Lower frequencies can be timed for a cycle (e.g. using a 10kc/s reference frequency, 0.2c/s can be determined to 1 in 50 000 in 5sec).

A frequency of some interest is 50c/s which requires 1000sec to count directly to 1 in 50 000. With a 10kc/s

Fig. 11. Complete frequency meter and chronometer

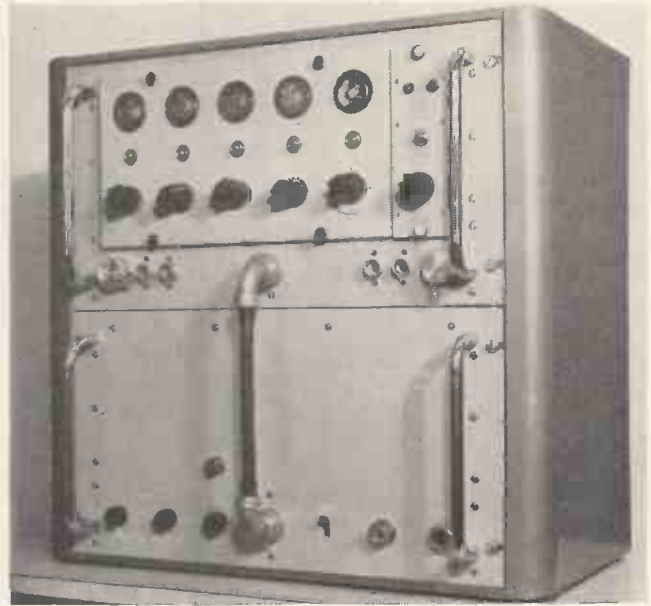
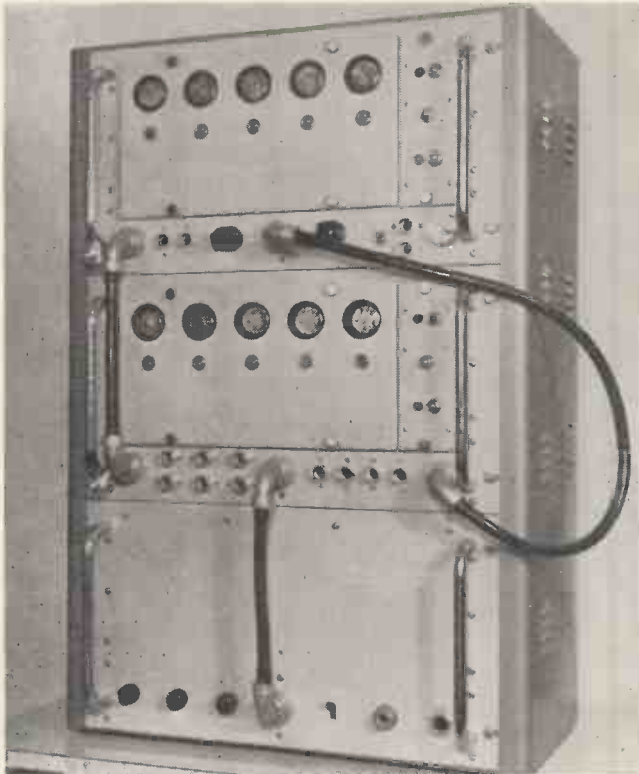

Fig. 12. Batching counter

reference, 1 cycle timing gives 1 part in 200 precision, although a more complicated vacuum tube microsecond timer will give 1 in 20 000 accuracy, using a 1Mc/s reference, providing the particular cycle chosen is not affected by transient voltage changes sufficient to alter the time between corresponding points on its waveform by more than 1 μ sec.

Using the batching counter set to 500 cycles and fed from the 50c/s to be measured, a time interval is produced which should be 10sec. The 10sec interval can be measured to one part in 100 000 using a type A counter chronometer, and a 10kc/s reference frequency. This method has been used to check a crystal signal generator which had to produce divided frequencies of 48, 48.5, 49, 49.5, 50c/s etc.

The batching counter was set to 480, 485, 490, 495, 500 etc. and in each case the amount the count differed from 100 000 was the error in parts in 100 000.

A similar use of the counter to reduce various frequencies to what should be a standard interval has been used for speed control.

The batching counter can, of course, be used to generate frequencies of the form f_s/n where f_s is a standard frequency such as 10 000c/s and n is any integer up to 99 999 but it is not always a convenient to have this inverse relationship with n (e.g. a direct setting of 10 000/783 is not often desired).

Conclusions

The equipment described above has been developed and has wide application. Further experience will indicate whether its reliability is better than that of hard valve counters. The unit construction and testing facilities undoubtedly make it convenient to service.

Acknowledgments

The equipment has been developed jointly by Messrs. Atkins, Robertson and Whiteford, Ltd., Glasgow, and the Mechanical Engineering Research Laboratory, East Kilbride, to the latter's specification. The authors gratefully acknowledge the permission of the Directors of both concerns to prepare this article.

REFERENCES

1. LESLIE, W. H. P. Precision Speed Control and Measurement (Mechanical Engineering Research Laboratory, Fluids Note 15 Dec. 1953.)
2. LESLIE, W. H. P. *Electronic Engng.* To be published.
3. HOUGH, G. H., RIDER, D. S. Some Recently Developed Cold Cathode Glow Discharge Tubes (Pt. 3). *Electronic Engng.* 24, 272 (1952).
4. HOUGH, G. H. The Development of a Multi-Cathode Decade Gas-Tube Counter. I.E.E. Monograph No. 30 (March 1952).

Subminiature Transformers and Transducers

By E. F. Dunkin* and D. L. Johnston*

Some features of subminiaturized design are described, and the technical limitations associated with small size are discussed in relation to audio and control frequency transformers and transducers. Below a certain critical size a miniature toroidal-shell construction has given results comparing favourably with laminated assemblies and, as a transformer, the signal power level rating is sufficient for junction-transistor circuits. This special construction is made from solid metal with an optically-finished joint, or pressed from sheet. When applied to transducers there is the unusual feature that the excitation and control fields are orthogonally related.

The practical design of subminiature audio-frequency transformers and transducers depends largely on empirical data obtained experimentally. The primary objective may be either maximum electrical efficiency or minimum size, but all too often these objectives are incompatible. Until recently, there was no need for a truly subminiature transformer (less than about a half inch cube). What may be termed "miniature" transformers (of volumes approaching this figure) were used in such applications as hearing aid amplifiers to match the output from a valve impedance, of perhaps $1M\Omega$, to an electromagnetic earpiece of $1k\Omega$ with a ratio of 31:1, and primary inductance of about 200H.

The rapid adoption of junction transistors in hearing aids and other applications, together with a general trend towards miniaturization in electronics, has greatly increased the use of small transformers. Resistance coupled transistor circuits may have advantages for some purposes, but it is

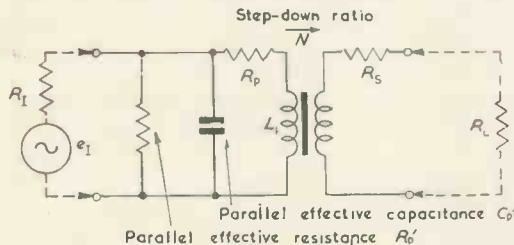

Fig. 1. Simplified equivalent transformer circuit at audio frequencies

usually found that three transformer coupled stages of grounded emitter transistors can have a gain exceeding that of four stages resistance coupled, if the impedances are matched with a step-down ratio for optimum power transfer. This alone would not justify the use of transformers, unless the dimensions of the latter are comparable with those of the transistor itself.

A typical low-level junction transistor amplifier will have an input impedance at the base of $1k\Omega$ and an output impedance at the collector of $20k\Omega$, so that a 4.5:1 step down ratio is used. If the power level is increased from stage to stage, the impedances will diminish and this ratio will be greater¹.

Electrical Performance of Miniature Transformers

EQUIVALENT CIRCUIT AND FREQUENCY RESPONSES

The circuit of Fig. 1 represents the transformer sufficiently well for audio frequency applications. Subminiature transformers also work surprisingly well as pulse transformers due to their small area and volume and correspondingly small capacitances and leakage inductance: it is less easy to provide a general equivalent circuit for such cases, which are best dealt with by successive approximation with prototypes.

Assuming transistor applications, the parameters in Fig. 1 are:—

- R_D primary d.c. resistance.
- L_D primary inductance (usually at 1000c/s and a stated direct current in winding).
- R_D' primary parallel effective loss resistance.
- C_D' primary equivalent lumped capacitance.

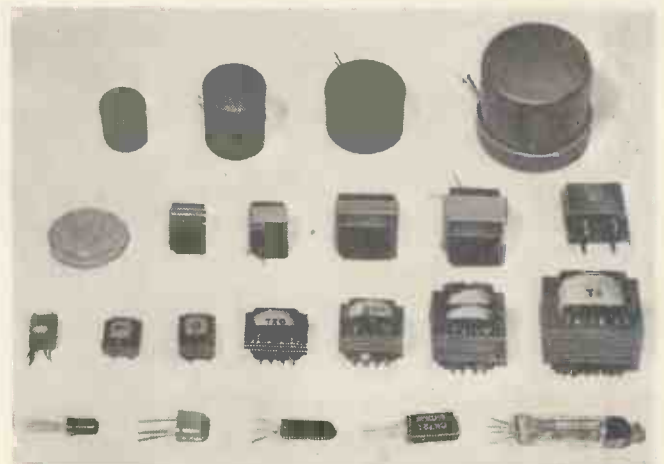

Fig. 2. A range of miniature transformers, having overall dimensions $\frac{1}{2}$ in \times $\frac{1}{2}$ in up to $\frac{1}{2}$ in \times $\frac{1}{2}$ in \times 1in, with screened and potted versions. Different types of junction transistors and subminiature valves are included for comparison of the sizes. One of the transformers is fitted with extended pins for mounting in printed-circuits.

- R_s secondary d.c. resistance.
- N step-down turns ratio.
- R_I signal source impedance (assumed resistive)
- R_L secondary load impedance (assumed resistive)

From numerical data the insertion loss and frequency response can readily be computed. The inductance characteristic is measured with a Hay bridge having facilities for superimposing d.c. and measuring ratio².

The inductance of a typical miniature transformer (type T in Fig. 2) is given in Fig. 3 against frequency. The dimensions are 0.40in \times 0.48in \times 0.66in with 11 pairs of laminations 0.015in thick, a cross section of 0.067cm². The mean magnetic path length is 3.0cm, and there are 3300 turns. If 0.003in thick laminations are used the inductance is less at low frequencies due to poor stacking.

In the above example mumetal is used, and a high initial permeability obtained, as shown in Fig. 4. With radiometal or with an intentional air-gap, the inductance varies less with saturating d.c., and this is important when there is a large signal, as in an output transformer, if distortion is to be kept within reasonable limits (see Fig. 5).

* Fortiphone Ltd.

In Fig. 6 is an example of a very high inductance transformer, used in a circuit to match a miniature valve to a transistor, the inductance characteristics being as in Fig. 7(a) and response obtained as in Fig. 7(b). Here the shunt capacitance limits the high frequency response, and the transformer insertion loss is rather high as the parallel effective resistance is $2M\Omega$.

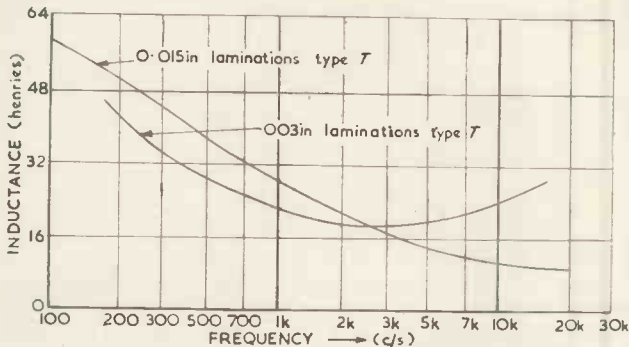

Fig. 3. Variations of inductance of a small transformer with frequency, for lamination thicknesses of 0.015 and 0.003in

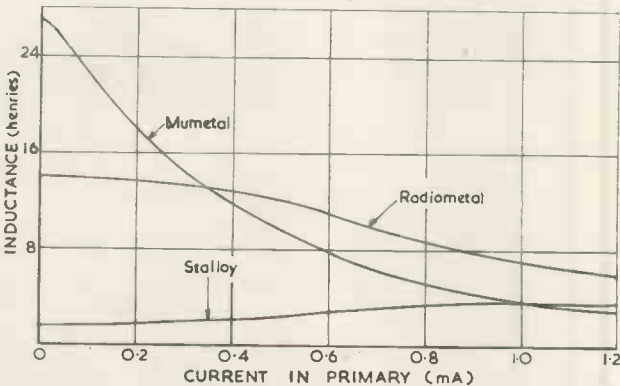

Fig. 4. Performance of different magnetic materials in a small transformer when saturating d.c. is present in the primary winding

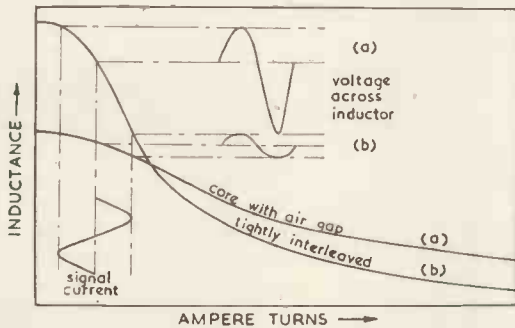

Fig. 5. Effect on signal of curvature and choice of working point on d.c. saturation curve of an inductor

When transistors are used, the effects of shunt loss and capacitance are negligible, because impedances do not usually exceed about $20k\Omega$ and the high frequency response is then greater. Fig. 8 is an example of a transformer coupled transistor amplifier (gain 70dB) fed by a magnetic microphone wound to match the transistor input impedance ($2.5k\Omega$), which is much more satisfactory than using a crystal microphone and step-down transformer. Fig. 9 shows a class-B push-pull amplifier with a gain of 55dB and an output of 0.25W.

OPTIMIZING A MINIATURE DESIGN

The physical size of a transformer is determined by the winding space necessary to accommodate a winding of

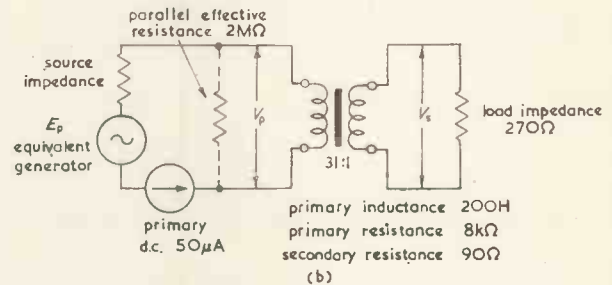
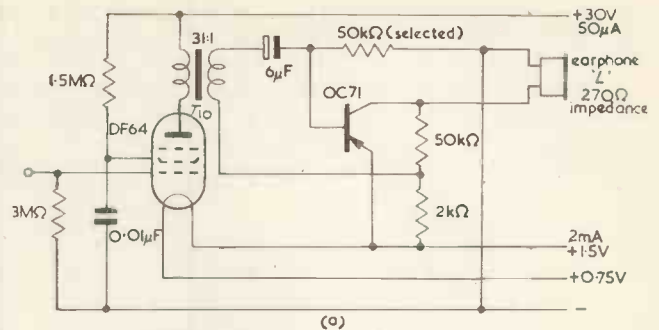

Fig. 6(a). Transformer matching a miniature valve to a transistor output stage
(b). Equivalent circuit of transformer

suitable resistance, and the magnetic cross-section required to give the desired inductance in the presence of a certain value of d.c. magnetizing ampere-turns.

If miniaturization is the main objective in a design, the permitted d.c. resistance should be as high as possible. The limiting factor here may be the series loss in relation to load impedance, or the d.c. voltage drop in transistor circuits. The direct current should be no more than necessary, and in signal-level circuits transistors will usually give as high a stage power gain at low d.c. levels as at their maximum or nominal rating. Where power output is required the use of push-pull can reduce the weight of the transformer by a factor of 5 or 10 times.

The frequency response, Fig. 10(a), is typical of that

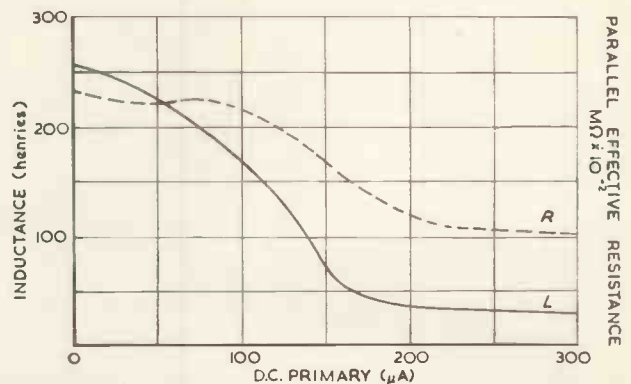
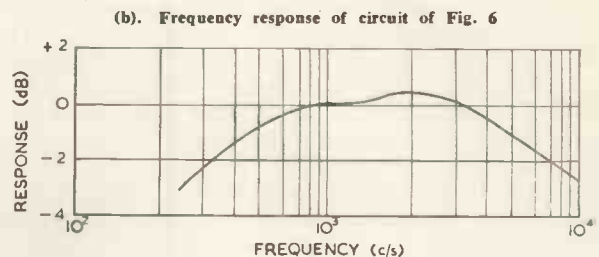

Fig. 7(a). Inductance characteristic of transformer in Fig. 6



(b). Frequency response of circuit of Fig. 6

usually obtained. It extends to a higher frequency than necessary for audio purposes, but does not go low enough. To obtain an optimum use of the available bandwidth, the inductance should be increased to move the band downwards in frequency, and there will be a corresponding cut at the top end due to increased capacitance.

It is important in transistor circuits to establish the work-

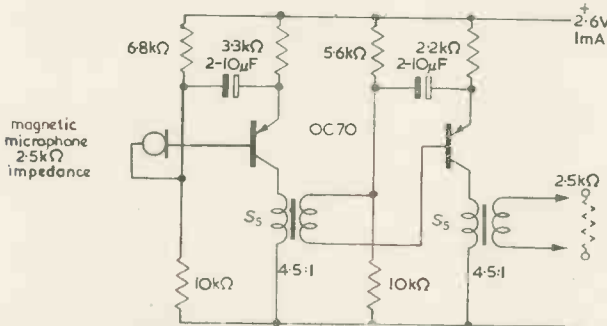

Fig. 8. Two-stage transistor amplifier matched to a magnetic microphone (2.5kΩ)

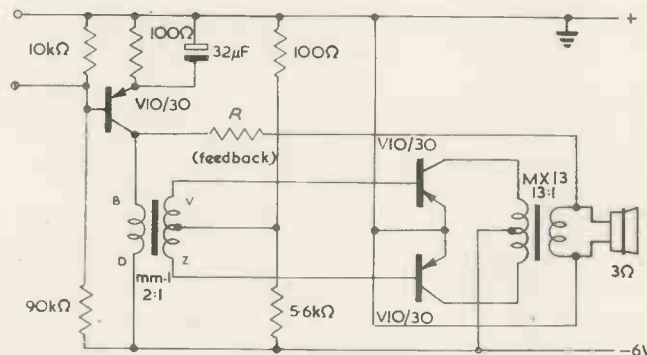

Fig. 9. Class-B push-pull transistor amplifier and driver stage

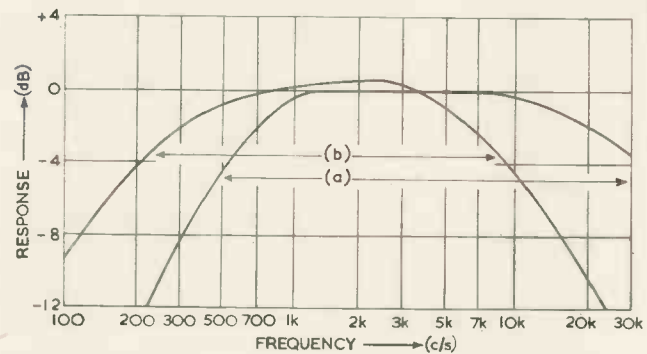

Fig. 10. Actual (a) and preferred (b) bandwidths of miniature transformer coupled circuits

ing values of the transistor input and output impedances, so that transformer ratios may be chosen accurately. Reference 1 is helpful in this connexion, and the experimental method is to find the optimum values of dummy loads while keeping the d.c. conditions constant.

With so many variables to consider, it is best to divide the development of a miniaturized transformer-coupled transistor amplifier into two stages. The first is to optimize the circuit design, using a selection of test transformers or a multi-ratio type of ample proportions, to establish d.c. conditions and optimum ratio. The second stage is to determine the minimum acceptable value of d.c. and inductance and the maximum permissible winding resistances,

and find the smallest size of transformer core which will meet this specification.

It is sometimes worthwhile to make a small number of trial designs, and plot transformer volume against insertion loss, to form an impression of the "break-even" point. In many cases it is "worth" 3dB loss to half the volume.

Magnetic and Mechanical Limitations

MAGNETIC MATERIALS

In small iron-cored components where the direct polarizing current is also small, there is great advantage in using ferro-magnetic materials of high initial permeability such as "mumetal" or "permalloy C", to obtain a high inductance with a minimum of weight and volume.

For example the miniature transformer with the inductance characteristics shown in Fig. 3 and 4 has a primary winding resistance of 1kΩ, due to the relatively small "window" area, so that, in transistor circuits, the practical working current is also limited by d.c. voltage drop: for mumetal the maximum useful d.c. is only 0.3mA, and for radio-

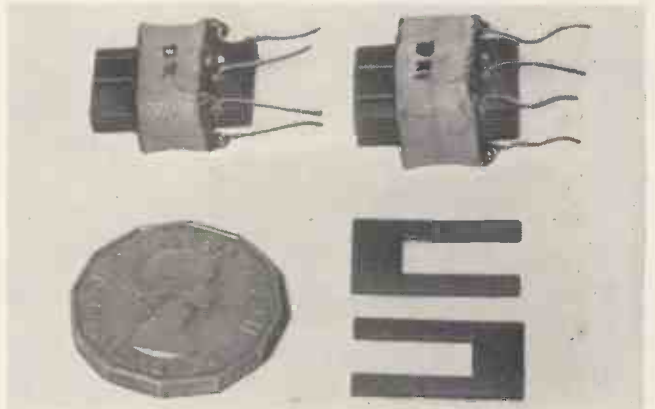

Fig. 11. Sub-miniature transducer, with special overlapping laminations

metal 0.75mA due to saturation. The 1kΩ series loss is not significant when connected to a preceding stage of 20kΩ impedance.

The variation of inductance with frequency is considerable, as already shown in Fig. 3; laminations 0.015in thick are usually acceptable for audio-frequency applications, but those as thin as 0.003in are more difficult to handle. Wound-tape toroids are better in performance but expensive to wind in the small sizes with very fine wire: in this respect C-cores are better, if the effective air-gap of the joint is acceptable. It would appear that if technical requirements dictate a thinner lamination than 0.003in, as in high frequency transducers, better practical results will be obtained with suitable ferrite cores.

FORMS OF CONSTRUCTION

It has been shown that imbricated (or interleaved) laminating is very inefficient magnetically⁴. This is because double flux density appears at the overlaps, so that some saturation occurs at no more than half the mean saturation flux for the whole cross-section. Also, because of this effect, the optimum practical lamination thickness at a particular frequency is usually about twice that to be expected from "skin effect" calculations.

Interleaving can be avoided by using special laminations with a long overlap, as shown in Fig. 11. This construction is appropriate to a transducer or a high impedance microphone transformer, where the full initial permeability is required. It also has the advantage of being astatic, so that little screening is required.

When an air-gap is required, either to obtain a flat saturation characteristic, or to stabilize the inductance, there is a practical difficulty in obtaining a certain range of inductance, because the change from interleaved laminations to butted laminations is associated with a ratio of 10:1 in inductance when the butt joint is un-machined.

Thus, a mumetal core of "E's" and "I's" with a cross



Fig. 12. Toroidal-shell transformer, and conventional type of equal ampere-turns performance

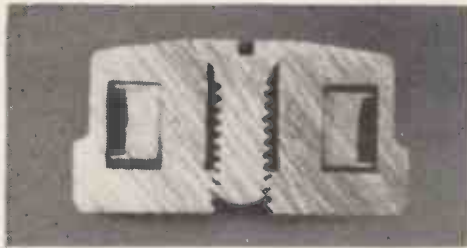

Fig. 13. Cross-section of transformer of "solid" construction with lapped joint, overall diameter 1/2 in

section of 0.217cm² and 3800 turns, gives the following results:—

Interleaved alternately, inductance	40 henries
interleaved in pairs	31.5 "
E's tightly butted to I's	3.4 "
E's butted to I's, 0.002in spacer	3.0 "
" 0.010in "	1.45 "
" 0.020in "	0.95 "

In this case the equivalent series air-gap when tightly interleaved, is about 0.0002in.

A NEW TYPE OF CONSTRUCTION

When the magnetic circuit is not fully utilized, the windings become longer than they need be, and a greater "window" cross-section is required to keep down the d.c. resistance. Conversely, if the transformer is made as compact as possible, savings in weight and volume are obtained both in the iron and the copper, for equivalent performance.

If a transformer is small enough only a single "lamination" is required to provide the magnetic circuit, and this is demonstrated in the "solid" core of Fig. 12 shown also in cross-section in Fig. 13. It is an inversion of the usually toroidally wound ring core, the core being a hollow "doughnut" with the coils inside.

This type of core has been successfully made by sintered powder metallurgy, and by hobbing or forging or machining from the solid, and the joint semi-optimally

finished so that the parts will "wring" together as with gauge blocks. This corresponds to a flatness of a few millionths of an inch. Alternatively, it can be pressed from sheet material and a lower grade of joint finish employed in conjunction with wide flanges, but it then is appreciably bigger.

The two transformers in Fig. 12 have equivalent characteristics, but the "solid" type is considerably smaller in volume, but not so much less in weight, as it is more compact and "denser" (see Table 1). The saturation curves at 1kc/s are similar, Fig. 14(a).

TABLE 1

	CONVENTIONAL	SOLID	PERCENTAGE OF CONVENTIONAL
Total weight (grams)	7.0	2.2	31
volume (cu.cm)	1.45	0.31	22
magnetic path length (cm)	3.0	1.17	39
magnetic cross-section (sq.cm)	0.067	0.052	78
mean coil circumference (cm)	3.0	2.37	79
number of turns	1 150	1 200	104

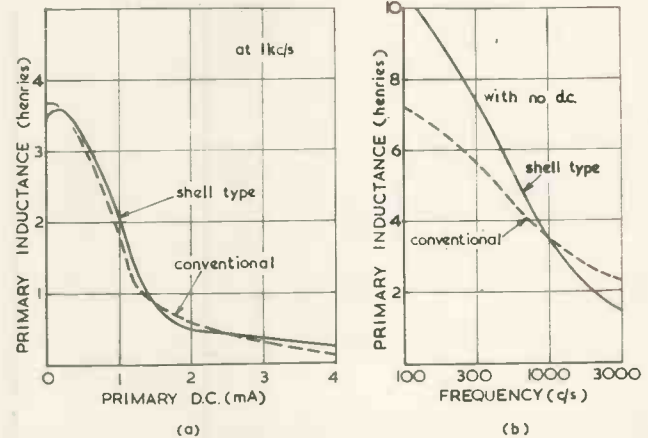

Fig. 14(a). D.C. saturation characteristic of shell and laminated transformers
(b). Variation of inductance with frequency

Fig. 14(b) shows that some magnetic skin effect is occurring at 1kc/s in the "solid" type, which is to be expected as this version has a wall thickness of 0.025in instead of the 0.015in of the laminations.

This unconventional form of construction therefore has a certain limiting size, above which its losses are excessive. Below the critical size it is more compact than a conventional transformer, and is more readily miniaturized further, should this ever be necessary. The model shown is comparable in size with present day transistors, but already very much smaller transistor assemblies have been made (see foreground of Fig. 2), and a requirement for components on the same scale can be anticipated.

Referring to Fig. 14(a), if we double the number of turns and therefore halve the current to saturate, we may reduce the core cross-section by a factor of 4, and still be left with 2.5H at 0.3mA, d.c., which is quite adequate for coupling small junction transistors in signal-level circuits. This is an important conclusion in connexion with a.c. control, resolving, and data processing circuits, where all the complex operations can therefore be carried out in sub-miniature components, with only the outputs raised to a higher power level using conventional components.

At 1kc/s the limiting size for the "solid" construction corresponds to a junction transistor amplifier (single sided) operating at a power level of about 1mW, and this can be increased to about 10mW with push-pull where the d.c. saturation current can be assumed balanced out within ± 20 per cent. For other frequencies these limiting power levels will remain the same, provided the "solid" core wall thickness is scaled down inversely as the frequency. The ultimate limit in frequency is determined by practical difficulties in handling very thin core-bodies.

These small metallic cores can be employed in computing circuits in the same way as ferrite core matrices, where a single conductor is threaded through a row of cores. Reference to Fig. 14(a) shows that 1.4 mA in 1200 turns will saturate the core, which is equivalent to 1.8A through a single wire threaded in the middle hole of the shell. The other circuits can be at high impedance, using the coils within the shell.

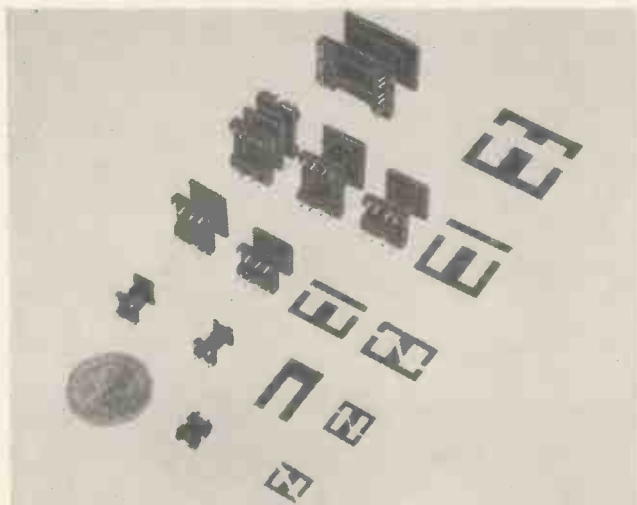

Fig. 15. Types of laminations and bobbins with moulded-in connecting pins, employed in sub-miniature transducers and transformers

MECHANICAL LIMITATIONS

When scaling down a core size, the windings become less "efficient" as wire gauges are reduced, and there will be a practical limit, in most cases before the winding resistance becomes excessive. There is no difficulty with experienced operators in random-winding 50 s.w.g. enamelled copper on high-speed multi-winders, provided the machine is carefully adjusted, as the breaking force for this gauge is about 16 grams. This wire is .001in diameter, and "first covering" enamel adds .0002in to this. A vinyl acetal "heat-stripping" enamel is preferred, as it fluxes just below soldering temperature.

Successful windings can be made with 52 s.w.g. wire (nominally .0006in diameter) but the cost of the wire is much higher and breaking strength only 8 grams, and the enamel thickness and "layering" combine to reduce the space factor from about 0.35 to 0.20. About 70 per cent more turns can be accommodated than with 50 s.w.g. In the

"solid" type cores a thin-walled enamelled mumetal bobbin is used to save space. When protected by vacuum varnish impregnation after desiccating, these fine windings are extremely reliable.

It is convenient to provide connecting pillars as moulded inserts in the bobbins of small conventional transformers (Fig. 15). This is more satisfactory than terminating to a lead-out wire in the winding. Thermosetting bobbins are to be preferred to thermoplastic and, in small sizes, a rigid bobbin is usually better than a nylon one. Although initially somewhat brittle, a phenol-formaldehyde bobbin becomes very strong after vacuum impregnation with varnish, and will then withstand the terminal pull test of 10 pounds specified in RSC 214. A moulded bobbin is much superior to a fabricated one in any pan-climatic test, as the laminae and joints of a pieced-up bobbin permit the penetration of moisture. Glass-fibre tape is used as the outer wrapping and, on impregnation, forms a tough protective sheath.

Difficulty has been reported in the encapsulation and potting of magnetic devices such as transducers, due to the effect of compressive stresses on the mumetal. This has resolved into a matter of scale, and is negligible in the case of magnetic assemblies below $\frac{1}{4}$ or $\frac{1}{2}$ inch in major dimensions. The reason for this is that the stresses are proportional to the linear dimensions, and are negligible for sub-miniature units. The best potting resins are, in fact, those that show slight shrinkage and have good adhesion, such as the epoxies and can be used unloaded in the smallest sizes.

Sub-miniature transducers

REALIZABLE PERFORMANCE

It is necessary that the full initial permeability of perm-alloy C, mumetal, or HCR be realized, and this requires special attention to the joints in the magnetic circuit. Fig. 11 shows a sub-miniature type of transducer with special laminations having ample overlap, the d.c. and a.c. saturation characteristics being given in Fig. 16. This indicates that the maximum frequency of excitation when using 0.015in laminations is about 1kc/s.

When normal interleaving is used, the small units become progressively less effective, as shown in Table 2, which represents the performance of the three imbricated-lamination transducer units illustrated in Fig. 17, in a magnetic amplifier with 1.6kc/s excitation. The normal transformer bobbins were employed.

Some of the loss of stage gain in the smallest size is attributable to the poor performance of available rectifiers at this low power level. The performance figures stated can be improved by a factor of 2 to 4 by using specially shaped and overlapped laminations, and the gain can be increased further by applying self excitation.

SPECIAL CONSTRUCTION FOR TRANSDUCATORS

The "solid" type of core was used for unit (d) in Fig. 17 and the results are given in the above table. It is roughly equivalent in performance to the conventional type (b), but is only 13 per cent the volume and 35 per cent the weight (another example of "denser" construction and cor-

TABLE 2

	a	b	c	d "solid"
Overall dimensions (cm.)	2.1 × 1.0 × 1.3	3.2 × 1.6 × 1.7	3.3 × 1.6 × 1.7	1.4 diam × 0.6
Volume outline (cu. cm.)	2.7	7.2	11.2	0.9
Weight (grams)	5.4	17.2	32.2	5.0
Stage power gain, no self excitation (after rectification)	×5	×10	×36	×19
Stage output power	1.8 mVA	55 mVA	200 mVA	20 mVA

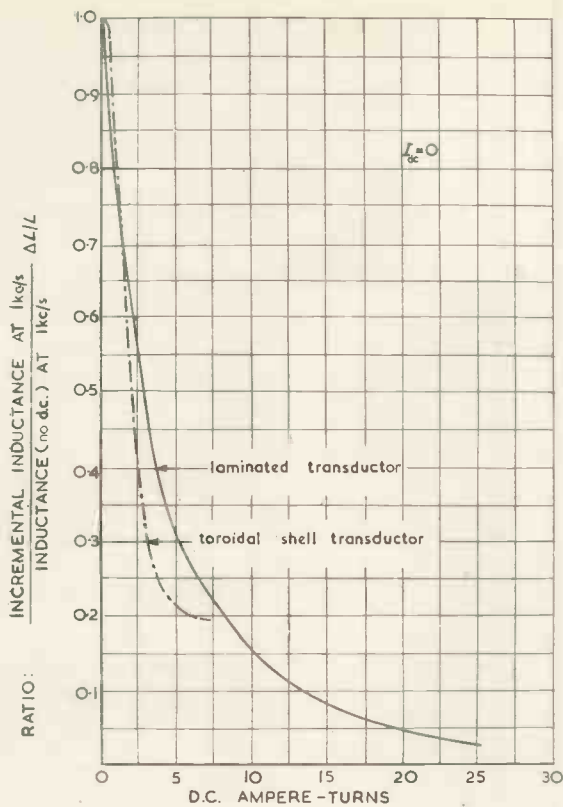

(a)

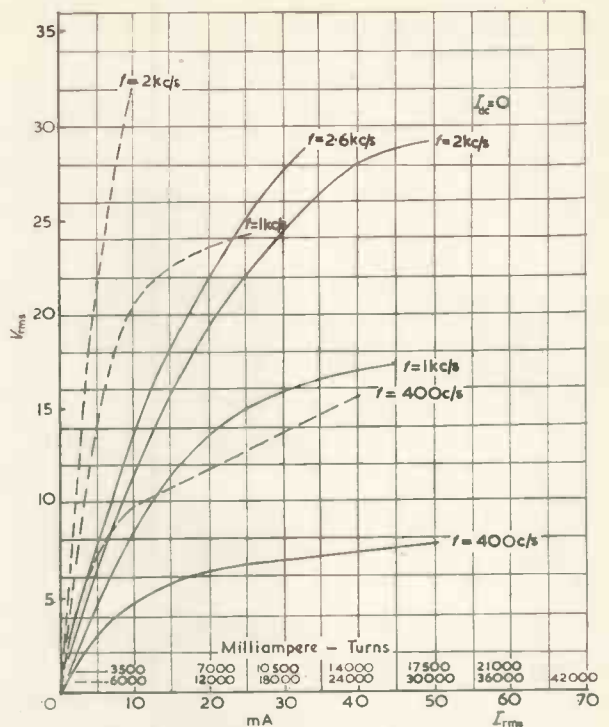

(b)

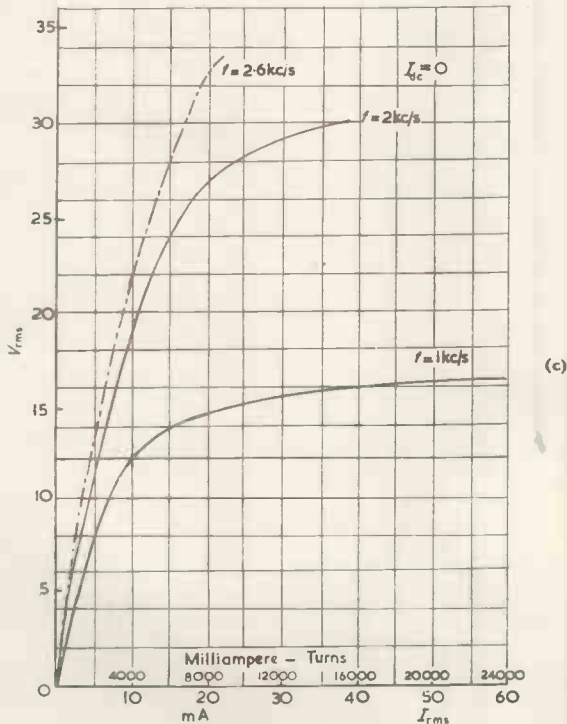

(c)

Fig. 16. D.C. and a.c. saturation characteristics of sub-miniature transductor shown in Fig. 11, and toroidal-shell transductor shown in Fig. 17 (a) D.C. saturation characteristics of sub-miniature transductor shown in Fig. 11 and toroidal-shell transductor shown in Fig. 17. (b) A.C. saturation characteristics of toroidal-shell transductor. Measurement made with two windings, viz. 600 turns 47 s.w.g. (broken lines) and 350 turns of 45 s.w.g. (full lines). (c) A.C. saturation characteristics of sub-miniature transductor shown—Fig. 11—wound with 400 turns of 43 s.w.g.

transductor as already discussed for the transformers based on the same principle. Fig. 16(b) shows that the above unit has its optimum performance below 1kc/s, the wall thickness being 0.015in and it is worthwhile noting that the optimum thickness for transductors is less than for transformers. For other frequencies this would be scaled in inverse proportions, and the maximum useful power rating remains constant and of the order of 10mW.

ORTHOGONAL MAGNETIC CIRCUITS

The "solid" core can be used with a cup and a lid, or with a cup either side of the lid, with internal coils. Alternatively, the most suitable winding, usually the excitation or control, is wound toroidally about the doughnut core. This is an unusual arrangement, because the signal and excitation fields are then orthogonally related. The core is saturated by the excitation without appreciably cross-coupling into the other windings. In fact this coupling is

Fig. 17. Three miniature transductors of conventional construction (the smallest is 2.1x1.0x1.3cm), (a), (b), and (c), and a toroidal shell core (d) equivalent in performance to (b)

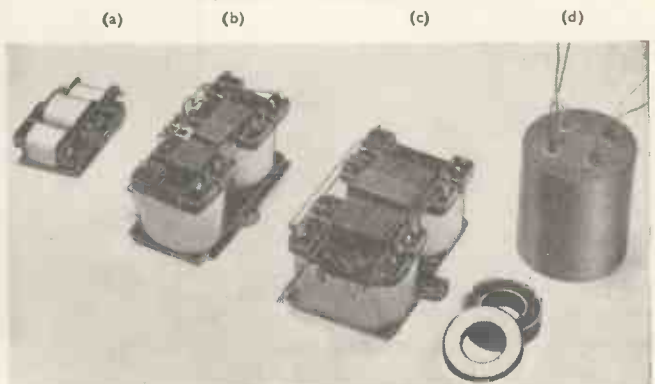

responsingly improved electrical characteristics and shorter air-gap).

Such a degree of miniaturization relative to conventional practice has important applications where considerable numbers of transductors are used at low signal levels in control system computing and resolving circuits.

There is a critical useful rating for the thin-walled solid

about $\frac{1}{4}$ per cent of that obtained with a winding in the same plane as the others.

Something similar has been used for sub-harmonic generation in the "magnetic cross valve"^{6,7}, and for transducers and magnetic modulators it appears to be limited to the lower power levels where the shell can be the thickness of a single lamination.

The losses are a little higher than a conventional trans-

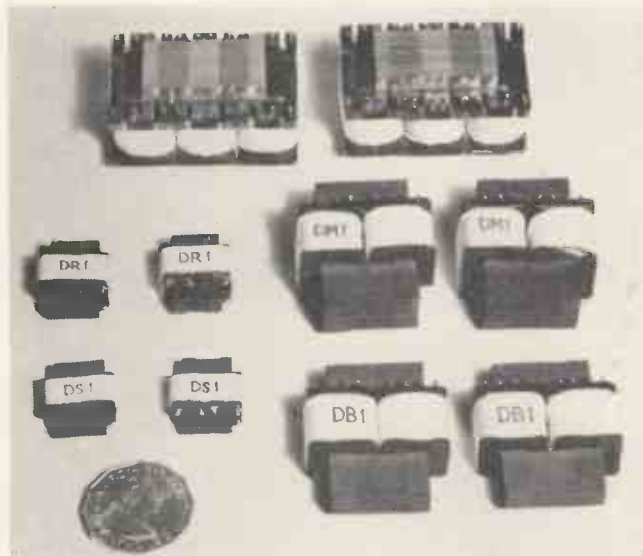

Fig. 18. Example of three-limb and two-limb miniature transformers. The volt-ampere ratings per pair at 400c/s are respectively 2VA, 0.5VA, 0.2VA, 80mVA and 40mVA.

ductor due to peripheral and circumferential eddy currents, but it is not worthwhile, here or in the case of transformers, slotting the core to prevent these currents.

The optimum proportions for the "doughnut" when miniaturizing are obtained by departing from exact scaling. For example, if the wall thickness is halved, it is better to reduce the linear dimensions to only $\frac{3}{4}$, as this minimizes the increase in eddy current losses, due to lowered circumferential resistance, and allows space for a winding of lower

resistance, so that the losses from this source are reduced.

Before concluding, mention must be made of special purpose components. Miniature inductors adjusted to resistance or inductance tolerances of a few percent, windings with multiple tapplings for experimental work and balanced chokes of low leakage inductance are now almost as commonplace as their larger counterparts.

Finally in an attempt to assess or summarize the present and future position of the sub-miniature inductor it may be stated that while copper loss is high and circuit Q values are relatively low, the requirements of low-level amplifiers are adequately met over the audio range. When attempting to improve the high frequency response or to operate very small units as transducers even at moderate frequencies it is necessary considerably to reduce iron losses, and solutions to the problems involved in the production and handling of very thin laminations have to be found. The alternative is to abandon conventional constructions and to adopt, for example, wound strip or ferrite core materials, which in turn have their own disadvantages, including that of higher cost. In this connexion ferrites having effective permeability approaching those of the thinner tape wound cores are becoming available.

At the other end of the scale the provision of the maximum possible inductance at low frequencies depends on materials of very high permeability which are only fully exploited if gapping losses are small and, unfortunately, if polarizing flux and current are also of a low order. Any improvement in the situation awaits the availability of better alloys than are at present obtainable.

REFERENCES

1. JOHNSON, L. B. An Improved System for Calculating the A.F. Performance of Junction Transformers. *Mullard Tech. Commun.* 1, 186 (1954).
2. DUNKIN, E. F., JOHNSTON, D. L. Subminiature Transformers and their Application to Junction Transistor Circuits. *Inst. Radio Engrs Transactions on Component Parts (PGCP-3)*, 30 (1955).
3. ROCKETT, F. Iron Core Transformers Run Smaller and Hotter. *Electronics*, 27, 136 (Nov. 1954).
4. SOWTER, G. A. V. Harmonic Distortion at Low Frequency in Circuits Containing Apparatus with Ferromagnetic Cores, especially High Permeability Nickel-iron Cored Transformers and chokes. (University of London Ph.D. thesis, 1945).
5. FORTHPHONE Ltd, patent applications 9170/54 and 13630/54.
6. HIGA, W. H. Theory of Magnetic Cross Valves. *Commun. Elect.* 18, 204 (1955).
7. MCCREARY, H. J. The Magnetic Cross Valve. *Trans. Amer. Inst. Elect. Engrs.* 70, Pt. 2, 1868 (1951).
8. MILNES, A. G., HUDSON, C. S. A range of 400 c/s and 1600 c/s Transducers for service use. *Electronic Engng.* 25, 322 (1953).
9. LEE, Reuben. *Electronic transformers and circuits.* (John Wiley & Sons Inc. New York. 1955).

Airborne Radio-Teleprinter

A new means of communicating information to the pilot of an aircraft in flight was yesterday successfully accomplished for the first time.

A British Overseas Airways Corporation Stratocruiser on a scheduled flight from London to New York automatically recorded on an airborne Teleprinter meteorological and navigational reports transmitted by radio stations in Britain and Newfoundland.

The special radio receiver used in the aircraft required no attention from the pilot other than switching from one frequency to another in mid-Atlantic. The Teleprinter started up automatically when signals destined for it were transmitted from the ground, and switched itself off at the end of each message. The flying staff were able to read as required the messages typed out on the page-teleprinter.

The experiment was carried out by B.O.A.C. in conjunction with the Ministry of Transport and Civil Aviation, and Standard Telephones and Cables Limited who built the special radio receiver and engineered the airborne installation, which weighs only 40lb. The Teleprinter used was developed for airborne use by Creed and Co. Ltd.

The airborne receiver and teleprinter

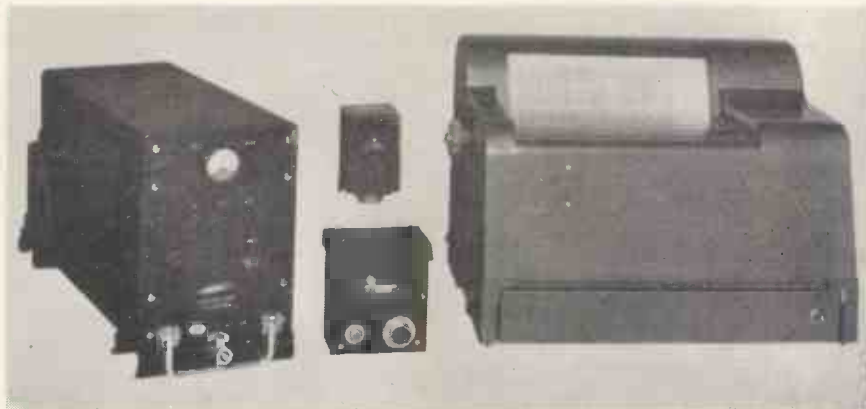

The Gas Filled Diode as a Digital Storage Element

By B. R. Taylor*, M.A. and R. Bird*, M.Sc., D.I.C.

The fact that gas filled diodes can be used as elements for the storage of binary information has already been indicated, and a scheme for the use of such diodes in a digital computer store has been described^{1,4}. The property of the gas filled diode which enables it to be used for storage is that of the difference between its igniting and burning voltages. The present article outlines two schemes for the use of such diodes; one in a computer input buffer store; the other in a parallel access computer store. The article also includes a description of the relevant characteristics of the special "difference diodes" used, and the results of experiments on their igniting and extinguishing times, and on their life.

GAS discharge diodes may be ignited by a potential difference (say V_i), the value of which depends upon the gas used, the pressure and the physical construction of the diode. If the diode is connected to a supply potential (V_s) through a resistance (R), when it is ignited the potential across the diode will fall to V_b (the burning potential) provided that $V_s > V_b$ and the current through the diode is within certain limits. This current $I_b = (V_s - V_b)/R$ and has a minimum value i_m below which the discharge will not maintain. In the case of difference diodes the design is such that $V_i \gg V_b$. This makes it possible to establish a constant voltage V_m such that $V_i > V_m > V_b$ allowing for the variation of V_i and V_b between diodes, and thus the continuous application of V_m through a resistor will maintain any diode in whatever state it happens to be.

The majority of experiments and working tests referred to were carried out on the Hivac XC14 difference diodes though a small amount of work has been done on the XC17 (a diode designed for greater speed in igniting and extinguishing.)

IGNITING VOLTAGE, BURNING VOLTAGE AND LIFE TESTS

The XC14 data sheet gives the initial V_k as 145V to 170V, and the initial V_b as $75V_{max}$ at $i_b = 0.5mA$. It is recommended that a diode should be regarded as having ended its life when V_i moves outside the range 140V to 180V, or when V_b rises above 80V. The value of i_m is given as $20\mu A$ with a $400k\Omega$ resistor in series, this value increasing as the resistance decreases.

Life tests were carried out on 50 XC14's, 30 of which were burnt continuously at approximately 0.5mA for 8 500 hours. The circuit consisted of $V_s = 150V$ and $R = 150k\Omega$ connected from diode cathode to earth. The remaining 20 were burnt at approximately 0.2 mA for about 2 500 hours and during this time they were pulsed continuously with a 100V negative going blocking oscillator pulse of about $5\mu sec$ duration, the p.r.f. being 1kc/s. This was applied to their cathodes through 150pF capacitors while R in this case was $390k\Omega$. Igniting voltages were periodically tested by measuring a slowly rising h.t. voltage and noting the values at which the various diodes ignited, while the burning voltages were read directly on the diodes.

It was found that 8 of the diodes in each group started life with $V_i < 145V$, none being outside the other stated voltage limits. Of the remaining 34 diodes, 2 rose suddenly above $V_i = 180V$ end of life limit, number 1 after 100 hours, and number 2 after 8 500 hours due to an air leak in both cases. The V_i of one (number 3) rose slowly and passed 180V at 3 400 hours. The V_b of all surviving diodes stayed beneath the 80V limit. The general trend in ignit-

ing and burning voltages was upwards, and was more pronounced in the case of those not being pulsed.

Extending the lower limit of the igniting voltage range to 140V initially and 135V for end-of-life, gave 4 initially unsatisfactory diodes among those which were not pulsed, and only 1 among those which were. Of the remaining 45, the only eventual failures were numbers 1, 2 and 3 above.

It appeared that little information as to the ultimate fate of a diode was to be gained by observing the trend during the first 100 hours or so, although number 1 above had failed during that time.

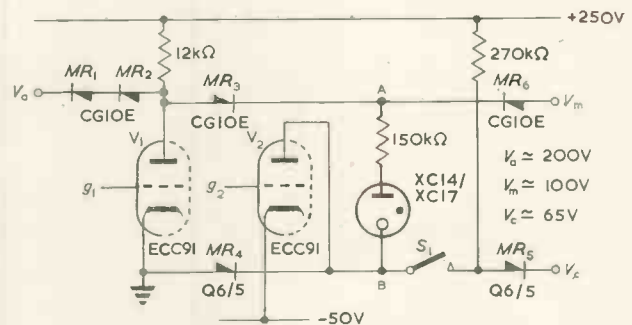

Fig. 1. Circuit for testing igniting and extinguishing times

IGNITING AND EXTINGUISHING TIME TESTS

Tests were carried out on about a dozen XC14's, and on a similar number of XC17's to get some idea of igniting and extinguishing times, where these were defined as the amount of time during which a change in voltage must be applied to a diode in order to ignite or extinguish it; the frequency of test being low (up to about one per second).

The circuit shown in Fig. 1 was used. Both V_1 and V_2 were normally conducting so that the CG10E germanium rectifiers ($MR_{1,3}$) were cut off, and point A was established at V_m . The diode, if initially burning, was maintained through V_2 , but point B could not fall below earth potential owing to the Q6/5 selenium rectifier (MR_4). To ignite a diode, a negative pulse of known length was applied to g_1 cutting off V_1 and allowing the anode to rise until clipped at V_a thus taking point A to V_a . This applied V_a to the diode, and by altering the pulse length, a point at which ignition just occurred could be found. To extinguish a diode a negative pulse of known length was applied to g_2 , cutting off V_2 and allowing its anode to rise until clipped at V_c . This applied a potential of $V_m - V_c$ to the diode, and again the pulse length could be altered and the length required for extinguishing found. The voltage $V_m - V_c$

* The British Tabulating Machine Company Ltd.

helped to disperse the ions in the diode, and by varying V_c an optimum value was established.

It was found that, particularly in the case of igniting times, very extensive tests would be necessary to establish any definite readings, as the time varied with V_m , V_a , the degree of illumination and the length of time for which the diode had been extinguished; it was also affected by knocking or vibration. It is also possible that other variables (e.g. electromagnetic pick-up and temperature) may affect the time significantly. It was, however, established that igniting times decreased with increasing illumination, with knocking and vibration and that they increased with the amount of time (T) which had elapsed since the diode had last been operating (up to T equals a minute or so). With $V_m = 100V$ and $V_a = 210V$, and with a diode in daylight, the longest igniting time found was $300\mu\text{sec}$. With the variation encountered it was impossible to distinguish between XC14's and XC17's.

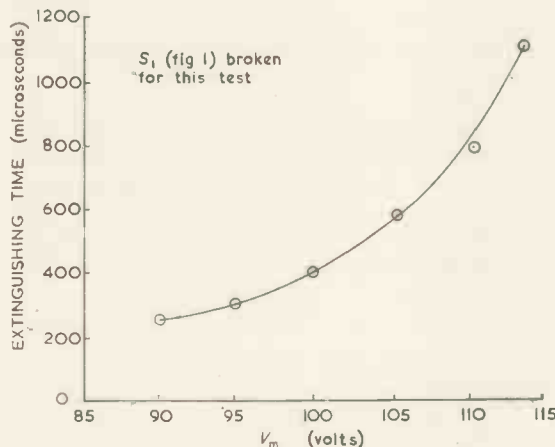

Fig. 2. Extinguishing time for an XC14

The extinguishing time varied with V_m and with V_c . It decreased with decreasing V_m due to a reduction in I_m (see Fig. 2) and seemed to be a minimum with $V_m - V_c = 30V$ to $40V$. The extinguishing time seemed to vary much less with other conditions. With $V_m = 100V$ and $V_c = 65V$, the longest extinguishing time found was $500\mu\text{sec}$ in the case of XC14's and $350\mu\text{secs}$ in the case of XC17's.

PULSATING THROUGH XC14'S.

If a change of potential is applied to one electrode of a burning gas filled diode, and if it is not of such a size and polarity as to extinguish the diode, it will emerge at the other electrode with attenuation and distortion depending upon the frequency spectrum of the input, and upon the impedance of the output circuit². A short pulse of a few microseconds duration will be attenuated more than a long one over the majority of its duration, but such a pulse will have no tendency either to ignite or extinguish a diode¹.

OSCILLATIONS

The XC14 diodes when ignited have a natural internal oscillation of $3V$ or so peak-to-peak amplitude and about 50kc/s p.r.f. The oscillation is approximately sinusoidal, and it does not seem to be possible to exercise it by altering the current through the diode. It is suspected that the oscillation is due to the negative resistance region in the diode characteristic³, though it has a much higher frequency than the sinusoidal oscillation mentioned in the reference.

SHIELDING

In some cases in which a diode was situated close to a metal chassis it was possible to ignite it even though, apparently, the striking voltage was not exceeded. This

effect appeared to be due to distortion of the electrostatic field within the diode, owing to the proximity of a conductor.

A metal shield round the diode returned to the cathode, prevented disturbance of the internal field and thus removed the effect. Alternatively, the diode could be removed from the proximity of conductors.

The Use of Difference Diodes in a Computer Input Buffer Store

Input to a computer involves a change in the speed at which information is handled, from the comparatively slow speeds of the mechanical input unit to electronic speeds. To hold up the computer while a particular batch of information is fed into it would be wasteful in calculating time, and for this reason buffer stores, which store the information taken from the mechanical unit, and emit it to the computer at electronic speed, are exceedingly useful. "Square loop ferrite" cores are popular for this purpose, but difference diodes can be used, and it is felt that the fact that the same information can, if necessary, be read from them several times without the necessity for resetting and that they can be visually checked, gives them advantages over cores.

An input buffer store capable of storing 80 decimal or sterling digits (a digit being defined for this purpose as a number from 0 to 11) on 320 diodes built into a mesh, has been built and tested. No number greater than 11 was actually stored as one digit, though it would have clearly been possible to extend the range to '0 to 15'. The device was designed to work in conjunction with a "Hollerith" punched card feed unit. The essentials are shown in Fig. 3.

INPUT TO THE STORE

Referring to Fig. 3, each diode has associated with it a vertical line, to which its cathode is connected through a $150k\Omega$ resistor, and a horizontal line to which its cathode is connected through a Q3/5 Unistor type of selenium rectifier. There are 80 vertical lines, each connected to one of 80 punched card hole sensing brushes on the feed unit. Each brush scans one column of an 80 column Hollerith card, and is connected to earth each time it senses a hole in the card. There are 11 possible hole positions in each column, and for each of these a different combination of the four emitter brushes and with them them appropriate horizontal lines, takes up a potential of $+110V$. This combination which is the binary equivalent of the hole position is controlled by the revolution of the coded commutator called the emitter. Only when a horizontal line is *not* connected to $110V$ via the emitter, and a card brush is earthed through a hole, will a diode ignite due to the application of the full $215V$ since the transformer primary windings present a low impedance to d.c. The diodes may be extinguished by breaking the $+110V$ line. The store is divided into 8 sections, each section storing 10 decimal or sterling digits in a computer word.

The authors feel that this method of setting up a diode using a gate consisting of a resistor and a rectifier is preferable to the use of voltage adding on resistors. The latter method considerably narrows the difference between the two voltages which are applied across a diode when it is required to ignite and to maintain it respectively. Due to this, the variation in characteristics from diode to diode, and the ageing of diodes, the tolerance of the circuit to supply changes becomes dangerously low.

OUTPUT FROM THE STORE

One section of the store at a time can be read out in parallel into a 40 stage register (on right in Fig. 3). Informa-

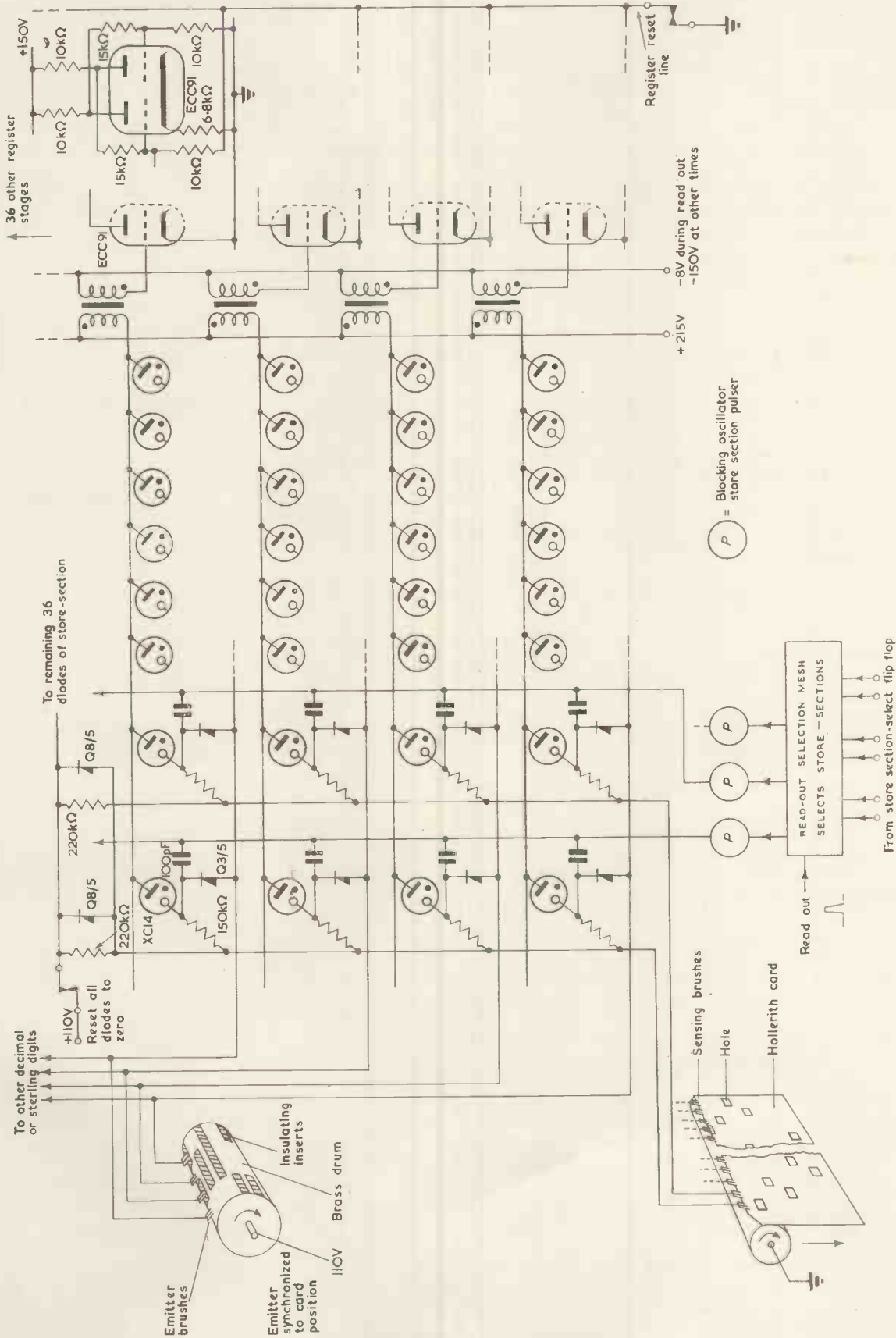

Fig. 3. Input buffer store.

tion stored in the register can then be fed into the computer in serial or in serio-parallel form. 100V negative 5 μ sec blocking oscillator pulses are fed to all the 100pF capacitors (connected to the diode cathodes as shown) associated with one selected store section. The selection is performed on a diode mesh which decodes the binary number of the desired section stored on three triggers, into the stimulation of one of the eight pulsing lines. The anodes of the 40 diodes in the section go, through 40 pulse inverting and amplifying transformers and set-up valves, to 40 different register stages. Each diode in a section, and each register stage, has a different significance in the resulting binary coded decimal or sterling number. The anodes of all 8 diodes having the same significance in each of the

further experimentation on the use of a single pulse read out, the access time may be reduced to 10 μ sec.

The recording time is, however, slow with the diodes at present available since it is necessary to extinguish diodes already ignited, and a millisecond should be allowed with the XC14 diode and the circuit proposed. As with the input buffer store the diodes indicate their contents visually and reading out does not destroy their contents.

Fig. 4 shows a portion of a possible digital store. Each vertical column of diodes is of one word length, the number of columns corresponding to the number of words stored. The diodes in one horizontal row store the binary digits of the same significance in each of the words, and all have access to the trigger V_2 in the input-output staticizer.

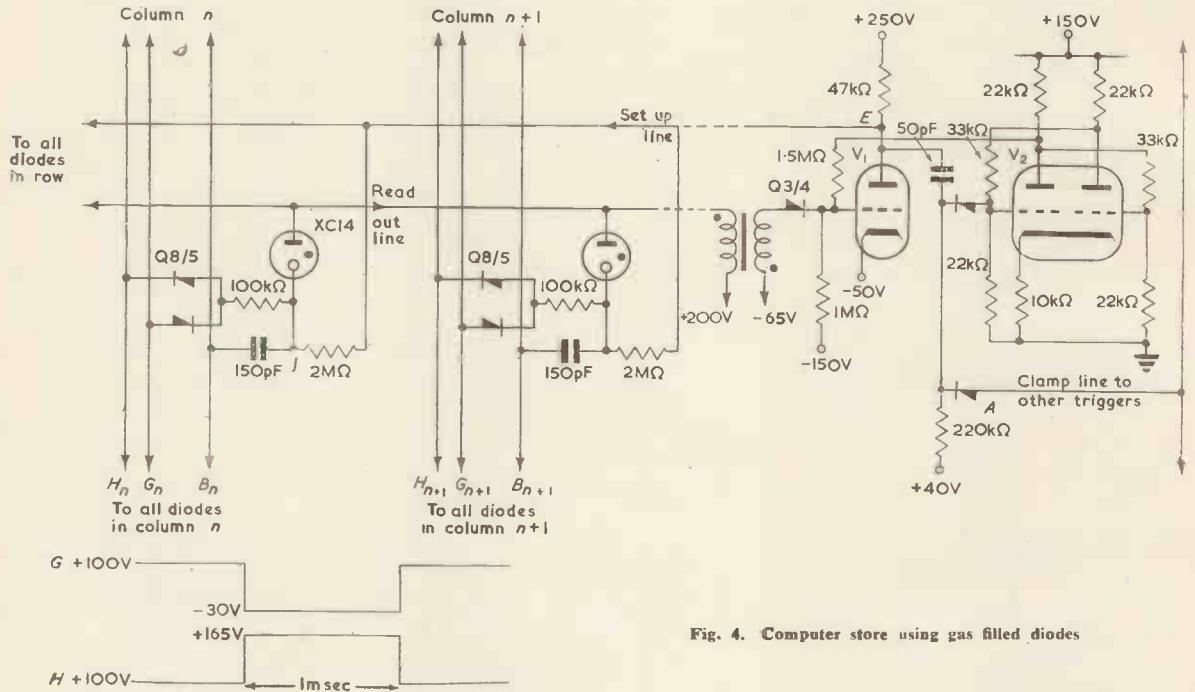

Fig. 4. Computer store using gas filled diodes

8 store sections are connected together, but only the diodes of the section being pulsed have any effect on the register stages. No pulses can get through diodes which are not ionized. It is found necessary to pulse with a burst of pulses rather than with one only, possibly because of the effect of the parasitic oscillation referred to previously. Four or five pulses at 20 μ sec interval are used successfully.

In order to test the efficiency of the store, the device constructed also incorporates means of checking the number set in the register against a number set on switches and uniselector contacts which represents the correct result for each card; this correct set-up is altered from card to card so that a failure to reset the store or register is detected. Only one store section of 40 bits is pulsed into the register and checked for each card, but the section pulsed varies from card to card.

One million cards have been fed into the device and checked, at a speed of 160 cards per minute. Five errors which were not due to the test circuits or to supply variations, were detected during this run.

The Parallel Access Computer Store

It is thought that the difference diode may be used to construct a matrix type store which may be recorded into, and read out of, electronically.

The access time for "read out" using a burst of pulses as described previously is about 100 μ sec, though with

There is one trigger per digit position of the computer word and it may form one stage of a shifting register.

The triode V_1 performs the dual function of an amplifier for both recording into and reading out of the store.

It is directly coupled to the trigger V_2 so that if the trigger is in the zero state with its left-hand anode at the "low" potential of 55V, V_1 will be cut off and its anode potential E will be about 220V. If, however, the trigger is in the one state its left-hand anode potential will be 105V and E will fall to approximately earth potential.

When it is desired to record into say column n of the store, the two vertical lines G_n and H_n corresponding to that column have impressed on them the waveforms G and H . Previous to this the cathodes of the diodes in column n had been connected to 100V via the 100k Ω resistors and the two Q8/5 Unistor type selenium rectifiers. If the diode is already ignited the point J will be at a potential of $(200 - V_b)$ volts. The waveforms G and H allow the point J to swing up or down in potential dependent upon the potential at E since the back resistance of the Q8/5 rectifiers is high compared with the 2M Ω resistor to E . If it is desired to store a 1, E is about earth potential and the diode ignites via the 2M Ω resistor if it was not already ignited. If a zero is to be stored then E is at about 200V and there is no potential source to maintain the diode if it was previously alight, so that it is extinguished.

Line H rises to 165V only during recording so that a

potential of about 35V remains across the diode to speed ionization.

Before read-out all triggers are cleared to zero electronically by circuits not shown. To read out word n from store the line B_n is pulsed with a burst of 4 or 5, $5\mu\text{sec}$ 100V negative going pulses spaced about $20\mu\text{sec}$ apart. Concurrently the left-hand grid of the trigger is "unclamped" by a negative pulse on line A . The purpose of this clamp line is to prevent disturbing the trigger state during recording or shifting. The reading pulses along B_n will pass through an ignited diode and be inverted by the transformer. The positive pulses from the transformer secondary are amplified and inverted by V_1 (which is maintained just below cut-off via the Q3/4 Unistor and the transformer secondary) and so sets the trigger by pulsing its left-hand grid.

A full scale store has not been constructed but the conditions have been simulated by a test circuit of a horizontal row (of 8 diodes) and a vertical column (of 40 diodes). More

than eight diodes on a horizontal row would probably require the division of the diodes into groups, each with its own inverting transformer and buffer rectifier.

The test circuit gave no errors for the limited period for which it was operated.

Acknowledgment

The authors gratefully acknowledge the help of Messrs. F. Foot and D. Hare, of the Research Laboratories of The British Tabulating Machine Company Ltd, in this work, and thank the Technical Director, Mr. C. G. Holland-Martin, for permission to publish this article.

REFERENCES

1. COUFFIGNAL, L. La Machine de L'Institut Blaise Pascal. Report of a Conference on High Speed Automatic Calculating Machines. (University Mathematical Laboratory, Cambridge, January 1950).
2. MACKAY, R. S., MORRIS, H. D. Transient Response of Glow Discharges with Applications. *Proc. Inst. Radio Engrs.* 42, 961 (1954).
3. EDWARDS, P. L. Relaxation Oscillations in Voltage-Regulator Tubes. *Proc. Inst. Radio Engrs.* 41, 1756 (1953).
4. Gas Diode Circuits for Electronic Computers. *Tele Tech.* p. 61 (July 1955).

New Microwave Television Link for I.T.A.

The General Electric Co. Ltd. has supplied and installed equipment for the Post Office for a microwave link between Birmingham and Lichfield. This extends the existing G.E.C. microwave link from London to Birmingham and the combined links will bring I.T.A. programmes from London to Lichfield. The new link went into general service on 17 February, with the inauguration of the I.T.A. programmes in the Midlands.

The microwave system provides two channels operating simultaneously on different radio frequencies in the direction Birmingham to Lichfield, and one channel in the reverse direction, each channel conveying vision programme signals. The two channels conveying signals to the transmitter accept a common input signal, and at Lichfield give two independent but identical outputs, thereby providing a high degree of reliability.

The microwave equipment was manufactured, supplied and installed by The Telephone Works of The General Electric Co. Ltd., in Coventry. During recent years the Company has supplied similar equipment for the cross-channel link which permits the interchange of programmes between the BBC and the Continent, the Swiss network across the Alps, the link in Canada between London and Windsor in the Province of Ontario, and between London and Norwich to feed the television transmitter serving East Anglia.

The new Birmingham to Lichfield link is 12 miles long. The system operates in the 1700 to 2300Mc/s band, and employs frequency modulation, which, together with the carefully designed circuits, gives the high performance required.

Other features of the equipment are the ultra high frequency coaxial-line oscillator, non-contact bridges for tuning r.f. equipment and amplifier circuits employing disk-seal coaxial-triode valves.

At each end of the system all three channels are radiated and received on a common aerial. Each aerial consists of a spun-aluminium paraboloid reflector, 8ft in diameter at Birmingham, and 12ft in diameter at Lichfield. These highly-directive aerials give an effective radiated power of about 1.5kW concentrated in a 5 degree beam. The multiplexing of channels is accomplished by the use of a double-probe launching unit and specially-designed combining filters.

The aerial at Birmingham is mounted on the top of Telephone House, 133ft above ground level, while at Lichfield

the aerial is mounted, at a height of 140ft, about one-third the way up the new Lichfield Television Station tower.

To prevent the ingress of moisture into the low-loss air-spaced coaxial-feeder cables, dry-air pressurization is used.

Transfer of BBC's London Television Station to Crystal Palace

The BBC's new London television transmitting station at Crystal Palace was brought into service on 28 March. The transmissions from the Alexandra Palace station, which began the first regular high-definition television service in the world in November 1936, have now come to an end. The new station incorporates the latest technical developments designed to improve the quality of the pictures and the reliability of the service.

The new transmitters operate on the same frequencies as Alexandra Palace (Channel 1, vision 45.0Mc/s, sound 41.5Mc/s) and the transmissions are vertically polarized.

Initially, the Crystal Palace station will use an aerial system mounted on a temporary 250ft mast and the effective radiated power will be 60kW (Vision), compared with 34kW from Alexandra Palace. This will give a considerable improvement in reception in the south-east of England. In some areas to the north-east of London the signal will be slightly weaker, but this will apply only until the summer of this year, when the signal-strength will be restored by the use of an improved aerial erected on the permanent tower at the Crystal Palace. This will increase the effective radiated power of the vision signal to 120kW. The final aerial on the finished tower is expected to be available for service before the end of 1957, when the e.r.p. will be further increased to 200kW.

Each stage of the development will be accompanied by an increase in the population served and the permanent installation is expected to bring about 1 200 000 more people within the service area of the London station. Moreover, for the great majority of viewers the effect of interference will be reduced because of the increase in power.

As already announced, it has been decided after consultation with the G.P.O., the Radio Industry and the Trade that the Crystal Palace station will use the same method of transmission of the vision signals as is used at all the post-war BBC television stations, the upper sideband being partially suppressed. In this respect the new station will differ from the existing station at Alexandra Palace which transmits both sidebands equally.

Band-Pass Characteristics of Low Asymmetry

By B. Easter*, M.Sc., A.M.I.E.E.

The nature of the asymmetry of conventional band-pass filter characteristics is considered using the concept of the complex frequency plane. An empirical rule is then stated whereby characteristics of much reduced asymmetry may be designed. The discussion is illustrated by two band-pass characteristics of similar form, one derived by conventional methods, and one by the procedure described.

IT can be shown from fundamental theory that a linear finite lumped-constant network cannot have a band-pass characteristic which is perfectly symmetrical about a frequency within the pass-band. In practical cases the degree of asymmetry will depend on the type of network and the ratio of the bandwidth to the nominal centre frequency of the pass-band. In general, the asymmetry may more easily be made small when this ratio is small. Interest in this subject has recently become increased due to two factors. Firstly, while larger bandwidths are being demanded in modern communication systems, the centre frequency of the amplifiers (e.g. intermediate frequency) passing these bandwidths may be limited by considerations of stability and valve performance; thus the passband may be a relatively large fraction, 0.3 to 0.5, say, of the centre frequency, and the asymmetry of the characteristics may be undesirably large if conventional design methods are used. Secondly, group delay characteristics are important in many modern applications, for example, in systems carrying frequency-division multiplex signals by frequency modulation. The asymmetry of the amplitude characteristic is relatively unimportant since the pass-band may be designed to have sufficiently small variations over the required range, but the asymmetry of the group delay characteristic makes the problem of equalization more complex, and the resulting networks more critical in adjustment and stability.

There would appear to be little published information on this subject. Rideout¹ has given details of a design having low asymmetry, but this is a special case, and no hint of a more general approach is given.

The General Response Function²

We briefly consider here the general response function $H(p)$ where

$$H(p) = \frac{\text{Output Voltage (or Current)}}{\text{Input Voltage (or Current)}}; p = j\omega$$

The relative amplitude response will be given by

$$A_{dB} = 20 \log_{10} |H(j\omega)|$$

The relative phase response will be given by

$$\phi = \angle H(j\omega)$$

It is well known that if the response is that of a linear lumped circuit, $H(p)$ will be a rational function of p , so that the response may be completely defined by the zeros and poles of $H(p)$, together with a multiplying constant. The relative amplitude response and the group delay characteristic may be considered as the sum of the contributions associated with each zero and pole since the latter are associated with the factors of the numerator and denominator of $H(p)$ respectively.

The contribution to the amplitude response from a single pole at $p = \sigma_0 + j\omega_0$ is given by

$$-10 \log \left[1 + \left(\frac{\omega - \omega_0}{\sigma_0} \right)^2 \right] \text{ dB}$$

and the contribution to the group delay is

$$-1/\sigma_0 \left[\frac{1}{1 + \left(\frac{\omega - \omega_0}{\sigma_0} \right)^2} \right] \text{ seconds}$$

The contributions from a zero will be of opposite sign. Note the symmetry of the contributions about the frequency ω_0 . Poles and zeros with complex co-ordinates will appear in conjugate pairs, and poles will only appear in the left-half plane, i.e. $\sigma_0 < 0$, if the network is positive, or active and stable.

Conventional Designs

An important class of band-pass circuit is formed by those having amplitude and phase characteristics which are symmetrical with respect to a logarithmic frequency scale. This includes characteristics which may be derived from low-pass characteristics by the simple transformation.

$$S = p + \omega_0^2/p$$

This transformation is equivalent to taking the low-pass network and adding a capacitance in series with each inductance, and adding an inductance in shunt with each capacitance, in all cases to produce circuits resonant at ω_0 . Examples are the constant- k band-pass filter and all symmetrically derived sections, some of the responses associated with the simple tuned circuit, and some of the staggered circuit arrangements used in valve amplifiers.

Further discussion of this class of characteristics will help to illustrate the factors associated with asymmetry.

Consider a band-pass characteristic of this type, having a pass-band which is only a very small fraction of the centre frequency ω_0 . We find that $H(p)$ has an approximately symmetrical group of poles and zeros in the neighbourhood of $+j\omega_0$, a conjugate group near $-j\omega_0$, and equal numbers of zeros at the origin and infinity. The number of zeros at the origin is equal to the number of poles in the group near $+j\omega_0$ less the number of zeros in the group. The response characteristics will be very nearly symmetrical in the vicinity of the pass-band. The main contribution to the relative response comes from the group of critical frequencies near $+j\omega_0$, the contributions from those at the origin and those near $-j\omega_0$ being small, as they are relatively remote from the pass-band. If, however, we examine the case of a pass-band which is an appreciable fraction of the centre frequency, a considerably greater degree of asymmetry will be apparent. Each group of critical frequencies is noticeably asymmetric and the contribution to the relative response from the zeros at the origin and the critical frequencies near $-j\omega_0$ is significant. As a relatively simple example, consider a fourth order Tchebyshev characteristic of bandwidth 0.5dB. The response is given in Fig. 1, the most noticeable feature being the relative rise of delay at the lower limit of the pass-band. This is to be expected, since the phase characteristic is symmetrical with respect to a logarithmic frequency scale. The contributions from the zeros at the

* The General Electric Co. Ltd, Wembley, England.

origin and the poles near $-j\omega_0$ are shown in Fig. 2 and it will be seen that while the amplitude component is large, the contribution to the delay is negligible. The configuration of the poles near $+j1.0$ is shown in Fig. 3, there will be a conjugate set near $-j1.0$ and four zeros at the origin. The asymmetry of the pattern of Fig. 3 is quite apparent: the poles lie in two pairs along radii from the origin. This asymmetry is necessary if the contribution to the amplitude response from these poles is to correct the slope of Fig. 2, and results in the asymmetry of the group delay shown in Fig. 1.

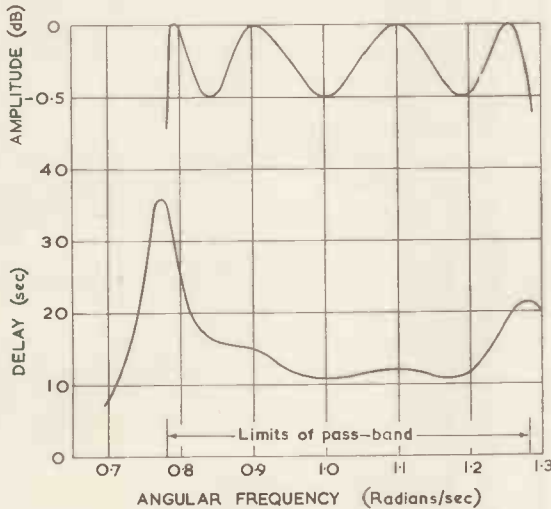

Fig. 1. Response of conventional band-pass characteristic

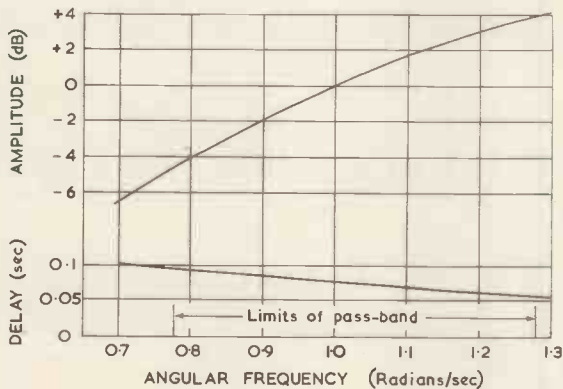

Fig. 2. Conventional design

Contributing to the response of Fig. 1 from zeros at the origin and poles near $-j1.0$.

It would seem that little improvement can be obtained by variation of the pole positions, at most a compromise can be effected between the asymmetries of the amplitude and group delay characteristics. However, as will now be shown, reduced asymmetry can be achieved by control of the number of zeros at the origin.

Characteristics of Low Asymmetry

In general it is found that if the number of zeros at the origin is made one half of that given by the corresponding characteristic of the class discussed above, the contribution to the relative amplitude response from the critical frequencies remote from the pass-band is very much reduced.

To illustrate this, we take the same basic example as already used, but assume only two zeros at the origin, and arrange the poles near $+j1.0$ (and at $-j1.0$) in the

symmetrical pattern given by the low-pass characteristic, as shown in Fig. 4. The response characteristics are shown in Fig. 5. As is shown in Fig. 6 the contributions to both the delay and the amplitude from the critical frequencies remote from the pass-band are small. The effect on the amplitude response is not negligible, but is only slightly asymmetric, and improvement could be made if necessary

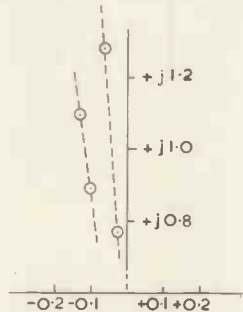

Fig. 3. Conventional design Configuration of poles near $+j1.0$

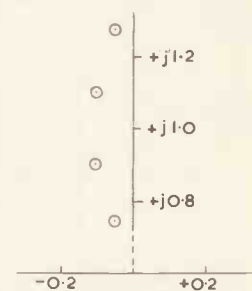

Fig. 4. Improved design Configuration of poles near $+j1.0$

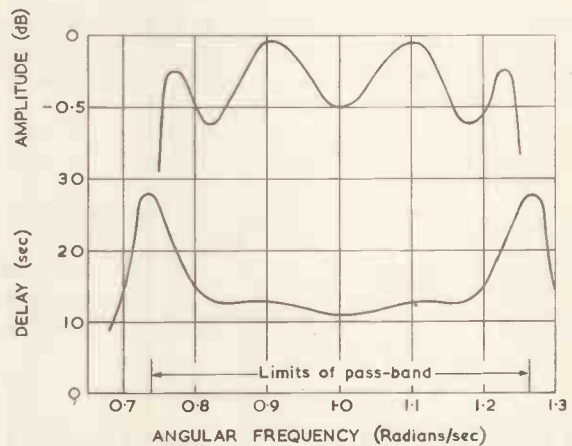

Fig. 5. Response of improved design

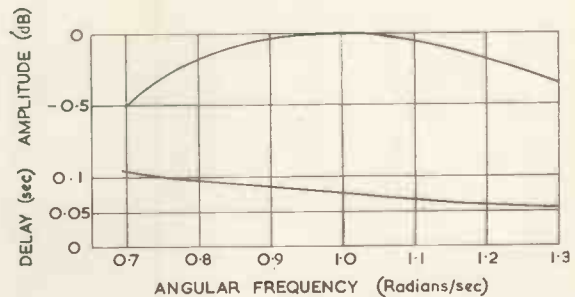

Fig. 6. Improved design

Contributions to the response of Fig. 5 from zeros at the origin and poles near $-j1.0$.

by empirical adjustment of the pole positions without serious effect on the group delay characteristic. It is to be noted that variations of group delay over any bandwidth centred at $\omega = 1.0$ have been reduced as compared with Fig. 1.

The design process may be summarized as follows:—

- (a) Design a low-pass function having the desired characteristics and a bandwidth of one half the required overall bandwidth. It must have an even order zero at infinity.
- (b) From each critical frequency $\sigma + j\omega$ of the low-pass

characteristic obtain two critical frequencies $\sigma + j(\omega \pm \omega_0)$ of the band pass characteristic, which is to be centred at ω_0 .

- (c) Choose the number of zeros at the origin equal to half the order of the zero at infinity in the low-pass case.

It is of interest that the response characteristics of the resulting design may be calculated from the response of the low-pass case in its band-pass and stop-band.

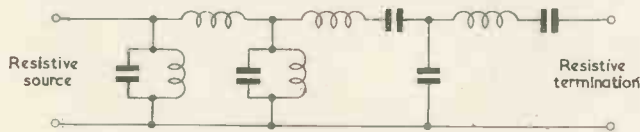

Fig. 7. Improved design
Possible configuration giving response of Fig. 5

For the example illustrated by Figs. 4, 5, 6, we take as the basis of the design the low-pass characteristic³ given by

$$|H(p)|^2 = \frac{1}{1 + 0.1220 \cos^2 (4 \cos^{-1} (\omega/0.25))}$$

giving a pass-band ripple of 0.5dB, and a bandwidth of 0.25rad/sec. $H(p)$ will have poles at $(-0.043835 \pm j0.25406)$ and $(-0.10583 \pm j0.10523)$; there is a fourth order zero at infinity.

This yields a band-pass characteristic with poles at $(-0.043835 \pm j1.25406)$, $(-0.043835 \pm j0.74594)$, $(-0.10583 \pm j1.10523)$ and $(-0.10583 \pm j0.89477)$, with a second order zero at the origin. This will give a bandwidth of 0.5rad/sec centred at 1.0rad/sec.

Realization of the characteristics may be achieved by insertion loss filter theory. The example above could be realized with the configuration of Fig. 7; it will be seen to

be similar to the coupled circuit filters described by Dishal⁴ and others, but the arrangement of the couplings is critical, as this controls the order of the zero at the origin. Bearing this in mind, it may often be decided by inspection whether a particular configuration can be designed to give characteristics as described. Alternatively the characteristic may be built up by a series of valve interstages as in normal stagger tuned amplifiers.

Conclusions

An empirical rule has been formulated for the design of band-pass characteristics of much reduced asymmetry. The procedure is particularly applicable to cases where the band does not greatly exceed half the nominal centre frequency. While the characteristics obtained are not ideal, further improvement may be made empirically.

A more general approach could yield better characteristics but would not be likely to give such a simple design procedure. It is to be noted that the procedure outlined leads to networks of, at most, only slightly increased complexity as compared with conventional designs. An immediate difficulty would be met in attempting a satisfactory analytical definition of asymmetry for the purpose of a more general approach.

It should be pointed out that the example used to illustrate the discussion was chosen quite arbitrarily: the principle has quite general application, and band-pass characteristics corresponding to any low-pass design may be derived.

REFERENCES

1. RIDEOUT, V. C. A Note on a Parallel-Tuned Transformer Design. *Bell Syst. Tech. J.* 27, 96 (1948).
2. BODE, H. W. Network Analysis and Feedback Amplifier Design. Ch. 7.
3. ORCHARD, H. J. Formulae for Ladder Filters. *Wireless Engr.* 30, 3 (1953).
4. DISHAL, M. Design of Dissipative Band Pass Filters. *Proc. Inst. Radio Engrs.* 37, 1051 (1949).

Two Trigger Circuits Useful as Sources of Rectangular Pulses

By G. G. E. Low*, M.Sc.

Two circuits are described which have been developed in connexion with certain problems in experimental physics. The first circuit is somewhat similar to a simple Eccles-Jordan trigger circuit but the present arrangement has the advantage of a comparatively low output impedance. The second circuit, which involves the use of only small hard vacuum valves, provides a simple method of generating high voltage positive pulses.

THE two circuits described in this note are bistable trigger circuits which in the present applications were controlled by low voltage rectangular pulses from a separate generator. The circuits may, however, be adapted to monostable or even free-running operation, and thus be used as actual pulse generators.

Modified Eccles-Jordan Circuit With Low Output Impedance

The circuit shown in Fig. 1 is in many respects similar to a simple Eccles-Jordan trigger circuit¹. The resistors which usually act as anode loads have, however, been replaced by two triodes (V_2 and V_2'). It is evident that the circuit has two stable positions in either of which one lower triode is conducting and one is cut off. The current through the conducting valve (say V_1) also passes through the resistor (R_1) in the anode circuit and consequently the upper valve in this chain (V_2) is provided with a negative bias. It

follows that the potential of the point x between the two valves is relatively low. In the case of the other chain, V_1' is cut off and consequently V_2' is unbiased and the potential of the point x' is relatively high. Thus, in operation the present scheme is very similar to the simple Eccles-Jordan circuit. In certain applications the circuit in Fig. 1 has, however, an advantage in that the output impedance from point x or point x' is quite low. Calculation shows in fact that, neglecting the currents through R_2 and R_3 , the output impedance from point x is given by

$$r_o = \frac{r}{1-F} = \frac{r_{a2}(r_{a1} + R_1)}{r_{a1} + r_{a2} + (\mu_2 + 1)R_1} \times \frac{1}{1-F}$$

where r represents the output impedance in the absence of feedback (the various symbols in this expression have their usual meanings, the subscripts referring to valves V_1 and V_2). The factor $1/(1-F)$ represents the effect of feedback ($F > 0$). It is evident that for F large, r_o is negative and this corresponds to the unstable state of the circuit which occurs during a transition between the two stable states.

* Department of Physics, University of Reading.

When the circuit is stable F is small and consequently the value of r_o approaches r . The value of F is given by the expression

$$F = x^2 \mu_1 \mu_1' \frac{(r_{a2} + \mu_2 R_1)(r_{a2}' + \mu_2' R_1)}{\{r_{a1} + r_{a2} + (\mu_2 + 1)R_1\} \{r_{a1}' + r_{a2}' + (\mu_2' + 1)R_1\}}$$

where x is the fraction of the voltage change at x or x' applied to the grid of V_1' or V_1 respectively (i.e. $R_3/(R_2 + R_3)$) and the remaining symbols have their usual meanings, the subscripts and dashes referring to the four valves V_1' , V_2 , V_1 , and V_2' . The small value of F , which corresponds to a stable state is a result of the low amplification factor and high anode impedance of the valve (either V_1 or V_1') which is necessarily cut-off in a stable position. Measurements on the circuit shown in Fig. 1 gave output impedances of roughly $2k\Omega$ and $10k\Omega$ for point x at a low potential and at a high potential respectively.

The component values specified are intended only as an example and they are not in any way critical. The grid bias battery can, of course, be replaced by a common cathode resistor.

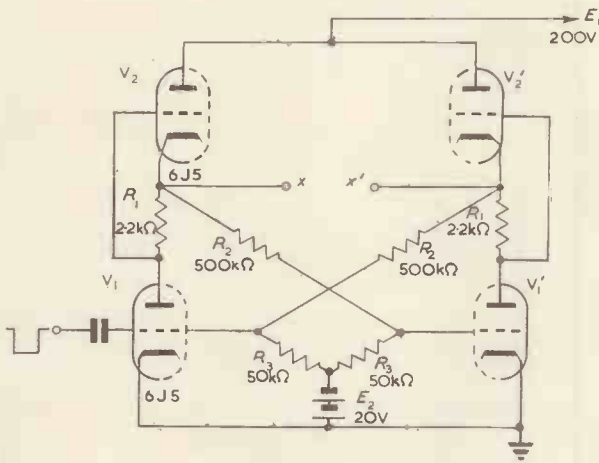

Fig. 1. Modified Eccles-Jordan circuit

Circuit for Providing High Voltage Positive Pulses

As is desirable in all high power pulse systems, the present circuit is arranged so that the output valve is cut off except for the duration of the pulse. The circuit, which is a development of Schmitt's cathode coupled circuit², is shown in Fig. 2. The valve V_1 is conducting except for the duration of a pulse, the self bias provided by the low value cathode resistor R_4 being negligible. In the absence of a pulse, therefore, the voltage drop across V_1 is low and the battery E_2 in the grid circuit of V_2 ensures that the latter valve is cut off. The application of a negative pulse to the grid of V_1 , however, renders it non-conducting and consequently the potential of its anode rises. Thus, the negative bias on the grid of V_2 is removed and this valve conducts heavily causing a large increase in the current through the two resistors R_4 and R_1 in the common cathode circuit. The resulting voltage drop across R_4 is sufficient to bias V_1 to cut-off and thus to perpetuate the state of affairs until the grid of V_1 is forced positive by the trailing edge of the input pulse. The voltage drop across R_1 causes the potential of the cathodes of V_1 and V_2 and their associated grid circuits to change from approximately earth potential to a voltage approaching h.t. Thus a positive pulse output can be obtained from the common cathode junction.

The valve V_3 is used as a load for V_1 in just the same manner as V_2' acts as a load for V_1' in Fig. 1. V_3 is used in the circuit because an important limitation on the rise-

time of a pulse is the rate of charging of the grid to earth capacitance of V_2 and if a normal load resistor is used in the anode circuit of V_1 a very small capacitance at this point increases the rise-time considerably. The use of V_3 reduces the impedance between the grid of V_2 and the supply voltage (the positive terminal of C_2) and thus restores the rise-time to a reasonable value while still preserving sufficient voltage swing to switch V_2 on and off. (The screen grid of V_2 and the anode of V_3 require approximately the same supply voltage so that it is convenient to connect these elements together and supply them by means of the resistor R_2 and decoupling capacitor C_2).

As a consequence of the large change in potential of the cathodes and grids of V_1 and V_2 etc. during a pulse, the input capacitor C_1 is charged to a high potential (it is assumed that the internal impedance of the input generator

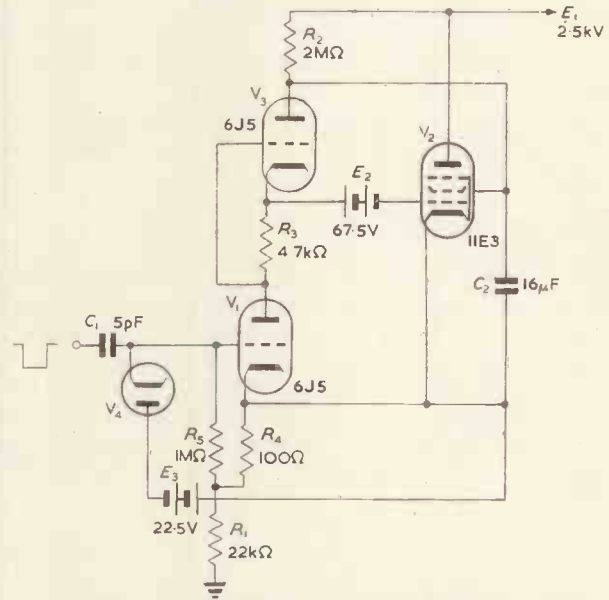

Fig. 2. Circuit for providing high voltage positive pulses

Two 6J5 valves with their elements connected in parallel were used for V_3

is relatively low). It is desirable, therefore, that C_1 should be low in order that the total charge involved is small. At the leading edge of a pulse the grid of V_1 is forced negative with respect to its cathode, first by the input pulse and then by the connexion to earth through C_1 . The diode V_4 is used, therefore, to limit the excursion of the grid and when the negative bias exceeds E_3 current flows and charges C_1 . At the trailing edge of a pulse the grid of V_1 is driven positive with respect to its cathode and the charge for C_1 is provided by the valve drawing grid current. Another problem which results from the large change in potential of the cathode circuits of V_1 , V_2 etc. during a pulse arises in connexion with the heater supplies. The heater to cathode potential of the various valves must not exceed a hundred volts or so and hence it is convenient to connect the secondaries of the heater transformer to the common cathode junction. This, of course, necessitates the use of a transformer with a low capacitance between primary and secondary windings.

Acknowledgments

The author wishes to thank Professor R. W. Ditchburn for placing laboratory facilities at his disposal, and the New Zealand Defence Research Organisation for financial support.

REFERENCES

1. ECCLES, W. H., JORDON, F. W. *Radio Review* 1, 43 (1919).
2. SCHMITT, O. H. *A Thermionic Trigger*. *J. Sci. Instrum.* 15, 24 (1938).

Some New Types of High-Voltage Low Current Vacuum Triodes

By R. Feinberg*, Dr.-Ing., M.Sc., and K. C. Burn*, B.Sc.

To meet the need in a particular field of modern electronic circuit techniques, some new types of high-vacuum triodes were developed to operate with anode currents of the order of one to ten milliamperes at anode voltages ranging from about one kilovolt to about twenty kilovolts. Characteristics and typical application examples for such valves are given.

THE development of high-voltage electronic devices operating with a direct current of small magnitude has created a need for new types of vacuum triodes to facilitate extending well established vacuum valve circuit practice into the new range in which direct currents of the order of one to ten milliamperes at voltages of the order of tens of kilovolts are required.

Three types of high-voltage vacuum triodes are described in this article, and various applications are indicated in principle.

Design and Characteristics of the New Valves

The three new valves are shown in the photograph Fig. 1. They operate with oxide coated, indirectly heated cathodes. Types HL10, HL20 and HR9 have 4 volt heaters, and types HL11, HL21 and HR10 have 6.3 volt heaters.

Types HL10 (HL11) and HR9 (HR10) are similar in general design. The anodes are cylinders attached to the anode stem, and the grid consists in each case of a number of parallel wires which are cylindrically arranged to form a squirrel-cage structure. The cathodes have a cylindrical surface.

The HL20 (HL21) has smaller dimensions. The anode is bell-shaped and sealed to the anode stem. A wire-mesh

* Ferranti Ltd.

Fig. 1. The new types of high-voltage low-current vacuum triodes
Left: HL10 (HL11). Centre: HL20 (HL21). Right: HR9 (HR10).
HL10, HL20, HR9 have 4V heaters. HL11, HL21, HR10 have 6.3V heaters.

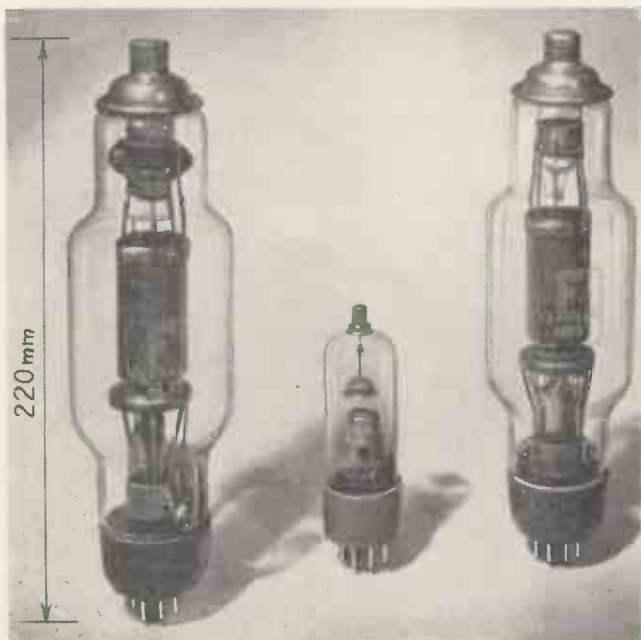

forms the grid, and the cathode is a top-covered hollow cylinder with a circular emissive area.

Typical characteristics and parameters of prototype valves are shown in Figs. 2, 3 and 4, respectively, and Table 1 gives typical data of the valves. The HL10 (HL11) and HL20 (HL21) are designed as "control" triodes and the HR9 (HR10) as a grid-controlled rectifier valve.

TABLE 1
Typical Valve Data

TYPE	V_p max (kV)	P_a max ¹ (watts)	μ	g_m (mA/V)	r_a (k Ω)
HL10 } HL11 }	20	40	about 300	about 0.7 ²	about 430 ²
HL20 } HL21 }	20	5	about 600	about 0.1 ³	about 6000 ³
HR9 } HR10 }	20 ⁴ 40 ⁵	40 ⁴ 15 ⁶	about 42 ⁷	about 0.6 ⁷	about 70 ⁷

1. $P_{a(max)}$ means the anode dissipation, i.e. the heat generated at the anode, by electron bombardment. (For distinction the term "total anode dissipation" means the heat at the anode including the heat received from the cathode and any other electrodes).
2. At $V_a = 20kV$, $I_a = 2mA$.
3. At $V_a = 20kV$, $I_a = 0.25mA$.
4. The valve being used with forward anode voltage only.
5. Peak inverse voltage at no load.
6. In rectifier operation.
7. At $V_a = 2kV$, $I_a = 2mA$.

Variable High-Voltage Resistor Operation

Each of the three new valves can be utilized as a variable high-voltage resistor. Fig. 5 shows, for example, the arrangement for testing the performance characteristic of a high voltage d.c. low-current power supply with one of the valves as a variable resistor. One HL10 (HL11) covers the load range from about 2kV to 20kV and one HR9 (HR10) the range from about 0.5kV to 5kV, in each case the load current for a single valve to be varied from zero to 10mA or so, the maximum current being determined by the maximum anode dissipation $P_{a(max)}$ given in Table 1. In cases where fine current control at values below 1mA load current are desired the HL20 (HL21) can conveniently be used within the limits given in Table 1.

Direct-Voltage Control and Stabilization

The diagram of Fig. 6 demonstrates the basic principle of the well-known series-parallel combination of two vacuum triodes, V_1 and V_2 , to achieve, respectively, either an arbitrary control of the load voltage V_2 , with the supply voltage V_1 at a fixed value, or stabilization of V_2 with V_1 being variable. Control of the valve V_2 may be manual in those cases where arbitrary control of the load voltage V_2 is required. But control of V_2 would in a practical case be

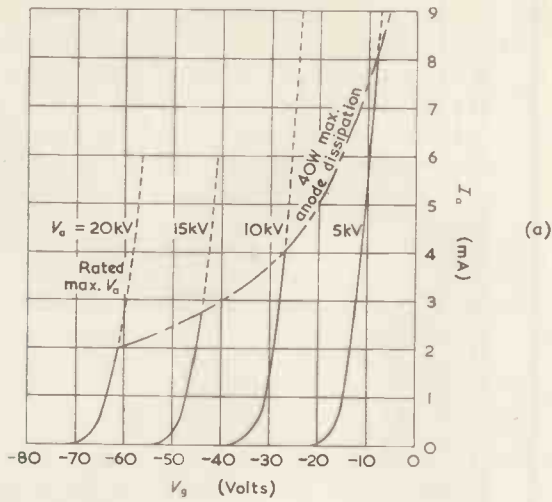

(a)

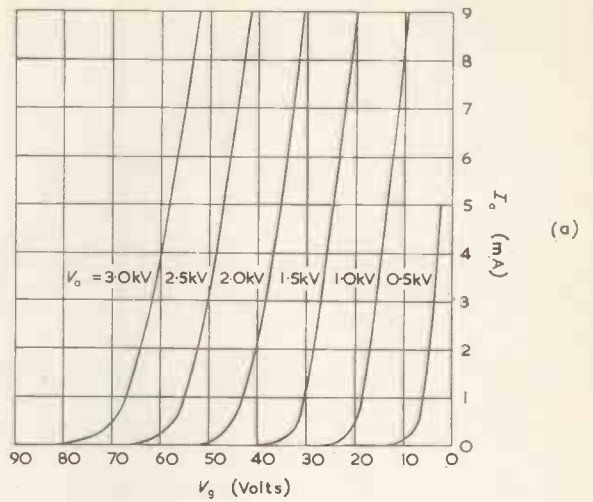

(a)

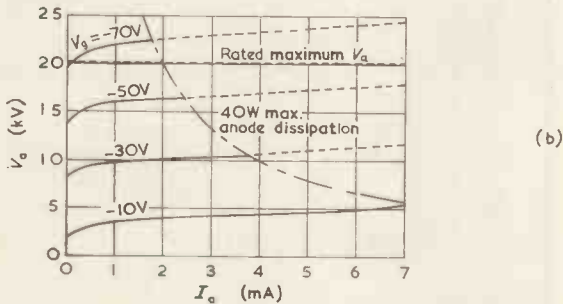

(b)

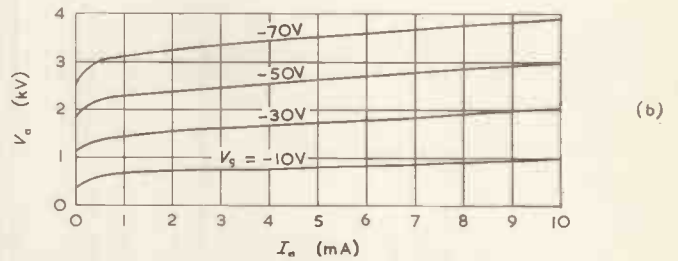

(b)

Fig. 2. Characteristics of HL10 (HL11)

Fig. 3. Characteristics of HL20 (HL21)

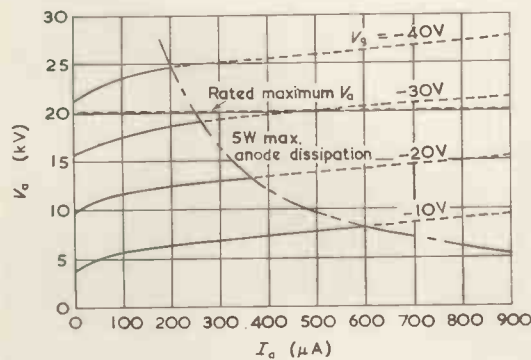
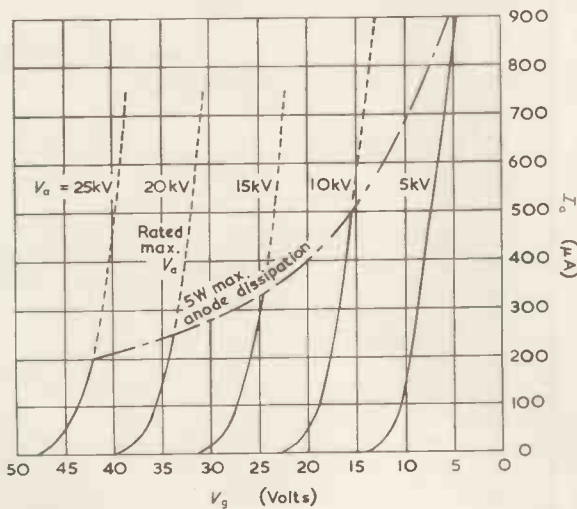

Fig. 4. Characteristics of HR9 (HR10)

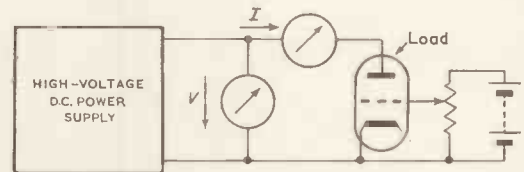

Fig. 5. Using a high-voltage valve as a variable resistor to test the performance characteristic of a high-voltage d.c. power supply

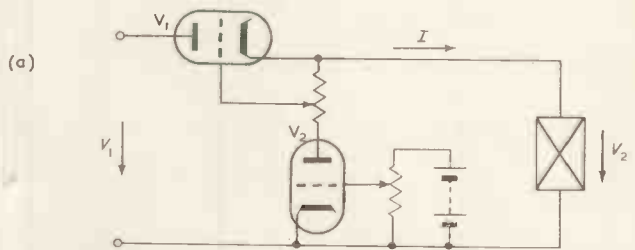
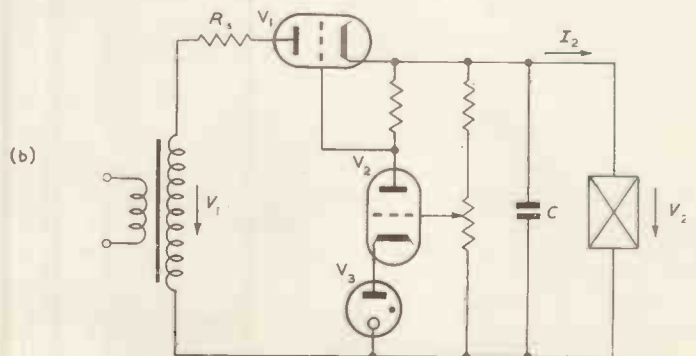

Fig. 6. Basic principle of direct voltage control and stabilization

Fig. 7. Basic principle of grid-controlled rectification with direct voltage stabilization



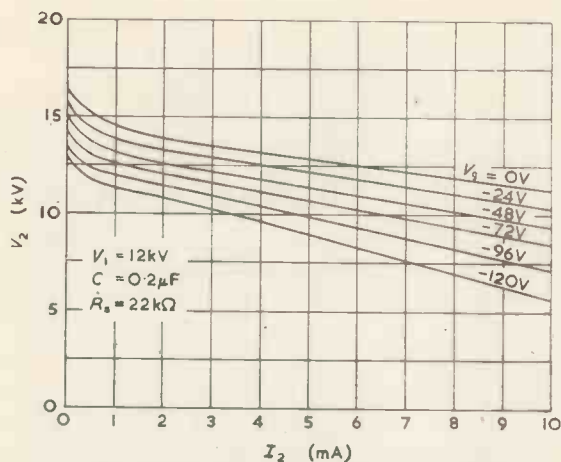

Fig. 8. Voltage regulation curves obtained with a type HR10 valve as V_1 in Fig. 7 but with a fixed grid voltage V_g as parameter

automatic, usually by electronic means, where V_2 is to be stabilized. The HL20 (HL21) is designed to function as V_2 and either the HL10 (HL11) or the HR9 (HR10) can be used, as the case may be, to function as V_1 .

Rectifier with Direct Voltage Control and Stabilization

Fig. 7 gives the basic diagram of a vacuum triode single-phase half-wave rectifier circuit with direct-voltage stabilization. The HR9 (HR10) is designed to function as V_1 , and the HR20 (HL21) can be used for V_2 . V_3 is a gas-filled cold-cathode diode functioning as a voltage reference valve.

To indicate the performance of the HR9 (HR10) in a circuit such as Fig. 7, a family of direct voltage regulation curves is shown in Fig. 8. The graphs of Fig. 8 have been obtained with a circuit similar to Fig. 7 but without the automatic grid control valve combination V_2 and V_3 . Instead a dry battery was used to give various fixed grid control voltages V_g for V_1 . The measurements were made with $V_1 = 12\text{kV}$, $R_g = 22\text{k}\Omega$, a type HR10 valve as V_1 , $C = 0.2\mu\text{F}$ and with a type HL10 valve as variable load.

Acknowledgments

The prototype valves were developed in the Physical Laboratory of Ferranti Ltd. Dr. J. A. Darbyshire made helpful suggestions, and Mr. J. S. Johnson was responsible for the production of the valves with which Mr. J. G. T. Owen obtained the various characteristics shown in this article.

Tolerance Limits in Matching

By W. Alexander*, Ph.D., M.Sc., M.I.E.E.

An adequate transfer of power, from a source to loading equipment, may be accomplished without an exact impedance match being made.

This article considers the level of power transfer attained for various degrees of mismatch, and gives generalized curves from which data of the above type can be obtained, for both reactive as well as resistive mismatch.

NUMEROUS instances occur in electronics where an impedance match, between two items or sections of a circuit, is necessary to promote a maximum exchange of the power available, or the development of maximum power in terminal equipment.

A general theorem which has developed out of this consideration is that known as "the maximum transfer of power" theorem. The conditions which it requires to be fulfilled are that (a) the reactances must be conjugate, and (b) the resistances of equal magnitude, where the two elements to be matched have complex impedances.

An important factor, which is not readily obvious from the theorem, is the extent to which a mismatch can be used in practice and still give a tolerably large, or a near maximum, transfer of power from source to load.

It is convenient to assume that the required matching is to be effected between the impedance of a load and that of an alternating voltage generator.

Keeping the consideration general, by assuming complex impedances for both, it is necessary to enquire as to the extent to which (a) the resistive parts can be mismatched, and (b) the reactive components can depart from the conjugate condition, in order that the power developed in the load shall be within a chosen tolerance of the maximum transferable.

In choosing the tolerance one can first turn to an

analogous case which again arises fairly frequently in electronics.

Established Frequency Tolerance

A criterion has been adopted, or has developed, in connexion with most radio-frequency circuits, where the characteristics of the circuit are frequency sensitive. This criterion is the frequency tolerance acceptable for normal operation and is usually termed the "bandwidth" of the circuit or equipment. By definition the bandwidth is that range of operating frequencies between which the power developed is not less than half its possible maximum value, the latter occurring often at a resonant condition of the circuit. Where the voltage, or current, developed in the circuit is the important feature, the bandwidth is accordingly the frequency range between which its magnitude is 0.707 ($1/\sqrt{2}$) of the maximum value.

A similar criterion is also adopted for audio-frequency amplifier circuits.

Tentative Matching Tolerance

Turning to the case in hand where the variation of the power developed is due to inequality or mismatch between a load and generator impedances, and where the frequency of operation is either constant or is not the primary consideration, by inference, or analogy, a possible tolerance suggests itself.

This tolerance could be defined as those limits of the

* The University, Nottingham.

impedance parameters of the circuit within which the power developed, in the driven part of the circuit, shall not fall below half the maximum possible value.

Analysis of the Simple General Case

Assume that the circuit consists of a generator of constant e.m.f. E volts r.m.s., having a complex internal impedance of $R_g + jX_g$, connected in series with a load impedance $R_L + jX_L$.

The power P developed in the load impedance is given by

$$P = \frac{E^2 R_L}{(R_L + R_g)^2 + (X_L + X_g)^2} \dots (1)$$

CONDITION FOR MAXIMUM POWER INTO LOAD

Making the load and generator reactances conjugate, that is $X_L = -X_g$, is the first step in attaining an optimum maximum. This leads to a value of power given by

$$P = \frac{E^2 R_L}{(R_L + R_g)^2} \dots (2)$$

Retaining this first consideration, the second condition for maximum power in R_L is given by differentiating P with respect to R_L and equating to zero. This gives

$$R_L = \pm R_g \dots (3)$$

The condition implied by $R_L = -R_g$, is that of self-oscillation in the circuit, that is infinite current or power for any finite voltage, and is outside the present consideration.

Where both R_L and R_g are positive gives the maximum finite power P_m , by substitution in equation (2), as

$$P_m = (E^2/4R_g) \dots (4)$$

LOAD RESISTANCE VALUES AT HALF POWER POINTS

The magnitude of the power developed at the half-power points will be

$$P' = P_m/2 = (E^2/8R_g) \dots (5)$$

The corresponding values of load resistance R_L' to give P' in the load is given by

$$P' = \frac{E^2 R_L'}{(R_g + R_L')^2} \dots (6)$$

where $P' = (E^2/8R_g)$

whence

$$R_L' = (3 \pm 2\sqrt{2})R_g \dots (7)$$

or

$$\left. \begin{aligned} R_{L1}' &= 0.17R_g \\ \text{and } R_{L2}' &= 5.83R_g \end{aligned} \right\} \dots (8)$$

R_{L1}' and R_{L2}' being the two values of R_L' which satisfy the prescribed condition.

This means that the load resistance can have any value lying between 17 per cent and 583 per cent of R_g for the power, developed in the load, to be greater than half that when exact equality obtains between the resistive parts of the load and generator impedances.

A very wide tolerance is prescribed by the above consideration.

VARIATION OF POWER TRANSFERRED TO LOAD WITHIN THE RANGE $R_L' = 0.17$ TO $5.83R_g$

In view of the wide tolerance obtained above a more general consideration is indicated. One approach to a wider picture is the generalized curve of Fig. 1. Here the fraction f of the maximum power P_m transferable from generator to load, is plotted against q , the corresponding values of load resistance expressed as a ratio of load to generator resistance, that is $q = (R_L/R_g)$.

The equation relevant to the curve of Fig. 1, which follows from equations (2) and (4), is

$$f = (P/P_m) = \frac{4R_L R_g}{(R_L + R_g)^2} = \frac{4q}{(q + 1)^2} \dots (9)$$

Several interesting points are illustrated by this curve.

(1) For a given fractional or percentage drop away from the maximum power value P_m , the tolerance, or more precisely the divergence, between the load and generator resistances R_L and R_g is greater when the load resistance is larger in magnitude, than when it is smaller than the generator resistance.

This effect is increasingly more pronounced as f decreases in magnitude.

(2) The converse to (1), which has perhaps a more practical significance, is that for a given mismatch, between

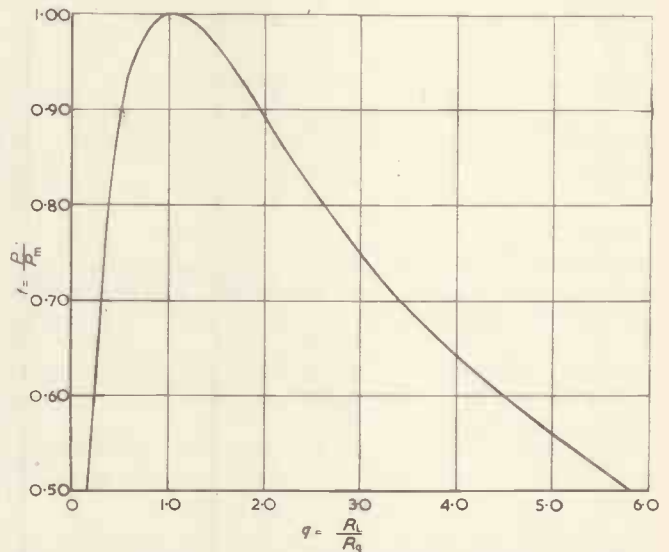

Fig. 1. Variation of power developed in a load, where the load resistance is varied

The load and generator reactances are assumed to be equal in magnitude and of opposite sign. (The variables are plotted as ratios, to give a dimensionless general curve.)

R_L and R_g , if R_L is greater than R_g the reduction in power into the load is somewhat less than if R_L is smaller than R_g .

Briefly, if a mismatch is unavoidable the load should, if possible, have the higher numerical value of resistance.

(3) Four sets of values, taken from Fig. 1 and shown in Table 1, are of particular interest.

(4) An interesting practical point is that one grade of commercial carbon resistor has a resistance tolerance of ± 20 per cent of the marked or coded value. It can be seen from Table 1 that such resistors, when used as the load to

TABLE 1.

POWER TRANSFER TOLERANCE (per cent)	UPPER AND LOWER LOAD RESISTANCE TOLERANCE VALUES (R_L/R_g)
(1) ± 1 per cent	1.22 — 0.82
(2) ± 10 per cent	1.93 — 0.51
(3) ± 25 per cent (Three-quarter power points)	3.00 — 0.33
(4) ± 50 per cent (Half-power points)	5.83 — 0.17

a generator, give a reduction in power transfer of not more than about 1 per cent at the widest points of its tolerance, assuming, of course, that the generator resistance is not itself subject to a possible tolerance discrepancy.

(5) Table 1 also shows that a two to one ratio of R_L to R_g gives, in round figures, a reduction of 10 per cent and a three to one ratio a reduction of 25 per cent in power transferred.

VARIATION OF POWER TRANSFER WITH (A) REACTANCE, AND (B) COMBINED REACTANCE AND RESISTANCE MISMATCH

Resistance Match, Reactance Mismatch

Taking the case of equality of the load and generator resistances, but with a mismatch between the corresponding reactances, and assuming that the sign of the load reactance is opposite to that of the generator

$$R_L = R_g, \quad X_L \neq -X_g$$

The power transferred to R_L as a fraction f of the maximum value is given by

$$f = (P/P_m) = \frac{4R_g^2}{4R_g^2 + (X_g - X_L)^2} \dots \dots \dots (10)$$

This leads to the following relationship between the reactances

$$X_L = X_g \pm 2R_g \sqrt{1 - f} \dots \dots \dots (11)$$

Thus in the case of reactance mismatch alone, the amount of power developed in the load depends not only on the relative magnitude of the load and generator reactances, but also on the magnitude of the generator, or load, resistance. The reactance tolerance, for a given reduction of power away from the maximum value, is greater the larger the numerical value of the generator, or load resistance.

This contrasts with the discreet conditions where resistance mismatch alone obtains.

Combined Resistance and Reactance Mismatch

The final consideration to complete the picture is the reduction of power transferred when reactive and resistive mismatches occur simultaneously.

Again from equations (1) and (4) the fractional transfer of power, f , to the load is given by

$$f = (P/P_m) = \frac{4R_L R_g}{(R_g + R_L)^2 + (X_g + X_L)^2} \dots (12)$$

Assuming that X_L is of opposite sign to X_g , and adopting the following ratio factors,

- (i) $(X_L/X_g) = m$, (ii) $(R_L/R_g) = q$, (iii) $(X_g/R_g) = p$.
- Equation (12) can be rewritten

$$f = \frac{4q}{(1 + q)^2 + p^2(1 - m)^2} \dots \dots \dots (13)$$

Since m , p and q are all variables, equation (13) leads to three sets of curves. These are plotted in Fig. 2. In all cases the fractional power transfer f is plotted against the ratio q , for a range of values of m between 0.2 and 2.0, the above being repeated for three values of p equal to 0.5, 1.0 and 2.0. Two main points evolve from consideration of these curves:

- (i) For small values of p , or X_g/R_g , the greater is the independence of power reduction on reactive mismatch. This is only to be expected, since small values of p prescribe values of reactance which are small compared with the resistances in circuit.
- (ii) Where a complex mismatch obtains, the power transfer tends to have a maximum value at values for q greater than unity. Also this divergence is greater, the greater the divergence of both p and m from unity.

This is due to the dependence of the load-current on the total impedance of the circuit. This will vary with m and q . Moreover, as the power developed in the load varies inversely as the square of the total impedance, accordingly it is not related solely to resistance variations, as for the case considered when dealing with "load resistance values at half power points."

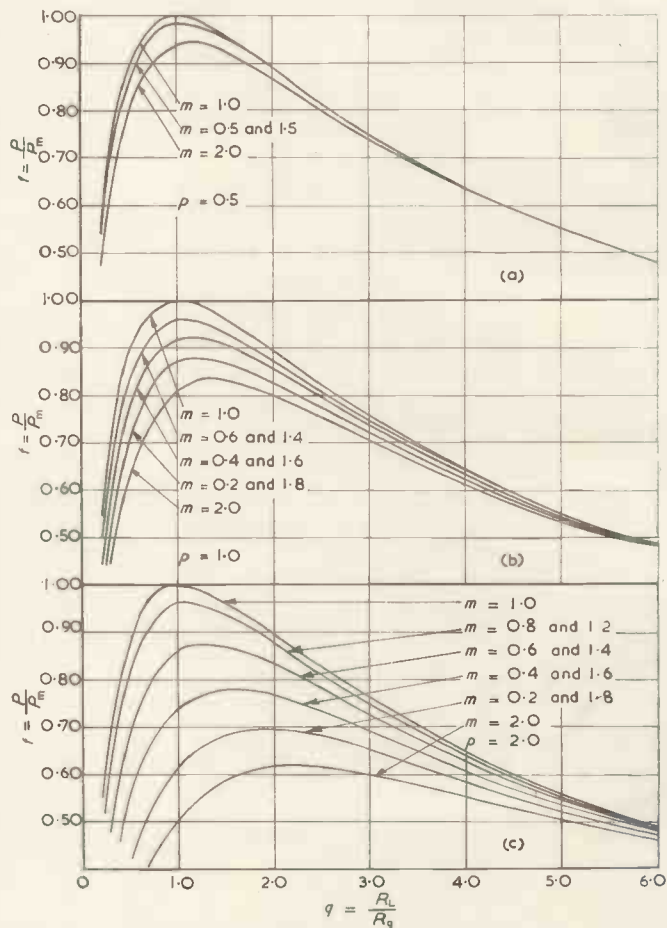

Fig. 2. Variation of power transferred, from a generator to a load, with various amounts of resistive and reactive mismatch, plotted as dimensionless curve

Conclusion

Where the reactances in circuit are conjugate, it is seen that the resistance tolerance between the half-power points is exceedingly wide.

Since matching can be effected on the low or high side, a rider to the above conclusion, in general terms, is that a mismatch on the high side where the load resistance is larger than the generator resistance, involves in many cases a much smaller loss of power than a mismatch on the low side.

The effect of reactance mismatch varies according to the relative magnitude of the reactances and resistances in circuit. The loss of power is decreasingly less the smaller the relative magnitude of the reactive components.

As to whether any one of the tolerance limits given in Table I could form a preferred tolerance, has not been completely explored in this article. Such a choice would depend on other factors, such as for instance the inherent characteristics and requirements of the equipment being considered in a particular case. Both cases (2) and (3) of Table 1 give useful easily memorized, "rule of thumb," tolerance factors.

Component Tolerance Effects in Feedback I.F. Amplifiers

By H. S. Jewitt*, B.Sc.

The effect of component tolerances on wideband feedback i.f. amplifiers is evaluated and equations for T and π feedback networks are given. It would appear that the feedback amplifier is preferable to the stagger tuned amplifier in that, neglecting other variables that may exist, it does not suffer asymmetry due to resistor variations.

IN a recent article¹, a broadband i.f. amplifier configuration was described which made use of negative feedback to obtain wide bandwidth, and design equations were quoted for typical circuits. One important aspect of any circuit is the effect on its performance of component variations. As is well known, components are made to certain tolerances, and the effect of these tolerances must be considered when the performance of a given circuit is to be evaluated.

The general method of attack on the problem of tolerance effects is to determine the circuit equation concerned, and then to differentiate this with respect to the parameters which may vary, to obtain expressions relating the change of the circuit output to the parameter change. This technique may be applied to a wideband i.f. amplifier to determine how the shape of the response curve may be expected to vary with component variation. This may be done with a new circuit, using a known circuit as a basis of comparison, and provides a method of evaluation for the new circuit. It may be performed at the beginning of the design process to decide which of several circuit configurations will most satisfactorily meet the required specification, or, if this has been decided, to determine to what tolerance components should be selected. The last of these possibilities is of great importance, as wide tolerance components are cheaper than highly accurate ones, and a cheaper product may well result if an unnecessarily high standard of performance is not provided. This may be done for the feedback i.f. amplifier, and it is then immediately possible to compare such an amplifier with the equivalent staggered (or other type) amplifier.

Figs. 1 and 2 give the circuit of the basic feedback pairs, Fig. 1 with the T feedback circuit, and Fig. 2 with the π feedback circuit. It was stated in the article referred to above that the general expressions relating shape coefficient, k , and effective damping resistance, R , with the resistors R_4 and R_5 of Fig. 1 are

$$R_1 = \frac{4GR}{2 - k + 2\sqrt{(2 + k)G}}$$

and

$$R_2 = \frac{4GR(2 - k)}{4G^2(2 + k) - (2 - k)^2}$$

In these expressions, G is the nominal gain per stage = $g_m R_s$, and g_m is the valve mutual conductance. Substituting $g_m R$ for G , we have

$$R_1 = \frac{4g_m R^2}{(2 - k) + 2\sqrt{(2 + k)g_m R}}$$

and

$$R_2 = \frac{4g_m R^2(2 - k)}{4g_m^2 R^2(2 + k) - (2 - k)^2}$$

These simultaneous equations may be solved to obtain k and R in terms of R_4 , R_5 , and g_m , which yields

$$k = \frac{2(R_4 + R_5)^2 - 2g_m R_4 R_5 (R_4 + 2R_5)}{(R_4 + R_5)^2 + g_m R_4 R_5 (R_4 + 2R_5)}$$

$$R = \frac{R_4(R_4 + 2R_5)}{\sqrt{[(R_4 + R_5)^2 + g_m R_4 R_5 (R_4 + 2R_5)]}}$$

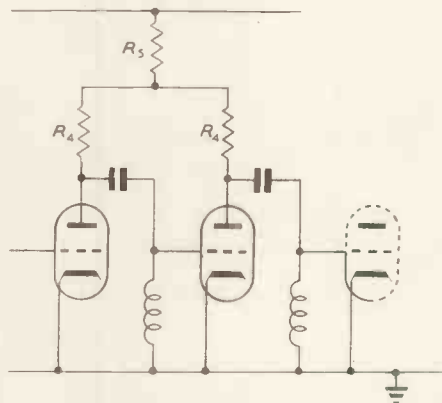

Fig. 1. T feedback circuit

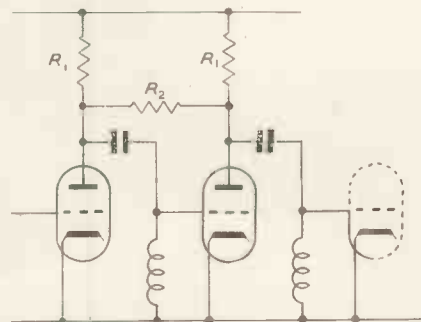

Fig. 2. π feedback circuit

and now differentiation of these expressions with respect to R_4 , R_5 , and g_m produces equations which state the variation of k and R with these three parameters. In the case of each differentiation, the other two parameters are assumed constant. To complete the examination of the feedback i.f. amplifier circuit, the circuit of Fig. 2, while of less

* Decca Radar Ltd.

practical interest, has been similarly treated; in this instance, the expressions for k and R are

$$k = \frac{2(R_1 + R_2)^2 - 2g_m R_1^2 R_2}{(R_1 + R_2)^2 + g_m R_1^2 R_2}$$

$$R = \frac{R_1 R_2}{\sqrt{[(R_1 + R_2)^2 + g_m R_1^2 R_2]}}$$

These expressions can be of considerable use in themselves; when an amplifier is designed, the substitution for the exact calculated values of components by the nearest practical values produces some change in the values of k and R obtained. The new values of these quantities may be calculated by using the expressions above, and the response curve plotted. A decision can then be made whether this is satisfactory, or whether closer or more distant values of components can reasonably be used.

Differentiation of the expression for k and R produces the required equations for variation of k and R with changes of R_1 , R_2 , and g_m . The expressions for the circuits of Figs. 1 and 2 are given below.

Fig. 1.

$$\frac{dk}{dR_4} = - \frac{8g_m R_5^3 (R_4 + R_5)}{[(R_4 + R_5)^2 + g_m R_4 R_5 (R_4 + 2R_5)]^2}$$

$$\frac{dk}{dR_5} = - \frac{4g_m R_4^2 (R_4 + R_5)(R_4 + 3R_5)}{[(R_4 + R_5)^2 + g_m R_4 R_5 (R_4 + 2R_5)]^2}$$

$$\frac{dk}{dg_m} = - \frac{4R_4 R_5 (R_4 + R_5)^2 (R_4 + 2R_5)}{[(R_4 + R_5)^2 + g_m R_4 R_5 (R_4 + 2R_5)]^2}$$

$$\frac{dR}{dR_4} = \frac{R_4 + R_5 [(R_4 + R_5)^2 + g_m R_4 R_5 (R_4 + R_5) + R_5^2 (1 + g_m R_4)]}{[(R_4 + R_5)^2 + g_m R_4 R_5 (R_4 + 2R_5)]^{3/2}}$$

$$\frac{dR}{dR_5} = \frac{2R_1^2 (R_1 + R_5) - g_m R_4^3 (R_4 + 2R_5)}{2[(R_4 + R_5)^2 + g_m R_4 R_5 (R_4 + 2R_5)]^{3/2}}$$

$$\frac{dR}{dg_m} = - \frac{R_4^2 R_5 (R_4 + 2R_5)^2}{2[(R_4 + R_5)^2 + g_m R_4 R_5 (R_4 + 2R_5)]^{3/2}}$$

Fig. 2.

$$\frac{dk}{dR_1} = - \frac{8g_m R_1 R_2^2 (R_1 + R_2)}{[(R_1 + R_2)^2 + g_m R_1^2 R_2]^2}$$

$$\frac{dk}{dR_2} = - \frac{4g_m R_1^2 (R_1^2 - R_2^2)}{[(R_1 + R_2)^2 + g_m R_1^2 R_2]^2}$$

$$\frac{dk}{dg_m} = - \frac{4R_1^2 R_2 (R_1 + R_2)^2}{[(R_1 + R_2)^2 + g_m R_1^2 R_2]^2}$$

$$\frac{dR}{dR_1} = \frac{R_2^2 (R_1 + R_2)}{[(R_1 + R_2)^2 + g_m R_1^2 R_2]^{3/2}}$$

$$\frac{dR}{dR_2} = \frac{R_1^3 (2R_1 + 2R_2 + g_m R_1 R_2)}{2[(R_1 + R_2)^2 + g_m R_1^2 R_2]^{3/2}}$$

$$\frac{dR}{dg_m} = - \frac{R_1^3 R_2^2}{2[(R_1 + R_2)^2 + g_m R_1^2 R_2]^{3/2}}$$

Using these expressions for the particular circuit to be employed, it is now possible to determine what effect changes in the resistors and the valve mutual conductances will have on the response curve. As an example of this, the amplifier used as an example of design in the article referred to will be compared, with respect to resistor variation, with a staggered amplifier designed to the same

specification. In the feedback amplifier concerned, a feedback quadruple was designed to give a bandwidth of 10Mc/s to -3 dB points on the response curve, the component values being (in the terminology of Fig. 1):

Underfeedback pair ($k = \sqrt{2}$) $R_{4u} = 1100\Omega$, $R_{5u} = 24\Omega$

Overfeedback pair ($k = -\sqrt{2}$) $R_{4o} = 2200\Omega$, $R_{5o} = 910\Omega$
 These values were obtained as the nearest standard 5 per cent resistor values to those theoretically calculated: g_m was assumed to be 7mA/V. To decide the extent to which this rounding off has affected the response curve, the values

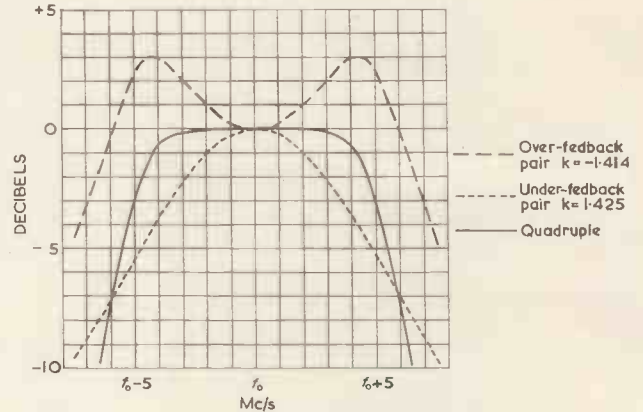

Fig. 3. Nominal curves

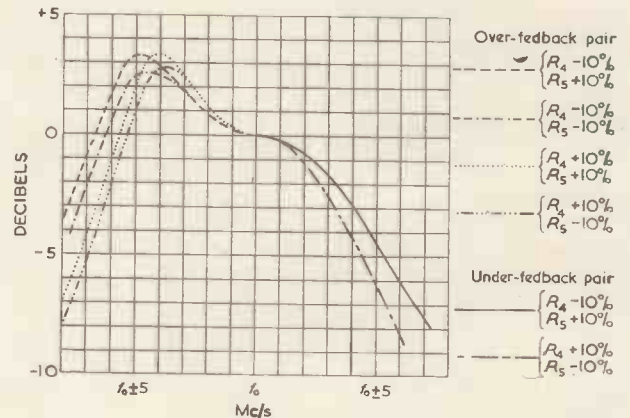

Fig. 4. Pair tolerance curves

of k and R with these values may be calculated using the expressions above. This results in

Underfeedback pair $k = 1.425$ $R = 1040\Omega$

Overfeedback pair $k = -1.414$ $R = 1088\Omega$

and, from these, a response curve may be plotted, using the approximation, quoted previously, that the response curve for a feedback pair is given by

$$y = \frac{1}{\sqrt{(1 + kx^2 + x^4)}}$$

This curve, and its component curves are shown in Fig. 3.

Now the variation equations may be used, and these produce the following relations for this circuit, if 10 per cent changes are assumed in the resistors:

Underfeedback pair.

$$dk(R_4) = -0.00044$$

$$dR(R_4) = 102\Omega$$

$$dk(R_5) = -0.049$$

$$dR(R_5) = -5.3\Omega$$

Overfeedback pair.

$$dk(R_4) = -0.0066 \quad dk(R_5) = -0.043$$

$$dR(R_4) = 85\Omega \quad dR(R_5) = -21\Omega$$

In each case, the subscript indicates the changing component, the other being assumed constant. Clearly, for the underfeedback pair, the effect of R_4 on k may be dis-

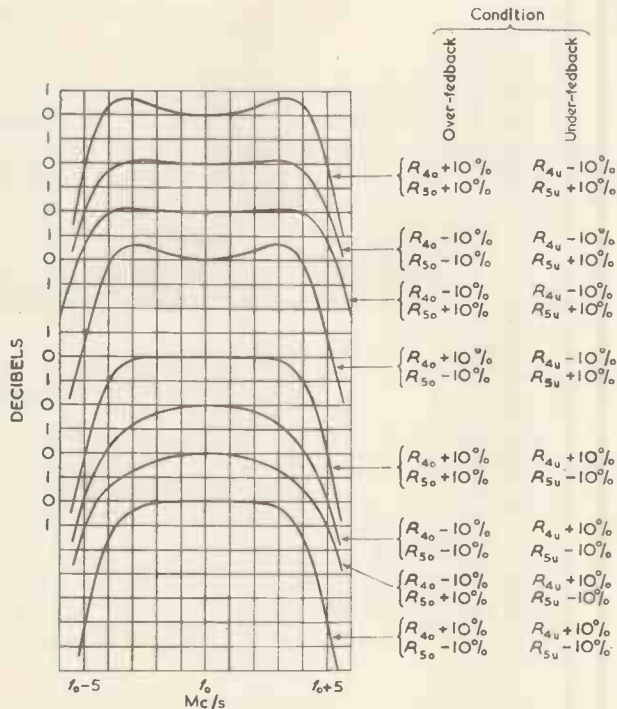

Fig. 5. Quadruple tolerance curves

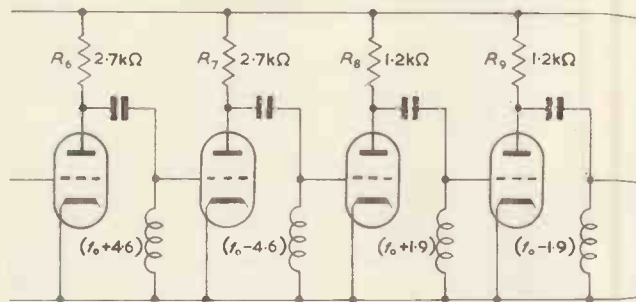

Fig. 6. Staggered quadruple

regarded, as may that of R_5 on R : but this does not hold for the overfeedback pair. These changes in k and R due to the resistor changes can be applied to the nominal values cited above, and response curves plotted to indicate the effect of the variations. Fig. 4 shows, on the left half of the graph, the variations in the response curve of the overfeedback pair, and, in its right half, those of the underfeedback pair. The curves are, of course, symmetrical about centre frequency, so that only one half of each curve need be drawn. By addition of the various curves of Fig. 4, the overall response curves for the quadruple may be drawn (Fig. 5) and these now indicate the worst variations to be expected if all resistors are at their tolerance limits simultaneously. If the tolerance limits are not reached, the response curve will obviously lie somewhere between the best and worst cases.

Examining Fig. 5, it can be stated that, for 10 per cent

resistors, the narrowest bandwidth expected will be 9Mc/s, the greatest 11.3Mc/s, and the greatest hump amplitude on a double-humped curve 0.8dB. It should be noted that the curves remain symmetrical about the centre frequency. This, in many applications, is a most important consideration, as signal distortion may be considerably less due to a reduction of channel bandwidth than it would be if the signal were passed through an asymmetrical channel.

As a comparison with these results, the corresponding curves for a staggered amplifier may be examined. If arithmetic symmetry in the staggering is assumed as a reasonable approximation for simplicity, the equivalent staggered quadruple to give the response curve produced by the feedback quadruple is specified by Fig. 6². This assumes the same valve as that of the feedback amplifier, with $g_m = 7\text{mA/V}$ and total stray capacitance in the circuit = 15pF. A selection of response curves from this ampli-

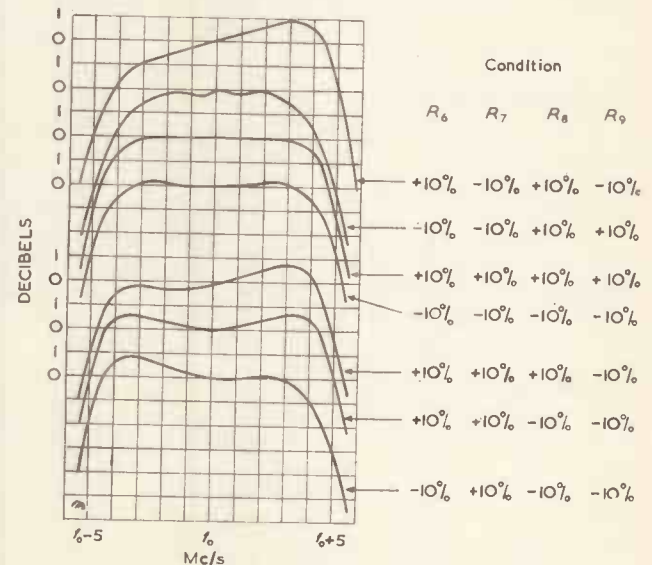

Fig. 7. Staggered quadruple tolerance curves

fier is shown on Fig. 7, again for the condition of ± 10 per cent tolerance variation in the resistors. It is rather difficult to state a bandwidth for some of these curves, as asymmetry is now apparent: but for the symmetrical curves, the degree of change is about the same as that of the feedback amplifier.

Conclusion

In conclusion, it may be stated that the foregoing presents all the necessary information for the tolerance effect determination of the feedback i.f. amplifier circuit; as to the comparison between amplifier types, the feedback amplifier would appear to be preferable to the staggered amplifier, principally because it suffers from no asymmetry due to resistor variation. It should, however, be clearly understood that the resistor variation only has been used as an example here, and that other variables exist, notably valve capacitance and valve mutual conductance, both of which influence the response curves.

Acknowledgments

The author is indebted to his colleague, Dr. R.W.A. Scarr, for checking the mathematics involved, and to the Directors of Decca Radar Limited for publication permission.

REFERENCES

1. JEWITT, H. S. Wideband I.F. Amplifiers. *Wireless World*, 60, 86 (1954.)
2. VALLEY, G. E., WALLMAN, H. Vacuum Tube Amplifiers. Ch.4 (McGraw-Hill, 1948).

Principles and Application of Electronic Analogue Computers

(Part 2)

By P. Heggs*, A.M.I.E.E.

IN Part 1 of this article two simple types of analogue were considered. We now turn to a consideration of the general purpose analogue computer. This class of machine consists of an assembly of units including operational amplifiers, integrators, multipliers, dividers, function generators, limiters, potentiometer panels, together with display units, power supplies, and a central or distributed inter-connexion or patch panel together with appropriate power supplies.

Scaling and Block Diagrams

As was mentioned in Part 1 either the equations of motion of a dynamical system are fed to the computer, or the machine is set up in terms of the appropriate transfer functions. The equations of motion must first be transformed into a form that is acceptable to the computer, and then represented by a set-up diagram drawn for each problem. If a central or distributed patch panel is used the problem so set up may be easily "read" from the computer with no further reference at all to the diagram.

The Operational Amplifier

This is a high gain direct coupled amplifier which may or may not be provided with some form of drift correc-

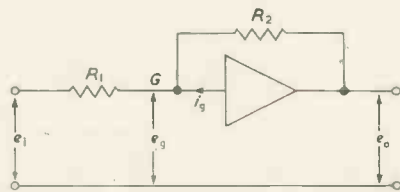

Fig. 5. Multiplication by a constant

tion, depending on the factors governing the design of the computer. It will accept a number of different inputs, sum them and multiply by a constant. The brief theory of operation is as follows.

In Fig. 5 applying Kirchoffs law to the grid point of the amplifier, and assuming no current flows to the grid:

$$1/R_1 (e_1 - e_g) + 1/R_2 (e_o - e_g) = 0$$

But

$$e_g = (e_o/A) \therefore 1/R_1 [e_1 - (e_o/A)] + 1/R_2 [e_o - (e_o/A)] = 0$$

Simplifying and writing A with a negative sign:

$$e_o = -e_1 (R_2/R_1) \frac{A}{(A+1) + (R_2/R_1)}$$

which if $A \rightarrow \infty$ gives:

$$e_o = -e_1 (R_2/R_1),$$

the grid voltage e_g being vanishingly small in the practical case.

Operational amplifiers are often fed from potentiometers as in Fig. 6.

$$e_o = -k(R_2/R_1) \quad e_o = -km$$

where $m = (R_2/R_1)$.

The Integrator

An operational amplifier shunted by a capacitor in place

of R_2 , enables integration to be carried out (Fig. 7). Assume that the amplifier gain is sufficient for the grid voltage e_g to be negligible compared with e_1 or e_o . The current flowing through R charges the capacitor with no counter voltage to oppose e_1 , thus:

$$(e_1/R) = -(Cde_o/dt) = -Cpe_o, \quad p = (d/dt)$$

$$e_o = (-1/pRC) e_1 = (-me_1/p),$$

m is denoted as the gain of the integrator and equal to the

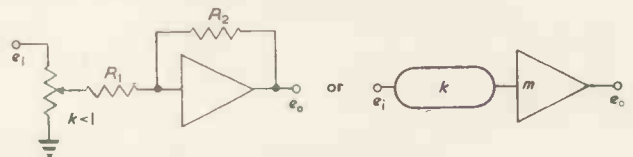

Fig. 6. Use of potentiometer for coefficient variation

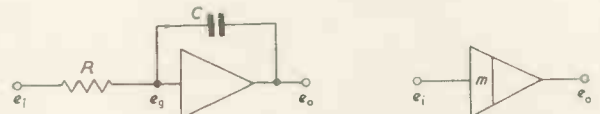

Fig. 7. Integrator



Fig. 8. Multiplier

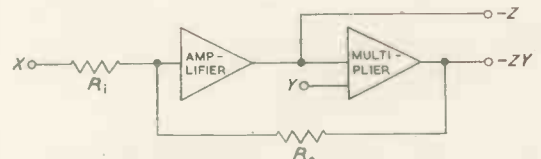

Fig. 9. Multiplier used with summing amplifier to operate as a divider

inverse of the time-constant RC , so that a constant input e_1 produces a straight line output e_o whose slope is determined by the value of m .

Both the summation amplifier and the integrator have been idealized, and practical limitations to this ideal performance always occur.

Multiplier

Here voltages proportional to X and Y are fed to the input, producing the product XY (Fig. 8). There is a variety of types.

Divider (Fig. 9)

If the output from a multiplier is fed back into the operational amplifier that drives it, while voltages proportional to X and Y are fed to the amplifier and multiplier respectively, then the output from the amplifier represents $k(X/Y)$.

Denoting the amplifier output by Z , then:

$$(X/R_1) = -(ZY/R_2)$$

Hence:

$$Z = -(R_2/R_1) (X/Y)$$

* Canadian Westinghouse Co. Ltd, formerly Saunders-Roe Ltd.

Limiter (Fig. 10)

If a voltage of given rate of increase with time is fed to the input terminal, the rate of increase of the output voltage may be changed or prevented completely by the diodes in conjunction with resistances R and R_1 .

If R_1 is reduced to zero and the diode is fed from a low impedance source, the output is a line of practically zero slope, providing $R \gg R_d$, where R_d is the diode resistance. This is shown in Fig. 10(b).

Suppose the equation of motion of a simple oscillatory system is:

$$(d^2x/dt^2) + 22(dx/dt) + 620x = -1240$$

i.e.:

$$p^2x = -22px + 620x + 1240 \dots \dots \dots (6)$$

An amplifier or integrator is usually designed so that its output will swing linearly between ± 50 or $\pm 100V$. Usually $\pm 50V$ is more economical. The problem, however, has a solution in its own units, e.g. feet, and the computer output may be related to so many volts per foot, or feet per sec. It is, however, convenient to forget the idea of volts, and consider the machine as having its

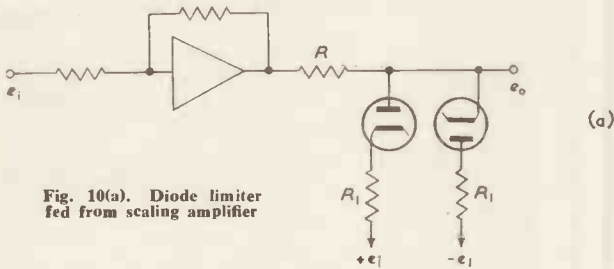
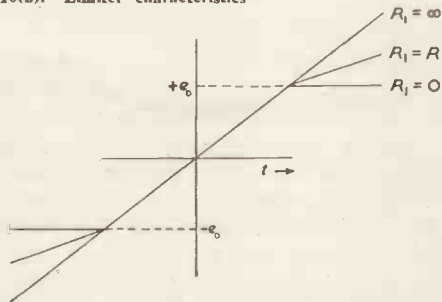

Fig. 10(a). Diode limiter fed from scaling amplifier

Fig. 10(b). Limiter characteristics



(a)

(b)

own units, letting the full output of an amplifier correspond to one machine unit.

The solution of the above problem is a damped sinusoid and in consequence the value of x as $t \rightarrow \infty$ will be less than the maximum value attained. This steady state value is easily seen to be $x = (-1240/620) = -2$, and x max might be 2.5 units.

Thus 2.5 problem units should correspond to 1 machine unit.

If the relation between problem and machine units is written $X = a_x x$, where X is the machine variable with a maximum value of 1, then if $X = 1$ when $x = 2.5$, $a_x = 0.4$ and the machine equation is written by substituting $x = (X/0.4)$ into equation (6),

$$p^2X = -(22PX + 620X + 496) \dots \dots \dots (7)$$

It will be noted that a capital P has been written for the original small p . This has been done to denote that machine time is being employed which may be made to differ from the problem time in the same way that the machine variable differs from the problem variable.

In the above case $P = p$, and the machine operates in real time, and the recorder pen would oscillate at the same frequency as the x in the original problem.

The equation is set on the machine in the following manner. Choose a value of $m = 10$ for each integrator, given by $0.1\mu F$ and $1M\Omega$ (Fig. 11).

Assuming that the output of the last integrator is X , then the input is $(-PX/10)$ since a sign reversal takes place in the unit. $(P^2X/100)$ appears at the input to the penultimate integrator and thus is the output from the summation amplifier. Equation (6) demands that P^2X is equated to the sum of the terms on the right-hand side and the sign reversed, so that if X and $(PX/10)$ are fed back to the inputs of a summation amplifier as shown in Fig. 11, and the gain constants adjusted accordingly, then the machine will be forced to solve the required equation. The constant term is conveniently made -1 machine unit.

The gain constants of the summation amplifier and the k 's of the potentiometer are found by equating the inputs to the output of the summation amplifier, viz:

$$P^2X = -(k_2 m_2 (PX/10) - k_3 m_3 X + k_1 m_1) \dots (7a)$$

or:

$$P^2X = -(10 k_2 m_2 PX - 100 k_3 m_3 X + 100 k_1 m_1) \dots (8)$$

the coefficients of which are then compared with those of equation (7)

$$\text{i.e. } P^2X = -(22PX + 620x + 496)$$

Thus if we make $k_2 m_2 = 2.2$, $k_3 m_3 = 6.2$, $k_1 m_1 = 4.96$ and give m_1, m_2, m_3 , integral values so that k_1, k_2, k_3 , turn out to be less than unity, a variation in the values of the original coefficients of equation (6) may be catered for.

Putting $m_1 = 10$, $m_2 = 5$, $m_3 = 10$, then $a_1 = 0.496$, $a_2 = 0.44$, $a_3 = 0.62$.

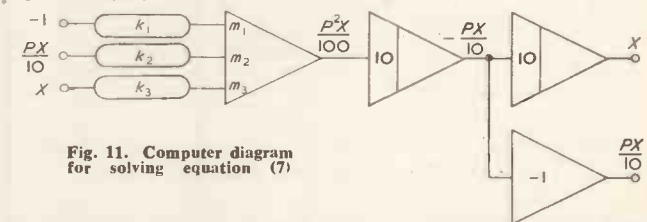

Fig. 11. Computer diagram for solving equation (7)

These latter values may be accurately set up on precision potentiometers, due allowance being made to correct the potentiometers for the effect of the loading due to the input resistors.

This problem had an angular frequency ω of $\sqrt{620} = 24.9$ rad/sec, which actually gave a pointer to the integrator gains of 10 used.

The whole time scale is speeded up or slowed down if the relation $P = a_p p$ is substituted in equation (6). The time scale will be multiplied by the factor n if both integrator gain factors m are multiplied by this quantity, while all other circuit values are held constant. The amplitude scaling will remain as before.

It can often happen that the initial choice of integrator time-constants causes certain amplifiers to overload. This condition may be corrected in a linear system by initially reducing the forcing function so that no amplifier will overload.

The gain factors of the overloading integrators may then be reduced while at the same time increasing the gain in another part of the subsidiary loop to preserve the identity of the problem under solution. Finally the forcing function is restored to its original value.

Imperfections in Computing Amplifiers

A number of these occur in practice among which are (i) drift of the output voltage due to drift at the grid of the input valve grid.

If the drift voltage at the input is δ then the output voltage drift is $-[(R_2/R_1) + 1]\delta$. This result is derived as follows.

Again applying Kirchoffs law to the point G (Fig. 12).

$$(1/R_1)(e_1 - e) + (1/R_2)(e_0 - e) = 0 \dots\dots (9)$$

But:

$$e_g = -(e_0/A) \text{ and } e = -(e_g + \delta) = -[(e_0/A) + \delta] \dots (10)$$

Substitution of e_g from equation (10) into equation (9) yields after solution for e_0 taking the limit of e_0 as $A \rightarrow \infty$ and $e_0 \rightarrow 0$ yields the required result. (ii) Integrator

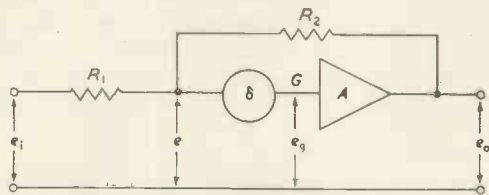

Fig. 12. Scaling amplifier with drift voltage in the feedback loop

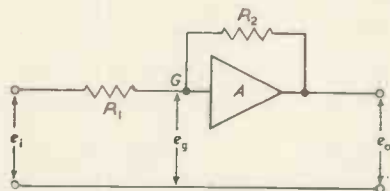

Fig. 13. Grid current at first grid of scaling amplifier

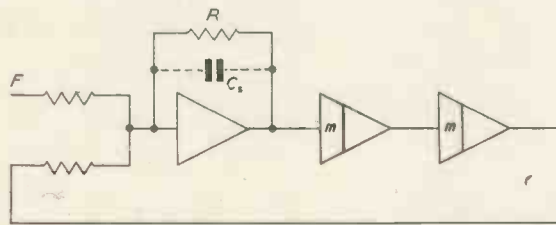

Fig. 14. Stray capacitance across a summing amplifier

with drift. A similar calculation to the one above with $R_2 = (1/pC)$ yields the operational expression:

$$e_o(p) = \frac{-\delta(p/m + 1)}{p/m} \dots\dots\dots (11)$$

If δ is taken as a unit step of drift then the solution of equation (11) is:

$$e_o(t) = -\delta(1 + mt)$$

where $m = (1/CR_1)$.

(iii) Grid current at the first grid. Writing for the junction G (Fig. 13).

$$(1/R_1)(e_1 - e_g) + (1/R_2)(e_0 - e_g) + i_g = 0$$

and solving for e_0 in the usual manner, letting $A \rightarrow \infty$, $e_1 \rightarrow 0$, yields the result $e_0 = -i_g R_2$. That is the whole of the grid current flows through the feedback resistor R_2 .

Grid current is thus a very real factor in affecting the accuracy of an analogue computer.

In the case of an integrator the grid current flows into the integrating capacitor and $e_0 = -(i_g t/C)$. Thus an integrator on open loop integrates both drift and grid current, and a poorly designed amplifier may saturate in a relatively short time. (iv) Inherent stray capacitance across a summation amplifier, or scaling amplifier. In the second order differential equation without damping represented by Fig. 14.

Given an initial forcing voltage F the system will continue to oscillate at its natural frequency. If, however, the natural frequency is raised by raising the integrator gains m , the constant sinusoid begins to diverge, since the presence of the stray capacitance C_s means that the computer is now solving a third order equation. For a given frequency

the divergence varies as the product $C_s R$, thus in a computer working repetitively at a speeded up time scale, the product $C_s R$ must be kept small. (v) Phase leads in computer systems. If in the above circuit the summation amplifier is made a summing integrator then the divergence in (iv) does not occur and the frequency may be doubled or even trebled. In this case, however, a convergence of the formerly constant sinusoid takes place due to positive phase shift. These two facts indicate that when computers are used repetitively summing integrators may be advantageously employed unless it is required to record the highest derivative in any degree of freedom.

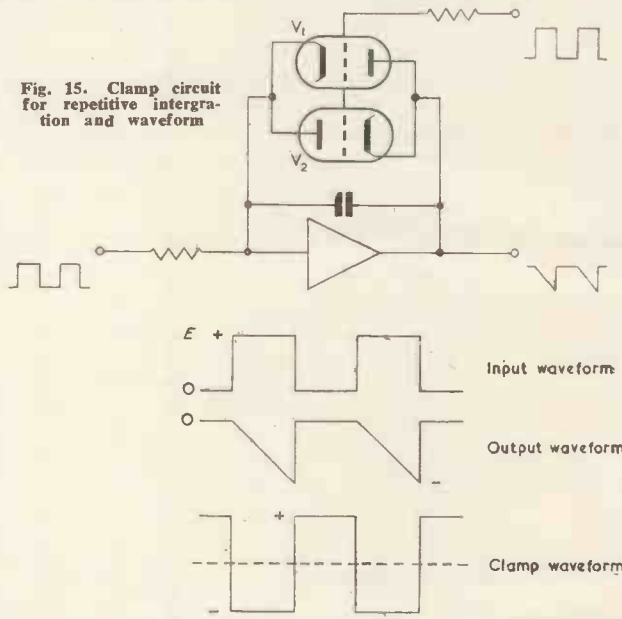

Fig. 15. Clamp circuit for repetitive integration and waveform

Single Sweep and Repetitive Operation of Analogue Computers

There are two basic uses to which an analogue computer may be put. One is that of obtaining an accurate and permanent record of the solution of a given problem, while the other is that of optimization of a dynamical system. Here many of the intermediate results will not require accurate solution or permanent recording.

In the first case a "single shot" record is taken on an accurate pen recorder, the machine is started, and stopped manually after the required time interval of solution has passed.

In the second case a cathode-ray display is used, while the units of the computer are electrically switched by means of suitable excitation waveforms.

This is most easily achieved by clamping the energy storage units such as integrators by means of triode valve clamps across the input and output terminals. The valves used for this purpose should have a low anode impedance, since there is always a small clamping error of about 1 per cent, which manifests itself as a false initial condition. A diagram of a clamped integrator is shown in Fig. 15.

Considering a single integrator the action of the circuit is as follows.

With a positive-going square pulse input, the integrator output runs negative during the time interval t , hence the clamp waveform must be of sufficient amplitude to hold V_1 cut-off while V_1 cathode is falling. After time t , capacitor C is charged to a voltage e , which during the positive period of the clamping waveform can be discharged through V_1 . For a negative input to the integrator a similar action takes place in V_2 .

(To be continued)

Improved Permanent Magnet Materials

Three new grades of permanent magnet material with a semi-columnar structure known as Alcomax II S.C., III S.C. and IV S.C. have been introduced by Permanent Magnet Association Manufacturers. The technical and economic benefits of these materials are most marked in a limited size range, but this range includes shapes and sizes which are particularly suited for loudspeaker magnet systems.

The possibilities and limitations of the new materials can be best explained by reference to the stages of development of the NiAlCoFe alloys from which the majority of magnets are now made. Table 1 lists the characteristics and important magnetic properties of the relevant materials.

TABLE 1

MATERIAL	FORM FOR FULL PROPERTIES	B_r (gauss)	$(BH)_{max}$ (m.g.o.)	H_c (oersted)
ALNICO	Any castable shape, any magnetization axis	7 250	1.7	560
ALCOMAX III	Simple shapes, minimum curvature of magnetization axis	12 500	5.0	670
COLUMAX	Lab. casting in special mould, heavily ground to simple block	13 450	8.6	840

Alnico, the prototype of the group, is isotropic, the listed properties are available along any magnetization path. Alcomax III exemplifies the improvement possible from a modification of the basic Alnico composition together with heat treatment in a magnetic field so as to get preferential properties in a pre-chosen magnetization path. Columax, in the form tabulated, probably represents the maximum possible development of the anisotropic NiAlCo alloys and has the highest known available magnetic energy. The difference between Columax and Alcomax III properties is the improvement due to the application of field heat treatment to alloy grains in which one crystallographic axis coincides with the field axis, as compared with such treatment applied to a random crystal assembly.

Despite considerable development work, the consistent attainment of full Columax properties remains difficult and the techniques involved are expensive and not readily applicable to bulk production. It has now, however, been established that a proportion of the improvement due to a columnar structure can be obtained by relatively simple means on castings of suitable proportions by careful control of foundry technique and that, for a given size, the improvement can be held at a consistent level without extra grinding. The structure is semi-columnar and the method is applicable to all three standard Alcomax alloys.

Fig. 1 gives demagnetization curves for normal Alcomax III and for a casting of Alcomax III S.C., while Fig. 2 shows typical etched cross-sections of each casting reproduced at full-size. The random grain structure of the normal alloy and the large proportion of nearly parallel columnar grains in the S.C. material are clearly seen.

It must be stressed that the properties shown are those characteristics of this size and proportion of casting and that the amount of improvement may differ with other sizes. In general, a worthwhile increase in properties is obtainable on magnets of circular cross-section of not less than about $\frac{1}{4}$ in diameter and with a magnetic length less than the diameter. A moderate degree of taper on the cross-section does not seriously affect the structure and air-gap field strength measurements confirm that such castings have markedly improved overall properties, although the shape is not suitable for accurate BH curve measurement. Any increase in the proportional amount of side surface is very detrimental to the development of the best struc-

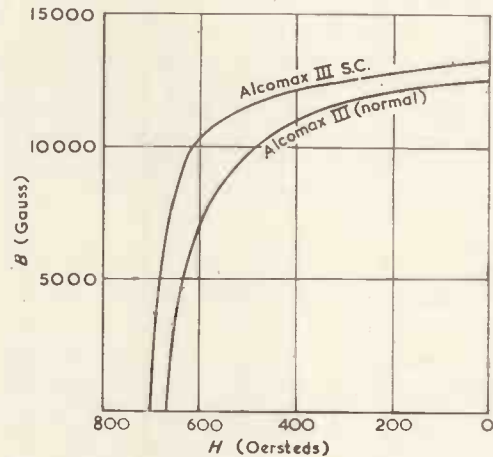

Fig. 1. Demagnetization curves of normal Alcomax III and of Alcomax III S.C.

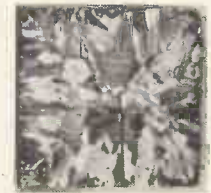

Fig. 2. Etched cross-sections showing grain structure at approximately full size

Left—Alcomax III S.C.

Right—Alcomax III

ture, therefore elongated blocks, ring magnets, or even the introduction of a cored hole in a cylindrical magnet, may result in no useful increase in properties. These points all relate to the necessity of minimizing freezing effects from any surface except the prospective pole faces when manufacturing the casting.

The BH curves show that maximum energy is available at about the same slope, BH , for normal and for S.C. material. It follows therefore that, in an existing design, a direct replacement of normal by S.C. of the same size and grade (II, III or IV) will give decreased air-gap field strength to the extent of half the percentage improvement in $(BH)_{max}$; alternatively to maintain the same average field strength, the magnet volume can be reduced inversely to the $(BH)_{max}$ increase, reducing length and diameter about equally.

It will be evident from this outline that the general sizes and proportions of many speaker centre-pole magnets are ideally suited for the new development, but that the frequently used cored centre hole must be replaced by other methods of fixing if maximum benefit is to be obtained.

A Chart for the Evaluation of Crystal Rectifier Constants

By I. M. Templeton*, M.A., D.Phil.

A universal chart is applied to a plot of experimental results on semi-logarithmic graph paper, and the parameters α and I_0 are read off directly. Using the method described it is possible to evaluate α , I_0 and r for a given crystal rectifier to within a few per cent in a very short time.

IT is well known† that the diode and diffusion theories of barrier-layer rectification lead to a voltage-current relationship of the form:

$$I = I_0 [\exp(\alpha V_b) - 1] \dots\dots\dots (1)$$

where I is the current and V_b the voltage across the barrier. The evaluation of the constants I_0 and α , which are useful in assessing the low-frequency performance of such a rectifier, is not a straightforward process. A method is proposed here whereby these constants may be derived rapidly to a reasonable degree of accuracy.

Derivation

First examine the properties of the theoretical relationship. From equation (1) it is found that:

$$\ln(I + I_0) - \ln I_0 = \alpha V_b \dots\dots\dots (2)$$

Thus a plot of $\ln(I + I_0)$ against V_b will be a straight line of slope α , with an intercept at $V = 0$ equal to $\ln I_0$. The corresponding plot of $\ln I$ against V_b will be a curve which becomes asymptotic to the straight line $\ln(I + I_0)$ at high values of V_b .

It is possible, therefore, to draw a family of curves for $\ln I$ against V_b , taking a fixed value of I_0 and various suitable values of α , which has the general appearance of Fig. 1. Such a plot may conveniently be made on a standard 3 cycle log \times linear graph sheet, taking I_0 as one of the unity lines. The range of I and V_b covered will depend on the application; in the case of the silicon crystal detector, ranges of barrier voltage up to 150mV and current from $I_0/10$ to $I_0 \times 100$ are suitable. Values of α may range from about 10 up to a theoretical maximum of 40 (for room temperature applications), the increment between successive curves depending upon the accuracy required in the final evaluation of α from measurements.

Since the values of I are plotted on a logarithmic scale the curves will have the same form for all values of I_0 . It is therefore possible to fit a tracing of this family of curves over any experimental plot made to the same scale, using $V = 0$ as a reference line. The value of α is estimated from the position of best fit of the experimental points to the empirical curves. Having obtained this fit, the value of current corresponding to I_0 may be read off from the scale on the experimental plot.

In order to derive values for barrier voltage from experimental measurements of current against applied voltage, it is necessary to know the magnitude of the ohmic spreading resistance r in series with the barrier. At all times we have:

$$V_b = V_{\text{total}} - Ir \dots\dots\dots (3)$$

A sufficiently accurate estimate of r may be made from the slope resistance of the crystal at high forward bias (such that $\exp(\alpha V_b) \gg 1$). In these conditions:

$$I \approx I_0 \exp(\alpha V_b) \dots\dots\dots (4)$$

therefore:

$$\left(\frac{\partial I}{\partial V_b}\right) = \alpha I_0 \exp(\alpha V_b) \approx \alpha I \dots\dots\dots (5)$$

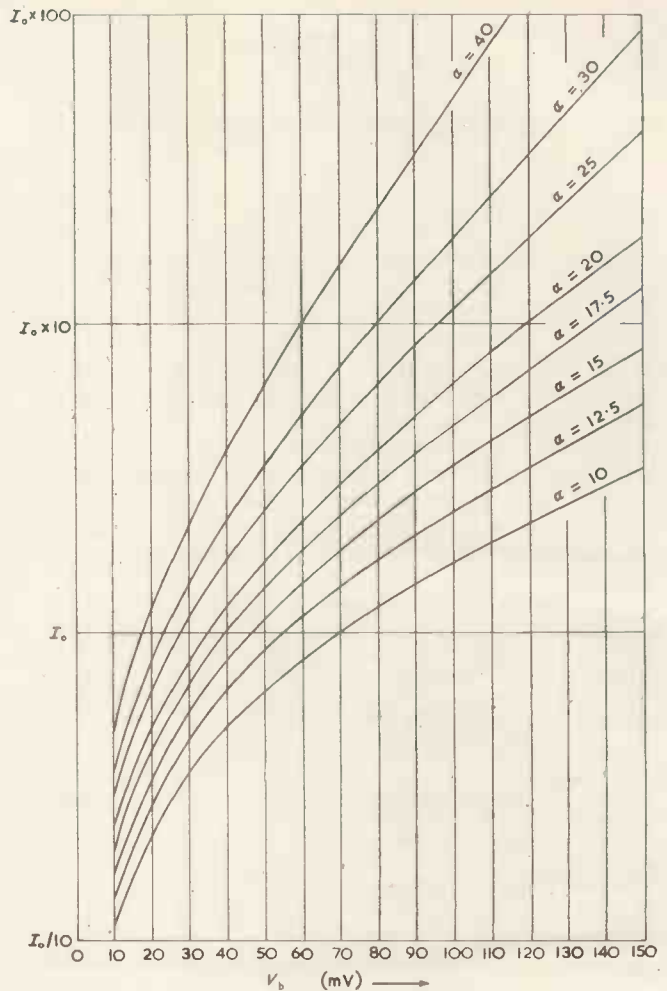

Fig. 1. Chart for evaluation of crystal rectifier constants

Thus, for a given value of I , the slope resistance of the barrier is given by:

$$\left(\frac{\partial V_b}{\partial I}\right) = (1/\alpha I) \dots\dots\dots (6)$$

and therefore the total slope resistance is given by:

$$\left(\frac{\partial V_t}{\partial I}\right) = (1/\alpha I) + r \dots\dots\dots (7)$$

In most practical cases $r \gg (1/\alpha I)$ when $\exp(\alpha V_b) \gg 1$. Thus α need only be known very approximately for sufficiently accurate correction to be made to the measured slope resistance. This slope resistance may conveniently be measured by an audio-frequency a.c. method or by making a plot of the forward V/I characteristic: in the latter case it should be noted that in many practical measuring circuits correction has also to be made for the resistance of the series milliammeter. A more accurate value for r may be obtained later when the value of α for the rectifier concerned has been calculated.

Conclusion

Using the method described it is possible to evaluate α , I_0 and r for a given crystal rectifier to within a few per cent, in little over ten minutes.

Acknowledgments

This investigation was carried out under a contract placed by the Department of Physical Research, Admiralty, and thanks are given to the Admiralty for permission to publish. The author is also indebted to his colleagues in the B.T.H. Research Laboratory for encouragement and assistance in this work.

* British Thomson-Houston Co. Ltd.

† TORREY, H. C., WHITMER, C. A. Crystal Rectifiers. (McGraw-Hill, 1943).

R.E.C.M.F. EXHIBITION PREVIEW

A description, compiled from information supplied by the manufacturers, of selected exhibits to be shown at the Exhibition of the Radio and Electronic Component Manufacturers Federation, in Grand Hall, Grosvenor House, Park Lane, London, W.1, from 10 to 12 April.

(Figures in parenthesis refer to Stand Numbers).

A. B. Metal Products (27)

AN entirely new multi-pole, multi-wafer rotary switch (illustrated below) compact in design and incorporating a number of interesting new features and known as the A. B. "E" type switch will be displayed, and in addition, a complete range of wirewound cement coated fixed resistors will make their debut.

The trend towards miniaturization will be reflected in a new miniature potentiometer of the "deaf aid" type.

A wide range of clarostat wirewound and composition element controls will be



shown including types suitable for incorporating in printed circuits.

A. B. Metal Products Ltd.,
17 Stratton Street,
London, W.1.

Aero Research Ltd. (90)

IN addition to the normal range of epoxy resins improved "Araldite" foam, flexible resins and high-temperature materials which retain their mechanical and electrical properties at temperatures of 200°C will be shown.

Aero Research Ltd.,
Duxford,
Cambridge.

AVO (26)

NEW equipment on view will include a wideband a.m.-f.m. signal generator type TFM and the signal generator type III. The latter instrument (illustrated above right) covers the frequency range of 150kc/s to 220Mc/s on fundamentals. The generator will supply a c.w. signal or a signal amplitude modulated at 1000c/s. R.F. signals are obtained via a screened concentric socket at an output impedance of 80Ω via a continuously variable attenuator and four-step decade multiplier giving a very low minimum, and maximum signals of 100μV, 1mV, 10mV and 100mV. In addition, a fixed

force signal of approximately 250mV is obtainable from the same output socket.

Another new piece of test gear is the Avo d.c. amplifier which will give full scale readings down to 3×10^{-12} A, with an accuracy of ± 2 per cent.

The Automatic Coil Winder & Electrical Equipment Co. Ltd.,
Avocet House,
92-96 Vauxhall Bridge Road,
London, S.W.1.



Daly (102)

DISCHARGE type electrolytics for photo-flash solenoid operation, mine exploders, and similar applications have been extended in capacitance value and working voltage. A typical example is a unit of 400μF at 500V d.c. measuring 2in diameter by 4½in long. A technique has been evolved to prevent loss of capacitance through rapid charge and discharge.

A wide range of electrolytics for printed circuits will be shown. These include conventional types adapted for this purpose and multi-capacitance types with standardized printed circuit fixing centres. As many as four capacitances can be provided in one unit designed for quick insertion and dip soldering.

Daly (Condensers) Ltd.,
West Lodge Works,
The Green,
Ealing, London, W.5.

Dubilier (77)

INCLUDED among the new components to be shown is a range of ultra high frequency filters (illustrated above right).

These coaxial filters have been



developed to provide effective suppression of supply circuits over the range 200 to 1300Mc/s. Each filter comprises a double "T" network using ceramic disk capacitors with a straight-through ferrite sleeved conductor, thereby reducing to a negligible amount the losses at the supply frequency and the special grade ferrite cores permit of a reasonable match at the u.h.f. to the incoming and outgoing lines. At 1300Mc/s, the suppression is of the order of 60dB.

Several types of components encapsulated in loaded epoxy resin will be shown. These include pulse forming networks and precision wire-wound resistors.

Dubilier Condenser Co. (1925) Ltd.,
Ducon Works,
Victoria Road,
North Acton,
London, W.3.

Edison Swan (61 & 106)

INCLUDED in the Edison Clix components will be a new range of domestic B7G and B9A valveholders which have a novel method of screening can attachment. The screening cans lock directly on to the holders and skirts are not required (illustrated below).

A new range of printed circuit valveholders uses the same method of screening can attachment.

Edison Swan Electric Co. Ltd.,
155 Charing Cross Road,
London, W.C.2.



Electro Methods (93)

AMONG the new components which will be displayed are a range of miniature rectangular connectors (illustrated below) which are manufactured under licence from Winchester Electronics, U.S.A. The connectors are moulded in Melamine and the pins and sockets are phosphor bronze, gold plated. This range also includes pivoted circuit connectors.

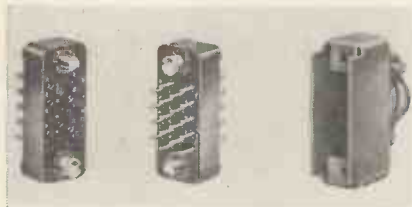

New designs of magnetic amplifiers will also be shown. These will include high stability amplifiers for control circuits operating from very small signal sources and saturable reactors in ratings up to 2kW.

Electro Methods Ltd.,
Caxton Way,
Stevenage,
Hertfordshire.

Ferranti (63)

A RANGE of silicon junction diodes (illustrated below) and ceramic valves will be shown for the first time.

The silicon diodes have a maximum p.i.v. between 60V and 120V and maximum voltage for 100mA forward current of 1.5V. The maximum mean dissipation at 20°C is 150mW and the maximum operating temperature 150°C.

The triode type UL10 ceramic valve is 2½in long and has a maximum diameter of 1in. It will give a continuous output of 15W at 1000Mc/s or it may be used under pulse conditions where it will give a peak output power of up to 15kW at the same frequency.

Ferranti Ltd.,
Hollinwood,
Lancashire.



Guest Keen & Nettlefolds (101)

IN addition to the more normal types of nuts, bolts, etc., a range of nylon screws will be on display. These are formed by moulding I.C.I. A.F. quality Nylon. The mouldings have an abrasive resistance even at high temperatures; the tensile strength is approximately 5 tons per square inch at room temperature and this strength increases until at -40°C the tensile strength is approximately 7 tons. Because of the elasticity of Nylon care must be taken in driving the screws,

otherwise the shanks will become elongated and the threads strip. Temperatures above 135°C (275°F) should not be exceeded and at approximately 250°C (480°F) de-moulding occurs.

Guest Keen & Nettlefolds
(Midlands) Ltd.,
Box No. 24, Heath Street,
Birmingham, 18.

Jackson (40)

TWO new variable capacitors will be shown. The first (illustrated below) is designed for use in a.m.-f.m. receivers and is a two gang capacitor in two sections. The a.m. section has a maximum capacitance of 532pF and the f.m. section 12pF. Robust construction and a wide air-gap in the f.m. section is provided to ensure stability.

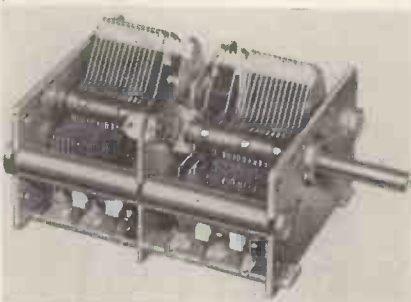

The second new capacitor is a sub-miniature two gang with a frontal area of 1½in × 1½in (including sweep of vanes) and a depth of 1 11/16in. It has a capacitance of 362pF.

Jackson Brothers (London) Ltd.,
Kingsway,
Waddon,
Surrey.

Labgear (144)

INCLUDED in this firm's exhibit will be a crystal drive unit which is intended for use with transmitters, the



accuracy of frequency control of which is normally insufficient to comply with the provisions of the Atlantic City 1947 Agreement of the International Telecommunications Union.

Basically the instrument consists of a crystal oscillator followed by a buffer isolation amplifier. Several features have been included to ensure that the frequency of the output is well within the prescribed limits of ±0.003 per cent. The crystal (which may be of the 10X, 10XJ or B inter-Services styles) is housed in a temperature controlled oven. The oscillator circuit is of the Pierce type modified to allow the crystal to be con-

nected between the control and screen grids of a pentode valve. Output to the buffer amplifier is taken from the anode circuit which reduces to a minimum loading on the crystal.

The buffer amplifier is of the conventional r.f. pentode type, the gain of which is adjustable by a screen grid potentiometer. A wide-band output transformer permits matching to a 75Ω load.

The unit will provide a minimum output of 250mW over the frequency range of 2 to 6Mc/s.

Labgear (Cambridge) Ltd.,
Willow Place,
Cambridge.

Marconi Instruments

A NUMBER of instruments of new design will be exhibited by this firm.

The f.m.-a.m. signal generator type TF1066 (illustrated below) covers 10 to 470Mc/s in five bands. The output from this signal generator can be set at any level between 0.2μV and 200mV and can be modulated in either of two ways; f.m. is monitored and variable up to a maximum of 100kc/s deviation; a.m. is monitored and variable to a maximum depth of 80 per cent. A special feature of the design is an incremental tuning system in which small frequency changes are



read from a meter with a direct calibration valid at all carrier frequencies. The TF1066 is a versatile general-purpose instrument and, in particular, a high-quality f.m. generator.

The u.h.f.-s.h.f. signal generator type TF1058 is a high-stability signal generator equipped with comprehensive incremental tuning facilities, and covers the range 1700 to 4000Mc/s in a single band. The output is monitored and can be accurately adjusted to any level between -165 and -30dB relative to 1W in 50Ω; in addition, uncalibrated high outputs up to 50mW are obtainable at most frequencies. Internal square-wave amplitude modulation is available as well as externally-applied pulse and frequency modulation, the latter having a maximum deviation of 5Mc/s.

Marconi Instruments Ltd.,
Longacres,
St. Albans,
Hertfordshire.

Mycalex and T.I.M. (2)

THE shaded pole motors to be shown by this firm are at present manufactured in two types.

G. L. Scott (125)

NEW products available include small strip-wound cores made from nickel iron alloys manufactured by powder metallurgy techniques by Henry Wiggin & Co. Ltd. Such alloys include a high permeability alloy for use in magnetic amplifiers, pulse transformers and miniatures using strip .004in, .002in, .001in and .0005in thick, and a domain-oriented material .004in, .002in and .001in thick for computer and other work where squareness of loop is required. An alloy having a 47 per cent nickel with low loss and good permeability characteristics is available in lamination form (as well as the 77 per cent high permeability alloy) but not thinner than .004in.

Geo. L. Scott & Co. Ltd.,
Cromwell Road,
Ellesmere Port,
Cheshire.



Type MA is an offset shaded pole motor (illustrated above), and type MC is a barrel-shaped motor.

The type MC motor can also be supplied with a flange or foot mounting with a single or double shaft extension.

All these shaded pole motors have self-aligning bearings with oil reservoirs, vacuum impregnated with high grade oil. They are silent in operation.

The rotors are dynamically balanced and the steel shafts have a ground finish.

The field coils are vacuum impregnated, and the shading rings are silver soldered.

The casing of the type MC motor has an enamel finish, and the motors are flash tested to 2kW.

Mycalex and T.I.M. Ltd.,
Ashcroft Road,
Cirencester,
Gloucestershire.

Partridge (50)

A FEATURE of this firm's display will be a new high fidelity "C" core output transformer type P.4014 (illustrated below) for the "distributed load" version of the Mullard 5-10 amplifier. Frequency characteristic flat within ± 1 dB 30c/s to 30kc/s, power rating 12W at 30c/s for $\frac{1}{2}$ per cent distortion.

Partridge Transformers Ltd.,
Roebuck Road,
Tolworth,
Surrey.

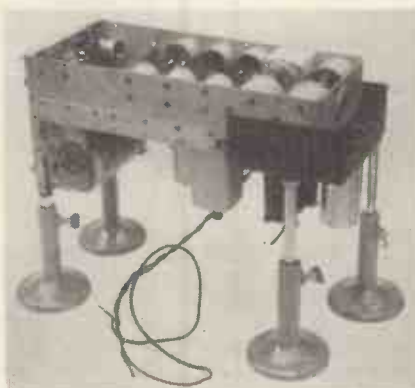
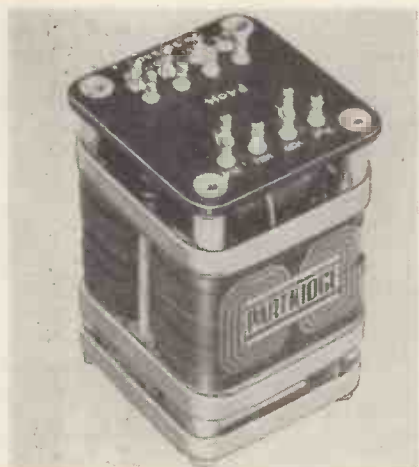

Spear Engineering (92)

SPEARETTE adjustable chassis servicing jacks (illustrated above) are normally supplied in sets of four.

Being adjustable for height they are capable of being set to accommodate the varying heights of projecting components. The top faces of the adjustable columns are insulated so that tests can be carried out with the chassis on the jacks.

Spear Engineering Co. Ltd.,
Titon Works,
Limpsfield Road,
Warlingham,
Surrey.

Suflex (33)

TWO new types of polystyrene capacitors have been recently developed.

The HSX type represents the latest trend towards miniaturization. The size is 10mm x 4mm and the capacitance range is 5 to 330pF; the working voltage is 125V d.c.

The HSS type is a new high quality component which complies with the joint Services type approval requirements of RCS.137 as a class 40/70 H.2 component, which is a particularly stringent specification. These capacitors are available in a range of sizes from 4.7pF to 0.01 μ F.

Suflex Ltd.,
35 Baker Street,
London, W.1.

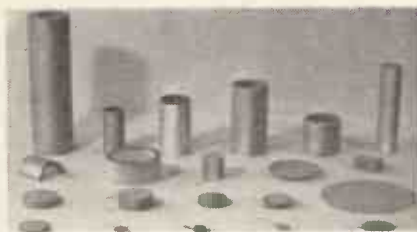

United Insulator (10)

SEVERAL new ceramic components will be shown, including stand-off insulators having threads formed in the ceramic, coil formers of miniature dimensions, and a comprehensive range of piezo-electric ceramic elements (illustrated above).

The main display will be a model water-wheel which demonstrates the action of The "Unipiezo" elements, the piezo-electric ceramics referred to above.

United Insulator Co. Ltd.,
Oakcroft Road,
Chessington,
Surrey.

Westinghouse (65)

A NUMBER of new developments of Westinghouse metal rectifiers will be shown for the first time. The new ranges of aluminium based high temperature units will be salient features (illustrated below). They are suitable for operation in ambients of up to 85°C, and the low cost potted varieties, designed to conform to classes H.1 and H.2, are particularly suitable for use in tropical receivers. The new units are available in assemblies rated for an input of 25V r.m.s. per element.

Specially processed rectifiers developed for magnetic amplifier circuits having very low and stable reverse characteristics are another recently developed range, as are also the DSF.4 range designed for Service requirements and capable of withstanding a very high g: There will also be a new and improved range of the contact cooled type of rectifiers that have already firmly established themselves in the radio and television industry.

Westinghouse Brake & Signal Co. Ltd.,
82 York Way,
King's Cross,
London, N.1.

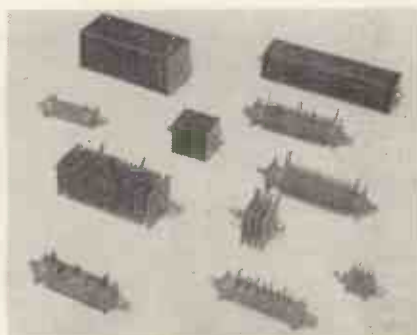

Short News Items

Radio Industry Council Premiums for Technical Writing. Premiums awarded for articles published in the public technical press during 1955 were presented at a luncheon given by the Public Relations Committee of the Radio Industry Council on 8 March. Mr. Arthur Clarkson, Vice-Chairman of the Public Relations Committee, presided and Mr. C. H. T. Johnson, Chairman of the Radio Communication and Electronic Engineering Association, presented the awards. One premium of 25 guineas was awarded for each of the following articles.

"A Novel Gas-Gap Speech Switching Valve" by A. H. Beck, T. M. Jackson and J. Lytollis (*Electronic Engineering*, January 1955).

"Memory Systems in Electronic Computers" by A. W. M. Coombs (*British Communications and Electronics*, March 1955).

"An Infra-Red Radiation Pyrometer" by R. A. Bracewell (*Electronic Engineering*, June 1955).

"Progress in High Power Ultrasonics" by Alan E. Crawford (*British Communications and Electronics*, August and September 1955).

Two premiums were awarded jointly in respect of the following three articles.

"A Frequency Modulator for Broad-Band Radio Relay Systems" by I. A. Ravenscroft and R. W. White (*Post Office Electrical Engineers' Journal*, July 1955).

"An Instrument for the Measurement and Display of V.H.F. Network Characteristics" by J. S. Whyte (*Post Office Electrical Engineers' Journal*, July 1955).

"Equipment for Measurement of Inter-Channel Crosstalk and Noise on Broad-Band Multi-Channel Telephone Systems" by R. W. White and J. S. Whyte (*Post Office Electrical Engineers' Journal*, October 1955).

The total number of articles submitted in 1955 was 62, compared with 24 in 1954, 37 in 1953 and 39 in 1952, the first year of the scheme.

Sir Robert Renwick, President of the Radio and Electronic Component Manufacturers' Federation, will open the 13th Annual Radio Component Show at Grosvenor House, London, W.1, at 11 a.m. on Tuesday, 10 April. There will be a preview for specially invited guests from 2.30 p.m. to 6.30 p.m. on Monday, 9 April, and opening hours subsequently will be from 10 a.m. to 6 p.m. on Tuesday and Wednesday 10 and 11 April, and from 10 a.m. to 5 p.m. on Thursday, 12 April. The exhibition

is private and tickets have to be applied for to the Federation at 21, Tothill Street, London, S.W.1. This year there will be 156 exhibitors compared with 142 in 1955.

H.M. The Queen has again consented to be patron of the National Radio Show to be held this year at Earls Court, London, from 22 August to 1 September.

The Production Exhibition, which will take place at the same time as the Conference (23-31 May) is directly related to the proceedings there and exhibits will enlarge on the subject to be discussed. The exhibition will fill the Grand Hall, Olympia. The conference hall has been specially built by the organizers, Andry Montgomery Ltd, 32 Millbank, London, S.W.1.

The 40th Physical Society Exhibition will be held at The Royal Horticultural Society's Old and New Halls, Westminster, London, S.W.1, from 14 to 17 May. The opening ceremony will be performed on Monday, 14 May, by Sir John Cockcroft. Visitors' tickets and further information may be obtained from the Physical Society, 1 Lowther Gardens, Prince Consort Road, London, S.W.7.

The Eleventh Annual Electronics Exhibition organized by the Northern Division of The Institution of Electronics will be held at the College of Technology, Manchester, from 12-18 July. The exhibition will incorporate a scientific and industrial research section, including exhibits from the universities, Government establishments, research associations and laboratories, hospitals and societies; a manufacturers' section displaying electronic devices from leading manufacturers, including a special display of sound recording and reproducing equipment. There will also be a programme of lectures and film shows on electronic topics. Admission to the exhibition will be by tickets available, free of charge, from the exhibitors or from the Honorary Exhibition Organizing Secretary, Mr. W. Birtwistle, 78 Shaw Road, Thornham, Rochdale, Lancs. Lecture programmes and lecture admission tickets will be available in June. Exhibition catalogues, price 2s. 6d. post free, will be on sale from 1 July.

The publishers of 'Radio-Electronics' announce that their address is now 154 W. 14 Street, New York 11, N.Y., U.S.A.

The first Anglo-U.S. Commercial Agreement for Atom Power Plants was recently announced. Mitchell Engineering Ltd, of London and Peterborough, and A.M.F. Atomics Inc, of New York (a subsidiary of the American Machine and Foundry Co.), have completed plans jointly to design and construct power plants in the Commonwealth and other countries. The agreement falls within the scope of the arrangements permitted by the United Kingdom Atomic Energy Authority and the United States Atomic Energy Commission for collaboration between firms in the two countries.

The Associated Electrical Industries/John Thompson organization, to be formed into a company to be known as The A.E.I./John Thompson Nuclear Energy Company, has as its main purpose the development and construction of power reactors and complete power stations. The new company will gain useful practical experience in constructing Britain's first privately owned research reactor which is to be constructed at the A.E.I. Research Establishment at Aldermaston Court in Berkshire. The site for the reactor has been cleared and levelled and design work completed. The reactor will be suitable either for research and engineering investigation or for training purposes. It will be used not only by all the companies of the A.E.I., but will be available to universities, technical colleges and research institutions for undergraduate and post-graduate instruction. A.E.I. will thus be assisting in the training and education of young engineers for the nuclear power programme in this country. Similar reactors are likely to be exported to countries anxious to increase their knowledge of nuclear physics.

The General Electric Co Ltd announce an important change in one of their trade marks. As from 2 April, all electronic valves hitherto sold under the trade mark OSRAM will be marketed under the trade mark G.E.C. This change of name applies only to the company's valves, and has been considered desirable because of the constantly widening range of the company's electronic devices, some of which have been sold under the trade mark OSRAM and some under G.E.C.

The annual dinner of The Institution of Electrical Engineers was held at Grosvenor House, London, on 23 February when the president, Sir George Nelson, was in the chair. The principal

guest was His Royal Highness The Duke of Edinburgh who proposed the toast of "The Institution" to which the President replied. His Royal Highness was elected an Honorary Member of The Institution last year.

Expansion plan for University College, London. An appeal has recently been launched by University College to all sections of British industry for immediate assistance towards a £2 000 000 project for training more engineers. Owing to inadequate accommodation and facilities, the College can accept only one of every nine applications and, of these nine, at least seven are fully qualified and suitable for entry to the Engineering Department. Under its development plans the College has acquired new sites adjoining the present Gower Street buildings. One site is immediately available for construction work estimated to cost £300 000, which is the first target of the appeal. As further funds become available two additional buildings, including a tower block of twelve storeys, will be added.

The Regional Advisory Council for Higher Technological Education has, for the eighth year in succession, prepared a summary of the applied research in electrical engineering at university colleges and technical colleges in London and the Home Counties in the session 1955/56. Copies are available on request from the Secretary, Mr. Stanley Price, Tavistock House South, Tavistock Square, London, W.C.1.

Automatic Telephone and Electric Co Ltd recently held an Open Day at their School of Electronics, Liverpool. The school is among the first of its kind in the country. It is immediately adjacent to the company's manufacturing and research departments and students can thus be familiar, at first hand, with the products being manufactured and systems under development. There is accommodation for 30 students and the school is run on similar lines to a university. Initially there are two types of course, one of three months' duration and the other of one academic year's duration.

The Guild of Air Traffic Control Officers proposes to hold an Autumn Convention, covering all aspects of air traffic control, at Southend on 4 and 5 October. Further information may be obtained from Mr. S. G. Fitch, The Guild of Air Traffic Control Officers, 118 Mount Street, Berkeley Square, London, W.1.

West Instruments Ltd have now moved to 52 Regent Street, Brighton, 1, Sussex. Telephone Brighton 28106.

The General Electric Co Ltd have established a Computer Service Group at their Wembley Research Laboratories. The purpose of the group is to provide an advisory service on mathematical problems relating to any aspect of the company's activities, whether it be cable making, valve research, power generation or the study of communication networks. An example of the type of work carried out by the group is the statistical analysis of the very large amount of data accumulated during the life tests on thermionic valves. The speed with which results are obtained enables the required information to be obtained quickly and economically and passed back to factory production lines. A "Hollerith" electronic digital computer, manufactured by The British Tabulating Machine Co Ltd, has been installed at the Laboratories and is already doing much useful work on behalf of the whole of the G.E.C. organization.

Pye Ltd, after demonstrating industrial television to the Atomic Energy Authority last year, were given a contract to design a special camera capable of being used inside an atomic reactor at the Authority's Cumberland factory. This has now been completed and has been delivered to Harwell for tests prior to its use at Calder Hall. The camera, which is based on Pye's normal industrial television equipment, has had to conform to certain very rigid specifications, and as a result of the experiments which were carried out at the Authority's premises it was found that special materials had to be used. As the equipment is to be used while the atomic pile is dangerous, the camera can be remotely controlled and is housed in a thin stainless steel casing 3½in in diameter and 30in long. A second camera, which is now being made, is to be supplied to the Authority within the next six months and will be used as a standby.

The Plessey Co Ltd have recently opened a new factory at Havant. A new type of rotary switch of advanced design is already in production. All Plessey switch production will gradually be transferred to Havant. The plant, which is located at Leigh Park Estate, Havant, Hants, is expected to provide employment eventually for at least 1 000 people.

Pliobond is a new quicksetting, thermoplastic adhesive composed of synthetic materials produced by The Good-year Tyre and Rubber Co Ltd. It resists water, chemicals oils and waxes. Bonds made with Pliobond have exceptional strength, up to 1 600lb/in².

JD Electronics (Birmingham) Ltd have announced price reductions in their range of transformers.

The Atomic Energy Authority are acquiring two built-up areas on Grove Airfield, near Wantage, as a site for a small outstation of the Atomic Energy Research Establishment, Harwell. These two areas are part of the airfield which the Air Ministry had decided to relinquish. The new outstation is mainly to provide laboratories to allow the Technological Irradiation Group to develop more rapidly. This group, a part of the Harwell Isotope Division, was formed in June 1955 in order to assist industry in making full use of the large amounts of radioactive material which will become available from the expanding atomic energy programme. Later it is proposed to transfer the Isotope School from Harwell to the new site on Grove Airfield.

20th Century Electronics Ltd. announce that they intend entering the photo-electric field and have recruited senior technical staff to run this new venture. Mr. A. E. Jennings has been appointed Head of the Photo-Electric Laboratory. He was formerly with E.M.I. Research Laboratories and was primarily concerned with pick-up tubes. They are equipping an area of over 8 000sq ft to extend research facilities and plan to include a substantial area of dust-free working space.

D. W. Heightman has recently resigned the position which he has held since 1950 as Chief Television Receiver Engineer of the English Electric Co Ltd, and has joined the Radio Rentals Ltd organization as Chief Engineer to the Group.

Tape Recorders (Electronics) Ltd have now moved to their new address at 784-788, High Road, Tottenham, Factories 14 and 17, Wingate Estate, London, N.17. Telephone number Tottenham 0811-3.

Savage (Transformers), of Devizes, Wiltshire, have recently made additions to their factory which have released a substantial portion of the works area for greater production.

Errata. In the article "Batch Production of Electronic Equipment" on p. 127 of the March issue, the name "Weidemann" should read "Wiedemann".

Reference is made to the use of Merton diffraction gratings in measurement applications, p. 109 of the March issue ("Digital Methods in Control Systems"), and it is stated that the development of this technique was performed by the N.P.L. Ferranti Ltd, Edinburgh, would like to point out that this technique was, in fact, developed and applied by them, and they hold the relevant patents. The gratings used are, of course, those used by the N.P.L. whose work has been devoted to the development of the techniques for producing the gratings themselves.

LETTERS TO THE EDITOR

(We do not hold ourselves responsible for the opinions of our correspondents)

Electronic Circuits

DEAR SIR.—Mr. S. R. Deards, reviewing the book "Electronic Circuits" by T. L. Martin in the November 1955 issue, complains bitterly of the *ad hoc* and incoherent collection of out-dated notions that constitute most electronic circuit courses in England.

It seems to me that you could do a great deal editorially to unravel some of this confusion simply by asking that your contributors use the now almost universally adopted "s" notation for the Laplace transformation and restrict the use of the "p" notation to Heaviside operational methods.

The article on the design of a d.c. amplifier for use with a slow analogue computer (January 1956 issue) is an example of the confusion of thought caused by the indiscriminate use of the "p" notation. The author states that he is using the Laplace transformation near the beginning of the article but in deriving the equation for an integrator later on, he defines "p" to be equal to d/dt and $1/p$ equal to $\int dt$ which is the definition of "p" in the Heaviside operational sense and is not true for the Laplace transformation unless the initial conditions are ignored.

Incidentally, there appears to be a term in R_0 missing from the equation for the summing amplifier.

Yours very truly,

ERIC CARR

Canadian Aviation Electronics Ltd.,
Montreal.

The author replies:

DEAR SIR.—In reply to Mr. Carr's letter I would like to state that although I agree with him that p is not completely defined as d/dt and $1/p$ by $\int dt$ except where the initial conditions are ignored, I put this simplified definition in for the benefit of those reading the article not as familiar with the Laplace transformation as Mr. Carr.

I can find nothing wrong with the equation for the summing amplifier, and can only assume that Mr. Carr did not notice the zero as the lower limit of the summation.

Yours faithfully,

H. FUCHS

Blackburn and General Aircraft Limited,
Brough, East Yorks.

The reviewer replies:

DEAR SIR.—Mr. Carr's letter prompts me to venture a few additional remarks in support of the opinion expressed in my recent book review. It seems to me that the majority of circuits courses in this

country bear little relation to contemporary circuit engineering and are designed without reference to the tremendous advances that have been made in the subject during the last thirty years. The theory of electric circuits is one of the finest examples of the application of mathematical reasoning to the study of physical phenomena but is presented in most technical colleges as a collection of standard rules to be applied in standard situations.

With the advent of television and radar the emphasis in circuit engineering shifted from the real frequency domain of Kennelly and Steinmetz to the more fundamentally important time domain. It has been the extensive development of time domain circuit theory in recent years that has enriched the science of electrical engineering and widened our understanding of circuit behaviour. The central concept in circuit theory is that of impedance but the modern concept has a much broader interpretation than the old Kennelly-Steinmetz concept. This was associated exclusively with the sine-wave steady-state response of systems and is the only case considered in most circuits courses.

If the student is to acquire a proper understanding of the notion of impedance his studies must begin with an enquiry into the impulsive and indicial responses of simple configurations. Such a course leads naturally and logically to the concept of complex frequency and hence to a full appreciation of the meaning of the impedance function and of the significance of real frequencies and resonance phenomena. The complex frequency plane¹ provides an ideal teaching aid and affords a deeper insight into circuit reaction than any other device. The most notable of the many text-books which have recently appeared and which approach the theory of linear circuits in the light of these new developments is Professor E. A. Guillemin's latest book, *Introductory Circuit Theory*².

The introduction of the sine-wave steady-state impedance concept by Kennelly in 1904 added complex numbers to the analytical resources of the circuit engineer who thereupon confused the algebra of complex numbers with plane vector analysis. Forty-five years ago, G. A. Campbell wrote³ "When the direction of a current is confined to one or the other of two opposite directions by the use of a linear conductor, we can vary its scalar magnitude only; it is no more correct to speak of representing this scalar quantity by a vector when it is complex than when it is real. It is only when the electrical phenomena takes place in two or three dimensions in space that vector variables are involved in the mathemati-

cal treatment." More recently, Professor E. Weber has observed that this mistake was the cause of delay in circuit theory development because it obscured the natural connexion with the elegant and powerful field of Cauchy's function theory⁴. Nevertheless, the heading *A.C. Vectors* is still to be found in the syllabuses of many of our technical colleges. This provides an example of what I have referred to as out-dated notions.

A reform in the teaching of circuit analysis is probably longest overdue. The usual muddled treatment of the mesh-method of analysis, when treated at all, is such that, to quote Professor Guillemin², the student "stores up a lot of trouble for himself that does not show until much later in his career when he meets a slightly unorthodox situation and suddenly discovers that he can't even get started on it." This would be remedied if the subject of circuit analysis were prefaced by a little elementary combinatorial topology—a subject which should have been introduced in elementary circuits courses long ago. Nodal analysis is never taught and quality is rarely mentioned. Quoting Professor Guillemin² again, the student "should be started off with the same basic concepts and processes of analysis that he will be using in his professional work four or five years later."

The literature of circuit theory is vast. A reorganization of the instructional approach to the subject in a manner compatible with this wealth of information would present no great difficulty and would redound very much to the credit of British technological education.

Yours faithfully,

S. R. DEARDS

Department of
Aircraft Electrical Engineering
The College of Aeronautics

REFERENCES

1. GUILLEMIN, E. A. *An Introduction to Modern Filter Theory*. Proc. Nat. Electronics Conf., Chicago, 9, 327 (1953).
2. GUILLEMIN, E. A. *Introductory Circuit Theory*. (Chapman and Hall Ltd. 1954.)
3. CAMPBELL, G. A. *Cisoidal Oscillations*. Trans. Amer. Inst. Elect. Engrs. 30, 873 (1911).
4. WEBER, E. *Introductory Speech to Symposium on Modern Network Synthesis held at the Polytechnic Institute of Brooklyn on April 16th, 17th and 18th, 1952.*
LE PAGE, W. R. *Symbolic Nomenclature for Sinusoids*. *Elect. Engrs. N.Y.* 68, 561 (1949).
THOMAS, J. A. (Correspondence) *Bull. Elect. Engrg. Educ.* 8, 84 (1952).

High Impedance Current Generators

DEAR SIR.—We have investigated "constant current" generator circuits somewhat similar to those described by Mr. J. H. McGuire (p. 529, December 1955 issue). Our application is to an analogue computer for the study of exponential exchange systems such as

are encountered in biology and chemistry. The requirements are as follows:

(a) The input current is a time variable which has to be duplicated in the load impedance without polarity reversal. It must flow into a virtual earth.

(b) The load impedance, Z , is a capacitance shunted by a resistance which may be large. It cannot be relied upon to carry steady anode current, and the generator impedance should approach infinity if possible.

The first of these requirements is met by the circuit of Fig. 1. Since Z is connected on the anode side of the h.t. circuit it follows that a pentode, if used, must be triode-connected.

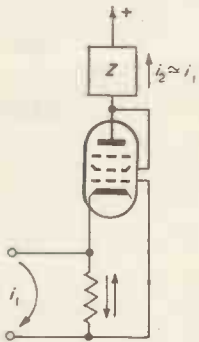

Fig. 1. Basic circuit

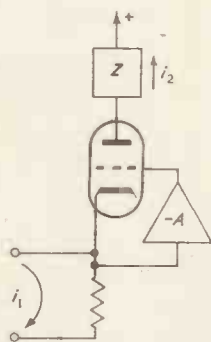

Fig. 2. Insertion of amplifier

The required characteristics of high output impedance, low input impedance and near-equality between i_1 and i_2 are all dependent on a large value of mutual conductance. In Fig. 2 an amplifier of gain $-A$ has been inserted between the cathode and grid of the valve; this has the effect of multiplying the mutual conductance by the factor $(A+1)$.

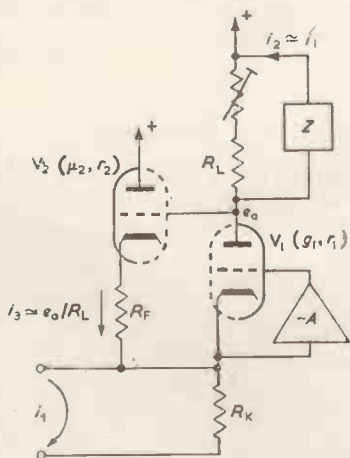

Fig. 3. Extension of Fig. 2

Z is still required to provide a d.c. path for the anode current and the effective impedance across it, although high, is finite. These objections can be

overcome by the circuit of Fig. 3. Suppose that the incremental voltage across Z has changed to a value e_a due to the signal current, i_1 , which has flowed in. The current in the d.c. bypass resistor, R_L , will have changed by an amount e_a/R_L . It is the function of the cathode-follower, V_2 , to supply an additional current, i_3 , at the input which exactly compensates for this effect. In these circumstances, if Z is a pure capacitance it will hold its charge indefinitely after the input current ceases.

To a first approximation the required conditions are obtained simply by making R_F equal to R_L . Owing to the finite mutual conductance of V_1 and V_2 , however, it is necessary to make R_L slightly more than R_F in order to obtain an infinite effective output impedance. As R_L is changed through the critical value the output impedance passes from a high positive to a high negative value. If R_F is too small the circuit becomes unstable, being then in fact a form of the Schmitt trigger circuit.

In practice Z may be coupled to the anode of V_1 through a blocking capacitor which may be of any value provided its reactance is fairly small compared with Z . When Z itself is a pure capacitance the circuit becomes an integrator which differs from the Miller type in that there is no reversal of polarity at the output.

The relations for the circuit of Fig. 3 are as follows:

$$i_1/i_2 = 1 + \Delta,$$

$$\text{where } \Delta = \frac{1}{(A+1)g_1 + 1/r_1} \left[(1/R_K) + \frac{1}{R_F + r_2/(\mu_2 + 1)} \right];$$

Output impedance = ∞ when:

$$R_L = (1 + \Delta)R_F / [M_2 - (R_F/r_1)\Delta],$$

where $M_2 = \mu_2 R_F / [(\mu_2 + 1)R_F + r_2]$;

Input admittance \approx

$$Ag_1 / [1 + (1/R_L + 1/r_1)Z] + 1/R_K + 1/R_F.$$

Yours faithfully,

B. D. CORBETT,

Department of Clinical Research,
University College Hospital
Medical School,
London, W.C.1.

The Author replies:

DEAR SIR.—Mr. Corbett's basic circuit (his Fig. 1) corresponds to the circuit of Fig. 3 in the article saving that a current instead of a voltage generator has been used. I find his development of the circuit most interesting in that it is quite different from mine.

Yours faithfully,

J. H. MCGUIRE

Department of Scientific and
Industrial Research,
Joint Fire Research Organization

A Modified Twin T Oscillator with Electronic Frequency Control

DEAR SIR.—It has recently been shown how a twin-T network of capacitors and resistors may be proportioned to give transmission with phase reversal at a certain frequency, and how such a twin-T may be used as a feedback circuit in an oscillator using only one valve. An interesting variation of this arises when the two T's, instead of being joined directly at their input ends, are arranged so that the relative amplitudes of the signals applied to them may be changed at will. This causes a change in the operating frequency.

Fig. A shows an oscillator designed to use this principle. The valve is a 6AS6, in which the division of current between the anode and the screen grid may be controlled by the suppressor grid. One of the T's is driven from the anode, the other from the screen grid. The suppressor grid, by controlling the division of current between these two electrodes, controls the relative amplitudes of the signal applied to the two T's, and thus the operating frequency.

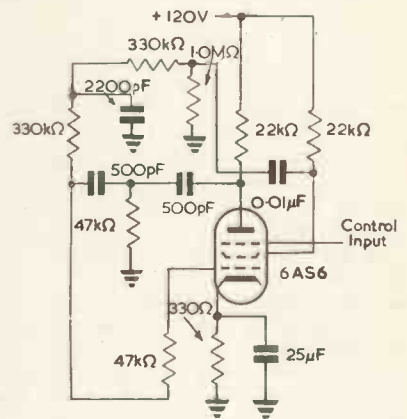

Fig. A. A modified twin-T oscillator

In practice, it was found possible to obtain a frequency swing of only a few per cent by suppressor grid control; however, that may be useful for some applications, and no especial effort was made to find what network would give the greatest swing. The output is best taken across a resistor in either the cathode circuit, or else between the junction of anode and screen grid resistors and the high tension supply. This eliminates most of the variation of amplitude with frequency.

It seems likely that this principle of controlling the division of a signal may have applications, as well as to oscillators, to such circuits as electronically controllable filters.

Yours faithfully,

H. L. ARMSTRONG,

Pacific Semiconductors Inc.,
Culver City, California.

I. M. J. TUCKER, A Twin-T RC Oscillator. *Electronic Engng.* 27, 346, 1955.

BOOK REVIEWS

An Introduction to Reactor Physics

By D. J. Littler and J. F. Raffle. 196 pp., 40 figs. Demy 8vo. Pergamon Press Ltd. 1955. Price 25s.

PUBLISHED on behalf of the U.K. Atomic Energy Authority, this book contains the material of declassified lectures given at the Harwell Reactor School. The aim is to provide a self contained treatment of elementary design principles for gas cooled thermal neutron reactors, of the type initially planned for the U.K. nuclear energy programme.

The main part of the book, Chapters IV to XII, Chapter XVI and appendices 1 and 2, follows up the results stemming from the fact that about 2.5 neutrons are emitted per fission in uranium, which in turn may be caused by absorption of only one neutron. The basic physics necessary for comprehension of the main discussion is briefly, but very well, explained in the first three chapters, and data relating to shielding, radiation detection for reactor control and health instrumentation, are given in Chapters XIII to XV and appendix 3.

A brief description of the physical processes of fission in chapter IV brings out the fact that the energy spectrum of neutrons emitted during fission is skew, with an average value of 2MeV and a most probable value of 0.72MeV. These neutrons interact with matter, either by elastic collisions with a suitable moderating material, eventually coming into thermal equilibrium, or else by nuclear reactions such as capture or fission. The two latter processes are competitive in a reactor. Since U^{235} , present in concentration of 0.7 per cent in natural uranium, has a high fission cross-section for thermal neutrons, a chain reaction may be induced in uranium distributed throughout a suitable moderator if at least one neutron per fission is available for absorption at thermal energy U^{235} . A consideration of the "book-keeping" of neutrons in a pile introduces the concept of k , the reproduction constant of a reactor. ($k-1$ represents the excess proportion of neutrons available for maintenance of a divergent reaction). Elucidation of the diffusion equations for neutrons leads to a predominantly mathematical discussion of the conditions for divergence and of calculation of lattice constants for an ideal pile, and also for one more nearly approaching practice. The latter has air-gaps around the uranium rods and is surrounded by a reflector which returns otherwise wasted neutrons to the system. These discussions require of the reader some facility in the use of Bessel functions.

The control of a pile both during start-up and at steady power is helped by

the existence of delayed neutrons from fission products, and complicated by the growth of poisons, which are fission products of high neutron capture cross-section. The authors deal with start-up in a chapter on pile kinetics, and give data on pile operating characteristics in Chapter XII.

The important subject of exponential measurements, in which the diffusion length of neutrons in the proposed lattice is determined, and which lead to a prediction of critical pile size is, rather oddly, relegated to the last Chapter, XVI.

For the remainder of the book, the authors desert their mathematical arguments and try to compress the essential data on the interaction of nuclear radiations with matter, the damage which such radiations may produce in bulk matter, and the instruments used for radiation detection, into three chapters. Possibly as a result of undue compression, several errors have crept into these sections, (e.g. the secondary emission ratio of dynodes in E.M.I. photomultiplier tubes is much greater than 2, and a 14 stage tube has a gain greater by a factor of 1000 than the figure given; naphthalene emits light at 3500Å, not 300Å; counters operating in the Geiger region are described, correctly, as having pulses of uniform height at a given anode voltage, while on the next page a bias curve incorrectly shows a variation in height), and the authors would perhaps have made better use of their space by omitting the sections on detectors and irradiation damage and giving more data on shielding and related aspects of pile construction. A greater number of references would also enhance the value of an avowedly introductory work.

Subject to the above reservations, the book clearly fulfils the authors' claims expressed in the preface, and should prove particularly useful to the increasing number of University students who will be studying reactor physics as part of their course.

J. SHARPE

Elements of Electronics

By H. V. Hickey and W. M. Villines. 487 pp., 150 figs. Demy 8vo. McGraw Hill Publishing Co. Ltd. 1955. Price 37s. 6d.

THE text of this book is based on the authors' experience in training "engineers and technicians" for the U.S. Navy. Approximately one-third of the book deals with elementary notions of electricity, magnetism and trigonometry. This material is treated at about the level of a secondary school course in this country. The remainder of the book discusses a number of electrical and electronic topics such as meters (one

chapter each for ammeters, voltmeters, ohmmeters and "multimeters"), amplifiers, receivers and transmitters.

Many of the diagrams are incorrect: for example on pages 297 and 401 a.c. input is shown connected across a bias battery; again, on page 417 automatic volume control is applied to the grid of a triode r.f. amplifier. Other instances are on page 353 where the grid waveform of a class-C amplifier apparently loses its negative half-cycle in the coupling capacitor, and on page 275 where three neon tubes are shown connected in parallel.

The inaccuracy of the diagrams is shared by the text: for instance in discussing the a.v.c. system on page 417 it is stated that "Since electrons travel at a great velocity, the time elapsed between the reception of a large-amplitude carrier and its reduction to a practical level will not be perceived by the listener". Again on page 407 a ganged tuning capacitor is discussed as follows:— "... The rotors of each are connected to the shaft, which is grounded. This protects the operator from any voltages and also tends to eliminate stray interference introduced into the circuits from the operator's body. Such interference is called body capacitance..."

The note inside the dust-cover claims that the book provides "a well rounded background for advanced studies". This statement is somewhat difficult to believe when the p.d. across a charged capacitor is referred to as an "e.m.f." (page 181) and the direction of an electric current is taken to be the same as that of electron flow (page 5). This particular violation of convention leads to difficulties in a number of diagrams as the flux is apparently reversed and, further, the left-hand rule given on page 78 is quite different from the left-hand rule long in use for the force on a conductor.

Inaccuracy and poor presentation are inexcusable in a text written at such an elementary level and render the book virtually useless.

V. H. ATTREE

Atomkraft

By Friedrich Münzinger. 94 pp., 61 figs., Large 8vo. Springer-Verlag, Berlin. 1955. Price DM10.50.

THIS slender volume, written by a well known German authority on stream power plant and particularly on modern high performance boilers, has the subtitle "A study on the technical and economic prospects of atom power stations" and is intended for engineers, power and general economists. The question is being discussed in the German technical press, what steps should be taken in Germany in order to catch up with the start other powers, particularly the United Kingdom, the U.S.A. and Russia, have made in the development of nuclear power for peaceful purposes. Those interested in this question and also other readers wishing to obtain a systematic and critical survey on the present state of the development will

welcome this treatise. It is confined mainly to a description and discussion of work done in this country and in U.S.A.

After a brief introduction dealing with the physical bases of atomic power and the fundamental requirements which the atomic piles or reactors must fulfil, first the thermally lightly loaded reactors with air-cooling, like those at Windscale and Calder Hall, and then the thermally heavily loaded reactors with liquid metal or water-cooling preferred in U.S.A. are described and illustrated. Water-cooling is also used in the small test reactor at Harwell and this and other test reactors under construction or projected in Canada and Holland are also briefly described. Some 100 different permutations are possible for the design of reactors by the use of different fissile materials applied in various shapes, of different moderators, reflectors and cooling agents. Only about 20 of these permutations may prove to be of practical value in the author's opinion.

These discussions occupy five chapters or about one third of the book. The subsequent chapters deal with the temperature distribution and the thermal deformations within the reactors, the critical examination of various reactors from a technical point of view, the steam and gas turbines used in connexion with reactors, the very important protective measures, the connexion between the reactors and the other components of the power plant, and finally the cost of fissile material and of the piles.

These chapters occupy about the second third of the book while the rest is devoted to an investigation on the question how far atom power stations will prove competitive with plant using conventional sources of energy. A final chapter deals with measures taken for educating the necessary personnel for designing, constructing and operating nuclear power plant. Reference is made to the courses held at Harwell.

A bibliography and a combined name and subject matter index complete this well produced book which, notwithstanding its small size, contains a wealth of instructive material collected from various sources as well as the author's sound critical opinions.

R. NEUMANN

Vacuum Valves in Pulse Technique

By P. A. Neeteson. 178 pp., 147 figs. Demy 8vo. Cleaver Hume Press Ltd. 1955. Price 27s.

THE main object of this book is to indicate how the behaviour of a network in which electron valves are used as switches can be studied with a view to more efficient use, and new applications. After introductory chapters on the opening and closing of switches in networks and some principles of operational calculus, there follows a study of the vacuum valve. The last chapters deal with the bistable, monostable and astable multi-vibrators.

The BEAMA Catalogue 1955-56

1 034 pp. LD4to. Iliffe & Sons Ltd. 3rd Edition. 1955. For private distribution.

THE descriptive catalogue pages have been designed throughout to a standard format, each section of the catalogue being printed in a distinctive second colour.

To help overseas buyers, particularly where nomenclature is concerned, a five language glossary of technical terms used in the Buyers' Guide is included. Product headings are listed in English, French, German, Portuguese and Spanish.

Other useful sections are the Classified Buyers' Guide, listing under more than 1 200 headings, the comprehensive range of electrical and allied equipment manufactured by BEAMA firms, and a Trade Directory giving principal addresses in the United Kingdom of all subsidiary or branch offices, etc., and over 4 000 names and addresses, grouped territorially, of member firms' overseas branches, representatives and agents.

Over 15 000 copies have gone to Trade Commissioners and representatives, overseas buyers, public utility officials, distributors and users in every country in the world.

Electrical Engineer's Reference Book

2 184 pp., 2 059 figs. Demy 8vo. 8th Edition. George Newnes Ltd. 1955. Price 70s.

THIS new edition has been extended to include several new sub-sections, the most important being: Gas Turbine Plants; Copper; Silicones; The Mechanism of Arc Extinction; Metal Rectifiers; Earthing; Rotating Amplifiers.

One of the interesting new articles is an authoritative survey of Nuclear Power for Electricity Generation, which describes the principles of Nuclear reactors and discusses the nuclear power programmes being carried out in this country and abroad.

In all the reference book contains thirty-two sections on modern standard practice and a survey of the most recent information on new developments in all branches of electrical engineering.

Magnetic Recording Handbook

By R. E. B. Hickman. 176 pp., 60 figs. Demy 8vo. George Newnes Ltd. 1956. Price 21s.

THIS book has been designed to interest and inform the recording enthusiast, both amateur and professional, and also the radio servicing engineer who is concerned with the maintenance of the wide range of magnetic recording devices now on the market. After describing briefly the development of magnetic wire and tape recording, the author presents the theory of the recording process, without recourse to mathematics. The practical requirements of a typical recording system are analysed, with the aid of illustrations and circuit diagrams.

Technical and mechanical details are given of a representative selection of modern domestic and professional recorders, film adapters and office dictating machines.

CHAPMAN & HALL

Abstracts of the Literature on SEMICONDUCTING AND LUMINESCENT MATERIALS

and Their Applications

Compiled by
BATTELLE

MEMORIAL INSTITUTE

11" x 8½" 200 pages 40s. net

This is the 1954 issue of abstracts whose publication annually is sponsored by the Electrochemical Society Inc. In the current volume greater detail is provided on each abstracted article. Fifty-three pages, including over 220 abstracted articles, are devoted to germanium and silicon and their applications, and the entire volume contains over 750 abstracts.

37 ESSEX STREET, LONDON, W.C.2

VOLTAGE STABILIZERS

By

F. A. Benson, M.Eng., A.M.I.E.E., M.I.R.E.
(University of Sheffield)

Price 12/6
(Postage 6d.)

This monograph describes the various devices employing saturated elements, glow-discharge tube circuits and thermionic valve arrangements for voltage stabilization. A comprehensive bibliography is included.

Order your copy through your bookseller
or direct from

Electronic Engineering

28 ESSEX STREET, STRAND, W.C.2

Meetings this Month

THE BRITISH INSTITUTION OF RADIO ENGINEERS

Date: 25 April. Time: 6.30 p.m.
Held at: The London School of Hygiene and Tropical Medicine, Keppel Street, Gower Street, London, W.C.1.
Lecture: Radio and Television Interference—its Growth and Effects.

Merseyside Section

Date: 11 April. Time: 7 p.m.
Held at: The Council Room, Chamber of Commerce, 1 Old Hall Street, Liverpool, 3.
Annual General Meeting.

North-Eastern Section

Date: 11 April. Time: 6 p.m.
Held at: The Institution of Mining and Mechanical Engineers, Neville Hall, Westgate Road, Newcastle upon Tyne.
Annual General Meeting.

THE INSTITUTION OF ELECTRICAL ENGINEERS

All London meetings, unless otherwise stated, will be held at the Institution, commencing at 5.30 p.m.

Date: 5 April.

Lectures: The Control and Instrumentation of a Nuclear Reactor.
By: A. B. Gillespie.

The Control of Nuclear Reactors.

By: R. J. Cox and J. Walker.

Reactor Control Ionization Chambers.

By: W. Abson and F. Wade.

Date: 26 April.

The Forty-Seventh Kelvin Lecture on Radio Astronomy.

By: A. C. B. Lovell.

Date: 27 April.

Held at: The Institution of Mechanical Engineers, 1 Birdcage Walk, Westminster, London, S.W.1.
Second Graham Clark Lecture: The Impact of Engineering on Society.

By: Sir Maurice Bowra.

Date: 30 April.

Discussion: The Efficient Use of Technical Personnel.

Opened by the President, Sir George H. Nelson.

Radio and Telecommunications Section

Date: 23 April.

Informal evening on Electronics and Automation.
Talk by: G. W. A. Dummer.

Mersey and North Wales Centre

Date: 9 April. Time: 6.30 p.m.

Held at: Liverpool Royal Institution, Colquitt Street.

Annual General Meeting.

North-Eastern Centre

Date: 9 April. Time: 6.15 p.m.

Held at: Royal Station Hotel, Newcastle upon Tyne.

Annual General Meeting.

North Midland Centre

Date: 19 April. Time: 7.15 p.m.

Held at: Yorkshire Electricity Board, Ferensway, Hull.

Lecture: Automatic Circuit Reclosers.

By: G. F. Peirson and A. H. Pollard.

Sheffield Sub-Centre

Date: 18 April. Time: 6.30 p.m.

Held at: The Grand Hotel, Sheffield.

Lecture: Atomic Energy in Industry.

By: J. N. Hill.

North-Western Centre

Date: 10 April. Time: 6.15 p.m.

Held at: The Engineers' Club, Albert Square, Manchester.

Lecture: High-Speed Photography.

By: W. D. Chesterman.

South-West Scotland Sub-Centre

Date: 11 April. Time: 7 p.m.

Held at: The Institution of Engineers and Shipbuilders, 39 Elmbank Crescent, Glasgow.

Scottish Centre Chairman's Address.

South Midland Centre

Date: 9 April. Time: 7.30 p.m.

Held at: The Malvern Winter Gardens.

Informal discussion on technical education.
To be opened by: K. R. Sturley and C. F. Partridge.

South Midland Radio and Telecommunication Group

Date: 23 April. Time: 6 p.m.

Held at: The James Watt Memorial Institute, Great Charles Street, Birmingham.
Annual General Meeting.

Southern Centre

Date: 11 April. Time: 6.30 p.m.

Held at: The College of Technology Extension, Anglesea Road, Portsmouth.

Annual General Meeting.

Date: 13 April. Time: 6.30 p.m.

Held at: The South Dorset Technical College, Weymouth.

Lecture: Application of Electronics to Accountancy.

By: W. Woods Hill.

THE INSTITUTION OF POST OFFICE ELECTRICAL ENGINEERS

Date: 6 April. Time: 5 p.m.

Held at: The Institution of Electrical Engineers, Savoy Place, Victoria Embankment, London, W.C.2.

Lecture: Repair of Telephone Instruments by Mass Production Methods.

By: W. H. Maddison.

THE TELEVISION SOCIETY

Date: 6 April. Time: 7 p.m.

Held at: The Cinematograph Exhibitors' Association, 164 Shaftesbury Avenue, London, W.C.2.

Lecture: A High Power Television Transmitter for Band IV.

By: V. J. Cooper.

Date: 19 April. (Time and place as above).

Lecture: Recent Progress in Transistors with reference to Television.

By: J. N. Barry.

PUBLICATIONS RECEIVED

PRODUCTION CONTROL AND RELATED WORKS STATISTICS is a report from the joint committee of the Institute of Cost and Works Accountants and The Institution of Production Engineers. The foreword is contributed by Sir Ewart Smith, Chairman of the British Productivity Council and Mr. James Crawford, Deputy Chairman. The report has been divided into two sections. Part 1 outlines the scope of the inquiry and summarizes the conclusions. Part 2 contains the detailed discussion and includes a special section devoted entirely to the smaller firm. Copies are obtainable, price 5s. per copy, post free, from the sole distributors, Gee & Co. (Publishers) Ltd., 27/28 Basinghall Street, London, E.C.2.

THE PRACTICAL ELECTRICIAN'S POCKET BOOK 1956 edition is now available, price 5s. It has been fully revised to accord with changes in wiring practice recommended in the 13th edition of the I.E.E. Wiring Regulations. Altogether there are 29 sections in this edition. Odhams Press Ltd., 6 Catherine Street, Strand, London, W.C.2.

WIGGIN NICKEL ALLOYS BY POWDER METALLURGY describes the method of production and includes properties of tables showing the improvements which may be obtained. Copies are obtainable from the Publications Department, Henry Wiggin & Co. Ltd., Thames House, Millbank, London, S.W.1.

MOLYBDENISED LUBRICANTS is a booklet which sets out in general terms the main facts regarding a recent advance in lubrication—the use of a solid material—Molybdenum Disulphide—as a lubricant. Rocol Ltd., Ibe House, Minories, London, E.C.3.

PRINCIPLES AND PRACTICE OF RADAR by H. E. Penrose and R. S. H. Boulding. The 5th edition of this book has recently been published and is similar in lay-out to the 4th (revised) edition. George Newnes Ltd., Southampton Street, London, W.C.2. Price 50s.

AMINOPLASTIC MOULDINGS is one of a series of reports covering tropical trials on plastics which have been arranged by the Ministry of Supply/British Plastics Federation Joint Sub-Committee. The report is published by Her Majesty's Stationery Office, price 4s.

BROWN BOVERI ELECTRONIC TUBES is a condensed catalogue, produced in Switzerland, in which the Brown Boveri Tube Department presents abridged technical data on their tubes. It is intended as a quick reference guide to their tube manufacturing programme. Brown Boveri & Co. Ltd., Baden, Switzerland. British Brown Boveri Ltd., 75 Victoria Street, London, S.W.1.

REGIONAL ADVISORY COUNCIL FOR HIGHER TECHNOLOGICAL EDUCATION, 7th Annual Report for the 12 months ended 31 August, 1955, has recently been published and it was submitted to the local education authorities of London and the Home Counties in November, 1955. Regional Advisory Council for Higher Technological Education, Tavistock House South, Tavistock Square, London, W.C.1.

REPRODUCING EQUIPMENT FOR FINE-GROOVE RECORDS is the subject of the fifth monograph in the BBC Engineering Division series. BBC Publications, 35 Marylebone High Street, London, W.1. Price 5s. Annual subscription £1.

STANDARD RANGE OF AERIAL CROSS-OVER UNITS AND FILTERS and PAPER CONDENSERS DIRECT REPLACEMENTS FOR AMERICAN RANGE TO SPEC.MIL-C-25A are the subjects of two brochures produced by The Telegraph Condenser Co. Ltd., North Acton, London, W.3.

PAPER INSULATED CABLES SOLID TYPE LEAD SHEATHED FOR VOLTAGES UP TO 33KV is a booklet recently issued by British Insulated Callender's Cables Ltd. The cables described in this publication conform to Part 1 of B.S. 480 of 1954. The general design and construction of these cables have been established for more than sixty years and are used in all parts of the world for underground high voltage systems and for the great majority of low voltage distribution mains. British Insulated Callender's Cables Ltd, Press Information Office, 21 Bloomsbury Street, London, W.C.1.

GUIDE DE L'ACHETEUR DE BIENS D'EQUIPEMENT EN EUROPE gives a classified list of engineering trade associations in Western Europe, printed in both French and English. Published by the Organization for European Economic Co-operation. Price 180Ffr. \$0.50. 3s. 6d.

DESIGN FOR BLOWING is a well designed brochure clearly explaining the principles of specialized air cooling by means of axial flow blowers published by Plannair Ltd of Leatherhead, Surrey. This Company has evolved an entirely new set of principles governing efficient air cooling and has designed a range of blowers in a wide variety of sizes, some large enough to ventilate engine rooms or armoured vehicles, others so small that they can be fitted into intricate electronic apparatus. Plannair Ltd, Windfield House, Epsom Road, Leatherhead, Surrey.

KOVAR EIN NUTZLICHER WERKSTOFF DER HOCHVAKUUM-UND GERATEBAUTECHNIK by Dr. Werner Espe is a recently published book on the use of Kovar for sealing glass to metal in the manufacture of valves. C.F. Winter'sche Verlagshandlung, Fussen/Bayern. Price DM.6.40.

VACUUM GAUGES, VACUUM ACCESSORIES, VACUUM COATING are the subjects of leaflets issued to supplement the catalogue on vacuum equipment produced by Edwards High Vacuum Ltd., Manor Royal, Crawley, Sussex.

PRODUCTS FOR SOLDERING ALUMINIUM is a booklet published by Enthoven Solders Ltd., Enthoven House, 89 Upper Thames Street, London, E.C.4. Copies are available on request.