

ELECTRONIC ENGINEERING

VOL. XXVI

No. 315

MAY 1954

Commentary

AN annual report of a company of the size of the Radio Corporation of America not only provides facts and figures relating to the company's activities but throws a good deal of light on the American radio and television scene.

By any standards the RCA is a very large organization and with some 65 000 people on its payroll it must rank as one of the largest companies in the world. Its annual report for the year 1953 which has just been published deals with hundreds of millions of dollars on a scale which leaves one somewhat breathless. The total sales of the company over the past year, for example, amounted to the staggering total of \$853 million—a sum which, at the present rate of exchange, approaches the cost of the Health Service in this country!

The main activities of the RCA are, of course, devoted to what is described as the entertainment side of electronics—namely radio and television—and some 75 per cent of total business came from this source with the National Broadcasting Company, its associated company, contributing another 20 per cent.

How big this entertainment is can perhaps be judged from the fact that some 60 per cent of the population is now within reach of at least one of the 356 television stations operating in America and that the total output of television receivers last year was of the order of 27 million. This is only one aspect and it should be noted in passing that nearly 240 million gramophone records were sold in America last year. Placed side by side they would undoubtedly reach a long way.

But of greatest interest in the report to most of us are the activities of the RCA research laboratories, and several noteworthy results have been achieved. Probably the most significant is the application of magnetic tape recording to the recording of both monochrome and colour television programmes which was publicly demonstrated for the first time in December of last year.

In this demonstration, a colour television programme originating in New York was carried some 45 miles by a microwave radio relay link to the laboratories in Princeton where it was viewed on colour receivers and recorded on magnetic tape. During part of the demonstration, both the live programme and the magnetic tape recording were reproduced simultaneously. This method of recording offers very great advantages over the existing methods of recording on film, although it is not clear yet whether it is, in fact, a commercial possibility. Further development work has to be completed but the method is undoubtedly attractive and might well herald the era of "electronic photography." It is expected that when the method is in full operation the cost of recording a colour programme on tape will be only five per cent of the present method of television recording on colour film. Equally important is the fact that

the recording is instantaneous and requires no chemical processing.

Another major development reported is a method which makes it possible to convert atomic energy directly and simply into small but usable quantities of electrical energy, with very high current multiplication. Actual details of how this has been achieved have not been given, but it appears that by bombarding specially developed semi-conductor units with beta radiation from a radioactive source the energy from the beta rays can be made to produce an electric current.

This new atomic battery, many times more efficient than any other type of radio active generator, produces as yet only very small amounts of energy—about a microwatt—and once again research on a considerable scale has to be carried out before any worthwhile amounts of power can be produced by this method.

* * *

With the closing of the Radio and Electronic Component Manufacturers' Exhibition at Grosvenor House and that of the Physical Society at Imperial College, the exhibition season is now at an end for the next few months.

Both these exhibitions have one feature in common in that the available accommodation is now stretched to capacity. At Grosvenor House the amount of space is fixed and the problem facing the R.E.C.M.F. over the past years has been to fit in it an ever increasing number of exhibitors. This year's exhibition was as successful as ever, but it is becoming apparent that Grosvenor House is bursting at its seams. What appears to be an obvious solution is to stage the exhibition in a larger hall, of which there are several in London, but this is not such an easy matter for there is a friendliness and intimacy at the R.E.C.M.F. exhibition which has grown up at Grosvenor House and which would be lost with a move elsewhere.

The accommodation which can be made available at Imperial College for the Physical Society's Exhibition has been growing less and in the last two years the exhibition has been confined to the main building. Because of this, the number of firms exhibiting had to be severely limited and, in order to overcome some of the disappointment, the exhibition catalogue this year included a section devoted to those items which had, in consequence, to be excluded.

The Physical Society has therefore taken its courage in both hands and plans are now afoot to hold next year's exhibition at the Royal Horticultural Hall. By doing so, the long and happy connexions with the College will have been severed with real regret to many, but the "Phys Soc" has always been a tiring and uncomfortable exhibition from the visitors' point of view, and the new move will do much to enhance the growing importance of this Exhibition.

High Speed Magnetic Amplifiers

and Some New Developments

By A. E. Maine*, A.R.Ae.S., A.Brit.I.R.E.

The basic principles of operation of the Ramey High Speed Magnetic Amplifier are outlined and a simple physical picture is presented emphasizing the all important flux changes. A short reference is made to the applications of these circuits including those due to Geyger and Lufcy. This leads to the development and description of some new circuit arrangements. During the course of the article an attempt is made to define the scope of "Half Wave" amplifiers in general, and to establish their true position in the art.

PERHAPS the most important feature of a magnetic amplifier that tends to limit its application is its relatively poor dynamic response. In conventional circuit practice this arises from the fact that the input circuits are essentially inductive, and if the control and output currents are regarded as simultaneous quantities there is an exponential lag between control voltage and output current. Analyses of the simple transductor, with and without self-excitation have resulted in equations expressing the time-constant in terms of the various circuit parameters, and although different authors have arrived at different forms of expression for the time-constant, all of these can be transposed into one fundamental form, given below:

$$\tau = 1/Kf \cdot V_L/V_o \cdot N$$

where τ = the time-constant in seconds

f = the operating frequency

V_L = the load voltage

V_o = the control voltage

N = turns ratio = T_o/T_L

Means for securing the minimum time-constant possible, in a practical circuit arrangement, has promoted a considerable amount of theoretical research, the most fruitful being that due to Ramey^{1,2}, whose treatment of the transductor as a voltage rather than an M.M.F. operated element led to the introduction of a new family of transductor devices. These are loosely called "Half Cycle" amplifiers since the time for complete response can reach this limiting amount (i.e. half cycle of the excitation frequency). A better general term to use may be "Half Wave" amplifier since the device characteristically furnishes load current in one half wave only—absorbing the control intelligence in the other. The foregoing remark enables us to specify the dominant magnetic property required of the core material. Because the load current flowing in a conduction half cycle must be uniquely determined by the flux "re-setting" conditions in the previous half cycle, it follows that the core material must be capable of "remembering" flux, i.e., it must possess a high value of remanence. Coupled with this, for reasons that will emerge later, a very high core permeability is desirable as well.

If we consider the simple circuit of Fig. 1(a) and assume that the core hysteresis loop is perfectly rectangular and the rectifier is ideal, then we may easily see the action that takes place when an alternating voltage E_a is applied. The voltage is of such a value that in the absence of the rectifier the core flux is just swept from knee to knee, or in other words the volt-seconds absorption of the core just corre-

sponds to $\int_0^{1/(2f)} E_a dt$. In the case mentioned the only current flowing will be the magnetizing current. With the rectifier

in circuit and E_a zero, going positive, the core flux might correspond to point A in Fig. 1(b). The moment voltage develops magnetizing current AB flows and the flux point travels upwards as the voltage wave develops to point C where saturation results. Current flows for the remainder of the cycle (max. value, say at D) the magnitude of this being determined solely by the instantaneous voltage and

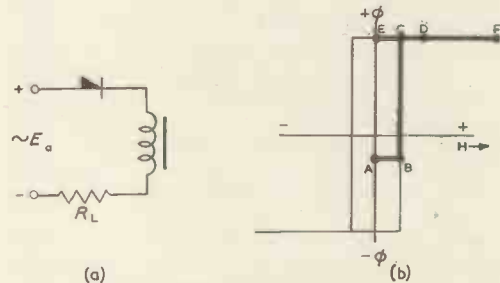

Fig. 1(a) Basic circuit diagram
Fig. 1(b) Flux diagram

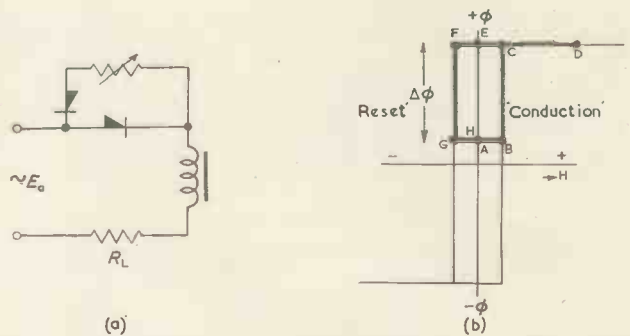

Fig. 2(a) Elementary amplifier with resistance control of output current
Fig. 2(b) Flux diagram showing re-set action

the circuit resistance. Upon the applied voltage reaching zero, the working point is returned to point E. For the following negative half cycle, the circuit current is zero owing to the blocking action of the rectifier. For all following positive half cycles, the core will be fully saturated, operating between points E and F and the entire half waves of voltage are applied to the load resistor. The load current is consequently at a maximum.

In order to establish values of load current intermediate between the cases considered, it becomes necessary to re-set the flux to some level in the negative direction during the non-conduction periods. The necessary additions to the simple circuit considered, lead to Ramey's circuit in its most elementary form. We merely add a second rectifier

* Servo System Design Dept., De Havilland Propellers Ltd.

and a variable control resistance as shown in Fig. 2(a). The circuit operation remains as before for the first positive half cycle, but when E_a goes negative, the flux is returned in the negative direction an amount determined by the voltage-time integral applied to the core during the negative half wave. The flux level set by this means is determined by the value of the resistance, in general, the lower the value of the resistance the greater the amount of flux re-setting. The locus of the flux working point now may assume the form given in Fig. 2(b). Since the flux scale may be interpreted as a voltage-time integral scale, it follows that the flux level set in a non-conduction period determines the point at which the core "fires" in the follow-half cycle. The resistance method of controlling the load current represents a restricted form of control and will not be considered further. If we add a secondary coil to the basic reactor, it becomes possible to set up a simple circuit wherein load current flows only in the primary circuit and re-set magnetizing currents flow in the secondary.

The arrangement is shown in Fig. 3 and constitutes Ramey's basic D.C. voltage controlled amplifier. Assuming a unity turns ratio, the auxiliary voltage E_a' is numerically equal to the applied voltage acting in the primary circuit. If the control voltage E_c is zero, it is easily seen that the core is fully re-set during the non-conduction period and hence the load current is at a minimum value. E_c is a direct

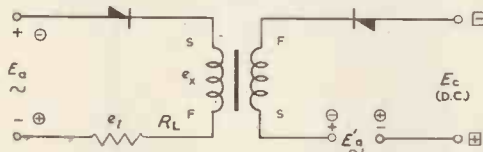

Fig. 3. Basic voltage controlled "Ramey" Amplifier

control voltage and may conveniently be thought of as a series of half sinusoids all of the same polarity (the output from a full wave bridge rectifier for example). The "plain" polarities shown in the figure represent the conditions for a conduction period and the circled symbols show the polarities during a re-set half cycle. In the latter case it will be noticed that E_a' is opposed by E_c , hence complete re-set will not occur except for the case when $E_c = 0$. An interesting point arising out of the re-set mechanism, not usually encountered with transducers is that the control source must accept power delivered into itself rather than having to furnish power into an external circuit. This might lead to the concept of infinite power gain, but in reality the fact that the magnetizing current is opposed to the control source voltage is of little consequence. Power gain must still be reckoned in terms of the voltage and current acting in the control source. If this were not the case, any conventional transducer with a bias and an opposed control source feeding a single input coil could lay claim to a system possessing an infinite power gain. This clearly represents a fruitless line of approach.

Referring to the arrangement of Fig. 3 and considering instantaneous values, we can write for the conduction half cycle:

$$e_a = e_x + e_L$$

where e_x = voltage applied to coil.

during re-set

$$e_x = e_a - e_c$$

hence

$$\int_0^{\pi} e_a dt = \int_0^{\pi} e_x dt + \int_0^{\pi} e_L dt \quad (\text{conduction})$$

and

$$\int_0^{\pi} e_x dt = \int_0^{\pi} e_a dt - \int_0^{\pi} e_c dt \quad (\text{re-set})$$

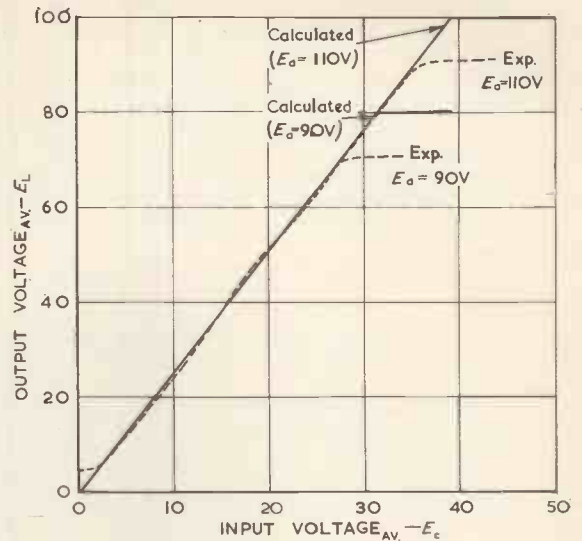

Fig. 4. Typical input/output characteristic for half-wave amplifier

assuming unity turns ratio,

$$\int_{\pi}^{2\pi} e_x dt = \int_0^{\pi} e_x dt = \Delta\phi$$

$$\therefore \int_{\pi}^{2\pi} e_L dt = \int_0^{\pi} e_c dt$$

The above expression shows that the load voltage is determined by the control voltage only and is independent of the circuit parameters and also the supply voltage providing that the output voltage is below the saturation level of the amplifier. The linearity between the input and output voltages is one of the most striking features of the half wave amplifier. The sort of output characteristic that may be expected is shown in Fig. 4, the failure to reach the maximum theoretical output being due to incomplete remanence and "resistive" voltage drops. It should be noted that poor remanence produces a constant voltage loss and is thereby not a fixed fraction of the applied voltage.

In order that a full wave rectified output may be obtained, the circuit arrangement of Fig. 5 may be used. This is Ramey's "parallel" amplifier and works in the manner described—one core re-setting while the other experiences a conduction period. The circuit additions shown dotted take no part in the basic action and are considered later.

If we now consider what overall properties the half wave amplifier possesses, we can say right away that providing the control signal change is synchronized to a re-set period (for a half wave unit) the amplifier has a one half cycle

Fig. 5. The "Ramey" full-wave parallel connected amplifier.

The dotted lines show a means of applying positive voltage feedback.

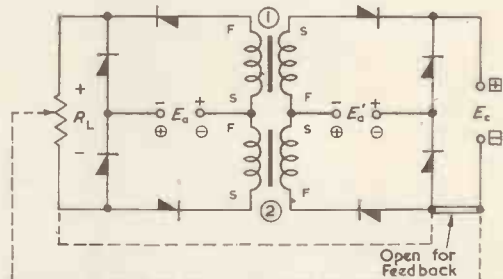

response. Secondly, for a unity turns ratio the voltage gain is unity, and thirdly the current gain is the ratio between the maximum load current with the unit fully rated thermally, and the magnetizing current. From this it follows that the power gain and the current gain are numerically equal. If the voltage gain is increased by reducing the control turns the current gain decreases in proportion and the power gain remains fixed. If we consider the fundamental gain/time-constant equation given earlier and set $K = 2$, it follows that $V_L/V_c \cdot N$ must equal unity.

For $\tau = \frac{1}{2}f$
since

$$IV/IT = W/IT = V/T$$

$V_L/V_c \cdot N$ can be arranged in terms of current and power gains, hence $W_g/I_g = 1.0$ for unity turns ratio and half cycle response.

These simple manipulations agree with observations and show that so long as the time response is half a cycle, the simple half wave amplifiers must have rather small gains. If the voltage gain is increased by means of positive voltage feedback (as shown by the dotted additions of Fig. 5) the term $V_L/V_c \cdot N$ exceeds unity and the half cycle response is destroyed; actually it increases with the amount of feedback and becomes very comparable with the time response of a conventional transductor working under similar conditions. These facts have been demonstrated experimentally. This leads one to suppose that the half wave amplifier has its own particular field of application, tending to add to the storehouse of transductor devices rather than to supplant those already there. Incidentally, it is worth noting that if the core material had an indefinitely large permeability, it would be possible to secure infinitely large current and power gains and yet preserve a half cycle response. Circuit ingenuity may increase the present obtainable gains, either by operating on the control current as Ramey suggests in his paper, or by making a bias source furnish the major part of the coercive force leaving the control signal to supply only the differential magnetization at the flanks of the hysteresis loop.

The half wave amplifier described forms the basic unit for building more elaborate structures possessing special properties. Geyger⁴ and Lufcy⁵ have developed circuits for the purpose of furnishing the control field requirements of 2-phase quick response electric servo motors. Geyger's basic circuits are given in Fig. 6(a) and (b) which shows both the transformer fed and bridge arrangements. In the bridge unit, diagonally opposite arms are accommodated on the same core, thus effecting an economy in components. It will be seen that the circuit is basically a bi-phase full wave rectifier with provision for controlling the load current over each half cycle. Like the full wave Ramey connexion, conduction of one half of the amplifier occurs while re-setting takes place in the other. By means of independent control of the firing angles of the two parts of the amplifier, arranged by suitable re-setting circuits, the magnitude and phase of the fundamental ripple frequency may be controlled, thus governing the speed and direction of the motor. A special feature claimed for the arrangement is that the D.C. component can be made to increase as the A.C. component diminishes, thus when the machine is coming to rest, a form of dynamic braking is automatically provided.

Lufcy's connexion (Fig. 6(c) and (d)) is remarkably similar to Geyger's except that in the bridge arrangement, the supply and load terminals are exchanged. This brings about a considerable modification to the mode of operation. Once again the fundamental ripple is used for controlling the motor field, but in this arrangement no use at all can be made of the D.C. component. In fact, acceleration of the machine in the high speed regime may be worsened on this account. Operation of the amplifier hinges on differentially re-setting the cores about a datum firing angle of, say, 90°. Arrival of the signal in one phase

retards the firing of one core structure and advances the firing angle of the other. During the time between the cores firing, a pulse of voltage of appropriate sign is applied to the motor. Reversal of the input signal reverses the polarity of the pulse and hence the phase of the fundamental ripple component. By means of tuning the motor, the effects of bad waveform are mitigated. With this amplifier both cores fire in one half cycle and both re-set in the other. Reviewing the operation described, three unfavourable points exist. Firstly, the need for simultaneous firing of the cores creates large circulating currents in the bridge, secondly, a substantial D.C. component is wasted in the motor and is injected into the supply main, and thirdly, the range of firing angles is considerably restricted. This latter point arises from the fact that immediately one core fires, twice the voltage integral is applied to the other—firing it much earlier than required. On the credit side it

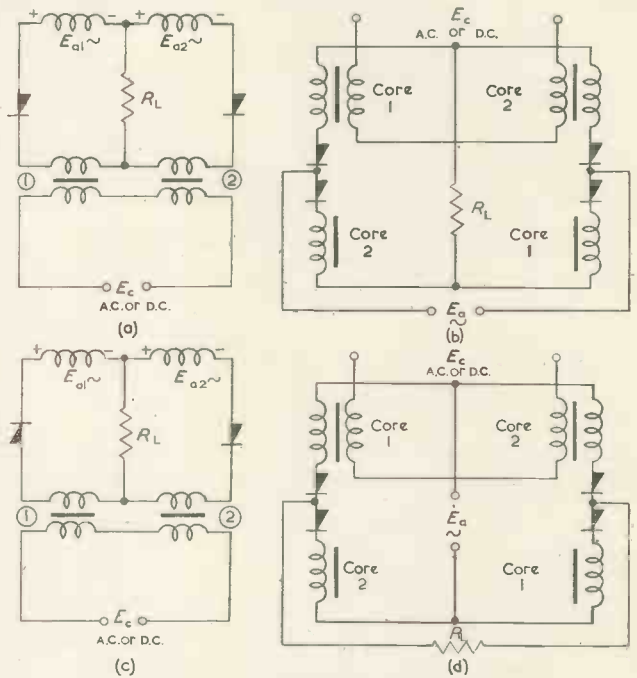

Fig. 6 (a) Basic transformer fed "Geyger" amplifier
(b) Bridge version of the "Geyger" amplifier
(c) Transformer fed "Lufcy" amplifier
(d) Bridge connected "Lufcy" amplifier

may be mentioned that both the Geyger and Lufcy amplifiers are very simple and will accept A.C. or D.C. control signals or combinations of both. While the amplifiers mentioned so far are quite satisfactory for many purposes they are nonetheless unsuitable in a great many other cases. This general lack of flexibility has promoted a study which has yielded a whole family of new amplifiers based on Ramey's original conception, but with the addition of circuit techniques which are believed to be new in this field—but are otherwise commonplace.

The new amplifiers about to be described are relatively more complicated than those discussed so far, but their very favourable properties tend to off-set this factor.

Let us assume that we require an amplifier that will give us a reversing D.C. output for a reversing phase input signal. We could draw out a provisional circuit such as that shown in Fig. 7 and check what action results. In this and subsequent analyses, "plain" polarities will represent simultaneous conditions in one half cycle, and circled symbols, conditions in the other. A polarity sign in a square indicates a steady term that does not change with alternating quantities elsewhere in the system. An "A.C." signal means

a voltage of the same frequency as the supply and with a stated phase relationship relative to the latter.

Referring to Fig. 7, Core 1 is seen to be entering a conduction period and the voltage induced in the secondary is prevented from causing a current flow owing to the rectifier being blocked by E_{b1} and E_c acting in series. Mean-

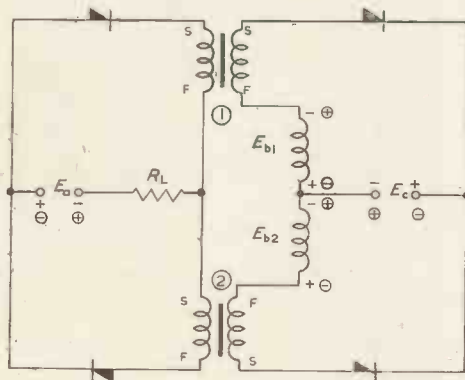

Fig. 7. A provisional circuit demonstrating unwanted current paths

while Core 2 is being re-set, with E_{b2} opposing E_c in the proper manner.

The net voltage induced into the primary circuit of Core 2 from the re-set circuit is balanced by E_a , conditions remain favourable until Core 1 fires, when the voltage E_a is effectively short circuited. Removal of this restraint from the re-set circuit of Core 2 effectively short circuits that core resulting in the flow of heavy current and the virtual cessation of the re-setting action. For the next half cycle, Core 2 enters a conduction period. Since E_c now opposes E_{b2} , the induced voltage causes a circulating current around the re-set path which short circuits Core 2. This condition is applied back to Core 1, hence large currents flow there. From these considerations it is perfectly clear that the circuit shown cannot work in the intended manner. The analysis has, however, served a useful purpose in showing why this is so.

In order to overcome the serious difficulties just considered, a rectifier blocking arrangement is added to both the load and control circuits. This leads to the first of the new amplifiers—the circuit arrangement being shown in Fig. 8. Here, considering the “plain” polarities, blocking

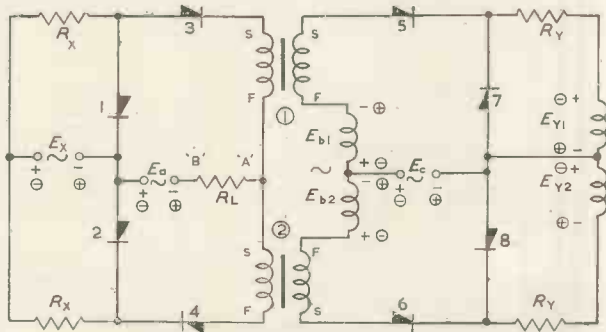

Fig. 8. The new “reversing phase input/reversing D.C. output” amplifier

rectifier 1 conducts, due to E_x and passes instantaneous current equivalent to that required in the load resistance. Core 1 load circuit may now be regarded as complete providing that any current caused to flow, due to E_a is ideally \leq than that furnished by E_x/R_x . Core 1 enters a conduction period, the induced voltage in the re-set path being blocked by E_Y since E_{b1} may be cancelled by E_c . Note that rectifier 7 cannot conduct. Meanwhile Core 2 is being fully

re-set by E_c and E_{b2} acting in series. The path is through rectifier 8 reversed on, since E_x/R_x just equals the magnetizing current. The induced voltage into Core 2 primary circuit is opposed by E_x and E_a in series. At some point Core 1 fires and E_a is removed from the re-set restraint circuit of Core 2. No large currents can flow in Core 2 re-set circuit since E_x still remains an opposing voltage, and any effort to draw more current through the re-set path blocks off rectifier 8. As a result, Core 2 is fully re-set. For the next half cycle, rectifiers 1 and 8 block and rectifiers 2 and 7 conduct. Core 2 enters a conduction period, but will never fire because it has previously been fully re-set. During this half cycle the voltage induced in Core 2 re-set path is cancelled by E_{b2} and E_x . Core 1, meanwhile, experiences “controlled” re-set because E_{b1} and E_c are in opposition as required; since rectifier 7 is conducting due to E_x , it represents a short circuit for the re-set path thereby completing it. The conditions outlined demonstrate that all the operating features required are provided, there being no circulating currents or restriction on the range of firing angles. The particular phase of input signal results in Core 2 being de-saturated the whole time—only Core 1 firing. This results in the end A of the load being made positive with respect to end B. A moment's study shows that if the phase of the input signal was reversed the two cores exchange their operation and the polarity of the load volt-

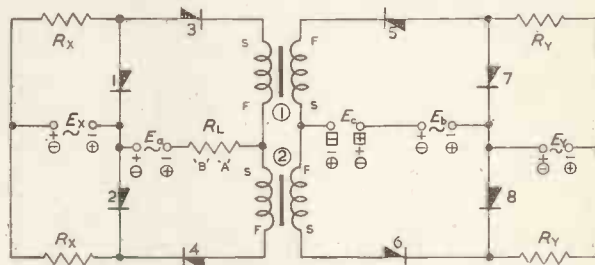

Fig. 9. A modified arrangement giving reversing D.C. output for reversing D.C. input

age becomes inverted. The device behaves as a half wave phase sensitive amplifier having a half cycle response and possessing the other features peculiar to the half wave family. The desirable performance has been achieved by doubling the power dissipated in the load circuit (due to losses in R_x) and making additions to the control circuit as shown. It should be recognized, of course, that since the control circuit is only called upon to handle magnetization requirements, all the rectifiers, transformers, etc., need only to be relatively very small. The circuit arrangement has been set up experimentally and worked in the predicted manner. Particularly noticeable was the large range of firing angles actually available. At the high output voltage end, the only limit appeared to be due to the rather poor remanence of the non-optimum laminated H.C.R. cores which were used. All tests of this, and other amplifiers were carried out at a supply frequency of 400c/s. Before passing on to other amplifiers, it may be mentioned that if a D.C. input signal is used, no output at all is obtained for one polarity, and an A.C. output of magnitude proportional to the input signal value results for the other polarity. In this latter case, no D.C. component is injected into the supply mains.

If the load circuits of Fig. 8 are left unaltered, a reversible D.C. output voltage for a reversing D.C. input signal may be obtained by means of modifying the control circuits. The new arrangement is shown in Fig. 9. Examining the arrangement we find that rectifiers 1 and 8 are conducting and rectifiers 2 and 7 are blocked (plain polarities). Core 1 enters a conduction period, and induces a voltage in its re-set circuit. This adds to E_c , but both are balanced off by E_b and E_x in series. During this time Core 2 is re-setting in a controlled manner, E_c opposing E_b with the magnetizing current flowing “reverse-on” into rectifier 8.

The voltage induced into Core 2 primary circuit is blocked in the way described for the previous amplifier. In the next half cycle all polarities except E_o reverse, the rectifier pairs 1,8 and 2,7 invert their functions and Core 2 enters a conduction period. The voltage induced into its re-set path is blocked simultaneously by E_o , E_b and E_Y acting in series. Core 1, meanwhile, is fully re-setting since E_b and E_o are adding. Induced voltage in Core 1 load circuit cannot cause current to flow there whether Core 2 fires or not. For the particular polarity of input signal considered, we see that Core 2 fires, making the end B of R_L positive with respect to end A. Core 1 being fully re-set once per cycle does not fire at all. The output voltage is therefore unidirectional and this will reverse in sympathy with the polarity of the input signal. It is interesting to check the operation of this circuit when using an A.C. input signal. Here we find that for one phase of input, the amplifier gives no response at all, and for the other phase the amplifier delivers an A.C. output voltage proportional to the input signal.

We have considered so far, two new circuits giving four functions: two functions are of direct use, the other two appearing to be of secondary interest. Since an important end product of the present study is to yield a full wave reversing phase output suitable for driving a two-phase motor, it is perhaps surprising that we study the secondary function first when thinking of a push-pull unit. Our first requirement will be to produce a reversing phase output for a reversing phase input. Here we take the basic diagram of Fig. 9 and arrange two such units in a mutually connected manner. We have seen that one unit will give a fixed phase output for a fixed phase input, ignoring the other input phase entirely. Hence when the two units are coupled together it is only necessary to ensure that one responds to a 0° input signal and the other to 180° input signal. As a result of this, the load resistance common to the two amplifier halves will absorb reversing phase A.C. power, the phase reversing with that of the input signal. Such an arrangement is shown in Fig. 10, a remarkable feature of this being the almost complete symmetry vertically and horizontally. The polarities shown result in the left-hand pair of amplifiers being in an "active" state, that is to say, capable of firing in turn on each half wave of E_a . The right-hand pair of cores are in a "passive" condition since both are fully re-set once per cycle. If the input signal is reversed in phase it is evident that the labels "passive" and "active" must be exchanged. A second very interesting feature of the amplifier concerns the operation if the input signal is D.C. Here we find that the output is Full Wave D.C. reversing polarity with the input signal. For example, if the D.C. signal has the same fixed polarity as the "circled" polarity shown, Cores 1 and 4 become active and Cores 2 and 3 passive. Reversing the input polarity inverts these functions. An important point to recognize for the D.C. input case is, that of three units of power expended in the whole load circuit, two are absorbed in the R_x blocking resistors and one unit in the load. This gives a theoretical power efficiency in the load circuit of 33 per cent which is double that obtainable using conventional reversing D.C. magnetic amplifiers. Furthermore, the wasted power is direct from the supply main and is not wasted "controlled" power as with conventional circuits. In practice the efficiency will be less than the stated figure owing to rectifier losses, but even so, a useful saving is possible.

Because the firing of a core is capable of adding voltage to the A.C. circuit of a "passive" amplifier section owing to coupling through the common load, the reactors are designed to absorb twice the voltage integral furnished by E_a acting alone. This makes the cores rather larger than they would otherwise need to be, but this is not always a serious disadvantage. The small output voltage normally encountered with half cycle amplifiers is practically missing from this double amplifier. This is because the small voltages due to magnetizing currents cancel one another out

in the load. As an example a unit delivering a maximum output voltage of 40V R.M.S. was found to have a residual output of only 0.15 volts at zero input signal.

The combined control and biasing circuits are of interest when it is considered that the centre tapped bias source (E_{b1-2}) effectively furnishes re-set to two cores in series, the combination acting as a balanced bridge with the appropriate cores being switched in and out of circuit at the proper times by the commutating action of rectifiers ABC and D and voltages E_{Y1} and E_{Y2} . The control signal may be regarded as being injected into the cores in parallel, and the source has indeed to supply magnetization itself. However, the separation of the control and bias functions by means of the bridge connexion permits the control source to have any impedance value at all, hence the only important specification for the control source is that it can furnish the required voltage and supply whatever magnetization current that may be needed. It is worth noting that if a full wave reversing D.C. output for reversing phase input is needed, this can easily be arranged by means of exchanging the control circuits of Fig. 10 for a composite control circuit based on that shown in Fig. 8. This modified circuit,

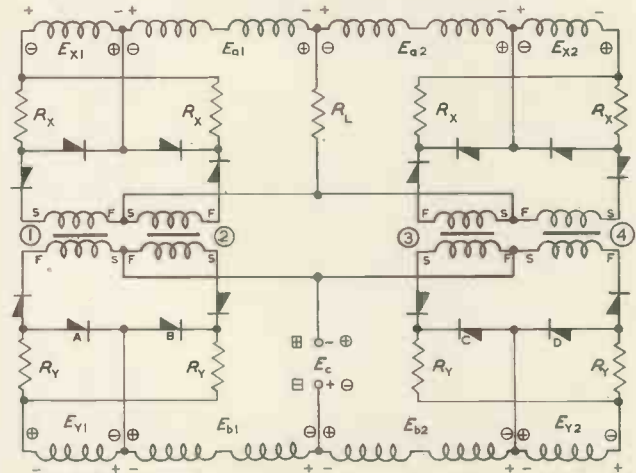

Fig. 10. A new push-pull circuit, giving reversing phase A.C. or reversing polarity D.C. output

as may be expected from conditions of symmetry, will also produce a reversing phase A.C. output for a reversing D.C. input.

In order to sum up the possible modes of action of the new circuits, the following table is given:

TYPE NO.	INPUT SIG.	OUTPUT SIG.	FIG. NO.	REMARKS
1	Rev. D.C.	Rev. D.C.	9	Half wave output
2	Fixed Polarity D.C.	A.C. Fixed ϕ	8	No output for inverted signal
3	A.C. Fixed ϕ	A.C. Fixed ϕ	9	As above
4	A.C. Rev. ϕ	Rev. D.C.	8	Half wave output
5*	A.C. Rev. ϕ	A.C. Rev. ϕ	10	—
6*	Rev. D.C.	Rev. D.C.	10	Full wave output
7*	A.C. Rev. ϕ	Rev. D.C.	—	Full wave output
8*	Rev. D.C.	A.C. Rev. ϕ	—	—

*Four core units—No D.C. component in supply.

With respect to the operation of the new amplifiers actually observed in the laboratory, these have worked satisfactorily in the predicted manner and results have been very encouraging even with the rather poor core construction used. At the present time a re-evaluation is under way employing the best possible cores and diffused junction germanium rectifiers, and it is expected that this will confirm the usefulness that the circuits appear to offer. A further study is under way aimed at simplifying the circuits and already promising results are being obtained. The

circuit complication and the power loss evident in the new amplifiers are considered to be a relatively small price to pay for the improved performance and overall flexibility—especially is this true if the power is drawn from the 50 or 60c/s supply mains.

In closing, it might be stated that the eight functions represent considerable scope for practical application, and already a type 5 circuit has been used very successfully to drive an American "Torque Unit" servo system embodying a type ck5 Eclipse-Pioneer two-phase motor. By means of tuning the motor, the output voltage was found to be almost a pure sine wave for all conditions of operation of the amplifier. The various circuit types may be cascaded or coupled with one another, or with conventional transducers or electronics. Perhaps a particularly useful combination would be a conventional transducer giving voltage gain feeding a type 7 amplifier supplying current gain. Such a unit could drive a proportional magnetic valve or perhaps a reversible d.c. motor. This is just one of the many possibilities that exist.

Fairly detailed measurements taken with some of the

new amplifiers show that the linearity and half cycle response of the basic half wave amplifier have been fully retained.

Acknowledgment

The author would like to express his appreciation to Messrs. de Havilland Propellers for giving permission to publish the work and also to his colleagues in the Magnetic Amplifier Design Department for their unstinting co-operation and enthusiasm. The author is indebted to Mr. S. Taunton and Mr. E. Wall for their helpful criticisms.

REFERENCES

1. RAMEY, A. R. On the Mechanics of Magnetic Amplifier Operation. *Trans. A.I.E.E.* 70, 1214 (1951).
2. RAMEY, A. R. On the Control of Magnetic Amplifiers. *Trans. A.I.E.E.* 70, 2124 (1951).
3. RAMEY, A. R. Magnetic Amplifier Circuits and Applications. *Trans. A.I.E.E.* (Elec. Eng. Sec.), 791 (Sept. 1953).
4. GEYGER, W. A. A New Type of Magnetic Servo Amplifier. *Trans. A.I.E.E.* 71, Part 1, 272 (1952).
5. LUFKY, SCHMID and BARNHART. An Improved Magnetic Servo Amplifier. *Trans. A.I.E.E.* 71, 281 (Sept. 1952).
6. RAMEY, A. R. The Single Core Magnetic Amplifier as a Computer Element. *Trans. A.I.E.E.* 71, Part 1, 448 (1952).
7. SCORGIE, D. J. Lead Networks Utilizing Saturable Core Memory. *Trans. A.I.E.E.*, Part 2, 297 (1953).

The Mixed Display of a Periodic Function and its Time Integral

By I. G. Baxter, B.Sc., A.R.C.S.

A single-beam cathode-ray tube is used for displaying a periodic voltage waveform and the time integral of each cycle. The integrals appear on the trace as spikes of varying heights, at the conclusion of each cycle.

IT is sometimes convenient to display two or more variables on a single-beam cathode-ray tube, using the time sharing principle and writing short segments of each record in turn. A variant of this method of recording two sets of information with one beam will now be described.

The necessity arose for integrating a blood flow rate recording, in which the flow was intermittent, in order to find out the volume per beat. The pattern of volume change with time was not required, so there was no point in making a continuous record of the integral; it was considered preferable to superimpose on the rate of flow record some kind of signal showing the beat volume.

A simple circuit (Fig. 1) has been contrived for carrying out the necessary operation, in the following manner. The flow rate signal is fed to a Schmitt trigger and to a suppressor-switched feedback integrator with accelerated flyback¹. At the beginning of a beat, as soon as the flow rate signal attains a certain value, the trigger switches on the integrating pentode, whose anode potential now proceeds to fall in the usual manner. At the end of the beat, when the flow rate signal returns to the datum level, the trigger rapidly switches the integrator off, so that the anode potential jumps back to its initial value. The amplitude of the return jump is equal to the antecedent fall, and is therefore proportional to the time integral of the flow rate signal.

A composite input is fed to the cathode-ray tube; that from the integrator is capacitance coupled, while the original signal is directly connected through a resistor. The time-constant of this simple RC mixing network is so chosen that the relatively slow change of potential at the integrator during the build-up is virtually blocked out, whereas the very fast recovery is readily transmitted. The

display on the tube face therefore takes the form of an undistorted flow rate record, with a sharp spike at the conclusion of each beat; the height of the spike is a measure of the beat volume.

The type of picture obtained is shown in Fig. 2, which shows a record taken when the circuit was being calibrated with a sawtooth input. The datum level is slightly higher than the lower limit of the waveform, so that the spikes arise just before the end of the down-going phase.

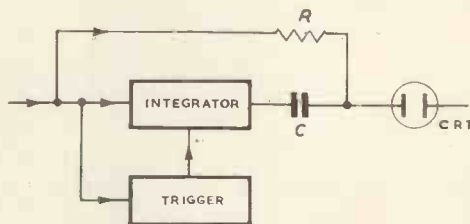

Fig. 1. Schematic diagram of circuit

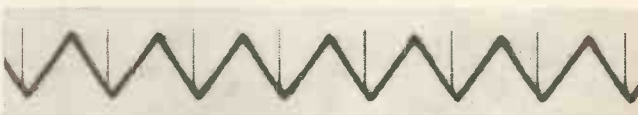

Fig. 2. Record obtained with sawtooth input

Conclusion

The method of display described above has proved convenient in use; it is simple, and no switching oscillator and mixer stage is required as in the usual time sharing methods². On the other hand, it is limited in its application to periodic waveforms—without unduly steep gradients, if distortion by the mixing stage is to be avoided. Furthermore, the integral is not presented continuously, and if the brilliance setting is correct for the spikes to be recorded photographically, the remainder of the trace is liable to be over-exposed; this shortcoming might be avoided by feeding a brightening pulse to the grid of the tube.

REFERENCES

1. ATTREE, V. H. Improving Fly-back Time on a Miller Timebase. *Electronic Engng.* 20, 97 (1948).
2. STURLEY, K. R., Electronic Switch. *Wireless World.* 59, 11 (1953).

A Cold-Cathode Scaling Unit

By C. D. Florida*, A.M.I.E.E. and R. Williamson*

A new scaling unit is described which uses cold-cathode decade scaling tubes, coupling between stages being performed by cold-cathode gas-filled triodes. The unit is slow compared with thermionic valve scaling units, but its 500 μ sec resolving time makes it suitable for nearly all applications using Geiger Muller counter tubes as the detecting elements. For those applications the new scaler is simpler and should be cheaper and more reliable than existing types.

ELECTRONIC counting apparatus is in wide and increasing use, both in research and in industrial applications of radio-active materials. Failure of such apparatus may be both embarrassing and costly. This article describes a scaling unit in which special efforts have been made to minimize the chances of failure.

The causes of unreliability in electronic equipment are many and no component is free from blame. However, thermionic valves in existing counting equipments have a fault rate of about 4 per cent per annum in average use and though the fault rate of other components is lower it tends to increase with temperature. For comparison with thermionic valves, the fault rate for cold-cathode gas-filled trigger triodes under similar conditions is about $\frac{1}{4}$ per cent per annum. Circuits using these valves run much cooler, because of the absence of heaters, so both the valves and other components may be expected to give better service.

Scaling circuits using cold-cathode trigger triodes have been devised¹ and have been in use for several years. As expected, the fault rate has been low. Such circuits have not found wide acceptance because of the long deionization times of the trigger triodes which result in long resolving times. Trigger triodes are now available with shorter deionization times, and the advent of the cold-cathode gas-filled decade scaling valve² has led to a major simplification in the design of scaling circuits. Thus a cold-cathode scaler is now a more attractive proposition.

Details of some scaling circuits have been published³ using these scaling valves, but these circuits use thermionic valves for coupling between stages or for driving the first stage. The full potentialities of cold-cathode valves for increasing reliability can, it is felt, only be realized if these functions are also performed by cold-cathode valves, though it is realized that some deterioration in resolving time may also result.

A five-decade scaler has now been designed using Dekatron cold-cathode gas-filled scaling valves, driving and stage inter-coupling being by cold-cathode gas-filled trigger triodes. The unit, which includes its own power supply, uses no thermionic valves and has an almost imperceptible temperature rise. Resolving time is less than 500 μ sec which, though long compared with thermionic valve scaling units, is suitable for nearly all applications where counting is performed with Geiger counters.

Geiger counters are usually used in conjunction with a quenching probe⁴ which imposes a known dead time on the system and also delivers a standardized pulse to the scaler. Counting rates in excess of those implied by the resolving time of the scaler can therefore be handled if the dead time determined by the probe unit is set at 500 μ sec, since the dead time is accurately known and losses can be calculated. The standardized pulse from the probe makes the provision of an input discriminator in the scaler unnecessary. Power supplies for the quenching probe are provided by the scaling unit.

A socket is provided on the rear of the scaling unit which makes available the supply lines used in the scaler and

also the mains transformer secondary winding; a cheap and simple power supply for a Geiger counter can be built using a corona stabilizer and a few other components.

A large amount of counting is now performed automatically using a timing unit to start and terminate the counting period. Extra components, e.g. relays, are sometimes needed in a scaling unit to make it possible to use the scaler with a timing unit, the number of extra components depending upon which particular timing unit is used. These extra components are unnecessary for the scaling unit as such and increase the cost of the unit. It was therefore decided that all extra components needed would be built into a small subsidiary box which could be plugged into the main assembly.

Circuit Description

The circuit diagram is shown in Fig. 1. The first decade comprises the Dekatron V_3 with driving trigger valves V_1 and V_2 , while the following four decades each use one driving valve only, e.g. V_7 Dekatron driven by V_6 trigger valve. Before dealing with the circuit in detail the operation of the Dekatron will be briefly described so that an appreciation of the requirements of the circuit will be possible.

The Dekatron consists of a central disk anode surrounded by 30 wires which are strapped to form three interlaced systems of 10 wires each. These systems are termed the cathode, first guide, and second guide systems. The guides are normally higher in potential than the cathodes, so the gaseous discharge passes between the anode and one of the cathode wires. If the first guide potential is reduced below that of the cathode the beam will transfer to the first guide wire adjacent to the cathode which was previously struck. If, then, as the first guide is released to its normal potential the potential of the second guide is reduced, the beam will transfer to the second guide. Finally, when this guide is released to its normal potential the beam will transfer to the next cathode. Thus two successive negative-going pulses will cause the beam to transfer from one cathode to the next.

One cathode wire is brought out separately: this cathode, the output cathode, provides the necessary information for the carrying operation.

The minimum duration of the negative-going transfer pulses is given in the test specification as 80 μ sec, while the amplitude necessary is about 100 volts.

Although the description given above implies the use of rectangularly shaped pulses, the Dekatron will operate quite satisfactorily from two successive negative-going exponential waveforms, providing certain precautions are taken and the maximum speed of about 4kc/s is not required.

THE INPUT STAGE

The input pulse is applied between trigger electrode and cathode of V_1 via an input transformer. Switch S_2 is used to change the polarity required of the input pulse by changing the direction of pulse current flow in the transformer primary. The return of the transformer secondary to the cathode of V_1 is through C_2 and the parallel com-

* A.E.R.E.

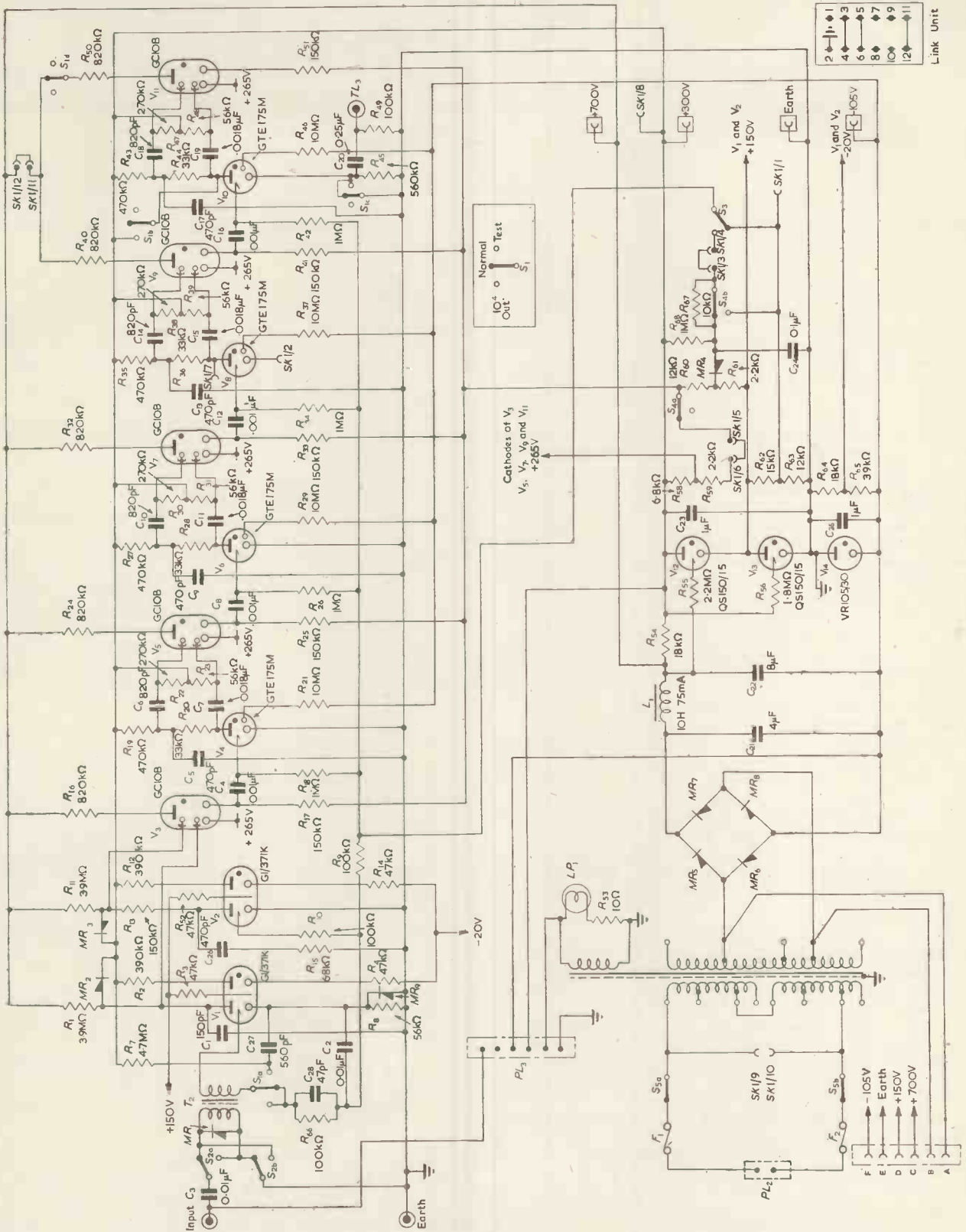

Fig. 1. The circuit of the scaling unit

combination of R_{66} and C_{28} , C_2 being a D.C. blocking capacitor to allow the necessary positive priming voltage to be applied between trigger and cathode, R_{66} being to limit trigger current flow, and C_{28} being a by-pass to R_{66} for pulse edges. As soon as the pulse amplitude becomes sufficiently great the trigger-cathode gap breaks down. This causes the main anode-cathode gap to break down, thereby discharging C_1 through the cathode load R_8 . The cathode waveform of V_1 is thus a sharply rising edge followed by an exponential decay of time-constant C_1R_8 and this waveform is applied through C_2 and R_{10} to the trigger electrode of the next trigger triode V_2 , causing the latter valve also to conduct.

Application of an input pulse thus causes both valves to conduct almost simultaneously. Guide 1 of the first Dekatron, V_3 , is connected directly to the anode of V_1 , and thus receives the full anode potential waveform of that valve, while guide 2 of the Dekatron receives an attenuated, delayed waveform from the anode of V_2 , the attenuation being produced by the potential dividing chain R_{13} , R_{11} and the delay by R_{13} and the self capacitance of the selenium rectifier MR_3 , which amounts to about 50pF at a reverse voltage of 100 volts. The Dekatron discharge thus switches initially to guide 1. V_1 extinguishes when the current drawn from C_1 , through R_1 and from the Dekatron, reduces to about 1mA, at which value of current the slope of the anode-voltage/anode-current characteristic of the valve becomes negative, and its anode potential thereafter recovers towards +700V at a rate determined by C_1 , R_1 and the Dekatron current. When the anode potential reaches 300 volts it is caught on the rectifier MR_2 and the cycle of operation of V_1 is complete. While the potential at the anode of V_1 is rising, that at the Dekatron second guide first falls due to the previously mentioned delaying action and then rises at a slower rate than that of V_1 anode due to a larger anode capacitance C_{26} . After a time of the order of 50 μ sec these two potentials become equal and shortly afterwards the Dekatron discharge switches to guide 2. The discharge remains on guide 2 until the potential at that point has risen to the potential of the Dekatron cathode system, when the discharge switches again, this time to the cathode adjacent to guide 2. Thus the discharge is shifted from one cathode to the next each time an input pulse is received. It will be noticed that D.C. coupling is used between V_1 and V_2 and the Dekatron. This is necessary to prevent bias shift at the Dekatron guides with input pulse rate; D.C. restoration after A.C. coupling is impracticable because of the high anode impedances associated with the trigger valves.

The carry pulse to the next decade is developed across R_{17} when the discharge reaches the output cathode, and is applied through C_4R_{18} to the input of the next decade.

THE LATER DECADES

The four decades following the input stage are all similar, so only the first, comprising V_4V_5 will be discussed. Since, for a resolving time at the input of 500 μ sec the minimum spacing between successive pulses is 5msec a simpler and slower type of circuit can be used.

When the trigger electrode of V_4 receives the carry pulse from V_3 the main gap of V_4 breaks down. The anode potential of V_4 therefore falls quickly by about 150 volts, but initially the potential across C_3 cannot change. As the anode of V_4 is connected via C_7R_{23} to guide 1 of the Dekatron V_5 , while the guide 2 system is connected by C_6R_{22} to C_5 , the Dekatron discharge initially switches to the guide 1 system. The potential at V_5 guide 1 then recovers towards 300 volts at a rate determined primarily by C_7R_{23} , while that at V_5 guide 2 falls as C_5 discharges. Shortly after the time at which the two potentials become equal the discharge transfers to the guide 2 system.

The type of trigger triode used for coupling between stages will remain conducting until the current passed through it is reduced to about 0.5mA. As the Dekatron

current is approximately constant at 0.6mA and R_{15} will pass 0.3mA the trigger triode remains conducting, passing 0.9mA, as long as the discharge remains on the guide 2 system. However, the Dekatron current, and that through R_{22} charges C_6 so that the potential of the guide system rises. When this potential slightly exceeds the cathode potential of the Dekatron the discharge switches to the next cathode. The current in the trigger valve therefore falls to below 0.5mA, so it extinguishes, allowing the anode potential to rise exponentially to 300 volts.

POWER SUPPLY

In addition to supplying the H.T. for the various lines in the scaling unit the power supply also delivers heater and H.T. supplies for use with a G.M. probe unit. The supply itself is conventional: bridge rectifier, LC smoothing, and neon stabilization.

COUNT ON-OFF SWITCH

Counting is started and stopped by the count on-off switch S_3 . In the off position the trigger bias of all the trigger triodes is reduced to +60 volts, while in the on position this has the normal value of +165 volts. The operation of switching off would produce a negative potential at the cathode of V_1 by coupling through C_2 and the negative potential could cause the valve to strike and so add in an extra count. This is avoided by placing the rectifier MR_3 in parallel with R_8 , the cathode load of V_1 .

RESETTING TO ZERO

A Dekatron can easily be reset to zero by forcing the tube current to flow through the output cathode. This is accomplished in the present scaling unit by breaking the bias chain across V_{12} at the junction of R_9 and R_{60} by operating the push-button switch S_{4a} . This causes the output cathodes of the Dekatrons to fall to +150V and the other cathodes to rise to the guide potential of +300V. Under these conditions the discharge passes to the output cathodes, and stays there when the reset switch is returned to its normal position. The purpose of the switch S_{4b} and the components R_{67} , R_{68} , MR_4 and C_{24} is to avoid faulty resetting if the reset switch is operated when the count switch is in the "on" position.

OUTPUT PULSE

The five decades enable random pulses to be counted with a statistical accuracy of 0.3 per cent. Cases may occasionally arise, however, where a higher accuracy may be necessary or where the total storage capacity of the counting system needs to be increased for some reason, such as in coincidence work. An output pulse derived from a trigger triode and occurring when 10^4 input pulses have been accepted, is therefore provided to drive another scaler or register. The circuit of the last trigger triode, V_{10} , is rearranged by the switch S_{10} when the output pulse is required, and the same switch extinguishes the final Dekatron V_{11} so that no doubt as to the correct scaler reading can arise. In its rearranged form the circuit of V_{10} has the time-constant in the cathode lead. As the valve triggers the anode current passes initially through R_{45} and R_{49} in parallel, but as C_{20} charges, the current through R_{49} diminishes exponentially with a time-constant of $C_{20}R_{49}$. When C_{20} is substantially fully charged the trigger valve extinguishes since the current through R_{45} is insufficient to maintain conduction. The resultant output pulse is of over 100 volts peak amplitude decaying with a time-constant of 25msec.

THE TEST POSITION

The switch bank S_{1a} switches one side of the input transformer secondary either to R_{66} and thence to the normal bias line or to the junction of C_{27} and R_7 . In the latter position V_1 becomes a self-running oscillator with a pulse repetition frequency, determined by R_7C_{27} of about 1 000p/s. Coupling to V_2 , and the operation of the rest of the scaling unit is the same as in normal counting operation.

Operation with Timing Units

During the design of this scaling unit particular attention has been paid to its operation in conjunction with two particular types of timing unit, but sufficient outlet points are available that there should be little difficulty in operation with other timing units.

It was mentioned earlier that in the interests of economy any extra components needed for timing unit operation would be built into subsidiary plug-in boxes. As some of these extra components are inserted in series with leads in the scaling unit links have to be broken before this is possible. A removable plug with appropriately linked pins is built into a box of the same size as that used for timing unit operation; upon removing this the links shown on the circuit diagram are broken.

One timing unit (A.E.R.E. type 1179) consists of a small synchronous motor which is arranged to operate and release change-over contacts with an intervening preset period of time. This timing unit is built into a frame which also carries a 12-pin plug. When the unit is plugged in the plug picks up mains input voltage on pins 9 and 10 to drive the motor. Counting is controlled on pins 3 and 4 which are in series with the front panel count key. The timing unit connects together pins 3 and 4 and thus activates the scaling unit for a pre-determined time.

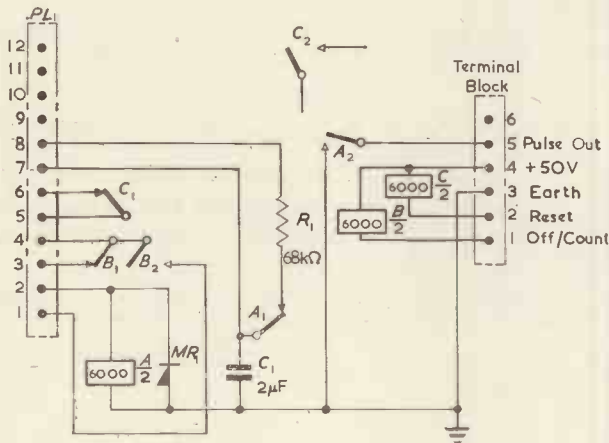

Fig. 2. The relay unit

In the other timing unit (A.E.R.E. type 1003) time is measured by counting down standard clock impulses by relay scales-of-ten. It is arranged so that it will operate and release contacts with an intervening preset period of time, displaying the total number of pulses received during the period, or it can be fed with pulses (e.g. from a scaling unit) and will measure and display the time taken for the number of these pulses to reach a pre-determined total. The former setting is known as the "preset time" and the latter as the "preset count" condition. The advantage of the preset count condition is, of course, that the same statistical accuracy is attained on each sample when measuring a batch of samples of variable source strength. The design of this timing unit is such that relays are necessary as coupling elements between the timing and scaling units; these relays are contained in a box which can be plugged into the scaling unit. The circuit diagram is shown in Fig. 2.

When pin 1 on the terminal block is earthed by the timing unit relay *B* is energized, causing pin 4 on the scaling unit plug to be taken to pin 1 by *B*₂. This removes the 165V priming voltage from all the trigger triodes, thus rendering the scaling unit inoperative. When the timing unit releases pin 1 from earth, the scaling unit pin 4 is transferred from pin 1 to pin 3, by *B*₂ and *B*₁, and the scaling unit operates.

One pulse is fed into the timing unit from the scaling unit for every 1000 input pulses received and is either displayed on the electro-mechanical register when the preset time condition is used or is counted by the relay scales when in the preset count condition. The last three digits of the total are displayed normally on the Dekatrons *V*₃, *V*₅ and *V*₇, and to avoid any ambiguity the last two Dekatrons, *V*₉ and *V*₁₁, are made inoperative by breaking the link across *SK*1/11 and *SK*1/12. The output pulse from the scaling unit is obtained from the trigger valve *V*₈, into



Fig. 3. The complete unit

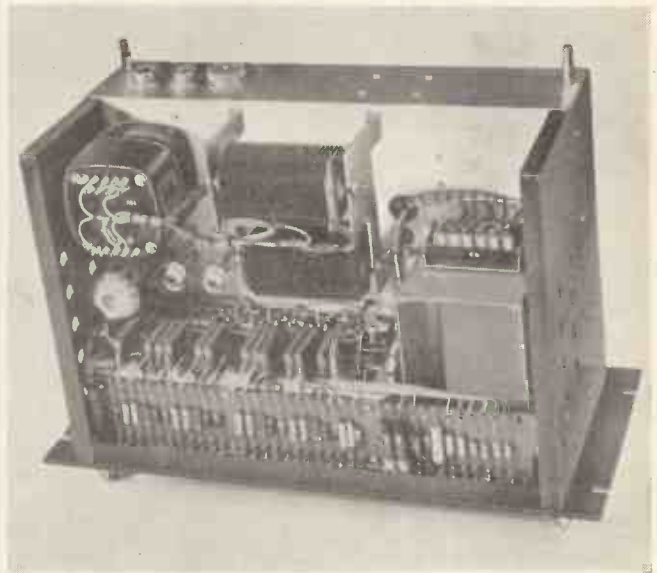

Fig. 4. The internal construction

whose cathode lead relay *A* is inserted. Upon triggering the relay operates, passing a pulse via *A*₂ to the timing unit and disconnecting the extra supply of current to *V*₈ by *A*₁. *C*₁ then continues discharging via *V*₈ and relay *A* until the total valve current is insufficient to maintain the discharge when the valve extinguishes, the relay de-energizes, and *C*₁ recharges through the 68kΩ resistor.

Resetting of the scaling unit from the timing unit is performed through relay *C*. This relay is energized during the reset period, causing pins 5 and 6 on the scaling unit to be open-circuited. This breaks the bias chain across *V*₁₂ in exactly the same manner as occurs during normal resetting of the scaling unit.

Construction

The scaling unit is contained in a box with a standard P.O. rack mounting 19in by 8½in front panel and with a depth over the connecting plugs of 14in. Photographs of both external and internal views are shown in Figs. 3 and

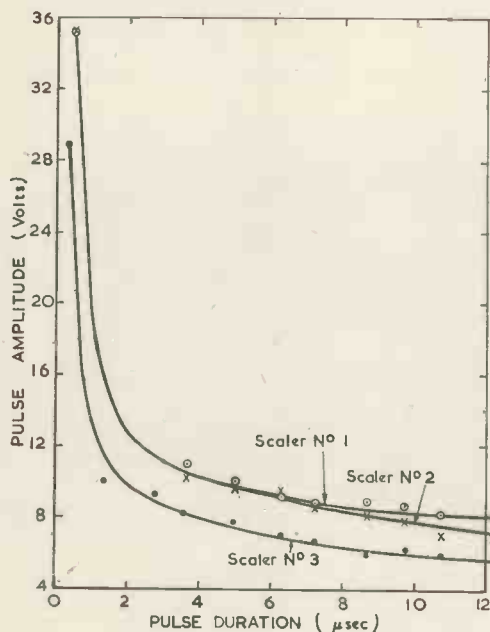

Fig. 5. Input pulse requirements

4: from the former the Dekatron display and the position occupied by the extra units can be seen, while the latter shows that any servicing necessary should be simple because of the open layout.

Conclusion

Very full tests have been carried out on several of these scaling units. Average resolving time is around 400µsec and the unit scales correctly over a mains input voltage range ± 10 per cent. The input pulse requirements are shown in Fig. 5 for three different units; it will be seen that a pulse of 10V amplitude and 10µsec duration is adequate for reliable operation. Operation from timing units is completely satisfactory. Prototypes of this scaling unit have been used in many parts of the world and have given very little trouble after transportation and in working in different climatic conditions. The most encouraging feature is that up to the present no failures of Dekatrons or trigger triodes have been reported. It appears, therefore, that the hope that this unit will mark a step forward in reliability may be realized.

Acknowledgments

The authors would like to express their gratitude to Messrs. Bacon and Acton, of Ericsson Telephones, Ltd., for helpful discussions on Dekatrons and trigger triodes, to Mr. Burnett of the same firm, from whose suggestion the interstage coupling circuit was developed, and to Mr. J. R. Adams and his staff at Ericssons Instrument Development Laboratory, whose ready co-operation and excellent workmanship made the development of this unit run smoothly.

The article is published by permission of the Director, Atomic Energy Research Establishment, Harwell.

REFERENCES

1. COOKE-YARBOROUGH, E. H., BRADWELL, J., FLORIDA, C. D., and HOWELLS, G. A. A Pulse-Amplitude Analyser of Improved Design. *Proc. Instn. Elect. Engrs.* 97 Pt. III (1950).
2. BACON, R. C., POLLARD, J. R. The Dekatron. *Electronic Engng.* 22, 173 (1950).
LAMB, J. L., BRUSTMAN, J. A. Polycathode Glow Tubes for Counters and Calculators. *Electronics* 22, 92 (Nov. 1949).
HOUGH, G. H., RIDLER, D. S. Multi-cathode Gas Tube Counters. *Electrical Commun.* 27, 214 (1950).
3. INGVAR-NILSSON. A Scaler using Dekatron Tubes. *Transactions of the Chalmers University of Technology* (Gothenburg, Sweden).
4. COOKE-YARBOROUGH, E. H., FLORIDA, C. D., and DAVEY, C. N. An Improved Quench Circuit for Geiger Counters. *J. Sci. Instrum.* 26 (1949).

A Fast-Rate Variable Pulse Generator

By J. C. Baker*

The design of a flexible pulse generator is described which is capable of supplying pulses up to 40 volts in amplitude over a repetition range from 0.8 to 330 000 pulses per second. Provision is made for internal or external triggering and the pulse width is continuously variable from 0.1 to 50 microseconds. A 6BN6 is employed as the final pulse shaping tube providing a very uniform output pulse at all frequencies.

IN the course of development work on various types of fast scaling circuits the need was felt for a source of pulses of constant amplitude over a frequency range from 10 to at least 200 000 pulses per second. None of the pulse generators commercially available seemed to meet the requirements and it was, therefore, decided to design and construct a unit for this purpose.

This generator provides a pulse with a rise time of 0.02µsec, a flat top and a delay time of 0.1µsec, a pulse width in two ranges from 0.5 to 50µsec, and with a pulse recurrence frequency of up to 350kc/s. Provision is made for external triggering by slow rising pulses or D.C. by using the familiar Schmitt trigger circuit as the trigger pulse generator.

Circuit Description

The complete circuit is shown in Fig. 1. It incorporates a number of unusual features and is described in detail below.

The circuit consists of the following parts: A trigger stage with provision for either internal or external triggering, a stage with a pulse width control, an amplifier and phase inverter, followed by a wave-shaping tube and an output phase splitter.

INTERNAL TRIGGERING

In this case the first stage is a free running Potter multi-vibrator (V_1). The frequency is controlled by varying the coupling constants between the two triodes; C in steps, and R continuously.

* Dept. of Mines and Technical Surveys, Ottawa, Canada.

A six position range switch (S_1) is provided and serves three purposes:

- To select the proper capacitor for a given frequency range.
- To paralyse the stage when an external trigger pulse is received.
- To paralyse the Schmitt trigger stage (V_2) on external operation.

The output from the multivibrator has essentially a rectangular waveform. This is differentiated on passing through the short CR coupling network and the negative pip removed.

The positive-going pip is used to trigger the univibrator pulse-width stage (V_3). Here the pulse-width is varied, (1) by the "wide/narrow" switch (S_2) which provides two values of the coupling time-constant, and (2) by a variable capacitor.

The variable capacitor was used in preference to a variable resistor as it affected the amplitude of the output to a lesser degree.

rise time too, but not as much as a variable potentiometer in the grid circuit would.

A variable output-voltage control is also provided which varies the screen voltage of the valve and, therefore, the amplitude of the output waveform.

The output stage (V_7) was designed as a phase-splitter to give equal positive and negative outputs.

EXTERNAL TRIGGERING

On external triggering the input signal is applied to the trigger pulse generator (V_2) and thence to the pulse-width univibrator (V_3). The design of a circuit to trigger on a slowly rising pulse such as low-frequency sine wave presented quite a problem. Obviously an RC coupled stage would be of no use at all because

$$V = \int 1/C dq/dt dt.$$

When dt is small, V is small; consequently very little feed-back voltage will be developed if RC coupling is used. Therefore D.C. coupling in a modification of the Schmitt trigger circuit was used.

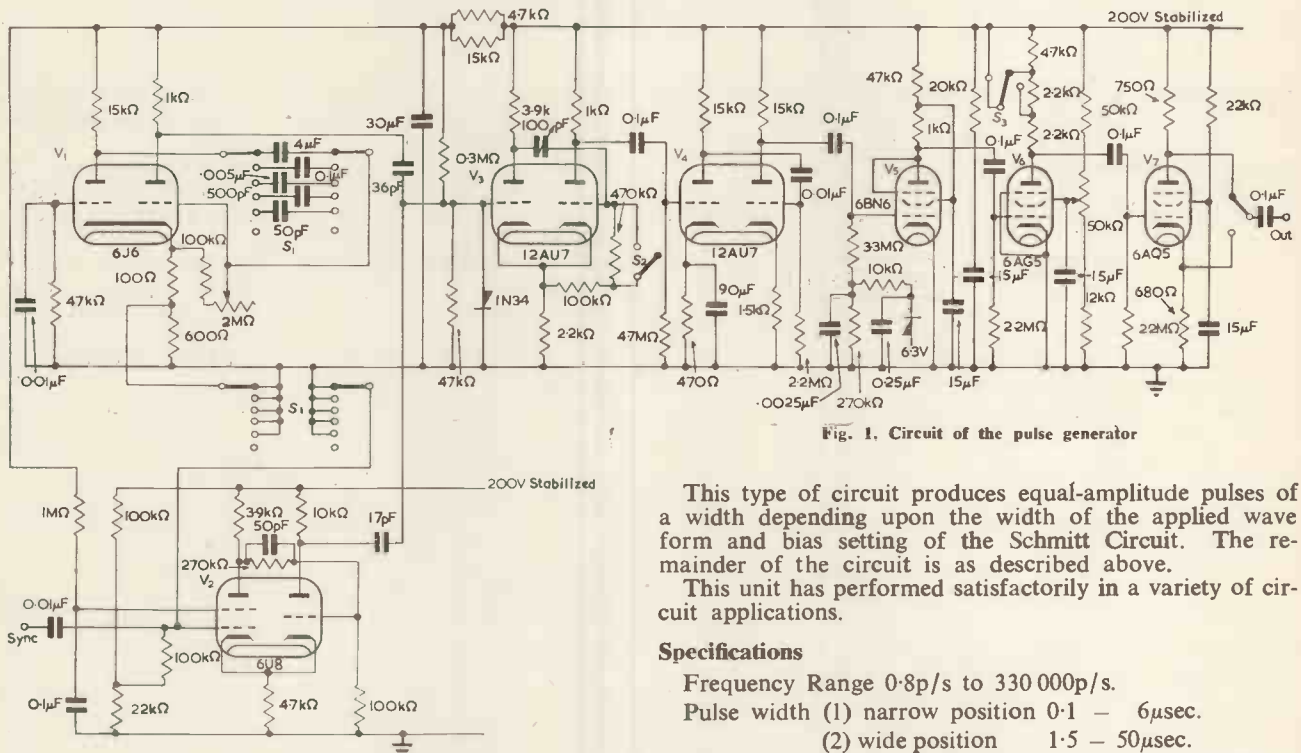

Fig. 1. Circuit of the pulse generator

This type of circuit produces equal-amplitude pulses of a width depending upon the width of the applied wave form and bias setting of the Schmitt Circuit. The remainder of the circuit is as described above.

This unit has performed satisfactorily in a variety of circuit applications.

Specifications

Frequency Range 0.8p/s to 330 000p/s.

Pulse width (1) narrow position 0.1 – 6μsec.

(2) wide position 1.5 – 50μsec.

Obviously the pulse width must always be less than the time of one cycle of pulse, but at lower pulse repetition, frequencies up to 50μsec pulses are obtainable.

OUTPUT AMPLITUDE

Attenuator setting	Output voltage (peak-to-peak)
1	8V
2	20V
3	40V

Output pulses are positive or negative and of equal amplitude

Rise time 0.02μsec

Decay time 0.1μsec

FREQUENCY RANGES

Switch position:

- 0.8 to 10p/s
- 8 to 125p/s
- 120 to 2.5kp/s
- 2 to 33kp/s
- 25 to 330kp/s
- External.

External trigger amplitude—Greater than 3V.

The output from this stage has a rectangular wave form with steep rise but with a sloping top.

The next double triode (V_4) is an amplifier and phase inverter to raise the amplitude to a sufficient value to apply to the clipper stage, a 6BN6 gated beam tube.

Due to the narrow grid base of this tube (V_5), excellent clipping action can be obtained but as the grid current of the tube charged the interstage coupling capacitor, there was a tendency for the waveshape to vary as the effective bias was changed. To prevent this, a negative voltage, equal to the peak voltage produced by the grid current was applied through a small selenium rectifier, type 4U1, to this grid. This voltage was derived from the heater line.

The next stage (V_6) is an amplifier with an anode load selected by a three-position switch (S_3). This method of amplitude control was chosen to preserve the rise time, as an ordinary potentiometer in the grid circuit has enough capacitance to ground to round off appreciably the waveform. Increasing the anode load will, of course, affect the

A Review of Magnetic and Ferro-electric Computing Components

By V. L. Newhouse*, Ph.D.

One of the most serious limiting factors to the reliability of high speed computers is the short life expectancy of the thermionic valves of which they are, at present, largely constituted. Magnetic materials which have only become available in the last few years have made possible the development of solid state computing devices which can be used at frequencies up to 1Mc/s. This review attempts to correlate and systematize the different lines of approach which have been used in their design and to present an account of the most important of these new computing elements.

THE tedious calculations involved in the solution of the differential equations of modern physics and the extent of the numerical work involved in the interpretation of the experimental data of ballistic trials, were two of the main reasons which led to the development of various mechanical calculators during the second world

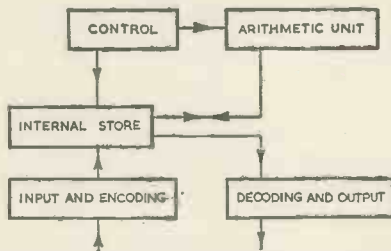

Fig. 1. Basic logical design of automatically sequenced digital computer, capable of making operating decisions according to data arrived at.

war. This work culminated in the construction of the first electronic digital computer at the University of Pennsylvania. This machine, which is still in use at the Aberdeen Proving Grounds of the U.S. Army, has proved to be the first of a large family of digital computers. These can be defined as calculating instruments handling numbers and instructions in pulse coded form.

The basic logical arrangement of a self-running digital computer is shown in the block diagram of Fig. 1.

Numerical information and instructions in numerical form are fed into the input unit and are passed on from there to the internal store.

This data is manipulated by the arithmetic unit. The intermediate results are fed back to the store and are eventually passed to the output unit and recorded in permanent form. The whole process is regulated by the control unit which itself draws its instructions from the internal store or memory. Such an internal store may consist of a relatively small capacity high speed section which can handle information at the rate of the control and arithmetic circuits, backed up by a lower speed store of considerably larger digit capacity. Further storage facilities can be made available outside the machine in the form of punched cards or tape, but an efficient electronic computer must possess a high speed store which is at least large enough to contain all the instructions necessary to carry out a particular calculation.

The earliest computers made use of Eccles-Jordan flip-flops as memory elements. This technique involves at least two valves per digit stored, and has in general been replaced by more economical methods.

Some of the different types of computer store which are at present in use or under development, are listed in Table I where they are classified into delay line and random access types. Each of these subdivisions can be further split up into regenerative and non-regenerative techniques. It is in the field of high speed storage that the promise of solid state devices to replace valves is greatest and the major part of this review is therefore devoted to memory techniques. These will be dealt with according to the order shown in the table, one column at a time, from left to right.

* Formerly Ferranti Ltd., now with RCA Laboratories, U.S.A.

TABLE 1
Logical Classification of High Speed Digital Stores

DELAY LINE		RANDOM-ACCESS	
REGENERATIVE	NON-REGENERATIVE	REGENERATIVE	NON-REGENERATIVE
Mercury D.L. Electro-Magnetic D.L. Magneto-Strictive D.L.	Magnetic Drum Hard Valve Ring-Counters and Stepping Registers Glow-discharge Multi-Cathode Valves Magnetic Counters, e.g. (Zahldrossel) Magnetic Stepping Registers Ferro-resonant Stepping Registers Ferro-electric Stepping Registers	All types of C.R. store, e.g., Williams' "Tube" type, Rajchman's "Selectron," etc — — — — —	Magnetic Core Store Ferro-electric Store — — — —

Regenerative Delay Lines

In all delay lines except the electromagnetic type where no transducer is required, incoming information in pulse form is converted into supersonic wave packets or pulses at the input of the delay line and reconverted at the other end. If the line is used as a regenerative store the output pulses are reshaped and fed back into the input section. Erasure of information is accomplished by interrupting the regenerative loop and this can be accompanied by the presentation of new information to the input of the line. The type of regenerative delay line which has been most widely used up-to-date, utilizes mercury as the propagating medium¹. It is too well known to merit description here, but some of its characteristic parameters are quoted in Table 2 in comparison with those for the magnetostriction delay line.

Lumped and distributed constant electromagnetic delay lines are widely used for delays of up to $10\mu\text{sec}$, but become unwieldy for delay times larger than this. A representative account of lumped constant delay lines has been given² previously. A typical continuously wound E.M. line is one which has been designed by the Manchester University Electrical Engineering Department. It has a length of 5.6in per microsecond, a characteristic impedance of $1.5k\Omega$, and a signal attenuation of approximately 0.1db/in. Other possibilities which are under investigation are based on the flow of holes in germanium and the low propagation rate of electromagnetic waves in ferrites.

pick-up position. When a stress wave is passed through the line, a voltage pulse will be obtained in turn from each output coil of a polarity dependent upon the direction of the local magnetization.

Comparison of Mercury and Magneto-Striction Delay Lines

In spite of the great difference in digits per foot between the mercury and the magneto-striction line, the latter is still the more economical in physical size. This holds even though a number of reflexion paths can be used in a single tank of mercury. As is shown in Table 2, the thermal coefficient of the delay time in nickel is less than half that in mercury. The difference is made even greater by the use of an Elinvar wire plated with nickel at the ends, as delay line material. The thermal coefficient of delay is then less than $0.01\mu\text{sec}$ per millisecond delay, per degree Celcius.

The only major disadvantage of magneto-strictive delay lines as compared to mercury lines, lies in the superior high frequency performance of the latter. Mercury delay lines can be used at a 5Mc/s digit repetition frequency utilizing a 15Mc/s carrier, whereas magneto-striction nickel delay lines appear to be limited at present to digit repetition frequencies of less than 1Mc/s. This disadvantage of the magneto-striction line is, however, compensated for to some extent by the fact that information can be taken from it at any point along its length.

TABLE 2
Comparison of Mercury and Magneto-Strictive Nickel Delay Lines

	MERCURY DELAY LINE	NICKEL DELAY LINE
(Velocity of sound)	c 5ft/msec	c 16ft/msec
Temperature coefficient of delay	c $0.3\mu\text{sec}/\text{msec}/^\circ\text{C}$	c $0.13\mu\text{sec}/\text{msec}/^\circ\text{C}$
Upper limit of usable pulse repetition frequency	c 5Mc/s	c 1Mc/s
Digits per foot at maximum usable repetition frequency	1 000	c 62.5

The Magneto-Striction Delay Line³

Like the mercury delay line this is an acoustic line in which a magneto-strictive wire is used as the propagating medium. In the simplest form of this device, the wire, which need not be straight, is threaded through coils at each end which act as the input and output transducers. If one of these is pulsed electrically, the portion of line affected by the resultant magnetic field will undergo a change in dimensions, and a stress pulse will be propagated along the line at the velocity of sound. If the portion of wire inside the second coil is polarized by means of a permanent magnet, a temporary change of induction will occur in it during the passage of the stress pulse and a corresponding voltage pulse will then be induced in the coil. The mechanism of the transformation from acoustic, to magnetic, and finally to electrical energy, is of some interest.

In the case of a wire made from material with a negative magneto-strictive constant such as nickel, an applied tension will rotate the vector of the magnetization in a transverse direction. In the demagnetized state these vectors are randomly oriented. A stress pulse will therefore produce a number of equal and opposite rotations with no net resultant change in induction. If, however, a magnetic polarizing field is applied, most of the magnetic vectors will be pointing in one direction or the other. The passage of a stress pulse will therefore produce a detectable change of induction whose polarity and magnitude is dependent upon the polarity and magnitude of the steady polarizing field.

This polarization can be provided by the remanent magnetization of the line itself which can thus be used as a dynamicizer. This is achieved by winding a number of output coils in different positions on the line which is locally magnetized in the appropriate direction at each

The Magnetic Drum and other Non-Regenerative Delay Lines

This type of store where information is recorded in circumferential tracks on a rotating drum coated with magnetic material is physically very different from any type of "line". It falls, however, into the same logical category since a particular piece of information is only available to a particular "reading" head at separate instants of time. The magnetic drum store has been used very widely in digital computing, and has found no rivals in its own field of large capacity—medium speed storage. A full description of a representative scheme has been given⁴.

The possible density of digit packing on magnetic drums and tape, is determined mainly by the size of the randomly occurring faulty regions in the magnetic material. In the case of a magnetic drum designed to hold several hundred information tracks, the figure of one hundred digits per inch is generally accepted as an upper limit. The corresponding figure for magnetic tape is similar and as reference to Table 2 shows, the maximum possible digit density in the case of the mercury delay line is of the same order of magnitude.

The delay lines which have been discussed above, have in common the fact that their recording media are continuous. Before proceeding to the discussion of stepping registers involving discrete bistable elements, a magnetic counting device employing a single saturable choke, will be described.

The Magnetic Counter or "Zahldrossel"⁵

The basic circuit of this elegant device which has been used for counting cycles of mains frequency in electrical welding equipment, is shown in Fig. 2. The magnetic material of the choke is chosen so as to possess the type of

hysteresis loop shown in an idealized form in Fig. 3. At the beginning of the count the iron is at point A of the hysteresis loop, having been saturated in a negative direction. During a counting run, half sine waves of voltage are applied to the choke through the rectifier (Fig. 2.) These drive the material in a stepwise manner towards a state of positive magnetic saturation. After a pre-determined number of pulses this condition is attained and any subsequently applied voltage pulses are now able to drive a current through the reset device which may be electro-mechanical or electronic. This in turn brings about the passage of a current pulse through the reset winding, restoring the initial conditions of negative saturation and providing an output pulse.

The number of pulses, r , required to "set" the core is given by the expression $r \int V dt = 2NaB_s \cdot 10^{-8}$ where N is the number of turns of the winding, a is the cross-sectional

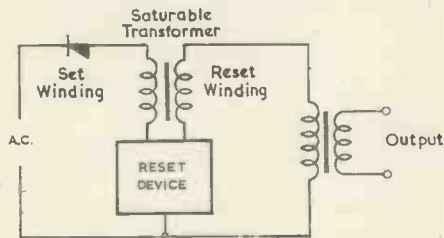

Fig. 2. Saturable transformer used as a counting element⁵

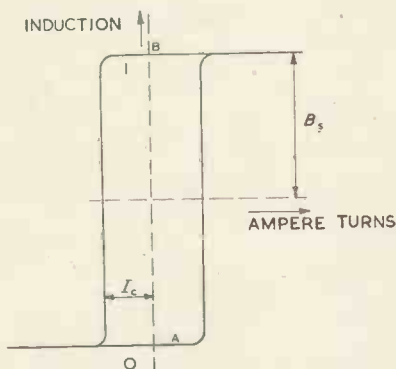

Fig. 3. Rectangular type hysteresis loop

area of the core and B_s the saturation induction of the core material. V refers to the voltage of the pulses applied and t is the time. In the present instance these pulses are semi-sinusoids, but in general there is no restriction on their shape provided only that $\int V dt$ is constant from one pulse to the next.

Stepping Registers and Ring Counters Using Valves

A stepping register is commonly defined as a chain of bistable elements connected in such a fashion that a whole group of digits can be sent along it, moving one element at a time. In a ring counter on the other hand, these are connected together in such a fashion that only one digit can be sent through it at one time, i.e. all but one of the bistable elements of a ring counter are always in the same state. Representative circuits for hard valve ring counters and stepping registers have been described⁶, but these are nowadays mainly of historical importance. Multi-cathode glow-discharge valves in which the glow discharge can assume up to ten different positions in one tube envelope, have recently become of engineering importance⁷. They are used as ring counters at relatively low speeds of operation.

Magnetic Stepping Registers

The use of a saturable magnetic core as a bistable computing element was first suggested by Professor Aiken of Harvard. This led directly to the development of a magnetic stepping register by Wang and Woo⁸ and indirectly to all the other devices described in the remainder of this review.

The stepping register which has just been mentioned is shown in Fig. 4. The transformers are constructed of material having the type of rectangular hysteresis loop shown in idealized form in Fig. 3. Two stable magnetic states are possible depending upon the polarity of the saturating pulse applied last. These two states of positive and negative remanence will be taken respectively to indicate the presence or absence of a binary digit.

Assume initially that all the cores in Fig. 4 are in a 0 state. An advancing current pulse i_1 is then applied to transformers 1, 3, etc., producing a negative magnetomotive force. Since all the elements are negatively saturated very little flux change will occur and cores 2 and 4, etc., will remain unaffected. If the first core is in state 1 while the rest are all in state 0, the application of the current pulse i_1 will cause a large change of flux in this core. The consequent large positive voltage induced across winding N_a of transformer No. 1 forces a current through

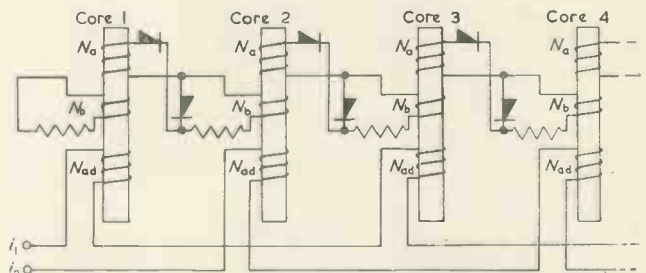

Fig. 4. Wang & Woo's magnetic stepping register⁸

the series connected rectifier in such a direction as to magnetize the next transformer in a positive direction. Providing that winding N_b on this core has less turns than N_a on core 1, the flux in core 2 changes faster than that in core 1, so that core 2 is driven into saturation in a positive direction before the output pulse from core 1 has ceased. A digit has thus been transferred from the first to the second stage of the register. By passing a current i_2 , the digit is transferred in a similar manner from core 2 to core 3. It is clear that by pulsing these currents alternatively, a group of digits can be stepped along the line provided that each digit is separated from the next by an empty buffer element. The purpose of the series rectifier is to avoid break-through of information to succeeding cores from a core which is being pulsed into the 1 position and the purpose of the shunt rectifier is to prevent feedback of information from one element to the previous cores, when that particular element is being reset from a 1 to a 0 state.

The speed of operation of such a register is limited by eddy current effects in the magnetic material. Using tape wound cores of Deltamax or similar material and germanium rectifiers, speeds of over 100kc/s are possible, provided that the tape thickness is kept to 1 mil or less. A delay-line of this type rated at a maximum operating speed of 128kc/s is commercially available at the present time.

Even higher operating speeds should be possible if rectangular loop ferrite materials are used as the saturating elements. Several manufacturers are engaged in research leading to the development of such a material, but the best rectangular loop ferrites at present available are not very suitable for use in a stepping register of the type described above because of the finite permeability of the remanence-

saturation section of their hysteresis loops. Circuits have, however, been designed in which this material defect is compensated for by connecting a core of constant permeability in opposition to each saturable core⁹. The differential permeability in the remanence-saturation section of such a compensated core is reduced to zero, whereas the permeability on the steep part of the hysteresis loop is only affected to an unimportant extent. Another development of interest lies in the use of capacitors between the saturable cores of a stepping register, so as to eliminate the necessity for buffer elements¹⁰. Potted four-element line sections of this type are available rated for a maximum operating speed of 16kc/s. The size and shape of the shift pulse appears to be rather more critical in this type of circuit than in the less economical designs described above.

A physically similar type of stepping register which is, however, based on a completely different logical approach, has been developed by R. A. Ramey¹¹. This utilizes "single core magnetic amplifiers" as the basic storage element. One version of this amplifier is shown in Fig. 5(a). This again utilizes a rectangular loop magnetic core which is coupled to a load and a control circuit. E_{AC} and E'_{AC} are alternating voltages (not necessarily sinusoidal) having the same phase. Their magnitudes are proportional

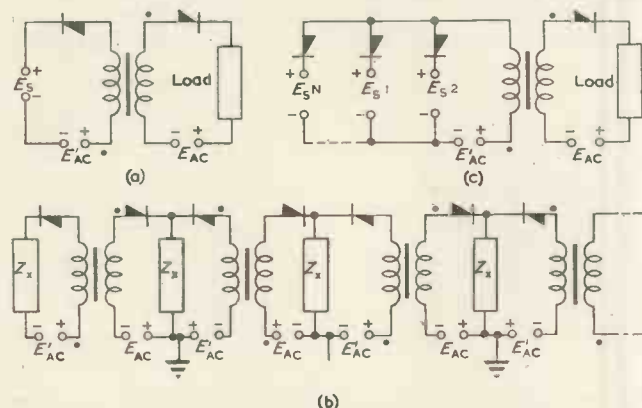

Fig. 5(a). Ramey's single core magnetic amplifier¹¹. (b) Magnetic amplifier and gate. (c) Magnetic amplifier delay line

to the turns ratio of the transformer and have the instantaneous polarities shown.

The operation of the amplifier can be considered in two separate periods, reset and gating. During the half cycle having the polarity indicated in Fig. 5(a) current can flow only in the control or reset circuit because of the blocking action of E_{AC} . The core thus proceeds from saturation by an amount dependent upon E_S and E_{AC} . During the next half cycle, current can flow only in the load circuit, thus tending to drive the core back to saturation. As soon as this has taken place, the whole of E_{AC} is impressed across the load for a period determined by the degree of reset of the previous half cycle. By making E_S when present large enough to prevent reset, the presence or absence of a load current in a particular half cycle, is dependent upon the presence or absence of the information voltage E_S in the previous half cycle.

The basic circuit of a stepping register constructed on these lines is shown in Fig. 5(b). A pulse appearing across the input impedance of stage 1 during a reset half cycle is reproduced on the output of that stage (which is also the input of stage 2) during the second half cycle. A particular information pulse or group of pulses thus encounters a delay of a number of half cycles corresponding to the number of stages it encounters in the line.

The coupling impedances Z_X utilize a diode each and are arranged to be very small for currents less than double the magnetizing currents of each stage, and very large for all

currents larger than this. This means that one core can be magnetized and an adjacent one reset through Z_X with practically no interaction. If, however, the first core has not been prevented from resetting, the full voltage E_{AC} will appear across Z_X during the magnetizing half cycle.

Since each coupling impedance involves a rectifier, the magnetic delay line of Fig. 5(b) is less economical in these components than the previously mentioned design. This is compensated for by the fact that since the single core magnetic amplifier has a high input impedance and a low output impedance any logical element consisting of these amplifiers can drive a large number of other similar devices without the necessity of utilizing intermediate amplifiers, having no logical function.

It is clear that a ring counter using two of any of the different elements mentioned, will perform the logical functions of a flip-flop. A single core amplifier supplied with two parallel inputs as in Fig. 5(c) will act as a coincidence circuit which only gives an output when both inputs were activated in the previous half cycle. It should be mentioned that any two element delay line connected back to back performs the logical functions of a flip-flop. Circuits of this type are described by Ramey¹¹.

The types of magnetic stepping register which have been discussed, may be called static insofar as they retain their information independently of the presence of any direct or alternating power supplies. This advantage has to be set

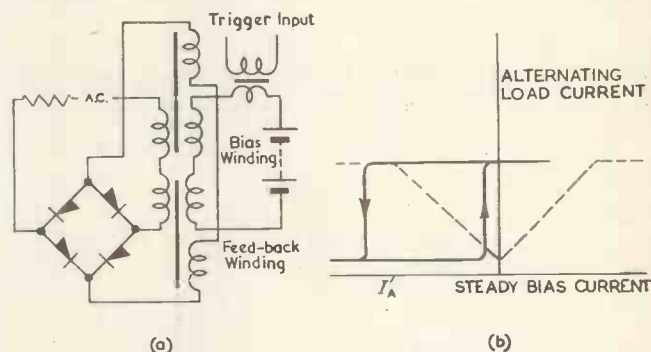

Fig. 6(a). Transductor circuit with feedback windings. (b) Bistable characteristic associated with more than 100 per cent positive feedback.

against the fact that they do not give a continuous indication of their state. A bistable device, which does not possess this undesirable feature can be obtained by applying more than 100 per cent positive feedback to an orthodox magnetic amplifier.

The characteristics and circuit arrangement of such a device are shown in Fig. 6. If such a transductor is biased to a point such as I_A , it becomes a bistable element which can retain its memory as long as the carrier power remains on. Although several patents have been taken out in respect of this type of circuit¹² it has never become very popular and would in any case now be replaced by the ferro-resonant type of flip-flop.

A saturable choke connected in series or parallel with a capacitor can, under certain circumstances, act as a bistable device when driven by an A.C. source. This effect was discovered early in the century and is known as ferro-resonance. The characteristics of the series and parallel connected saturable choke are shown in Figs. 7(b) and (c) together with dotted elliptical resistive load lines. It can be seen that the acceptor circuit of Fig. 7(b) is bistable in series with a low resistance (the so-called open-circuit stable case) and that the rejector circuit of Fig. 7(c) is bistable with a high series load, thus corresponding to the short-circuit stable case. The changeover of one of these circuits from one state to the other takes several cycles of excitation frequency.

A circuit for a ferro-resonant flip-flop based on the series

connected arrangement is shown in Fig. 8. The common capacitor C_0 is of such magnitude that one, but only one, of the two elements L_1 and L_2 will always be in resonance. If L_1, C_1 of Fig. 8 is in resonance, a pulse applied to input No. 2 will cause the voltage at P to drop, driving L_1, C_1 out of and L_2, C_2 into resonance. By simply joining input 1 and 2 the device will operate as a single input flip-flop, although it is then rather more critical with regard to the width of the triggering pulse. A ferro-resonant flip-flop can drive several others through conventional diode gates since each ferro-resonant element acts as a power amplifier. Circuits in which they perform as binary counters, ring counters and stepping registers, are described by Isborn¹⁵.

The greatest attraction of ferro-resonant devices is the fact that the saturable chokes used in these circuits do not require a closed magnetic circuit. They can, in fact, be constructed from a thin strip of mumetal pushed into a

quite uneconomical in view of the amount of hardware which would be necessary to provide access to any core at any time.

An elegant solution to the problem of economical access was, however, suggested by Forrester¹⁵, whose ideas have since been followed up in several laboratories. This scheme makes use of rectangular hysteresis loop toroids, wired up as shown in Fig. 9(a).

Assume for the moment that all the cores in the array of Fig. 9(a) are in the 0 state. Positive current pulses of magnitude $\frac{1}{2}I_0$ sent along lines A and B will leave the core at their intersection in state 1, but will not permanently alter the magnetic state of any of the other cores of the system. The selected core can be restored to its original state (again without affecting any of the other cores) by sending negative current pulses along lines A and B. The change of induction of the switched core gives rise to a voltage pulse on the read winding CD. The state of a particular element, such as that at the intersection of A and B, is determined by switching it in a negative direction. If the element was in stage 1 a pulse will appear on the read winding and if the information content of the core is to be retained, it is returned to state 1 by subsequently applying positive current pulses to the selection lines A and B. Since during the selection process, currents of $\frac{1}{2}I_0$ are passed along each of the selection windings it is essential that none of the cores on these windings should suffer an appreciable permanent

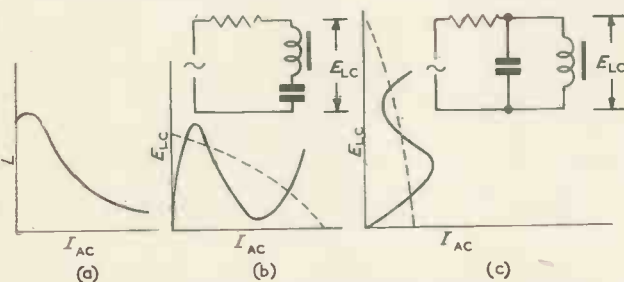

Fig. 7(a). Inductance variation of saturable choke with A.C. excitation. (b) Alternating voltage-current characteristic of series-connected ferro-resonant circuit. (c) Alternating Voltage-Current characteristic of parallel-connected ferro-resonant circuit

Elliptical resistive load lines are shown dotted in (b) and (c).

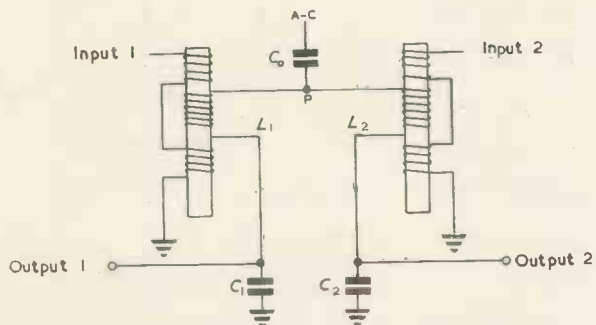

Fig. 8. Isborn's ferro-resonant flip-flop¹⁵

cylindrical coil assembly. Commercial models of these devices are available which can be switched at 100kc/s and which utilize a carrier frequency of 2Mc/s.

Random Access Storage

The great disadvantage of delay line storage (which has already been mentioned) is the fact that a given piece of information is not available at a given point at any time. Although claims have been made that this disadvantage can be nullified by skilful programming, random access methods of high speed storage have been adopted in most of the general purpose machines which have been constructed to date. All the methods at present in use utilize the charge storage properties of an insulating surface, possessing secondary emission properties. Access to different spots of the surface is in most cases provided by an electron beam, using standard cathode-ray tube techniques.¹⁴

Magnetic toroids could, of course, be used in a straightforward manner for random access information storage at the rate of one core per digit; but such a system would be

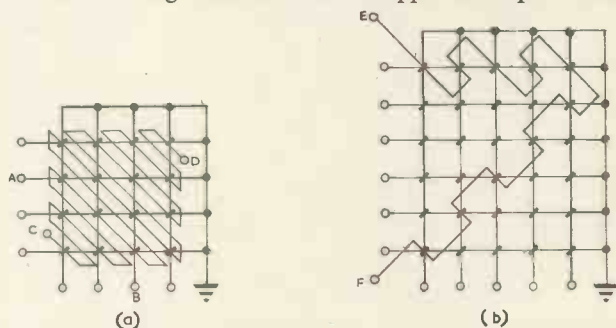

Fig. 9(a). Two-dimensional magnetic core store. (b) Magnetic core pattern generator with a figure "7" winding

change of induction when subjected to repeated magnetization pulses of this magnitude, i.e. the core material must be able to discriminate between currents of I_0 and $\frac{1}{2}I_0$. Even though existing magnetic toroids are satisfactory from these points of view, it is impossible to avoid a comparatively small reversible change of induction when a particular core is subjected to a "non-selecting" current pulse of magnitude $\frac{1}{2}I_0$. The read winding in Fig. 9(a) is therefore threaded through the array in such a manner that the voltage pulses induced on it by the cores on any two intersecting selection lines will tend to cancel out.

If a two-dimensional arrangement of the type described contains n^2 units the problem of selecting one out of an assembly of n^2 information units has been reduced to that of selecting 2 out of $2n$ selection lines. Assuming for the moment that each selection line requires two valves, this leads to $n^2/2n = \frac{1}{2}n$ storage positions per selection valve. Developmental models of this type of store, using ferrite cores, have been described^{16,25}. Two types of three-dimensional array were described by Forrester (*ibid*) in which three selection windings pass through each core. A three-dimensional storage lattice of side n would thus provide as many as $n^3/6n = 1/6 n^2$ digits per selection valve. Arrays of this type are under development both in this country and in the United States.

High Speed Switching

Instead of the construction of multi-dimensional arrays, development work is believed up to now to have been

mainly concentrated on the investigation of economical methods of selecting one out of n selection lines. This type of work has applications to other fields than that of magnetic core storage.

A typical high speed switch using magnetic cores is described by K. H. Olsen¹⁷ and utilizes saturable cores wound according to a binary scheme as shown in Fig. 10.

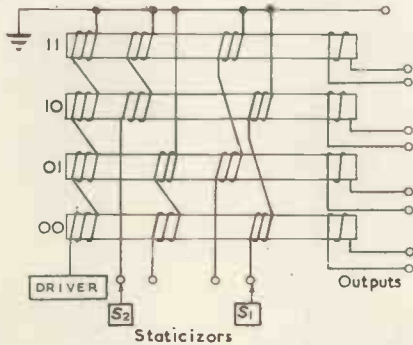

Fig. 10. Olsen's binary-wound selector switch employing saturable transformers¹⁷

The staticizers S_1 and S_2 control the flow of saturating current along the selection windings in such a manner that for any given configuration only one core remains unsaturated (01 in the case illustrated). When the drive winding is activated the unsaturated core acts as a transformer and a current of either polarity can be switched to the selected line. For satisfactory operation, the selected core must be returned to the same state as the unselected one.

If initially all the transformers are saturated in a negative direction, then when a positive pulse is applied to the drive winding, the selected core will be switched over to positive saturation and none of the others will be affected provided that the saturating currents are sufficiently large. Before the switch can be reset to select an alternative line, a negative pulse must be sent along the drive winding, thus returning the selected core to negative saturation. With this type of multi-position switch, a positive pulse on a particular line must therefore always be followed by a negative one at a later time. If two such switches are used in conjunction with the type of storage matrix described above, the reset outputs can be used to reset the selected storage core. If reset of the storage core is not required, the switches are reset at different times, so that their reset outputs do not coincide. Alternatively, a "cancellation pulse" can be sent along another winding threaded through each core of the memory matrix and the switches can be reset simultaneously without resetting the selector core. A type of switch similar to the one under discussion has been described by Rajchman¹⁸.

Binary pattern switches of the type described, are extremely economical in valves, but are difficult to put into operation using present-day ferrite materials. A type of switch which is less ambitious in terms of valve economy, and somewhat easier to construct and operate, uses the winding scheme of Fig. 9(a)^{25,26}. The three types of winding shown are all used for input purposes in this device and in addition each core is provided with a separate output winding which is not shown. Winding CD is used for pulsed currents and also carries a steady current for "biasing off" the unselected cores in a negative direction. To select a particular line, currents are sent along two selection wires so as to bring the toroid at their intersection to the remanence point of the hysteresis loop. (Point A in Fig. 3). When a positive magnetization pulse is sent along winding CD a positive voltage pulse is produced on the selected output line. The switched core can be reset either by a negative magnetization pulse along CD or simply by switching off the gating currents passing through the selection wind-

ings. It should be noted that in distinction to the memory system of Fig. 9, this switch requires current pulses along the selection wires of one polarity only, thus necessitating only one valve per selection winding. Material considerations are also much less critical in this switch than in the memory, since by the use of a sufficiently large biasing current, and correspondingly large selection currents, the non-selected cores can be kept saturated in a negative direction to any desired extent. The same applies to the binary wound switches described above.

Magnetic Core Pattern Generator¹⁹

This is an extremely simple device used to generate numbers and figures on a cathode-ray tube screen. It consists of a two-dimensional raster of saturable cores threaded as shown in Fig. 9(b). All the cores are initially at a state of negative remanence. By means of the vertical and horizontal selection windings, the cores are switched to a positive saturation one at a time as described in connexion with the core store above. The position of the particular core being switched is arranged to correspond to the position of a normally blacked out electron beam sweeping across the face of a cathode-ray tube. Whenever a core lying on a wire EF is switched, a voltage pulse appears on this line and this is used to intensity modulate the electron beam of the cathode-ray oscillograph. An array of dots in the shape of a figure "7" is thus produced on the face of the tube. Any other symbol can be produced in a similar manner by threading it into the core matrix. It is an interesting fact that if a large number of symbols are threaded through the matrix, these can all be reproduced simultaneously though not, of course, on the same cathode-ray tube.

Ferro-electric Development

The description of the magnetic pattern generator closes the review of magnetic computing elements. The next few years may see the development of an analogous series of ferro-electric computing devices based on the hysteresis properties of barium titanate and similar materials. These substances suffer a lattice distortion on the application of an electric stress, and are characterised by a hysteresis loop of the type shown in Fig. 11(a). A circuit used to demonstrate the charge storing properties of this material is shown in Fig. 11(b). A positive voltage pulse large enough to saturate the crystal will leave it in state 1 of the hysteresis loop. Because of the shunting action of the diode

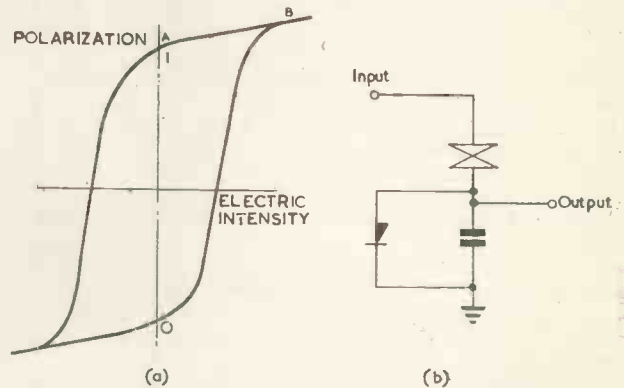

Fig. 11(a). Ferro-electric hysteresis loop. (b) Single digit memory.

no signal will appear across the output capacitor. Any further positive input pulse will give rise to reversible excursions along section AB of the hysteresis loop. If a negative pulse is now applied to the saturable capacitor, the material will be reset to stage 0 and a comparatively large amount of charge will be liberated by the ferro-electric, giving rise to a large voltage pulse across the output capacitor. This charge will eventually leak away with a time-constant

depending upon the resistive load across the output terminal.

A stepping register making use of these elements has been described by Anderson²⁰. This author also suggests a design for a random access ferro-electric memory which bears a close resemblance to the magnetic core store described above. This would consist of a crystal plate of rectangular loop ferro-electric material, printed with conducting lines on either side as shown in Fig. 12. Each cross-over point erasure of one particular digit is accomplished by applying a voltage pulse half as large as that necessary to polarize the material to one of the top electrodes and one of equal and opposite magnitude to one of the electrodes on the other side. Only at the electrode intersection will the voltage across the ferro-electric be large enough to give rise to a change of state.

For this and the other ferro-electric devices, a rectangular hysteresis loop is clearly a necessity. Up to the present it has only been possible to obtain this type of characteristic in single crystals of barium titanate. Arguing by analogy to

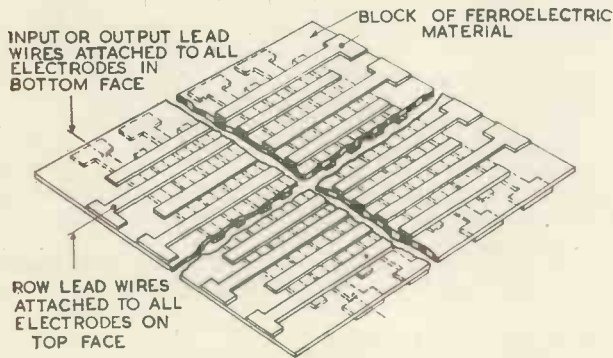

Fig. 12. Random-access store proposed by Anderson²⁰

the development of ferro-magnetic materials, it seems possible that an "alloy" of barium titanate will eventually be produced which even in a polycrystalline state (perhaps grain oriented), will possess a rectangular hysteresis loop.

Future Developments

The major part of the preceding review has been concerned with the discussion of devices utilizing magnetic material with a rectangular hysteresis loop. At the time when most of these circuits were conceived and developed no rectangular loop ferrites were available. The metallic materials which had been developed possessed very nearly "ideal" magnetic characteristics, but their use at high frequencies was severely limited by eddy current effects. The so-called clock spring cores, which are now, however, commercially available, consisting of spirally wound strips only a fraction of a mil in thickness, can be switched from one end state to the other in a few microseconds^{21,22}. These toroids are however delicate to handle and expensive to produce. It would, therefore, be rather uneconomical to construct a random access store using one clock-spring core per digit. In the last few months, however, rectangular loop ferrite toroids have become available commercially²³. These have been specially designed for use in random access storage, and as mentioned above, a two-dimensional core memory using them has been described by Albers-Shoenberg and Brown¹⁶.

It is of interest that to date it has only been possible to produce the desired rectangular loop characteristics in gasless cores. It would seem, therefore, that the stresses developed through shrinkage of these cores in manufacture play an essential part in producing the desired characteristic. It is to be expected that the limitation to toroidal shapes will eventually be overcome, and it is likely also that the comparatively high coercivity of present-day rectangular loop ferrites will soon be reduced.

As materials with even more rectangular magnetization characteristics become available, random access stores utilizing four or more selection lines per core, will become possible, with a consequent increase in valve economy. Another useful material development would be the production of a ferrite with a hysteresis loop similar to that of mumetal, since this would make the production of high frequency magnetic amplifiers possible. It should be mentioned in this connexion that dielectric amplifiers, using barium titanate, are already under development and may soon become a practicable engineering possibility²⁵.

Rectangular loop materials have only been available for such a short time that their possible range of application has as yet only been entered. The binary wound switch described above, may, for instance, be regarded as a type of binary-decimal convertor, and this emphasizes the fact

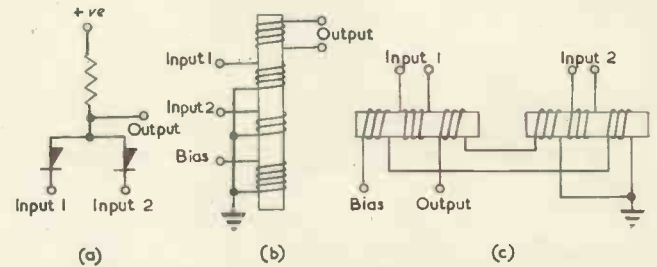

Fig. 13(a). Diode gate: "and" for positive inputs "inclusive or" for negative inputs. (b and c) Magnetic analogues, using rectangular loop magnetic material

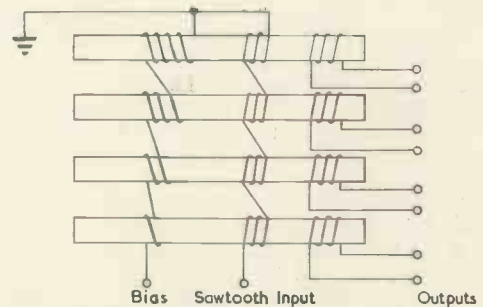

Fig. 14. Pulse separator circuit, using saturable transformers

that any logical circuit using diodes, has an analogue using saturable cores.

A very simple example of this is shown in Fig. 13(a) which shows the simplest diode logical circuit. For positive inputs this acts as an "and" gate, giving a positive output pulse only when both positive inputs coincide. With negative going inputs, on the other hand, the circuit acts as an "inclusive or" gate which produces a negative going output in the presence of either or both inputs. The magnetic core analogue of this device is shown in Fig. 13(b). The biasing winding carries a negative current of I_0 .

If positive currents of magnitude I_0 are applied to the input windings, the device acts as an "and" gate, whereas if input currents of magnitude $2I_0$ are used the circuit acts as an "or" gate. This type of transformer "or" gate does however lack one facility which is associated with its diode analogue. The input circuits are not isolated from one another. An "or" gate which does not suffer from this disadvantage is shown in Fig. 13(c). Each of the transformers shown has a rectangular magnetization characteristic. As long as the output current is kept much below I_0 either transformer can be set and reset without any interaction with the other.

Another field of application of rectangular loop toroids

is in the field of analogue devices, since saturable transformers are ideally suited for comparing the magnitude of two currents. As an example of this, consider the economical pulse separator circuit of Fig. 14. The saturable transformers are each provided with differing amounts of steady negative bias. The application of a sawtooth waveform to the input winding will give rise to pulses on the output windings *a*, *b*, *c* and *d*, in turn. The provision of pulses on these different lines at long intervals, is facilitated by the provision of a staircase instead of a sawtooth current waveform. This type of circuit could be used for providing the selection pulses for the magnetic pattern generator of Fig. 9(b).

Conclusion

It is hoped that all the more important developments in magnetic and ferro-electric computing devices, of which any published information exists, have been included in this review. At the same time an attempt has been made to note as yet unpublished contributions, such as papers presented at various professional conventions, etc. Six out of the twenty-six references listed come into this category. Since a detailed account of even the more important published circuits would have been impossible in an article of this size, they have only been described insofar as was necessary to illustrate the design techniques of which they are an example.

Perhaps the greatest advantage of ferro-electric and ferro-magnetic devices over their thermionic equivalents, is their vastly longer lifetime. In addition, the reduction in power dissipation, associated with the absence of heaters, enables full use to be made of present day miniaturization techniques. Although it would not be true to say at the moment that a practicable high speed computing system could be constructed from magnetic devices alone, this state of affairs is being rapidly approached and awaits only the development of a high speed magnetic amplifier.

The optimum utilization of magnetic and ferro-electric circuits does, however, require a certain amount of reorientation on the part of the logical designer of computing machinery. It is hoped that this review may be of some help in this regard and that it may encourage further interest in non-electronic solid-state computing devices.

Acknowledgments

The author would like to thank Mr. R. H. Barker, of the Ministry of Supply Signals Research and Development Establishment, for his helpful criticism of this article, and Messrs Ferranti Ltd for permission to publish it. All the original work described in this review was carried out under a development contract with the Directorate of Scientific and Industrial Research.

REFERENCES

1. WRIGHT, M. Mercury Delay Line Storage. National Physical Laboratory, Symposium on Automatic Digital Computation, March 1953.
2. M.I.T. Radar School. Principles of Radar (McGraw-Hill, 1946).
3. ROBBIN, R. C., MILLERSHIP, R. Application of Magnetic Delay Lines. National Physical Laboratory, Symposium on Automatic Digital Computation, March 1953.
4. WILLIAMS, F. C., KILBURN, T., THOMAS, G. E. Universal High Speed Digital Computers: A Magnetic Store. *Proc. Instn. Elect. Engrs.* 99, Pt. 2, 94 (1952).
5. DUFFING, P., TSCHERMAK, M. Die Zahldrossel, ein Magnetisches Schaltungselement. *Siemens Austria Z.* 26, 140 (1952).
6. Staff of E.R.A. Assoc. Inc. High Speed Computing Devices (McGraw-Hill, 1950).
7. HOUGH, G. H., RIDLER, D. S. Some Recently Developed Cold Cathode Glow Discharge Tubes and Associated Circuits (Part 3). *Electronic Engrg.* 24, 272 (1952).
8. WANG, A. Magnetic Delay Line Storage. *Proc. Inst. Radio Engrs.* 39, 401 (1951).
9. FISHMAN, M. A High Speed Shift Register Using Magnetic Binaries. *Inst. Radio Engrs. National Convention*, March 1952.
10. RUHMAN, S., WOO, W. D., KODIS, R. D. Magnetic-Shift Register Using One Core Per Bit. *Inst. Radio Engrs. National Convention*, March 1953.
11. RAMEY, R. A. The Single Core Magnetic Amplifier Used as a Computer Element. *Commun. and Electronics*. No. 4, p. 442 (January 1953).
12. MILES, J. G. Bibliography of Magnetic Amplifier Devices and the Saturable Reactor Art. *Trans. Amer. Inst. Elect. Engrs.* 70, Pt. 2, 2104 (1951).
13. ISBORN, C. Ferro-resonant Flip-Flops. *Electronics* 25, 121 (April 1952).
14. KNOLL, M., KAZAN, B. Storage Tubes and their Basic Principles (Chapman & Hall, 1952).
15. FORRESTER, J. W. Digital Information Storage in Three Dimensions Using Magnetic Cores. *J. Appl. Phys.* 22, 44 (1951).
16. BROWN, D. R., ALBERS-SHOENBERG, E. Ferrites Speed Digital Computers. *Electronics* 26, 146 (April 1953).
17. OLSEN, K. H. A Magnetic Matrix Switch and its Incorporation into a Coincident-current Memory. M.I.T. Master of Science Thesis, 1952.
18. RACHMAN, J. A. Static-Matrix Memory and Switching Circuits. *RCA Rev.* 13, 183 (1952).
19. GORDON, B. M., NICOLA, R. N. A High Speed Magnetic Core Output Printer. *Proc. Assoc. Computing Machinery*, Toronto, Sept., 1952.
20. ANDERSON, J. R. Ferro-electric Storage Elements for Computer and Switching Systems. *Commun. and Electronics* No. 4, p. 395 (January 1953).
21. LITTMAN, M. F. Ultrathin Tapes of Magnetic Alloys with Rectangular Hysteresis Loops. *Commun. and Electronics* No. 7, 220 (July 1953).
22. SANDS, A. E. The Behaviour of Rectangular Hysteresis Loops under Current Switch Conditions. *Proc. Inst. Radio Engrs.* 40, 1246 (1952).
23. GELBARD, E. Magnetic Properties of Ferrite Materials. *Tele-Tech.* 11, (May 1952).
24. PENNEY, G. N., HORSCH, J. R., SACK, E. A. Dielectric Amplifiers. *Commun. and Electronics*, No. 5, p. 68 (March 1953).
25. RAJCHMAN, J. A. A Myriabit Magnetic-Core Matrix Memory. *Proc. Inst. Radio Engrs.* 41, 1407 (1953).
26. NEWHOUSE, V. L. Interim Report on Magnetic Core Storage. (Ferranti Ltd., 1953).

Gas Clean-up in Xenon Thyratrons*

In order to obtain long life from an inert gas-filled thyatron it is essential to take precautions to ensure that:

- (1) The cathode shall not be destroyed by bombardment.
- (2) The gas shall not be driven into the electrode structure or "cleaned-up".

The two effects are inter-related in that failure to observe either condition will lead to the other fault.

However, for design purposes condition (1) is met by observing the limiting anode current and filament voltage ratings quoted for the valve.

The gas clean-up effect operates whenever a high voltage exists between two valve electrodes in the presence of an active, or residual ion population.

This occurs if, when the valve is conducting a substantial forward current, this current is stopped in a few microseconds and it is immediately followed by a rapid rise of inverse voltage across the valve.

Under these conditions residual positive ions are

accelerated by the high voltage across the valve and become imbedded in the anode. This effect is expressed quantitatively as:

The product of rate of anode current decay and the rate of initial inverse anode voltage rise.

The rate of anode current decay is expressed in amperes/microsecond and is taken over the last 10 microseconds of current conduction. The average rate of inverse voltage rise is expressed in volts/microsecond and is taken over the first 200V.

This product is known as the *valve commutation factor* and when a maximum value is quoted, care must be taken to ensure that it is not exceeded.

If the commutation factor is too high it may be lowered by the use of snubbing circuits. These usually take the form of simple resistance-capacitance or inductance-capacitance networks placed in the thyatron anode-cathode circuit. Such circuits are effectively low-pass filters and they prevent rapid voltage or current changes from being impressed on the valve.

* A Communication from Mullard Ltd.

Impulse Noise Generators

Simulation and Measurement of Ignition Interference for Tests on Sound and Vision Receivers

By M. V. Callendar, M.A., A.M.I.E.E.

This article describes two generators suitable for testing sound or vision receivers for their response to impulsive noise from car ignition systems and other sources. One is based on a spark plug with variable gap and controllable output and the other includes a thyratron valve giving pulses with any desired time relation to the synchronizing (usually television line) pulses. The article concludes by describing a method of calibration applicable to the generators, and to other noise sources.

IT is generally agreed that in work on the suppression of ignition interference in sound or television receivers one of the chief obstacles to progress is the difficulty in obtaining a stable and reproducible source of interference. Allied to this is the problem of how to measure the output of such a generator.

Most investigators start with a car running outside the laboratory window, but are forced to abandon this procedure by the variation in intensity of interference from day to day and even from minute to minute, not to speak of the objections of the car owner.

A second stage is to set up in the laboratory a system comprising coil and spark plug, with contact-breaker and distributor run from an electric motor. This is more convenient than a car, but requires rather careful screening and still suffers from unpredictable variations and from the difficulty of feeding a known and adjustable signal from the source to the set under test.

Another difficulty inherent in ignition interference investigations arises from the fact that the interference produced by different cars, and even by any one car at different times, can vary greatly in respect of the pulse waveform produced at each ignition cycle (or main spark), as well as in the more obvious respect of peak intensity of radiated field. Some typical oscillograms showing this effect are given in a paper by Eaglesfield¹. Two separate phenomena contribute to this state of affairs: first, the main resonance of the induction coil can convert the single spark expected into a short train of sparks separated by a period of the order of $100\mu\text{sec}$. Secondly, a more recalcitrant phenomenon often produces a long train of sub-sparks (separated by only 1 to $10\mu\text{sec}$) each time the sparking potential is applied, the intensity of these sub-sparks being rather lower than that of the main spark.

The importance of this effect is often under-estimated: while it does not actually increase the radius of interference from a vehicle, it does greatly augment the intensity of interference on sets within, say, half this radius. The subjective interference on television if a train of 100 pulses are visible can reasonably be said to be 100 times that from a single pulse. Moreover, the subjective loudness of an audio pulse is proportional to its area provided it is not too long (not over about half a millisecond), and the output pulse from a receiver is formed by the integration of all the sub-pulses in the train. The level of the main spark is usually limited by the circuit (whether it includes a limiter stage or not) and hence the loudness of the interference is here increased nearly in proportion to the number of sub-pulses.

Generator Using a Sparking Plug

The circuit for a simple generator giving results close to

those from a car ignition system is shown in Fig. 1. An old 50c/s television E.H.T. transformer was used, with a rectifier, charging a capacitor (shunted by the spark plug) through a high value resistor to a maximum of about 5kV. The output is obtained from an 80Ω ladder attenuator run from the sparking voltage via a small capacitor, and is fed to the set under test via a coaxial cable. The whole unit is, of course, contained in a screen-

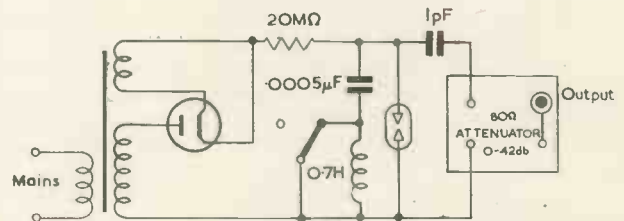

Fig. 1. Sparking plug generator

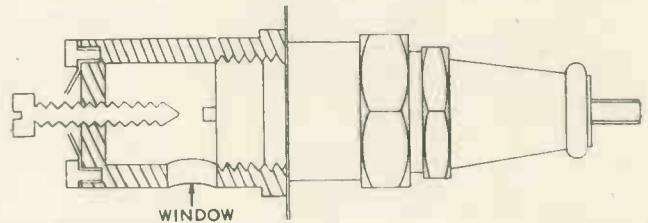

Fig. 2. Construction of the sparking plug

ing box. A screw-adjusted gap is used, as shown in Fig. 2, and the breakdown voltage varies from 1 to 3kV according to setting.

With the gap at maximum, a low repetition frequency, corresponding to a car idling, is obtained: the spark is very roughly synchronized to a sub-multiple of the mains frequency. As the gap is reduced, the repetition frequency increases owing to the shorter time required to charge the capacitor to the lower sparking voltage. When the tuned circuit LC is switched in, the damped oscillation from it produces a train of two or three pulses, spaced by about $100\mu\text{sec}$, for each main spark, except when the gap is adjusted to near the maximum or minimum for sparking; moreover, each pulse is followed by a train of up to 20 sub-pulses separated by 3-5 μsec , and some 6db lower in amplitude than the main pulse.

This unit has proved quite suitable for testing ignition suppressors in sound receivers. The relative merit of different types is very dependent upon the repetition frequency and waveform of the interference to be sup-

* E. K. Cole, Ltd.

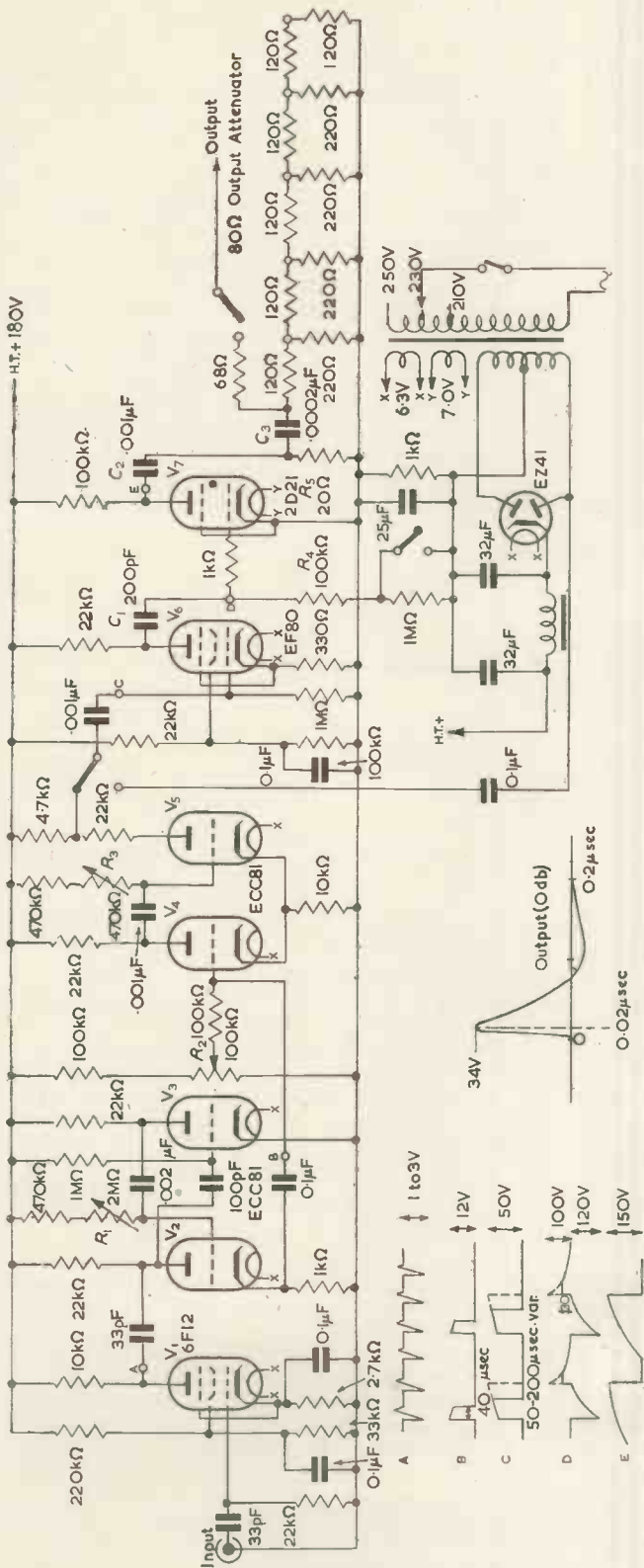

Fig. 3. Thyatron interference generator

pressed, and a series of tests is therefore made for single and multiple sparks, and at different settings of the spark gap, simulating different ignition systems and different engine speeds.

The basic weakness of any generator including a spark plug, viz. that its operation is not stable with time, should, where possible, be minimized by comparing the suppressor circuits by direct change-over switching.

To measure the output of interference from an ordinary sound receiver, a simple C.R.O. with quick starting triggered time-base was made up: a scan time of about 1 millisecond was usually best. For most purposes, the output pulse itself can be used as the trigger, only the first few microseconds of the relatively long output pulse being lost. If the fine structure of the original ignition pulses is to be observed, it is, of course, necessary to use a wideband receiver (e.g. a T.V. sound or vision receiver): in this case, a very interesting hour can be spent beside an arterial road, observing the various patterns obtained from passing cars. The waveforms can also be observed on the screen of a T.V. receiver, though the interpretation of the results is here more difficult unless the receiver is modified as shown by Eaglesfield¹.

Thyatron Generator

For tests upon vision receivers, it is often essential to be able to synchronize the pulses accurately to the picture: the reasons for this are (see photographs, page 203):

- (a) The effect of interference upon time-base synchronization is critically dependent upon the position of the interference pulse relative to the line sync pulse, and this timing must therefore be controllable at will.
- (a) The annoyance value of the spot (and sometimes also its reaction on the sync) is often enhanced by the appearance of a train of white and black spots, due to ringing and/or overloading in various stages of the receiver: to investigate this a steady spot in a fixed position is required.

A stable, known magnitude of interfering signal is also even more desirable than in the case of tests on sound receivers.

The interference generator described below (see Fig. 3) complies with both these requirements. This generator cannot provide multiple pulses, but this is usually unimportant in vision receiver testing: since the receiver circuits are sufficiently wideband to treat each of the pulses separately, the effect of multiple pulses (or pulses of a different repetition frequency) is easily visualized from tests upon single pulses. The generator is also intended for sound receiver testing in those cases where a stable, controllable interference signal is more important than the ability to vary the waveform: in this case the thyatron is triggered from the 50c/s supply as shown in the circuit.

When used for television testing, the line sync pulses are applied to the sync input socket via a screened lead from some convenient point: they may be picked off from anode of the sync separator of the set under test via a 2pf capacitor, or may be extracted direct from the picture signal generator. The picture seen is a vertical line of spots (spaced several lines apart) which can be moved across the tube face to any desired position. An explanation of the circuit follows.

The input pulses (line sync) are differentiated, and V₁ is biased to select the positive resultant: thus the output of V₁ consists of small negative pulses (see A on circuit) irrespective of the sign or amplitude of the sync input, provided the latter exceeds, say, 1V.

The first double triode (V₂ and V₃) forms a multi-vibrator running at approximately 1 to 3kc/s, the frequency being adjustable by R₁. This is synchronized by

the pulse from V_1 , and produces an output of $40\mu\text{sec}$ pulses (B) at a frequency which is an integral submultiple, usually between $1/3$ and $1/10$, of the line frequency. These are fed to the second double triode (V_4 and V_5) acting as a single shot multivibrator: the bias for best synchronizing is preset by R_2 . The output from the second multivibrator is a pulse (C), whose start is coincident with a line pulse, and whose length is adjustable from about 50 to $200\mu\text{sec}$ by R_3 . The end of this pulse, after reversal by V_6 , and differentiation by R_4C_1 , to give a waveform as D, triggers the thyatron, which discharges C_2 very rapidly (E), producing a short pulse across R_5 . The timing of this pulse relative to the line sync pulse is, of course, determined by the setting of R_3 .

The output is adjusted as desired by means of the 80Ω attenuator: an ordinary oak pattern switch has been used for this, and gives satisfactory attenuation up to 48db at 50Mc/s provided that care is taken to minimize common impedances and stray capacitances between the input and output ends of the network.

Calibration of Output of Interference Generators

The output of the above generators consists of very short pulses containing significant components up to and over 100Mc/s : care must be taken therefore in the method of connexion when attempting to view them directly on an oscilloscope, and a fast and quick-starting scan is, of course, required. In the case of the thyatron generator, it has been found possible to obtain a stable image of the pulse on the $2\mu\text{sec}$ scan of the pulse viewer described in a previous article² by synchronizing both the thyatron generator and the viewer from the pulse generator (see above article). The pulse is shown in Fig. 3: in length and rise time it is comparable to the current pulse in an actual ignition system reported by Nethercot³, but in form it is aperiodic instead of showing a damped oscillation of frequency around 50Mc/s .

This difference should not be important, since the first tuned circuit in the receiver will convert any pulse input into a damped wave-train of its own frequency. Tests on insertion of lead inductance in series with the plug on the spark generator showed appreciable resonant effects, but with the thyatron results were largely negative.

With the apparatus available, it was not found possible to obtain a satisfactory picture of the output pulse from the spark generator owing to the low frequency and inexact repetition which results in a very faint and "jittery" trace.

After further consideration and experience it appeared that the most useful calibration would be one in terms of effect on the receiver rather than in terms of peak pulse voltage at the generator terminals, since the effect of a pulse of given amplitude will depend upon its length and waveform in a manner which it would be difficult to allow for. It is required then to find the input E.M.F. to a receiver from an ordinary signal generator (preferably square wave modulated) which will give the same peak output from the receiver as is obtained from the interference generator: this we can term the Equivalent Interference Voltage or E.I.V. It must always be kept in mind, however, that the E.I.V. is a function of the receiver as well as of the interference source, and this for three separate reasons:

- The output increases with the bandwidth of the receiver, as for any pulse input.
- Time-constants in the signal rectifier and output indicator circuits affect the results.
- Integration of the trains of sub-pulses can cause the E.I.V. with a narrow band receiver to be much greater than would be expected from its bandwidth.

In numerous published studies^{3,4}, the E.I.V. from sources of interference has been measured, using various specially

built receivers, and has been generally described merely as the Interference Voltage: this description is apt to mislead anyone reading such papers in a cursory manner, since the figures obtained have naturally varied greatly with the bandwidth of the receiver employed. Provided that it is fully realized that the voltages quoted are not absolute, this dependence upon bandwidth is not as serious a disadvantage as the dependence upon pulse shape which is encountered if one attempts to specify the output of the generator directly in peak volts.

If the E.I.V. is measured with a receiver of the type which will actually be used in practice, the figures obtained are particularly useful in that they show immediately the degree of visual interference to be expected for a given signal strength. The layout when using an ordinary T.V. receiver (bandwidth 2.5Mc/s for -3db) for calibrating an interference generator is shown in Fig. 4. The vision interference suppressor was disconnected and the picture tube was biased back 20V from the bias required to make the raster just visible with no input. The input attenuator was then adjusted until the interference spots were just visible on the tube: the input for a just visible signal from the signal generator with square wave modulation was then noted. A series of linearity checks showed no overloading provided the output level did not

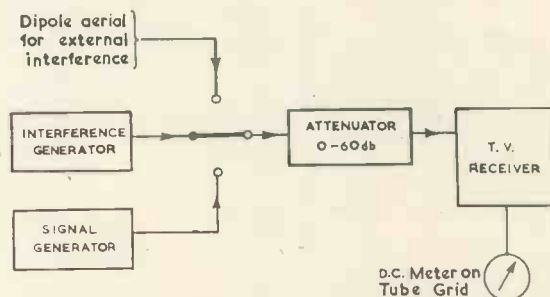

Fig. 4. Method of calibrating generator

exceed the 20V used. The presence of a signal voltage, provided it was less in amplitude than the interference, had little effect upon the measured E.I.V., though it sometimes altered the form of the interference somewhat (e.g. by introducing a black spot following the white).

By this simple method, different types of interference generator could be compared for E.I.V., and the E.I.V. produced by different cars in a television aerial could also be measured. The use of the picture tube as above is justified, crude though it may appear, by the relative difficulty of synchronizing the output pulse for viewing on an oscillograph: figures were, as a matter of fact, repeatable to $\pm 1\text{db}$ which is quite sufficient for work of this type.

Tests were made at 45Mc/s on a number of cars and motor bicycles located about 30ft from the base of an ordinary H aerial elevated to a total height of 40ft on the front of a 20ft high building. These showed an E.I.V. of 30 to 100mV , apart from a few cases where the level was as low as 10mV . For full information upon levels of interference and upon the improvement obtained by resistance suppressors, the papers by Nethercot³ and Pressey⁴ should be consulted: their figures for field agree reasonably with the E.I.V. quoted above.

The maximum output of the thyatron generator at 45Mc/s was set at an E.I.V. of 200mV : the output of the spark plug generator was rather dependent upon the type of spark, and the maximum varied from about 200mV with single spark and minimum gap up to about 1V with multiple spark and maximum gap. The effect of these adjustments on E.I.V. would, of course, have been con-

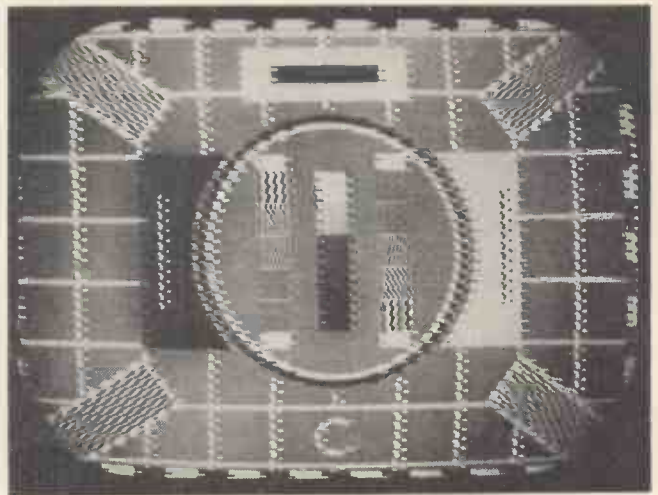
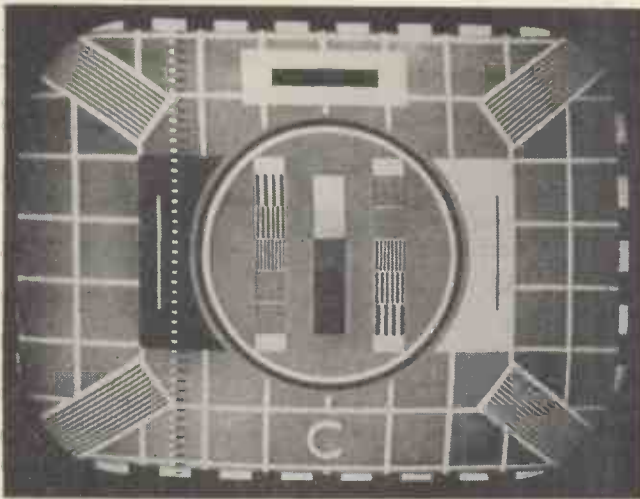

Effect of interference from the thyatron generator on a T.V. set displaying test card C.

In the left-hand picture, the interference pulses occur in the middle of the lines, and have no effect on the synchronizing. In the right-hand picture, the pulses are adjusted to coincide with the start of the synchronizing pulses, and the line following each is displaced. Note that interference pulses can be spaced further apart if required.

siderably greater if measured on a narrow band receiver, owing to the integration of the multiple sparks which would here occur.

Although both the generators were originally designed to simulate ignition interference, they can be used to investigate the effects of the other common type of impulsive interference, which originates in sparking at contacts in electrical machines. The same need arises here for a generator which is more stable in operation than say, an electric motor, the interference from which depends critically upon the state of the commutator: such motors usually produce a large number of pulses per frame of a television picture, and so the closest simulation will be obtained from the spark

generator with gap adjusted to near the minimum usable.

Acknowledgments

The author would like to acknowledge the work of Mr. J. Killick and Mr. S. Matthews on the construction and testing of the generators described, and to thank Messrs. E. K. Cole, Ltd., for permission to publish the results of work done in their laboratories.

REFERENCES

1. EAGLESFIELD, C. C. Motor Car Ignition Interference. *Wireless Eng.* 23, 265 (1946).
2. CALLENDAR. Television Set Testing. *Wireless World.* 58, 42 (1952).
3. NETHERCOT. Ignition Interference. *Wireless World.* 53, 352 & 463 (1947). (Summarizes results from various papers.)
4. PRESSEY, B. G., ASHWELL, G. E. Radiation from Car Ignition Systems. *Wireless Engineer.* 26, 31 (1949).

Measuring the Accuracy of Magnetic Delay Units

By G. Jamieson*

A description is given of a Time Interval Marker (a unit which provides trains of accurately spaced negative pulses), and its use in estimating the accuracy of time delays obtainable with a recording system.

THE recording of speech and music by magnetic methods has now become firmly established, and most modern recorders are capable of reproducing the original information so that amplitude and phase variations due to changes in recording and playback speeds are not apparent to a critical ear. With the increasing use of these devices in many laboratory applications, and as storage units in computers and other electronic apparatus, however, it has become necessary in many cases to assess the accuracy with which a nominal time delay period can be maintained, and to measure and compare the performance of various types of machine with an independent

accurate standard and so provide a quantitative estimation of merit.

The following technique was used for this purpose, and proved to be quite adequate to supply the required information.

The following facilities were available from a time interval marker which was developed with a view to its use in this and other similar applications:

- (a) Trains of negative pulses at 1msec, 10msec and 100msec intervals, each locked in phase with a standard 1kc/s sine wave input, and available independently at variable amplitude.
- (b) A common output which provided any combination

* Royal Naval Scientific Service.

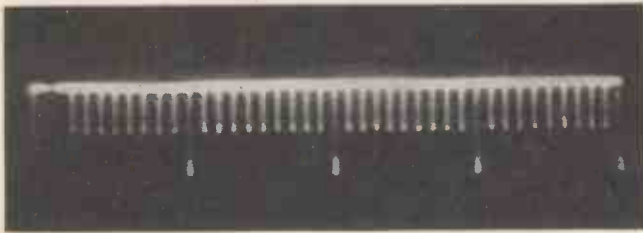

Fig. 1. Ruler display, 1msec intervals with larger pulse every 10msec

of these pulse trains, which when fed to a C.R.O. can form a "ruler" type display calibrated in time (as in Fig. 1).

- (c) 10msec and 100msec time-bases which were locked to the ruler pulses, i.e., the time-base was triggered simultaneously with the respective pulse appearing at the output terminals.

A double beam display of the external time-base was provided.

Method of Measurement

The ruler type display was shown on one beam of the C.R.O. and the appropriate negative pulses fed to the recording unit, these being played back and displayed on the other beam after a time interval of $Tn + t$, where T is

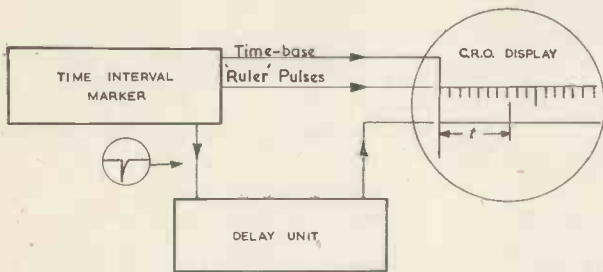

Fig. 2. Schematic layout

the time-base period, n an integer and t the time represented by the distance of the pulse from the start of the time-base (see Fig. 2).

The departure from the nominal delay period was shown by relative movement of the delayed pulses against the calibrated background.

Using the 100msec time-base calibrated at 1msec intervals (every tenth pulse being of greater amplitude) and feeding the 100msec negative pulses to the delay unit, errors of the order of 0.5msec can be detected.

Further accuracy was gained by using the 10msec time-base calibrated at 1msec intervals, and feeding the 10msec pulses to the recorder, when errors in the region of 0.1msec can be easily detected. (This is not strictly 10 times more accurate than the previous method as resolution is lost due to the lack of sub-divisions).

Measurement of recorder accuracy in this way readily shows up both the relatively rapid fluctuations of delay time (due to tape flutter, changes in friction, etc.), and the effects of slow drift or periodic changes in the speed of the driving motor.

Permanent records of results are somewhat difficult to obtain due to the difference in intensities of the time-base line and the sharp negative pulses. This was to some extent compensated for by applying the 1msec pulses to the beam trigger of the C.R.O. so

that in effect, the pulses were made to brighten themselves.

Typical Results

Errors in a number of recorders of both drum and tape types were checked, and accuracies varied from ± 0.5 msec in the worst case, to ± 0.1 msec. The photographs shown in Fig. 3 are two of a number taken at random intervals and actually show the error to be between 0.1 and 0.2msec. (In this case the error was estimated to be ± 0.1 msec, which appeared to be about the optimum which could be expected using conventional drive motors). The total delay time was approximately 300msec. While it must be admitted that only a few specific units were tested, it seemed that the same order of accuracy could be attained with both types, if comparable drive units and workmanship are used.

Time Interval Marker

No originality is claimed for this unit, as quite usual circuits are used. Such a unit was suggested¹ in 1948.

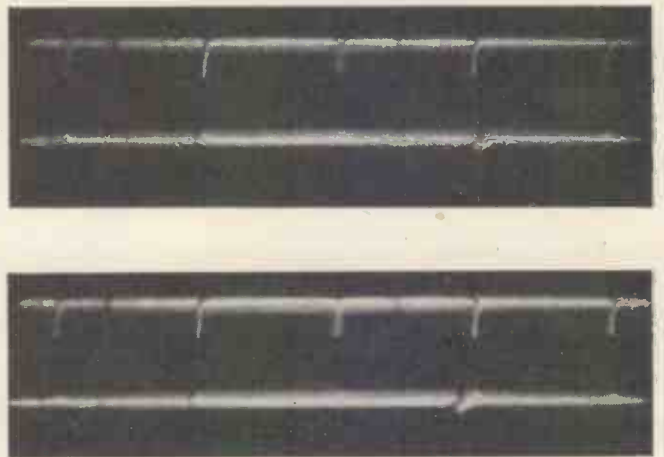

Fig. 3. Delayed pulse shown against 10msec time-base, calibrated at 1msec intervals

However, as it has proved to be extremely useful in the laboratory, and provides an alternative method of counting down to that described by McAuslan², it is felt that a description would be welcomed.

A block schematic of the instrument is shown in Fig. 4 and a circuit diagram in Fig. 5.

A standard 1kc/s sine wave input is squared, differentiated and rectified to give a train of negative pulses at 1msec intervals which are "counted down" by two Sanatron circuits in cascade, each dividing by ten. The three outputs, i.e., 1msec, 10msec and 100msec trains of pulses, are made available independently via cathode-followers.

Provision is also made to combine the three outputs in a resistive network to provide a ruler display.

The use of the Sanatron run-down waveforms to provide external time-bases ensures a perfectly stable display.

Fig. 4. Arrangement of the time interval marker

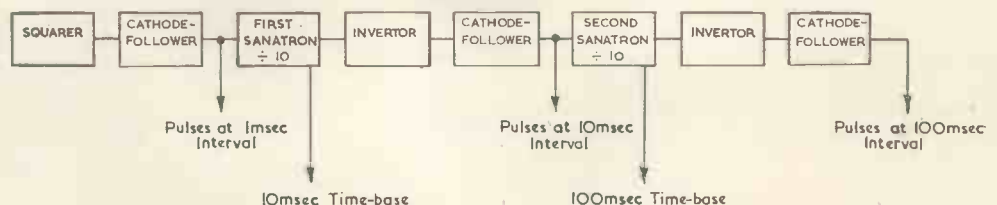

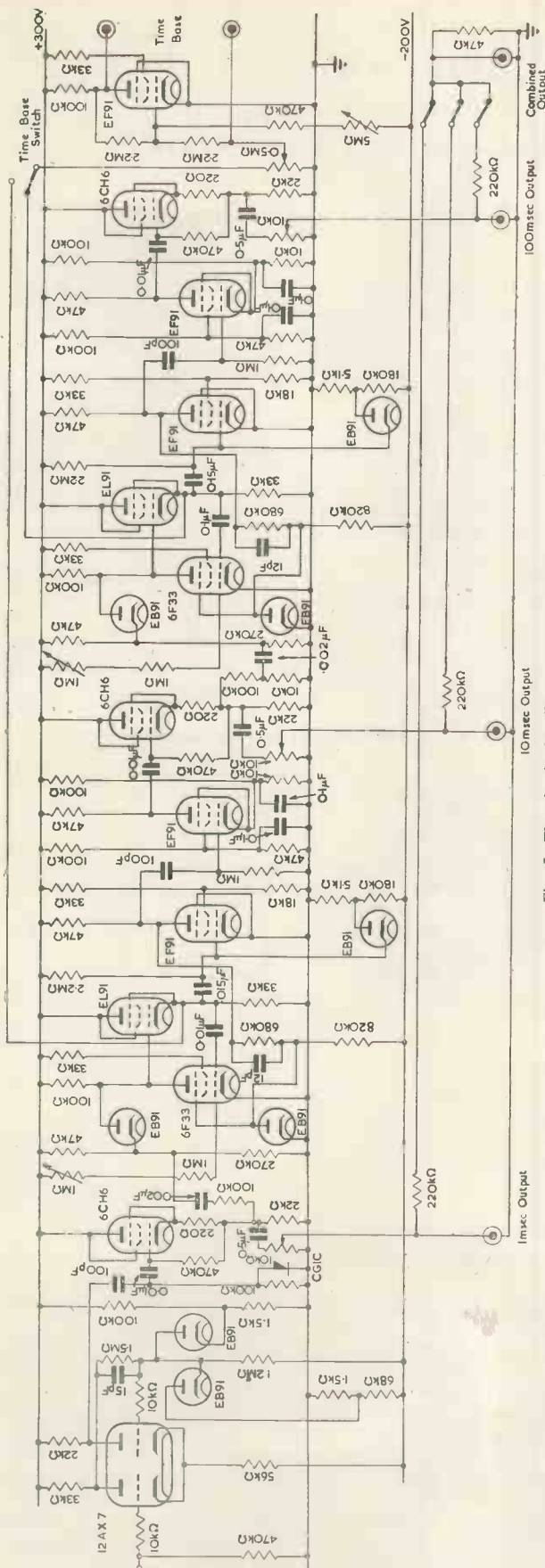
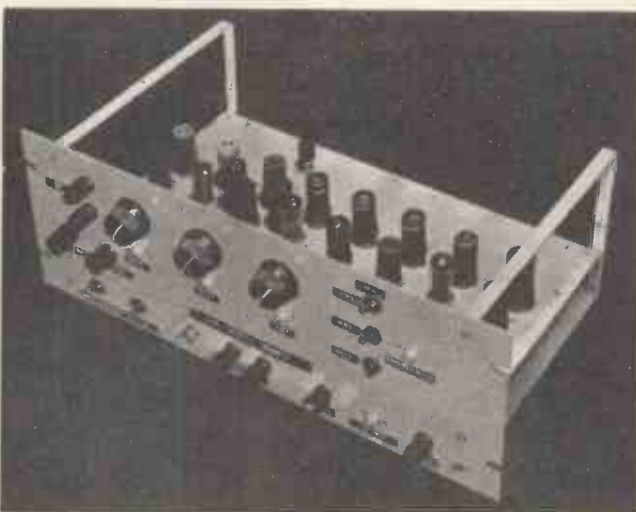

Fig. 5. The circuit described



The complete instrument.

The squaring of the standard 1kc/s sine wave is carried out by a bistable multivibrator (Schmitt trigger) circuit. The square wave (of 1msec period) from the second anode is differentiated, rectified and fed via a cathode-follower to the 1msec output potentiometer, and to the triggering injection diode of the first Sanatron divider.

The run-down period of the Sanatron plus the flyback time, is arranged by adjustment of the time-constant of the Miller capacitor and its associated resistor to be between 9 and 10msec. A cathode-follower is included in the Sanatron to give a rapid flyback at the end of the run-down.

The output at the anode of the triggering valve is a positive square wave of period 9.5msec, say. This waveform is differentiated and fed to an inverter biased so that the negative pulses are clipped and the positive pulses converted to negative. (The original negative pulses cannot be used as they should be out of phase with the ruler, i.e. they should occur about midway between the ninth and tenth millisecond pulse if the count is to be stable.)

The inverter output is fed via a cathode-follower to the 10msec output potentiometer and to the triggering injection diode of the second Sanatron.

The action of this second Sanatron is the same as the first, but the run-down time-constant is altered to give a run-down of nearly 100msec. Again the square wave from the anode of the triggering valve is differentiated, inverted and clipped, and fed via a cathode-follower to the 100msec output potentiometer.

A common output terminal is provided to which any combination of the three outputs can be switched, giving the ruler display.

The waveforms from the Sanatron cathode-followers can be switched via a see-saw circuit to connect with external terminals so that synchronized time-bases (10msec and 100msec) are available.

Acknowledgments

The work described in this article was done at H.M. Underwater Detection Establishment and the author wishes to thank Mr. J. W. R. Griffiths for help and advice, and the Admiralty for permission to publish.

REFERENCES

1. BRIGGS, B. H. The Miller Integrator. *Electronic Engng.* 20, 243 (1948).
2. MCAUSLAN, J. H. L. A Dekatron C.R.O. Time Marker. *Electronic Engng.* 24, 567 (1952).

Impedance-Frequency Variations of Glow-Discharge Voltage-Regulator Tubes

By F. A. Benson*, M.Eng., Ph.D., A.M.I.E.E., M.I.R.E. and G. Mayo*, B.Eng.

Measurements have been made to determine the variation of impedance with frequency of four types of tube over the range 20c/s to 10kc/s. The tube impedance has been shown to consist of resistive and reactive components, the reactance being inductive. The impedance and resistance of a given tube increase considerably with frequency. The inductance-frequency curve of a tube shows a pronounced maximum in the region of 100c/s.

It has been pointed out by several investigators^{1,2,3} that the A.C. impedance of a glow-discharge voltage-regulator tube at high frequencies is considerably greater than the value which is quoted in data sheets for low frequencies. Andrew¹ has drawn attention to this fact and mentions a few interesting experiments on 7475 and 85A1 tubes over the frequency range 50 to 20 000c/s. He states that it would be useful to have information about the nature of the impedance, which he thinks may well be complex. A graph has been given by Benson² showing that the impedance of Stabilivolts increases with frequency, but the upper frequency limit of the graph is only 6kc/s. Hunt³ has published an interesting article on some of the limitations of voltage stabilizers. He explains that although a glow-discharge tube is usually assumed to be equivalent to a constant voltage in series with a resistor, in actual fact, due to ion-inertia effects in the gas, there is a quadrature component in the valve current when an alternating voltage is applied. The equivalent circuit then approximately consists of a constant-voltage device in series with a resistor and inductor. Some typical resistance-frequency and inductance-frequency characteristics of a particular type of tube have also been given and briefly commented on by Hunt.

The authors have investigated in detail the variations of impedance with frequency of a number of glow-discharge tubes of both the high-stability and normal types. The nature of the impedance has also been determined in each case. Both new tubes and tubes which are undergoing life tests have been examined. The purpose of this article is to present the results of the work.

Measurements

The impedance of each tube was first measured over the frequency range 20c/s to 10kc/s. The circuit used is shown in Fig. 1 and is fundamentally similar to that employed by Andrew¹ for his investigations. An audio-frequency oscillator (A.F.O.) supplies a voltage across a non-inductive resistor R_1 and the glow-discharge tube under test. R_1 , which has a value of 4k Ω , provides a load for the oscillator and also a means of measuring the A.C. through the

tube by reading the voltage developed across it (V_1) with a valve-voltmeter VV_1 . It was decided to make the dropping resistor R_2 of large value (65k Ω) and to use a fairly high D.C. supply voltage so that the shunting effect of R_2 across the tube could be neglected.

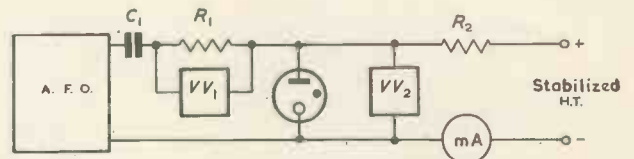

Fig. 1. Circuit used for impedance measurements

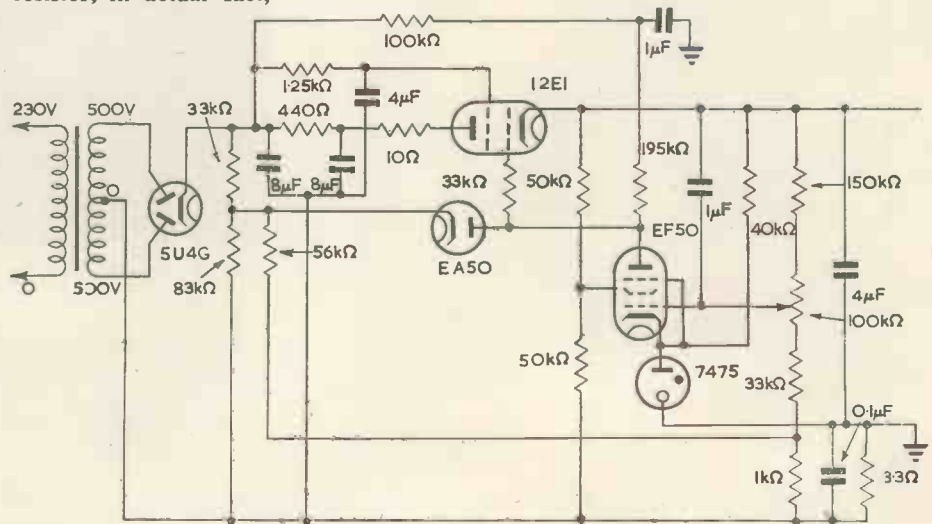

Fig. 2. 300 volt stabilized supply

An electronically-stabilized power supply was used to provide the D.C. voltage. The D.C. through the tube could be maintained constant at any particular value by means of an output-voltage control on the power-supply unit. The stabilized power supply has some interesting features and the circuit of it has, therefore, been included because it may be found useful for other applications. It is shown in Fig. 2. The design follows fairly closely the conventional arrangements with additional correcting devices except that the anode load resistor of the amplifier valve has not been taken to the stabilized supply for reasons given previously by one of the authors⁴. The supply could be improved by making some slight modifications so as to

* University of Sheffield.

use a high-stability reference glow-discharge tube instead of the 7475 type.

The A.C. voltage (V_2) across the tube under test was measured with a valve millivoltmeter VV_2 . (Fig. 1.)

A number of 85A1 tubes were first examined. Preliminary tests with a D.C. of 5mA and an audio frequency of 50c/s showed that by increasing the output voltage from the audio oscillator a voltage of up to 1 volt could be maintained across the tube. Increasing the oscillator output voltage further resulted in instability and a high voltage across the tube. This was caused by the tube extinguishing on negative-voltage peaks.

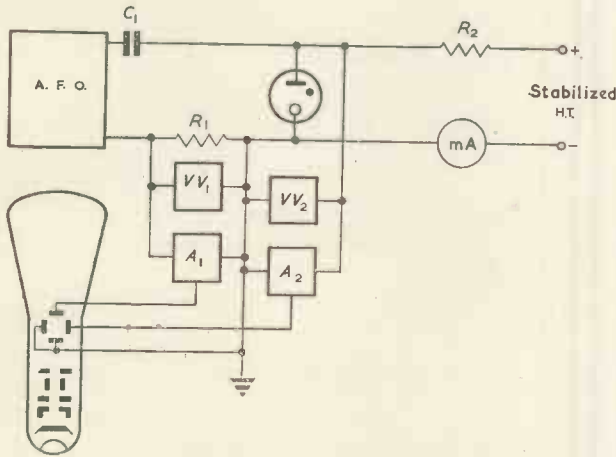

Fig. 3. Circuit used for phase-angle measurements

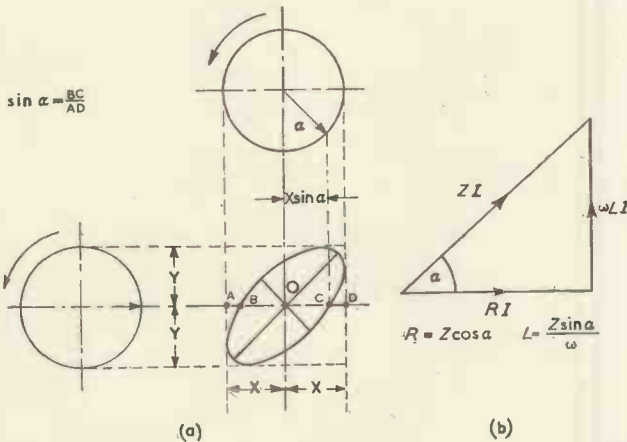

Fig. 4. Determination of phase-angle α , then the values of R and L

Readings of VV_1 and VV_2 (i.e. V_1 and V_2) were taken over the stated frequency range with a constant voltage of 0.5V across the tube, this being chosen because it gave a reasonable swing about the D.C. operating point without deionization on negative half cycles.

The impedance Z of each tube could easily be calculated from the readings as follows:

$$\text{The A.C. through the tube is } I = V_1/R_1.$$

$$\text{Hence } Z = V_2/I = V_2 \cdot R_1/V_1.$$

$$\text{In the particular case above } V_2 = 0.5V \text{ and } R_1 = 4k\Omega.$$

$$\therefore Z = 2000/V_1$$

Several 85A2 and 7475 tubes were then examined with the direct current through each tube at 5mA and finally

some 5130 tubes were tested at a direct current of 50mA.

Having obtained figures for the variation of impedance of several types of tube it was desired to find the resistive and reactive components of the impedances.

A suitable way of doing this is to measure the phase-angle existing between voltages V_1 and V_2 . This could be done by connecting the two voltages to a cathode-ray oscillograph, the resulting ellipse traced out on the screen giving a measure of the phase-angle^{5,6}. The oscillograph was first connected to the circuit of Fig. 1, but after some initial tests it was found more convenient to connect R_1 in the cathode lead of the glow-discharge tube so that the "common" connexion of the oscillograph could be earthed. Fig. 3 shows the circuit used. Trouble was first experienced due to relative phase shifts in the two amplifiers of the oscillograph. This was overcome by using similar amplifiers from two identical oscillographs and then using the X and Y plates of one of the oscillographs. Zero phase shift was then obtained at all frequencies.

Since ellipses were traced out on the screen of the oscillograph the tubes were known to have a reactive component. At high frequencies the tubes were very reactive. The phase-angle α between V_1 and V_2 , in each case, was calculated from the expression given on Fig. 4(a). Knowing α the reactance and resistance of each tube could be found from the impedance measurements as shown in Fig. 4(b).

The phase-angle measurements do not give an indication as to the nature of the reactance. In order to establish that the reactance was inductive and not capacitive, the effect of placing a capacitor in parallel with a tube was noted. Using a small capacitor (of capacitance 0.05 μ F) across the tube the original ellipse could be brought to a straight line at some frequency. This shows that the reactance of the capacitor must be of opposite sign to that of the regulator tube, i.e. the latter is inductive.

Results

Impedance-frequency curves for several tubes of the four types examined are shown in Figs. 5, 6, 7 and 8. Because of the large number of readings taken, only the limiting curves have been drawn for each type to avoid confusion. These curves show quite clearly the variations in the characteristics from tube to tube of the same type. The mean impedance-frequency curves have been plotted on Fig. 9 for easy comparison of the four types of tube. Typical inductance-frequency and resistance-frequency curves for the four types of tube are plotted on Figs. 10, 11, 12 and 13.

Oscillograms were taken of some of the ellipses and other phenomena observed on the cathode-ray oscillograph and these are shown in Figs. 14-19.

Discussion of Results

It is seen from Figs. 5-9 that the impedance of a glow-discharge tube increases with frequency. The increase of impedance is almost linear with frequency (the graphs are plotted with a log-frequency base). There are considerable variations in the impedance curves from tube to tube even of the same design. Such variations might have been anticipated from previous work on other tube characteristics⁷. The 85A1 and 85A2 tubes have fairly similar characteristics as would be expected in view of the similar manufacturing techniques which they employ. The variations from tube to tube are less for the 85A2 type than the 85A1. Results obtained for several 85A1 tubes which had been operating continuously for over 30 000 hours at a constant current of 5mA and for a number of 85A2 tubes which had been operating continuously for over 20 000 hours at the same current show that life does not noticeably affect the impedance-frequency curves. Work has not been carried out on the

7475 and S130 tubes after life test. It seems safe to assume however, from previous work on these tubes⁷ that their impedance-frequency curves will vary very greatly with life. This is so because the normal running-voltage/current curves of these tubes have been found⁷ to change rapidly both in magnitude and shape during continuous operation.

Out of twenty S130 tubes tested, few were capable of giving reliable results. Most tubes exhibited severe negative-resistance portions in their characteristics. In view of this only six tubes which gave fair performance were examined. With this type it was found impossible to develop more than about 0.1V across some tubes at low

increase being again almost linear with frequency, and at a given frequency the S130 tubes have much smaller resistances than the other types tested.

It has already been stated that on placing a small capacitor in parallel with the stabilizer tube the phase-angle

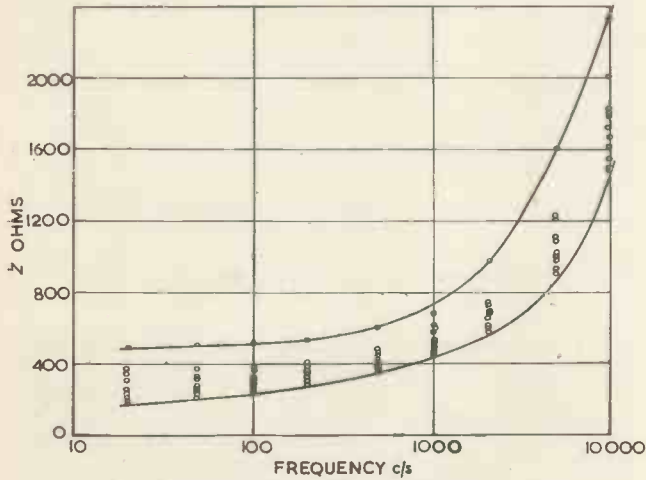

Fig. 5. 85A1, impedance of ten tubes

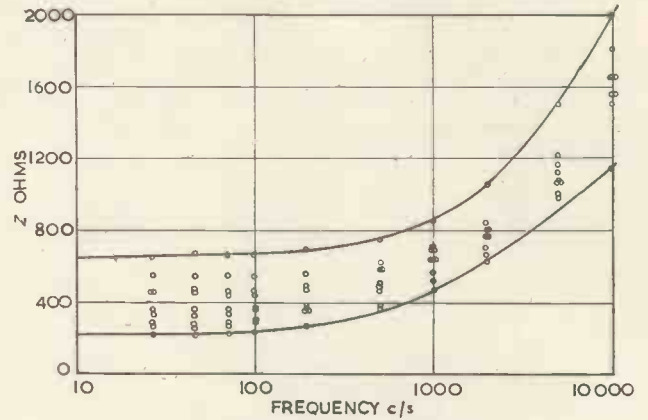

Fig. 7. 7475, impedance of ten tubes

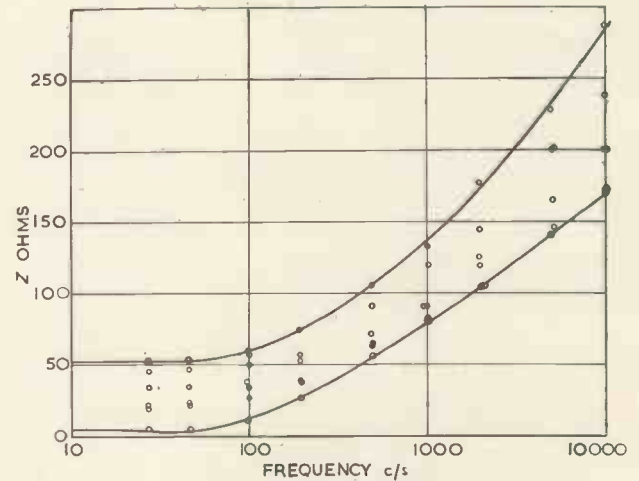

Fig. 8. S130, impedance of six tubes

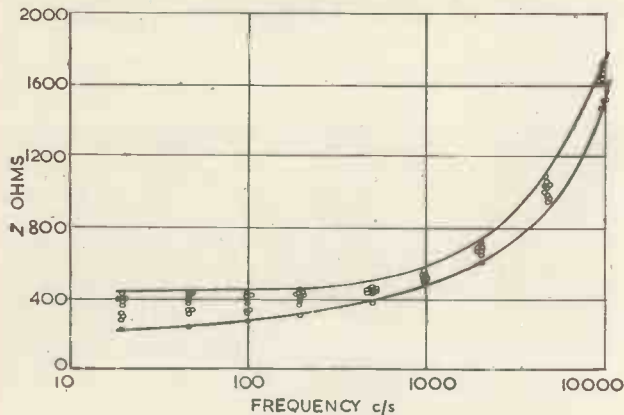

Fig. 6. 85A2, impedance of ten tubes

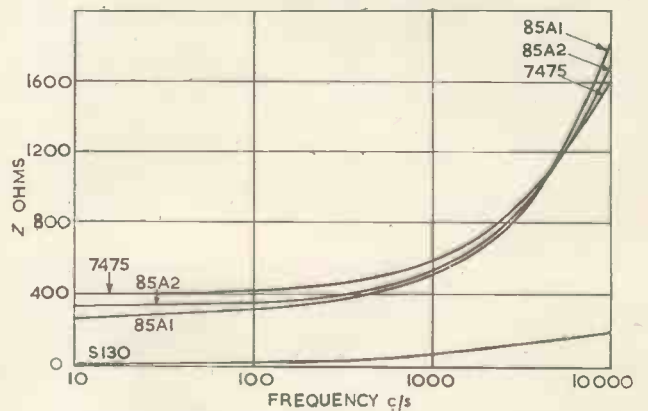

Fig. 9. 85A1, 85A2, 7475 and S130 impedance curves mean values

frequencies due to their very low impedance. It can be seen from Fig. 8 that the impedances in some cases are only a few ohms, although one tube has a value of about 50 ohms at low frequencies.

Figs. 10, 11, 12 and 13 show that the inductance-frequency and resistance-frequency curves for the four types of tube are of the same general forms. The value of the inductance of all tubes seems to be of the same order and all the inductance-frequency curves have a maximum value in the region of 100c/s. The inductance may be attributed to the effects of ion inertia. The fact that the inductance is a maximum at a particular frequency seems to indicate that a mechanical resonance of the ions occurs at this frequency. The points on the inductance-frequency curves at the lower frequencies are slightly scattered, the reason being that where the phase-angle is small the errors become larger due to the dimensions of the ellipse⁵.

The tube resistance increases with frequency, the

ellipse could be brought to a straight line at some frequency. The condition for a parallel LC circuit to act as a pure resistance is that the frequency f should equal

$$\frac{1}{2\pi} \sqrt{\left(\frac{L - CR^2}{L^2C} \right)}$$

A check was, therefore, possible on the measurements. Values of L and R obtained by experiment, together with the value of C used, were substituted in the above expression. This gave a calculated value of f which could be compared with the frequency at which the phase-angle ellipse was converted to a straight line.

A capacitor placed across the tube may be advantageous in removing the inductive effects at 50-100c/s and reduc-

applied A.C. voltage, i.e. a large current swing about the mean D.C. (2-8mA approx.) This trace represents dynamically the characteristic of the tube over its operating range. There is a variation of impedance over the current range shown by the changing slope of the curve. The high-stability types give traces which are very much straighter

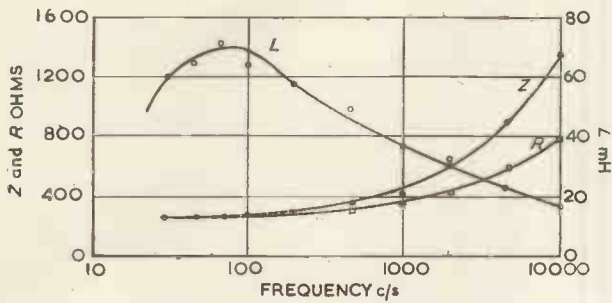

Fig. 10. 85A1, impedance, resistance and inductance

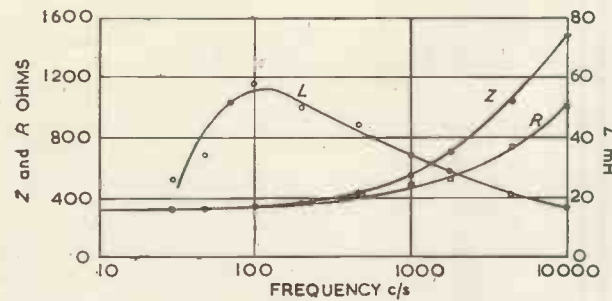

Fig. 11. 85A2, impedance, resistance and inductance

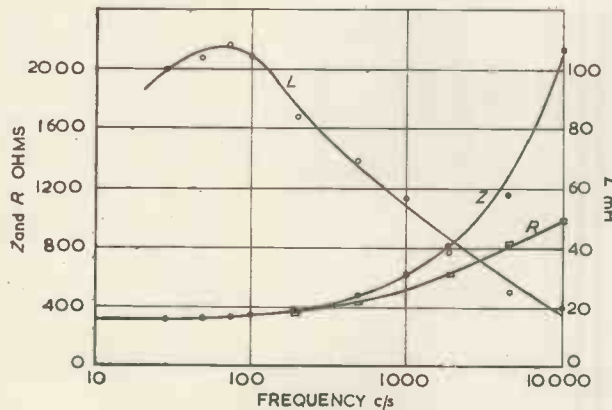

Fig. 12. 7475, impedance, resistance and inductance

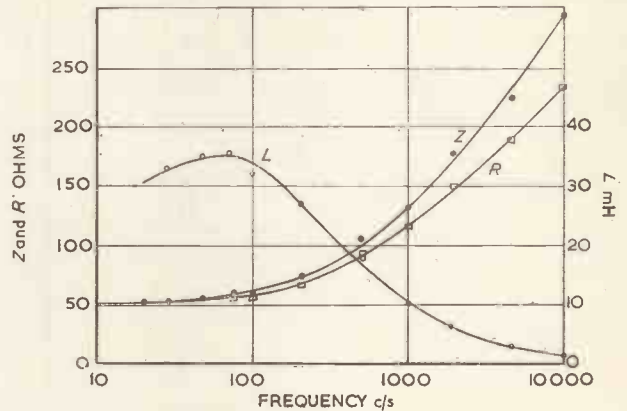

Fig. 13. S130, impedance, resistance and inductance

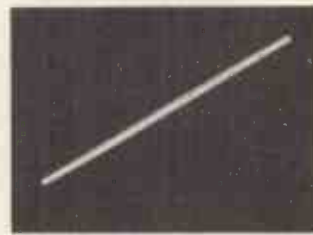

Fig. 14. 85A2, 20c/s, 5mA, D.C.

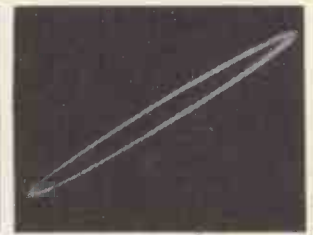

Fig. 15. 85A2, 200c/s, 5mA, D.C.



Fig. 16. 85A2, 2000c/s, 5mA, D.C.



Fig. 17. 7475, 20c/s, 5mA, D.C. (Large current swing)

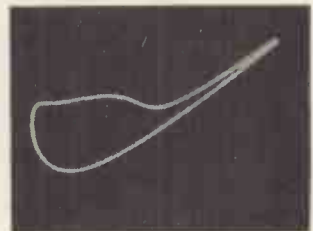

Fig. 18. 85A1, 20c/s 3mA, D.C.

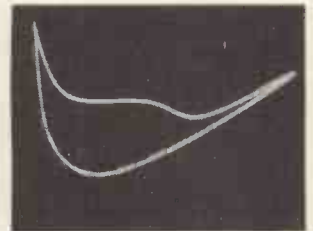

Fig. 19. 85A1, 20c/s 3mA, D.C.

ing ripple voltages in the output. A large capacitor (greater than $1\mu\text{F}$) often causes relaxation oscillations which may be due to the inductance of the tube, together with possible negative-resistance portions in the characteristic. However, a value of $0.1\mu\text{F}$ has been found a satisfactory value to use⁹. This should suppress any tendency for the tube to oscillate.

Figs. 14, 15 and 16 show the ellipses obtained with an 85A2 tube at 20, 200 and 2000c/s respectively. These are also typical of the other types of tube investigated. The increase in reactance with frequency can be readily interpreted.

Fig. 17 shows a 7475 tube at 20c/s with a rather large

over a similar range, except in the region of 2mA where a loop is visible due to hysteresis effects. Figs. 18 and 19 show this effect with the 85A1 tube over a current range 2-5mA approx., Fig. 19 being over a slightly larger range. A further increase would cause the tube to become extinguished in the region of 1mA.

The S130 tubes showed ellipses similar to the other types, but in many cases pronounced oscillation and instability took place. In troublesome cases the tubes were rejected as it would be impossible to interpret fully the results obtained. Changes in the shape of the ellipses were accompanied by changes in the area of cathode glow.

Other investigators^{8,9} have obtained similar results to the above at the lower frequencies, but no mention of inductive effects and no measurements beyond 120c/s have been made. Kiryluk⁸ suggests a circuit for selection of optimum operating conditions for reference tubes. His experiments were made at 50c/s where the effects of inductance begin, and although hysteresis may be present in the static characteristic the effects attributed to this effect may be partly due to inductance at 50c/s. A better frequency for observation of the dynamic characteristic is 15-20c/s where the reactance is greatly reduced due to lower inductance and the lower frequency. The method does give a good indication of the static characteristic and enables the best operating range to be selected for a given tube very quickly.

Acknowledgments

The work recorded in this article has been carried out in the Department of Electrical Engineering at the University of Sheffield. The authors wish to thank Mr. O. I. Butler, M.Sc., M.I.E.E., A.M.I.Mech.E., for facilities afforded in the laboratories of this department. They also wish to acknowledge the kindness of Mullard Ltd, in supplying some of the tubes for examination.

REFERENCES

1. ANDREW, A. M. The Design of Series-Parallel Voltage Stabilizers. *Electronic Engng.* 24, 385 (1952).
2. BENSON, F. A. Voltage Stabilizers. (Electronic Engineering Monograph, 1950).
3. HUNT, J. E. P. Some Limitations in Voltage Stabilizers. *Instn. Elect. Engrs. Stud. Quart. J.* 23, 12 (1952).
4. BENSON, F. A. The Design of Series-Parallel Voltage Stabilizers. *Electronic Engng.* 24, 118 (1952).
5. BENSON, F. A., CARTER, A. O. Phase-Angle Measurements Using a Cathode-Ray Tube. *Electronic Engng.* 22, 238 (1950).
6. BENSON, F. A., SEAMAN, M. S. A Note on Phase-Angle Measurements Using a Cathode-Ray Tube. *Electronic Engng.* 25, 100 (1953).
7. BENSON, F. A. A Study of the Characteristics of Glow-Discharge Voltage-Regulator Tubes. *Electronic Engng.* 24, 396 and 456 (1952).
8. KIRYLUK, W. Voltage-Regulator Tubes (Letter). *Electronic Engng.* 25, 83 (1953).
9. ELMORE, W. C., SANDS, M. *Electronics*, p. 369 (McGraw Hill, 1949).

Desk Audiometer for Research Work

Providing Pure Tone and Speech Tests

The large desk audiometer illustrated has recently been installed in the Otological Department of the Queen Elizabeth Hospital, Birmingham, where it is to be used for research work carried out under the direction of Mr. Norman Crabtree, F.R.C.S. It has been designed and built by Alfred Peters & Sons, Ltd., Sheffield.

This audiometer is intended for carrying out hearing measurements with pure tones, and speech in either a free field or with ear-phones. For free field work the patient is in one silent room, with the operator and the instrument in another. The operator views the patient through a sound-proof window, and the patient's answers are obtained by means of a talk back circuit.

The facilities offered by the instrument are very extensive and it has been designed to be as flexible as possible.

There are two entirely independent pure tone channels, each providing pure tones from 0 to 12 000c/s, and each with its own attenuator and interrupter. The control panels for these are on either side of the central output selector panel.

There is a built-in tape recorder and three-speed record player, with which recorded speech tests may be carried out, as well as live voice speech tests using the microphone circuit. Both the microphone and recorder circuits each

have their own continuously variable attenuator and their own five position tone control and output meter.

The panel on the extreme left is the automatic interrupter and masking control panel. Provision is made for automatic complete interruption of the pure tone notes or the masking notes at any desired rate, and both intensity

and frequency modulation of the pure tone notes can be obtained. The noises which are used for masking a good ear when the deafer ear is under test are several in number and include white noise (thermal agitation). The masking noises have their own separate continuously variable attenuator.

There is a 2½ in cathode-ray tube incorporated in each pure tone channel for monitoring purposes, as well as an output meter. On pressing a button, the two pure tone channels can be exactly synchronized in frequency on one

cathode-ray tube. A small row of buttons at the bottom of the central panel select sentences of instruction which light up a glass screen in front of the patient.

There are in all five separate continuously variable attenuators in this instrument of a new design which are also used in the standard audiometer made by Alfred Peters & Sons, Ltd. This is to be described in detail in a later issue.

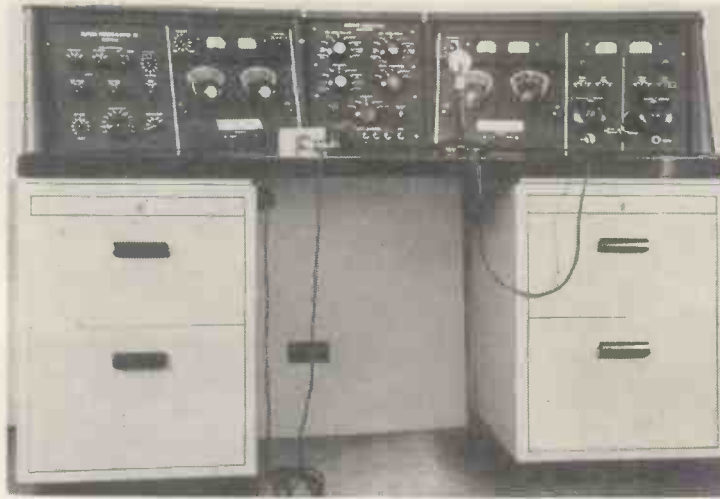

The desk audiometer.

A High-speed Electro-Magnetic Counter

By G. H. Townend*

A description is given of the design and development of an electro-magnetic counter suitable for industrial application. The counter will operate at speeds up to 60 counts per second if fed with pulses of equal on to off times. The power required to operate the counter is of the order of 0.25W. The counter should have a life in excess of 10^8 counts.

AUTOMATIC counting is being used in industry on an increasing scale where a comparatively large number of small articles is produced, and this laboratory has been concerned with the development of counting methods for a number of years.

It is often convenient to use a detector which produces an electrical signal corresponding to each product to be counted; this signal operates an electromagnetic counting register.

It was felt that there was no electromagnetic register available which was well suited for this application, and it was therefore decided to develop one. This instrument possibly has a much wider application, and it is now being manufactured by Hall Telephone Accessories.

Design Aims

The design aims in developing the counter were as follows:—

- (a) Great reliability. Industrial counters may be used for bonus schemes, etc., and unless reliable would not be acceptable.
- (b) Long life. An industrial process working at one per second will make in a year's single shift working about seven million parts. Certain screw-making machinery for example may produce up to about ten products per second. It was decided to aim at a life of at least one hundred million without any servicing.
- (c) Suitable for industrial conditions. This means that it should be robust and completely sealed so that it can operate in dirty and dusty atmospheres.
- (d) The counter should have a six figure digital registration.
- (e) The operating power should be low; in order to keep the circuit associated with the counter simple.
- (f) The counter should operate accurately when subjected to overload, so that voltage variations, component tolerances, etc., are unimportant. Ideally the maximum power input to the counter should only be limited to its ability to dissipate the heat.
- (g) The cost should be low.
- (h) A high counting speed is desirable. Although industrial counting speeds are unlikely to exceed about ten

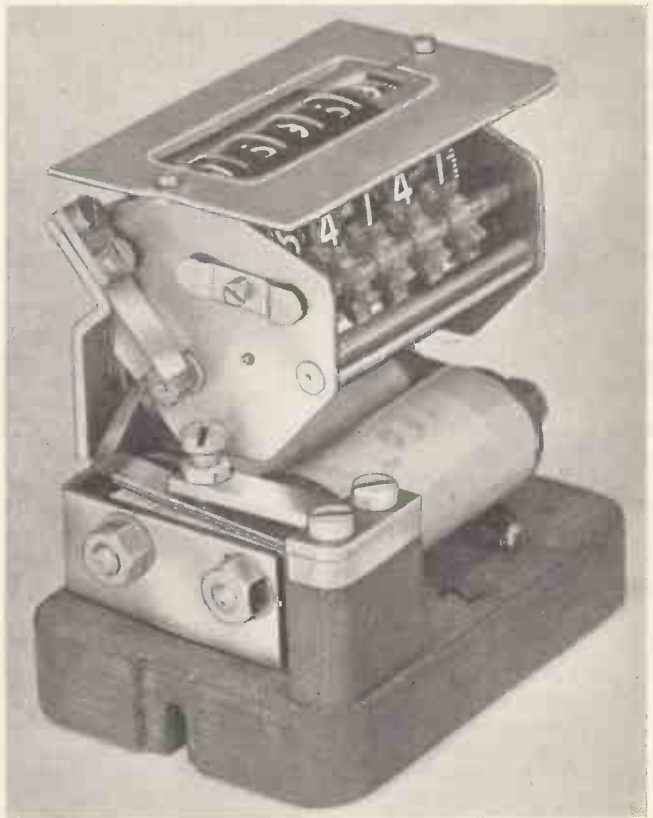

A prototype of the counter

per second the impulse from the detector may only last a small fraction of the operating cycle. A counting rate of 50 per second with equal on to off times should cover all requirements.

It has been the author's experience that many of the failures on existing counters are due to the reset mechanism. It was therefore decided to develop a non-resettable counter.

General Design Considerations

The above design specification implies a very simple device. The approach has been to choose the simplest scheme and design it to meet the specification. It will be assumed from the start therefore that the counter consists of an electromagnet attracting an armature which operates a pawl and ratchet mechanism connected to the counting train. The armature return stroke is spring operated. A fixed pawl prevents the ratchet from rotating backwards.

DRIVE MECHANISMS.

There are three possible ways of driving such a mechanism:—

- (1) Drive the ratchet on the forward stroke of the armature.
- (2) Drive the ratchet on the backward stroke of the armature.
- (3) Drive the ratchet on the forward and backward strokes.

In the third type of drive the required armature motion for a given rotation of the ratchet is halved compared with types (1) and (2). As this decreases the air-gap in the magnetic circuit and so decreases the electrical power required to operate, it looks attractive. However the attractive force on the armature is dependent on the current in the electromagnet and consequently if the current varies, the speed of

* G.K.N. Group Research Laboratory.

motion of the armature varies. If the forward motion of the armature operates the ratchet then excessive speed may be built up in the counting train which will cause over-counting as there is no positive stop to forward motion of the wheels. It is therefore better to operate on the spring return motion of the armature. Here the motion is always constant and provided the fixed pawl in operating dissipates at least half the energy stored in the main armature return spring over-counting cannot occur.

Various attempts were made to make the forward motion of armature substantially independent of the current by having a saturating armature. No success was obtained.

COUNTER TRAIN

Assuming the counter train to be of the usual type, that is a series of wheels numbered 0-9 connected by intermittent gearing, then to register a count of one, the digit wheel is normally indexed through 1/10th revolution. However, in the case of all the counting wheels being set on 9 it is necessary to index all the wheels through 1/10th revolution to register a count of one.

In designing the counter it is necessary therefore to cater for indexing all wheels through one count in the time allowed by the highest counting speed required.

Assume n wheels of inertia I have to be moved through an angle θ in time t . Assuming the type of motion remains constant, e.g., simple harmonic, the maximum K.E. of the wheels will be proportional to $nI \theta^2/t^2$. The energy to be stored in the return spring will also be proportional to $nI \theta^2/t^2$ if the only important inertia is that of the counting wheels. I is determined by practical consideration such as the diameter of wheel which will give readable figures, and the minimum thickness of material which can be used; t is determined by the required operating speeds. One way in which θ may be altered is to subdivide the digits wheel and rotate it only 1/100th revolution per count. The energy which must be stored in the spring is then reduced by a factor of 100, and so the electrical power to operate the counter is reduced by approximately the same factor. As only five wheels are required for a six-figure counter the total inertia is reduced by 1/6th. It is by subdivision of the digits wheel that the design specification outlined above has been met.

RATCHET

If the ratchet wheel is connected direct to the counting train either the 100 tooth ratchet wheel required has appreciable inertia or the teeth are uncomfortably small. It is therefore better to use a small ratchet, say ten tooth, and a ten to one gear train.

The inertia of the counting wheel system and of the armature together with the required counting speed determines the strength of the armature return spring. The fixed pawl is designed to dissipate half of the energy of the main spring on each count, thus preventing over-counting. It will be seen later that it is desirable to keep the gap in the magnetic circuit small. A small armature travel and consequently a small operating pawl movement is desirable. This is limited by keeping the ratchet teeth a reasonable size and a 3/16in diameter ten-tooth ratchet has been used. The operating pawl movement is approximately 1/16in.

MAGNETIC CIRCUIT

The above consideration determines the design of the armature return spring. One must now consider what design of magnetic circuit can be used to move the armature against this spring most efficiently, i.e., with the minimum electrical input.

Consider the magnetic circuit in Fig. 1 and assume that all the reluctance is in the air gap.

$$\text{Force on armature} = F = \frac{2A B_g^2}{8\pi}$$

where A = pole area

B_g = flux in gap

$$\text{Total flux round the circuit } \theta = B_g \times A = \frac{4\pi ni A}{g}$$

$$\text{Hence } B_g = \frac{4\pi ni}{g}$$

$$F = \frac{4\pi A n^2 i^2}{g^2}$$

It will be shown later that the D.C. dissipation in the coil is proportional to $n^2 i^2$ so the force per unit dissipation is proportional to A/g^2 .

Therefore for an efficient system the pole area A should be large and the gap small. As the force $\propto 1/g^2$ it will pay to keep the gap small and increase the pawl travel to the required amount by mechanical leverage.

During development a polarized magnetic circuit such as

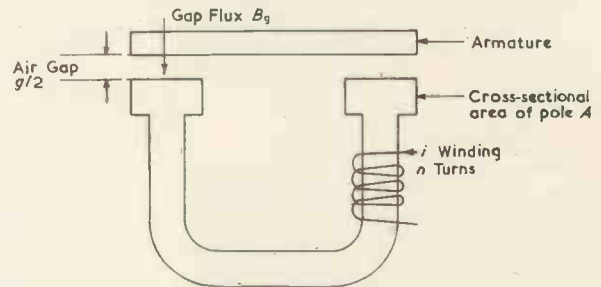

Fig. 1. The magnetic circuit

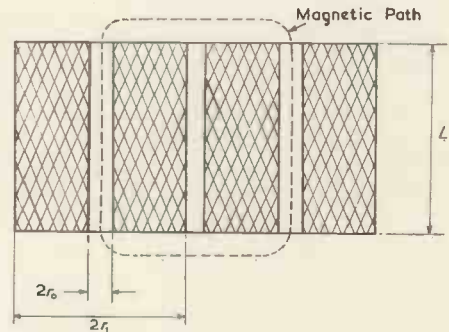

Fig. 2. Diagram of winding

used in the Carpenter relay was tried. Such a magnetic circuit is theoretically more efficient. In practice it is neither very easy to make or adjust.

WINDING

It is now necessary to consider the desirable dimensions for the windings. Assume that the winding is carried on two bobbins inside radius r_0 outside radius r_1 and that the length of the bobbins is l . (Fig. 2.)

If the cross sectional area of the bobbins is $2A$ and n the total number of turns on the winding then assuming perfect winding the cross-sectional area of the wire = A/n

$$\text{Resistance of winding} = \frac{2\pi \left(\frac{r_1 + r_0}{2} \right) n\rho}{A/n}$$

where ρ is the resistivity.

$$\text{Now } A = 2 (r_1 - r_0) l$$

$$\text{Power dissipated} = \frac{\pi (r_1 + r_0) n^2 i^2 \rho}{(r_1 - r_0) 2l}$$

Hence to obtain a given $n^2 i^2$ (and so force) with the minimum resistive dissipation r_0 should be as small as possible and l as large. Since, as already shown, the pole area A should be large it will pay to swell up the magnetic circuit near the armature. The minimum value of r_0 is determined by keeping the reluctance of the yoke small compared with the air-gap reluctance. In practice leakage offsets the advantage of increased length of bobbin over a length to diameter ratio of about four.

MAGNETIC MATERIAL

As the magnetic circuit has a considerable air-gap it would appear at first sight that a particularly soft magnetic material is not necessary. A soft material is however required in order to allow the armature to move away from the pole faces when the operating current is removed and not be held there by the remanent magnetism. A material with a low coercivity is therefore required. Permalloy B was found to be suitable.

Constructional Details

The construction adopted is shown in Fig. 3. The drawing is of the production model, the photograph (page 211) of the prototype. A strip of beryllium copper is sandwiched between two shorter strips of cold rolled silicon iron, which form the armature. The copper strip projecting at one end is clamped to form the main armature return spring and the other end provides the moving pawl. A further strip of beryllium copper forms the fixed pawl. (The pawls must operate at high speed and they must be light if high forces are to be avoided. A flexible strip seems the most satisfactory design). The pawls act on a ten-tooth ratchet made of nylon; the use of nylon for the ratchet increased the life of the counter many times. The pole pieces are shaped as shown to obtain high pole area with magnetic leakage kept to a minimum.

The counting train is one used in a Metropolitan Vickers kW. hr. meter. The wheels are die cast. It is ideally suited to the job and the only alteration required is the addition of a nylon ratchet.

Performance

The performance is briefly as follows:—

- (1) The counter will operate accurately at any speed up to 60 counts per second, if fed with pulses of equal on to off times.
- (2) The current required to operate the counter is that which dissipates $\frac{1}{4}$ watt in the counter coil. The coil can be comfortably wound to about $10k\Omega$ so the safe operating current can be as low as 5mA.
- (3) The life of the counter is in excess of 10^8 counts.
- (4) The counter is unaffected by overload.

Applications

As mentioned earlier the counter probably has wider

Diffraction Gratings in Industry

For some time the National Physical Laboratory has been developing a new method, suggested by Sir Thomas Merton, for making diffraction gratings. Although primarily intended as components of spectrometers for analysing radiation, the "Merton-N.P.L." gratings are finding a very useful application in industry. They can be used for precise measurement of length and the control of machine tools. For these purposes long accurate transparent gratings are needed. By the new process they can be produced quite cheaply.

If two of these gratings are placed one upon the other with their rulings inclined at a small angle, dark lines or fringes are produced. They run at right angles to the rulings, and resemble the moire effect of watered silk. If, now, one of the gratings is kept at rest and the other is moved very slowly in the direc-

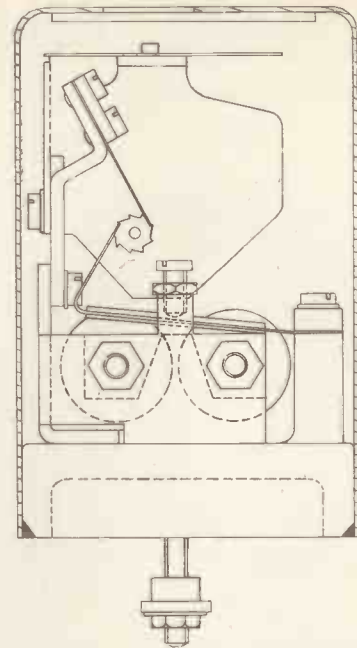

Fig. 3. End view of counter with cover cut away

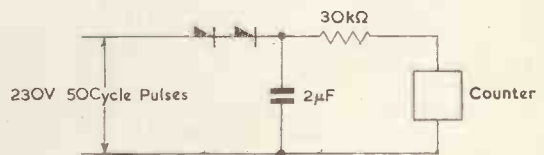

Fig. 4. Circuit for A.C. operation

application than industrial counting. For example by switching a half wave rectified 50c/s supply on to the counter a simple timing device is obtained.

Because of its high speed of response the counter will not count on 50c/s A.C. without a suitable external circuit. It may be required to do so where the main feature required from the counter is its long life, and a circuit for A.C. operation is given in Fig 4. A.C. operation will, of course, be limited to about ten counts per second.

Conclusion

The reader may have guessed by now that the counter came first and the specification later. The specification is no less useful on this account.

tion of the fringes, the fringes are found to move also, but at a greatly magnified rate. The number of them which pass across the field of view can readily be counted by a photocell and electronic counter. This method lends itself to very accurate and rapid measurement, for when gratings ruled with 10 000 grooves per inch are moved in this way the fringe counter will record the movement in ten-thousandths of an inch.

An industrial firm is collaborating with the Light Division of the N.P.L. in applying this method to the control of machine tools, such as jig borers, and are working out a further application of it to the automatic control of machines. When this work is completed it will be possible for elaborate machining operations to be performed from instructions stored in a tape recorder.

The 38th Physical Society Exhibition

A description of selected exhibits from the Physical Society's Exhibition, held at Imperial College, South Kensington from 8 to 13 April.

Airmec

Wave Analyser type 853

THIS wave analyser and selective measuring set operates over the frequency range of 30kc/s to 30Mc/s and will accept an input between 1 μ V and 1V. It consists, essentially, of a frequency-changer followed by a low-pass filter, a precision low-frequency attenuator, an audio amplifier, detector and a meter. In addition to its use as an analyser it is suitable for making measurements of insertion loss, field strength, etc.

The analyser is capable of measuring second harmonics 70db down and higher harmonics 90db down on the fundamental. The accuracy is ± 1 db with the calibration curves supplied and of the order of ± 0.1 db when used with the calibrating oscillator type 858.

Oscillator type 858

This oscillator, which covers the frequency range of 30kc/s to 30Mc/s, is designed primarily as a calibrator for the wave analyser described above and gives alternative fixed levels of output suitable for setting up this unit. It may also be used in any application where a c.w. oscillator with low harmonic distortion and stabilized output level is required.

Airmec Ltd,
High Wycombe,
Bucks.

Baldwin

Electrometer Voltmeter

(Illustrated on right)

THE Baldwin "Hyzee" voltmeter is based on the circuit originated by Farmer¹ and further developed by Brown and Kandiah². This instrument has a high degree of robustness and stability of calibration, is directly calibrated in volts and has B.S.S. 89/1937 first grade accuracy. The circuit is such that the capacitance is less than 12pF while the effective input resistance is approximately 10¹³ Ω . The measuring range is 0.500V in 6 ranges.

1. FARMER, F. T. An Electrometer for Measurement of Voltage on Small Ionization Chambers. *Proc. Phys. Soc.* 54, 435 (1942).
2. BROWN, D. E., KANDIAH, K. A Very High Impedance Valve-voltmeter. *Electronic Engng.* 24, 320 (1952).

Baldwin Instrument Co., Ltd,
Brooklands Works,
Dartford, Kent.

Burndept

Hand and Clothing Monitor, 1319A

THE Neucleonics Division of the Vidor-Burndept Group made their first appearance at the Physical Society Exhibition and showed several pieces of equipment suitable for use in hospitals, research laboratories and industry; included in these was the hand and clothing monitor.

This is a health monitor designed in conjunction with A.E.R.E. Harwell. It is used in centres where radio-active

material can contaminate the hands and clothing of personnel. Before leaving the centre, operatives check their hands by inserting each, in turn, into a port on the front of the instrument. Two large area scintillation counters count the alpha radiation emitted from contamination on the front and back of the hand. The clothing is checked for alpha contamination with a scintillation probe detector attached by a lead to a socket on the front of the instrument and for beta/gamma radiation with a Geiger counter probe. The readings showing the amount of contamination are displayed, in each case, on a meter mounted on the front panel. The meter is marked in terms of "TOLERANCE", to a full scale reading of two tolerances. The tolerance for each type of radiation is that laid down by the Health Physics Division of Harwell. The instrument is contained in a standard 3ft rack.

Burndept Ltd,
Erith, Kent.



Cintel

Incremental Inductance Bridge

THIS bridge is designed for the measurement of iron cored inductors having a Q value of not less than 3. Inductance from 0 to 1000H is measured in seven ranges, the lowest calibrated value being 0.01H. The range of Q measurement is from 3 to infinity and the superimposed D.C. is continuously variable from 0 to 1A. The fixed frequency of the bridge is 50c/s, balance being indicated on a valve-voltmeter to an accuracy of better than ± 5 per cent of full-scale on all ranges.

Cinema Television Ltd,
Worsley Bridge Road,
Lower Sydenham,
London, S.E.26.

Cossor

Oscilloscope Model 1058

(Illustrated top right)

THE main feature of this new addition to the Cossor range is the use of a



C.R.T. employing post deflexion acceleration. It has a direct coupled amplifier with a maximum gain of 20 and a bandwidth of 0 to 3.5Mc/s, the maximum sensitivity through the amplifier being approximately 0.4V/cm. An X amplifier is also incorporated and using this the time-base sweep can be expanded up to 5 times the tube diameter; any portion of the expanded trace can be examined by operation of the X-shift control.

A. C. Cossor Ltd,
Highbury Grove,
London, N.5.

Dawe Instruments

Electronic Gauge, type 1106

(Illustrated below)

THIS gauge is made for comparing to close limits the dimensions of mechanical components, as for example, the diameter or length of roller bearings. The equipment consists of a differential transformer type gauge head together with a high gain amplifier and indicating meter. The gauge is set up with a standard gauge block and any variations in

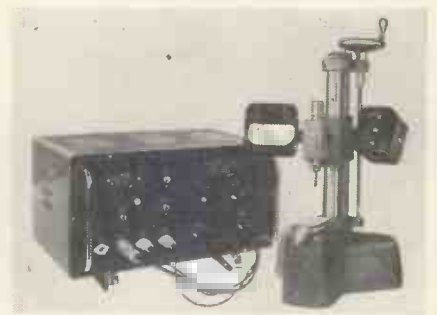

the diameter of the test sample are indicated directly on the meter. In addition low, pass, and high limit indicator lamps are provided to facilitate the rapid sorting of components. Four ranges are provided, ± 0.001 , ± 0.003 , ± 0.01 and ± 0.03 in full-scale.

Dawe Instruments Ltd,
99 Uxbridge Road,
London, W.5.

Decca
S-band Oscillator
(Illustrated below)

THE oscillator shown by Decca Radar provides a compact S-band bench source. It employs a CV2221 valve in a hybrid cavity and provides a minimum output of 200mW from 2.500 to 4.100Mc/s. A method of output coupling is used which automatically ensures that the coupling is either capacitive or inductive, whichever is correct for the frequency being used. A direct reading wavemeter (7 to 12cm) and a variable piston attenuator (0 to 120db) are fitted.

Decca Radar Ltd,
1-3 Brixton Road,
London, S.W.9.



Dynatron
Pulse Analyser type N.101

THIS single channel pulse analyser is for measuring the amplitude of voltage pulses in nuclear laboratories.

The instrument has a fast threshold amplifier (gain 5), followed by two discriminators, suitably biased. An output pulse is obtained when the lower discriminator only is triggered. The result is that the analyser transmits only those pulses which have amplitudes within a narrow voltage range. Seven channel widths are available, selected by a switch, giving highly stable and reproducible settings. The wider channel widths are useful for transmitting the whole of a group of pulses in a coincidence experiment.

The position of the lower limit of the channel is continuously variable from 5 to 50 volts, and is read by means of a large mirror scale voltmeter on the front panel. For very accurate work this voltage may be measured with an external voltmeter or potentiometer connected to terminals on the front panel. These terminals also serve for introducing an external bias supply to extend the range beyond 50 volts. This may be a completely independent variable supply, or more simply a battery which adds to the internal bias.

Dynatron Radio Ltd,
The Firs, Castle Hill,
Maidenhead, Berks.

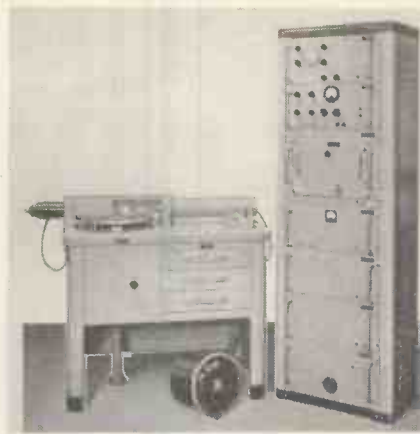

Ekco

Antenna Pattern Recorder Type E59
(Illustrated above)

ANTENNA Pattern Recorder Type AE59 has been developed for the accurate recording of radiation patterns of centimetric antennae. The antenna under test is rotated through 360° while being illuminated by a fixed transmitting antenna. With the exception of the transmitter, all the equipment is mounted in a rotatable cabin, adjustment of the transmitter frequency being effected by remote controls.

Either cartesian or polar co-ordinate graph paper can be used and the amplitude scale in each case is 10db per inch.

In operation the received c.w. signal is mixed with a modulated signal from a local oscillator, the resultant I.F. is fed, together with an anti-phase reference signal, to an I.F. amplifier. The amplitude of the reference signal is controlled by a servo-driven piston attenuator. If the two signals are unequal, an amplified error signal drives the piston attenuator in a direction which reduces the error and a pen attached to the piston drive mechanism records the amplitude of the received signal in terms of the attenuation law of the piston.

Ekco Electronics Ltd.,
Ekco Works,
Southend-on-Sea,
Essex.

E.M.I.

Wide Band Distributed Amplifier
(Illustrated below)

THE E.M.I. distributed amplifier has an input impedance of 75Ω and an output impedance of 200Ω. The amplifier has a bandwidth of from 20c/s to 80Mc/s (6db down at limits) giving a rise time of 8mμsec; the gain is 13 at the

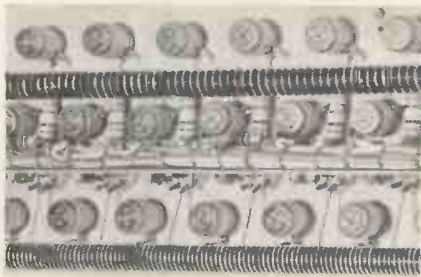

maximum output 150V. In conjunction with a high speed oscilloscope such as the E.M.I. Waveform Monitor type 3794TA it can be used to display sharp fronted pulses and measure rise times of 0.01μsec. In the illustration of part of the underside of the chassis the grid and anode delay lines and the sectional trimmers are shown.

Electric and Musical Industries Ltd,
Hayes, Middx.

Electronic Instruments
Vibrating Capacitor D.C. Amplifier
(Illustrated below)

IN this new D.C. amplifier the vibrating capacitor unit, styled the "Vibron," is mounted on a standard octal base and may, in fact, be handled as simply as a conventional valve. The Vibron amplifier was shown in three different forms; as a general purpose laboratory instrument, as an industrial pH meter and as a nucleonic weight gauge.

The laboratory amplifier has input ranges of 10mV, 100mV and 1V and an output of 1mA on all ranges. The input impedance is 10^{12} to $10^{16}\Omega$ according to



the particular application. The zero stability is better than $\pm 100\mu V$ and an interesting feature of the design is that the whole amplifier comprises only five valves, in addition to the Vibron unit.

Electronic Instruments Ltd,
Red Lion Street,
Richmond, Surrey.

Elliott

Microwave Instruments

INCLUDED in a wide range of microwave instruments shown by Elliott Bros., was the 3.2cm torque vane wattmeter type B228. This wattmeter measures microwave power in terms of mechanical torque exerted on a reactive vane supported in a waveguide. The torque is measured by a calibrated quartz suspension and torsion head. The instrument has been introduced to provide an improved method of measuring absolute power in the 3.2cm waveband. It avoids the use of a water calorimeter and enables greater accuracies to be achieved. Minimum detectable signal 100mW in normal use; peak power limit 30kW.

Magnetic Amplifiers

In addition to a low level D.C. magnetic amplifier and a range of standard 400 and 1600c/s transducers this firm were also showing a demonstration magnetic amplifier. This is a flexible

general purpose magnetic amplifier designed expressly to enable engineers to familiarize themselves at first hand with magnetic amplifier technique and, as such, should prove very useful. The amplifier is designed in a manner enabling transducers to be used singly, in push-pull, or in cascade. The bias and the feed-back on the stages in use can be varied independently. Change-over between the various circuit arrangements is achieved rapidly by making the appropriate connexions to a terminal block at the front of the amplifier. A list of suggested experiments is provided for the benefit of users.

**Elliott Brothers (London) Ltd.,
Century Works,
Lewisham, London, S.E.13.**

**Ericsson
Scaling Unit Type 1221B
(Illustrated below)**

FIVE scale-of-ten Ericsson Dekatron tubes in this all-cold cathode unit display the count up to a normal maximum of 10^5 , which may be extended by feeding into a similar unit or a mechanical register.

Pulse amplitude discrimination is not provided in this instrument as the unit is intended for use with a G.M. counter or a probe unit type 1014A, when noise



problems are non-existent. However, pulses from any source may be counted, provided that they are of a minimum amplitude of 10V peak, and a minimum duration of $25\mu\text{sec}$ at 50 per cent of the peak amplitude. The maximum counting rate is 2000p/s.

Application of the input pulses is controlled by an OFF-COUNT key and all decades are reset to zero by a push button. The main selector switch, when set to the TEST position, applies to the input an internally generated signal for checking purposes.

A plug-in relay unit is available to operate the scaling unit in conjunction with an A.E.R.E. type 1003 Timing Unit. If preset timing intervals up to 30 minutes only are required then a plug-in unit incorporating a type 1179A Miniature Timing Unit may be used. The required interval is adjustable in half minute steps.

**Ericsson Telephones Ltd,
Beeston, Notts.**

**Evershed & Vignoles
10kV Insulation Testing Set**

THIS addition to the "Megger" range has a double scale, the outer having a range of 60 to 200 000M Ω and the inner 0 to 1 000M Ω . The instrument, which is of the true ohmmeter type, is

mains operated. Special precautions have been taken to eliminate brush discharge and also to ensure that a circuit is not left in a highly charged condition after testing.

**Evershed & Vignoles Ltd,
Acton Lane Works,
Chiswick, London, W.4.**

Ferranti

Transient Photometric Unit

THIS apparatus has been developed in order to analyse the operating characteristics of intermittent and stroboscopic gas-discharge tubes.

The tube under investigation is arranged to operate under its typical conditions of discharge and the relationship between current, voltage and light output are displayed on three specially designed oscillograph tubes.

The time-bases of all three tubes are synchronized and transients extending from $1\mu\text{sec}$ up to $100\mu\text{sec}$ can be displayed visually or photographically recorded. The apparatus is also readily adaptable in investigations in connexion with electron emission from cold cathode or thermionic cathodes under pulse conditions.

C.R.T. Photo-recorder

This unit has been designed to enable photographs to be taken of pictures from the face of a cathode-ray tube.

The received signal is observed on a small cathode-ray tube operating continuously and the photograph is obtained from another similar tube operating at high definition and provided with spot wobble to minimize the effect of the line structure on the recorded picture.

The camera is incorporated in the unit and the exposure is automatically controlled by an electronic switch circuit so that it includes only one complete field or, if necessary two complete fields (one complete frame).

The unit can be used to obtain a photographic record of any operation which has been carried out at a remote distance and which is capable of being transmitted and received by television methods.

**Ferranti Ltd,
Hollinwood,
Lancs.**

G.E.C.

Recorder for Two Variables

THE recorder shown is a machine which is able to accept D.C. input voltages proportional to two variables and plot a curve representing the function of one of the variables against the other.

The chart paper, which measures 40cm x 30cm is wrapped around a drum driven by a position control servo system. A ball point pen is driven across the surface of the paper in a direction parallel to the axis of the drum by a second similar servo system. A solenoid mechanism is incorporated for lifting the pen from the paper.

The performance of the servos is such that the dead zone is less than $\pm 0.2\text{mm}$, the linearity is within ± 0.2 per cent and the scaling accuracy, which relies on voltage regulating tubes, can be within about ± 1 per cent. The speed of response is such that a step of 35cm is completed in from 0.5 to 0.7 second depending on which gear ratio is in use.

Smaller steps are completed in a roughly proportionately shorter time.

The recorder was shown in use with an attachment for plotting valve characteristics and for measuring the accuracy of resolver synchros by a comparison method.

The instrument, which has many applications in simulator and general laboratory work, was designed for work on a Ministry of Supply contract.

**The General Electric Co., Ltd.,
Wembley,
Middlesex.**

Joyce, Loebel

Dual Channel Stabilized H.T. Unit

THIS versatile power supply consists of two identical but completely separate H.T., D.C. channels, each electronically stabilized over the range of 120V to 420V at 0 to 250mA, D.C. The mains input D.C. output voltage change per channel is better than 1000, the output resistance less than 0.5Ω and the ripple less than 1mV, R.M.S.

Any pair of the four D.C. output terminals may be linked by a selector switch; a further switch enables any one terminal to be earthed. Thus, the two variable-voltage D.C. channels may be used separately with either positive or negative earthed as required; they may be connected in series addition and earthed to give a positive or negative supply. By a novel circuit they may be connected in series opposition to give a single supply which may be swung through zero from positive to negative voltage; by means of another new circuit they may be paralleled to give a single supply of double current rating (500mA), the current being always exactly divided between the two channels. The same order of regulation is maintained in all these combinations.

The unit contains a number of other features, such as self-check facilities and an unusual number of heater supplies.

**Joyce, Loebel & Co., Ltd.,
Vine Lane, Northumberland Street,
Newcastle-upon-Tyne, 1.**

Muirhead

**Selective Amplifier-Detector Type D-669
(Illustrated below)**

THE circuit of this instrument is based on that of the Muirhead-Pametrada Wave Analyser. It provides a simple and convenient method of obtaining discrimination in A.C. bridge measurements where the bridge output at balance contains an appreciable harmonic voltage. It can be tuned to any frequency between 30c/s and 30kc/s to give a harmonic suppression of 36db or better, or may be used as a flat-response amplifier-detector if



required. The calibration of the tuning dial enables the fundamental frequency to be measured accurately. Visual indication is given on a meter, but a phone jack is also provided.

The frequency accuracy is better than 1.5 per cent over most of range. The input signal for full scale reading is $300\mu\text{V}$ to 3V into $100\text{k}\Omega$, controlled by an input potentiometer calibrated in the range 0-80db.

Wave Correlator Type D-727A

This instrument has been designed to be used with the Muirhead-Pametrada Wave Analyser in the investigation of vibration and noise in multiple-shaft rotating machinery, and enables the sources of vibration to be localized.

The total vibration frequency spectrum is passed through the analyser and a selected frequency (known as the signal input) compared in the correlator with a frequency obtained from a pick-up on one of the rotating shafts (known as the pulse input).

If the signal frequency is a multiple of the pulse input frequency then one of two neons will light, according to the phasing. If the two frequencies are not harmonically related the neons will flicker. The frequency of flickering is given by the difference between the signal input and the nearest harmonic of the pulse input.

Muirhead & Co. Ltd,
Beckenham,
Kent.

Mullard

Wide Band Oscilloscope MKII

THIS instrument has been designed primarily for analysis of complex waveforms. A triggered time-base of constant sweep length is employed which may be triggered either by an external sine wave (50c/s to 2Mc/s), or a positive or negative pulse, or by an internal pulse generator (2c/s to 200kc/s). This pulse generator can also be synchronized from an incoming signal. By this means it is easily possible to synchronize the display up to 20Mc/s at a repetition rate of 200kc/s .

A delay system permits the start of the time-base to be delayed after the trigger pulse by up to ten times the sweep time, thus enabling small sections of a complex waveform to be examined in detail.

The Y amplifier has a maximum sensitivity of 10mV/cm peak-to-peak, a rise time of $0.03\mu\text{sec}$, and a useful bandwidth from d.c. to 15Mc/s . An X amplifier is also included, having a maximum sensitivity of 100mV/cm peak-to-peak, a rise time of $0.1\mu\text{sec}$, and a useful bandwidth from d.c. to 5Mc/s .

Voltage can be measured to better than ± 1 per cent on all positions of the attenuator. Time can be measured to ± 1 per cent by using the delay and to better than ± 3 per cent using the X shift.

Mullard Ltd,
Century House,
Shaftsbury Avenue,
London, W.C.2.

Salford

One-third Octave Spectrometer

(Illustrated above right)

THIS spectrometer is a complex wave analyser of a robust construction. It can analyse waveforms containing frequencies between 10c/s and 100kc/s ; the waveform is picked up and dissected into

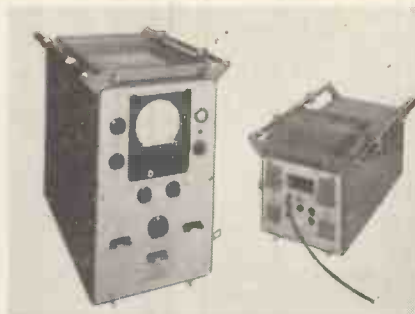

component parts, these parts being shown as separated vertical lines on a cathode-ray tube, each line corresponding to a particular frequency component, the amplitude of which indicates the strength of that particular component. The equipment is divided into two parts, a power unit and display unit. By a method of preselection, it is possible to choose one of three sets of filters, three filters covering an octave.

There are altogether 38 filters. The range of the instrument being 13 octaves, i.e., $10-100,000\text{c/s}$.

Salford Electrical Instruments Ltd,
Peel Works, Silk Street,
Salford 3, Lancs.

Solartron

Low Frequency Decade Oscillator

THE model OS.103 is an RC feedback type of oscillator which covers a frequency range of 0.01c/s to 11kc/s . Tuning is effected by three decade dials and a four position frequency multiplier. The frequency accuracy is claimed to be within ± 1.5 per cent at any setting.

A feature of the frequency selective network is that it generates voltages which are 90° apart in phase. These voltages are brought out to terminals on the front panel and provide 10 volts R.M.S. per phase at 0° , 90° , 180° and 270° . By feeding the 0° and 90° outputs simultaneously to a thermocouple voltmeter, an indication of the output voltage on terms of true R.M.S. value is obtained irrespective of the frequency. A balanced attenuator enables the 10 volts output at 0° and 180° to be divided down in 100 steps to 10 millivolts so that precisely known voltage levels can be obtained even at the lowest frequency.

Solartron Laboratory Instruments Ltd,
Solartron Works, Queens Road,
Thames Ditton, Surrey.

Sunvic

Plug-in Counter Units

(Illustrated below)

A RANGE of plug-in units for binary and decade counting was exhibited.

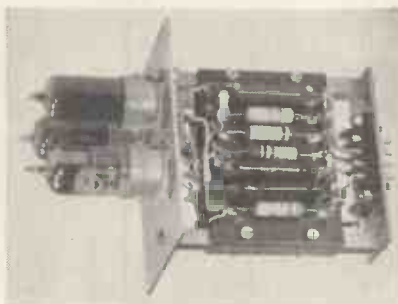

These include hard valve scalars, pre-amplifiers, input (pulse forming) and mechanical output units. Decade counting using the hard valve scalars is obtained by the use of three scale-of-two units in conjunction with a special scale-of-two unit. A Dekatron unit is also available where the counting rate is not so high. A plug-in rate meter for showing the mean rate at which pulses are being received was also shown. A counter unit which will give an output after a pre-determined number of pulses have been received is also available for use in batching processes, etc.

Sunvic Controls Ltd,
10 Essex Street,
London, W.C.2.



20th Century Electronics

Square Faced Cathode-Ray Tubes

(Illustrated above)

THE range of 20th Century precision cathode-ray tubes has been increased by the addition of two types having square faces of six inches diagonal. The provisional type numbers of these are SqD6 and SqS6; the former has a double gun and the latter a single gun. The characteristics are similar to the standard round faced tubes.

20th Century Electronics Ltd,
Dunbar Works, Dunbar Street,
West Norwood,
London, S.E.27.



Wayne Kerr

X-Band Oscillator

(Illustrated above)

THIS instrument uses a low voltage klystron CVX5028 in a coaxial line cavity. A special coupling system ensures that the power output is constant to better than 2db in the band $8\ 500$ to $10\ 000\text{Mc/s}$.

The associated equipment consists of stabilized power supply and internal modulator providing square wave and saw-tooth. Provision is also made for external modulation if required.

Wayne Kerr Laboratories Ltd,
Sycamore Grove,
New Malden,
Surrey.

LETTERS TO THE EDITOR

(We do not hold ourselves responsible for the opinions of our correspondents)

A Simple Circuit for Moisture Measurement

DEAR SIR.—In many industries the need for accurate measurement of moisture contained in different kinds of material is of great importance.

There are already a number of moisture meters in use, the various principles of their operation were described¹ in some detail by the author in 1950.

Described below is a simple device which can be employed to indicate, compare, or measure the moisture content of such varied materials as biscuits, wool, cotton, grain, milk-powder, tobacco, alcohol, wood, cardboard, and many other substances.

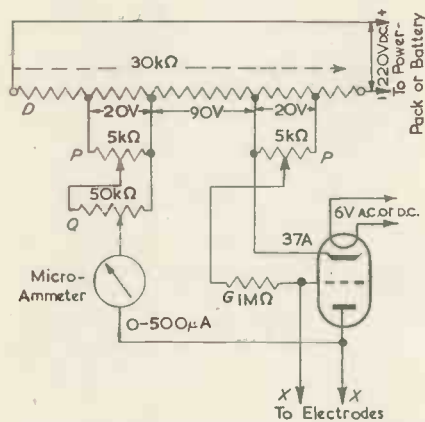

Fig. 1. A simple circuit for moisture measurement. Leads X are attached either to two electrodes which are pressed against the material under test or, alternatively, a dual electrode on which the contact plates are set at a fixed distance apart may be employed.

As shown in Fig. 1 the microammeter is connected between the anode of the valve and the slider of the high resistance potentiometer Q.

The electrodes (not shown) are connected to the anode of the valve and its grid.

A number of electrodes suited to various materials have been described. E. H. Jones² has shown when electrodes are pressed against a material that after a certain pressure has been reached a further increase does not alter appreciably the meter deflexion. The pressure required will, of course, depend on the size and shape of the electrodes and on the material. Jones gives the maximum pressure likely to be required as 20kg applied by hand or by spring loading.

The sensitivity of the valve circuit described above can be judged by the result of the following tests.

A sheet of cardboard 12cm × 30cm × 1.5mm was laid on a sheet of glass,

the day being warm and sunny. Two flat circular brass disk electrodes (each 3.5cm in diameter and fitted with insulating handles) were pressed with force against the smooth surface of the cardboard, the distance between the electrodes from centre to centre was 10cm.

A microammeter deflexion of 200μA was obtained. The test was repeated on a wet day and the meter then registered 425μA. The cardboard was thus shown to be hydroscopic. It should be stated that on both occasions to the touch the cardboard seemed to be quite dry.

The conductance of a material in reciprocal ohms can be obtained by the usual substitution method.

The sensitivity of the instrument may be reduced as desired by changing the value of the grid resistor and substituting one of lower resistance. Conversely it may be increased by employing a more sensitive meter, or the distance between the electrodes can be adjusted to suit special requirements.

Yours faithfully,

G. C. BLAKE,
University of Sydney.

REFERENCES

- BLAKE, G. G. Conductimetric Analysis at Radio-frequency (including a chapter on Moisture Meters). (Chapman & Hall, London.)
JONES, E. H. A Moisture Meter for Textile Materials. *J. Sci. Instrum.* 17 (March 1940).

An Alternating Current Stabilizer

DEAR SIR.—There are several queries which I wish to raise concerning the Alternating Current Stabilizer described recently by Mr. P. A. V. Thomas¹. This stabilizer has an output power which is approximately the same as one described some time ago by J. C. S. Richards², and appears to be rather more complicated, besides having a few disadvantages.

Presumably the 1LN5 is used as a saturated diode, and it would be interesting to hear why such a valve is preferred to 29C1, which is specially designed to operate under such conditions. The total power consumption of 8-10 watts of the 29C1 heater and anode circuits is surely not an objectionable loss in a stabilizer with an output of 240 watts. Also, the 29C1 has a considerably shorter response time than a miniature valve, and is not susceptible to changes in ambient temperature, as has been shown by V. H. Attree³.

The most sensitive heater voltage will depend on the H.T. voltage and anode load. The curve of Fig. 3 of Mr. Thomas's article has been drawn for an H.T. voltage of 250 volts, while in the circuit of Fig. 2 the H.T. voltage would be about 315 volts. Also, for a given H.T. voltage and anode load, the balance condition of a saturated diode bridge is not altered by changing the diode heater voltage.

Heater power is not in itself a criterion of response time. F. H. Hibberd⁴ has shown that for filaments of a given material, the response time is proportional to the diameter of the wire, and thus for a minimum response time a filament with the lowest current consumption would be the best, even if it required a relatively high voltage.

It would be interesting to know whether the stabilizers V₁₋₆ are really necessary. We have built an A.C. stabilizer using a saturated diode and a transformer in which all the internal power requirements are fed from the output of the unit without any D.C. stabilization for its H.T. supplies and it has functioned satisfactorily. If the glow-discharge tubes are necessary, it would surely be better to use high stability ones, such as 85A1's, instead of the VR105/30's, which have a limited life⁵. In addition, it may be necessary to connect striking resistors between the H.T. line and the anodes of V₅ and V₆.

The use of 30 s.w.g. wire for the transformer control winding seems extravagant, as it would occupy a winding space or about 5sq.in. 40 s.w.g. wire would appear to be adequate, as it will carry 18mA at a current density of 1000A/sq.in. and would require a winding space of just under 1sq.in. compared with about ½sq.in. for the A.C. windings.

It would appear desirable to arrange the auto-transformerappings so that the stabilizer ranges overlap slightly. As Fig. 4 shows, there are regions where the stabilizer would find difficulty in keeping the output voltage within the limits if there were rapid fluctuations in mains voltage without frequent use of the switch.

Glow-discharge tubes when used as indicators do not respond to the peak value of the A.C. voltage, unless their supply is smoothed with a rather large input capacitance. Generally it is better to design the filter so that the tube responds to the mean value, as this is not affected to such a large extent as the peak value by harmonic distortion.

It would be interesting to know how the output voltage of the stabilizer varies with changes in load current and mains frequency.

Collinge and Marsham⁶ have described an electro-mechanical stabilizer which does not have the disadvantage of intermittent operation, as is the case with Long's⁷ and Mr. Thomas's⁸ previous units.

Yours faithfully,

M. S. SEAMAN,
Department of Electrical Engineering,
University of Sheffield.

REFERENCES

1. THOMAS, P. A. V. An Alternating Current Stabilizer for Supplying Valve Heaters. *Electronic Engng.* 25, 522 (1953).
2. RICHARDS, J. C. S. A Stabilized A.C. Supply for Lamps and Valve Heaters. *J. Sci. Instrum.* 29, 333 (1951).

3. ATTREE, V. H. A Differential Voltmeter using a Saturated Diode. *J. Sci. Instrum.* 29, 226 (1952) and Saturated Diode Operation of Miniature Valves. *Electronic Engng.* 25, 27 (1953).
4. HIBBERD, F. H. The Transient Behaviour of Thermionic Filaments with Temperature Limited Emission. *J. Sci. Instrum.* 29, 280 (1952).
5. BENSON, F. A. A Study of the Characteristics of Glow-Discharge Voltage-Regulator Tubes. *Electronic Engng.* 24, 396 and 456 (1952).
6. COLLINGE, B., MARSHAM, T. N. An A.C. Stabilizer. *J. Sci. Instrum.* 28, 374 (1951).
7. LONG, J. V. P. A Simple Electro-Mechanical Voltage Stabilizer. *Electronic Engng.* 24, 26 (1952).
8. THOMAS, P. A. V. A Simple Electro-Mechanical Voltage Stabilizer. *Electronic Engng.* 25, 37 (1953).

The Author replies:—

DEAR SIR,—In reply to Mr. Seaman's letter, I should first like to thank him for his information concerning the stabilizers of Richards, Collinge and Marsham, as I was not aware of these articles at the time.

As regards the use of the ILN5, Mr. Seaman will see from my original article that this valve was only used from convenience and not preference and I agree with him (see my original article), that the filament should be small in diameter, and I agree, therefore, that there is no objection to a high voltage heater, providing the current rating is low.

The H.T. voltage supplying the diode is not much lower than the test voltage 350V¹ and in any case the anode current is almost independent of the anode voltage in the saturation region as shown by Fig. 3 in the article of Benson and Seaman². As to Mr. Seaman's point concerning the bridge, the anode voltage of the diode must vary with variation of the heater voltage, due to variation of the saturation current as shown by Fig. 2 and Fig. 3 of my original article.

As I am no longer at the Royal Technical College, Glasgow, I cannot check the necessity for V₄, V₅ and V₆; they were inserted as a precautionary measure against instability and I doubt if it would warrant the high stability of 85A1's. As regards striking resistors, these appeared not to be necessary in practice.

No doubt a smaller wire size could have been used for the control winding of the transductor, but the core used (originally a 500VA transformer that was to hand) had a large winding area and using a thicker wire than necessary made far easier winding and also the large core kept down the turns/volt which also helped in the construction of the transductor.

Again, the transformer was one that was to hand and suited the purpose, even if not perfectly; certainly more tapplings could be provided to give closer tolerance on the output voltage variation, but this would mean more switch positions and possibly, therefore, more switching operations. Of course, one could probably overcome the problem by an automatic tap-changer operated by suitable minimum and maximum current limits of the transductor control current, but this would seem to be over-complicating the stabilizer.

Naturally, the stabilizer is affected by frequency and load current as the transductor is a variable series inductor, but providing neither varies greatly the stabilizer will maintain the output voltage constant, that is providing the control

current does not reach its limiting values as with variations of the input voltage.

Yours faithfully,

P. A. V. THOMAS,
Glasgow, W.2.

REFERENCES

1. THOMAS, P. A. V. An Alternating Current Stabilizer (Correspondence). *Electronic Engng.* 26, 133 (1954).
2. BENSON, F. A., SEAMAN, M. S. Characteristics of the Temperature-Limited Diode Type 29C1. *Electronic Engng.* 25, 462 (1953).

Microphony in Voltage Reference Tubes

DEAR SIR,—Voltage references glow discharge tubes such as the 85A1 and QS83/3 are being used in regulated power supplies with an output stability in the millivolt region, where the short term stability of the supply is determined by the characteristics of the voltage reference tube rather than the associated circuits.

It is of interest to note that under these conditions the microphonic properties of the voltage reference tube can be an important factor. Measurements of the transient changes in the voltage drop of the reference tube under recommended operating conditions are given in Table 1.

REFERENCE VALVE TYPE	INITIAL PEAK OF TRANSIENT FOR AN IMPULSE OF 1FT. LB./SEC. (M.V)	TIME TO DECAY TO 1/E OF INITIAL VALUE (MSEC.)	APPROX. FUNDAMENTAL FREQUENCY (C/S)
QS83/3	0.3	3 approx.	1000 approx.
85A1	15	30	800 to 1000

The results are consistent from valve to valve of the same type. There is no accompanying change in D.C. level from the valve.

The reason for the large difference in the two types is obvious when the construction is considered. In the QS83/3 the central anode wire is supported at both ends of the cathode by punched micas, whereas in the 85A1 the anode is a wire supported at one end only by welding to one of the base pins. It is obvious that this type of construction would be extremely microphonic, and it would appear that the design of this valve could be improved by supporting the free end of the anode wire.

R. E. AITCHISON.

Senior Lecturer in Communication Engineering.

C. T. MURRAY.

Lecturer in Electrical Engineering, The University of Sydney.

The Measurement of Very Small Direct Currents

DEAR SIR,—It would be of interest to know, in respect of the use of capacitance modulator electrometers as D.C. amplifiers for very small currents as mentioned in the article by Mr. M. W. Jervis in the March issue, whether resistance modulator electrometers, using the variation in resistivity of bismuth with magnetic flux, have ever been considered.

It is known that very fine bismuth wire with a resistance of 30Ω/cm can be

obtained fairly readily in short lengths, and is used in vacuum thermopiles.

It may therefore be possible to place a non-inductively wound coil of fine bismuth wire in an alternating magnetic field and thus avoid electro-magnetic pick-up while removing difficulties with contact potentials. The resistivity of bismuth is stated to vary by a ratio of about 13 to 1 for a field change of zero to 100 gauss, when orientated correctly as regards the crystallographic axes.

Yours faithfully,

D. F. T. ROBERTS,
Murex Welding Processes Ltd.
Waltham Cross,
Herts.

The Author replies:—

DEAR SIR,—I would like to thank Mr. Roberts for his remarks concerning the use of the magneto-resistance effect of bismuth in D.C. amplifiers. To the writer's knowledge, this has not been used and is not mentioned in Kessler's comprehensive review (ref. 25 of the article). It has, of course, been used for measuring magnetic fields¹.

The figures for the magnitude of the effect quoted by Mr. Roberts (a resistance change of 13 times for a flux density of 0-100 gauss) seem very large. According to Smith¹, the change of resistance at 20°C. for a field change of 0-4 000 gauss is about 15 per cent. This is in agreement with the investigation of Donovan and Conn².

The main difficulty in using bismuth in a sensitive D.C. amplifier is its high thermo-electric E.M.F. (about 75μV/°C. against copper). This would necessitate temperature stabilization or precise thermal balancing. The magneto-resistance effect is also sensitive to temperature, a change of 20°C. having the same effect as about 2 000 gauss³.

A similar scheme, more suitable for higher input resistances, is that of using the change in permittivity with voltage of barium-strontium titanate crystals³. The modulation is rather inefficient, however, and the temperature effect large.

Yours faithfully,

M. W. JERVIS,
Research Laboratory,
Associated Electrical
Industries Ltd.
Aldermaston,
Berkshire.

REFERENCES

1. SMITH, G. S. A New Magnetic Flux Meter. *Trans. A.I.E.E.* 56, 441 (1937).
2. DONOVAN, B., CONN, G. K. T. The Electrical Conductivity of Bismuth Fibres—magneto-resistance and the crystalline structure. *Phil. Mag.* 40, 283 (1949).
3. URKOWITZ, H. A Ferro-electric Amplifier. *J. Franklin Inst.* 254, 517 (1952).

Errata.—In the letter from D. Morris on page 177 of the April issue the following errors occurred: Line 3 should read "Q of the same RC Circuit." Column 3, line 12 should read "The choice of model has been unfortunate; a series LCR circuit . . ." Line 19 "inductor" should read "inductance."

Editor's Note.—An article defining Q as a mathematical parameter will be published shortly.

The Electronic Musical Instrument Manual

By Alan Douglas. 221 pp., 187 figs. Demy 8vo. Second Edition. Sir Isaac Pitman & Sons Ltd. 1954. Price 30s.

THIS second edition represents a striking advance, both in quality and scope, over the first edition. The number of pages has been increased from 143 to 221, many diagrams have been added and some existing ones improved. There is an adequate bibliography and a good index.

The type of reader the author had in mind is clearly one fairly familiar with electronic techniques. Such a person will find much to interest him. The same cannot be said of the non-technical musician, who would find much of the book after the first three chapters too technical. It would have widened the appeal of the book if the musician's point of view had been given more prominence in the later chapters. One realizes the danger of giving offence to the protagonists of the various tone-producing systems, and must consider this a possible reason for Mr. Douglas's devotion to less controversial matters.

If one allows for this limitation the book is comprehensive, well-written and up-to-date, and since no reviewer has ever found a book wholly without blemish it should be realized that the matters singled out for criticism in what follows are details.

The book starts with three chapters on sound and music. The subject is well compressed into the limited space but the writing shows signs of haste, as, for example, in Fig. 1 where wavelength is inserted on a time-graph. A more exact treatment of intensity and loudness would have been valuable. The vital distinction between the decibel and the phon is not made clear. It is a pity that the author did not reproduce some of C. P. Boner's beautiful frequency-spectra published in 1939 instead of the crudely-drawn Fig. 14.

An excellent basis for understanding the whole subject is furnished by Chapter IV which is a greatly expanded version of the original chapter on the generation of oscillations. A few errors occur as on pages 52 and 63, and it is disappointing to see obsolete types of valve featuring in the circuit diagrams.

No great alteration has been made to Chapter V on amplifiers, mixers, etc. A defect in this otherwise useful chapter is the confusion of acoustic and electrical powers on page 102. Figures which put the power level of a large concert organ only 9db above that of a reed organ suitable for a room must surely be suspect.

The next chapter is an admirable and very detailed description of some commercial instruments, with full circuit diagrams in some cases. It may come as a disappointment to organists that although nearly seven pages are devoted to the Hammond "chord organ" (an instrument in which the accompaniment to a melody is provided by "canned chords" elicited by push-buttons) the Constant Martin organ receives only three pages and the Gregorian, Jennings and Midgley-Walker organs no mention at all.

The considerably-expanded last chap-

BOOK REVIEWS

ter deals with techniques likely to be of interest to experimenters and amateur constructors and forms an attractive feature.

Considering the exorbitant prices of many books nowadays this one represents good value for money and will be found as useful as a work of reference as it is profitable and stimulating at a first reading.

K. A. MACFADYEN.

Advances in Electronics Volume IV

Edited by L. Marton. 344 pp., 118 figs. Demy 8vo. Academic Press Inc., New York. 1952. Price 58.50.

THE issue of a fourth volume in this series indicates that this collection of topical expert field-surveys is now firmly established as a regular event.

It is with some diffidence that one approaches this book, whose highly qualified authors all hail from either universities or large official bodies or companies. They are all American except for Professor Massey, of University College, London, who contributes the long opening chapter on Electron Scattering in Solids. After a brief introduction to the theoretical and practical importance of this subject in various branches of physics there follows a mathematical review of some less well described aspects of the subject such as elastic and inelastic scattering, multiple scattering and diffusion of electrons in a solid scatterer and the relation of different scattering processes to the electrical resistance of metals, alloys and semi-conductors. The various formulas derived will doubtless be of value to specialist workers in the latter field and in electron-microscopy.

G. A. Morton, of RCA, reviews the Scintillation Counter, which has developed into one of the most valuable tools for detecting high-energy radiations. Superiority of phosphor-crystal to gas-ionization detectors is claimed in respect of efficiency and proportionality of energy conversion and in resolving time. Phosphor-crystals are broadly reviewed and data tabulated. A photo-multiplier is required in preference to a conventional photocell plus high-gain amplifier because of the few photo-electrons per scintillation and the extremely short rise-time requirement, which could not be otherwise reconciled with high input-impedance and high signal-to-noise ratio. Much development of photo-multipliers has taken place recently, the performance of commercially available types (RCA and EMI) being tabulated and discussed in some detail. Finally a number of applications are discussed in radiation detection and monitoring, scintillation-counter spectrometry and time measurements in nuclear events.

Fluctuation Phenomena are described by

Prof. Van de Ziel, with particular emphasis on the value of simple Fourier analysis in some important noise problems. The theory is applied to a number of noise generators, including thermionic valves, photocells, semi-conductors and crystal valves, and to noise in receivers.

One of the more spectacular achievements of recent years has been the development of high-speed automatically-sequenced Electronic Digital Computers. C. V. L. Smith, of the Office of Naval Research at Washington, omits a historical review here since several earlier successful machines were entirely electromechanical. He discusses systems in general, including the functions of various parts, followed by a discussion of special electron tubes and circuits. In storage devices the related importance of capacity and access time, often tending to be inversely proportional, is emphasized. Among the current techniques using magnetic drum, acoustic delay line and electrostatic storage tube it is particularly heartening for British engineers to read of the great interest aroused in America by Prof. F. C. Williams' scheme using conventional cathode-ray tubes. Two specially developed tubes are the Whirlwind tube, of the mosaic collector type, which has an auxiliary gun and beam to "hold" any signal once "written" on the storage surface, and the RCA Selector, which avoids critical deflexion voltages. This tube needs only 18 leads to control 256 storage elements. Special requirements of electron tubes in arithmetic and control organs are noted, particularly for on/off operation, stable characteristics and long life. Finally, two particular recent computers are described: Whirlwind, developed by MIT, uses the Whirlwind tube and incorporates a "marginal checking" preventative maintenance scheme that detects circuits and components on the verge of failure; "SEAC", developed at the National Bureau of Standards, uses a mercury acoustic storage line but has provision for a Williams-type storage tube when feasible. Its circuits are unusual in being based upon crystal-diode "logical operators" followed by power amplifiers comprising beam-power valves with pulse transformers.

The increasing congestion of radio transmitting channels has led to serious attempts to exploit microwave frequencies for commercial purposes. A promising source of power would seem to be the c.w.-magnetron, which has an unexcelled efficiency of 50-70 per cent in this region. As a basically self-excited oscillator, the magnetron is not however easily modulated within normal exacting specifications. J. S. Donal, Jr., of RCA, in reviewing Modulation of c.w. Magnetrons, makes it plain that considerable effort is being devoted to this problem,

and considers the various methods of amplitude and frequency modulation and the minimizing of mixed modulation. This chapter, which reviews American practice only, will be of considerable interest to radio engineers as much of the work is claimed to be not only unpublished but still under development.

The Magnetic Airborne Detector, which detects disturbances in the earth's magnetic field by measurement from an aircraft, is an excellent example of an old idea fashioned into a powerful new instrument through the application of new techniques paralleled in other fields. W. E. Fromm, of Airborne Instruments Laboratory, Inc., writes of its history and development from the detection of submarines off-shore in World War I and from the air in World War II to present and future uses in geophysical prospecting. The heart of the system is the magnetic detector proper, which must be capable of responding to small but abnormal changes of field strength in an already large field, caused by neighbouring magnetic disturbances. The problem is complicated in particular by the fact that the disturbing field strength is inversely proportional to the cube of distance, thus severely limiting range; by the need of very high angular stability in holding the reference position of the detection element during flight; by operational noise levels including magnetic factors inside and outside the aircraft besides the normal electronic factors. The most convenient sensitive practical detector is the saturable-core-magnetometer which, as the name implies, consists of an iron-cored coil excited with A.C. to saturation, producing a spectrum of harmonics. The even-order harmonics are in general introduced or increased by the action of the ambient field upon the core material and may be filtered off, amplified and rectified to indicate the ambient field changes. This magnetometer is also ideally suited for the necessary position stabilization because of its small size and high sensitivity. Correction within only 5 or 6 minutes of arc, irrespective of large changes in aircraft position, is obtained through an electronically-controlled servomechanism. The magnetometer itself will also be of interest in laboratory and industrial measurements of extremely small magnetic fields and currents generally.

In the final chapter, Multichannel Radio Telemetering is described by M. G. Pawley, of the National Bureau of Standards, and W. E. Triest, of International Business Machines Corp. The theory of telemetering has been described in the previous volume of this series and here the authors give a largely descriptive review. The aircraft industry gave the original stimulus to the development of the technique as planes became increasingly fast and expensive, requiring more and more test data during the flight of models. Completely automatic data transmission by radio became essential with the evolution of radio-controlled target aircraft and guided missiles in World War II.

The various methods of telemetering, including frequency division and time division systems, are described. In discussing general factors determining the choice of a system, the importance of

availability and standardization are stressed, and it is noted that the best overall accuracy is about 2 per cent and the channel response in subcarrier systems is around 100 to 200c/s for galvanometer recorders. Higher frequency response requires a higher subcarrier frequency and C.R.O. technique. The authors consider that future trends will demand not merely improved performance but automatic data-reduction equipment to cut manual labour costs. Similarly new techniques such as magnetic recording may eliminate the time-delay and costs of photographic processing. Better pick-ups are required. Some of these problems are common to digital computers and mutual advance is likely.

This is undoubtedly a valuable book of reference, including excellent and copious bibliographies at the end of each chapter, in addition to detailed contents lists and comprehensive author and subject indices. The quality of printing and binding well match the high standard of presentation.

J. C. FINLAY.

Guide to Audio Reproduction

By David Fidelman. 232 pp., 55 figs. Demy 8vo. John F. Ryder, Inc., New York. 1953. Price 51.80.

THE purpose of this book is to present a complete and basic introduction to the American principles and techniques of sound reproduction, so that those interested in it can acquire the necessary background to pursue their interest in this field. The book is intended for those who have some familiarity with the basic principles and components of electronic circuits, but who are not necessarily specialists.

Introduction to Ultra-High-Frequency Radio Engineering

By S. A. Knight, 256 pp., 202 figs. Demy 8vo. Sir Isaac Pitman & Sons Ltd. 1954. Price 21s.

THIS book is intended as a guide to the methods and techniques of modern U.H.F. radio and radar engineering. It is written primarily for those engineers, students and members of the technical branches of the Services who wish to obtain a working background of the subject without complicated mathematical theory or unnecessary detail. All that is assumed is a knowledge of elementary radio systems and general techniques.

Four-Place Tables of Transcendental Functions

By W. Flugge. 136 pp. Demy 8vo. Pergamon Press. 1954. Price 25s.

THIS book contains tables of transcendental functions for the benefit of those who want to use them in computations of slide-rule accuracy or slightly more. The formulae needed for handling the functions are included, and every effort has been made to represent them so that they may be used safely also by those not thoroughly trained in the details of higher analysis.

CHAPMAN & HALL

Just Out

THE INSULATION OF ELECTRICAL EQUIPMENT

Edited by

Willis Jackson

D.S.C., D.PHIL., M.I.E.E., F.R.S.

340 pages 139 figures 42s. net

THE AMPLIFICATION AND DISTRIBUTION OF SOUND

by

A. E. Greenlees

A.M.I.E.E.

Third Edition, Revised

300 pages 114 figures 35s. net

37 ESSEX STREET, LONDON, W.C.2

The latest

"Electronic Engineering"
monograph

RESISTANCE STRAIN GAUGES

By J. Yarnell, B.Sc., A.Inst.P.

Price 12/6 (Postage 6d.)

This book deals in a practical manner with the construction and application of resistance gauges and with the most commonly used circuits and apparatus. The strain-gauge rosette, which is finding ever wider application, is treated comprehensively, and is introduced by a short exposition of the theory of stress and strain in a surface.

Order your copy through
your bookseller or direct from

Electronic Engineering

28 ESSEX STREET, STRAND
LONDON, W.C.2

Short News Items

Cambridge Summer School in Automatic Computing. A Summer School in programme design for automatic digital computing machines will be held in the University Mathematical Laboratory at Cambridge during the period 13-24 September. It will be along the same lines as those held previously. A detailed syllabus and form of application for admission may be obtained from Mr. G. F. Hickson, M.A., Secretary of the Board of Extra-Mural Studies, Stuart House, Cambridge, to whom the completed application form should be returned not later than 30 June.

The Electro-Physiological Technologists' Association will be holding their annual general meeting in London during May. This will consist of an all-day Saturday meeting with papers and demonstrations of interest to electro-physiologists. The exact date and venue have not yet been verified but non-members desirous of attending should write for full details to Mr. G. Johnson, Honorary Secretary, Hurstwood Park Hospital, Haywards Heath, Sussex.

The Société Française des Ingénieurs Techniciens du Vide, on the occasion of the fiftieth anniversary of the publication of the first paper dealing with Oxide Coated Cathodes, is organizing an International Convention in Paris on 24 and 25 June. Papers accepted by the Organizing Committee will be presented by the authors, or a summary will be read by the secretary. All contributions should be received by 15 May. Further details and information may be obtained from the Société Française des Ingénieurs Techniciens du Vide, 44 Rue de Rennes, Paris vi.

The British Thomson-Houston Co. Ltd., Ferranti Ltd., and the General Electric Company Ltd. share an initial order of \$6½M. placed by the Hazeltine Electronics Corporation of New York City under its offshore procurement prime contract with the U.S. Navy Department. Further orders are expected to be placed shortly. These three British firms will manufacture electronic equipment and associated test gear in the United Kingdom which will be installed in ships and ground stations as part of the North Atlantic Treaty Organization defence system. It is estimated that these initial orders will take two and a half years to complete.

Marconi's Wireless Telegraph Co Ltd. together with Amalgamated Wireless (Australasia) Ltd and the Canadian Marconi Company, recently sponsored the first meeting of an Aeronautical Radio Conference at Chelmsford. One of the principal objects of the Conference was to facilitate the exchange of views,

opinions and information relative to all aspects of the aeronautical radioelectric services.

The British Institution of Radio Engineers are holding an Industrial Electronics Convention in Christ Church, University of Oxford, from Thursday 8 July to Monday 12 July. The whole of the 1954 Convention will be devoted to the application of electronics to industrial controls, processes and computation. The programme is divided into six sessions which include Industrial Applications of Electronic Computers, Electronic Methods of Testing (X-rays, ultrasonics, radioactive devices, etc.), Electronic Control (transducers, actuators, motor control, magnetic amplifiers, welding, etc.). The final session will be entirely devoted to a discussion on how electronics can increase production which will be opened by Sir Walter Puckey, President of the Institution of Production Engineers. Accommodation is being provided in the College and further details concerning the convention may be obtained from the Secretary of the British Institution of Radio Engineers, 9 Bedford Square, London, W.C.1.

The De Havilland Engine Company Limited announce that all inquiries and correspondence for the Buying, Sub-Contracts and Plant Managers Departments should, in future, be addressed to them at Leavesden Airfield, Leavesden, Herts. Telephone Number Garston 2261.

The Atomic Energy Research Establishment has opened a new wing to the Radiochemical Laboratory. This will extend the facilities for work on chemical and metallurgical problems involved in designing new types of reactors for power production.

Mr. H. G. Foster, Managing Editor of ELECTRONIC ENGINEERING, is leaving for the United States on 3 May. He will be visiting the principal American and Canadian centres of research and development in electronics, and expects to be away for seven weeks.

JUNE ISSUE

The June issue of "Electronic Engineering" will be devoted entirely to the subject of H.F. communications. The number of editorial pages will be increased and will contain articles covering H.F. communications in all its aspects. The price will remain unchanged at 2s. and copies may be obtained direct from the publishers or from any news-agent.

The Ministry of Supply announces that Colonel J. D. Haigh has been appointed Director of Electronics Research and Development (Defence) and Mr. H. W. Forshaw has been appointed to succeed Dr. G. W. Sutton as chief superintendent, Signals Research and Development Establishment, Christchurch.

Mr. A. G. Peacock has resigned his position as secretary of the Scientific Instrument Manufacturers' Association and has joined the Board of Mervyn Instruments, St. John's, Woking, Surrey.

Mr. Arthur E. Skan, a director of Tufnol Ltd, Birmingham, has been elected Chairman of the British Plastics Federation.

Colonel A. J. Norman, Managing Director of Scott Insulated Wire Company Ltd, through his solicitors, Ellis Peirs and Co, wishes to make it known that he is in no way connected with the pending prosecution of Colonel Frank Norman who is charged with being concerned in the attempted export of strategic material to Gdynia.

Mr. N. C. Robertson, C.M.G., M.B.E., Deputy Managing Director of E. K. Cole Ltd, has been formally elected a Director of Ekco Electronics Ltd. A wholly-owned subsidiary company of E. K. Cole Ltd, Ekco Electronics Ltd was formed last year to handle the marketing, installation and maintenance of Ekco electronic and nucleonic equipment.

Meetings. The Institution of Electrical Engineers will hold the following meetings this month, to be held at the Institution, commencing at 5.30 p.m.

Date: 5 May. Lecture: The Reflection and Absorption of Radio Waves in the Ionosphere. By: W. R. Piggott; and Some Notes on the Absorption of Radio Waves Reflected from the Ionosphere at Oblique Incidence, by W. J. G. Beynon.

Date: 6 May. Lecture: Electric Traction Using Single-Phase 50c/s Current. By: M. Garreau; and Electric Locomotives on the Valenciennes-Thionville Line. By: F. Nouvion.

Date: 11 May. Lecture: Measurement as a Factor in Understanding. By: K. J. R. Wilkinson.

Date: 13 May. Lecture: Fuel Supplies of the Future (at 6 p.m.). By: E. F. Schumacher.

Erratum. On page 134 of the March issue, paragraph (f) of the letter from the Edison Swan Electric Company Ltd should read "The rate of response for small filament voltage changes is of the order of 0.05 seconds".