

Electronic Engineering

FEBRUARY 1953

BICC

P.T.F.E.
R. F. CABLES

BICC are now producing radio frequency cables insulated with P.T.F.E. (polytetrafluoroethylene) capable of withstanding temperatures from minus 75° C up to 250° C.

Inner and outer conductors are of silver-plated copper wire, while overall protection is provided by an impregnated glass braid.

for use at
Extreme Temperatures

minus 75°
to plus 250°
C

Due to limited supplies we regret that this cable is only available against approved contracts.



BRITISH INSULATED CABLES
NORFOLK HOUSE, NORFOLK STREET, NORWICH

CABLES LIMITED
NORWICH

EDISWAN

CLIX

Offer the widest range of type-approved valve-holders

which includes:—

B7G, B8G, B9A and B9G

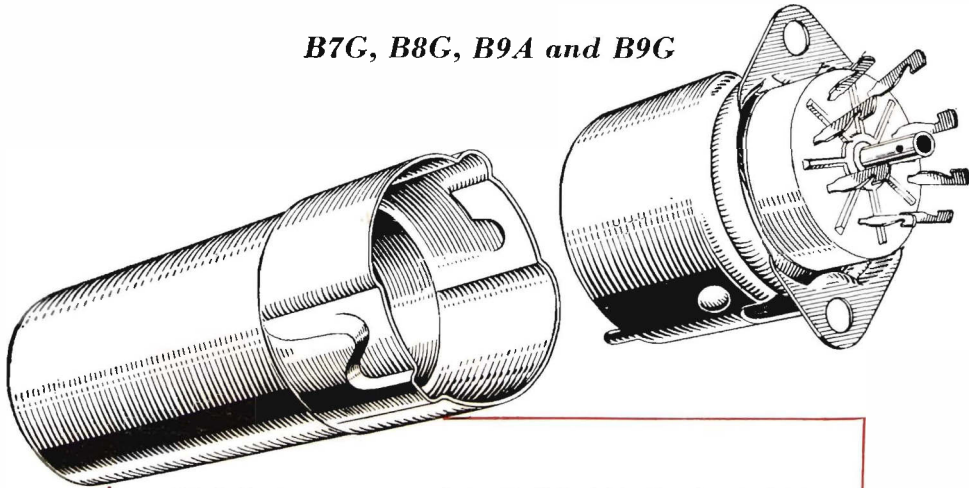

All fully type-approved to R.C.S. 251 Grades 1 & 2. Categories 1 & 2. Together with a complete range of screening-cans & top-cap connectors.

Comprehensive catalogue of EDISWAN CLIX radio components available from

THE EDISON SWAN ELECTRIC COMPANY LIMITED

155 Charing Cross Road, London, W.C.2. Sales Dept: 21 Bruton Street, W.1

Member of the A.E.I. Group of Companies

OFFICIAL APPOINTMENTS (Cont'd.)

£410 × £15(3) × £20(1) to £475 per annum, pending Whitley Council Scales. Applications as soon as possible, stating age, experience, and with two references, to the Hospital Secretary. W 1648

SITUATIONS VACANT

The engagement of persons answering these advertisements must be made through a Local Office of the Ministry of Labour or a Scheduled Employment Agency if the applicant is a man aged 18-64 inclusive or a woman aged 18-59 inclusive unless he or she, or the employment, is excepted from the provisions of the Notification of Vacancies Order, 1952.

AERONAUTICAL SERVICE ENGINEER required in Johannesburg, South Africa, for installation flight testing and servicing of instruments. Practical and theoretical knowledge of A.C. and D.C. amplifier systems and Electronic engineering practice essential. Experience of electro-mechanical, servo and synchronous transmission systems, together with H.N.C. or equivalent preferable. Second-class passage paid to successful applicant. Apply with full details of experience, etc., to Personnel Manager, Sperry Gyroscope Co. Ltd., Great West Road, Brentford, Middlesex. W 2239

AIRMEC LIMITED, High Wycombe, Bucks. have vacancies for: Technical Assistants; applicants should have Ordinary or Higher National Certificate and, preferably, have experience of electronic equipment. Development Engineers: applicants should have a Degree in electronic subjects, preferably telecommunications, and at least 3 years' experience of electronic equipment. Apply, giving full particulars, to the Personnel Officer. W 1633

A JUNIOR DRAUGHTSMAN (20-22), who has completed his National Service, is required for interesting work on centimetre-wave transmitting valve design. Applicants must hold the National Certificate and must be prepared to continue studies for H.N.C., for which facilities are available. Help given in securing accommodation in the area. Apply in writing, giving full details of age, qualifications and experience, to the Staff Manager (Ref. RL S/632), Research Laboratories of the General Electric Company Limited, North Wembley, Middlesex. W 2188

A JUNIOR ENGINEER is required by a company manufacturing aircraft instruments, for their laboratory in the Surrey area. He will be required to undertake experimental work and some design work in connexion with electronic and magnetic amplifiers and similar devices. Applicants should possess or be studying for a Degree or Higher National Certificate in Electrical Engineering. Write, giving age, qualifications and experience, to Box No. W 1647.

A MANUFACTURER of Television Receivers in the North West requires the services of a Television Design Engineer experienced in modern circuit techniques, and able to initiate and carry out simple development projects. Candidates should be between 25 and 35 years of age, and should have a University Degree or equivalent qualification. The post is permanent and pensionable and arrangements will be made to house the successful applicant. Please reply quoting reference CIH to Box No. W 2169.

APPARATUS ENGINEERS. Standard Telephones & Cables Ltd. have vacancies for electro-acoustic and telephones switching apparatus engineers. Age 20 to 35 years. Candidates should have preferably an Honours Degree, and possess initiative and ability with good practical outlook, enabling them to carry through investigations and development work with limited supervision. A good mathematical background and an interest in laboratory work is also desirable. Good salaries will be paid according to age, qualifications and experience. Write in confidence to Personnel Manager, Oakleigh Road, New Southgate, giving full particulars. W 2192

a first-class Degree in physics and mathematics. Salary in the range of £800-£1100 per annum. The field of work includes guided transmission, propagation, and electro-magnetic properties of semi-conductors. Applications should be in writing and addressed to the Personnel Manager, Standard Telecommunication Laboratories Limited, Progress Way, Enfield, Middlesex. W 2201

ASSISTANT CHIEF OF TEST (ELECTRICAL) required by light engineering factory, Stockport district, to take full responsibility for electrical test and inspection of radio and radar instruments. Applicants must be familiar with A.I.D., C.I.A., A.S.R.E. inspection procedures. Previous experience in similar position essential. Good technical qualifications an advantage. Write stating experience, age and salary required. Box No. W 2232.

A VACANCY in Research Laboratories for an Instrument Engineer for mechanical design and layout of electronic apparatus. Experience on electronic measuring instruments and working to Government specifications desirable and mechanical design in some field of electronic apparatus essential. Qualifications: up to A.M.I.E.E. or A.M.I.Mech.E. an advantage. Write giving full information to Personnel Officer, Ericsson Telephones Limited, Beeston, Nottingham. W 2204

BELLING & LEE LTD., Cambridge Arterial Road, Enfield, Middlesex, require research assistants in connexion with work on electronic components, fuses, interference suppressors and television aerials. Applicants must be graduates of the I.E.E. or possess equivalent qualifications together with similar laboratory experience. Salary will be commensurate with previous experience; five day week, contributory pension scheme. Applications must be detailed and concise, and will be treated as confidential. W 138

BRITISH OVERSEAS AIRWAYS CORPORATION urgently require Flight Simulator Maintenance Engineers, based near London Airport, for maintenance and modification of electronic computer type Flight Simulators. Candidates should have radio or electronic engineering background with elementary knowledge of mechanics, aerodynamics and mathematics to standard of elementary calculus. Desirable additional qualifications: (a) Pass in a City and Guilds subject in Telecommunications group; (b) Aircraft Radio Maintenance Engineer's licence; (c) experienced in design, construction or maintenance of electronic computers. Duties: 3-shift system covering 24 hours per day. Salary according to qualifications £11 14s. to £13 19s. per week, plus shift pay (approx. 32s. per week). Applications to be addressed to Staff Superintendent (Recruitment), B.O.A.C., London Airport, Hounslow, Middlesex. W 2200

BRITISH TELECOMMUNICATIONS RESEARCH LTD., associated with Automatic Telephone & Electric Co. Ltd. and British Insulated Callender's Cables Ltd., require a well qualified development engineer for work on Transmission Networks and Wave Filters. Applicants should have had previous experience in this field. An attractive salary will be offered to suitably qualified candidates. The position will be permanent and is covered by the superannuation scheme. Application should be made to the Director of Research, B.T.R. Ltd., Taplow Court, Taplow, Bucks, giving full details of qualifications and experience. W 2225

DESIGNER/DRAUGHTSMAN with H.N.C. is required by the Research Laboratories of The General Electric Co. Ltd., North Wembley, Middlesex, for work on the mechanical design of centimetre wave transmitting valves and associated apparatus. Some previous experience is desirable. Apply to the Staff Manager (Ref. RLO/179) stating age, qualifications and experience. W 2116

DESIGN DRAUGHTSMEN. Vacancies exist for Senior and Junior Design Draughtsmen in the Engineering and Research Departments of the Company. Applicants with previous experience in the design of aircraft instruments, electrical/electronic equipment and small mechanisms will be preferred, but general technical ability will be the first consideration. Permanent progressive posts, with superannuation benefits. Apply to Personnel Manager, Smiths Aircraft Instruments Ltd., Bishops Cleeve, near Cheltenham, quoting references, full particulars of previous experience, and salary required. W 2206

DESIGNER DRAUGHTSMAN, for small but growing company on South Coast. Ordinary National Certificate or equivalent in Electronic Engineering. Experience of electronic instruments and Ministry work. State age, experience and salary required to Industrial & Scientific Instruments Ltd., 30/32 Teville Road, Worthing. W 1646

DESIGN ENGINEER. Required by company of radio manufacturers in Johannesburg, South Africa. Write giving details of qualifications and experience and enclose copies of testimonials. State marital status and salary required to P.O. Box 1604, Johannesburg, South Africa. W 2181

DEVELOPMENT ENGINEERS, Senior and Junior, for Radio, Television and Electronics, North London area. Previous experience of circuit development work essential. Details of qualifications, experience and salary required, c/o newspaper, to Box No. W 2240.

DEVELOPMENT ENGINEERS are required by the Electronics Division of Murphy Radio Limited to work with a subsidiary Company at Ruislip, Middlesex. The work may be in the general field of Electronics but special projects require Personnel to work on ground and airborne aerial systems and telemetry. Applicants should write in the first instance quoting "Engineers Ruislip" giving full particulars of their experience and qualifications to Personnel Department, Murphy Radio Limited, Welwyn Garden City, Herts. W 2152

ELECTRICAL ENGINEER with some knowledge of electronics required by well-known firm of precision electrical instrument makers, S.E. London, for testing and calibrating. Qualifications: H.N.C. or Degree. Pension scheme. Full particulars of age, experience and salary required to Box No. W 2228.

ELECTRICAL ENGINEER. A well-known company in S.E. London has vacancies for engineers for development and design of laboratory instruments. The work covers a wide range of measurement techniques, mainly in the audio frequency range. Applicants should have experience in the design of audio frequency electronic apparatus, and qualifications to H.N.C. or higher. Write giving details of experience, qualifications and salary required to Box No. W 2177.

ELECTRONIC ENGINEER required by Capacitor Manufacturers (London) for development work on test instruments and electrical research. Permanent position with long-term scope. Write Box No. W 1636.

ELECTRONIC ENGINEER is required by firm in the Guildford area for development work on aircraft instruments and electronic equipment. Applicants should possess a University Degree or Higher National Certificate, or equivalent qualifications, and preferably have had laboratory experience in Physics, electrical engineering or instrument technology. They should apply, giving details of qualifications and experience, to Box No. W 1638.

ELECTRONIC ENGINEER required by new division of prominent Engineering Concern in Northern Ireland for development work on Guided Weapons and other projects. Degree or equivalent in electrical engineering or physics, with good practical experience, preferably of D.C. Amplifiers, Electronic Computation, Pulse Technique or Miniature Equipment. Good salary and prospects for man with originality. Details of housing accommodation available and facilities for removal supplied at interview. Send full details of age, qualifications and experience, quoting reference E.E.1, to Box No. W 2180.

CLASSIFIED ANNOUNCEMENTS
continued on page 4

CLASSIFIED ANNOUNCEMENTS

The charge for these advertisements at the LINE RATE (if under 1" or 12 lines) is: Three lines or under 7/6, each additional line 2/6. (The line averages seven words.) Box number 2/- extra, except in the case of advertisements in "Situations Wanted," when it is added free of charge. At the INCH RATE (if over 1" or 12 lines) the charge is 30/- per inch, single column. Prospectuses and Company's Financial Reports £14. 0s. 0d. per column. A remittance must accompany the advertisement. Replies to box numbers should be addressed to: "Electronic Engineering," 28 Essex Street, Strand, London, W.C.2. Advertisements must be received before the 14th of the month for insertion in the following issue.

OFFICIAL APPOINTMENTS

ADMIRALTY. Royal Naval Scientific Service. Engineers and Physicists (particularly with electronics) required for appointments in (a) Senior Scientific Officer and Scientific Officer grades (Ref. A246/52A) and (b) Senior Experimental Officer, Experimental Officer, and Assistant Experimental Officer grades (Ref. A247/52A) in Experimental Establishments in London, Portsmouth, Weymouth areas and Scotland. Candidates, British subjects, for (a) must possess first or second class Honours Degree in Physics or Engineering, or high professional attainments such as corporate membership of appropriate professional institution with suitable experience and responsibility, and for (b) should possess one of following qualifications: University Degree in Science, Engineering or Mathematics, Graduate membership of appropriate professional institution, Higher National Certificate, Final Certificate of five-year grouped course in relevant subject at City and Guilds of London Institute or comparable institution, Higher School Certificate with Mathematics or Science as principal subject or equivalent qualification. S.S.O.'s at least 26 years of age with at least three years' approved experience, London salary scale (men) £812-£1,022 per annum; S.O.'s at least 21 years £440-£707; S.E.O.'s at least 35 years £844-£1,075; E.O.'s at least 26 years £628-£786; A.E.O.'s at least 17½ years £274-£586. Rates for women and posts in Provinces somewhat lower. Starting salaries above minima may be granted according to age and experience. All appointments unestablished (with F.S.S.U. for S.S.O. and S.O.) but with some opportunities to compete for established posts. Application forms from M. of L. and N.S. Technical and Scientific Register (K), Almack House, 26, King Street, London, S.W.1, quoting appropriate reference. W 2220

£50 A YEAR TAX FREE bounty is paid to electronic artificers joining special section of the Army Emergency Reserve. Men with City and Guilds Final Certificate in Telecommunications and Radio and up-to-date experience in current electronic engineering practice will be needed to maintain electronic instruments controlling fire of anti-aircraft guns which protect vital centres of Great Britain should war break out. By joining the AER a man will not only be playing a vital part in the defence of this country but will also know his exact role in the event of war. Minimum rank Staff Sergeant. Minimum of 15 days training per year with Regular Army rates of pay in addition to bounty. Further details from DDME, Anti-Aircraft Command, "Glenthorn," Stanmore, Middlesex, or the War Office (AG.10/EA3), London, S.W.1. W 2178

B.B.C. requires a limited number of Technical Assistants, aged 21 or over, in Operations and Maintenance Department, for service at Transmitter, Studio and Television Centres throughout the United Kingdom. Knowledge of mathematics, electricity and magnetism to School Certificate standard; experience in electrical or radio engineering an advantage. Salary £360 p.a. with annual increments to £470 p.a. maximum. Promotion prospects. Application forms from Engineering Establishment Officer, B.B.C., London, W.1 (enclosing addressed foolscap envelope). W 2216

BOROUGH POLYTECHNIC. Borough Road, S.E.1 Department of Electrical Engineering and Physics. The Governors invite applications from suitably qualified candidates for the post of Senior Lecturer in the above department to begin duties in September, 1953. Applicants should be graduates of a British University and have had industrial experience in either design or operation of electrical machinery or experience in light current work, preferably involving the use of Pulse Techniques. Teaching experience would be an additional recommendation. The salary payable will be in accordance with the scale for Senior Lecturers as provided by the Burnham (Further Education) Report, 1951 (£1,040 by £25 to £1,190 per annum plus London allowance of £48 or £36). Particulars of the vacant post and forms of application may be obtained by sending a stamped addressed

foolscap envelope to the undersigned. Douglas H. Ingall, Principal. W 1637

BRISTOL MENTAL HOSPITAL MANAGEMENT COMMITTEE requires an Electronics Engineer (non-resident) to service, maintain and construct electro-encephalographic and electro-physiological equipment at Barrow Hospital, near Bristol. Salary according to age, qualifications and experience. Applications, giving full details and names of two referees, should be sent promptly to the Group Secretary (Applns/33), Bristol Mental Hospital, Fishponds, Bristol. W 2218

CROWN AGENTS FOR THE COLONIES. Chief X-ray Maintenance Technician, Medical Department, required for the Gold Coast Local Civil Service for two tours each of 18 to 24 months in the first instance. Consolidated salary £1,260 rising to £1,610 a year. Gratuity payable on satisfactory completion of final service at the rate of £37 10s. for every completed period of three months' service. Outfit allowance £60. Free passages. Liberal leave on full salary. Candidates must have served a regular apprenticeship to electrical engineering and have had considerable subsequent experience in the testing and repair of X-ray plant and electro-medical equipment. Apply at once by letter, stating age, full names in block letters, and full particulars of qualifications and experience, and mentioning this paper, to the Crown Agents for the Colonies, 4, Millbank, London, S.W.1, quoting on letter M.29758.B. The Crown Agents cannot undertake to acknowledge all applications and will communicate only with applicants selected for further consideration. W 2219

DEPARTMENT OF SCIENTIFIC AND INDUSTRIAL RESEARCH invites applications for unestablished Experimental Officer post at Torry Research Station, Aberdeen, for research into the physics of fish preservation involving investigations of properties of smoke, measurement of moisture, high vacuum techniques, colorimetry and servo-control methods. Pass Degree or H.N.C. with practical experience in physics and electronics; capacity for design and invention. Minimum age 26, preferably under 31. Salary £597-754. Forms from M.L.N.S. Technical and Scientific Register (K), Almack House, King Street, London, S.W.1, Quoting A.116/52/A. Closing date 13th February, 1953. W 2170

GRAYLINGWELL HOSPITAL. Chichester, Sussex. Electro-encephalographic Recordist required. Duties will consist of routine clinical recording and associated clerical work, with some assistance to the Research Department. Candidates should have, or be willing to study for, the grade of Junior Member of the Electro-Physiological Technologists Association. Experience is desirable, but applications will be considered from new entrants to this field. Salary will be according to age and experience. Applications to the Medical Superintendent. W 2227

INSTITUTE OF CANCER RESEARCH. Physics Department. Physicist or electronic engineer required to assist in research and clinical work on the applications of physics to diagnostic radiology. Applicants should preferably have had experience of modern electronic techniques such as television or radar. Salary within the range £565-£750 per annum according to qualifications and experience. Applications, giving the names of three persons to whom reference can be made, should be received by the Secretary, Institute of Cancer Research, The Royal Cancer Hospital, London, S.W.3, not later than a fortnight from the date of this advertisement. W 2223

MINISTRY OF SUPPLY. R.A.E., Farnborough, Hants, requires (1) Experimental Officer for experimental design of aircraft aerials for modern high-speed aircraft. Thorough knowledge of properties of aerials, transmission line filters and matching units, practical experience of measuring techniques and aerial development in VHF band essential. Knowledge of aircraft constructional materials and techniques as far as these affect aerial design also required. (2) Assistant Experimental Officer for design and test of communications receivers particularly on UHF and higher frequencies. knowledge

of crystal controlled transmitters and circuit techniques and skill in the layout and wiring of experimental models, would be an advantage. Duties may include flying as observer. Qualifications: Higher School Certificate (Science) or equivalent, but higher qualifications in physics or electrical engineering may be an advantage. Salary within ranges: E.O. (Minimum age 26), £597-£754; A.E.O., £264 (age 18)—£555. Women somewhat less. Posts unestablished. Application forms from M.O.L.N.S., Technical and Scientific Register (K), Almack House, 26, King Street, London, S.W.1, quoting D 484/52A. Closing date 13th February, 1953. W 2164

MINISTRY OF SUPPLY. Radar Research and Development Establishment, Malvern, Worcs., requires Physicists and Electrical Engineers for interesting development work leading to radar equipment for services. Opportunity to acquire good knowledge of micro-wave techniques. Qualifications: Higher School Certificate (Science) or equivalent, but other qualifications such as H.N.C. or a Degree in Physics or Electrical Engineering may be an advantage. Salaries within ranges, Experimental Officer (Minimum age 26) £597-£754, Assistant E.O., £264 (age 18)—£555. Women somewhat less. Posts unestablished. Application forms from M.O.L.N.S., Technical and Scientific Register (K), 26 King Street, London, S.W.1, quoting A337/52/A. Closing date, 14th February, 1953. W 2179

MINISTRY OF SUPPLY. R.A.E., Farnborough, Hants, requires: (1) Physicists or Engineers to work on problems connected with either generation and distribution of electric power in aircraft, or on problems of electro-technology arising in design and development of aeronautical equipment. Aptitude for practical work essential, some knowledge of maths. desirable. Ref. D.6/53A. (2) Engineer with extensive electronic or electrical experience for development work on the application of electronic and electrical equipment to flight vibration testing of aircraft. Ref. D.7/53A. Quals: Higher School Cert. (Science) or equivalent, but further training in physics, elec. or mech. eng., as appropriate to the standard of Degree or H.N.C., may be an advantage. Salary within ranges, Experimental Officer (min. age 26), £597-£754, Assistant E.O., £264 (age 18)—£555. Women somewhat less. Posts unestablished. Application forms from M.O.L.N.S., Technical and Scientific Register (K), 26 King Street, London, S.W.1, quoting appropriate reference. Closing date 13th February, 1953. W 2212

MINISTRY OF SUPPLY. Telecommunications Research Establishment, Malvern, Worcs., requires Electrical Engineers and Physicists for (a) the Scientific Officer grade (Ref. A5/53/A) and (b) Experimental and Assistant Experimental Officer posts (Ref. A6/53/A) for research and development work on radio and electronic equipment in the Radar, Physics and Engineering Departments. Work ranges from fundamental research on circuitry and physics of the solid state, to devising and developing in collaboration with Industry electronic devices for the R.A.F. and Naval Aviation. Ample scope for initiative and originality over a very wide field concerned mainly with electronics. Qualifications for (a) 1st or 2nd class Honours Degree in Physics or Light Electrical Engineering and for (b) Higher School Certificate (Science) or equivalent, but further training in Physics or Electrical Engineering to standard of H.N.C., pass Degree, etc., may be an advantage. Salaries within ranges: Scientific Officers, £417-£675; Experimental Officers (min. age 26), £597-£754; Assistant E.O., £264 (age 18)—£555. Women somewhat less. Posts unestablished but F.S.S.U. benefits may be available for S.O. grade. Application forms from M.O.L.N.S., Technical and Scientific Register (K), 26, King Street, London, S.W.1, quoting appropriate reference. Closing date 13th March, 1953. W 2217

MEETING A WIDESPREAD DEMAND

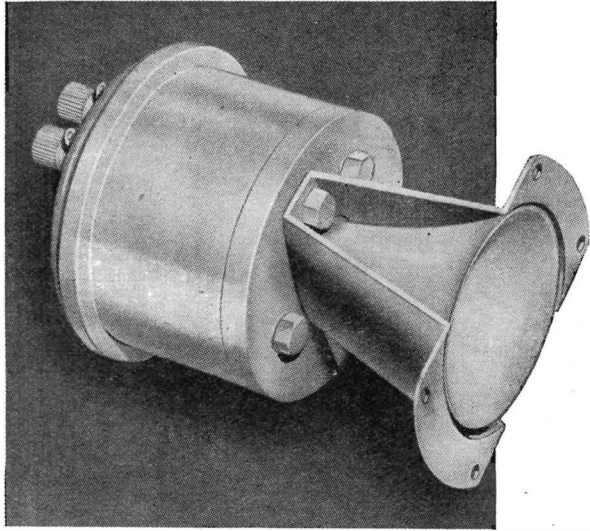

Stentorian

PRESSURE TYPE TWEETER UNIT

Since its introduction a few months ago this unit has proved exceedingly popular. It can be used with any cone speaker, providing very high quality reproduction at remarkably low cost.

The Unit is of the moving coil pressure type and is similar to that embodied in the 10" and 12" Concentric Duplex Loudspeakers. The speech coil is of aluminium wire, wound on an aluminium former which is rigidly fixed to an aluminium diaphragm. The speech coil and diaphragm is situated at the rear of the magnet and the centre pole hollowed out to form the commencement of the horn, in the centre of which is located the phase equalizer.

Speech coil impedance: 15 or 30 ohms. Flux Density: 14,000 gauss. Response: 2,000-14,000 c/s. Power handling capacity: 3 watts. Price 75/6d. It is recommended that a suitable cross-over network of between 2,000-3,000 c/s be used



* Our London showrooms at 109 Kingsway, are now open from 9 a.m. to noon every Saturday, when the complete range of Stentorian speakers may be heard and examined by appointment. Please write or telephone HOLborn 3074.

WHITELEY ELECTRICAL RADIO CO. LTD · MANSFIELD · NOTTS

RESISTORS

CLEAR THAT PRODUCTION
BOTTLENECK
NOW!

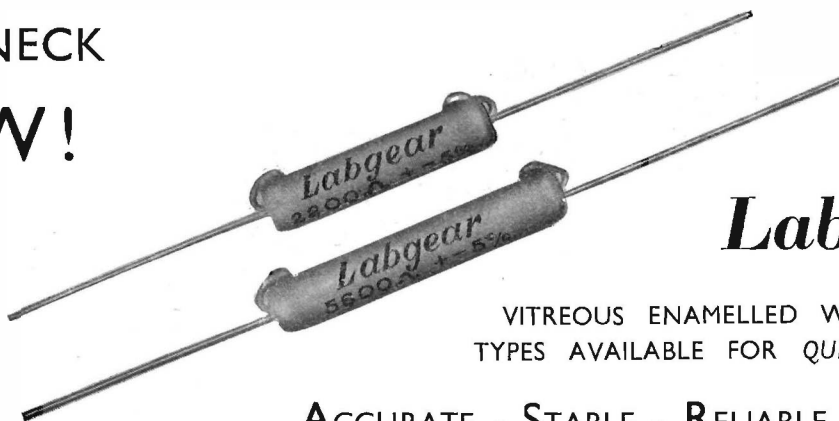

Labgear

VITREOUS ENAMELLED WIRE-WOUND
TYPES AVAILABLE FOR QUICK DELIVERY

ACCURATE · STABLE · RELIABLE · ROBUST

Labgear (Cambridge) Ltd.

WILLOW PLACE, CAMBRIDGE

PHONE 2494 (2 lines)

SITUATIONS VACANT Cont'd.

The engagement of persons answering these advertisements must be made through a Local Office of the Ministry of Labour or a Scheduled Employment Agency if the applicant is a man aged 18-64 inclusive or a woman aged 18-59 inclusive unless he or she, or the employment, is excepted from the provisions of the Notification of Vacancies Order, 1952.

ELECTRONIC ENGINEER required for Turbine Laboratory. Should possess a Degree in Electrical Engineering, and previous laboratory experience in Physics, Electrical Engineering or Instrument Technology would be an advantage. (Situation S.W. Middlesex.) Send details of qualifications, experience and salary required to Box No. W 1645.

ELECTRONICS ENGINEER. Ford Motor Company Limited, of Dagenham, Essex, require man aged not more than 35 with experience of electronics applicable to motor vehicle development. Exceptional opportunity. First-class remuneration. Non-contributory pension. Reply to Salaried Personnel Department giving brief details of experience. Quote ref. GSE/2. W 2193

ELECTRONIC TEST ENGINEER with sound mechanical knowledge required by well-known firm of precision electrical instrument makers, S.E. London. Permanent. Progressive. Pensionable. Apply, stating age, qualifications, experience and salary required to E/T, Box No. W 2234.

ENGINEER required to take charge of electronic laboratory engaged on servomechanisms. Apply stating age, experience and salary required to Evershed & Vignoles Ltd., Acton Lane Works, Chiswick, W.4. W 2231

ENGINEER OR PHYSICIST required in the Development Department of a large firm engaged in the production of navigational and scientific instruments. Applicants will be directly responsible to the Chief Development Engineer and must have a good Degree in Physics or Electrical Engineering. A flair for Mathematics would be considered most desirable, also some experience in the field of Gyroscopic and Electro-mechanical Servo systems would be an advantage but not an essential. Salary £500-£700 per annum according to age and experience. Please apply to S. G. Brown, Ltd., Watford. W 1632

ENGLISH ELECTRIC CO. LTD., Luton, have a vacancy for an Electronic Engineer with Drawing Office experience capable of translating Laboratory ideas into engineered equipment. H.N.C. or equivalent an advantage but not essential. Salary in range £500-£650 according to qualifications and experience. Please reply, quoting Ref. 1071, to Central Personnel Services, English Electric Co. Ltd., 336/7, Strand, W.C.2. W 2191

EXPERIENCED Radio Testers and Inspectors required for production of communication and radio apparatus. Also Instrument makers, wiremen and assemblers for Factory Test apparatus. Apply Personnel Manager, E. K. Cole Ltd., Ekco Works, Malmesbury, Wilts. W 146

EXPERIENCED Technical Illustrators, Technical Writers and Parts List Compilers required for work on electronic equipment. Apply, in writing, with full details to Mr. G. B. Ringham, Flight Simulator Division, Redifon Ltd., 59, Webber Street, S.E.1. W 2213

FERRANTI LIMITED (Moston) have a vacancy in the Physical Laboratory for a circuit development engineer for specialized test equipment. Applicants should possess at least H.N.C. or equivalent qualification and should preferably have had some experience in the development of test equipment. A good knowledge of television and radar circuit techniques is desirable. Permanent staff appointment with pension benefits. Forms of application from M. R. J. Hebbert, Staff Manager, Ferranti Ltd., Hollinwood, Lancs. Please quote reference LA. W 2238

GRADUATE Electrical Engineers, age 25-35, with Degree or H.N.C. and practical experience in servos, electronics, or tele-communications, required for Development work on low power servo systems. Apply with full particulars to Manager, Engineering Department & Labour, Vickers-Armstrongs Ltd., Crayford, Kent. W 2230

GRADUATE physicists or engineers are required for work concerned with (a) magnetron development, (b) micro-wave measurements, and (c) pulse modulators. Preference will be given to men with some previous experience in these fields. An initial period will be spent in the Laboratories to gain further experience with a view to ultimately taking over the technical responsibility in valve production and testing at a factory in the north of England. Please apply in writing to the Staff Manager (Ref. RLO/205), Research Laboratories of The General Electric Co. Ltd., North Wembley, Middlesex, giving full particulars of age, qualifications and experience. W 2166

GRADUATE PHYSICIST or Electrical Engineer is required for work on microwave measurements and test apparatus. Previous experience desirable. Apply in writing to the Staff Manager (Ref. RLO/334), Research Laboratories of The General Electric Co. Ltd., North Wembley, Middlesex, stating age and record. W 2222

JUNIOR ENGINEER required for manufacturer's Service Department in West London. Some previous knowledge of Electronic Measuring Instruments essential. Commencing salary up to £450 p.a., according to experience. Write with full details of age, technical qualifications, general education and past experience to Box No. W 2199.

LABORATORY SUPERINTENDENT required to supervise Research and Development Laboratories of prominent engineering concern in Northern Ireland engaged on work of national importance. The position involves responsibility for providing equipment, supplies and services in the Laboratories; also control of Laboratory personnel. Candidates should possess organizing ability and be familiar with the running of a Laboratory or Work Shop. Experience of Light Electrical or precision mechanical equipment essential. Ex-officers of technical branches of the Services considered. Details of housing accommodation available and facilities for removal supplied at interview. Send full details of age, qualifications and experience, quoting reference L.S.I., to Box No. W 2190.

LARGE RADIO MANUFACTURER has the following vacancies in radio receiver development department: (1) Senior development engineer, with experience in the design and development of domestic and/or car radio receivers. (2) Development assistant, to assist in the construction and testing of new models. (3) Designer-draughtsman, preferably with previous experience of radio receivers. Reply, with full details of previous experience and salary expected to Box No. W 2217.

MCMICHAEL RADIO LTD. require Senior and Junior Engineers in their equipment division laboratory at Slough. Training and experience in the field of applied electronics (including communications) and experience of working with Government Departments are the chief qualifications required. Write, stating age and full details of training, qualifications and experience to the Chief Engineer, Equipment Division, McMichael Radio Ltd., Slough, Bucks. W 157

MUIRHEAD & CO. LTD., Elmers End, Beckenham, have a vacancy for a Development Engineer with electronic and electrical design experience. H.N.C. or Degree in physics or electrical engineering. Interesting and varied work on laboratory instruments, e.g., R.C. oscillators, bridges, feed-back amplifiers, recorders, etc. Apply by letter to Personnel Manager stating salary required. W 2235

MURPHY RADIO LTD. have vacancies for experienced testers and inspectors for work on radio and electronic equipment with a subsidiary company at Ruislip, Middlesex. A number of qualified project supervisors are also required. Applicants should write in first instance giving full particulars of their experience and qualifications to Personnel Dept., Murphy Radio, Ltd., Welwyn Garden City, Herts. W 2101

MURPHY RADIO invite applications for posts as Development Engineers in their Electronics Division. Applicants should have Degree in Engineering or Physics or equivalent qualifications preferably with some industrial experience and should be capable of undertaking original development work and of leading a design team. Reasonable prospects of housing for London

applicants. Employment is permanent and pensionable and offers excellent opportunity of broadening experience. Applications giving full details of experience and qualifications may be forwarded in confidence to Personnel Manager, Murphy Radio Ltd., Welwyn Garden City. W 2184

MURPHY RADIO have vacancies in their Electronics Division for a first-class Senior Design Draughtsman and a Senior Mechanical Designer. Applicants should be up to at least National Certificate Standard and have had experience in design of Electronic Equipment, small mechanisms or similar work and must be capable of working on their own initiative. Reasonable prospects of housing for London applicants. Employment is permanent and pensionable and offers excellent opportunity of broadening experience in this interesting field of work. Full details of experience and qualifications should be included in applications which may be forwarded in confidence to Personnel Manager, Murphy Radio Limited, Welwyn Garden City. W 2183

NELSON RESEARCH LABORATORIES, The English Electric Co., Ltd., Stafford, require a man to undertake the calibration and standardization of electrical instruments, high frequency equipment and temperature measuring equipment. Previous experience of instrument calibration (other than house service meters) is essential. There will be scope in this vacancy for a keen and competent man to extend facilities and develop methods and equipment. Please reply, quoting reference 1072, to Central Personnel Services, The English Electric Co., Ltd., 336/7, Strand, London, W.C.2. W 2195

NELSON RESEARCH LABORATORIES, English Electric Company Ltd., Stafford, require Laboratory Assistants for experimental work in Physics, Engineering and Metallurgy, including magnetic materials, magnetic devices, dielectrics, measuring instruments, electrical measurements at all frequencies, small electrical machines, servo systems, valves and vacuum devices. Applicants should possess Higher National Certificate or higher qualifications. Experience in these fields is desirable but not essential. Salary according to qualifications and experience. Please reply stating age, qualifications and present employment to Central Personnel Services, English Electric Company Ltd., 336/7, Strand, W.C.2, quoting Ref. SA28. W 2196

PHYSICISTS AND ENGINEERS required for development work on cold cathode tubes for use in communications. Applicants should possess a Degree in physics or engineering or H.N.C. in electrical engineering, preferably with previous experience in similar work. The posts are pensionable and carry salaries commensurate with qualifications and experience. Applications with full details are to be addressed in the first instance to the Managing Director, Hivac Ltd., Greenhill Crescent, Harrow, Middlesex, and will be treated in confidence. W 2202

PYE LIMITED, CAMBRIDGE. Expanding television development programme has created vacancies for a number of senior television engineers with practical experience in the design of receiving and transmission equipment. The positions to be filled carry salaries in the region of £650 to £1250 per annum. Applications should be made to the Chief Television Engineer. W 2203

PYE TELECOMMUNICATIONS LTD., Ditton Works, Cambridge, has a vacancy for a Technical Writer. Experience of compiling technical literature and handbooks on electronic subjects essential. Please apply, giving age and full details to the Personnel Manager. W 2194

PYE TELECOMMUNICATIONS LTD., Ditton Works, Cambridge, will shortly have vacancies for senior and junior engineers. Experience in V.H.F. design and engineering is essential. Vacancies also exist for engineers with specialist experience in multi-channel V.H.F. Telephony. Salary according to qualifications and experience. Please apply, stating age, qualifications and experience to the Personnel Manager. W 156

CLASSIFIED ANNOUNCEMENTS
continued on page 6



Men against the sea

By a majestic change known only to the sea, this friendly ally can become a frightening enemy. There are times when a man feels very small and his ship seems a pitiable thing.

In times of danger a captain reflects on those who gave him command. The men who designed and built his ship, the crew that help him sail her : confidence in these gives the captain confidence in himself.

The instruments that help him are themselves helped by Parmeko transformers, particularly in radar, making safer 'blind' approach to shore. Parmeko are proud of their part in the chain of confidence that enables man to challenge and conquer the cruel sea.

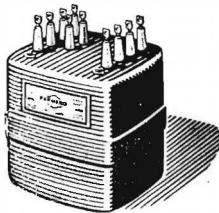

PARMEKO of **LEICESTER**

Makers of Transformers for the Electronic and Electrical Industries

SITUATIONS VACANT (Cont'd.)

The engagement of persons answering these advertisements must be made through a Local Office of the Ministry of Labour or a Scheduled Employment Agency if the applicant is a man aged 18-64 inclusive or a woman aged 18-59 inclusive unless he or she, or the employment, is exempt from the provisions of the Notification of Vacancies Order, 1952.

REQUIRED. Experienced Senior Electrical Draughtsmen with knowledge of aircraft radio, and electrical installations for work on experimental engine flight development and various projects. Draughtsmen from other branches of the electrical industry will be fully considered for these posts. Please write giving full particulars of experience and salary required to Personnel Manager, D. Napier & Son Ltd., Luton Airport, Beds. W 2210

RESEARCH AND DEVELOPMENT ENGINEER required for experimental work in connexion with the large-scale production of furniture in North London. Should have reached Degree standard in Engineering or Physics and should also have knowledge of electronics, including generation, transmission and matching of loads at frequencies between 1 and 20 Megacycles per second. An interest in administration and a good mechanical aptitude are desirable. Salary according to training and experience. Box No. W 2163.

RESEARCH AND DEVELOPMENT ENGINEERS are required by British Telecommunications Research Ltd., a Company associated with The Automatic Telephone & Electric Co. Ltd. and British Insulated Callender's Cables Ltd., for work on long term development projects in Wide-band Line Communication. A number of posts with salaries in the range £500-£1000 per annum are available for suitably qualified engineers or physicists with experience in this field. Further posts are available for technical assistants with salaries in the range £300-£600 according to qualifications and experience. Applications are also invited from Hons. Grads. in physics or electrical engineering who are considering careers in the research and development side of the telecommunications industry. There is a superannuation scheme and the company works a five-day week. Applicants joining early in the year will be eligible for full annual holidays. Application should be made to the Director of Research, British Telecommunications Research Ltd., Taplow Court, Taplow, Bucks, giving age and full details of education, qualifications, experience and approximate salary required. W 2226

RESEARCH ENGINEERS required, age 25-35. Applicants should be of Degree standard, preferably with Communications training and sound mathematical background. The work is experimental and concerned with various problems in electronics and acoustics. Applications stating age, previous experience and salary required should be addressed to Personnel Department, Kelvin & Hughes Ltd., New North Road, Barking, Essex. W 2189

SENIOR DRAUGHTSMEN. A number of Senior Draughtsmen are required immediately for layout work in the construction of prototypes and customer-built electronic and electro-mechanical equipment. Previous experience essential. Good salaries offered to first-class men. Stable employment under good staff conditions. Five-day week. Contributory Pension Scheme. Apply to Personnel Officer, Mullard Research Laboratories, Cross Oak Lane, Salford, Near Redhill, Surrey. W 2176

SENIOR AND JUNIOR DRAUGHTSMEN required for work on small mechanical and electro-mechanical devices. Seniors must be capable of initiating and developing original ideas and producing accurate production drawings. Juniors required for detailing, circuit diagrams, etc. Excellent working conditions in country surroundings. Bus services to Kingston, London, Guildford pass the premises. Modern equipment, five-day week, canteen, pension scheme, sports and social club, with recreational facilities. Salaries commensurate with knowledge and experience, and travelling expenses for interviews will be paid. Applicants must be of British nationality and details of age and experience should be addressed to The Manager, Cottage Laboratories Ltd., Portsmouth Road, Cobham, Surrey. W 2211

SENIOR ELECTRONIC RESEARCH ENGINEER required to carry out work on development of Electronic Nucleonic instruments. Only engineers having had previous experience in this type of work, or experience in pulse and wide band amplifier technique, should apply. Excellent opportunities offered to selected candidate whose ability meets requirements. Write stating age and previous experience to Chief Engineer, Electronics Division, Burndep Ltd., Erith, Kent. W 2198

SENIOR ENGINEER required to be responsible for development of electronic control systems and associated test apparatus. Candidates should preferably have experience of airborne equipment. Applications, which will be treated in strict confidence, to state age, qualifications and experience. Quoting reference EE/SE, write Box No. W 2215.

SENIOR TEST ENGINEERS. South Manchester. Several vacancies for well qualified test engineers for work on radio and radar equipment. Previous experience on testing and fault diagnosis essential. Write stating age and experience. Box No. W 2233.

SERVICE ENGINEER aged 25-30 required for Pyrometry section of the Morgan Crucible Co., Ltd. Successful applicant should have Ordinary National Certificate or equivalent and practical experience of installation maintenance and calibration of all types of flow pressure and temperature instruments and electronic and mechanical controls. Position is permanent and pensionable. Write giving details of age, experience, qualifications and salary required to the Staff Manager, Battersea Church Road, S.W. 11. W 2209

SOLARTRON LABORATORY INSTRUMENTS LIMITED require Senior and Junior Draughtsmen for development work on Electronic projects. The work offers considerable scope for men with initiative. Attractive salaries in excess of A.E.S.D. rates will be offered to suitable applicants. Applications to Solartron Laboratory Instruments Ltd., 22, High Street, Kingston-on-Thames. W 2241

S. SMITH & SONS (England) Limited, Bishops Cleeve, Cheltenham. The Parent Company of Smiths Aircraft Instruments Ltd. have a number of immediate and future vacancies in their Laboratories for Research Engineers, Physicists and Development Engineers for work on Guided Weapons, Aircraft Instruments and Automatic Pilots. The vacancies are at various levels of responsibility. For the more senior posts applicants should have an Honours Degree or equivalent and must be capable of leading a team and have knowledge and experience in one or more of the following fields: (a) Servo Mechanisms. (b) Aerodynamics. (c) Electronics (preferably including Magnetic Amplifiers). (d) Instrument Mechanisms. (e) Small Electric Motors. Other posts are available for applicants with qualifications ranging from Higher National Certificate to Honours Degree, preferably with knowledge and experience in one or more of the above fields. The scale of commencing remuneration will range, according to age, record and technical qualifications, from £550 to £1500 per annum. All posts are pensionable and accommodation assistance will be afforded successful applicants, with guaranteed housing after completion of a satisfactory probationary period. Applications are to be made on the appropriate forms (quoting Ref. GWI/H) obtainable from the Personnel Manager at the above address. W 2185

T.C.C. invite applications for the positions of Technical Sales Representatives in the radio, electronic and electrical industries. Applicants should state, in detail, their age, qualifications, experience and salary required. Only first-class men are being entertained—preferably those with previous experience in the industry. Write (in confidence) to Sales Director, The Telegraph Condenser Co. Ltd., North Acton, W 3 W 2243

TECHNICAL ASSISTANT. with experience in electronic work, required for development laboratory in large Telecommunication Engineering Works. Give particulars of experience, education and technical training, certificates held, and commencing salary required. London, S.E. Area. Box No. W 2221.

TECHNICAL ASSISTANTS required for work in Electronics Laboratory. National Certificate standard. Experience in development of VHF Equipment, Pulse and Wide Band Amplifier technique. Good prospects. Write stating age, qualifications and experience to Personnel Dept., Burndep Ltd., Erith, Kent. W 2175

TECHNICAL ASSISTANTS for cathode-ray tube technical production control in N.W. London. O.N.C. Standard in Electrical Engineering essential. Salary £416-£550 according to age, qualifications and experience. Apply Box No. W 2187.

TECHNICAL ASSISTANTS for radio valve technical production control in N.W. London. O.N.C. Standard in Electrical Engineering essential. Salary £416-£550 according to age, qualifications and experience. Apply Box No. W 2188.

TECHNICAL ENGINEERS with Degree or equivalent for Radio Valve Development. Previous experience desirable. Position of some responsibility. Applications to Personnel Department, Osram-G.E.C., Hammersmith, W.6. W 2186

TECHNICAL WRITER required for Publicity Department of leading valve manufacturers. Advertising experience an advantage. Age 26-30. Apply stating salary required to 487, Box No. W 2229.

THE BRITISH THOMSON-HOUSTON CO., LTD., require (A) a Technical Assistant to maintain electronic equipment at their Lutterworth works. Applicant must hold Ordinary National Certificate (Elec), and have had experience in similar work. (B) Experienced men for the wiring of electronic equipment including radar. Applicants must be capable of working directly from theoretical circuit diagrams. Owing to accommodation difficulties, only single men can be considered for both these posts. Apply stating age, salary required, and previous experience to: Employment Office, The British Thomson-Houston Co., Ltd., Rugby. W 2162

THE GENERAL ELECTRIC CO. LTD., Brown's Lane, Coventry, requires Senior and Junior Electronic Development Engineers for work on Guided Weapons and like projects, particularly in the field of Microwave and Pulse Applications. Mechanical Development Engineers, Designer Draughtsmen and Draughtsmen, preferably with experience of Radar type equipments, also required for the above projects. Salary according to age, qualifications and experience. Houses will be allocated to selected staff. Apply by letter stating age and experience to The Personnel Manager (Ref. R.G.). W 158

THE PLESSEY CO. LTD. invites applications for a Divisional Sales Manager possessing sound technical knowledge and commercial experience of Electro-Chemical products and Powder Metallurgy. This is a new important position created by the expansion of these activities at their new factory in Northants, and calls for an executive able to take initiative and be fully responsible for all its commercial activities and future expansion. Details should be addressed to Executive Director and Joint Secretary, the Plessey Company Ltd., Ilford, Essex, quoting reference EE/DSM. W 2205

THORN ELECTRICAL INDUSTRIES LTD., in the course of the formation by their subsidiary, Radar Components Ltd., of a new team to undertake work of National Importance in the Thermionic Valve field, require several Junior Technical Assistants (19 to 22 years of age). Candidates who should have a definite interest in Vacuum Physics and a willingness to apply their scientific knowledge to development and production rather than to pure research, must be of Inter. Standard in Mathematics, Physics and Chemistry and have had some industrial experience. Applications giving full particulars of technical training and experience should be addressed to the Employment Manager, Thorn Electrical Industries Ltd., Great Cambridge Road, Enfield, Middlesex. W 2182

TRIALS ASSISTANTS required for Guided Missiles. Advertiser wishes to thank all those who replied to this advertisement under Box No. W 2964 and would advise that these positions have now been satisfactorily filled. W 2224

UNIVERSITY GRADUATES in electrical engineering and physics are invited to make application regarding vacancies in an Engineering Department for development work on air-

CLASSIFIED ANNOUNCEMENTS
continued on page 8

SOLARTRON LABORATORY AMPLIFIER

GAIN STABILITY 0.1%

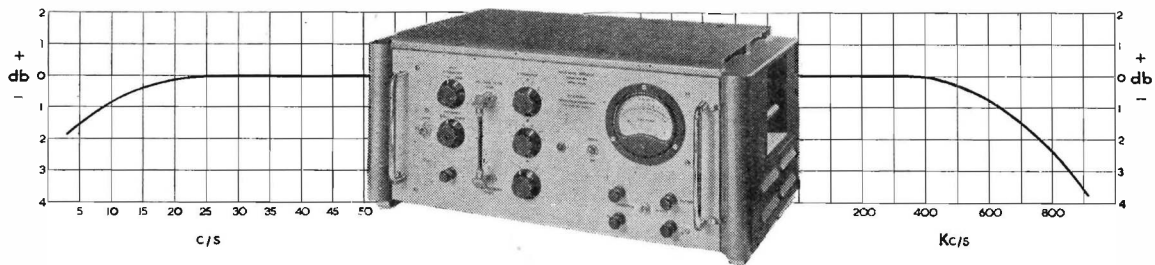

MODEL AWS 51A

SPECIFICATION

FREQUENCY RESPONSE: Level 15 c/s-350 Kc/s.

GAIN: 94 db. Sensitivity 25 Microvolts.

DISTORTION: Negligible at full output.

INPUT IMPEDANCE: 600 ohms or 100 Kiloohms.

ATTENUATOR: 60 db variable in 1 db steps, with an additional 20 db input pad.

OUTPUT: 240 volts peak to peak for C.R.T. deflection, or, 5 volts on meter for voltmeter readings.

A versatile new amplifier which can be used as a highly sensitive valve voltmeter, a deflection amplifier for C.R.T.s or, with an external filter as a frequency selective amplifier, or bridge detector.

Features include ● Excellent gain stability ● Low noise level ● Good phase shift characteristics resulting from inverse feedback ● Level response ● Steel bench case in grey hammer finish ● 19 in. polished anodized dural panel.

Write for details of this and other high quality instruments to :

SOLARTRON

WIDE RANGE OSCILLATORS ● PULSE GENERATORS ● VIDEO AMPLIFIERS ● REGULATED POWER SUPPLIES

SOLARTRON LABORATORY INSTRUMENTS LTD., 22 High St., Kingston, Surrey.

KINGSTON 8981 P.B.X.

It's important...

... to know the right people!

When specialised precision work is required you should know about us. For the Electronics Industry, for instance, we produce all kinds of Metal Fabricated Units in addition to the manufacture of Cabinets, Control Panels, Transformer Tanks, Chassis Assemblies, Components, Pressings and Stampings to individual specification. Why not consult us now and be sure you know the right people to solve your metal fabrication problems.

SPENCER & SONS
(MARKET HARBOROUGH) LTD.

**METAL FABRICATION FOR
THE ELECTRONICS INDUSTRY**

We are always pleased to advise on any specialised fabrication work without obligation.

GREAT BOWDEN ROAD · MARKET HARBOROUGH, E · LEICESTERSHIRE · PHONE: 2651/2

SITUATIONS VACANT (Cont'd.)

The engagement of persons answering these advertisements must be made through a Local Office of the Ministry of Labour or a Scheduled Employment Agency if the applicant is a man aged 18-64 inclusive or a woman aged 18-59 inclusive unless he or she, or the employment, is exempted from the provisions of the Notification of Vacancies Order, 1952.

borne electronic equipment, theoretical and experimental work on aircraft fuel contents gauges. Send details of qualifications and experience, quoting ref E12, to Chief Development Engineer, Waymouth Gauges & Instruments Ltd., Station Road, Godalming, Surrey. W 1639

WORKS MANAGER required. Higher National Certificate or equivalent in Electronic or Radio Engineering. Development experience. Keen man for small but growing Instrument Company on South Coast. State age, experience, qualifications, salary required to Industrial and Scientific Instruments Ltd., 30-32 Teville Road, Worthing. W 1635

YOUNG ENGINEER, 21-25, required for interesting situation in a development department associated with quantity production of light electrical components. Workshop experience and Higher National Certificate an advantage. Box No. W 2214.

YOUNG MEN (20-22) who have completed their National Service are required to fill a limited number of vacancies for interesting research work in Electronics Illuminating Engineering, and Magnetic Materials. Applicants must have exemption from Intermediate B.Sc., and experience in a technical arm of the Services, although not essential, would be an additional qualification. Facilities are available for further education, and the successful applicants will be encouraged to study for a University Degree. Help given to those seeking accommodation in the area. Apply in writing, giving full details of age, qualifications, and experience to the staff Manager (Ref. RLS/628), Research Laboratories of the General Electric Company Limited, North Wembley, Middlesex. W 2167

YOUNG ENGINEERS with University Degree or equivalent qualification required for interesting work on scientific and industrial instrumentation. Apply giving personal details and salary required to Cambridge Instrument Co. Ltd., Sydney Road, Muswell Hill. W 1597

A further "Situations Vacant" advertisement appears on page 52 in displayed style.

SITUATIONS WANTED

A **YOUNG** Indian engineering graduate with wide experience in Radio and brilliant career who is receiving training with a famous Continental Radio Factory, desires appointment under some British firm to work on their staff in India. Box No. W 1644.

FOR SALE

AMERICA'S famous magazine Audio Engineering, 1 year subscription 28s. 6d.; specimen copies 3s. each. Send for our free booklet quoting all others; Radio Electronics, Radio and Tele. News, etc. Willen Limited (Dept. 9), 101 Fleet Street, London, E.C.4. W 108

COMPONENTS. Our 1953 Catalogue is now available giving full details of our comprehensive range of components. Watts Radio, 8 Baker Street, Weybridge, Surrey. W 1634

ELECTRONIC COMPONENT SUPPLIES. We specialize in the supply of Electronic Components, Accessories, Test Equipment, etc., for Government Depts., Industrial Concerns, Research Establishments, Laboratories, Colleges, etc. Your enquiries and orders will receive our prompt attention. Holiday & Hemmerdinger Ltd., 74/78 Hardman Street, Deansgate, Manchester, 3. Tel.: Deansgate 4121. W 148

FLUORESCENT LIGHTING KITS. All types from 30s. Control units, starters, holders. Simple instructions. "Dynalite Electrical", 38 Stevedale Road, Welling, Kent. W 1640

MAGSLIPS at 1/10th to 1/20 of list prices. Huge stocks. Please state requirements. K Logan, Westalley, Hitchin, Herts. W 116

MINIATURE BALL BEARINGS, Steel Balls, Stainless Steel and Phosphor Bronze Balls. Prompt delivery. Distributors: Inslay (London) Ltd., 21/22 Poland Street, London, W.1. Tel.: GERrard 8104 and 2730. W 155.

SINE-COSINE RESOLVERS (3" Magslip Transmitters No. 5, AP 10861). Brand new, each in maker's tin. Offered in quantity at less than one tenth of cost. Export inquiries invited. P.B. Crawshaw, 166 Pixmore Way, Letchworth, Herts. W 153

WEBB'S 1948 Radio Map of the World, new multi-colour printing with up-to-date call signs and fresh information; on heavy art paper 4s. 6d., post 6d. On linen on rollers 11s. 6d., post 9d. W 102

EDUCATIONAL

CITY & GUILDS (Electrical, etc.) on "No Pass—No Fee" terms. Over 95 per cent successes. For full details of modern courses in all branches of Electrical Technology send for our 144-page handbook—Free and post free. B.I.E.T. (Dept. 337C), 17 Stratford Place, London, W.1. W 142

FREE. Brochure giving details of courses in Electrical Engineering and Electronics, covering A.M.Brit., I.R.E., City and Guilds, etc. Train with the Postal Training College operated by an Industrial Organisation. Moderate fees. E.M.I. Institutes, Postal Division, Dept. EE29, 43, Grove Park Road, London, W.4. (Associate of H.M.V.). W 2808

THE UNIVERSITY OF SOUTHAMPTON. Department of Electronics. The Department of Electronics gives an advanced course at Honours Degree standard in Electronics. The course is full-time for one academic year and the University grants a Diploma by examination to students who successfully complete the course. Entry qualification is a University Degree in Physics or Electrical Engineering, or its equivalent. The next course will commence in October, 1953, and application for admission should be made now to the Academic Registrar, from whom further details may be obtained. W 2236

SERVICE

CAPACITY available for assembly and wiring, also reconditioning radio transmitter receiver equipments and units all types, amplifiers, etc. South London area. Write Box No. W 2118.

CAPACITY AVAILABLE for Assembly and Wiring of Electronic equipments. Design and development undertaken if required. Comprehensive experience in modern top-priority techniques. Fully conversant with Service requirements. Omicron (Electronics) Limited. Precision Electrical, Mechanical & Electronic Engineers, 74, Burlington Road, Coventry. W 1643

METALWORK. All types cabinets, chassis, racks, etc., to your own specifications. Philpott's Metal Works, Ltd. (G4BI), Chapman Street, Loughborough. W 2862

SOLDERING TAGS and Eyelets, Screws, Nuts and Washers for all purposes. Thos. Allnutt & Co., Lee Chapel Lane, Langdon Hills, Essex. Laindon 122. W 1562

SUB-ASSEMBLIES AND WIRING; electronic instruments, radio, etc. Skilled personnel. Medium capacity. Box No. W 1641.

BUSINESS OPPORTUNITIES

AGENTS with established connexions with Engineers, Radio manufacturers, Electrical Appliance manufacturers required for all areas by North-west firm manufacturing Nameplates, Dials, etc. Existing accounts will be transferred. Commission basis only. Applicants should state age, experience, territory required and names of principal customers. Applications which will be treated in strict confidence to be addressed to the Managing Director, Woodmet Limited, Globe Lane, Dukinfield. W 1642

PATENTS

THE PROPRIETORS of British Patent No. 557,675 relating to Improved Device for Measuring Force Electrically, are desirous of entering into arrangements by way of licence or otherwise on reasonable terms for the purpose of exploiting the same and ensuring its full development and practical working in this country. Interested parties who desire a copy of the Patent Specification and further particulars should apply to Matthews, Haddan & Co., of 31/2, Bedford Street, London, W.C.2. W 2208

THE PROPRIETOR of British Patent No. 563,561 relating to Electronic Translating Devices is desirous of entering into arrangements by way of licence or otherwise on reasonable terms for the purpose of exploiting the same and ensuring its full development and practical working in this country. Interested parties who desire a copy of the Patent Specification and further particulars should apply to Matthews, Haddan & Co., 31/2, Bedford Street, London, W.C.2. W 2207

The TYPE C.F.B. AUDIO TRANSFORMER

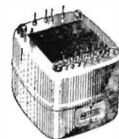

Technical information in Data Sheet No. 3.

EARLY DELIVERY

Designed to exacting formulae—built to a rigid specification the C.F.B. series is universally acknowledged without rival. Incorporating the latest grain orientated strip wound 'C' cores, the C.F.B.s assure the full audio band width with the absolute minimum distortion. Here are some brief figures: series leakage induct. 10 m.H.; primary shunt induct. 130H. Coupling between primaries:—Leakage induct. for one half, other shorted, 30mH. D.C. resistance per half primary 88 ohms: Power up to 60 w. from 2 c/s-30 kc/s, distortion less than 1 per cent with no negative feed back.

PARTRIDGE TRANSFORMERS LTD
ROEBUCK ROAD · KINGSTON BY-PASS · TOLWORTH · SURREY
TELEPHONE: BLM 6100 6727 0

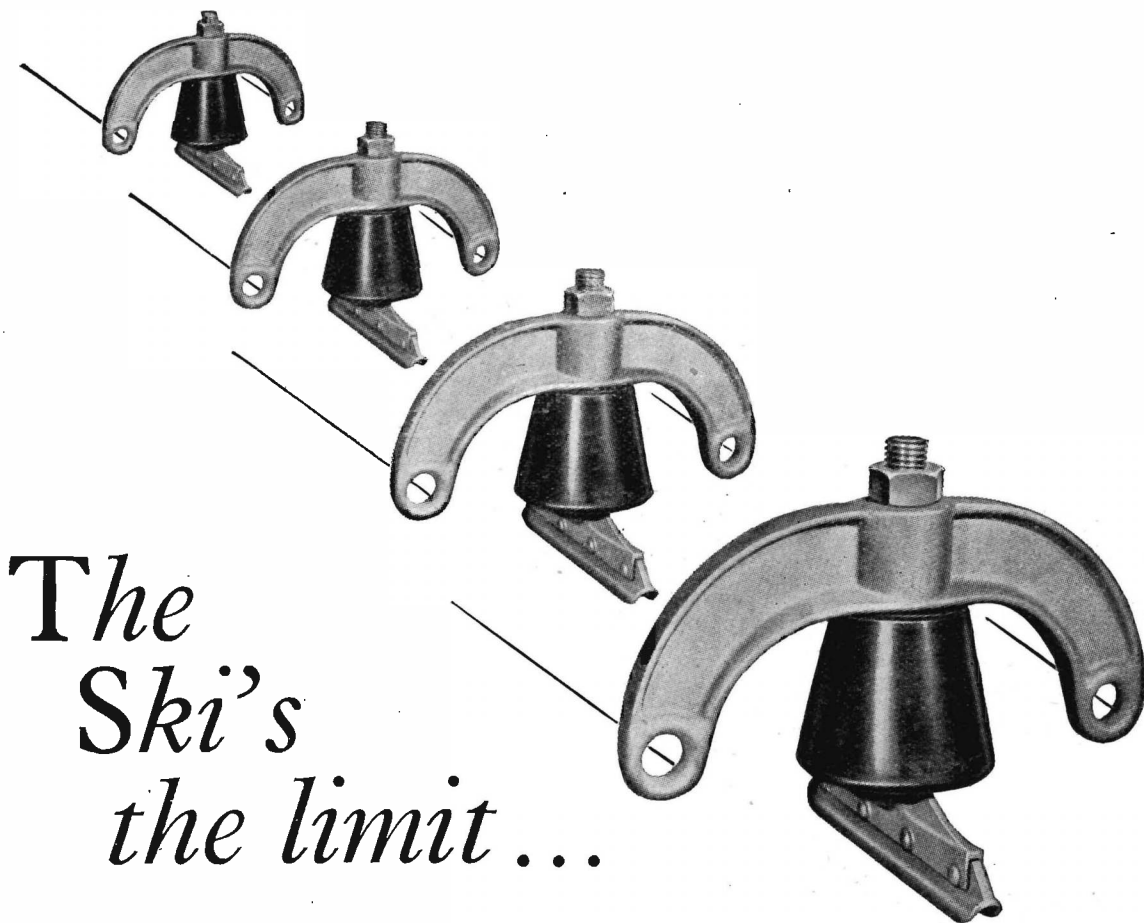

The Ski's the limit...

Our four winter sports enthusiasts are in reality Tufnol bell insulators for overhead power lines. They help us to point to the unlimited potentialities of Tufnol in industry generally.

By way of example: in the case of the moulded Tufnol bell insulators illustrated, absolute reliance can be placed on the impressive figures of its electrical strength and tensile breaking strain — and those figures hold

good under the most adverse conditions of exposure for many, many years.

But Tufnol is also supplied in sheets, tubes, rods, bars, angles, channels, and other standard sections, to be drilled, tapped, sawn, milled, turned,

A group of Tufnol Gears. Tufnol is suitable for most types of gears.

punched, or routed to your own specification — in your own workshops if required. Tufnol asks no favours — it can be machined accurately

and as easily as hardwood without revealing any of the obvious defects of either wood or metal when subject to corrosive conditions, moisture, impact, or simple wear and tear.

The only limit set to the uses of Tufnol is the limit of your own ingenuity in employing this very versatile material.

HOW MUCH IS KNOWN ABOUT TUFNOL?

We have prepared literature containing all the data relevant to Tufnol as a material and many authenticated instances of its application to engineering and industrial problems. Our own Technical Staff are always ready to co-operate in, and report factually on, any proposed new development. Why not write TODAY?

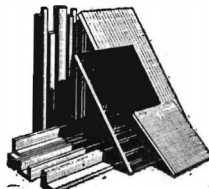

TUFNOL
REGISTERED TRADE MARK
An ELLISON Product

TUFNOL LTD • PERRY BARR • BIRMINGHAM • 22B

248

Redifon

WORLD RADIO

LINKS NATION TO NATION—
CITY TO CITY, VILLAGE & OUTPOST
AIRPORT TO AIRCRAFT—
SHIP TO SHIP & SHIP TO SHORE



REDIFON LIMITED, BROOMHILL ROAD, LONDON S.W.18.

Vandyke 7281

Ceramic stand-off Insulators

by
U.I.C.

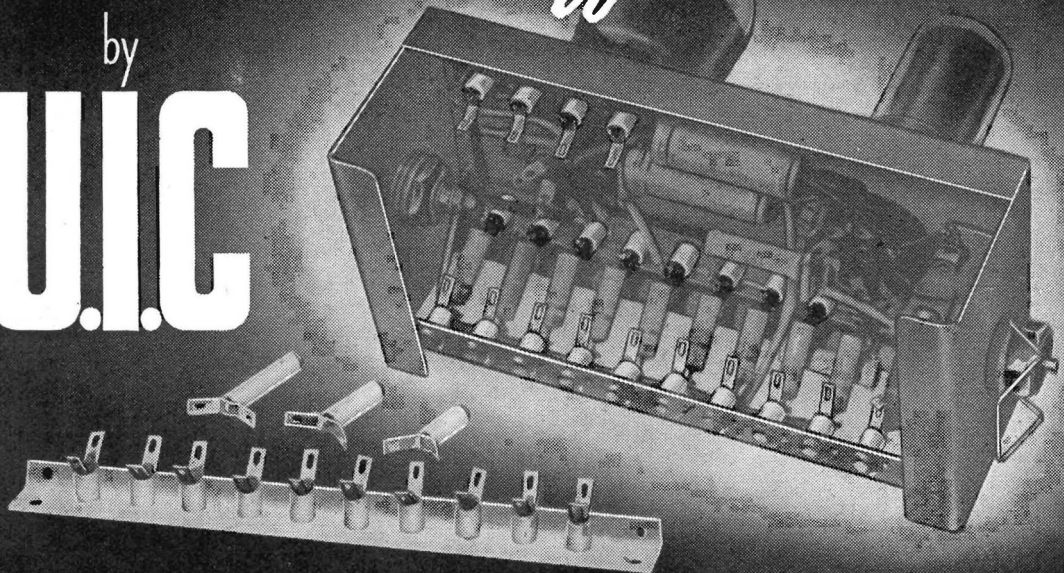

UNITED INSULATOR CO. LTD. OAKCROFT RD. TOLWORTH · SURBITON · SURREY
TELEPHONE: ELMBRIDGE 5241 CABLES: CALANEL, SURBITON



Electronic LEAK DETECTOR

*Convenient
Accurate
Sensitive*

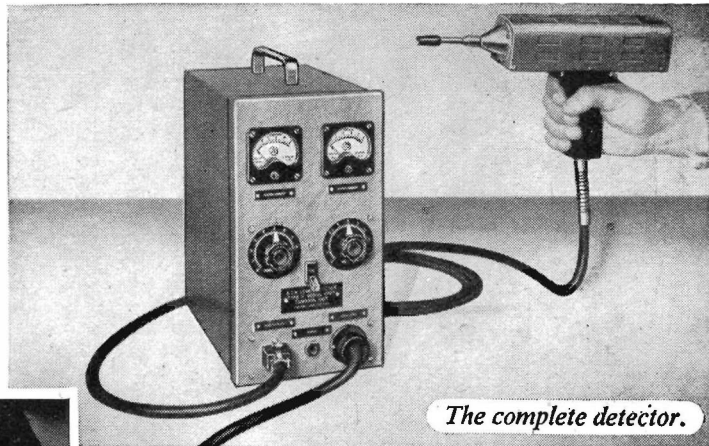

The complete detector.

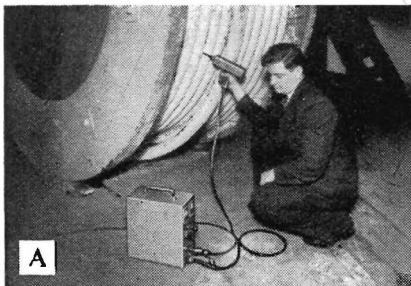

A

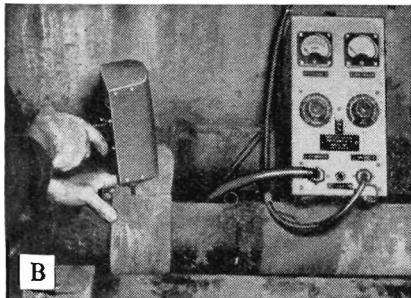

B

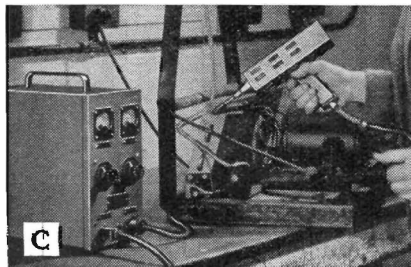

C

Leaks in containers or pipes imperceptible by other means can be easily and accurately located by the BTH Type H Electronic Leak Detector. This instrument, developed in the BTH Research Laboratories to detect the vapours of halogen compounds in air, is sensitive enough to react to Arcton (CCL_2 , F_2) escaping from a container at the rate of 1/50 oz. per year. The detector is easily portable—eminently suited to use in the laboratory or on the assembly line, or for service testing in the field. Applications include testing of refrigeration and air-conditioning plant, which already contains a halogen-bearing compound, and leak-testing of tanks, pipes, joints, welds, pneumatic systems, etc. by introducing a suitable "tracer" gas into the system under test. The detector emits, by means of a small built-in sounder, a series of clicks; a change of frequency denotes the presence of a leak. For work in noisy surroundings headphones are available.

Illustrations show use of the detector in examining for leaks (A) Gas-filled cables (B) Pipe seams (C) Refrigerator unit.

THE
BRITISH THOMSON-HOUSTON

COMPANY LIMITED, RUGBY, ENGLAND

Member of the AEI group of companies

A4293



Who is switching off the supply?

Are you? Do you realise that roughly half this country's supplies of new steel are made from scrap? That factories like yours are among the main sources of the raw material needed in the steel-works? It is vitally important that these sources should not be allowed to dry up.

Do not forget that scrap does not begin and end with the daily turnings in your machine shop. There is another form of scrap. Obsolete machines and equipment, redundant buildings, in fact everything containing iron and steel which has outlived its effective purpose — all this is scrap and should be sent off to your local scrap merchant as soon as possible.

Search your works for it and turn it in. You will be doing yourselves a great service.

Visit Stand No. 1

at the National Electrical Engineers
Exhibition, Earls Court, March 25-28
— and see what STEEL is doing to
help the national effort.

Issued for the STEEL SCRAP DRIVE by the
British Iron and Steel Federation and the National Federation of
Scrap Iron, Steel and Metal Merchants.



Precision in process control

The Ignitron is designed for precision control of processes involving the use of comparatively low voltages and high currents—for example, resistance welding and X-ray exposure control.

It exhibits some important advantages over other methods ;

the ignitron combines the precision and freedom from mechanical problems of the thermionic valve with the robustness of the contactor ;

it is compact, moderate in weight and has a long life.

'ENGLISH ELECTRIC' Ignitrons are made in a range of standard sizes, interchangeable with all other types in common use. They can be water-cooled and are suitable for line voltages of 250-600 volts.

'ENGLISH ELECTRIC'

ignitrons

THE ENGLISH ELECTRIC COMPANY LIMITED, QUEENS HOUSE, KINGSWAY, LONDON, W.C.2
Rectifier Sub-station Department, Stafford

WORKS: STAFFORD · PRESTON · RUGBY · BRADFORD · LIVERPOOL · ACCRINGTON

I.G.I.

FEBRUARY 1953

13

ELECTRONIC ENGINEERING 3

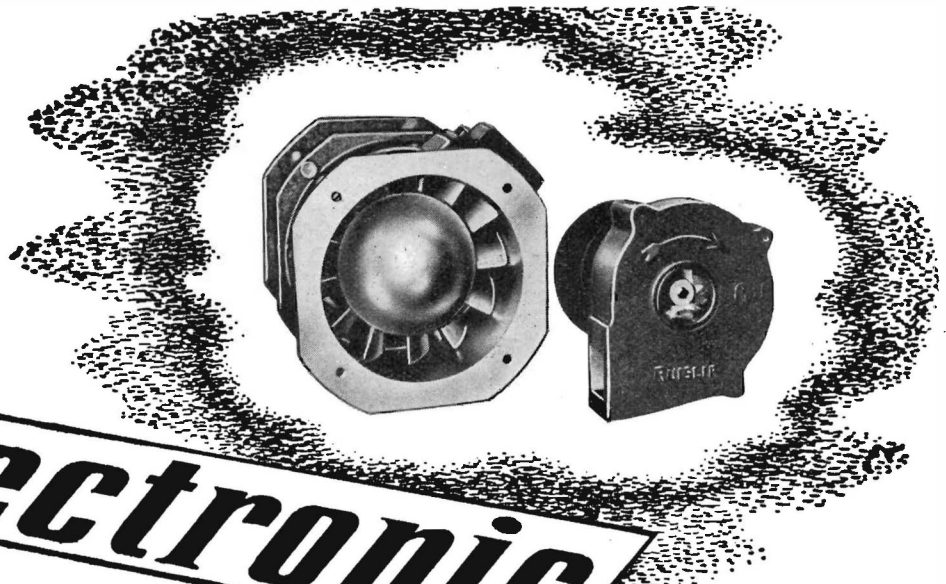

Electronic COOLING

The wide range of blowers for force-cooling of valves and maintenance of desired temperature levels in electronic and general electrical apparatus is typical of the progress maintained by **ADI**. The illustration shows the smallest of the blowers (4" Axial Flow type and 2½" Centrifugal type), but our range covers duties from 5 c.f.m. up to many thousands of c.f.m. at pressures up to 45 or more inches w.g. These blowers are used in MARINE & AERODROME RADAR INSTALLATIONS, AIRCRAFT AUTOMATIC PILOTS, COMMUNICATION AND BROADCASTING STATIONS, R.F. HEATING EQUIPMENT, Etc. Let us know your application—we shall be pleased to put forward our proposals.



Complete
Air Treatment
Plant

AIR CONTROL INSTALLATIONS LTD.
RUISLIP MIDDX.

Telephone: Ruislip 4066 (8 lines)



Telegrams: Controlair, Ruislip

BIRMINGHAM

MANCHESTER

GLASGOW

Getting quarts

The illustrations of the A.B. "H" Type Switch, right and miniature "H" Type, below are approximately actual size.



into pint pots...

Successfully tackling the problem of getting a quart into a pint pot is this miniature version of the well-known A.B. "H" Type Switch. It has been introduced to meet the demand for a switch of the same complete reliability and versatility as the standard "H" Type, but conforming to the contemporary trend towards more compact design.

Early deliveries can be given, and your enquiries are cordially invited.



METAL PRODUCTS LTD.
16, BERKELEY STREET, LONDON, W.1

Telephone: GROsvenor 5206/7 Telegrams: Abmet, Piccy, London.

For Mutual and Self Inductance measurement...

..... in the range $0.001\mu\text{H}$ to 30mH , the 'CINTEL' Mutual and Self Inductance Bridge will be found unequalled for accuracy and simplicity of use. Also measuring resistance in the range $100\mu\Omega$ to 3000Ω , this bridge is an essential piece of laboratory equipment, full details of which are available on request.

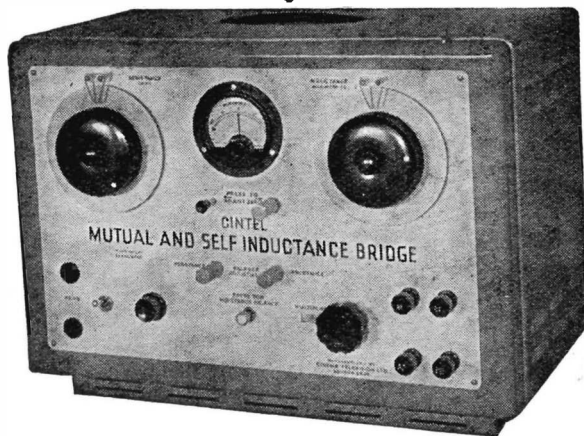

CINEMA-TELEVISION LIMITED

A Company within the J. Arthur Rank Organisation

WORSLEY BRIDGE ROAD · LONDON · SE 26

Telephone: HITHer Green 4600

F. C. Robinson & Partners Ltd.,
287 Deansgate, Manchester, 3

SALES AND SERVICING AGENTS
H. Hawnt & Co., Ltd.,
59 Moor St., Birmingham, 4

Atkins, Robertson & Whiteford Ltd.,
100 Torrissdale Street, Glasgow, S.2



REGISTERED TRADE MARK

Advanced design for fast triggering

From amongst the wide range of *Standard* thermionic tubes for industrial applications, these three are undoubtedly leaders in their class; designed and built to do the job better... quicker... and to offer a level of reliability that is traditionally *Standard*.

Standard VALVES for a full life.

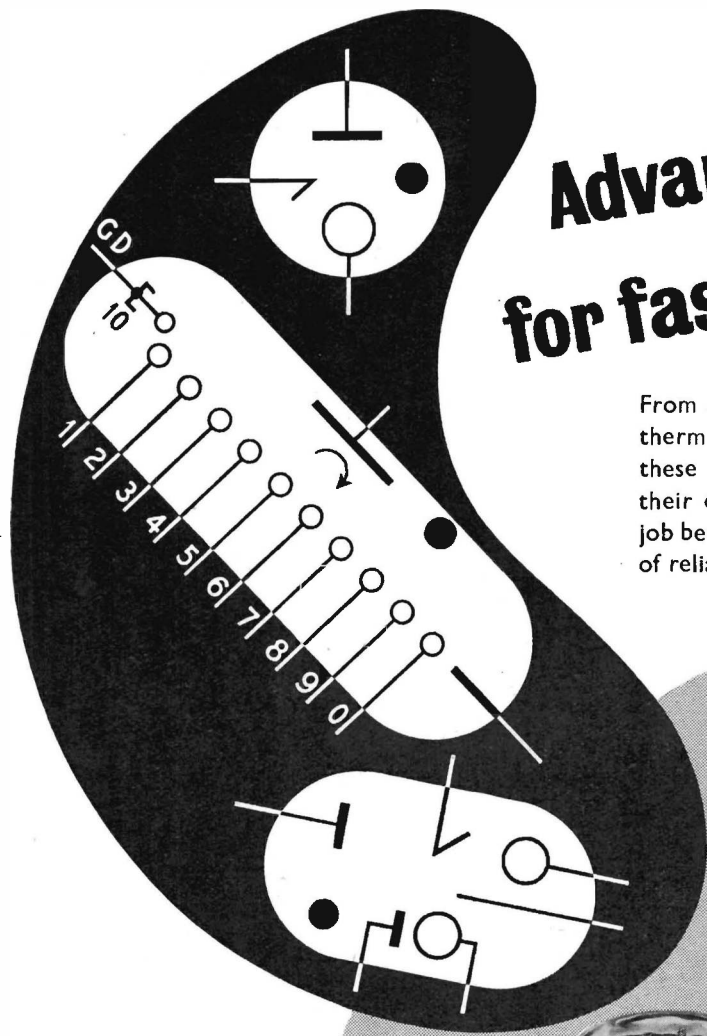

G1/235G
Sub-Miniature
Cold-Cathode
Gas-Filled Relay

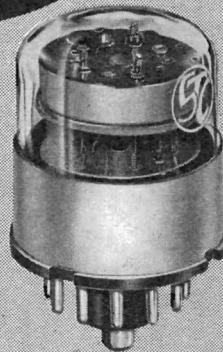

G10/241E
"Nomotron"
Unidirectional Cold-
Cathode Gas Tube
Decade Counter



G1/371K
High-Speed
Primed-Trigger
Cold-Cathode Tube



Standard Telephones and Cables Limited

Registered Office: Connaught House, Aldwych, London, W.C.2

RADIO DIVISION • Oakleigh Road • New Southgate • London • N.11

METAL BONDING WITHOUT PRESSURE

'ARALDITE' Type 1

—A Hot-Setting Synthetic Resin with outstanding adhesive properties

MADE IN OUR DUXFORD FACTORY—DELIVERY FROM STOCK

WHAT IS 'ARALDITE'?

'Araldite' Type 1 is a completely new synthetic resin developed as a hot-setting adhesive primarily for bonding metals. It is available in rods about 11 in. long and as a powder. Both forms are supplied in two colours: "natural", which gives a very light brown shade, and "silver", which imparts a metallic tint to the bond. For use when gap-filling properties are not required, 'Araldite' Type 15, a hot-setting solution, is recommended. A cold-setting form of 'Araldite' is also available.

HOW IS IT APPLIED?

The surfaces to be bonded are first heated to 100–120°C. The 'Araldite' rod is then rubbed (or the powder is sprinkled) on the surfaces, when the resin will melt and flow with ease. Curing requires the application of heat alone. Light clamping or a simple jig suffices to hold the surfaces in contact. *No skilled labour is required.*

CURING TIMES?

These range from approximately 10 minutes at 240°C. to 7 hours at 140°C. and proportionately longer at lower temperatures.

STRENGTH?

'Araldite' bonds possess unusually high mechanical strength under both static and dynamic loading. They are resistant to high humidity and to common organic solvents.

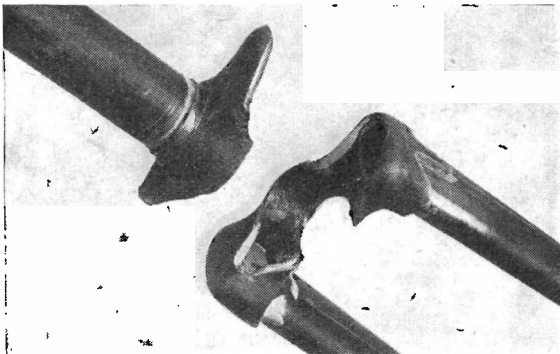

These 'Araldite'-bonded bicycle forks were tested to destruction. Note that the metal has fractured, not the joint.

OTHER APPLICATIONS?

'Araldite' Type 1 produces excellent bonds with porcelain, china, mica, quartz, etc., provided proper attention is paid to differing coefficients of thermal expansion. Because no water or other volatile substance is evolved during setting, 'Araldite' is especially recommended for bonding non-porous materials.

CORROSION?

'Araldite' does not cause corrosion and light alloys can be anodised before or after bonding.

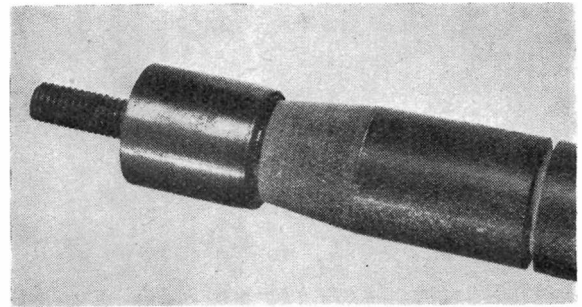

High strength and durability are features of 'Araldite'. Here, Type 1 adhesive is used to bond metallic ferrules to Mycalex insulator rods for high-voltage apparatus.

NOTE

'Araldite' (Regd.) is also available in the form of a Surface Coating Resin (which is particularly suitable for protecting light alloy castings from corrosives) and as a Casting Resin with adhesive and electrical properties that afford many uses in the manufacture of radio and electrical components.

Further details will be supplied gladly on application.

AERO RESEARCH LIMITED

A CIBA COMPANY

DUXFORD · CAMBRIDGE

Phone: SAWSTON 187



By Appointment to the Professional Engineer...

ATTENUATORS · FADERS · STUD SWITCHES AND TOGGLE SWITCHES
WIREWOUND POTENTIOMETERS · HIGH STABILITY CARBON RESISTORS
WIREWOUND RESISTORS · PLUGS AND SOCKETS · TERMINALS
KNOBS DIALS AND POINTERS

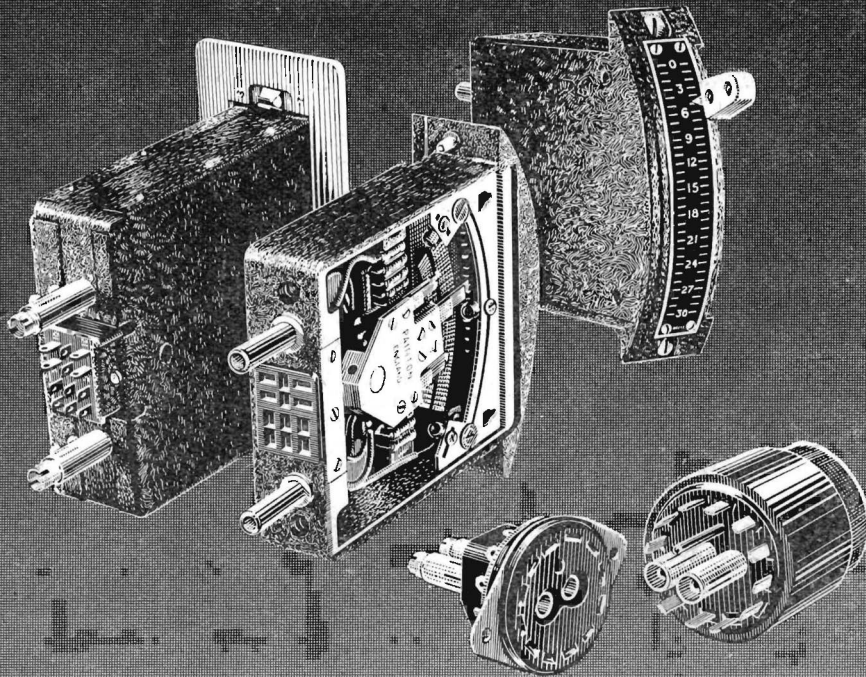

TELEVISION CONTROL FADER

A 30-step Instrument with coaxial input and output facilities · Frequency response substantially flat to 8Mc./s. · Cueing and signal contacts incorporated.

TELEVISION PLUG AND SOCKET

Incorporating 2 P.O. No. 1 Coaxial-Connectors and 12 contacts of 5-Amps./500 V. rating. The Plug has a die-cast cover with built-in cable clamp.

PAINTON

Northampton England

The "Belling-Lee" page for Engineers

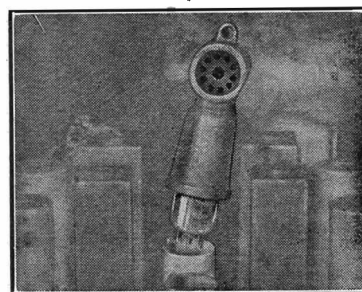
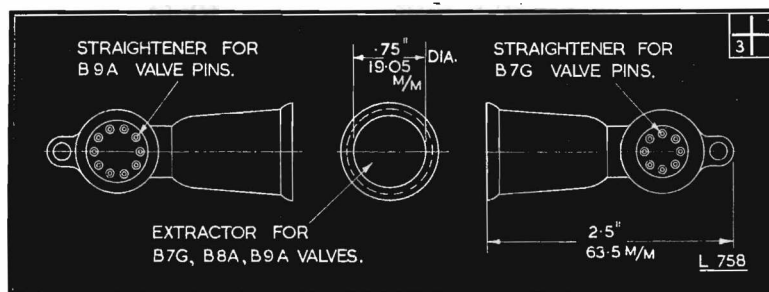

VALVE EXTRACTOR

Suitable for B7G, B8A, and B9A valves, this novel valve extractor will be found extremely useful for removing valves from equipment made up of closely packed components.

LIST NUMBER

L 758

The extractor is moulded in rubber, and a pin straightener for B7G and B9A valves is incorporated in the handle. This pin straightener is accurately moulded in a hard phenolic material; and will obviate the damage to valves and/or holders caused through trying to force insertion with bent pins.

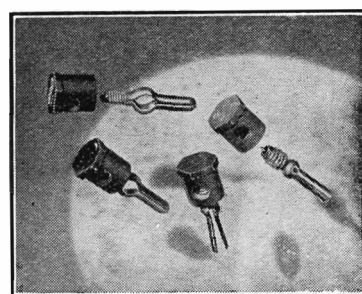
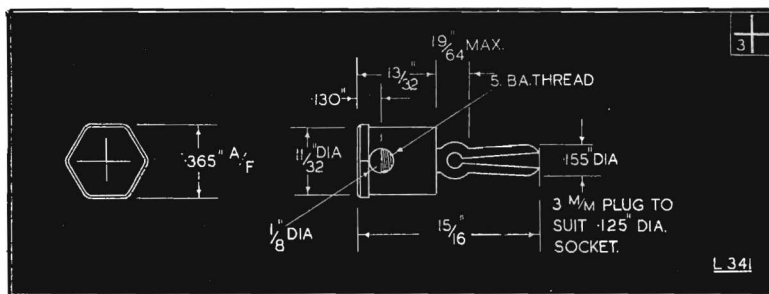

"BOWSPRING" WANDER PLUG

The "bowspring" design of the turned brass pins gives a remarkably strong contact. Moulded in black or red phenolic material, and fitted with hexagonal cap; side loading for flexible leads.

LIST NUMBER

L 341

Can be supplied lettered, subject to special quotation.

Please write for Catalogue P.347/EE.

BELLING & LEE LTD
CAMBRIDGE ARTERIAL RD., ENFIELD, MIDDX., ENGLAND

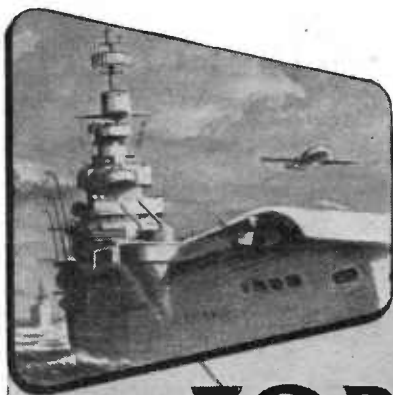

FOR PRECISION

E.M.I. MINIATURE WAVEFORM MONITOR TYPE WM.3

Y AMPLIFIER FEATURES

- Critically damped ;
- Rise Time $0.15 \mu\text{s}$;
- Bandwidth D.C. - 3.5 Mc/s ;
- Sensitivity
- 20 mv/cm to 70V/cm :
- Amplitude Gating eliminates
- Overload Defects ;
- Differential Input Circuits.

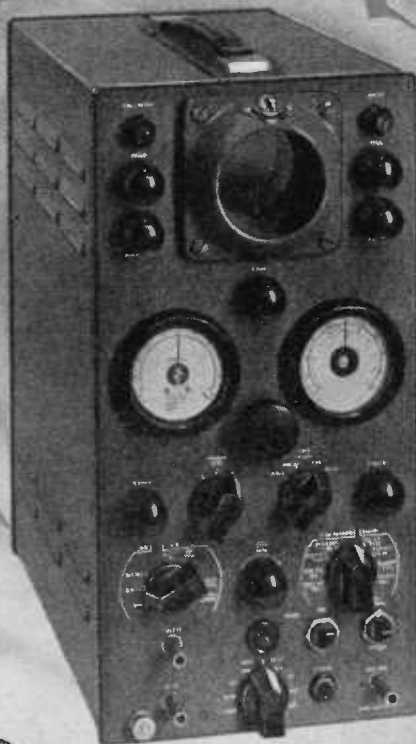

ADDITIONAL FACILITIES

- Direct Time Measurement
- to $\pm 2\%$ F.S.D.
- from $0.5 \mu\text{s}$ to 40 ms
- Sync./Trig. Amplifier with
- Amplitude — Frequency —
- Phase Discrimination :
- Direct Voltage Measurement
- A.C./D.C. to $\pm 2\%$ F.S.D.
- from $\pm 20 \text{ mv}$ to $\pm 500\text{V}$.

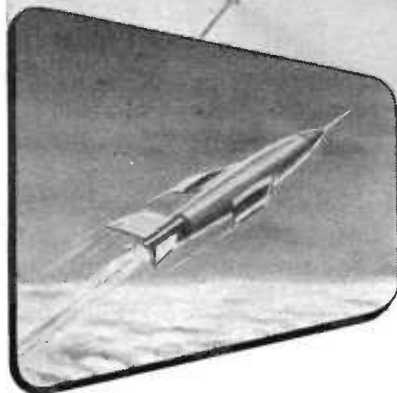

AN OSCILLOSCOPE BY
E.M.I. FACTORIES LTD.,
HAYES, MIDDLESEX

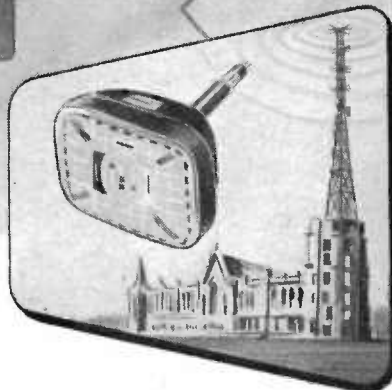

E.F.12

THE

STABILISED POWER SUPPLY TYPE 776

provides all the necessary power supplies for electronic equipment in the **LABORATORY** and **WORKSHOP**.

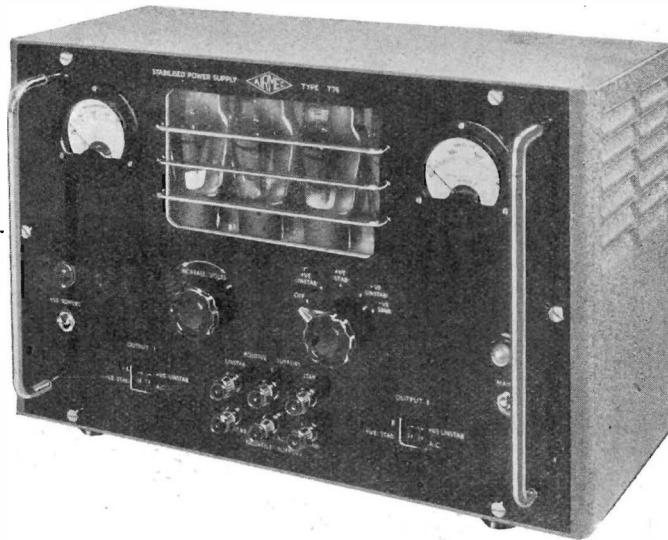

OUTPUTS

Positive

STABILISED output continuously variable from 200-350V at maximum currents of 200-100 mA. Output voltage change is less than 0.5 per cent for ± 10 per cent input change. Unstabilised output of 500V at 200 mA.

Negative

STABILISED output of 85V at 5 mA. Unstabilised output of 500V at 3 mA.

Alternating

6.3V at 5A.

THIS UNIT, NOW IN STOCK, operates on 100-130 and 200-250V, 50 c/s mains. It is fitted with both voltage and current meters, and a single meter switch enables them to be connected to any of the four direct outputs. An output control enables the stabilised positive supply to be varied continuously between 200 and 350V, and a separate switch controlling all D.C. outputs is fitted for convenience of operation.

Full details of this or any other Airmec instrument will be forwarded gladly upon request.

AIRMEC
L I M I T E D

HIGH WYCOMBE — BUCKINGHAMSHIRE — ENGLAND

Telephone: High Wycombe 2060

Cables: Airmec High Wycombe



Mullard Ferroxcube
being extruded into
rods for H.F. cores.

MAGNETIC MATERIALS Extensive
research and manufacturing facilities have established

Mullard as the leading producers of magnetic materials.
They were the first, for example, to introduce Ferroxcube, the
world's most efficient magnetic ferrite; 'Ticonal' anisotropic
permanent magnets, renowned for their high stability and high
energy output; and Ferroxdure, an entirely new type of
permanent magnet with the insulating properties of a ceramic.

The wealth of experience gained from these developments is
available to all users of magnetic materials through the Mullard
advisory service. An enquiry to the address below will put a
team of specialised engineers at your disposal.



Mullard

'TICONAL' PERMANENT MAGNETS • FERROXDURE PERMANENT MAGNETS
FERROXCUBE MAGNETIC CORE MATERIAL

MULLARD LTD., COMPONENT DIVISION, CENTURY HOUSE, SHAFTESBURY AVENUE, LONDON, W.C.2.

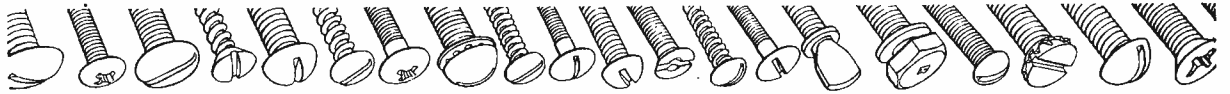

Dear Sir,

How do you dictate? To a secretary, or to a Dictaphone Time-Master? Speaking for ourselves, we find both methods have their advantages. Based on more important considerations, preferences are shown in industry too - such as the use of Linread screws and small fasteners when it comes to assembling a product. Yes, a Dictaphone for example. Representative of the great names in their own fields of manufacture, Murphy, Hawker, Hoover and Dictaphone, among others, all specify Linread. To us this association is one of pride in our work. To you, however, it has been presented in a series of advertisements as conclusive proof that in accuracy, quality of material and doing the job for which they are intended, Linread screws are as good as screws can be. They are, in fact, the best.



We supply all industries requiring small fasteners of the highest quality to hold together the products they manufacture. Our specialists are always at your service to advise and assist you with your own particular problems.

LINREAD LTD. STERLING WORKS COX ST. BIRMINGHAM 3

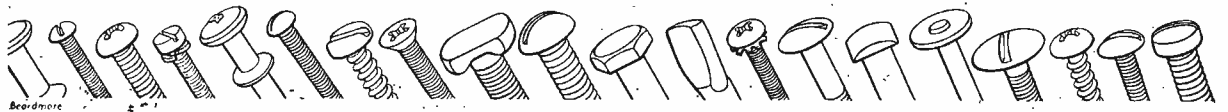

Exceptional impedance range

With forty-eight impedance steps from 2.5Ω to $20,000\Omega$ for balanced inputs—and a similar number for unbalanced at one-quarter the impedance—the instrument is ideal for optimum load matching. Two important design features play a great part in this meter's excellent performance over so wide a range of impedance. First, the use of a resistance network* to select the significant figures of the input impedance value. Second, decade multiplication of impedance by a transformer with a wound-strip core of anisotropic alloy.

* Brit. Pat. 648,944



Audio Frequency Output Power Meter TF893

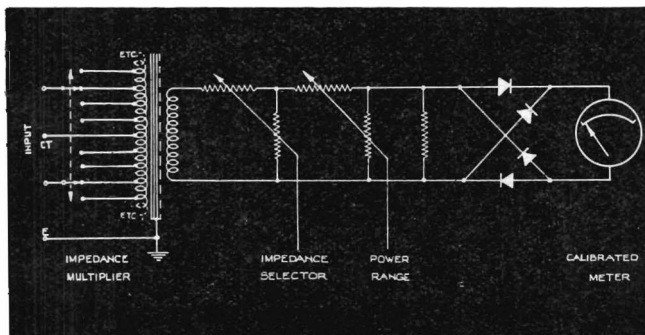

RANGE

Power :

20 μ W to 10W in five ranges

Impedance :

0.625 Ω to 20,000 Ω

Frequency :

Practically flat response over range exceeding 500:1

MARCONI INSTRUMENTS

Signal Generators • Valve Voltmeters • Frequency Standards • Bridges • Wave Meters • Wave Analysers • Beat Frequency Oscillators

MARCONI INSTRUMENTS LIMITED • ST. ALBANS • HERTS • Telephone: St. Albans 6161/7

Midland Office: 19 The Parade, Leamington Spa. **Northern Office:** 30 Albion Street, Hull. **Export Office:** Marconi House, Strand, London, W.C.2

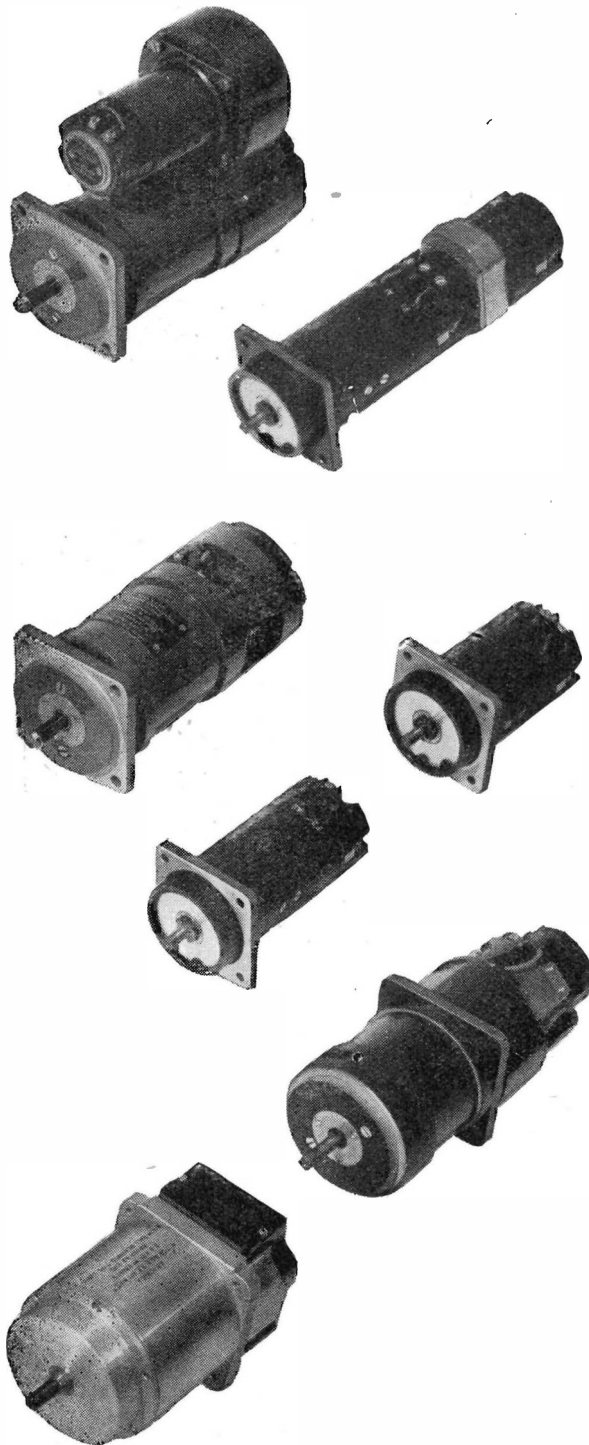

F.H.P. MOTORS

TYPICAL D.C.

SERVO MOTORS FOR ELECTRONIC CONTROL

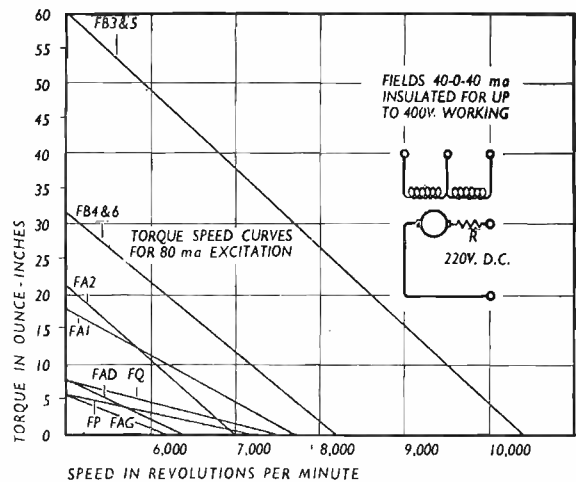

Frame Size	Armature Moment of Inertia Oz Ins ²	Brush and Bearing Friction Oz Ins	Generator Output Per 1000 R.P.M. Volts
FP	0.5	0.5	—
FAG	0.75	1.2	20
FQ	0.75	0.5	—
FAD	1.0	1.2	20
FA1	1.6	0.75	—
FA2	1.9	1.2	20
FB*3 FB*5	2.0	1.0	—
FB4 FB6	2.0	1.0	—

* FITTED WITH A SEPARATELY EXCITED BLOWER MOTOR

EVERSHED

Motors may be supplied with a limited range of alternative Armature and Field Windings.

All motors rated for a standstill temperature rise of 55°C. Please send for the Evershed Small Motors Data Book E.E. 266.

EVERSHED & VIGNOLES LIMITED ACTON LANE WORKS · CHISWICK · LONDON · W.4.

Telephone : Chiswick 3670

Telegrams : Megger, Chisk, London

Cables : Megger, London.
6/84a

Modern in conception, design and performance, the E.2., with its exceptionally wide range, not only fulfils to-day's needs of radio and television, but anticipates the requirements of tomorrow. More than ordinary care has been used in screening and filtering. As a result, stray field is less than $3\mu V.$ at 100 Mc/s.

- Frequency accuracy of $\pm 1\%$ extends over the whole range.
- Output voltage $1\mu V.$ to 100mv. and approx. 1v. at full R.F. Socket.
- Internal modulation; external modulation to 80%
 - A.F. Output variable 0-50v. at 400c/s.
 - Size $13" \times 10\frac{1}{4}" \times 8"$.
 - Weight $17\frac{1}{2}$ lbs.

Advance

signal generator

ADVANCE TYPE E2

100 Kc/s - 100 Mc/s ON
FUNDAMENTALS

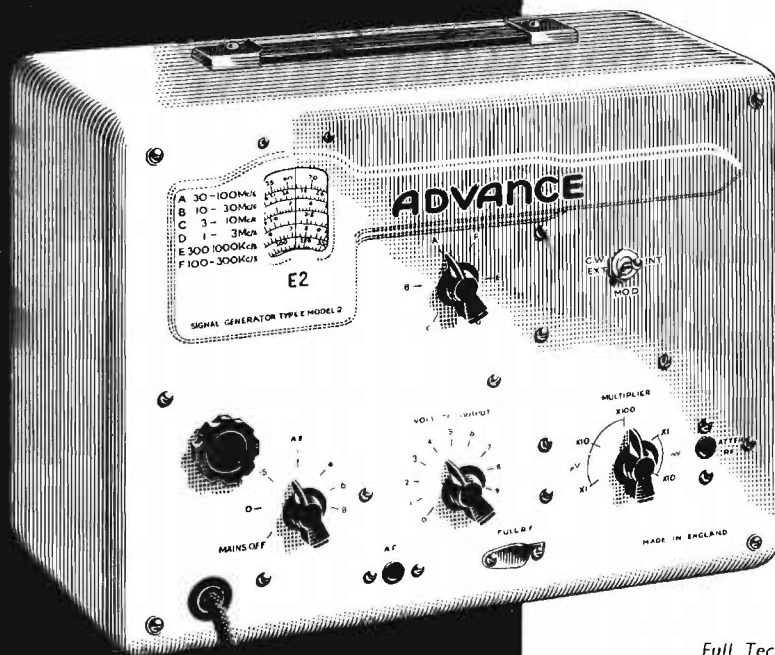

Full Technical Details available in
Folder S/14/M

G.E.C.

SELENIUM RECTIFIERS

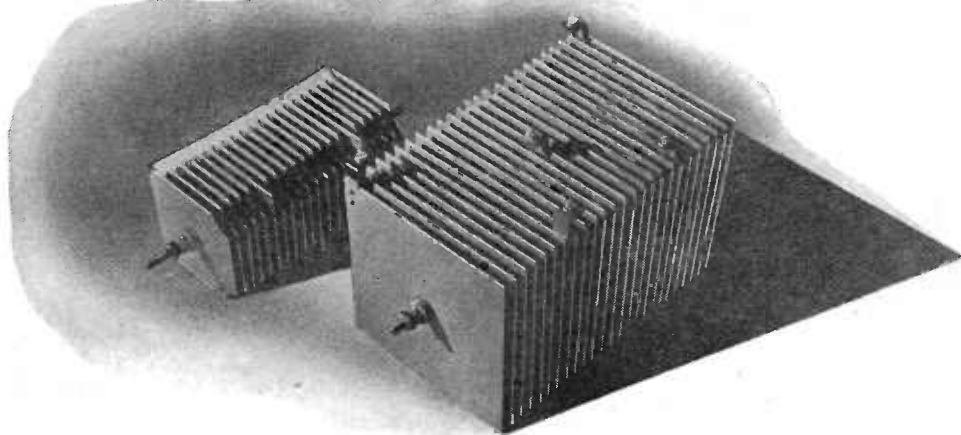

Full particulars of the G.E.C. range of Selenium Rectifiers are available on application to your nearest G.E.C. Branch, E. S. & V. Department, Magnet House, Kingsway, London, W.C.2, or the address below —

LOW FIRST COST

HIGH EFFICIENCY

MAXIMUM STABILITY

NO MAINTENANCE

LONG LIFE

COOL RUNNING

SALFORD ELECTRICAL INSTRUMENTS LTD · SALFORD 3 · LANCs

A SUBSIDIARY OF THE GENERAL ELECTRIC CO. LTD. OF ENGLAND.

Standard

push button
ATTENUATOR



for true **V.H.F.** measurements

This outstanding "Standard" V.H.F. Attenuator now in its second year of production remains the first and only accurate instrument of its kind and continues to meet a heavy demand from leading organisations and authorities the world over.

Four models now available

Characteristic Impedance	75 ohms	50 ohms
0-9 db in 1db steps	Type 74600-A	Type 74600-E
0-90 db in 10 db steps	Type 74600-B	Type 74600-F

All types will handle inputs up to 0.25 watts.

Accuracy of D.C. adjustment

0-9 db Models: The insertion loss error will not exceed ± 0.05 db for any setting.
0-90 db Models: The insertion loss error for the 90 db setting will not exceed + 0.3 db. For other settings this limit falls linearly to a value of +0.06 db at the 10 db setting.

High frequency performance

0-9 db Models: At 50 Mc/s the insertion loss error for the 9 db setting will not exceed ± 0.15 db. For other settings this limit falls linearly to a value of ± 0.05 db for the 1 db setting.
0-90 db Models: At 50 Mc/s the insertion loss error will not exceed ± 0.1 db per step.
N.B. All insertion loss errors are relative to zero db setting.

Ready for Building into your own equipment.

Calibration charts for frequencies up to 100 Mc/s for the 0-9 db models or 65 Mc/s for the 0-90 db models can be supplied on request.



Standard Telephones and Cables Limited

Registered Office : Connaught House, Aldwych, London, W.C.2

TRANSMISSION DIVISION, NORTH WOOLWICH, LONDON, E16

An entirely new development...

THE METROVICK UNIVERSAL METER

This latest Metrovick product in the field of electronics gives the Electronic and Radio Engineer all he needs in a multi-range instrument for the measurement of current, resistance and voltage. In addition, provision for R.F. Voltages is made by the inclusion of a probe which employs a diode valve for rectification. All sections give indication on the same moving coil instrument, and a multiplier switch enables all the A.C. and D.C. ranges, except the 1000 volt scales to be trebled if required.

Though so compact, the instrument is robust enough to be used constantly under average conditions. It weighs only 17 lb., and is contained in an attractive steel case in cream or blue hard stoved enamel, fitted with leather carrying handle.

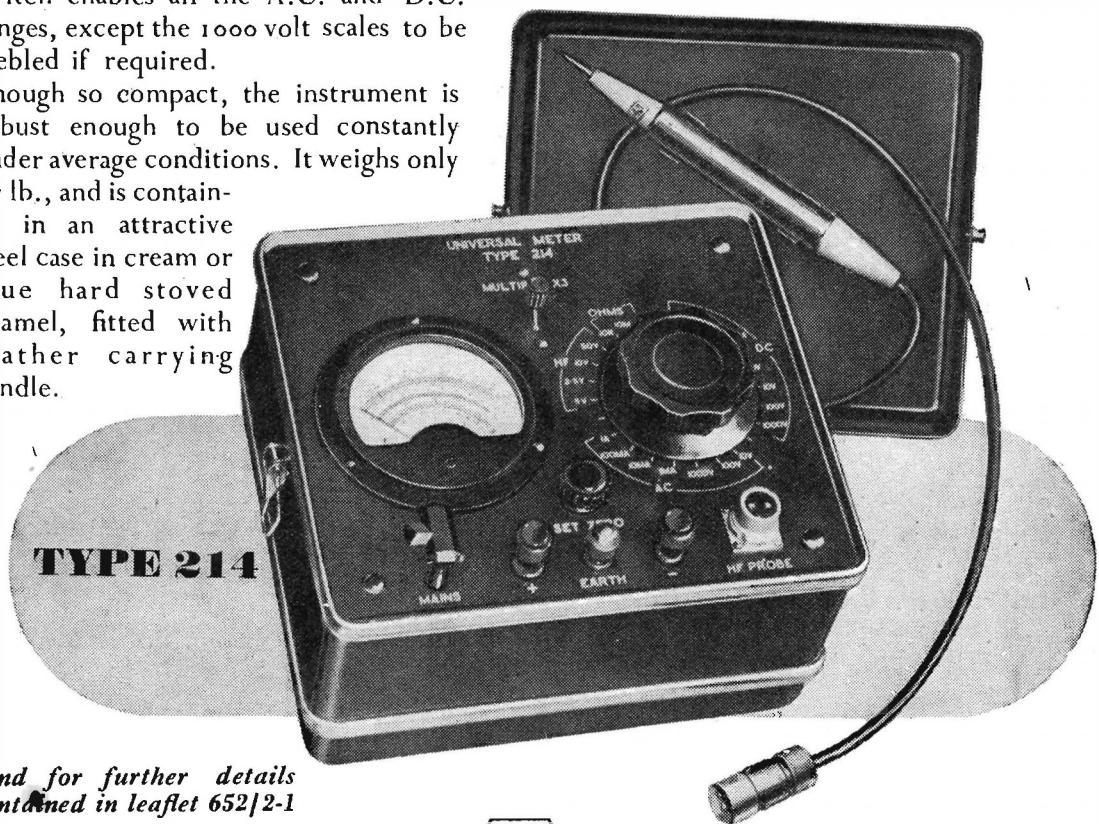

*Send for further details
contained in leaflet 652/2-1*



METROPOLITAN-VICKERS ELECTRICAL CO. LTD.
TRAFFORD PARK, MANCHESTER 17

Member of the A.E.I. group of companies

R/E.901

MUIRHEAD

technique

A JOURNAL OF INSTRUMENT ENGINEERING



Please mail me
free of charge
your quarterly journal
"technique"

NAME _____

POSITION _____

COMPANY _____

MAILING ADDRESS _____

VOLUME 6 • NUMBER _____

POST
THIS COUPON

77

to
MUIRHEAD & CO. LTD • BECKENHAM • KENT • ENGLAND

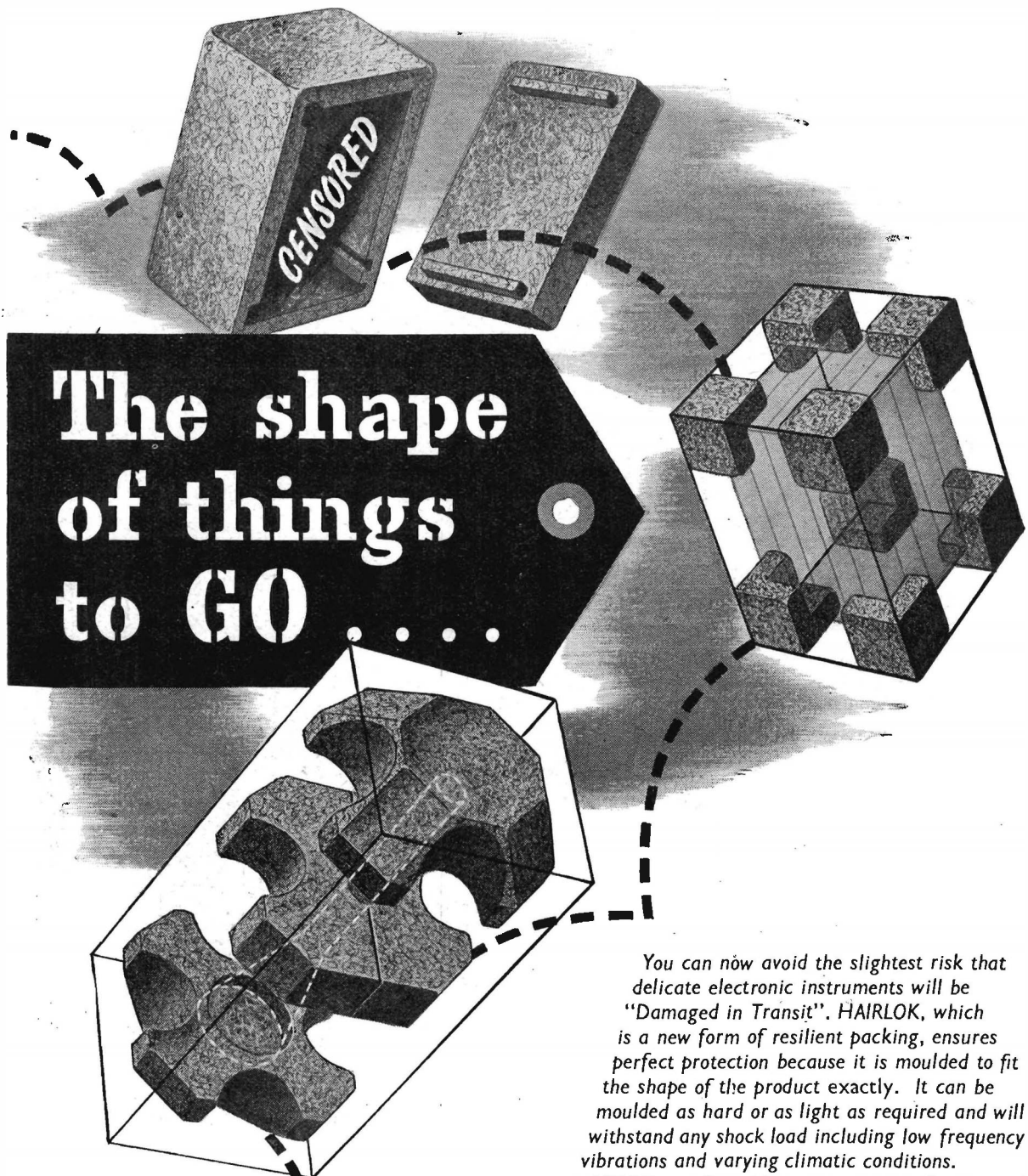

The shape of things to GO

You can now avoid the slightest risk that delicate electronic instruments will be "Damaged in Transit". HAIRLOK, which is a new form of resilient packing, ensures perfect protection because it is moulded to fit the shape of the product exactly. It can be moulded as hard or as light as required and will withstand any shock load including low frequency vibrations and varying climatic conditions. HAIRLOK complies with government specification and is non-staining to silver. To ensure that equipment is "Received in Perfect Condition" specify Hairlok packing. We shall be glad to send full details on request.

THE Hairlok COMPANY LIMITED

IDDESLEIGH HOUSE, CAXTON STREET, LONDON, S.W.1. TELEPHONE: ABBEY 6722

Quick delivery
of die-pressed ceramics
is now available.....

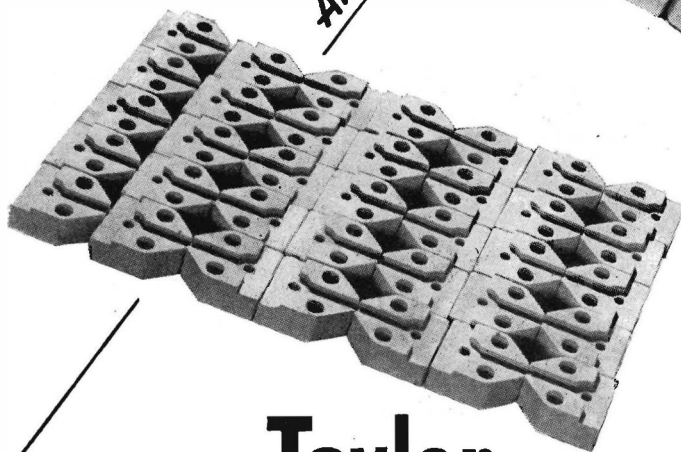
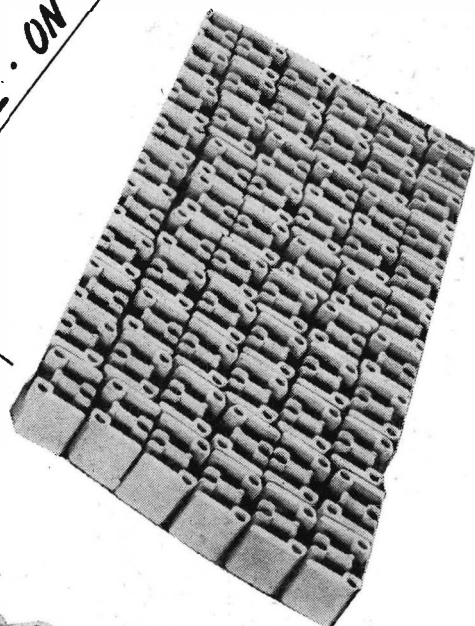
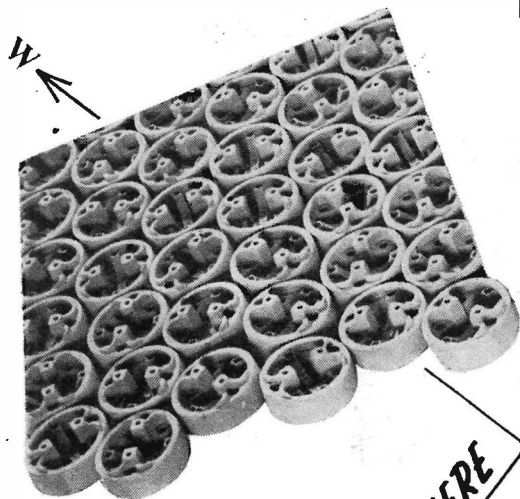

ANYWHERE ANYTIME · ON TIME

Taylor Tunncliff & Co., Ltd.



PORCELAIN AND CERAMIC INSULATORS FOR ALL ELECTRICAL PURPOSES
OVERHEAD LINE INSULATORS · SWITCHGEAR INSULATORS · BUSHES AND BUSHINGS · DIE MADE ARTICLES FOR LOW VOLTAGE
APPLICATIONS · CERAMICS FOR RADIO FREQUENCIES · REFRACTORIES FOR HEATING APPARATUS · FISH SPINE BEADS ETC.

HEAD OFFICE : EASTWOOD · HANLEY · STAFFS. Stoke on Trent 5272/4

LONDON OFFICE : 125 HIGH HOLBORN · W.C.1. Holborn 1951/2

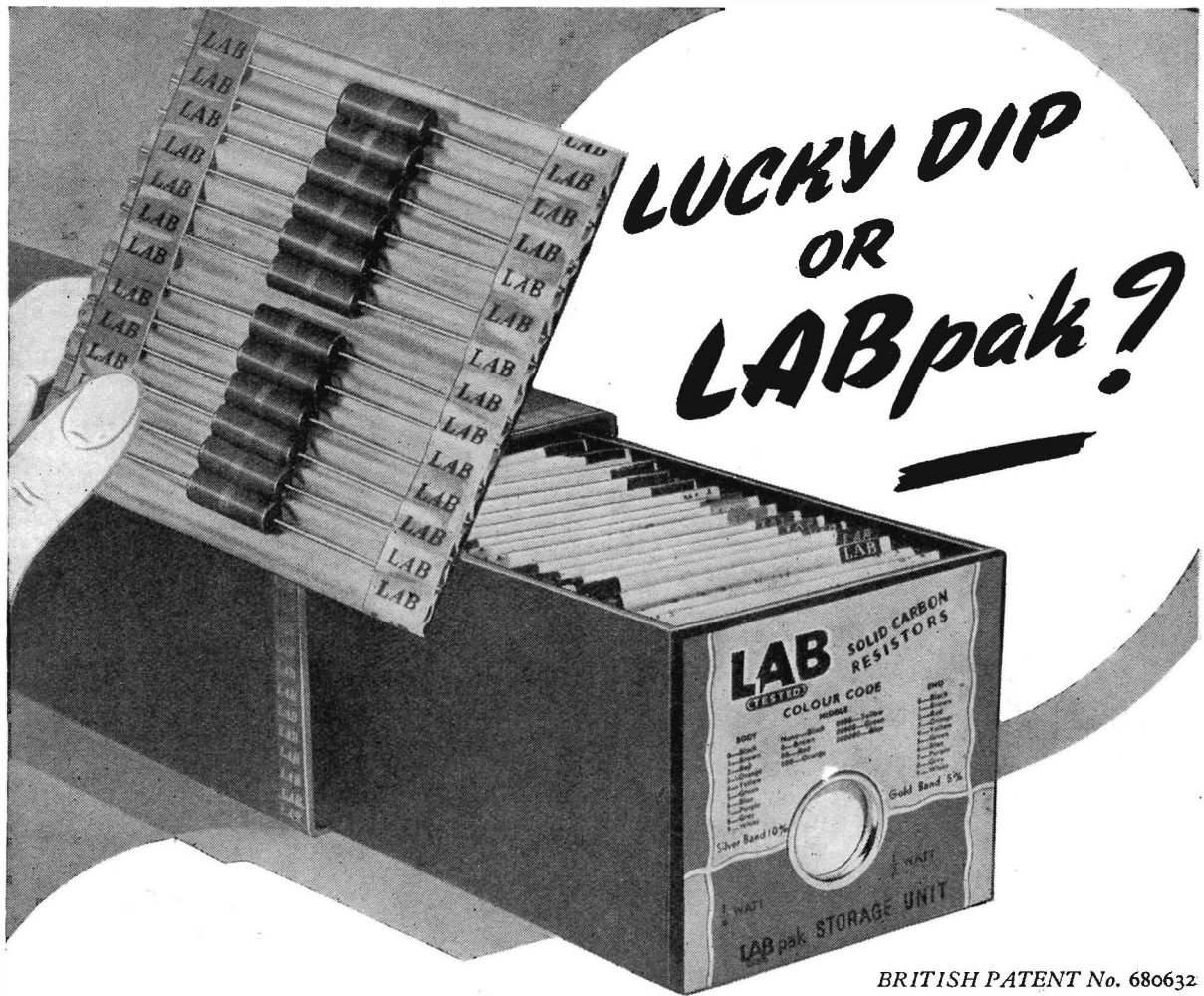

BRITISH PATENT No. 680632

The **LAB** TESTED CONTINUOUS STORAGE UNIT

Do you grope through boxes of resistors, pick up and discard several before you find the one you want, or do you merely 'flick' through the cards in the 'LABpak', lift the right one and detach the resistor all in a matter of seconds?

All users of LABpak'd resistors 'flick' through, making selections with certainty and speed. Each 'LABpak' Continuous Storage Unit will hold 700 resistors separately carded in ohmic value, rating and tolerance, and offers finger-tip selection with card index simplicity. Empty cards are merely replaced with full ones from stock.

There's nothing like the LAB storage unit for

speed, accuracy and compactness — and it's FREE with the initial purchase of 180 type 'R' or 240 type 'T' resistors.

The Lab Continuous Storage Units are available from your normal source of supply, but more detailed information can be obtained on request

RESISTOR SPECIFICATION					
Ref.	Type	Loading	Max. Volts	Range	Dimensions
T	$\frac{1}{2}$ -watt	$\frac{1}{2}$ -watt	250	10 ohms	$\frac{3}{8}'' \times \frac{3}{16}''$
R	$\frac{1}{2}$ -watt	1-watt	500	to 10 megohms	$\frac{1}{4}'' \times \frac{1}{8}''$

Tolerance available $\pm 20\%$, $\pm 10\%$, $\pm 5\%$

THE RADIO RESISTOR COMPANY LIMITED

50 ABBEY GARDENS, LONDON, N.W.8

Telephone: Maida Vale 5522



Keeping Electricity in its proper place

MICA WASHERS are the economic and efficient answer to many problems in all forms of electrical apparatus. Produced in an almost endless variety of shapes and sizes, these washers can be manufactured in practically unlimited quantities by M & I with their unique facilities at Empire Works. Up to about 0.040" the block mica can be used in its natural thicknesses, but above this thickness it is customary to build up the block with a suitable cement.

The manufacture of washers from block mica is normally confined to diameters not exceeding about 2.5". Above this size it is more economical to machine washers from micanite sheet, the grade normally employed being Hard Micanite Board.



THE MICANITE & INSULATORS CO. LTD.

Empire Works, Blackhorse Lane, Walthamstow, London, E.17

BRANCH OFFICES AT BIRMINGHAM, CARDIFF, GLASGOW, MANCHESTER AND NEWCASTLE-UPON-TYNE AND REPRESENTATIVES IN MOST COUNTRIES THROUGHOUT THE WORLD.

Manufacturers of MICANITE (Built-up Mica Insulation). Fabricated and Processed MICA. PAXOLIN Laminated Materials. PANILAX Laminated Materials and Mouldings. EMPIRE Varnished Insulating Cloths and Tapes. HIGH VOLTAGE BUSHINGS and TERMINALS. Distributors of Micoflex-Duratube Sleeveings, Micoflex-Durasleeve (Plastics-covered flexible metal conduit) and Kenutuf Injection Mouldings (in most thermoplastics including P.V.C.).

Faultless Fluxing means precision Soldering



ENTHOVEN PRODUCTS ENSURE FAULTLESS FLUXING

ENTHOVEN **aids**

to precision soldering

Enthoven solders and specialities ensure faultless fluxing and sound, long-lasting joints in all electrical and electronic equipment.

SUPERSPEED

"White Flash" activated rosin cored solder for general electrical work. The unique stellate core gives six points of rapid solder collapse, ensuring faultless fluxing. In 1 lb. and 7 lb. reels and specially designed Industrial Service Pack. Also with coloured cores for circuit or operator's identification.

SUPERSPEED

"XX" double-activated rosin cored solder for use on severely tarnished surfaces.

LAMP SOLDER

Nos. 1 & 2. One or both of these will meet your particular requirements.

TELECENE

liquid activated rosin-based flux for pre-tinning and dip-soldering.

KEMICOR

non-deliquescent fluxed cored solder for soldering copper and copper base alloy (for use with non-electrical equipment).

Cored and solid solder rings and solid solder washers available to customers' specifications.

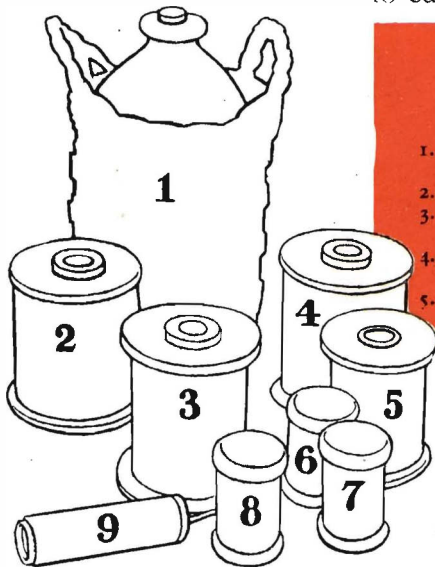

Key to the Enthoven products shown opposite:

- | | |
|--|--|
| 1. "Telecene" liquid activated rosin based flux. | 6. A 1 lb. reel of Superspeed "White Flash". |
| 2. Enthoven Lamp Solder No. 2. | 7. A 1 lb. reel of Enthoven Kemicor". |
| 3. A 7 lb. reel of Superspeed "White Flash". | 8. A 1 lb. reel of Enthoven Lamp Solder No. 1. |
| 4. A 7 lb. reel of Enthoven "Kemicor". | 9. An Industrial Service Pack of Superspeed "White Flash". |
| 5. A 5 lb. reel of Superspeed "White Flash". | |

Made at the **ENTHOVEN** Solder Factory

Marketed by Enthoven Solders Ltd., Enthoven House, 89 Upper Thames St., London, E.C.4.

E. 3477

51

Once upon a time
there was a
designer who

did not know all the advantages of unbrako socket

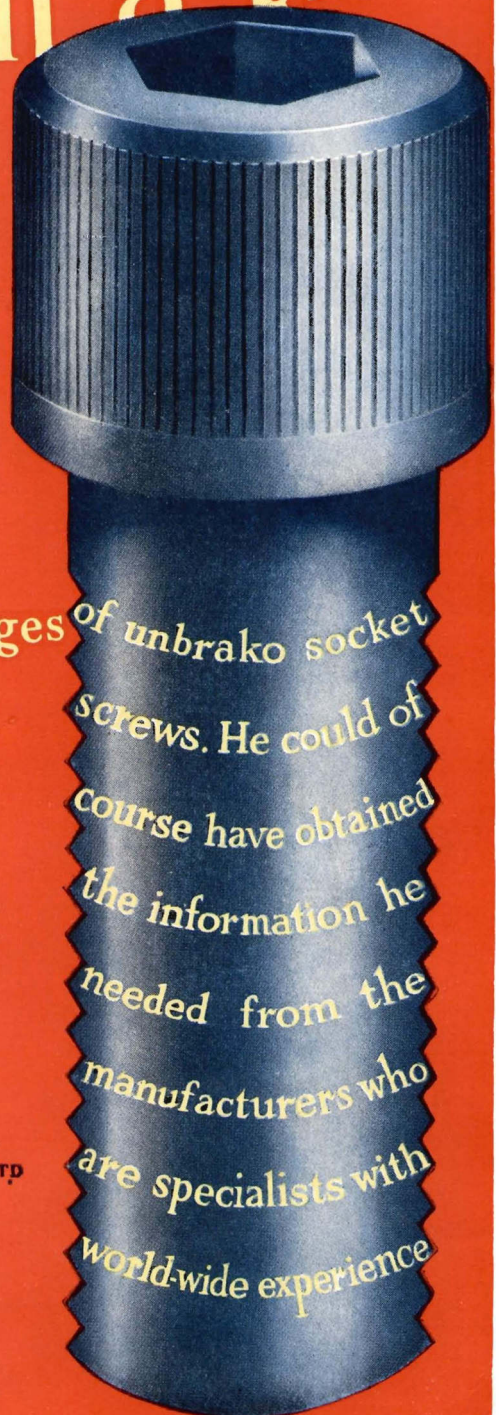

screws. He could of course have obtained the information he needed from the manufacturers who are specialists with world-wide experience



UNBRAKO SOCKET SCREW CO LTD
BURNABY ROAD, COVENTRY

over
90%
WATT/HOUR EFFICIENCY

and savings up to $\frac{4}{5}$ of the size and $\frac{5}{6}$ of the weight in comparison with other storage batteries of similar capacities !

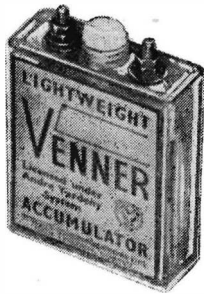

The Venner silver-zinc accumulator is ideal when exceptionally high rates of discharge are a necessary requirement.

Weight and space saving by Venner Accumulators is vital in many projects to-day.

Write for Brochure VA/LM.

VENNER *Lightweight* **ACCUMULATORS**

VENNER ACCUMULATORS LTD.
Kingston By-Pass, New Malden, Surrey
Telephone : MALden 2442



Electronic Engineering

Incorporating *ELECTRONICS, TELEVISION and SHORT WAVE WORLD*
Managing Editor, H. G. Foster, M.Sc., M.I.E.E.

Vol. XXV

FEBRUARY 1953

No. 300

Contents

Commentary	45
The Scanning Electron Microscope and the Electron-Optical Examination of Surfaces	46
By D. McMullan, M.A., Ph.D.	
The Design of a Direct-Reading Thermistor Bridge with Temperature Compensation	51
By R. M. Pearson, B.Eng., and F. A. Benson, Ph.D., M.Eng., A.M.I.E.E., M.I.R.E.	
New BBC Transmitting Station	57
Time-Division Multiplex Systems (Part 2)	58
By J. E. Flood, Ph.D., A.M.I.E.E.	
A Corona Stabilizer E.H.T. Supply for Proportional Counters	63
By P. Holton and J. Sharpe, B.Sc., A.M.I.E.E.	
A Differential Transformer Gauge and Amplifier for Measuring Small Displacements	66
By D. T. R. Dighton, M.Sc., A.R.C.S., A.Inst.P.	
Noise Performance of V.H.F. Receivers	68
By E. G. Hamer, B.Sc., A.M.I.E.E.	
A Low Voltage Stabilizer with Saturated-Diode Control	71
By V. H. Attree, B.Sc.	
A D.C. Amplifier for use in pH Measurements	74
By C. Morton, B.Sc.	
Automatic Temperature Compensation	78
By R. H. Mapplebeck	
Radar Pulses on Target per Scan	80
By R. C. Colle	
Notes from the Industry	81
Letters to the Editor	82
Book Reviews	84
Electronic Equipment	86
Meetings this Month	88
Publications Received	88

Published Monthly on the last Friday of the preceding month at
28 Essex Street, Strand, London, W.C.2.

Phone: CENTRAL 6565. Grams: 'LECTRONING, ESTRAND, LONDON'

Subscription Rate:
(Home or Abroad) Post Paid 12 months 26s. or \$3.75 (U.S.)

Classified Advertisements, Page 1
Index to ADVERTISERS, 78

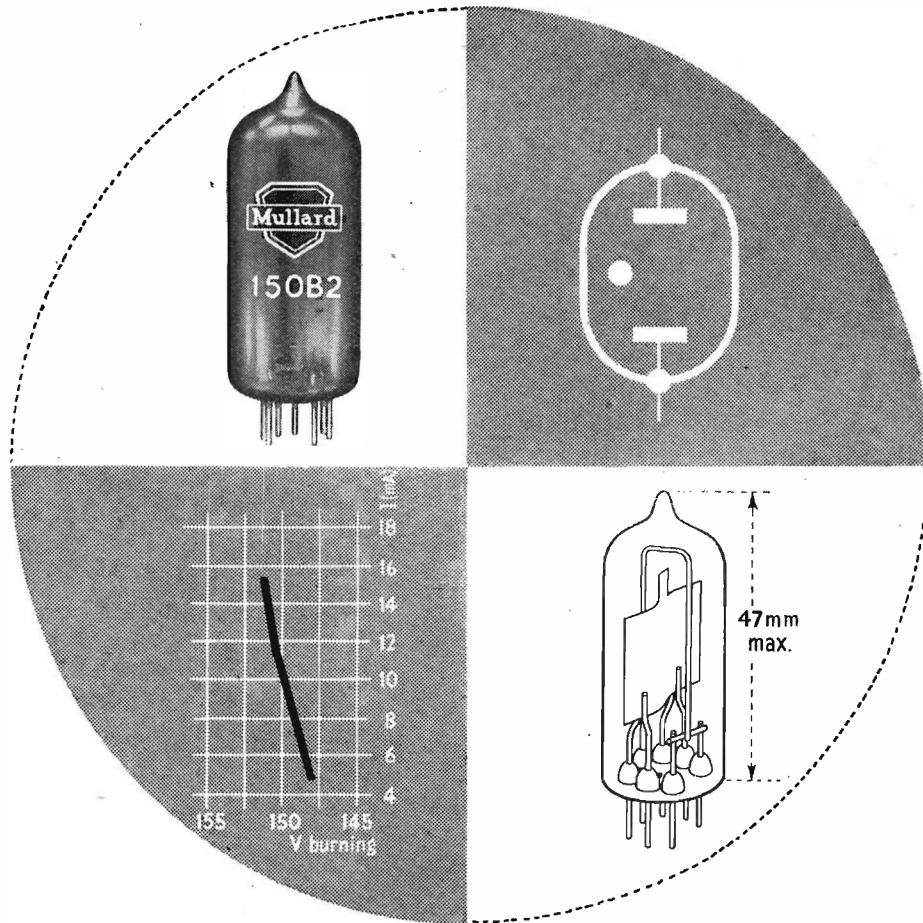

A New Standard of Reliability in Voltage Stabilising Devices

Employing the sputtered metal technique, successfully proved in the 85A2 voltage reference tube, this new Mullard 150 volt stabiliser, the 150B2, sets a new standard of reliability in voltage stabilising devices.

Some of the more outstanding advantages of this tube include close tolerance burning voltage, very much reduced voltage fluctuations, freedom from sudden large jumps throughout the working current range, and a voltage output variation of less than one per cent throughout life.

Constructed on the miniature B7G base, the 150B2 should prove of great value in the design of compact industrial equipments where an extremely accurate and reliable performance coupled with a maximum saving in space is required.

Brief technical details of this tube are given below. More comprehensive information will be gladly supplied on request.

PRINCIPAL CHARACTERISTICS

Nominal burning voltage	150 V	Max. ignition voltage	180 V	Current range	5 to 15 mA
Incremental resistance at 10 mA	250 Ω	Base	B7G		

Mullard



MULLARD LTD., COMMUNICATIONS & INDUSTRIAL VALVE DEPT., CENTURY HOUSE, SHAFFESBURY AVENUE, LONDON, W.C.2
MVT 127

Electronic Engineering

Vol. XXV

FEBRUARY 1953

No. 300

Commentary

THE thermionic valve is without doubt responsible for the enormous development in broadcasting and communications which has taken place during the last thirty or forty years. From the early fragile triodes of Fleming and De Forest has grown a multiplicity of types each with its own specific purpose, and along with the cathode-ray tube, which incidentally has a much longer history, the valve has completely revolutionized the science of measurement to such an extent that today few laboratories are complete without at least an oscilloscope.

As far as we are aware, the Moullin valve voltmeter, designed some thirty years ago, was one of the earliest electronic measuring instruments as such, and its advantages were immediately apparent. As the radio industry grew it was only logical that the manufacturers of transmitting and receiving equipment should design and make their own electronic measuring apparatus to meet the needs in their own test rooms and laboratories, but several manufacturers realized the wider applications of these new instruments to other branches of research and industry, and some of the more enterprising set up new and entirely separate organisations for the specific purpose of designing and manufacturing electronic measuring apparatus. The sensitivity, accuracy and speed of measurement generally have been considerably increased by electronic methods which depend fundamentally on a range of devices to convert the physical quantity to be measured into a proportional electrical signal. One of the simplest of these transducers is the resistance strain gauge and its influence in the field of measurement is likely to be profound.

It is only during the last fifteen years or so that extensive use has been made of it, but the principle is due to Kelvin who as far back as 1856 observed that the resistance of a wire when stretched within its elastic limit varied directly as the applied strain.

Thus the modern resistance strain gauge, together with the capacitance and inductance type pressure gauges has opened up an entirely new field of electronic instrumentation which can be applied to many industrial and research problems. For example, prior to the strain gauge, the design of a structure for a maximum strength-weight ratio was largely a matter of conjecture. The only instruments available to the designer were the optical and mechanical extensometers which, although accurate, were limited by reasons of cost and size, and their use outside a materials testing laboratory was not extensive.

Where the structure was subject to vibratory stress the situation was far more acute and there existed practically no instrument to provide data on the magnitude and effect

of vibratory stresses, with the result that designers were forced to include a factor of safety—more appropriately a factor of ignorance—in their design calculations. This lack of knowledge led on one hand to heavy, cumbersome but safe structures, and on the other to not infrequent failure of apparently well-proportioned machines. In short, design was largely a matter of hit or miss.

To some extent this lack of knowledge was not of great moment, particularly in the design of structures where the vibratory stresses were low, and the engineer could produce a design with an adequate safety factor which still looked right. But this state of affairs could not be tolerated by the aircraft designer who was faced with new and much more difficult problems.

As the power of engines and the speed of aircraft both increased, it became apparent that vibration and stress fatigue in the materials and components of the aircraft were among the limiting factors, and the aircraft industry was among the first to set up separate organizations to study this problem of vibration.

The tools and equipment were almost non-existent and one of the first tasks of these newly founded vibration laboratories was to equip themselves with the necessary vibration measuring devices and it is mainly to the aircraft industry alone that the successful evolution of the modern resistance strain gauge is due.

The early resistance strain gauge was made not of wire but in the form of a carbon rod which, although possessing high sensitivity suffered from a number of serious defects. However, in spite of its defects it was the only strain gauge available and with its relatively simple electronic apparatus the solution to the problem of the measurement of vibratory stress was in sight for the first time.

* * *

A number of readers have expressed difficulty in finding the list of contents of this and other journals and have commented on the lack of uniformity or accepted practice in this matter. There are, of course, a number of positions in a journal where the contents can be placed and each has its own particular advantage—and disadvantage. In our own case we place the list of contents on the last right-hand advertising page preceding the main editorial pages.

This, of course, does make rapid reference in a complete issue a little more difficult, but this can be overcome if the issue is turned back slightly so that the pages are stepped. Held in this position, the black title block at the top of the contents column acts as a thumb guide for easy reference.

The Scanning Electron Microscope and the Electron-Optical Examination of Surfaces

By D. McMullan*, M.A., Ph.D.

THE conventional transmission electron microscope¹ has become so universally used that only a brief description of its principle is necessary. An electron gun directs an intense monochromatic beam of electrons on to the specimen and the electrons leaving the specimen are focused by two or more electron lenses on to a fluorescent screen. Generally the specimen is in the form of a thin section not more than a few thousand Angstrom units (Å) thick, and image contrasts are formed partly by absorption but mainly by the scattering of electrons outside the aperture of the objective lens, and also by the energy losses of the electrons passing through the specimens combined with the chromatic aberration of the objective. Thus the specimen must be thin enough to allow the passage of the electron beam and the examination of metals in this fashion is ruled out unless they are in the form of thin foils. Attempts have been made to cut sections thin enough for the electron microscope from solid metal specimens, but even if such a section could be cut mechanically, almost inevitably the process of cutting would introduce a spurious structure (artefact) into the thin metal film.

The most successful method of examining metals by transmission is due to Heidenreich². A thin section (about 100 microns†) of the metal (Heidenreich used aluminium) is cut mechanically or rolled and is electro-polished until a hole develops, when the polishing is immediately stopped. Heidenreich found that the edges of the hole were only a few hundred Angstrom units thick and he was able to obtain high resolution micrographs with a standard electron microscope. This method can only be used for metals which can be easily cut and it is still likely that artefacts will be produced during the cutting process. It has not been employed to any great extent.

Replicas

Up to the present most of the electron microscopy of surfaces, in particular metal surfaces, has been done with the aid of replicas³. There are several different methods commonly employed, but in all a replica of the metal surface is made in the form of a thin film of plastic or metal oxide and this is examined by transmission in the electron microscope. The contrasts in the image are formed by the variations in the thickness of the replica corresponding to the elevations and depressions in the surface of the metal specimen.

It is unnecessary here to describe in detail the various procedures for making replicas, but it must be stressed that these methods of determining the structures of metal

surfaces have certain disadvantages. Apart from the difficult nature of the techniques themselves and the great care necessary to ensure that artefacts are not produced during the stripping of the replica from the surface, and that the results are really reproducible, the interpretation of the micrographs is not easy as a result of the rather complicated way in which the image contrasts are formed. In addition, the resolving powers of these replica methods are appreciably less than those of modern electron microscopes, being of the order of 300Å for plastic replicas. In spite of these objections much useful information has been obtained by their use. However, it is plain that it would be a considerable advantage if surfaces could be observed by more direct methods analogous to the optical metal-lurgical microscope and with higher resolutions.

Emission Microscopes³

Several types of microscope have been made for the direct examination of metal surfaces using electrons emitted by the specimen itself for forming a magnified image with a suitable electron-optical system. The emission may be brought about in several ways, but thermionic emission has so far proved to be the most successful. Microscopes using photoelectric and secondary emission have also been described. Field emission is utilized in the point projection microscope with which tungsten points have been magnified by about a quarter of a million times without the use of lenses.

The thermionic emission microscope has a resolving power appreciably better than the optical microscope, the best that has been obtained being about 500Å, but this is somewhat inferior to replica methods. There is a good possibility that the resolving power of the thermionic emission microscope will be improved, but even so it suffers from the grave disadvantage that the specimen must be raised to a very high temperature. There are few metals which will give sufficient electron emission when pure without melting or evaporating. However, by coating the specimen with barium which is preferentially absorbed by one metal of an alloy or by one crystal face, it is possible to obtain sufficient emission at a temperature of about 1000°C. But even so the micrographs obtained in this way can only give information on the properties of the metal at high temperatures.

Reflexion Methods

Attempts have been made to obtain images by reflexion in the conventional electron microscope. The specimen is illuminated with electrons at grazing incidence and the electrons leaving the specimens are focused by the objective lens.

* Department of Engineering, University of Cambridge.

† (1 micron = 10⁴Å).

Either electrons leaving the specimens normally (Ruska)⁴ or at a grazing angle (v. Borries)⁵ have been used, but neither method has given really satisfactory results. This is because the electrons from the specimens have lost considerable energy and up to the present it has not been possible to make electron lenses sufficiently achromatic to focus them with high resolution. The intensity of the image with Ruska's method is also very low, and v. Borries' arrangement, which has looked more promising, introduces considerable geometric distortion in the image, while the resolution in one direction is only 1/14th of the resolving power of the instrument used, the specimen being at an angle of 4° to the axis. But in spite of these objections the method has the merit that the preparation of the specimen follows normal metallurgical practice and the results are easily repeatable.

Another instrument, which was first proposed by Knoll⁶ in 1935 is the scanning electron microscope. A source of electrons is imaged on the specimen and the intensity of the beam leaving the specimen is recorded. The electron spot is moved over the specimen and a magnified image of using this principle were constructed by v. Ardenne⁷ and using this principle were constructed by v. Ardenne⁷ and Zworykin⁸.

v. Ardenne's Scanning Electron Microscope⁷

Although v. Ardenne's microscope was used for transparent specimens only and showed little advantage over conventional types of microscope, it is still necessary to describe it as it was the first scanning microscope to be built (1938). A schematic diagram of the microscope is shown in Fig. 1. A demagnified image of the crossover of the electron gun *G* was focused on the specimen *S* by two magnetic lenses *L*₁ and *L*₂. Two sets of deflexion coils were mounted just above the lens *L*₂ and the deflexion of the electron spot at the specimen was proportional to the currents in these coils. The specimen was scanned, as in a television picture, in parallel straight lines, the ratio of the rates of sweep giving the number of lines per scan. Immediately below the specimen was a photographic film mounted on a drum. The picture was recorded by rotating the drum and simultaneously moving it laterally by means of a suitable screw mechanism. The currents in the deflexion coils were controlled by potentiometers mechanically coupled to the drum mechanism, so that the current in one set of coils was proportional to the lateral movement of the drum, and in the other set the current varied with the angular position of the drum. The magnification of the microscope was the ratio of the deflexion of the spot to movement of the photographic film. An aperture was included between the specimen and the film to increase the contrast of the micrograph, by absorbing the electrons that had been widely scattered by the specimen.

The intensity of the electron beam at the specimen was very low (about 10⁻¹³A) and it was therefore necessary to record the picture over a period of about 20 minutes in order to obtain an image of reasonable density on the photographic film.

Since the image was not visible until the film had been developed, focusing was a difficult proceeding, it being necessary to find the setting by trial and error.

The results with this microscope were inferior to conventional electron microscopes but v. Ardenne pointed out that the scanning microscope should show advantages with thick specimens.

He also proposed that, instead of a photographic recording, the electron beam should be collected by an electrode, amplified and used to modulate a cathode-ray tube. The surfaces of opaque specimens could then be examined in terms of their secondary emitting properties.

Zworykin's Microscope⁸

A scanning electron microscope designed especially for opaque specimens was described by Zworykin and others in 1942. The specimen was scanned by an electron spot as in v. Ardenne's microscope, the main difference being that electrostatic lenses were used instead of magnetic ones. The total accelerating voltage was 10kV but the specimen was held near the potential of the gun cathode so that the effective voltage of the primary electrons was only 800V.

This was done as it was considered that the low voltage was especially favourable for producing large differences in the secondary emission to the surface. Attempts to collect and amplify the secondary electron current with valve amplifiers were unsuccessful because of the very poor signal-to-noise ratio obtained. The noise is mainly due to the thermal noise in the input resistor of the amplifier and since the electron current is of the order of 10⁻¹²A, this noise completely masks the signal except with an impractically long scanning time.

A considerable improvement in the signal-to-noise ratio was obtained by using a photomultiplier, an input resistor, of course, being no longer required. The secondary electrons were directed on to a fluorescent screen which was held at 10kV with respect to the specimen. The light from the screen was focused on to the cathode of the photomultiplier and the signal-to-noise ratio was further improved by square wave modulating the scanning beam and clipping the output from the multiplier. It was still necessary to scan the specimen for a period of several minutes and the picture was recorded on a facsimile recorder. Correct focus was found by observing the waveform of the output from the photomultiplier and setting for maximum high frequency components in the signal.

Some micrographs were published showing a resolution of about 500Å but the interpretation of them was inconclusive. It is well known that with primary voltages below a few thousand volts the secondary emission ratio is very dependent on the cleanness of the surface and in a demountable system with oil pumps it is practically impossible to prevent a thin layer of oil forming on the specimen, and this layer plays a significant part in determining the contrasts in the final micrograph. This difficulty has been overcome in the scanning electron microscope described below and, in addition, a number of other improvements have been incorporated including direct viewing of the picture before recording.

A New Scanning Electron Microscope

A conventional electron microscope constructed in the Engineering Department of the University of Cambridge has been modified for scanning. This microscope is a two stage instrument with electrostatic lenses. The geometry of the electron gun and lenses is based on papers by Bruck^{9,10}. Astigmatism correction has not yet been incorporated and, for this reason, the resolution of electron micrographs taken with the instrument (in transmission) have been somewhat inferior to that of similar instruments, being of the order of 200Å.

When used as a scanning microscope the projector lens is removed and the final fluorescent screen is replaced by a special assembly comprising deflexion coils, electrostatic lens, specimen stage and electron multiplier. A block

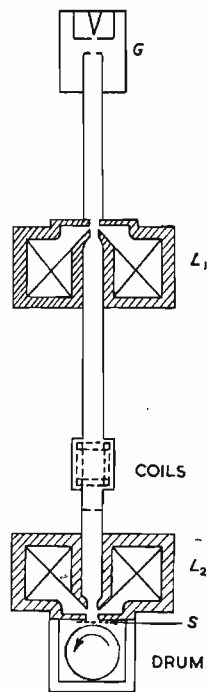

Fig. 1. Schematic diagram of v. Ardenne's scanning electron microscope

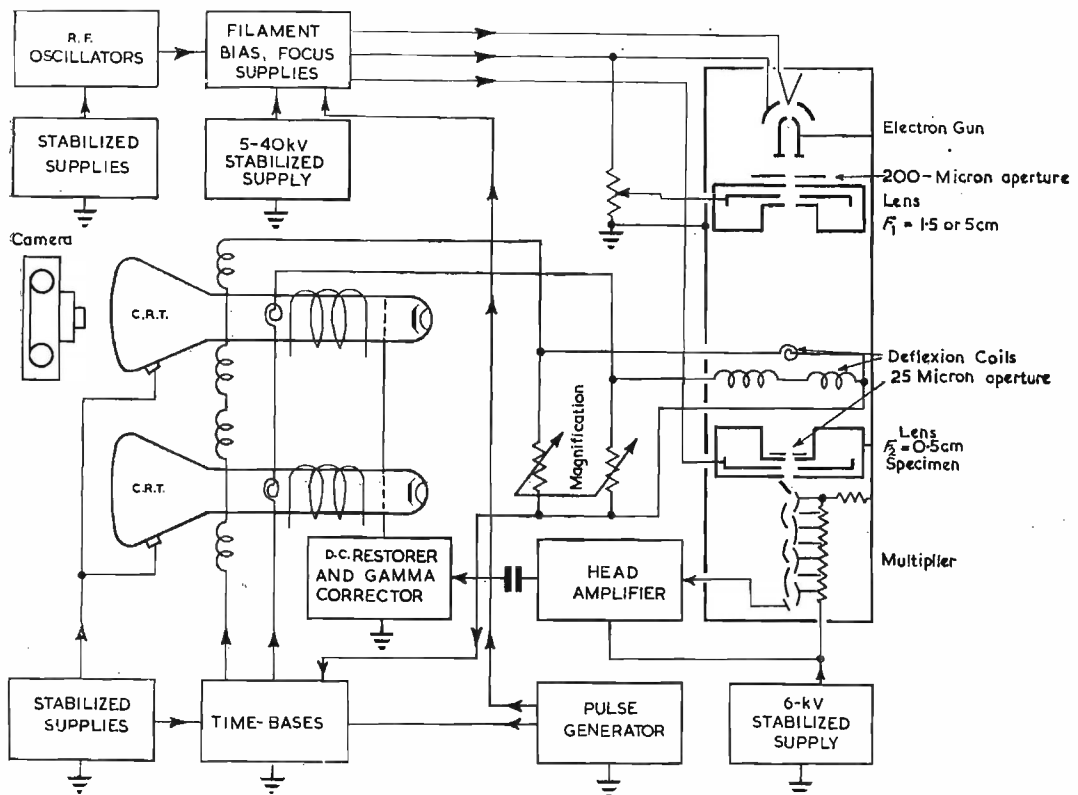

Fig. 2. Block schematic diagram of scanning electron microscope

schematic of the microscope is shown in Fig. 2 and a photograph in Fig. 3.

The electron-optical system is shown on the right-hand side of Fig. 2. The diameter of the cross-over in the electron gun is about 50 microns and the total demagnification of the lenses can be set to between 500 and 2 500 times by adjusting the voltage on the central electrode of

Fig. 3. The scanning electron microscope

The viewing screen is between the microscope column and the racks containing the scanning circuits and power packs. The electron multiplier is mounted below the table of the microscope stand and is lowered when changing the specimen.

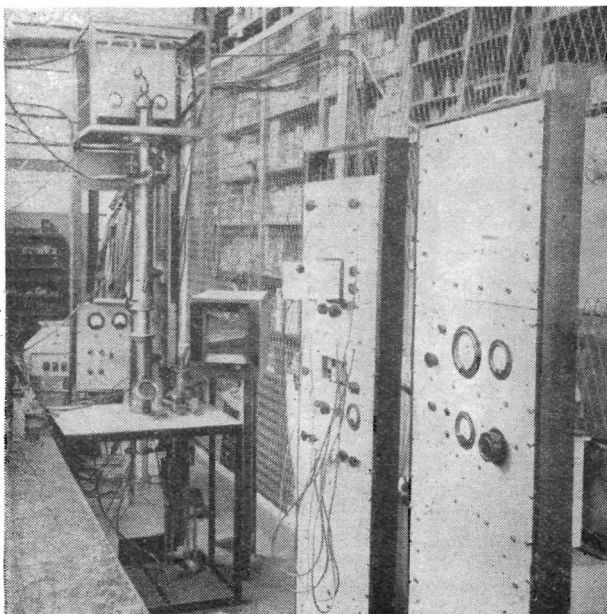

the first lens. The diameter of the spot focused on the specimen can, therefore, be between 200 and 1 000Å. The accelerating voltage can be varied between 5 and 40kV. The electron spot is deflected magnetically by coils mounted just above the second lens. Since the beam current is only about 10^{-10} A with a spot diameter of 1 000Å and even less with smaller diameters, it is necessary to scan the specimen comparatively slowly in order to obtain a reasonable signal-to-noise ratio (this is proportional to the square root of the scanning beam current). In this microscope there are 405 lines (interlaced) per picture and about 0.9 pictures per second for direct viewing and 550 lines and one picture in 300 seconds for recording when the spot diameter (and hence beam current) is reduced to obtain maximum resolving power. The deflexion coils in the microscope are connected in series with those on the cathode-ray tubes which re-assemble the picture. The magnification of the microscope increases with the reduction in the value of resistances connected across the microscope coils. The cathode-ray tube used for direct viewing has a long persistence screen (zinc sulphide—zinc cadmium sulphide) which integrates several successive scans and reduces the effects of noise on the video signal.

The specimen may be mounted normally to the scanning beam or as is shown in Fig. 2 at an angle. Each way has special advantages as is described later in the article.

The electron current from the specimen is amplified directly in an electron multiplier^{11,12} having beryllium-oxide coated dynodes which can be exposed to the air without damaging them. The main reason for using direct electron multiplication instead of Zworykin's fluorescent screen and photomultiplier arrangement is the poor frequency response of fluorescent screens at low excitations. Even zinc sulphide, silver activated and nickel quenched has a decay of about a millisecond when the beam current is of the order of 10^{-8} A/sq.cm compared with a few microseconds at high excitations. Although the frequency

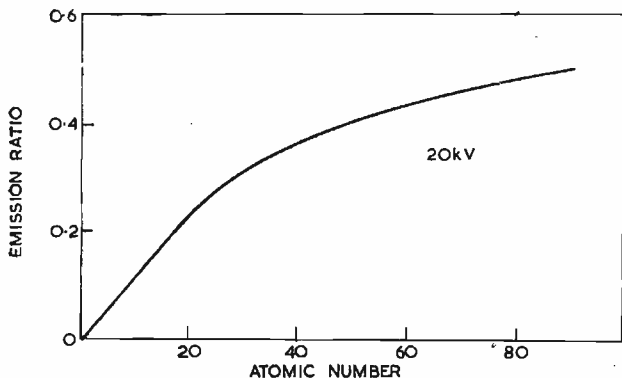

Fig. 4. Electron emission ratio as a function of atomic number, 20kV primary electrons (after Palluel)

response is adequate for recording it is too poor for the relatively high rates of scanning necessary for visual observation.

The output of the electron multiplier is further amplified by a two-stage head amplifier and after passing through the gamma corrector modulates the cathode-ray tubes.

In this microscope the most important improvements over Zworykin's microscope lie in the arrangement of the specimens and in the use of high voltage electrons for avoiding the effects of specimen contamination. A high voltage scanning beam has the disadvantage that if the specimen is scanned perpendicularly only poor contrast can be obtained owing to the relatively small variation in the secondary emission ratios of different metals with primary electron voltages greater than a few kilovolts. Palluel¹³ has published a curve (Fig. 4) showing that the intensity of the reflected* (high velocity) electrons is a function of the atomic number. Some measurements made by the author with normal incidence were repeatable even in a poor vacuum and with oil diffusion pumps. Thus perpendicular scanning can be used when the surface has two or more constituents having widely differing atomic numbers. It must be noted in passing that any roughness of the surface of specimens will be visible in the final picture because the emission ratio increases when the beam strikes at an angle. Etched specimens could, therefore, be examined in this way, but it is better to scan the specimens at an angle of about 25 degrees. It has been found that when metals are bombarded by high-velocity electrons at an angle the intensity of the reflected high velocity beam collected by an electrode subtending an angle of 30° to the metal surface is prac-

* In this article the term "reflected" is applied to all the emitted electrons, other than true secondaries which have energies of only a few electron volts.

Fig. 5. Variation of electron emission ratio as a function of specimen angle for aluminium with 25kV primary electrons

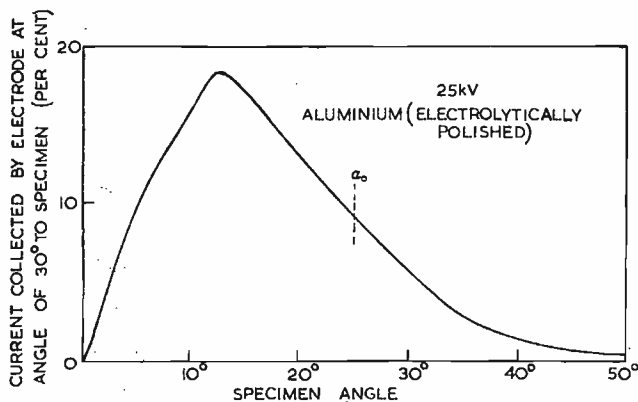

tically independent of the atomic number of the metal. The intensity, however, is very sensitive to changes in the angle of the incident beam, as can be seen from Fig. 5, which is for aluminium bombarded by 25kV electrons. When a metal surface is polished and etched, as for examination with an optical metallurgical microscope, faces of the crystals are exposed and will be orientated in various planes. Image contrasts are generally formed with an optical metallurgical microscope by light being specularly reflected by the crystal faces into or outside the aperture of the objective lens. Similarly, contrasts are formed with an etched specimen at an angle in the scanning electron microscope by the reflection of electrons into the collecting system, the intensity depending on the

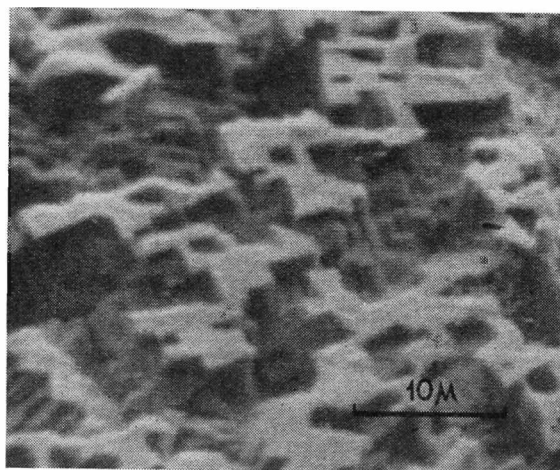

Fig. 6. Etched aluminium. Angle 25°, magnification $\times 2000$, 16kV, 1.5×10^{-10} A beam current, exposure 5 seconds

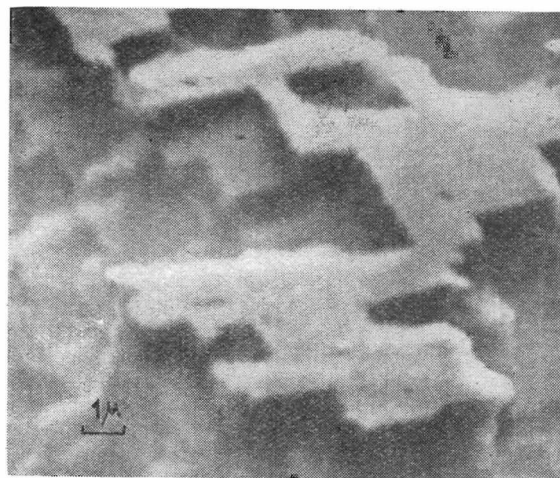

Fig. 7. Etched aluminium. Angle 25°, magnification $\times 6000$, 16kV, 10^{-12} A beam current, exposure 300 seconds

orientation of the crystal faces. Fractures and scratches on the surfaces of materials also produce large contrasts. It should be noted that with the specimen at an angle the scanning spot will be elongated in one direction with consequent deterioration of the resolution in this dimension.

Results

Some typical micrographs taken with the microscope are shown in Figs. 6, 7 and 8. The specimen in Figs. 6 and 7 was annealed aluminium electrolytically polished

and etched with hydrofluoric, nitric and hydrochloric acids, and mounted at an angle in the microscope. Fig. 6 (exposure time five seconds) gives a fair indication of the quality of the visible picture on the cathode-ray tube. As can be seen this is quite good enough for selecting a suitable part of the specimen for recording with higher resolution. Fig. 7 was recorded over a period of five minutes with a smaller spot size. The specimen angle was 25 degrees and as can be seen there is a well marked stereoscopic effect in the micrographs, giving the impression that the specimen is being viewed at this angle. The scanning beam voltage in each case was 16kV. A higher voltage (25kV) was used initially, but a worse resolution was obtained with aluminium specimens. This was due to the penetration of the electrons which pass right through the crystals near their edges. It still occurs at 16kV as can be seen from the light bands which extend along the far edges in Figs. 6 and 7, but at 6 000 times magnification it does not appreciably affect the resolution. The lack of sharpness in Fig. 7 is mainly due to imperfect magnetic shielding which limits the effective spot diameter to about 500Å. The regularly spaced streaks in this figure are "hum" bars which are curved owing to the frequency drift of the line time-base during recording.

To obtain higher useful magnifications it may be necessary to reduce the electron penetration by lowering



Fig. 8. Mild steel. Perpendicularly scanned, magnification $\times 1500$, 15kV, 1.5×10^{-10} A beam current, exposure 300 seconds

the beam voltage still more or by allowing only the electrons which have suffered small energy losses to enter the electron multiplier. In any case with heavier metals the penetration is of course less. No trouble has been experienced with contamination of the specimen under electron bombardment there being no visible change even when an area of the specimen has been exposed to the beam for several hours.

Fig. 8 shows a micrograph of a mild steel specimen mounted normal to the scanning beam. So far it has proved impossible with the present microscope to collect more than a very small percentage of the electrons reflected from a normally mounted specimen. It has, therefore, been necessary to work with a high beam current with consequently a poor resolving power. With direct observation of the specimen which had been electrolytically polished (but was unetched) the only details observable were some slag inclusions, but considerably more detail can be seen in Fig. 8 which was recorded for five minutes. The magnification is 1 500 times and the beam voltage 15kV. Examination of the specimen with an optical microscope showed a very similar picture,

although much of the structure visible is due to scratches and staining during the electro-polishing process.

Conclusions

Preliminary results obtained with the relatively inefficient instrument described in this article are very promising. They show that it is possible to obtain pictures of surfaces directly without making replicas. The interpretation of the micrographs seems fairly straightforward, but of course a very much larger number of different types of specimen will have to be examined and the results compared with those obtained with other methods and, in particular, with the optical microscope. It should be possible, with modern magnetic lenses, to obtain a spot diameter of the same order as the resolving power of the conventional transmission electron microscope. With oblique scanning, as a result of the penetration of the electrons into the specimen, it is not certain whether the resolving power of the scanning microscope can be as high as the spot diameter, if this is of the order of tens of Angstrom units. The penetration of course decreases with the reduction of the accelerating voltage and it may be necessary to work with very low voltages to obtain a high resolution. Difficulty may then be experienced with the contamination of the specimen by oil vapour. At present it is difficult to assess all the advantages and disadvantages of the scanning electron microscope. However there are three clear advantages; the direct observation of the surface of the specimen, the simple preparation of the specimen by standard metallurgical polishing and etching methods and the reproducibility of the results.

Acknowledgments

The author wishes to thank Mr. C. W. Oatley for suggesting the investigation into the possibilities of the scanning microscope and for his continued help and encouragement. He is also greatly indebted to Dr. A. S. Baxter of the Cavendish Laboratory for the loan of one of his electron multipliers, without which the microscope could not have reached its present stage of development. Thanks are also due to the Department of Scientific and Industrial Research for grants towards the cost of the instrument.

In preparing this article the author has made use of some of the information and diagrams in his paper entitled "An Improved Scanning Electron Microscope for Opaque Specimens" which is to be published as Paper No. M1381 in the Proceedings of the Institution of Electrical Engineers, Part II, proofs having been made available to the public in September, 1952.

REFERENCES

1. GABOR, D. The Electron Microscope. (Electronic Engng. Monograph, 1946.)
2. HEIDENREICH, R. D. Electron Microscope and Diffraction Study of Meta Crystal Textures by Means of Thin Sections. *J. Appl. Phys.* 20, 993 (1949).
3. COSSLETT, V. E. The Electron Microscope. (Butterworth, London, 1946.)
4. RUSKA, E., and MÜLLER, H. O. Über Fortschritte bei der Abbildung Elektronenbestrahlter Oberflächen. *Z. Phys.* 116, 366 (1940).
5. V. BORRIES, B. [Sublichtmikroskopische Auffösungen bei der Abbildung von Oberflächen im Übermikroskop. *ibid.* 370.
6. KNOLL, M. Aufladepotential und Sekundäremission elektronenbestrahlter Körper. *Z. Tech. Phys.* 16, 767 (1935).
7. V. ARDENNE, M. Das Elektronen-Rastermikroskop, Theoretische Grundlagen. *Z. Phys.* 109, 553 (1938).
8. ZWORNYKIN, V. K., HILLIER, J., and SNYDER, R. L. A Scanning Electron Microscope. *Bull. Amer. Soc. Test. Mat.* 117, 15 (1942).
9. BRUCK, H., BRICKA, M. Sur un nouveau canon électronique pour tubes à haute tension. *Ann. Radioélectricité.* 3, 339 (1948).
10. BRUCK, H., ROMANI, L. Sur les propriétés de quelques lentilles électrostatiques indépendantes. *Cah. de Phys.* 24, 1 (1944).
11. ALLEN, J. S. An Improved Electron Multiplier Particle Counter. *Rev. Sci. Instrum.* 18, 739 (1947).
12. BAXTER, A. S. Detection and Analysis of Low Energy Disintegration Particles. Dissertation, Cambridge University, 1949.
13. PALLUEL, P. Sur la mécanisme de la rediffusion électronique par les métaux. *C. R. Acad. Sci.* 224, 1551 (1947).

The Design of a Direct-Reading Thermistor Bridge with Temperature Compensation

By R. M. Pearson*, B.Eng., and F. A. Benson†, Ph.D., M.Eng., A.M.I.E.E., M.I.R.E.

The characteristics of bead and disk thermistors are discussed and the difficulties encountered in the design of direct-reading temperature-compensated thermistor bridges for the measurement of microwave power are described. The design calculations for one suitable form of portable, direct-reading bridge are presented.

A GOOD deal of information is available on the design of temperature-compensated thermistor bridges, but the majority of it relates to circuits employing thermistors of American manufacture¹. Further, there are several difficulties and limitations encountered in preparing an actual design which are not generally realized. The purpose of this paper is to point out and comment on such problems.

The characteristics of some British thermistors of both the bead and disk type are first obtained and the information is used to design a temperature-compensated thermistor bridge for the measurement of 3cm microwave power in a waveguide. The actual method used in the design follows fairly closely that given by Montgomery¹.

Characteristics of Thermistors

BEAD THERMISTORS

It has been found¹ that the resistance of a bead thermistor R of American manufacture can be represented very nearly by the expression:

$$R = Je^{B/(K+CP)} \text{ ohms} \dots\dots\dots (1)$$

where J , C and B are constants,

K is the absolute ambient temperature,

and P is the electrical power dissipated in the thermistor in watts.

This expression has been shown to be true to the degree of accuracy required in the design of temperature-compensated thermistor bridges using American thermistors, and figures for the important constants B , C and J have been published. It might well be expected that the parameters of thermistors of British manufacture will also obey expression (1) but the authors were unable to find any proof of this. Further, there appears to be no easily-available information on the values of the constants of any British thermistors or whether there are large variations in these constants from sample to sample. In view of this, some experiments were carried out on four bead thermistors of the type commonly used in bridges for the measurement of 3cm microwave power (namely type E2361/20).

The two factors which determine the resistance of a bead thermistor are the ambient temperature and the electrical power dissipated. Apparatus was thus needed so that the resistance could be measured while the other two parameters were varied separately. It is known that a law which holds for a bead thermistor when it is dissipating D.C. power also holds for A.C. power up to frequencies of about 10 000Mc/s above which discrepancies may occur². The circuit used for the examinations of the

bead thermistors is shown in Fig. 1. A simple Wheatstone bridge measures the bead resistance. The power dissipated in the bead is varied by altering the bridge current with R . The thermistor current at bridge balance can easily be calculated from the bridge current as read on ammeter A . The beads under test were strapped round the bulb of a thermometer and were hung in an electrically-heated oven with a glass door so that the temperature of the beads could be read. Owing to the dependence of the thermistor resistance on the power being dissipated in the bead, the bridge can be balanced for any value of A_3 by varying R . (A_1 and A_2 being kept equal). Readings of bridge current

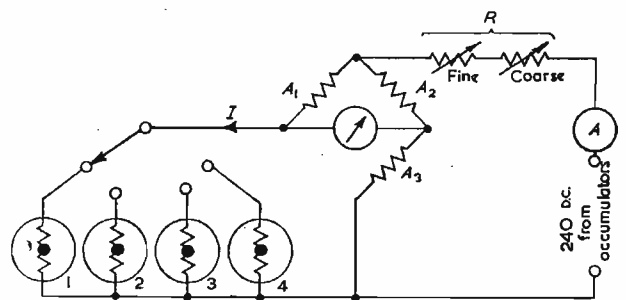

Fig. 1. Circuit employed for examining bead thermistors

at balance were first taken at 10°C intervals throughout an ambient temperature range 21°C to 80°C using the oven. A further set of readings was taken at 4°C with the thermistors suspended in an ice box.

For each current reading at bridge balance the power dissipated in the thermistor was calculated. The resulting resistance power curves are shown in Fig. 2. The information contained in these curves can be used, as shown in the Appendix, to prove that law (1) is nearly true and for the evaluation of the constants B , C and J .

The constants for the thermistors tested are given in Table 1.

TABLE 1

THERMISTOR	J	B (°K)	C (°K/WATT)
1	0.309	2 609.4	8 770
2	0.392	2 400	8 130
3	0.373	2 570	8 620
4	0.529	2 430	9 360

It should be pointed out that it is difficult to measure the exact ambient temperature of a bead since the thermometer bulb cannot be brought into contact with it, due to the glass envelope. In practice the best way of mounting for temperature measurement is to strap the bead to the thermometer bulb.

* Now with the General Electric Co. Ltd.
† The University of Sheffield.

DISK THERMISTORS

The fundamental difference between disk and bead thermistors is one of physical size. Thus, while the disk thermistor is very sensitive to ambient temperature variations its size is such that the heat generated by any electric current flowing in it is easily dissipated and the temperature rise of the element due to this is small.

It has been suggested¹ that if the current flowing in a disk thermistor is kept low (less than 0.5mA) then C in expression (1) will be very small and the resistance of the thermistor is given by

$$R = J e^{B/K} \dots \dots \dots (2)$$

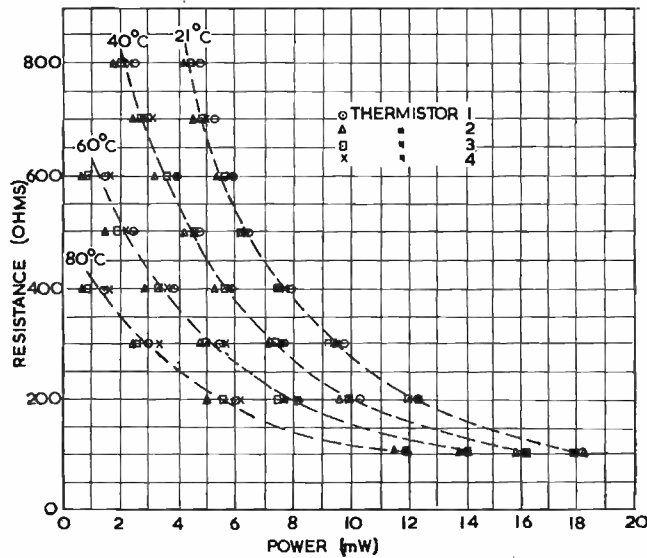
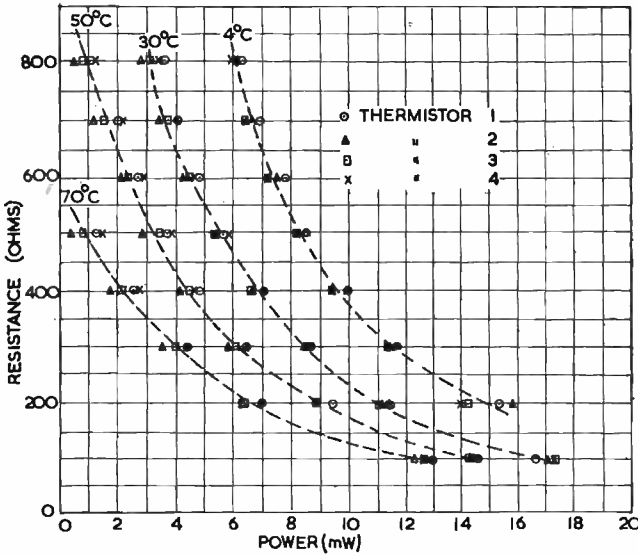

Figs. 2 (a) and (b). Resistance-power curves for bead thermistors type E2361/20

J and B will not, in general, have the same values as for bead thermistors.

Some experiments have been carried out on two common disk thermistors (type KB420) to see if law (2) holds for British thermistors and if so, to calculate the values of the constants B and J . The method of changing ambient temperature was the same as for the bead-thermistor tests and the same bridge was used for the measurement of resistance. A_1 was made equal to A_2 . R was adjusted so that the thermistor current was less than $500\mu A$ at bridge-

balance. Readings of current, temperature and A_2 were taken.

Law (2) was proved by plotting $\log_e R$ against $1/K$ and noting the straight line which results (Fig. 3).

Equation (2) can be written:

$$\log_e R = \log_e J + B/K$$

Thus, B and J are obtained directly from Fig. 3. B is the slope of the line and $\log_e J$ is the intercept on the $\log_e R$ axis. The average values of the constants for the two disk thermistors tested are $B = 4199^\circ K$ and $J = 0.2739 \times 10^{-3} \text{ ohm}$.

Measurement of Microwave Power

The power to be measured is directed on to a bead thermistor in such a way that it is all absorbed. The resulting change in resistance of the bead can be used as a measure of the power. The easiest way to measure the resistance change is to incorporate the thermistor in one arm of a Wheatstone bridge as in Fig. 4.

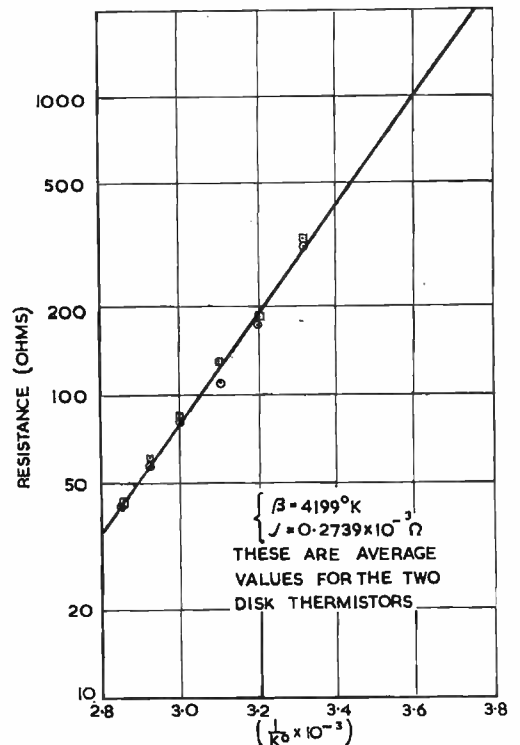

Fig. 3. Characteristics of disk thermistors type KB420

From Fig. 2 it is seen that given an ambient temperature, the resistance of the bead can be brought to any desired value by varying the power being dissipated in it. Thus, in Fig. 4 the D.C. power being dissipated in the bead is equal to $I_1^2 R$. I_1 can be adjusted to any value by varying E and so in this way the bead resistance can be made equal to A , i.e. the bridge can be balanced with D.C.

Thus, microwave power can be measured by (a) balancing the bridge on D.C. (b) introducing the microwave power on to the thermistor, (c) rebalancing the bridge on D.C. Given a fixed ambient temperature, the difference in D.C. powers dissipated in the thermistor in (a) and (c) gives the microwave power.

It is more convenient for portable test-sets to read the microwave power directly on a meter. It is shown below that for Fig. 4 the amount of bridge unbalance is directly proportional to the microwave power causing the unbalance providing this power does not exceed about 2mW.

Due to the microwave power let the resistance of the

thermistor decrease by δ , then $R = A - \delta$ where $\delta \ll A$. It is found that:

$$I_g = \frac{E\delta}{4A(A+R_g)} \left[1 + \frac{\delta}{4(A+R_g)} \cdot \frac{3A+R_g}{A} \right] \dots (3)$$

If the microwave power has value ΔP watts then:

$$\delta = \partial R / \partial P \cdot \Delta P \text{ ohms} \dots (4)$$

where $\partial R / \partial P$ is the slope of the resistance-power curve of the thermistor for a given ambient temperature.

Substituting (4) in (3):

$$I_g / \Delta P = \frac{E \partial R / \partial P}{4A(A+R_g)} \left[1 + \frac{\partial R / \partial P \cdot \Delta P}{4(A+R_g)} \cdot \frac{3A+R_g}{A} \right] \dots (5)$$

This is an expression for the bridge sensitivity in amps/watt.

It is found that the thermistor is most easily matched into a standard 3cm waveguide (internal dimensions 1in. \times $\frac{1}{2}$ in.) when its resistance is fixed, by a d.c. current, at 250-350 ohms. It was decided here to use a bridge with all arms equal at 300 ohms.

From Fig. 2 $\partial R / \partial P = 4.96 \times 10^4$ ohms/watt at room temperature (21°C).

Let $A = 300$ ohms.

$\Delta P = 2\text{mW}$ = the maximum power to be measured.

and $R_g = 500$ ohms (a reasonable assumed value).

$$\text{Thus } \frac{\partial R / \partial P \cdot \Delta P}{4(A+R_g)} \cdot \frac{3A+R_g}{A} = 0.0014$$

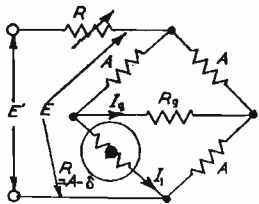

Fig. 4. Bridge circuit for measurement of resistance changes of thermistor beads

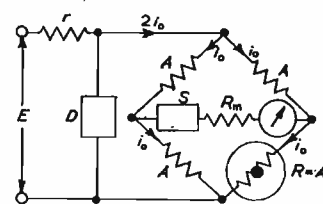

Fig. 5. Thermistor-bridge circuit with compensating networks S and D

This is small compared with unity so that (5) becomes

$$I_g / \Delta P = \frac{E \cdot \partial R / \partial P}{4A(A+R_g)} \dots (6)$$

Thus if E and $\partial R / \partial P$ are constant, $I_g \propto \Delta P$.

It is seen from Fig. 2 that if the maximum power to be measured is restricted to 2mW, the thermistor characteristics are nearly straight, i.e. $\partial R / \partial P$ is constant. E may be kept constant by using a stable power supply. Microwave powers up to 2mW can, therefore, be measured by metering I_g , assuming the ambient temperature is constant.

The bridge sensitivity should, of course, be as high as possible. From (6) it is seen that bridge sensitivity is directly proportional to E and inversely proportional to R_g . The value of E is fixed within fairly narrow limits when A is fixed. E must be sufficient to bring the thermistor resistance to A ohms, given a constant ambient temperature.

Temperature Compensation of Thermistor Bridge for Measurement of Microwave Power

Consider the bridge of Fig. 4 balanced with d.c. with no microwave power introduced. The first effect of a change in ambient temperature is that the thermistor resistance changes and the bridge becomes unbalanced. For the balance on d.c. to be maintained for all ambient temperatures the balancing d.c. power being dissipated in the thermistor must change in such a way as to annul the change of resistance due to ambient-temperature variations. This is done by varying E , the voltage across the

bridge using a variable resistor R in the supply line in series with the bridge. R can be a combination of fixed resistors and a disk thermistor which has a resistance-temperature characteristic such as to automatically keep the bridge balanced (see later).

As E varies, however, so does the bridge sensitivity, as given by (6). This variation can be compensated for by varying A (which is difficult as this is in three bridge arms) or R_g (the easier method). The method used is to introduce in series with the meter a network of fixed resistors and a disk thermistor which has a resistance-temperature characteristic suitable to cancel out the variations in bridge sensitivity in a given ambient-temperature range.

A suggested practical bridge circuit is shown in Fig. 5; S and D are the compensating networks containing resistors and a disk thermistor. It was decided to use a combination of r and D for the voltage-correcting device because if D is placed in series with the bridge, the disk-thermistor network would be required to carry the whole bridge current. This would complicate design since the current taken by the disk thermistor may have to be quite large and the law $R = Je^{B/K}$ would not hold.

Two methods can be used for determining exactly how networks D and S must vary with temperature for perfect compensation.

- (a) By experiment,
- (b) by calculation from a knowledge of the characteristics of the bead and disk thermistors.

(a) The bridge is built up with networks S and D replaced by decade resistance boxes. The bridge with the thermistor mount is placed in a temperature-controlled oven and balance is obtained with d.c. The temperature in the oven is then varied over the range through which the bridge is to be compensated. Balance is maintained by varying D and a plot of D against temperature K is obtained. A network containing a disk thermistor can now be designed (as shown later) which will have this temperature-resistance characteristic. This network is substituted for the decade resistance box and the first part of the compensation is achieved.

A known quantity of microwave power is next dissipated in the bead thermistor and the meter gives a reading which, providing the ambient temperature remains constant, is proportional to the microwave power. The microwave power is kept constant and the oven temperature is again taken through the desired range. While this is done, decade-box S is varied so as to keep the meter reading, and hence the sensitivity, constant. The plot of S against K also enables a compensating network to be designed.

The above method requires a chamber whose temperature can be regulated from near freezing point to the maximum temperature at which the bridge is desired to operate. Further, the process would have to be carried out again if the bead thermistor is changed. It is thus more convenient to be able to calculate values for plotting the D - K and S - K curves.

(b) Consider the bridge circuit of Fig. 5 at balance with the currents as shown. Analysis shows:

$$D = \frac{Ar}{E/2i_0 - (A+r)} \dots (7)$$

Now, the power dissipated in the bead thermistor = $P = Ri_0^2 = Ai_0^2$ since the bridge is balanced. Further $A = Je^{B/(K+CP)}$ at balance.

$$\text{Therefore, } i_0 = \sqrt{\frac{1}{CA} \left(\frac{B}{\log_e A/J} - K \right)} \dots (8)$$

Substitution of (8) in (7) gives an expression connecting D and K , from which a curve can be drawn. This curve

is smooth, having no discontinuities and thus only three values of K need be taken. It is seen in the Appendix that to calculate J , B and C for the bead thermistors, three values of temperature were taken. These are, in fact, the two extremes and a value in the centre of the temperature range over which compensation is desired. These values of temperature were taken in obtaining the D - K curve.

To find the S - K curve, consider the conditions in the bridge circuit when some microwave power is being dissipated in the thermistor.

Let: Resistance of bead thermistor now = R_T
 Voltage across „ „ = e_t
 Current flowing in „ „ = i_t
 Microwave power dissipated = P_t
 (say the max. value of 2mW)
 D.C. power dissipated = p

Then,

$$R_T = e_t/i_t = J e^{\left\{ \frac{B}{K+C(P_t+D)} \right\}} \dots\dots\dots (9)$$

$$p = e_t \cdot i_t \dots\dots\dots (10)$$

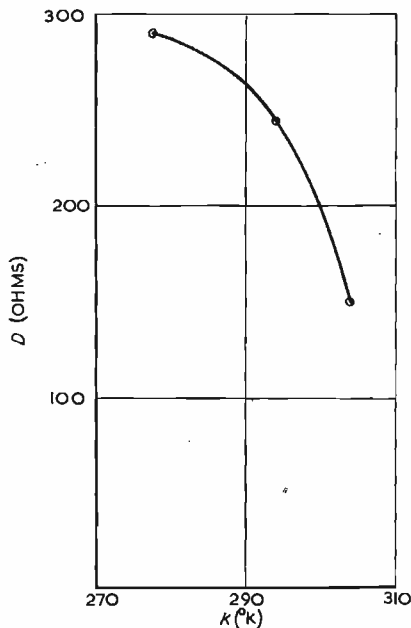

Fig. 6. D-K curve for bridge circuit

From (9) and (10)

$$P_t = \frac{B/C}{\log_e e_t/i_t} - e_t i_t - K/C \dots\dots\dots (11)$$

Let the resistance of the meter arm of the bridge = $R_g = S + R_m$

where R_m is the resistance of the meter.

The microwave power P_t produces an unbalance current in the meter arm (I_g) and the problem is to find the relationship between S and K such that I_g/P is constant over the desired temperature range. To do this e_t and i_t are found in terms of A , E , R_g , r , D and I_g . Note that R_g and D are the only terms which vary with temperature and it is already known how D varies with temperature.

From analysis of the bridge in the unbalanced condition:

$$e_t = \frac{AE'}{2(R_0 + A)} \left[1 - \frac{(3R_0 R_g + 2AR_0 + 2AR_g + A^2) I_g}{AE'} \right] \dots\dots\dots (12)$$

and

$$i_t = \frac{E'}{2(R_0 + A)} \left[1 + (R_0 R_g + 2AR_0 + 2AR_g + 3A^2) \frac{I_g}{AE'} \right] \dots\dots\dots (13)$$

where $E' = E/(1+r/R)$ and $R_0 = r/(1+r/D)$. Substituting (12) and (13) in (11) and fixing $P_t = 2\text{mW}$ and I_g at $300\mu\text{A}$ (which was convenient) an expression results connecting R_g and K and, since R_m is constant, S and K .

The calculation here is long and involved, but not impossibly so. It is advisable to use a calculating machine if cumulative errors due to approximations are to be avoided. Only three values of K need be considered again, preferably the ones at which the thermistor constants were calculated.

Practical Results

The bead thermistor constants J , B and C were calculated (see Appendix) at 4°C (277°K), 21°C (290°K) and 60°C (333°K) with $r = 4000$ ohms*, the values of D required for compensation were calculated from (7) and (8) and the resulting D - K curve is shown in Fig. 6.

Using this D - K curve and taking a value of bridge sensitivity ($P_t = 2\text{mW}$ produces $I_g = 300\mu\text{A}$) e_t and i_t can now

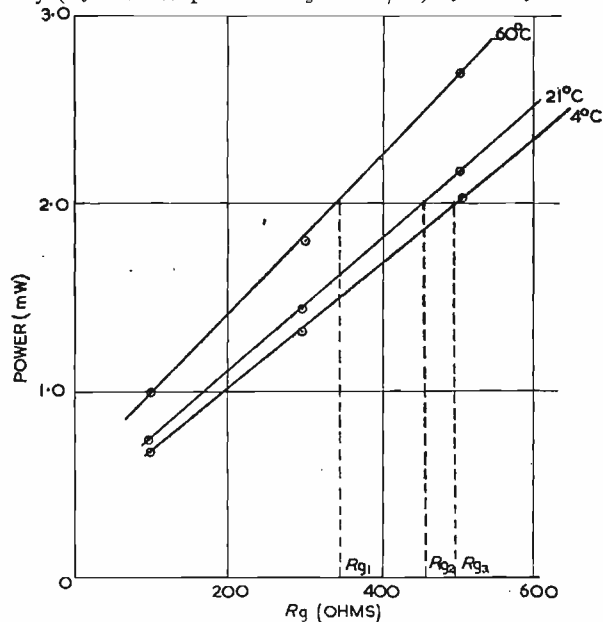

Fig. 7. Power/meter-arm resistance curves for bridge circuit

be calculated at the three temperatures under consideration from (12) and (13) for, say, three values of R_g . Substituting these values in (11) Table 2 can be drawn up.

TABLE 2

R_g (OHMS)	100	200	300
P at 4°C . (mW)	0.645	1.309	2.031
P at 21°C . (mW)	0.731	1.429	2.155
P at 60°C . (mW)	1.01	1.795	2.657

From Table 2 the curves of Fig. 7 can be drawn, and from these, values of R_g (R_{g1} , R_{g2} and R_{g3}) necessary to maintain constant sensitivity for $P_t = 2\text{mW}$ can be deduced. Thus, knowing the meter resistance the S - K curve is easily obtained.

Matching Networks

It is now necessary to devise networks having resistance-temperature characteristics which match the D - K and S - K

* The reason for this particular value is given later.

curves obtained. The network of Fig. 8 has been suggested¹ as being suitable. It has been pointed out that using this network the *D-K* and *S-K* curves cannot be matched exactly, although exact matching can be obtained at three points in the temperature range and only small deviations will occur between these points. An algebraic method has been given for finding suitable values of R_{11} , R_{12} and R_{22} for a given disk thermistor so that matching is achieved. The authors experienced considerable difficulty in using this method with S.T.C. KB420 disk thermistors. It was only after very considerable experimentation with the values of r that a three-point match was obtained for drift compensation. For sensitivity compensation a three-point match was not obtained and a graphical method of solution was evolved.

The algebraic method will now be outlined. If the resistance looking in to the terminals of the network of Fig. 8 is R' , then $R' = E/I_1$ and network analysis gives:

$$(R' - R_{11}) J_e^{B/K} + R_{22} (R' - R_{11}) + R_{12}^2 = 0 \dots (14)$$

For drift compensation, the values of D for the three chosen temperatures are found and these are substituted for R' in Equation (14). The disk thermistor resistances ($J_e^{B/K}$) are also calculated for the three temperatures. Thus, three equations are obtained from (14) corresponding to the three temperatures and there are three unknowns, R_{11} , R_{22} and R_{12} . Providing $R_{11} \geq R_{12}$ and $R_{22} \geq R_{12}$ there is a physically realizable network which matches the *D-K* curve in three points.

Now r has considerable effect on the shape of the *D-K* curve and it was found that unless r lay in the approximate range $2k\Omega$ to $4.5k\Omega$ for the particular thermistors in use a physically realizable network could not be obtained. It was found that when $r < 2.0k\Omega$ then $R_{11} < R_{12}$ and for $r > 4.5k\Omega$ $R_{22} < R_{12}$. The value of r also has a considerable effect on the shape of the *S-K* curve (for any given value of bridge sensitivity) and it was found impossible to obtain a three-point match. It was necessary, therefore, to find some way of seeing exactly how the $R'-K$ curve varied as the values of R_{11} , R_{22} and R_{12} were changed and also some convenient way of comparing this with the particular *S-K* (or *D-K*) curve to be matched.

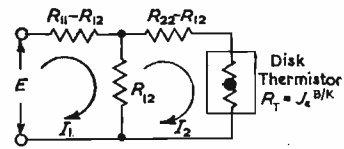

Fig. 8. Network with a resistance-temperature characteristic suitable for matching *D-K* and *S-K* curves

A graphical method of matching was consequently devised. Rearrangement of Equation (14) gives:

$$R' = R_{11} - \frac{R_{12}^2}{R_T + R_{22}} \dots (15)$$

where R_T is the disk thermistor resistance $J_e^{B/K}$. Since the manner in which R_T varies with K is known, D and S may be plotted against R_T instead of K . Using Equation (15) R may be plotted against R_T . Thus, the sets of curves to be matched can be arranged with a common axis. The shape of each curve can be changed by altering the appropriate parameters and the shapes can be easily compared by virtue of the common axis.

To alter the shape of the *D-R_T* curve, r may be varied and to alter the *S-R_T* curve both r and I_g may be varied. From Equation (15) it is seen that the shape of the $R'-R_T$ curve is controlled by the term $-R_{12}^2/(R_T + R_{22})$ while its vertical position above the R_T axis is fixed by R_{11} . Thus, the matching process consists of varying R_{12} and R_{22} until the shape of the $R'-R_T$ curve is the same as that of the *S-R_T* (or *D-R_T*) curve. then, by adjustment of R_{11} displace the vertical position of the $R'-R_T$ curve until final matching is obtained. Of course, the values chosen for R_{11} , R_{22} and R_{12} must satisfy the conditions $R_{11} \geq R_{12}$ and $R_{22} \geq R_{12}$. This matching process was used in the design of the bridge described below. Although it was not possible to obtain a

three-point match for the *S-K* curve a useful degree of temperature compensation can be obtained as can be seen from the final matching curves of Fig. 9.

Design Calculations for Temperature-Compensation Bridge

The design outlined below applies to a bead thermistor having the following constants:

$$B = 2609.4^\circ K$$

$$C = 8770^\circ K/watt$$

$$J = 0.309 ohm$$

These constants were calculated, for one particular bead tested, at $4^\circ C$ ($277^\circ K$) $21^\circ C$ ($294^\circ K$) and $60^\circ C$ ($333^\circ K$) and so these temperatures are used in plotting the *D-K* curve and in producing the necessary equations for designing the matching network. Results of the *D-K* curve calculations are given in Table 3, assuming $r = 4000$ ohms and $A = 300$ ohms.

Disk thermistors type STC KB420 were used in the compensating network. For this type $B = 4199^\circ K$ and $J =$

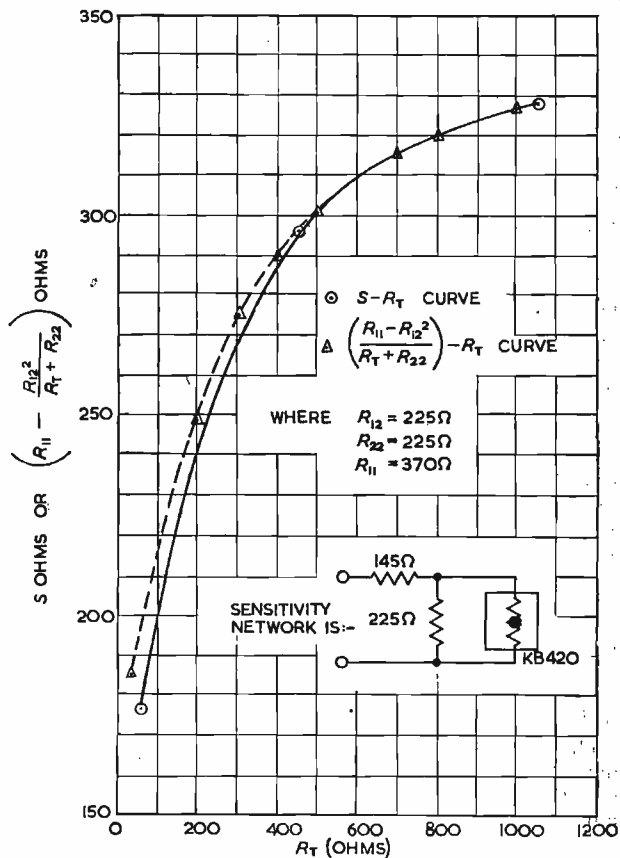

Fig. 9. Matching of $R'-R_T$ and $S-R_T$ curves to give a useful degree of temperature compensation

0.2739×10^{-3} ohm. The values of $J_e^{B/K}$ at the three temperatures are given in Table 4.

TABLE 3

K (°K)	D OHMS
277	291.26
294	243.8
333	146.66

TABLE 4

K (°K)	$J_e^{B/K}$ OHMS
277	1 048.2
294	439.062
333	81.84

The drift-matching network equations are thus:

$$(291.26 - R_{11}) 1048.2 + R_{22} (291.26 - R_{11}) + R_{12}^2 = 0 \dots (16)$$

$$(243.8 - R_{11}) 439.1 + R_{22} (243.8 - R_{11}) + R_{12}^2 = 0 \dots (17)$$

$$(146.66 - R_{11}) 81.84 + R_{22} (146.66 - R_{11}) + R_{12}^2 = 0 \dots (18)$$

These give:

$$R_{11} = 349.42 \text{ ohms}$$

$$R_{22} = 307.28 \text{ ohms}$$

and $R_{12} = 279 \text{ ohms}$

and the resulting matching network is given in Fig. 10.

Prior to sensitivity compensation it is necessary to fix the bridge sensitivity. It was decided that the maximum power to be measured would be 2mW (since this is the maximum range over which the bead-thermistor resistance-power characteristics are linear). After some experimentation with design, the meter arm current resulting from the application of 2mW was set at 300 μ A.

From the $P-R_g$ curves shown in Fig. 7 Table 5 is obtained giving the required values of R_g to keep the power at 2mW at the three matching temperatures together with the corresponding values of S obtained by subtracting the meter resistance (this is 166 ohms with 25 ohms of the 50 ohm variable shunt in circuit).

TABLE 5

K ($^{\circ}K$)	R_g (OHMS)	S (OHMS)
277	495	329
294	460	294
333	342.5	176.5

The $S-K$ curve becomes the $S-R_T$ curve when K is expressed in terms of R_T . S and the function of the matching network $R_{11} - R_{12}^2 / (R_T + R_{22})$ are both plotted against R_T on Fig. 9. R_{11} , R_{12} and R_{22} have been adjusted to give as good a match as possible under the specified conditions. The sensitivity matching network resulting from the best values of R_{11} , R_{12} and R_{22} is also shown on Fig. 9.

It will be seen from Fig. 9 that the match is not a three-point one, but the error between 40 $^{\circ}$ and 30 $^{\circ}C$ is always less than $\frac{1}{2}$ per cent, while at 60 $^{\circ}C$ it is at its greatest, being 9 per cent.

The complete temperature-compensated bridge is shown in Fig. 11. The value of r is made variable 4000 \pm 250 ohms to provide a "set-zero" control for balancing the bridge on D.C. A variable preset 50-ohm resistor is put in series with the 180 ohm meter shunt. This provides a means of standardizing the bridge. A known 2mW of microwave power can be dissipated in the bead thermistor and, using the variable resistor in the meter-shunt arm, the meter can be adjusted to read full scale. The scale will then be a measure of power from 0 to 2mW.

Bridge Power Supplies

The success of this bridge as a means of measuring micro-wave power depends to a large extent on its ability to stay balanced with D.C. The effects of ambient-temperature variations have been overcome as described

Fig. 11. Temperature-compensated thermistor-bridge circuit

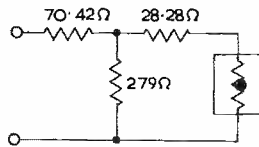
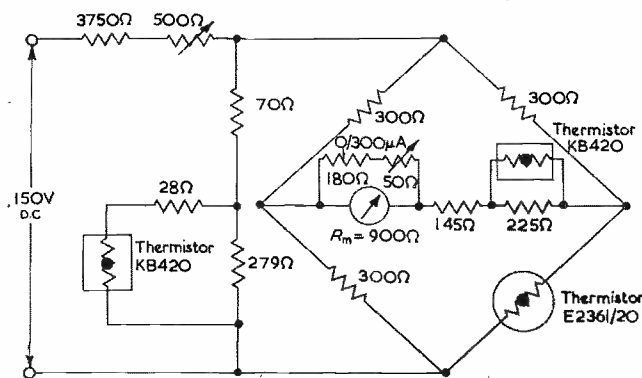

Fig. 10. Drift-matching network for use in temperature-compensated thermistor bridge

already. However, if the applied voltage E , which was chosen as 105 volts in the particular design considered, changes, then the D.C. balance will change.

Considerable difficulty is experienced using a normal full-wave rectifier power unit working from the A.C. mains, the voltage of which varies drastically over short periods (16 per cent is common). It was found that a 5 per cent change in E caused an 80 per cent change of meter reading.

Many published circuits are quite inadequately stabilized for present-day mains variations. For example, a simple full-wave rectifier unit followed by a simple glow-discharge tube stabilizer was found to be unsatisfactory for voltage variations of ± 10 per cent. In fact, for a 1 per cent accurate D.C. balance the voltage applied must be kept constant to better than 0.05 per cent. The most convenient power supply would be an electronically-stabilized one³

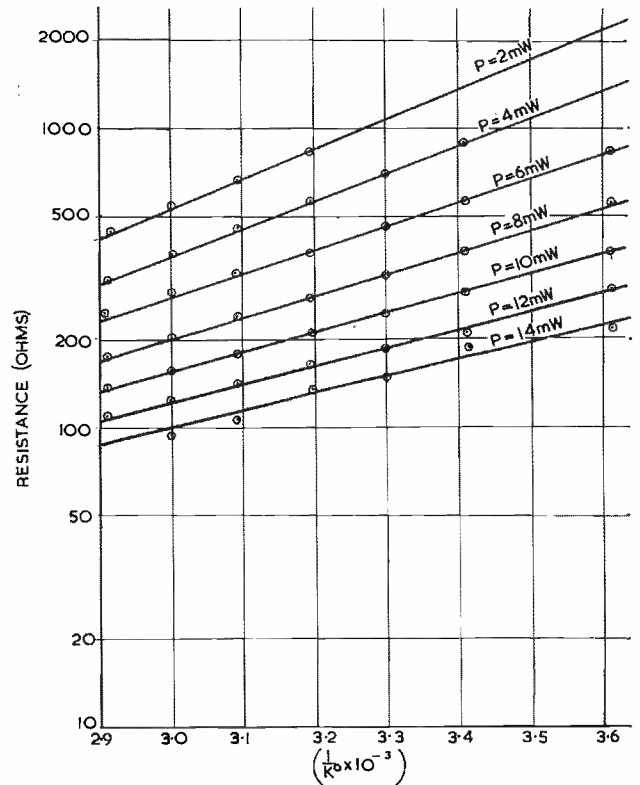

Fig. 12. Characteristics of bead thermistors type E2361/20

using a good reference element and fed from the A.C. mains via a rectifier unit.

The authors used a H.T. accumulator with a permanently-attached voltage monitor and a manual control of voltage.

Acknowledgments

The work recorded in this paper has been carried out in the Department of Electrical Engineering at the University of Sheffield. The authors wish to thank Mr. O. I. Butler, M.Sc., A.M.I.E.E., for the facilities offered in the laboratories of this Department and for his encouragement and interest in the work.

APPENDICES

1. ESTABLISHMENT OF APPROXIMATE BEAD THERMISTOR EQUATION $R = Je^{B/(K+0P)}$ FROM EXPERIMENTAL RESULTS
Experimental curves showing the relationship between R and the parameters P and K which change it are shown in Fig. 2. If these curves be replotted as in Fig. 12 a series of approximately parallel straight lines is obtained.

If the special case of $P = 0$ is considered, then a similar

straight line would be expected, the equation of which could be written:

$$\log_e R = \log_e J + B/K \quad (19)$$

where J and B are constants,

or, rewriting,

$$R = J e^{B/K} \quad (20)$$

Now it is seen from Fig. 2 that to maintain a constant value of R while increasing P , K must fall. Further, since the curves for equal increments of K are approximately equally spaced in the direction of the P axis, then if P be increased by an amount P_1 and the resulting decrease in K to maintain R constant is K_1 , then $K_1 = -CP_1$ where C is a constant, or

$$K_1 + CP_1 = 0 \quad (21)$$

Thus, when $P \neq 0$ Equation (20) should be written:

$$R = J e^{B/(K+CP)}$$

2. THE CALCULATION OF THE VALUES OF BEAD THERMISTOR CONSTANTS J , B AND C FROM EXPERIMENTAL RESULTS

The law derived in Appendix 1 will be used and figures for the calculation of the constants will be taken from Fig. 2. It is shown in Appendix 3 just how accurate the law is. The limits of ambient temperature over which compensation is required are 4°C and 60°C (i.e. $K_1 = 277^\circ\text{K}$, $K_2 = 333^\circ\text{K}$). The powers required to bring the bead to a resistance of 300 ohms at these two temperatures are $P_1 = 11.69\text{mW}$ and $P_2 = 5.3\text{mW}$ respectively.

The thermistor equation can be rewritten as:

$$\log_e R = \log_e J + B/(K + CP) \quad (22)$$

Therefore

$$\log_e R = \log_e J + B/(K_1 + CP_1) \quad (23)$$

and

$$\log_e R = \log_e J + B/(K_2 + CP_2) \quad (24)$$

Subtracting these last two equations,

$$B \left(\frac{1}{K_1 + CP_1} - \frac{1}{K_2 + CP_2} \right) = 0$$

Therefore $K_1 + CP_1 = K_2 + CP_2$

$$\text{or } C = \frac{K_2 - K_1}{P_1 - P_2} = 8700^\circ\text{K/watt}$$

The power required to bring the bead to $R_3 = 400$ ohms at $K_3 = 294^\circ$ (21°C) is $P_3 = 8\text{mW}$.

and

$$\log_e R_3 = \log_e J + B/(K_3 + CP_3) \quad (25)$$

Subtracting (24) from (25)

$$B = \frac{(K_2 + CP_2)(K_3 + CP_3)(\log_e R_3 - \log_e R_1)}{(K_2 + CP_2) - (K_3 + CP_3)}$$

$$B = 2609.36^\circ\text{K}$$

Also subtracting (23) from (25)

$$\log_e J = \frac{(K_1 + CP_1) \log_e R_1 - (K_3 + CP_3) \log_e R_3}{(K_2 + CP_1) - (K_3 + CP_3)}$$

$$= -1.1754.$$

Therefore $J = 0.309$ ohm.

3. EXAMPLES ILLUSTRATING THE ACCURACY OF THE BEAD THERMISTOR LAW

Examples are worked out below, taking various values of P and K to check the accuracy of the bead-thermistor law against the experimentally-obtained results plotted on Fig. 2.

Example 1

Take $P = 3\text{mW}$ and $K = 353^\circ\text{K}$ (80°C)

From Fig. 2, $R = 300$ ohms.

Assuming the thermistor law to be true and using the constants obtained in Appendix 2:

$$R = 0.309 e^{2609.36/(353+8.77 \times 3)}$$

$$= 304.5 \text{ ohms.}$$

The percentage error between the two results is $4.5/300 \times 100 = 1.5$ per cent.

Example 2

Take $P = 4\text{mW}$ and $K = 313^\circ\text{K}$ (40°C)

From Fig. 2, $R = 564$ ohms

Using the law $R = 558$ ohms

Percentage error = 1.064 per cent.

Example 3

Take $P = 1\text{mW}$ $K = 313^\circ\text{K}$ (40°C)

From Fig. 2, $R = 186$ ohms.

Using the law $R = 181$ ohms.

Percentage error = 2.69 per cent.

It is found that in the power range 5mW to 10mW the error in using the formula does not exceed 2 per cent. At higher powers near to the burn-out power of the beads (about 25mW) errors are in the region 2.5 per cent. Thus, while it seems reasonable to use the law for temperature-compensation calculations, it should not be used when a very accurate figure for the bead resistance is required.

REFERENCES

- MONTGOMERY, C. G. *Technique of Microwave Measurements*. (McGraw Hill, 1947).
- COLLARD, J., NICOLL, G. R. and LINES, A. W. *Proc. Phys. Soc.* 63, Section B. 215 (1950).
- BENSON, F. A. *Voltage Stabilizers*. (Electronic Engineering Monograph 1951).

New BBC Transmitting Station

The new permanent transmitting station near Barnstaple has recently taken over the West of England Home Service from the temporary transmitter which has been operating from a caravan on the site. The equipment is designed for completely automatic operation*. It comprises two Marconi transmitter units working in parallel to give an output of 1½kW. Main and reserve crystal controlled drives are provided, and automatic frequency control equipment will shortly be installed. The incoming programme is checked by an automatic line monitor which compares the programme applied to the transmitter at Barnstaple with coded information sent over a separate circuit from Bristol. By this means the monitor is able to check line noise and frequency response and if a fault is observed its first action would be to change over to a spare set of programme input equipment. If the fault was not cleared by this step, the programme to the transmitter would be interrupted, but it would be restored later if the monitor had observed the incom-

ing programme to be trouble-free over a pre-determined period. Parts of the monitor equipment at each end of the line are duplicated. If one section at the sending end fails, a local alarm is given and a "safe" signal is automatically sent to line which prevents the station equipment at the receiving end of the line taking executive action. If one section at the transmitting station failed, the second set would automatically take over. Further automatic monitoring equipment supervises the performance of the transmitting equipment itself by comparing the programme fed to the transmitter with that being radiated, and in the event of a fault in one of the transmitter units it would be automatically disconnected, leaving the station running on reduced power. A telephone indicator device has also been installed. A telephone call to the station will cause this equipment to send to line a series of coded tone-pulses from which the engineers can determine the state of the various items of equipment at the station.

* PEACHEY, F. A., TOOMBS, R. BBC New Automatic Unattended Transmitter. *Technique, Electronic Engng.* 24, 446 (1952).

Time-Division Multiplex Systems

(Part 2)

Pulse-Amplitude Modulated Systems

By J. E. Flood* Ph.D., A.M.I.E.E.

SOME early workers^{1,2} in the field of T.D.M. used pulse-amplitude modulation (P.A.M.) because of its simplicity, but it proved unsuitable when the transmission path was subject to much injected noise as, for instance, radio links can be. P.A.M. has therefore been superseded by systems, such as pulse-position modulation, which employ pulses of constant amplitude. Some radio links, however, have used an amplitude-modulated T.D.M. system to frequency-modulate the radio-frequency carrier^{22,35}. P.A.M. is also an intermediate step in some systems which finally use another type of pulse modulation^{26,37,38}, because of the simplicity and cheapness of the apparatus required to be individual to each channel.

Pulse-amplitude modulation is attractive for systems not subjected to much injected noise. A preliminary survey of electronic automatic telephony²⁴ has suggested that the

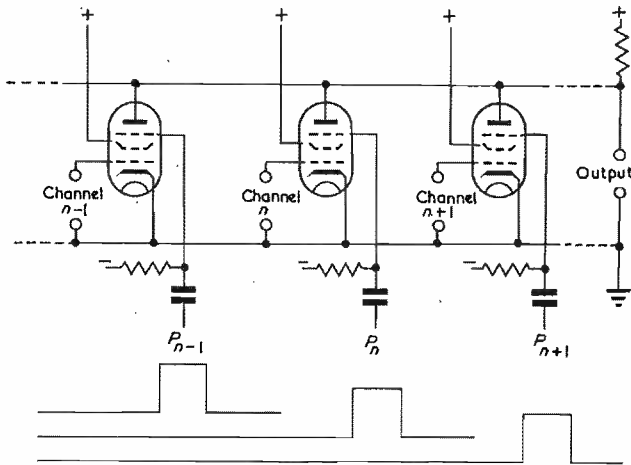

Fig. 8. Pentode valve sending gates for T.D.M. system

multiplex transmission most suitable for handling the many conversations passing through one switch might well use time-division and amplitude-modulation. This may well lead to a revival of interest in pulse-amplitude modulation.

Circuits for Pulse-Amplitude Modulation

A simple form of modulator is a pentode valve gate circuit such as those shown in Fig. 8. The modulating signal is applied to the control grid which is biased to the centre of the linear portion of the valve characteristic. The suppressor grid is biased beyond cut-off so that anode current only flows during the positive pulses which are applied to the suppressor. When a modulating signal is applied to the control grid and a pulse-train to the suppressor grid, a train of amplitude-modulated pulses of current flows in the anode load resistor. A time-division multiplex system is formed by connecting to a common load impedance

valves to whose suppressor grids are applied pulse trains which are spaced in time as shown in Fig. 8.

The development of germanium crystal diodes^{39,40} with a ratio of backward to forward resistance of the order of 10^4 enables rectifier switches to be made which have an attenuation of the order of 80db when switched off. These diodes have an inter-electrode capacitance of about 1pF, which enables the switches to be operated by short pulses and used as gates in T.D.M. systems. Fig. 9 shows a crystal

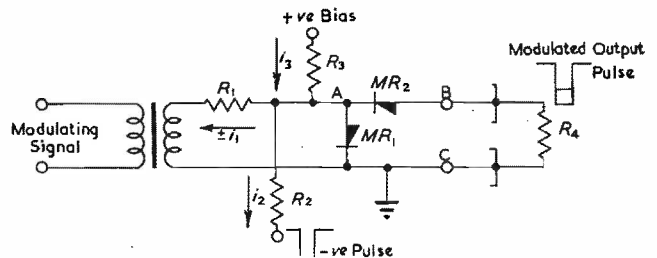

Fig. 9. Gate circuit using germanium crystal rectifiers

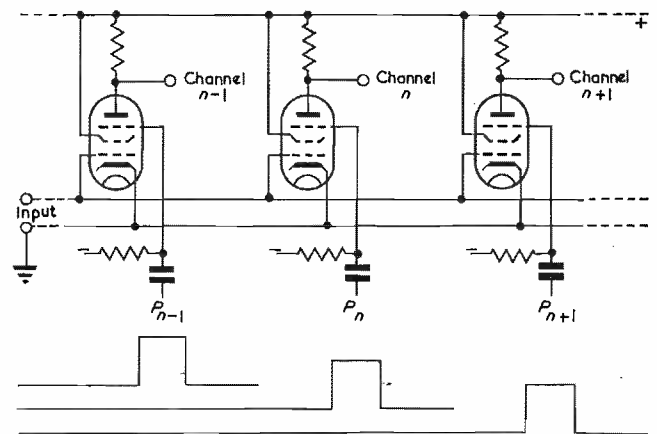

Fig. 10. Pentode valve receiving gates for T.D.M. system

diode gate which can be used as a pulse-amplitude modulator for a T.D.M. system. A current i_3 flows from the positive bias voltage source through rectifier MR_1 to earth. The p.d. across MR_1 makes the potential of point A positive, thereby ensuring that rectifier MR_2 is non-conducting. When a negative pulse is applied, a current i_2 flows in R_2 and, if i_2 is greater than i_3 , point A becomes negative, MR_1 ceases to conduct and a current $i_2 - i_3$ flows through MR_2 and the load resistor R_4 . The application of a modulating signal causes a current $\pm i_1$ to flow in R_1 and, when a pulse is applied, the current which flows in R_4 is $i_2 - i_3 \pm i_1$. The pulses which appear across R_4 are thus amplitude-modulated. In order to construct a T.D.M. system, several gates operated by time-spaced pulses may

* Formerly Research Branch, Post Office Engineering Department.

be commoned at points B and C to a single load resistor R_4 as shown. The forward resistance of MR_2 varies with the current flowing through it, causing harmonic distortion of the output signal. In order to reduce the distortion to a low level, R_1 , R_2 and R_3 should be large compared with the forward resistance of MR_2 . The need to make R_1 large causes the gate to have a large insertion loss, so subsequent amplification is required: this can be provided economically by an amplifier in the transmission path common to all the channels.

When used at the receiving end of a T.D.M. system the valve gate would have its control grid connected, in common with those of the gates of all the other channels, to the source of signal comprising the pulse-trains of all the channels as shown in Fig. 10. A pulse of anode current flows only when one of the pulses of the input signal coincides with the pulse applied to the suppressor grid. The valve therefore amplifies linearly the pulse of the selected train and does not pass the pulses of other channels. The crystal gate shown in Fig. 9 can be used at the receiving end by replacing the load resistor R_4 by the source of negative signal pulses and taking the output from the transformer. The output signal from either type of gate can be demodulated by means of a low-pass filter whose cut-off frequency is approximately half the pulse-repetition frequency.

When a low-pass filter is used for demodulation, the ratio between the demodulated output voltage and the modulation voltage on the pulses is equal to the ratio

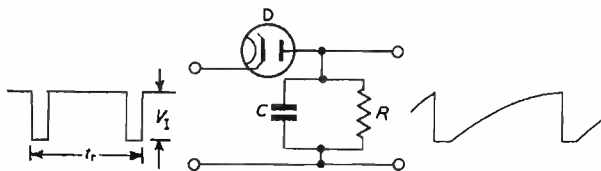

Fig. 11. The pulse lengthener circuit

between the length of the pulses and their repetition period, i.e. the duty ratio. For example, if the duty ratio is $1/100$ the output voltage is $1/100^{\text{th}}$ of the modulation voltage on the pulse, causing a loss of 40db between the input to the modulator and the output from the demodulator. Of this 40db loss, 20db occurs because the sending gate only transmits for $1/100^{\text{th}}$ of the time and the remaining 20db because the demodulating low-pass filter accepts only the power contained in the modulating frequency components of the pulse waveform: all the power contained in the sidebands of the P.R.F. and its harmonics is rejected. Considerable audio-frequency amplification is therefore required after the demodulating filter.

An output voltage nearly equal to the modulation voltage on the pulses can be obtained by using each received pulse to charge a capacitor to its peak voltage and allowing the capacitor to retain its charge during the interval between pulses. A circuit which performs this function is called a pulse lengthener. Fig. 11 shows a simple diode detector used as a pulse lengthener. When a negative pulse is applied, the capacitor C is charged to the peak voltage of the pulse through the diode D ; after the pulse, the diode becomes non-conducting and the potential across the capacitor decays exponentially with time-constant CR . When an amplitude-modulated pulse-train is applied to the input terminals, an amplitude-modulated saw-tooth waveform is obtained across the capacitor. The longer the time-constant CR , the greater is the ratio η of the output signal voltage to the modulation voltage on the pulses, but the smaller is the maximum depth of modulation which the input pulse-train may have without causing non-linear distortion at high modulating frequencies. Fig. 12 shows the variation with time-constant of the efficiency η and the permissible depth of modulation: the equations for these curves are determined in the appendix.

An efficiency of nearly 100 per cent can be obtained by making the time-constant large compared with the pulse repetition period but, in order to allow the lengthener to handle pulses with an appreciable depth of modulation without severe harmonic distortion another means must be provided to discharge the capacitor^{43,44,45}. The circuit⁴⁵ shown in Fig. 13 uses two triode valves which are normally

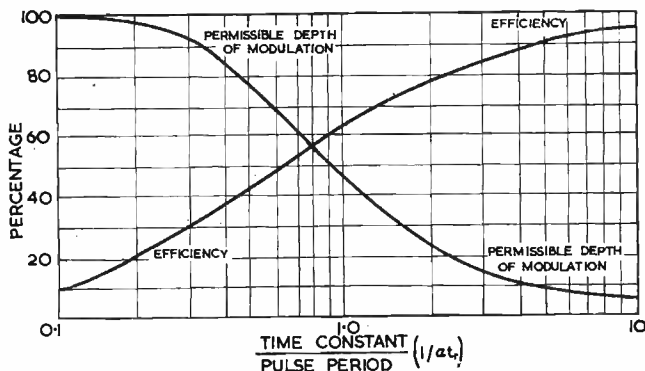

Fig. 12. Performance of pulse lengthener circuit

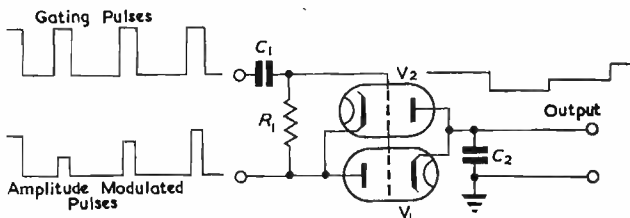

Fig. 13. Combined gating and pulse lengthening circuit

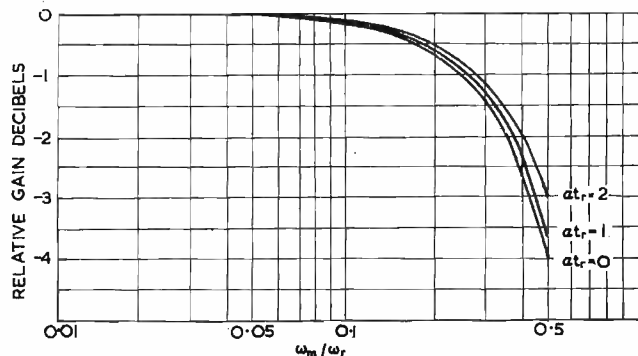

Fig. 14. Attenuation distortion characteristics of pulse lengtheners

both biased beyond cut-off by the charge on C_1 . Application of a positive gating pulse to the control grids causes either V_1 or V_2 to conduct depending on whether the height of the modulated signal pulse is greater or smaller than the P.D. across C_2 . In this way the P.D. across the capacitor C_2 is made to vary in steps according to the amplitudes of the pulses received.

The lengthener shown in Fig. 13 avoids the limitations on the efficiency and permissible depth of modulation which apply to the simple circuit of Fig. 11. Both circuits, however, cause attenuation distortion at the higher modulating frequencies. Fig. 14 shows the amplitude-frequency responses corresponding to several time-constants, calculated from a formula due to Kleene⁴³. When a flat overall gain-frequency characteristic is required, equalization must therefore be provided.

Multiplexing by Stages

It is economically advantageous to use pulse-amplitude modulation as an initial stage in systems with a large number of channels, even when another type of modulation is used finally. The construction of a system with a large number of channels by commoning together a large number of gates, presents problems because of the large stray capacitances involved; the total capacitance of all the gates and of the necessarily long connecting leads can be considerable and the pulses must necessarily be very short. The problem of pulse generation and distribution is also difficult if there is a large number of gates, each of which must be supplied with an individual pulse whose timing must be accurately controlled relative to the other pulses. These problems can be simplified by using more than one stage of multiplexing.

The construction of systems with a large number of channels also presents problems when frequency-division multiplexing is used. A large number of modulators have to be commoned together through different filters and a large number of different carrier frequencies have to be generated. Again, the problems can be simplified by using more than one stage of multiplexing. A coaxial cable carrier transmission system⁴¹ is built up from super-groups of 60 channels each of which uses two stages of multiplexing and this requires no more than seventeen carrier frequencies.

A pulse-amplitude modulated T.D.M. system with sixty channels each of 4kc/s nominal bandwidth can also be constructed with two stages of multiplexing, as shown in Fig. 15. Each audio-frequency channel is connected to a pulse modulator which is supplied with pulses of 10 μ sec duration and 8kc/s P.R.F. The outputs from twelve channel-modulators, each fed with a different train of 10 μ sec pulses, are commoned to provide the input to a gate which is operated by pulses of 1 μ sec duration and 96kc/s P.R.F. Any channel therefore modulates every twelfth pulse applied to this gate, the intervening pulses being modulated by the other eleven channels in the group.

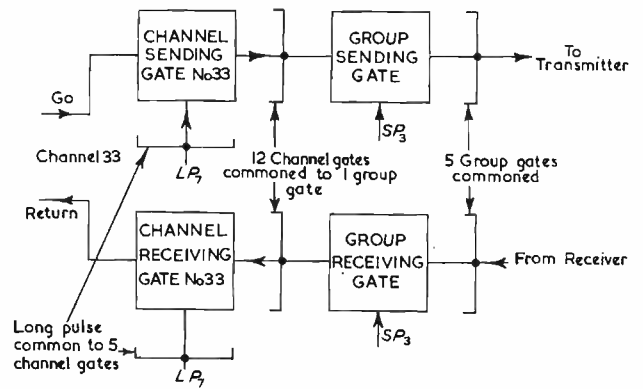
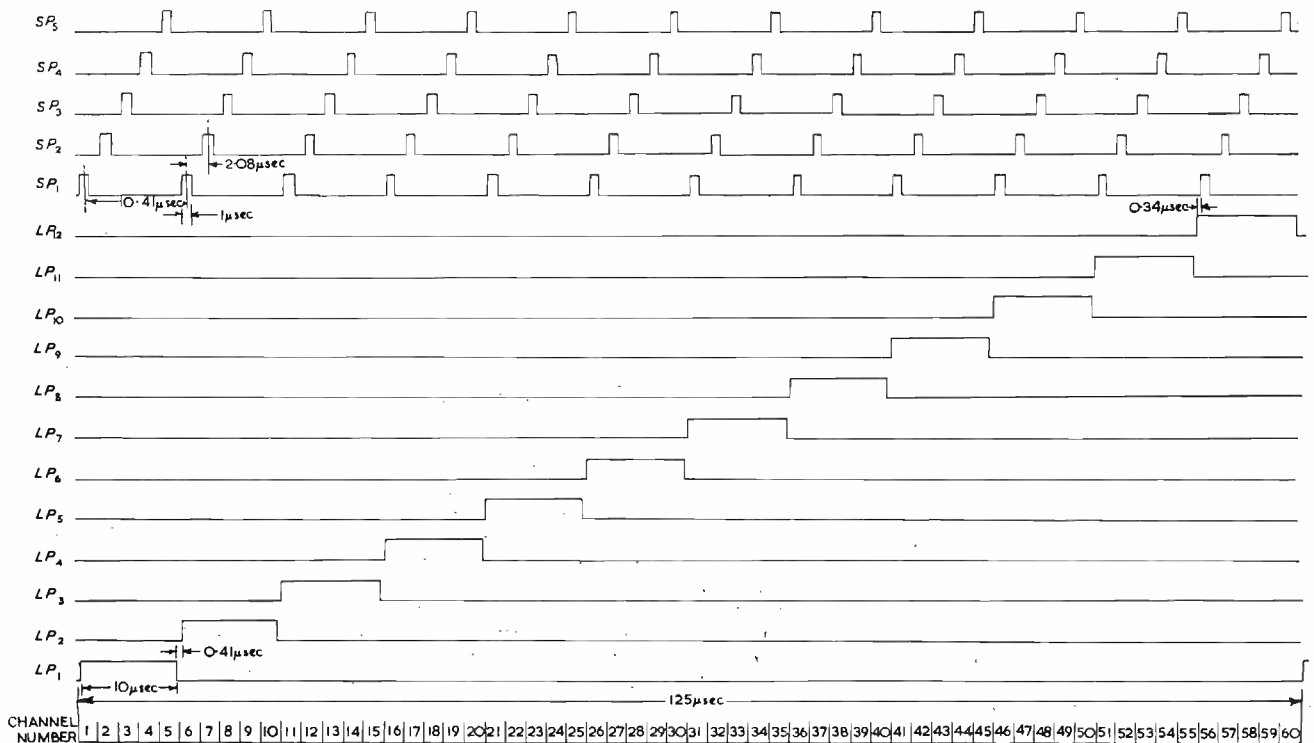

Fig. 15. 60-Channel T.D.M. system using two stages of multiplexing

The outputs from five such group-modulators are commoned to a single highway which therefore carries pulses modulated by each of the sixty channels. The system requires only twelve different trains of long pulses (10 μ sec, 8kc/s), each one of which operates five channel gates,* and five different trains of short pulses (1 μ sec, 96kc/s) as shown in Fig. 16. The stray capacitances of no more than twelve channel gates and of no more than five group gates are ever connected together in parallel. If only one stage of multiplexing were used, sixty different pulse-trains would have to be employed and each gate would have across its output terminals the total stray capacitance of all the sixty gates of the system.

* For satisfactory operation, the system described must have 10 μ sec pulses whose rise- and fall-times are less than 0.34 μ sec in order to prevent distortion of the pulses of channels whose short pulses coincide with a long pulse near its beginning or end (e.g. the pulses of channels one and five). If sufficiently small rise- and fall-times cannot be obtained, two series of long pulses may be used, the second displaced in time from the first so that use is never made of the pulse near its beginning or end⁴².

Fig. 16. Timing of pulses for 60-channel T.D.M. system



Inter-Channel Crosstalk

Crosstalk occurs in a time-division multiplex system if the transfer characteristics of the common transmission path vary sufficiently with frequency to cause the pulse waveforms to spread in time so that the received pulses interfere with each other. Non-linear distortion does not give rise to crosstalk in T.D.M. systems. The transfer characteristics of a guided path, such as a transmission line, may vary sufficiently over the wide band of frequencies required to transmit the pulses, to make the crosstalk level prohibitive for a T.D.M. system.

A uniform radio path will have no effect on the shape of the pulses, apart from imposing a constant delay and attenuation†. The aerial circuits usually have sufficient bandwidth not to affect the pulse envelope adversely, so the principal distortion arises from the restricted bandwidth of amplifier circuits, which therefore constitute the chief source of crosstalk in T.D.M. systems.

The bandwidth of the amplifiers is required to be large, so the crosstalk caused by distortion at high frequencies and the crosstalk caused by distortion at low frequencies can be calculated independently. Attenuation and phase distortion at high frequencies prevent a pulse of one channel from decaying to zero before the time at which the gate of the next channel is opened to receive its pulse, as shown by Fig. 17. The crosstalk caused by typical amplifier

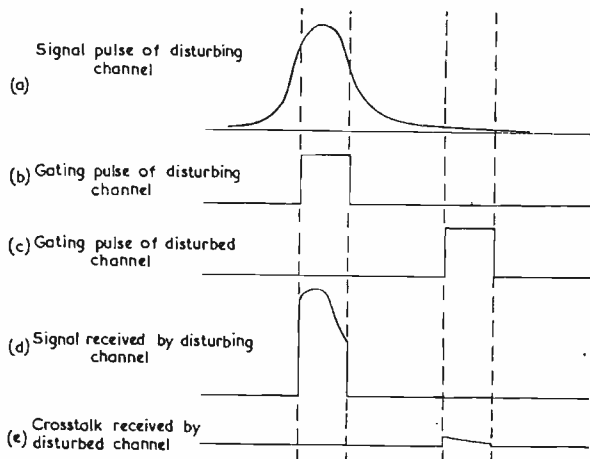

Fig. 17. Crosstalk caused by distortion at high frequencies

circuits such as those shown in Fig. 18 can be calculated from their known transient responses⁴⁶. The crosstalk is usually negligible except between channels whose pulses are adjacent and is independent of the frequency of the modulating signal. If the high-frequency distortion is severe, there will be appreciable crosstalk from each channel to several nearby channels, to those preceding the pulse as well as to those succeeding it. This is not a practical condition, however, because the amount of adjacent channel crosstalk will be intolerably large. Certain time-dependent effects in thermionic and crystal valves can also produce crosstalk effects similar to those caused by high-frequency distortion in passive networks^{47,48,49}.

Distortion at low frequencies causes modulation to be developed on the D.C. level present between the pulses and thus causes crosstalk from each channel into all the other channels of the system. It is therefore necessary for the crosstalk caused by low-frequency distortion to be attenuated considerably more than that caused by high-frequency distortion, which is usually only appreciable between adjacent channels. The low-frequency cut-off of the common transmission path must therefore be considerably lower than the lowest modulating frequency

† Multi-path transmission can, however, be a source of crosstalk, because a pulse arriving by an indirect path will be displaced from the correct time and may interfere with the pulse of another channel which has arrived by the direct path.

employed. Typical networks causing distortion at low frequencies are the coupling and decoupling circuits shown in Fig. 19. The crosstalk caused by such networks has been calculated and has been found to vary inversely with the frequency of the modulating signal.⁴⁶

Narrow-band T.D.M.

In order to make the crosstalk caused by high-frequency distortion negligible, a T.D.M. system must usually have a much greater bandwidth than a carrier system with the same number of channels. Several methods have been

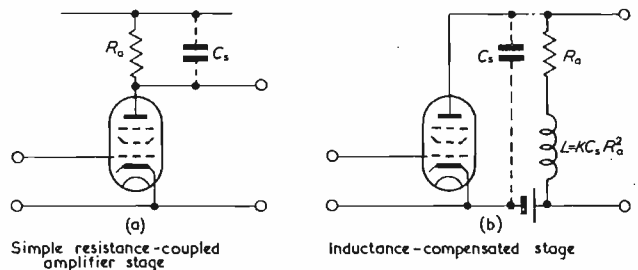

Fig. 18. Typical amplifier circuits causing distortion at high frequencies. (C_s is total anode-earth stray capacitance)

proposed for overcoming this disadvantage of T.D.M. systems^{22,50,51,52}. The fundamental principle of these methods is to restrict the bandwidth of the system at the transmitting end by means of a filter, thus causing crosstalk, and to attempt to cancel out the crosstalk at the receiving end by adding a fraction of the signal voltage of the disturbing channel to the signal of the disturbed channel in anti-phase with the crosstalk voltage.

Fig. 20 shows a typical crosstalk correcting circuit containing four delay networks. Each delay network has a delay equal to the time interval between adjacent pulses. From the junctions of these networks the signals are fed through attenuators and buffer amplifiers with polarity inversion when required. At the time t_n at which the n^{th} channel pulse is passing through A_3 , the $(n+1)^{\text{th}}$ is passing through A_2 , the $(n+2)^{\text{th}}$ through A_1 , the $(n-1)^{\text{th}}$ through A_4 and the $(n-2)^{\text{th}}$ through A_5 . By adjustment of the attenuations and polarities, the signal voltages transmitted through A_1 , A_2 , A_4 and A_5 can be made to cancel the crosstalk voltages from channels $n-1$, $n-2$, $n+1$ and $n+2$ which are transmitted through A_3 together with the signal voltage from channel n . The output voltage at time t_n therefore consists of the signal voltage from channel

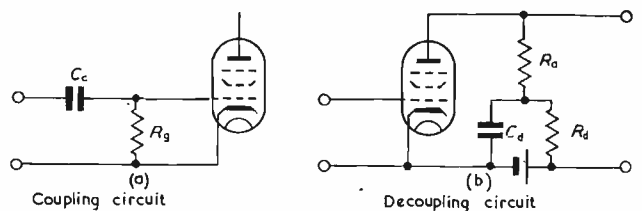

Fig. 19. Typical circuits causing distortion at low frequencies

n together with negligible residual crosstalk voltages from channels $n+3$, $n+4$. . . etc., and $n-3$, $n-4$. . . etc.

In order to reduce as much as possible the crosstalk caused by the filter at the sending end, the filter is made to cut off relatively slowly. The ideal aimed at is to make the filter have a linear phase characteristic and an amplitude characteristic which follows the Gaussian error curve:

$$A_t = e^{-(f/f_0)^2} \dots \dots \dots (1)$$

where f_0 is the frequency at which $A_t = 1/e$, i.e., the frequency at which the amplitude response is 8.7db down. Because the length of the pulse is much less than $1/f_0$, the shape of the response of the filter to the pulse is closely

that of the response to a unit impulse, which is given by^{53,54}

$$v(t) = e^{-(\pi f_0 t)^2} \dots \dots \dots (2)$$

Boothroyd and Creamer²² have described a pulse-amplitude modulated T.D.M. system with thirty channels and a P.R.F. of 8kc/s; the spacing between adjacent channel pulses is therefore 4.16μsec. The sending-end filter has an amplitude response which is approximately 40db down at 130kc/s. A network with the Gaussian amplitude response given above has 41db attenuation at 130kc/s when $f_0 = 60$ kc/s. Fig. 21(a) shows the attenuation-frequency response of the network and Fig. 21(b) shows the corresponding impulse response. At 4.16μsec before and after the peak of each pulse the voltage is only 5.4db below the peak voltage; in the absence of the crosstalk correcting network, the adjacent channel crosstalk attenuation would therefore only be 5.4db.

In order to cancel the adjacent channel crosstalk the corrector circuit must subtract from each channel the signals of the two adjacent channels, each attenuated 5.4db. If the corrector circuit is not exactly in perfect adjustment, there will still be some adjacent channel crosstalk, and to ensure that this is attenuated at least 45db the tolerance on the loss of each attenuator, including its buffer ampli-

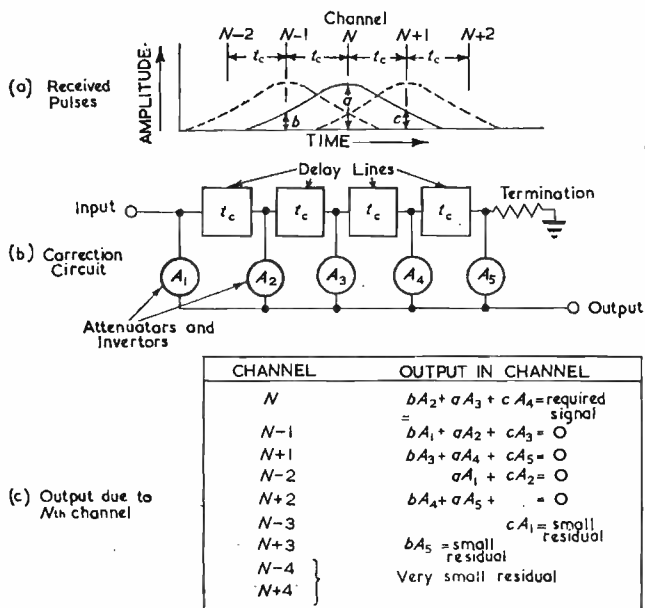

Fig. 20. Typical crosstalk connecting circuit

fier, is ± 1 per cent and the tolerance on the delay of each delay line is ± 0.9 per cent*.

The amplifier gain will change slightly with valve ageing even with a large amount of negative feedback and the delay of the lines will vary slightly with humidity and temperature changes. Moreover, the components of the sending end filter must be as stable as those of the corrector circuit and the phase response of the entire transmission path must be kept practically constant with time. It must therefore be difficult to maintain the crosstalk attenuation of 45db for a reasonable time after setting up the system.

Narrow-band working with crosstalk correction circuits is therefore unsuitable for pulse-amplitude modulated T.D.M. systems, such as telephone systems, which require high inter-channel crosstalk attenuation. For systems which

* The voltage error caused by small change in time is:

$$\delta v = (dv/dt) \delta t = -2(\pi f_0)^2 t e^{-(\pi f_0 t)^2} \delta t \quad (\text{from Equation (2)})$$

$$\therefore \delta v/v = -2(\pi f_0)^2 t \cdot \delta t$$

do not require high crosstalk attenuation, such as those carrying voice-frequency telegraph channels, narrow-band working would appear practicable. Another possible application of the crosstalk corrector circuit is to pulse-code modulated T.D.M. systems: narrow-band working could be achieved in this case because it is only necessary to obtain a small ratio between each pulse and interfering signals.

APPENDIX

The pulse lengthener circuit is shown in Fig. 11. If the duration of each pulse is small compared with the period (t_r) between pulses, and the forward resistance of diode D is sufficiently small for the capacitance C to be charged

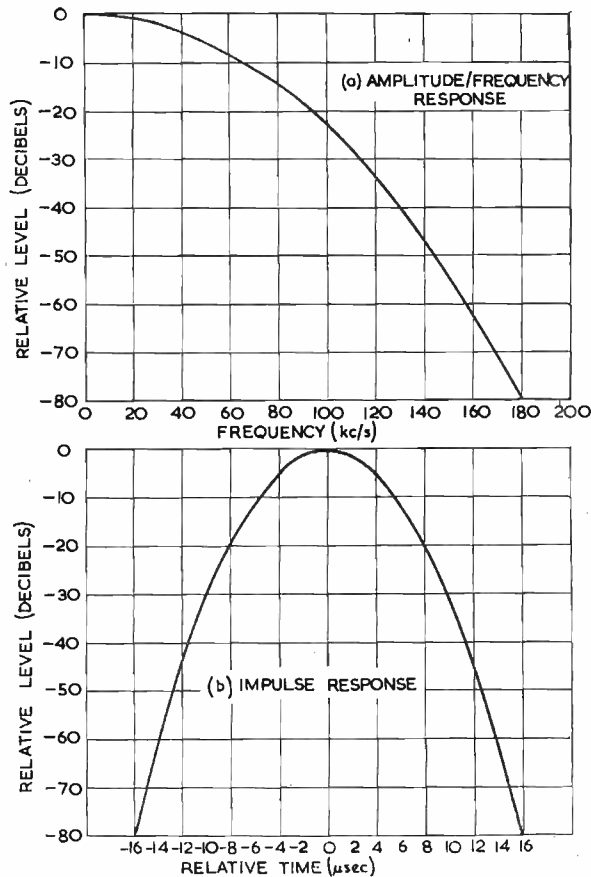

Fig. 21. Response of Gaussian filter

substantially to the peak voltage of the input pulse during each pulse, the mean voltage across C when the input pulses are unmodulated is:

$$V_I/t_r \int_0^{t_r} e^{-at} dt = V_I \left[\frac{1 - e^{-at_r}}{at_r} \right] \dots \dots \dots (1)$$

where $a = 1/CR$ and t_r is the pulse repetition period.

The voltage across C at the end of the period between two successive pulses is $V_I e^{-at_r}$. If the input pulse-train is amplitude-modulated, the output voltage from the circuit will be distorted if the height of any input pulse is less than the voltage remaining across C due to the preceding pulse. If the modulating frequency is one-half the P.R.F. (this is the highest permissible modulating frequency), the depth of modulation (m) is the greatest which may be used with-

out distortion when the height of the smallest pulse is equal to the voltage remaining across C at time t_r after the largest pulse.
i.e.,

$$V_1(1 - m) = V_1(1 + m)e^{-at_r}$$

$$\therefore m = \frac{1 - e^{-at_r}}{1 + e^{-at_r}}$$

$$= \tanh \frac{1}{2}at_r \dots \dots \dots (2)$$

When the depth of modulation is less than the maximum and the modulating frequency is low, the peak output voltage at the modulating frequency, from Equation (1), is:

$$mV_1 \left[\frac{1 - e^{-at_r}}{at_r} \right]$$

The ratio η_o of the output signal voltage to the modulation voltage on the pulses is therefore given by:

$$\eta_o = \left[\frac{1 - e^{-at_r}}{at_r} \right] \dots \dots \dots (3)$$

At high modulation frequencies this ratio is less, however; Kleene⁴³ has shown that when the modulation frequency is $\omega_m/2\pi$ the ratio is:

$$\eta_m = \left[\frac{1 + e^{-2at_r} - 2e^{-at_r} \cos \omega_m t_r}{(at_r)^2 + (\omega_m t_r)^2} \right]^{1/2} \dots \dots \dots (4)$$

(To be continued)

REFERENCES

GENERAL

1. BENNETT, N. R. Time Division Multiplex Systems. *Bell Sys. Tech. J.*, 20, 199 (1941).
2. ROBERTS, F. F., SIMMONDS, J. C. Multichannel Communication Systems. *Wireless Engr.*, 22, 538 (1945).

SYSTEMS USING P.A.M.

22. BOOTHROYD, W. P., CREAMER, E. M. A Time-Division Multiplexing System. *Elec. Engng.*, N.Y. 68, 583 (1949).
24. FLOWERS, T. H. Electronic Telephone Exchanges. *Proc. Instn. Elect. Engrs.* 99, Part 1, 181 (1952).
35. MORTENSON, E. M., YOUNG, C. B. A short-haul radio communication link channelised by Time Division. *Elect. Engng. N.Y.*, 70, 1094 (1951).
36. MEACHAM, L. A., PETERSON, E. An experimental multichannel P.C.M. system of toll quality. *Bell Syst. Tech. J.* 27, 1 (1948).
37. STANDARD TELEPHONES AND CABLES, LTD., LABIN, E. British Patent 610464.
38. LIBOIS, L. J. Un Equipement Multiplex à 24 voies téléphoniques. *Onde Electrique.* 30, 23 (1950).

MISCELLANEOUS

39. DOUGLAS, R. W., JAMES, E. G. Crystal Diodes. *Proc. Instn. Elect. Engrs.* 98, Pt. III, 157 (1951).
40. BETTRIDGE, B. R. A. Germanium Crystal Valves. *Electronic Engng.* 23, 414 (1951).
41. BROCKBANK, R. A., FLOYD, C. F. Wideband Transmission over Coaxial Cables. *Instn. P.O. Elect. Engrs.* Paper No. 190.
42. LEVY, M. M. G.E.C. British Patent 663782.

PULSE LENGTHENER CIRCUITS

43. KLEENE, S. C. Analysis of Lengthening of modulated Repetitive Pulses. *Proc. Instn. Radio Engrs.* 35, 1049 (1947).
44. BENDIX AVIATION CO. British Patent 650472.
45. COLUMBIA BROADCASTING COMPANY, SCHLESINGER, K. U.S. Patent 2,532,332.

CROSSTALK

46. FLOOD, J. E., TILLMAN, J. R. Crosstalk in Amplitude-Modulated Time-Division Multiplex Systems. *Proc. Instn. Elect. Engrs.* 98, Pt. III, 279 (1951).
47. METSON, G. H., WAGENER, S., HOLMES, M. F., CHILD, M. R. The life of oxide cathodes in modern receiving valves. *Proc. Instn. Elect. Engrs.* 99, Pt. III, 69 (1952).
48. TILLMAN, J. R., BUTTERWORTH, J., WARREN, R. E. The Dependence of Mutual Conductance on Frequency of Aged Oxide-Cathode Valves and its Influence on their Transient Response (Instn. of Elect. Engrs. Monograph No. 56R).
49. TILLMAN, J. R., YEMM, H. The Decay of Current in Germanium Diodes. *Phil. Mag.* 41, 1281 (1950). See also Ref. 1.

NARROW-BAND PULSE COMMUNICATION

50. Multiple Signal Transmission Systems. British Patent, 605128.
51. RADIO CORPORATION OF AMERICA. British Patent 656023.
52. RODDAM, T. Narrow-Band Pulse Communication. *Wireless World*, 56, 202 (1950).
53. ROBERTS, F. F., SIMMONDS, J. C. Some properties of a special type of exponential pulse. *Phil. Mag.* 34, 822 (1943).
54. ROBERTS, F. F., SIMMONDS, J. C. Further properties of recurrent exponential and probability function pulse waveforms. *Phil. Mag.* 35, 459 (1944).

A Corona Stabilizer E.H.T. Supply for Proportional Counters

By P. Holton* and J. Sharpe*, B.Sc., A.M.I.E.E.

The requirements of E.H.T. supplies for use with proportional counters employed for radioactive assay work are outlined and a simple type of supply having the required characteristics is described, using corona stabilizer tubes.

PROPORTIONAL counters, and particularly gas flow proportional counters¹ are much used for the assay of alpha particle and low energy beta particle emitters.

Counters of this type are used with an amplifier. The amplitude of the input pulse fed into this is a function of the ionization produced in the gas by the abstraction of energy from a particle, and of the gas multiplication, M , occurring near the anode wire. The latter is determined by the nature of the gas flowing through the counter, by the counter geometry, and by the voltage, V , applied to the anode. Fig. 1 shows how the gas multiplication factor M varies with V for argon and methane in a particular counter. (Argon is used normally for alpha counting and methane for beta counting.)

In an ideal alpha counter all initial ionizing events would be of the same magnitude, and the ideal curve (plot

of number of pulses/unit-time of amplitude greater than a variable discriminator bias, for a fixed anode voltage) would be as Fig. 2(a). Owing to compromises within the design of the counter, the usual curve is as Fig. 2(b).

The complete bias curve of a beta counter is of very different shape, Fig. 2(c), owing to the wide variation in pulse amplitude given by the continuous spectrum of a beta emitter and the variation of path length within the counter. Fig. 2(d) shows a working bias curve, which is the initial part of Fig. 2(b) and 2(c) expanded.

Owing to the vastly different values of specific ionization (number of ion pairs/cm path) produced by alpha and beta particles, in the ratio of 30 000 to 50-500 ip/cm, the gas multiplication used in an alpha counter may be as low as 10-15, while the beta counter may require between 3 000 and 20 000 depending on the maximum energy of the beta emitter. From Fig. 1, it will be seen that the alpha counter using argon will operate at c 1 000V, while the beta counter

* Atomic Energy Research Establishment.

may operate at c 2 500V. In each case the gas multiplication varies approximately by a factor of 2 for a change in anode voltage of 100V. It will be seen that variation of anode voltage for a fixed amplifier gain and discriminator bias is equivalent to stretching or contracting the bias curves as shown by dotted lines in Fig. 2(b), and this may be corrected for, within certain limits, by variation of amplifier gain in the opposite sense, requiring c 6db for 100V change in E.H.T. On the other hand, the slight slope to the bias curve which may exist, due to the use, for example, of a thick source, requires that the E.H.T. shall be stable to a fairly high degree over the period of an experiment.

Thus, if the bias curve slope is 0.2 per cent/volt and the discriminator bias is set at 20V, an increase in the E.H.T. of 100V will cause the 10V bias point to move out to 20V, giving a 2 per cent change in count rate. Thus for really accurate work, the E.H.T. should be stable to better than 10V over periods of a day or two.

With the particular counter, for which the proposed E.H.T. supply was designed, it was found that over the range 850V to 1 100V for alpha counting in argon and

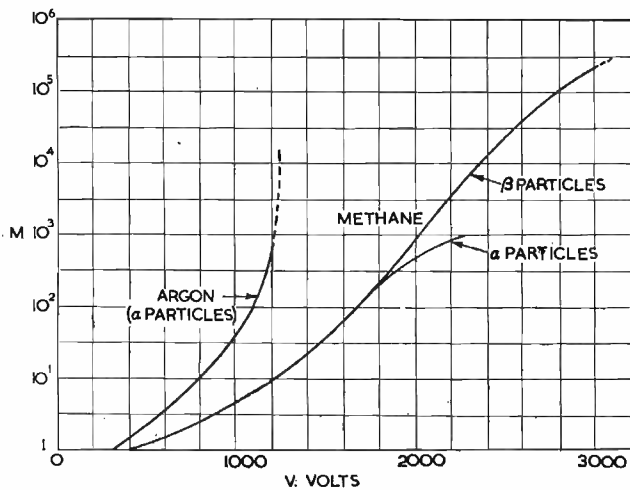

Fig. 1. Gas Multiplication (M) / Anode Voltage (V)

Flow counter. Argon and Methane, atmospheric pressure brass cathode 35 mm. dia., anode wire 0.012 mm. dia.

2 200V to 3 000V for beta counting in methane, adjustment of amplifier gain could always bring a suitably flat bias curve within the operating range of the discriminator connected to the associated scaler.

A suitable power pack for proportional counter work should thus provide a voltage around 1 000V for alpha counters, and about 2 500V for beta counters. In addition, it is convenient for certain applications to be able to operate an alpha counter with hydrogen as the flow gas. This requires c 1 600V. The stability at these potentials should be better than 10V over the period of a day or two, and should never produce a voltage below 850V or above 1 100V for alpha (argon) counting, below 1 500V or above 1 700V for alpha (hydrogen) counting, and below 2 200V or above 3 000V for methane beta counting. The maximum current drawn from the supply by the counter would not exceed 1 μ A.

In the interests of simplicity and cheapness, it was decided to investigate the use of corona stabilizer tubes for this application.

Characteristics of Corona Stabilizers

A corona stabilizer consists of a concentric anode and cathode in an envelope filled with a few millimetres pres-

sure of a suitable gas, usually hydrogen. They have been described by S. W. Lichtman² and work has been carried out at the A.E.R.E. by F. Wade and J. Biram³ and under a Ministry of Supply development contract by E. E. Shelton of Nucleonic and Radiological Developments, Ltd., from whom the tubes used in this investigation were obtained.

The characteristic of a circuit employing a tube having an a.c. resistance of R_c , in series with a resistor R_s is given by

$$\text{Stability ratio, } s, = \frac{\Delta V (\text{Stabilized})}{\Delta V (\text{Applied})} = \frac{R_c}{R_c + R_s}$$

Table 1 gives selected values of s , R_s and R_c .

S (per cent)	4	2	1	0.25	0.1
R_c (k Ω)	400	200	100	100	100
R_s (M Ω)	10	10	10	40	100

Since, in the application considered, no appreciable load current is taken, we may calculate the tube current from

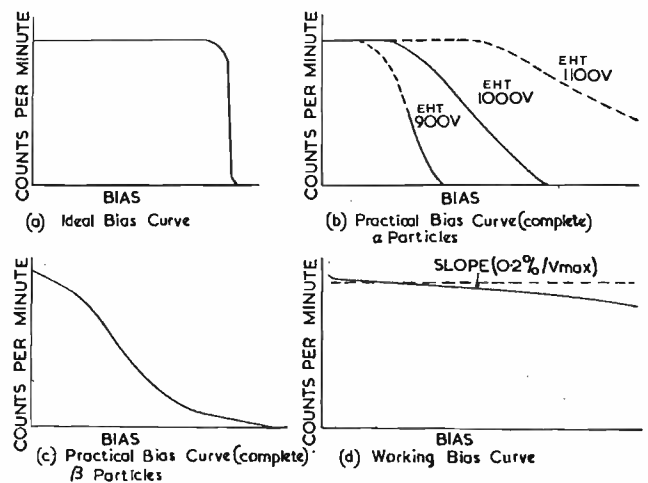

Fig. 2. Bias curves

the voltage drop in the series resistor. Thus, with an input voltage V_1 and a stabilized voltage of V_2 , we have $i = \frac{V_1 - V_2}{R_s}$ so that for $R_s = 10\text{M}\Omega$, $V_1 = 3\text{000V}$, and $V_2 =$

2 400V, $i = 60\mu\text{A}$. The minimum value of tube current is determined by the onset of instability in the tube. It was found experimentally that $i_{\text{min}} \text{ c } 5\mu\text{A}$ was satisfactory for tubes giving V_2 600 and 800V, but that some 1 000V tubes would oscillate at values of current below 14 μ A. It was found necessary in some samples to connect a capacitor in parallel with the tube in order to achieve stability².

One tube was found to be unstable at all currents until a 50pF capacitor was connected in parallel, when stability was achieved at currents above 14 μ A. In other tubes, stability was reached at 10-11 μ A, showing no improvement with parallel capacitance, while in still others, i_{min} was brought down from 17 μ A to 15 μ A by 50pF in parallel, and to 12.5 μ A by 1 000pF in parallel.

For the proposed unit, employing 1 000V, 600V and 800V, tubes in series, it was therefore decided to design for a minimum current of 15 μ A, giving a minimum value of V_1 of 2 250V for $R_s = 10\text{M}\Omega$ and to connect 50pF in parallel with the 1 000V tube.

Since the current taken by the counter from the unit is effectively zero, the percentage variation of V_1 may be taken as being that of the mains supply, which in our case is 230V -15 per cent, +5 per cent. The stability requirement is 10V in 2 500V, 0.4 per cent, so that a value of s of 3 per cent is needed. Thus, with $R_s = 10M\Omega$, R_c must be 300 000 ohms, and this must be made up from the sum of the A.C. resistances of three tubes.

Information from N.R.D. shows that over the range of voltages in which we are interested for the present application, R_c varies from c 50 000 to 140 000 Ω so that it is not too difficult to obtain a series R_c of 300 000 Ω .

With V_{min} of 2 550V at 200V A.C. input, the power supply must be designed to give 2 930V at 230V input. A value of 3 000V was taken. The maximum power dissipated in the tube circuit is then

$$\frac{3\ 150 \times 750}{10^7} = \frac{1}{4} \text{ watt, with a current of } 75\mu\text{A.}$$

It will be seen that only a low current transformer is required and that a dry rectifier multiplying circuit may be used without difficulty to derive the E.H.T.

Design of E.H.T. Supply

The first model was made to give 3 stabilized voltages 1 000V, 1 600V and 2 400V, as mentioned above. A small transformer, of dimensions 2in. cube, giving 400V output

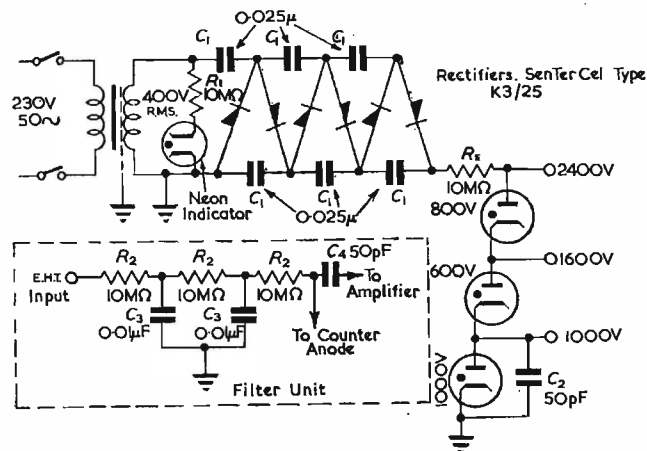

Fig. 3. 2 400V corona stabilizer E.H.T. supply and filter unit

for 230V input was connected to a 3-element Cockcroft-Walton circuit, employing SenTerCel rectifiers type K3/25, as shown in Fig. 3. The transformer, rectifiers, and tubes were mounted on a Perspex sheet chassis mounted within a metal box of dimensions 6in. by 5in. by 4½in. (Fig. 4). The three tapping points were connected to sockets, and the output plug was connected to a short flexible lead terminating in a wander plug, enabling the required voltage to be selected.

A neon lamp in series with 10M Ω was connected across the secondary of the transformer, and was visible through a window in the box.

The box containing the circuit was mounted on a panel carrying the proportional counter so that the main switch and cover plate for the voltage selector plug were accessible from the front of the panel, while the E.H.T. output and mains input plugs were available at the rear. The E.H.T. output was connected through a short length of coaxial cable to the filter unit and counter, as shown in Fig. 3.

The stability of E.H.T. output voltage with change in mains input was found to be $2\ 400 \pm 4V$ for $230V \pm 25V$ A.C. corresponding to an R_c of 0.24M Ω . The output rose by 3V as the temperature of the unit was raised from 20°C to 40°C.

The E.H.T. supply described above has been run intermittently, most "on", for a total "on" time of 1 500 hours, with no measurable change in the output voltage, and checks have shown that at no time has it contributed to the background count rate of apparatus to which it was connected.

Other smaller power supplies for 1 000V operation have been made using 230V-400V transformers similar to that used in the larger unit and a smaller number of rectifiers to give the E.H.T. voltage of 1 400V fed to the stabilizer. In another application, the E.H.T. supply to a BF_3 proportional counter has been stabilized at the correct value by connecting the stabilizer tube between E.H.T. input and earth in the hermetically sealed filter box attached to the counter⁴.

Conclusion

The work described above has shown that corona stabilizer tubes may be used to provide inexpensive E.H.T. units for use with proportional counters, and that such

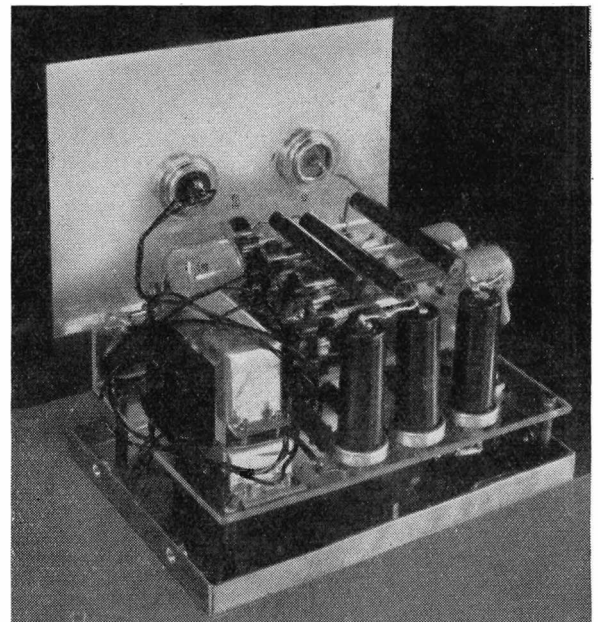

Fig. 4. A corona stabilizer power supply unit

units are free from spurious pulses and have the required short and long term stability.

Acknowledgments

The transformers used were designed by T. P. Lynott. This article is published by permission of the Director, Atomic Energy Research Establishment. Fig. 4 is Crown Copyright.

REFERENCES

1. SHARPE, J., TAYLOR, D. Nuclear Particle and Radiation Detectors. *Proc. I.R.E.*, 98, 209 (1951).
2. LIGHTMAN, S. W. High Voltage Stabilization by Means of the Corona Discharge between Coaxial Cylinders. *Proc. I.R.E.* 39, 419 (1951).
3. BIRAM, J., WADE, F. Low Voltage Corona Discharge Stabilization Tubes. A.E.R.E. Memo EL/M52.
4. SHARPE, J. A Sealed E.H.T. Filter Box for BF_2 Proportional Counters. *J. Sci. Inst.* To be published.

A Differential Transformer Gauge and Amplifier for Measuring Small Displacements

By D. T. R. Dighton,* M.Sc., A.R.C.S., A.Inst.P.

A design of differential transformer gauge capable of giving a full-scale deflexion for displacements of 0.0001 inches is described. As the gauge operates at 50c/s, the associated equipment can be very simple. A stable amplifier for use with the gauge gives a full scale deflexion for 0.2 millivolts R.M.S. This amplifier, which has a detection limit of about 1 microvolt, is useful as a balance indicator for 50c/s A.C. bridge circuits.

some care in the winding of the secondary coils in order to make the signal in the zero position as small as possible. The coils must be closely matched for number of turns and mean diameter. Dissimilar coils result in a signal which does not fall to zero but reaches a minimum, changes in phase and then increases. The presence of third harmonic in the zero signal indicates uneven saturation of the armature; this can usually be removed by annealing. With these precautions, zero signals of less than 0.5 millivolts R.M.S. can be obtained, permitting full-scale deflexions for movements of less than 0.0001 inches.

The sensitivity of the gauge is approximately proportional to both the magnitude and frequency of the primary

THE term "differential transformer gauge" is a convenient and descriptive method of referring to those devices in which the movement of a coil or armature increases the electromagnetic coupling between two coils at the expense of two others. It is usual to make one coil common, giving three in all; a convenient arrangement is shown in Fig. 1(a). The primary coil is supplied with alternating current which magnetizes the armature *A*. Two secondary coils *S*₁ and *S*₂ are connected in opposition. When the armature is in the symmetrical position, equal voltages are induced in the secondaries and the output is zero. Movement of the armature in one direction gives an A.C. signal proportional to the displacement and bearing a certain phase relationship to the primary supply. Movement in the opposite direction gives a similar signal but differing in phase from the first by 180°. The output from the transformer may be amplified and rectified in a phase-sensitive detector giving an output current proportional to armature movement. While this, the moving-armature gauge, is usually the simplest and most convenient type, the moving-coil gauge shown in Fig. 1(b) is occasionally preferable since the primary current causes no mechanical reaction on the specimen being measured.

A number of articles have recently been published describing the use of differential transformer gauges, but few of these give details of the design of the gauges themselves or their performance. Some units make use of audio- or radio-frequency supplies to the primary coils; the high sensitivity obtainable by using a mains-frequency supply does not seem to be commonly appreciated.

This article describes the design of a moving-armature gauge and amplifier designed to give a full-scale deflexion of the output meter for a stylus movement of 0.0001 inches. It was necessary also for the gauge to exert a pressure of not more than 3 grams on the specimen being measured.

Detailed Design of Gauge

The gauge head itself consists of the three coils wound on a Tufnol bobbin and surrounded by a mild steel sheath to prevent electromagnetic coupling of the secondary coils with other electrical equipment. The dimensions of the bobbin and sheath are shown in Fig. 2. The specification for the coils is: Primary-1 200 turns 36 s.w.g. enamelled copper, secondaries-3 000 turns 42 s.w.g. enamelled copper. When used with a soft iron armature of diameter 0.187 inches and length 0.875 inches the sensitivity of the gauge is 7 millivolts R.M.S. per 0.001 inch armature movement for a primary supply of 6 volts R.M.S. at 50c/s.

When the gauge is required for use with a full-scale deflexion for less than 0.001 inches, it is necessary to take

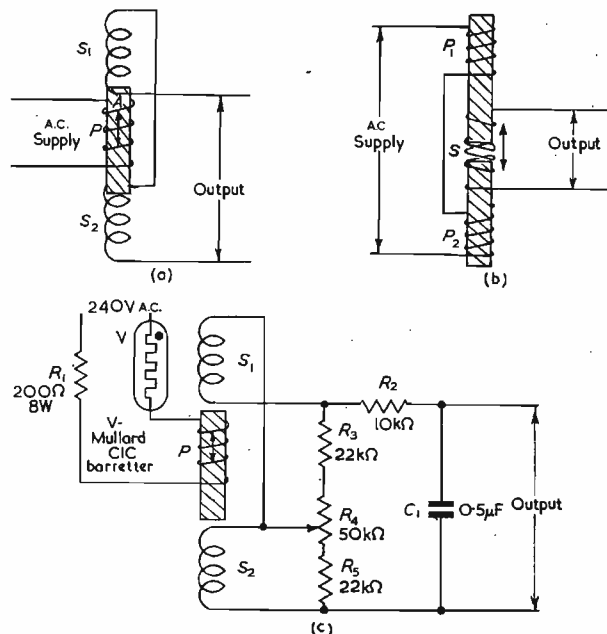

Fig. 1. Differential transformer gauges (a) moving-armature, (b) moving-coil, (c) moving-armature with electrical zero-set and frequency compensation

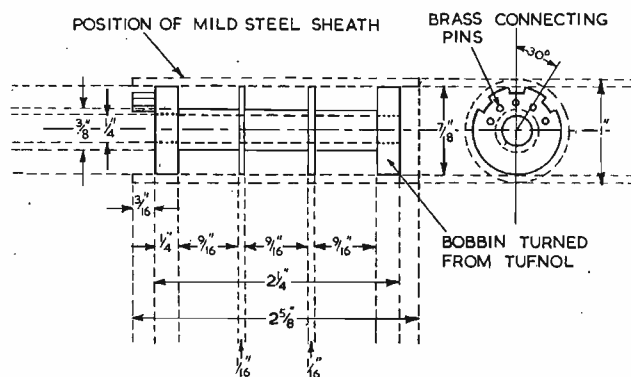

Fig. 2. Dimensions of differential transformer gauge bobbins and sheath

current. In cases where it is important, the effect of varying supply voltage can be overcome by operating the primary in series with a Mullard CIC barretter. Variations in mains frequency are not normally important since the effect on sensitivity is not usually greater than +2, -4 per cent. If necessary the effect can be reduced by the addition of a simple RC integrating network across the output from the gauge as is shown in Fig. 1(c). This will, of course, result in some loss of sensitivity.

When working with high sensitivities difficulty is

* Research Laboratories, Kodak Ltd.

encountered in positioning the gauge accurately to give a zero meter reading. The provision of an electrical "zero set" covering a range of about ± 0.0005 inches is desirable—a convenient arrangement is shown in Fig. 1(c).

The linearity of this type of gauge and amplifier combination has been shown to be within ± 1 per cent for armature movements between 0.1in. and 0.001in. It has not been possible to check the linearity to this accuracy for full-scale movements of 0.0001in., but it is not expected to be appreciably worse than this figure.

The armature can be supported either on horizontal leaf springs or by attaching it to a horizontal pivoted arm. The latter arrangement is preferable, especially when a low pressure is necessary: the weight of the armature and mounting can be counterbalanced and pressures as low as 1 gram can be used.

Amplifier for Use with the Gauge

The amplifier must be capable of giving full-scale deflexion of the output meter for 50c/s input signals of about 0.5 millivolts R.M.S. It must also be phase-sensitive. The circuit described below satisfies these conditions and has been found valuable in a number of applications as a balance indicator for bridge circuits fed from the a.c. mains supply. Thus, it has been used for temperature measurement with thermistors and resistance thermometers, and sensitivities as high as a few thousandths of a degree Celsius for full-scale deflexion are obtainable. It has been used as a photometric balance indicator when fed from two photo-electric cells connected in opposition. In this case the alternating signal is generated by a fluctuating light source or by using an alternating supply for the anodes of the photo-cells.

VALVE CIRCUIT

The circuit shown in Fig. 3 employs two pentodes V_1 and V_2 as voltage amplifiers, each giving a gain of about 100. The triode V_3 feeds the phase-sensitive detector by means of the shunt-fed transformer T_1 .

DETECTION CIRCUIT

The phase-sensitive detector is a modified version of a ring-bridge demodulator. The operation of the circuit can be most easily followed by ignoring the effect of the rectifiers MR_1 and MR_3 . When no signal is present across the output of T_1 , rectifiers MR_2 and MR_4 rectify the alternating reference voltage across R_{16} and R_{17} , developing equal D.C. potentials across C_9 and C_{10} . When the signal from the amplifier is in phase with the signal at the upper end of R_{16} the potential across C_9 is increased at the expense of that across C_{10} , causing a deflexion of the meter. When the amplified signal is of the opposite phase the reverse is the case. The purpose of MR_1 and MR_3 is to provide full- instead of half-wave rectification. These two rectifiers also prevent high back-voltages developing across MR_2 and MR_4 when large signals pass through the amplifier. The sensitivity of the detector is such that a signal of 20V R.M.S. developed at the anode of V_3 gives an output current of 1.0mA, in a load of 1 000 Ω .

VARIABLE PHASE-SHIFT SOURCE

To obtain optimum sensitivity with the phase-sensitivity detector it is necessary for the reference voltage across R_{16} and R_{17} to be exactly in phase or exactly out of phase with the signal from the amplifier. With a unit used for a particular application, this can be ensured by supplying the reference voltage either direct from a winding on the mains transformer or from the mains supply through an RC circuit giving the necessary phase shift. For a general purpose amplifier, however, which may be used with a variety of different input circuits each with a characteristic

phase shift, some means of readily varying the phase of the reference potential is desirable. This can be done conveniently by the use of a Magslip Resolver¹. With the component values shown in Fig. 3 the amplitude variation for a 360° phase shift is about 10 per cent, but as the performance of the detector circuit is almost independent of the magnitude of the reference voltage this variation is of no consequence.

The procedure in using the amplifier is to rotate the spindle of the resolver until the sensitivity is a maximum. Since the phase can be varied through 360°, it is possible to get whichever output polarity is more convenient in a given application.

PERFORMANCE OF THE AMPLIFIER.

Each valve of the amplifier has negative feedback provided by un-bypassed cathode resistors. Resistors R_{13} , R_{14}

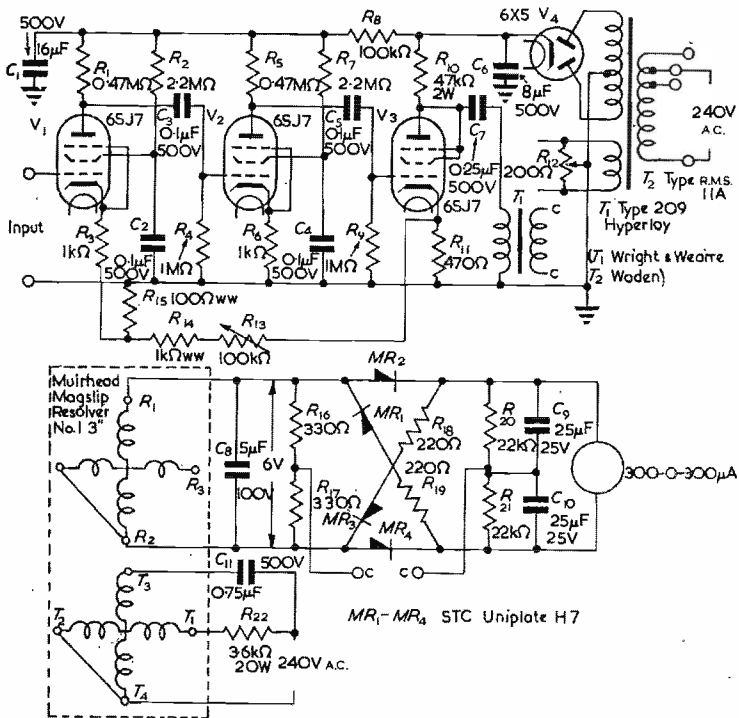

Fig. 3. Amplifier for use with the differential transformer gauge

and R_{15} give overall feedback and control the amplifier gain. The performance of the amplifier is thus virtually independent of changes of supply voltage and valve characteristics. At the maximum gain setting with a full-scale deflexion for 0.2mV R.M.S., changes of mains voltage from 200 to 270V do not alter the gain by more than ± 2 per cent. At one-fifth of full gain the change over this input range cannot be detected.

USE WITH DIFFERENTIAL TRANSFORMER GAUGES

The circuit diagram of the amplifier (Fig. 3) shows a form suitable for general use as a balance indicator for 50c/s a.c. bridges. When used with differential transformer gauges it is necessary to provide a series of range settings. This is conveniently done by the provision of a selector switch and appropriate fixed resistors in the feedback line in place of R_{13} . By making the anode load of V_3 a potentiometer, pre-set adjustments to compensate for barretter or gauge characteristics may be made. In this application the variable phase-shift source is unnecessary and the reference voltage may be obtained by applying 240V A.C. to R_{16} and R_{17} through a 0.25μF capacitor.

REFERENCE

1. FRASER, W. *Muirhead Tech.* 4, 19 (1950)

Noise Performance of V.H.F. Receivers

By E. G. Hamer*, B.Sc., A.M.I.E.E.

THE sensitivity of v.h.f. receivers has been specified in the past by the signal input required, at a given depth of modulation, to produce a specified audio power output. This figure, together with information as to the bandwidth, maximum audio output and distortion have given a measure of the overall performance of the receiver. More recently additional information has been supplied such as the level of spurious responses, and the unwanted signal required to cause blocking or cross modulation. It was found that as the sensitivity of receivers increased noise was introducing a limit to the maximum usable sensitivity obtainable. In recent years a considerable effort has been expended investigating the effects of noise in limiting the absolute sensitivity of receivers¹, and various circuits have been analysed theoretically and tried experimentally to see which would give the best performance with respect to noise.

Most modern v.h.f. receivers, particularly those used for mobile communications systems, have sufficient gain for their performance to be limited by noise, and it is important that the noise effects should be reduced to a minimum. The resultant audio noise output is due to several causes, the major sources of noise being:

- (a) atmospheric noise due to lightning discharges,
- (b) cosmic noise due to solar bodies,
- (c) man-made noise from electrical equipment,
- (d) thermal noise in the aerial and receiver input circuits,

and of these sources the circuit designer has no control over (a) and (b), while the audible effects of (c) can sometimes be mitigated by special circuits, and the noise contribution due to the receiver input circuits can be reduced to a minimum by the use of special valves and circuits. Dealing in turn with the various forms of radio noise we have atmospheric noise which is mainly due to lightning discharges and other natural effects and will, of course, vary greatly with the time of day, year, weather, and the geographical location. Above frequencies of 40Mc/s the level of atmospheric noise is usually less than the receiver and aerial thermal noise except in the case of local thunderstorms, and it can therefore be neglected in the design of v.h.f. receivers and systems. It is usually assumed that the peak amplitude of atmospheric noise is proportional to the square root of the receiver bandwidth.

Cosmic noise is normally a small component and can be neglected at v.h.f. unless man-made noise is absent, or a highly directive aerial array is being used, and happens to be pointing at a solar body. Cosmic noise decreases approximately as the inverse cube of the frequency, and can generally be completely neglected at frequencies above 200Mc/s. In special cases it can be taken into account by assuming an increase or decrease in the amount of thermal noise from the aerial.

Man-made noise may take many forms, and will be greatest in densely populated and industrial areas. Certain types such as that due to diathermy and industrial radio frequency heating machines will be the same irrespective of the receiver bandwidth, while that due to automobile ignition will increase with an increased receiver bandwidth.

Ignition interference is usually of a very peaky nature, and its audible effects can often be reduced by the use of suitable audio limiter circuits, but in some cases in

certain areas the man-made noise may originate from so many sources as to have the same form of random distribution as thermal noise, and the mean man-made noise level will be high. In such cases audio limiter circuits will be ineffective and no improvement in man-made noise performance can be obtained. This, of course, refers to any particular system or type of modulation, as certain systems may have a superior performance with respect to a given amount of random and man-made noise than other systems using different types of modulation. It is usually assumed that the receiver output due to man-made noise increases uniformly with receiver bandwidth, although from recent investigations it does not appear to increase quite as rapidly as the receiver bandwidth. Man-made noise in general decreases with frequency in a complex manner, the variation depending on the type of man-made noise and other local factors. Typical measured figures in England evaluated on a statistical basis for the noise level exceeded for a total of 1 minute in every hour with respect to a power of one watt, are:

Town	77Mc/s	-165db	per cycle of bandwidth
"	172Mc/s	-175db	" " " "
Country	77Mc/s	-180db	" " " "
"	172Mc/s	-180db	" " " "

These compare favourably with typical median values for the U.S.A., where half the sites have lower values of peak noise power, which are:

Town	100Mc/s	-160db	per cycle of bandwidth
"	200Mc/s	-166db	" " " "
Country	100Mc/s	-166db	" " " "
"	200Mc/s	-172db	" " " "

The figures quoted above are averaged on a statistical basis for a large number of sites and may be considerably increased in the immediate vicinity of large industrial areas, or town centres where there are a large number of vehicles in close proximity to the receiver.

Thermal noise is due to the thermal agitation of electrons in resistances, and the r.m.s. value of the equivalent thermal noise voltage in series with the resistance is given by:

$$e^2 = 4kTR\Delta f$$

where k = Boltzman's constant = 1.38×10^{-23} joules/degree Kelvin

T = Absolute temperature in degrees Kelvin.

Δf = Bandwidth in cycles per second.

R = Resistance in ohms.

At normal temperature this is usually taken as -204db with respect to a power of one watt per cycle of bandwidth, and this type of noise has a uniform distribution of power throughout the radio frequency spectrum. The figure quoted is an average value as the instantaneous peak value of thermal noise will be greater than the average value.

The sources of thermal noise are the aerial itself, the receiver input circuits, and the input valves. It can be shown that the thermal noise contribution due to the aerial itself is the same as that due to a resistance equal to the radiation resistance of the aerial, and at the same mean temperature of the aerial. If in special cases it is desired to take account of cosmic noise the aerial is assumed to have a higher temperature than its physical temperature.

* Research Laboratories of the General Electric Co., Ltd.

The input circuits of the receiver also generate thermal noise and in this case the noise power is the same as that which would be generated by a resistance equal to the effective resistance of the tuned circuit allowing also for the losses in the valve. A careful choice of input circuit and a valve with a high input resistance at the frequency concerned will reduce this noise to a minimum. If the gain of the first stage is low the second stage may also contribute an appreciable amount of thermal noise to the total thermal noise power output of the receiver.

Valves contribute, however, another source of noise and this is due to the random motion of electrons which leave the cathode. In the case of multi-electrode valves an additional amount of noise is caused by the "partition effect", that is the random division of the cathode current among the various electrodes.

For the purpose of circuit analysis these effects may be simulated by means of a hypothetical noise generator in series with the grid of a perfect valve, and a convenient way to simulate random noise is to use a resistance of a suitable value as the noise generator. This resistance does not exist as a physical ohmic resistance in the usual way and when analysing the circuit it must only be treated as a generator of a noise voltage. It is also a convenient figure to quote to indicate the merit of a valve for low noise applications. The "noise resistance" of a valve is intimately related to the mutual conductance and the following formulæ give the approximate "noise resistance" of various valve types:

Triode amplifiers $R_n = 2.5/g_m$

Pentode amplifiers $R_n = \frac{I_a}{I_a + I_{g2}} \left\{ 2.5/g_m + \frac{20I_{g2}}{(g_m)^2} \right\}$

Triode mixers $R_n = 4/g_c$

Pentode mixers $R_n = \frac{I_a}{I_a + I_{g2}} \left\{ 4/g_c + \frac{20I_{g2}}{(g_c)^2} \right\}$

Multi-grid mixers and

Convertors $R_n = \frac{20I_a[I_K - I_a]}{(g_c)^2 I_K}$

where R_n = equivalent "noise resistance" in ohms

g_m = mutual conductance in mhos

g_c = conversion conductance in mhos

I_a = anode current in amperes

I_{g2} = screen grid current in amperes

I_K = cathode current in amperes

and typical values are:

Triode amplifiers 200-400 ohms

Pentode amplifiers 700-2 000 "

Pentode mixers 3 000-5 000 "

As would be expected due to the additional partition noise of the multi-electrode valves, pentodes have a much larger noise resistance than triodes, and with the object of reducing receiver thermal noise to a minimum triode valves are to be preferred for the input stages. Triode valves have the disadvantage of large input to output capacitances, and special circuits must be used to overcome this difficulty. Among the more common triode valve input circuits are those using neutralizing, and grounded grid connexions. The advantage of the neutralized circuit for narrow band applications is the higher voltage gain per circuit. Several previous authors have analysed various types of circuit with respect to their thermal noise performance and have derived formulæ for the combined thermal noise due to the circuit and valve to be a minimum².

When the input circuit consists of a silicon crystal mixer a similar technique may be employed to allow for the thermal noise generated by the crystal. Usually where the crystal mixer is used in a v.h.f. receiver it is desirable to use a low noise i.f. amplifier following it, and often a

cascode circuit is used for the input stages of the i.f. amplifier. The cascode circuit consists of a neutralized triode input stage followed by a grounded grid triode second stage, giving the advantage of a large power gain with a stable circuit arrangement.

One important factor has up to now been neglected and is the transit time effects, which are due to the finite time taken for the electrons to travel from the cathode of the valve to the various electrodes. These effects assume greater importance at the higher frequencies; but the consideration of transit time effects at the higher frequencies is somewhat empirical, and at the lower frequencies the noise contributions are small. It has been found possible to improve the noise performance of v.h.f. receivers by detuning the input circuits although the mechanism of this is as yet not fully understood and it creates additional problems with the gain and the stability of the circuits³.

The performance of a receiver with respect to thermal noise is usually specified as the ratio of the actual noise power output of the receiver when connected to its aerial, to the noise power output which would be obtained if the aerial were the only source of thermal noise in the system. This assumes that over-loading of the receiver and detector is not taking place, that is the whole receiver from input to output is a linear device under the conditions of test. This ratio is usually expressed in decibels and is termed the noise factor of the receiver. For a given input circuit this figure does not depend on the bandwidth of the receiver as determined by the following i.f. stages. When the amount of thermal noise from the aerial has been predicted the total effective thermal noise including that due to the receiver is obtained by multiplying by the noise factor. This only applies to thermal noise, and must not be used directly when evaluating any other form of noise component. An improvement in receiver noise factor will only decrease the thermal noise contributions at the output of the receiver, and the noise output due to other sources will not be effected.

The noise factor is primarily determined by the design of the input stage, although further stages may make a small contribution to the total noise power output. In such cases the overall noise factor is:

$$N = N_1 + \frac{N_2 - 1}{G_1} + \frac{N_3 - 1}{G_2} \dots \text{etc.}$$

where N_1, N_2, N_3 , etc., are the noise factors of the individual stages defined in a similar way to that for the complete receiver, and G_1 is the power gain from 1 to 2, G_2 from 2 to 3, etc.; and with normal receiver designs using r.f. valve amplifiers the contribution of all the other stages apart from the input stage is less than 15 per cent.

Where a silicon crystal mixer is used we have:

$$N = 1/G_c \left\{ N_1 G_c + (N_{i.f.} - 1) \right\}$$

where G_c is the conversion power gain of the crystal mixer, N_1 is the noise factor of the crystal mixer, and $N_{i.f.}$ is the overall noise factor of the i.f. amplifier. $N_1 G_c$ is usually called the noise temperature t_r of the crystal mixer; and at v.h.f. for silicon crystals has a value approximately equal to 1 when the local oscillator injection power is 1 milliwatt.

$$\text{Hence } N \approx N_{i.f.}/G_c$$

and from this equation can be seen the importance of having a low noise factor i.f. amplifier when a direct silicon crystal mixer is used.

Fig. 1 shows the variation of the levels of the various types of noise with frequency; in the case of thermal noise a resultant thermal noise level has been drawn allowing for the noise factor likely to be obtained with carefully designed receivers at the appropriate frequencies. Fig. 1 must only be taken as a general guide to the noise levels because, as previously stated, the noise is not exactly

proportional to bandwidth in all cases; and slightly different forms of statistical analysis have been applied to the various types of noise; this especially refers to man-made noise where allowance is normally made for short duration peaks of high noise level.

The noise factor of a receiver may be measured in several ways, but the basis of nearly all the methods is that if a known signal, or additional known amount of random noise is added to the existing noise input, and the actual increase of noise power output noted, the total input noise may be evaluated. The noise contribution from the aerial, or equivalent aerial load can be calculated and that due to the receiver itself evaluated. A convenient method is to vary the extra input until the total noise output power from the receiver has been doubled.

In one method a signal generator is used whose output impedance is equal to the appropriate aerial impedance, a known c.w. signal at the receiver centre frequency is injected and varied until the total R.F. power at the receiver detector has been doubled. For this test the usual detector must be replaced by a calibrated R.F. power measuring device such as a thermocouple or bolometer bridge, and if the output power level has been doubled the receiver noise factor is given by:

$$N = \frac{P}{kT\Delta f}$$

where P = c.w. input power to double the detector power
 Δf = Receiver bandwidth (usually taken at the 3 or 5db points depending on the shape of the receiver frequency response curve)
 kt can be taken as -204db per cycle of bandwidth.

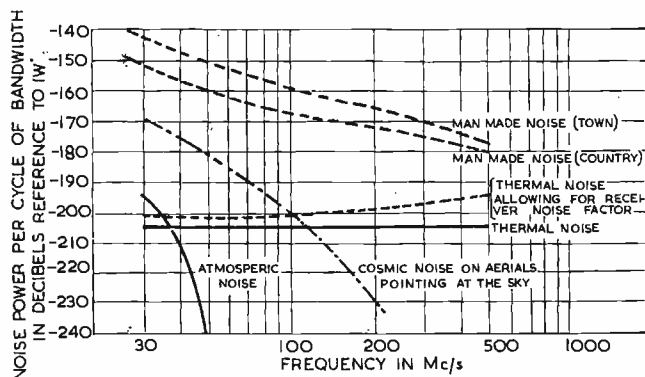

Fig. 1. Radio noise levels

This method is not often used as it means modifying the detector circuits of the receiver being tested.

A more convenient method is the use of a calibrated source of random noise, and the one most commonly used at v.h.f. is the diode noise generator.

In this case, the difficulties of making an accurate determination of the effective bandwidth of the receiver and the characteristic of the detector vanish. The noise current I_n of a diode valve when working in the temperature saturated region is

$$I_n^2 = 2eI_0\Delta f$$

where e = electron charge

I_0 = D.C. current through the diode valve

and hence the mean square noise voltage across an external resistor R in parallel with the diode is:

$$E_n^2 = 2eI_0R^2\Delta f$$

this is in addition to the thermal noise power available from the resistor itself. The impedance of the diode is also shunted across the resistance, but the value of the diode impedance is usually large compared to that of the

resistor. If now R has the same resistance as the appropriate aerial of the receiver and is connected to the receiver input, the noise output power of the receiver in the absence of any diode current will be proportional to $4kTR\Delta fN$. With the diode switched on and the filament current adjusted so as to double the noise output power we have:

$$2eI_0R^2\Delta f = 4kTR\Delta fN$$

$$N = e/2kT RT_0$$

and if $T = 300^\circ\text{K}$

$$N = 20I_0R$$

or in decibels $N = 10\log_{10} 20I_0R$

this formula enables the noise factor of the receiver to be measured directly, assuming the existence of a suitable noise diode and circuit.

The type CV172 noise diode valve has been used successfully up to frequencies of 250Mc/s before effects due to the resonance of the leads, and transit time effects have invalidated the results. Improved noise diode valves have been developed capable of being used up to 500Mc/s and Fig. 2 shows a photograph of a miniature diode and disk resistor. It has been found that the high frequency resistance value of the disk type resistor is the same as the D.C. value to frequencies much higher than 500Mc/s, and Fig. 3 shows a circuit diagram of a noise generator suitable for frequencies up to 500Mc/s. The diode and stray capacitances are resonated at the receiver centre frequency by means of a shunt coil. Recently further methods have been developed for increasing the useful range of diode noise generators and these include the use of symmetrical diode arrangements, and peaking inductances in series with the terminating resistor⁴.

Measurements made in the past indicate that the following noise factors may be obtained by careful design

40Mc/s	3db
100Mc/s	4db
200Mc/s	6db
500Mc/s	10db

above 500Mc/s simple based valves are not yet commercially available, and either more elaborate types such as disk seal valves, or direct crystal mixers must be used.

It is important when designing radio receivers to assess beforehand if the additional complexity and cost of a low noise factor design is justified. The improvement due to a low noise factor design only applies to thermal noise, and not general radio noise such as that due to atmospheric and man-made sources.

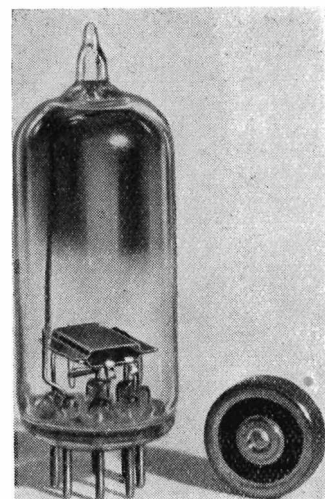
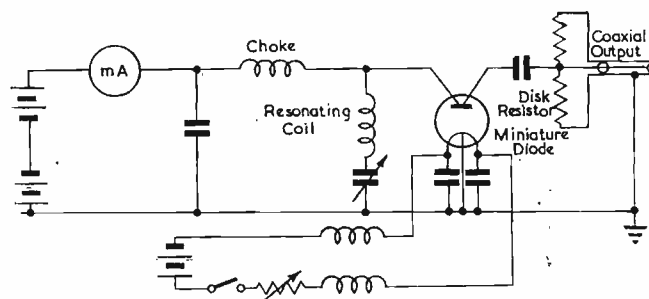

Fig. 2. A miniature diode and a disk resistor

Fig. 3. Thermal noise generator



The deciding factor will be the frequency at which the system is to operate and also the type of service, as the greater the frequency the greater will be the contribution made by the thermal noise components. To some extent the type of service will influence the choice as the characteristics of noise depend on its origin. Thermal noise is evenly distributed over the frequency spectrum, and it is not possible to reduce the audible effects of this type of noise by special post detector circuits on any given system. Man-made noise may, however, have peaks of short duration very much larger than the mean level, and in certain cases, such as mobile communications systems, special post detector circuits may be used to reduce the audible effects of this type of noise.

Even if these noise effects cannot be reduced, but are only of short duration, they may be acceptable for a simple radio link provided they do not degrade the intelligibility of the receiver signal too greatly. In the case of a more elaborate system such as one carrying a large number of telephone circuits, a short interruption of service may have serious operational effects, and the peak

level of man-made noise should be the criterion of design. At frequencies in the region of 100Mc/s the man-made noise is dominant, and as long as the receiver noise factor is reasonable there would seem little point in special low noise factor designs. Above 200Mc/s particularly for mobile services, thermal noise is the dominating factor and an improvement in the receiver noise factor would give a direct improvement to the range of a system. For nearly all multi-channel systems except at frequencies above 500Mc/s a reasonable low noise factor receiver design is required, but the system as a whole must be designed to override the peak noise bursts to man-made causes.

REFERENCES

1. NORTH, D. O. The Absolute Sensitivity of Radio Receivers. *R.C.A. Review* 332 (1942).
2. BURGESS, R. E. Signal to Noise Characteristics of Triode Input Circuits. *Wireless Eng.* 22, 56 (1945).
3. HARRIS, I. A. A Note on Induced Grid Noise and Noise Factor. *Jour. Brit. I.R.E.* 10, 396 (1950).
4. JOHNSON, H. Methods of Extending the Frequency Range of Untuned Diode Noise Generators. *R.C.A. Review.* 10, 251 (1951).

A Low Voltage Stabilizer with Saturated-Diode Control

By V. H. Attree*, B.Sc.

The stabilizer uses a 1T4 miniature valve as the control-element and will deliver up to 10W A.C. or 7W D.C. A 10 per cent change in mains voltage, or a 50 per cent change in load current, affect the output voltage by 0.1 per cent. A "constant-current" output can be obtained by a simple circuit change.

A STABLE low-voltage supply suitable for running thermal devices, such as valve heaters and photometer lamps, may be obtained with a wide variety of circuits¹⁻¹⁰. Apart from the non-linear bridge^{1,2}, and the use of a pilot-lamp and a photocell^{3,4}, these circuits all employ some form of variable impedance connected in series with the mains-supply. This impedance may be either a transformer loaded on its secondary with a pair of valves⁵⁻⁸, or a saturable choke controlled by an auxiliary winding^{9,10}. A variable impedance in series with the supply usually results in a stabilizer with a poor output waveform and a restricted range of control. The waveform may be improved by filters, but the stabilizer then becomes sensitive to changes in frequency. Stabilizers working at the mains frequency have the difficulty that, in order to give a control voltage proportional to the R.M.S. value, the voltage-sensing device must integrate the energy over a complete cycle. For this reason the response to a sudden input change occupies several cycles of the supply. Saturable transformers give a response within the A.C. cycle but are affected by changes both in frequency and ambient temperature. However, for some purposes the performance of a saturable transformer is quite satisfactory. If the output of an A.C. stabilizer is rectified and smoothed to provide low-voltage D.C., temperature effects in the metal rectifiers are troublesome and, further, the ripple can only be removed by a multi-element filter having large value components.

Some of the difficulties of previous designs are avoided in the present stabilizer which uses a 2kc/s multivibrator¹¹

controlled by a series modulator. The multivibrator arrangement improves the speed of response and reduces the amount of filtering required in order to obtain a smooth D.C. output. The control voltage is derived from the emission current of a saturated diode. The diode itself provides a considerable degree of voltage amplification so that the multivibrator may be controlled without an intermediate D.C. amplifier. The stabilizer is practically independent of ambient temperature changes, has a short warm-up time and good long-term stability. As the circuit is of the series degenerative type with the voltage-indicator connected across the output, the response time of the diode is much reduced by the effect of feedback.

The diode is an ordinary 1T4 miniature valve run under reduced filament-current conditions. The properties of miniature valves used in this way have been given in a previous article¹². In the present instance the 1T4 is run at an anode voltage of 15-20V with an emission current of 16 μ A. The low filament consumption, 12mW in the 1T4 as compared with 3.2W for the Mazda 29C1¹³, results in an extremely flexible stabilizer design. For instance with simple circuit changes a "constant-current," instead of "constant-voltage", may be obtained or the stabilizer may be used with a battery to give increased power output. As the diode is an R.M.S. device the stabilizer may be used equally well to give an A.C. output (at 2kc/s) or a D.C. output.

Circuit Description

The circuit diagram of the stabilizer is shown in Fig. 1. The 2kc/s multivibrator consists of the 6V6

* Fluid Motion Laboratory, University of Manchester.

tetrodes V_2 and V_3 which are cross-connected between screen and control grids; with this arrangement the frequency of oscillation is not greatly affected by changes in the power taken from the anode circuit. The 1T4 saturated diode V_5 controls the grid voltage of the EF55 series-modulator V_4 . An increase in the output voltage of the stabilizer, brought about by changes in the mains supply or the load, increases the filament temperature and hence the emission current of V_5 . This makes the grid of V_4 more negative, which compensates for the change by tending to reduce the power output of the oscillator.

The push-pull anode transformer is an ordinary radio type with a tapped secondary winding, giving transformation ratios ranging from 25:1 to 100:1. A series of measurements of power output against secondary load (curves not shown) indicates that peak output-power is obtained with an effective anode-to-anode load of 10-12k Ω . Maximum power into a matched load is about 12 watts. The h.t. consumption is 75mA at 300V, or 22.5W, so the efficiency is about 50 per cent.

The anode supply for the saturated diode is stabilized at +140V by the miniature neon N_1 (this neon need not have a high stability). One side of the diode filament is

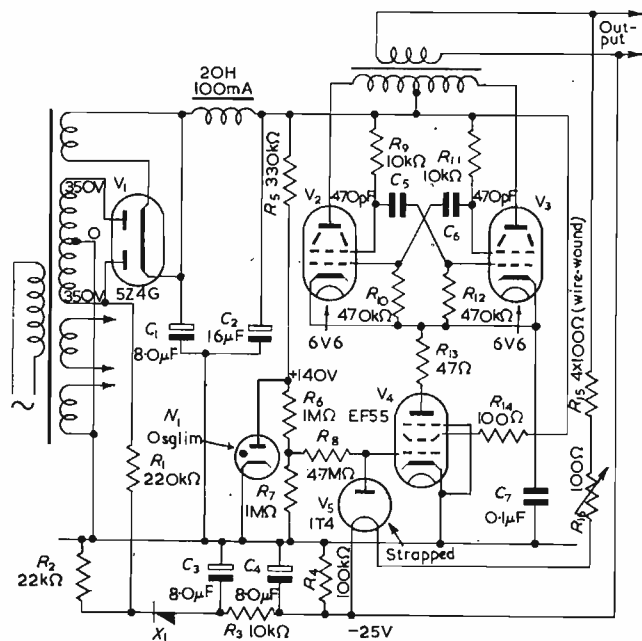

Fig. 1. Circuit diagram

returned to a 25 volt negative supply obtained from the selenium rectifier X_1 . Under normal operating conditions the grid of V_4 is about 5V negative to earth, so the anode-filament voltage of the diode is 20V. The diode anode-current is 15-16 μ A. The arrangement of the diode circuit has the disadvantage that one side of the stabilizer output is returned to the negative supply. If it is required to earth the output, the anode of the diode must be resistance-coupled to the grid of the EF55. Except for a slight reduction in the loop-gain, this does not affect the action of the stabilizer. The diode filament is run from the stabilizer output with the control resistors R_{15} and R_{16} in series. The relation between the total resistance in the diode filament-circuit and the stabilizer output-voltage is shown in Fig. 2. The diode filament-current is substantially constant so that the relation is linear. A variation in $R_{15} + R_{16}$ from 0-500 Ω alters the stabilizer output from 0.5 to 10V. For ease of control R_{15} consists of four 100 Ω wire-wound resistors connected in series and provided with a wafer-type shorting switch; fine adjustment is by the

100 Ω wire-wound potentiometer R_{16} . Where a time-delay circuit is provided to protect the load during warm-up (see later) the relay contacts are arranged to short-circuit both R_{15} and R_{16} .

The loop-gain of the stabilizer depends to a small extent on the load and is usually about 200. For example, at an output voltage of 6.0V a voltage change of 1.0V on the grid of the modulator V_4 gives a change of 1.2V in the output. The saturated-diode V_5 develops a change of 1.0V at V_4 grid for an alteration of only 5mV in the stabilizer output so the loop-gain in this case is 1.2V/5mV = 240 times. If the output-transformer is adjusted to a ratio of 40:1 the output impedance is 7 Ω and the effect of the stabilizing action is to reduce this to 7/241 or 0.03 Ω . Variations in the voltage of the mains-supply affect the screen voltage of the modulator V_4 so that the effective value of the loop-gain, for supply changes, is somewhat smaller. Under normal load conditions the loop-gain, for supply changes, is not less than 100 so that a 10 per cent change in the supply alters the output by less than 0.1 per cent.

The diode emission is slightly affected by changes in the temperature of its surroundings¹², and it is desirable to mount the diode away from the remaining valves in the stabilizer, all of which run fairly hot.

Where the stabilizer is used to run thermal devices it is usually possible to use the 2kc/s a.c. output without rectification; but where a d.c. supply is needed the rectifier circuit shown in Fig. 3 is suitable. The selenium rectifier has four 67mm single disks in bridge connexion. The

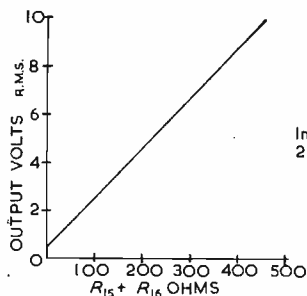

Fig. 2. Stabilizer control characteristics

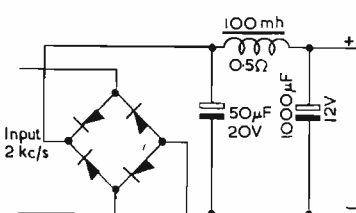

Fig. 3. Rectifier circuit

rectifier output is smoothed by a low-resistance choke and a 1000 μ F capacitor. The choke consists of the secondary of a small speaker transformer, the resistance is 0.5 Ω and the inductance, at 2A d.c., is 100mH. The d.c. output voltage is 60-70 per cent of the r.m.s. value of the a.c. input, and the residual ripple is less than 1mV. The power efficiency of the rectifier is not known because it is difficult to estimate the power-factor with non-sinusoidal waveforms, but 6-7W of stabilized d.c. power may be obtained at 2-15V. Somewhat less power is available at voltages outside this range. The capacitance of the selenium rectifier is of the order of 0.02 μ F per sq. cm of disk area giving a total capacitance of 1.0 μ F for a 67 mm disk. The reactance of 1.0 μ F at 2kc/s is only 80 Ω and it seems likely that 2kc/s is about the highest frequency that can be used without serious loss of rectifier efficiency. When the stabilizer is used with the rectifier to give d.c. the voltage-sensing diode is, of course, connected on the d.c. side.

Warm-up Protection

When the stabilizer is switched on the valve heaters and h.t. warm up at about the same rate. The diode filament is cold and the EF55 modulator goes into grid current. The oscillator now starts, its output increasing very rapidly and overshooting its nominal value during the time required for the diode filament to warm-up. The

over-voltage, which lasts for about 0.5 sec, may damage a load which has a short thermal time-constant.

Many methods were tried to slow the build-up of the oscillator output but no simple way of doing this could be found. However, adequate protection is obtained if the diode series resistor is short-circuited until the stabilizer has settled down. The nominal output of the stabilizer is then 0.5V and the maximum voltage attained during the overshoot is only 0.7V. At the instant the short-circuit is removed the diode filament is already at its working temperature and the stabilizer output rises immediately to the correct value, with no overshoot.

The warm-up process may be made automatic by using the time-delay circuit shown in Fig. 4. The circuit, which is similar to that described by Lucas¹³, has the advantage that it gives protection against surges caused by re-establishment of the mains supply after a brief interruption. The current through the 10MΩ resistor R_1 charges the 1.0μF capacitor C_1 and the relay operates after an interval of about two minutes. If the supply is interrupted the capacitor rapidly discharges through the low grid-cathode impedance of the valve and the delay cycle repeats when the mains are re-established.

An excessive load maintained on the stabilizer-output causes the EF55 to take a heavy current and to overheat. If the load is then suddenly removed the output voltage rises, increasing the diode temperature. However, the maximum anode-current of the diode may be insufficient to pull the EF55 out of grid-current, because of thermionic emission from the overheated grid, so that the diode temperature continues to rise until the filament burns out. The risk of filament burn-out in this way may be eliminated by an EA50 diode connected between a negative potential of 1.2V and the grid of the EF55. In normal use, with a fixed stabilizer load, overheating of the EF55 cannot occur and the additional diode is unnecessary. The diode is not shown on the circuit diagram, Fig. 1.

Boost Operation

In order to increase the stabilized power available a battery (or independent low-voltage supply) may be connected in series with the stabilizer output, Fig. 5. The diode filament, with an appropriate series resistor, is run from the output of the combination. The filament current drain is 25mA representing a power consumption in the

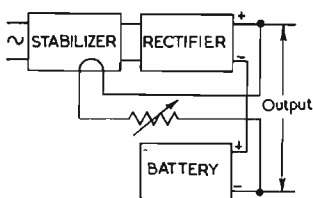

Fig. 5. Boost operation.

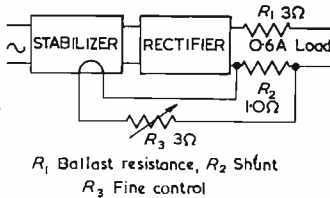

Fig. 6. Constant current operation

voltage-sensing circuit of 25mW per volt of output. The output impedance will be $(R_1 + R_2)/(a + 1)$ where R_1 and R_2 are the output resistances of the stabilizer and the base supply respectively and a is the loop gain. Voltage variations are also reduced by the ratio $a + 1$.

With boost operation a voltmeter should be connected across the stabilizer output to ensure that the stabilizer is working in its control region.

Constant-Current Operation

When a constant-current power supply is required for a load of less than about 25mA, a pentode valve, with its anode impedance increased by cathode feedback, is all that is necessary. Such an arrangement will give an equivalent source voltage of 1 to 5kV¹⁴, which is high enough to make the current substantially independent of changes in load resistance or back E.M.F. However, in some applications such as hot-wire velometry in water, a constant-current of the order of an ampere is required. A constant-current of this magnitude may be obtained from the stabilizer by connecting the filament of the control diode across a low-resistance shunt in series with the load, Fig. 6. The output impedance is increased by the factor $(a + 1)$ and the equivalent source voltage becomes very large.

As an example of what can be done we will consider a specific application. The hot-wires used in our laboratory are of platinum 0.001 in. diameter and 0.1 in. long; the working current is 0.6A. The p.d. across the wire which is a measure of the water velocity, varies in the range 0.4-0.7V. In the earlier water channel work the wire was run from a 10V battery with a control resistor in series to set the current. A change in p.d. of 0.3V across the wire represented a 3 per cent change in current so that frequent adjustments of the control were necessary in order to keep the current constant. With the stabilizer arranged as shown in Fig. 6 a change in p.d. of 0.3V alters the current by only 0.05 per cent which represents an equivalent source voltage of 700 volts.

In the constant-current circuit the loop-gain is slightly less than in the constant-voltage case. This effect, which is due to the non-linear properties of the diode-filament, is discussed in detail elsewhere¹⁵.

Conclusion

The stabilizer has been used in our laboratory principally for running hot-wires and thermistors used in heat-loss flow-measurement. The stability has proved to be considerably better than with the batteries previously employed. In the opinion of the author the performance of the 1T4, run under suitable operating conditions as a saturated-diode, compares quite favourably with that of special diodes having pure tungsten filaments.

REFERENCES

- CAMPBELL, A. On Test Room Methods of A.C. Measurement. *J. Instn. Elect. Engrs.* 30, 889 (1901)
- LEWIS, F. G. H. An Automatic Voltage Regulator. *Proc. Phys. Soc.* 34, 17 (1921-22).
- DIERTART, Co. Electronic Voltage Regulator. *Rev. Sci. Instrum.* 15, 352 (1944).
- WIGHT, K. C. A Note on an Automatic Control for Maintaining a Constant Intensity Light Source. *J. Sci. Instrum.* 28, 276 (1951).
- RIDENOUR, L. N., LAMPSON, C. W. Thermionic Control of Ionization Gauge. *Rev. Sci. Instrum.* 8, 162 (1937).
- NELSON, R. B., WING, A. K. Emission-regulating Circuit for an Ionization Gauge. *Rev. Sci. Instrum.* 13, 215 (1942).
- GLYNNE, A. A Differential Electronic Stabilizer for A.C. and Some Applications. *J. Instn. Elect. Engrs.* 90, Part II, 101 (1943).
- PATCHETT, G. N. A New Precision A.C. Voltage Stabilizer. *J. Instn. Elect. Engrs.* 97, Part II, 529 (1950).
- HELTERLINE, L. Diode-controlled Voltage Regulators. *Electronics* 20, 96 (June, 1947).
- RICHARDS, J. C. S. A Stabilized A.C. Supply for Lamps and Valve Heaters. *J. Sci. Instrum.* 28, 333 (1951).
- COOKE-YARBOROUGH, E. H., BRADWELL, J., FLORIDA, C. D., HOWELLS, G. A. A Pulse Amplitude Analyser of Improved Design. *J. Instn. Elect. Engrs.* 97, Part III, 108 (1950).
- ATTREE, V. H. Saturated-Diode Operation of Miniature Valves. *Electronic Engng.* 25, 27 (1953).
- LUCAS, J. H. An Electronic Time Delay Circuit. *Engineer* 186, 439 (1948). (See also *Wireless World* 55, 51 (1949); 55, 156 (1949); 55, 196 (1949)).
- ATTREE, V. H. An Electronic Simulator for Biological Research. *J. Sci. Instrum.* 27, 43 (1950).
- ATTREE, V. H. A Differential Voltmeter using a Saturated-diode. *J. Sci. Instrum.* 29, 226 (1952).

A D.C. Amplifier for use in pH Measurements

By C. Morton*, B.Sc.

A description is given of a differential amplifier suitable for use in pH measurements, or as a D.C. valve voltmeter for general purposes. The design is based upon that of the amplifiers used in electrocardiography and encephalography, but differs in the following respects: (1) phase inversion is effected without the aid of potential dividers, common feedback resistors, or other auxiliary circuit components; (2) the gain control, by means of which the degree of negative feedback is continuously adjustable between the limits of zero and 100 per cent, takes the form of a variable resistor, r_o , in series with the load; adjustment of this control does not disturb the zero setting of the galvanometer or recorder; (3) despite the complexity of the amplifier, which may comprise several voltage-amplifying stages, the calibration is readily and accurately calculable by means of the simple relationship $i_o = E/[(\alpha + \beta)r_o + \gamma]$, where i_o is the output current resulting from an applied voltage E , α is the feedback fraction, and β and γ are constants; (4) provision is made for eliminating zero disturbances due to ± 20 per cent changes in supply voltage by applying negative feedback differentially to the amplifier; (5) in order to adapt the amplifier for pH measurements, automatic compensation for changes in the E.M.F. of the electrodes due to temperature fluctuations is provided by means of a thermistor.

THE exacting requirements of electrocardiography and electroencephalography¹ have led to the development of D.C. amplifiers, usually of the differential or push-pull type, of outstanding sensitivity, linearity, zero stability, and permanence of calibration. In its simplest form (Fig. 1) the differential amplifier is constituted by shunting the microammeter or recorder M across the series-connected

itude, the addition of numerous accurately-adjusted resistors controlled by ganged switches is necessary. In modern physiological amplifiers, the gain control usually takes the form, first suggested by Goodwin,³ of a variable rheostat connected across the points A and B (Fig. 1) in such a manner that, in the minimum or short-circuit position of the control, the negative feedback resistors r_1 and r_2

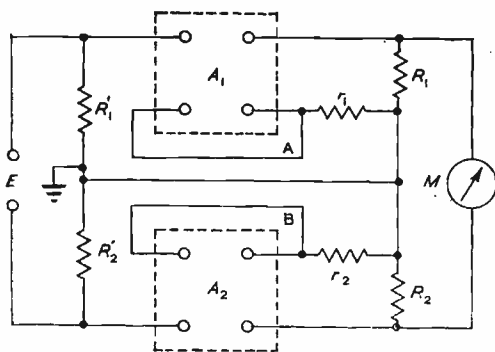

Fig. 1. Simple form of differential amplifier

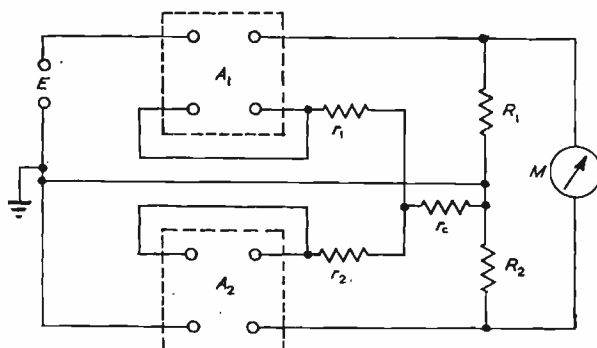

Fig. 2. Modification using common feedback resistor

load resistors R_1 and R_2 of identical amplifiers A_1 and A_2 ; the potential E to be measured or recorded is subdivided, by means of a potential divider R_1', R_2' , into equal voltages which are applied to the input circuits of A_1 and A_2 in anti-phase, and negative feedback resistors r_1 and r_2 are included in the input circuits with the object of stabilizing the gain and thus ensuring permanence of calibration.

The inclusion of the potential divider R_1', R_2' in the input circuit necessarily reduces the input resistance of the amplifier, and is open to serious objection when the source of E.M.F. is of high internal resistance. In the design of several physiological amplifiers, the difficulty is overcome by the use of a cathode-coupling device, due to Schmitt², in which phase inversion is accomplished by means of a third feedback resistor r_c (Fig. 2) common to the input circuits of both A_1 and A_2 .

One of the most difficult problems associated with the design of a differential D.C. amplifier is the provision of a convenient form of gain control. In the circuit of Fig. 1, the gain is rigidly fixed by the feedback fractions $\alpha_1 = r_1/(R_1 + r_1)$ and $\alpha_2 = r_2/(R_2 + r_2)$ and, in order to provide a means of varying the gain in steps of known mag-

nitude, the degree of anti-phased input voltages may be varied over a wide range. This method is inconvenient in that each adjustment of the gain control entails readjustment of the electrical zero of the indicating or recording instrument, due to the fact that the points A and B are not in general at the same potential: further, as the gain is not a simple function of the ohmic value of the control, the calibration is necessarily more or less empirical.

In the amplifier⁴ now described (Fig. 3), phase splitting is effected, in a manner which is explained later, without the aid of potential dividers, common feedback resistors, or other additional circuit components. The degree of negative feedback is continuously adjustable between the limits of zero and 100 per cent by means of a variable resistor r_o in series with the microammeter or recorder M ; as no current flows along this path in the absence of an applied E.M.F., operation of the control does not disturb the zero setting of the galvanometer or recorder.

The main advantage of the circuit arrangement of Fig. 3 lies in the ease with which, despite the complexity of the amplifiers A_1 and A_2 , each of which may comprise several stages of amplification, the value of the load resistor r_o

* Chelsea Polytechnic.

required for any desired degree of voltage amplification or power output may be computed. It is shown later that the load current is given by:

$$i_o = E/[(\alpha + \beta)r_o + \gamma] \dots\dots\dots (1)$$

where α is the feedback fraction and β and γ are constants for a given amplifier. An amplifier of this type to which a potential E is applied behaves as an electrical generator of voltage E and internal resistance γ : the maximum current output, obtained when r_o is short-circuited, is:

$$i_o(\text{max}) = E/\gamma \dots\dots\dots (2)$$

and the maximum or open-circuit voltage ($r_o = \infty$) is:

$$v_o(\text{max}) = E/(\alpha + \beta) \dots\dots\dots (3)$$

A maximum power output of:

$$w_o(\text{max}) = E^2/4\gamma(\alpha + \beta) \dots\dots\dots (4)$$

is obtained when $r_o = \gamma/(\alpha + \beta)$ ohms, the output current and voltage under these conditions being equal to half their respective maximum values.

By suitable design of the amplifier, the values of β and γ may be made very small and, when r_o is large, Equation (1) reduces to:

$$i_o = E/\alpha r_o \dots\dots\dots (5)$$

the output voltage $i_o r_o = E/\alpha$ being then independent of

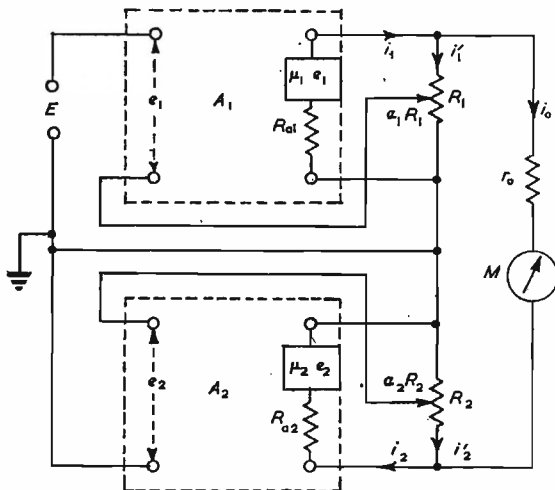

Fig. 3. The amplifier described

the characteristics of the amplifier. On the other hand, where r_o is very small, the voltage sensitivity

$$i_o/E = 1/\gamma \dots\dots\dots (6)$$

becomes very great; by suitable choice of the value of r_o , any desired degree of negative feedback between the limits of 100 per cent as expressed by (5) and zero as represented by (6) may be obtained. The control r_o may take the form of a tapped resistor controlled by a selector switch (a convenient arrangement for a multi-range valve voltmeter or deflexion pH meter) or of a continuously variable resistor; in either case, the calibration is readily and accurately calculable by means of Equation (1).

The Choice of Valves

As the D.C. resistance of the glass electrode may exceed 500M Ω , the use of electrometer valves in the input stage of an amplifier designed for use in pH measurements with the aid of this electrode is essential. The only British electrometer valves which appear to be available for use in a mains-operated amplifier are the Ferranti electrometer tetrodes and the Mullard ME1400 electrometer pentode, the cathodes of which are indirectly heated. The

Ferranti valves, while possessing exceptionally high input resistance, are necessarily costly and inefficient by comparison with normal receiving valves; on the other hand, the ME1400 acts as a fairly efficient amplifier, but its performance is less satisfactory from the point of view of input current. The latter valve is an R.F. pentode of the short grid base type, and is operated at screen and anode potentials of 45 volts. In the course of this work it was discovered that a variable-mu R.F. pentode acts as a moderately efficient D.C. amplifier when operated at screen and anode voltages below the ionization potential (8-10 volts) of the residual gas within the envelope, and under these conditions provides a more satisfactory compromise between the opposing requirements of low grid current and high amplification. As valves of this type do not appear to have been used previously as electrometer substitutes, the characteristics of the KTW61, when operated under these conditions, are summarized in Table 1.

Thorpe⁵ claims that the grid current of a triode-connected R.F. pentode is independent of the grid voltage over a wide range. This statement is not borne out by the published grid current-grid voltage characteristic curve of the ME1400, or by the experience of the writer in the use of R.F. pentodes as electrometer substitutes. The author finds, however, that when R.F. pentodes are used, not as triodes, but as voltage-amplifying pentodes, the grid current at constant grid voltage is determined by the screen and heater voltages, and is sensibly independent of the anode

TABLE 1.

Characteristics of electrometer valves and electrometer substitutes

	ME1400		KTW61		BM6A
	AS PENTODE	AS TRIODE	AS PENTODE	AS TRIODE	AS TETRODE
V_h (volts)	4.5	4.5	4.7	4.7	4.0
V_a (volts)	45	45	9	9	6
V_{g2} (volts)	45	—	9	—	4
V_{g1} (volts)	-2	-2	-1.4	-1.4	-3
I_a (μ A)	80	100	82	110	175
I_{g2} (μ A)	20	—	28	—	200
I_{g1} (μ A)	6	6	0.2	0.2	0.3-0.006
g_m (μ A./V.)	240	300	100	165	100
r_a (K Ω)	5000	65	10000	36	20
μ	1200	20	1000	6	2

voltage: the anode voltage of the KTW61, for example, when operated at screen, heater, and grid voltages of 9, 4.7, and -1.4 respectively, may be raised from 9 to 27 volts without significant increase in grid current. This behaviour is readily accounted for by the fact that the anode current of an R.F. pentode is substantially independent of the anode voltage; in the case cited, the increment in anode current for a three-fold increase in anode voltage amounts to only 1.8 μ A, or about 2 per cent of the total anode current. Using a carefully selected KTW61 valve in conjunction with an anode resistor of 2M Ω , a measured voltage gain of 160 may be attained over a short range, while restricting the input current to 2×10^{-13} A. For the Ferranti BM6A the maximum voltage gain is 2, with grid current ranging from 3×10^{-13} to 6×10^{-15} . The grid current of the KTW61 may be further reduced by operating the grid at the contact potential point. In order to minimize grid current due to photo-electric emission and other causes, efficient screening of the valve from light and from external electric fields is important; it is also essential to earth the transformer secondary winding which supplies the heater voltage.

For the output stage of the amplifier, it is convenient to use a double triode, such as the ECC32 or ECC34, of the type in which independent cathodes are indirectly heated by means of a common heater.

Practical Circuit Design

Amplifiers of the type now described are incorporated in the pH indicator manufactured by the Cambridge Instrument Company. The practical circuit diagrams of two amplifiers which were used as prototypes are given in Figs. 4 and 5, and the principal characteristics are summarized in Table 2. Other modifications of the basic circuit of Fig. 3 are possible, but appear to possess no special advantages. The characteristics of the second amplifier, however, can be considerably improved, without increased input current, by rearranging the circuit connexions in such a manner that the KTW61 valves function, not as triodes, but as voltage-amplifying pentodes.

As the relationship between input and output voltages is linear within approximately ± 0.1 per cent, a moving-coil galvanometer or recorder with the customary linear scale is suitable for use as an indicating or recording instrument. The overall resistance $R_o = E/i_o$ of the completed instrument, i.e., the voltage E which must be applied in order that unit current may flow through the indicator or recorder, is:

$$E/i_o = (\alpha + \beta)r_o + \gamma \dots\dots\dots (7)$$

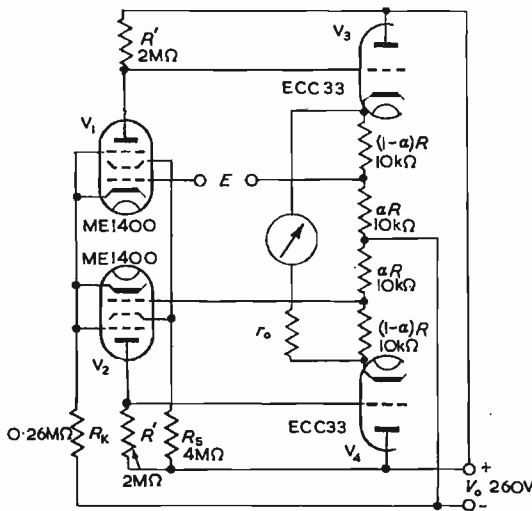

Fig. 4. A practical circuit

The R_o/r_o graph is thus a straight line of slope equal to $\alpha + \beta$. The intercept of this line on the R_o axis gives the internal resistance γ of the amplifier in ohms and, assuming the current sensitivity and coil resistance of the indicator or recorder to be known, the value of r_o which must be used in order that full scale deflexion may be obtained on the application of any desired voltage E is readily found by interpolation.

The second amplifier (Fig. 5) was adapted for use as a pH indicator by the addition of the electrode-standardizing network $R_2R_3R_{10}$ and the temperature compensator r, r_1, r_2 , the latter being connected, by means of flexible leads, to the plug P . The temperature-compensating element consists of a thermistor r immersed in the solution under investigation. As the author has pointed out previously⁶, this form of resistance thermometer has the advantages over the more familiar type that, due to its small dimensions (0.05in. diameter) and consequent low heat capacity, it responds almost instantaneously to temperature changes and is capable of use when only a few

drops of solution are available. When measuring or recording the pH value of a solution, the plug P is inserted in the jack J ; as the temperature rises, the resistance of the thermistor diminishes, and a higher proportion of the output current is diverted through it. The values of r, r_1 and r_2 are so chosen that, despite the increase in the E.M.F. of the electrodes due to the rise in temperature, the deflexion of the galvanometer or recorder remains unchanged, provided that the pH value of the solution is constant. In order to determine the appropriate values of r_1 and r_2 the plug, temporarily connected to an adjustable resistance box, is inserted, in the jack J , and the resistance box is adjusted to values R and R' such that full scale deflexion is obtained with applied E.M.F.s of $14 \times 0.000198T$ and $14 \times 0.000198T'$ volts respectively, where T and T' are the temperature limits (on the Absolute scale) between which automatic temperature compensation is desired. The appropriate values of r_2 and r_1 are then given by $r_2 = [-b - (b^2 - 4ac)^{1/2}]/2a$ and $r_1 = R - rr_2/$

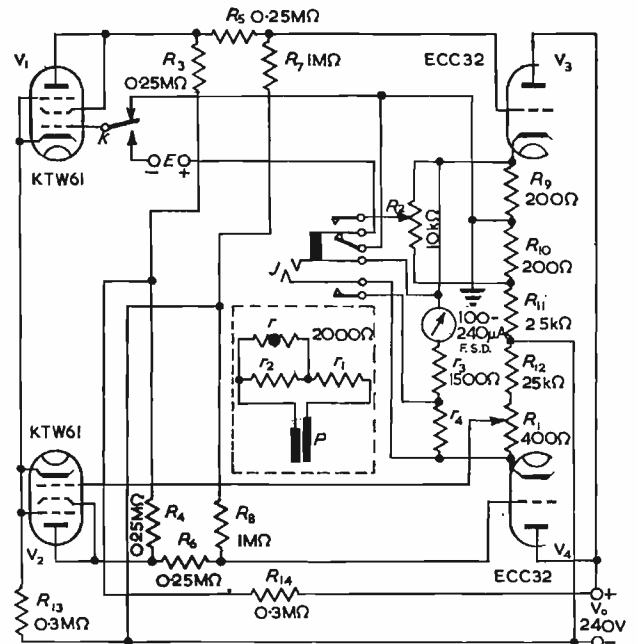

Fig. 5. A practical circuit using KTW61 valves

($r+r_2$) respectively, where $a=1-(r-r')(R-R')$, $b=r+r'$, $e=rr'$, and r and r' are the resistances of the thermistor at the temperatures T and T' respectively.

The connexions are so arranged that either the pH value of the solution in which the electrodes are immersed, or the E.M.F. of the electrodes in millivolts, may be read on the scale of the instrument. After adjusting the pointer for zero deflexion by means of R_{11} , the key K is depressed, when the pointer indicates the pH value of the solution; on withdrawing the plug, the reading of the instrument gives the E.M.F. of the hydrogen ion cell in millivolts. The normal ranges of the instrument for full scale deflexion are 14pH units or 1400mV, but provision may be made for alternative ranges by means of a tapped resistor controlled by a selector switch. The purpose of the network $R_2R_3R_{10}$ is to permit of the application of a correction for changes in the E.M.F. of the hydrogen ion cell due to variations in the asymmetry potential of the glass electrode or other

TABLE 2. Principal characteristics of circuits shown in Figs. 4 and 5

CIRCUIT DIAGRAM	α	β	γ	i_o (MAX) (μ A./V)	w_o (MAX) (μ W./V)	I_{g3} (μ A.)
Fig. 4	0.5	0.024	28 Ω	36000	17000	6.0
Fig. 5	1.0	0.33	283 Ω	3534	664	0.2

causes. If, when using a buffer solution of known pH value, an incorrect reading is obtained, R_2 is adjusted until the pointer indicates the correct value: subsequent readings on other solutions will in general be correct for about 24 hours.

Theory

The method by which phase inversion is effected may be explained with the aid of Fig. 3. The application of a positive potential E to the control grid of the input stage of A_1 produces an output current i_1 which, on entering the network r_o, R_1, R_2 divides into components i_o and i_1' flowing through r_o and R_1 respectively. These components reunite at the junction of R_1 and R_2 , and the p.d. established across $\alpha_2 R_2$ due to the component flowing through it impresses a negative potential upon the control grid of the input stage of A_2 . The output voltages $i_1' R_1$ and $i_2' R_2$ are accordingly anti-phased. Using the notation of the figure, and assuming for the sake of simplicity that $R_1 = R_2 = R$ and $R_{a1} = R_{a2} = R_a$ (the latter being the impedance of either of the valves in the output stage) the following relationships apply:

$$i_1 = i_1' + i_o \dots\dots\dots (8)$$

$$i_2 = i_2' + i_o \dots\dots\dots (9)$$

$$i_o r_o = (i_1' + i_2') R \dots\dots\dots (10)$$

$$e_1 = E - i_1' \alpha R \dots\dots\dots (11)$$

$$e_2 = -i_2' \alpha R \dots\dots\dots (12)$$

$$\mu_1 e_1 = i_1 R_a + i_1' R \dots\dots\dots (13)$$

$$\mu_2 e_2 = i_2 R_a + i_2' R \dots\dots\dots (14)$$

where μ_1 and μ_2 are the overall amplification factors of A_1 and A_2 respectively. Elimination of i_1' , i_2' , e_1 and e_2 from these equations gives:

$$i_1 = [\mu_1 E + i_o R(1 + \mu_1 \alpha_1)] / [R_a + R(1 + \mu_1 \alpha_1)] \dots (15)$$

and

$$i_2 = i_o R(1 + \mu_2 \alpha_2) / [R_a + R(1 + \mu_2 \alpha_2)] \dots\dots\dots (16)$$

It follows from Equation (16) that the magnitude of the anti-phased voltage which appears across R_2 , that is, the extent to which phase splitting occurs, is directly proportional to the load current i_o , and is thus governed by the value of the load resistor r_o . Distortion of the output voltage due to non-linearity of the valve characteristics is minimized if i_1 and i_2 , each of which contributes to the load current i_o , are approximately equal. If the values of α_1 and α_2 are adjusted in such a manner as to satisfy the relationship $\mu_1 \alpha_1 = \mu_2 \alpha_2 = \mu \alpha$, we have from Equations (15) and (16):

$$i_1 - i_2 = \mu E / [R_a + R(1 + \mu \alpha)] \dots\dots\dots (17)$$

from which it appears that the equality $i_1 = i_2$ is approached as the values of R , μ , and α are increased. In practice, although no additional components are incorporated in the circuit with the deliberate object of effecting phase inversion, certain components which are included for other purposes may contribute to this effect; for example, the common cathode resistors R_k and R_{13} (Figs. 4 and 5 respectively), which are necessary in order that the cathodes of the input valves may operate at suitable potentials, also serve the purpose of reinforcing the coupling between the two halves of the amplifier.

By elimination of i_1 and i_2 from Equations (15) and (16), it may be shown that the voltage sensitivity is:

$$i_o / E = 1 / [(a + \beta) r_o + \gamma] \dots\dots\dots (18)$$

where

$$\beta = (R_a / R + 1) \mu \dots\dots\dots (19)$$

and

$$\gamma = 2R_a / \mu \dots\dots\dots (20)$$

Although the terms β and γ have been described previously

as "constants" of the amplifier, it is clear from Equations (19) and (20) that they are, in fact, dependent upon the variable parameters μ and R_a : however, when both μ and r_o are sufficiently great, the voltage sensitivity

$$i_o / E = 1 / \alpha r_o \dots\dots\dots (21)$$

is independent of the amplifier characteristics, and constancy of calibration is assured.

The circuits of Figs. 4 and 5 differ from that of Fig. 3 in that the output valves function as cathode-followers: in other words, in addition to overall negative feedback from output to input, 100 per cent negative feedback is applied independently to the output stage. By methods of analysis similar to that used above, it may be shown that for these circuits the values of β and γ are given by:

$$\beta = 1/m \left\{ 1 + \frac{1}{\mu} (R_a / R + 1) \right\} \dots\dots\dots (22)$$

and

$$\gamma = 2R_a / m \mu' \dots\dots\dots (23)$$

where m is the voltage gain of the first stage and μ' and R_a represent the amplification factor and impedance respectively of either of the output valves.

Zero Stability

It is often necessary to ensure that the zero setting of a pH recorder giving full scale deflexion for, say, 2pH units (approximately 120mV) shall remain undisturbed by fluctuations of ± 20 per cent in the voltage of the power supply. This exacting requirement may be met by applying negative feedback differentially to the two halves of the amplifier. The voltage gain factor of an amplifier, i.e. A_1 or A_2 in Fig. 3, is $\mu = \partial V / \partial E$, the rate of change of the output voltage with change in applied e.m.f.; by analogy, the extent to which fluctuations in the supply voltage are amplified may be expressed in terms of a supply voltage gain factor $\phi = \partial V / \partial V_s$, the change in output voltage for unit change in supply voltage. Reverting to Fig. 3, and assuming for the sake of simplicity that $r_o \gg R_1 + R_2$, an increase ∂V_s in the common supply voltage to A_1 and A_2 will give rise to increased output voltages $\partial V_1 = \phi_1 \partial V_s - \mu_1 \alpha_1 \partial V_1 = \phi_1 \partial V_s / (1 + \mu_1 \alpha_1)$ and $\partial V_2 = \phi_2 \partial V_s / (1 + \mu_2 \alpha_2)$ across R_1 and R_2 respectively, where ϕ_1 , μ_1 , α_1 and ϕ_2 , μ_2 , α_2 are the values of ϕ , μ and α for A_1 and A_2 respectively. As ∂V_1 and ∂V_2 are in phase, the resultant voltage developed across r_o is equal to $\partial V_1 - \partial V_2$, and if the values of α_1 and α_2 be adjusted in such a manner as to satisfy the relationship $\phi_1 / \phi_2 = (1 + \mu_1 \alpha_1) / (1 + \mu_2 \alpha_2)$ the load current will be unaffected by fluctuations in the supply voltage. This adjustment is conveniently carried out by a method of trial and error, e.g., by noting the galvanometer deflexion produced by artificially-induced changes of ± 20 per cent in supply voltage for various values of α_1 , while maintaining α_2 at a constant value. If a stabilization curve is then constructed by plotting the galvanometer deflexion against the corresponding values of α_1 ; it will be found that, in the region of optimum zero stability, the galvanometer deflexion for ± 20 per cent supply voltage change passes through zero and changes sign.

Acknowledgment

The author is indebted to the University of London and the Royal Society for research grants.

REFERENCES

1. DICKINSON, C. J. *Electrophysiological Technique*. (Electronic Engng. Monograph 1950).
2. JOHNSTON, D. L. Electro-Encephalograph Amplifier. *Wireless Engr.* 24, 231 (1947).
3. ASHER, H. A D.C.-A.C. Amplifier for Use in Physiology. *Electronic Engng.* 23, 170 (1951).
4. SCHMITT, O. H. *J. Sci. Instrum.* 15, 136 (1938).
5. GOODWIN, *Yale J. Biol. Med.* 14, 101 (1941-42).
6. Brit. Pat. Nos. 636 212 and 657 955.
7. THORP, R. H. A Direct Reading pH Meter. *Electronic Engng.* 17, 671 (1945).
8. MORTON, C. *Trans. Faraday Soc.* 44, 588 (1948).

Automatic Temperature Compensation

Some Notes on Frequency Compensation for Ambient Temperature Effects

By R. H. Mapplebeck*

IN tuned circuits where temperature variation is likely to affect frequency stability, it is often desirable to apply some form of automatic compensation, the exact manner of application depending upon the circuit temperature coefficient required.

To understand the necessity for compensation it is of assistance to examine some of the physical changes that occur in coils and capacitors with change of temperature.

Coils

For a single layer solenoid, a shape in common use in radio and television technique, the approximate inductance according to Wheeler may be written:—

$$L = \frac{r^2 N^2}{9r + 10l} \mu H$$

Where l = length of winding in inches.

r = radius of winding in inches.

N = Total turns of the coil.

It can readily be seen that a change of radius has the greater effect and increasing temperature therefore increases L . If it is assumed that the coefficient of radial and axial expansion α_r and α_l respectively are equal, the inductance for an increase in temperature of $t^\circ C$. becomes:

$$L + \Delta L = \frac{r^2(1 + \alpha t)^2 N^2}{9r(1 + \alpha t) + 10l(1 + \alpha t)} \dots \dots \dots (1)$$

$$= \frac{r^2 N^2}{9r + 10l} (1 + \alpha t)$$

Simplifying this,

$$\alpha = \frac{\Delta L}{L.t}$$

Where $\alpha = 16 \times 10^{-6}$ parts / $^\circ C$. for copper.

But $f = 1/2\pi\sqrt{LC}$

and $f - \Delta f = 1/2\pi\sqrt{(L + \Delta L)C}$

Where Δf is the decrease in frequency due to increase ΔL in L .

Therefore $f - \Delta f/f = \sqrt{(L/L + \Delta L)}$

or $1 - \Delta f/f = (1 + \Delta L/L)^{-1/2}$

Expanding by the Binomial Theorem and neglecting $(\Delta L/L)^2$ and all higher powers, $\Delta L/L$ is so small,

$$\Delta f/f = \frac{1}{2}(\Delta L/L) \dots \dots \dots (2)$$

Therefore the ratio of change in frequency due to the unhindered expansion of a copper coil is 8×10^{-6} parts / $^\circ C$. or for a normal temperature rise of say, $30^\circ C$. the ratio change of frequency is 240 parts in 10^6 or 240c/s in one megacycle in this case.

Since the increase in radius has the opposite effect to increase in length it is possible, by suitably selecting α_r and α_l to make the inductance sensibly independent of temperature over the small ranges likely to be encountered in low power circuits such as receivers, wave-meters, oscillators and other electronic equipment.

Re-writing equation (1) and substituting with α_r and α_l

$$L + \Delta L = \frac{r^2(1 + \alpha_r t)^2 N^2}{9r(1 + \alpha_r t) + 10l(1 + \alpha_l t)}$$

To obtain the condition of no change of inductance it is necessary to differentiate with respect to temperature and equate to zero.

$$\text{When } t = 0 \frac{d(L + \Delta L)}{dt} = 9r\alpha_r + 10l(2\alpha_r - \alpha_l) = 0$$

Whence $\alpha_l/\alpha_r = 2 + 9r/10l$

By satisfying the above equation for the ratio of axial and radial expansion it is possible to make L independent of temperature. In practice, approximations to this may be obtained by using copper-plated low temperature coefficient materials such as invar for the coil or by shrinking the coil on to a former of lower coefficient of about 7×10^{-6} parts per degree centigrade. This is not an economic proposition however, and results sufficient for average needs may be obtained by using ordinary copper wire and compensating by indirect means such as employing a high Q single turn loop loosely coupled to the coil to be compensated but mounted on a device which moves the loop relative to it with change of temperature.

Two such devices are shown in Figs. 1(a) and 1(b). In the former, the coupling loop is mounted between two

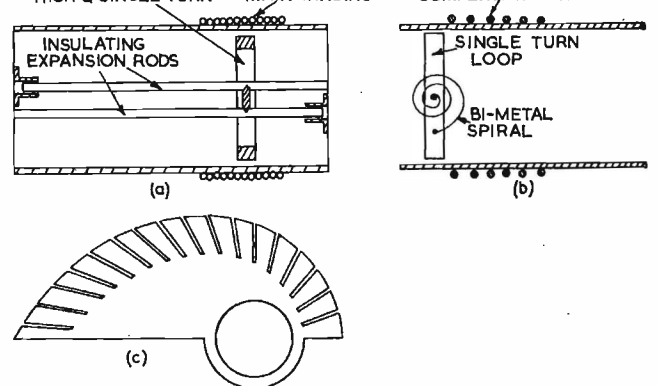

Fig. 1(a). Sectionalized view of inductive temperature compensator
Fig. 1(b). Inductive compensator with single turn loop free to move on spindle to which bi-metal spiral is anchored.

Fig. 1(c). Bi-metal split vane for capacitive temperature compensator

rods of insulating material (of suitable coefficient of expansion) anchored at opposite ends of the coil former respectively and free to move at the other. Expansion or contraction of these rods imparts a rotary movement to the loop giving a frequency shift to the coil that by predetermined design may be arranged to compensate for coil expansion or contraction.

In the latter, movement of the loop is provided by a spiral bi-metal strip which tends to coil and uncoil with change of temperature, and it is a relatively simple matter to adjust the length of the strip and position of the loop to obtain optimum compensation.

Capacitors

Changes in geometry other than that of the plate systems in commercially constructed variable capacitors may occur with temperature changes and, more important still, quite large changes of permittivity with temperature may take place in the solid insulators of the capacitor if less perfect than quartz. Such capacitors often have a high temperature coefficient and their effect on oscillator frequency is generally much greater than coil changes, which

* Marconi Instruments Ltd.

explains why some designers of H.F. equipment prefer to utilize high quality fixed capacitors with variable inductance tuning. Also the temperature coefficient of a variable capacitor is rarely constant throughout its range of travel, therefore, for correct compensation, the coefficient should be in conformity with its "law" otherwise it will be complete only at one part of the travel, falling off at either side of that point.

A suitable compensator may consist of an end plate on the moving spindle made from bi-metal sheet with many radial slots cut round its periphery and following the same shape as the other plates. Compensation will then occur with change of temperature by the bending of each slotted portion of the bi-metal plate, which must be mounted on its spindle in the correct sense to give either a positive or negative coefficient as required (see Fig. 1(c)).

Compensation for frequency drift with temperature may therefore be effected by fitting individual capacitive or inductive compensators to capacitor and coil respectively, and here, there is much scope for practical ingenuity in designing such compensators.

It is possible however, partially to offset the effects of ambient changes by compensating for an "effective" temperature coefficient of capacitance equivalent to

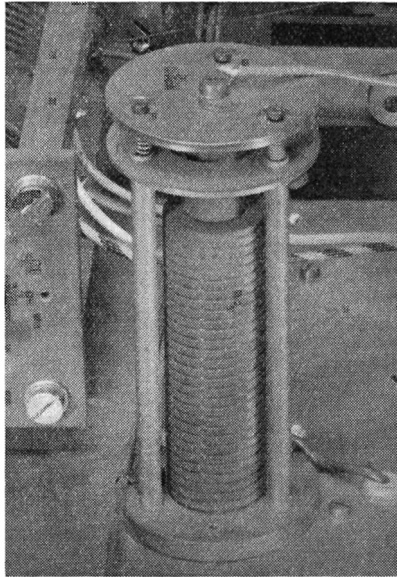

Fig. 2. Temperature compensator mounted in position

$\Delta C/C + \Delta L/L$ the composite temperature coefficient of frequency being given by $\Delta f/f = \frac{1}{2}(\Delta C/C + \Delta L/L)$ (See Equation (2)).

It should be noted that ΔL and ΔC are lumped values which include the L_o of the capacitor, the C_o of the coil respectively and any other strays.

Such collective circuit compensation though not accurate enough for standard equipment, nevertheless may be used in many instances to considerable advantage but is possible only if the temperature of the coil and capacitor are at the same level and is effective for only such temperature changes as may be produced by ambient conditions. The application should therefore be limited to instruments of low power where the temperature of the coil and capacitor is likely to be the same and not to the heating effects caused by the differing oscillatory currents in coil and capacitor as would occur in a transmitter or other high-power equipment.

Therefore, to retain the high degree of frequency stability required by modern narrow-band receivers and test gear it is quite usual to include across the tuned circuits some form of capacitance compensator, values for which may vary from about 2pF and 8pF.

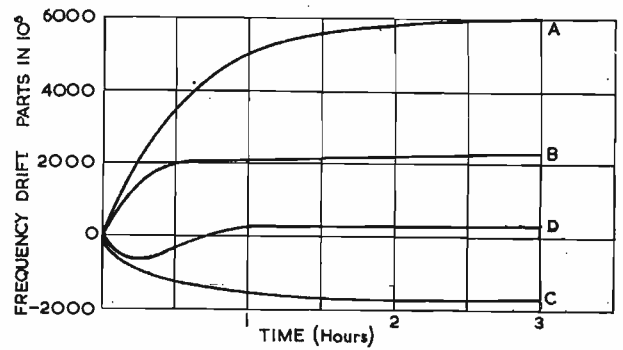

Fig. 3. A. No compensation
B. Compensation without heater
C. Compensation with heater only
D. Complete compensation

As is well known, fixed capacitors having predetermined temperature coefficients are available and occupy little space, but many manufacturers prefer to make up their own adjustable compensators to special design.

Example

Experiments were carried out with a capacitive compensator consisting of a small metal disk mounted at the extremity of a rod of insulating material having a cyclic law of expansion and contraction, and arranged to form the moving element of a capacitor of about 2pF having a negative coefficient with increase in temperature (see Fig. 2). It was mounted in close proximity to, and connected across the tuned circuit of the oscillator of an experimental heterodyne wavemeter which, in its uncompensated state was observed to have a positive frequency drift with increase of temperature. A heater winding consisting of a few turns of fine resistance wire wound on to the rod of insulating material and fed with current from the filament voltage supply, was intended to give rapid expansion when switching on from cold, to offset corresponding initial changes in frequency due to valves and other components warming up.

Reference to Curve A, Fig. 3, shows frequency drift at 1Mc/s over a period of some three hours after switching on from cold without any compensation being applied. In this condition, as can be seen, the frequency stability was 6000 parts in 10^6 .

Curve B, Fig. 3, is the frequency drift with the compensator connected but without the heater winding, the total final drift being of the order of 2000 parts in 10^6 .

Curve C, Fig. 3, is the degree of compensation brought about by the heater winding alone. In this condition as would be expected the coefficient is in a negative direction, the change taking place from the instant of switching on.

With the oscillator in its case and the temperature compensator fully connected the combined effect on frequency was as shown in curve D of Fig. 3, the drift now reduced

Fig. 4. Effect of adjusting compensator capacitance through critical point

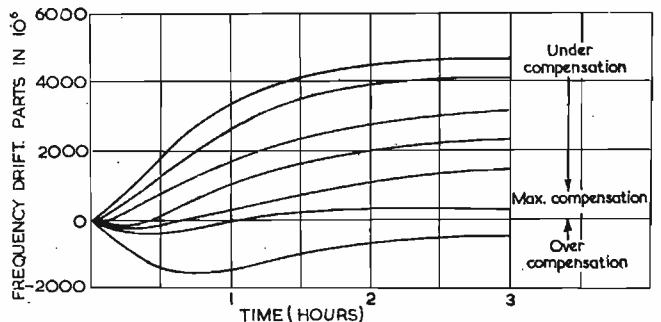

to the order of 300 parts in 10^6 . Careful adjustment of the heater voltage reduced the initial dip in curve D somewhat, but it is doubtful whether the time taken for this adjustment to suit the characteristics of individual instruments would be worth while in ordinary routine mass production testing.

Maximum compensation and therefore minimum drift was of course only obtained when the capacitance of the compensator was set to its critical value achieved by observing the results of a number of heat runs similar to those indicated by the family of curves in Fig. 4, which show the degree of compensation obtained for various settings of the compensator capacitance.

It is again emphasized that the results given are of an

experimental nature only and as such, have only been used as a means of illustration.

Conclusion

Although unlikely to satisfy the requirements of very accurate instrumentation, the foregoing notes may be of assistance in designing simple temperature compensators for low power R.F. work where small amounts of frequency drift can be tolerated.

Acknowledgment

Grateful acknowledgements are made to Marconi Instruments Ltd. for permission to use the photograph in Fig. 2.

Radar Pulses on Target per Scan

By R. C. Coile*

The range equation is a useful formula in radar system design as it expresses relationships among system parameters. The range equation is usually written¹:

$$R_{\max} = \sqrt[4]{\frac{P \sigma A^2 X^2}{4\pi S_{\min} \lambda^2}}$$

where R_{\max} = maximum ranges of detection

P = pulse power

σ = radar cross section of target

A = area of antenna aperture

X = a dimensionless constant depending on the antenna

S_{\min} = minimum detectable signal power.

One must consider the effect of the following parameters on the performance of the radar: (1) pulse repetition frequency, (2) azimuth scanning rate, (3) azimuth beamwidth, (4) pulse length, (5) beam shape in elevation angle, and (6) wavelength. The minimum detectable signal power, S_{\min} , is affected by the first three parameters. To a good approximation², S_{\min} varies inversely with the square root of the number of pulses per scan on the target

$$S_{\min} \approx 1/\sqrt{N_{sc}}$$

N_{sc} , the number of pulses per scan on the target is given by the expression³:

$$N_{sc} = f_r \theta / \omega$$

where f_r = pulse repetition frequency

θ = azimuth beamwidth in degrees between half power points.

ω = angular scanning rate in degrees per second.

This equation may be rewritten as:

$$N_{sc} = f_r \theta / 6n$$

where n = antenna rotation rate in R.P.M.

This nomogram (Fig. 1) permits rapid calculation of the number of pulses on target per scan as affected by antenna rotation rate, antenna beamwidth, and pulse repetition frequency. To find the number of pulses on target per scan of a radar with antenna rotation rate of 10 R.P.M., antenna beamwidth of 1.5 degrees, and pulse repetition frequency of 800, lay a straightedge (1) between 10 R.P.M. on the antenna rotation scale and 1.5 degrees on the

antenna beamwidth scale. Then lay a straightedge (2) between the intersection of the first straightedge and the index line and 800 on the pulse repetition frequency scale and read off the answer of 20 on the pulses on target per scan scale.

The nomogram has a scale of $S_{\min} \approx 1/\sqrt{N_{sc}}$ to give a quick appreciation of the dependence of the minimum detectable signal power on antenna rotation, beamwidth and pulse rate.

REFERENCES

1. RIDENOUR, L. N. Radar System Engineering, p. 22, (McGraw Hill Publishing Co.).
2. *ibid* p. 596
3. *ibid* p. 119

Fig. 1. The nomogram

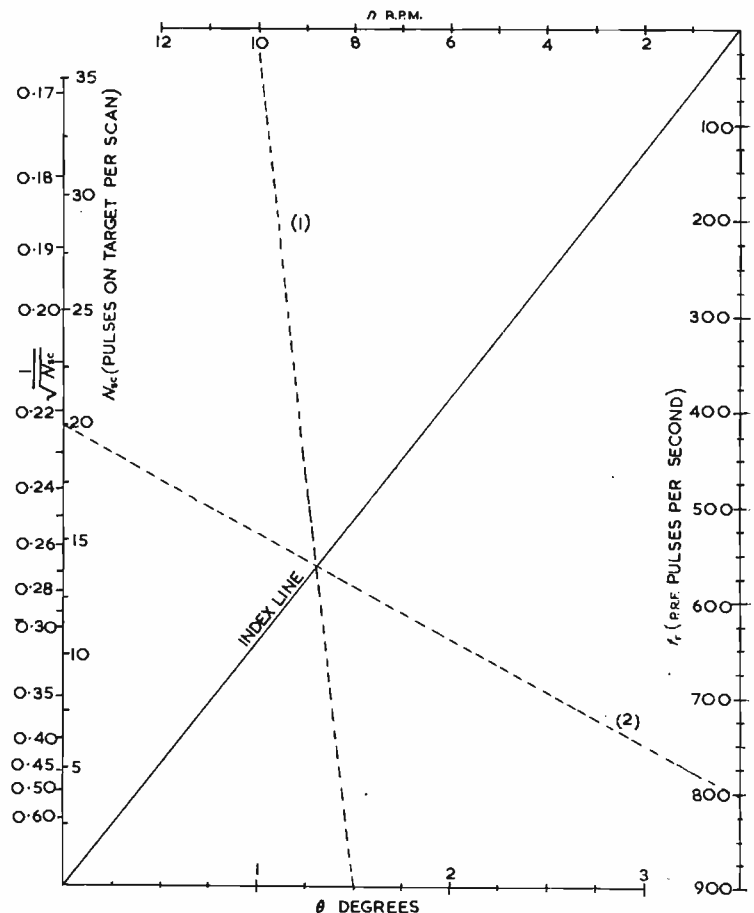

* Massachusetts Institute of Technology.

Notes from the Industry

George Kent, Ltd. have formed a Canadian company under the title of Kent Norlantic, Ltd., at Horner Avenue, Toronto 14. This organization takes over from the parent company the responsibility of marketing Kent industrial instruments throughout Canada. Arrangements are being made for stocks to be held to meet Canadian delivery requirements of new equipment and spares.

London and Home Counties Regional Advisory Council for Higher Technological Education have issued a bulletin on special courses in higher technology to be held in the spring and summer this year. Copies of the bulletin and information may be obtained from the Secretary, Regional Advisory Council, Tavistock House South, Tavistock Square, London, W.C.1.

Plessey communications equipment in R.A.F. Austers. In order to standardize the V.H.F. equipment in Austers engaged in artillery co-operation, the R.A.F. has now completed arrangements for the installation of the Plessey transmitter-receiver type P.TR.61 in all these machines. Specifically designed for light and medium aircraft, the transmitter-receiver, which is particularly simple to operate by virtue of single knob tuning of both sections, has already been adopted by the Belgian and Netherlands Air Forces, and by civil airlines in many parts of the world.

Exports of British Radio equipment in October last, according to Customs and Excise figures recently issued by the Radio Industry Council, were valued at £1,963,695. This was a little below the monthly average for last year, but the value of exports for the first ten months of the year exceeded £20 million, compared with £18 million for the same period of 1951.

Dumfries Transmitting Station. The BBC proposes to build a low-power transmitting station at Mousewold near Dumfries, in accordance with the previously announced plan to improve reception of the Home Service programmes. As the building and installation will take some time to complete, a temporary transmitter has been installed in a caravan on the site and radiates the Scottish Home Service on 371 metres (809kc/s).

Redruth Home Service Transmitter. To improve reception of the West of England Home Service in the vicinity of Redruth, Cornwall, the BBC is to add a third transmitter to its present station at Redruth. The new transmitter will be of 2kW power and will share the wavelength of 206 metres (1457 kc/s) which is already used by other stations radiating the West of England Home Service.

Midland Silicones, Ltd., 19 Upper Brook Street, London, W.1, announce that, to meet the demand for DC 4

compound in a convenient sized packing, this is now available in 2 oz. tubes from Direct T/V Replacements, 134-136 Lewisham Way, New Cross, London, S.E.14, to whom inquiries should be sent. Originally developed in America as a waterproof seal and dielectric for high-voltage ignition systems, DC 4 has become well-known for its many applications in the maintenance of transmitter, television and other electronic equipment.

German Radio and Television Exhibition. It has been decided by the representatives of the German radio industry, in agreement with the local authorities, to hold an exhibition from August 29 to September 6 this year. The fair will take place on the Dusseldorf exhibition grounds.

Philips Electrical, Ltd. announce the acquisition of the Columbia American label and will periodically be issuing records of famous celebrities. As a temporary measure the recording will be undertaken by Universal Programmes Corporation and until they acquire their own studios Philips will be recording at Portland Place and Conway Hall.

The British Standards Institution has just announced that it will move at the end of next summer into a single self-contained office block at 2 Park Street, Mayfair, London, W.1. At present the Institution spreads over 24 and 28 Victoria Street, and also 24 Gillingham Street. The concentration of the staff and facilities under one roof will aid efficiency and economy.

Radiovisor Parent, Ltd. have recently celebrated their twenty-fifth year as designers and manufacturers of photo-electric equipment. They were the first company to develop industrial photocell applications in this country, and in 1927 patented the first really practical commercial light-sensitive cell.

Alfred Hinde, Ltd., Wolverhampton, have published the second issue of the Wire Reference Year Book and Directory (1952/53 edition). In the innumerable headings wire is traced through from the rod to a wide variety of finished wire goods, wire machinery and processes being included. The book also contains a useful brand names section, articles on wire, British Standards and a number of tables. The price of the publication is 25s.

British Plastics Exhibition change of date. The opening of the second British Plastics Exhibition and Convention at Olympia, London, originally fixed for Wednesday, June 3, the day after the Coronation, has been postponed until Monday, June 8. The exhibition will close on Thursday, June 18, instead of Saturday, June 13. Hours of opening will be 10 a.m. to 6 p.m., and the price of admission 2s. 6d.

Mr. R. P. Browne, secretary of the Radio Industry Council, has entered

hospital for an orthopaedic operation and has been given leave of absence for some months, Mr. G. B. Campbell, the deputy secretary, will be acting in Mr. Browne's absence, under the director, Vice-Admiral J. W. S. Dorling.

The Board of Trade has been informed by the United Kingdom Trade Commissioner at Pretoria of a call for tenders by the Department of Transport, Alexander Bay, for the supply of radio equipment. The Department has also been informed by the British Embassy at Montevideo of a call for tenders by the Administracion Nacional de Puertos, for the supply of a radio electric communications receiver.

The Radio Club of America have awarded the Armstrong Medal, one of radio's prized honours, to a Briton, Captain Henry J. Round. Captain Round is one of the few surviving pioneers who assisted Marconi in his early work, and first came into public prominence after the end of World War I. when his skilled radio work was revealed.

Marconi's Wireless Telegraph Co., Ltd., through their Italian company, are undertaking a co-ordinated group of orders for British television equipment, amounting to £300,000. The orders are for studios at Rome and Milan, medium-power transmitters at Rome and Pisa, and outside broadcasting units at Rome. When completed, this equipment will give Italy a permanent television network on a national scale.

Belling and Lee, Ltd. The following senior executives have been appointed executive directors with effect from January 1, 1953. Mr. A. Cook, M.B.E. (Secretary), Mr. N. D. Bryce (Sales Manager), Mr. E. A. Taylor (Commercial Sales Manager). These executives have all held responsible positions in the company for over twenty years.

RIC Premiums for Technical Writing. The Radio Industry Council are again considering awards to non-professional contributors of technical articles on radio published during the past year in any journals which the public can buy. Awards of 25 guineas, up to an average of six a year, are normally made at the close of each year. One interim award has already been made, however, in respect of an article by Mr. J. R. Acton published in the February, 1952, issue of ELECTRONIC ENGINEERING, entitled "A Single Pulse Dekatron," which was considered of special interest. Writers are asked to submit published articles (five copies if possible) to the Secretary, Radio Industry Council, 59 Russell Square, London, W.C.1, with a signed declaration of eligibility, that is that they are not paid a salary mainly or wholly for writing and are not earning 25 per cent or more of their income by articles or book royalties.

Electrical Industries Benevolent Association. It is announced that when all expenses were paid in connection with the Electrical Industries Ball, a total profit of £1,411 5s. 10d. has been credited to the funds of the Association.

Erratum. Since publication of the January issue, we have been informed that the address of the Hilton Electric Company is now 52 Pool Street, Wolverhampton.

LETTERS TO THE EDITOR

(We do not hold ourselves responsible for the opinions of our correspondents)

A High Quality Power Amplifier

DEAR SIR,—Mr. Miller, in his letter in the October number, raises the issue that valve manufacturers quote much higher figures for power output for a given distortion than are obtainable in practice. This is quite a common complaint from amplifier designers and I would like to attempt to explain this apparent anomaly.

The valve manufacturer, in expressing the performance of his product, must eliminate as far as possible the effects of the output circuit, the many variants of which modify the results obtained. The valves are operated looking into a resistive load of the stated value, and, as would be expected, measurements are made on samples whose characteristics are as close as possible to the published figures. A distribution of power output either side of the quoted figure similar to that obtained for anode current, mutual conductance, etc., for a large number of samples is then to be expected. Generally, if auto-bias is recommended it is used for the measurements, fixed bias being employed only when specified.

In the same way the amplifier designer usually ignores the harmonic and inter-modulation distortion produced by the loudspeaker and specifies the performance of his amplifier into a resistive load. He also ensures that the component values are as close as possible to the optimum, and fully expects variations in performance when further models employing components of normal tolerance are constructed.

When the published figures of valve power output are not achieved, quite often the losses in the output transformer are neglected. In a cheap radio type transformer working into 3 ohms the secondary resistance sometimes reaches this value, thus accounting for half the valve's output. Mr. Miller has achieved a commendably low output impedance of 1.6 ohms in a 15-ohm termination, but even this accounts for nearly 1.5 watts when 14 watts are dissipated in the load. At 14 watts output, therefore, some 15.5 watts are being delivered by the 6V6 valves. As Mr. Miller so rightly says, the distortion rises very rapidly towards maximum output so that the higher distortion level is not surprising.

For Mr. Richter's information I have found the metal 6J7, as distinct from the glass versions 6J7G and 6J7GT, in most ways as good as the EF37 for microphony. A good number of 6J7 valves are the equal of EF37A as regards hum and microphony, and a substantial yield can be obtained by selection.

Yours faithfully,
F. W. IRONS,

Standard Telephones & Cables, Ltd.

* *Electronic Engng.* 24, 469 (1952).

The author replies:

DEAR SIR,—I am indebted to Mr. Irons for his elucidation of valve manufacturers'

power output figures and am gratified to find that my suppositions regarding loads and matching are correct. He, very rightly, points out that I have omitted to name the losses in the output transformer as another contributing factor to account for the discrepancy. However, I think that Mr. Irons is wrong in his contention that when 14 watts are being delivered to the load 1.5 watts are necessarily being dissipated in the source impedance. The source impedance is a function of the feedback factor while the transformer losses are constant and unaffected by the application of feedback. Also, I feel that he is unduly severe on transformer designers. I have measured several output transformers and in no case did the secondary resistance exceed 0.5Ω.

Yours faithfully,
E. J. MILLER,
Edgware, Middlesex.

Volume Compression and Expansion

DEAR SIR,—Mr. Pope's comments in the December issue make a further useful contribution to the design of volume compressors. The question of distortion is of interest since these circuits do not reduce distortion produced by non-linearity in the control valve, in the same way as does a normal negative feedback amplifier. This is because the output signal voltage is attenuated by the feedback in approximately the same ratio as the distortion voltage. In fact the effect is for the distortion to peak at somewhere about the middle of the control voltage working range, as is shown by the figures given in Mr. Pope's original article.

A simple method of avoiding the cathode choke, when an input transformer is permissible, is shown in Fig. D which is a re-arrangement of my Fig. A.

A possible design for a low-distortion expander using push-pull control valves is shown in Fig. E. Since the control bias voltage component is balanced out in the feedback loop, the impedance presented to the control line, at the grids of the variable- μ valves, is maintained at a high value. The characteristics of the

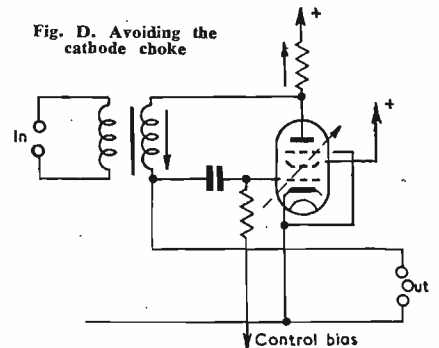

transformer do not affect fidelity when the control valves approach cut-off at high volume levels.

Yours faithfully,
BRIAN D. CORBETT,
Department of Clinical Research
University College Hospital,
London, W.C.1.

The Differential Amplifier

DEAR SIR,—In Mr. Davies's article on "The Differential Amplifier with a Useful Modification" appearing in your September issue, his derivation of equation (5), the gain ratio of the amplifier, is obscure, due, it would appear, to three erroneous mathematical statements.

(1) Equation (1) for i_2 should have a positive sign. This follows quite simply from the solution of the pair of simultaneous equations derived from the two meshes of Fig. 1(c).

(2) The output voltage is correctly given by $E_o = -i_2 R_L$, and not $i_2 R_L$ as stated in Mr. Davies's analysis. This is evident upon consideration of the simplified and equivalent circuits of Figs. 1(b) and (c). Here a valve having an input voltage e is replaced by an equivalent voltage μe . Now this equivalent voltage will give rise to a voltage of the correct phase across R_o , the cathode resistor, i.e., a voltage in phase with the input voltage, but will lead to an erroneous voltage as far as phase is concerned, for E_o ; i.e., the derived output voltage

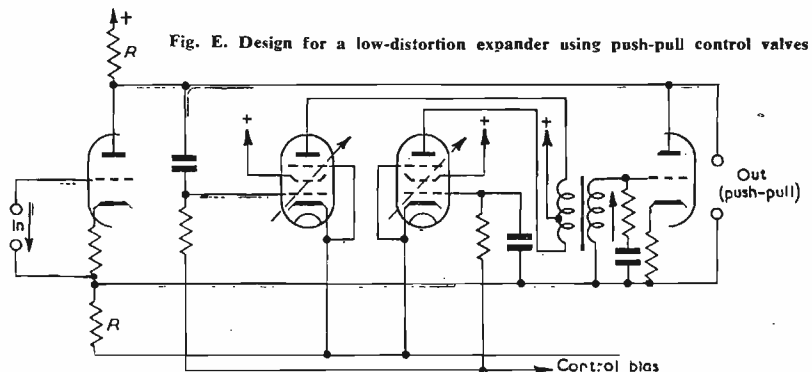

Fig. E. Design for a low-distortion expander using push-pull control valves

will be in phase with the input voltage! In order to rectify this anomaly we must prefix this derived value of E_o by the minus sign.

(3) Equation (3) for the push-pull gain of the amplifier is correct as given but obviously was not obtained with the aid of equation (1) for i_2 and the identity $E_2 = -E_1 = E$ for these give—

$$\frac{E_o}{E} = \frac{i_2 R_L}{E} = - \frac{(a + \gamma) R_L}{\eta}$$

Use of the corrected expressions for i_2 and E_o produces the same result because we have changed the signs of both E_o and i_2 . The error here appears to be due to the use of the identity $E_2 = -E_1 = E$. Since we are making E_1 the reference voltage—this is surely logical and, doubtless, as Mr. Davies intended—the correct identity is $E_1 = -E_2 = E$. Using this identity and the corrected expressions for E_o and i_2 we obtain the correct expression for the gain, viz.:

$$\frac{E_o}{E} = \frac{i_2 R_L}{E} = \frac{(a + \gamma) R_L}{\eta} = M_1$$

Equation (4) is correct as given for here the errors cancel out, and it follows that equation (5) is also correct as given.

One further point I should like to raise is this. Is it not "gilding" the amplifier by a factor of 2 to state that the push-pull gain is given by E_o/E ? The input voltage under push-pull conditions is surely $2E$.

Yours faithfully,
VERNON S. E. LEWIS,
Carshalton, Surrey.

The author replies:

DEAR SIR,—The author wishes to thank Mr. Lewis for pointing out the apparent confusion existing over the signs in equation (1), the expression for E_o and E_1 and E_2 .

It is now felt that the more conventional approach of taking circulating currents of the same direction is to be preferred to that shown in Fig. 1(c); although the latter does give a more realistic picture of the circuit conditions. By reversing the direction of i_2 in Fig. 1(c) and the polarity of E_2 in Fig. 1(b) we proceed as follows:—

$$e_1 = E_1 - R_c(i_1 - i_2)$$

$$e_2 = E_2 + R_c(i_1 - i_2)$$

The basic equations using the same abbreviations are then:—

$$i_1 a - i_2 b - \mu_1 E_1 = 0$$

$$-i_1 c + i_2 d - \mu_2 E_2 = 0$$

from which we obtain

$$i_2 = \frac{(\mu_2 E_2 a + \mu_1 E_1 c)}{ad - bc} \quad \& \quad i_1 = \frac{(\mu_2 E_2 b + \mu_1 E_1 d)}{ad - bc}$$

Now E_o will still be given by $i_2 R_L$ for the sign of the expression for i_2 will, in all cases, determine the polarity of E_o . Thus E_o is positive with the negative voltage applied to the second grid (assuming E_1 is zero).

To obtain an expression for k it is quite arbitrary whether we use in this case $E_1 = -E_2 = E$ or $E_2 = -E_1 = E$ for the push-push condition; remembering that $E_1 = E_2 = E$ now applies to the push-pull condition. It is the modulus of k which is actually required in practice and the sign obtained for k is really unimportant.

M_1 is given by $\frac{(a + \gamma)}{\eta} R_L$ as before, using $E_1 = E_2 = E$ and M_2 is given by $-\frac{(a - \gamma)}{\eta} R_L$ as before, using $-E_1 = E_2 = E$.

Although the basis for the derivation of k is clearly shown Mr. Lewis may prefer to use $2E$ for the push-pull voltage but it is a small point when it is remembered that k can be made infinite by adjustment of E_2 !

Yours faithfully,
B. F. DAVIES,
Chelmsford, Essex.

Voltage-Regulator Tubes

DEAR SIR,—I have been following Mr. Benson's excellent series of articles with great interest.

The stabilized H.T. power supplies manufactured by this company are often required to have regulation of 0.1 per cent, or better. This demands a very stable reference voltage, which renders some commercial gas tubes useless, unless some means of selection is adopted.

I note that Mr. Benson plots the static characteristics of the gas tubes, which must be very laborious.

I have tried using a dynamic test (Fig. 1) which not only reveals the hysteresis, discontinuities and A.C. resistance of the tube, but also permits a rapid selection of the best operating point for each tube individually.

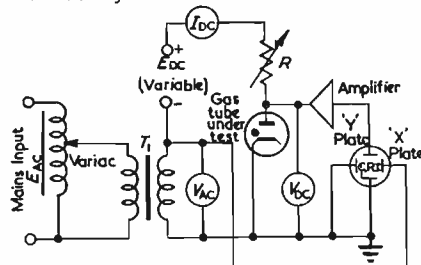

Fig. 1. Dynamic test

The stabilized H.T. power supply E_{DC} , of low output impedance (about 0.1 ohm) and the variable resistor R , are adjusted until the d.c. conditions suit the gas tube under test. I_{DC} and V_{DC} meters monitor the current and the voltage of the tube respectively. The source of the sweeping voltage E_{AC} , for convenience 50c/s mains supply, is adjusted by means of a Variac and monitored by the meter V_{AC} .

The secondary of the isolating transformer T_1 is of low resistance, its purpose being to exclude D.C. from the E_{AC} source. V_{AC} is also used as a time-base for the C.R.O. display and the residual A.C. voltage developed across the tube under test is amplified and applied to the Y plate. Typical examples of traces obtained are shown in Fig. 2.

Some refinements could be added such as a blanking out pulse at the modulator grid of the C.R.T. to determine forward or return sweeps on the hysteresis loop. If necessary, the tests can be carried out at different frequencies using a voltage sweep source other than 50c/s mains.

Care must be taken to eliminate any phase-shift in the amplifier at the frequency concerned, which will otherwise distort the trace.

All the parameters can be varied to explore and thus avoid any discontinu-

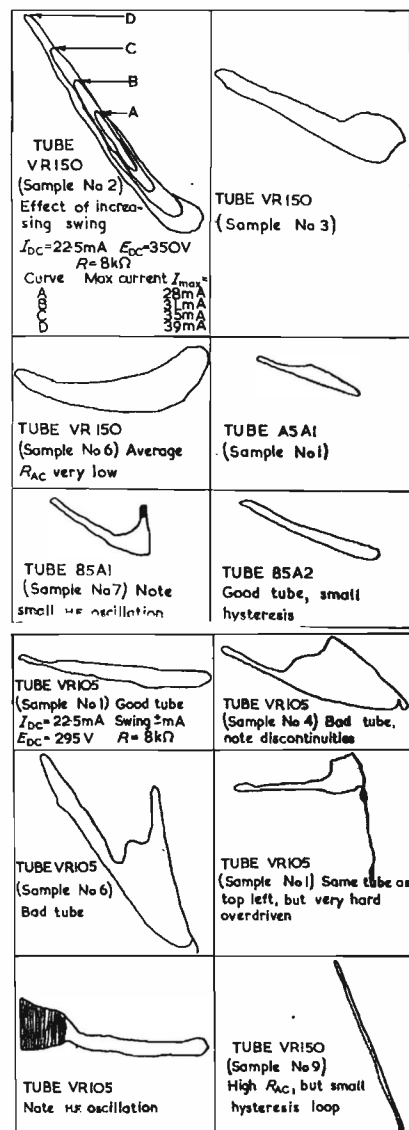

Fig. 2. Typical traces

ities and kinks in the tube characteristics under different working conditions.

The number of completely rejected gas tubes can be reduced, as nearly every tube has some useful range.

The average slope of the trace is a measure of the A.C. resistance of the tube.

$$R_{AC} = \frac{dV}{V_{AC}} R \quad \text{where } dV \text{ is the A.C. voltage developed across the tube.}$$

The easiest way to calibrate the screen of the C.R.T. in terms of R_{AC} is to substitute a variable resistor for the tube and adjust it until a straight line trace (no hysteresis effect present with the resistor) matches the average slope of the hysteresis loop.

The approximate instantaneous current through the tube is given by:—

$$i = \frac{E_{DC} + V_{AC} \sin \omega t - V_{DC}}{R}$$

E_{DC} is usually chosen to be at least twice V_{DC} .

Yours faithfully,
W. KIRYLK,
All-Power Transformers Ltd.,
Byfleet, Surrey.

Fundamentals of Radio Communication

By A. Sheingold. 235 pp., 56 figs. Medium 8vo. D. van Nostrand and Macmillan, New York. Chapman & Hall Ltd., London. 1952. Price 21s.

THIS book sets out to present the fundamentals of radio communication in a descriptive manner, and it should prove useful to the student meeting radio for the first time and intending to make a career as a technician rather than as an engineer. The style is clear and lucid, there are few misprints, and text and diagrams are up to the standard of the best American text books. It suffers from two disadvantages; first, in trying to cover so wide a field it is almost impossible to avoid being superficial and this is particularly evident in chapters 10 (Amplification of Large Alternating Voltages), 11 (Rectifiers and Rectifier Filter D.C. Sources) and 19 (Image Transmission Systems or Television Techniques). Second, it is a book to help a student on his way but once this purpose has been served it will have little reference value.

There are 21 chapters each averaging about 20 pages; many of them contain fully worked examples, which are a valuable illustration of the text. It is unfortunate that the problems set at the end of some chapters are not supplied with answers. About three quarters of the script is concerned with A.M. transmission and reception, the remaining one-quarter glancing at frequency modulation, basic pulse circuits such as the sawtooth, square wave and short impulse generators, ultra high frequency techniques (a short description of the klystron, and magnetron), image transmission (television transmission and reception), special communication techniques (single sideband and pulse) and radar and radio navigation.

The use of "image" when television is meant might confuse a reader who has heard of this term in connexion with superheterodyne reception, and reference to clamping (Chapter 17) when actually D.C. restoration is meant, may also be puzzling.

Turning now to the main section on A.M. transmission and reception we find, after the introductory chapter, four chapters on basic circuits and components. On page 46 are given formulae for calculating the inductance of rectangular air-cored coils, but dimensions are unfortunately unspecified, the use of "flat" to describe the characteristics of a correctly terminated line (p. 107) might be allowed in a lecture, but is unwise in print. Chapter 6 gives a good working picture of general propagation problems, and the next two chapters are concerned with valve construction and valves as circuit elements. American definitions for distortion appear in the next discussion on small signal amplification. On page 217 in the section on large signal amplification the suggestion is made that the harmonic components of anode current produced by Class B or C operation can be reduced or eliminated by suitable choice of anode load whereas, in fact, they are only prevented from developing a voltage. Chapter 12 attempts to separate oscillators into feedback and non-feedback types, classifying beat fre-

quency and U.H.F. oscillators as non feedback. No oscillator has yet been produced which does not employ feedback to maintain continuous oscillation. In the next chapter on amplitude modulation fig. 13.6 may mislead the student by suggesting that the oscillatory current peak value is equal to peak pulse current. There is also a statement on p. 281 that the velocity microphone is unidirectional; this directional characteristic can only be obtained by combining pressure gradient (velocity) and pressure operated characteristics.

K. R. STURLEY.

Rocket Propulsion

By Eric Burgess. 235 pp., 56 figs. Medium 8vo. Chapman & Hall Ltd. 1952. Price 21s.

IN writing this book the author has set himself a difficult task. Drawing from material he has presented over the course of many years in the form of lectures and essays in rocketry he sets out to furnish the link between the "popular" and advanced works in this field of engineering science.

As the title suggests, the emphasis is placed on the rocket propulsion aspect, although an appreciable part of the book deals with the application of rockets in general, including that for inter-planetary travel.

The opening chapter concerns elementary theory applicable to rockets and their motors, and in a concise and easily readable manner the significance of the basic parameters, jet velocity, jet flow, specific impulse, etc., is explained. Special attention is directed to the question of mass ratio required in order to achieve a given ratio of vehicle to jet velocity. In this context, the important advantage of the multi-step construction is discussed. As in succeeding chapters this one closes with a detailed resumé of the main points already considered.

The second chapter deals with the types of fuels required for solid and liquid burning rockets. At an early stage a distinction is made between the properties of propellants and high explosives. Subsequent discussion identifies the important characteristics that should be possessed by a fuel for use with practical rocket motor. Next a considerable number of thermo-chemical reactions are reviewed and the theoretical jet velocities for these are calculated. This chapter is well written and certainly provides a sound basis for the more serious student.

The third chapter deals with the rocket motor in general and with the all important combustion chamber in considerable detail. The physical processes of combustion are carefully traced from the entry of the fuel into the chamber to the high velocity exhaust gases ejected from the throat. This verbal treatment is followed by a more rigorous examination of the duty cycle stated formally in thermodynamic terms. A considerable

fund of practical information is included in this chapter relating to problems of cooling and to kindred factors pertinent to the design of the combustion chamber itself. The following chapter discusses problems of tankage, fuel feed, and fuel injection: the material here, is essentially of an engineering nature and there are several references to schemes employed in past German rockets. Surprisingly, there is no reference to the expendable tank construction which has been well received in rocket circles of recent years.

On page 119, one finds that the tensile strength of a material has been expressed in atmospheres. It seems difficult to justify the use of the unit in this manner.

As far as this reviewer is concerned the next two chapters devoted to control of flight and long range rockets do not maintain the same high standard of technical dissertation as evinced in the earlier part of the book. In particular the section dealing with control of flight is definitely weak. The known problems of the vehicle control both within and without the atmosphere are not clearly stated.

The only control scheme receiving any really detailed consideration is one of rather academic interest employing a pendulum control for zenithal trajectories.

On page 133 it is incorrectly stated that the German Enzian missile was steered by means of controlling the thrust line of the motor. In actual fact all models of this weapon employed aerodynamic control provided by servo operated Elevons fitted to the wings.

A short chapter entitled "Long Range Rockets" follows the control section and in the main comprises an essay on the military use of rocket weapons. Questions of world politics and strategy are raised here.

In the chapter dealing with the inter-planetary flight the author gives a balanced treatment of the factors involved with emphasis upon the mass ratios required for various journeys employing practical fuels. Tabulated results and a discussion of these clearly show that such journeys based on present day techniques represent a problem of the first magnitude.

The final chapter of the book deals in a rational manner with the dream of all inter-planetary enthusiasts, that is to say, the possible use of atomic energy as a means of propulsion. Making guesses as to likely efficiencies and jet velocities it is shown that a substantial reduction of mass ratios would seem to be possible. There having been so much rubbish published elsewhere regarding this particular application of atomic energy it is refreshing to read in this book a more cautious and enlightened idea of what may or may not be possible.

The book closes with four appendices: Three are of a mathematical nature and

BOOK REVIEWS

one traces the history of the Rocket Society Movement in this country. The second appendix concerning expansion nozzles should be of direct use to practising engineers.

The book is well printed on good quality paper and there are many excellent photographs and illustrations. It is considered that the author has come very near fulfilling his aim although the discerning reader may sense a lack of completeness and continuity in places. Generally, the author has done a service to rocketry, and it is fair to say that the book is good value for the price charged.

A. E. MAINE.

Advanced Antenna Theory

By S. A. Schelkunoff. 216 pp., 64 figs. Medium 8vo. John Wiley & Sons, Inc., New York, and Chapman & Hall Ltd., London. 1952. Price 52s.

"ANTENNAS: Theory and Practice" reviewed previously presents the results of aerial theory from an engineering standpoint. In "Advanced Antenna Theory" the emphasis is rather upon the development of the theory itself and the mathematical techniques required. Much remains to be done before the theory can be said to be complete and an authoritative account of its present state by one of its leading exponents is very welcome.

The first chapter provides a background to the main text by summarizing the solutions of Maxwell's equations which lead to spherical waves and to the modes of propagation for a biconical transmission line. A valuable section stresses the intimate relation between Maxwell's field equations and Kirchoff's circuit equations and indicates the connexion between small aeriels and circuit elements.

The second chapter, occupying nearly half of the book, is devoted to the "mode theory of antennas" developed by the author over a number of years. The aerial is regarded as a multi-mode transmission line and the modes of propagation are determined using the methods of the first chapter. The amplitudes of these modes are then calculated to give the required impressed field, which is itself found from the known properties of the generator and feeder to which the aerial is connected. This method of solution is most easily applied to a biconical aerial, and besides illustrating clearly the mechanism of operation has the advantages that the functions required in the solution arise from either spherical waves or the modes of the biconical transmission line and are of a form suitable for numerical evaluation. Secondly it is found that only the principal or TEM mode need be considered in finding the radiation properties of the aerial: the other modes have, however, a considerable effect upon the input impedance. Finally it is possible to obtain results for many aeriels of practical importance by perturbing the surface of the biconical aerial.

Many early attempts to determine the properties of an aerial began with a study of the resonances of a conducting spheroid and this approach is dealt with in the third chapter. The analysis is relatively straightforward but difficulties are encountered in obtaining numerical results because of the complicated nature of the functions involved. A third method of solution is discussed in the

two following chapters. All the aerial properties may be calculated directly from the current distribution in the surface. It is possible to obtain an integral equation for this distribution and it was from such an equation that Pocklington was led to the well-known approximation that the current in a thin aerial is distributed sinusoidally. In general it is not possible to solve the integral equation exactly and the usual method, due to Hallén, is based on an iterative procedure. Several workers have used this method and the differences between their results are discussed in some detail. More recently variational methods of solution have been tried and these are also outlined.

In the final chapter the resonances of thin conductors are studied and numerical results are given. The book concludes with examples for which answers are provided and a number of appendices mostly in the form of numerical tables.

The most important feature of this book is that it provides for the first time a clear account of the author's own work on the mode theory. This should certainly be studied by any mathematically-minded aerial engineer. The remainder gives a very readable account of the other methods of solution and is a useful introduction to, and commentary on, the appropriate published papers, the more important of which are listed in the references.

J. BROWN

F.B.I. Register of British Manufacturers 1952-53

922 pp. 25th edition. Royal 8vo. Iliffe & Sons, Ltd. Price 42s.

THIS directory is recognized as a standard export reference book to British industry and is compiled by the publishers in close collaboration with the Federation of British Industries. The 1952/53 Register comprises seven sections, including a classified Buyers' Guide listing over 6,000 F.B.I. member firms under more than 5,000 alphabetical trade headings. The introductory information and instructions on the use of the Register are translated into French and Spanish, and all sections have guide cards for easy reference.

The Register provides a substantial cross-section of the most important producers of British goods over a very wide range of industry and is considered of the utmost value in promoting Britain's export trade.

"Wireless World" Diary 1953

80 pp. reference material, plus the usual diary pages of a week to an opening. Iliffe and Sons Ltd. October 1952. Price 6s. 1½d. (Morocco leather) or 4s. 7d. (rexine).

THIS well-known diary, now in its 35th year of publication, again presents 80 pages of information useful to those in the radio industry. The reference section includes details of standard frequency transmissions and lists radio organizations in the United Kingdom and abroad, while the technical data section contains useful formulae such as those for frequency-wavelength conversion and the extension of the range of meters.

CHAPMAN & HALL

Just Out

THE CATHODE RAY OSCILLOGRAPH IN INDUSTRY

by

W. Wilson

D.S.C., M.I.E.E., F.INST.P., etc.

(Manager, G.E.C. Development Laboratory, Wotton)

Fourth Edition, Revised

288 pages 201 figures 36s. net

ESSENTIALS OF MICROWAVES

by

R. B. Muchmore

(Member of the Technical Staff, Research & Development Laboratories, Hughes Aircraft Company, U.S.A.)

236 pages 202 figures 36s. net

A first-class introductory text.

37 ESSEX STREET, LONDON, W.C.2

Recent

'Electronic Engineering' Monographs

VOLTAGE STABILIZERS

By F. A. Benson, M.Eng., A.M.I.E.E. M.I.R.E., University of Sheffield.

Price 12/6

ELECTROPHYSIOLOGICAL TECHNIQUE

By C. J. Dickinson, B.A., B.Sc., Magdalen College, Oxford.

Price 12/6

RESISTANCE STRAIN GAUGES

By J. Yarnell, B.Sc., A.Inst.P.

Price 12/6

CATHODE RAY TUBE TRACES

By H. Moss, Ph.D.

Price 10/6

Order your copy from your bookseller or direct from

Electronic Engineering

28 ESSEX STREET, STRAND
LONDON, W.C.2

ELECTRONIC EQUIPMENT

A description, compiled from information supplied by the manufacturers, of new components, accessories and test instruments.

Phase Meter (Illustrated below)

THE K159 phase meter is a simple, self-contained instrument which gives a direct reading of the phase difference between two sinusoidal signals with sufficient accuracy for most normal laboratory purposes. Besides being more accurate than the conventional method of observing Lissajou figures with the aid of a cathode-ray oscilloscope, it avoids the use of relatively elaborate and expensive equipment.

By connecting the two inputs to terminals on the instrument and carrying out a very simple procedure, the phase difference may be read on the scale of a meter calibrated from 0 to 90 degrees. Phase angles from 90 degrees

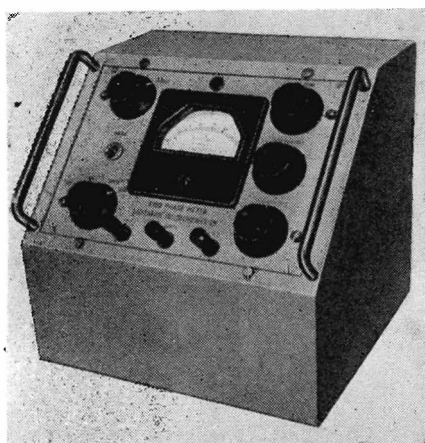

to 180 degrees may be measured by inverting one of the inputs and subtracting the reading from 180 degrees. The instrument does not discriminate between angles of lead and lag, but this may be readily determined, in cases where there is any ambiguity, by introducing a small phase shift of known sense into one of the input circuits.

The instrument employs a variation of the three voltmeter method, whereby each of the inputs is first adjusted to a standard amplitude and the difference between them measured by means of a differential valve voltmeter. It is clear that when the two signals are exactly in phase, the measured difference will be zero, whereas when they are in opposite phase, the difference will be twice the amplitude of either signal. For intermediate phase angles the output voltage is given by:—

$$V_o = 2V_s \sin \theta/2$$

As the scale is very cramped between 90 degrees and 180 degrees the meter is calibrated from 0 to 90 degrees only, measurements between 90 degrees and 180 degrees being taken by inverting one of the inputs as described above.

The accuracy of the instrument is $\pm 3^\circ$ from 20c/s to 20kc/s and $\pm 8^\circ$ from 5c/s to 100kc/s. The input impedance is $2M\Omega$ and it will handle input amplitudes

between 1.5 and 10V; the input waveform must, however, contain less than 3 per cent harmonics.

Southern Instruments, Ltd.,
Hawley, Surrey.

New Mullard Valves

THE EF95 is an r.f. pentode with an exceptionally low noise factor (3.5 at 100Mc/s), it is suitable for use at frequencies up to 200Mc/s. It is constructed on the B7G base and has characteristics similar to those of the American 6AK5. It has a slope of 5.1mA/V and the optimum performance can be obtained with an h.t. supply of 180V. The heater consumption is 175mA at 6.3V.

The 150B2 is a B7G type high performance stabilizer working at 150V. It is intended for use as a simple stabilizer over the current range of 5 to 15mA. The sputtered metal technique, as used in the 85A1 and 85A2, is employed to ensure freedom from trouble caused by the liberation of contaminating gases from the walls of the tube.

A fluorescent anode type tuning indicator for use with all dry battery receivers has recently been introduced. This is the DM70 which is of sub-miniature construction and has a viewing area of $\frac{3}{4}$ in. by $\frac{1}{4}$ in. The optimum control curve is obtained with an anode supply of 60V, a grid potential of -9.5V being necessary for extinction. The filament consumption is 25mA at 1.4V.

Mullard, Ltd.,
Century House,
Shaftesbury Ave., London, W.C.2.

Video Amplifier (Illustrated below)

THE new Solartron video amplifier Model AWS.52 has been designed for use as an oscilloscope deflexion amplifier for the measurement and viewing of pulses of extremely short duration and fast rise time as well as a general purpose deflexion amplifier, where high gain, stability and accuracy are required. The amplifier has a bandwidth from

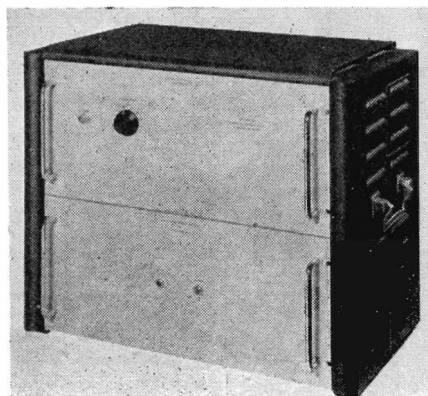

50c/s to 20 Mc/s and a level response with a maximum loss of 1½db. The natural time of rise when used with a pulse input is less than 0.02 microseconds, so that fast pulse waveforms encountered in radar, television and certain types of communication equipment can be passed without fear of distortion of the waveshape.

The amplifier is of the Class A type with a gain of 50db and the output stage, a v.h.f. type twin beam tetrode, produces 150 volts peak-to-peak push-pull so that direct connexion can be made to the Y deflexion plates of an oscilloscope.

A 50db attenuator which can be adjusted in steps of 10db, each step being frequency compensated, is incorporated in the instrument.

A separate regulated h.t. supply unit providing 225 volts at 300 milliamps is mounted beneath the amplifier which is housed in a two-tier steel case.

Solartron Laboratory Instruments Ltd.,
22 High Street,
Kingston-on-Thames, Surrey.

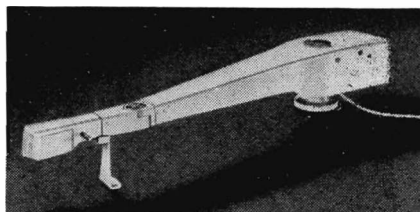

Transcription Pick-up (Illustrated above)

THE E.M.I. type 17 pick-up is designed mainly for professional and studio use and will accommodate disks up to 17in. diameter. Interchangeable plug-in heads fitted with cantilever mounted sapphire styli of either 0.0025in. or 0.0015in. are available. The frequency response is sensibly level from 30-12 000c/s on standard records and from 30-10 000c/s on microgroove records. The sensitivity is -60db/cm/sec R.M.S. transverse velocity (0db=1mW), and the impedance, measured at 1 000c/s is 1Ω , while the total harmonic distortion, measured at 400c/s, is less than 5 per cent for a recording level of +20db referred to 1cm/sec R.M.S. transverse velocity.

A unique feature is the single pivot arm suspension which offers negligible resistance to normal horizontal and vertical movement. An oil damping system is incorporated to provide a retarding effect against violent movement.

Two types of transformer are available for use with the pick-up. Type 34 680 CQ for matching into a high impedance circuit and type 46 775E for matching into 200 or 600 Ω balanced or unbalanced lines. The outputs from the transformers are approximately 30mV, 4mV, and 2.5mV respectively.

E.M.I. Sales and Service, Ltd.,
Hayes, Middx.

Stabilized E.H.T. Unit
(Illustrated below)

THE E.H.T. supply unit type 532 is designed for the operation of Geiger-Müller tubes, ionization chambers and proportional and scintillation counters.

The output voltage is continuously variable, in three overlapping ranges, between the limits of 300 and 3000V

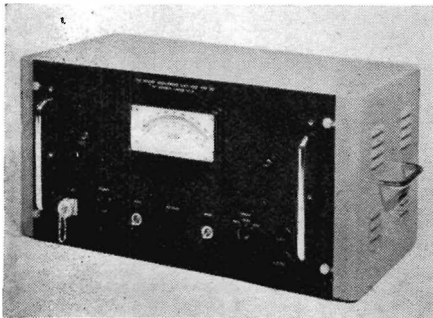

at a current of 3mA. Either the positive or negative pole can be earthed by means of a change-over switch.

A 10 per cent change in mains input voltage produces a change in output voltage of less than 0.05 per cent, while the output ripple is less than 0.03V R.M.S. The output impedance is less than 500Ω. The unit has a short term drift of less than 0.1 per cent in ten hours and a long term drift of less than 0.2 per cent in 100 hours.

Isotope Developments, Ltd.,
120 Morgate, London, E.C.2.

Plessey "E" Series I.F. Transformer
(Illustrated below)

THE new E/19 I.F. transformer is an all purpose unit of inexpensive construction, combining small physical dimensions and a performance approaching that of the 'C' type transformer.

The 'E' type transformer has a Q factor of 85 and an overall bandwidth for two stages of 7.7Kc/s at 6db, and 15.4kc/s at 20db. The standard coils are tuned by 100pF capacitors, and both stages are identical. Other values of tuning capacitance, coupling, etc., can be supplied to meet special bandwidth requirements. An improved

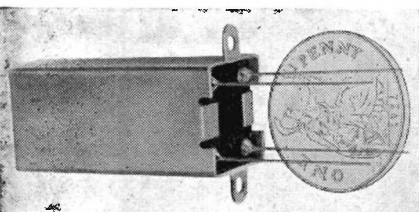

method of core positioning, which utilizes a new high viscosity, chemically stable, packing compound between core threads and bobbin, allows the core to be adjusted over a wider temperature range than hitherto.

The Plessey Co. Ltd.,
Ilford, Essex.

Cored Silver Solder

WITH the co-operation of Johnson Matthey of Hatton Garden, Ersin Multicore Solder is now available in

Comsol alloy. This tin/lead/silver solder has a melting point of nearly 300°C which is 113°C above the melting of the usual tin/lead alloys.

Ersin Multicore Comsol solder is normally supplied in 16 s.w.g. and is intended for soldering processes where components are likely to be subjected to excessive working temperatures. It is believed that Comsol may also be suitable for use on radio and electrical equipment being subjected to sub-zero temperatures, although research into this is at present still proceeding.

Multicore Solders, Ltd.,
Maylands Avenue,
Hemel Hempstead, Herts.

Sub-Miniature Potentiometer
(Illustrated below)

THIS sub-miniature potentiometer, in which an on-off switch is incorpor-

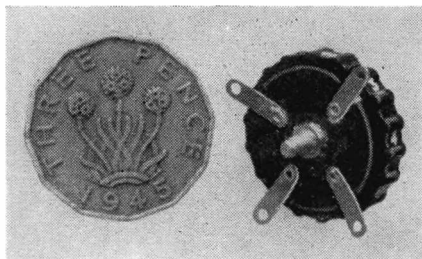

ated, has an overall diameter of 7/8 in. and is 1/4 in. thick. It is available in a range from 3 to 6MΩ with a logarithmic track or a value of 1MΩ with a linear track. The electrical noise level is -60db relative to 1V and it will handle a continuous signal of 100mW with a maximum D.C. of 10μA. The switch is rated at 100mA at 50V.

John Bell and Croyden,
117 High Street, Oxford.

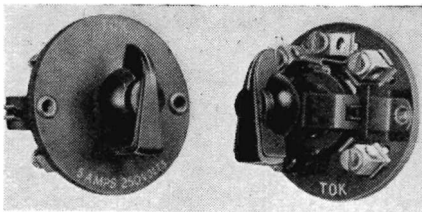

Rotary Switches
(Illustrated above)

THE Tok series K10 rotary switches are designed to handle 5A at 250V and, although primarily intended for a.c. they can be used to a limited extent in d.c. circuits at a reduced rating.

The switch is built up on a laminated plastic foundation, the contacts are of phosphor bronze and indexing is by means of an arrangement of two flat springs, each of which is anchored at one end and is free to move at the other. The switch blades are of brass and the blade insulation is laminated plastic.

Over fifty different switching sequences are available in types for either flush or box mounting.

Tok Electrical and Industrial
Mechanisms, Ltd.,
2 Wadsworth Road,
Perivale, Middx.

Valve Getter Firing
(Illustrated below)

THE Radyne 1kW R.F. heater illustrated is designed specially for valve getter firing and is constructed to fit below the normal vacuum bench, being only 13in. wide, 40in. high and 27in. deep. The unit is provided with a high impedance output transformer so that leads can be run up to twelve feet from the generator. In the unit illustrated the cover has been removed from the output transformer in order to show the way in which the leads leave the front of the unit and go underneath it so as to appear above at the rear of the vacuum bench. The output power is controlled by a Variac.

Another 1kW R.F. heater, made by the same firm and also designed for valve getter firing, is fitted with two 10ft. flexible leads at the ends of which are twin hand applicators. Either applicator can be energized independently by a press-button mounted on the applicators.

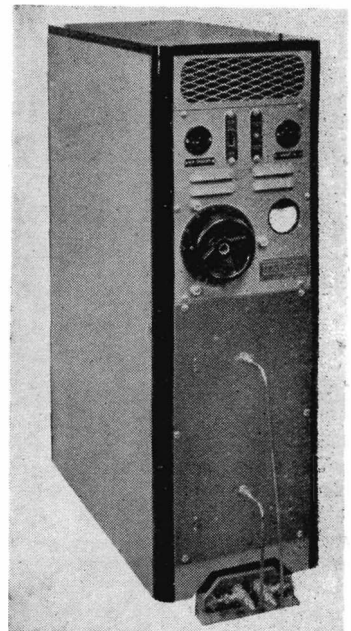

Mounted on the front of the unit, is a R.F. contactor complete with all the necessary interlocks to ensure that only one applicator can be energized at a time.

This equipment is mounted on castors to facilitate movement round a laboratory.

Radio Heaters, Ltd.,
Eastheath Avenue,
Wokingham, Berks.

Anti-Vibration Mountings

HARRISFLEX anti-vibration instrument mountings have been specially designed for the mounting of scientific instruments and light machinery. The mountings consist basically of rubber chemically bonded to metal, the rubber acting as the anti-vibration medium. The range of stud and unit type mountings can be stressed in every combination of torsion, shear, compression and tension and can be loaded in any plane.

Howard Clayton-Wright Ltd.,
Wellesbourne,
Warwickshire.

Meetings this Month

THE BRITISH INSTITUTION OF RADIO ENGINEERS

Date: February 11. Time: 6.30 p.m.
Held at: London School of Hygiene and Tropical Medicine, Keppel Street, London, W.C.1.
Lecture: Modern Trends in Communications Materias.
By: L. A. Thomas, B.Sc.

Scottish Section

Date: February 5. Time: 7 p.m.
Held at: Department of Natural Philosophy, the University, Edinburgh.
Lecture: The Principle of Electronic Computing Machines.
By: B. V. Bowden, Ph.D.

North-Eastern Section

Date: February 11. Time: 6 p.m.
Held at: The Institute of Mining and Mechanical Engineers, Neville Hall, Westgate Road, Newcastle-upon-Tyne.
Lecture: Design Considerations of a Commercial F.M. Receiver.
By: F. H. Beaumont.

West Midland Section

Date: February 24. Time: 7.15 p.m.
Held at: Wolverhampton and Staffordshire Technical College, Wulfruna Street, Wolverhampton.
Lecture: The Development of the Radio and Electronics Industry in India.
By: G. D. Clifford.

Merseyside Section

Date: February 5. Time: 7 p.m.
Held at: North Wales Electricity Board Service Centre, Whitechapel, Liverpool.
Lecture: A Port Radio-Telephone System.
By: D. G. Holloway.

BRITISH KINEMATOGRAPH SOCIETY

Date: February 4. Time: 7.15 p.m.
Held at: G.B. Theatre, Film House, Wardour Street, London, W.1.
Lecture: Production Techniques in the Making of Educational Films.
By: Frank A. Hoare, M.B.K.S.

BRITISH SOUND RECORDING ASSOCIATION

Date: February 20. Time: 7 p.m.
Held at: The Royal Society of Arts, John Adam Street, Adelphi, London, W.C.2.
Lecture: The Human Ear and Audiometry.
By: T. S. Litterer, M.Sc., Ph.D.

Manchester Centre

Date: February 23. Time: 7.30 p.m.
Held at: The Engineers' Club, Albert Square, Manchester.
Lecture: Loudspeakers.
By: H. Collings-Wells.

Portsmouth Centre

Date: February 12. Time: 7.15 p.m.
Held at: The Central Library, Guildhall, Portsmouth.
Lecture: Reproduction in the Home.
By: P. J. Walker.

THE ELECTRO-PHYSIOLOGICAL TECHNOLOGISTS' ASSOCIATION

Date: February 7. Time: 10.30 a.m.
Held at: Institute of Psychiatry, Maudsley Hospital, Denmark Hill, London, S.E.5.
General Meeting.

THE INSTITUTION OF ELECTRICAL ENGINEERS

All London meetings, unless otherwise stated, will be held at the Institution, commencing at 5.30 p.m.

Joint Meeting

Date: February 10.
Held at: The Institution of Mechanical Engineers, Storey's Gate, St. James's Park, London, S.W.1.
Lecture: Ignition Interference with Television Reception.
By: A. H. Ball and W. Nethercott.

Radio Section

Date: February 11.
Lecture: A Method of Designing Transistor Trigger Circuits.
By: Professor F. C. Williams, O.B.E., D.Sc., D.Phil., F.R.S., and G. B. B. Chaplin, M.Sc.

Measurements Section

Date: February 17.
Lecture: The Measurement of Blade-Tip Clearances in Aircraft Turbines by a Capacitance Method.
By: I. A. Mossop, B.Sc.Tech., and F. D. Gill, B.Sc.(Eng.).
And: Photographic Exposure Timers Providing Compensation for Supply Voltage Variations (Proceedings I.E.E., Part II, October, 1952).
By: R. J. Hercock, B.Sc., and D. M. Neale, B.Sc.

Faraday Lecture

Date: February 18. Time: 6.30 p.m.
Held at: Central Hall, Westminster, S.W.1.
Lecture: Light from the Dark Ages, or the Evolution of Electricity Supply.
By: A. R. Cooper.
(Admission by ticket obtainable from the Institution.)

North Staffordshire Sub-Centre

Date: February 2. Time: 7 p.m.
Held at: The Crown Hotel, Stone.
Lecture: The Determination of Time and Frequency.
By: Humphry M. Smith, B.Sc.

Rugby Sub-Centre

Date: February 4. Time: 6.30 p.m.
Held at: The Rugby College of Technology and Arts.
Lecture: Electricity in Newspaper Printing.
By: A. T. Robertson.
Date: February 17. (Time and place as above.)
Lecture: The Electrolytic Analogue in the Design of High-Voltage Power Transformers.
By: D. McDonald.

Southern Centre

Date: February 4. Time: 6.30 p.m.
Held at: The Municipal College Extension, Portsmouth.
Lecture: Principles of Colour Television.
By: J. H. Mole, Ph.D., and J. W. R. Griffiths, B.Sc.
Date: February 16. Time: 6.30 p.m.
Held at: The Guildhall, Southampton.
Faraday Lecture: Light from the Dark Ages, or the Evolution of Electricity Supply.
By: A. R. Cooper.

THE INSTITUTION OF POST OFFICE ELECTRICAL ENGINEERS

Date: February 16. Time: 5 p.m.
Held at: The Institution of Electrical Engineers, Savoy Place, Victoria Embankment, W.C.2.
Lecture: An Approach to the Economics of P.O. Engineering Training.
By: F. C. Meade, B.Sc.(Eng.), A.R.C.S., A.M.I.E.E.

Informal Meeting

Date: February 4. Time: 5 p.m.
Held at: The Conference Room, 4th Floor, Waterloo Bridge House, London, S.E.1.
Lecture: Methods of Investigation in the Telephone Branch Circuit Laboratory.
By: M. Mitchell, M.B.E., B.Sc.(Eng.), A.M.I.E.E.

THE INSTITUTE OF NAVIGATION

Date: February 20. Time: 5 p.m.
Held at: The Royal Geographical Society, 1 Kensington Gore, London, S.W.7.
Lecture: The Operation of Jet Aircraft.
By: Captain R. C. Alabaster, D.S.O., D.F.C.

RADIO SOCIETY OF GREAT BRITAIN

Date: February 27. Time: 6.30 p.m.
Held at: The Institution of Electrical Engineers, Savoy Place, W.C.2.
Lecture: Oscilloscopes.
By: F. Hicks Arnold.

THE TELEVISION SOCIETY

Date: February 12. Time: 7 p.m.
Held at: The Cinematograph Exhibitors' Association, 164 Shaftesbury Avenue, London, W.C.2.
Lecture: The Importance of the D.C. Component.
By: D. C. Birkinshaw, M.B.E.
Date: February 27. (Time and place as above.)
Lecture: The Scanning Electron Microscope.
By: D. McMullan, M.A.

THE WOMEN'S ENGINEERING SOCIETY

Date: February 17. Time: 7 p.m.
Held at: 35 Grosvenor Place, S.W.1.
Lecture: Heavy Water in Nuclear Physics.
By: A speaker from A.E.R.E., Harwell.

PUBLICATIONS RECEIVED

EDUCATION DURING NATIONAL SERVICE is a guide to the facilities available for national servicemen to advance their technical or professional training. There are sixty correspondence courses covering City and Guilds Examination subjects, and over 600 other correspondence courses on a wide range of subjects. The booklet is published by Her Majesty's Stationery Office, Kingsway, London, W.C.2, price 3d.

CODES, DIMENSIONS AND WEIGHTS OF RECTIFIER STACKS is a bulletin giving the dimensions and weights of SenTerCel spindle mounted rectifier stacks. It deals primarily with standard stacks and contains a complete explanation of the coding system which is used to describe them. There are forty pages devoted to dimensions and weights of the stacks, and an index of drawings and tables for this section is included. Standard Telephones and Cables Ltd., Rectifier Division, Warwick Road, Boreham Wood, Herts.

BIRLEC PUBLICATIONS NO. 82, 83 AND 84 are three leaflets describing equipment for humidity control. Leaflet No. 82, "Birlec Electro-dryer Moisture Absorbers", deals with standardized equipment for removing moisture and moisture vapour from compressed air and other gases. A different design of Birlec Electrodryer is described in leaflet No. 83; these units are principally used for maintaining low humidities in process, storage and other rooms in industries such as food processing, pharmaceutical manufacturing and electrical engineering. Ancillary to the Electrodryer is the Electrofilter, described in leaflet No. 84, which is of assistance when drying compressed air, as oil in droplet or vapour form is often carried over from the compressor to the supply line. Birlec Ltd., Tyburn Road, Erdington, Birmingham 24.

THE IDENTIFICATION OF THREADING DIES has now reached a third edition. It includes, and illustrates, thread rolling dies which have been added to the range of Wharco products, and identifies some 300 chaser dies, with over 100 illustrations. Details of sixty different series of the principal screw thread systems of the world are also given. W. H. A. Robertson and Co. L'd., Small Park Division, Lynton Works, Bedford.

EDISWAN METAL-GLASS SEALS is a brochure describing the Ediswan multiple metal-to-glass seals which provide any number of terminals in a single mounting which may be soldered into a can in one operation without loosening the individual terminals. The booklet is obtainable from the Technical Publications Department, Edison Swan Electric Co. Ltd., 155 Charing Cross Road, London, W.C.2.

MOLECULAR MICROWAVE SPECTRA TABLES by Paul Kisliuk and C. H. Townes gives the frequencies, assignment of quantum numbers, and intensities of about 1800 microwave absorption lines. It also includes the values of other pertinent molecular data, such as rotational constants, dipole moments, quadrupole coupling constants, and rotation-vibration interaction constants. Only molecular lines of frequency greater than 1000 megacycles are listed. References are given for all data in the tables, and a tabulation of Casimir's function is included. Indices give an alphabetical list of authors and of molecules by name and chemical symbol. The book is National Bureau of Standards Circular 518, and can be ordered from the Government Printing Office, Washington 25, D.C., U.S.A., price 65 cents, excluding postage.

TECHNICAL BOOK LIST is a list of technical books, collated under thirty-nine subject classifications, which are now available or will be published shortly. The information has been supplied by publishing houses, and is arranged alphabetically. It should prove of interest to those compiling a library on a special subject, or wishing to expand one already in existence. Single copies can be obtained from The Publishers' Circular Ltd., 171 High Street, Beckenham, Kent, price 2s. 6d.

ARCOLECTRIC SWITCHES SUPPLEMENT TO CATALOGUE NO. 126 contains details of new products: a door switch, a push-pull switch and several signal lampholders. Each component is described and illustrated by diagrams and a photograph. Arcoelectric Switches Ltd., Central Avenue, West Molesey, Surrey.

Electrodeposited Rhodium

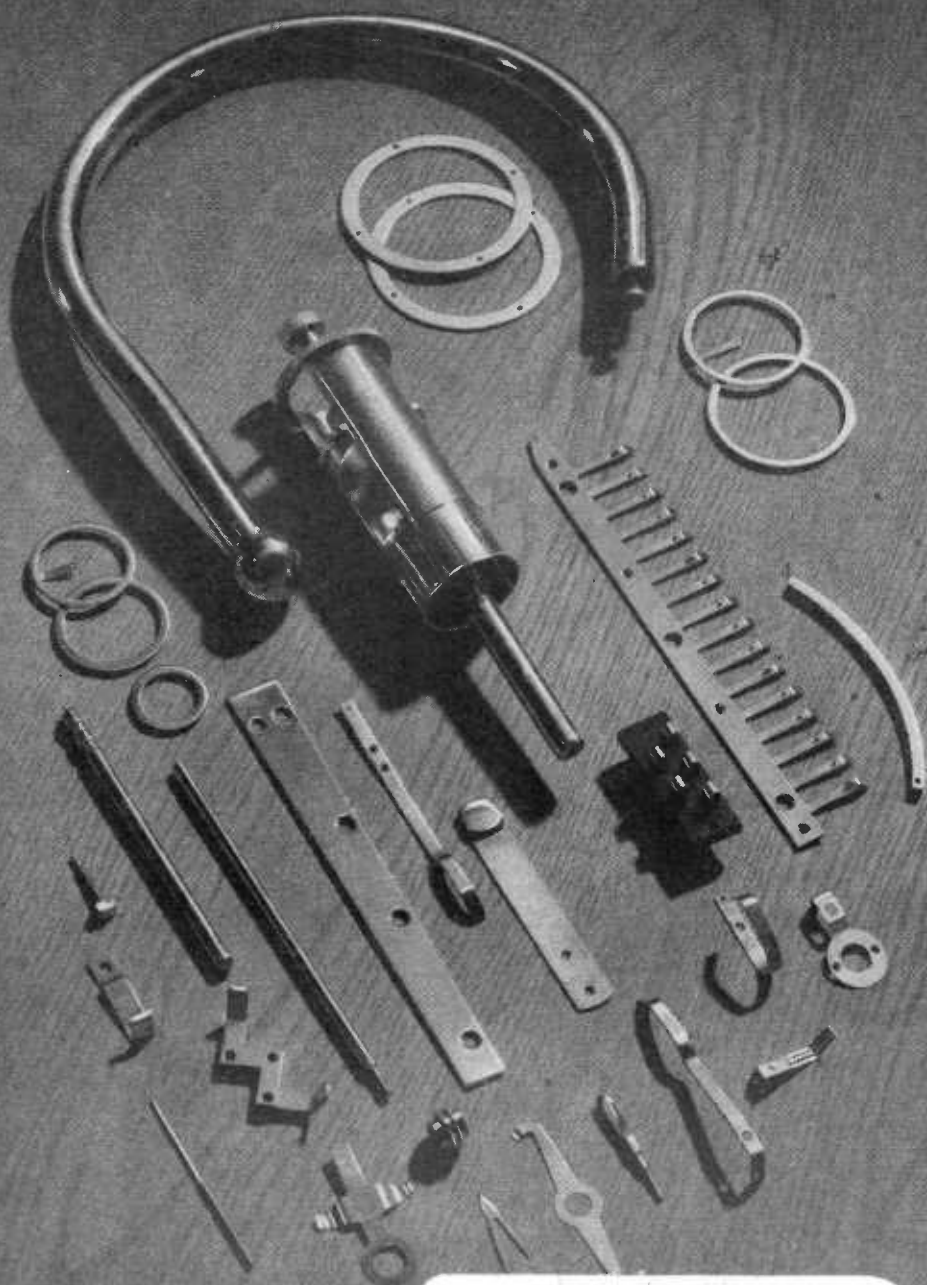

- Technical advice
- Comprehensive facilities —

One of the Specialised Services of

**Johnson
Matthey** 

JOHNSON, MATTHEY & CO., LIMITED, HATTON GARDEN, LONDON, E.C.1. Telephone: HOLborn 9277
Vittoria Street, Birmingham, 1. Telephone : Central 8004. 75-79 Eyre Street, Sheffield, 1. Telephone : 2921Z

PRODUCTIVITY PROFUNDITIES:

One of the
greatest
contributions to
productivity is
Reliability

If you're looking for high productivity you can't afford to take chances on reliability, and only fine quality will give you the reliability you need for consistently high performance. These attributes are synonymous with **SALTER**.

You can rely on

SALTER

SPRINGS



GEO. SALTER & CO. LTD., WEST BROMWICH

M-W.342

Precision Cathode Ray Tubes

Close Tolerance

Single Beam Tubes

(Types S.6 and S.4)

These Tubes have been designed for applications where accurate measurements are required. They have high plate sensitivities with excellent deflection linearity and negligible defocusing over a large useful area of screen. Due to the accurate alignment, trapezium distortion and orthogonality errors are very small. The flat face-plates are ground and polished both internally and externally. Tubes can be supplied with any phosphor.

20th Century Tubes

Type	S.6	S.4
Diameter	6 in.	4 in.
Overall length (mm.) ...	475	375
Sensitivity X	700	350
mm./V x VA ₃ Y	1100	700
Y Capacity	5 μf	5 μf
Heater Volts	6.3	6.3
VA ₃ Max. KV.	5	5
VA ₁ Max. KV.	2	2
VA ₂ (VA ₃ =2KV) volts ...	300	300
Phosphors { Blue	S6B	S4B
{ Green	S6G	S4G
{ Long Persistence	S6D	S4D

MANUFACTURERS
OF PRECISION
CATHODE RAY TUBES
AND
GEIGER COUNTER
TUBES

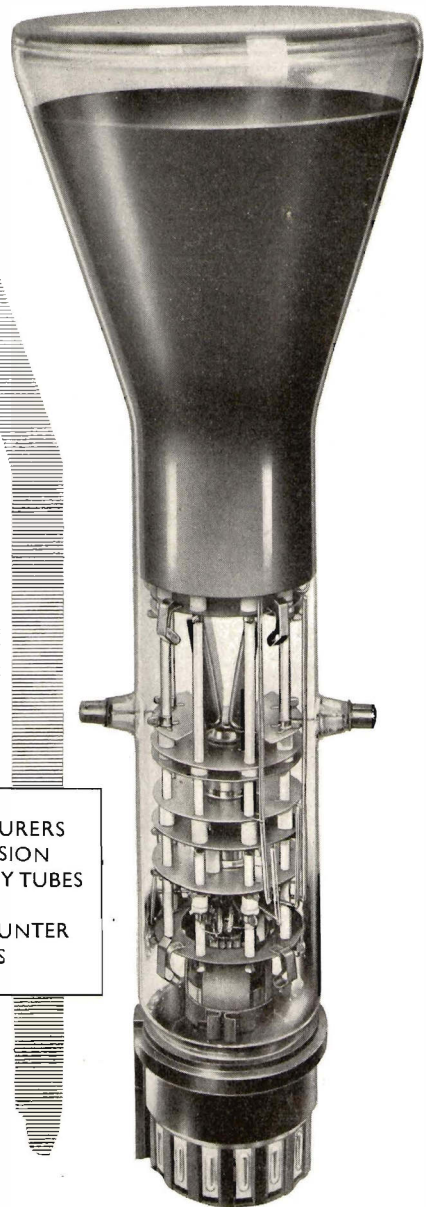

**20th Century
Electronics Limited**

20th CENTURY ELECTRONICS LTD.

DUNBAR WORKS, DUNBAR ST., LONDON, S.E.27

Telephone: GIPsy Hill 2277

FINE GAUGE—LONG LENGTHS

Nickel Chrome RESISTANCE WIRES

Although the spider may have pioneered the production of a fine gauge strand of continuous length we have added refinements of our own. Our speciality is Resistance Wire manufactured in long lengths to reduce your operational changes. Our normal range covers gauges down to 50 s.w.g. to customers' specifications, but even finer gauges, equally consistent in uniformity and accuracy, are available on application.



Cromaloy V

FOR CONSISTENCY

A. C. SCOTT & CO. LTD., CROMALOY HOUSE, CITY RD., MANCHESTER

dm AS 13

USE ITS HEAD

to make an easy job of things.

Short of a self-driving screw (which G.K.N. have yet to invent) nothing could be easier to use than Phillips Recess Head Screws.

The recess head fits and clings closely to the driver. The screw goes in straight and swiftly even in cramped or overhead positions and requires much less force.

Phillips heads are available in a wide range of screws including wood screws, metal threads and N.P.K. self-tappers.

PHILLIPS RECESS HEAD SCREWS

Quicker, Neater, Easier, Safer.

GKN

GUEST KEEN & NETTLEFOLDS (MIDLANDS) LIMITED
SCREW DIVISION BOX 24, HEATH ST. BIRMINGHAM 18

5/p/2105.

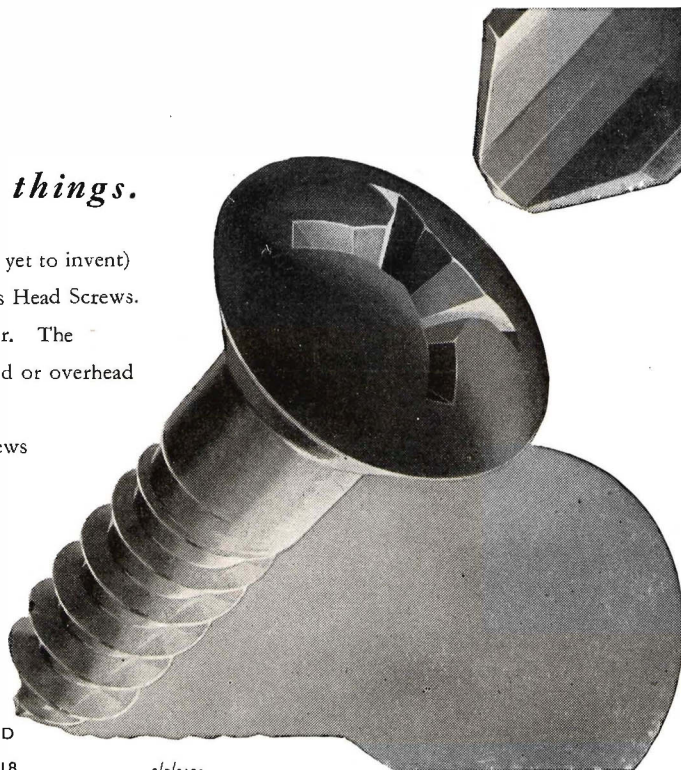

40 MARCONI RADIO BEACONS

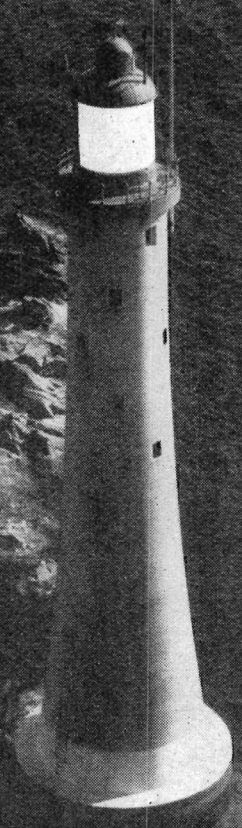

will ring the British Isles

From the Channel Islands to the Shetlands, from the Thames to the West Coast of Ireland . . . 40 lighthouses and lightships around the coasts of Great Britain and Ireland are to be equipped with Marconi Marine Beacons by the Lighthouse

Authorities. These M.F. Beacons will be fully duplicated with changeover switching, indicating and alarm facilities; in addition specially selected stations in the vicinity of the main ports will provide 'request' transmissions.

MARCONI marine beacons

MARCONI'S WIRELESS TELEGRAPH COMPANY LTD · CHELMSFORD · ESSEX



The B.B.C. make wide use of this valve

The Ediswan Mazda AC/SP3.RH is an indirectly heated Pentode with a special heater construction designed to reduce hum due to A.C. fields within the valve. Its high working slope makes it very suitable for use in audio frequency stages employing negative feed back.

The high-slope short grid-base characteristic renders it suitable also as an harmonic generator and as an oscillator in high stability crystal drive equipment. Provided precautions are taken to minimise hum due to external wiring the AC/SP3.RH may also be successfully employed in the early stages of amplifiers where the reduction of hum, noise and microphony is of primary importance. Many of these valves have been supplied to the British Broadcasting Corporation for use in their special recording, amplifying, and crystal controlled precision drive equipments, some of which are illustrated on this page.

B.B.C. Type D. Recorder Line Amplifier LFA/1 using two pentode connected AC/SP3.RH valves

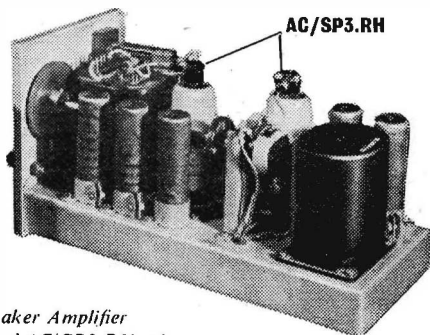

B.B.C. Type D. Recorder Loudspeaker Amplifier LSM/7 using three pentode connected AC/SP3.RH valves

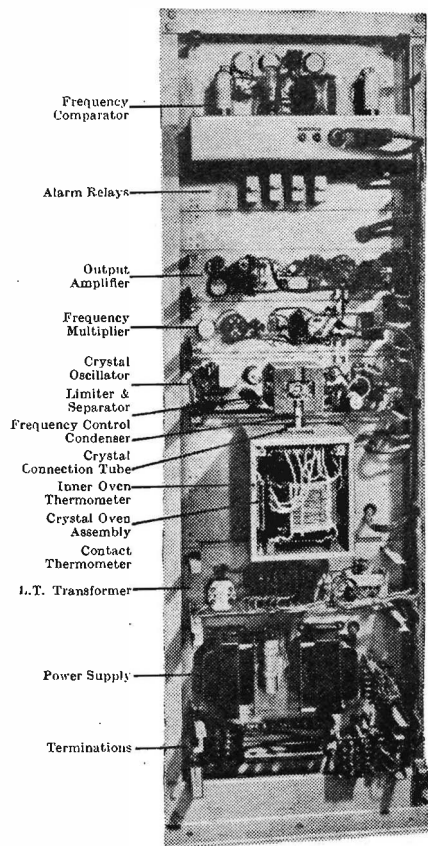
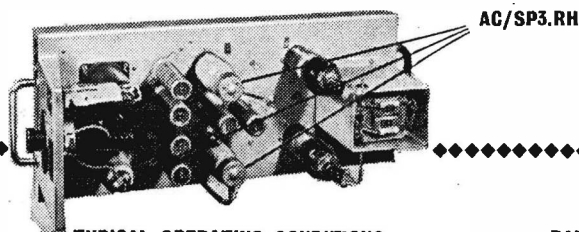

B.B.C. Crystal Drive Equipment (Type CP-17E) using nine AC/SP3.RH valves in the crystal maintaining amplifier, frequency divider, frequency multiplier and oven temperature relay.

TYPICAL OPERATING CONDITIONS

Anode Voltage (Va)	250	250	250	250
Screen Voltage (Vg2)	80	100	160	200
Grid Bias (Vg1)	1.25	1.7	2.75	3.5
Anode Current (mA)	7.8	7.9	10.5	12.3
Screen Current (mA)	2.45	2.5	3.3	3.85
Mutual Conductance (mA/V)	7.0	7.0	7.45	7.6
Anode AC Resistance (ra) (Meg ohms)	0.55	0.55	0.4	0.3
Input Capacity (Hot) (μ F)	20	19.9	19.7	19.5

RATING

Heater Voltage	V _h	4.0
Heater Current (Amps)	I _h	1.0
Maximum Anode Voltage	V _a	250
Maximum Screen Voltage	V _{g2}	250
Mutual Conductance (mA/V)	g _m	7.7

Taken at V_a=250; V_{g2}=100; V_{g1}=1.5

BASE

British 7 pin	Pin No. 5 Heater
Pin No. 1 Metallising	Pin No. 6 Cathode
Pin No. 2 Anode	Pin No. 7 Screen (G2)
Pin No. 3 Suppressor Grid (G3)	Top Cap Control Grid (G _h)
Pin No. 4 Heater	

EDISWAN

MAZDA

VALVES AND CATHODE RAY TUBES

THE EDISON SWAN ELECTRIC COMPANY, LTD., 155 CHARING CROSS ROAD, LONDON, W.C.2
Telephone — Gerrard 8660 Member of the A.E.I. Group of Companies Telegrams — Ediswan Westcent London RV97

THE LABORATORY MODEL 50 WATT AMPLIFIER

(Suitable for vibration analysis, ultrasonics, etc.)

The latest form of this amplifier has a power output exceeding 50 watts over all the frequency range 10 c.p.s., to 35,000 c.p.s., and reduced power above and below these frequencies.

The standard output is 3.75 and 15 ohms impedance with heavy tertiary feedback which can be changed to voice coil for the 15 ohm balanced output if required. Other impedances within reasonable limits can be supplied to order.

Special versions of this model can be supplied for frequencies up to and exceeding 120 KC's with slightly restricted low frequency end.

The standard finish is in a well ventilated steel case, or rack mounted to special order on 10½ in. panel.

Measurements 22 in. x 18½ in. x 16 in.

Weight 61½ lbs.

FOUR-WAY ELECTRONIC MIXER

This unit has 4 built-in balanced and screened microphone transformers, normally of 15-30 ohms impedance. It has 5 valves and selenium rectifier supplied by its own built-in screened power pack : consumption, 20 watts.

Suitable for recording and dubbing, or large P.A. installations since it will drive up to six of our 50 watt amplifiers, whose base dimensions it matches.

The standard model has an output impedance of 20,000 ohms or less, and any impedance can be supplied to order.

Manufactured by:

VORTEXION LIMITED

257-263 THE BROADWAY, WIMBLEDON, LONDON, S.W.19

Phones : LIBERTY 2814 & 6242-3

Grams : "VORTEXION, WIMBLE, LONDON."

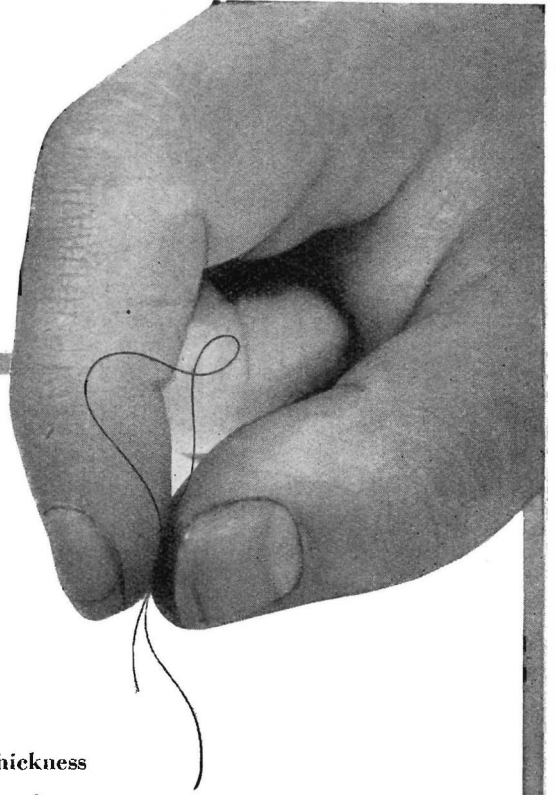

Quarter the thickness of a human hair

The average human hair is $\frac{4}{1000}$ of an inch in thickness (.004" diam. if you'd rather be technical) and our finest enamelled copper wire is only $\frac{1}{1000}$ when insulated with five separate coats of enamel; one pound of it would measure 316,000 feet, or some 60 miles. Amazingly fine in every way — it must be of course to bear the name Connolly. Let us know if you'd like further details of this or any of our other winding wires.

The largest manufacturers of fine enamelled wire in the world.



CONNOLLYS (BLACKLEY) LTD., MANCHESTER, 9

Telephone: CHEETHAM HILL 1801

Telegrams: "CONNOLLYS BLACKLEY"

LONDON OFFICE:

34, Norfolk Street.

STRAND W.C.2 TEMple Bar 5506

BIRMINGHAM OFFICE:

15-17 Spical Street,

BIRMINGHAM, 5 Midland 2268

Osram

VALVES

ARE RECOMMENDED FOR THE
"RADIO CONSTRUCTOR'S" LARGE SCREEN TELEVISOR

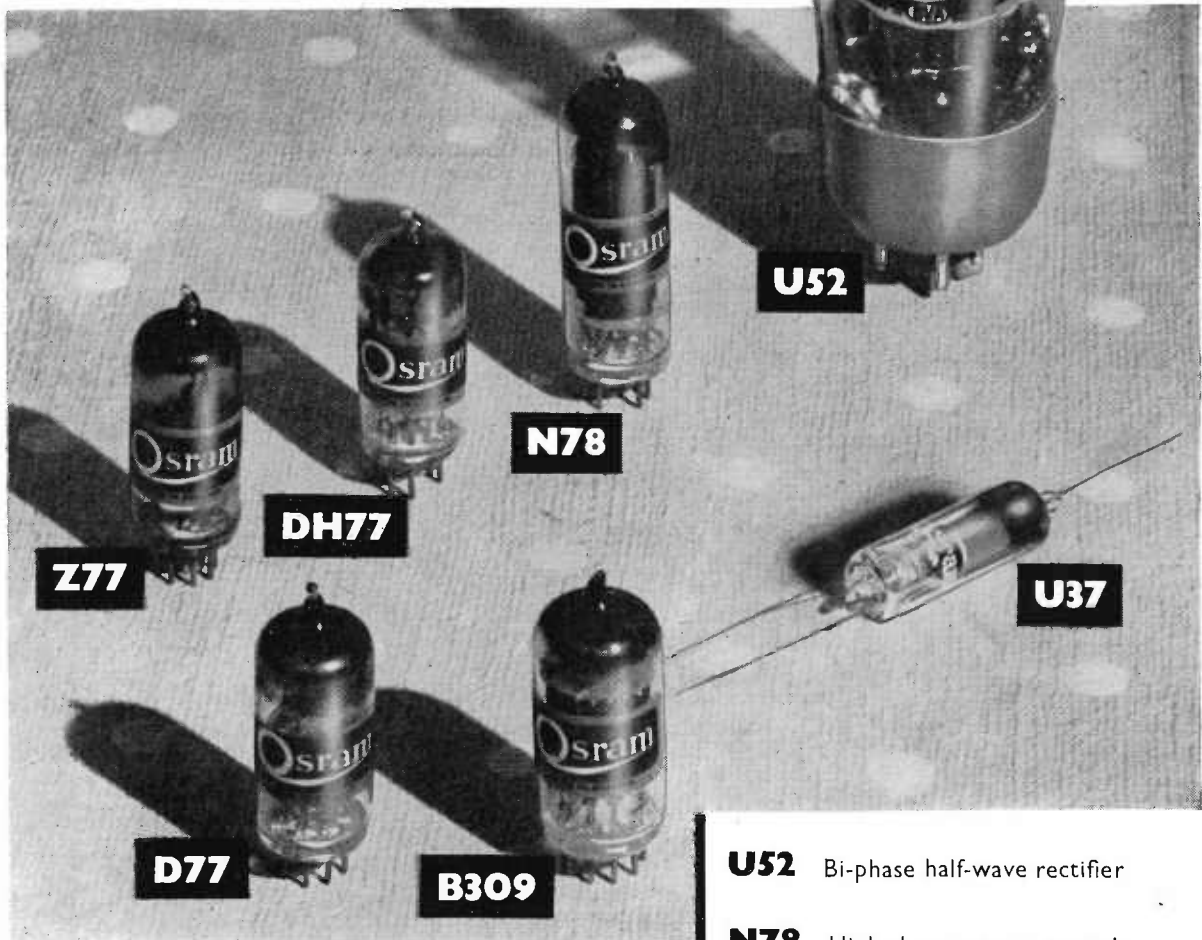

★ Only by using the valves specified can you be sure of the best results from your television.

★ The designers have found that the valves illustrated are the best for the job.

★ Use Osram valves for their proved consistency of performance.

Also specified:- G.E.C. 16" Aluminised cathode ray tube Type 6901A.

THE GENERAL ELECTRIC CO. LTD., MAGNET HOUSE, KINGSWAY, W.C.2

- U52** Bi-phase half-wave rectifier
- N78** High slope output pentode
- DH77** Double-diode triode
- Z77** High slope R.F. pentode
- D77** Low impedance double diode
- B309** Medium impedance double triode
- U37** Miniature E.H.T. rectifier

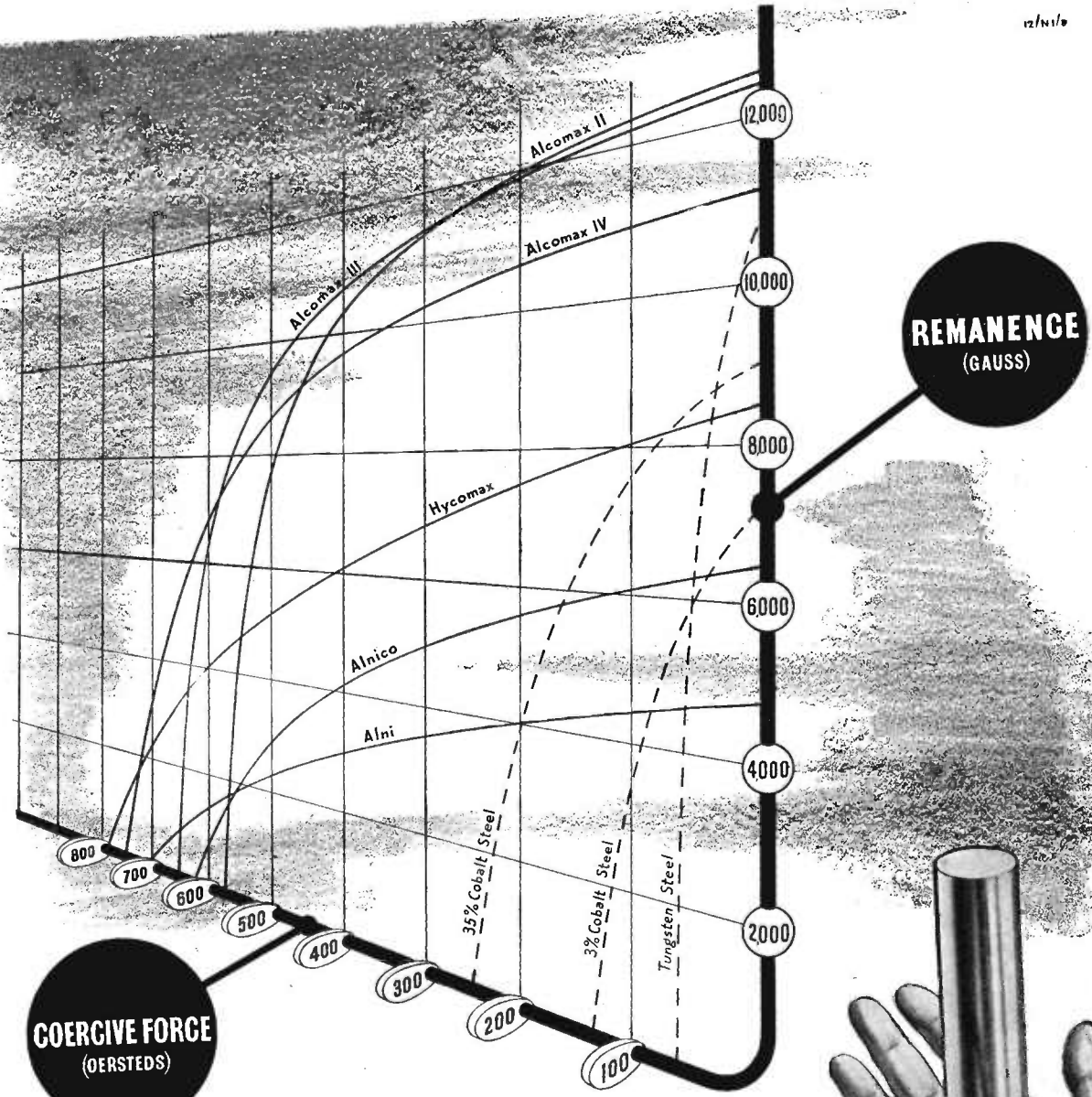

**Same energy —
1/20 the weight**

A range of permanent magnet alloys, in which the principal elements are nickel, aluminium and iron, has resulted from continuous development over a period of years. These alloys have a very high coercive force which, in combination with their low specific gravity, enables a magnet of the same energy to be made one-twentieth the weight of a tungsten steel magnet.

The diagram shown above is based on curves taken from our publication, "The Magnetic Properties of the Nickel-Iron Alloys" which will be sent free on request.

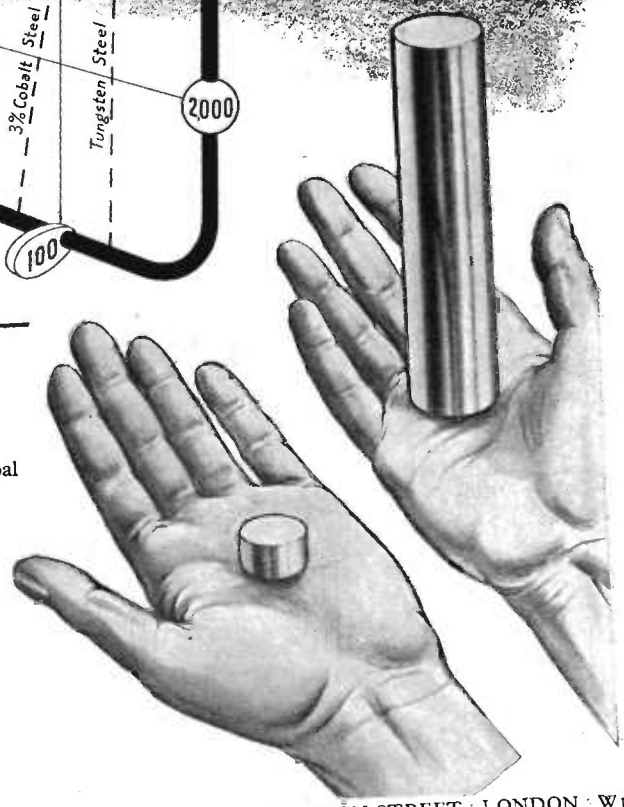

THE MOND NICKEL COMPANY LIMITED · SUNDERLAND HOUSE · CURZON STREET · LONDON · W1



High permeability magnetic alloys

by *Standard*

have steadily been improved and extended in range over many years and are produced by a Company which has the unique advantage of being large scale users of these materials.

As a result of this, much direct experience of the requirements and the applications of magnetic alloys is available, thus giving a full appreciation of the desirable characteristics and the actual conditions of use.

V-PERMENDUR for high permeability with unusually high flux density. Specially applied to high quality diaphragms and pole pieces.

PERMALLOY C for highest initial permeability. Useful for wide frequency band transformers, current transformers, chokes, relays and magnetic shielding.

PERMALLOY B for higher flux densities than Permalloy C and high incremental permeability. Suitable for low power and intervalve transformers.

PERMALLOY D for very high resistivity without undue lowering of maximum flux density or of Curie point. Small variation of permeability with frequency. Ideal for H.F. applications.

Standard Telephones and Cables Limited

Registered Office: Connaught House, Aldwych, London, W.C.2

TELEPHONE LINE DIVISION North Woolwich, London, E.16 ALBERT DOCK 140

DE HAVILLAND

Advanced Guided Weapon Projects

Technicians are needed for key positions in an expanding team engaged on research, design and development work. Permanent and progressive posts, both senior and junior, are available for men of ability and enthusiasm who can offer sound knowledge and experience. This is a unique opportunity of acquiring advanced techniques and promotion prospects are good.

Reference.

- 17 DESIGNERS experienced in servo mechanisms, gyros, hydraulics, pneumatics, materials and structures related to aircraft or armament work.
- 17A DRAUGHTSMEN—SENIOR, INTERMEDIATE and JUNIOR for varied aspects of design.
- 18 MATHEMATICIAN for work on control systems. Knowledge statistics and noise. First-class honours or higher degree.
- 19 PHYSICISTS—SENIOR—for research team. With honours degree and industrial experience.
- 20 PHYSICISTS as research workers for field and laboratory tests, with good degree and some industrial experience in electronics or specialising in mathematics.
- 21 ELECTRONIC ENGINEERS—SENIOR—to be responsible for section engaged in work as reference 22 below.
- 22 ELECTRONIC ENGINEERS experienced in one or more of following—circuit development, miniature and sub-miniature techniques, magnetic amplifiers and equipment.
- 23 DEVELOPMENT ENGINEERS, H.N.C. standard, experienced structural testing (preferably aircraft), knowledge of strain-gauge equipment an advantage. Capable of working on own initiative planning test equipment and analysing test results.
- 24 DEVELOPMENT ENGINEERS, H.N.C. standard, familiar small electro-mechanical equipment, pneumatic and hydraulic servo systems for testing and developing. Knowledge electronic test equipment a distinct advantage. Should have experience in undertaking planning, carrying out and analysing of complete tasks.
- 26 INSTRUMENT ENGINEERS—experience of electro-mechanical instruments (gyros, small specialised motors, relays, etc.).
- 27 SERVO ENGINEERS—practical experience of servo mechanisms.
- 28 LABORATORY ASSISTANTS, qualified H.N.C. City and Guilds standard, for varied work.
- 29 WIREMEN—advanced laboratory standard.
- 30 WIREMEN—familiar circuit diagrams, radio or radar maintenance experience. Young ex-Servicemen particularly invited to apply.
- 31 TRIALS ASSISTANT—experience as reference 30 above.

Apply in confidence quoting reference number of post in which interested to :

The Personnel Manager,
DE HAVILLAND PROPELLERS LTD.
Hatfield · Hertfordshire.

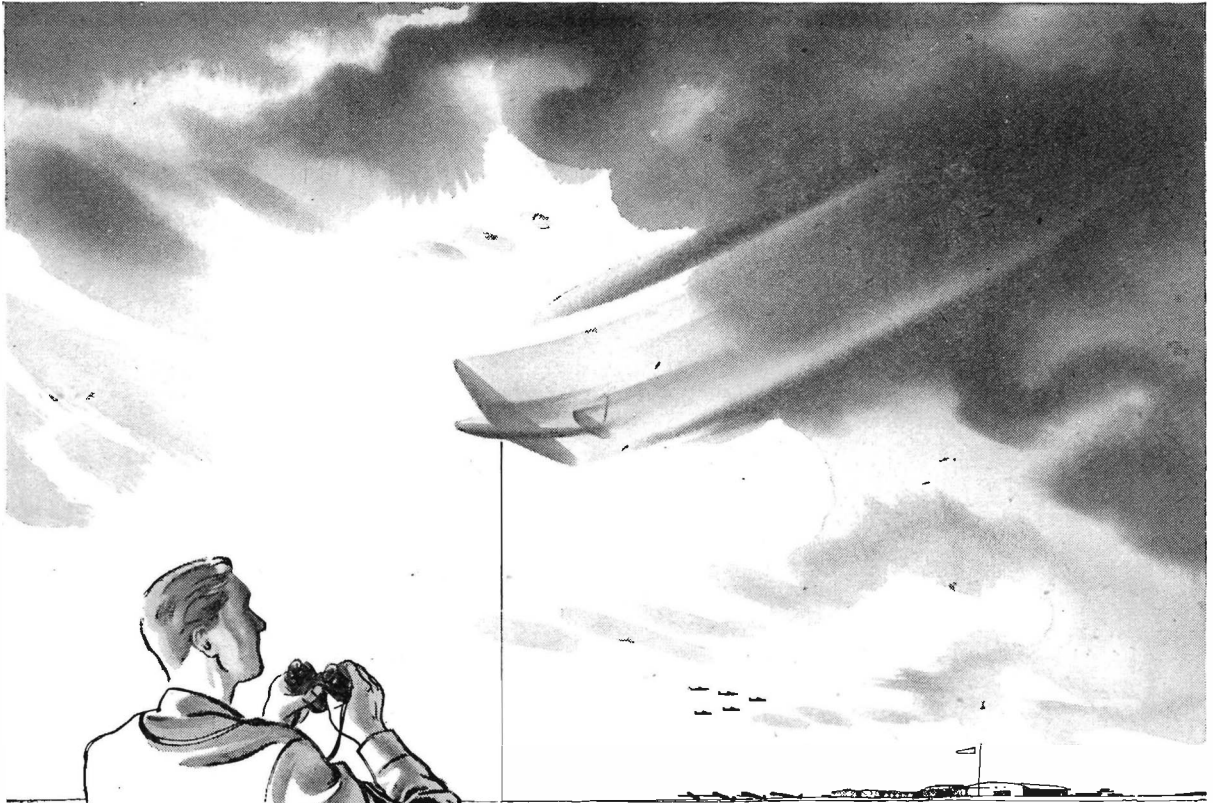

The Vital Link . . .

. . . upon which the pilot's safety depends is the consistent functioning of his radio and radar equipment. One dry or H.R. joint among the thousands of soldered joints in these precision instruments may mean the failure of a whole circuit endangering both pilot and machine.

FAULTLESS FLUXING PRESERVES THE VITAL LINK

Dry or H.R. joints are impossible with Superspeed for the flux is always released in exactly the correct proportion. This faultless fluxing action is achieved by the unique STELLATE core which gives six points of rapid solder collapse. At soldering temperature the activated rosin flux is released immediately for effective spreading and wetting. Superspeed is being used more and more in the production of service equipment where faultless joints are essential.



Superspeed

"WHITE FLASH" ACTIVATED ROSIN-CORED SOLDER

for general electrical, electronic and telecommunication work and all standard uses. A.I.D. and G.P.O. approved. Complies with M.O.S. Specification DTD 599. In all standard tin/lead alloys, 10-22 s.w.g. Sample of Superspeed and the comprehensive Superspeed booklet gladly sent on request. Technical advisers are available for free consultation.

MANUFACTURED BY THE **ENTHOVEN** GROUP

* Marketed by Enthoven Solders Ltd., Enthoven House, 89, Upper Thames Street, London, E.C.4. *



Glass-to-metal Seals

The present abnormal conditions of supply have placed increased emphasis on the correct choice of constructional materials. As an example, the Nilo range of nickel-iron alloys provides a range of compositions each having distinctive characteristics and developed to meet a specific requirement.

We believe that our revised publication, which includes tabular data on the properties of the various grades of alloy, together with examples of their industrial use, will prove a useful guide to the selection of the correct grade of material.

May we send you a copy?

HENRY WIGGIN & COMPANY LIMITED

Wiggin Street, Birmingham 16

35/NU/S

a "Fitting" Feature.



A
W - B - G

**PRECISION
METAL PRESSING**

The W.B.G. Organisation was established for the production of Highest Quality Metal Pressings and Stampings in large capacity and, for the past half-century, has given service to some of the most famous names in Industry.

WE SHOULD LIKE TO SERVE YOU

WRIGHT, BINDLEY & GELL LIMITED

TELEPHONE:
VICTORIA 2295/6/7 (PB.X)

PERCY ROAD, GREET
BIRMINGHAM, 11.

TELEGRAMS:
BINDLEY B'HAM.11.



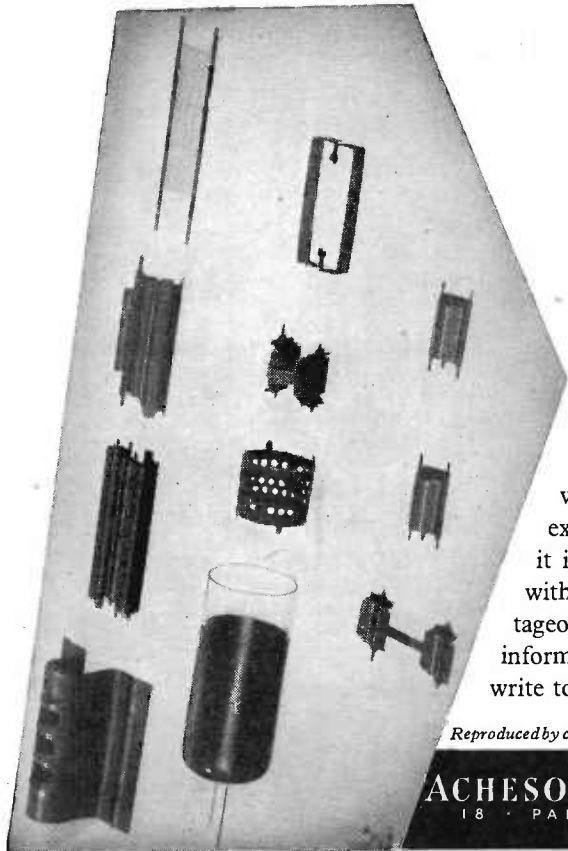

Secondary emission – and temperature – REDUCED

The film formed by 'dag' colloidal graphite is inert to electron bombardment and minimises secondary emission. These properties have led to the extensive use of 'dag' colloidal graphite for the treatment of valve grids and envelopes. The smooth graphite functions excellently as a 'black body'; therefore the substrate on which it is deposited is kept at a lower temperature than is the case with an untreated surface. The treatment is particularly advantageous when used on anodes. For full information on these and other applications write to Dept. D.18.

Reproduced by courtesy of The Edison Swan Electric Company Limited

ACHESON COLLOIDS LIMITED
18 · PALL MALL · LONDON · S.W.1



TAS/AC 6



Manufacturers of Ammeters, Voltmeters, Ohmmeters, Wattmeters and frequency meters for switchboard or portable use.

**MULTI-RANGE TEST SET
SERIES 100**

The universal testing set for Service Engineers. Sensitivity—10,000 ohms per volt. Strong metal case with carrying handle, complete with leads having detachable bulldog clips and test prods. Size 9 × 5½ × 4 ins.

MEASURING INSTRUMENTS (PULLIN) LTD.
Electrin Works, Winchester St., London, W.3
Tel.: ACOm 4651/3 & 4995.



RANGES

AC/DC VOLTS: 10, 25, 100, 250, 500, 1,000.

DC MILLIAMPS: 2.5, 10, 25, 100, 500.

AC/DC MICROAMPS: 100 Microamps 10v range.

RESISTANCE RANGES: 0/1 Meg (13,500 ohms mid-scale) 0/10,000 ohms (135 ohms mid-scale).

ALL-POWER

STABILIZED POWER SUPPLIES

SERIES 500

A new range of Stabilized Power Supplies is now in production.

DETAILS ON REQUEST



ALL-POWER TRANSFORMERS LTD.

CHERTSEY ROAD, BYFLEET, SURREY.

TEL.: BYFLEET 3224.

FOR HIGH FIDELITY RECORDINGS

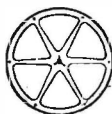

Careful design and rigid control in manufacture, provide the critical listener with a reliable hard-wearing tape that will help to get the very best results from any tape recorder.



MAGNETIC DATA

Coercivity 240-260 Oerstedes
 Total Remanent Flux . . . 0.4/0.5 lines $\frac{1}{4}$ in. width
 Uniformity throughout a reel ± 0.5 d.b.

FREQUENCY RANGE

50 c/s to 10 Kc/s at a playing speed of $7\frac{1}{2}$ in./sec.

Medium coercivity gives a high signal output with an extended high-frequency response, whilst still retaining an easy erasure. Signal/noise ratio is high; transfer and distortion are negligible.

PLAYING TIMES (per track)

REELS	1 $\frac{1}{2}$ " / SEC	3 $\frac{1}{2}$ " / SEC	7 $\frac{1}{2}$ " / SEC	15" / SEC
1200 Ft.	120 Min.	60 Min.	30 Min.	15 Min.
600 Ft.	60 Min.	30 Min.	15 Min.	7 $\frac{1}{2}$ Min.
300 Ft.	30 Min.	15 Min.	7 $\frac{1}{2}$ Min.	3 $\frac{1}{2}$ Min.

Further information obtainable on request.

2,400 ft. professional reels (10 $\frac{1}{2}$ " diameter double sided spools) now available

Write to :— MINNESOTA MINING & MANUFACTURING CO. LTD., 167 Strand, London, W.C.2. Telephone: TEMple Bar 6363

ALWAYS "FIT"



CASTORS

THE WORLD'S BEST

Loads up to **30 TONS** per castor. Wheel diameters from 2" to 44". All types of wheels and head fittings can be selected from our range of over

7,000 TYPES & SIZES

ASK FOR BROCHURE

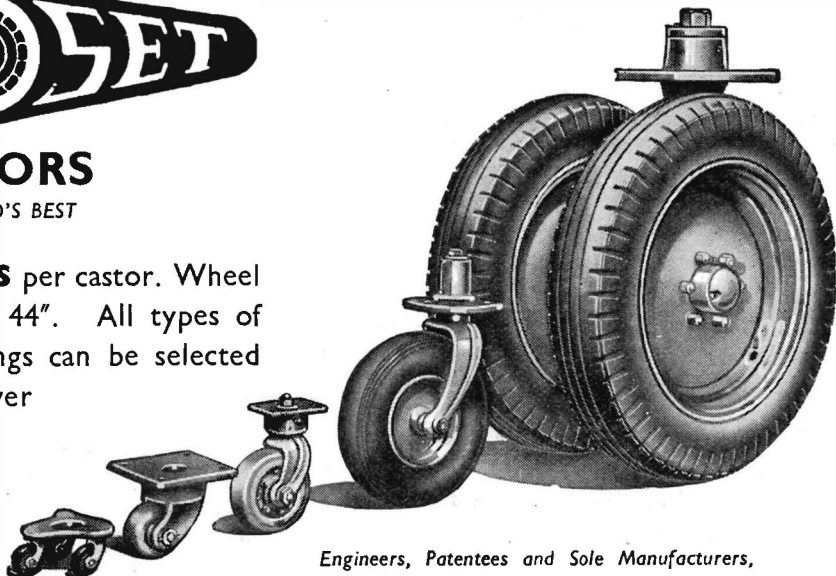

Engineers, Patentees and Sole Manufacturers,

AUTOSSET (PRODUCTION) LTD., Dept. O, Stour St., B'ham 18

EST. OVER 30 YEARS.

Please mention "Electronic Engineering"

EDG 1143/4

AT2

For Industrial and Laboratory Use

All types of A.C. apparatus—motors, furnaces, rectifiers, transformers—can be controlled by a single Regavolt whose output can be set, regardless of the load current, precisely at any voltage from 0 to 30% above the supply. Its rugged design for heavy industrial duty ensures reliability under severe working conditions.

Special designs can be made for incorporation in your own apparatus in addition to the wide range of single, 3 phase, hand and motor driven models listed in our catalogue No. 3131.

HIGH EFFICIENCY—

COMPETITIVE PRICE



"REGAVOLT"
REGULATING TRANSFORMER

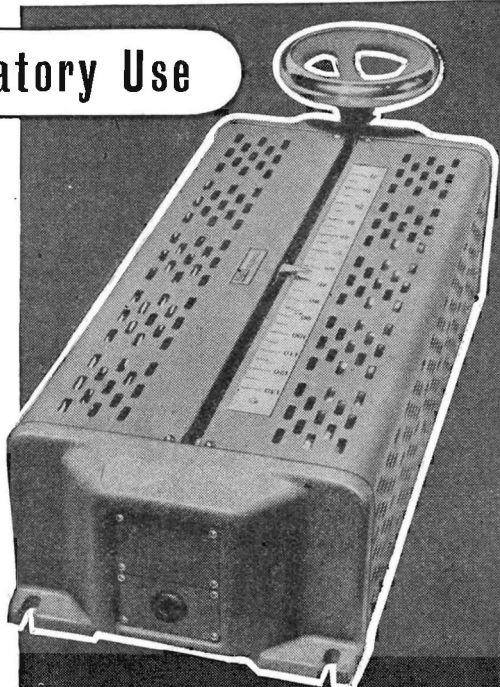

THE BRITISH ELECTRIC RESISTANCE CO. LTD.

Specialists in the control of current and voltage for more than 25 years

Queensway, Ponders End, Middlesex.

Telephone: HOWard 1492.

Telegrams: Vitrohm, Enfield.

BR3131/T

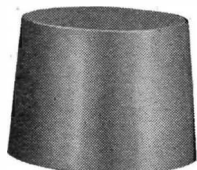
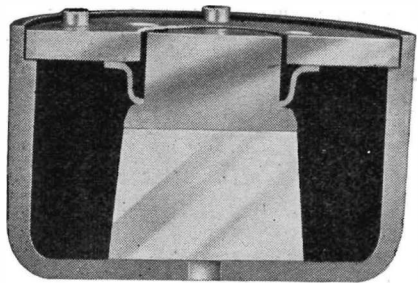

PERMANENT MAGNETS

A COMPLETE SERVICE —
ADVISORY AND SUPPLY —
FOR SPECIALISED INDUSTRIES

The most efficient method of using the high energy Permanent Magnet materials in the manufacture of Loud Speakers is shown in this illustration.



DARWINS LTD

TINSLEY · SHEFFIELD · 9

D27/A

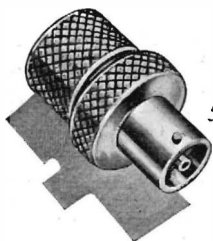

58 series plug

Panel Mounting Socket, type 58C

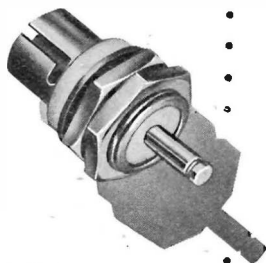

Socket, type 58 S/V



TELCONNECTORS

**co-axial plugs
and sockets**

The connectors illustrated are designed for use with the smaller diameter R.F. cables, such as Telcon PT.1.M, PT.11.M, AS.60.M, etc. Produced for instrument designers and general application, the 58 Series Plug and Socket has a capacitance of less than $7 \mu\mu\text{F}$. The 58C panel mounting socket shown will accept any plug in the 58P Series.



All types are readily available in various sizes and combinations. Write for publication Tj1.

TELCON **RF** cables

THE TELEGRAPH CONSTRUCTION & MAINTENANCE CO. LTD
Head Office: 22 OLD BROAD STREET, LONDON, E.C.2. Tel: LONDON Wall 7104
All enquiries to: TELCON WORKS, GREENWICH S.E.10. Tel: GREENWICH 3291



MODEL MV.1

A NEW MILLIVOLTMETER

by RIVLIN INSTRUMENTS

Model MV.1, is a high quality instrument for measuring A.C. Signal Voltages in eight ranges from 10 mV to 25 V f.s.d. in the frequency range 20 c.p.s. to 500 kc/s. A high impedance cathode follower feeds a three-valve amplifier through a range controlling attenuator, the output of the amplifier being connected to the meter through a crystal rectifier bridge. About 20 db negative feedback is applied around the amplifier system resulting in high gain stability and this, together with additional electronic stabilisation, ensures freedom from the effects of normal mains voltage variations.

The degenerative characteristics of the input cathode follower are used to provide a low capacitance input connection at the end of a coaxial cable, thereby dispensing with the need for a bulky probe.

Model MV.1 may also be used as a stable amplifier with a maximum gain of 10,000. Output connections at low impedance are provided and in this application the frequency response remains unaltered.

Construction of this Millivoltmeter is to the high standards associated with the products of Rivlin Instruments. Components are of high quality and conservatively rated, and no electrolytic condensers are used in H.T. circuits. Model MV.1 is supplied in a case for bench use but, if required, the panel can be withdrawn and the instrument mounted into a standard rack without modification. Early delivery can be offered.

Descriptive literature and details available on request to Dept. 5.

RIVLIN INSTRUMENTS LTD., 7a, Maitland Park Villas, London, N.W.3. Telephone: GULiver 2960



The De Luxe Home Built TELEVISOR and RADIOGRAM

By W. I. FLACK, M.I.R.E., Fellow of the Television Society

Price 6/6

This booklet gives all the details necessary for the building of a comprehensive home entertainer incorporating a Televisor and a three wave-band radio-gramophone.

The design of the De Luxe Televisor is based on the well known "Electronic Engineering" Home-Built Televisor and this booklet enables the earlier version to be modified to the De Luxe model which uses all the latest circuit techniques and refinements.

Order your copy through your Bookseller or direct from:—

Electronic Engineering

28 ESSEX STREET, STRAND, LONDON, W.C.2.

BALDWIN

DUNLOP

STATIGUN

FOR THE MEASUREMENT OF
ELECTROSTATIC CHARGES

A self-contained battery operated instrument for the direct indication of voltage gradient: reads on three ranges with full scale values of 2 kilovolts per foot to 200 kilovolts per foot.

In use it is pointed at the charged surface and if necessary adjusted for range.

It will indicate if the charge is positive or negative.

OF PARTICULAR APPLICATION TO ALL PROCESSES IN WHICH ELECTROSTATIC CHARGES ARE DEVELOPED AND MAY BE A NUISANCE OR SOURCE OF DANGER.

It will also measure charge and resistance to earth with extra accessories.



Weight 3½ lb.

Write for Leaflet E.E. 123

BALDWIN INSTRUMENT CO. LTD., DARTFORD, KENT

Telephone: Dartford 2989 & 2980

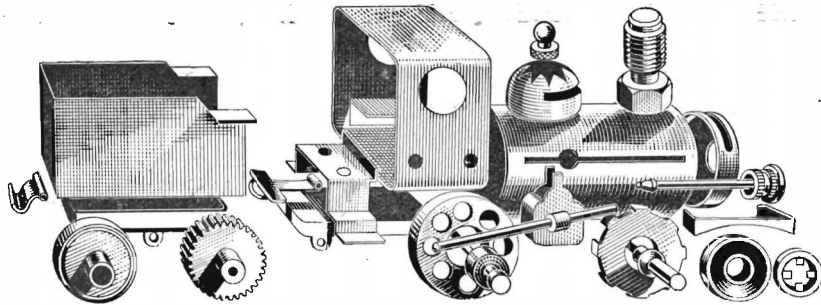

HIGH SPEED AUTOMATICS

Modern machinery and mass production methods give you top quality capstan and automatic work and sheet pressings at a price you are sure to like—and on time.

GRIFFITHS, GILBART, LLOYD & CO., LTD.,

EMPIRE WORKS,

PARK ROAD

BIRMINGHAM 18

Tel.: NORthern 6221.



Precision Temperature Control between 15°C and 75°C

THE Mullard Temperature Controller, E7594, measures and controls within very fine limits the temperature of water baths and similar apparatus. Compact and adaptable, this instrument can be set at any temperature between 15°C. and 75°C. It has a control accuracy of $\pm 0.02^\circ\text{C}$. at the working point, and a calibration accuracy of $\pm 1^\circ\text{C}$.

A temperature sensitive element is provided for direct immersion in the liquid to be controlled.

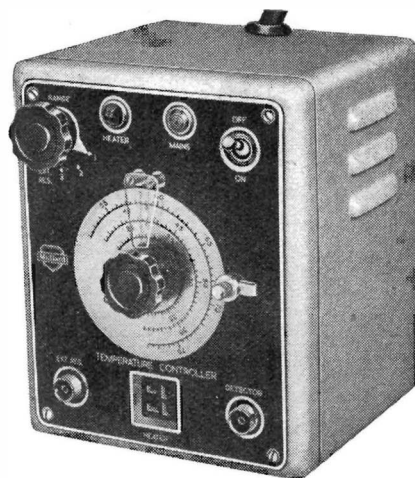

The temperature controller is one of a number of high-grade scientific instruments now being developed by Mullard. Full details of those at present available will be gladly supplied on request.

Mullard



NORTHERN AGENT: F. C. ROBINSON & PARTNERS, LTD.
287 DEANS GATE, MANCHESTER, 3.
SCOTTISH AGENT: LAND, SPEIGHT & CO. LTD.
73 ROBERTSON ST., GLASGOW, C.2.

MULLARD LTD · EQUIPMENT DIVISION · CENTURY HOUSE · SHAFESBURY AVENUE · LONDON · W.C.2

Technical Control

Close technical control of production is an all-important factor in the manufacture of Telcon Metals. Accurate tests and measurements are made at various stages in the course of production and the illustrations show two of the many routine examinations conducted in our well-equipped laboratories.

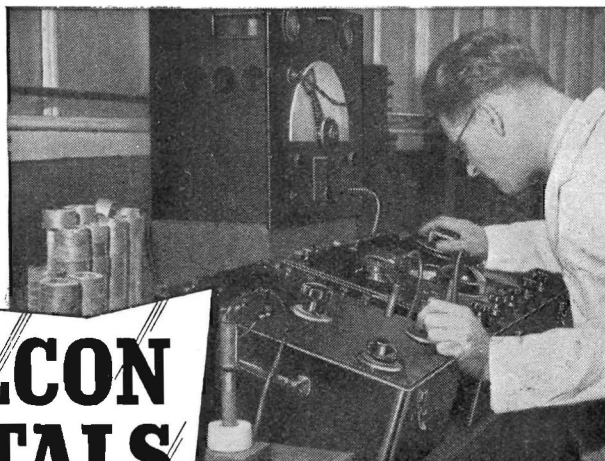

Routine Factory testing of Mumetal toroidal cores.



TELCON METALS

Precision measurement of magnetic characteristics of toroidal Mumetal cores by the Ferrometer.

MAGNETIC ALLOYS — Mumetal, Radiometal, H.C.R., Rhometal, Permendur, R2799, 36/64, Dust.
RESISTANCE ALLOYS — Pyromic, Calomic, Telcuman, Telconstan, Telconal.
SPECIAL ALLOYS — Thermostatic Bimetals 140, 400, 15, Telcoseal, Invar, Beryllium-Copper.



The Telegraph Construction & Maintenance Co. Ltd

Head Office: 22 Old Broad Street, London, E.C.2
Telephone: LONDON Wall 7104

Enquiries to: Telcon Works, Greenwich, London, S.E.10
Telephone: GREENWICH 3291

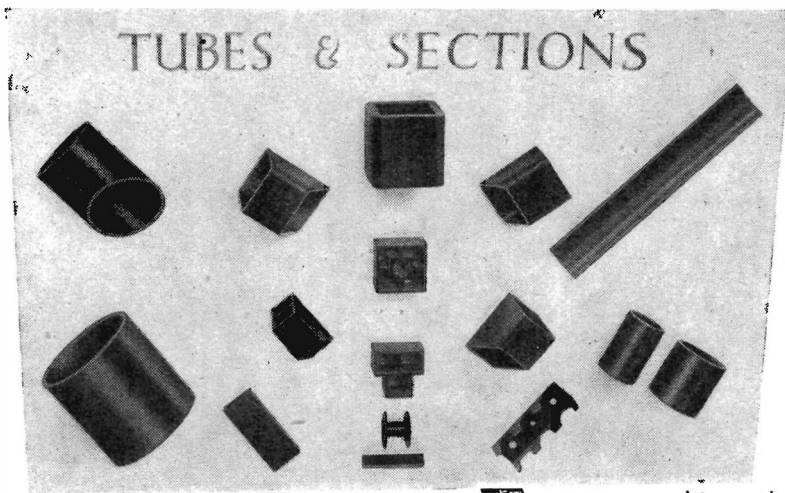

TUBES & SECTIONS

**Here's
the
answer . . .**

to your manufacturing problem: you require Components to resist moisture and corrosion, to be light and strong, resilient and sound proof

Our laminated tubes & sections

combine these characteristics with high dielectric properties and low price.

• Our technical service will gladly co-operate and advise.

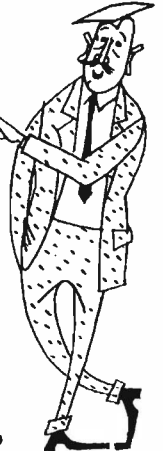

Resinoid & Mica Products Ltd.

COLONIAL WORKS
MARY ST · BALSALL HEATH
BIRMINGHAM 12
Tel.: CALTHORPE 1303

28 QUEEN ANNE'S GATE
WESTMINSTER
LONDON S.W.1
Tel.: WHITEHALL 8892

WESTERN HOUSE
MIDLAND ROAD
BRISTOL 2
Tel.: BRISTOL 22906

L 3520 D

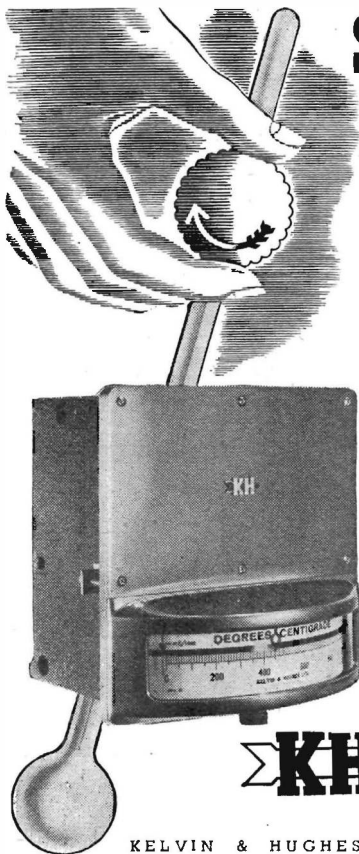

SELECTIVE HEAT CONTROL

KH26

With the new Kelvin Hughes Electronic Controller Mk3, the smaller industrial organisation can reap the benefit of highly accurate and sensitive control without adding to normal maintenance personnel. Using a common chassis and unit construction, Kelvin Hughes have achieved standardisation on five different instruments, thus reducing servicing difficulties and cost to the user.

The range covers everything from the straightforward two-position type, to the proportional, with reset programme control. All are designed to protect the plant in the event of failure. Let us send you full particulars.

*The New **KELVIN HUGHES**
Mark 3 Range
Electronic Temperature Controllers*



KELVIN HUGHES PRECISION INSTRUMENTS

KELVIN & HUGHES (INDUSTRIAL) LIMITED · 2 CAXTON STREET · LONDON · S.W.1



*the name which helps to sell
the Best Radio Grams*

Throughout the Years . . . Throughout the World . . .
Garrard has reigned supreme in producing Turntable
Units of unsurpassed quality.

Manufacturers who use Garrard Units in their finest
instruments always mention them by name in their
sales specifications.



'SINCOMAX'

is the registered trade name for

MUREX SINTERED COMPOSITE MAGNETS

Regd. Trade Name No. 707978

The Trade Name SINCOMAX has been registered for the Sintered Composite Magnets which are manufactured by Murex Ltd. The soft iron pole pieces and the magnetic alloy are pressed and sintered as an integral unit thus avoiding any loss of the flux between magnet and pole. The photomicrograph inset shows this transition area magnified 12 times.

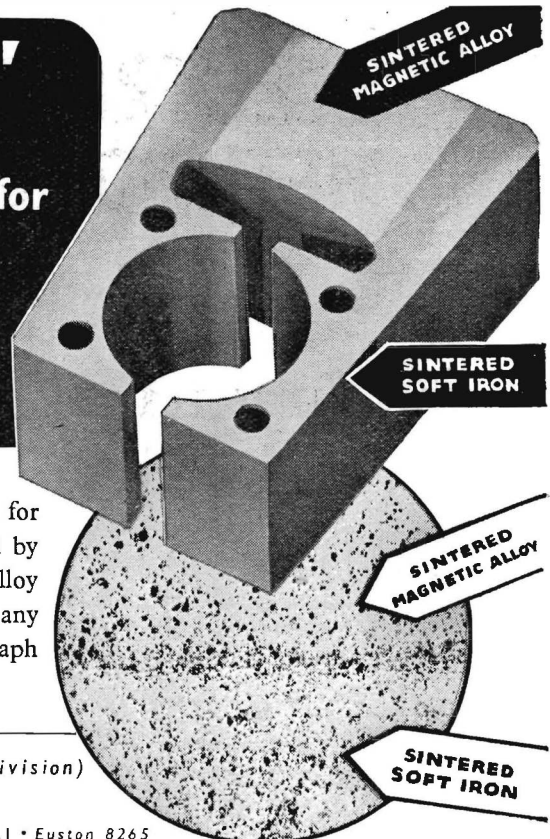

MUREX LIMITED (*Powder Metallurgy Division*)

RAINHAM • ESSEX • Rainham, Essex 3322

London Sales Office: Central House, Upper Woburn Place, W.C.1 • Euston 8265

Fluid Rubber Compositions

Have You Seen This Broadsheet which Describes the
SEALING AND COVERING OF ELECTRICAL COMPONENTS ?

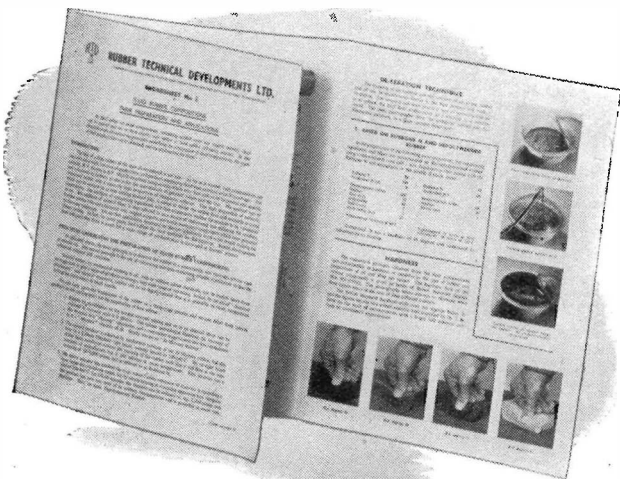

The sealing of small electrical components by means of rubber will provide protection against atmospheric conditions and give insulation from mechanical shock. Fluid Compositions, which can be poured, set by vulcanisation to products which are resilient; the hardness can be varied over a wide range according to requirements. The rubber can be made to adhere to metal, if desired, and shrinkage during vulcanisation does not exceed 2 per cent.

The preparation of fluid rubber compositions is described in R.T.D. Broadsheet No. 2. This broadsheet, which is issued free, has been produced by Rubber Technical Developments, Ltd., a non-profit-making development unit operated jointly by The British Rubber Producers' Research Association and The British Rubber Development Board.

Application for Broadsheet No. 2 should be made to :—

THE BRITISH RUBBER DEVELOPMENT BOARD
MARKET BUILDINGS • MARK LANE • LONDON • E.C.3

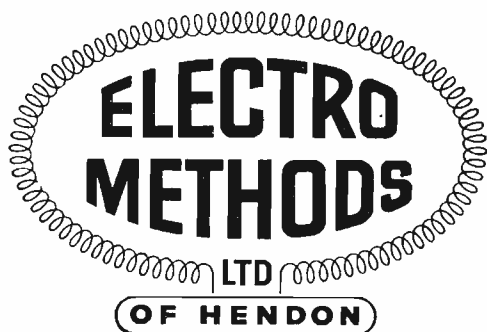

—the first name for
precision
RELAYS

GENERAL-PURPOSE : TIME-DELAY
MERCURY : HEAVY-DUTY

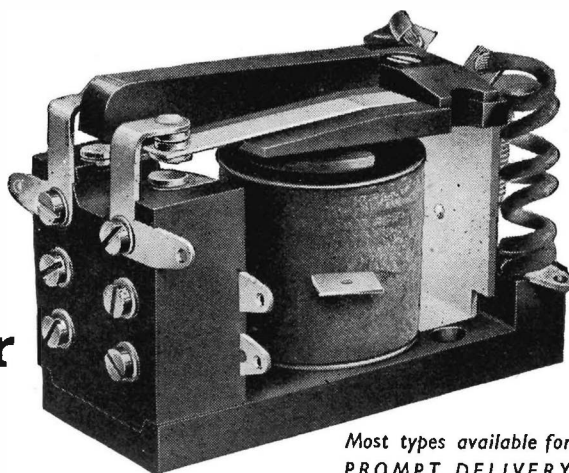

Most types available for
PROMPT DELIVERY

Complete technical data of our extensive range of standard relays will be forwarded on request. The unrivalled experience of our technicians is at all times at your disposal.

If you have a relay problem it will pay you to consult us.

ELECTRO METHODS LTD., Division RI,
THE VALE, LONDON, N.W.11. Telephone GLAdstone 6611

SPECIALISTS IN THE MANUFACTURE OF RELAYS, THERMOSTATS, MAGNETIC AMPLIFIERS

EGEN

first and foremost!

Egen Potentiometers are recognised everywhere for their dependability and are constantly being specified by radio and electronic engineers. A specialised carbon deposition guarantees perfect electrical stability. Note these features:—

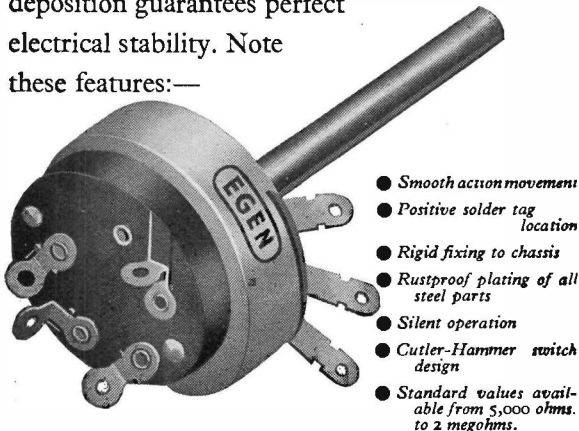

- Smooth action movement
- Positive solder tag location
- Rigid fixing to chassis
- Rustproof plating of all steel parts
- Silent operation
- Cutler-Hammer switch design
- Standard values available from 5,000 ohms to 2 megohms.

Egen Potentiometers are also available with single pole or double pole switch and without switch. Switches only supplied separately if required.

PRE-SET RESISTORS.
A wire-wound pre-set resistor for panel or chassis mounting: Multi-unit banks available to special order.

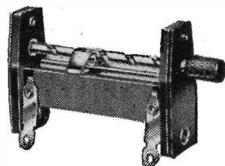

SUB MINIATURE VOLUME CONTROL
For use in Deaf Aids and other miniature electronic apparatus.

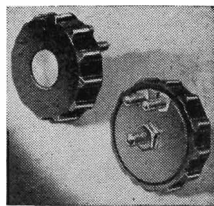

Overall diameter less than 1/2"

Export enquiries welcomed

EGEN

POTENTIOMETERS

EGEN ELECTRIC LTD

Charfleet Industrial Estate, Canvey Island, Essex. 'Phone: Canvey 691 & 2

Isotopes in Industry and Research

ISOTOPE DEVELOPMENTS ARE MAKING STANDARD EQUIPMENT

in the Radioactive field

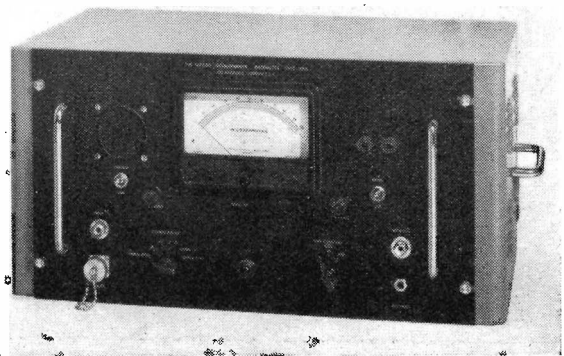

UNIVERSAL RATEMETER TYPE No. 550

The Isotope Development Ratemeter is a general purpose instrument capable of covering a wide range of counting rates with a maximum error of only $\pm 1\%$. Its robust nature makes it equally suitable for industrial, medical and laboratory purposes whilst its versatility and accuracy simplify many radio-active measurements which have previously required the use of a scaler. Aural and visual count rate is provided. It is designed for the following counting requirements:

HALOGEN QUENCHED GEIGER-MÜLLER COUNTERS for which power supplies are provided operating up to a count rate of 1,000 per second.

SCINTILLATION OR PROPORTIONAL COUNTERS operating at moderate speeds of 0 to 10,000 counts per second.

THE ISOTOPE PRE-SCALER TYPE No. 510 has been designed as an ancillary unit for scintillation or proportional counters operating at high speeds of the order of 100,000 counts per second.

Standard equipment, easily serviced, is now being produced in quantity. Servicing manuals are available and Isotope Developments run a prompt maintenance service for all their equipment. A wide field is being found for the many uses of radioactive isotopes and advice is given willingly on application.

**ISOTOPE
DEVELOPMENTS LTD.**

120, MOORGATE, LONDON, E.C.2

Telephone: METropolitan 9641 (5 lines)

Midland Agent: HAWNT & CO. LTD., 59 MOOR STREET, BIRMINGHAM, 4

Northern Agent: A. M. LOCK & CO., CROMPTON ST., CHADDERTON, Oldham, Lancs.

THE NEED FOR

Quicker Servicing

THE BPL UNIVERSAL TEST SET

Laboratory sensitivity combined with robust construction makes the B.P.L. Universal Test Set the ideal all-purpose set for electricians and radio engineers. Sensitivity is 20,000 ohms per volt for D.C. or A.C. and two ohms ranges allow precise measurement of low resistances. The easy-to-read two-colour dial and mirror scale provide added accuracy. Ranges: A.C./D.C. Volts: 10, 50, 100, 500, 1,000; D.C. Current: 100 μ A, 1 mA, 10 mA, 100 mA; Resistance: 0-10,000 ohms (first divn. 10 ohms), 0-1 megohm. List Prices: £11 10s. 0d., incl. test leads, subject to Trade Discount.

We also supply B.P.L. Super Rangers and D.C. Test Sets, Moving Coil and Moving Iron Panel Mounting Meters and a comprehensive range of Measuring Bridges and Electronic Testing instruments. Write today for full details.



LEADS TO

British Physical Laboratories

Radlett, HERTS.

London Stockist: M.R. Supplies, Ltd., 68 New Oxford Street, W.C.1

dmBP3

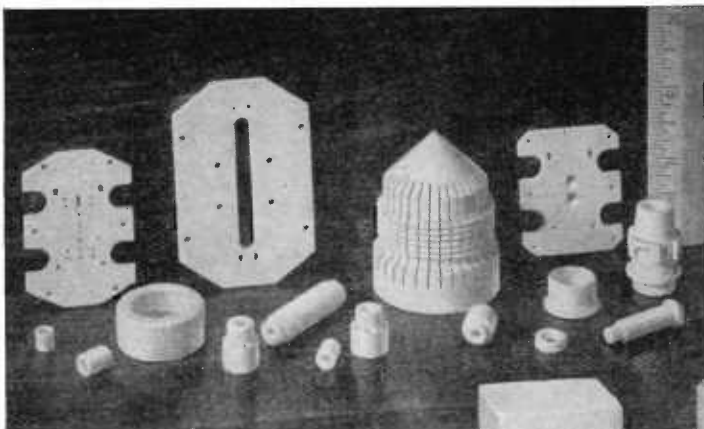

STEATITE

... for all high
frequency applications

Over a century of experience in this highly specialised field.
We invite your enquiries.

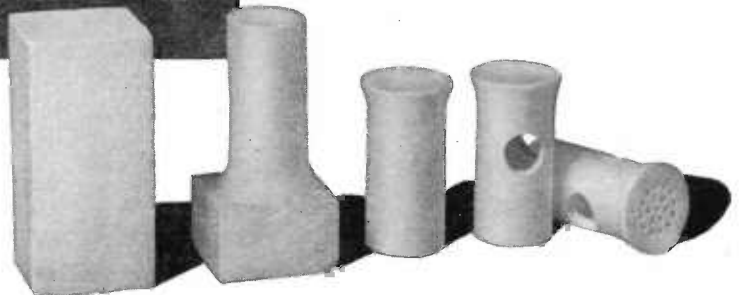

Machined to special designs and fine limits.



WILLIAM SUGG & COMPANY LIMITED
VINCENT WORKS, REGENCY STREET, WESTMINSTER, S.W.1 VICTORIA 3211

This specialist service in NICKEL AND NICKEL ALLOYS

FURNACE ELEMENTS	Nickel alloys for long life at high temperatures ; for certain special atmospheric conditions ; for furnace constructional work.
DOMESTIC APPLIANCES	'Nichrome' V for long life at temperatures up to 1150°C ; 'Nichrome' for temperatures up to 950°C ; other alloys for less exacting conditions.
THERMO-COUPLES	'T1/T2' alloys (nickel-chromium and nickel-aluminium) for temperatures up to 1100°C, are identical with the best-known wires formerly imported. Also Special 'Advance' (nickel-copper) for use with copper or iron.
RADIO and TV FIELD	Cathode nickel, pure nickel and nickel-manganese, for sleeves, anodes, grids, filaments, supports, glass metal seals, etc.
LAMP INDUSTRY	Nickel-manganese for supports, grids, and lead wires ; special alloys for a variety of efficient joints between metal and glass.
SPARK PLUGS	Alloys of the correct physical properties and temper to meet manufacturing requirements in centre and side electrodes ; and such as special strip for stamping out multi-point discs for aircraft plugs.
FINE WIRES	Very fine wires from 0.002 in. downwards in various alloys, such as 80/20 Nickel Chrome, Pure Nickel, etc., for specialised applications.

BRITISH DRIVER-HARRIS

CO. LTD.

MANCHESTER 15

*The greatest name
in electrical resistance*

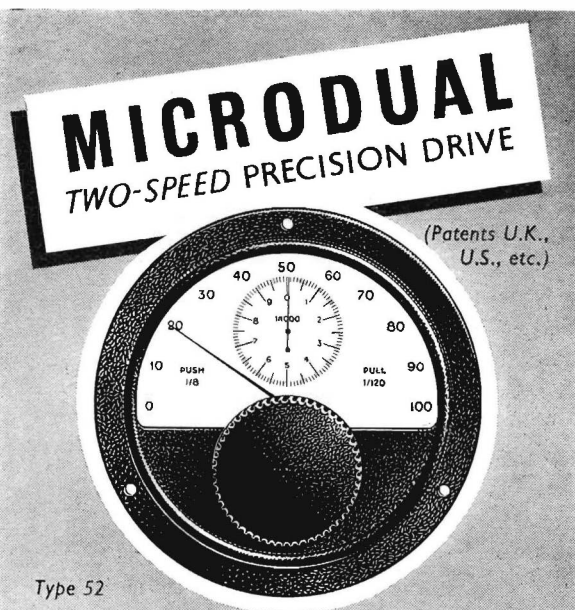

TWO SPEEDS · SINGLE CONTROL FREE OF BACKLASH

- Accuracy of scale reading 100%
- Coarse searching speed plus fine setting control.
- Single control knob displaced axially to select the speed ratio.
- Spring-loaded gears with automatic take-up of any wear or play between primary and secondary drives.
- Pointers geared directly to centre spindle.
- Security in operation: friction clutch obviates overdriving.

TYPE No.	NUMBER OF DIAL MARKINGS	EFFECTIVE SCALE LENGTH	SPEED RATIOS	
			COARSE	FINE
52	1,000	3.3 feet	1 : 8	1 : 120
63	1,000	3.3 feet	1 : 8	1 : 120
57	2,000	6.6 feet	1 : 15	1 : 200
56	2,000	6.6 feet	1 : 15	1 : 200
53	2,000	6.6 feet	1 : 15	1 : 200



Other TRANSRADIO specialities:—
COAX Low Capacitance Cables.
COAX Precision Connectors.

TRANSRADIO LTD

138A CROMWELL RD., LONDON, S.W.7, ENGLAND

THE WAYNE KERR INDUCTANCE METER

From $.05 \mu\text{H}$ to 100 mH
measured simply – quickly
and accurately

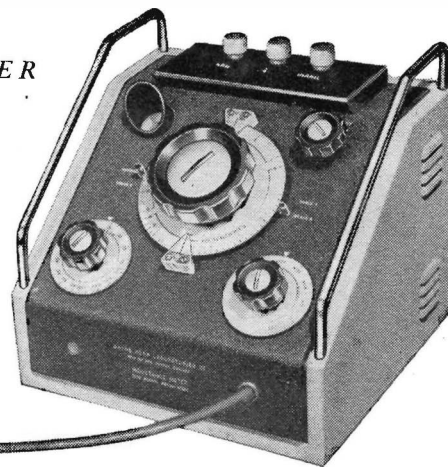

The Wayne Kerr Inductance Meter uses a stable variable frequency oscillator to resonate the unknown inductance with a known capacity. Calibration and scale reading accuracy are sufficient to give direct reading within $\pm 2\%$ for values above $1 \mu\text{H}$ and relative measurements can be made with even greater accuracy. A subsidiary scale indicates the value of Q at

the resonance frequency. This feature is useful when measuring small production runs of coils, a purpose for which the instrument is particularly suitable.

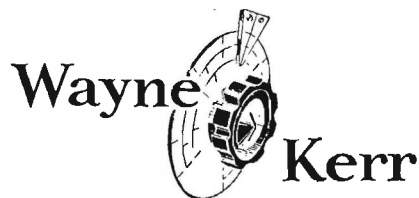

THE WAYNE KERR LABORATORIES LIMITED NEW MALDEN SURREY Tel: MAL 2202



... finding
Vacuum Leaks

—Quickly . . . Economically

The most effective method of locating leaks in vacuum plant depend on probing the system with a tracer gas using an indicator to detect immediately its entry through the leak. We have developed a range of leak detection equipment in which these principles are employed.

Send for full details . . .

W. EDWARDS
 & CO. (LONDON) LTD., LONDON, S.E.26
 Phone: SYDenham 7026 Grams: EDCOHIVAC,
 (8 lines) Souphone, London

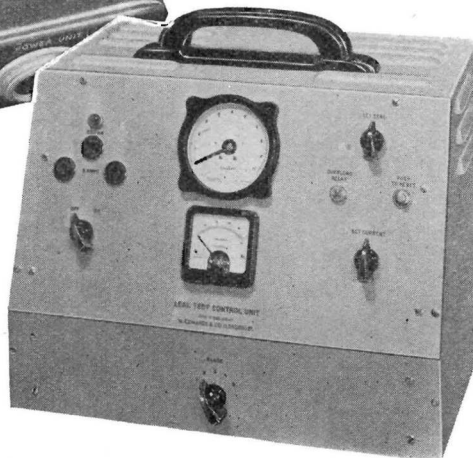

Examples include:—

(top)
MODEL LT.2. Operates with a Pirani gauge and a hydrogen probe. A highly sensitive device.

(bottom)
PALLADIUM-BARRIER LEAK DETECTOR. Its sensitivity and specific response brings it in comparison with the mass spectrometer but without its complications or expense.

**REDUCE YOUR
PRESS TOOL COSTS**

**THE HUNTON UNIVERSAL BOLSTER OUTFIT
FOR SHEET METAL PIERCING AND
BLANKING ON FLY PRESSES**

Bolster Frame with
2 adjustable gauges
and insertable steel
Holders for Dies
 $\frac{1}{4}$ in. to $3\frac{1}{2}$ in. bore
diameter.

Two Punch Holders
with detachable
positive-action
Strippers take the
complete range of
Punches $\frac{1}{4}$ in. to
 $3\frac{1}{2}$ in. diameter

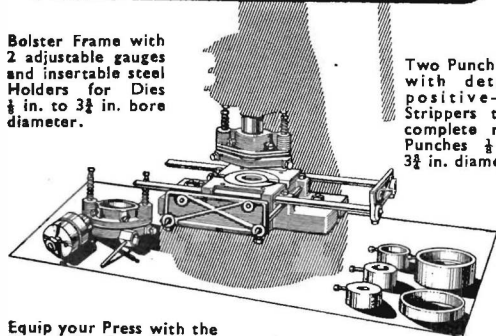

Equip your Press with the
Hunton Outfit and use inexpensive
standardised Punches and Dies $\frac{1}{4}$ in. to $3\frac{1}{2}$ in. diameter obtain-
able from stock—in $\frac{1}{8}$ in. sizes—when you need them.
Standardised Tools also available at short notice for Square, Oblong
and other shapes, Louvre Forming (up to 8 in. long), Corner Notch-
ing, Corner Radiusing, Angle Iron Notching and Piercing, etc.
Get the Outfit now—Buy Punches, Dies and tools as you need
them

Descriptive brochure and prices on request.

HUNTON LIMITED

Phoenix Works, 114-116, Euston Road, London, N.W.1
Telephone: Euston 1477 Telegrams: Untonexh, London

For your attention This Month :—

We can now offer a complete range of

STABILIZED POWER SUPPLIES

covering all voltages from

1 Volt to 75,000 Volts

Suitable equipment from our range can be selected
having specifications which will meet almost any
requirement.

Complete price list and full
technical data on request

Henry A. Patterson & Partners Ltd.

ELECTRONIC LABORATORY FURNISHERS

156 High Holborn, LONDON, W.C.1.

Phone: CHAncery 7717

and at High Wycombe. Phone: PENN 2334

IT'S NEW- IT'S TRUVOX

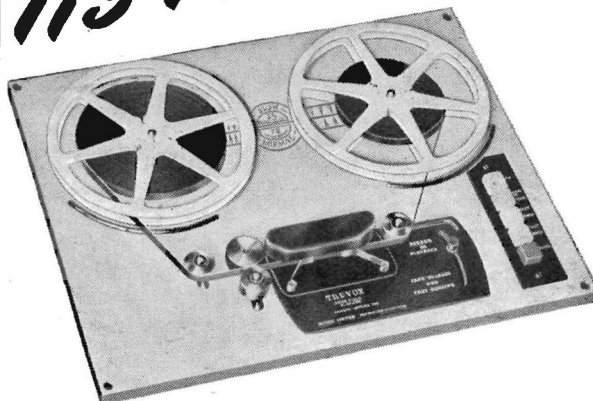

TAPE DECK MARK III

(Patents Applied For)

THESE ARE THE MAIN FEATURES:—

1. Three-motor drive.
2. "Drop-in" Tape loading.
3. Push-button control, electrically and mechanically interlocked.
4. Separate push-button brake.
5. "Fast-forward" and "fast-rewind" without tape wear.
6. Silent drive eliminating "wow" and "flutter."
7. Half-track working, and two tape speeds of $7\frac{1}{2}$ inches per second, or $3\frac{3}{4}$ inches per second.
8. Visual playing-time indicator.
9. With a suitable amplifier, the equipment covers a frequency range from 50-10,000 c.p.s. at $7\frac{1}{2}$ inches per second.

22 Gns.

MODEL TR2
200/250 volts
A.C. mains only.

The deck is designed for building into
complete recorders which can be
handled by inexperienced personnel.

.. and it's available NOW!

TRUVOX LIMITED

EXHIBITION GROUNDS,
WEMBLEY, MIDDLESEX

Telephone: WEMbley 1212

knobs

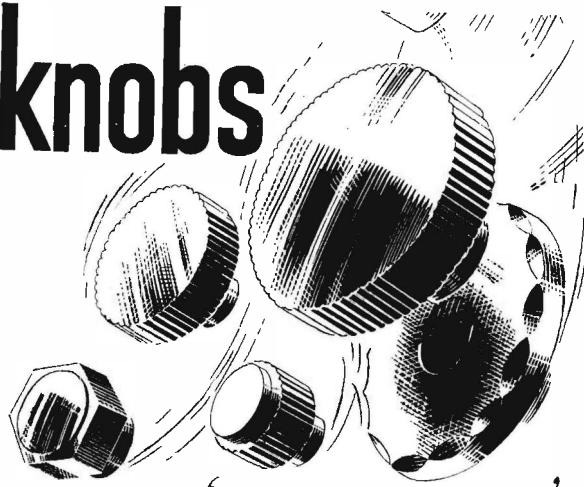

AND *know-how*

Although radio amateurs the world over have always been fond of knobs, the scientist and research worker likes his instruments to be efficient and functional and to perform their ancillary tasks as accurately and unobtrusively as possible. Nagard Oscilloscopes are designed with just these points in mind.

When the capacity and accuracy of Nagard instruments are considered, the controls are astonishingly few in number. Those that are present are clearly marked and perform specific and essential functions free from interaction with other controls. In addition, the six inch flat screen, well placed to avoid distracting ambient light and provided with a clearly marked and internally illuminated graticule, allows comfortable viewing together with accurate trace measurement. The instruments are of unit construction and cover a very wide band with exceptionally high gain.

A further aid to the operational efficiency of Nagard Oscilloscopes is provided by the Nagard Floor Trolley. This is carefully designed for mobility and enables the viewing angle of the screen to be easily adjusted. The trolley has three point support for stability on uneven floor surfaces, occupies very little floor space and is robustly constructed.

The Nagard Organisation exists to aid research, where accurate measurement of dynamic phenomena is involved. If you would like details of Nagard Wide Range Calibrated Oscilloscopes or Amplifiers, or would be glad of the co-operation of Nagard technicians to solve a definite problem, please communicate with the manufacturers.

- MODEL L 103 For High Speed Transients.
- MODEL A 103 For Pulse Work and Repetitive Signals up to 10 Mc/s.
- MODEL F 103 For General Work at Frequencies up to 1 Mc/s, High Gain D.C. Y Amplifier, Excellent Triggering.
- MODEL G 103 As above but with Slow Speed Time Base.
- MODEL H 103 Extra High Gain D.C. Y Amplifier up to 200 Kc/s.

NAGARD
LTD

See what you measure!

18, Avenue Road, Belmont, Surrey

VIGILANT 0345

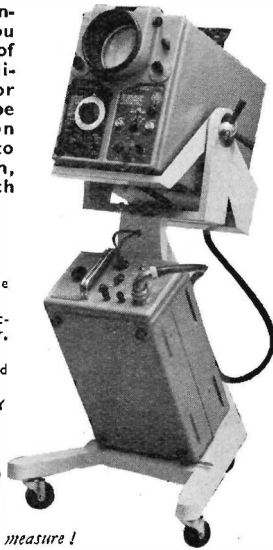

Selenium RECTIFIERS

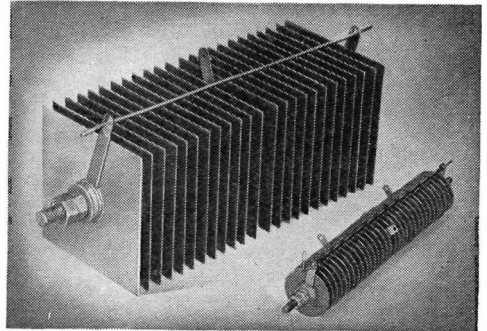

What do you look for in a good rectifier?

- HIGH EFFICIENCY ● LIGHT WEIGHT
- UNIFORM CHARACTERISTICS
- SMALL SIZE ● INFINITE LIFE
- COMPLETE RELIABILITY

Our rectifiers consistently live up to these standards and moreover, we are able to offer a—

SPEEDY DELIVERY

What is your rectifier problem? We cordially invite your enquiry and place our experience at your disposal.

THE AUTOMAT COMPANY
104 HAZELHURST ROAD, WORSLEY, LANC'S

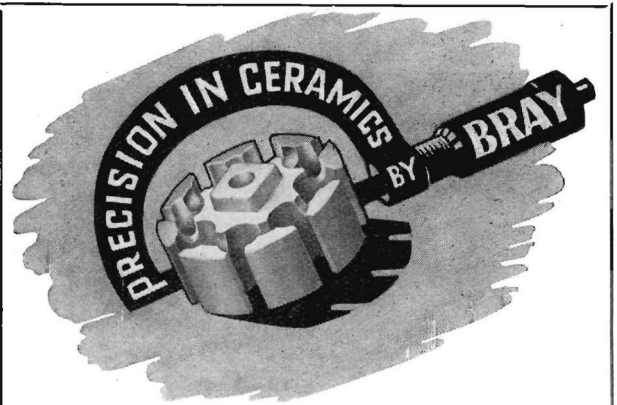

Quantity production of small automatically made pieces in Steatite, Porcelain, and Rutile materials for electric cooling and heating equipment, and telecommunication apparatus.

BRAY



GEO. BRAY & CO. LTD., Leicester Place, Leeds 2.

Tel.: 20981/8. Grams.: "Bray, Leeds 2"



*Pioneers and specialists
in Small Valves*

SUBMINIATURES
MINIATURES
MIDGETS
GAS TRIODES
ELECTROMETERS
COLD CATHODE
TUBES

HIVAC LTD

GREENHILL CRESCENT, HARROW-ON-THE-HILL,
MIDDLESEX. Telephone: HARrow 2655

TUNGSTEN WELDING ELECTRODES FOR INERT GAS ARC WELDING



Molybdenum
Tubes and other
Molybdenum Com-
ponents.

Tungsten Rods and three-
piece Lead Wires for tungsten
to glass seals.

X-ray Targets with or without
cast-on copper body.

Rotating Anodes.

Tungsten Contact Rivets and Screws.

ELECTRO-ALLOYS Ltd.

12, BRUNEL RD., LONDON, W.3.

Makers of TUNGSTEN and MOLYBDENUM Products

EFFICIENT LUBRICATION

—40° F
to
1000° F



RAGOSINE

ANTI-SCUFFING PASTE

ALREADY IN PRODUCTION USE FOR:

Testing Machine Jaws.

Holding bolts and studs of steam and gas
turbines, furnace controls, etc.—entirely
prevents galling and seizing.

Conveyor chains and cables operating in
high temperature ovens.

High speed drills and cutting tools—applied
to cutting edge to prolong tool life.

Die casting mould lubricant.

Life-time lubricant in instrument assemblies.

AND MANY OTHER PURPOSES

Full details sent on request.

RAGOSINE

OIL CO. LTD.

IBEX HOUSE, MINORIES, LONDON, E.C.3.
MINERVA WORKS, WOODLESFORD, NR. LEEDS, YORKS

HADDON

POTTED TYPE TRANSFORMERS

Complete range of 8 sizes available for early delivery.

Compound filled.

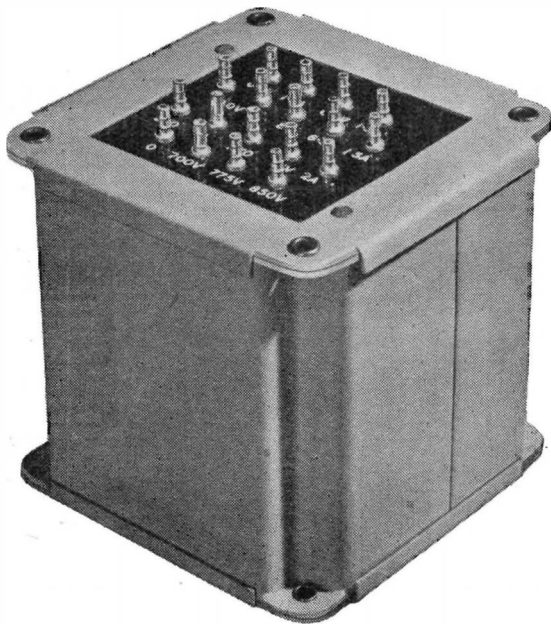

May we have details of your requirements?

Haddon Transformers Ltd.

27-35 MASONS AVENUE
WEALDSTONE · HARROW · MIDDLESEX

Telephone : HARrow 9022-3



*If we had only
been about in 1250*

we should have been fashioning natty suits of armour—styling them in the latest trends of fashion—and ensuring that they met the particular needs of the moment. That is our business. Fashioning metal—sheet metal—to do a particular job and do it well—as well as it can be done. If you have a job that should be tailor-made to your requirements, write and tell us about it, we can do it.



RITHERDON & CO. LTD.
LORNE STREET, DARWEN.
Telephone : Darwen 1028.

**DONOVAN
ACCESSORIES**
for the
**ELECTRONIC
APPARATUS
MANUFACTURER**

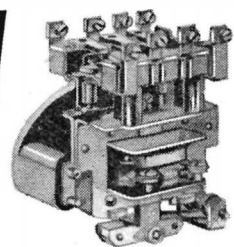

Type A.11 A.C. POWER RELAY—4-pole with N.O. or N.C. contacts.

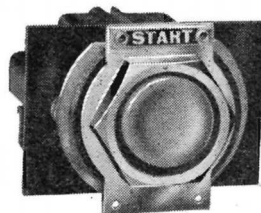

Type C.30 PUSH BUTTON UNIT arranged for mounting on customers' own cover plate.

**TYPE J.96
TERMINAL BLOCKS**

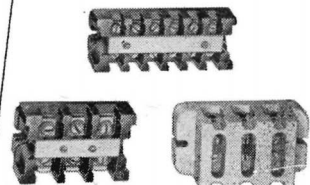

Made in 15, 30 and 60 amp. sizes.

THE DONOVAN ELECTRICAL CO. LTD.
Safuse Works · Stechford · Birmingham, 9.

FIXED CONDENSERS OF ALL TYPES

Both Paper & Mica

Large stocks available for immediate delivery. Your specific enquiries, giving full details, will receive immediate attention. Our prices show substantial savings.

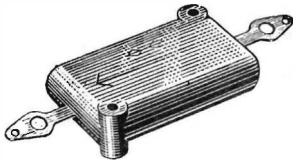
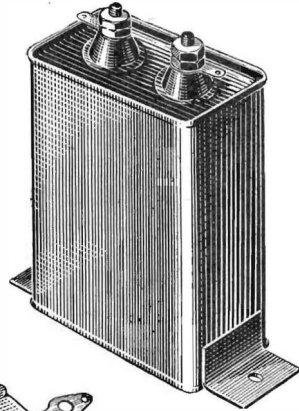

CLAUDE LYONS LTD.

Electrical & Radio Laboratory Apparatus

180 Tottenham Court Rd., London, W.1. Tel. MUSeum 3025

Announcing the

SCALAMP ELECTROSTATIC VOLTMETER

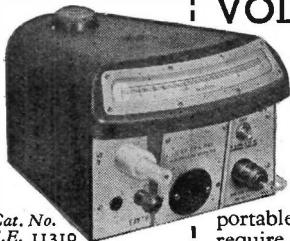

Cat. No. E.E. 11310

**DIRECT READING.
ZERO CURRENT DRAIN.**

THREE SECONDS PERIOD.

LAMP OPERATES FROM MAINS OR 4 VOLT BATTERY.

BRIGHT SPOT-AND-HAIRLINE INDICATOR.

This instrument introduces a completely new conception of electrostatic voltmeter. It is compact, portable and robust, and does not require critical levelling or special mounting. The movement has a taut suspension, is critically damped, and readings can be taken with rapidity and ease. Three models are available:

Cat. No. E.E. 11308
1 - 5 kV A.C. D.C.
Cat. No. E.E. 11309
3 - 10 kV A.C. D.C.
Cat. No. E.E. 11310
5 - 18 kV D.C. and
5 - 12 kV A.C. R.M.S.

Please write for illustrated leaflet.

SCIENTIFIC  INSTRUMENTS

W. G. PYE & CO. LTD., GRANTA WORKS, CAMBRIDGE

THE HARVEY POWER UNIT

DC Output Stabilised 200-350V 0-120 mA
AC Output Unstabilised 0.4-0.6-3V 3A

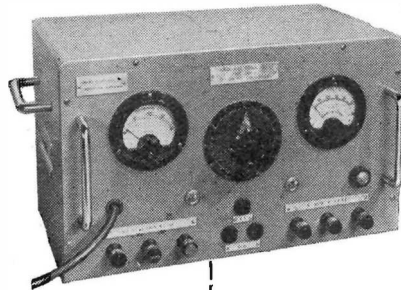

A piece of High Quality Equipment designed for general laboratory use at a moderate price

Delivery from stock. Available for rack mounting if desired. Write or phone NOW for details.

HARVEY ELECTRONICS LTD.

Precision Mechanical and Electrical Engineers

273, Farnborough Road, Farnborough, Hampshire.

Telephone : FARNBOROUGH 1120

Graham Gear Co Ltd

**SPURS
SPIRALS
BEVELS
8-100 D.P.**

**STATION ROAD
BROOKMANS PARK, HERTS.
Tel:- HATFIELD 3130**

ABOVE ALL OTHERS

POTTED AND COMPOUND FILLED TRANSFORMERS AND CHOKES

made by Woden are the answer when the call is for transformers to operate under exacting industrial conditions, coupled with adverse climatic conditions.

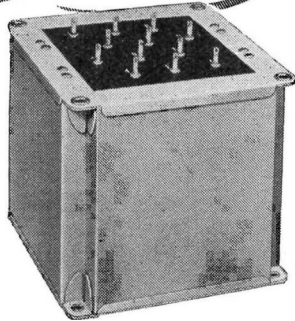

Every transformer leaving our factory is subjected to a rigid inspection, and is fully impregnated with moisture proof filling compound by the latest vacuum and pressure process. The fact that "WODEN" are the choice of many leading radio and television manufacturers is proof enough of the quality of our products.

Please send for latest Catalogue.

WODEN TRANSFORMER CO LTD

MOXLEY ROAD, BILSTON, STAFFS.

TELEPHONE : BILSTON 41959

The LATEST and IMPROVED TAPE

For all popular tape recording machines

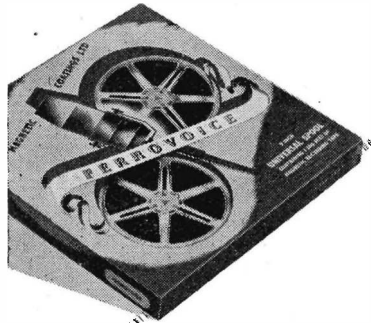

NOTE THESE OUTSTANDING FEATURES:

- Twin track recording with uniform response.
- High play-back level and low noise component.
- Lightweight precision balanced spool.
- Ferrovoice spools keep wear, tear and rotation noise to a minimum.

FERROVOICE REGO

Trade enquiries invited.

MAGNETIC COATINGS LTD, 38 GROSVENOR GARDENS LONDON SW1. Phone SLOane 9129

Specially wound on transparent perfectly balanced plastic spools which fit all popular types of tape recorders. FERROVOICE improves the performance of all recorders. Provides twin-track recording of the highest standards of quality and faithfulness. Tape wear and rotation noises are reduced to the minimum. Ferrovoice gives the highest standards of recording and reproduction.

Technical features:—
Tape width 0.247 in. ± 0.001 in. Medium coercivity — ease of erasure — frequency response 50 c/s to 10 Kc/s at $7\frac{1}{2}$ in. per sec.

PRICE
22/6
RETAIL

The Tape YOU will ultimately use

L. WILKINSON WHOLESALE AND EXPORT
19, LANSDOWNE ROAD, CROYDON

Phone : CRO 0839

Telegrams : "WILCO" CROYDON

Racks, Standard P.O. type for 19 in. panels, 6 ft. high, steel channel sides and heavy angle base. We also stock the angle type.

Relays, P.O. type 3000 or 600, quotation by return. Please state resistance of coil required and contact build-up.

Relays, Siemens' High Speed 2×100 ohms or 2×1700 ohms 15/- each. Many other types of Relays in stock.

Key Switches, P.O. type 212 or 215, available from stock in quantity at 5/- each.

Rectifier Units, Input 110/220 volts A.C. Output 140/200 volts 2 amp. D.C. in 20-volt steps, in metal cabinet $30 \times 19 \times 18\frac{1}{2}$ in., with 0/3 ammeter, fuses, switches, sliding resistance. £35 carriage extra.

Rectifier Unit, P.O. type. Input 200/250 volts A.C. Output 50 volts 0.75 amps D.C. Westinghouse. 70/-, carriage 10/-.

Jacks, Bakelite Igranite, P.73

Variac Transformers, Type 80 CO. Input 200/240 volts. Output 220 v. 7.5 amps. £7 10s. each.

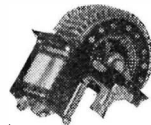

MAGNETIC RELAYS



BUILT TO YOUR SPECIFICATION

Speedy Deliveries of Types:—P.O. 600 and 3000, Siemens High Speed, A.C. Relays 6 to 400 volt

LARGEST EX-GOVT. STOCK IN GT. BRITAIN

Unselector Switches, Telephone Switchboards, Telephone Components, Plugs, Jacks, Handsets — Government Contractors.

JACK DAVIS (RELAYS) LTD. (Dept. E.E.)

36 PERCY STREET, LONDON, W.1

Phones : MUSeum 7960, LANgham 4821

THE LATEST in AIR DIELECTRIC TRIMMERS

Encased in acetate container for extra protection

Width: 16.5 m/m. Length: 22 m/m. Height: 1.5 to 8pF—7.5 m/m. 1.5 to 20pF—10 m/m. 2 to 26pF—11 m/m. 2 to 32pF—12 m/m. Law: Straight line capacity. Power Factor: Less than .001. Insulation: Over 2000 megohms. Voltage: 500 D.

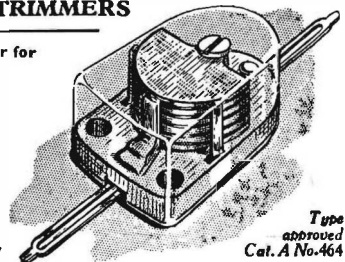

Type approved Cat. A No.464

OXLEY DEVELOPMENTS CO. LTD.

ULVERSTON, NORTH LANCs. TEL: ULVERSTON 3306

"SPEARETTE"

MINIATURE VALVE RETAINING CLIPS

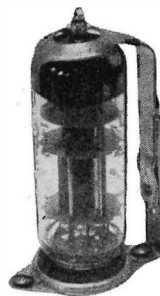

Types available for B7G and B9A base Valves

SPEAR ENGINEERING Co. Ltd.

WARLINGHAM, SURREY

Phone : Upper Warlingham, 2774

DECALS

THE MODERN TRANSFER FOR MARKING CONTROL PANELS ON RADIO AND ELECTRONIC EQUIPMENT

Bold white lettering $\frac{1}{8}$ " high · Supplied in books of six pages totaling 500 different words or equivalent in letters or numerals · Covers various branches of electronics · For Research Labs. · Repair Establishments · Amateurs

CONVENIENT · EFFECTIVE · INEXPENSIVE

Price 4/9 per book. (Post 3d.)

ALEXANDER EQUIPMENT LTD.
CHILDS PLACE, EARLS COURT, S.W.5

Phone :—FRO 6762

FIRE! WHERE'S YOUR NU-SWIFT?

The World's Fastest Fire Extinguishers
— for every Fire Risk

Pressure-operated by sealed CO₂ Charges

NU-SWIFT LTD. · ELLAND · YORKS

In Every Ship of the Royal Navy

'Radiospares' Quality Parts

The
Service Engineer's
First Choice



POTENTIOMETERS

Wire-wound and Composition types. Single, Ganged, Tandem Units. Characteristics: linear, log., semi-log., non-inductive, etc. Full details on request.

RELIANCE

RELIANCE MNFG., CO. (SOUTHWARK), LTD.,

SUTHERLAND ROAD, HIGHAM HILL, WALTHAMSTOW, E.17.

Telephone: Larkwood 3245

SCREENED CONNECTORS

for cables of 0.2" to 1.03" O.D.
Single and multi-way types.
Special types fitted with coupling rings.
Cable joining connectors.

U.S. Type Connectors as illustrated.

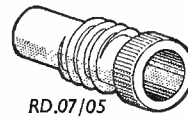
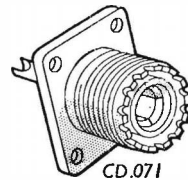
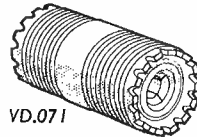
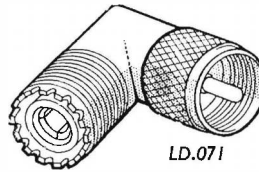
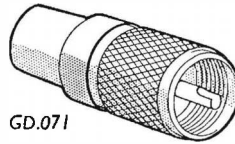

CABLE O.D.	TYPE	CODE NO.
0.41"	Straight plug	GD.071
0.25"	Reducing adaptor	RD.07/05
0.2"	Reducing adaptor	RD.07/03
fits on GD.071 CD.071 VD.071	Elbow plug adaptor	LD.071
fits on GD.071 LD.071	Bulkhead (Junction) adaptor	VD.071
fits on GD.071 LD.071	Chassis receptacle	CD.071

Other Transradio specialised products:

CO-AX air-spaced articulated

Very Low Loss Cables.

Microdual Two-speed Precision Drives.

TRANSRADIO LTD

138A CROMWELL ROAD, LONDON, SW7, ENGLAND

Telephone: FREmantle 4421 (P.B.X.)

BRADMATIC

LIMITED

Bradmaster Model 5 Tape Desk

Two speeds, 3½ and 7½ I.P.S. Double track. Three heavy duty motors. Fast wind and rewind without unlacing. New type Servo Band Brakes. Push Button Control. Three separately shielded heads. Takes 7 inch 1,200 ft. reels. Dimensions: 13½" x 15½" x 6½" deep.

Price: Fitted with 6RP heads — — £42/0/0

Price: Fitted with SRP heads — — £41/0/0

Bradmaster Model 5c Tape Desk

Takes 9½" 2,250 ft. reels. Double track. Larger Reel Motors. Programme time: 55 mins. @ 7½ I.P.S. 110 mins. @ 3½ I.P.S. Dimensions as Model 5.

Price (with 6RP Heads) Standard size panel — £45 10 0

Price (with 6RP Heads) Large panel 20" x 14½" £47 10 0

A recorded frequency range of 50-11,000 c.p.s. at 7½ inches per second can be obtained by using a Model 5 Tape Desk with a type A1 recording amplifier utilising a Williamson or similar high quality main amplifier for playback.

Portable Recorders

In rexine-covered case, fitted with model 5 Tape Desk (6RP heads) and C.J.R. type D.1 amplifier with monitoring. Provision for external loudspeaker. Complete with microphone and leads.

Price £119.15.0

High Fidelity Sound Heads, Type 5RP (record play) £3/5/0. Type 6RP (Super Fidelity), £3/15/0. Type 5E (Erase), £3/5/0. Scotch Boy, E.M.I. tape, 35/- per reel; G.E.C. tape, 30/- per reel. Gevasonor (Belgian), 35/- per reel. Amplifiers and Microphones. Now available: All Mumetal Screening Cans suitable for Bradmatic Heads, 8/6 each.

Trade supplied.

Send for Lists.

BRADMATIC LIMITED

STATION ROAD · ASTON · BIRMINGHAM 6

Phone: EAST 0574 Grams: Bradmatic, Birmingham

FREE

A VALUABLE BOOK

NEW!

Home Experimental Kits now form part of the following courses: Draughtsmanship, Carpentry, Chemistry, Photography, Commercial Art, Radio and Electronics, etc.

E.M.I.

INSTITUTES
associated with
MARCONIPHONE
COLUMBIA &
H.M.V.

(His Master's Voice)

COURSES FROM
£1
PER MONTH

which details the wide range of Engineering and Commercial courses of modern training offered by E.M.I. Institutes — the only Postal College which is part of a world-wide Industrial Organisation.

Courses include training for: City and Guilds Grouped Certificates in Telecommunications; A.M. Brit. I.R.E. Examination, Radio Amateur's Licence, Radio & Television Servicing Certificates, General Radio and Television Courses, Radar, Sound Recording, etc. Also Courses in all other branches of Engineering.

POST NOW

Please send, without obligation the FREE book E.M.I. Institutes, Dept. 11K 43 Grove Park Rd., Chiswick, London, W.4

Name
Address

TC.10EX

"SANOID" FIRST AID

For over fifty years we have studied and supplied the specialised First Aid requirements of Industry. We believe our efforts have been of advantage to those we are privileged to serve, as on many occasions we have been able to meet the particular needs of various industries and conditions.

May we help you? Our wide experience is at your service, and we should be pleased to send you our current catalogue and price list.

A PRODUCT OF
Cuxson Gerrard & Co. Ltd.
OLDBURY BIRMINGHAM

FIRST AID SPECIALISTS
ESTABLISHED 1878

High-class equipment needs
the best components

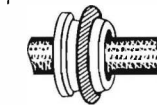

The Insuloid
"RING LOCK"
Cable Bush



The Insuloid
"PLASKLIP"
Cable Clip

Such
as
these

APPROVED FOR SERVICE USE
INSULOID MANUFACTURING Co. Ltd.
SHARSTON WORKS, LEESTONE AVENUE
WYTHENSHAW, MANCHESTER
Tel.: Wythenshawe 2842

P.3



Dept. E.E.

18 TOTTENHAM
COURT ROAD,
LONDON, W.1.

Tel.: MUSeum 2453/4539

Business Hours: Monday-Friday 9—5.30 Saturday 9—1

RELAYS

D.C. COIL RESISTANCE

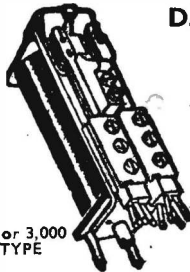

600 or 3,000
TYPE

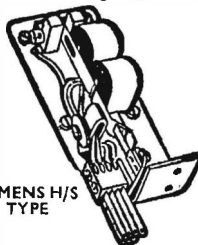

SIEMENS H/S
TYPE

3,000 TYPES: 1.9Ω to 80,000Ω
600 TYPES: 0.4Ω to 9,200Ω.

ALSO LARGE STOCKS OF
DOUBLE & TRIPLEWOUND
AND SLUGGED COILS.

CONTACTS

3,000 TYPES: up to 8 sets.
600 TYPES: up to 4 sets.
3,000 TYPES: Make (M), Break (B), in Twin-silver, Twin-platinum, Dome-silver (2 amp.), Tungsten (5 amp.), and Flat-silver (8 amp.). Charge-Over (C), in all but Tungsten: Make-Before-Break (K), in Twin-silver and Twin-platinum.

600 TYPES: (M), (B) and (C), in Twin-silver and Twin-platinum.

SPECIAL
High resistance slugged coils (up to 10,000 OHMS with 1" slug) now available.

ARE

MAGSLIPS
SELSYNS

words at the back of your mind? Then why not write to:
SERVOTRONIC SALES (Incorporating HOPTON RADIO),
1, Hopton Parade, High Road, Streatham, London, S.W.16,
for their Price List and technical data? or better, ring STReatham 6165?



HIFI LTD., 150, HIGH STREET, LYE,
STOURBRIDGE, WORCS. Telephone: LYE 261

A. C. FARNELL LTD.

15 PARK PLACE

LEEDS, 1.

Offer the following Instruments from stock

COSSOR	Oscillographs 1035 and 1049. Oscillograph camera and drive units. Oscillograph Trolleys and Telecheck 1320.
WAVEFORMS	'Radar' Vid. & Sync. Generator and Kilovoltmeter
ADVANCE	R.F. Signal Generators E2, B4A, D1 and J1 Audio. 60 and 150 watt Constant Voltage Transformer.
AVO	Wide Range Signal Generator. Model 8, Model 7 and E.T.M.
MULLARD	High Speed Valve Tester.
DAWE	Strobeflash, Strobotorch, Sound Level Meter, Vibration Meter, Moisture in Timber Meter.
MSS	PMR/I Tape Recorder.
TELEQUIPMENT	WG4 Waveform Generator.

Telephone: Leeds 32958/9

HIGH PURITY

GERMANIUM DIOXIDE

(GeO₂)

Manufactured by

ELGAR LABORATORIES

(ELGAR TRADING LTD.)

240 High St., Harlesden,
London, N.W.10, England.

Cables: ELGATRAD, LONDON

MOULDINGS

(Thermo Setting)

SPECIALISTS to Electrical
and Radio Trades

Large or small quantities
to your Specification

MOULDS MADE IN OUR
TOOL ROOM

Established 1928

HARRISON BROS

(PLASTICS) LIMITED

39-43, BRANSTON ST. BIRMINGHAM 18

'Grams: Arisun Birmingham

'Phone: COLmore 4270

POWER Transformers

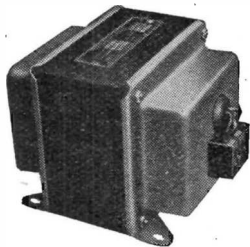

10VA to 100kVA Open,
Enclosed, Oil Cooled,
D.W. and Auto

For Industrial Engineering,
Furnaces, Electronics, Phase
Conversion, etc.

THE TRANSFORMER & ELECTRICAL CO. LTD

Eastern Works, Walthamstow, London, E.17

Phone: KEYstone 5031/2

BRASS, COPPER, BRONZE,
ALUMINIUM, LIGHT ALLOYS
IN ROD, BAR, SHEET TUBE, STRIP, WIRE

3000 STANDARD STOCK SIZES

H. ROLLET & CO., LTD.

6 CHESHAM PLACE, LONDON, S.W.1.

SLOane 3463

WORKS:

36, ROSEBERY AVENUE, LONDON, E.C.1

"No Quantity too Small"

also at

Liverpool - Manchester - Birmingham - Leeds

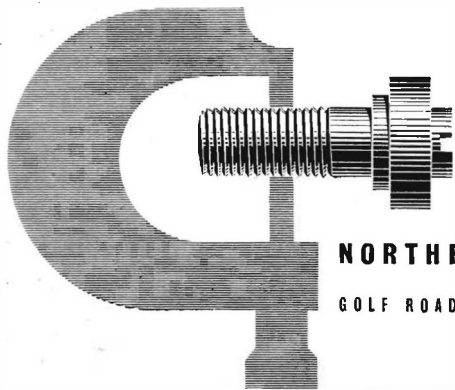

CONSISTENT ACCURACY...

...in precision auto-turned parts

Trouble-free assembly is guaranteed by first class workmanship
and modern plant.

For the quantity production of parts turned to your own
specification, up to a maximum diameter of 1 1/4", send to...

NORTHERN AUTOMATIC SCREW CO. LTD.

GOLF ROAD · HALE · ALTRINCHAM · CHES · PHONE · ALT · 2184 · 2497



INDEX TO ADVERTISERS

A.B. Metal Products Ltd.	15	English Electric Co., Ltd., The	13	Oxley Developments Co., Ltd.	74
Acheson Colloids Ltd.	55	Enthoven & Sons Ltd., H. J.	36, 37 and 53	Painton & Co., Ltd.	19
Advance Components Ltd.	27	Eric Resistor Ltd.	Cover iii	Parmeko Ltd.	5
Aero Research Ltd.	18	Evershed & Vignoles Ltd.	26	Partridge Transformers Ltd.	8
Air Control Installations Ltd.	14	Farnell Ltd., A. C.	77	Patterson & Partners Ltd., Henry A.	69
Airmec Laboratories Ltd.	22	Garrard Engineering & Manufacturing Co., Ltd., The	63	Pye & Co., Ltd., W. G.	73
Alexander Equipment Ltd.	75	General Electric Co., Ltd., The	49	Radio Resistor Co., Ltd.	34
All-Power Transformers Ltd.	56	Graham Gear Co., Ltd.	73	Radiospares Ltd.	75
Automat Co., Ltd.	70	Griffiths, Gilbert, Lloyd & Co., Ltd.	60	Ragosine Oil Co., Ltd.	71
Autoset (Production) Ltd.	57	Guest, Keen & Nettlefolds (Midlands) Ltd.	44	Redifon Ltd.	10
Baldwin Instrument Co., Ltd.	60	Haddon Transformers Ltd.	72	Reliance Mfg. (Southwark) Ltd.	75
Belling & Lee Ltd.	20	Hairlok Co., Ltd., The	72	Resinoid & Mica Products Ltd.	62
Bradmatic Ltd.	75	Harrison Bros. (Plastics) Ltd.	77	Ritherdon & Co., Ltd.	72
Bray & Co., Ltd., George	70	Harvey Electronics Ltd.	73	Rivlin Instruments	59
British Driver-Harris Co., Ltd.	67	Hifi Ltd.	76	Rollet & Co., Ltd.	77
British Electric Resistance Co., Ltd.	57	Hivac Ltd.	71	Salford Electrical Instruments Ltd.	28
British Insulated Callender's Cables Ltd.	Cover i	Hunton Ltd.	69	Salter & Co., Ltd., George	42
British Iron & Steel Federation	12	Insuloid Manufacturing Co., Ltd.	76	Scott & Co., Ltd., A. C.	44
British Physical Laboratories Ltd.	66	Isotope Developments Ltd.	65	Servotronic Sales	76
British Rubber Development Board, The	64	Johnson, Matthey & Co., Ltd.	41	Solartron Laboratory Instruments Ltd.	7
British Thomson-Houston Co., Ltd.	11	Kelvin & Hughes Ltd.	62	Speare Engineering Co., Ltd.	74
Castle Engineering Co. (Nottingham) Ltd., The	78	Labgear (Cambridge) Ltd.	3	Spencer & Sons (Market Harboro') Ltd.	7
Chapman & Hall Ltd.	85	Leland Instruments Ltd.	Cover iv	Standard Telephones & Cables Ltd.	17, 29 and 51
Cinema-Television Ltd.	16	Linread Ltd.	24	Sugg & Co., Ltd., William	66
Connolly's (Blackley) Ltd.	48	Lyons Ltd., Claude	73	Taylor, Tunnickiff (Refractories) Ltd.	33
Cuxson, Gerrard & Co. Ltd.	76	Magnetic Coatings Ltd.	74	Telegraph Construction & Maintenance Co., Ltd., The	58 and 61
Darwins Ltd.	58	Marconi Instruments Ltd.	25	Transformer & Electrical Co., Ltd., The	77
Davis Supplies Ltd., Alec	76	Marconi's Wireless Telegraph Co., Ltd.	45	Transradio Ltd.	67 and 75
Davis (Relays) Ltd., Jack	74	Measuring Instruments (Pullin) Ltd.	58	Truvox Ltd.	69
De Havilland Aircraft Co., Ltd., The	52	Metropolitan-Vickers Electrical Co., Ltd.	30	Tufnol Ltd.	9
Donovan Electrical Co., Ltd.	72	Micanite & Insulators Co., Ltd.	35	Twentieth Century Electronics Ltd.	43
Edison Swan Electric Co., Ltd., The	Cover ii and 46	Minnesota Mining & Manufacturing Co., Ltd.	56	Unbrako Socket Screw Co., Ltd.	38
Edwards & Co. (London) Ltd., W.	68	Mond Nickel Co., Ltd.	50	United Insulator Ltd.	10
Egen Electric Co., Ltd.	65	Muirhead & Co., Ltd.	31	Venner Ltd.	39
Elco Plastics Ltd.	78	Mullard Ltd.	23, 40 and 61	Vortexion Ltd.	47
Electro-Alloys Ltd.	71	Murex Ltd.	63	Wayne-Kerr Laboratories Ltd.	68
Electro-Methods Ltd.	64	Nagard Ltd.	70	Whiteley Electrical Co., Ltd.	3
Electronic Engineering Monographs	59 and 85	Northern Automatic Screw Co., Ltd.	77	Wiggin & Co., Ltd., Henry	54
Elgar Trading Ltd.	77	Nu-Swift Ltd.	75	Wilkinson, L.	74
E.M.I. Factories	21			Woden Transformer Co., Ltd.	74
E.M.I. Institutes Ltd.	76			Wright, Bindley & Gell Ltd.	54



THERMOPLASTIC
& THERMOSETTING

Precision Mouldings

Quick Deliveries

**TOOL MAKERS - MOULDERS - ASSEMBLERS
AND LAMINATED TUBE MAKERS**

ELCO

Plastics Ltd.

& TUBE LAMINATION LTD

DESBOROUGH PARK ROAD,
HIGH WYCOMBE, BUCKS.

Telephone: High Wycombe 1921/2



*... It's surprising
where you find them*

The list of "Castle" Components knows no limit. Whatever your needs may be — in Repetition work in all Metals — we can meet them exactly. Machining and Light Assemblies, too. *Send for brochure.*



**THE
CASTLE ENGINEERING
COMPANY (NOTTINGHAM) LIMITED**

HASLAM STREET • CASTLE  BOULEVARD • NOTTINGHAM

6133

ERIE

High Stability Resistors

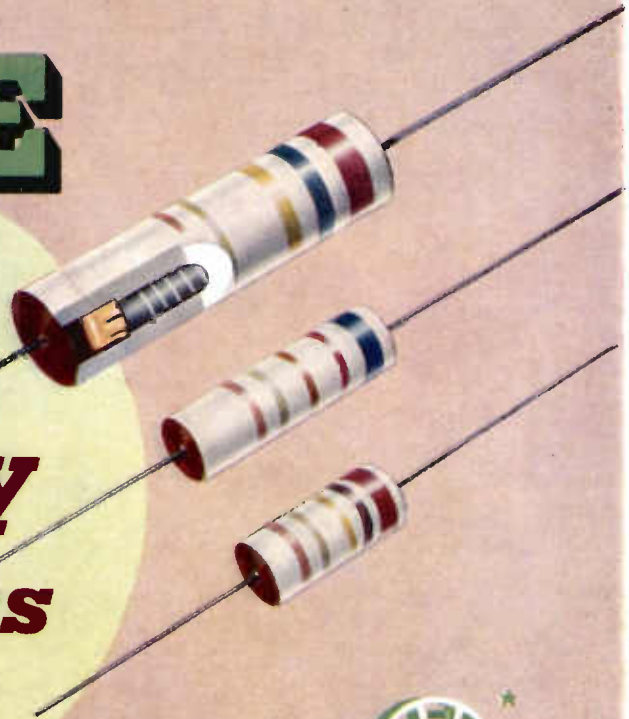

THE ONLY HIGH STABILITY RESISTOR IN THE WORLD in which the supersensitive cracked carbon film is free from direct contact with paints, lacquers and other finishes which have a detrimental effect under extremes of temperature.

THE ONLY HIGH STABILITY RESISTOR IN THE WORLD which has an effective vitrified barrier which protects the film and gives complete freedom from soldering troubles, and from damage in transit, in handling and in assembly.

ERIE* fully protected high stability resistors are fully type approved by the R.C.S.C., whose tests not only confirm that all their characteristics are well within the specified limits, but also reveal that, in particular, they have an average noise-level of 0.1 microvolts per D.C. volt applied and a maximum noise-level of only 0.2 microvolts as against the permitted maximum of 0.5 microvolts.

FURTHERMORE, their over-all stability is such that there is no need to order a closer tolerance than the application actually demands.

TYPE	MAX. PEAK VOLTS D.C.	RATING AT 85° C.	RESISTANCE RANGE OHMS	R.C.S.C. STYLE	R.C.S.C. TYPE APP. CERT.	APPROVED RESISTANCE RANGE OHMS	DIMENSIONS MAX.	
							LENGTH	DIA.
100	500	$\frac{1}{4}$ watt	10-3 Meg.	RC3M	525/3	10-1 Meg.	1.300"	0.375"
108	325	$\frac{1}{2}$ watt	25-1 Meg.	RC3N	592/3	27-1 Meg.	0.800"	0.255"
109	250	$\frac{3}{4}$ watt	100-510,000 ohms	RC3L	626/2	100-510,000 ohms	0.540"	0.255"

STANDARD TOLERANCES $\pm 1\%$, $\pm 2\%$, $\pm 3\%$, $\pm 4\%$, $\pm 5\%$ and $\pm 10\%$.

ERIE* Resistor Ltd

* Registered Trade Marks

ERIE Resistor Limited, Carlisle Road, The Hyde, London, N.W 9 Tel: COLindale 8011

Factories: London and Great Yarmouth: Toronto, Canada: Erie, Pa., U.S.A.

Leland Ceramic Condensers

The background of the advertisement is a close-up photograph of a metal surface with a vertical ribbed texture. Scattered across this surface are several different types of ceramic capacitors. Some are cylindrical with labels like 'LCC', '7500V', '500 P', and '100'. Others are smaller, disc-like components. In the lower-left corner, there is a row of several small, pointed metal components, possibly trimmer capacitors or related parts.

LELAND PRECISION CERAMIC CONDENSERS

are now available from stock in a wide variety of types :

- ★ **TEMPERATURE COMPENSATING TYPES** in a range of closely controlled Temperature Coefficients both positive and negative, approved by Ministry of Supply for Services equipment.
- ★ **HIGH-K RANGE** includes miniature tubes, plates and special purpose chassis mounting types.
- ★ **BROADCAST RECEIVER AND TELEVISION SERIES** includes fixed, variable and pre-set trimmer types in a wide range of sizes and values.
- ★ **TRANSMITTER TYPES** of high power-handling capacity in a variety of extremely compact pots, plates and tubes for mounting in air or oil.

Enquiries for standard and special types invited.

LELAND
INSTRUMENTS LTD

23 MILLBANK • WESTMINSTER • LONDON • S.W.1