

Electronic Engineering

NOVEMBER 1951

A MOULDED-ON COUPLER

with 23 contacts

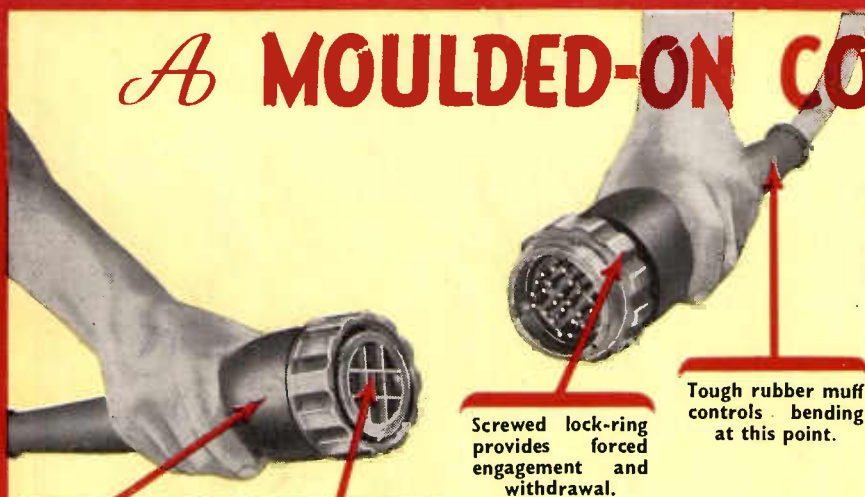

Contacts secured by Polythene injection moulding in gun-metal shell.

Group screening designed to suit individual requirements.

Screwed lock-ring provides forced engagement and withdrawal.

Tough rubber muff controls bending at this point.



As the smallness of the ingeniously designed BICC Multicore Camera Trailing Cable is made possible by the use of solid conductors, this moulded-on coupler was developed mainly to overcome end breakage, which otherwise would be a serious problem with this type of cable. But the unique design of this coupler presents other advantages—it ensures reliable contact, adequate screening and great mechanical strength, leading to a long and trouble-free life.

BICC T/V Camera Cables with moulded-on couplers have satisfactorily withstood arduous service on BBC T/V Cameras.

POLYPOLE CABLE COUPLER

BRITISH INSULATED CALLENDER'S CABLES LIMITED
NORFOLK HOUSE, NORFOLK STREET, LONDON, W.C.2

TWO SHILLINGS

The core of the Motor is the Electrical Stamping



 SANKEYS...
ARE THE LARGEST
MANUFACTURERS
OF ELECTRICAL
STAMPINGS IN
EUROPE



**SANKEYS
"STALLOY" &
"LOHYS"**
Electrical Sheets
are Rolled at
The MANOR WORKS

JOSEPH SANKEY & SONS LTD.

ESTABLISHED 1834

BANKFIELD WORKS, BILSTON STAFFS, ENG.

TELEGRAMS - SANKEY - BILSTON

LONDON OFFICES: ULSTER CHAMBERS, 160 REGENT STREET W 1.

CLASSIFIED ANNOUNCEMENTS

The charge for these advertisements at the LINE RATE (if under 1" or 12 lines) is: Three lines or under 7/6, each additional line 2/6. (The line averages seven words.) Box number 2/- extra, except in the case of advertisements in "Situations Wanted," when it is added free of charge. At the INCH RATE (if over 1" or 12 lines) the charge is 30/- per inch, single column. Prospectuses and Company's Financial Reports £140s. 0d. per column. A remittance must accompany the advertisement. Replies to box numbers should be addressed to: "Electronic Engineering," Morgan Bros. (Publishers), Ltd., 28, Essex Street, Strand, London, W.C.2. Advertisements must be received before the 14th of the month for insertion in the following issue.

OFFICIAL APPOINTMENTS

ADMIRALTY. Applications are invited from Engineering, Electrical and Ship Draughtsmen for temporary service in Admiralty Departments at Bath. Candidates must be British subjects of 21 years of age and upwards, who have had practical Workshop and Drawing Office experience. Salary will be assessed according to age, qualifications and experience within the range £320-£545 per annum. Applications giving age and details of technical qualifications, apprenticeship (or equivalents) Workshop and Drawing Office experience, should be sent to Admiralty (C.E.II, Room 88), Empire Hotel, Bath. Candidates required for interview will be advised within two weeks of receipt of application. W 137

ADMIRALTY. Vacancies exist for Electrical and/or Mechanical Engineering Draughtsmen in Admiralty Research and Development Establishments located in the vicinity of Weymouth, Portsmouth, Teddington (Middlesex) and Balclock, Herts. Draughtsmen experienced in light current, electro-mechanical, precision mechanical and electronic equipment are particularly needed. Candidates must be British subjects of 21 years of age and upwards, who have had practical workshop experience (preferably an apprenticeship) together with Drawing Office experience. Appointments will be in an unestablished capacity, but opportunities may occur for qualified staff to compete for established posts. The salaries offered depending on age, experience, ability and place of duty will be within the range £320-£560 p.a. Hostel accommodation is available at some Establishments. Applications, stating age and details of technical qualifications, apprenticeship (or equivalents) Workshop and Drawing Office experience, should be sent to Admiralty (C.E.II, Room 88) Empire Hotel, Bath, quoting DM/R.D. Original testimonials should not be forwarded with application. Candidates required for interview (at London or Bath whichever is nearer) will be advised within two weeks of receipt of application. W 2111

ADMIRALTY: Electrical Engineers. The Civil Service Commissioners invite applications from men for six vacancies. The posts are pensionable. Candidates must have been born on or before 1st August, 1921. They must have a University Honours Degree in Engineering or equivalent qualification and a minimum of two years practical training followed by eight years practical experience in a responsible Electrical Engineering post, or such other experience as the Commissioners consider equivalent. Salary Scale £850-£1,150 for posts in London—somewhat lower in the provinces. The salary scale is at present under review and would not be less than £900 to £1,200 for posts in London. Full particulars and application forms from the Civil Service Commission, Scientific Branch, Trinidad House, Old Burlington Street, London, W.1, quoting No. S 210/51. Completed application forms must be returned by 15th November 1951. W 2206

ADMIRALTY: Principal Scientific Officer. The Civil Service Commissioners invite applications for a permanent appointment in the Royal Naval Scientific Service for temporary assignment to the staff of the British Joint Services Mission, Washington, U.S.A. Candidates must possess either a First or Second Class Honours Degree in Physics or Engineering or be corporate members of one of the professional institutions or able to produce evidence of outstanding qualifications and experience for this post. Sound knowledge of the radio valve industry in this country including manufacturing techniques and the development of commercial radio valves is essential and knowledge of the industry in the U.S.A. will be an advantage. The officer appointed will also be expected to familiarize himself with development work in this country and with Service requirements, and to make effective contact with the technical staffs of the American Service and industry. Candidates must have been born on or before 1st August 1920. Inclusive London salary scale (men) £1,000-£1,375; (women) £880-£1,200. Exceptionally a starting salary above the minimum may be granted according to qualifications and experience. In addition to the normal emolu-

ments of the grade the usual mission allowance will be paid. The post is superannuable under the Federated Superannuation System for Universities. Further particulars and application forms from Secretary, Civil Service Commission, Scientific Branch, Trinidad House, Old Burlington Street, London, W.1, quoting No. S 4078/51. Completed application forms must be returned by 15th November 1951. W 2169

ADMIRALTY. Draughtsmen experienced in electrical engineering techniques are required for temporary service in the Electrical Engineering Department, Admiralty, Bath. Candidates must be British subjects and have served an apprenticeship or had equivalent workshop experience together with Drawing Office experience. Promising candidates who fulfil these conditions but lack sufficient Drawing Office training will be given a course of training in drawing and allied subjects at the Bath Technical College. Fees for the course will be paid by the Admiralty and trainees will be paid their normal salaries during the training period. Salary will be assessed according to age, qualifications and experience within the range £320 to £545. Minimum of range is linked to age 21. Applications stating age, details of technical qualifications and apprenticeship (or equivalent) and Drawing Office experience should be sent to the Admiralty, Empire Hotel (C.E.II, Room 88), Bath. Candidates selected for interview will be advised within two weeks of receipt of application. W 2168

ADMIRALTY. Vacancies exist in the Electrical Engineering Department, Admiralty, Bath, for Temporary Technical Class Grade III officers experienced in production methods and/or estimating and costing. Candidates must be British subjects and have served an apprenticeship or had equivalent workshop experience followed by experience in one or more branches of electrical engineering manufacture. Possession of Ordinary National Certificate is desirable. Salary will be assessed according to age, qualifications and experience within the range £437-£545. Minimum of range is linked to age 26 and a deduction of approximately £20 per annum is made for each year below that age. Applications stating age, details of technical qualifications and apprenticeship (or equivalent) and workshop experience should be sent to the Admiralty, Empire Hotel (C.E.II, Room 88, Section E.E.D.), Bath. Candidates selected for interview will be advised within two weeks of receipt of application. W 2166

ASSISTANT (SCIENTIFIC) CLASS: The Civil Service Commissioners give notice that an Open Competition for pensionable appointment to the basic grade will be held during 1951. Interviews will be held throughout the year, but a closing date for the receipt of applications earlier than December 1951, may eventually be announced either for the competition as a whole or in one or more subjects. Successful candidates may expect early appointments. Candidates must be at least 17½ and under 26 years of age on 1st January 1951, with extension for regular service in H.M. Forces, but other candidates over 26 with specialized experience may be admitted. All candidates must produce evidence of having reached a prescribed standard of education, particularly in a science subject and of thorough experience in the duties of the class gained by service in a Government Department or other civilian scientific establishment or in technical branches of the Forces, covering a minimum of two years in one of the following groups of scientific subjects: (i) Engineering and physical sciences. (ii) Chemistry, bio-chemistry and metallurgy. (iii) Biological Sciences. (iv) General (including geology, meteorology general work ranging over two or more groups (i) and (iii) and highly skilled work in laboratory crafts such as glass-blowing. Salary according to age up to 25—Men £215 (at 18) to £330 (at 25)—£455; rather less in the provinces and for women. Opportunities for promotion. Further particulars and application forms from Civil Service Commission, Scientific Branch, Trinidad House, Old Burlington Street, London, W.1, quoting No. S 59/51. Completed application forms should be returned as soon as possible. W 2222

APPLICATIONS ARE INVITED by the Ministry of Supply for the following appointments at the Atomic Energy Research Estab-

lishment, Harwell, Berks. 1, Physicists (Ref. A.266/51/A). Senior Experimental Officer to take charge of, and Experimental Officer to assist in the industrial applications of radioactive isotopes, involving complex techniques. Electronics, vacuum and/or radio-activity experience would be an advantage. 2, Chemical Engineers (Ref. F.670/51/A). Experimental Officers and Assistant Experimental Officers with experience in erection and operation of chemical plant on the pilot or semi-technical scale or in process development on the laboratory or larger scales. 3, Chemical and Metallurgical Analysis (Ref. F.670/51/A). E.N. Experimental Officers and Assistant Experimental Officers for analytical work. Two of the posts are connected with the analysis of heavy metals rare elements and their alloys. Experience of metal analysis desirable. 4, Metallurgists (Ref. F.669/51/A). Experimental Officer or Assistant Experimental Officer with experience in heat treatment to operate small vacuum melting and precision heat-treatment furnaces. A good working knowledge of normal types of temperate controllers and pyrometers is essential, and ability to use and construct vacuum systems would be an advantage. 5, Development Engineers (Ref. C.565/51/A). Senior Experimental Officer or Experimental Officer for development of special types of plant and instruments requiring remote control or for operation under onerous conditions of temperature, pressure and corrosion, e.g. pumps valves, filters, etc. Suitable experience in a chemical works. Minimum acceptable qualifications include Higher School Certificate with a science subject as principal subject, Higher National Certificate, etc.; higher qualifications, e.g. a University Degree in an appropriate subject would be an advantage. Salary will be determined on age, qualifications and experience within the ranges: Senior Experimental Officer (minimum age 35) £742-£960. Experimental Officer (minimum age 28) £545-£695. Assistant Experimental Officer £240 (at age 18)-£505. Rates for women somewhat lower. Posts are unestablished. Application forms obtainable from the Ministry of Labour and National Service, Technical and Scientific Register (K), York House, Kingsway, London, W.C.2, quoting appropriate reference number. Closing date 12th November 1951. W 2172

CHEMISTS, PHYSICISTS, Electrical Engineers and Biologists are invited by the Ministry of Supply to apply for appointments at the Tropical Testing Establishment, Port Harcourt, Nigeria. A 23/51A Senior Scientific Officer to lead a group of physicists and engineers studying the effects of tropical conditions on service materials and equipment. Candidates should have a 1st or 2nd Class Honours Degree in physics or electrical engineering or equivalent qualification and experience of radio communications or of methods of physical and mechanical testing. F 686/51A Scientific Officer to work on analytical or biochemical investigations in connexion with deterioration of equipment under tropical conditions. Candidates should have a 1st or 2nd Class Honours Degree or equivalent qualification in chemistry with experience of micro-analysis or biochemistry. G 349/51A Senior Scientific Officer or Scientific Officer to study the biological attack on materials and equipment under tropical conditions. Candidates should be biologists with a 1st or 2nd Class Honours Degree in Botany or Zoology or equivalent qualification and with post-graduate research experience in mycology, microbiology, entomology or biochemistry. For the senior grade candidates must be at least 26 years of age and have had at least 3 years post-graduate research experience. Posts A 23/51A and F 686/51A are open to men only and married quarters are available. Appointments are for an initial tour of 18 months but further tours may be arranged by mutual agreement. Consideration will be given to further employment in U.K. at the end of service in W. Africa. Salaries will be assessed on age, qualifications and experience within the following ranges: Senior Scientific Officer—£750-950. Scientific Officer—£400-£650. Rates for women are somewhat lower. The posts are unestablished but carry benefits under F.S.S.U. In addition a foreign service allowance is payable varying from £200-£350 per annum according to marital

OFFICIAL APPOINTMENTS (Cont'd.)

status. Subject to certain conditions, passages by sea from the U.K. can be provided at public expense for families. A detailed explanation will be given to candidates selected for interview. Application forms obtainable from Ministry of Labour and National Service, Technical and Scientific Register (K), York House, Kingsway, London, W.C.2, quoting the appropriate reference number. Closing date 9th November 1951. W 2183

CROWN AGENTS FOR THE COLONIES.

Assistant Inspecting Engineer (Electronic), required for duties in the United Kingdom to visit manufacturers' works to advise and assist in maintaining required standards and to carry out inspection and acceptance tests in connexion with contracts covering a wide variety of radio and electronic products. Applicants should have served an apprenticeship with a firm manufacturing radio and associated equipment and have had subsequent experience on the manufacturing and technical side of the industry. They should preferably be corporate members of the Institution of Electrical Engineers or be in a position to obtain this within two years. The salary scale is £475 x £25 to £650. The £475 minimum is linked to entry age at 25 with an addition of £25 for each year above that age up to £600. Extra duty allowance of 8% of annual salary is also payable at present. Travelling expenses and/or car mileage allowance, with appropriate subsistence allowances are paid. Engagement will be on unestablished terms with a prospect, after satisfactory service and as vacancies occur of appointment to established and pensionable staff and promotion to a higher grade. Apply at once by letter, stating age, full names in block letters and full particulars of qualifications and experience and mentioning this paper to the Crown Agents for the Colonies, 4 Millbank, London, S.W.1, quoting M.25691.B, on both letter and envelope. The Crown Agents cannot undertake to acknowledge all applications and will communicate only with applicants selected for further consideration. W 2218

ELECTRICAL AND ELECTRONIC ENGINEERS required by Ministry of Supply in London: Malvern, Worcs.; Chertsey, Surrey; Bromley and Sevenoaks, Kent; with some posts elsewhere (including Bucks. and Berks.). Qualifications: British, of British parents. Engineering apprenticeship or equivalent training and either Corporate Member of Institution of Civil, Mechanical or Electrical Engineers or Associate Fellow Royal Aeronautical Society, or appropriate professional attainments or experience. Duties: Design and development of equipment and installations or standardization or planning and progressing, or control of production or inspection of radio, radar and general electrical apparatus for airborne equipment, navigational aids, test and measuring equipment, flight instruments, air and ground communications, guided weapons, fighting vehicles, electro-mechanical and servo systems, weapons and fire control. Also general installation and maintenance of electrical equipment, plant and factory services. Salaries: Between £575 and £1,200 (London) with a few posts up to £1,450 a year, dependent on qualifications and experience. Rates in provinces and for women slightly lower. Posts are unestablished but periodical opportunities arise to compete for established pensionable posts. Paid sick leave: annual leave initially 25 days (30 in London) plus public holidays: normal working week 44 hours. Candidates' preference for a particular area will be met if possible. Applications on form from Ministry of Labour and National Service, Technical and Scientific Register (K), York House, Kingsway, W.C.2, quoting Reference No. D408/51A/E.M. W 2205

ELECTRICAL ENGINEERS and **Physicists** are invited by the Ministry of Supply to apply for appointments in the Experimental Officer Class at Experimental Establishments near Southend, Carlisle and in South Wales, for work connected with out-of-door instrumentation. 1. (A) **Physicists** or **Electrical Engineers** preferably with some knowledge of experimental range technique and procedure. For some posts a knowledge of electronics or mathematics is required—(A 262/51/A). 1. (B) and for others experience in design of electronic apparatus and interest in technical photography is desirable—(A 263/51/A). 2. **Physicist** with interest in chemistry—(A 264/51/A). 3. **Physicist** with interest in mathematics to examine experimental records obtained during trials—(A 261/51/A). Minimum acceptable qualification is Higher School Certificate with Physics as a principal subject but higher qualifications particularly to

Degree standard would be an advantage. Salary will be determined according to age, qualifications and experience within the following ranges: Senior Experimental Officer (minimum age 35) £742 to £960. Experimental Officer (minimum age 28) £545 to £695. Assistant Experimental Officer £240 (at age 18) to £505. Rates for women somewhat lower. The posts are unestablished. Application forms obtainable from Ministry of Labour and National Service, Technical and Scientific Register (K), York House, Kingsway, London, W.C.2, quoting the appropriate reference number. W 2167

ENGINEER required by Ministry of Supply in Bickley, Kent. Qualifications: British of British parentage; regular engineering apprenticeship and either be corporate member of one of the Institutions of Civil, Mechanical or Electrical Engineers, or have exempting qualifications; knowledge and experience of modern electronic engineering and practical experience in the large scale manufacture of electronic equipment and be familiar with modern processes, tooling and methods employed in the use of metals and plastics for the electronic industry. Duties: Responsible for inspection of radio fuses and some development work. Salary: £900-£1,200 p.a. Unestablished, periodical competitions for establishment. Application forms from Ministry of Labour and National Service, Technical and Scientific Register (K), York House, Kingsway, W.C.2, quoting reference No. D 435/51 A. Closing date 9th November 1951. W 2215

ESSEX EDUCATION COMMITTEE. South East Essex Technical College and School of Art, Longbridge Road, Dagenham. Laboratory Steward required in Physics laboratories mainly for radio-communications and electronics, applicant should be over 21 years of age, and able to undertake maintenance and repair of wide range of test gear. Salary £310 x £15 to £415 plus London "weighting." For forms of application apply to the Clerk to the Governors. W 2179

MINISTRY OF CIVIL AVIATION. Telecommunications Technical Officers: The Civil Service Commissioners invite applications for men for pensionable posts. Candidates must be at least 23 and under 28 years of age on 1st August 1951 with extension for regular service in H.M. Forces. They must possess (a) the Ordinary National Certificate in Electrical Engineering or (b) City and Guilds Intermediate Certificate in Telecommunications Engineering, plus City and Guilds Certificate Radio III or (c) City and Guilds Certificates Telecommunications Principles III and Radio III or (d) produce evidence of an equivalent standard of technical education. Candidates must also have had not less than 8 years' experience in an appropriate telecommunications field, including manufacturing or maintenance or operating in industry or a Government Department or the Armed Forces. The London salary scale is £400-£575 (rather less in the provinces) but to the minimum will be added £20 for each year above 23 but not exceeding age 28. Prospects of promotion. Further particulars and application forms from Civil Service Commission, Scientific Branch, Trinidad House, Old Burlington Street, London, W.1, quoting No. S 207/51. Completed application forms must be returned by 10th November, 1951. W 2177

PROFESSIONAL ENGINEERS in Government Departments. The Civil Service Commissioners announce an Open Competition to be held during 1951 for permanent appointments in many Departments of the Civil Service for a wide variety of engineering duties. Applications will be accepted at any time but not later than 31st December 1951, and selected candidates will be interviewed as soon as possible after the receipt of their Application Forms. Candidates are advised to apply as early as possible. Age Limits: Candidates must be under 35 on 30th November 1951 with extension for regular service in H.M. Forces and for established Civil Service. For appointments in the Post Office they must be 21 or over, in the Ministry of Supply, 23, and in all other Departments 25 or over on that date. Minimum Qualifications vary for different posts. Generally a University Degree in Engineering or Corporate Membership of the Institutions of Mechanical Engineers, Electrical Engineers or Civil Engineers, or passes in or exemption from Sections A and B of the corresponding Associate Membership examinations, or evidence of exceptionally high professional attainment are required. For certain posts, Corporate Membership of the Institute of Fuel by examination or the Institution of Chemical Engineers, or Graduate Membership of the Institution of

Chemical Engineers or Associate Fellowship of the Royal Aeronautical Society or an Honours Degree in Physics will be accepted instead. The salary on appointment will be fixed according to age. The salary for men aged 25 in London is £575 rising by annual increments of £25 to £750 and by £30 to £900. Salaries for women and for posts outside London are lower. There are prospects of promotion to higher grades on scales for men in London of £900-£1,200, £1,250-£1,450 and above. Further particulars and application forms from Secretary, Civil Service Commission, Trinidad House, Old Burlington Street, London, W.1, quoting No. S85/51. W 2187

TECHNICAL GRADES II AND III required by Ministry of Supply Establishment in Norfolk. Duties: Preparation of schedules of radio and radar equipments and installations involving the breaking down into assemblies, sub-assemblies and components for provisioning action; instructional memoranda on the installation of radio and radar equipment in Service aircraft. Qualifications: British, of British parentage; recognised apprenticeship followed by a few years experience in an appropriate trade and preferably possess the Higher National Certificate (Ordinary National Certificate for Technical Grades III) or City and Guilds Certificate in relevant subjects. Should be able to interpret drawings, circuit diagrams and specifications. Knowledge of Component Standardization Committee specifications and procedure an advantage. Salaries: Technical Grade II—£540-£645 p.a. (one post), Technical Grade III—£437-£545 p.a. (two posts). Unestablished, opportunities for establishment may arise. Application forms from Ministry of Labour and National Service, Technical and Scientific Register (K), York House, Kingsway, W.C.2, quoting reference No. D454/51-A. W 2225

SITUATIONS VACANT

A COST ESTIMATOR is required by the Midland Industrial Electronics Department of a well-known Company. Applicants should be of H.N.C. standard, and able to draw up equipment schedules and pre-costs. Previous experience in the electronic engineering field essential. Please write giving full details and quoting ref. IBC to Box No. W 2203.

A LABORATORY ASSISTANT required capable of taking charge of electrical and electronic equipment for a Guided Missiles Project. Duties will include calibration and minor repairs of instruments. Applicants with the necessary experience will also control Sub-standard Room and undertake design of laboratory equipment. Full particulars to Box No. W 2190.

A NEW DEFENCE PROJECT of National Importance being undertaken by a well known Aircraft Company located in the Northern Outskirts of London, offers highly paid and interesting posts for suitably qualified applicants. Vacancies exist in Senior (salaried grades) and for Junior Engineers in various categories: (a) **Physicists** with experience in electronic problems. (b) **Physicists** with experience in optical work. (c) **Electronic Engineers** with Servo-Mechanism experience. (d) **Electronic Engineers** with experience of low frequency work and measuring systems. (e) **Electrical Engineers** with experience in small motor design and development. Applicants for Senior posts should possess a good University Degree and preferably should have some industrial experience. Applicants for Junior posts should have a good industrial experience, be qualified either by City & Guilds certificate or by Inter B.Sc. Write full details, qualifications, experience, age, salary sought to Box A.C. 65489 Samson Clarks, 57-61 Mortimer Street, W.1. W 2136

A NUMBER of Senior and Junior vacancies for Radio, Radar, Electronic, Television, etc., Development, Service Engineers, Draftsmen, Wiremen, Testers, Inspectors, etc. Urgently required. 30 Television Service Engineers. Write in confidence: Technical Employment Agency, 179 Clapham Road, London, S.W.9. (BR1xton 3487). W 113

A NUMBER of vacancies exist for Electro-Mechanical Designers with a good Degree in mechanical and electrical engineering, or similar qualification, and several years' experience in a Laboratory or Factory design department. Successful candidates will be expected to work in laboratory teams or in laboratory factory

CLASSIFIED ANNOUNCEMENTS
continued on page 4

RHODIUM

for contact stability

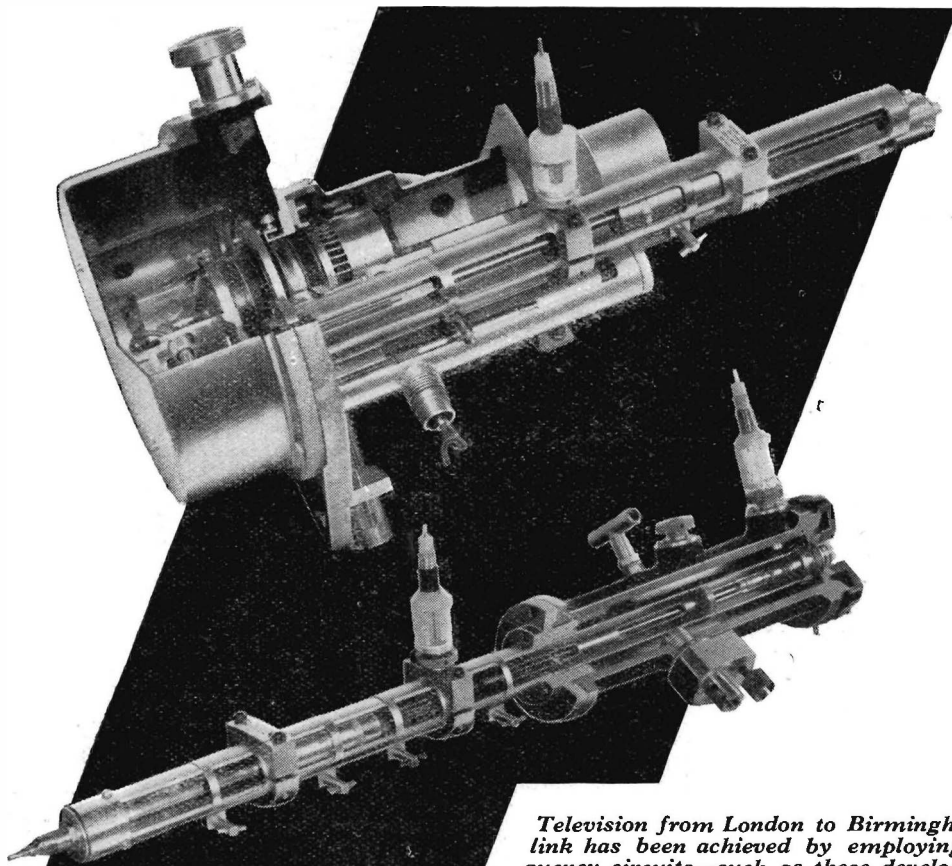

Television from London to Birmingham by radio link has been achieved by employing radio-frequency circuits—such as these developed by The General Electric Company, Ltd., which incorporate rhodium plated contact surfaces.

Electrodeposited rhodium, completely non-tarnishing and of great hardness, is an ideal protective finish and sliding contact surface for all radio- and audio-frequency applications. There is little or no loss through skin currents and the high surface finish of the deposit gives smooth operation without electrical noise due to variations in resistance.

One of the Specialised Services of

Johnson 
Matthey

The properties and applications of electrodeposited rhodium are fully discussed in data sheet 2053, available on request.

JOHNSON, MATTHEY & CO., LIMITED, HATTON GARDEN, LONDON, E.C.1
Telephone : HOLborn 9277

Birmingham : Vittoria Street, Birmingham, 1.

GD196

NOVEMBER 1951

3

ELECTRONIC ENGINEERING

SITUATIONS VACANT (Cont'd.)

teams on interesting and varied projects, and to be responsible for the mechanical design of equipment. The posts are permanent and pensionable. Salary according to qualifications and experience and consistent with present day levels. Application form from Personnel Officer, Mulard Research Laboratory, Cross Oak Lane, Salfords, near Redhill, Surrey. W 2116

A PROJECT ENGINEER is required by a well-known firm of instrument makers to direct the work of a section responsible for the layout and installation of specialized electronic equipment in aircraft. Applicants should be qualified Electrical Engineers, having experience in, and with enthusiasm for, this kind of work. They are asked to send full particulars of experience and training, stating salary required and quoting Ref. PE to Box No. W 2182.

APPLICATIONS ARE INVITED for the responsible position of flight engineer for Guided Missiles. Applicant should be of Degree standard and have practical experience of mechanical and electrical installation. Knowledge of telemetry and servo mechanisms is desirable, though not essential. North London district. Write full details, qualifications, experience, age, salary sought to Box A.C. 65692 Samson Clarks, 57-61 Mortimer Street, W.1. W 2155

A SENIOR ENGINEER is required by the Industrial Electronics Department of The English Electric Co. Ltd. for design and circuit work on valve type HF heating generators. Applicants should have good experience in this type of work or on radio transmitters. A University Degree is desirable but not essential. Please write giving full details and quoting ref. 357 to Central Personnel Services, English Electric Co. Ltd., 24/30, Gillingham Street, London, S.W.1. W 2160

A WELL-KNOWN COMPANY invites applications for the following positions in its Midlands Industrial Electronics Department: (1) R.F. Heater Design Engineer, for design and circuits work on induction and di-electric heaters. A senior man is required able to control a section. Applicants should have experience of this type of work or of radio transmitters. Preference given to those with University Degree (ref. CEG). (2) Electronic Control Gear Design Engineer, for design of Motor Controllers, Automatic Control and Servomechanisms. Experience essential, and Degree or H.N.C. an advantage (ref. GBH). (3) Electronic Instrument Design Engineer for design of instruments and sensing and control devices. Experience essential and a Degree or H.N.C. an advantage (ref. ICI). All these positions offer excellent scope for keen electronic engineers on work of considerable interest. Please apply giving full details and quoting appropriate reference No. to Box No. W 2204.

A WELL-KNOWN COMPANY requires the following Staff for its Midlands Industrial Electronics Department:—(1) A Mechanical Engineer (Design) for development work on electronic equipment. This is a senior position and applicants with a University Degree and experience of this type of work will be preferred (ref. IDJ). (2) An R.F. Heater Application Engineer for test work on sam/pes and design of applicators. Metallurgical knowledge and at least a H.N.C. considered an advantage (ref. HPH). Please write giving full details and quoting appropriate reference to Box No. W 2213.

AN ELECTRONIC ENGINEER is required by firm in the Guildford area, for development work on aircraft instruments and electronic equipment. Applicants should possess a University Degree. Higher National Certificate or equivalent qualifications, and preferably have had laboratory experience in Physics, Electrical Engineering or Instrument Technology. They should apply, giving details of qualifications, experience and required salary to Box No. W 1364.

AN INDUSTRIAL GROUP in Trafford Park invites application for a vacancy in its Research Department for research and development work connected with electrical insulation. Applicants should be of Degree or H.N.C. standard in physics, electrical engineering or mechanical engineering, with experience of experimental techniques. The salary will be according to accepted standards for scientific staff. W 2212

ASSISTANT DEVELOPMENT ENGINEER required by well-known Midland Company, preferably with Honours Degree in mechanical or

electrical engineering and with practical experience in instrument manufacture or precision engineering. Age 28/35. Salary in the order of £800 p.a. depending upon qualifications and experience. Box No. W 2209.

BELLING & LEE LTD., Cambridge Arterial Road, Enfield, Middlesex, require research assistants in connexion with work on electronic components, fuses, interference suppressors and television aerials. Applicants must be graduates of the I.E.E. or possess equivalent qualifications together with similar laboratory experience. Salary will be commensurate with previous experience. Applications must be detailed and concise, and will be treated as confidential. W 138

BUSH RADIO LIMITED require a number of Engineers and Physicists for new Research and Development Laboratories which are being formed at Plymouth. (a) A Qualified Senior Engineer for a responsible position. The applicant should have a University Degree in Physics or Electrical Engineering, or have passed the graduation examination of the I.E.E. He will be required to make preliminary theoretical investigations to initiate experimental work and to direct assistants. (b) A Senior Engineer—preferably with a good theoretical background. A successful applicant will be required to carry through to the production stage, design and development of radar and similar equipment. (c) A Transformer Designer—the applicant should be experienced in the design of small power transformers (less than kVA), chokes, audio-transformers, and pulse transformers, and will be expected to carry through to the production stage the design of power supplies and other associated equipment. Experience of servomotors and generators would be useful, but is not essential. (d) A Research Physicist or Engineer—the applicant should have a University Degree in Physics or Electrical Engineering. Ability to apply mathematics to electrical problems is required as well as a flair for experimental work in the field of electronics. Previous experience is not essential. Candidates for the posts (a) and (b) above should have had at least five years' experience in the design of electronic equipment especially in the following fields:—Pulse techniques, C.R.T. displays, telemetering equipment, microwave equipment and aerials, servo mechanisms. The Laboratory is situated in pleasant surroundings on the outskirts of Plymouth and there is a pension scheme in operation. Candidates should write giving full details and salary required to the Chief Engineer, Bush Radio Limited, Power Road, Chiswick, W.4. W 2170

CHIEF OF SALES and Contracts Section required by the North Midlands Industrial Electronics Department of a well-known Company. Commercial experience on contracts, sales statistics and correspondence and handling representatives essential. Experience in heavy or electrical engineering fields desirable. Technical knowledge whilst an advantage is not essential. Commencing salary in region of £700 per annum. Please write, giving full details and quoting ref. HBG to Box No. W 2202.

COMPETENT TECHNICIANS with experience of testing, servicing or installing radio and electronic equipment generally required by well-known firm. Ex-service personnel with radio or radar experience particularly suitable. Good salaries are offered according to age and experience. Write giving full details and quoting ref. DGF to Box No. 2198.

DEVELOPMENT ENGINEER, 25/30, education to H.N.C. or higher, for old established firm of Precision Electrical Instrument Makers in Beckenham area. The work is in connexion with electronic industrial control devices and servo mechanisms. Applicants should have experience of electronic circuit design and knowledge of light electro-mechanical apparatus and small electric motors. Applications giving full particulars of age, experience and salary required to Box No. W 2176.

DEVELOPMENT ENGINEER required for well-known firm of electrical instrument makers situated in North London. Man with good technical and mechanical knowledge for experimental work. Apply Box No. W 2211.

DEVELOPMENT ENGINEERS required for work on the following: (a) Circuit development and design on a wide range of electronic instruments. Degree in Physics or Electrical Engineering essential and some industrial experience desirable. (b) Development of pressure pick-ups and electro-mechanical transducers. Candidates should have Degree in mechanical or electrical engineering and an interest in both fields. Southern Instruments Limited, Fernhill, Hawley, Camberley, Surrey. W 1359

DEVELOPMENT ENGINEERS for Electronic and Electrical Instruments required. High priority work. Location South Wales. Pension Scheme. Salary £500 to £700 p.a. Technical qualifications and industrial experience to Box 191 C.R.C., 29, Hertford Street, London, W.1. W 2195

DRAUGHTSMEN are invited to make an appointment with E.M.I. Engineering Development Limited, to discuss the several vacancies available at their Hayes and Feltham branches. All grades of designers and draughtsmen are required for a wide range of engineering products for which their experience may be suited. Details will be sent by post on request, and/or strictly confidential interviews arranged without obligation. Posts available offer a maximum of interest, technical information and experimental facilities, and long term employment prospects with good salary to suitable applicants. Apply, giving fullest details of experience, qualifications, etc., to Personnel Department EB/A, E.M.I. Engineering Development Limited, Hayes, Middlesex. W 2071

E. K. COLE, LIMITED, have vacancies for testers at their Electronics Division. Experience in the testing of Radar, Communications or Electronics equipments to Ministry specifications, essential. Full details in writing to the Personnel Manager, Malmesbury, Wilts. W 2091

ELECTRICAL INSTRUMENT MAKER required for small quantity production of specialized instruments. Must be capable of light assembly, wiring, testing and calibration and able to work on own initiative. Technical background desirable to H.N.C. standard. Good opportunity and prospects for right man. Apply in writing to Personnel Officer, W. Edwards & Co. (London) Limited, Worsley Bridge Road, Lower Sydenham, London, S.E.26. W 2174

ELECTRONIC AND RADIO ENGINEERS. Applications are invited for the position of Field Trials Engineer to lead a team engaged in the usage and application of V.H.F. Radio-Link Systems. Practical experience desirable, but not essential. Salary according to qualifications. Write giving full details and quoting ref. DHG to Box No. W 2165.

ELECTRONIC ENGINEERS and experienced radio mechanics required for developing and maintaining equipment for measuring vibrations and stress analysis in connexion with gas turbine engine development. Apply Armstrong Siddeley Motors Limited, Coventry. W 2175

ELECTRONIC ENGINEERS are invited to apply for an appointment in the Research Laboratories of the English Electric Valve Co. Ltd. at Chelmsford to work on the development of experimental television circuits. Applicants should have considerable experience of this type of work; with particular reference to camera tubes, together with a Science Degree or equivalent qualifications. Remuneration will be dependent on qualifications and experience and the position will offer ample scope for advancement. Please write giving full particulars and quoting ref. 440B to Central Personnel Services, The English Electric Co. Ltd., 24/30, Gillingham Street, London, S.W.1. W 2197

ELECTRONIC ENGINEERS are invited to apply for an interesting position in the Telecommunications Research Laboratory of British Insulated Callender's Cables Ltd., situated at Kirkby, Nr. Liverpool. Duties include the design and development of electronic instruments for use in connexion with cable research and manufacture. The minimum qualifications required are a Degree in physics or light current electrical engineering, and experience in electronic instrument design. Applications, in writing should be submitted to: The Staff Officer, B.I.C.C. Ltd., Prescott, Lancs. W 2217

ELECTRONIC ENGINEERS—Attractive positions are available in the organisation of a large manufacturing company located in Lancashire. Three Engineers are required with scientific and fundamental knowledge of Electronic component parts and their functional circuits with application to storage principles and binary system. Three other engineers wanted with knowledge and experience of Electronics which will enable them to reduce to practice developments resulting from research carried out by first three Engineers, to provide signalling, storing and transmitting systems for Telecommunicating purposes. Applicants should reply stating age, experience and salary required to Box No. 262. Dorland Advertising Limited, 18-20, Regent Street, London, S.W.1. W 2188

CLASSIFIED ANNOUNCEMENTS
continued on page 6

EKCO SCINTILLATION COUNTER TYPE N502

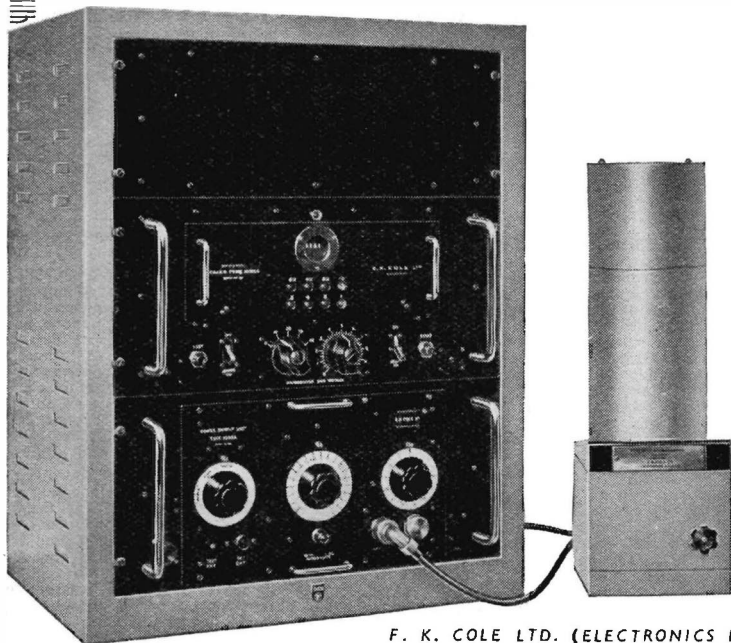

For the first time in this country EKCO make available a self-contained Scintillation Counter for the accurate measurement of Alpha and Beta particles and Gamma rays. A high-gain, low dark-current photo-multiplier tube, in a lead castle giving adequate shielding, is combined with a wide band fed-back linear amplifier thereby providing a self-contained unit suitable for use with an Ekco Scaler 1009A, a Ratemeter 1037A or other suitable counting equipment. In general, counting may be accomplished at higher rates and with much greater efficiency than with the conventional G.M. counter.

Full details of this and other Ekco equipment for the Radiochemical Laboratory will be sent on request

EKCO

ELECTRONICS

F. K. COLE LTD. (ELECTRONICS DIVISION) 5 VIGO STREET, LONDON, W.1

FERROXCUBE

FERROMAGNETIC FERRITE

FOR TELEVISION

THE improvement in television components, with their smaller size and greater efficiency, is largely due to Ferroxcube, the new Mullard magnetic core material.

The uses of Mullard Ferroxcube in the production of TV components fall into these three main groups:

LINE OUTPUT TRANSFORMER COILS

Since the advent of wide-angle television tubes, with the accompanying demand for increased E.H.T. supplies, the need for line output transformers of the highest possible efficiency has been greater than ever. Mullard Ferroxcube, with its low iron losses, completely fulfils this need — also facilitating the assembly of small, compact transformer units by means of solid, non-laminated U-shape cores.

DEFLECTION COIL YOKES

Mullard Ferroxcube cores in ring form are ideal for producing the magnetic circuit around deflection coils. Used in this way, Mullard Ferroxcube makes possible the construction of efficient deflector coils with a high Q factor. In order to simplify assembly problems, these ring cores are supplied either in the form of a complete circle, as two semi-circles, or as castellated yokes.

LINEARITY AND PICTURE WIDTH CONTROLS

Mullard Ferroxcube can very conveniently be extruded into rods and tubes. In this form it is ideal for use in linearity and picture width controls, providing a smooth control in a compact assembly.

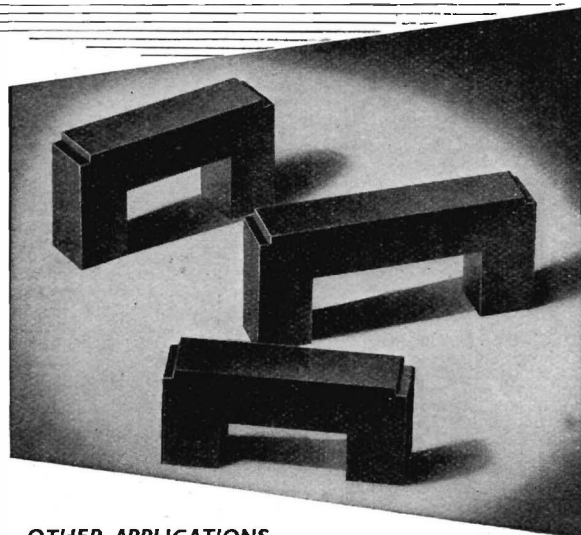

OTHER APPLICATIONS

In addition to its uses in television receivers, Mullard Ferroxcube is also being widely employed in line communications, radar, and other specialised electronic equipments. The purposes for which it is already being most successfully applied in such equipments include filter networks, wide band transformers, magnetic amplifiers, and pulse transformers.

PLEASE WRITE FOR FULL DETAILS



Mullard FERROXCUBE

FERROMAGNETIC FERRITE

MULLARD LIMITED · CENTURY HOUSE · SHAFTESBURY AVENUE · LONDON · W.C.2. (MF376)

SITUATIONS VACANT (Cont'd.)

ELECTRONIC OR RADIO ENGINEER required to supervise a laboratory testing radio components including electrolytic and ceramic condensers, volume controls, and magnetic materials, etc. Applicants should be familiar with the properties of these components. Previous experience of testing desirable. Apply in writing to The Plessey Company Limited, 186, Watling St. East, Towcester, Northants. W 2192

ELECTRO-HYDRAULICS, LIMITED require a Chief Electrical Engineer to be responsible for the design and development of light electrical equipment for aircraft and other purposes. Applicants should have a first or second class Honours Degree, have served an apprenticeship, or had similar practical training and have had some experience of the control of design and development groups. Knowledge of servo systems and aircraft control gear would be an advantage. Apply: Chief Designer, Electro-Hydraulics, Limited, Warrington. W 1342

ELECTRO-MECHANICAL ENGINEERS with good academic qualifications, apprenticeship, theoretical background and knowledge of production methods, required for development work. Experience in electrical methods of computation, servo theory and instrument design desirable. Apply with full details of age, experience and salary required to the Personnel Manager, Sperry Gyroscope Company Limited, Great West Road, Brentford, Middlesex. W 2102

ELECTRONIC ENGINEER required to join a team of research workers investigating a new field in the use of electronic equipment. Qualifications include an Honours Degree in Physics or Engineering which, if in the computing and pulse circuit fields, would be considered an asset. Salary would be according to qualifications and experience, ranging up to £1,000 per annum. Contributory pension scheme. Box No. W 2100.

ELECTRONIC ENGINEERS with good academic qualifications and apprenticeship required for development work. Experience in one or more of the following desirable: Control systems, D.C. Amplifiers, computing devices, video circuits, microwave techniques. Apply with full details of age, experience and salary required to the Personnel Manager, Sperry Gyroscope Company Limited, Great West Road, Brentford, Middlesex. W 2101

EXPERIENCED Electronic Wiremen required immediately for top priority Government Contracts. Excellent wages, working conditions and prospects for the right type of applicant. Apply: Peto Scott Electrical Instruments, Addlestone Road, Weybridge, Surrey. W 2058

ENGINEER for transformer design work, used to small power audio and pulse transformer work, required by prominent Aircraft Firm in the London Area. Highest technical ability and experience of miniaturization required. Write full details, qualifications, experience, age, salary sought to Box A.C. 64420, Samson Clarks, 57-61, Mortimer Street, London, W.1. W 2045

ENGINEERS are required by Marconi's Wireless Telegraph Company Ltd., Chelmsford, for the Development and Design of Sound Studio Apparatus. Applicants should have B.Sc. or equivalent qualifications and experience in the design of studio equipment, amplifiers and associated circuits. Operational studio control experience also an advantage. Salaries in the range of £500 to £750 are offered depending upon qualifications and experience. Please apply quoting reference 936 to Central Personnel Services, The English Electric Company Limited, 24/30, Gillingham Street, London, S.W.1. W 2193

ENGINEERS required for development, servicing and instruction on electronic equipment. National Certificate standard. Previous experience on electronics or radar desirable. Remuneration according to experience and qualifications. Apply—Construction Department, The British Thomson-Houston Co. Limited, Rugby. W 2201

FERRANTI, LIMITED, Moston Works, Manchester, have staff vacancies in connexion with special electronic valve development and manufacture in association with an important Radio Tele-Control project. (1) Senior Valve Engineers to take charge of Research and development work. Qualifications include a good Degree in Physics or Electrical Engineering and extensive experience in charge of development work. Salary according to

qualifications and experience in the range of £1,100-£1,600 per annum. Please quote Ref. S.V.E. The company has a Staff Pension Scheme, and will give housing assistance in special cases. Application forms from Mr. R. J. Hebbert, Staff Manager, Ferranti, Limited, Hollinwood, Lancs. W 2044

INSTRUMENT ASSEMBLERS with some electrical knowledge required, also test room assistants, for well-known instrument Company situated in North London. Good working conditions and canteen. Apply Box No. W 2210.

INSTRUMENT TECHNICIANS required to assist with development work in connection with industrial instrumentation. Apply Cambridge Instrument Co. Ltd., Sydney Road, Muswell Hill, N.10. W 2122

JUNIOR ENGINEERS required at Stafford for development of Electronic instruments and devices. Write stating age, qualifications and experience, and quoting ref. 932, to Central Personnel Services, English Electric Co. Ltd., 24/30, Gillingham Street, London, S.W.1. W 2161

JUNIOR ENGINEERS required for assisting in the development and production of highest grade television transmissions and other equipment. Applicants should possess sound fundamental knowledge of both radio and television practice, be capable of wiring to a high standard and of producing own component layouts. City & Guilds, Higher Nat. or similar qualifications an advantage, but comprehensive practical experience may be acceptable. Five-day week. Pension scheme. Write, stating age, experience and salary required to Cinema-Television Limited, Worsley Bridge Road, Lower Sydenham, S.E.26. W 2189

JUNIOR ENGINEERS to assist in the design, construction and test of laboratory models of special electronic circuits. Some experience of similar work desirable and a knowledge of radar circuits, design and operations an advantage. Salary up to £600 per annum. Please write giving full details and quoting ref. 815c to Central Personnel Services, English Electric Co. Ltd., 24/30, Gillingham Street, London, S.W.1. W 2159

LABORATORY ASSISTANT required for Instrument Section. Previous experience in making and repairing indicating and electronic instruments essential. Higher National Certificate or equivalent qualification would be an advantage, but is not essential. Apply in writing to the Staff Manager (Ref. GBLC/G/18), Research Laboratories of the General Electric Co. Limited, Wembley, Middlesex, giving full details of age, qualifications and experience. W 2181

LEADING AIRCRAFT instrument manufacturer has a vacancy for an Electronic Engineer with a good knowledge of aircraft engines and the application of electronic analysis systems. Engagement will be on a monthly basis and successful applicant will be required to travel. Commencing salary according to qualifications and experience, but not less than £450 p.a. Superannuation scheme. Application to:—Box A.C. 66506, Samson Clarks, 57-61, Mortimer Street, London, W.1. W 2224

LEADING TELEVISION equipment manufacturer has a vacancy for an experienced electronic circuit engineer to work on a special development of unusual interest now in its early stages. The applicant should have practical experience of electronic equipment development; an understanding of the principles underlying modern television cameras is essential, and practical experience on such equipment would be most desirable. An interest, preferably combined with experience, in the allied fields of optics and photography would be considered a great advantage. Apply to Box No. W 2207.

MURPHY RADIO LTD., have vacancies for senior mechanical designers in their electronics division. A full and varied programme ensures opportunity of widening experience with excellent prospects. Application giving particulars of training and experience should be made immediately to Personnel Dept., Murphy Radio Ltd., Welwyn Garden City. W 2131

NORTH LONDON Radio Valve factory has vacancies for junior technicians to cover various grades of work including assembly, processing, glass technology, inspection, etc. Give full details of qualifications, experience, etc. Box No. W 1365.

PATENTS ENGINEER required for Patent Investigation work in connexion with Electronic circuits. Applicants must have a University Degree in Electrical Engineering (Light Current) or Physics. Some previous practical experience on Research or Design advantageous or alternatively suitable technical experience in the Services. Write giving age, fullest details of

education and experience, together with salary required to Personnel Department (PDB), Electric & Musical Industries Limited, Hayes, Middlesex. W 2185

PHYSICIST with experience in the electronic field required to aid in the direction of a team of research workers investigating a new field in the use of electronic equipment. Only first class men with an Honours Degree in Physics need apply. The salary will be in conformity with the successful applicant's ability and experience, but will not be less than £1,000 per annum. Contributory pension scheme. Box No. W 2099.

PHYSICISTS AND ENGINEERS—Applications are invited from men with a good Honours Degree, who are interested in research or development work in connexion with thermionic transmitting valves. Several vacancies are available with varying degrees of responsibility. Only qualified men from young graduates to first-class seniors with energy and enthusiasm will be considered. A five-day week is in operation and the appointments are pensionable. Write to Personnel Manager, Standard Telephones & Cables Limited, Ilminster, Somerset. W 2184

PHYSICISTS OR PHYSICAL CHEMISTS required for laboratory in Northamptonshire, to carry out varied and interesting work on new ceramic and metallic materials. Applicants should have a good science degree and be familiar with techniques for measuring magnetic and dielectric properties. Experience in designing radio and electronic components from these materials an advantage. Salary £450-£650 according to qualifications and experience. Box No. W 2051.

PLANNING ENGINEER required to assist in the planning of Development of prototype electronic equipment. Duties will include preparation of estimates and schedules and the checking of progress. Experience in a similar capacity is desirable and tact in handling people is of great importance. The post offers considerable prospects. Applicants should write in confidence, giving full details of experience, salary required and when free for interview and appointment, to the Personnel Department, E.M.I. Engineering Development Limited, Hayes, Middlesex, quoting ED/49. W 2186

PLANNING ENGINEERS with jig and tool design and estimating experience required for Electronics Division of E. K. Cole Ltd., Malmesbury, Wilts. Apply Personnel Manager, stating age, experience and salary required. W 2223

PROCESS ENGINEER required by Component Manufacturers in S.W. London. Qualifications to H.N.C. standard and experience in Light Electrical or Radio Laboratory essential. Apply stating age, experience and salary required to Box No. W 2208.

PROJECT ENGINEERS required for assisting in the development and production of highest grade Television transmission and other equipment. Applicants must be capable of taking charge of a complete project which includes supervision, progressing, testing and installation. Qualifications are desirable up to Degree standard, but lower grade qualifications and comprehensive practical experience will be considered. 5-day week. Pension scheme. Write, stating age, experience and salary required to Cinema-Television Limited, Worsley Bridge Road, Lower Sydenham, S.E.26. W 2200

PROMINENT AIRCRAFT firm in Greater London area, commencing new project of great National importance, offers unique opportunity for advancement. High salaries with monthly staff status and Pension Scheme offered to suitably qualified applicants. Electronic Engineers with 1st Class Honours Degree in Mathematics or Engineering preferably with several years' practical experience, though not essential. Apply, stating age, nationality and experience to Box Ac.58212, Samson Clarks, 57-61 Mortimer Street, W.1. W 131

RADIO ENGINEER to take charge of Low Power transmitting station in U.K. Applicants should be between ages 28-38 years and preferably married and prepared to live on site. Possession of own car would be an advantage. Salary £500 per annum plus free accommodation. Excellent superannuation scheme. Box No. W 2164.

RADIO MECHANICS required for work on centimetre equipments at Stanmore. Previous experience essential. Progressive staff positions. Five-day week. Write giving full details of age,

CLASSIFIED ANNOUNCEMENTS
continued on page 8

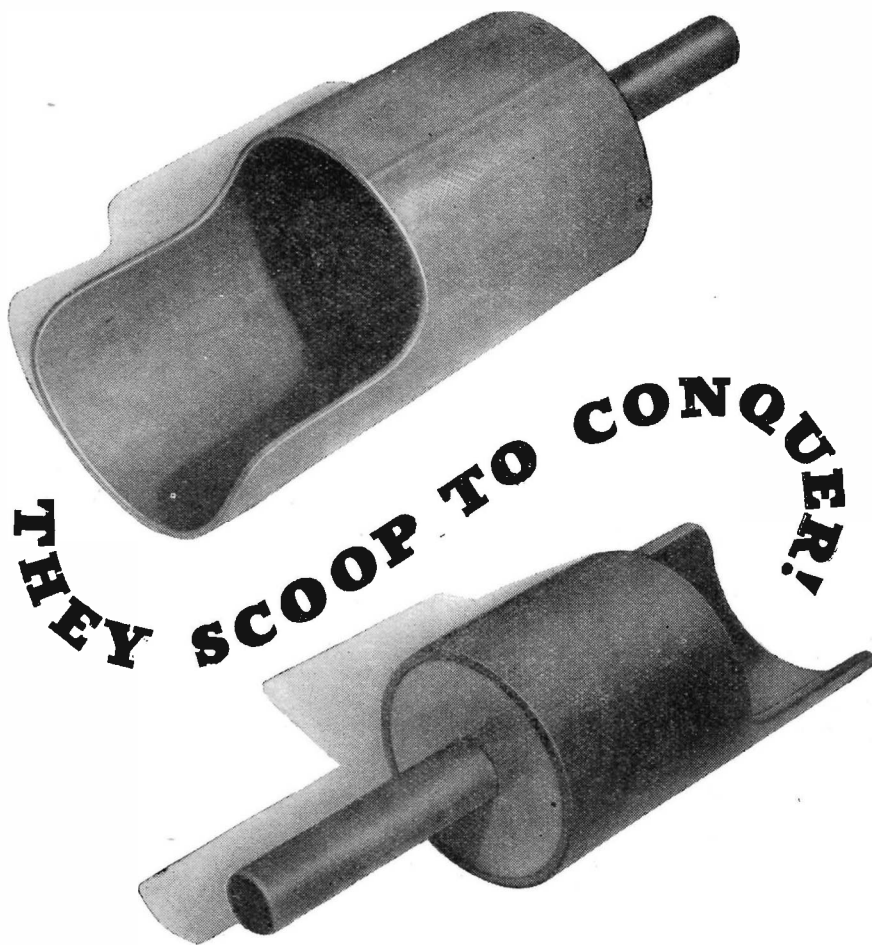

THEY SCOOP TO CONQUER!

BETWEEN THE ACTS of mixing the constituents of his formula, the Chemist pauses to reflect on the fitness for purpose of the scoop in his hand. Before Tufnol was available for such uses, corrosion was a factor which considerably

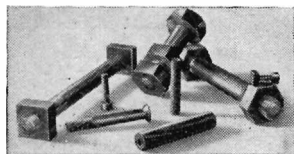

A group of Tufnol bolts and screws turned from rods, with nuts made from Tufnol sheets.

impaired the efficiency of certain types of chemical equipment. Even more important was the way in which Tufnol completely eliminated the danger

which a spark from metal contact could cause in the handling of explosive compounds.

In every industry, men with inventive minds, out to conquer the deficiencies of the more conventional materials, find inspiration in Tufnol. A good electrical insulator, possessing high compressive, shear, tensile and impact strengths, it resists moisture and corrosion, is light in weight and can be easily and accurately machined by the usual engineering

methods. It is supplied in sheets, tubes, rods, bars, angles, channels, or specially moulded shapes. Have you considered its use? There may be a way to use Tufnol whereby you could scoop your competitors.

TUFNOL COULD HELP YOU

There is sure to be a way in which Tufnol could be used to your advantage. What Tufnol has done is compiled in various technical publications. What it will do in new fields our Technical Staff will be glad to help you find out. Let us know where your interests lie. Why not write TODAY?

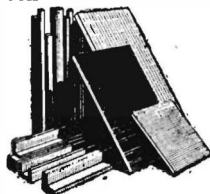

TUFNOL
REGISTERED TRADE MARK
 An ELLISON Product

TUFNOL LTD

PERRY BARR

BIRMINGHAM

22 B
 253

SITUATIONS VACANT (Cont'd.)

experience and qualifications to the Staff Manager (Ref. GBLC/G/44), Research Laboratories of the General Electric Co. Limited, North Wembley, Middlesex. W 2180

REQUIRED by an old established firm at their Research Laboratories, Borehamwood. Senior Draughtsmen for design of specialized Electronic Equipment or Mechanical and Electrical precision devices. Sound general engineering and practical experience. Higher National Certificate standard preferred. Must be capable of undertaking design work calling for originality and initiative. Salary up to £625. Five-day week of 39½ hours. Apply Box No. W 140.

RESEARCH ENGINEERS age 25-35. Applicants should be of Degree standard preferably with communications training and sound mathematical background. The work is experimental and is concerned with various problems in electronics and acoustics. Application stating technical qualifications, practical experience and salary required should be addressed to the Personnel Department, Kelvin & Hughes Limited, New North Road, Barkingside, Essex W 2199

RESEARCH LABORATORIES of The General Electric Co. Ltd., Wembley, Middlesex, have vacancies on a Major Guided Weapon Project at their Stanmore Laboratories for engineers and physicists with at least three and preferably five years' experience in the generation and handling of waveforms for radar computers or pulse multiplex systems. These openings will offer good prospects in experimental teams and attractive starting salaries will be paid. All applications should be sent to the Staff Manager (Ref. GBLC/16) stating age, qualifications and experience. W 2171

ROLLS-ROYCE LIMITED. Derby, have vacancies for Graduates to work on the study of vibration characteristics of Rolls-Royce Gas Turbine and piston type Aero Engines, under laboratory conditions, on the test bed and in flight. Some knowledge of electrical measurements is an advantage but extensive electronic knowledge is not essential. Salary according to age, qualifications and experience. W 2143

SENIOR AND JUNIOR Development Engineers required in the components laboratory of the Plessey Co. Ltd. The vacancies are in connexion with the design and development of components mainly for radio and television. For the senior positions a Degree in engineering or physics, or equivalent qualification is required, and for the junior positions Inter B.Sc or Higher National Certificate. Salary will be in accordance with qualifications and industrial experience. Applicants should state full details of experience to Personnel Manager, The Plessey Co. Ltd., Ilford, Essex. W 2216

SENIOR DRAUGHTSMEN: Metropolitan-Vickers Electrical Co. Ltd., require for their Trafford Park works, a number of senior draughtsmen preferably with experience in Radio and Radar equipment. For qualified men these jobs are permanent, five-day week under good conditions. Apply in writing stating age, experience, qualifications, salary required, etc., marking envelopes "Radio D.O." to Personnel Manager, Metropolitan-Vickers Electrical Co. Limited, Trafford Park, Manchester 17. W 2140

SEVERAL DRAUGHTSMEN are required for work on electronic engineering projects. Some of the vacancies are for senior men of at least HNC standard who have spent a number of years in a Laboratory or Factory design department and are capable of original layout work. Other posts are for detailing draughtsmen capable of producing Workshop drawings from such layouts. Salaries will be at current levels according to qualifications and experience. Prospects of promotion are good and the posts fall within the Company's Pension Scheme. Application form from the Personnel Officer, Mullard Research Laboratory, Cross Oak Lane, Salfords, near Redhill, Surrey. W 2117

SEVERAL ELECTRONIC ENGINEERS or Physicists are required, who have graduated in Physics or Telecommunications and have two or three years' radar experience, to take charge of the development of particular sections of a project involving radar. The work includes design of pulse generators, timing wave form oscillators, electronic computers, V.H.F. transmitters and receivers, and servo systems. In addition, Technical Assistants are needed with H.N.C. or equivalent qualifications. All the positions available are for work of high interest in a new and expanding field. Applications, which will receive prompt attention, should give the fullest details of education and professional

experience with appropriate dates. Apply Employment Manager, Vickers-Armstrongs Ltd., (Aircraft Section), Weybridge. W 2121

SPERRY GYROSCOPE CO. LTD., Great West Road, Brentford, Middlesex, require Electro-Mechanical Engineers with good academic qualifications, apprenticeship, theoretical background and knowledge of production methods, for development work. Experience in electrical methods of computation, servo theory and instrument design desirable. Apply with full details of age, experience and salary required to the Personnel Manager. W 2221

SPERRY GYROSCOPE CO. LTD., Great West Road, Brentford, Middlesex, require Electronic Engineers with good academic qualifications and apprenticeship required for development work. Experience in one or more of the following desirable:—Control systems, D.C. amplifiers, computing devices, video circuits, microwave techniques. Apply with full details of age, experience and salary required to the Personnel Manager. W 2220

STUDENT ASSISTANTS required to train as Physicists or Engineers (Mechanical and Electrical). Applicants should at least have matriculated or obtained a General Certificate of Education at ordinary level and should be prepared to study for a University Degree on a part time day basis. Every encouragement is given to enable students to become qualified Physicists or Engineers. The work of the Laboratories covers electronic, electrical and mechanical precision instruments and mechanisms. Applications in writing to:—Research Laboratories of Elliott Brothers (London), Elstree Way, Borehamwood, Herts. W 2214

TECHNICAL ASSISTANTS required for interesting Laboratory and Field work connected with Guided Missiles Project. Applicants to be between 20 and 35 years of age with, at least, National Certificate (Electrical) or equivalent. Experience of R.F. technique up to 500 mc. would be an advantage. Full particulars to Box No. W 2191.

TECHNICAL LABORATORY Assistants with experience in the fields of radio and electronics are required for work in the Stanmore area. Apply in writing giving full details of age, qualifications and experience to the Staff Manager (Ref. GBLC/G/820), Research Laboratories of The General Electric Co. Limited, North Wembley, Middlesex. W 2139

THE FOLLOWING vacancies exist in the Design Department of a Company operating a large number of Wire Broadcasting Systems.—1. Senior Engineer to take charge of Radio Frequency Section. Must have a Degree and have had at least three years' practical experience of Television design. Salary: £800 to £1,000 per annum, according to experience. 2. Junior Engineers, age 20 to 25, with Degree or graduateship of I.E.E. or I.R.E. Salary £400 to £500 per annum. 3. Laboratory Assistants capable of writing and testing radio equipment under supervision. Salary: £8 per week. Please send full particulars to Box No. W 2178.

THE GENERAL ELECTRIC CO., LTD., Radio and Television Works, Coventry, have vacancies for Development Engineers, Senior Development Engineers, Mechanical and Electronic, for their Development Laboratories on commercial and Government work of national importance. Fields include Microwave and Pulse Applications. Salary range £400-£1,250 per annum. Vacancies also exist for Specialist Engineers in Component design, valve applications, electro-mechanical devices and small mechanisms. The Company's Laboratories provide excellent working conditions with Social and Welfare facilities. Superannuation Scheme. Assistance with housing in special cases. Apply by letter stating age and experience to the Personnel Manager (Ref. CHC.) W 2999

UNIVERSITY COLLEGE, LONDON (Gower Street, W.C.1), has vacancies in Department of Physics for young men for constructing electronic and general physical research apparatus. Scale £221 x £13-£338 p.a. plus London weighting of £20. Application forms from the Secretary, quoting Physics/6. W 2194

VACANCIES EXIST for men with qualifications in Electrical Engineering or Physics for interesting development work of National importance. These positions are permanent and pensionable. Apply Personnel Manager, Standard Telephones & Cables Limited, North Woolwich, E.16, quoting reference 2371. W 2196

SITUATIONS WANTED

1st CLASS HONOURS GRADUATE Telecommunication Engineering, age 26, seeks suitable post. Box No. W 1367.

FOR SALE

AMERICA'S famous magazine Audio Engineering, 1 year subscription 28s. 6d.; specimen copies 3s. each. Send for our free booklet quoting all others; Radio Electronics, Radio and Tele. News, etc. Willen Limited (Dept. 9), 101 Fleet Street, London, E.C.4. W 108

COSSOR OSCILLOSCOPE, Model 1035, six months old, less than 12 hours' use. Reason for sale. Box No. W 1361.

GALVANOMETERS by leading British Manufacturer, complete with Plush-lined Leather Cases, £7. Full particulars on request. Klystrons type 723A/B, 70s. Cavity Magnetrons, type 2J49, 90s. Brand new. Thousands of Valves, Components, etc., in stock. Electrad Radio, 69, High Street, Belfast, N.1. W 1363

MAGSLIPS at 1/10th to 1/20 of list prices. Huge stocks. Please state requirements. 'K. Logan, Westalley, Hitchin, Herts. W 116

MARCONI INSTRUMENTS for sale. Standard Signal Generator, TF144G, £75. Universal Impedance Bridge, TF373D, £50. Valve Voltmeter, TF428B, £30. Output Power Meter, £12. The above instruments were purchased new direct from makers and have had 100-300 hours' use only. All in perfect order, untempered with, and immaculate as new. Also Furzehill BFO, £20. S. Brewer & Son, Ebbw Vale, Mon. Phone 3282. W 1356

MERCURY SWITCHES are made by Hall Drysdale & Co. Ltd., of 58 Commerce Road, Wood Green, London, N.22. 'Phone BOWes Park 7221-2. W 107

TO MANUFACTURERS, Universities and Teaching Institutions. There is a wide scope for research and development into the use of servo control elements in industry and applied science. We can supply ex stock many types of Magslips, Selsyns and other servo elements, Inductive Potentiometers (Ipot) and Ball and Plate Integrators for electrical computation. We also have available Magslip gears and mountings. All goods are of ex-Government origin but are fully guaranteed by us and are offered for immediate delivery and at a fraction of Manufacturers' list prices. Write for our free brochure "Synchros," and our price list to: Servotronic Sales, Abbey Road, Belvedere, Kent. W 1352

TOROIDAL COILS, manually wound to one per cent. Bel Sound Products Co., Marlborough Yard, Archway, N.19. ARC. 5078. W 139

WEBB'S 1948 Radio Map of the World, new multi-colour printing with up-to-date call signs and fresh information; on heavy art paper, 4s. 6d., post 6d. On linen on rollers, 11s. 6d., post 9d. W 102

SERVICE

FIRST-CLASS Maintenance Service of electronic and electro-mechanical apparatus. Greater London area. Sub-contracts undertaken. Phone BRixton 6745. W 1358

GLASSBLOWING repetition and scientific, by Hall Drysdale & Co. Ltd., of 58 Commerce Road, Wood Green, London, N.22. 'Phone BOWes Park 7221-2. W 109

WANTED

URGENTLY WANTED: 10/20-kVA High Frequency Alternator, 100 kcs. or thereabouts. Box No. W 2219.

'Radiospares'
Quality Parts

THE SERVICE ENGINEER'S FIRST CHOICE



Infra - red Photo - conductive cells

For Pyrometry, Spectroscopy, and the Detection of Radiant Heat

These lead sulphide cells are the fastest and most sensitive devices for the detection and measurement of infra-red radiation in the 1 to 3 micron wavelength

region of the spectrum. They are sensitive to source temperatures as low as 200°C, and they respond to temperature variations within 100 microseconds.

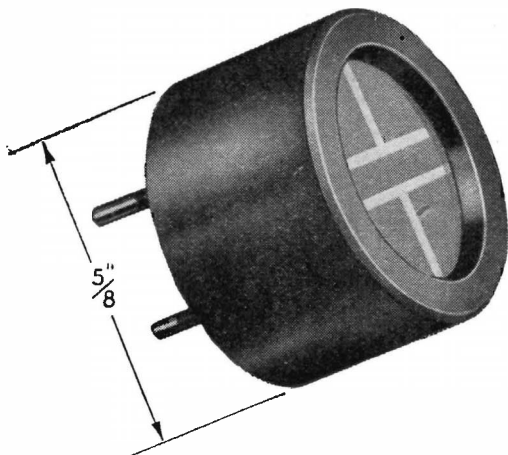

Left: Type "M", for detection and pyrometry, is of minimum dimensions and simple mechanical construction.

Below: Type "C.1", for detection and spectroscopy. This cell has provision for cooling by carbon dioxide, a feature which considerably increases its sensitivity.

Other BTH infra-red devices include: Nernst filaments (as infra-red sources), special infra-red transmitting glass, and semiconductor bolometers.

Full particulars on application.

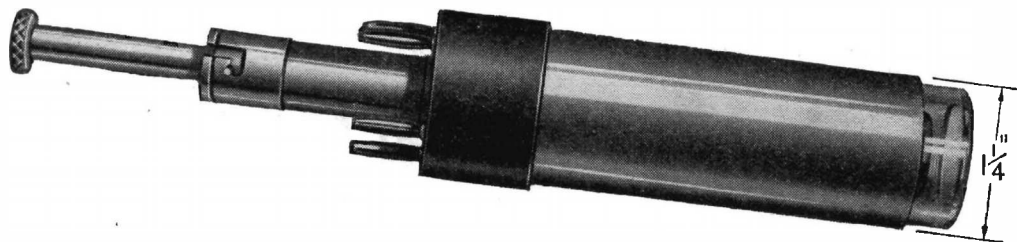

BRITISH THOMSON-HOUSTON

THE BRITISH THOMSON-HOUSTON CO., LTD., RUGBY, ENGLAND

A3986

Member of the AEl group of companies

The EDISWAN ES85

The Ediswan ES85 is a directly heated thoriated tungsten filament triode designed primarily for use as a class B power amplifier or modulator.

When used as an amplifier a pair of ES85's will deliver approximately 250 watts of power at audio frequencies.

They are, therefore, suitable for use in large public address systems, wired wireless networks or as A.F. modulators in transmitting equipment.

The ES85 may also be employed in R.F. equipments providing the frequency does not exceed 6.0 mcs.



rating

Filament voltage (volts)	Vf	10
Filament current (amps)	If	3.25
Maximum Anode voltage (kv)	Va (Max)	1.25
Maximum Anode Dissipation (watts)	Wa	85
Mutual Conductance (mA/V)	gm	4
*Amplification Factor		12.5
Anode Impedance (ohms)		3,100
Maximum Operating Frequency at full rating (mcs)		6
Maximum Audio Output 2 valves (watts) W out (Class B push pull)		245

* Taken at $V_a = 1 \text{ kV}$. $V_g = -55\text{v}$.

Further details of this and other Ediswan Valves are available on request.

EDISWAN

SPECIAL PURPOSE VALVES

THE EDISON SWAN ELECTRIC COMPANY, LTD., 155 CHARING CROSS ROAD, LONDON, W.C.2

Member of the A.E.I. Group of Companies

EV63

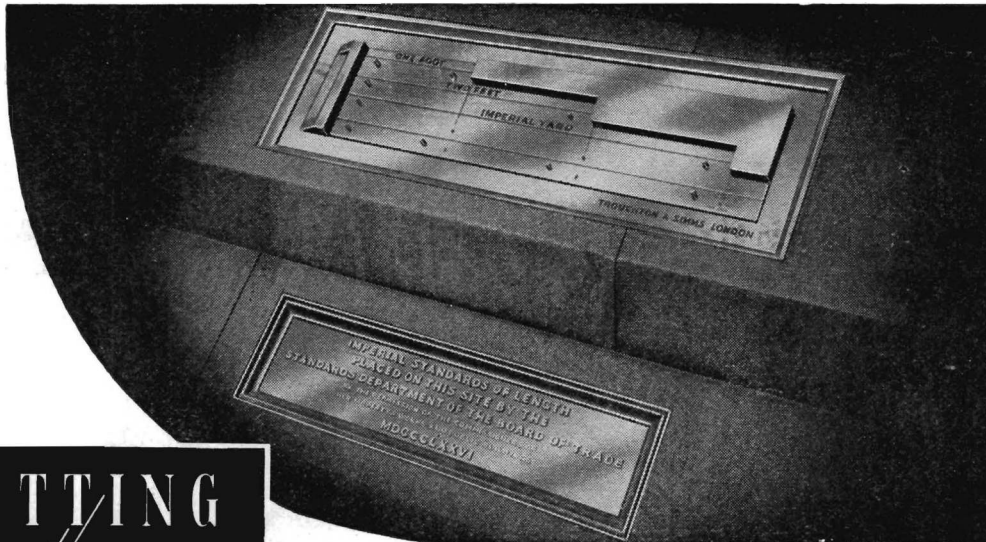

Imperial Standards of Length
—Trafalgar Square London.

SETTING *the* STANDARD

In every branch of industry, in laboratories and scientific research establishments, in the services and in fact, wherever electrical maintenance and measurement are of prime importance, "AVO" Electrical Testing Instruments maintain a reputation unexcelled for robustness and dependable accuracy. They are frequently used as a standard by which other instruments are judged.

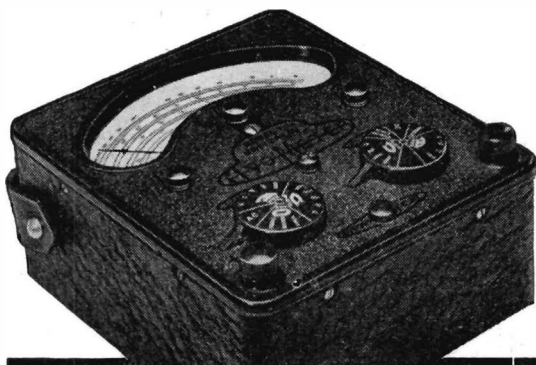

The Model 7 Universal Avo Meter is a typical example of a modern "AVO" multi-range meter. It is a combination AC/DC instrument providing on a 5-inch hand calibrated scale 50 ranges of readings of Current, Voltage, Resistance, Capacitance, Power Output and Decibels. The total resistance of the instrument is 500,000 ohms, and its small power consumption and precision accuracy make it the choice of radio, television and electrical engineers throughout the world.

Write for a FREE copy of the Comprehensive Guide to "Avo" instruments.

THE STANDARD OF Dependable ACCURACY.



THE AUTOMATIC COIL WINDER & ELECTRICAL EQUIPMENT CO., LTD.
WINDER HOUSE · DOUGLAS STREET · LONDON · S.W.1 Telephone: VICTORIA 3404/9

55.1.

AIRMEC

Ionisation Testers



AIRMEC IONISATION TESTERS provide the only known method of ensuring that the life of an electrical component, cable or equipment is not shortened by ionisation currents occurring at or below the working voltage. These instruments enable the quality of insulating materials to be determined, and provide an excellent means of testing components for faulty impregnation and dampness.

An important feature of the testers is their high source impedance which, by limiting the current to a low value, ensures the maximum safety for both operator and equipment under test.

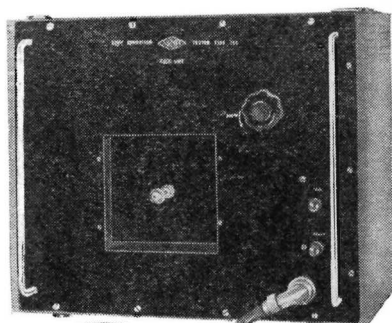

THE 5KV IONISATION TESTER, TYPE 732, illustrated above, has been in production for over three years, and has recently been modified to incorporate several improvements. Besides indicating the threshold voltage at which ionisation occurs between the limits 250 and 5,000 volts, the instrument now gives a direct meter indication of leakage currents, and enables the value of insulation resistance to be determined. Furthermore, an output jack is provided so that ionisation may be detected by the use of headphones or an external meter.

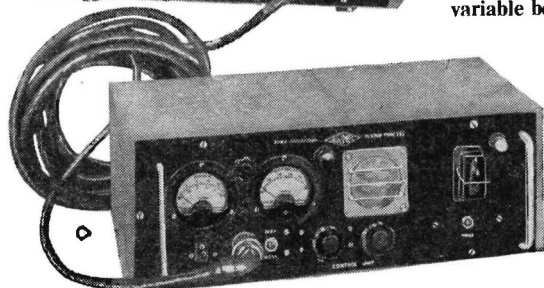

THE 20KV IONISATION TESTER, TYPE 755, which is illustrated on the left, operates on the same principle as the 5KV model but over a higher voltage range, a test voltage continuously variable between 3 and 25 KV being available from the H.T. Unit of the equipment. This unit is connected by a cable carrying low voltages only to an Indicator Unit which may be situated up to 12 yards away. The output current is limited to a very low value by its high source impedance, and as a further safety precaution, an interlocking circuit is provided to enable the H.T. Unit to be operated in a cage.

The Indicator Unit besides providing audible indication of ionisation, incorporates both voltage and current meters to enable leakage current and insulation resistance measurements to be made.

Further details of these or any other Airmec instruments will be forwarded gladly upon request

AIRMEC LABORATORIES **LIMITED**

HIGH WYCOMBE • BUCKINGHAMSHIRE • ENGLAND
TEL.: HIGH WYCOMBE 2060 CABLES: AIRMEC HIGH WYCOMBE

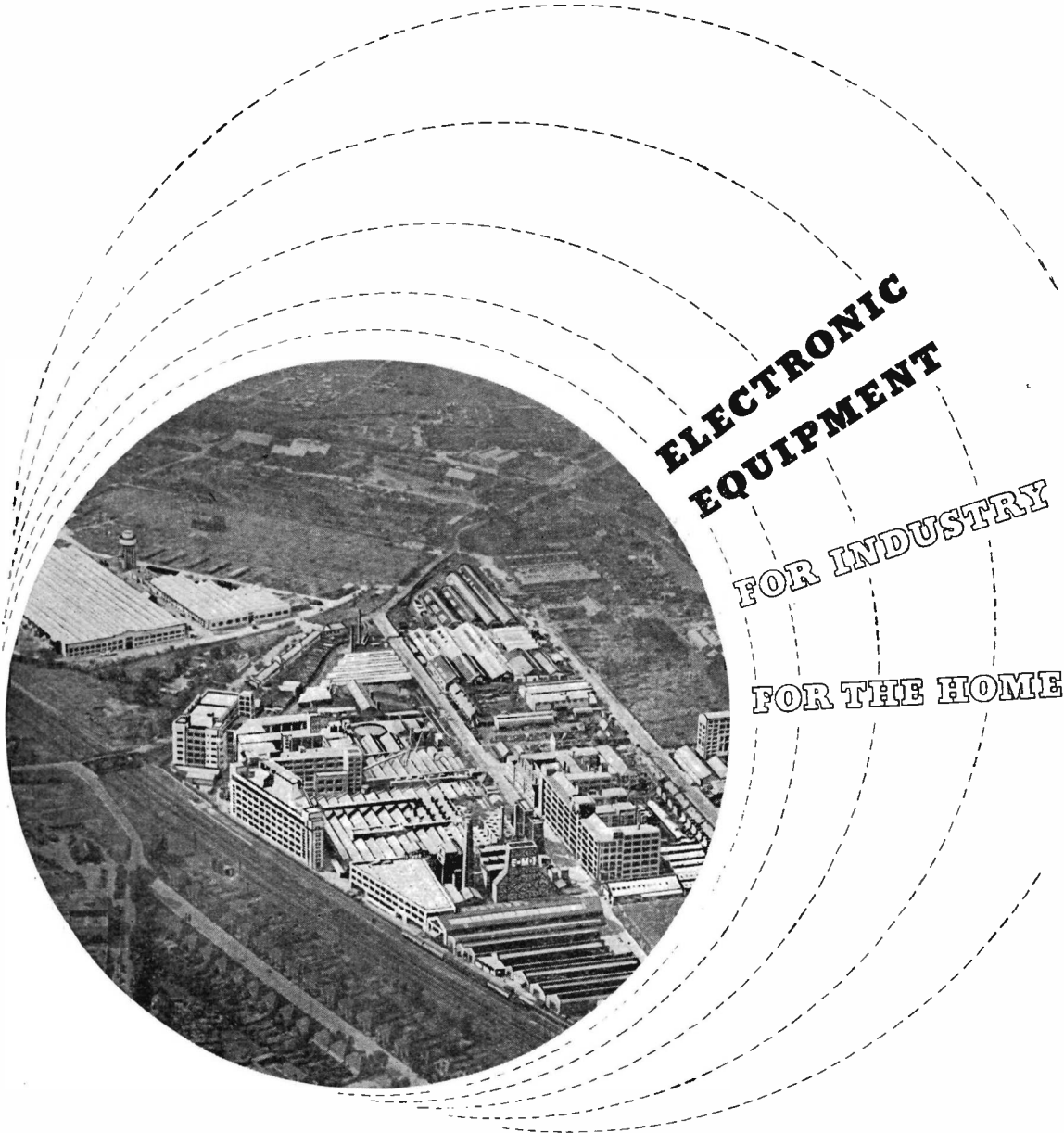

Electronic equipment designed and manufactured by E.M.I. speeds industrial production and brings higher standards of comfort to the home.

E.M.I. *are the leading British organisation for the Design, Development and manufacture of Electronic Equipment of all kinds. The following are typical of the range of equipment supplied:—*

- COMPLETE TELEVISION AND RADIO SYSTEMS • AIRBORNE RADAR
- R.F. INDUCTION AND DIELECTRIC HEATERS • DICTATION MACHINES
- DISC AND MAGNETIC TAPE RECORDERS • DOMESTIC APPLIANCES



ELECTRIC & MUSICAL INDUSTRIES LTD. HEADQUARTERS: HAYES · MIDDLESEX · ENGLAND

E.220

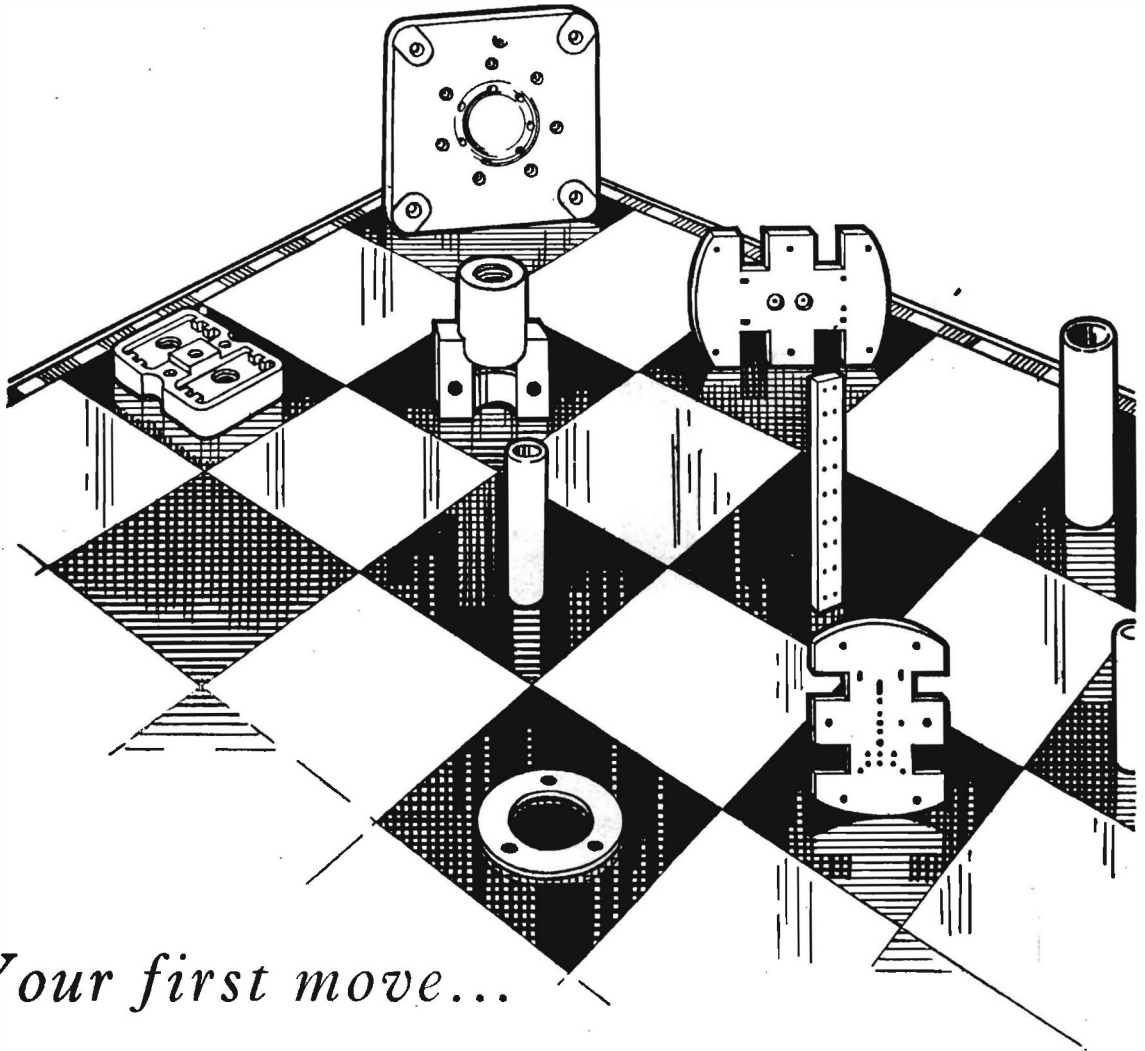

Your first move...

FOR BETTER INSULATION

CONSULT Bullers



Makers of Low Loss Ceramics

Made in Three Principal Materials —

FREQUELEX

An insulating material of Low Dielectric Loss, for Coil Formers, Aerial Insulators, Valve Holders, etc.

PERMALEX

A High Permittivity Material. For the construction of Condensers of the smallest possible dimensions.

TEMPLEX

A Condenser material of medium permittivity. For the construction of Condensers having a constant capacity at all temperatures.

BULLERS LIMITED, 6 Laurence Pountney Hill, London, E.C.4

Phone : Mansion House 9971 (3 lines)

Telegrams : " Bullers, Cannon, London "

BL5

DUBILIER *Miniature* VOLUME CONTROL TYPE Y

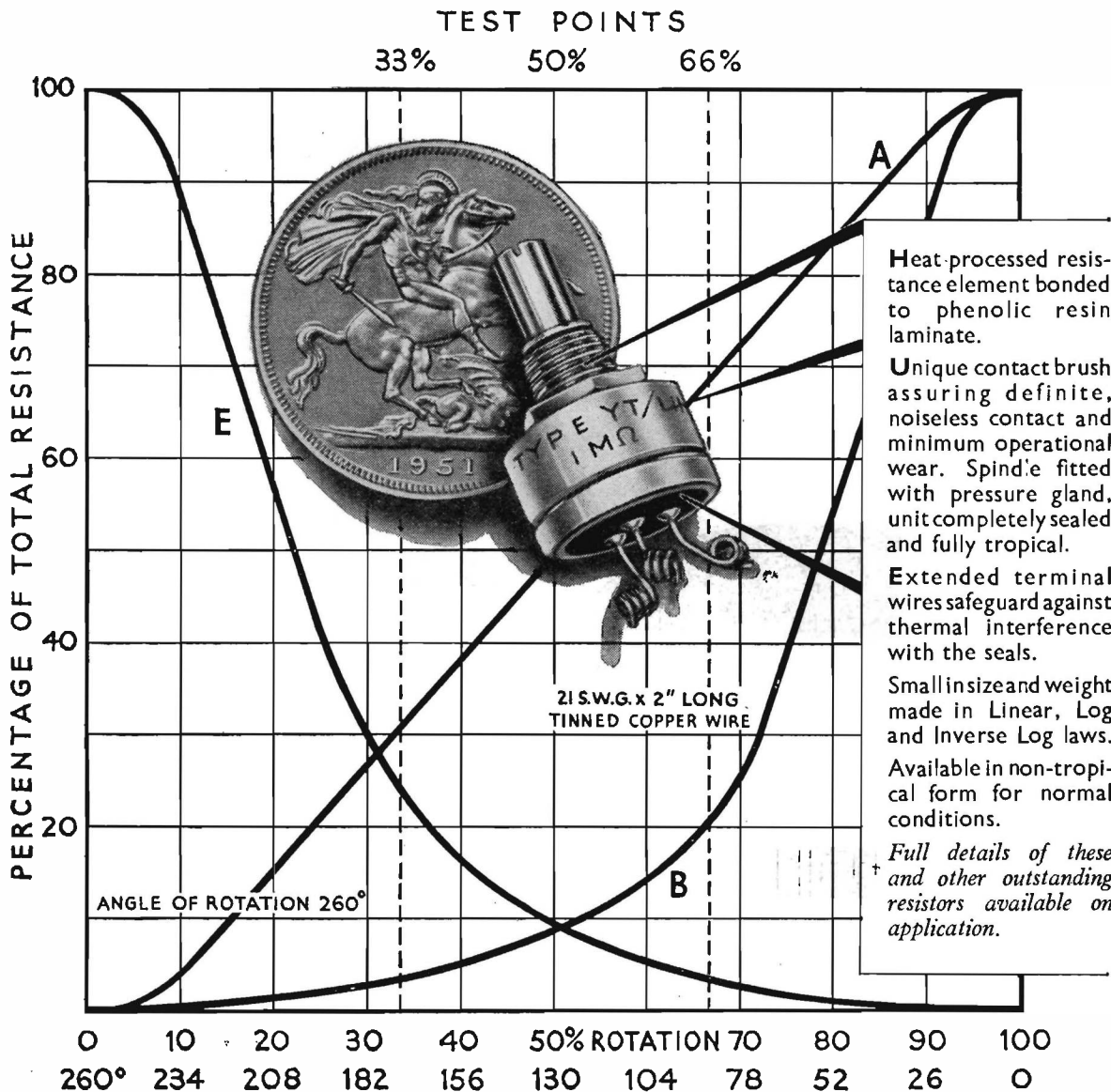

Heat processed resistance element bonded to phenolic resin laminate.

Unique contact brush assuring definite, noiseless contact and minimum operational wear. Spindie fitted with pressure gland, unit completely sealed and fully tropical.

Extended terminal wires safeguard against thermal interference with the seals.

Small in size and weight made in Linear, Log and Inverse Log laws. Available in non-tropical form for normal conditions.

Full details of these and other outstanding resistors available on application.

A CROWN OF RESISTOR ENGINEERING ACHIEVEMENT

DUBILIER

RESISTORS

DUBILIER CONDENSER CO. (1925) LTD., DUCON WORKS, VICTORIA ROAD, NORTH ACTON, W.3.
 Telephone : Acorn 2241 (5 lines) Telegrams : Hivoltcon, Westphone, London
 Cables : Hivoltcon, London, Marconi International Code.

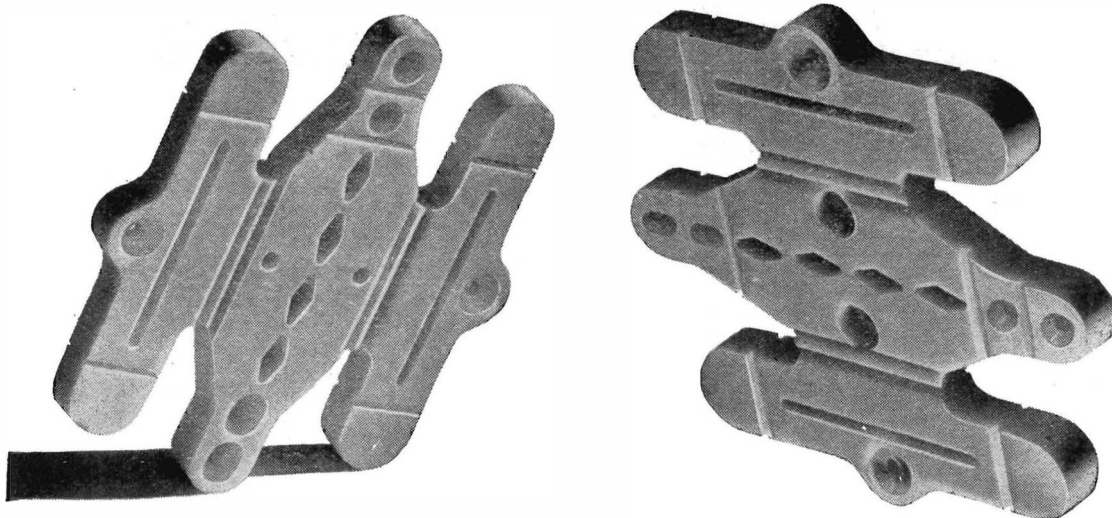

**from every
point of view**

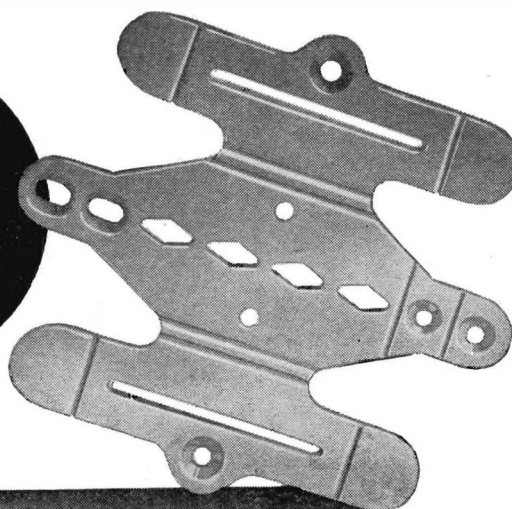

Frequentite is the most suitable insulating material for all high frequency applications. Seventeen years ago we introduced the first British-made low-loss ceramic, and consultation with us before finalising the design of new components is a wise precaution.

STEATITE & PORCELAIN PRODUCTS LTD.

Head Office: Stourport-on-Severn, Worcestershire. Telephone: Stourport 111. Telegrams: Steatite, Stourport



S.P.66

Light . . . robust . . . durable

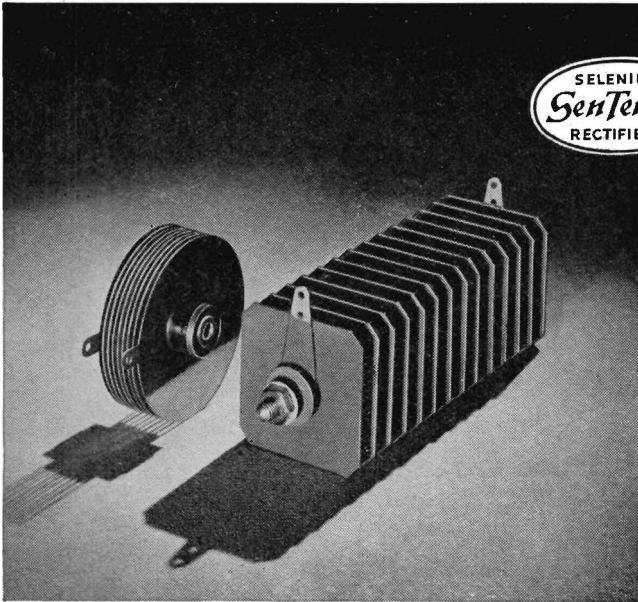

miniature H.T. Rectifiers

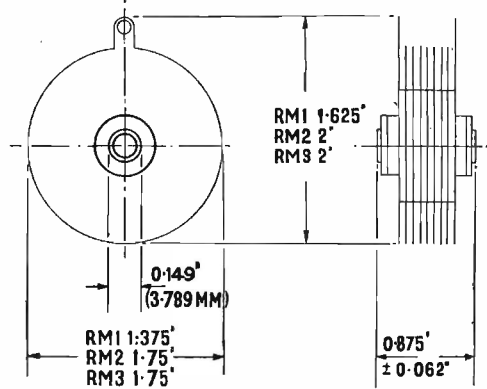

SenTerCel miniature H.T. Selenium rectifiers offer these unique features :

- Instant starting — no warming-up period
- Unlimited instantaneous overload
- No limit to size of reservoir capacitor
- Withstand overloads such as charging current of deformed electrolytic capacitors.
- Low heat dissipation
- Practically indestructible in service
- Simple mounting — no valve holder
- Simple wiring — two connectors only
- Small size . . . low weight
- Low cost

Ratings

TYPE	RM1		RM2		RM3		RM4		
	35°C	55°C	35°C	55°C	35°C	55°C	35°C	40°C	55°C
Maximum ambient temperature	35°C	55°C	35°C	55°C	35°C	55°C	35°C	40°C	55°C
Maximum output current (mean)	60mA	30mA	100mA	60mA	120mA	90mA	275mA	250mA	125mA
Maximum input voltage (r.m.s.)	125V		125V		125V		250V		
Maximum peak inverse voltage	350V		350V		350V		700V		
Max. instantaneous peak current	Unlimited		Unlimited		Unlimited		Unlimited		
Weight	1 oz.		1.4 oz.		2 oz.		4.5 oz.		

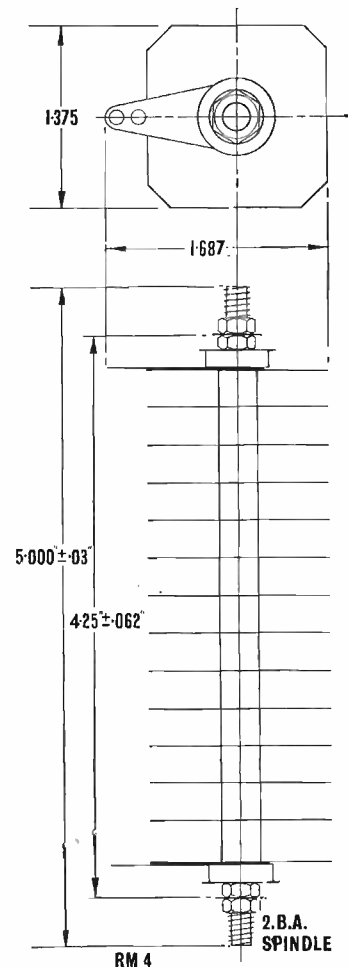

Standard Telephones and Cables Limited

Registered Office : Connaught House, Aldwych London, W.C.2

RECTIFIER DIVISION : WARWICK ROAD, BOREHAM WOOD, HERTS.

Phone : Elstree 2401

Grams : SenTerCel Borehamwood

Decade Capacitance Units for Panel Mounting

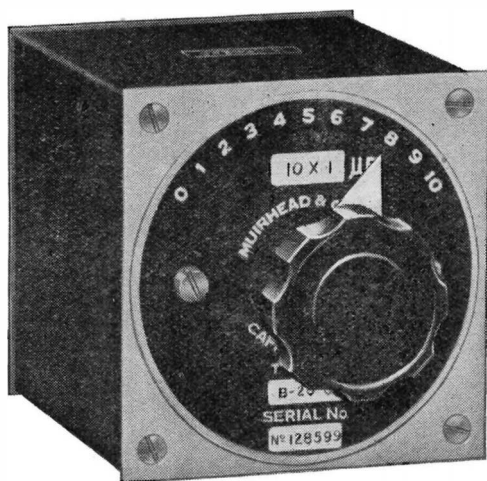

THESE self-contained units employ hermetically sealed mica capacitors, and in consequence a high stability is attained. The individual capacitance steps are normally adjusted to an accuracy of $\pm 1\%$, but can be adjusted to $\pm 0.1\%$ if requested (except for the lowest values), thus providing a decade unit which can also be used as a standard when occasion demands. Designed for panel mounting, these units find many applications in A.C. bridges, A.F. oscillators, and other instruments.

Specification

- Accuracy:** 0.001 μF steps $\pm 5\%$ ($\pm 1\%$ for an extra charge).
0.01 μF and 0.1 μF steps $\pm 1\%$ ($\pm 0.1\%$ for an extra charge).
- Stability:** Within $\pm 0.1\%$.
- Temp. Coeff:** -20 to $+50$ parts in 10^6 per $^{\circ}\text{C}$.
- Power factor:** Less than 0.0005 at 1000 c/s.
- Insulation:** 10,000 megohm-microfarads.
- Wkg voltage:** 250 volts peak.

Standard Models

- B-23-A** 0.01 μF in steps of 0.001 μF
B-23-B 0.1 μF in steps of 0.01 μF
B-23-C 1 μF in steps of 0.1 μF

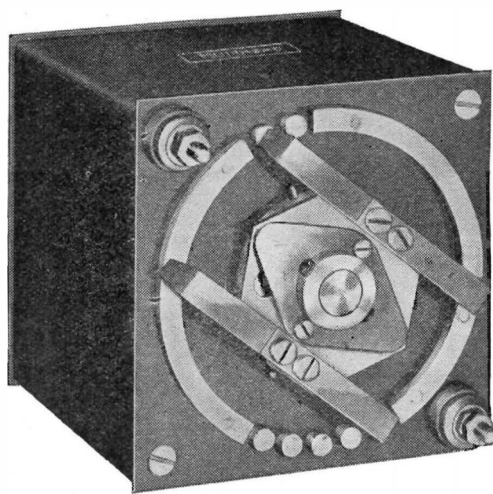

**For further details
write for Bulletin B-654**

MUIRHEAD & Co. LTD.
 PRECISION ELECTRICAL INSTRUMENT MAKERS
 BECKENHAM · KENT · ENGLAND

Telephone : BECKenham 0041

Telegrams & Cables : MUIRHEADS ELMERS-END

PRECISION
MUIRHEAD
 ELECTRICAL INSTRUMENTS

49K

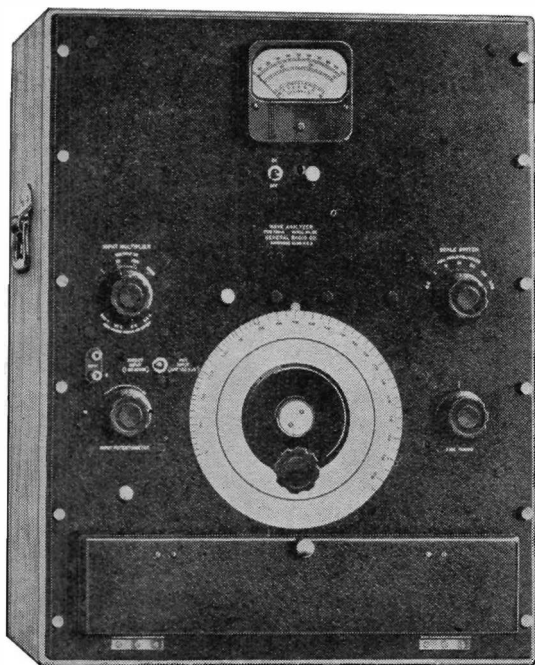

INPUT VOLTAGE RANGE 1,000,000-1

THIS analyser offers the simplest, most accurate and most direct method of measuring the amplitude and frequency of the components of any complex electrical waveform.

In its essentials it consists of a heterodyne-type vacuum-tube voltmeter with a highly selective i-f filter using three quartz bars. At only 60 cycles from resonance the attenuation is down by 75 decibels, yet tuning is very easy by virtue of the 4-cycle flat-top characteristic at resonance. Standards for both voltage and frequency are built into the analyser and can be used to check its calibration at any time.

The Type 736-A Wave Analyser is ideally suited for hundreds of types of harmonic-distortion measurements on any type of audio apparatus, broadcast receivers and transmitters, telephone and public address systems, oscillators, amplifiers and other vacuum-tube circuits; hum measurements on a-c operated communications equipment; harmonic-induction studies on telephone lines.

SPECIFICATIONS

FREQUENCY RANGE: 20 to 16,000 cycles.

SELECTIVITY: About 4 cycles flat-top band width. Response is down 15 db at 5 cycles, 30 db at 10 cycles, 60 db at 30 cycles from peak.

VOLTAGE RANGE: 300 microvolts to 300 volts full scale. Over-all range is divided into four major ranges, each of which is divided into seven scale ranges.

VOLTAGE ACCURACY: Within $\pm 5\%$ on all ranges.

HUM: Suppressed by at least 75 db.

INPUT IMPEDANCE: 1 megohm for direct voltage measurements; 100,000 ohms with input potentiometer.

ACCURACY OF FREQUENCY CALIBRATION: $\pm (2\% + 1 \text{ cycle})$

BUILT-IN CALIBRATORS: For both voltage and frequency.

Write for complete data on this **WAVE ANALYSER** and **CATALOGUE L** covering a wide range of laboratory apparatus

GR13

CLAUDE LYONS LTD.

ELECTRICAL AND RADIO LABORATORY APPARATUS, ETC.
180 Tottenham Court Road, London, W.1, and 76 Oldhall Street, Liverpool, 3, Lancs.



SPECIAL CELLS

FOR SPECIAL PURPOSES

Included in the wide range of "CINTEL" photo-electric cells you will probably find the very one suited to your own particular requirement; but if your problem calls for a cell of special properties, then we are prepared to make it for you.

With over 70 different types in our range, and equivalents for most other manufacturers' cells, we are in a position to solve your photo-cell problem.

Full technical information is available on application to:—

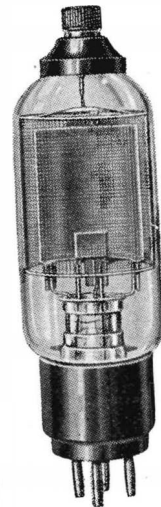

TYPE VA 39
FOR
ACCURATE
PHOTO-
METRIC
WORK

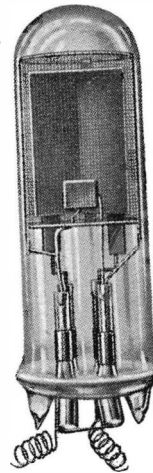

TYPE QVA 39
QUARTZ
ENVELOPE
SENSITIVE
DOWN TO
1900 AU.

CINEMA-TELEVISION LIMITED

A Company within the J. Arthur Rank Organisation

WORSLEY BRIDGE ROAD · LONDON · SE 26

Telephone: Hither Green 4600

SALES AND SERVICING AGENTS

F. C. Robinson & Partners Ltd.,
287, Deansgate, Manchester, 3

H. Hawnt & Co., Ltd.,
59, Moor St., Birmingham, 4

Atkins, Robertson & Whiteford Ltd.,
100, Torrisdale Street, Glasgow, S.2



REGISTERED TRADE MARK



Communication and Industrial Valves by *Standard*

The comprehensive range of high-quality valves manufactured by **Standard** includes types for almost every application, representative of which are :

Broadcast, Communication and Television transmission

Airborne and Mobile V.H.F. Equipment

Microwave links

Telephone and Telegraph Coaxial and line transmission

D.C. Power Supply Rectification

R.F. Heating

Counting and Computing

Motor Speed Control

Welding Control

Medical Diathermy

Voltage Stabilisation

X-Ray

Vacuum Measurement

Thermocouples

STANDARD engineers are available for consultation and their co-operation is assured to designers and technicians throughout industry wishing to take advantage of **Standard's** long experience in the field of valve engineering.

Please write to:

Standard Telephones and Cables Limited

Registered Office: Connaught House, 63 Aldwych, London, W.C.2

RADIO DIVISION — OAKLEIGH ROAD, NEW SOUTHGATE, LONDON, N.11

EVERSHED SPECIAL DUTY F.H.P. MOTORS

TYPICAL A.C. SERVO MOTORS FOR ELECTRONIC CONTROL

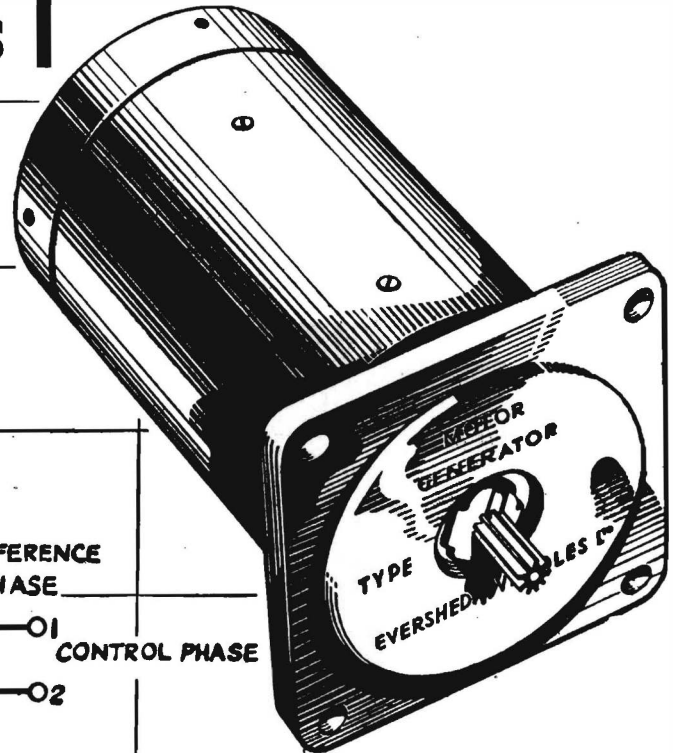
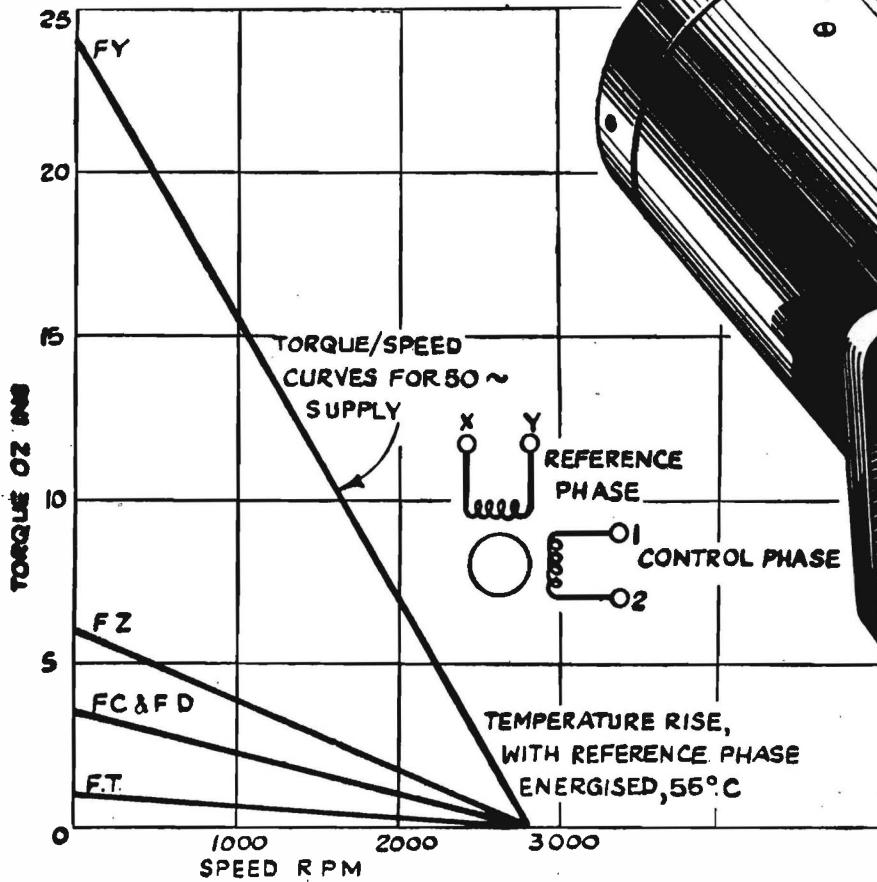

Motors wound for 50-240 volts working, 50 and 60 C.P.S.

Antihunt induction-generator may be fitted to all motors, giving 0.75 V./1000 R.P.M.

All motors rated for a temperature rise with reference phase energised of 55°C.

Send for the
Evershed Small Motors'
Data Book. E.E. 22

FRAME SIZE	MOMENT OF INERTIA OZ. INS. ²	REFERENCE PHASE WATTS.	CONTROL PHASE WATTS.	OUTPUT WATTS.
F.T.	.10	—	—	—
F.C.	.18	8.6	14	2.5
F.D.	.2	8.6	11	2.5
F.Z.	.27	12.0	12	4.5
F.Y.	.6	35.0	35	17.0

EVERSHED AND VIGNOLES LIMITED

ACTON LANE WORKS · CHISWICK · LONDON · W4

Telephone: Chiswick 3670

Telegrams: Megger, Chisk, London

Cables: Megger, London

5/165

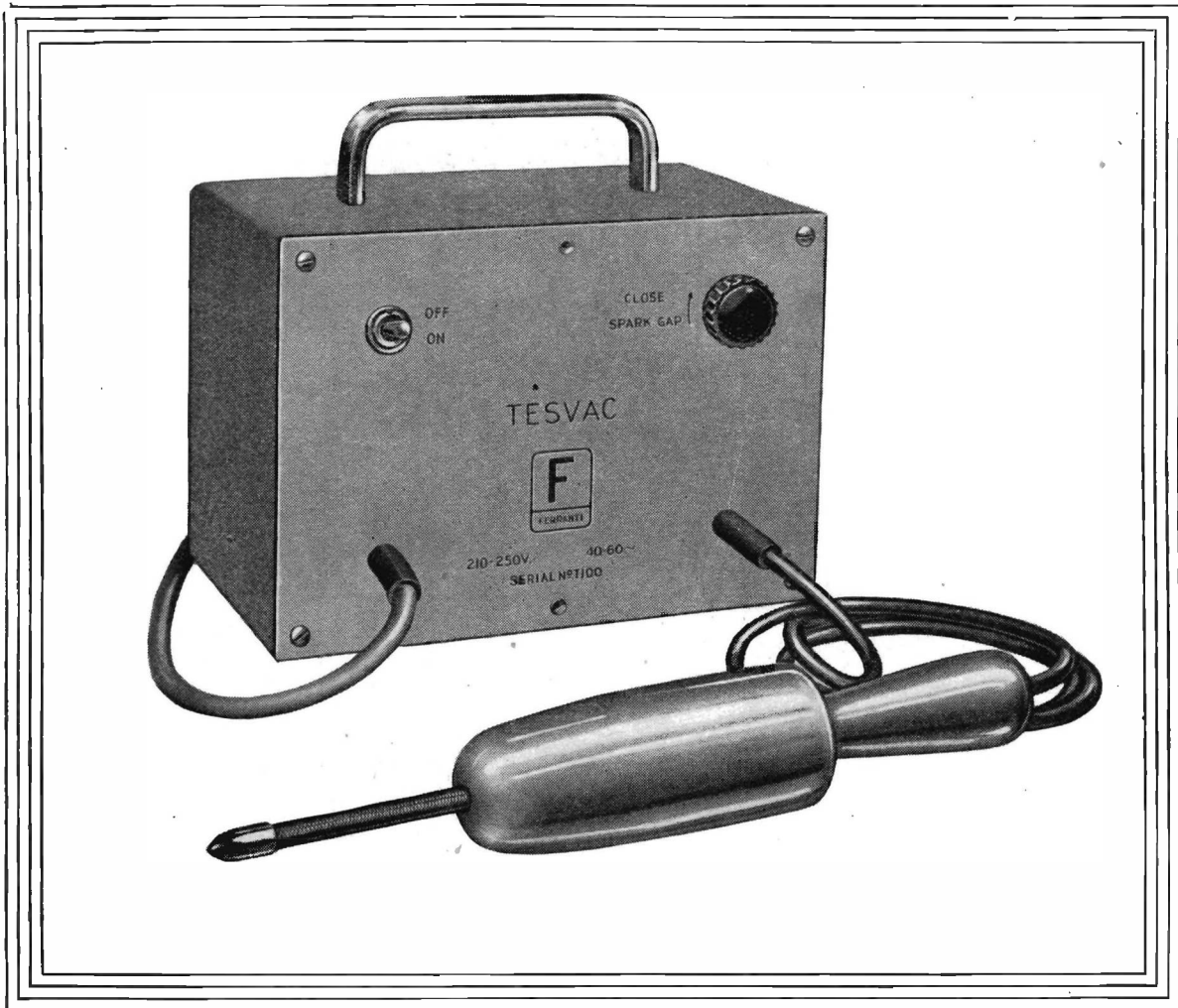

FERRANTI TESVAC

High Frequency Vacuum Tester

HIGH FREQUENCY Approximately 4 megacycles per second.
HIGH VOLTAGE Approximately 25 kV. maximum.

Simple and Safe to Use

Please write for list IN.101

FERRANTI LTD., HOLLINWOOD, LANCASHIRE & 36 KINGSWAY, LONDON, W.C.2



Outstanding in its class...

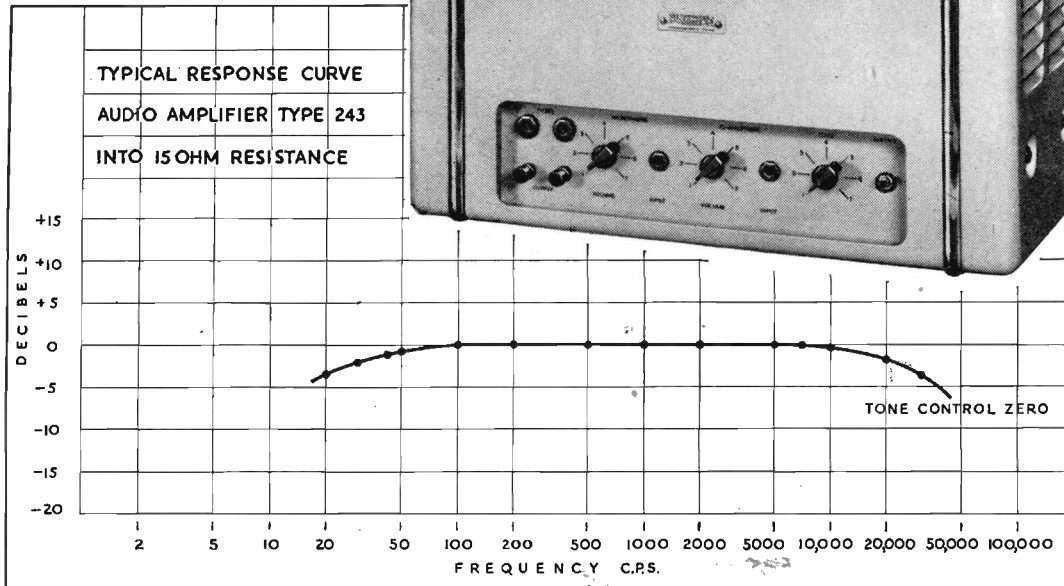
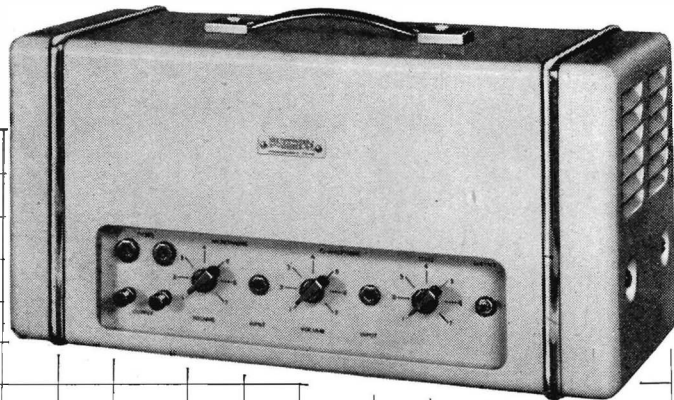

The METROVICK audio amplifier

TYPE 243

The type 243 amplifier is designed for use with high grade public address systems, for the connoisseur of quality and for industrial applications where faithful response over the audio range from 30 to 15,000 cycles is required. This Metrovick instrument is outstanding in its class and provides an output of 20 watts.

SPECIFICATION

Supply: 200/250V 50 c/s single-phase; consumption approximately 170 VA for full output.

Input: Gramophone not exceeding 0.2V for full output. Microphone not exceeding 0.02V for full output. The two circuits can be mixed as required.

Impedance: 7 ohms, 15 ohms and 45 ohms.

Output: 20 watts with negligible distortion.

Tone Control: Continuously variable.

Response: ± 1 db from 30 to 15,000 c/s at zero position of tone control.

Controls: These are recessed to avoid damage and are illuminated when in operation.

Dimensions: 18 $\frac{1}{2}$ " x 8 $\frac{1}{2}$ " x 10 $\frac{1}{2}$ ".

Weight: 60lb. net.

Finish: The instrument is housed in an attractive steel case, stove enamelled in cream or blue as desired. A leather carrying handle is fitted.

METROPOLITAN-VICKERS ELECTRICAL COMPANY, LIMITED, TRAFFORD PARK, MANCHESTER, 17

Member of the A.E.I. group of companies



METROVICK *Applying Electronics to Industry*

19598A

RE/ 101



An Announcement. . .

DUREX ABRASIVES LTD. wish to announce that as from June 14th, 1951, the name of the Company has been changed and is now the MINNESOTA MINING & MANUFACTURING COMPANY LTD. Identification will be as before, except that the words "Scotch Boy" will be used instead of "DUREX" as a prefix to the name of the material, e.g. "Scotch Boy" Magnetic Recording Tape instead of "Durex" Magnetic Recording Tape.

Existing high standards in the quality of the products will be maintained, the change is in name only.

'SCOTCH BOY' Magnetic Recording TAPE



ANOTHER  PRODUCT

Manufactured by :—

MINNESOTA MINING & MANUFACTURING COMPANY LTD
167, STRAND, LONDON, W.C.2, and SLOUGH

Room for a little 'un



A mass of resistances, wires and condensers — how do you squeeze a switch in there? We'll tell you. Use our Type B.T. switch. It has been specially designed for small spaces and simple switching. You'll find it a godsend. It's an even better switch too since it has had an overhaul in our Development Section. Here are some improvements we have made to it:

The contact blades are fixed in a new way. This makes them rigid all the time.

The drive spindle is positioned definitely in the wafer. This provides double bearing.

Steady contact resistance.

Improved insulation between contacts.

Positive contact.

Self-cleaning action.

All these help to make the Type B.T. an efficient and lasting switch. Why not try it?

WALTER SWITCHES — MADE FOR LIFE

Walter Instruments

LIMITED

GARTH ROAD, LOWER MORDEN, SURREY. Telephone: DERWENT 4421-2-3

CRC46

**WIDE RANGE
NAGARD TYPE 103
OSCILLOSCOPE AND
WAVE FORM MONITOR**

NOW IN CONVENIENT FORM. A VERSATILE AND ACCURATE RESEARCH TOOL FOR THE PROBLEMS OF TODAY AND TOMORROW.

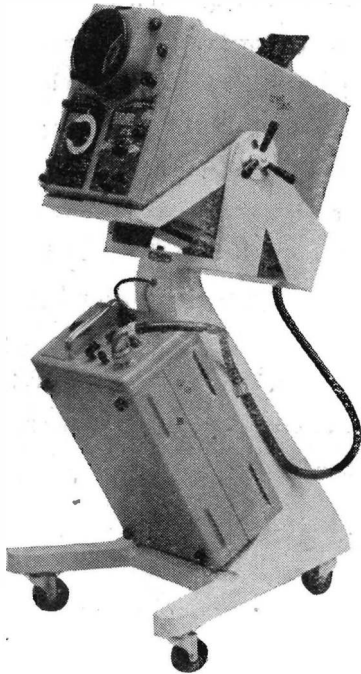

See **TRULY** what you measure !

D.C. AMPLIFIERS in three ranges and **TIME BASES** in two ranges enable the accurate display of an infinite variety of **WAVE FORMS**.

HIGH SPEED MODEL comprises :—
SWEEP SPEEDS up to 55 mm. per μ sec.
RISE TIMES to 0.04 μ sec.

LOW SPEED MODEL comprises :—
SWEEPS from 50 mm. per sec. to 50 mm per 10 μ sec.
Y AXIS SENSITIVITIES of—
15 mm. per mV up to 2 Mc/s, or
75 mm. per mV up to 20 Kc/s.

NAGARD
LTD

18, AVENUE ROAD, BELMONT, SURREY.

Telephone No. Vigilant 0345.

Electronic Engineering

Incorporating *ELECTRONICS, TELEVISION and SHORT WAVE WORLD*
Managing Editor, H. G. Foster, M.Sc., M.I.E.E.

Vol. XXIII

NOVEMBER 1951

No. 285

In This Issue

Commentary	413
Germanium Crystal Valves	414
By B. R. A. Bettridge	
New Plastic Technique	417
Minimum Phase Networks	418
By J. A. Tanner, M.Eng., Ph.D.	
A Method of Capacitance Measurement	423
By A. M. Andrew, B.Sc.	
Equipment for Acoustic Measurements (Part 3)	424
By C. G. Mayo, M.A., B.Sc., M.I.E.E., D. G. Beadle, B.Sc., A.C.G.I., A.M.I.E.E., W. Wharton, A.M.I.E.E.	
"Deoxo" Catalytic Gas Purifier	428
The Measurement of Microphony in Valves	429
By R. Bird, M.Sc., D.I.C.	
The Parallel-T Network as a Linear Mixer	432
By John S. Nisbet, B.Sc.	
Submerged Repeaters	433
The Holme Moss Television Transmitter	434
A Beacon Range Indicator	436
By J. H. McGuire, B.Sc.	
Blocking Oscillator Amplitude Control	439
The Prediction of A.F. Response No. 1	440
By N. H. Crowhurst, A.M.I.E.E.	
Making a T.V. Receiver Display Its Own Response Curve	443
Measuring Circuits Using Rectifiers	444
By E. H. W. Banner, M.Sc., M.I.E.E., F.Inst.P.	
Production of Short Pulses from a Simple LCR Circuit	446
By F. A. Benson, M.Eng., A.M.I.E.E., M.I.R.E., G. V. G. Lusher, B.Eng.	
The Anode Connexion of Cathode-Ray Tubes	447
A Nomogram for Multivibrator Design	448
By W. R. Luckett	
Letters to the Editor	449
Electronic Equipment	450
Book Reviews	452
Notes from the Industry	455
Meetings this Month	456

Published Monthly on the last Friday of the preceding month at
28 Essex Street, Strand, London, W.C.2.

Phone: CENTRAL 6565. Grams: 'ELECTRONING, ESTRAND, LONDON'

Subscription Rate:
(Home or Abroad) Post Paid 12 months 26s. or \$3.75 (U.S.)

Classified Advertisements, Page 1
Index to ADVERTISERS, Page 56

A Range of Industrial Photocells

53CV
End-on-Series

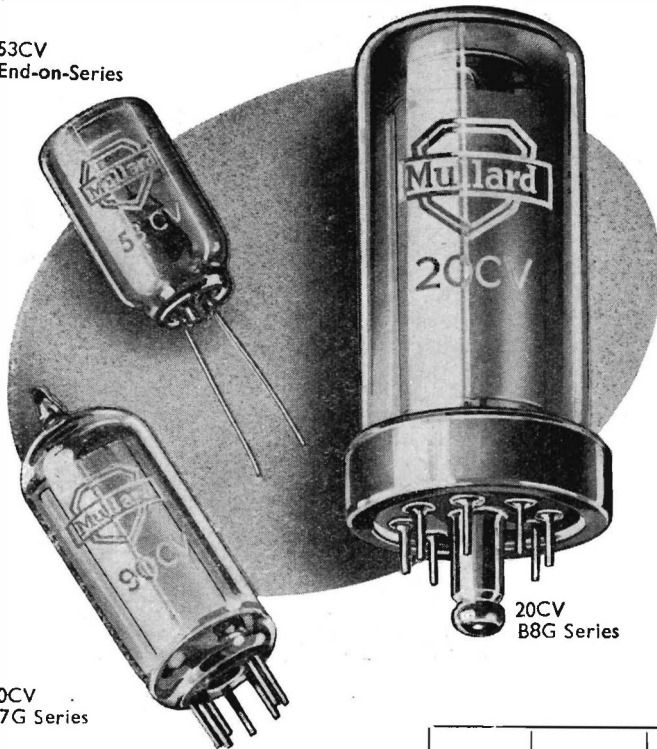

90CV
B7G Series

20CV
B8G Series

As a result of extensive research both in material and design Mullard now make available a comprehensive range of photocells ideally suited for industrial applications.

The range falls into two main groups. The caesium-silver-oxide cathode (C type) cells, with a high sensitivity to incandescent and infra-red radiation; and the caesium-antimony cathode (A type) cells, with a high sensitivity to daylight.

Brief technical details are listed below. Fuller information on these and special photocells is available on request.

Mullard

News Letter

If you are not already on the mailing list for this service of advance information on new valves, please write to us for full particulars on your business letterheading.

Type	Base	Max. Anode Supply Voltage (V)	Max. Cathode Current (μ A)	Max. Dark Current (μ A)	Sensitivity to colour temp. 2,700°K (μ A/l)	Max. Gas Amplification Factor
20AV	B8G	150	10	0.05	45	—
20CG	B8G	90	5	0.1	150	10
20CV	B8G	250	20	0.05	25	—
90AG	B7G	90	2.5	0.1	200	7
*90AV	B7G	100	5	0.05	45	—
*90CG	B7G	90	2	0.1	125	10
*90CV	B7G	100	10	0.05	20	—
58CG	Wire-in	90	1.5	0.1	88	9
58CV	Wire-in	100	1.5	0.05	15	—

* These valves are included in the new Government list of preferred valves for the services.

Mullard

Thermionic Valves and Electron Tubes

INDUSTRIAL POWER VALVES · THYRATRONS · INDUSTRIAL RECTIFIERS · PHOTOCELLS
FLASH TUBES · ACCELEROMETERS · CATHODE RAY TUBES · STABILISERS AND
REFERENCE LEVEL TUBES · COLD CATHODE TUBES · ELECTROMETERS, ETC.



MULLARD LTD., CENTURY HOUSE, SHAFTESBURY AVENUE, LONDON, W.C.2

MVT 86A REV

Electronic Engineering

Vol. XXIII.

NOVEMBER 1951

No. 285.

Commentary

AS we go to press this month, the largest television transmitter in the world will be opened with the usual speeches and ceremonies and, by the time this issue appears in print, television will be within the reach of another eleven million people within the rectangle formed by Grimsby, Bridlington, Chester and Lancaster. This transmitter, a brief description of which appears elsewhere, is located at Holme Moss and is the third of the B.B.C.'s high power transmitters which together will cover some 80 per cent of the population of Great Britain.

Its progress has been delayed by last winter's bad weather which prevented building operations and the erection of the imposing 750 mast. It is in an extremely exposed position about 1,750ft above sea level and in consequence considerable precautions have had to be taken to ensure its operation in all conditions of weather.

In addition to a low-power transmitter, which will serve as a standby in the event of failure of the mains transmitter, there is a spare 150ft mast with an emergency aerial, and switching arrangements are such that either transmitter can be connected to either aerial. This low-power standby is, in fact, identical with the five low power transmitters, the construction of which was stopped earlier this year by the limitations of capital expenditure. Residents in those areas which were to be served by these low-power stations are now unlikely to obtain the television service for several years to come and they may feel justifiably aggrieved that Lancashire and Yorkshire are being served so well.

Holme Moss is, of course, an outstanding achievement—indeed it might be said it is the only achievement—to the credit of the B.B.C. since Sutton Coldfield was opened in December 1949, and it is a great pity that Holme Moss could not have been sufficiently advanced for its opening to be included in the B.B.C.'s annual report for 1950-51* which has just been published.

This time last year, Sutton Coldfield had been in operation for some months and the Beveridge Committee had just published the report on its findings, giving us a glimpse of the exciting things to come. Construction of Holme Moss was proceeding, orders for the equipment for Kirk O'Shotts had been placed, tenders sent out for the five low-power transmitters and there was every hope that a decision would be reached with regard to the v.h.f. transmissions from Wrotham.

But almost immediately the clouds of rearmament descended with the result that the five low-power transmitters have been abandoned, Wrotham seems to have been quietly forgotten, until, perhaps, the Postmaster General enlightens us regarding the new system of modu-

lation, which may render Wrotham obsolete, and beyond temporary measures to improve the Home Service in S.E. England, the chaotic condition likely to arise this winter in the broadcast wavelengths have been ignored.

Through no fault of its own, the B.B.C.'s high hopes have almost completely disappeared and its 1950-51 report contains very little to record in engineering progress in the year under review for Holme Moss and the new Third Programme Transmitter at Daventry will have to wait for next year's report. Small wonder therefore, that this uninspiring document has escaped the attention given to its predecessor.

The only evidence it does provide is on the decreasing value of our money; whereas the 1949-1950 report cost 3s., the present one with slightly more pages costs 4s. 6d.

* * *

Now that the Festival of Britain celebrations designed to mark a hundred years progress since the Great Exhibition of 1851 have come to an end, one of the problems which arises is what is to be done with the South Bank site when the various temporary buildings have been removed.

It seems only too clear that the fate of the upstream section is sealed for, according to a statement issued last month by the London County Council, it is proposed to erect still more Government buildings on this site including conference halls which would, it is stated, relieve the shortage of such buildings existing in London. The position of the downstream section between Waterloo and Hungerford bridge is, however, more hopeful.

On this site, the Royal Festival Hall is to remain, as originally planned, and between the Festival Hall itself and Waterloo bridge, space has been reserved for a National Theatre. The buildings occupied during this Festival by the administrative staff will probably be handed over to the Council of Industrial Design and we are glad to learn that it is proposed to retain the Telekinema. This we are sure will be welcomed by both the film and television industries.

Plans are advanced for the Scientific Centre upon which we commented on this page in January of this year and it now appears that this will be erected on the derelict site further downstream from Waterloo Bridge facing Somerset House, and will form part of the reclamation schemes extending to Blackfriars Bridge.

These plans, of course, are separate from the South Bank plans and it is emphasized that they are dependent on financial and economical conditions. A seven acre site has been allocated to the Science Centre which will provide office accommodation for the Department of Scientific and Industrial Research, a new patent office library, and new buildings for the Royal Society and the other learned societies now struggling in Burlington House.

Annual Report and accounts of the B.B.C. for the year 1950-1951. H.M.S.O. Cmd. 8347. Price 4/6.

Germanium Crystal Valves

An Assessment of Characteristics and Applications

By B. R. A. Bettridge*

LARGE scale production of germanium crystal diodes has been in existence for some time both in this country and the U.S.A. and great quantities are already being used. There has, however, been little published in the way of a critical examination of their characteristics as they affect circuit applications.

It is probably true to say that although most types of rectifier have particular fields in which they have special advantages none has such a wide range as the thermionic diode. This, therefore, is the best standard with which to compare the germanium diode which is similar in its adaptability.

Fig. 1 shows its size and at the same time gives an idea of its construction. It is clear that from a purely physical aspect it is not difficult to fit a crystal diode in almost any part of a circuit, and such places as inside an I.F. screening can, immediately spring to mind. They are, of course, designed specifically for soldering into the circuit, their robustness and very long life making it quite unnecessary to cater for easy replacement. From the electrical point

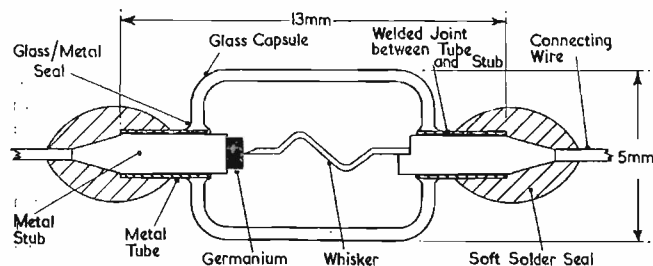

Fig. 1. Dimensions and construction of a germanium diode

of view they are equally accommodating, the absence of a heater allowing circuit positions denied to the thermionic diode because of heater-to-cathode capacitance.

These kind of advantages are so clear cut that they have been widely stressed as sales points and it is not proposed to cover this ground again in detail.

Characteristics

The complete picture from the electrical aspect is fairly complex. Fig. 2(a) shows the general shape of a germanium diode curve of current against applied voltage. As well as showing the high ratio of back resistance to forward resistance, it also illustrates how at a reverse voltage known as the turnover voltage the back resistance suddenly becomes zero and then negative. Although use of this region has been suggested for oscillators, it is not to be recommended since it is almost certain to result in the permissible reverse current rating being exceeded. Nor is this operation sufficiently stable, due to the overload condition causing a temperature rise and consequent change of characteristic. More detailed static current-voltage curves are shown in Fig. 2(b). To one accustomed to thermionic diodes these curves may look odd and perhaps even unpromising. An immediately obvious

point is the presence of appreciable reverse current. This cannot be ignored but it will be seen later, when looking at individual applications that its effect is often of no consequence, and it is important to realize this, as often the crystal rectifier tends to be condemned out of hand before its undoubted merits are appreciated.

The curves show higher values of forward current than would be expected for so minute a device; this is possible because its high forward conductance keeps the dissipation low and average currents of 50mA can be handled. In the reverse direction quite small currents result in appreciable dissipation because of the high impedance and a limit of 2mA is therefore imposed.

Effect of Temperature

Another point of difference between these curves and those of thermionic diodes is the variation with temperature which is fundamental to semi-conductor type rectifiers. This may sometimes have to be taken into account but cases are not numerous where it becomes a serious disadvantage. For instance in the television applications described below the variations can be safely ignored. In practical use as a rectifier the constant impedance load tends to swamp variations of the rectifier impedance. In addition the variation can be kept even lower by ensuring that the input voltage is kept reasonably high—say of the order of 10 volts. Variations will be most apparent where a crystal is operating into a very low resistance load, such as a meter, with an input of less than 1 volt, but even here the situation is no worse than with metal rectifiers.

A final point of general comparison is that of permissible reverse voltage, where although thermionic diodes have a limit, it is usually high enough to be disregarded in all circuit applications except power rectifiers. With germanium diodes the limit tends to be lower, a figure of 60 volts being quoted for many types and since this limit varies from one type to another it should always be examined. In passing it should be remarked that published ratings for germanium diodes are usually for 20°C. and appreciable lowering of permissible reverse voltage takes place at higher temperatures.

Frequency Rise

A parameter not ascertainable from the curves is the frequency response. This is good as would be expected from the low capacitance and lack of transit time effects in a crystal. The point at which a falling off occurs varies somewhat from one crystal type to another and also depends to some extent on operating conditions. In fact the matter is considerably more complex than might be supposed considering the apparent simplicity of the device. In general, however, when used in normal circuits no appreciable falling off is to be expected up to 100 or 150Mc/s and useful results can even be obtained in the 400Mc/s band where thermionic diodes are getting beyond their limit. These remarks apply to the high back voltage types of crystal whose characteristics have been shown in Figs. 2(a) and 2(b); special types to be described later are effective up to 1,000Mc/s.

* Osram Valve & Electronic Dept., G.E.C.

Applications

In dealing with specific applications the technical aspect will be the main criterion. However, it would be as well to mention that the cost of crystals is to a large extent based on the magnitude of their reverse resistance. It is probable that this state of affairs will continue even though the difference may become less marked, and it is therefore reasonable when designing a circuit to make it

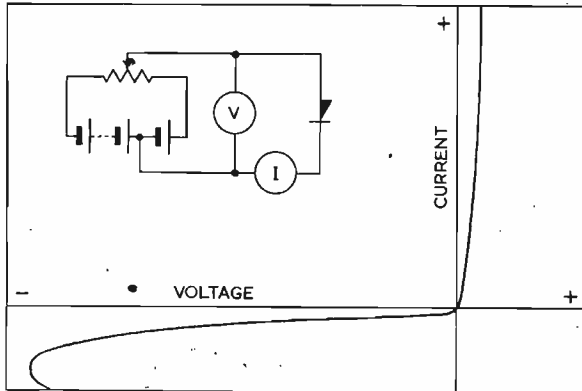

Fig. 2(a). General shape of germanium diode characteristic

suitable for the lowest back resistance that can be tolerated rather than work to some theoretical standard of perfection.

In broadcast receivers the only diodes commonly used, other than power rectifiers, are for detection and A.V.C. The necessary diodes can be cheaply provided in the same envelope as the A.F. amplifier so that their substitution by germanium diodes is not an immediately obvious course. The possibility worth investigating most appears to be the case of a low cost set with no amplifier valve between the detector and output stage.

In television receivers, however, there are more diodes in normal use some of which, for technical reasons, cannot share an envelope with another valve system, while several of them have associated circuits where, with little or no alteration, germanium diodes can conveniently be used.

Vision Detector

The preservation of bandwidth is a prime consideration in designing a vision channel and deliberate damping of

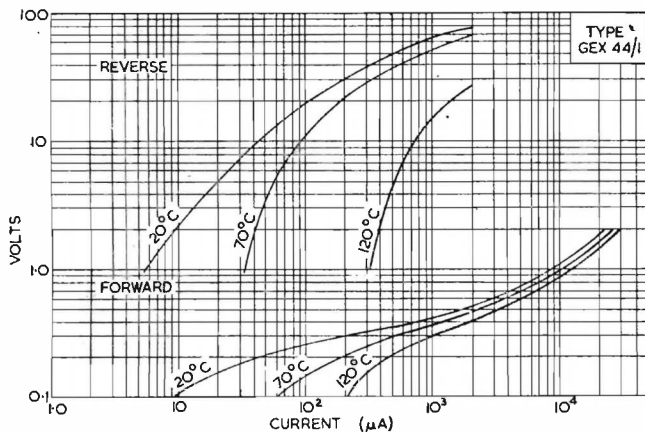

Fig. 2(b). Static curves of a typical crystal type GEX44/1

tuned circuits is quite common. The damping produced by one of the lower back impedance germanium diodes is therefore no disadvantage while its low capacitance (less than 1pF), is a definite advantage. It can be used, therefore, as a direct replacement of a thermionic diode, a typical circuit being shown in Fig. 3. This is applicable

to a superhet or a T.R.F. receiver. Where the circuit is specifically designed around a germanium diode advantage should be taken of its low capacitance by increasing the inductance of the circuit feeding it. In a circuit such as this, using a low diode load, the forward resistance of the diode has to be low for reasonable efficiency. Special low impedance diodes, or diodes in parallel have sometimes been used to cover this requirement, which is adequately met by germanium diodes. The question of back voltage limit is not likely to arise in this circuit but it might be mentioned that it has been found that diodes with the best H.F. performance usually have a lower turn-over voltage. This was in fact used at one time as a basis of selection for television detectors, where limits of 60 volts maximum and 30 volts minimum were imposed.

T.V. SOUND DETECTION AND NOISE LIMITING

In the sound channel, bandwidth is of less importance and circuits are usually arranged for higher gain. There is, however, a practical limit imposed by the interference problem. A common form of noise consists of sharp impulses which can be very effectively dealt with by quite simple circuits, but only provided that the steep waveform is retained. This means that some damping of the H.F. circuits is not objectionable and demands that all A.F. circuits up to the limiter must have a good high frequency response, so that a low value diode load is therefore called for. A typical value would not be above 47,000 ohms and where this is the case a germanium diode can be used in place of a thermionic diode with no circuit alterations.

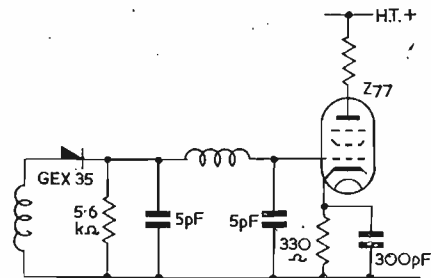

Fig. 3. A typical vision detector circuit

If, however, it is advantageous to alter the position of the diode physically or electrically to help screening or filtering it should be borne in mind that as the crystal detector has no heater, there are no limitations imposed by consideration of hum introduction.

A typical circuit, Fig. 4, shows a crystal being used in an orthodox circuit as sound detector followed by another as noise limiter. The latter is so biased as to conduct normally and follow the A.F. signal. On receiving a steep fronted negative impulse, the time constant of R and C holds the cathode positive long enough to prevent the impulse being passed on.

A crystal with a very low reverse impedance would not be good in this circuit, but one of moderate impedance is highly effective. It will be noted that both sides of the crystal are well above earth potential.

There have been limiter circuits published which rely on the almost infinite back resistance given by the thermionic diode, the operation of these is completely upset by the shunting effect of the finite value given by a germanium crystal and the substitution in these circuits should not be attempted.

SPOT LIMITER

On the vision side the fitting of a limiter is normal practice. Two kinds are commonly employed both using a backed-off diode but one is biased by the actual signal while the other has a fixed potential applied from a network. The first type in its simplest form consists of a diode shunted by a high resistance in series with a capacitor

connected between cathode and modulator of the cathode-ray tube. The capacitor becomes charged to peak white and the long time constant holds the diode at this bias so that sharp impulses above peak white are short circuited. There is inevitably some clipping of whites with this system which is sufficiently serious in practice with any but the highest back resistance types to outweigh the advantage of simplicity.

The other type is fixed to a predetermined level corresponding to the defocus point of the tube in use and adjustment has to be provided to cater for tube variations. This is a little more complicated but is free from the clipping described above. A typical circuit is shown in Fig. 5. The germanium diode can be used here with advantage, owing to its low capacitance. Its low forward resistance gives completely effective limiting while its reverse resistance is not low enough to cause shunting of the video load. The back voltage limit must be watched, particularly if the temperature in the region of the crystal is high.

FRAME SEPARATOR

To illustrate a case where a general purpose germanium diode cannot be directly substituted we may take the

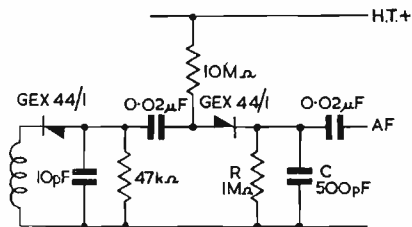

Fig. 4. Germanium crystals used as sound detector and noise limiter

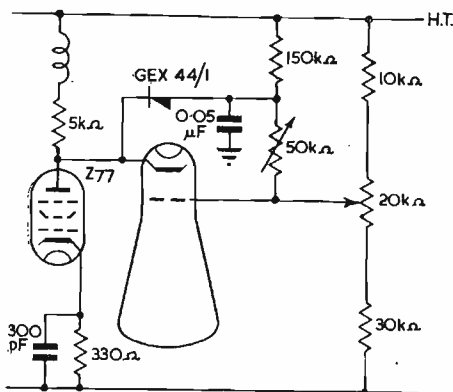

Fig. 5. Spot limiting by germanium diode

circuit in Fig. 6. Here the diode is intended to let through the frame pulses from the network in the anode circuit of the separator valve while holding back the smaller line pulses, complete elimination of the latter being, of course, essential for a reliable interlace.

A crystal diode of moderate back resistance will let through an appreciable amplitude of line pulse even when backed off so that the desired elimination does not take place.

Lowering values of associated resistances would help the germanium diode to be more effective but this would have repercussions on the rest of the circuit. The size of the pulse required and the type of time-base would have to be taken into consideration when deciding what alterations could be made, so that no general solution is possible.

The above are probably the most likely television applications but another possibility is worth considering. By using a germanium diode as mixer the pentode normally used for the purpose could be used instead as an I.F. ampli-

fier; this would give considerably higher gain in its new position. A special type of crystal to be described later has been developed for mixer use.

MISCELLANEOUS APPLICATIONS

Turning now to miscellaneous applications, deaf aid equipment provides a good example. Some form of A.V.C. is desirable in these instruments but provision of diodes in the very small amplifying valves used is not practicable. Here the germanium diode is ideal, in view of its minute size.

If a regular F.M. service is introduced there will undoubtedly be a widespread use of germanium diodes in discriminator circuits, where it is a great convenience to be able to mount the rectifiers in the I.F. transformer screening can itself. For the present, it is worth noting that although matched crystals are sometimes recommended their use is not really essential. The forward resistance is low enough not to matter while the back resistance may be swamped by a resistor in parallel.

In addition to the large scale uses mentioned above there are naturally many special uses. They are particularly attractive for such things as field strength meters where normally thermionic diodes needing a heater supply have to be used. Examples of this kind could be multiplied but they are not of sufficiently general interest to justify inclusion in this survey.

Recent Developments

The foregoing has concerned itself with crystal types which have been available in this country for some time.

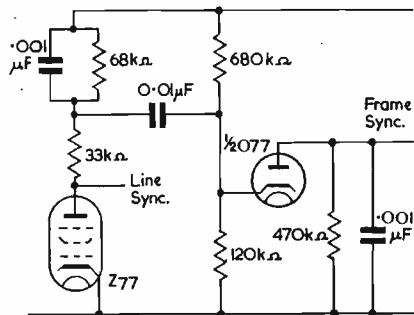

Fig. 6. Frame separator circuit using thermionic diode

Some more recent developments are described separately below.

It has already been mentioned that greater efficiency at high frequencies is given in general by crystals of lower turnover voltage. By the addition of traces of other elements to the germanium, crystals have been made having an excellent performance as mixers in the range 100-1,000 Mc/s. They are characterized by a capacitance as low as the normal range combined with an exceptionally low forward resistance even at a fraction of a volt. This is offset by a much lower turnover voltage (in the region of 10 volts) but, for mixer or meter rectifier work this point is of little importance.

Such crystals have recently been introduced and a typical characteristic is shown in Fig. 7.

By further modifications, still higher values of forward conductance can be achieved although at the expense of some increase in capacitance. The figure is still low enough for good efficiency at moderate frequencies and for carrier telephony applications such a device is superior to other rectifiers at present available. Incidentally, for meter work this exceptionally low value of forward resistance is naturally an advantage and, furthermore, it means that the crystal constitutes so small a part of the total resistance that temperature variations assume much less importance.

Triodes¹

The subject of germanium crystals cannot be left without mention of the triode or "transistor".

A great future is likely for this device in certain fields, although in its present form it seems doubtful whether it will find wide application in normal radio or television sets. Its low input impedance, lowish output and rather high noise figure provide circuit problems and limitations. Nevertheless it should be mentioned that the technical feasibility of its use in radio has been illustrated by the demonstration of an all crystal triode set working a loud speaker.

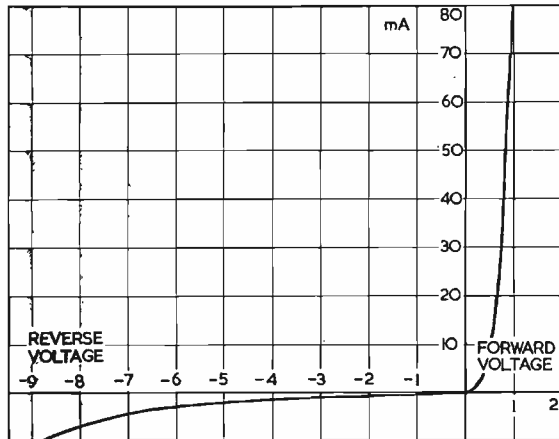

Fig. 7. Characteristic of typical low impedance crystal type GEX66

Unlike the germanium diode, it requires the application of operating voltages and current flows in both bias and H.T. circuits. Absence of a filament does, however, give material saving and in the case of a small amplifier total consumption for comparable gain would be substantially less with crystal triodes than with subminiature thermionic valves. The elimination of the L.T. supply is not, however, always the chief advantage. The small size, robustness and long life are of greater importance in equipments such as automatic computing machines, some of which at present use so many thousands of thermionic valves that their frequent failure constitutes a serious problem. Germanium diodes are already finding their way into these equipments in large numbers and doubtless triodes will follow when freely available. A further point in favour

of their use is that a single crystal triode can be made to work as a relaxation oscillator instead of having to use a back coupled pair.

Robustness has been achieved in the triode by a form of construction shown in Fig. 8. It will be seen that the problem of obtaining two contacts on the crystal a few

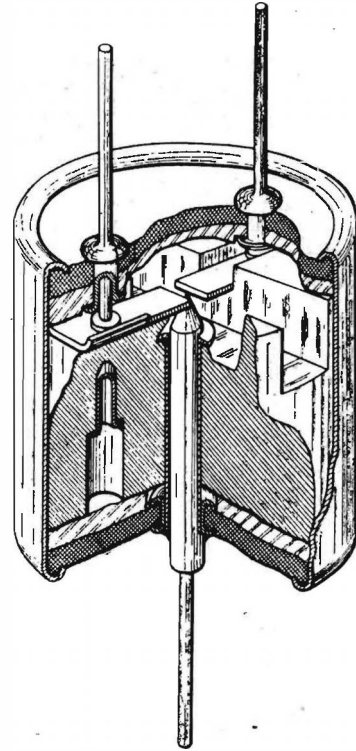

Fig. 8. Constructional details of a crystal triode

thousandths of an inch apart has been solved by using two thin blades separated by a gap of controlled width into which the apex of a conical piece of germanium is inserted. Consistent production is, therefore, possible without highly skilled and critical operations during assembly.

REFERENCE

- ¹ The Germanium Triode, *E. Engg.* XXIII, 393 (1951).

New Plastic Technique for Radio Manufacturers*

RADIO Manufacturers engaged on defence contracts are shortly to adopt a new plastic technique—the result of experiments by the Ministry of Supply Telecommunications Research Establishment—to produce lighter, simpler and smaller radio and radar sets for the Forces.

Secret of the new technique is a liquid plastic, developed in America for laminating aircraft bodies, which is impervious to all ordinary temperatures, moisture and vibration.

Since the material became available in England, Supply Ministry scientists have been experimenting with it to make "potted circuits"—the breaking-down of complicated radar and radio sets into small assemblies enclosed in plastic blocks. The Ministry has now passed the results of its researches to manufacturers engaged on defence projects.

The jungle of wires and small components which makes

up the modern radio or radar apparatus will largely be replaced by neat cubes of plastic material, in which the circuits are embedded.

Maintenance in the field by Servicemen will be greatly simplified as the cubes can quickly be replaced by unskilled men. Because they are so cheap to produce—the radio parts are simply assembled, placed in a mould, covered with plastic and left to set—there will be no necessity to send back parts to field workshops for repair.

In addition, since the plastic blocks are proof against heat extremes, vibration, moisture, fungi and changes in pressure, expensive and complicated protective devices such as pressurized boxes will no longer be necessary.

One of the greatest advantages of the material, however, is that it enables lighter and smaller sets to be constructed. No less than 38 miniature radio components have been assembled by Supply Ministry scientists in a block of plastic measuring $1\frac{1}{4}$ by $2\frac{1}{4}$ by $11/16$ inches.

* Communication from the Ministry of Supply

Minimum Phase Networks

By J. A. Tanner, M.Eng., Ph.D.*

A GREAT deal has been written about the design of feedback systems both in connexion with telecommunications and with automatic control systems. In particular, it will be found that the literature includes a long list of relations between gain and phase-shift discovered by a wide variety of authors.

Perhaps the most important contribution to network theory and feedback amplifier design is that of H. W. Bode,¹ who has shown that a specification of the gain *versus* frequency characteristic of a network does not define the phase *versus* frequency characteristic, but that it does define the minimum phase lag that the network can have at every frequency. The particular network which, while having the specified gain characteristic, has also the minimum value of phase lag at every frequency is known as a Minimum Phase Network.

The object of this paper is to summarize the characteristics and properties of Minimum Phase Networks chiefly with regard to their use in servo systems. It is desirable that the networks used for phase equalization of servo loops should, in general, be Minimum Phase Networks. Exceptions to this rule are discussed later.

List of Symbols

- \hat{v}_o = Output voltage from network system, expressed in operational form.
 - \hat{v}_i = Input voltage to network system, expressed in operational form.
 - K = Constant multiplier.
 - p = Laplacian operator.
 - α = Damping ratio.
 - T_1, T_2, T_a , etc. = Network time-constants, sec.
 - S_1, S_2, S_3 , etc. = Network time-constants.
 - \hat{A}_m = Transfer function of Minimum Phase Network.
 - \hat{A}_n = Transfer function of Non-minimum Phase Network.
 - A = Logarithmic gain of Minimum Phase Network.
 - \hat{A}_s = Loop gain transfer function.
 - Z_1, Z_2, Z_a , etc. = Component network impedances expressed in operational form.
 - Z = Terminating impedance expressed in operational form.
 - ω = Angular frequency, radians per sec.
 - f_c = Arbitrary reference frequency, cycles per sec.
 - u = Logarithm of the ratio f/f_c .
 - M = Mutual-inductive coupling, henrys.
 - L = Self-inductance, henrys.
 - R = Resistance, ohms.
 - C = Capacitance, farads.
 - k = Slope of gain characteristic (dA/du)
- (The use of a circumflex over a symbol denotes that the quantity concerned is expressed in operational form.)

Definition of Minimum Phase Networks

A Minimum Phase Network is a network whose transfer function⁴ (viz., the operational expression for the output voltage as a function of the input voltage), has no zeros or poles⁷ appearing in the right half of the complex p -plane.

Consider for example the following transfer function:

$$\hat{v}_o/\hat{v}_i = \frac{K(I + pT_1)(I + pT_2)\dots(I + pT_n)}{(I + pT_a)(I + pT_b)\dots(I + pT_x)} \dots \quad (1)$$

* National Physical Laboratory, Teddington.

where K is the gain constant and T_1, T_2, T_a , etc., are the network time constants. The zeros and poles appear only in the left half of the p -plane and the system is therefore of Minimum Phase structure.

In the following case the transfer function contains a zero in the right half p -plane:

$$\hat{v}_o/\hat{v}_i = \frac{K(I - pT_1)(I + pT_2)\dots(I + pT_n)}{(I + pT_a)(I + pT_b)\dots(I + pT_x)} \dots \quad (2)$$

and the system is therefore of Non-minimum Phase structure. In general, the transfer functions of Non-minimum Phase Networks have a factor either of the form $(I - pT)$ or $(I - 2\alpha pT + p^2T^2)$ in the numerator or denominator.

The case of a *pole* appearing in the right half p -plane can arise only in unstable active networks, e.g., an unstable Minor Loop in a servo system. This case is physically unrealizable in a network consisting entirely of passive elements and buffer amplifiers, but would in any case be a Non-minimum Phase structure.

The occurrence of poles and zeros on the imaginary (or real frequency) axis in the p -plane is dealt with in Appendix (3).

Properties of Minimum Phase Networks

From consideration of the gain transfer functions of stable networks, viz., passive networks (in which also may be included buffer amplifiers or any device which merely multiplies the transfer function by a constant) and stable active networks, it can be shown that a Minimum Phase Network will have at every frequency a smaller phase-shift algebraically, (lag being taken as positive), than a Non-minimum Phase Network having the same gain characteristic.² In fact no Non-minimum Phase Network can have a smaller phase shift algebraically than the Minimum Phase Network having the same gain characteristic.

This, the title property of Minimum Phase Networks, applies only to stable networks. It should be noted that unstable active networks may have transfer functions which imply a negative lag. In such cases, however, there exists no Minimum Phase Network having this form of phase characteristic.

Another important property is that all Minimum Phase Networks, irrespective of circuit configuration or component values, have the same mathematical relation between the gain *versus* frequency characteristic and the phase *versus* frequency characteristic. In other words, if one of these characteristics is given for a network which is known to be of Minimum Phase type, the other characteristic is completely defined.

Contrast this with four terminal networks in general, for which there is no such relationship; i.e., it is possible to have a large number of networks all having the same gain *versus* frequency characteristic, but having different phase *versus* frequency characteristics, and vice-versa.

The nature of this unique relationship is discussed in detail by Bode.^{1,2} Briefly, the phase-shift at any frequency is proportional to a weighted average of the gain slope over the entire logarithmic frequency scale. The equation is given in Appendix (2), Equation (25).

A wide variety of circuit configurations satisfies the definition of a Minimum Phase Network. Some particular

configurations satisfy the definition irrespective of the component values, whereas others prove to be Minimum Phase Networks only if certain limitations are imposed on the components. General considerations of circuit configurations which fulfil the Minimum Phase definition and those which do not are given in the section on network configurations.

It is perhaps worth noting that a Minimum Phase Network cannot have infinite attenuation at any frequency other than zero or infinity, nor can it have infinite gain at any single frequency, finite or otherwise. This follows from the definition of these networks.

All-pass Networks

There exists a class of stable networks which have the property of constant transfer gain but a phase shift which is a function of frequency. These networks are often referred to as "All-pass" sections.

Such networks are all Non-minimum Phase Networks since the only all-pass section having a Minimum Phase characteristic is the "straight-through" or direct connexion. In the case of the direct connexion, the transfer gain is unity and the phase-shift is zero at all frequencies, which is consistent with the relation given in Appendix (2), Equation (25).

A useful concept is that any stable Non-minimum Phase Network may be synthesized by connecting in tandem (so that they would not interact) a Minimum Phase Network having the same transfer gain characteristic and an all-pass section designed to make up the necessary phase shift. Thus the transfer function of the original Non-minimum Phase Network may be considered as the product of the transfer function of a Minimum Phase Network having the same gain characteristic and the transfer function of an all-pass section.

Consider, for example, the following Non-minimum Phase Network characteristic:

$$\hat{A}_n = \frac{K(1 - pT_1)(1 + pT_2) \dots (1 + pT_n)}{(1 + pT_a)(1 + pT_b) \dots (1 + pT_x)} \dots (3)$$

The Minimum Phase Network having the same gain characteristic is given by:

$$\hat{A}_m = \frac{K(1 + pT_1)(1 + pT_2) \dots (1 + pT_n)}{(1 + pT_a)(1 + pT_b) \dots (1 + pT_x)} \dots (4)$$

and it is sometimes convenient to write:

$$\hat{A}_n = \hat{A}_m(1 - pT_1)/(1 + pT_1) \dots (5)$$

In this expression, the factor $(1 - pT_1)/(1 + pT_1)$ is the transfer function of an all-pass network.

Minimum Phase Networks in Feedback Systems

The property of a Minimum Phase Network of having the least phase lag associated with a given gain characteristic makes it more suitable for the purpose of phase equalization of servo loops, in most cases, than a Non-minimum Phase Network having the same gain characteristic. A Non-minimum Phase Network would introduce a greater lag at all frequencies. However, whether the addition of lag is a step in the direction of stability or otherwise depends upon the particular system considered, and may be easily observed from the Nyquist diagram. For most stable systems, the addition of lag reduces the stability margins achievable with a given high frequency cut-off and therefore, in general, it is desirable to restrict the networks used to those of Minimum Phase structure. Nevertheless it is shown in Appendix (1) that the addition of lag can effect stabilization for particular systems. (It should be noted that the phrase "addition of lag" is used here to imply an increase in phase angle without change in gain).

There are special cases in which it would be definitely undesirable to restrict the networks used to those of Minimum Phase type. For instance, in the case where infinite attenuation is required in a system at a specified

frequency, (e.g., for the purpose of eliminating a noise component), it is necessary to use a network having a null response at that frequency. Such a network will inevitably not be of Minimum Phase structure.

The fact that a fixed relation exists between the gain and phase shift characteristics of a Minimum Phase system is of great value from the computational standpoint. For instance, it is often necessary in designing a servo system to choose an equalizer which will give the system a desired performance. Both the gain characteristic and the phase characteristic are, of course, vital factors in the design, and unless the structures used are restricted to Minimum Phase Networks, it is necessary to calculate separately both the gain and the phase characteristics of the equalizer and to investigate the effect on the overall performance. If, however, only Minimum Phase structures are to be permitted, the gain characteristic of the equalizer can be prescribed and the phase characteristic can then be deduced from this—using Equation (25)—before either a circuit configuration or the component values are decided upon. In addition to providing a basis for detailed calculation, Equation (25) makes possible a rapid approximate deduction of the form of the phase characteristic associated with a Minimum Phase Network having a given gain characteristic. An example of this is given in Appendix (2).

It will be appreciated that the use of Equation (25) would be rather involved for general computational purposes. For convenience, the given gain characteristic may usually be approximated with sufficient accuracy by straight line asymptotes and the phase computed by means of the procedure developed by Bode for this purpose,¹ as briefly outlined in Appendix (2).

Particular Network Configurations

By definition, the gain transfer function of a Minimum Phase system contains no zeros or poles in the right half p-plane. The gain transfer function of a given network or system thus provides the means of investigating whether or not the system is Minimum Phase. To illustrate this point, the following ladder network systems are considered.

THE GENERAL LADDER NETWORK

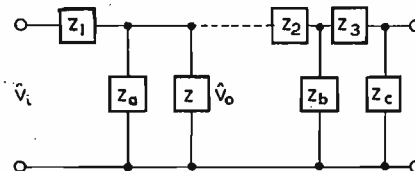

Fig. 1. Ladder network

The quantities Z_1, Z_2, Z_a , etc., are the component network impedances expressed in operational form. Since the response of a single section is to be investigated, component Z is added representing the input impedance of the network to the right of that point. For the network section considered, the transfer gain is given by the following expression:

$$\begin{aligned} \hat{v}_0/\hat{v}_1 &= \frac{ZZ_a/(Z + Z_a)}{Z_1 + ZZ_a/(Z + Z_a)} \\ &= \frac{Z_a'}{Z_1 + Z_a'} \dots (6) \\ &\quad (\text{where } Z_a' = ZZ_a/(Z + Z_a)) \end{aligned}$$

Provided that the component impedances $Z_1, Z_2, Z_a \dots Z_a'$, etc., are those of physically realizable passive elements, it follows that individually they can have zeros (and, of course, poles) only in the left half p-plane. Thus the above transfer function can have zeros only in the left half p-plane. The transfer function therefore fulfils the Minimum Phase definition and further it may be observed that the definition is satisfied for all values of the components.

A similar form of transfer function would be obtained for each successive T-section or π -section of the network,

and the transfer function of the whole network is then the product of all these individual transfer functions. It follows that the general ladder network is inherently a Minimum Phase structure.

The limitation which has been imposed on the components, namely that they shall be physically realizable passive networks, is unduly restrictive; for instance, the addition of a linear amplifier without feedback (or even a stable amplifier with frequency independent feedback) would simply multiply the transfer function by a constant. It may therefore be concluded that any ladder network of physically realizable elements is a Minimum Phase structure provided it includes only passive elements and buffer amplifiers.

THE LATTICE NETWORK

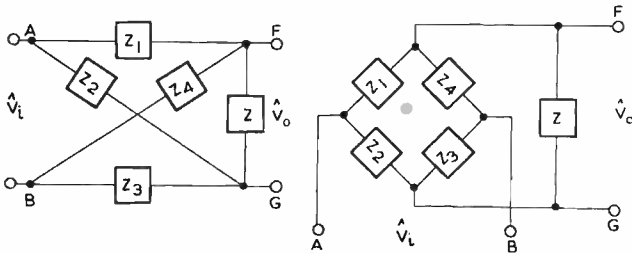

Fig. 2.—The Lattice Network

The gain transfer function for the above general lattice is given by:

$$\hat{v}_o / \hat{v}_i = \frac{\pm(Z_2 Z_1 - Z_1 Z_3)}{(Z_1 + Z_2)(Z_3 + Z_4)} \cdot \frac{1}{[1 + Z_1 Z_2 / Z(Z_1 + Z_2) + Z_3 Z_4 / Z(Z_3 + Z_4)]} \quad (7)$$

in which the impedance $Z_1, Z_2, Z, \text{ etc.}$, are expressed in operational form.

It is evident from the numerator expression that a zero may or may not appear in the right half p -plane depending on the particular component impedance values. The convention adopted regarding the sign of the numerator expression is discussed as follows:—

In any analysis in which the phase angle between \hat{v}_o and \hat{v}_i is required, it is, of course, necessary to specify the polarity. For instance, in the above expression for \hat{v}_o / \hat{v}_i , \hat{v}_i is taken to mean \hat{v}_{AB} and \hat{v}_o is taken to mean \hat{v}_{FG} . Should \hat{v}_o be taken instead as \hat{v}_{GF} it would be necessary to multiply the whole expression by -1 , corresponding to a phase change of 180 degrees. Thus the phase-shift associated with the transfer function differs by 180 degrees according to whether \hat{v}_o is taken as \hat{v}_{FG} or \hat{v}_{GF} . The numerator of Equation (7) is written as $\pm(Z_2 Z_1 - Z_1 Z_3)$ and the convention adopted is that the sign of the numerator is chosen to make the phase-shift, wherever possible, zero at zero frequency.

The special case in which $Z_2 Z_1 = Z_1 Z_3$ corresponds to the balanced bridge condition which results in zero transfer gain at all frequencies. It is, of course, obvious that such an "all-stop" network must represent a Non-minimum Phase structure.

Considering the Wien bridge network of Fig. 3, which finds application in systems where frequency selectivity is required.

The transfer function is given by:

$$\hat{v}_o / \hat{v}_i = \frac{p^2 C_4 C_3 R_1 R_3 + p(C_4 R_1 + C_3 R_3 - C_3 R_2 R_4 / R_1) + 1}{p^2 C_4 C_3 R_1 R_3 + p(C_4 R_1 + C_3 R_3 + C_3 R_2 R_4 / R_1) + 1} \quad (8)$$

Thus for Minimum Phase operation $(C_4 R_1 + C_3 R_3)$ must be greater than $(C_3 R_2 R_4 / R_1)$, which reduces to:

$$C_4 / C_3 + R_3 / R_4 > R_2 / R_1 \quad (9)$$

When the following relation is satisfied, viz.:

$$C_4 / C_3 + R_3 / R_1 = R_2 / R_1 \quad (10)$$

the network is found to have a null response (zero transfer

gain), and this occurs at a frequency given by:

$$\omega = 1 / \sqrt{C_3 C_4 R_2 R_1} \quad (11)$$

The relation (Equation (10)) which gives the necessary condition for a null response, is found to be identical with the relation between these components when the network is on the point of changing over from Minimum Phase to Non-minimum Phase operation. Since Equation (25) is not satisfied for such boundary networks, it is convenient to class them all as Non-minimum Phase Networks.

With $(C_4 / C_3 + R_3 / R_1)$ less than (R_2 / R_1) , the network would have a Non-minimum Phase characteristic, since the transfer function would then have two zeros located in the right half p -plane.

In short, a balanced Wien bridge becomes a Minimum Phase structure if the value of one of the components is

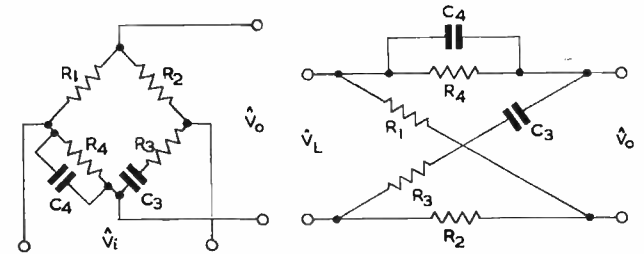

Fig. 3—Wien bridge network

changed in a given direction, and becomes a Non-minimum Phase structure if the value of that component is changed in the opposite direction.

In many applications, the symmetrical lattice configuration is used, in which case, referring to Fig. 2, $Z_2 = Z_1$, and $Z_4 = Z_3$. The gain transfer function then becomes:

$$\hat{v}_o / \hat{v}_i = \left(\frac{Z_3 - Z_1}{Z_2 + Z_1} \right) \cdot \left(\frac{1}{1 + (2/Z) \cdot Z_1 Z_2 / (Z_1 + Z_2)} \right) \quad (12)$$

For example, in the symmetrical lattice network (Fig. 4):

$$\begin{aligned} Z_1 &= R \\ Z_2 &= 1/pC \\ \text{and } \hat{v}_o / \hat{v}_i &= \frac{1/pC - R}{1/pC + R} \\ &= \frac{1 - pT}{1 + pT} \quad \dots \dots \dots (13) \end{aligned}$$

where $T = RC$

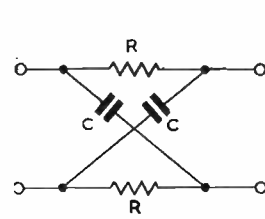

Fig. 4—Symmetrical lattice network

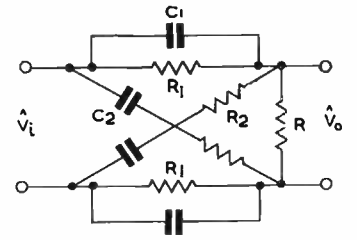

Fig. 5—Special type symmetrical lattice network

The gain transfer function has a zero located in the right half p -plane, and the network is therefore of Non-minimum Phase type, irrespective of the values of R and C . It may be observed that the gain remains constant and equal to unity at all frequencies. Only the phase shift varies with frequency. This network is one of the class known as all-pass.

A particular symmetrical lattice, Fig. 5, which is sometimes used in the phase equalization of servo loops will now be considered.

Referring to Fig. 2,

$$Z_1 = \frac{R_1 / pC_1}{R_1 + 1/pC_1} \quad Z_2 = R_2 + 1/pC_2$$

$$Z = R$$

† Lampert, W. E. C.: "Naval Applications of Remote Positional Controllers." *Journal I.E.E.*, 1947, 94, pt. 2A, No. 2, p. 294.

$$\text{and } \hat{v}_o/\hat{v}_i = \left(\frac{Z_2 - Z_1}{Z_2 + Z_1} \right) \cdot \left(\frac{1}{1 + (2/Z) \cdot Z_1 Z_2 / (Z_1 + Z_2)} \right)$$

$$= K \left(\frac{p^2 R_1 R_2 C_1 C_2 + p(R_1 C_1 + R_2 C_2 - R_1 C_2) + 1}{p R_1 R_2 C_1 C_2 + p[K(R_1 C_1 + R_1 C_2) + R_2 C_2] + 1} \right) \quad (14)$$

where $K = R/(R + 2R_1)$

For the network to fulfill the Minimum Phase condition,

$$R_1 C_1 + R_2 C_2 > R_1 C_2$$

i.e. $C_1/C_2 + R_2/R_1 > 1$ (15)

The case in which $(C_1/C_2 + R_2/R_1)$ is equal to unity corresponds to the change-over point from Minimum Phase to Non-minimum Phase operation, and with this relation between the components the network has a null response at a frequency given by:

$$\omega = 1/\sqrt{R_1 R_2 C_1 C_2} \quad (16)$$

It should be noted that for circuit configurations which are capable of a null response, a necessary relation between the circuit components may be deduced as a condition that there shall be a null response. Such circuit configurations may be either Minimum Phase or Non-minimum Phase according to the value of the circuit components, and a second relation between the circuit constants may be deduced which must be satisfied if the circuit is to be of Minimum Phase structure. This will be in the form of an inequality as shown in Equations (9) and (15).

THE BRIDGED-T NETWORK

The transfer function for the network of Fig. 6 may be expressed as follows:

$$\hat{v}_o/\hat{v}_i = \frac{Z_2 Z_3 + Z_1 Z_4 + Z_2 Z_2 + Z_3 Z_3}{Z_1 Z_2 + Z_2 Z_3 + Z_1 Z_4 + Z_1 Z_2 + Z_4 Z_3 + (Z_2 Z_1 + Z_2 Z_3 + Z_3 Z_1) Z_1 / Z} \quad (17)$$

The numerator in the above expression is of the second

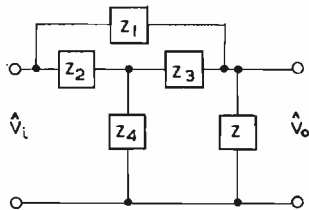

Fig. 6—Bridged-T network

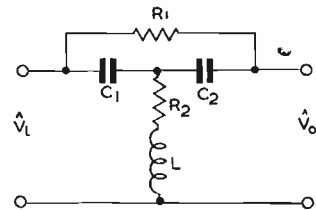

Fig. 7—Bridged-T network

order in Z . For the ladder network (Equation (6)), and the lattice network (Equation (12)), the numerator of the transfer function is linear in Z and in such a case it is possible to conclude immediately that the network is of Minimum Phase structure if all the terms in the numerator are positive. From Equation (17), however, it is evident that the network may be either of Minimum Phase or Non-minimum Phase structure, and it is not possible to deduce in general terms the necessary condition for it to be a Minimum Phase Network. It is necessary to compute the zeros for any given values of circuit components.

Consider for example the bridged-T network of Fig. 7, which has frequency selective properties.

The transfer function is given by:

$$\hat{v}_o/\hat{v}_i = \frac{p^3 T_1 T_2 T_3 + p^2 (T_2 T_3 + S_1 T_3 + T_2 T_1) + p(T_2 + S_1) + 1}{p^3 T_1 T_2 T_3 + p^2 (T_2 T_3 + S_1 T_3 + T_2 T_1) + p(T_2 + S_1 + S_2) + 1} \quad (18)$$

where

$$T_1 = R_1 C_1, T_2 = R_2 C_2, T_3 = L/R_2, S_1 = R_2 C_1, S_2 = R_1 C_2$$

For Minimum Phase operation the following relation must be satisfied:

$$(T_2 + S_1)(T_2 T_3 + S_1 T_3 + T_2 T_1) > T_1 T_2 T_3$$

and this reduces to

$$L(C_1 + C_2) + R_1 R_2 C_1 C_2 > R_1 L C_1 C_2 / R_2 (C_1 + C_2) \quad (19)$$

If the left hand side of Equation (19) is less than the right

hand side, then the network has a Non-minimum Phase characteristic. The particular case in which

$$L(C_1 + C_2) + R_1 R_2 C_1 C_2 = R_1 L C_1 C_2 / R_2 (C_1 + C_2)$$

gives the necessary relation for conjugate zeros to appear on the real frequency axis, and results in the network having a null response.

THE PARALLEL-T NETWORK

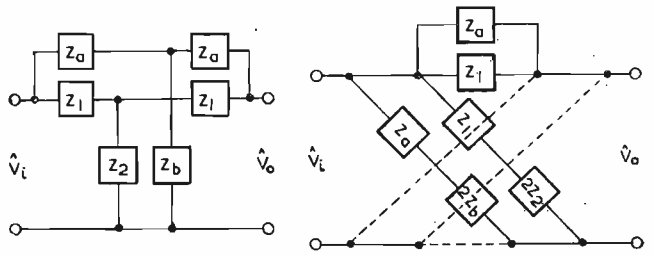

Fig. 8—(a) Parallel-T network (b) Equivalent lattice network

The parallel-T network is generally used in the symmetrical form shown in Fig. 8(a). (For this, the equivalent lattice is shown in Fig. 8(b).) The transfer function is given by:

$$\hat{v}_o/\hat{v}_i = \frac{2(Z_b Z_1^2 + Z_2 Z_a^2 + 2Z_2 Z_1 Z_b + 2Z_2 Z_b Z_a)}{(Z_1 + 2Z_2)(Z_a + 2Z_b)(Z_1 + Z_a) + Z_a Z_1 (Z_1 + Z_a + 2Z_2 + 2Z_b)} \quad (20)$$

The numerator is now of cubic order in Z and, as in the case of the bridged-T structure, it is not possible by inspection to deduce a general relation which must exist between the component impedances for the network to have a Minimum Phase characteristic. Each arrangement of circuit components must be investigated individually. The network of Fig. 9 is an example of a commonly used frequency selective circuit.

It will be seen to be an asymmetrical parallel-T structure whose transfer function is given by:

$$\hat{v}_o/\hat{v}_i = \frac{p^3 T_1 T_2 T_3 + p^2 T_1 (S_2 + T_3) + p(T_1 + S_1) + 1}{p^3 T_1 T_2 T_3 + p^2 T_1 (T_3 + S_2) + p^2 T_2 (T_1 + T_3 + S_1) + p(T_1 + S_1 + T_2 + S_2 + T_3) + 1} \quad (21)$$

where

$$T_1 = R \cdot C, T_2 = R \cdot C, T_3 = R \cdot C, S_1 = R_1 C, S_2 = R_2 C$$

For Minimum Phase operation

$$T_1(S_2 + T_3)(S_1 + T_1) > T_1 T_2 T_3$$

which reduces to

$$R_1(R_2 + R_3)/R_2 R_3 > C_2/(C_1 + C_3)$$

The case in which $[R_1(R_2 + R_3)/R_2 R_3]$ is equal to $[C_2/(C_1 + C_3)]$ gives the necessary relation for conjugate zeros to appear on the real frequency axis, in consequence of which the network will have a null response.

THE LADDER NETWORK WITH MUTUAL-INDUCTIVE COUPLING

The general expression for the transfer function of the above network is given by:

$$\hat{v}_o/\hat{v}_i = \frac{(Z_1 \pm pM)}{(Z_a + Z_1)(Z_1 + Z_2 + Z_b) - (Z_1 \pm pM)^2} \quad (22)$$

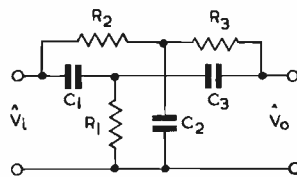

Fig. 9—Frequency selective circuit

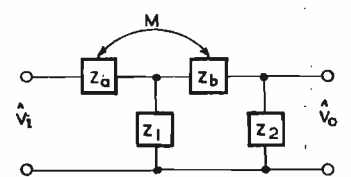

Fig. 10—Ladder network with mutual inductive coupling

In the case where a positive sign is associated with the mutual inductive coupling M , the network has a Minimum Phase characteristic, and this holds for all values of the component impedances.

When the negative sign is associated with the mutual coupling, the network may have a Minimum Phase characteristic or a Non-minimum Phase characteristic depending on the component values. For example if Z_1 is of the form $(R + pL + 1/pC)$ the condition for the network to be of Minimum Phase structure is that L be equal to or greater than M . If $L < M$, the network will have Non-minimum Phase structure.

Acknowledgments

The author wishes to record his indebtedness to Professor Emrys Williams and Mr. David Morris of the University College of North Wales for their valuable suggestions in the preparation of this paper.

APPENDICES

1. An example of the use of a Non-minimum Phase Network in a Servo System

Consider a servo system of the Zero Position-error type, having a loop gain transfer function of the following form:

$$\hat{A}_s = \frac{K(1 + pT_1)}{p(1 + 2\alpha pT + p^2T^2)(1 + pT_2)} \dots (23)$$

The denominator expression has a highly oscillatory mode, as may be appreciated from the Nyquist plot of the whole transfer function, (locus 1, Fig. 11). (For the purpose of plotting this function the following values have been adopted: $T_1 = 0.05$ sec., $T_2 = 0.14$ sec., $T = 0.07$ sec., $\alpha = 0.07$, $K = 5.0$).

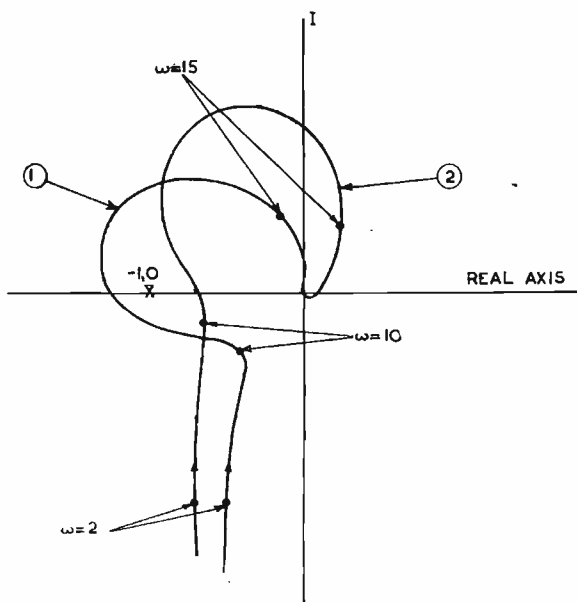

Fig. 11—Nyquist diagram

The system represented by locus 1, Fig. 11, encloses the critical $(-1,0)$ point and the system would be unstable. Stabilization may, of course, be achieved by the addition of Proportional-derivative networks in the loop, or by the addition of Proportional-integral networks. The latter introduce an increase in phase-shift together with a decrease in loop gain with increasing frequency. Should such a decrease or increase of gain with increasing frequency be undesirable in any particular case, stabilization may alternatively be effected by the use of an all-pass network.

This would introduce an increase in phase shift with increasing frequency, but would not decrease the gain.

For instance the addition of an all-pass network having

the following transfer function

$$\hat{A}_n = \frac{1 - p(0.03)}{1 + p(0.03)} \dots (24)$$

modifies the Nyquist diagram as shown in Fig. 11, locus (2), and the system becomes stable.

The effect of retaining the loop gain at the higher frequencies is to increase the speed of response of the servo. In this case, then, the use of a Non-minimum Phase Network is justified.

2. The Gain-Phase Integral

The relation between the phase *versus* frequency and gain *versus* frequency characteristics for a Minimum Phase system is given by Bode as follows:

$$\left\{ \begin{array}{l} \text{Angle of lag at} \\ \text{frequency } f_c \end{array} \right\} = - \frac{1}{\pi} \int_{-\infty}^{+\infty} \frac{dA}{du} \log \coth |u/2| du \dots (25)$$

where A is the logarithm of the gain, and u is $\log f/f_c$. Equation (25) implies that the lag at a particular frequency f_c is proportional to the integral, over the whole logarithmic frequency ranges from $u = -\infty$ to $u = +\infty$, of the product of dA/du and a weighting factor $\log \coth |u/2|$. The expression dA/du is simply the slope of the gain characteristic plotted on a logarithmic scale. The weighting factor determines the relative importance of the derivative term dA/du in the various parts of the frequency spectrum, and is large in the vicinity of $f = f_c$. Thus, while the derivative of the transfer gain at all frequencies enters into the phase shift, the derivative in the neighbourhood of $f = f_c$ is relatively more important than

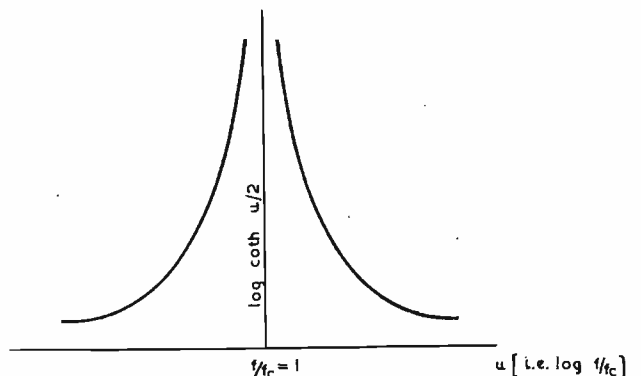

Fig. 12—Graph of weighting factor

the contributions from the remoter parts of the spectrum. It is often convenient to superimpose the graph of the weighting factor on the graph of the gain characteristic; the graph of the weighting factor is given in Fig. 12.

It is thus possible to make a rapid deduction of the approximate form of the phase characteristic of a given Minimum Phase Network simply by inspection of its gain characteristic. Consider, for example, the following gain characteristics (sketched in asymptotic form) and the deduced phase characteristics.

With reference to Fig. 13, it may be observed that the slope of the gain characteristic is constant and negative (i.e., $dA/du = -k$) over the frequency interval between f_2 and f_3 . Elsewhere in the frequency spectrum the slope is zero. The phase shift at a frequency f_1 remote from f_2 and f_3 may be deduced as approaching zero since the weighting factor at that frequency, associated with the sloping portion of the gain characteristic, is small. At frequency f_3 , the weighting factor, and therefore the phase shift, reaches a maximum value on account of the odd symmetry of the gain characteristic about this abscissa. From this data the approximate form of the phase characteristic may be sketched, as shown in Fig. 13.

A further illustration of the deduction of the phase characteristic from a given asymptotic gain characteristic is given in Fig. 14.

It should be noted from Equation (25) that if the gain characteristic exhibits odd symmetry about a frequency f_3 , the phase characteristic must exhibit even symmetry about that frequency, and vice-versa. This will be observed from a comparison of Figs. 13 and 14.

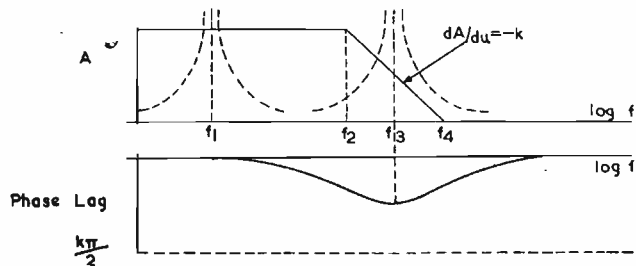

Fig. 13. Deduction of Phase characteristic from Gain characteristic. (For convenience the graph of the weighting factor, shown dotted, is superimposed in two positions on the gain characteristic)

Poles and Zeros on the Real Frequency Axis

It is possible for poles and zeros of the gain transfer function to be located on the imaginary or real frequency axis in the p -plane.

The physical significance of such poles is that networks in whose transfer functions they occur are capable of sustained transients, i.e., transients whose amplitudes are maintained with time but do not increase.

In passive networks (in which also buffer amplifiers may be included), poles will be found on the real frequency axis only in the unrealizable case of networks which are composed of pure reactances.

However, in the case of active networks, e.g., a Minor Loop in a servo system, poles would occur on the real frequency axis if the gain around the Loop were adjusted

to the exact boundary between the regions of stability and instability (i.e., to the boundary between decaying oscillation and increasing oscillation). Any such system which has poles on the real frequency axis may be considered to depart from the Minimum Phase condition.

The occurrence of zeros on the real frequency axis is often met with in both passive and stable-active networks.

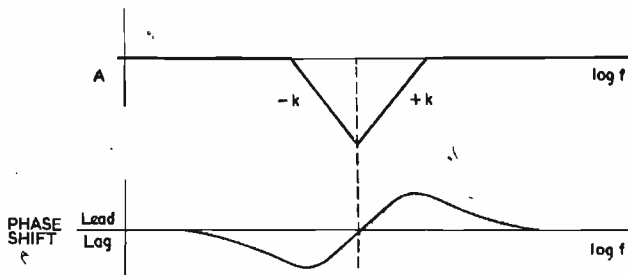

Fig. 14. A further example of Phase characteristic deduced from Gain characteristic

Conjugate zeros of this type are characterized by the network having a null response. It has been shown that the same relation between the circuit parameters gives both the condition for the existence of a null and the boundary between Minimum Phase and Non-minimum Phase operation.

REFERENCES

- BODE, H. W. : Network Analysis and Feedback Amplifier Design, Van Nostrand, (1945.)
- BODE, H. W. : Relations between Attenuation and Phase in Feedback Amplifier Design, *Bell System Tech. Journal*, 19, 421-454, (1940.)
- JAMES, H. M., NICHOLS, N. B., PHILLIPS, R. S. : Theory of Servomechanisms, McGraw-Hill, (1947.)
- GREENWOOD, I. A., HOLDAM, J. V., and MACRAE, D. : Electronic Instruments, p. 261, pp. 230-231. McGraw-Hill, (1946.)
- GRAHAM, R. E. : Linear Servo Theory, *Bell System Tech. Journal*, 25, 616-651, October, (1946.)
- LAUER, H., LESNICK, R., and MATSON, L. E. : Servomechanism Fundamentals, McGraw-Hill, (1947.)
- GARDNER, M. F., and BARNES, J. L. : Transients in Linear Systems, John Wiley, (1942.)

A Method of Capacitance Measurement

by A. M. Andrew, B.Sc.*

WHEN fault-finding in electronic equipment containing electrolytic capacitors, it is often necessary to make measurements on capacitors of nominal capacitance 2 to 50 μ F.

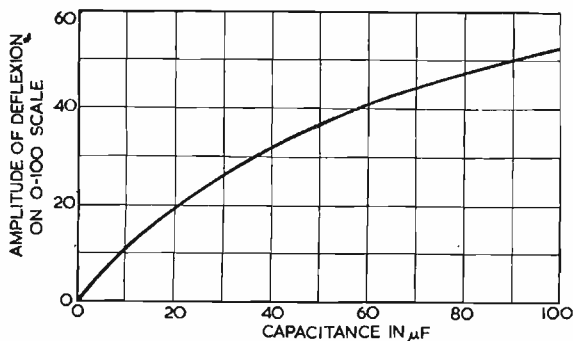

Fig. 1. Calibration of Model 7 Avometer

Capacitors are often tested qualitatively by connecting them to an ohmmeter and observing whether the needle kicks. This test applies a unidirectional voltage and may easily be made quantitative. The Avometer Model 7, set

* Department of Physiology and Psychological Medicine, University of Glasgow.

to its megohms range, is particularly suitable for this measurement, provided the working voltage of the capacitor is not less than 9 volts.

A suitable procedure is as follows:—

(a) Set zero with the "Q" knob as for resistance measurement.

(b) Connect the meter to the capacitor. If this is electrolytic, the black lead of the Avo must be connected to the positive side of the electrolytic, and the red lead to the negative side.

(c) The swing of the Avo pointer when the capacitor is first connected may be noted, but it is more convenient to ignore this swing while making the connections, and then to discharge the capacitor by turning the D.C. switch to the 1 volt position for a few seconds. When the switch is returned to the megohms position, the swing of the pointer is noted. For capacitors greater than about 16 μ F, a nasty jar to the meter results from this method of discharging, and it is better to turn the D.C. switch to the blank position between the megohm and 1 volt positions and to short circuit the capacitor for a few seconds before turning to the 1 volt position to make sure the discharge is complete.

(d) Having determined the amplitude of swing as measured on the 0-100 scale, the capacitance may be determined from Fig. 1. If the amplitude is less than 20, the capacitance may be taken as numerically equal to the amplitude, so it is then unnecessary to refer to the graph.

This method of capacitance measurement is extremely simple and the only instrument required is to be found in most laboratories.

Equipment for Acoustic Measurements

(Part 3)

Acoustic Pulse Measurements

By

C. G. Mayo,* M.A., B.Sc., M.I.E.E., D. G. Beadle,* B.Sc.(Eng.), A.C.G.I., A.M.I.E.E.,
and W. Wharton,* A.M.I.E.E.

IN 1945, when acoustic research was recommenced by the B.B.C., it was decided to investigate the use of pulses for determining the acoustic properties of studios as an adjunct to normal reverberation methods. Mason and Moir¹ had already used pulses and their results showed sufficient promise to make further investigation worthwhile. At first some standard apparatus was modified and used for the initial laboratory experiments, but it soon became evident that special lightweight equipment would have to be developed for field use. The original apparatus consisted of five units, a triggered time-base, an oscilloscope, a tone pulser, a microphone amplifier and a mains unit, having a total weight of 160lb. In the new design these units were reduced to two, a tone pulser and a triggered time-base oscilloscope, with a total weight of less than 42lb.

Fig. 1 is a block schematic diagram of the complete equipment and Fig. 2 is a photograph of the units ready for use. In operation a pulse of tone is radiated into the studio under test by means of a loudspeaker and the sound in the studio is picked up by a microphone, which is connected to the amplifier incorporated in the oscilloscope, and hence to the Y plates of the cathode-ray tube. The time-base is triggered concurrently with the start or end of the tone pulse and makes one complete sweep at a speed which is adjustable within wide limits. The build-up or decay of sound in the studio can thus be observed on an appropriate time scale for tone pulses of any frequency or duration.

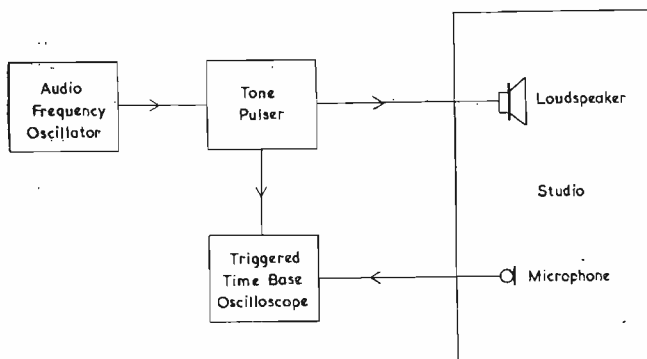

Fig. 1. Block schematic diagram of experimental chain

The tone pulser has a triggering circuit which initiates the tone pulse and also the time-base of the oscilloscope. The circuit is so arranged that it will generate either single pulses of tone or repeated pulses at a repetition rate which can be varied to suit the size of the studio.

Considerable use has been made of well-known techniques in radar timing and pulse circuits. The fact that the time scale is in seconds rather than microseconds has made most problems easier but, in a few instances, special modifications have been required.

The Triggered Time-Base Oscilloscope

The triggered time base oscilloscope contains a 3in. cathode ray tube and a time-base which may be set for

* Research Department, B.B.C. Engineering Division.

either single triggered strokes or self-running as required. In addition there is a Y plate amplifier with sufficient gain to raise signals from microphone level for application to the Y plates. The unit complete with power supplies weighs just under 30lb, and the layout has been designed to give good accessibility to all components, while keeping the dimensions of the carrying case (7in. by 15in. by 12in. high) as small as possible. B7G based valves are used throughout with the exception of the first stage of the Y plate amplifier and the low voltage H.T. rectifier,

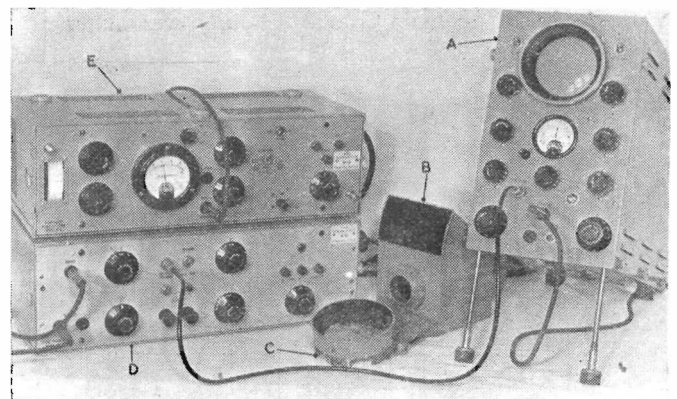

Fig. 2. Equipment for acoustic pulse measurements
(a) Triggered time-base oscilloscope. (b) Camera attachment. (c) Graticule.
(d) Tone pulser. (e) Audio frequency oscillator.

and holders are provided to carry a spare for each type of valve. Fig. 3 is a circuit diagram of the oscilloscope.

THE TIME-BASE AND FLYBACK SUPPRESSION CIRCUIT V_1 TO V_7
The time base circuit is preceded by a delay circuit consisting of V_1 and V_2 which can delay the initiation of the time-base by an interval continuously variable from 1-250 milliseconds. This delay can be used as necessary by throwing the switch S_1 , which normally allows the triggering pulse to by-pass the delay circuits.

Both the delay and time-base circuits are based on the Miller integrator^{2,3} principle, which may be described with reference to the simplified circuit of Fig. 4.

Before the arrival of the initial triggering pulse the circuit is in a state of equilibrium with the control grid acting as a diode and drawing current from the H.T. line

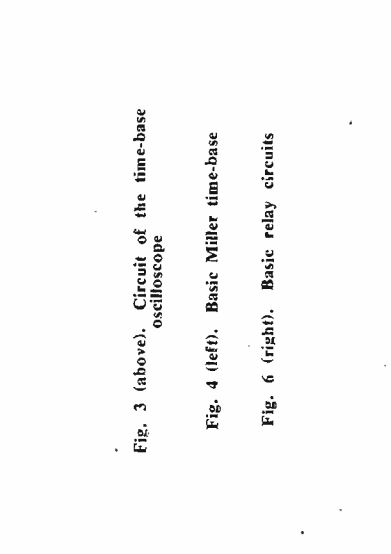
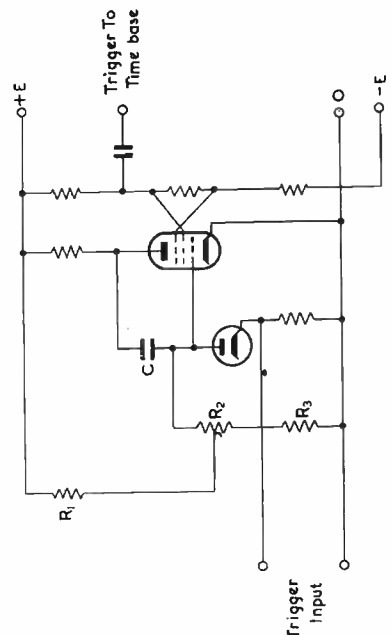
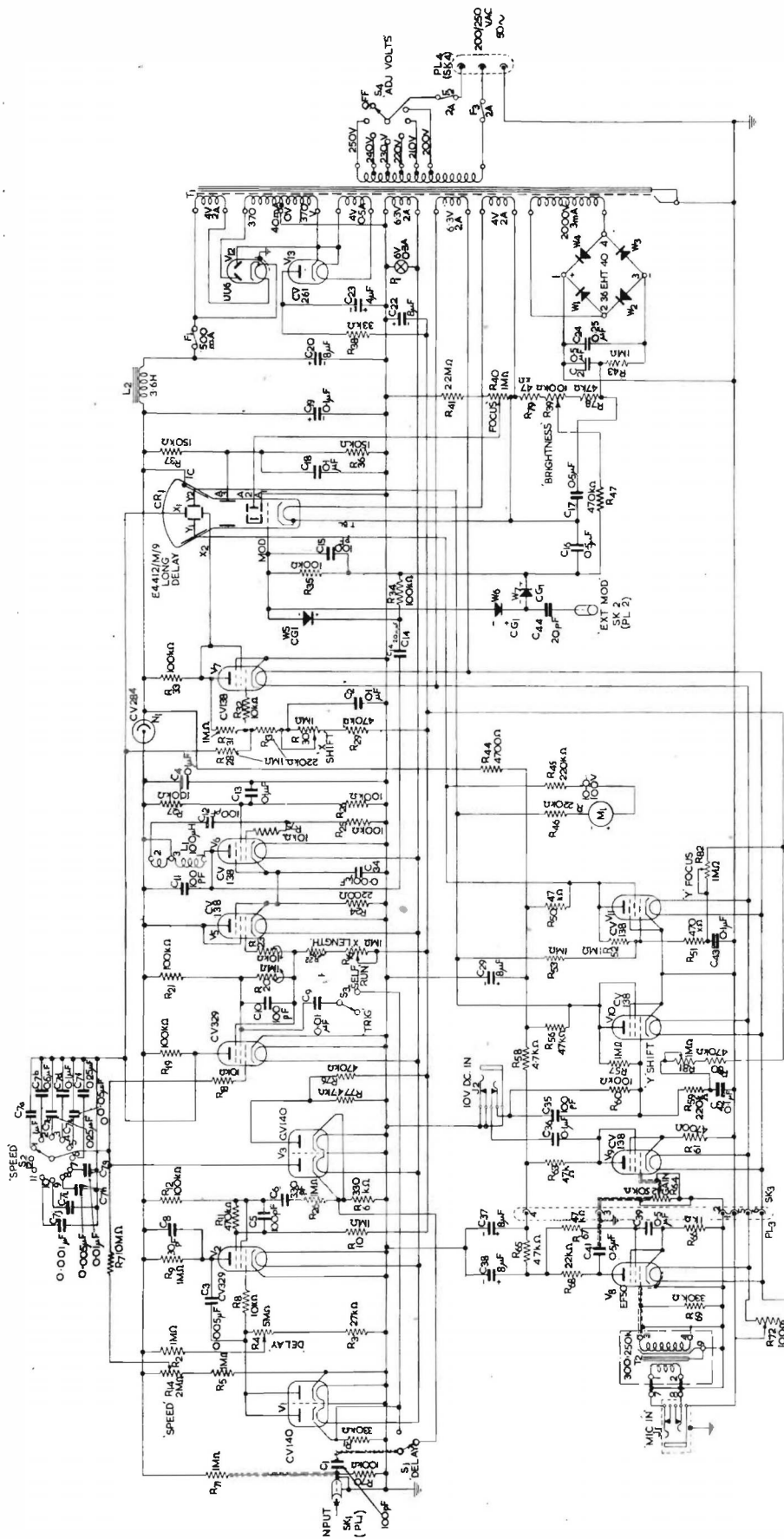

Fig. 3 (above). Circuit of the time-base oscilloscope

Fig. 4 (left). Basic Miller time-base

Fig. 6 (right). Basic relay circuits

via R_1 and the high resistance R_3 . The control grid being thus at earth potential, the valve draws a heavy space current and if it is assumed that the whole of this space current flows from the screen, the voltage drop across the screen resistance R_6 is high and the screen potential is correspondingly low. The values of R_7 and R_8 are so chosen that the suppressor grid is now at a sufficiently negative potential with respect to the cathode to cut off the anode current completely and the circuit is thus in a stable condition with the anode potential held at the full H.T. voltage E and the capacitor C charged to a potential of E volts.

The trigger voltage is a negative pulse, introduced at the cathode of the diode D_1 , which drives the grid momentarily negative and the valve space current is thus cut off, causing the potential of the screen and suppressor grids to rise sharply. The suppressor grid is now at a sufficiently high potential to allow anode current to flow, causing a drop of anode potential which, by means of the charged capacitor C , carries the grid negative. The anode current is thus arrested and the anode potential can only drop as C discharges into the anode.

A state of equilibrium is then set up in which the anode

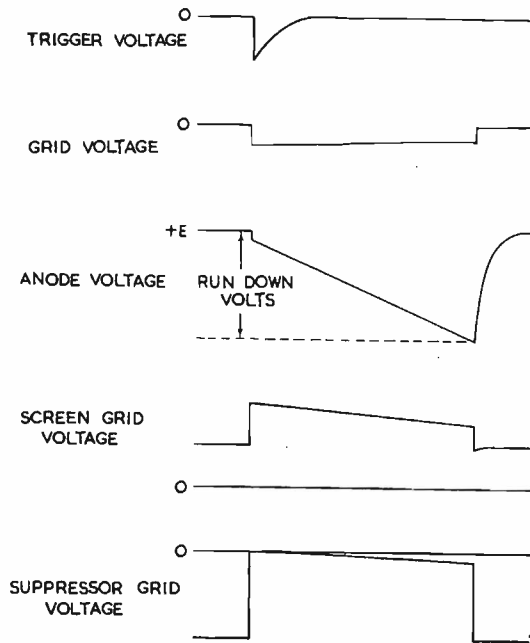

Fig. 5. Time-base waveforms

potential decreases as C discharges and this decrease of anode voltage is linear with time as may be shown as follows.

Let I be the current flowing to discharge C and e_c the voltage across the capacitor C . Then:

$$I = C \frac{de_c}{dt}$$

Since the control grid is almost at earth potential the current I will flow from the H.T. line (at potential E) via R_3 . Also e_c will be equal to e_a the anode voltage, to a first approximation:

$$I = E/R_3 = C \frac{de_a}{dt} \text{ and } de_a/dt = E/R_3C$$

The rate of change of anode voltage is thus seen to be linear with time.

When the anode potential is falling the anode current must be rising and this rise will be accompanied by an increase of potential on the control grid. This will cause the "run-down" to deviate from a linear law, since the grid voltage will not remain at earth potential and the current I will therefore vary during the cycle.

If μ is the gain of the valve and E_T is the change of anode volts the voltage change on the grid will be approximately:

$$e_g = E_T/\mu$$

During the cycle the current will thus vary by an amount:

$$\delta I = E_T/\mu R_3$$

If the gain of the valve is of the order of 100, a figure easily obtainable in practice, $E \gg E_T/\mu$ and the current will remain constant, giving a linear "run-down".

The decrease of anode volts continues until the anode "bottoms". The capacitor C continues to discharge into the anode and the grid potential therefore rises sharply, causing a rise of screen current which drops the screen potential and with it the suppressor grid potential. The drop in suppressor grid potential is sufficient to cut off the anode current. The capacitor C then recharges through the anode load R_3 and the diode action of the control grid, thus resetting the circuit in its initial condition for the next triggering pulse.

The potentials on the various electrodes during the cycle are shown in Fig. 5.

The methods employed for speed control on the time base are to switch the capacitor C for coarse control and, for the fine control, to vary the potential e which provides the charging current of the capacitor. A reduction of e increases the "run-down" time of the anode, but as e becomes comparable with the voltage changes on the grid, the action is no longer linear and in view of this the values of R_1 and R_2 are so chosen that the potential e varies in the ratio 3:1. This gives a good overlap between the various capacitances and provides adequate "fine" control.

The method of obtaining variable delay is shown in Fig. 6. In this circuit non-linearity of the rate of change of anode volts is unimportant as we are interested only in the time taken, hence a substantial reduction of the potential e is permissible. The action is as follows:—

The resistance R_2 is five times the resistance R_1 , and R_3 is about $1/50$ of R_1 . The minimum delay is obtained with the slider of R_2 at the grid end of the potentiometer in which position the "run-down" time is proportional to

$$R_1/E$$

The maximum delay is obtained with the slider at the bottom end of R_2 where the potential available is

$$\frac{E R_2}{R_1 + R_3} \approx E/50$$

The series resistance is $R_2 = 5R_1$ and the "run-down" time is thus proportional to

$$\frac{E/50}{5R_1} = \frac{250R_1}{E}$$

The delay time may thus be varied approximately in the ratio 250:1.

The square wave form of the screen grid is used after differentiation to deliver a triggering pulse in both the delay and time base circuits. In the delay valve the pulse is used to trigger the time-base, and in the time-base the pulse triggers the delay valve via the switch S_3 (Fig. 3) when a self-running time-base is required.

The "Miller run-down" of the time base valve thus provides a linear sweep for the cathode-ray tube; one of the X plates is driven direct from the time-base valve and the other via the directly coupled phase reversing valve V_7 , so that a push-pull drive is provided and trapezoidal distortion obviated. The time-base is continuously variable between 5 milliseconds and 15 seconds by means of the coarse and fine controls. The length of sweep is adjustable by R_1 , which determines the end of the "run down" before the time-base valve resets and R_3 varies the grid potential and hence the anode potential of V_7 , thereby giving an X shift.

FLYBACK SUPPRESSION

The suppressor grid of the time-base valve V_4 provides a suitable wave form for the suppression of the flyback by application of a negative potential to the grid of the cathode-ray tube. The grid of the cathode-ray tube is at a high negative potential with respect to earth and consequently a capacitor must be interposed. The sweep times used in the instrument are so long that an inconveniently large capacitor would be required, and to overcome this difficulty the flyback suppression pulse is converted to radio frequency. The circuit associated with V_6 forms a 1Mc/s oscillator which is switched on and off by the suppressor grid of the time-base valve via V_5 . The radio frequency pulses so formed are transmitted through the high-voltage working capacitor C_{14} and are converted to a negative voltage for suppression of the flyback by the rectifier W_3 . The provision of rectifiers W_6 and W_7 permits grid modulation from an external source.

THE Y PLATE AMPLIFIER

The Y plate amplifier V_8 to V_{11} has sufficient gain to raise signals from microphone level for direct application to the deflexion plates of the cathode-ray tube.

A high step-up input transformer is used so that the signal at the grid of V_8 is sufficiently great to enable a.c. to be used on the heater supply to this valve. Some cathode feedback prevents overloading of the input stage

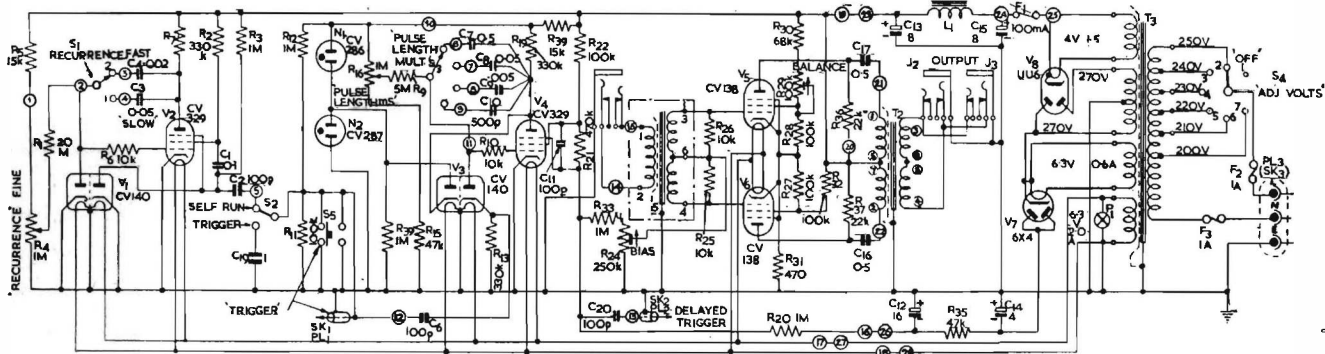

Fig. 7. Circuit of the tone pulser

at high sound levels. The second stage also employs cathode feedback, but here a gain control $R_{6,1}$ is provided on the grid. V_{10} and V_{11} form a direct coupled paraphase pair and provide a balanced push-pull drive for the Y plates of the cathode-ray tube.

As the focus of the tube is dependent upon the mean potential of the Y plates, a control $R_{8,2}$, in conjunction with the Y shift control $R_{8,1}$, has been provided to adjust the mean potential for best average focus over the face of the tube.

The meter M_1 , calibrated in volts, indicates the potential difference between the Y plates, and may therefore be used for calibrating the Y deflexion.

THE CATHODE-RAY TUBE AND POWER SUPPLIES

Since many of the phenomena in acoustics may take seconds to elapse, the time-base speeds are very slow and a cathode-ray tube with a long after-glow screen is used to obtain oscillograms for immediate observation. When a permanent record is required a camera attachment is used for taking either single photographs or repeated traces by moving the film at constant speed.

The low voltage rectifier, a UU_6 , provides 370 volts for the time-base circuits and microphone amplifier, while the negative potentials required for the bias of the time base, delay, and D.C. amplifier valves are derived from a miniature half-wave rectifier with RC smoothing. A neon voltage regulator N_1 is placed in series with the H.T. supply to the time base circuits as a protection for the capacitors against voltage surges.

The E.H.T. supply for the cathode-ray tube is derived from a bridge rectifier and conventional RC smoothing is used.

The Tone Pulser

The tone pulser receives tone from an external audio-frequency oscillator and by means of a stabilized electronic switch converts it into pulses of accurately known length. The instrument is completely self-contained and is enclosed in an aluminium carrying case measuring 17in. by 6in. by 10in. high. Its weight is 12lb.

The circuit of this instrument is shown in Fig. 7. V_3 , V_4 , N_1 and N_2 constitute the stabilized electronic switch which is operated either by a push button for a single pulse or, if repeated pulses are required, by a transistron oscillator V_2 . V_5 and V_6 form a push-pull audio-amplifier which is switched on and off by the electronic switch.

THE PUSH BUTTON TRIGGER AND TRANSISTRON OSCILLATOR

The push button trigger circuit, consisting of R_{11} , R_{12} , C_6 , C_{19} and one of the diodes of V_3 , provides a single negative pulse to start the electronic switch and the time-base of the triggered time-base oscilloscope. Prior to operation of the push button S_5 the capacitor C_6 will be charged up to a voltage determined by R_{11} and R_{12} . When S_5 is closed the voltage across R_{11} is reduced to zero and the charge on C_6 is applied directly

across R_{13} in such a manner that the cathode of the diode is negative with respect to earth. C_6 is small and discharges rapidly through R_{13} resulting in a sharp negative pulse at the cathode of the diode.

When the push button is released, C_{19} prevents the voltage across R_{11} from rising rapidly and giving a positive pulse across R_{13} . The diode removes all positive excursions of voltage and a single negative pulse appears at the grid of the electronic switch.

The transistron oscillator is used to provide an automatic negative triggering pulse at any predetermined interval between 0.5 and 30 seconds. It consists of V_1 and V_2 and their associated components. The circuit is based on the Miller integrator principle already described, but is made self-running by connecting the suppressor grid to earth and a capacitor between the suppressor grid and screen grid. The mode of operation can be followed by reference to Fig. 8.

Suppose that the valve is acting in the normal manner as a Miller integrator, that C_1 is discharging into the anode and that the linear decrease of anode volts dependent upon R_3C_1 is occurring. The screen grid will be at a relatively high potential and C_2 will be charged to this voltage.

At the end of the anode "run-down" the screen current will increase rapidly and the screen potential will drop. The capacitor C_2 will then carry the suppressor grid negative with respect to earth and cut off the anode current. C_1 will then commence to recharge through the anode load R_3 and at the same time C_2 will commence to dis-

charge through R_7 and the screen grid so that the potential of the suppressor grid begins to rise. The time constants of these circuits are so arranged that C_1 becomes fully charged before C_2 has discharged sufficiently to allow anode current to flow. When the potential across C_2 has dropped sufficiently to allow the suppressor grid to become positive enough for anode current to flow, the "run-down" of the anode volts commences and the screen potential suddenly rises. C_2 then recharges through R_8 and the time constant is such that this is completed well before the end of the "run-down".

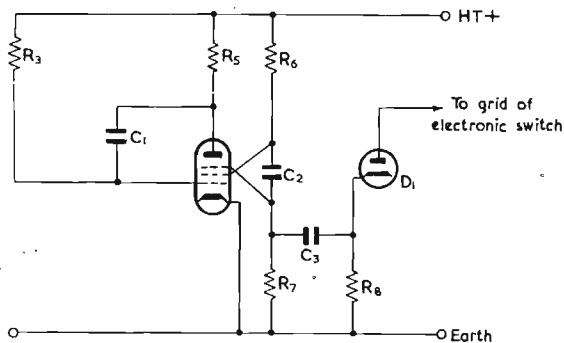

Fig. 8. Basic transition

The waveform of the suppressor grid voltage is differentiated by the network C_3R_8 and appears at the anode of diode D_1 as a sharp negative pulse which is used to trigger the electronic switch.

THE ELECTRONIC SWITCH

The circuit consists of a Miller integrator valve V_4 , which produces single triggered strokes. The operating time of the electronic switch can be varied between one millisecond and 20 seconds by the switch S_3 and the potentiometer R_{16} . The anode "run-down" is stabilized by the voltage regulators N_1 and N_2 , and the capacitors C_7 to C_{10} are adjusted so that with the slider of R_{16} at H.T. potential, the circuit produces square pulses of accurate length at the suppressor grid of V_4 . These pulses are used for switching the audio-amplifier which will produce pulses of tone of known length, and also for the delayed trigger pulse for initiating the time-base of the oscilloscope at the end of the tone pulse.

THE AUDIO-FREQUENCY AMPLIFIER

The audio-frequency amplifier consists of V_5 and V_6 connected in push-pull. The frequency characteristic is flat to $\pm \frac{1}{4}$ db from 25 to 10,000c/s and the overall gain is 20db. The input and output impedances are both 600 ohms.

The suppressor grid potential of the electronic switch is used as a bias for V_5 and V_6 which allows the circuit to operate either as a normal amplifier or carries the grids to a point well beyond cut-off. The amplifier is by this means disabled except when the electronic switch is "running down" and the suppressor grid is at zero potential, leaving the push-pull grids with their normal working bias.

Since V_5 and V_6 are connected in push-pull, anode voltage surges caused by the switching bias on the grids are in antiphase and cancel out. The potentiometer R_{29} adjusts the balance of the valves and makes possible an almost complete elimination of the switching surge. The

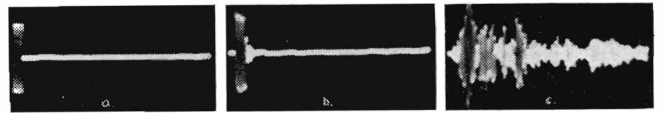

Fig. 9. (a) Pulse produced by tone pulser. (b) Same pulse after reproduction and subsequent pick up in an anechoic room. (c) Same pulse after reproduction and subsequent pick up in a reverberant room

amount of switching bias used to operate the amplifier is controlled by R_{21} and is adjusted in relation to the level of the tone fed into the instrument.

It should be noted that the switching surge is distinct from the transient produced by suddenly starting the tone pulse. The effect of the transient can be seen to be small by reference to Fig. 9 which shows (a) a pulse of 1,000c/s tone as produced by the tone pulser, (b) the same pulse after reproduction on a loudspeaker and subsequently picked up on a microphone in an anechoic chamber, and (c) in a reverberant room.

The equipment is very satisfactory in operation and some interesting results of pulse technique in studying the build up and decay of sound in auditoria have been described by Somerville.⁴ The use of the equipment for tracing echo paths is also discussed.

In conclusion the authors wish to acknowledge the help of their colleagues in the B.B.C. Engineering Research Department, and in particular the work of Mr. S. H. Holmes on the mechanical layout. They are also indebted to the Chief Engineer of the B.B.C. for permission to publish this article.

REFERENCES.

- MASON, C. A. and MOIR, J. Acoustics of Cinema Auditoria, *J.I.E.E.*, 88, pt. III, May (1941).
- WILLIAMS, F. C. Introduction to Circuit Techniques for Radiolocation, *J.I.E.E.*, 93, pt. IIIA, No. 1 (1946).
- BRIGGS, B. H. The Miller Integrator, *Electronic Engineering*, XX, 243, 279, 325. (1948).
- SOMERVILLE, T. A Comparison of the Acoustics of the Philharmonic Hall, Liverpool, and St. Andrew's Grand Hall, Glasgow, *The B.B.C. Quarterly*, IV, No. 1, April, (1949).

"Deoxo" Catalytic Gas Purifier*

MANY industrial processes require gases which are virtually free from oxygen. There are several known methods whereby the unwanted oxygen can be removed, and the "Deoxo" process has much to recommend it.

By this process, the removal of oxygen from hydrogen or from inert gases is accomplished by passing the gas over a specially prepared catalyst, which brings about combination of hydrogen and oxygen in the ratio of 2:1 by volume to form water vapour. This reaction will take place at room temperature. The resultant water vapour is carried away in the gas stream and can be removed by any standard dehydrator.

The heat generated by the catalytic reaction amounts to

a temperature rise of approximately 10°C (18°F) for each 0.1 per cent of the oxygen removed. The standard equipment will operate at any pressure up to 50lb per square inch.

The unit is connected to the gas supply, and it will operate indefinitely without attention.

The advantages of this system are: there are no operating expenses; no electrical current, auxiliary heating or water-cooling required, and no maintenance expenses.

From the nature of the reaction it will be clear that unwanted oxygen or hydrogen can be removed from inert gases such as nitrogen, argon, helium, neon, carbon-dioxide, and saturated hydro-carbons, provided that there is always a ratio of two volumes hydrogen to one volume oxygen in the gases to be treated. If one or other of these gases is not present in the free state, it must be added to the gas stream ahead of the purifier in the correct volume necessary to effect a complete combination.

* Communication from Baker Platinum, Ltd.

The Measurement of Microphony in Valves

By R. Bird,* M.Sc., D.I.C.

UP to the present the reduction of the microphony in valves has been very much regarded as a matter of trial and error. However, it is becoming more and more important, so that more definite methods of microphony detection have become necessary as an aid to better valve design.

An early method of investigation of a purely qualitative nature was to connect the valve as the first stage of an

valve will cause the loop to oscillate at one of the natural resonant frequencies of the valve structure. The amplifier gain for the threshold of oscillation (measured from the grid of the test valve) is then taken as a *figure of merit* for the valve. The disadvantages of this simple and convenient method are that both the frequency and the gain level of oscillation depends on the overall phase shift in the "loop", and particularly on the spatial relationship between the loudspeaker and the test valve.

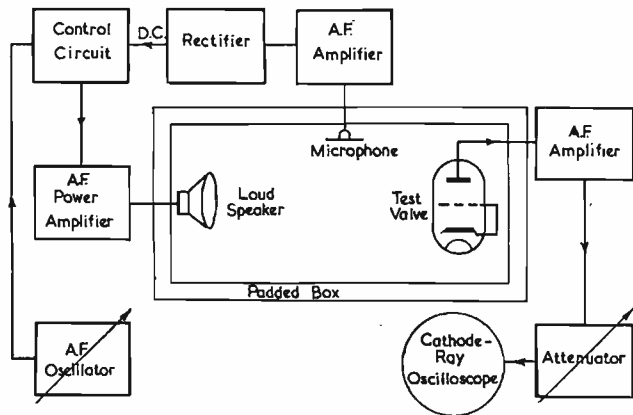

Fig. 1. Apparatus for measuring the microphonic output of a valve

audio-amplifier and give it a "standard" blow with a small hammer, the volume, pitch and quality of the audio-frequency output from a loudspeaker giving some idea of the merit of the valve. This method, though extremely crude, had the virtue of simplicity and is still used as a production test for large quantities of valves. This paper is an attempt to describe some of the methods now available for a more searching investigation into the nature and causes of microphony.

The "Howl Round" Method

A better idea of the level of microphony in a particular valve may be obtained by connecting it as the first stage of a variable gain audio-frequency amplifier while it is situated in the acoustic field from a loudspeaker fed by the output of the same amplifier. At a certain amplifier gain the acoustic feed-back from the loudspeaker to the

The Variation of Microphonic Output with Frequency

An attempt has been made by previous workers to determine the absolute microphonic performance of a valve by relating its electrical output to the frequency and intensity of a sound field in which it is situated. A schematic diagram of a similar apparatus used by the author is shown in Fig. 1. The test valve, functioning as an amplifier, is placed in the acoustic field from a loudspeaker in a chamber which is padded in an attempt to reduce acoustic standing waves. The microphonic output from the test valve is amplified a known amount and then displayed on a C.R.T. screen. The acoustic pressure within the padded chamber is kept approximately constant by an audio-automatic volume control (A.V.C.) system. The loudspeaker output is controlled by the A.V.C. voltage applied as bias to a variable conductance valve in the loudspeaker driving amplifier. This A.V.C. voltage is the rectified output from a second amplifier fed from a crystal microphone in the sound field from the loudspeaker. Thus an increase in sound output above a fixed level increases the negative

Fig. 2. Microphonic output from high slope miniature pentode

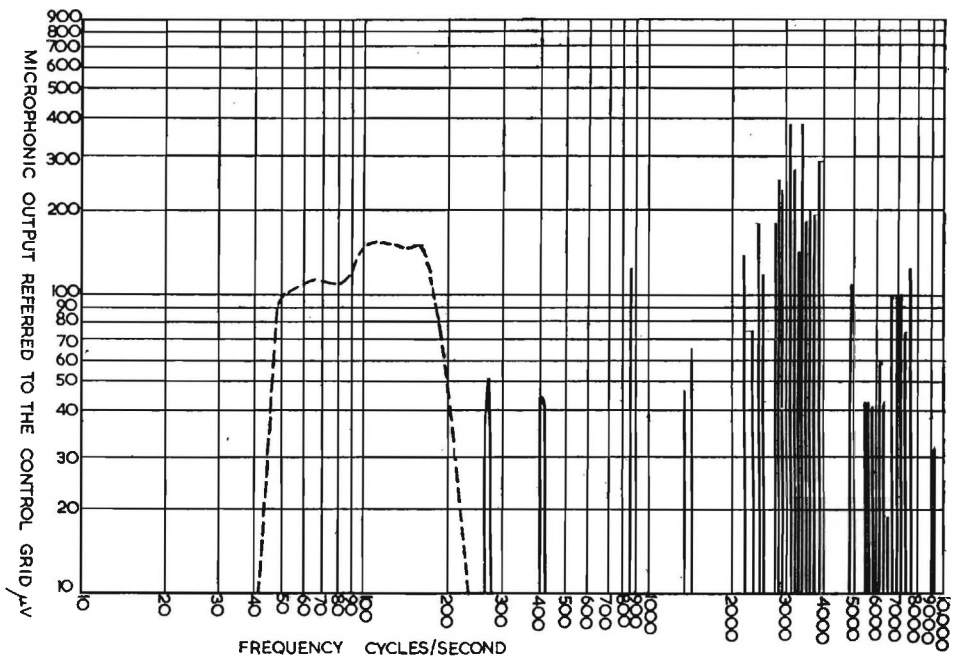

* British Tabulating Machine Co., Letchworth, Herts. Formerly with G.E.C. Research Laboratories, Wembley, Middx.

bias on the variable conductance valve and so tends to reduce the loudspeaker output again, partially counteracting the original rise.

To test a valve, the frequency of the sound wave excitation is varied slowly through the audio-range and the valve output is noted at those frequencies at which an internal resonance is excited. The microphonic performance is most conveniently quoted as the voltage input to the test valve grid to produce an anode current modulation equal to that produced by the microphony. A typical pentode valve response diagram is shown in Fig. 2. It is usually found that some of the low frequency responses are very flat and may hardly be termed resonances, while those above, say 1kc/s, have a very high Q, being excited over a frequency band of only a few cycles. The method, though giving a good indication of the behaviour of the valve is not an absolute measure of microphony; for unfortunately, owing to standing waves, the sound pattern within the padded chamber is by no means uniform. The audio A.V.C. system keeps the sound pressure at the face of the crystal microphone approximately constant, but the pressure at the test valve may vary over a wide range. The method might be made absolute if the loudspeaker, test valve, and controlling microphone were situated in an "acoustically dead" room.

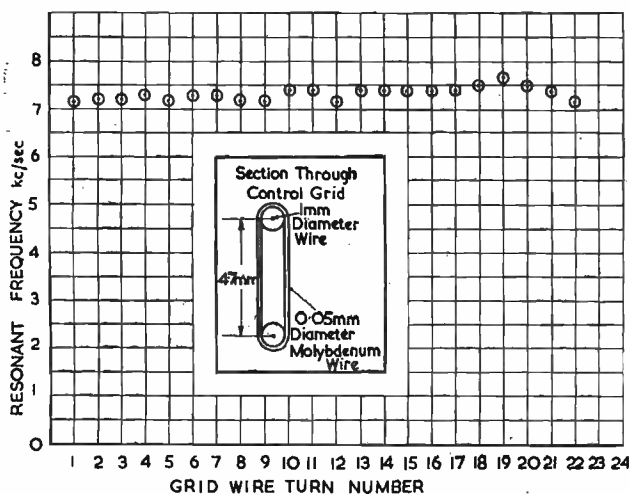

Fig. 3. Resonant frequency of individual control-grid wires of a miniature pentode

Location of the Vibrating Element

Before structural changes in a valve can be made to reduce microphony it is essential to know which portion of the valve assembly is responsible for the microphonic output at a particular frequency.

OPTICAL METHODS

The valve structure may be observed stroboscopically while subjected to vibration and the offending portion detected visually. With the high gain miniature valves now in production, movements of less than a thousandth of an inch in grid or cathode structure will modulate the electron stream appreciably and it will be necessary to use a microscope to detect them.

Observation through the glass envelope of the valve is often difficult because the anode, shield, or the getter patch may obscure the inner electrodes. Valve electrodes, particularly the cathode, often become loose in their micas and then may refix themselves, so that a particularly troublesome vibration may cure itself while the effect is being investigated. Breaking open the envelope on the other hand, destroys the valve, and may also in the pro-

cess remove resonances or alter the microphonic performance in other ways.

The resonant frequencies of the elements within the valve can, in theory, be calculated, but in practice the mathematics soon become very involved. For instance, calculation of the resonant frequency of grid wires is difficult, since they often have complex shapes, unknown tensions, and indeterminate mechanical properties. However, these frequencies may be found experimentally as follows. The grid structure, consisting of the two support wires and the grid wire helix, is cemented to a small moving coil such as those found in moving coil earphones. The coil is replaced in the field of its permanent magnet and driven by a powerful audio-oscillator of variable frequency. The wires are observed through a low-power microscope and as the resonant frequency of each individual wire is reached, the wire springs into vibration and becomes blurred. The spread of resonant frequencies in the wires of the control grid of a miniature R.F. pentode whose performance is shown in Fig. 2 may be seen in Fig. 3.

THE BRIDGE METHOD

It has been suggested by Dr. E. G. James, of the G.E.C. Laboratories, that the capacitance change produced between a vibrating electrode and its neighbours might be used as a method of locating individual vibrations.

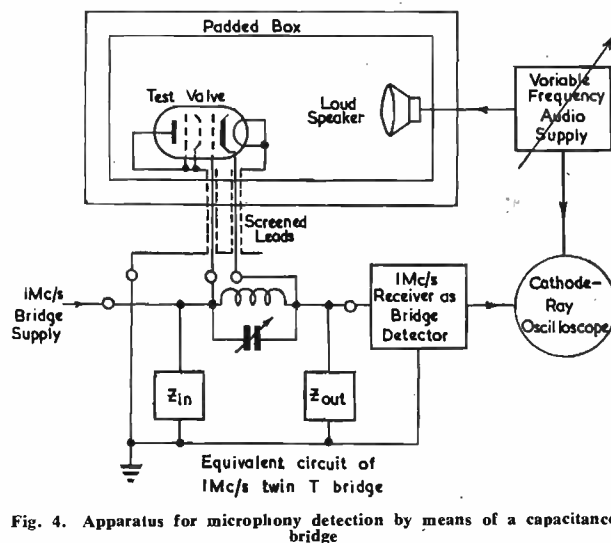

Fig. 4. Apparatus for microphony detection by means of a capacitance bridge

A highly sensitive capacitance bridge of the Twin-T type¹ was found to be suitable for this purpose and the 1Mc/s bridge used could detect a capacitance change of 0.00003pF. This type of bridge measures the capacitance and conductance between two, live terminals to earth.

The same acoustical excitation system is used as in Fig. 1, while the valve and bridge connexions are as shown in Fig. 4.

A pair of adjacent valve electrodes such as the control and screen grids are connected to the live terminals of the bridge through two lengths of coaxial cable, the remaining electrodes being earthed to the cable screening. The coaxial cable connexions are used primarily to reduce the stray capacitance between the live wire terminals so that variation in these strays will not affect the balance of the bridge.

Clearly the bridge will become unbalanced cyclically when a natural frequency of vibration of one of the two live electrodes is excited. The frequencies and approximate magnitudes of the bridge unbalance are recorded for each pair of adjacent electrodes in the valve, the results being presented as in Fig. 5.

If a capacitance change occurs at the same frequency in two adjacent pairs of electrodes it may be concluded that it is the common member which is vibrating. It may be argued that every vibration should produce an unbalance in two different pairs of electrodes at the same frequency, whereas in practice, sometimes only one is detected. This is probably due to the capacitance unbalance being too small to be detected in the second pair. It is found in practice that harmonics in the loudspeaker output also excite vibrations in the valve, and it is therefore, advisable to check this by comparing the output of the bridge detector aurally with the output from the loudspeaker exciting the test valve. Thus vibrations due to loudspeaker harmonics may be separated from those due to the fundamental, and a true picture of the resonant frequencies obtained. The output from the bridge when a resonance is excited is an amplitude modulated 1Mc/s signal. If the resonance inside the valve is of the order of 10kc/s then the bandwidth of the radio receiver used as the bridge detector must be at least this, for even single sideband reception.

not necessarily modulate the electrons stream sufficiently to be detected. Anode vibrations in a pentode are an obvious example of this.

The frequencies at which microphony is most troublesome are those below 1,000c/s, for vibrations above this frequency may be prevented from reaching the valve by mounting it in a special resilient holder.

Below 1,000c/s one of the most common causes of microphony is a loose cathode. The cathode cannot be rigidly held at each end since it needs to expand and contract with the rise and fall of temperature. If prevented from expanding the hot cathode will "bow" or bend as it becomes mechanically weak at 800° C. On the other hand if one end passes through a tight fitting mica which still allows the cathode to slide it may wear itself loose after a number of heating cycles. One possible method of overcoming this difficulty is to fix it to the two micas, securely at one end and by thin flexible strips at the other.

The variation in microphonic performance between valves of the same type, produced concurrently on one

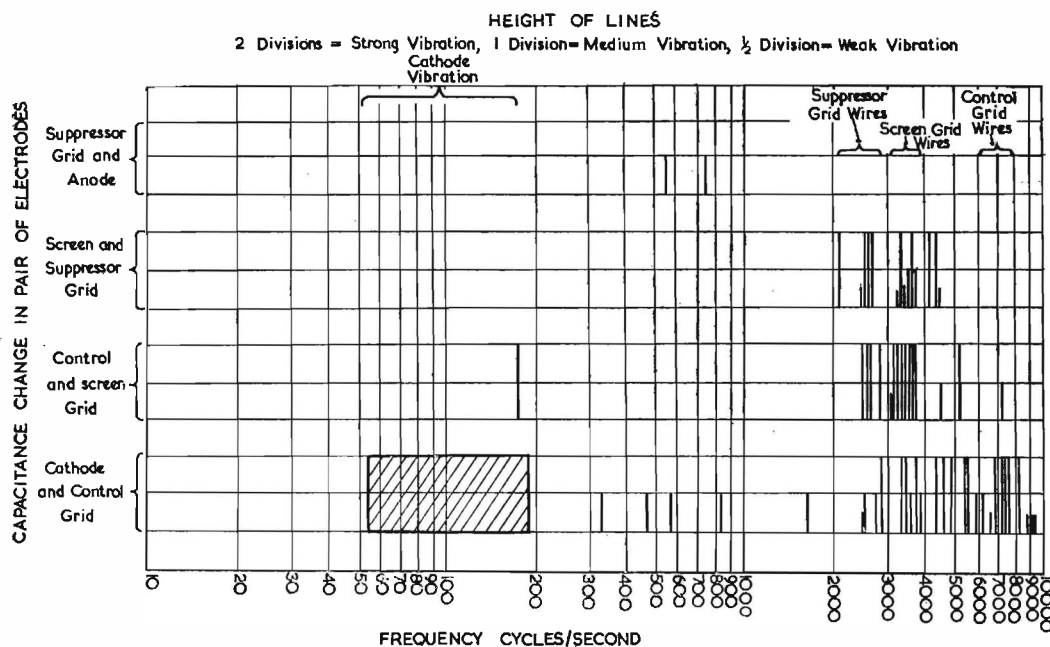

Fig. 5. Variation with frequency of capacitance between adjacent electrodes in a miniature pentode

Discussion of Results

Fig. 2 shows the frequency response of a typical miniature B7G based pentode when used as an amplifier, and Fig. 5 the corresponding mechanical resonances as detected by the bridge method.

It is obvious that the large microphone output centred on 100c/s is due to a vibration of the cathode as shown by the capacitance change method.

Similarly the outputs at about 7,000c/s are due to control grid resonances (probably the grid wires themselves). This is borne out by actual measurement of the control grid wire resonant frequencies which are shown in Fig. 3.

There are, on occasion, microphonic outputs which have no detectable capacitance change associated with them, e.g., a grid wire vibration in the plane of the grid will have a definite effect on the space current, but a very small effect on the capacitance between grid and cathode or screen.

Conversely, there are vibrations within the valve which change the capacitance between the electrodes, but may

assembly line may be as large as that between different types. Thus, to get a fair picture of the performance of any valve type a large number of specimens must be tested. It should then be possible to select the troublesome frequency ranges and attempt to isolate the offending portion of the structure by the optical or the capacitance method. The particular mode of vibration may perhaps be detected by the optical method, but if this is not possible, it must be located by trial and error. The field of possibility has, however, been considerably reduced and successive modification to the structure will eventually provide a solution. Thus the design of a valve with low microphony is a long and tedious process, but research continues in an attempt to produce a truly non-microphonic valve.

Acknowledgment

In conclusion, the author wishes to tender his acknowledgments to the M.-O. Valve Co., Ltd., on whose behalf the work described was carried out.

REFERENCE

- JAMES, E. G. and PROCTOR, R. F. A Radio-Frequency Capacitance and Inductance Bridge. *J.I.E.E.*, 92. Part III. 287. (1945).

The Parallel-T Network as a Linear Mixer

By J. S. Nisbet, B.Sc.(Eng.) *

IN many applications it is desired to mix the outputs of two oscillators without introducing coupling between them over a small frequency band. This may be done using a parallel-T network, which, because of its cheapness and small size, has great advantages in some circuits.

The two oscillators are connected to the terminals OA and OB respectively of the parallel-T network shown in Fig. 1, and the output obtained across OC or OD. As there is zero transfer impedance between OC and OD at the null frequency of the circuit, no voltage is fed from one oscillator to the other, and at that frequency there is theoretically no coupling. Portions of the voltages applied by both oscillators are developed across the mid-shunt arms.

The null conditions may be derived most simply by consideration of the transfer impedances of the two T-sections. When these are equal numerically and opposite in sign the net current in OB is zero, and the null conditions obtain.

In this application it is usually desirable that the network should be symmetrical, since in these circumstances the portion of each oscillator voltage produced across either shunt arm is the same and the balance is less sharply defined than with an asymmetrical arrangement. The number of unknowns is thereby reduced.

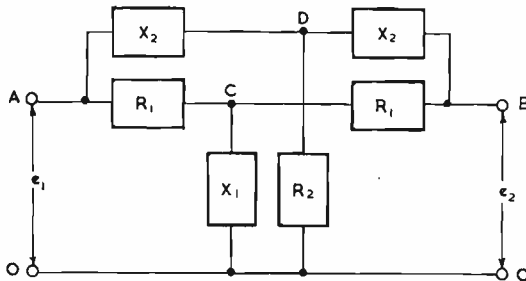

Fig. 1. The parallel-T network

The equation for the perfect null is then:

$$O = 2R_1 + R_1^2/jX_1 + 2jX_2 - X_2^2/R_2 \dots \dots (1)$$

This equation can be solved in terms of R_1 by introducing an arbitrary coefficient m such that:

$$X_2 = mR_1 \dots \dots \dots (2)$$

substituting Equation (2) in Equation (1)

$$R_2 = \frac{1}{2}m^2R_1 \dots \dots \dots (3)$$

and

$$X_1 = \frac{1}{2}R_1/m \dots \dots \dots (4)$$

We therefore have a theoretically infinite range over which values of m and R_1 can be chosen, and it is necessary to find optimum values for them.

Transfer Ratio

The transfer ratio, or ratio of the voltage across a mid-shunt arm OC or OD (Fig. 1) to the input voltage at the terminals OA or OB producing it, may be evaluated by considering the other input terminal short circuited. The transfer ratio is the efficiency criterion of the network, and should be as large as possible.

For the terminals OC the transfer ratio can be shown to be:

$$T_c = \frac{1}{R_1/jX_1 + 2} \dots \dots \dots (5)$$

by substituting the values found in Equation (4)

$$T_c = \frac{1}{2(1 - jm)} \dots \dots \dots (6)$$

and for the terminals OD

$$T_d = \frac{1}{(R_2 + jX_2)/R_2 + 1} \dots \dots \dots (7)$$

which by substitution reduces to

$$T_d = \frac{1}{2(1 + j/m)} \dots \dots \dots (8)$$

These relationships are plotted in Fig. 2. It can be seen that theoretically the greatest transfer ratio is obtained for terminals OC with m equal to zero, and for OD with m equal to infinity. R_2 is proportional to m^2 , and as m rises R_2 becomes very large. In practice the effect of the output impedance and impurities in elements becomes large, so that the transfer ratio for OD does not continue to increase with m indefinitely, and may have a maximum value with m about 2 to 3.

Input Impedance

The input impedance of OA at null frequency is most

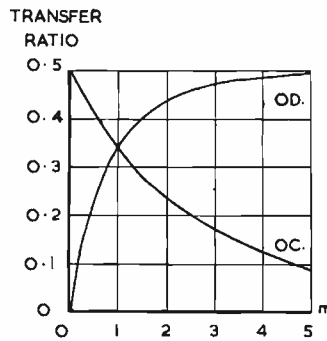

Fig. 2. Transfer ratio

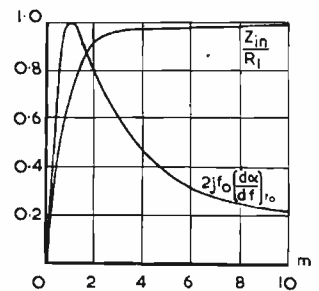

Fig. 3. Input impedance and frequency sensitivity

easily determined by considering the network short circuited at OB. As the transfer impedance from OA to OB is zero this short circuit has no effect on the input impedance. The expression for Z_{in} when simplified is:

$$Z_{in} = \frac{[R_1 + jX_1 R_1/(R_1 + jX_1)] [jX_2 + jX_2 R_2/(R_2 + jX_2)]}{(R_1 + jX_2) + jX_1 R_1/(R_1 + jX_1) + jX_2 R_2/(R_2 + jX_2)} \dots \dots \dots (9)$$

substituting the values derived in Equations (2), (3) and (4).

$$Z_{in}/R_1 = \frac{m[1 + 1/(1 - 2jm)] [j + m/(2 - jm)]}{1 + jm + 1/(1 - 2jm) + m^2/(2 - jm)} \dots \dots \dots (10)$$

Values of Z_{in}/R_1 are plotted in Fig. 3 for a range of values of m . The input impedance is zero for m equal to zero, and rises to R_1 asymptotically as m tends to infinity. The application of networks with low values of m is severely restricted due to the resultant low input impedance. The input impedance can be increased by raising the value of R_1 or using a larger value of m . No great advantage is obtained by raising m beyond about 2.

Sharpness of Null

When the parallel-T circuit is used as a measuring bridge or filter it is usually desirable to obtain the sharpest pos-

* Nash & Thompson, Ltd., Tolworth, Surrey.

sible cut off, i.e., the maximum possible attenuation at the null frequency, with as small an attenuation as possible elsewhere. With the mixer circuit, however, it is desirable to have a high attenuation over the frequency band at which coupling is possible.

The ratio of the voltage e_2 produced across the terminals OB by the voltage e_1 across the terminals OA. $a = e_2/e_1 =$

$$\frac{R_1^2 R_2 - 2X_1 X_2 R_2 + 2jR_1 R_2 X_1 - jX_1 X_2^2}{(X_1 + R_1)(X_2 + R_1)(X_2 + R_2) + X_1 R_1 (R_2 + X_2) + R_2 X_2 (R_1 + X_1)} \quad (11)$$

Differentiating this with respect to frequency and substituting conditions for null at frequency f_0

$$(da)/(df)_{f_0} = 2/f_0 \frac{R_1 X_1}{j(X_1 X_2 + R_1 R_2)} \quad (12)$$

substituting Equations (2), (3) and (4) in Equation (12)

$$jf_0 (da)/(df)_{f_0} = \frac{m}{m^2 + 1} \quad (13)$$

This factor is plotted against m in Fig. 2 which shows that the maximum frequency sensitivity is obtained when m is equal to unity. For a wide attenuation band it is thus desirable either to have values of m less than about 0.25 or as large as possible. As these two conditions correspond to the maximum transfer ratio for the terminals OC and OD respectively it is not difficult in practice to realize a frequency sensitivity of less than half of that obtained with m equal to 1, in a satisfactory network.

Conclusions

A satisfactory network for mixing should have a high transfer ratio, a high input impedance, and low frequency sensitivity. It appears from the previous theory that from considerations of transfer ratio and frequency sensitivity the value of m should either be considerably greater or smaller than unity, and that from considerations of input impedance m should not be too small. In practice, however, other factors are important. It is found that when very small capacitors and high resistors are used the effect of intercapacitances becomes large and the performance of the network may differ considerably from that obtained by theoretical analysis. The attenuation at the null fre-

quency and the transfer ratio will be reduced while the network values required for optimum null may differ considerably from the expected values. These effects are also obtained if poor quality capacitors are used. The practicable range of values of m will vary with operating frequency, precautions taken in screening and spacing, and value of R_1 . In most cases, however, it should be possible to utilize a value of m of between 2 and 3.

In the original application it was desired to mix the outputs from two oscillations in order to tune the variable frequency oscillator to the standard frequency. Using a parallel-T mixer circuit no difficulty was experienced in avoiding coupling down to a frequency difference of less than one cycle/second at 50kc/s. By this means it was possible to use a Y63 tuning-eye as modulator and detector.

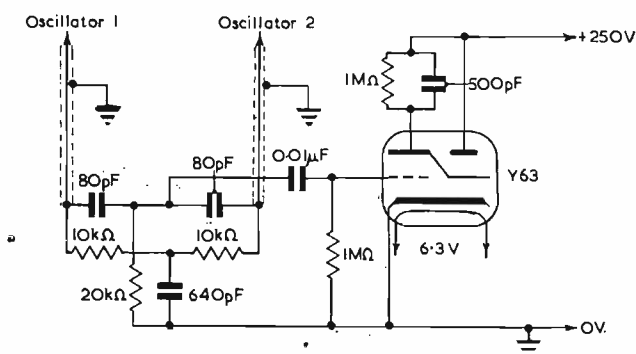

Fig. 4. Mixer and detector circuit

A circuit of the mixing and modulating section is shown in Fig. 4.

Acknowledgments

This article is based on work done in the laboratories of Nash & Thompson, Ltd. The author wishes to express his thanks to the directors of the firm for their permission to publish the article.

BIBLIOGRAPHY

- ¹ TUTTLE W. N., Bridged-T and Parallel-T Null Circuits for Measurements at Radio Frequencies *Proc. I.R.E.*, 28, 23, (1940).
- ² GIVENS, M. P., and Saby, J. S., A Simplified Analysis of the Parallel-T Null Network *Rev. Sci. Instrum.*, 18, 342, (1947).
- ³ HARRIS, G. R., Bridged Reactance-Resistance Networks *Proc. I.R.E.*, 37, 882, (1949).

Submerged Repeaters for the Netherlands-Denmark Coaxial Cable Link

OF the many projects designed to extend and improve telecommunication facilities in Western Europe since the war, the laying of a submarine telephone cable link between the Netherlands and Denmark has, undoubtedly, attracted most technical interest among telecommunication engineers all over the world.

General interest in the project and much scientific research and development work in implementing it have been stimulated by the fact that two single coaxial submarine cables of the latest design have been used for the first time over a total submarine distance of 263 kilometres (about 141 nautical miles). This is from Oostmahorn on the Netherlands coast, 40 kilometres north-east of Leeuwarden, across the North Sea to Romo, a small island connected by causeway to the West coast of the Jutland peninsula in Denmark, and is the world's largest polythene insulated, solid dielectric submarine coaxial cable, manufactured in Great Britain by Submarine Cables, Ltd. From here a "Standard" coaxial system operating over four-tube coaxial cables supplied by the Nordiske Kabel-og-Traadfabriker of Copenhagen extends telecommunication facilities to Copenhagen making, at the same

time, a substantial contribution to the Danish inland network. Further extensions of existing facilities from Copenhagen to Malmo in Sweden and thence to Gothenberg, Oslo, Stockholm and Helsinki, will be realized with the laying of a short submarine link to Malmo, and completion of the Swedish coaxial system, work on which is already far advanced.

Standard Telephones and Cables, Ltd., who undertook the provision of submerged repeaters for the Oostmahorn-Romo link were faced with a number of scientific problems for which there were few precedents in the telecommunications art.

Features of the submerged repeater design which are of particular interest are the fact that transmissions in both directions are amplified by the same amplifier. In the Netherlands to Denmark direction the 36 telephone channels with a carrier spacing of 4kc/s as recommended by the C.C.I.F. occupy the frequency band 24 to 168kc/s, while in the opposite direction of transmission their counterpart of 36 channels occupy the band from 208 to 352kc/s. The 40kc/s displacement between these two directional bands is employed in the repeaters to discriminate the direction in which each is transmitted after amplification by the common amplifier. This is done by means of high-pass and low-pass filters.

The

HOLME

MOSS

TELEVISION
TRANSMITTER

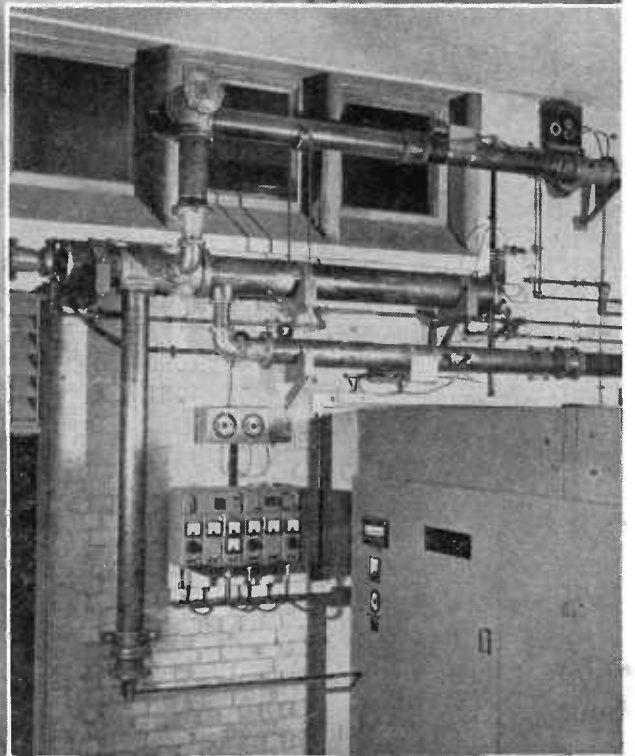
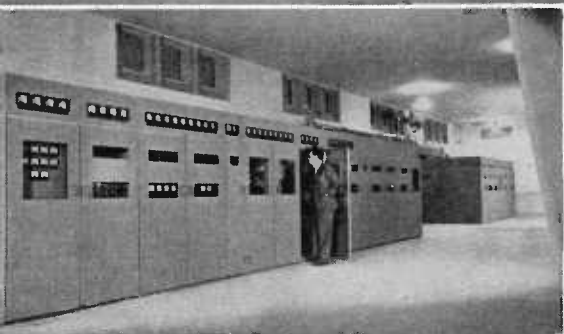

HOLME MOSS, which was officially opened on October 12, is the second high-power transmitting station to be completed under the B.B.C.'s post-war plan for extending the television service. It will bring television within reach of 11 million people, over and above the 18 million already served by the existing stations at Alexandra Palace and Sutton Coldfield.

The station comprises a building housing the two main transmitters, a smaller building for two standby transmitters, a 750ft mast supporting the main transmitting aerial, and a 150ft mast for a standby aerial. The main vision transmitter, which is grid-modulated in the final R.F. stage, operates on a carrier frequency of 51.75Mc/s, has a peak-white output power of 45 kilowatts, and is the most powerful television transmitter in the world. The main sound transmitter, which operates on a frequency of 48.25Mc/s, has a carrier power output of 12 kilowatts. In addition, there are standby vision and sound transmitters of 5 kilowatt and 2 kilowatt power respectively.

Holme Moss will transmit the same programmes as the Alexandra Palace and Sutton Coldfield stations. The vision programme signals are sent from London via Birmingham and Manchester over coaxial cables provided and operated by the G.P.O. The signals can be sent in both directions simultaneously.

The station is on a 150 acre site adjoining the Holmfirth-Woodhead Road and is some eight miles south of Huddersfield. The altitude is 1,750ft, which, with the 750ft mast, brings the transmitting aerial to a height of 2,500ft above sea level.

Aerial

A single array radiates the sound and vision signals. It consists of eight vertical folded dipoles arranged in two identical groups placed one above the other and separated by a distance of approximately one wavelength. Each of the four dipoles in the two groups is mounted on one face of the square-section topmast, the dipoles on opposite faces being approximately two-fifths of a wavelength apart. The average gain of the aerial in a horizontal direction is approximately 4db. The dipoles are constructed of galvanised steel strip and incorporates $7\frac{1}{2}$ -kW heaters to prevent ice formation. They are improved versions of those used at Sutton Coldfield, being wider and giving a better impedance/frequency characteristic.

Transmitter Block

This section of the building is divided longitudinally into three main areas by two partition walls. In the central area thus formed are the sound and vision transmitters, arranged in line. The area bounded by the partition wall behind the transmitters and the outside wall of the building is divided into three: the centre section contains the power conversion plant for the two transmitters, and the two end sections the valve cooling plant. By placing the valve cooling plant in rooms remote from the control room, the amount of noise reaching the control room is minimised.

Along the other side of the transmitter hall is the control room, placed approximately in the centre of the transmitter hall, and flanked by the vision and sound lines termination rooms.

A description of the photographs shown on the opposite page is as follows:—

(Centre) Exterior of the new B.B.C. television station at Holme Moss. The standby mast can be seen in the background. (Photograph by courtesy of Marconi Wireless Telegraphy Co., Ltd.)

(Right) The combining circuit for the high-power vision and sound transmitters. The combined vision and sound radio-frequency signals are taken by a single concentric feeder to changeover switches at the base of the main mast. Below the combining circuit are reflectometers for indicating the forward and backward power at various points in the system.

(Top left) The main transmitter hall containing the $\frac{1}{2}$ kW vision transmitter (left) and the 12 kW sound transmitter (right). The combining circuit is mounted on the wall between the two transmitters.

(Bottom left) The control desk for the high-power vision and sound transmitters. The interlock indicator panels are mounted on the wall facing the control desk.

The vision transmitter has an overall length of 31ft, which includes a power distribution cubicle 10ft long. The transmitter is built in eight cubicles placed side by side. Viewed from the front the radio frequency stages are arranged in order of increasing power from left to right and the modulator from right to left. Thus the radio-frequency output stage is next to the final modulator stage.

The power conversion plant for the transmitter is contained in an enclosure 35ft long which is located behind the transmitter.

The sound transmitter is 15ft 6in. long with a power conversion plant enclosure 14ft 3in. long, and is similar to the sound transmitter at Sutton Coldfield. It has a carrier power of 12kW and employs high-power Class B modulation with the usual negative feedback circuits, which result in total harmonic distortion figures of less than 2 per cent at levels of modulation up to 95 per cent, over the normal range of modulating frequencies. The carrier noise level is better than 60db below 100 per cent modulation.

Control Room

Both transmitters are operated from a single control desk in the control room. Windows between the control room and the transmitter hall afford the engineer on duty a clear view of both transmitters.

The control systems of both transmitters are conventional, being sequence interlocked and operated by means of toggle switches on the control desk. The correct functioning of the various interlocks in the complicated control circuit is indicated by lamps on three interlock indicator panels which are on the wall facing the control desk.

(Below) The control desk for the medium-power standby transmitters, part of which can be seen immediately in front of the desk.

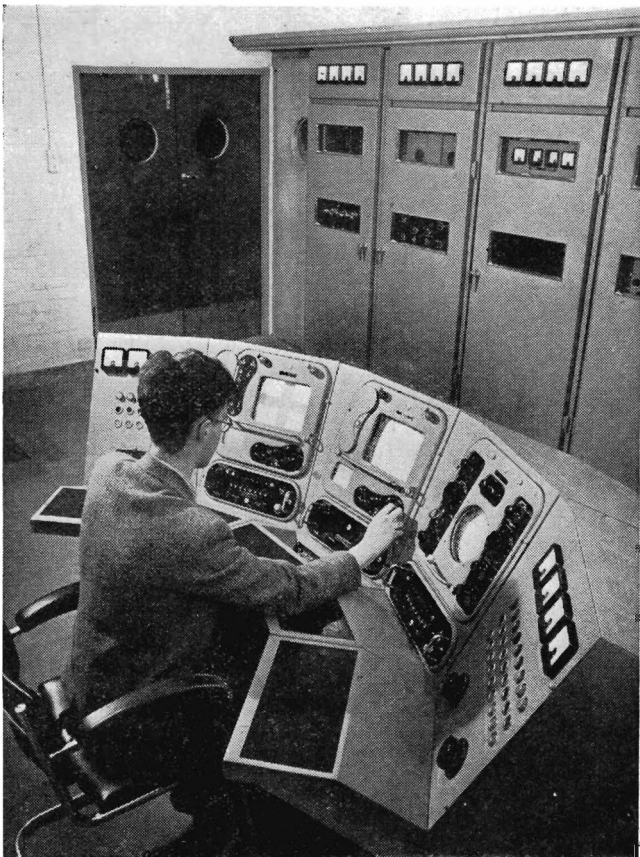

A Beacon Range Indicator

By J. H. McGuire, B.Sc. *

THE proposed beacon range indicator, used in conjunction with two or three ground stations constitutes a radio navigational system depending on range measurements. The airborne equipment provides a means of indicating on a meter, in an aircraft, the range of the aircraft from a beacon at any particular instant. Interrogation is achieved by one group of three pulses, their separation being a code unique to any one aircraft, and a pulse group selector in the aircraft ensures that these three pulses are the only ones accepted. By using this technique it is hoped that 1,000 aircraft could use one beacon every two minutes with a chance of no reply of the order of 1 in 7,000 times and of an incorrect reading of 1 in 3×10^9 times. The latter chance can be neglected compared with the chance of the same result occurring due to a failure of whatever equipment be used to fulfil the function.

A radio aid to navigation is a facility which is currently regarded not merely as a valuable accessory but as a necessity for an aircraft and the beacon range indicator here proposed fulfils this function by presenting to the navigator in the aircraft his range from each of two or three ground equipments.

By making use of one ground station the aircraft position would be known to be on a circle centred on the ground station. Use of another station would then eliminate as possible positions of the aircraft all but the two points of intersection of the two circles thus obtained. Should it not be possible to eliminate the ambiguity by means of previous knowledge a third ground station could be interrogated.

For the most convenient and the widest application of the system an aircraft would carry a chart bearing systems of concentric range circles centred on the ground stations.

The system depends essentially on range measurements only and on the use of more than one ground station, as accurate determination of both range and bearing from one ground station is not easy.

General Principles of the System

The proposed system uses pulse technique to determine the range of an aircraft by interrogating a slave beacon on the ground. This function is also performed by Rebecca-Eureka equipments but it is hoped that the proposed system is an improvement, as range is simply presented on a meter, and as approximately 1,000 aircraft, each requiring range information at two minute intervals, may use the beacon at the same time. No attempt is made to present D.F. information and the range meter is not continuous reading. The system differs from Rebecca-Eureka in that a range reading is achieved by interrogation with only one pulse group instead of by a pulse train. A pulse group is used in place of a single pulse so that different aircraft using the same beacon need not interfere with each other.

When a range reading is required, a button, in the aircraft, is pushed and three pulses are transmitted, their separations being a code unique to the particular aircraft. A pulse width of one microsecond and a maximum separation of fifty microseconds would allow of about a thousand different codes, for a discrimination of one-and-a-half microseconds at the pulse group selector and a time stability of half-a-microsecond at the pulse generator can easily be achieved. Thus the separation of two pulses provides about thirty to thirty-five codes and by using three pulses this number is squared.

The ground beacon retransmits the pulses without disturbing the code but introduces a fixed delay greater than

a hundred microseconds so that the aircraft and beacon transmissions cannot overlap.

The airborne receiver is sensitive for a period of, say, three milliseconds after the completion of the associated transmission and its output is fed to a pulse group selector so that pulses associated with other aircraft do not appear at the pulse position discriminator. The latter is thus presented with one pulse and gives a voltage output derived from a sawtooth voltage waveform initiated from the airborne transmitter. This voltage is measured by a valve voltmeter and registers the range on a meter. As the operation is only performed once for each range requirement the pulse position discriminator and valve voltmeter are memory devices and the reading only remains true to within 1 per cent for, say, 10 seconds.

When a considerable number of aircraft is using the same beacon, two effects can occur. Firstly the ground

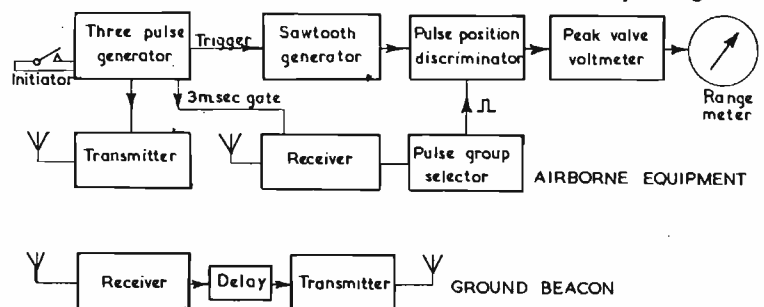

Fig. 1. Block schematic of beacon range indicator

beacon might not recover sufficiently quickly from a transmission to retransmit a particular pulse and secondly a combination of pulses from other aircraft might coincide with the code of a particular aircraft and give a false range presentation. The effect of a pulse not being retransmitted would be that the airborne range meter would not register and in the Appendix it is shown that, under typical conditions, with a thousand aircraft using the beacon, the chance of this happening is 1 in 7,000. The second phenomenon is more serious and the chance of its occurring is less than 1 in 3×10^9 . This chance may be neglected compared with the chance of the same result due to failure of whatever equipment be used to fulfil the function.

Fig. 1 is a block schematic diagram and presents sufficient information for a general appreciation of the system. Further diagrams give more detail with regard to circuits which are vital to the system.

Pulse Group Generator

The pulse group generator is the coding device, the setting of which is unique to any particular aircraft and

* Formerly Ministry of Supply.

corresponds to the setting of the pulse group selector of the associated receiver. The code is in the time separation between three similar pulses and the separations between successive pulses must therefore be independently variable. To perform this function in the most economical fashion it is possible that a simple flip-flop circuit would be sufficiently stable (in time) to be used as the delay mechanism. Alternatively delay lines could be used to ensure reliability.

The output of the pulse group generator is then passed to the pulse shaper, modulator and transmitter. As the latter, together with the ground equipment are not critical to the system no reference is made to them. The pulse width used would be a factor governing range accuracy and would probably be of the order of a microsecond.

Receiver

The airborne receiving equipment required is conventional as far as the second detector, saving that it is only sensitive for, say, three milliseconds after the completion of the airborne transmission. This could be achieved by

flip-flops cannot be used in place of delay lines in this circuit (as in the pulse group generator).

Pulse Position Discriminator

To obtain a range reading it is necessary to measure the time interval between the pulse group selector and the pulses transmitted from the aircraft. This is done by the pulse position discriminator and valve voltmeter shown in Fig. 3. The former is a four diode "clamp,"^{2,3} and is, in effect, merely a switch which connects C_1 to the sawtooth for the duration of the received pulse. The sawtooth generator is not shown but is initiated from the pulse group generator, its voltage at any instant thus being a linear function of time referred to the third of the transmitted pulses as origin. To the pulse input terminals of the "clamp" are applied both the outgoing pulses and that from the pulse group selector, the former serving merely to charge C_2 so that the circuit will operate. While C_2 is charged and no pulse appears across the transformer, B is isolated from A, C and D, and, provided the

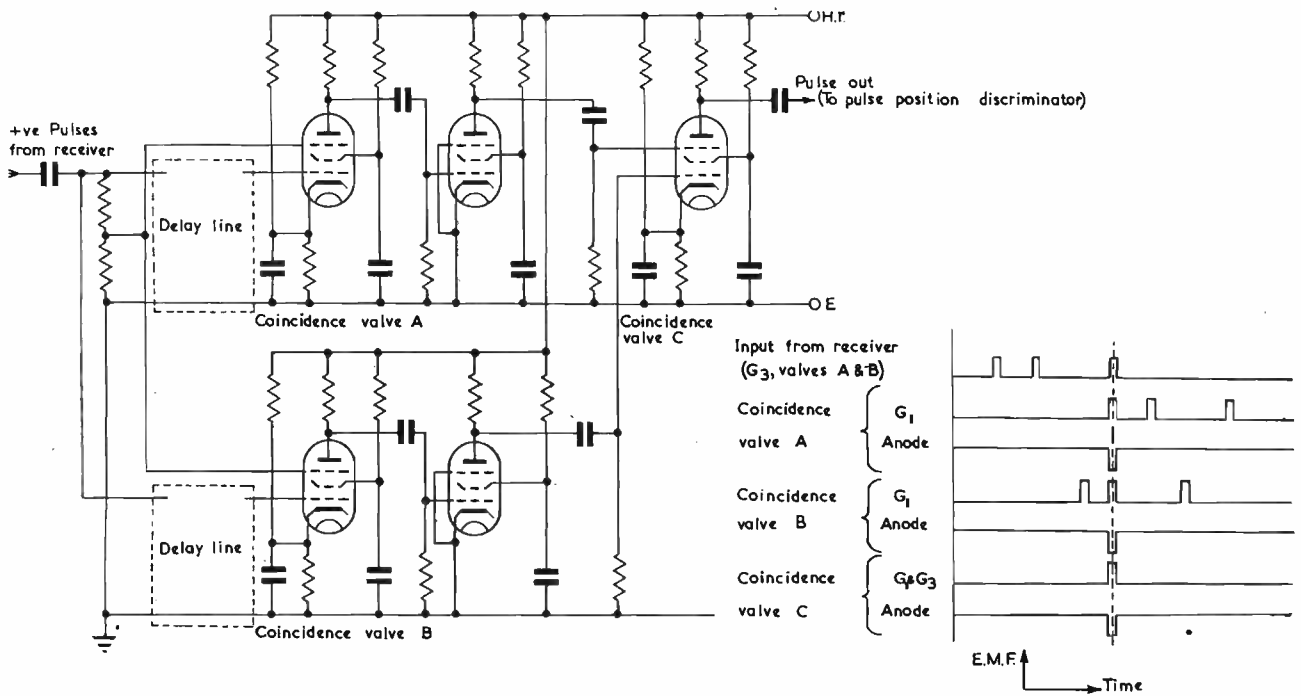

Fig. 2. Pulse group selector

triggering a three millisecond flip-flop from the third pulse of the pulse generator and applying it to the local oscillator of the receiver, assuming the latter to be a super-heterodyne.

Essential features of the airborne equipment are the pulse group selector, to which the receiver output is applied, the pulse position discriminator and the associated valve voltmeter circuit. These will now be described in more detail.

Pulse Group Selector

The function of the pulse group selector is to reject from the receiver output all pulses from the beacon not initiated from the particular associated airborne transmitter. Coincidence technique is used similar to that of the synchronizing pulse separator of a pulse communication equipment due to D. G. Reid.¹ The circuit is shown in Fig. 2 and provided the input only includes one group of pulses satisfying the code, the output will be one pulse corresponding to the third of the required group. Delay

excursion of A is within the potentials of C and D, B remains so. When a pulse appears however, C, B and D are brought to the potential of A. Thus the potential of B, when the receiver has become inoperative, will be a measure of the required range and it merely remains to measure this before C_1 discharges by an appreciable amount. Unfortunately, as the parallel resistance across C_1 must be considered to be as low as 10 megohms, this period is only of the order of hundreds of microseconds and the circuit following C_1 is necessary to present a reading on the range meter which is true to within some 1 per cent for say 10 seconds. The function of the circuit is merely to charge successively larger capacitors within the time the preceding ones maintain their charge to within 1 per cent, until a value of capacitance is arrived at that will maintain its charge to within the required limits for the required time. The waveforms shown in Figs. 4 and 5 provide help in appreciating the operation. Consideration of the circuit shows that the sawtooth must be positive going and that

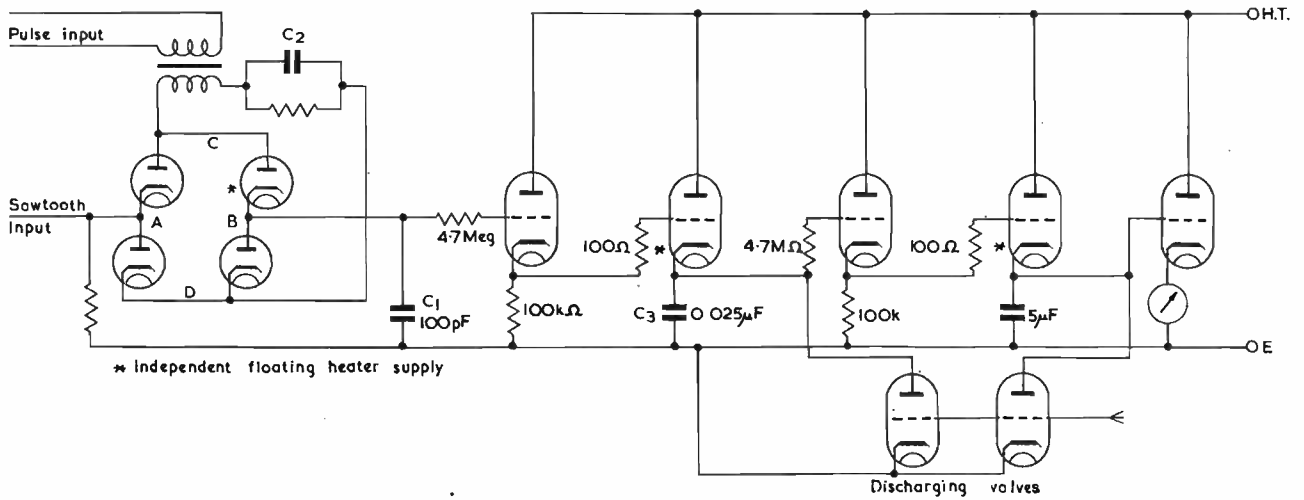

Fig. 3. Pulse position discriminator and range indicator

discharging valves are necessary, functioning 10 seconds after the airborne transmission is completed, to prepare the circuit for subsequent repeats of the operation.

Conclusion

The system is easy to operate, gives a presentation which is appreciated by air crews, and does not involve equipment which is heavy or bulky. Its limitations are those common to all pulse beacon responder systems, viz., that assuming one microsecond pulses are used, a bandwidth of two megacycles is necessary, and therefore the carrier frequency would have to be of the order of hundreds of megacycles. The memory and coding techniques employed, however, allow many more aircraft than is usual to use any one beacon.

An interesting adaptation of the system to possible requirements would be to include a pulse group selector in the beacon. The latter would thus be used by only one aircraft at a time and its detection by any other party would be almost impossible.

Acknowledgments

Acknowledgment is due to Mr. D. M. Mackay of the Physics Department, King's College, London, for advice regarding strobing techniques.

APPENDIX

FAILURE OF SYSTEM WHEN BEING USED BY 1,000 AIRCRAFT
As referred to in the text the system can fail in one of two ways when a number of aircraft is using the beacon.

(a) The less serious of these effects is that no range reading may be presented in the aircraft due to the beacon's not having recovered sufficiently quickly from a previous interrogation to receive and re-transmit one of the aircraft's pulses. The chances of this occurring when conditions are worst will be considered.

Suppose 1,000 aircraft are using the beacon every two minutes, that both beacon and aircraft use a pulsewidth of less than one microsecond and that the beacon recovery time is two microseconds. The distribution of interfering pulses is considered to be random.

One of the three pulses from the particular aircraft considered will not be re-transmitted if a beacon transmission has occurred within two microseconds of the arrival of that pulse. The chance of this occurring is therefore three times the probability of a pulse occurring in a particular two microsecond interval = $3 \times$ average number of interfering pulses per second \times 2 microseconds.

The average number of interfering pulses per second

will be

$$3 \times \text{number of aircraft} \times \text{rate of repetition of pulse groups (sec}^{-1}\text{)}$$

$$= 3 \times 1000 \frac{1}{2 \times 60} = 25$$

\therefore chance of a suppression

$$= 3 \times 25 \times 2 \times 10^{-6} = 1.5 \times 10^{-4}$$

i.e., 1 in 7,000

A more detailed analysis would take account of the fact that as the resolution of the pulse group selector is finite the interfering pulse might be accepted even though not coincidental with the required pulse. The chance of such circumstances arising is, however, slight (less than once

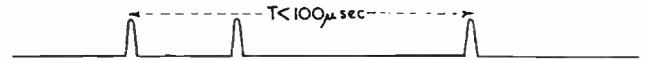
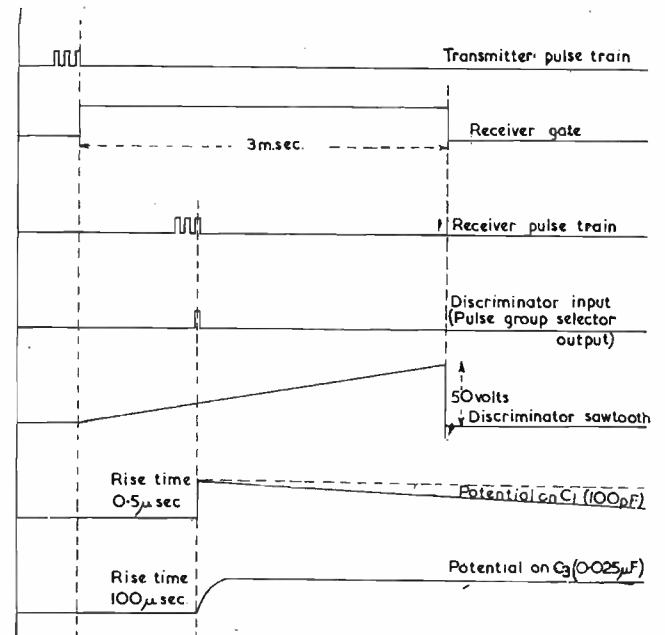

Fig. 4. Transmitter pulse group

Fig. 5. Waveforms



per 7,000 operations) and the range error that would result would be small (less than 200 yards).

(b) A more serious effect would be that the range meter should present a false reading. This could occur if a combination of three pulses from other aircraft coincided with the code of a particular aircraft while its receiver was sensitive.

Assume as before that there are 1,000 aircraft using the beacon every two minutes; that the aircraft receiver is sensitive for three milliseconds and that the effects of pulse-width and pulse group selector resolution allow a total time variation of three microseconds in the position of a pulse for acceptance.

The chance of one unwanted pulse from the beacon appearing at the receiver while it is sensitive

= average number of random pulses per second (as previous) \times time interval for which receiver is sensitive (seconds)

$$= 25 \times \frac{3}{1000} = 7.5 \times 10^{-2}$$

The chance of a second pulse occurring at a suitable separation from the first to pass the first part of the pulse group selector

$$= \text{average number of pulses per second} \times 3 \text{ microseconds} = 25 \times 3 \times 10^{-6} = 7.5 \times 10^{-5}$$

Similarly for a third pulse.

Thus the chances of a combination appearing

$$= 7.5 \times 10^{-2} \times (7.5 \times 10^{-5})^2$$

$$= 4.2 \times 10^{-10}$$

i.e., 1 in 2.4×10^9 times.

This chance may be neglected compared with the chance of the same result due to failure of whatever equipment be used to fulfil the function.

REFERENCES

- ¹ REID, D. G. A 60 cm. Multi-channel System employing Pulse Position Modulation. *J.I.E.E.*, 94, Part IIIa, No. 13, (1947).
- ² WENDT, M. R. and FREDENDALL, G. L. Automatic Frequency and Phase Control of Synchronization in Television Receivers. *Pro. I.R.E.*, January, (1943.)
- ³ WILLIAMS, F. C. Introduction to Circuit Techniques for Radiolocation. *J.I.E.E.*, 93, Part IIIa, No. 1, (1946).

Blocking-Oscillating Amplitude Control*

THE amplitude of the output from a blocking oscillator in which the oscillation takes place between the screen and the grid of a pentode whose anode is arranged to discharge a time-base capacitor, is often controlled by adjusting the point on a potentiometer, connected across the supply rails, to which the anode load is connected. This arrangement is shown in Fig. 1. It is, of course, possible to use a variable resistance instead of a potentiometer in the anode circuit or a capacitor may be connected between the anode tap on the potentiometer and the negative H.T. rail.

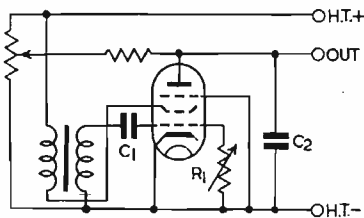

Fig. 1. Anode control

An alternative arrangement in which the amplitude is conveniently adjusted by changing the bias applied to the suppressor grid is shown in Fig. 2. The charging capacitor C_2 is made of large value so that it charges only to a small extent in the charging time allotted. As the circuit sets itself in an equilibrium condition in which every discharge of the capacitor is followed by an equal charge, the amplitude of the generated sawtooth can be adjusted by altering the extent of discharge. Since the duration of the blocking of the oscillator circuit, i.e., the time constant circuit C_1R_1 , the extent of the discharge, i.e., the amplitude, can be controlled by adjusting the rate of discharge and this is done by controlling the negative potential applied to the suppressor electrode by adjustment of R_2 . The charge-discharge cycle is located at a part of the charging

characteristic which depends upon the equilibrium conditions and, as the cycle does not extend over a very large part of the charging characteristic, the generated waveform is sufficiently linear. When the suppressor grid potential approaches zero, variation of the frequency control R_1 also causes a change in the amplitude of the sweep. In order

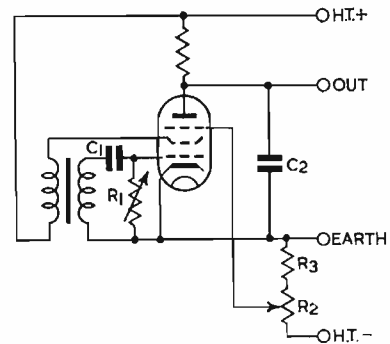

Fig. 2. Suppressor grid control

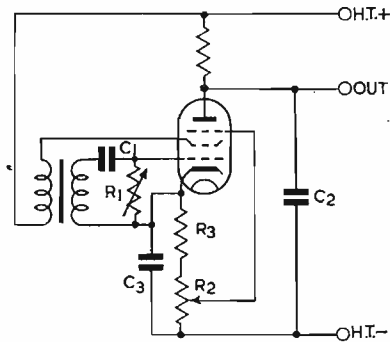

Fig. 3. Suppressor grid control without negative H.T. supply

to prevent this, a small fixed resistor R_3 may be provided so that the suppressor grid potential is prevented from approaching too close to zero.

Fig. 3 shows an alternative circuit in which the necessity for a negative H.T. supply is avoided. The capacitor C_3 must, of course, be of sufficient capacitance to ensure that only a steady potential appears at the suppressor grid.

* Communication from E.M.I. Engineering Development, Ltd.

The Prediction of Audio-Frequency Response

No. 1—Circuits with Single Reactance Element

By N. H. Crowhurst, A.M.I.E.E.

THIS is the first of a series of data sheets for facilitating the prediction of response characteristics in equipment designed for the transmission of a wide band of frequencies. While primarily intended for application in the audio-frequency range, they can be applied, either directly or with certain approximations, to any frequency response prediction. The present data sheet deals with the simple case in which only one reactance is responsible for a cut-off characteristic in either direction. This may be either shunt inductance or series capacitance for low frequency cut-off, or for high frequency cut-off, shunt capacitance or series inductance.

adding the amplitude responses as given by the charts in decibels, and by adding the phase responses, with due attention to sign.

Figs. 1 to 4 illustrate how practical circuits employing series or shunt reactance elements are reduced to equivalent values for the purposes of the charts. Figs. 5 to 7 illustrate the use of the charts.

The shunt inductance network shown in Fig. 1(a) may represent a choke or transformer coupled circuit. If a coupling capacitor is used, this chart can only be used provided the circuit values can be represented by real equivalent non-interacting networks. Otherwise the next data sheet in this series must be used. For all cases the following data sheet is generally more direct where two reactances of opposite kinds contribute toward the same cut-off direction.

To apply these charts to iron-cored components, it is essential that the inductance can be approximated within limits as to constant value. Components in which the core has an air-gap usually fulfil this condition. A later data sheet provides for cases where this approximation does not hold. In applying the network of Fig. 1(a) to transformer coupling it is necessary to refer the resistance elements of the network to the same winding of the transformer, generally the primary circuit. If the transformer has a step-up ratio of $n/1$, the resistance across the secondary winding must be divided by n^2 to obtain the value of R . Any iron losses in the transformer should also be included in computing the value of R . The reciprocal

time constant $\frac{rR}{(r+R)L}$ gives the value of k required to find the correct response characteristic on Chart I.

The network of Fig. 2 is directly applicable to resistance capacitance coupling circuits. It may also be used for partial representation of choke capacitance coupling, provided the values can be represented by equivalent non-interacting elements having real constants. The reciprocal

time constant $\frac{1}{(r+R)C}$ gives the required value of k .

The network of Fig. 3 can be used for resistance capacitance coupling networks, and also for transformer coupled arrangements, provided leakage inductance is either sufficiently small to have negligible effect within the range, or gives a time constant sufficiently different from that due to the resistance capacitance combination so that the circuit may be represented by equivalent non-interacting elements having real time constants. The time

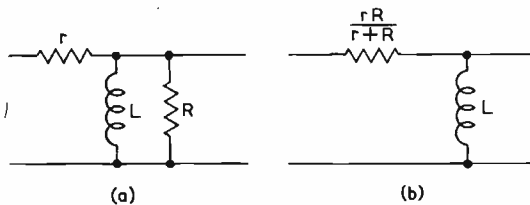

Fig. 1. Equivalent circuit for low frequency cut-off, using shunt inductance

$$k = \frac{rR}{(r+R)L}$$

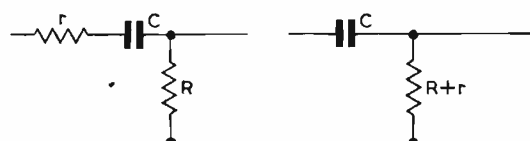

Fig. 2. Equivalent circuit for low frequency cut-off using series capacitance

$$k = \frac{1}{(r+R)C}$$

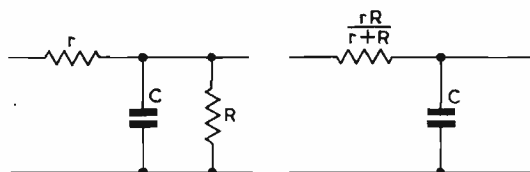

Fig. 3. Equivalent circuit for high frequency cut-off, using shunt capacitance

$$k = \frac{rR}{r+R}$$

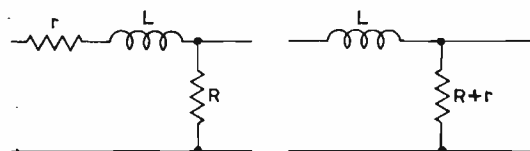

Fig. 4. Equivalent circuit for high frequency cut-off using series inductance

$$k = \frac{L}{r+R}$$

All circuits have a high frequency cut-off, and most have a low frequency cut-off, although some circuits employ d.c. coupling, extending the response down to zero frequency. For the use of the present charts it is assumed that only one cut-off characteristic contributes to the response at any one frequency within the pass range, or that there is no interaction between the reactance elements responsible for each cut-off, or alternatively that it is possible to represent the circuit by an equivalent employing real non-interacting values.

Separate non-interacting, or equivalent non-interacting networks employing one reactance element producing cut-off of the same or opposite type can be treated by

constant for use with the chart is $\frac{rRC}{r+R}$. For transformer coupled arrangements, all elements must be referred to the same winding.

The network of Fig. 4 is applicable where leakage inductance has the predominant effect. This is generally the case in power output circuits in which the impedances are low. The time constant for use with the chart is

$$\frac{L}{r+R}$$

Equivalent Non-interacting Networks

Where two reactances are present in the same network in such a way that their effect cannot be treated separately, it is sometimes possible to reduce the circuit to an equivalent in which the effects can be treated separately, as if there were two networks separated by some unidirectional device such as an ideal thermionic valve. It is only necessary to know the time constants, or reciprocal time constants, of the equivalent non-interacting networks, to be able to apply the present charts for predicting the response.

In any network where the two reactances are of the same kind, either inductance or capacitance, the equivalent non-interacting constants can be found by drawing equivalent non-interacting networks, multiplying the

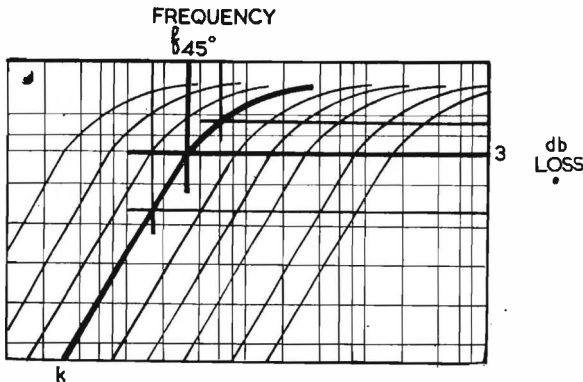

Fig. 5. Illustrating the use of Chart 1

attenuation factors, and equating the real and imaginary parts of the two expressions. Sometimes one expression will include a fixed attenuation factor not in the other, in which case the solution is found by equating the ratio of the real parts to the ratio of the imaginary parts. There will always be a real solution where both reactances are of the same kind.

Different reactances may be combined in a network in one of two ways: They may produce ultimate cut-off characteristics of opposite type, one high frequency and one low, in which case the circuit can be reduced to some form of tuned circuit; or they may contribute towards the same type of cut-off either high or low frequency. In the former, provided the Q of the equivalent tuned circuit is less than 2, it will be possible to reduce the arrangement to equivalent non-interacting networks of the types shown in either Figs. 1 and 3 or Figs. 2 and 4, and the appropriate constants may be found by removing a factor from one of the attenuation factors, usually the one obtained as the product of the non-interacting factors, such that the real parts are equal, and then equating terms in $j\omega$ and $1/j\omega$.

The other way of combining two reactances in a network may also be reduced to the form of a tuned circuit, but both reactances contribute toward the same type of ultimate cut-off, although there may be a peak in the vicinity of cut-off. Circuit values resulting in a peak, or

any case where the response at the frequency found by projecting the ultimate 12db per octave slope up to intersect with the zero line is above -6db, will not reduce to equivalent non-interacting networks having real constants. All cases of two reactance networks in this group are treated in the next data sheet of this series.

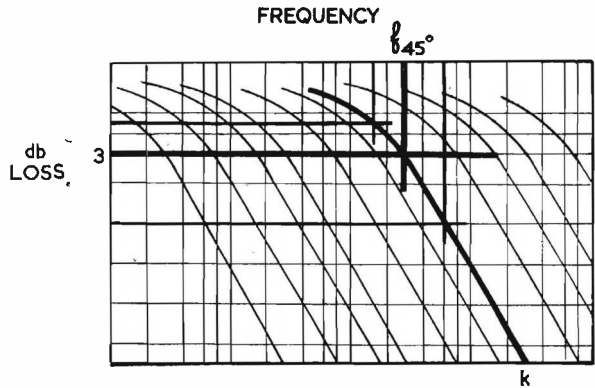

Fig. 6. Illustrating the use of Chart 2

Use of Charts

On the two charts giving the amplitude characteristics, the curve against the appropriate k value, found as indicated in Figs. 1 to 4, will give the complete frequency response, decibels against frequency.

Chart 2, giving high frequency cut-off characteristics, can also be used to give an approximate response curve of a high Q tuned circuit in the vicinity of resonance, provided that the frequency of deviation from resonance is a small fraction of the actual frequency. The chart will give decibel loss from the response at peak against detune frequency, if k is taken as,

$$k = Q/\pi f_c$$

where f_c is the operating or carrier frequency.

The phase response is obtained from the third chart, the reference frequency being obtained from the amplitude response chart. The 3db point on the amplitude characteristic gives the frequency for the 45° point on the phase response. When the high frequency cut-off curves are used to approximate the response of a high Q circuit, the phase response will be approximated referred to the phase transfer angle at peak frequency, usually approximately 90°. The relative phase will be leading for frequencies below resonance and lagging for those above resonance.

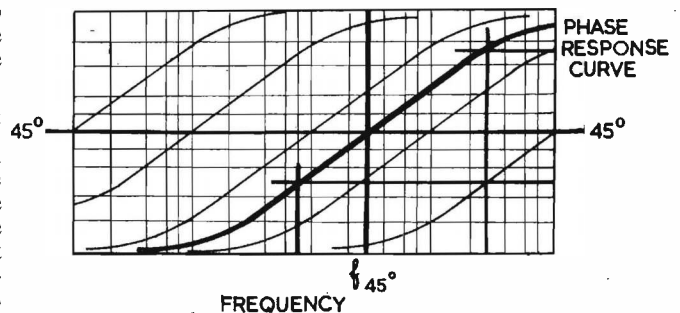

Fig. 7. Illustrating the use of Chart 3

Example 1

Circuit of Fig. 1: $r = 20k\Omega$, $R = 75k\Omega$, $L = 35H$.

From the formula, $k = 450$; Referring to Chart 1, this gives the following points:

17db,	10c/s	4.8db,	50c/s	• 1db,	145c/s
11.3db,	20c/s	3.8db,	60c/s	0.2db,	320c/s
8.3db,	30c/s	2db,	93c/s	0.05db,	600c/s
6.25db,	40c/s				

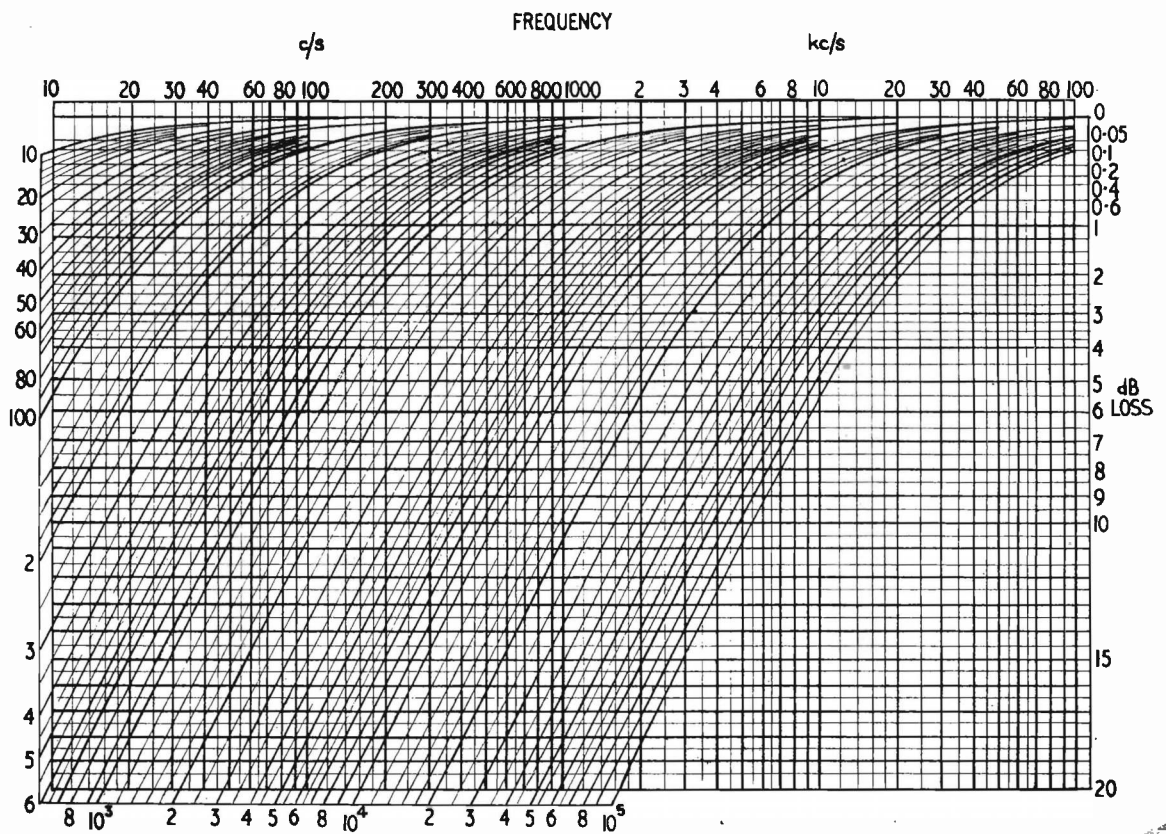
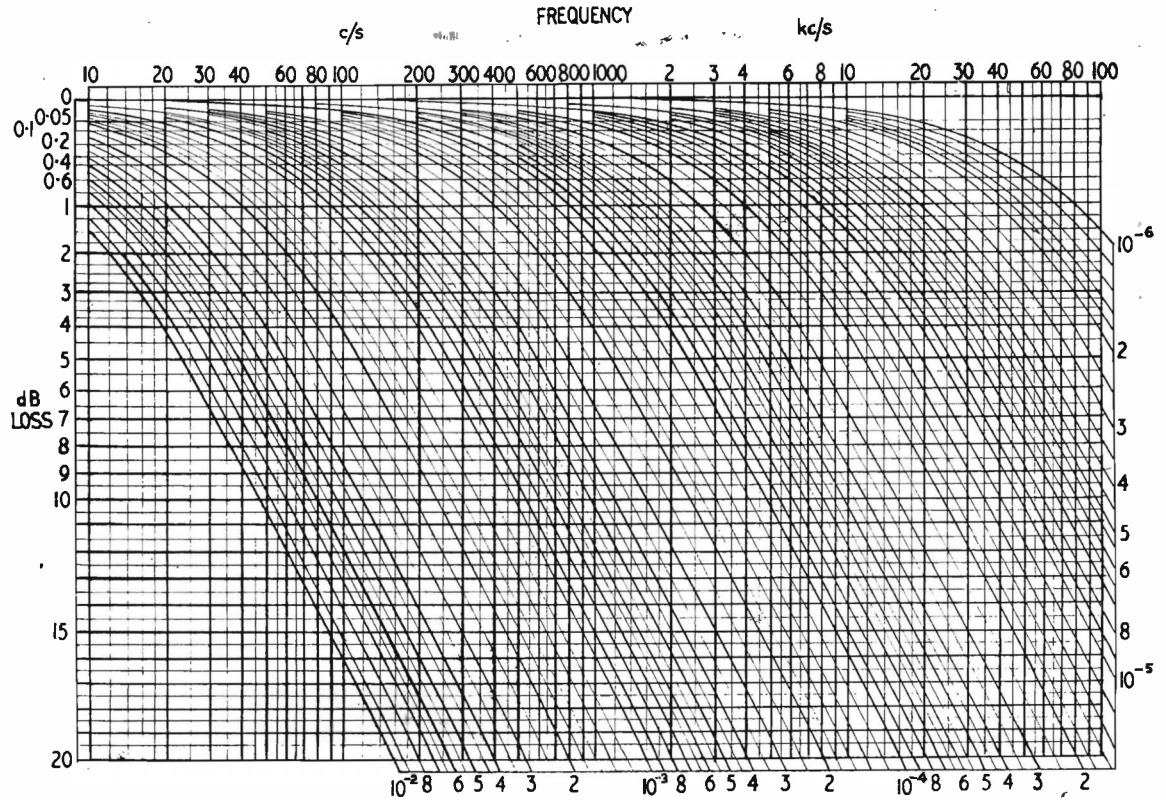

Chart 1. Low frequency cut-off

Chart 2. High frequency cut-off



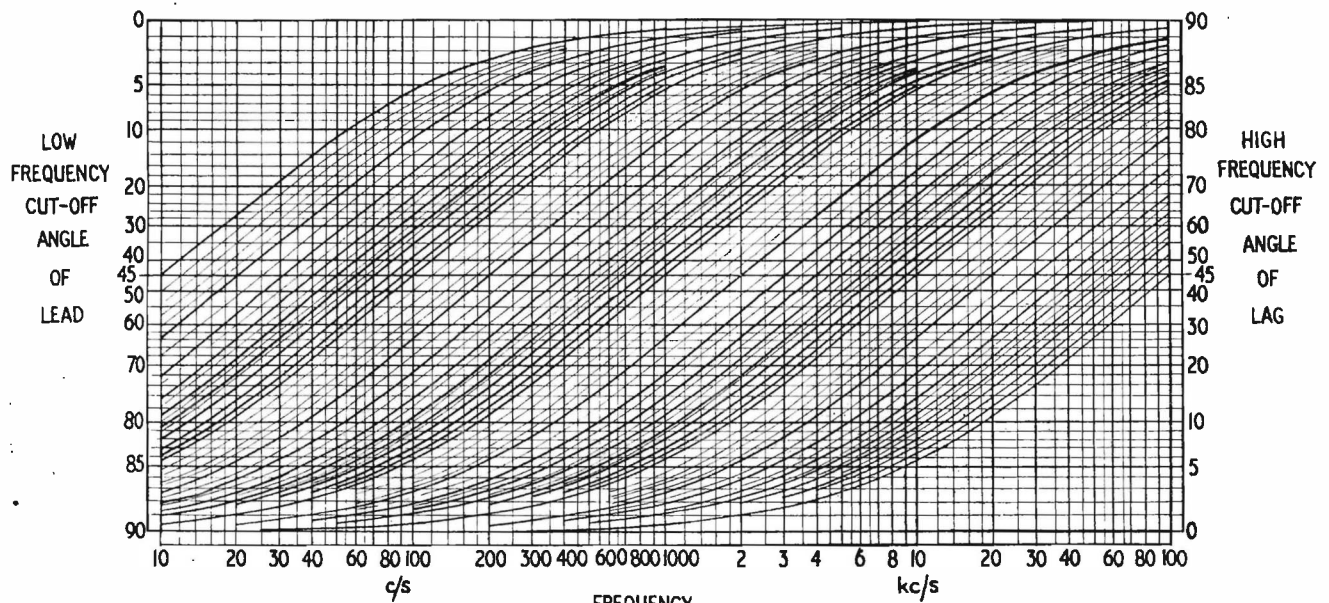

Chart 3. Frequency-phase

Referring the 3db frequency to the phase chart, the following phase angles are obtained:

82°, 10c/s	50°, 60c/s	20°, 200c/s
74.5°, 20c/s	40°, 85c/s	10°, 400c/s
68°, 30c/s	30°, 128c/s	5°, 780c/s
60°, 42c/s		

Example 2

Circuit of Fig. 2: $r = 7k\Omega$, $R = 30k\Omega$, $C = 0.06\mu F$.

By the formula, $k = \frac{1}{2,220 \times 10^{-6}} = 450$. Response as for Example 1.

Example 3

Circuit of Fig. 3: $r = 40k\Omega$, $R = 120k\Omega$, $C = 500pF$. Using the formula, $k = 1.5 \times 10^{-5}$; Referring to Chart 2: 3db point, 11kc/s, other points as follows:

0.05db, 1,250c/s	2db, 8,250c/s	11.6db, 40kc/s
0.2db, 2,400c/s	6.5db, 20kc/s	13.5db, 50kc/s
1db, 5,400c/s	9.4db, 30kc/s	19.2db, 100kc/s

Referring the 3db frequency to the phase chart, the following phase angles are obtained:

5°, 1,000c/s	40°, 9,200c/s	70°, 31kc/s
10°, 2,000c/s	50°, 13kc/s	80°, 60kc/s
20°, 4,000c/s	60°, 19kc/s	85°, 120kc/s
30°, 6,400c/s		

Example 4

Circuit of Fig. 4: $r = 5k\Omega$, $R = 15K\Omega$, $L = 0.3H$.

By the formula, $k = 1.5 \times 10^{-5}$. Response as for Example 3.

Example 5

Circuit tuned to 1Mc/s, $Q = 50$. By formula, $k = 1.6 \times 10^{-5}$. Response curve similar to that in Examples 3 and 4, but with 3db point at 10kc/s.

Making a Television Receiver Display its own Response Curve*

THERE are many excellent wobulator oscillograph equipments available for testing response curves of television receivers but it is possible by means of comparatively simple apparatus to make the television receiver display its own response curve.

Basically, we require to plot in Cartesian co-ordinates two variables, one being the test frequency and the other the response of the apparatus at the test frequency. If we modulate the test oscillator by the frame frequency time-base of the receiver, then the frame scan of the receiver will provide one co-ordinate for the display. All we have to do now is to develop the other co-ordinate. It would be inconvenient to modulate the amplitude of the line scan so this scan is allowed to perform normally. Instead, the

cathode-ray beam is brightened at the time after the commencement of the scanning of each line which is proportional to the response of the receiver at that time. In this way a dot pattern representing the desired response curve is developed with the frequency axis vertical and the amplitude response horizontal.

The apparatus required consists of an oscillator capable of being frequency modulated by the frame scan of the receiver, and a device for generating a short (1μsec is suitable) brightening pulse for the cathode-ray tube of the receiver at the appropriate times during each line scan. This device may conveniently take the form of a two-valve trigger circuit, e.g., a cathode coupled pair with cross coupling between the anode of one valve and a grid of the other, which is driven on one grid by the line scanning waveform from the receiver and on the other grid by the response of the receiver to the oscillator frequency modulated by the frame scanning waveform of the receiver. A short circuited delay line in the anode of one of the valves of the pair will provide the desired short pulses for brightening the cathode-ray tube of the receiver at the appropriate times. Suitable circuits are shown in Patent Specification No. 633,081.

* Communication from E.M.I., Ltd.

Measuring Circuits Using Rectifiers

By E. H. W. Banner, M.Sc., M.I.E.E., F.Inst.P.

THE use of self-contained rectifier instruments is now common for many A.C. measurements, the particular applications being to audio and carrier frequencies, to low-power circuits where the greater consumption of the comparable A.C. instruments would upset the circuit conditions, and to lower current ranges than are practicable with moving-iron and other A.C. instruments. There is also a case in which the rectifier instrument is supreme: that is, the measurement of the mean value of the current, when this is required.

Rectifier instruments are commonly used indiscriminately for many A.C. measurements where a moving-iron instrument would not only be better electrically but also economically.

An indicating instrument of the moving-coil type used with a rectifier necessarily reads the mean value of the current; if then the R.M.S. value is required, as is almost always the case, a multiplying factor is necessary. In self-contained rectifier instruments this is taken care of in the calibration, but when external rectifiers are assembled with instruments the correct factor must be used to obtain R.M.S. readings. In both cases the ratio of the R.M.S. to mean reading implies a sinusoidal waveform, so that for non-sinusoidal waveforms a possibly serious error may

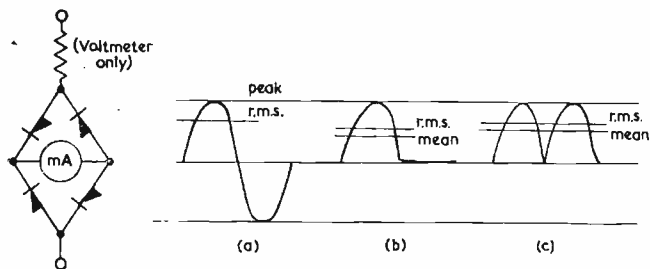

Fig. 1. Bridge circuit for full-wave rectifier; Resistor external to bridge for voltmeter

Fig. 2. Sine waves: (a) Full wave (b) half-wave rectified (c) full-wave rectified

battery, although there are now valves available with a very small requirement of heating power.

Metal rectifiers of the "barrier-layer" type are available for such measurements, both of copper-oxide and selenium. Generally single-element rectifiers are needed for these measurements, as will be seen from the Figures, whereas in self-contained rectifier instruments they are almost always four-element units in a bridge arrangement for full-wave measurements. Copper-oxide have the better characteristics.

Except for occasional measurements in low-power and low-voltage circuits a single element alone is insufficient, as in this case the full reverse voltage is applied to the rectifier every other half-cycle. Two such units back-to-back will therefore restrict the reverse voltage to that required for the indicating instrument, usually less than a volt. Where a single rectifier unit is used the indicating instrument will, of course, only read one-half of the wave, depending on the polarity of connexion of the rectifier in the circuit.

The special instrument rectifier units used for such instruments have a full-scale voltage drop of nearly one volt. For very low current ranges where the voltage drop across the movement may be very high then it will be necessary to add more rectifier units in series.

With the usual bridge connexion of four elements the

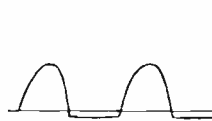

Fig. 3. Common imperfectly rectified waveform

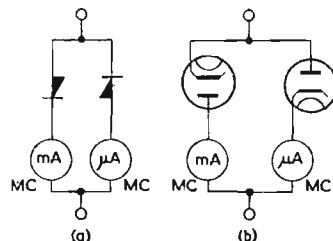

Fig. 4. (a) Metal rectifier circuit for measuring forward and reverse current in Fig. 3; (b) equivalent valve circuit

arise. This is the chief limitation to the use of rectifier instruments, apart from the extra cost, as it is usually more expensive than a moving-iron instrument of first-grade accuracy, for low frequencies.

In addition to the use of complete rectifier instruments it is sometimes very convenient to assemble separate rectifiers and moving-coil instruments for special measurements in the laboratory and some of the special uses will be discussed.

Types of Rectifier

Three general types of rectifier are available—thermionic or valve; metal or barrier-layer; crystal. The thermionic valve has the great advantage of very high ratio of reverse to forward resistance, being much higher than that of a metal rectifier. A necessary precaution is to choose a thermionic valve, usually a diode, or it may be a triode or other multi-electrode valve with anode and grids connected, with sufficient emission from the filament to deal with the greatest current to be measured. This also involves the actual operating condition of running the filament or heater at the correct voltage for this emission current. The drawback to this type of valve is, of course, the need for a filament or heater supply of current, either mains or

voltage is always restricted, with minimum effect on the circuit. In such bridges the indicating instrument should not be removed from the rectifier network and the rectifier energized. Fig. 1 shows this circuit: for the rectifier voltmeter all the series resistance is external to the rectifier network, and in this way any higher ranges are obtainable as easily as with a moving-coil instrument for D.C.

In the circuits shown a rectifier symbol means either type of rectifier as applicable, and with the above limitations borne in mind. In Fig. 4 only, both types of rectifier are shown for comparison.

The third type of rectifier is the crystal, although it was first in chronological sequence. The original crystal rectifier of pre-broadcasting days was somewhat uncertain in its action, but more recently crystal rectifiers have returned to modern practice, particularly for ultra-high frequencies.

Effect of Rectifier on Circuit

It has been stated above that due to the lower consumption of a rectifier instrument than that of any other A.C. instrument, except an electrostatic voltmeter, such instruments have application to A.C. circuits where the power taken from the circuit must be negligible: it should be zero for a true reading. This brings in a further complication,

however, as the rectifier does not have a constant resistance but one that varies considerably, depending on the current passing, being less as the current is increased. A measurement of the resistance of a rectifier by a bridge method is usually meaningless, as there is no one resistance.

The use of a rectifier voltmeter on a.c. mains usually causes no error, both on account of the high power-capacity of the mains and to the fact that the high series resistance of the voltmeter completely swamps the resistance change of the rectifier.

In a low-power circuit, such as is common in audio-frequency work, the addition of a variable resistance instrument may entirely alter the current in the main circuit, and as this alteration is not constant it cannot easily be taken into account.

The criterion is that for a voltmeter, the current consumption of the instrument should be as low as possible, leading to a high-resistance instrument acting as almost a pure resistance in the circuit. For current measurement the rectifier resistance characteristics, forward and reverse, should be as flat as possible, as well as having a very high ratio of reverse to forward resistance. The ratios between peak, R.M.S. and mean values can now be considered. Three common cases are taken, sinusoidal a.c.; half-wave rectified and full-wave rectified. They are drawn so that the peaks are the same in all cases. In the a.c. case the mean value is zero over a full cycle, but it is conventionally taken as twice that of the half-wave value, so that it is $2/\pi$ times the peak. Fig. 2 shows the above three cases, (a) is the a.c. case. The peak factor, or ratio of peak to R.M.S. is $\sqrt{2}$ or 1.414. (b) is the half-wave case where the R.M.S. and mean values are reduced as the current is effective for only one-half of the cycle. The peak factor is

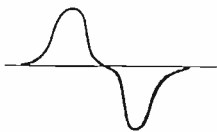

Fig. 5. Non sinusoidal waveform

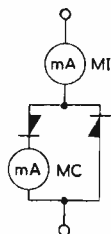

Fig. 6. Metal rectifier circuit to read (half) mean value, and R.M.S. as in Fig. 5

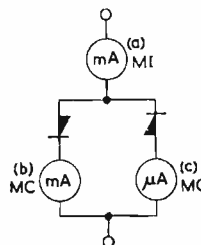

Fig. 7. Metal rectifier circuit to measure mean value of forward and reverse current, and R.M.S. value

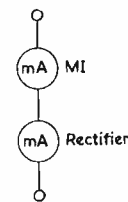

Fig. 8. Instruments to measure R.M.S. and mean value of an A.C. to obtain form-factor

now 2 and the form factor 1.57. (c) is the full-wave rectified case, with the peak factor $\sqrt{2}$ or 1.414 and the form factor 1.111.

Measurement of Nominally-unidirectional Waveforms

The perfectly rectified case of Fig. 2(b) does not usually obtain in practice and a small reverse current, as in Fig. 3 results. It is sometimes necessary to measure this small reverse current and by making use of one or other of these circuits this may be done. Two rectifier elements are required, connected back to back, each with a moving-coil instrument in series. For the forward current a higher range instrument will be required; in a given case it may well be that a milliammeter and a microammeter will be required for the forward and reverse current respectively.

For the most accurate results valve rectifiers are needed, in order that the ratio of resistances may be as high as possible. Fig. 4(a) and (b) shows the measuring circuit, with alternative rectifiers. The true mean current will be indicated for each half wave, although the reverse half wave is usually very distorted, being nearly flat on account of current limitation by the rectifier, if thermionic. Because of this the peak, R.M.S. and mean values will be nearly the same, for the reverse half-wave. The circuit also forms a test for balance of forward and reverse current, using similar range instruments for both halves.

Measurement of R.M.S. and mean value

Where the current is such that it can be read on an R.M.S. instrument, such as a moving-iron, then the current in a non-sinusoidal waveform which is symmetrical about its axis as in Fig. 5 can be read by the circuit of Fig. 6, where one-half of the rectified current is read on the moving-coil instrument as mean value and the total current is read on the moving-iron (or electrodynamic, etc.) instrument as R.M.S. value. The ratio of the two, the form factor, is therefore determined. Similarly the circuit may be combined with that of Fig. 4 to measure mean values of forward and reverse current, where they differ, and also R.M.S. current in the complete wave. In Fig. 7 the various instruments read: (a) total R.M.S. current; (b) half mean forward current; (c) half mean reverse current. It is true that full-wave and half-wave currents are not directly comparable, but circuits such as these do give valuable information of a quantitative nature that is not obtainable by other means, oscillographic methods being largely qualitative.

Instead of the two rectifiers shown in Figs. 4, 6 and 7 with a milliammeter (or microammeter) reading half the current, an ordinary self-contained (full-wave) rectifier instrument may be used, this reading full line current, but its reading has to be divided by 1.111 if the mean current is required as it is calibrated in R.M.S. units, although actually measuring true mean current.

A very simple and rapid test for waveform can be carried out by the simultaneous use of an R.M.S. instrument, and a mean instrument (Fig. 8). The former may be a moving-iron, electrodynamic, induction or thermal and the latter a rectifier and moving-coil type; both are connected

in series. Within the limits of accuracy of each instrument a departure from sinusoidal waveform can be determined to the same order; a sine wave having no harmonic effect on the R.M.S. instrument to cause error, whereas any distortion will cause a waveform error which is not taken up by the calibration of the rectifier instrument. On the other hand the R.M.S. instrument will read the true R.M.S. value independently of any waveform departure from sinusoidal.

Perhaps it may be pointed out here that both the moving-iron and electrodynamic types are reasonably good on poor waveforms and low frequencies, as is also to a less extent the induction instrument of modern first-grade design and performance. But for complete independence of waveform and a very wide frequency range then one of the thermal types is essential; both the older hot-wire and the more modern thermo-E.M.F. types are equally good in this respect, although the latter has a better performance in general, especially overload capacity, but neither is really robust and should not be used where another type will do. In general thermal instruments should be restricted to high frequencies and poor waveforms.

It is of interest to recall that in one respect the instrument engineer is a pessimist as he is upset at measuring poor waveforms, but the radio engineer is an optimist as he calls such waveforms "rich in harmonics."

Voltage Measurements

Although only current measurements have been dealt with in detail above, most of the considerations apply also to voltage measurements. Generally current waveforms are more liable to distortion by the measuring circuit as often a voltage is generated or induced as an R.M.S. voltage and then subsequent waveform distorting units, such as partially-saturated iron-cored elements lead to current waveform distortion.

For a first-order check of voltage waveform the use of two different types of instrument is applicable, except for the shunt connexion of the instrument in the circuit instead of in series. The author well remembers a case where a

rectifier voltmeter was suspected of being very inaccurate; it was used to measure the filament voltage on the secondary of a small transformer. A moving-iron voltmeter temporarily connected in parallel gave a different reading, but when both voltmeters were tested in parallel on a test-bench both read alike. The circuit discrepancy of 7 per cent was due to waveform error of the transformer, which was of poor design with a non-sinusoidal secondary waveform, such as may commonly occur when economics limits the iron in the magnetic circuit. In this example the rectifier instrument could not be used, and this limitation should be borne in mind in the use of rectifier instruments.

Production of Short Pulses from a Simple LCR Circuit

by F. A. Benson,* M.Eng., A.M.I.E.E., M.I.R.E., and G. V. G. Lusher,* B.Eng.

IT is probably fairly well-known that a highly-damped oscillatory circuit may be used for the production of short pulses from a sudden voltage change. The purpose of this short note is to give some information on the type of pulse which can be obtained using the simple circuit shown in Fig. 1. A positive-going voltage change is

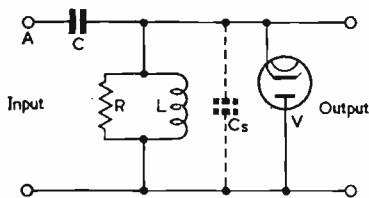

Fig. 1. Circuit for position voltage charge

applied through a capacitor C to a parallel circuit L , C_s , and R with a diode V across it. C_s represents the sum of the anode-cathode capacitance of the diode and the self capacitance of the coil L .

Explanation of the Circuit Action

The positive-going voltage applied at the point A, "kicks" the oscillatory circuit L , C_s and R into oscillation. If the diode and damping resistor R are disconnected, the waveform shown in Fig. 2(a) is obtained. With the insertion of the damping resistor R the wave is reduced in time, but is still oscillatory as illustrated by Fig. 2(b); and with the diode connected, the unwanted negative portion is nearly removed. This is shown in Fig. 2(c).

The effects of varying the coil inductance and changing the value of the damping resistor are illustrated in Fig. 3. With the damping resistor R constant at 3,000 ohms, and the input voltage change supplied from a multivibrator giving an output of 20 volts amplitude at a frequency of 6.5kc/s, the results obtained using a diode type EA50 may be summarized as follows:—

Fig. 3	Coil Inductance (μH)	Time of Rise (μSec)	Amplitude of Pulse (volts)
(a)	400	0.8	1.60
(b)	180	0.6	1.35
(c)	33	0.5	0.30

The damping resistor is most effective between the range of 3,000 to 150 ohms, and Fig. 3(d) shows the effect on pulse (c) of reducing the damping resistor from 3,000 ohms down to 2,000 ohms.

The waveforms of Fig. 2 were obtained with a $250\mu\text{H}$ coil and a damping resistor of 2,000 ohms. In this case a

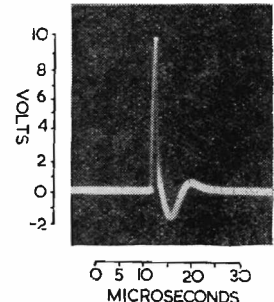
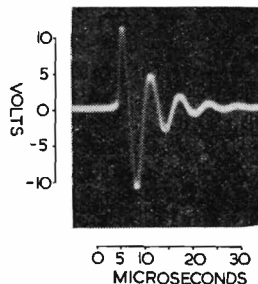
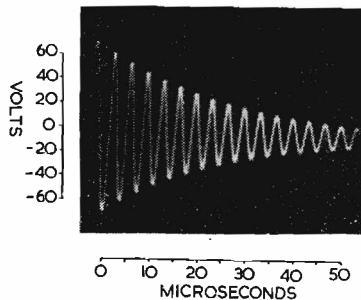
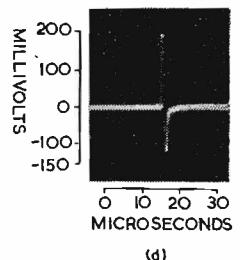
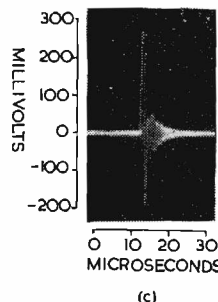
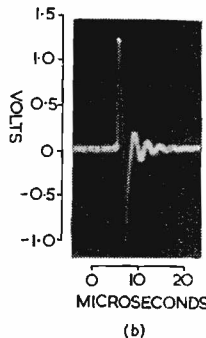
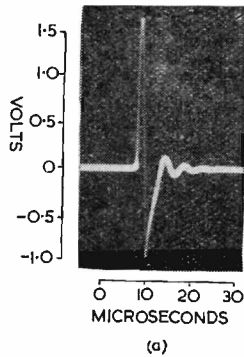

Fig. 2. Typical waveforms showing effect of disconnecting damping resistor and/or diode

Fig. 3. Waveforms showing the effect of varying the coil inductance L and the damping resistor R



* University of Sheffield.

pulse having an amplitude of approximately 10 volts, a time of rise of 0.7 microsecond and a width of 2 microseconds, was obtained using a positive-voltage source from a multivibrator at a frequency of 6.5kc/s and approximately 60 volts amplitude.

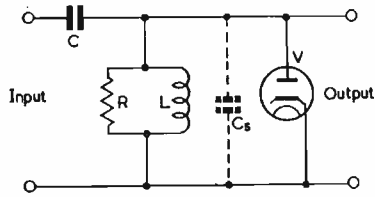

Fig. 4(a). Circuit for negative voltage charge

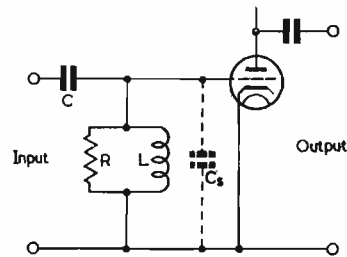

Fig. 4(b). Circuit for negative voltage charge using a triode

Conclusions

The simple circuits shown give short pulses, not easily obtained from "clipping" and differentiating circuits. Pulses with amplitudes from a few hundred millivolts to about 10 volts and time of rise from 0.5 to 0.8 microsecond

are conveniently produced by the simple circuit of Fig. 1. If a negative pulse is required, a negative-going voltage change is used, with the diode connected as shown in Fig. 4(a). If added amplification is required, use can be

made of a triode (Fig. 4(b)). In this case C_s is the sum of the grid-cathode capacitance and the stray capacitance of the coil L . The grid-current effects are the same as those produced by the diode current in Fig. 1 and 4(a).

A Simple Method of Making the Anode Connexion in Cathode-Ray Tubes*

IN cathode-ray tubes which are designed for high potential working, it is normal to bring the anode lead out through the bulb rather than through the pinch, since the latter carries all the other comparatively low potential, leads.

Although a number of methods of bringing out this lead are in use, most of them are more complicated than is necessary, since the current to be carried is rarely in

ing seal is perfectly vacuum-tight, while the platinum film remains intact and forms an electrically conductive path from the inside to the outside of the bulb. If the interior of the bulb is now coated with an electrically conductive substance, such as evaporated aluminium or graphite, contact is made between this and the platinum film. External contact to the film can be obtained by placing a metal cap, filled with a conductive bakelite paste, over the protruding end of the glass rod (Fig. 1(c)). Although the platinum film may have a coefficient of expansion which differs from that of the glass, and this is particularly marked in the case of boro-silicate glasses, there is

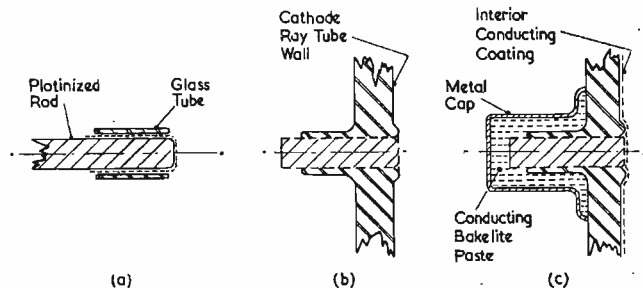

Fig. 1. Method of making anode connexion. (Broken lines represent platinized surfaces)

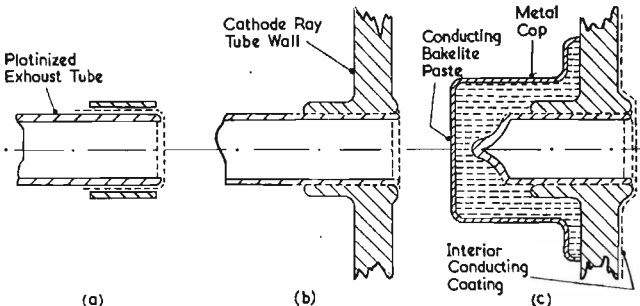

Fig. 2. Anode connexion combined with exhaust tabulation

excess of 1 milliampere. Almost invariably, the conducting element, which forms the vacuum seal to the glass bulb, consists of a wire of an appropriate material, for example, tungsten for the harder borosilicate glasses, Kovar for the softer glasses which are designed to seal to this metal, and Dumet or platinum for the soft lead or soda lime glasses.

There is, however, another, and more simple method, which is not so widely known, of effecting contact through the glass. Essentially, this consists of the use of a platinum-coated glass rod and a typical application of this method is described below.

A glass rod, a few millimetres in diameter, is coated with one of the well-known platinum paints, such as Hanovia No. 1, which may be applied by dipping, painting or spraying. The rod is then fired at about 700° C. This forms the paint into a film of metallic platinum which has good electrical conductivity. A small glass tube is then placed over the platinum film and fused to it (Fig. 1(a)). The assembled rod and tube are then fused through the wall of the cathode-ray tube bulb (Fig. 1(b)). The result-

no danger of cracking the glass as, owing to the thinness of the platinum film, it will yield to any stresses which are set up.

In making television tubes, it is usual to provide a tubulation through which the tube is exhausted. A further economy can be made by combining this with the anode lead-out. This can be effected in the following manner:

The glass tube, which is to form the exhaust tubulation, is coated with platinum paint and fired. It is then covered with a glass sleeve which is fused to it (Fig. 2(a)). The complete tubulation is sealed into position through the wall of the cathode ray tube bulb (Fig. 2(b)) and, after pumping, the tubulation is sealed off in the usual way. The exhaust pip is covered with a suitable metal cap which is filled with an electrically conductive bakelite paste (Fig. 2(c)). By this means, electrical contact to the interior of the bulb is obtained, while the metal cap protects the exhaust pip.

In certain cases, particularly when the glass employed requires only a low temperature for the sealing operation, e.g., soft glass, it is possible to seal the metallized rod or tube to the envelope without using an intermediate glass sleeve.

* Communication from E.M.I. Engineering Development Ltd.

A Nomogram for Multivibrator Design

By W. R. Luckett

THE Abraham and Bloch astable multivibrator is probably the best known of all relaxation oscillators, and is of considerable importance since many other pulse circuits are derived from it and its general design data can be applied to most other types of multivibrator.

The general principles of operation are equally well known and are fully described elsewhere.

It is proposed to describe a practical method of multivibrator design, which is very rapid to apply and avoids repeated calculations when it is desired to assess the effect on the semi-period of component value changes within their tolerance limits, and of supply voltage changes.

Fig. 1 is to be taken as the basic circuit diagram and Fig. 2 gives the waveforms for the full period at the anode and grid of V_1 .

The equation for the semi-period $t_1 = \frac{R_{L2} \cdot r_{g2}}{R_{L2} + r_{a2}} + R_{g1} \cdot C_{g1} \cdot \log_e \frac{E_{HT} - e_{n1} + E_{g1}}{E_{BASE1} + E_{g1}}$ seconds

and similarly for $t_2 = \frac{R_{L1} \cdot r_{g1}}{R_{L1} + r_{a1}} + R_{g2} \cdot C_{g2} \cdot \log_e \frac{E_{HT} - e_{n2} + E_{g2}}{E_{BASE2} + E_{g2}}$ seconds

and $t_1 + t_2 = T$ the complete period.

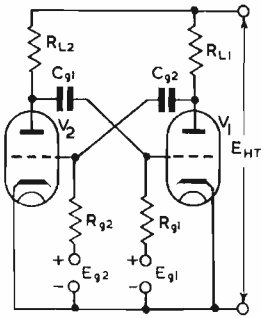

Fig. 1. Basic circuit diagram

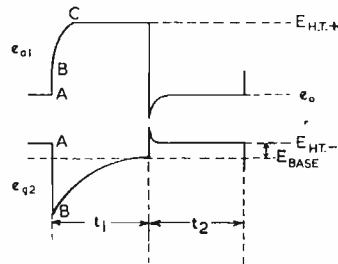

Fig. 2. Voltage waveforms at anode and grid of V_1 .

To simplify the design operation we may reduce to equation for t_1 and t_2 to

$$t_1 = R_{eq1} \cdot C_{g1} \cdot \log_e \cdot E_{eq1} \text{ seconds}$$

$$\text{and } t_2 = R_{eq2} \cdot C_{g2} \cdot \log_e \cdot E_{eq2} \text{ seconds}$$

The equations given above neglect the effect of stray circuit and valve capacitances, but has not been found a disadvantage since it is more normal only to calculate the approximate semi-periods, and provide some means of adjustment.

Design Procedure

Having decided on a value of E_{HT} and a valve type, an anode load line should be drawn on the anode characteristic curves, having a slope which will give the required output voltage, taking the grid excursion as being from zero to anode current cut-off.

It is now possible to calculate a value for E_{eq} . Referring to the nomogram, draw a line through this value of E_{eq} and the required semi-period, t , to the reference scale. Come back from this point on the reference scale to the scales of R_{eq} and C_g where a convenient combination of values may be chosen.

It should be observed that the value of E_{eq} is least affected by changes in e_0 and E_{BASE} when E_g is large.

The foregoing method of finding R_{eq} and C_g assumes

that C_g is fully charged at the commencement of the semi-period. Referring to Figs. 1 and 2, at the commencement of t_1 when e_{g1} starts to fall from A towards B, e_{a1} rises towards B.

The equivalent circuit is shown in Fig. 3(a), and it is assumed that C_g does not charge during this part of the semi-period.

When e_{a1} reaches B, $e_{g2} = E_{HT}$, and V_2 draws grid current, the equivalent circuit becoming that shown in Fig. 3(b), e_{a1} rising exponentially towards E_{HT} .

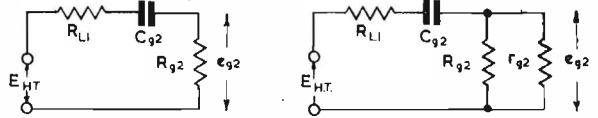

Fig. 3 (a and b) equivalent circuits

Thus C_g will charge to E_{HT} through $R_{L1} + \frac{R_{g2} \cdot r_{g2}}{R_{g2} + r_{g2}}$

and this must be completed in the duration of the semi-period t_1 .

When $T = RC$, it can be taken for most practical purposes that the charging current is zero when $T = 5RC$. Thus our equation for the rise time becomes

$$t_r = C_g \cdot \left(R_{L1} + \frac{R_{g2} \cdot r_{g2}}{R_{g2} + r_{g2}} \right) \cdot 5$$

Scales for t_r , C_g and $R_{L1} + \frac{R_{g2} \cdot r_{g2}}{R_{g2} + r_{g2}}$ are given in the nomogram and it is only necessary to draw a line through any two known factors to find the third unknown.

Fig. 4. The nomogram

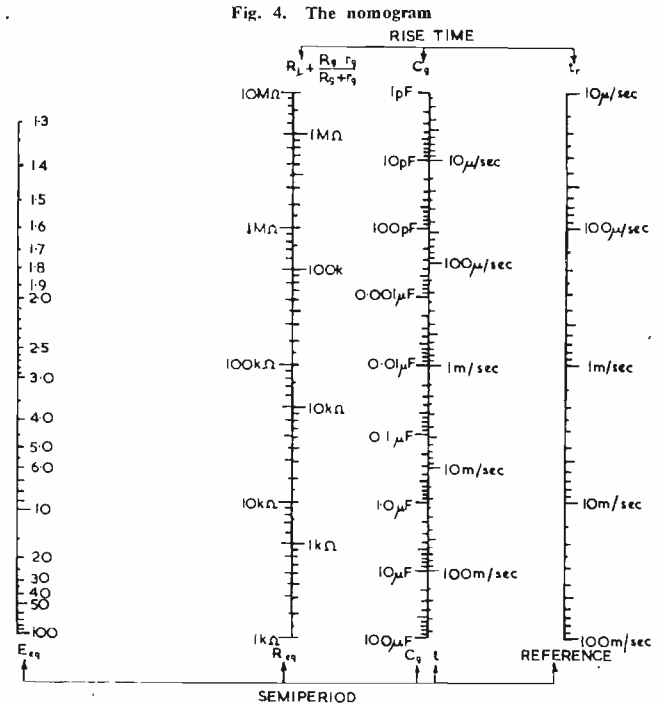

Example

It is required to design a multivibrator using a 6SN7 valve, with $E_{HT} = 300V$, to give a peak to peak output voltage of $200V$, t_1 to be $500\mu\text{sec}$, t_2 to be 1msec , t_1 to have a rise time of $50\mu\text{sec}$.

A $20k\Omega$ load line drawn on the anode characteristics of a 6SN7 with $E_{HT} = 300V$ gives $E_{HT} - e_0 = 210V$ and $E_{BASE} = 18V$.

In order to maintain long term time stability make E_{g1} and $E_{g2} = 300V$.

(Continued at foot of facing page)

Letters to the Editor

(We do not hold ourselves responsible for the opinions of our correspondents)

Electron Flash in Research

DEAR SIR.—I would like to challenge a statement in Mr. Long's letter in the July 1951 issue describing the effects of contact bounce in the primary circuit switching of an X-ray transformer. While I do not disagree with his final conclusions, I would point out that although large current surges will occur if the primary circuit is completed at an instant when the mains voltage is nearly zero, no voltage surges will appear in the windings from this cause. I suggest that the high transient voltages which have been found are the result of the interruption of the primary current during the re-opening phase of the contact bounce.

The primary current transient to which Mr. Long refers, is present during the period required to establish the normal phase relationship between current and voltage in the highly inductive primary circuit. Unless the primary circuit is completed at an instant when the current would have been zero even if steady state conditions had been established some time previously, a transient will occur. The time required for the current to settle down to its normal value will depend on the losses in the circuit since these affect the decrement of the transient component. During this period of abnormality the transformer is striving to raise its primary back E.M.F. up to its normal value by drawing a large current—the secondary induced E.M.F. which is proportional to the primary induced E.M.F. (i.e., back E.M.F.) will, in fact, tend to be below normal rather than excessively high.

Yours faithfully,
F. C. CONNELLY,
Welwyn Garden City, Herts.

The author replies:

DEAR SIR.—I would like to thank Mr. Connelly for the interest in my letter on the use of an electronic flash, published in the July issue of ELECTRONIC ENGINEERING.

I agree that it is the momentary interruption of the primary

current that gives rise to the high voltage surges in the secondary, plus the oscillation produced due to the valves V1, V2, V3 and V4, suffering from shock ionization and some cold emission.

Yours faithfully,
A. G. LONG,
London.

Electrical Computing

DEAR SIR.—In Part I of the series "Some Aspects of Electrical Computing" published in your June 1951 issue, Mr. J. Bell refers to mechanical methods of multiplication.

It is important to note that the method described by the author, i.e., utilizing a "ball and disk" mechanism, can only be regarded as a multiplying mechanism if the displacement (y) of the wheel or ball from the centre of the disk is a fixed quantity. The system shown in Fig. 2 of the article is essentially an integrator mechanism; for example, if x and y are continuously varying quantities, the rotation of the output shaft is:

$$Z = \int y dx$$

The system cannot be regarded, therefore, as equivalent to the electrical multiplier shown in Fig. 3. The usual method of obtaining the product (xy) using ball and disk mechanisms is to write:

$$xy \equiv \int y dx + \int x dy$$

and to represent this identity mechanically by using two ball and disk mechanisms and adding unit (i.e., mechanically differential).

Yours faithfully,
A. PORTER,
Head of Research Department,
Ferranti Electric Limited,
Canada.

The author replies:

DEAR SIR.—I was interested to receive Dr. Porter's letter regarding the use of the ball, disk and roller mechanism as

illustrated on Fig. 2 of my article on Electrical Computing.

I agree with the substance of Dr. Porter's letter, but I prefer to express in a slightly different way the statement regarding the setting of the quantity "Y" in Fig. 2. The mechanism does not multiply if the input "X" occurs before or at the same time as the input "Y". For correct multiplication "Y" must be set first and then "X".

The subsequent part of Dr. Porter's letter describing the utilization of two mechanisms as integrators in order to obtain the product, is correct in every respect but somewhat elaborate. It will be appreciated that the article was on electrical computing and the references to mechanical computing were necessarily restricted.

While the ball, disk and roller mechanism is regarded by Dr. Porter as an integrator, it can equally well be regarded as a differentiator. This could have been described in the section under "Rate of Speed Measurement" in Part I of the article or in the section on "Differentiation and Integration" in the second part of the article. It will be realized, however, that lack of space prevented undue elaboration.

Yours faithfully,
J. BELL,
Beckenham, Kent.

Photons and Electrons

DEAR SIR.—I would like to draw attention to an error in my review of Mr. K. H. Spring's book on "Photons and Electrons" on page 241 of the June issue of ELECTRONIC ENGINEERING. In this review I suggested the inclusion of a list of symbols. In fact, there is a complete and perfectly satisfactory list, together with the numerical values of the more important constants on Page 104, which I had unfortunately overlooked. I must apologize for this quite inexcusable mistake.

Yours faithfully,
J. H. FREMLIN,
Birmingham 15.

Make $R_{L1} = R_{L2}$ in which case

$$E_{CQ1} = E_{CQ2} = \frac{E_{HT} - e_a + E_v}{E_{BASE} + E_g} = \frac{510}{318} = 1.6$$

Determine the maximum value of C_{G1} that can be employed when $t_{r2} < t_2 = 1\text{msec}$.

If r_g is taken as $1k\Omega$

$$\frac{R_{G1} \cdot r_{G1}}{R_{G1} + r_{G1}} + R_{L2} \cong 21k\Omega$$

and referring to the nomogram scales for $t_r \cdot C_{G1} < 0.01\mu\text{F}$.

Applying known factors to the nomogram scales for t_r , one combination of values is

$$C_{G1} = 0.001\mu\text{F} \text{ and } R_{G1} = 1.0M\Omega$$

$\frac{R_L + R_a}{R_L \cdot R_a}$ is so small compared with R_v that it can be ignored and R_{CQ} becomes equal to R_g .

The rise time of t_1, t_{r1} , must be $50\mu\text{sec}$, so that taking

$$\frac{R_{G2} + r_{G2}}{R_{G2} \cdot r_{G2}} + R_{L1} \cong 21k\Omega \text{ and referring to the nomogram scales for } t_r \cdot C_{G2} = 470\text{pF}.$$

The value of $R_{CQ2} = R_{G2}$ can now be determined from the t_r scales, the nearest preferred value being $4.7M\Omega$.

$e_o = \text{Anode to } E_{HT} \text{ voltage when } e_v = E_{HT}$.

$E_{BASE} = G_1$ voltage required to give $I_a = 0$, with E.H.T. between anode and cathode

$$r_a = \frac{\delta e_a}{\delta i_a} \quad r_g = \frac{\delta e_g}{\delta i_g}$$

$$R_{CQ1} = \frac{R_{L1} + r_{G1}}{R_{L1} \cdot r_{G1}} + R_{G1} \quad R_{CQ2} = \frac{R_{L1} \cdot r_{a1}}{R_{L1} + r_{a1}} + R_{G2}$$

$$E_{CQ1} = \frac{E_{HT} - e_{o2} + E_{G1}}{E_{BASE1} + E_{G1}} \quad E_{CQ2} = \frac{E_{HT} - e_{o1} + E_{G2}}{E_{BASE2} + E_{G2}}$$

$$t_{r1} = \text{Rise time of } t_2 \quad t_{r2} = \text{Rise time of } t_1$$

ELECTRONIC EQUIPMENT

A description, compiled from information supplied by the manufacturers, of new components, accessories and test instruments.

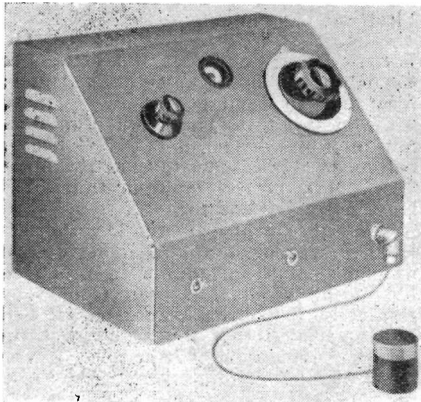

Paint Thickness Tester

(Illustrated above)

MESSRS. NASH AND THOMPSON, LTD. have designed a tester to measure the thickness of paint, enamel, and other non-conducting coatings on non-ferrous metal bases.

The range of the paint thickness tester is 0 to .06in. with a reading accuracy of about $\pm .0005$ in. The measurement is taken over a circular area of $\frac{1}{4}$ in. diameter and a flat area of at least $\frac{1}{4}$ in. diameter is necessary.

In operation the instrument is aligned on a sample of uncoated base metal. The calibrated dial is set to zero and the left hand dial rotated in a clockwise direction until the "magic-eye" closes. This should be done 5 minutes after the instrument has been switched on. The test head should then be placed on the coated surface and the calibrated dial rotated until the "magic-eye" again closes. By reference to a calibration chart the dial reading can be converted to film thickness. The same calibration curve may be used for all non-ferrous base metals.

The principle of operation of the instrument is the employment of the change in inductance of a small coil at 100kc/s when placed in the vicinity of a conducting plate as a measure of its separation from the plate. This separation is the film thickness. There are two identical oscillators, one containing a standard coil and the other the test head coil. The test head coil is placed on the base metal and the two oscillators set to the same frequency. When the test head is placed on the film surface its inductance alters, changing the frequency of the oscillator containing it. This frequency is then reset to the standard value by a variable capacitor, the change in value of which is a measure of film thickness.

**Nash and Thompson, Ltd.,
Oakcroft Road,
Tolworth, Surrey.**

Mullard Automatic Conductivity Controller

(Illustrated below)

A NEW conductivity controller, recently introduced by Mullard, Ltd., provides a convenient and sensitive method for controlling chemical or concentration changes in a wide variety of industrial processes.

The instrument employs a modified Wheatstone Bridge network, which is supplied by an internal oscillator, operating at a test frequency of 2.9kc/s, and electrical process control is effected by use of an amplifier and relay circuit which are incorporated. Arrangements are provided whereby a visual or aural warning may be given if the ionic concentration of the solution under control either rises or falls from a pre-determined value.

The conductance of the solution may be kept within specified limits by using the controller relay to add solute to the liquid required. In addition, the actual conductance at any time can be quite

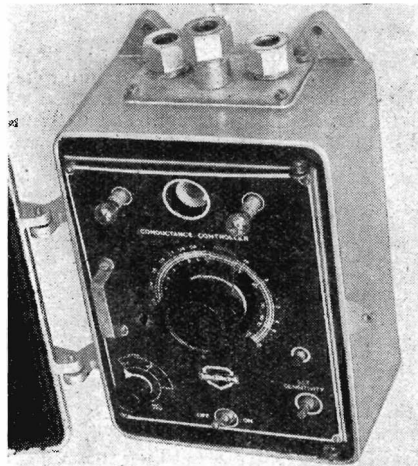

simply observed by means of a magic eye balance indicator and a direct reading bridge dial located on the front panel of the instrument.

The instrument dial is calibrated in micro-mhos and the readings must be multiplied by the cell constant to obtain the measurement of conductivity. An inner scale is also provided, reading from 1 to 100 parts per million of sodium chloride. When working on this range, it is necessary to use a special jacketed conductivity cell, which then makes temperature compensation automatic.

Used for conductance measurement or control, the instrument gives an accuracy of 3 per cent. For control applications in terms of parts per million of sodium chloride, the accuracy is 2 per cent, while as a comparator the instrument gives an accuracy of 2 per cent.

Single-pole, 250V 1A change-over contacts are brought out from the relay, and

are available for external use. The remaining pair of contacts are used for operating the two indicating lamps on the instrument panel.

The electrodes used for insertion into the liquid under test consist of two pieces of platinum foil fused into a rigid glass body. Flexible leads are brought out for connexion to the controller. Three types of cell are available, and can be supplied with either bright or platinum blacked electrodes.

**Mullard, Ltd.,
Century House,
Shaftesbury Avenue,
London, W.C.2.**

Television Signal Generator

(Illustrated below)

THE Waveform W.90 signal generator is a compact television signal source which provides a constant signal, modulated with the correct synchronizing and blanking pulses to enable quantitative measurements of the various stages of a receiver, or comparison between different receivers, to be made.

The R.F. generator provides a continuously variable signal over the television band of 40Mc/s to 70Mc/s. The output is controlled by an attenuator of 20db steps in conjunction with an R.F. control and calibrated meter, providing between 1 microvolt and 100 millivolts at a source impedance of 80 Ω . A higher output of approximately 500mV is available for multi-distribution.

Combined in the instrument is an independent R.F. oscillator with the same frequency range as the generator, which can be internally modulated with an audio tone of 400 cycles or externally modulated from a radio receiver or pick-up. The output is regulated by a separate R.F. control and then applied to the common step-attenuator enabling a combined sound and vision signal of predetermined strength to be available for injection into a receiver.

The video modulation is in accordance with the B.B.C. standards and includes horizontal and vertical blanking pulses and the correct synchronizing pulses. The ratio of sync to modulation is carefully maintained and the half line frame pulses and the front and back porches of the line pulses are included. The following patterns may be obtained via switches on the front panel: blank

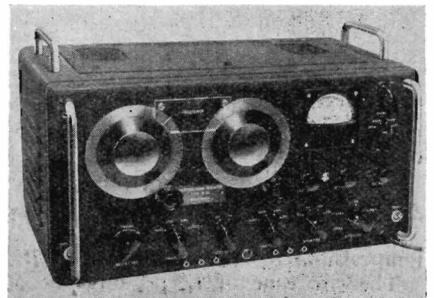

black raster for sync separator checking; blank white raster for interlace checks and hum or breakthrough checking; line modulated with 1 microsecond pulses for checking line linearity, V.F. response, ringing, etc.; line modulated with 0.5Mc/s, 1.5Mc/s and 2.5Mc/s bars for checking receiver bandwidth; a centre black bar to be inserted for checking linearity by the two halves method; frame modulated with a graded step waveform for contrast and V.F. stage checking (Gamma); frame modulated with wide black bars for checking L.F. response, or frame modulated with thin lines for checking frame linearity. Any of the line and frame patterns may be combined to produce a complex pattern, e.g. the third and eighth together provide a crosshatch pattern suitable for observing "pin cushion" and "barrel" distortion and the combined effect of non-linearity of line and frame.

The complete video waveform is available for V.F. checks and the complete sync waveform, line sync pulses and frame sync pulses are brought out separately. Line and frame blanking pulses can be brought out separately for use with flying spot scanners or monoscope tubes.

Waveforms, Ltd.,
26 Oakleigh Road,
New Southgate,
London, N.11.

Conductivity Recorder

(Illustrated below)

GEORGE KENT, LTD. have developed a circuit incorporating a resistance thermometer immersed in the flowing liquid for measuring the conductivity of boiler feed water, which gives



full automatic compensation without recourse to a reference cell. The resistance thermometer is subject to accurate control and it forms part of a circuit operated from A.C. mains. The scale law of the instrument is in conductance units, and is linear.

The makers claim that the compensation is highly accurate over the temperature range of 0° to 100°C. The temperature coefficient of conductivity is not constant over a range of industrial liquids, varying from 1½ to 3 per cent per °C, but the device is flexible and can be adjusted to suit all conditions. For boiler feed-water this circuit is used with a Kent P-type cell.

A number of conductivity cells, each working in a different solution, and each accurately compensated for the particu-

lar temperature coefficient concerned, may be connected to the same multi-point, multi-range recorder. The adjustment knobs for the temperature-compensation circuits are situated on the recorder, and the adjustments are quite simple to make.

George Kent, Ltd.,
Luton, Beds.

Germanium Crystal Rectifiers

(Illustrated below)

THE Westinghouse Brake and Signal Co. have introduced a wide range of germanium crystal rectifiers. These are of hermetically sealed ceramic construction, and are only one half inch long by

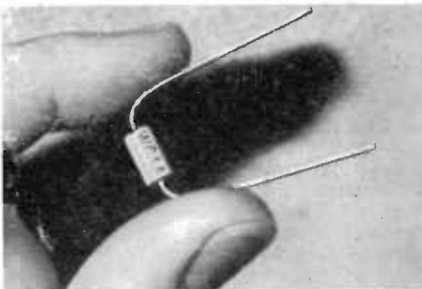

three sixteenths inch diameter. The range of types covers peak working voltages up to 100V and forward currents of 50mA.

These crystal rectifiers are suitable for detectors, limiters, instruments and general purposes, the self capacitance of all types being approximately 1pF.

Each crystal rectifier is mounted on a colour-coded card giving the rating particulars. A leaflet is available from Westinghouse showing which type to select for each of the sixteen applications for which these germanium crystal rectifiers are considered particularly suitable.

Westinghouse Brake and Signal Co., Ltd.,
82 York Way,
King's Cross,
London, N.1.

The Radar Kilovoltmeter

(Illustrated top right)

THE Radar Kilovoltmeter has been introduced to meet the need for an inexpensive instrument to measure the E.H.T. voltage applied to the anode of television cathode-ray tubes.

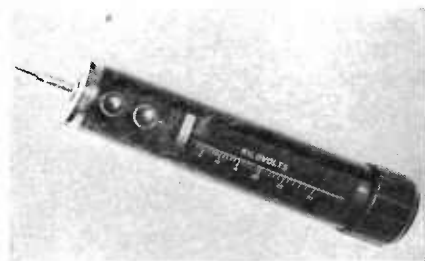

It has a single range of 3 to 30kV and features a scale which is substantially linear over a length of nearly 2½in.

The shape and dimensions of the Kilovoltmeter enables the voltage to be measured while the tube is still fixed in the receiver. No load is presented by the instrument at the correct setting.

The Kilovoltmeter consists essentially of a calibrated spark gap. In use the flexible lead is connected to the chassis of the receiver or power pack and the end prod is applied to the point to be measured. The spherical electrodes forming the gap are then screwed together until flash-over occurs. A slight turn of the control knob will cause the breakdown to cease and the voltage indicated on the scale may be read off.

Waveforms, Ltd.,
26 Oakleigh Road,
New Southgate,
London, N.11.

Zeva Electric Soldering Tools

(Illustrated bottom right)

Zeva electric soldering tools are made under a patented process of manufacture whereby the electric heating elements are hermetically sealed into the aluminium heads of the tools. It is claimed that these elements never need replacing.

The cut-away illustration shows a typical tool of the Zeva range. It features: metal covering to retain an even soldering temperature; an adjustable copper bit, with an eccentric pin for fixing it; a porcelain connector for the cable, and a porcelain pear to prevent strain on the heating element leads.

Several types of tool are available, with different shaped heads, in wattages ranging from 70 to 800.

Automatic Coil Winder and Electrical Equipment Co., Ltd.,
Winder House,
Douglas Street, London, S.W.1.

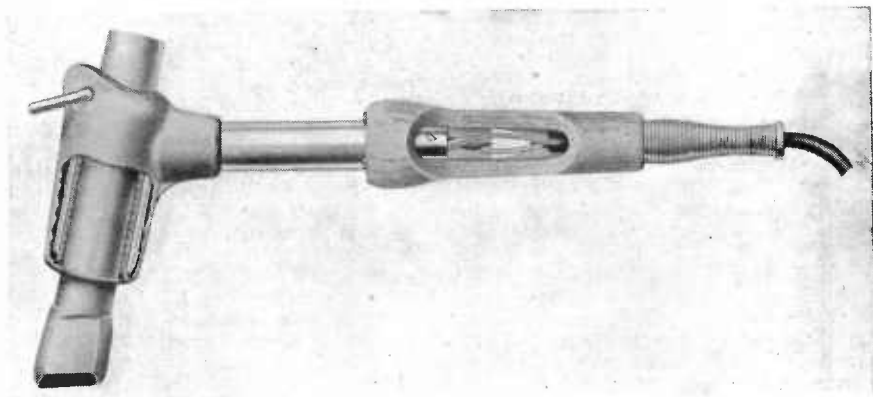

Radio Communication at Ultra-High Frequency

By J. Thomson. 1st Edition. 203 pp., 99 figures. Methuen and Co., Ltd. 1950. Price 21s. net.

THE use of ultra-high frequencies for communication purposes is a relatively new and rapidly developing branch of radio and is one that is likely to see important advances in the next few years, both for broadcasting and for point-to-point radio relay systems. For example, in Great Britain a radio relay link for television using frequencies of about 1,000Mc/s has been in operation between London and Birmingham during the past two years and another using frequencies of about 4,000Mc/s is under construction between Manchester and Edinburgh; in the U.S.A. a 4,000Mc/s system operating between New York and San Francisco, and comprising over 100 relay stations in tandem, is due to commence operation shortly. Consideration is also being given to the use of frequencies between 400 and 800Mc/s for television and sound broadcasting, and extensive trials are now in progress in America.

According to the definitions of the British Standards Institution the "ultra-high frequency" band is that between 300Mc/s and 3,000Mc/s (100cm. to 10cm. wavelength), the scope of this book is however somewhat broader and covers the band 100Mc/s to 10,000Mc/s.

The literature on U.H.F. techniques is at present mainly to be found in published papers in the technical Press and there is a real need for a textbook providing an introduction to these techniques in a form suitable for use by engineers, physicists and students. This book goes part of the way to filling the need but, as is inevitable in a rapidly developing art, there is an appreciable gap between the material presented and the techniques used in practice.

The book opens with a discussion of the use of resonant cavities and transmission lines as circuit elements; this section could, with advantage, have been expanded to include the use of such elements in wave-filters since these are important features in the more advanced communication systems.

The treatment of grounded grid triode valves and klystron oscillators and amplifiers in the next two chapters is very good, but the discussion of travelling-wave valves (p. 70-71) leaves much to be desired. The conductor on which the wave is propagated is "helical", not "toroidal"; it also said that such valves are noisy whereas in fact noise factors of 10 to 12db are obtained in the best travelling wave valves, which is about the same as in a good crystal mixer, at frequencies of the order of 3,000Mc/s.

Chapter IV (written by Mr. P. E. Trier) gives a satisfactory analytical treatment of the design of input circuits from the noise aspect, but does not give much information on the practical construction of circuits such as crystal mixers using coaxial lines or waveguides.

In Chapters V and VII techniques for modulating a carrier in amplitude, phase or frequency, or by pulses, are discussed and the various systems are compared in terms of the signal-to-noise ratio for a given transmitted power and bandwidth.

BOOK REVIEWS

However, one of the most important considerations in the design of a multi-channel communication system, i.e., crosstalk between channels, is not dealt with.

Carrier frequency stabilization is an essential feature of all communication systems in view of the need to economize in the use of the frequency spectrum, and a large part of Chapter VI is properly devoted to the use of crystal control techniques for this purpose. It is a little surprising however that more space was not given to the use of resonant cavities for frequency control, such as the Pound and Jenks discriminators since these are compact, simple and well adapted to U.H.F. systems.

Chapter VII on "Communication Systems" is the least satisfactory chapter in the book—much of it is taken up by inadequate discussions of "Propagation" and "Aerials"—neither of which goes far enough to be of real assistance to the system designer or even to the student, for example the only aerial depicted is a bi-conical horn.

Although this book has obvious limitations, it is at least a beginning to the work of presenting a full and properly co-ordinated account of the application of U.H.F. techniques to communication purposes, and for this this author is to be congratulated.

W. J. BRAY

The Theory and Design of Inductance Coils

By V. G. Welsby. 180+xii pp., 10 plates, 51 diagrams. Macdonald and Co. 1950. Price 18s.

COIL-DESIGN is often a matter of trial and error. This book performs a useful service in throwing a spot-light on the many diverse factors involved, and in indicating the most fruitful line of approach to a given problem whether the coil be air-cored or whether it be wound on laminated or powdered-iron cores. Incidentally, it seems a pity that Dr. Welsby has perpetuated the use of the term "dust cores." The distinction between dust and powder is important as cores made from dust (which describes material of a particle size much less than one micron in diameter) may easily have very high coercive forces making them useless in low-loss coils. Elsewhere the author is more happy in his choice of phraseology and his careful distinction (on p. 58) between "apparent permeability" and "inductance ratio" and his avoidance of the term "effective permeability" are particularly welcome.

Dr. Welsby is not always careful to state the scope of conditions for which his statements are valid. For example, on p. 108, equation 191, holds for low frequencies only, a fact which does not emerge until ten pages later. Also it is not made clear that a "double-hump" *O/f* curve is shown in Fig. 39 is the exception rather than the rule, and is only likely to occur with multi-layered coils.

Dr. Welsby is an acknowledged expert in the field of inductances for use in the telephone industry. One wishes that the title had some reference to the fact that the book itself is largely restricted to this sphere of interest. The specialized problems involved in radio-coil design receive only small attention, and the subjects of coupled coils and adjustable inductances are omitted. A reference to Grover's "Inductance Calculations" would have been appropriate.

Apart from these limitations the book is to be recommended as a very useful contribution to the subject of coil-design. Chapter X, on graphical aids, and Chapter XIII, which contains numerical examples are especially helpful.

P. R. BARDELL

Elektromaschinen, Band I (Electrical Machines, volume I)

By Dr. Kurt Seidl. XII—180 pp. with 96 illustrations and 9 tables. Franz Deuticke, Vienna. 1951. Price £1 10s. 10d.

ALTHOUGH there exist quite a few textbooks on electrical machinery this will be welcomed by students able to read a German text, as it is at the same time comprehensive and concise and is written from a modern point of view. The M.K.S. system of units is used. In an appendix the equations for oscillations are derived as these are useful for forming technical notions and allow of treating the system of fundamental technical laws on a common mathematical basis. Mechanical-acoustical, electro-magnetic-optical and thermic phenomena can thus be brought into mutual relation and the analogies existing between them can be made apparent. Extensive tables serve for showing these relations. This first volume deals only with fundamentals, with transformers and with asynchronous machines. Perhaps the subtitle of the book: "Textbook for technical colleges, technical and general universities" is somewhat misleading for British readers, as they are accustomed to find in a textbook examples of problems to be solved by the student which are of such a high educational value. For the circle diagram of the induction motor two derivations are given, while no mention is made of the circle diagram of transformers. The book is well produced.

R. NEUMANN

Electronic Applications

By Henry A. Miller. 110 pp., 48 diagrams, 21 plates. E. and F. N. Spon Ltd. 1951. Price 18s.

WHEN an author is limited in the number of pages, diagrams and plates which he may use, he must be particularly careful in his choice of subject matter and avoid using diagrams or photographs which convey no useful information. The book falls short in both these respects.

The first chapter attempts to cover the subject of electron tubes including diodes,

triodes, tetrodes, gas filled triodes, ignitrons, photo electric cells, cathode-ray tubes and X-ray tubes in twelve pages and the treatment is quite inadequate.

Chapter 2 on "Electronic Motor Control" and Chapter 3 on "Regulating and Counting" both illustrate the broad principles very well and contain some useful applications.

It is not clear why high frequency induction heating and dielectric heating are relegated to Chapter 9 headed "Miscellaneous Applications of Electron Tubes." The subject is sufficiently important to merit a chapter to itself, although the author has done well in the four pages he has allowed himself. Ultrasonic control receives even less space and is dealt with in half a page, but no mention is made of the Hughes Ultrasonic Flaw Detector which is widely used in this country on a commercial basis.

The author has devoted Chapter 7 (20 pp.) to Radio, Radio Control, Radar and Television, and would have been well advised to omit these subjects altogether. Nowadays they are classed under the heading of Telecommunications and are not usually considered as coming within the accepted field of electronic applications.

In his preface the author states that the book "is intended to appeal to students, engineers and everyone concerned with modern scientific and industrial development." The student will look in vain for an explanation of fundamentals and the expert will be annoyed by the many misleading statements such as that on page 70 where the author, speaking of waveguides, says "These consist essentially of parallel wires definitely spaced."

This book attempts to deal with a vast subject in the space of one hundred and ten pages and, in the opinion of the reviewer, it fails to achieve its purpose.

L. I. FARREN

Vacuum-tube Voltmeters

By John F. Rider. 2nd Edition. 422 pp., 215 illustrations. John F. Rider Publisher, Inc. 1951. Price \$4.50.

THIS is the second edition of a book first published in 1941. It describes in what might be termed a popular style most of the circuits which can be used in constructing valve voltmeters. None of the circuits is examined in detail and very few mathematical expressions are used in the text.

The first chapter describes the fundamental features of measuring instruments and explains the difference between peak, R.M.S. and average readings. The next two deal with diode and triode valve voltmeters respectively, and the following chapter is devoted to rectifier-amplifier instruments. After a discussion of tuned valve voltmeters, the book proceeds to amplifier-rectifier and slide-back circuits. The measurement of steady voltages, current and resistance by valve voltmeters is followed by descriptions of various types of R.F. and D.C. probes. Further chapters on the design and construction of valve voltmeters are followed by the methods used in their calibration, testing and practical applica-

tions. Each chapter closes with a few questions relevant to the preceding material.

The remainder of the book (136 pages) is occupied by circuit diagrams of commercial (American) valve voltmeters and verbatim copies of the manufacturers' instructions for their maintenance and repair. The circuit diagrams in this section illustrate most convincingly the need for standardization in drawing-office practice because the 48 drawings contain many needless variations in valve symbols. Moreover the clarity of the diagrams is impaired by the use of widely different layouts for similar types of circuits. The book ends with an extensive bibliography of valve voltmeter literature.

There are a number of errors. For example on p. 240 it is stated that the probe in Fig. 12-7 is subject to a considerable steady potential but the diagram in question shows the probe connected between the control grid of an R.F. amplifier and earth, and there is no steady potential. In calculating the input impedance of a diode detector on p. 186 (one of the few examples of the use of mathematics) the author omits to take into account the conduction current of the diode, usually the predominant factor. He does, however, allow for the shunting effect of a resistor which is not included in the detector circuit but is associated with a second diode used for balancing purposes.

In conclusion, it may be said that the book provides an extensive survey of the valve voltmeters in commercial use and should prove useful to readers as long as they do not wish for detailed treatment of individual types of circuit.

S. W. AMOS

Fundamentals of Automatic Control

By G. H. Farrington, B.Sc., A.C.G.I. 1st Edition. 285 pp. 169 figures. Chapman and Hall Ltd. 1951. Price 30s.

THIS book contains a thorough analysis of the fundamentals underlying the application of "process control," it does not deal in any detail with servo mechanisms as such.

The treatment, while mathematical, is accompanied by descriptive matter and analogies so that a reasonably wide section of the engineering profession can benefit from perusal of it. A chemist without some knowledge of electrical theory would not get very far, but an electrical engineer with some mathematical ability having once mastered the definitions contained in the first two chapters and thus reorientated his thinking in terms of process control will be able to digest the subsequent material.

The fundamental difficulty of isolating the functions of any one operator in a closed loop is seen in the author's references on page 4 to a measuring instrument in such a loop. This measuring instrument is used to detect the state (for example, the temperature) of the object being controlled and the output of the instrument causes the process to be modified to achieve the desired state.

The output of the instrument is called by the author the "measured value", and he says "It should be fully recognized that it is the measured value which

CHAPMAN & HALL

Just Published

ENCYCLOPEDIA ON CATHODE-RAY OSCILLOSCOPES AND THEIR USES

Compiled by

John F. Rider

and

Seymour D. Uslan

Size: 11" x 8½" 992 pages 3000 illus.
75s. net

Practically every kind of oscilloscope and synchroscope manufactured during the last ten years is described and discussed in this exhaustive volume. Theoretical and practical data for the oscilloscope in virtually all its applications are given.

37 ESSEX STREET, LONDON, W.C.2.

Just Published

A HOME-BUILT TELEVISOR FOR SUTTON COLDFIELD AND HOLME MOSS RECEPTION

by

W. I. FLACK, M.I.R.E.,

Price 5/6 (post free 5/9)

This booklet fully describes the design and construction of a high quality fixed tuned television receiver for reception from either Sutton Coldfield or Holme Moss.

For those constructors who wish to convert the existing Sutton Coldfield receiver for reception from Holme Moss, construction details and coil data are contained in a leaflet obtainable from the Circulation Department (post free 6d.)

Electronic Engineering

28 ESSEX STREET, STRAND,
LONDON, W.C.2.

BOOK REVIEWS (Continued)

is actually being controlled." It would appear to be more exact to say that "it is the measured value which is effecting the control and therefore errors of measurement will occasion errors in the state of the controlled object." The author's meaning, however, is clear to the unbiased reader, and such inconsistencies as appear are perhaps unavoidable in a book on this subject in which the aim is to attain an appreciation of the fundamentals underlying a wide variety of controls.

The conditions for stability in control are examined, and derivative and integral controls are dealt with. Further sections discuss the features and similarities between electrical, pneumatic and hydraulic transmission links, also discontinuities due to load changes, etc.

The chapters on plant analysis and on controlling units should prove very useful to both the process control designer and operator.

J. BELL

Applied Electricity

By Edward Hughes, D.Sc., Ph.D., M.I.E.E. 412 pp., 269 figures. Longmans Green and Co., London. 1950. Price 10s. 6d.

THE volume under review is one of a series of engineering textbooks written by Drs. Morley and Hughes. The first three of these were written jointly and cover the work required for the first two years of the Ordinary National Certificate in Engineering. For the third year's work two separate volumes have been published, one by Dr. Morley on "Applied Mechanics" and the present volume by Dr. Hughes.

A knowledge of the matter contained in the previous volume is assumed and there are frequent references back to them. There is a liberal use of worked examples and each chapter concludes with groups of questions chosen largely from published examination papers. The answers to these questions appear at the end of the book.

In a subject so well defined as this Dr. Hughes has wisely refrained from any experimental deviations from what is general. The chapter headings are:—

I. Electromagnetism, II. Electrostatics, III. D.C. Generators and Motors, IV. Single Phase Circuits, V. Three Phase Circuits, VI. Transformers, VII. Alternators, VIII. Production of a Rotating Magnetic Field, IX. Alternators (Continued), X. Synchronous Motors XI. Induction Motors, XII. Thermionics, XII. Electric Lamps and Illuminations, XIV. Symbolic Notation.

To the electronic engineering student chapters IV and VI will be of particular value since in these Dr. Hughes deals rigorously with subjects of fundamental importance to the science. Chapter XII encompasses a great deal in a small space, and includes the construction and use of diodes (including gas filled rectifiers), single and three phase mercury arc rectifiers, the triode and its characteristics,

equivalent circuit and use as an amplifier, the thyatron and the cathode-ray oscillograph.

This book will be welcomed by engineering students and teachers. It is well written and free from any irritating mannerisms. The line diagrams are useful, the index comprehensive, and altogether it is a most useful book.

K. G. LOCKYER

Magnetic Tape Recording

By P. A. Tarry. 4th Edition. 70 pp., 12 figs. Audigraph Ltd., 74 Great Hampton Street, Birmingham 18. 1951. Price 6s. 6d.

THE notes contained in this edition have been compiled from the results of development work on magnetic recording on both tape and wire.

The equipment produced with the aid of these notes conforms to the standards now being set up by the British Standards Institution.

Since the publication of the first edition of this book considerable advance has been made in the technique and design used for recording, and the author has brought it up to date in the new edition.

The Scientific Instrument Manufacturers' Association Handbook

pp. S.I.M.A., 20 Queen Anne Street, London, W.1. 1951. Price £1 and by enquiry at the S.I.M.A. offices.

THE 1951 edition of the S.I.M.A. Handbook gives an interesting account of the history of the British scientific instrument industry. The main features of the book are a directory of 104 British scientific instrument manufacturers who are members of the Association, and an index giving the sources in this country of some 2,500 scientific instruments. The index is a fifth larger than that of the previous edition, published in 1947.

The British Standards Year Book 1951

400 pp. The British Standards Institution. August, 1951. Price 7s. 6d.

THIS year, the British Standards Year Book contains a list of the 1,700 British Standards current at December 31, 1950, with a brief description of the subject-matter and scope of each one. In addition, a supplement listing the British Standards issued between January 1 and March 31 of this year is included. A complete subject index simplifies reference.

It also lists the current membership of the General Council, which guides the Institution's general policy; or the four Divisional Councils—building, chemical, engineering and textile—which direct the standardization work; and of the 56 Industry Standards Committees, each representing a major British industry, and through which each subject is dele-

gated to some 2,000 technical committees and sub-committees, whose members bring specialist technical and commercial knowledge to bear upon every standardization project undertaken.

Guide to Broadcasting Stations

Sixth Edition. 94 pp. "Wireless World," Dorset House, Stamford Street, London, S.E.1. August, 1951. Price 2s.

DESPITE the efforts of international bodies and representations from individual governments the congestion in the long and medium wave broadcasting bands in Europe is eased but very little. There are at present nearly 200 stations working on unauthorized frequencies. Operating details of these stations, and of about 350 authorized transmitters are included in the sixth edition of "Guide to Broadcasting Stations." This small book also includes details of about 1,400 short-wave broadcasting stations operating in 117 countries.

All the stations are listed both geographically and in order of frequency, and the details have been checked against the frequency measurements made at the B.B.C. receiving station at Tatsfield.

The list giving operating details of nearly fifty V.H.F. broadcasting stations in Europe gives some indication of the growth of this form of broadcasting since the publication of the last edition, which listed only eleven. Details of fourteen European television transmitters and a number of Consol and standard frequency stations are also included.

Practical Electrician's Pocket Book 1952

Edited by Roy C. Norris. 566 pp. Odhams Press Ltd. October, 1951. Price 5s.

THE 1952 edition of the Practical Electrician's Pocket Book contains new chapters, including contributions on private generating plant and emergency lighting systems. The former is a review of the types of petrol, paraffin and diesel engine generator sets with advice on how to select, install and maintain them, and the latter is an explanation of the Keep-alite system and similar installations, illustrated by wiring diagrams.

To the section on wiring has been added a comprehensive article on the use of the ring main, and cables are included by an article entitled "Cables for Distribution of Sound" by R. C. Mildner, M.Sc., M.I.E.E., while the subjects of phase-conversion and electro-plating are described by S. F. Philpott, M.I.E.E.

A useful article by G. B. Proctor deals with the choice, installation and maintenance of power transformers as used in factories, and a new chapter on portable electric tools covers types, choice, use, maintenance, safety precautions, etc.

The section on interference suppression has been enlarged to include methods of dealing with interference with television caused by small domestic appliances.

Altogether the Pocket Book contains over 30 sections covering the everyday problems of the electrician.

Notes from the Industry

Convention on "The British Contribution to Television" April 28—May 3, 1952. The planning of the Television Convention which is being arranged by the Radio Section on behalf of the Council of the Institution of Electrical Engineers is now well advanced, and some general information can now be given. Further details will be announced from time to time.

The whole field of television will be covered in nine sessions, each of approximately two hours' duration, at which a survey paper and a number of supporting papers will be discussed. The titles of the sessions are: Programme origination; Point-to-point transmission; Broadcasting stations; Propagation; Receiving equipment (two sessions); Non-broadcasting applications; and System aspects. There will also be an historical paper and a broad survey paper to act as an introduction to the whole Convention. In addition to these technical sessions there will be a number of visits to industrial and other appropriate organizations.

There will be no early proofs or reprints, but meeting proofs of all papers will be available shortly before the Convention. Non-members and overseas visitors will be welcome, and suitable notices are being circulated to sister institutions and engineering societies abroad. Non-members wishing to attend will be required to pay a registration fee.

The proceedings of the Convention, comprising the opening addresses, the full text of all the papers and reports of the discussions, will be published in four issues of Part IIIA of the Proceedings of the Institution of Electrical Engineers.

Southall Technical College. We have been informed by the Middlesex County Council that there are still vacancies for the Southall Technical College's course on electro-acoustics. Enquiries should be addressed to Mr. T. B. Wheeler, Chief Education Officer, Beaconsfield Road, Southall, Middx.

Speed of Light Experiments—Apparatus on Show. Last year it was announced that experiments at the National Physical Laboratory had shown that the figure normally accepted for the speed of light was inaccurate by eleven miles a second. The apparatus used in the experiments is being exhibited at the Institution of Electrical Engineers, Savoy Place, W.C.2, until November 30.

The exhibit consists of a cavity resonator in which a radio wave is reflected backwards and forwards between the two ends. When the time of travel between the ends equals the time interval between successive waves, they build up to an electrical resonance which can be detected with very high precision. Visitors may do this themselves.

H.R.H. The Duke of Edinburgh, K.G., F.R.S., graciously accepted the office of President of the City and Guilds of London Institute for the Advancement of Technical Education recently.

The connexion between the Royal Family and the City and Guilds of London Institute goes back to 1881 when His Royal Highness Prince Leopold, Duke of Albany, laid the foundation stone of the Finsbury Technical College.

British Standard for Limits of Radio Interference (B.S. 800:1951) is a revision of B.S. 800 which specifies the limits of magnitude, duration and frequency of occurrence of radio interference which may be generated by many types of electrical appliances over a frequency band of 200kc/s to 160kc/s. These limits are considered to be adequate for the protection from such interference of the majority of radio broadcast receivers operating within this frequency range.

The standard does not apply to ignition systems of internal combustion engines, nor to industrial, scientific and medical radio frequency equipment, which are covered by other British Standards and Codes of Practice, nor to interference arising from defective electric installations.

THE HOLME MOSS TELEVISOR

Details for converting the Sutton Coldfield version of the ELECTRONIC ENGINEERING Home Built Televisor for reception of the transmissions from the new station at Holme Moss are now available. The leaflet is price 6d., post free.

A new booklet giving the complete constructional details for a Televisor suitable for the reception of either Sutton Coldfield or Holme Moss is also available, price 5s. 6d., postage 3d.

These publications can be obtained from our Circulation Department at 28 Essex Street, Strand, W.C.2.

The principal amendments in the new edition of this Standard are: a simplification of the technique of measurement of the noise voltage of the terminals of the interfering appliance; and increase in the permissible upper limit of the terminal noise voltage from 500 to 1,500 microvolts; a revision of the limits of the duration and frequency of occurrence of radio interference, and the postponement of the use of radio-interference-free-mark until the specification is extended to cover the frequencies in use for television. The postponement has been necessary because it was found that electrical appliances which could satisfy the limit requirements in the lower frequency bands might, nevertheless, cause intolerable interference in the television frequency band.

Copies of this standard may be obtained from the British Standards Institution, Sales Department, 24 Victoria Street, S.W.1, price 3s., post free.

Publications Received

AIR SEPARATION PLANTS FOR OXYGEN, NITROGEN AND THE RARE GASES is an interesting booklet issued by Messrs. Petrocarbon Ltd., 44a Dover Street, London, W.1, which describes plants for the large or small scale production of oxygen, nitrogen, and gases such as technical argon. It is believed that these plants are the first of their kind to be manufactured in this country on a commercial scale. Further details may be obtained from Petrocarbon Ltd.

REPORT OF THE COMMITTEE ON THE ORGANIZATION AND CONSTITUTION OF THE BRITISH STANDARDS INSTITUTION is a booklet giving the findings of the Cunliffe Committee. It emphasises the importance of standardization, and recommends urgent expansion. In order to achieve this, higher subscriptions should be paid. The report is available from His Majesty's Stationery Office, price 1s. net.

EDWARDS' HIGH FREQUENCY TESTERS is a brochure describing two new high frequency testers made by W. Edwards & Co. (London), Ltd., of Worsley Bridge Road, Lower Sydenham, S.E.26. Field testing has proved these units to be convenient and an inexpensive source of high tension and frequency for numerous laboratory and workshop duties, although they were primarily intended for vacuum indication and leak detection in glass systems.

EXIDE IRONCLAD FOR BATTERY TRACTION. This new 40-page catalogue, published by Chloride Batteries, Ltd., of Clifton Junction, near Manchester, will be of interest to users of electric trucks, as it deals with the range of Exide-Ironclad batteries for electric traction applications.

ENGINEERING EDUCATION IN THE REGION is the third edition of a pamphlet issued by the Regional Advisory Council for Higher Technological Education in London and the Home Counties. It gives general information about the various types of course available (e.g., from engineering crafts, National Certificates, etc.) for students from the time they leave school. An outline is also given of the facilities available for students who are qualified to follow courses for university degrees and research. Also included is a list of the colleges concerned in the region, with the course offered during the session 1950/51, which it is thought may be a useful guide on which to base inquiries regarding present or future facilities. The booklet is obtainable from the Regional Advisory Council, Tavistock House South, Tavistock Square, London, W.C.1, price 1s.

STANDARDIZATION—AN ESSENTIAL INSTRUMENT OF INDUSTRIAL PROGRESS is a booklet telling what British Standards are, and how they are evolved and used. It also deals briefly with the principles of standardization and how the work is controlled and financed. The British Standards Institution, 24/28 Victoria Street, London, S.W.1.

THE TESTING OF HEARING AIDS—N.I.D. BOOKLET NUMBER 490 contains three interesting papers on the work of the Technical Department of the National Institute for the Deaf by D. B. Fry and P. Denes. The first is an informative introduction to the work of the department, the second deals with the evaluation of hearing aids, and the third the techniques of hearing and measurement. The booklet is obtainable from the National Institute for the Deaf, 105 Gower Street, London, W.C.1, price 1s.

RADAR IN MERCHANT SHIPS—SITING PRECAUTIONS is the Ministry of Transport Notice No. M.352, and replaces Notice No. M.317 issued in 1948. It contains information and guidance for ships where radar has been installed. In the case of new ships, much of the advice is worth considering at the time when the ship is designed, rather than at the stage of building. Copies of the new Notice are obtainable, free of charge, from the Ministry of Transport, Marine (Navigational Aids) Division, Berkeley Square House, London, W.1, or from the M.O.T. Marine Survey offices at the ports.

ELECTRONIC ELEMENT CHART is compiled by Llewellyn Oulton, M.Sc., and contains short notes on the atoms in the universe. It is obtainable from the University of London Press Ltd., Warwick Square, London, E.C.4, price 1s. 6d.

MEETINGS THIS MONTH

THE BRITISH INSTITUTION OF RADIO ENGINEERS

London Section

Date: November 21. Time: 6.30 p.m.
Held at: London School of Hygiene and Tropical Medicine, Keppel Street, Gower Street, London, W.C.1.
Lecture: Developments in High Frequency Transmitter Cabinets.
By: R. C. Mildner.

North Eastern Section

Date: November 14. Time: 6.0 p.m.
Held at: Neville Hall, Westgate Street, Newcastle-on-Tyne.
Lecture: Television Aerial Design.
By: G. L. Stephens.

Scottish Section

Date: November 6. Time: 7.0 p.m.
Held at: University College, Dundee.
Date: November 7. Time: 7.0 p.m.
Held at: The University, Edinburgh.
Date: November 8. Time: 7.0 p.m.
Held at: The Institute of Engineers and Shipbuilders, Glasgow.
Lecture: The Brain as a Piece of Communication Equipment.
By: H. W. Shipton, A.M., Brit. I.R.E.
(The above three meetings will be held jointly with the Scottish Sections of the Institute of Physics).

South Midlands Section

Date: November 14.
Held at: Rugby.
Details may be obtained from the Local Honorary Secretary, C. Stokes, B.Sc., 6 Esterton Close, Coventry.

West Midlands

Date: November 27. Time: 7.0 p.m.
Held at: Wolverhampton and South Staffs. Technical College.
Details may be obtained from the Local Honorary Secretary, R. A. Lampitt, 20 Northfield Grove, Merry Hill, Wolverhampton.

THE BRITISH SOUND RECORDING ASSOCIATION

Portsmouth Centre

Date: November 1. Time: 7.0 p.m.
Held at: Central Library, Guildhall, Portsmouth.
Lecture: Recording at the B.B.C.
By: R. C. Patrick.
Date: November 14. Time: 7.0 p.m.
Held at: Central Library, Guildhall, Portsmouth.
Lecture: Microgroove Recording and Reproduction.
By: E. D. Parchment.

London Meetings

Date: November 16. Time: 7.0 p.m.
Held at: The Royal Society of Arts, John Adam Street, London, W.C.2.
Lecture: Electrical and Mechanical Problems of Record Reproduction.
By: K. R. McLachlan and R. Yorke.

THE INSTITUTE OF PHYSICS

Midland Branch and Education Group

Date: November 10. Time: 11.30 a.m.
Held at: The University, Edgbaston, Birmingham.
Conference: The Teaching of Physics in Technical Colleges.
By: Dr. D. S. Anderson, Dr. M. R. Gavin, F.Inst.P., and Dr. H. Lipson, F.Inst.P.

Electronics Group

Date: November 13. Time: 5.30 p.m.
Held at: The Institute of Physics, 47 Belgrave Square, S.W.1.
Lecture: Electrical Properties and Structure of Evaporated Films.
By: Dr. F. Ashworth, F.Inst.P.

Industrial Radiology Group

Date: November 16. Time: 6.30 p.m.
Held at: The Institute of Physics, 47 Belgrave Square, S.W.1.
Lecture: The Design of X-Ray Tubes.
(Joint meeting with the Institute of X-ray Technology).

INSTITUTION OF ELECTRICAL ENGINEERS

All London meetings, unless otherwise stated, are held at the Institution of Electrical Engineers, Savoy Place, W.C.2, at 5.30 p.m.

Ordinary Meeting

Date: November 8.
Lecture: The London-Birmingham Television-Cable System (Radio Section paper).
By: T. Kilvington, B.Sc.(Eng.), F. J. M. Laver and H. Stanesby.

Radio Section

Date: November 14.
Lecture: The Life of Oxide Cathodes in Modern Receiving Valves.
By: G. H. Metson, M.C., Ph.D., M.Sc., S. Wagener, D.Phil., M. F. Holmes, B.Sc., and M. R. Child.
Date: November 26.
Discussion: Should Broadcasting be Superseded by Wire Distribution?
Opened by: P. P. Eckersley.

Measurements Section

Date: November 6.
Discussion: Measurements Involved in the Testing of Protective Equipment.
Opened by: H. S. Petch, B.Sc.(Eng.).
Date: November 20.
Lecture: Universal High-Speed Digital Computers: A Small Scale Experimental Machine.
By: Professor F. C. Williams, O.B.E., D.Sc., D.Phil., F.R.S.; T. Kilburn, M.A., Ph.D., and G. C. Tootill, M.A., M.Sc.
Lecture: Universal High-Speed Digital Computers: A Magnetic Store.
By: Professor Williams, T. Kilburn and G. E. Thomas, M.Sc.
Lecture: The Position Synchronization of a Rotating Drum.
By: Professor Williams and J. C. West, B.Sc.
Lecture: Universal High-Speed Digital Computers: Serial Computing Circuits.
By: Professor Williams, A. A. Robinson, M.A., Ph.D., and T. Kilburn.

Education Discussion Circle

Date: November 12. Time: 6 p.m.
Discussion: The Equipment of an Electrical Engineering Laboratory.
Opened by: A. Draper, B.Sc.(Eng.), and T. Siklos, Dipl. Ing.

Informal Meeting

Date: November 19.
Discussion: Light Electrical Engineering and the Mechanical Engineer.
Opened by: T. E. Goldup.

District Meetings

Date: November 12. Time: 6.30 p.m.
Held at: The Crown and Anchor Hotel, Ipswich.
Lecture: Television.

Cambridge Radio Group

Date: November 6. Time: 6 p.m.
Held at: The Cambridgeshire Technical College.
Address by the Chairman of the Radio Section.
By: D. C. Espley, O.B.E., D.Eng.

Mersey and North Wales Centre

Date: November 5. Time: 6.30 p.m.
Held at: Liverpool Royal Institution, Colquitt Street, Liverpool.
Lecture: The Life and Work of Oliver Heaviside.
By: Professor G. H. Rawcliffe, M.A., D.Sc.

North Eastern Radio and Measurements Group

Date: November 5. Time: 6.15 p.m.
Held at: King's College, Newcastle-on-Tyne.
Lecture: Crystal Triodes.
By: T. R. Scott, D.F.C., B.Sc.
Date: November 19. Time: 6.15 p.m.
Held at: King's College, Newcastle-on-Tyne.
Lecture: An Electronic Process-Controller.
By: J. R. Boundy, B.Sc., and S. A. Bergen, M.B.E.

Sheffield Sub-Centre

Date: November 21. Time: 6.30 p.m.
Held at: The Grand Hotel, Sheffield.
Lecture: Modern Developments in Atomic Energy.
By: T. E. Allibone, D.Sc., Ph.D., F.R.S.

North Western Radio Group

Date: November 28. Time: 6.30 p.m.
Held at: The Engineers' Club, Albert Square, Manchester.
Lecture: An Investigation into the Mechanism of Magnetic Recording.
By: P. E. Axon, O.B.E., M.Sc.

North Western Utilization Group

Date: November 27. Time: 10 a.m., 2.30 p.m., and 6.15 p.m.
Held at: The Engineers' Club, Albert Square, Manchester.
Conference: The I.E.E. Report on "Electricity as an Aid to Productivity."
Lecture: Motive Power in the Factory.
By: H. Dreghorn, B.Sc.
Lecture: Handling of Materials.
By: G. V. Sadler.
Lecture: The Inspection of Materials.
By: J. Foster Veivers.

South Midland Radio Group

Date: November 26. Time: 6 p.m.
Held at: The James Watt Memorial Institute, Great Charles Street, Birmingham.
Informal Lecture: The Life and Reliability of a Radio Valve.
By: H. G. Metson, M.C., Ph.D., M.Sc.

North Staffordshire Sub-Centre

Date: November 5. Time: 7 p.m.
Held at: P.O. Central Training School, Stone.
Lecture: Television.
By: C. T. Lamping.

Rugby Sub-Centre

Date: November 21. Time: 6.30 p.m.
Held at: The Rugby College of Technology and Arts, Rugby.
Lecture: Crystal Diodes.
By: R. W. Douglas, B.Sc., and E. G. James, Ph.D.
Lecture: Crystal Triodes.
By: T. R. Scott, D.F.C., B.Sc.

South Western Sub-Centre

Date: November 28. Time: 3 p.m.
Held at: The Rougmont Hotel, Exeter.
Informal Lecture: The Operation and Maintenance of Television Outside-Broadcast Equipment.
By: T. H. Bridgewater.

THE INSTITUTION OF ELECTRONICS

Southern Branch

Date: November 14. Time: 6.45 p.m.
Held at: Southampton University College.
Lecture: The Technique of Trustworthy Valves.
By: G. P. Thwaites, B.Sc., A.M.I.E.E.
Date: November 21. Time: 7.0 p.m.
Held at: H.M.S. Phoenix, Stamsshaw, Portsmouth.
Lecture: X-rays and Radioactivity.
By: Inst. Lt. Cdr. R. E. Ward, A.C.G.I., R.N.

INSTITUTION OF POST OFFICE ELECTRICAL ENGINEERS

Date: November 21. Time: 5.0 p.m.
Held at: The Conference Room, 4th Floor, Waterloo Bridge House, S.E.1.
Informal Lecture: Telecommunication in Aviation.
By: W. P. Nicol, A.R.Ae.S.

SOCIETY OF INSTRUMENT TECHNOLOGY

Date: November 27. Time: 7.0 p.m.
Held at: Royal Society of Tropical Medicine and Hygiene, Manson House, Portland Place, London, W.1.
Lecture: The Visual Presentation of Instrument Data.
By: K. F. H. Murrell, M.A., F.R.P.S.

THE TELEVISION SOCIETY

Date: November 8. Time: 7 p.m.
Held at: The C.E.A., 164 Shaftesbury Avenue, London, W.C.2.
Lecture: The Murphy V.200 Television Receiver.
By: P. Kidd.
Date: November 23. Time: 7 p.m.
Held at: The C.E.A., 164 Shaftesbury Avenue, London, W.C.2.
Lecture: Television Distribution by Wire.
By: K. J. Easton, A.M.I.E.E.

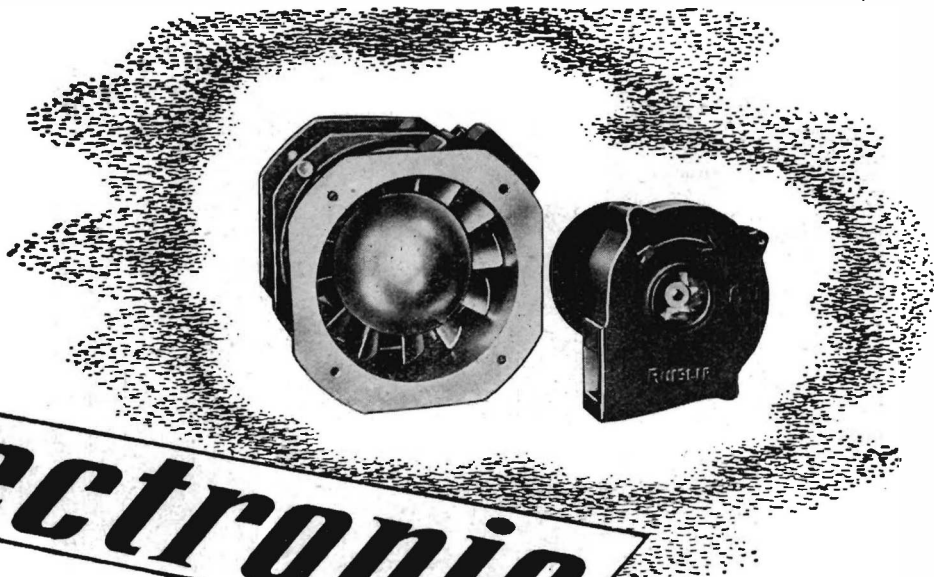

electronic COOLING

The wide range of blowers for force-cooling of valves and maintenance of desired temperature levels in electronic and general electrical apparatus is typical of the progress maintained by **ACI**. The illustration shows the smallest of the blowers (4" Axial Flow type and 2½" Centrifugal type), but our range covers duties from 5 c.f.m. up to many thousands of c.f.m. at pressures up to 45 or more inches w.g. These blowers are used in MARINE & AERODROME RADAR INSTALLATIONS, AIRCRAFT AUTOMATIC PILOTS, COMMUNICATION AND BROADCASTING STATIONS, R.F. HEATING EQUIPMENT, Etc. Let us know your application—we shall be pleased to put forward our proposals.



Complete
Air Treatment
Plant

AIR CONTROL INSTALLATIONS LTD.
Manchester RUISLIP, MIDDX. Glasgow
 Telephone : Ruislip 4066 (8 lines) Telegrams : Controlair, Ruislip

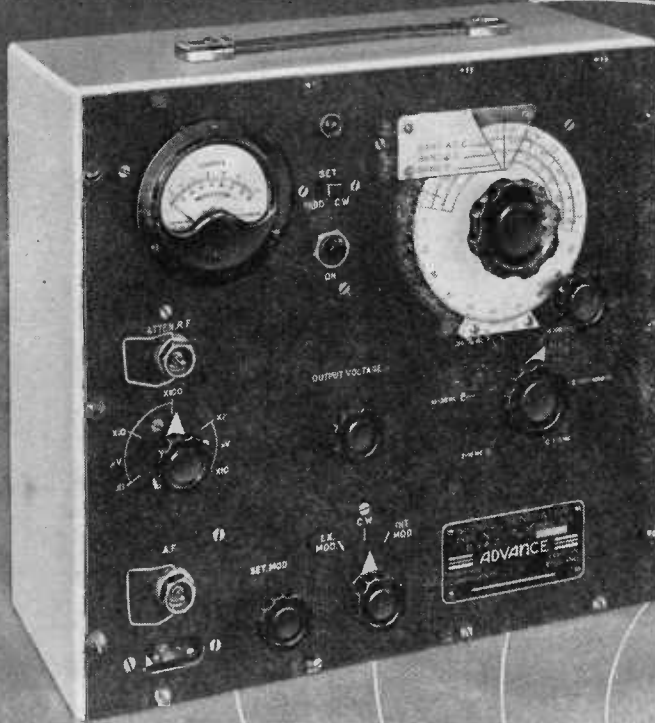

Advance type B4

Here is a tried and proven general purpose sub-standard Signal Generator which is essentially simple to use. One special feature of the B4 is the accuracy of the R.F. output over the entire frequency range, achieved by the use of a crystal voltmeter and the subsequent elimination of all circuits having poor frequency characteristics.

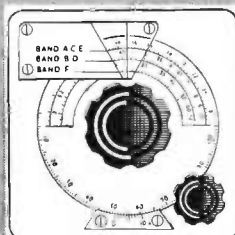

MODEL A
100 kc/s - 70 mc/s
in six bands

MODEL B
30 kc/s - 30 mc/s
in six bands

Calibration accuracy of both models is $\pm 1\%$

Others of the many advantages of the B4 are described in Folder No. S/11/L, a copy of which will gladly be sent on request.

Advance
SIGNAL GENERATOR

ADVANCE COMPONENTS LTD., BACK RD., SHERNHALL ST., LONDON, E.17
Phone: LARKSWOOD 4366/7/8

'ENGLISH ELECTRIC'

electronic insulation tester



Designed for industrial electrical testing

It provides for the first time **10-kV D.C.** in a truly portable equipment having the following outstanding features :

Non-lethal output adjustable from 500 to 10,000-volts.

Measurement up to 250,000 megohms.

High accuracy on comparative tests.

Rejection of surface leakage current.

Aural indication of ionisation.

Price **£55** · Size : 15" × 10" × 6" · Weight : 23 lbs.

The **ENGLISH ELECTRIC** Company Limited

QUEENS HOUSE, KINGSWAY, LONDON, W.C.2

Industrial Electronics Dept. Stafford

Works : STAFFORD · PRESTON · RUGBY · BRADFORD · LIVERPOOL

EN. 1.

**FOR HIGH SPEED
PRECISION SOLDERING**

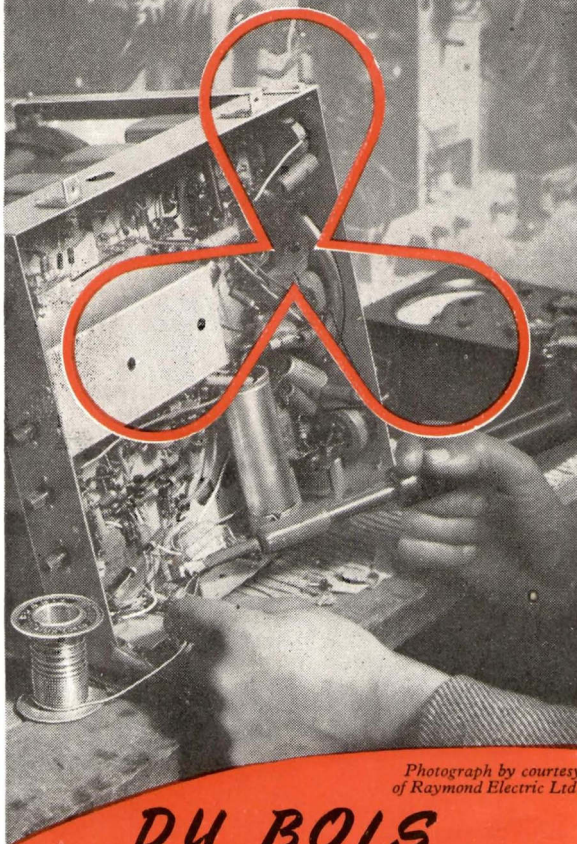

*Photograph by courtesy
of Raymond Electric Ltd.*

**DU BOIS
TRI-SOL**

Activated
RESIN-CORED SOLDER

Tri-sol offers a consistently high standard of flux for high-speed precision soldering. Specially designed for radio, television and electrical assemblies. The core reduces the thickness of the solder wall, ensuring the correct proportion of flux. Prov. Pat. 6654/50

Write for free sample and descriptive literature

**THE DU BOIS CO. LTD., 15 BRITANNIA STREET,
KING'S CROSS, LONDON, W.C.1 TERminus 6624**

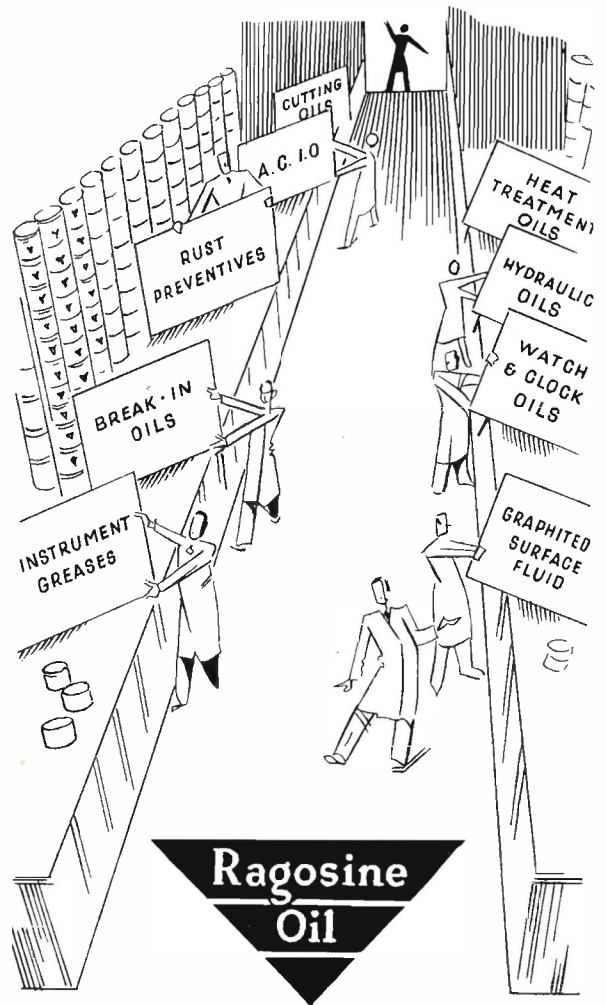

Oil for many functions made available for specialized purposes by Ragosine. Write for the highly informative literature available on the entire subject of specialized instrument lubrication—and if you have a particular problem our Technical Staff will gladly design the answer

Ragosine
INSTRUMENT
LUBRICATION

RAGOSINE OIL CO. LTD.

MINERVA WORKS, WOODLESFORD, nr. LEEDS
London Office: IBEX HOUSE, MINORIES, LONDON, E.C.3.

n.d.h.

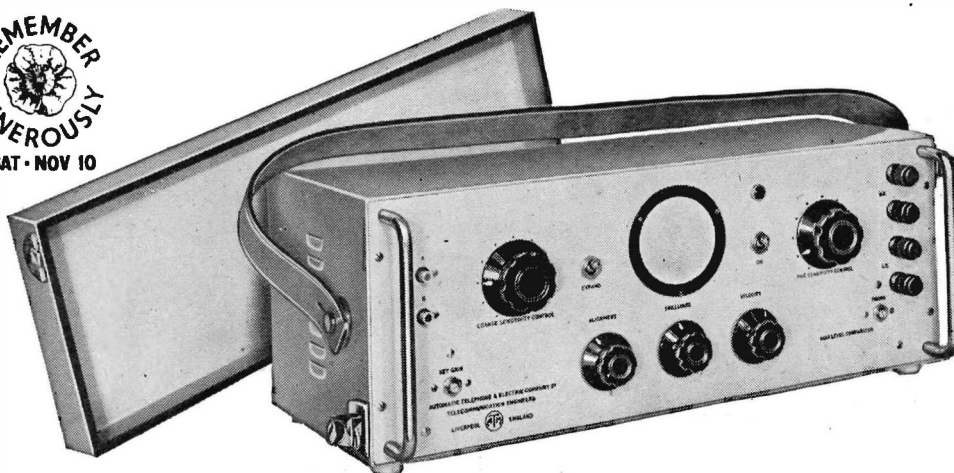

PRECISION MEASUREMENTS IN LINE TRANSMISSION

In the measurement of losses and gains greater accuracy can be achieved if a visual instead of an audible means is employed. The illustration depicts an electronic voltage comparator in which a cathode ray tube is used as an indicator of the relative magnitudes of a standard signal and the unknown signal to be tested. In the position of maximum sensitivity an input signal of 30 microvolts will give a 1 cm deflection on the screen which allows a comparison accuracy equivalent to 0.1db. Measurements can be made from 100 c/s to 200 Kc/s. This instrument, which is extremely simple to operate, is used as the sensitive detector in the measurement of losses in channelling equipment, amplifier gains, crosstalk and harmonic distortion in amplifiers, etc.



Distributor

AUTOMATIC TELEPHONE & ELECTRIC CO. LTD.

(Radio and Transmission Division), Strowger House, Arundel St., London, W.C.2

Telephone: TEMple Bar 9262.

Cablegrams: Strowgerex, London.

Manufacturers

AUTOMATIC TELEPHONE & ELECTRIC CO. LTD., Liverpool & London
TELEPHONE MANUFACTURING CO. LTD., St. Mary Cray, Kent

ATE/TMC

A8411-B.105

**A
NEW
development
in**



**...reduced power
factor by 50%
...increased R.F.
loading 100%**

Intensive development of electrodes, dielectric and processing now provides a new and greatly improved Hunt-Ingram Capacitor — the MARK 51.

In this latest type, the power factor has been reduced to a limit not exceeding 0.1%; as a result the R.F. loadings can be increased by approximately 100%.

Among the many applications are:—

- HF. Heating (blocking and bypass);
- High Altitude Airborne Service;
- Delay Networks in Pulse Circuits;
- Radio Transmission;
- Voltage Dividers and Stabilising Units.

They are particularly useful in High Voltage and Power R.F. equipment. Full information is freely available and enquiries are invited from designers.

TYPE M20 13" x 6½" R.F. loading 140 kVA.

5000-10000 pf. 10 kV. Pk. Wkg.

1000—3000 pf. 15 kV. Pk. Wkg.

TYPE M10 6½" x 6½" R.F. loading 70 kVA.

500—2000 pf. 15 kV. Pk. Wkg.

TYPE M5 6½" x 3¼" R.F. loading 35 kVA.

150 — 500 pf. 15 kV. Pk. Wkg.

R.F. loading ratings are at room temperature (15-20°C.)

REGISTERED
HUNTS
CAPACITORS
THE TRADE MARK OF RELIABILITY

A. H. HUNT LTD · WANDSWORTH · ENGLAND · ESTD. 1901 Tel: BATtersea 3131

The "Belling-Lee" page for Engineers

"MINIFUSE" & MINIATURE FUSES

U.K. patent 647049

LIST No. L:562
Miniature Fuses

Ratings
50, 100, 250, and
500mA

1, 2.5, 4 and 7 amp,

LIST No. L754
"Minifuse"

Ratings
10, 15 and 25mA
H.R.C. type

Ideal where space is a limiting factor. A miniature fuse with a wire element only $\frac{5}{8}$ in. by $\frac{1}{8}$ in.

The results of long development enable such a fine element to be handled in production to give reliable results from 10mA to 25mA.

Useful in the protection of small meters, test and laboratory gear, etc.

Ratings from 50mA comply with R.C.L. 261.1.

Fusing time with 120 per cent overload = 1 second.

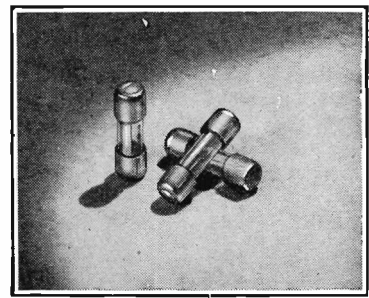
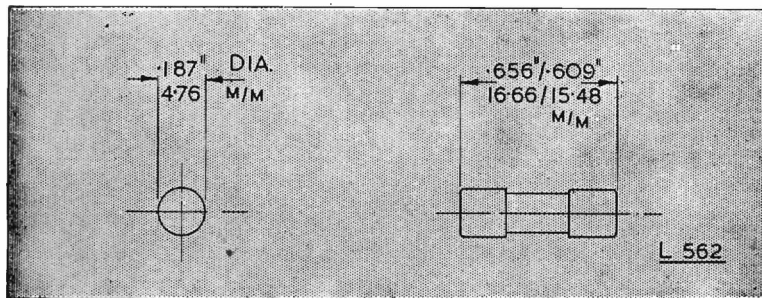

SCREENED COMPARTMENTS—SECTIONALISED

A screened compartment has two purposes, to provide an interference free space in which to test, calibrate or use high gain electronic equipment; to surround equipment known to be creating radio interference.

In the first instance very great care and experience is required in design, and invariably a double screen is necessary.

Where electric power supply is required inside a compartment interference filters of the correct current rating can be supplied and fitted, and the effectiveness of the screen is limited by the efficiency of such filters. We can now provide suppression from 150 Kc/s to 300 Mc/s.

With the inclusion of these mains filters the screening attenuation at the very high frequencies is in the order of 55 db.

Screened power transformers, additional electric fittings, benches, shelves, etc., can be provided to customers requirements.

To allow access to the site, and to facilitate easy transportation the compartments are sectionalised, adequate provision being made for bonding. An important feature of design is sliding doors which operate in steel channels and, when closed, maintain multi-point electrical contact all round.

The screening requirements for the second category are not so severe, nor are the limits yet laid down under the Wireless Telegraphy Bill.

May be obtained
tropically finished
to service requirements

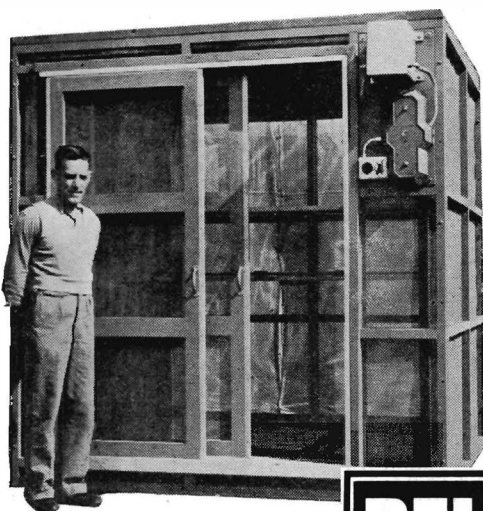

Illustration shows a typical screened compartment, designed to customer's special requirements. Design and prices submitted on request.

BELLING & LEE LTD
CAMBRIDGE ARTERIAL RD., ENFIELD, MIDDX., ENGLAND

Valve book of the year!



CHARACTERISTICS OF RECEIVING VALVES
ELECTRONIC DEVICES · CATHODE RAY TUBES
PHOTO CELLS · GERMANIUM CRYSTALS
COMPARATIVE AND REPLACEMENT TABLES
COMPREHENSIVE REFERENCE to G.E.C. television,
radio and communication equipment with valve combinations.
TYPICAL VALVE CIRCUITS

PRICE

5/-

*Plus 9d. for postage
and packing.*

Apply to your
radio retailer
for your copy.

THE GENERAL ELECTRIC CO. LTD., MAGNET HOUSE, KINGSWAY LONDON, W.C.2.



HIGH QUALITY REPRODUCTION

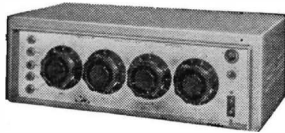

FOUR-WAY ELECTRONIC MIXER

This unit has 4 built-in balanced and screened microphone transformers, normally of 5-30 ohms impedance. It has 5 valves and selenium rectifier supplied by its own built-in screened power pack, consumption 20 watts. Suitable for recording and dubbing, or large P.A. installations since it will drive up to six of our 50 watts amplifiers whose base dimensions it matches. The standard model has an output impedance of 20,000 ohms or less, any impedance can be supplied to order.

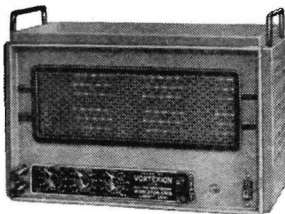

OTHER MODELS IN OUR
RANGE OF AMPLIFIERS ARE—
"SUPER-FIFTY WATT." "THIRTY WATT."
"10-15 WATT RECORD REPRODUCER."

These are fitted in well-ventilated steel cases with recessed controls as illustrated.

Full details on request

EXPORT ENQUIRIES INVITED



"FIFTY and THIRTY WATT" CINEMA AMPLIFIERS

as illustrated for single or double P.E.C. input with separate adjustable bias. Full range of tone controls to suit all needs with built-in Exciter Supply if required.

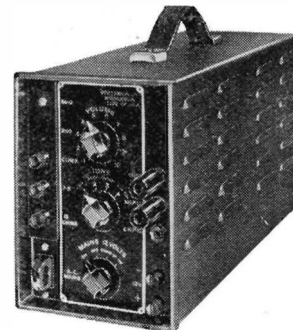

TYPE C.P. 20A AMPLIFIER for A.C. Mains and 12 volt working giving 15 watts output, has switch change-over from AC to DC and "Stand-by" positions. Consumes only $5\frac{1}{2}$ amperes from 12 volt battery. Fitted with mu-metal shielded microphone transformer for 15 ohm microphone, provision for crystal or moving iron pick-up with tone control for bass and top. Outputs for 7.5 and 15 ohms. Complete in steel case with valves.

VORTEXION LIMITED

257-261 THE BROADWAY, WIMBLEDON, LONDON, S.W.19

Telephones : LIB 2814 and 6242-3.

Telegrams : "Vortexion Wimble, London"

Finger-tip selection
Positive segregation
Carries complete range in
minimum of space

700 LABpak'd RESISTORS

10 ohms — 10 megohms
in a Space 12" × 4" × 4"

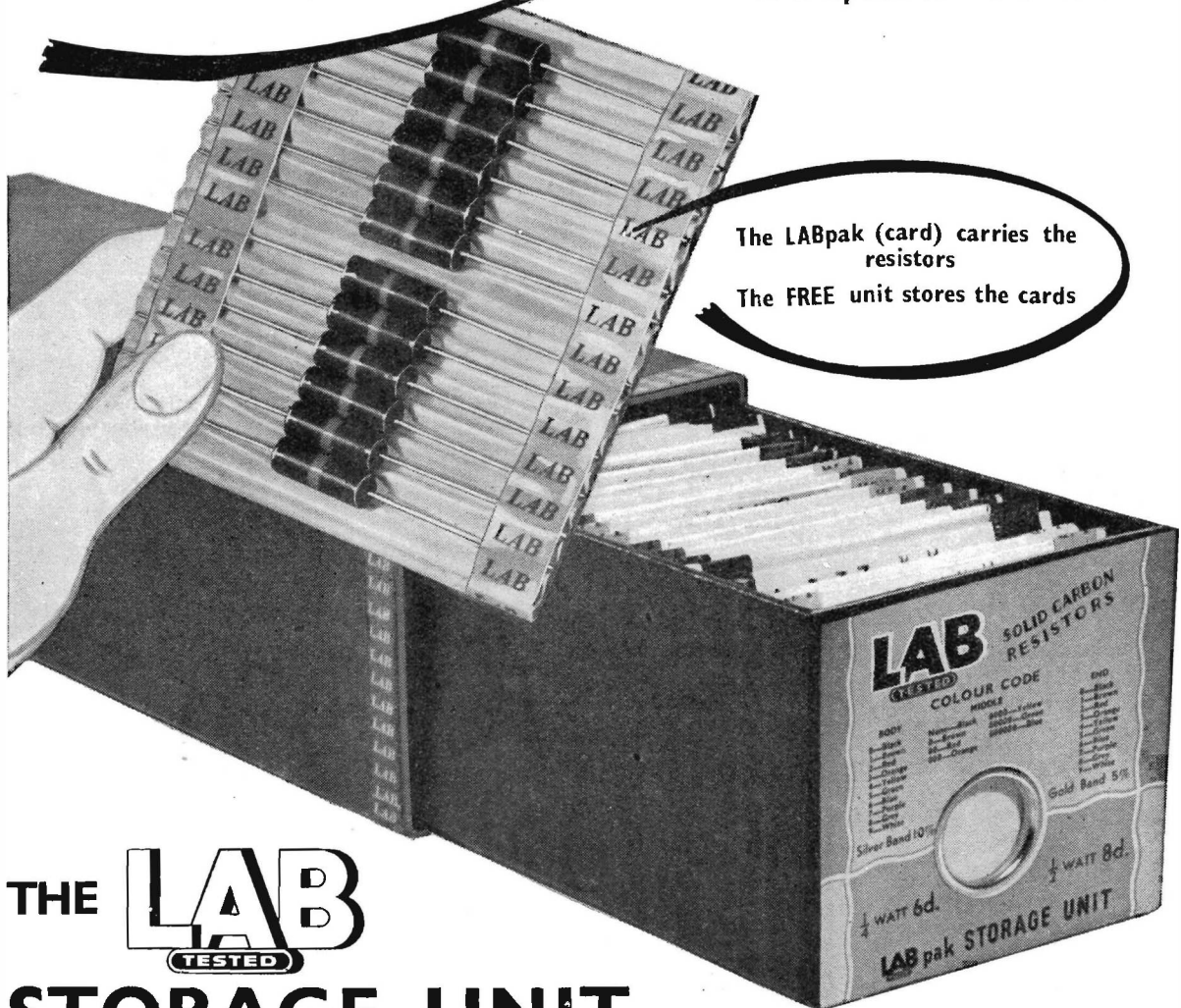

The LABpak (card) carries the resistors
The FREE unit stores the cards

THE **LAB** TESTED STORAGE UNIT

is designed to provide a comprehensive range of resistors for research and experimental laboratories and small production units. It is supplied free with an initial purchase of

180 Type R Resistors (Order LSUC $\frac{1}{2}$)
or 240 Type T Resistors (Order LSUC $\frac{1}{4}$)

Alternatively you may specify your own Ohmic values from the preferred range. Thereafter replacements and additions, ready carded, are always available from stock.

Your local radio wholesaler will handle your needs, but more detailed information can be obtained from

THE RADIO RESISTOR COMPANY LTD.,
50, Abbey Gardens London, N.W. 8. Tel. : Maida Vale 5522

RESISTOR SPECIFICATION

Ref.	Type	Loading	Max. Volts	Range	Dimensions
T	$\frac{1}{4}$ -watt	$\frac{1}{2}$ -watt	250	10 ohms to 10 megohms	$\frac{3}{8}$ " × $\frac{1}{16}$ "
R	$\frac{1}{2}$ -watt	1-watt	500	10 megohms	$\frac{1}{2}$ " × $\frac{1}{4}$ "

Tolerance available $\pm 20\%$, $\pm 10\%$ $\pm 5\%$

Not enough to go round

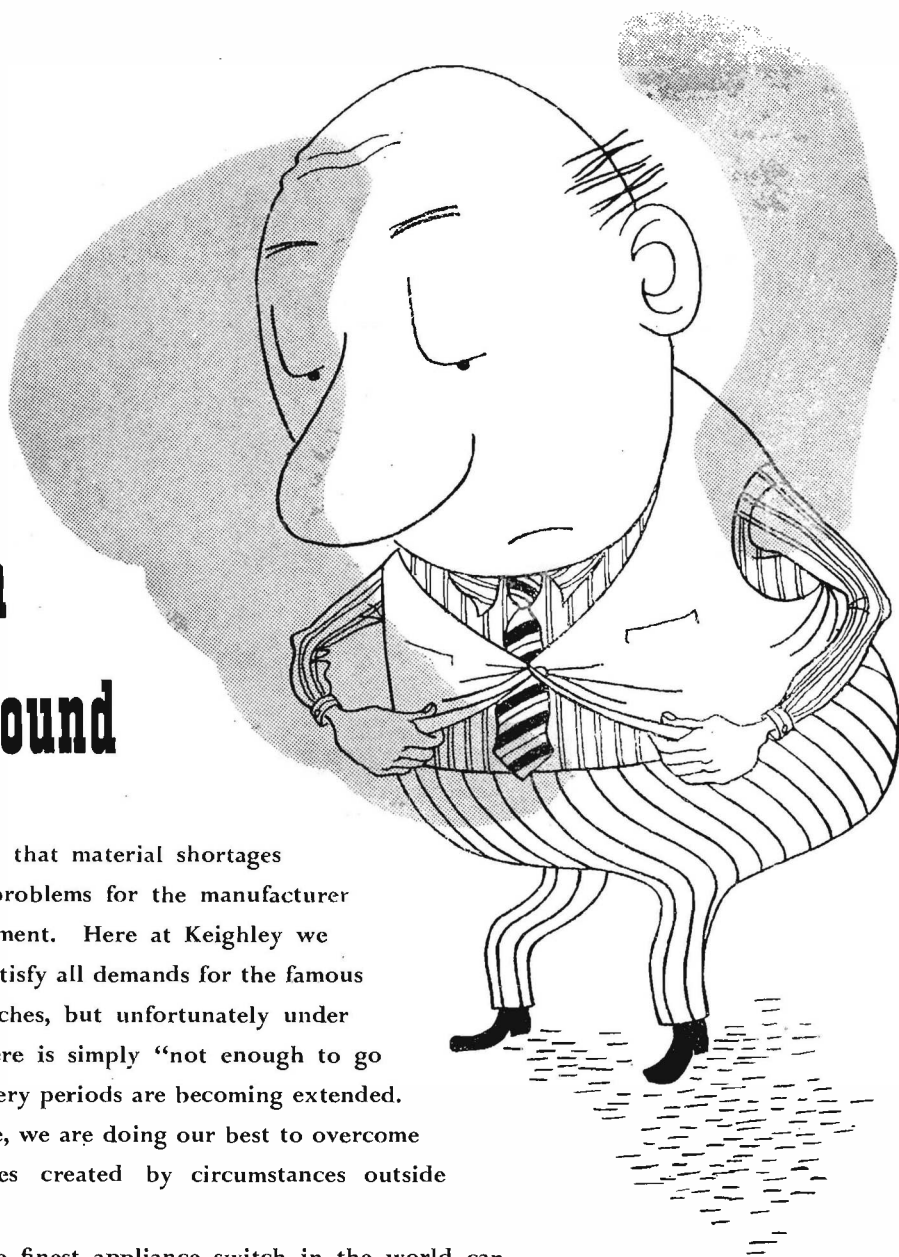

It is sad, but true, that material shortages and priorities create problems for the manufacturer of electrical equipment. Here at Keighley we are endeavouring to satisfy all demands for the famous Cutler-Hammer switches, but unfortunately under present conditions there is simply "not enough to go round", and delivery periods are becoming extended.

In the meantime, we are doing our best to overcome the difficulties created by circumstances outside our control.

Making the finest appliance switch in the world can be an embarrassment, when most manufacturers endorse our claims and continually ask for more.



"THE SWITCH PEOPLE"

N · S · F L I M I T E D · K E I G H L E Y · Y O R K S

Phone: Keighley 4221/5. Grams: ENESEF, Keighley. LONDON OFFICE: 9 Stratford Place, W.1. Phone: Mayfair 4234

Licenseses of Igranic Electric Co. Ltd. for the above products of Cutler-Hammer Inc. Milwaukee. U.S.A.

COMPLETE VACUUM SYSTEMS FOR EXHAUSTING

...MIDGET VALVES

To meet the many and varied demands of electrical and electronic industries, Edwards Combined Vacuum Systems are available in a range of standard models, or may be ordered to suit individual requirements. A wide range of vacuum gauges are also available.

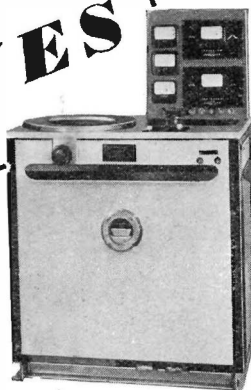

...or GIANT ELECTRON TUBES

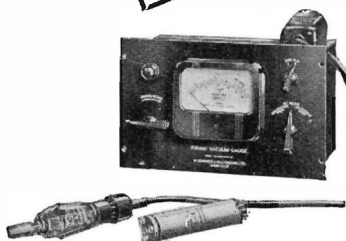

W. EDWARDS

& CO. (LONDON) LTD.
LOWER SYDENHAM · LONDON · S.E.26

Telephone: SYDenham 7026 (8 lines)

...For better vacuum service

30 YEARS VACUUM EXPERIENCE

Telegrams: Edcohvac, Souphone, London.

MUREX are now making

ZIRCONIUM

ROD · WIRE · SHEET

in commercial quantities

In addition to Tungsten, Molybdenum and Tantalum we are now making ZIRCONIUM ROD, WIRE and SHEET in commercial quantities. We shall be pleased to have details of your requirements. Technical literature available on request.

MUREX LTD · (Powder Metallurgy Division) · Rainham · Essex Tel.: Rainham, Essex, 240
LONDON SALES OFFICE: CENTRAL HOUSE, UPPER WOBURN PLACE, W.C.1 Tel.: EUSton 8265

BALDWIN PROTECTION ELECTROMETER

A robust, portable battery-operated instrument for dosage measurement of α and γ radiation at tolerance level.

The present tolerance dose is 100 mr per day.
The range of the instrument is 200 mr.

Ionization chambers supplied for use with the instrument are of the personnel protection type; any number of these may be used with the one instrument.



Write for details—Leaflet No. 122

BALDWIN INSTRUMENT CO. LTD., DARTFORD, KENT

Dartford 2989 & 2980

Northern Agents: F. C. Robinson & Partners Ltd., 287 Deansgate, Manchester, 3

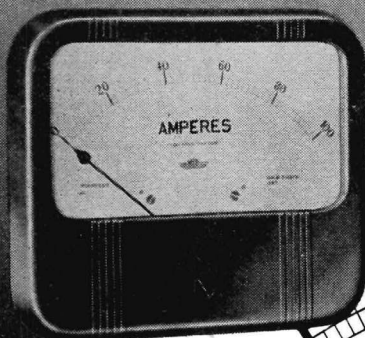

ACCURACY IS NOT
ENOUGH . . .

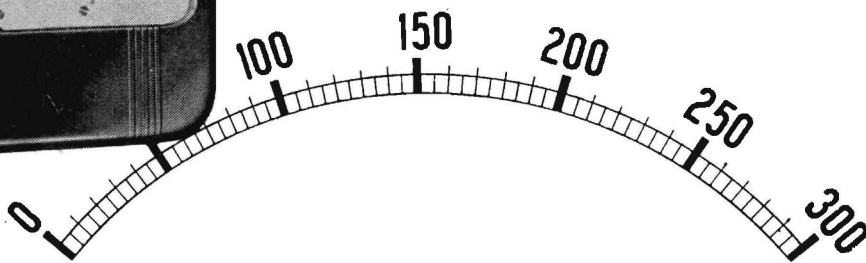

The most accurate measuring instruments in the world are only of use if they can be read easily. A feature of the range of Pullin Rectangular instruments is the extreme legibility of their scales.

Available in all the standard ranges in sizes 3", 3½" and 6". Let us know your requirements and we shall be pleased to make recommendations regarding suitable instruments.

PULLIN RECTANGULAR INSTRUMENTS

Measuring Instruments (Pullin) Ltd., Electric Works, Winchester St., London. W.3. Phone: ACOrn 4651

SULLIVAN-GRIFFITHS
PORTABLE UNIVERSAL AC-DC BRIDGE TESTER
 FOR DIRECT READING MEASUREMENTS OF
 RESISTANCE, INDUCTANCE, CAPACITANCE AND CONDUCTANCE

RANGES

RESISTANCE
 A.C. & D.C.
 0.3 ohms to
 3 megohms

CONDUCTANCE
 0.3 micromhos
 to 3 mhos

ACCURACY
 1 per cent

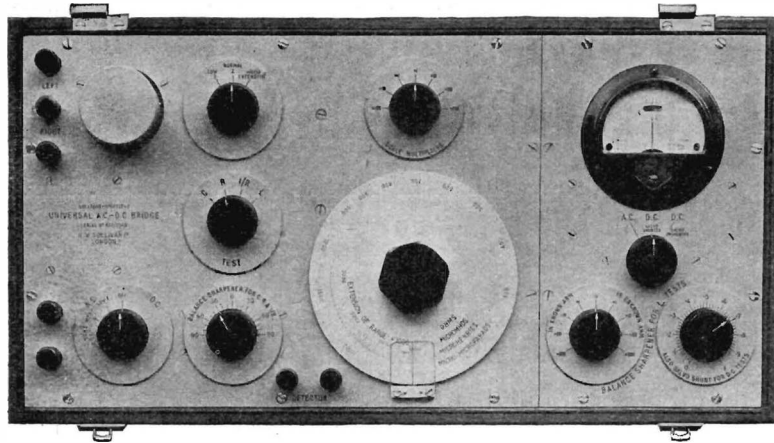

RANGES

CAPACITANCE
 30 $\mu\mu\text{F}$ to 30 μF

INDUCTANCE
 30 μH to 30 H

ACCURACY
 1 per cent

H. W. SULLIVAN
 LIMITED
 LONDON, S. E. 15

List No. AC900—Universal AC-DC Bridge Tester (with self-contained source).

List No. AC901—Simple model for AC measurement of capacitance, resistance and conductance only (also with self-contained source).

Telephone ; New Cross 3225 (P.B.X.)

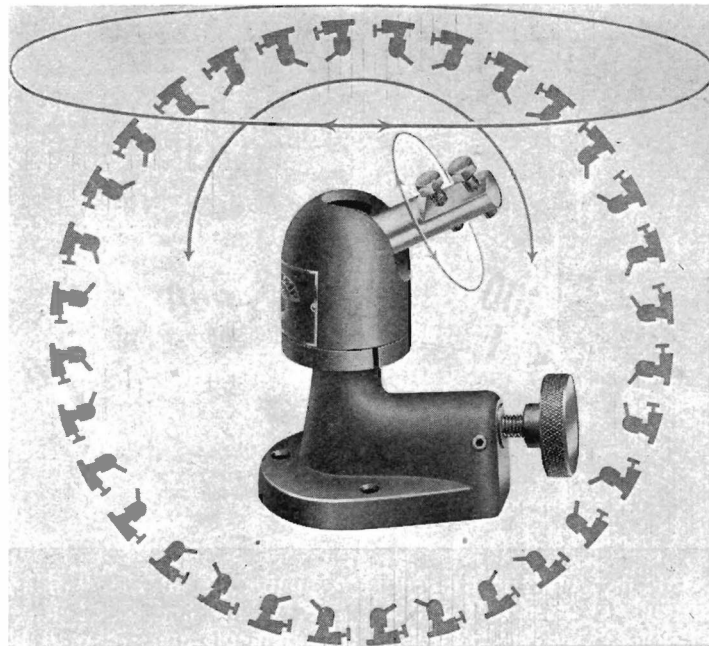

The "HYDRACLAMP" holds any object or assembly at any desired compound angle in the hemisphere allowing the operator complete freedom of both hands and complete accessibility to any part. The object is rigidly held by hydraulic pressure which can be instantly released to allow movement to any fresh position.



SPENCER, FRANKLIN LTD.
 292 HIGH HOLBORN, LONDON, W.C.1. TEL: HOLBORN 1436/7
 TELEGRAMS: SPENKLIN, HOLB, LONDON CABLES: SPENKLIN, LONDON

ISOLATE that **VIBRATION**

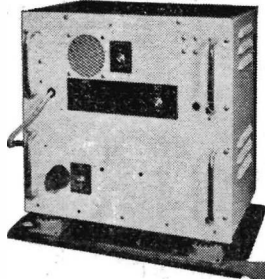

through **EQUIFLEX**

THE ALL-METAL SPRING MOUNTING

- EQUAL FLEXIBILITY
IN ALL DIRECTIONS
- CAN BE LOADED IN ANY DIRECTION
- UNAFFECTED BY CLIMATIC CONDITIONS
- VARIOUS TYPES FROM 1-35 lbs PER UNIT
- VIBRATION IS BOTH DANGEROUS AND COSTLY

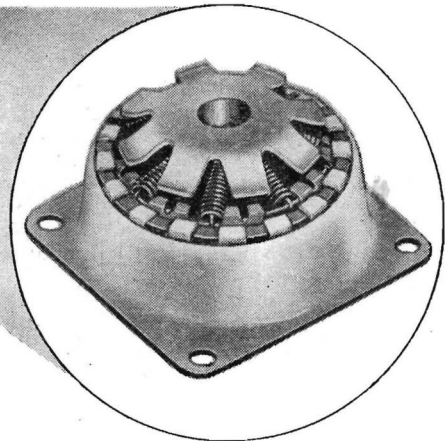

Write for Catalogue and Price List to

A. WELLS & CO. LTD.
STIRLING RD WALTHAMSTOW, LONDON E.17.

M.O.S. TYPE APPROVED. PATENT NO 571026
FOREIGN PATENTS GRANTED

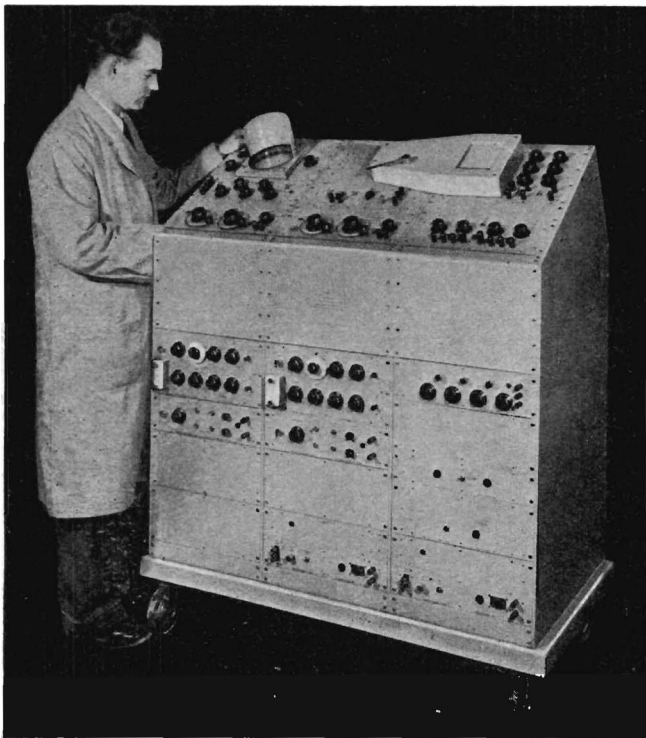

OSCILLOGRAPHS FOR ALL PURPOSES

The ME24 Type illustrated has F.M. Pre-amplifiers for capacity pick-ups, D.C. Pre-amplifiers for strain gauges, two recording tubes with a built-in recording camera, a large monitor tube, a time-base and a time-marker oscillator. This is a high-quality instrument capable of making a wide range of measurements. Write for our new catalogue.

S O U T H E R N I N S T R U M E N T S L I M I T E D

HAWLEY, CAMBERLEY, SURREY.

Telephone: Cambarley 1833/4.

Telegraphic Address "Minrak, Camberley, England."

P 524

**AN IMPRESSIVE
LABORATORY STANDARD**

VIDEO OSCILLATOR TF 885 is a wide range beat frequency oscillator, impressive alike in performance, stability and appearance. It embodies thermally screened oscillators, dual frequency standardisation, a ladder-network attenuator and really effective automatic level control. The output, monitored by a valve voltmeter, may be of sine or square waveform and is continuously variable from $316\mu\text{V}$ up to 31.6V (1 watt into 1000Ω) sinewave, or 64V peak-to-peak squarewave.

The frequency cover — 2 bands on a generous 8-inch dial — is 25 c/s to 5 Mc/s sine and 50 c/s to 150 kc/s



square. At full load individual harmonics are generally below 3%, falling considerably at lower outputs. The frequency characteristic is within 1 db, as are the attenuator steps at other than extreme h.f. attenuation.

Further particulars are obtainable from any of the addresses below.

MARCONI instruments

MARCONI INSTRUMENTS LTD · ST. ALBANS · HERTS · PHONE ST. ALBANS 6161/7
 London Office: Marconi House, Strand, W.C.2. Midland Office: 19 The Parade, Leamington Sp. Northern Office: 30 Albion Street, Hull.

**TOROIDAL
POTENTIOMETERS
10-1000 WATTS**

Ceramic Insulation only—and approved for Tropical conditions. Complete Ceramic Rings for strength. Approved by all Government Departments. Reasonable Delivery.

Also precision Toroidal-wound Potentiometers (including 360° of winding with up to eight tapping points) and Helical-wound Potentiometers of 3600° of winding. All are available with sealed spindles and glass or ceramic terminal seats.

Specialists in ALL TYPES OF TOROIDAL WINDINGS

P. X. FOX LIMITED
 HORSFORTH YORKSHIRE · ENGLAND
 Telephone: Horsforth 2831
 Telegrams: Toroidal, Leeds

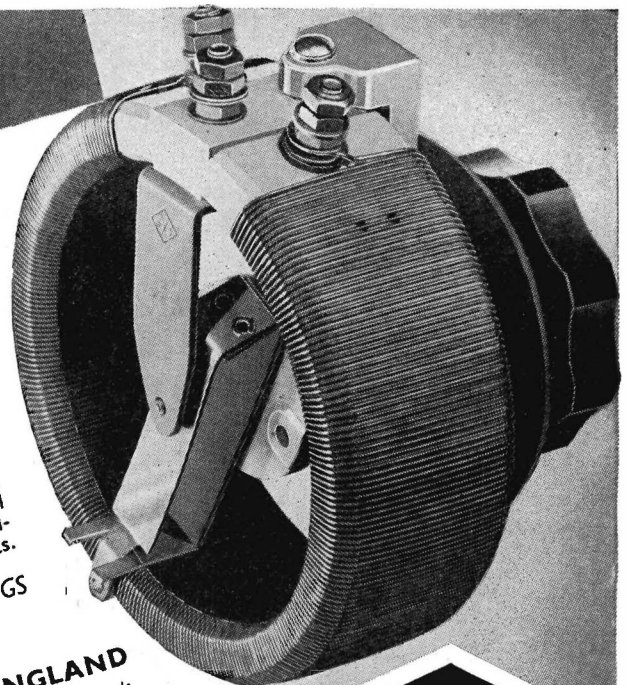

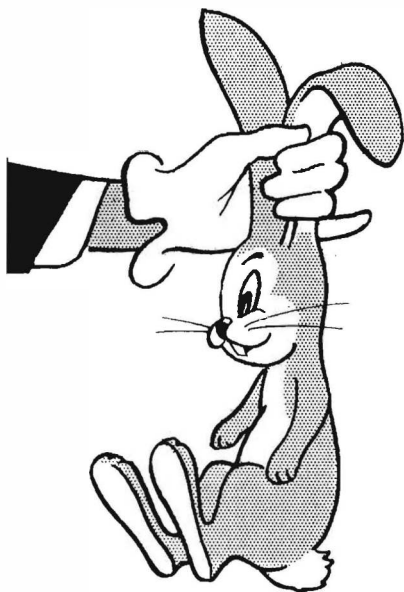

Not magic

... it's the result of
intensive engineering research

There's no magic in the design of Vitavox loudspeakers, there are no short cuts to perfection. The magician's approach to loudspeaker design has produced many a red herring out of the hat by mistake and the years of steady development work which we have undertaken show that it's not all done by mirrors.

A typical example of Vitavox design for sound, Bitone Reproducers are intended for quality reproduction in small halls, the use of multicell horns in the high frequency channel ensuring maximum fidelity over a wide area.

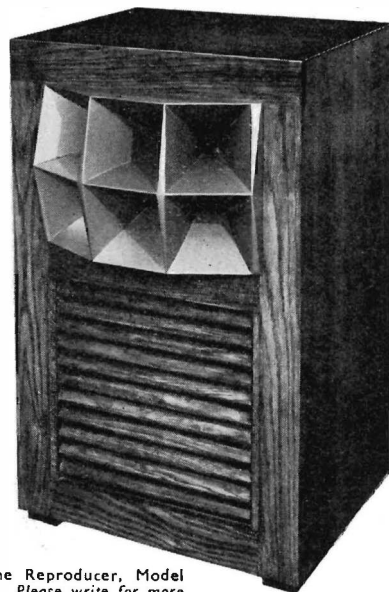

Bitone Reproducer, Model 6201. Please write for more details if you are interested.

VITAVOX

LOUDSPEAKERS AND MICROPHONES

VITAVOX LIMITED • WESTMORELAND ROAD •
LONDON N.W. 9. Telephone : COLindale 8671-3

Consult the Specialists about **MAGNETIC ALLOYS**

When selecting stamping materials for the cores of small transformers, chokes, relays, etc., or shields and screening boxes to house them, it always pays to consult the acknowledged specialists.

There's a world of difference between "transformer iron" and one of the Telcon high permeability nickel-iron alloys. The difference is chiefly a matter of *magnetic performance*.

Each of the soft magnetic alloys of the Telcon Metals family is scientifically formulated and processed, under laboratory control, to possess a known combination of electrical and magnetic properties most suited to a particular range of operating conditions. The practical advantages are that by selecting the grade appropriate to a given application, useful savings in weight and bulk become possible with a worthwhile increase in efficiency.

Manufacturers are invited to write for technical advice and details of design data.

TELCON METALS



THE TELEGRAPH CONSTRUCTION & MAINTENANCE CO., LTD.

Head Office: 22 Old Broad Street, London, E.C.2.
Enquiries to: Telcon Works, Greenwich, S.E.10.

Telephone: LONDON Wall 7104
Telephone: GREENWICH 3291

MYCALEX

THE INSULATOR

REG. TRADE MARK

GLASS BONDED MICA.
The nearest to a perfect insulator. Complies generally with
B.S.S. 488, 737, 738, 1540, 1598, etc.

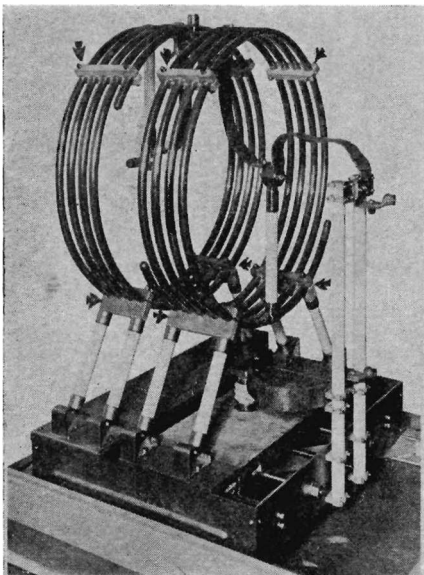

Photograph by courtesy of the Standard Telephone & Cables Ltd.

Supplied to customers' requirements as rods, sheets and mouldings of any shape.

NO shrinkage after moulding. Metal inserts incorporated during moulding process.

FOR RADIO AND ELECTRONIC EQUIPMENT INSULATION—Low loss at H.F.—Power Factor between .0005 and .0015 for different grades—Very high S. and V. resistivity—Permittivity between 6 and 9 for different grades—Electric strength 550 V. per .001 inch.

FOR POWER FREQUENCY EQUIPMENT INSULATION—Arc resistant — Non-tracking. For Arc shields — Switch Gear — H.V. Tension and compression insulators and Brush Holders, etc.

Oil and Water absorption nil. Maximum working temperature 400°C.

Also manufacturers of H.V. Capacitors, Heater Panels and Thermostats.

MYCALEX CO. LTD. Ashcroft Rd., Cirencester

London Office: 85, Gracechurch Street, London, E.C.3.

Contractors to H.M. Government and Service Departments.
A.I.D. Approved.

Telegrams and Telephones; Cirencester 400 (3 lines).

The Coupling Coil of a 200 KW Transmitter shown, is held to correct pitch and alignment by means of MYCALEX clamps as indicated by arrows.

AN AUDIO FREQUENCY RESPONSE CURVE

when plotted point by point is a tedious and lengthy operation. A bottleneck in production, it requires numerous instruments and operatives who could be used more profitably elsewhere.

The **MODEL 1900 AUDIO FREQUENCY RESPONSE CURVE TRACER** (see illustration) incorporates in the one instrument all the circuiting needed for taking a response curve. It automatically draws on the screen of a cathode ray tube a full and accurate curve once in **5 SECONDS**, repeating it as often as desired.

The instrument's small size, portability and moderate price, plus its high speed of operation, make it invaluable wherever a response curve must be taken.

For details write to:—

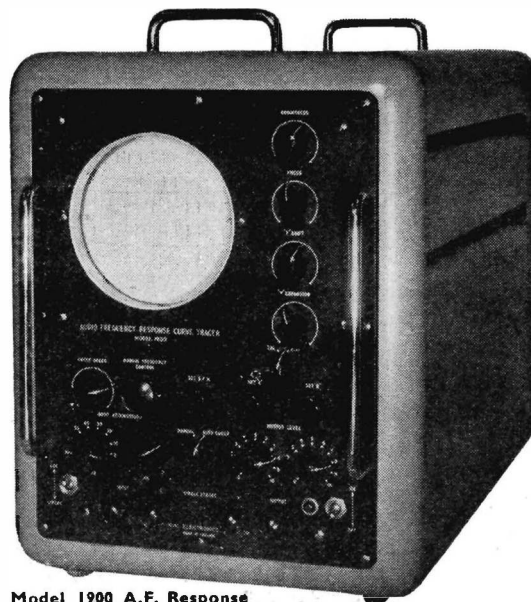

Model 1900 A.F. Response Curve Tracer

INDUSTRIAL ELECTRONICS
Makers of Industrial Controls and Precision Instruments
99, GRAYS INN ROAD, LONDON, W.C.1. Phone: HOLborn 9873/4

PHILIPS announce
a wide extension to their range of

**ELECTRONIC
INSTRUMENTS**

by the introduction of instruments

for the **RADIO AND
ALLIED INDUSTRIES**

The range includes:

- Standard Condensers
- Oscilloscopes
- H.F. Oscillators
- A.F. Oscillators
- Measuring Bridges
- Valve Voltmeters
- Electronic Switches
- Electronic Relays
- Power Supplies
- Television Pattern Generators
- Variable Transformers
- Electronic Test Meters

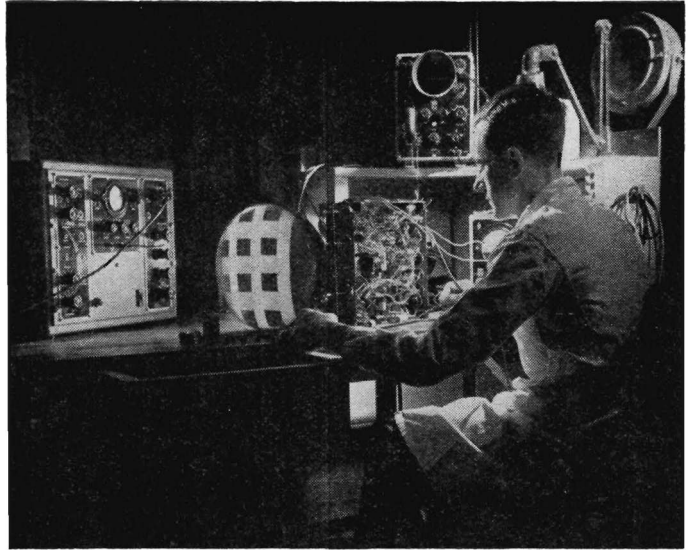

PHILIPS ELECTRICAL

LIMITED

CENTURY HOUSE. SHAFTESBURY AVENUE, LONDON, W.C.2.

(P1971)

PANAX EQUIPMENT LTD.

MANUFACTURERS OF INSTRUMENTS AND EQUIPMENT FOR THE RADIOCHEMICAL LABORATORY

Our Range includes :—

- COMPLETELY SELF-CONTAINED GEIGER MULLER COUNTING EQUIPMENT COMPRISING PRE-AMPLIFIER-SCALER-MECH: REGISTER AND STABILISED POWER SUPPLY ● RADIATION MONITOR FOR A.C. MAINS OPERATION ● PORTABLE BATTERY OPERATED MONITOR FOR BETA GAMMA DETECTION ● UNIVERSAL LEAD CASTLE FOR USE WITH MOST TYPES OF LIQUID AND END WINDOW COUNTERS ● PROTECTIVE GM TUBE HOLDERS ● STABILISED POWER SUPPLIES ● EHT UNITS FROM 0-10 KV ● OSCILLOSCOPES.

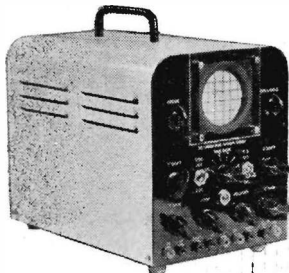

MODEL 2-D OSCILLOSCOPE
A compact instrument for general purpose use.

**MODEL 50-A RATE OF COUNT
G-M MONITOR**
For detecting and measuring Beta Gamma radiations.

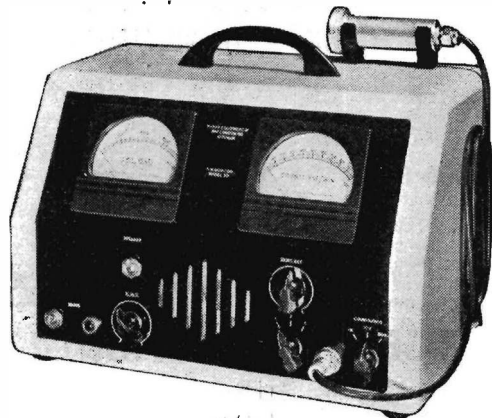

PANAX EQUIPMENT LTD.
173 LONDON RD., MITCHAM, SURREY.

Telephone : MITcham 2006-7

BARE & INSULATED RESISTANCE WIRES

Eureka (Regd.) and Nickel-Chrome

'Eureka' (Regd.) and Nickel-Chrome Resistance Wires can be supplied BARE or with STANDARD COVERINGS of cotton, silk, rayon, enamel and glass.

These wires have been used for many years for winding resistances for instruments, control apparatus, etc.

'Eureka' with its low temperature coefficient is always in demand for precision work, while Nickel-Chromes are used where a high resistance is required in a limited space.

Full details gladly supplied upon request — please address your enquiries as follows:



INSULATED WIRES



BARE WIRES

**THE LONDON ELECTRIC WIRE COMPANY
AND SMITHS, LIMITED**
LEYTON, LONDON, E. 10.

VACTITE WIRE COMPANY LTD.
75 ST. SIMON STREET,
SALFORD 3, LANCs.

ALWAYS "FIT"



CASTORS

THE WORLD'S BEST

Loads up to **30 TONS** per castor. Wheel diameters from $1\frac{5}{8}$ " to 40". All types of wheels and head fittings can be selected from our range of over

6000 TYPES & SIZES

ASK FOR BROCHURE

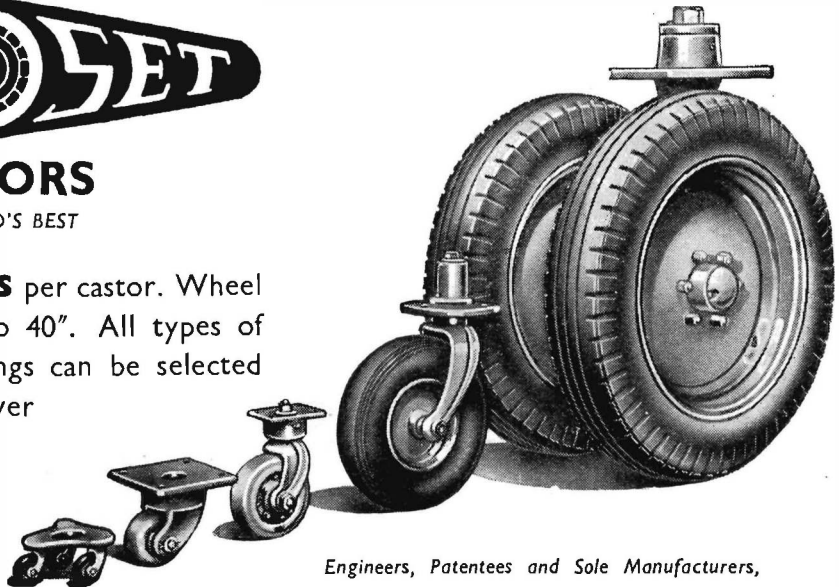

This may be news to you but it is not to thousands of satisfied customers!

Engineers, Patentees and Sole Manufacturers,

AUTOSET (PRODUCTION) LTD., Dept. M, Stour St., B'ham 18

EST. OVER 30 YEARS.

Please mention "Electronic Engineering"

EDG 1143/4
AT2

Industrial High Vacuum



By J. R. Davy, B.Sc., F.P.S., Chief Physicist, Messrs. Barr & Stroud, Ltd. The author has had considerable experience in the application of high-vacuum technique in industry, and his book is of great value to the high-vacuum physicist and to industrial technicians and students. It deals fully with the pumping system and allied mechanisms, with the application of the plant to industrial purposes, and with the basic theory. 82 illustrations. 25/- net.

Pitman

Parker Street, Kingsway, London, W.C.2

CO-AXIAL RELAY

TYPE SCX

Characteristic Impedance 45 or 70 Ω.

Body size only

$2\frac{1}{2}'' \times 1\frac{3}{8}'' \times 1\frac{1}{8}''$.

Further details in List 245/B.

NOTE:

Reserved at present for Services and Industrial purposes.

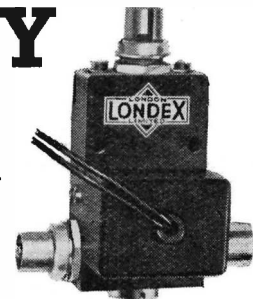

LONDEX LTD



Anerley Works,
London, S.E.20.

Tel.: SYDenham 6258.

create —
to originate, develop,
form, manufacture,
construct, accomplish

Creators Ltd.

We at CREATORS LTD. know that plastics can form an integral part of the electrical and electronic trades, and we are proud to present the following "combined services" to the industry:—

Fabrication of Junction Sleeves which are made to our customers' requirements.

Extrusions of all technical shapes.

Tool insulation. Pliers, snips, wrenches, etc. (Tested by the National Physical Laboratory to 31,000 v.)

Injection Moulding.

High Frequency Welding.

PLUS — A comprehensive Engineering Section for the manufacture of combined Plastic and Metal products.



CREATORS, LTD.
NEW HAW WEYBRIDGE SURREY
BY FLEET 3207 & 3420



Only with **CO-AX**
P.F. CABLES

AIR-SPACED ARTICULATED



Patents
Regd. Trade Mark.

THE LOWEST EVER
CAPACITANCE OR
ATTENUATION

IMMEDIATE
DELIVERIES

SPECIALISTS IN AIR-SPACED
ARTICULATED CABLES SINCE 1929

TRANSRADIO LTD.
CONTRACTORS TO H.M. GOVERNMENT
138A CROMWELL ROAD, LONDON SW7
ENGLAND

LOW ATTEN TYPES.	IMPED OHMS	ATTEN. db/100ft	LOADING %/100ft	O.D."
A 1	74	1.7	0.11	0.36
A 2	74	1.3	0.24	0.44
A34	73	0.6	1.5	0.88
LOW CAPAC TYPES.	CAPAC. pF/ft	IMPED. OHMS	ATTEN. db/100ft	O.D."
C 1	7.3	150	2.5	0.36
PC1	10.2	132	3.1	0.36
C11	6.3	173	3.2	0.36
C 2	6.3	171	2.15	0.44
C22	5.5	184	2.8	0.44
C 3	5.4	197	1.9	0.64
C33	4.8	220	2.4	0.64
C44	4.1	252	2.1	1.03

HIGH POWER
FLEXIBLE

PHOTOCELL
CABLE

VERY LOW
CAPACITANCE

"Cyldon" Variable CAPACITORS

from **MINIATURE TRIMMERS to HIGH VOLTAGE TRANSMITTER CAPACITORS**

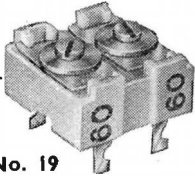

No. 19
Miniature Mica
Compression Trimmer

The 3 forms in which this compact variable capacitor is available make it useful as a miniature I.F. trimmer for use in small coil packs, etc. No. 19, illustrated, is a dual trimmer on a common base. No. 19a is a dual trimmer with a steel strip tapped 8 B.A. for mounting. No. 19g is a multi-way trimmer in 2, 4, or 6 sections, banked in mixed capacities to customers specifications. Each is tested for insulation breakdown throughout its capacity range at 250 v. D.C.

Full details of the complete "Cyldon" range and list of Agents for Home and Overseas available from the manufacturers:

SYDNEY S. BIRD & SONS, LTD.
CAMBRIDGE ARTERIAL ROAD, ENFIELD, MIDDX.
Phone: Enfield 2071-2. Grams: Capacity, Enfield.

No. 25
Mica
Compression Trimmer

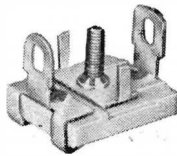

Although suitable for very small equipment, its range of maximum capacities—up to 750 pF.—gives it wide application. No. 25, illustrated, is for chassis mounting or wire suspension. (Illustration is of under side.) No. 25g is a multi-way assembly for coil packs, fixed station trimming, etc., on a mounting plate pierced for chassis or stand-off mounting. In units of mixed capacities to a maximum of six banks.

WILLIAM H. SMALL LTD.

Phone: Victoria 0223, 2003
Grams: Small, Victoria 0223, 2003
Birmingham

**WRIGHT STREET
SMALL HEATH
BIRMINGHAM. 10**



WASHERS in all materials
PRESSED NUTS Brass & Steel
PRESSINGS in all Metals,
Bakelite & Fibre.

*The basis
of world
standards*

Technical excellence supported by constant research and an unrivalled knowledge and experience of Radio Frequency Cable applications, ensures the continuance of the lead established by TELCON in the Radio Frequency Cable field.

Even before the introduction of Telcothene* as a cable dielectric, an application pioneered by TELCON, a range of Radio Frequency cables with unique capacity and attenuation characteristics was produced, using Telconax.

Today, developments are still going on and the solution of any problems involving the application of Radio Frequency cables will be found in the wide range manufactured by TELCON.

* Telcothene (Regd.)—Polythene processed by Telcon to provide specific characteristics.

TELCON R.F. CABLES

THE TELEGRAPH CONSTRUCTION & MAINTENANCE CO. LTD

Head Office: 22, OLD BROAD STREET, LONDON, E.C.2.

Telephone: LONDON Wall 7104

Enquiries to TELCON WORKS, GREENWICH, S.E.10.

Telephone: GREENWICH 3291



Founded 1864

STANDARD VISUAL ALIGNMENT EQUIPMENT

For TELEVISION, RADAR, CO-AXIAL CABLES, Etc.

USED BY LARGE MANUFACTURERS FOR ACCURATE
PRODUCTION ALIGNMENT AND CIRCUIT DEVELOPMENT

TYPE 42 WOBBULATOR

A complete alignment equipment for M.O.S. and other receivers having an I.F. of 9,720 kc/s

Sweep : ± 250 kc/s.

Calibration : 50 kc/s. markers in relation to 9,720 kc/s.

Markers superimposed on receiver response curve.

Output flat over band.

Attenuator system monitored and continuously variable from $1\mu V$ to 100 mV. Impedance 75 ohms.

TYPE 40 WOBBULATOR

Designed in conjunction with the B.B.C. Research Dept. for measuring the characteristic impedance of co-axial lines terminated by resistive loads or radiating elements.

USE :

Measuring the uniformity of co-axial cable.

Checking television and F.M. transmitting feeders and aerial arrays. Impedance calibrated 40-100 Ω .

Impedance changes of 1% are immediately displayed over a 10 mc/s. band.

Crystal calibration of frequency.

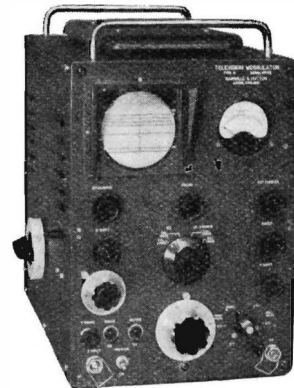

TYPE 41 TELEVISION WOBBULATOR

A self-contained instrument, covering all B.B.C. frequencies, for the alignment of television receivers to standard signal generator accuracy.

6 ranges sweeping 10 Mc/s including output for I.F. of 8-22 Mc/s.

Calibration by 1 Mc/s and 5 Mc/s. Crystal markers superimposed on receiver response curve. additional sound marker on each range.

Output flat and monitored.

Attenuator system $1\mu V$ -100 mV.

Y amplifier 0.75V input for 4 cms. trace.

SAMWELL & HUTTON

Electronic Equipment Manufacturers,

Combine Works,

1, GOODMAYES ROAD, ILFORD, ESSEX.

Seven Kings C342

WEBB'S *Radio*

can let you hear the **LATEST** developments in
HIGH FIDELITY

The VITAVOX KLIPSCHORN Reproducer

This is the world-famous corner speaker built to give the nearest possible approach to realism. Although of massive construction (weight 210 lbs) the space occupied is not excessive, and reproduction remains well balanced at low-volume level.

Price **£135**

The MORDAUNT DUPLEX Reproducer

The speaker for the connoisseur of sound reproduction. Uses a pair of highly specialised units for bass and treble, working into carefully designed exponential acoustic systems. Most critical listeners acclaim the Mordaunt to be the finest available speaker

Price **98 gns**

The above two speakers represent the peak in reproduction.

WEBB'S ALSO HAVE A FULL RANGE OF LOWER PRICED UNITS

There is a serious shortage of high-fidelity L.S. units owing to scarcity of magnets, but Webb's can usually help with leading makes. While stocks last we can offer at the old price:—

THE VITAVOX "K12/20" PM Unit, 15 ohms, price **£11 0 0** (present list price **£14 0 0**)

ACOUSTICAL "Q.U.A.D." AMPLIFIER

A new amplifier of great merit, with a really comprehensive Control Unit allowing for room compensation, also optional three-position filter control enabling the best possible results from differing transmissions and recordings. In addition the filter slope is controllable. From a practical view-point the controls allow full justice to modern records AND MAKE OLDER RECORDS SOUND VERY GOOD

Price **£35**

WEBB'S RADIO, 14 SOHO STREET, OXFORD STREET, LONDON, W.1.

Telephone : GERrard 2089

Shop Hours : 9-5.30. Saturdays, 9-1

Drayton MOTOR UNITS

RQ10

for

The Drayton R.Q. is a miniature capacitor induction type motor with a current consumption at 230 volts 50 cycles of 0.09 amps pf. 0.9. It is available:

R.Q.G. GEARLESS for running at 2700 r.p.m. continuously or intermittently in either direction or continuously reversed.

R.Q.R. GEARED for continuous running or reversing at speeds from 27 mins. per rev. to 600 revs. per min.

R.Q.H. GEARED for high final shaft speeds for continuous running, forward or reverse.

Send for List No. M 302-1

actuating valves, dampers, rheostats, geneva movements, rocking baths, flashing signs, illuminated models, soldering and welding fixtures, rotating tables, automatic light strip feed, lubricating and other small pumps, small machines, animated displays, vibrators, developing baths, agitators, fans, aspirators and similar devices.

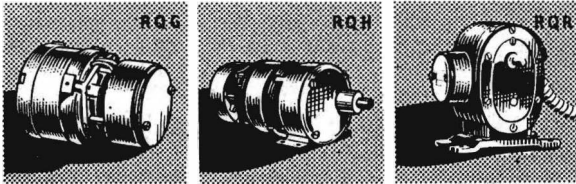

Drayton Regulator & Instrument Co. Ltd., West Drayton, Mdx. W. Drayton 2611

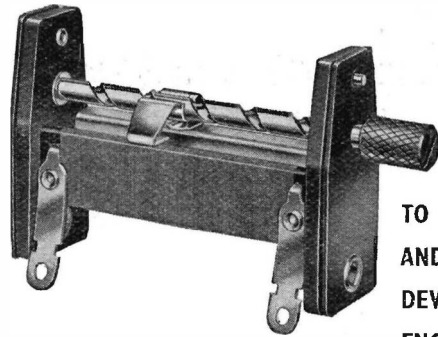

TO RADIO
AND T/V
DEVELOPMENT
ENGINEERS

This midget pre-set variable resistor with new double-slider gives greater stability and makes accurate adjustment easier. Designed for panel or chassis mounting: available in any value from 10 to 25,000 ohms.

EGEN
ELECTRIC LTD

Charfleet Industrial Estate, Canvey Island, Essex. Phone: Canvey 691



Dept. E.E

18 TOTTENHAM
COURT ROAD,
LONDON, W.1

Tel.: MUSeum 2453/4539

Shop hours: Monday - Friday 9-5.30
FULL MAIL ORDER FACILITIES.

Saturday 9-1
Please add postage

RELAYS

D.C. COIL RESISTANCE

3,000 TYPES: 1.9Ω to 80,000Ω
600 TYPES: 0.4Ω to 9,200Ω

ALSO LARGE STOCKS OF
DOUBLE & TRIPLE-WOUND
AND SLUGGED COILS.

CONTACTS

3,000 TYPES: up to 8 sets.
600 TYPES: up to 4 sets.

3,000 TYPES: Make (M), Break (B), in Twin-silver, Twin-platinum, Dome-silver (2 amp.), Tungsten (5 amp.), and Flat-silver (8 amp.). Change-Over (C), in all but Tungsten; Make-Before-Break (K), in Twin-silver and Twin-platinum.

600 TYPES: (M), (B) and (C), in Twin-silver and Twin-platinum.

SPECIAL

3,000 type Relays with 80,000Ω coils operating on approx. 600 μA. with up to four sets of contacts.

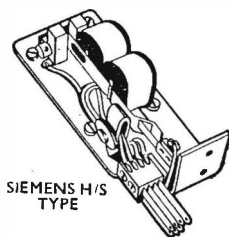
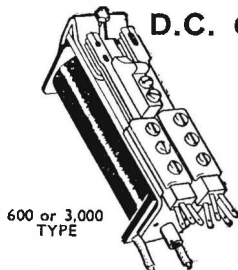

Electrolytic Iron Powder

'SINTREX'
BRAND

Its exceptional purity makes it especially suitable for electrical and magnetic applications. Supplied in a wide selection of mesh gradings.

**GEORGE COHEN
SONS & CO. LTD**

BROADWAY CHAMBERS
TELEPHONE:

THE
600
GROUP

LONDON - - - W.6.
RIVERSIDE 4141

EX/501/1P20

LAMALAC

INSULATION

SYNTHETIC RESIN LAMINATED MATERIALS

Sheet, Rod and Tube in all dimensions, Bobbins & Coil Formers to any specification

MICA AND MICANITE SHEET AND MANUFACTURED PARTS

MICA & MICANITE SUPPLIES LTD.,
BARNBURY SQUARE, LONDON, N.1.

Phone: NORTH 3032/5 Grams: MICASULIM, LONDON

WILKINSON'S OF CROYDON

AUTO TRANSFORMER, 230/115 volts 500 watts 50 cycles, fully shrouded, new. Made by Met. Vic. £4 10s. each.
RECTIFIERS SELENIUM $\frac{1}{2}$ wave 24 V 150 mA, 2s. 5d. each; 444 V 40 mA, 9s. 3d. each; Voltage Doubler, 168 V 40 mA, 7s. 6d. each; Bridge type 24 V 75 mA, 3s. 4d. each; 36 V 2.5 amp 27s. each; 48 V 75 mA, 5s. 7d. each; 48 V 150 mA, 6s. 10d. each; 96 V 600 mA, 31s. each; 96 V 2.5 amp, 66s. each.

MIRROR GALVONOMETERS 30 microamps per standard scale 20° sweep strong construction 5in. by 3 $\frac{1}{2}$ " £7 10s. each.
TEST SET 205. Wavemeter range. 3.05 to 3.35 centimeters, built-in oscillator with 9 valves including Klystron type CV.129, etc., in good condition, £20.

MICROAMMETER 0-50 2 $\frac{1}{2}$ Flush Type, contained in Test Set 28. A very sensitive meter. Only 50s. each, complete.
PHOTOMULTIPLIER WITH NETWORK No. 931A. Contained in Transmitting Unit APQ9. £5 each. Carriage and packing 10s.

BLASTING GALVANOMETER. Scale 0-25. Westinghouse. With leather case. New and boxed, 55s. each.
19, LANSDOWNE ROAD, CROYDON
CRO : 0839

THE BRITISH NATIONAL RADIO SCHOOL

ESTD. 1940

Now in our eleventh year and still—

NO B.N.R.S. STUDENT HAS EVER FAILED

to pass his examination(s) after completing our appropriate study course. Nothing succeeds like SUCCESS and what we have done already for so many of your colleagues, we can do again for YOU.

All our courses are conducted by correspondence, on INDIVIDUAL lines and our Syllabus includes preparation for the following examinations: A.M.Brit.I.R.E.: City and Guilds, Radio, Telecommunications, Mathematics and P.M.G. (theory only). Other courses include what we believe to be the finest RADAR course available anywhere.

Free Booklet (please mention this advt.) from—

STUDIES DIRECTOR

BRITISH NATIONAL RADIO SCHOOL

66 ADDISCOMBE ROAD, CROYDON

Phone Addiscombe 3341



Quantity production of small automatically made pieces in Steatite, Porcelain, and Rutile materials for electric cooking and heating equipment, and telecommunication apparatus.

BRAY



GEO. BRAY & CO. LTD., Leicester Place, Leeds 2

Tel.: 20981/8. Grams: "Bray, Leeds 2"

B.P.L. TEST SETS

NOW AVAILABLE

AT NET PRICES

B.P.L. UNIVERSAL TEST SET

£5 - 18 - 6

B.P.L. SUPER RANGER 1,000 Ω /v.

£13 - 10 - 0

B.P.L. SUPER RANGER 20,000 Ω /v.

£15 - 10 - 0

Prices include postage and packing, and are applicable to Home Market only.

end your order direct to:

British Physical Laboratories

HOUSEBOAT WORKS, RADLETT, HERTS.

Tel.: Radlett 5674-5-6

"TECHNICAL EXCELLENCE"

—combines with beauty and soundness of DESIGN in the



OXLEY
AIR DIELECTRIC TRIMMER

Width: 1.5 m/m. Length: 22 m/m. Height: 1.1 to 8pF—7.5 m/m. 1.8 to 20pF—19 m/m. 2 to 20pF—11 m/m. 2 to 32pF—12m/m. Low: Straight line capacity. Power Factor: Less than .001. Insulation: Over 2,000 megohms. Voltage: 500 D.C.

Types approved Oct. 4 No. 464.

OXLEY DEVELOPMENTS CO. LTD.
ULVERSTON, NORTH LANCs. TEL: ULVERSTON 3384

AMBITIOUS ENGINEERS

HAVE YOU HAD YOUR COPY OF "ENGINEERING OPPORTUNITIES"?

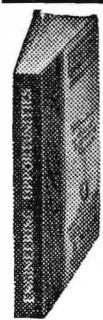

Whatever your age or experience—you must read this highly informative guide to the best paid engineering posts. The handbook contains particulars of A.M.I.C.E., A.M.I.Mech.E., A.M.I.M.I., A.M.Brit.I.R.E., and other important Engineering Examinations, and outlines home-study courses in all branches of Civil, Mechanical, Electrical, Automobile, Radio and Aeronautical Engineering, Government Employment, Draughtsmanship, Building and Plastics, Matriculation, etc. We Guarantee "NO PASS—NO FEE"

If you are earning less than £14 a week you cannot afford to miss reading "Engineering Opportunities." It tells you everything you want to know to secure your future. Write for this enlightening guide to well paid posts NOW—FREE and without obligation.

BRITISH INSTITUTE OF ENGINEERING TECHNOLOGY

BIET

337a Shakespeare Hse., 17/18 Stratford Place, London W1

The tricky ones were fun!

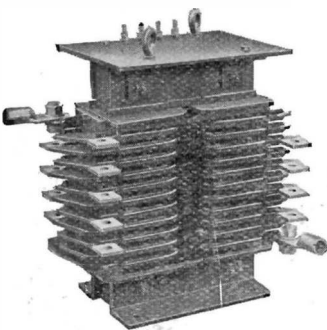
They still are to our technical staff but present conditions are giving our production Manager a nasty headache—the 'fun' therefore must be confined to priority jobs for the time being.

Telephone **SAVAGE**  **DEVIZES** Devizes 536

SAVAGE TRANSFORMERS LTD. NURSTEED RD., DEVIZES, WILTS.

SOLONS FOR ESSENTIAL JOBS!



Use SOLONS for the jobs that matter—this modern precision tool makes soldering speedier, simpler and more reliable. 5 models: 65 watt with oval tapered and round pencil bit; 125 watt with oval tapered and round pencil bit; 240 watt with oval tapered bit; each with 6 feet 3-score Henley flexible. Voltage ranges from 100 to 250. Write for folder Y.10.

HENLEY SOLON TRADE MARK
ELECTRIC
SOLDERING IRONS
FOR INDUSTRIAL USE

W. T. HENLEY'S TELEGRAPH WORKS CO. LTD.
51-53 Hatton Garden, London, E.C.1.

"SPEARETTE" MINIATURE VALVE

SCREEN CAN EXTRACTORS.
PIN ALIGNING TOOLS. For Radio,
EXTRACTING TOOLS. Television,
RETAINING CLIPS. Telecommunications,
WIRING JIGS. and Electronic Equipment
of all types.

SPEAR ENGINEERING CO. LTD.
TITAN WORKS, WARLINGHAM, SURREY
Telephone: Upper Warlingham 2774

"J.B." SERVICE (BEXLEYHEATH) LTD.
5 MAYPLACE ROAD WEST, BEXLEYHEATH, KENT

OFFER

PRESTCOLD REFRIGERATION UNIT FOR RIVET STORAGE. METERED TEMPERATURE DOWN TO 10° C. £150.

ANTENNA PEDESTALS, ROTATING, NAVY TYPE, CNM-10 ACH. 115 VOLT, 60 CYCLE. £50.

RESISTANCES VARIABLE. HAND-WHEEL DRIVE. 10 OHMS, 3.5 AMP., 5.70 OHMS, 7.8 AMP., 5.7 OHMS, 8 AMP. ALL TYPES, 17/6 EACH.

PUBLIC ADDRESS SPEAKERS, 2" 3" FLARE. EXCELLENT CONDITION. £3.

SOCKETS, CLIX TYPE, REF. 10H/260B. ENQUIRIES INVITED FOR QUANTITIES.

ALL-METAL SPRING MOUNTS, WELLS TYPE ENQUIRIES INVITED FOR QUANTITIES.



MICA

DISCS
DIAPHRAGMS
ELEMENT STRIPS
CONDENSER PLATES
SPECIAL SHAPES
RAW MICA
WASHERS
etc

BRITISH MICA CO^{LTD} - BEDFORD.

TECHNICAL BOOKS

H. K. LEWIS & Co. Ltd., invite inspection of their stock of books on all branches of Radio and Electrical Engineering. Catalogue on request.

LENDING LIBRARY : Technical and Scientific.
Annual Subscription from TWENTY-FIVE SHILLINGS

Prospectus Post Free on Request.

THE LIBRARY CATALOGUE revised to December 1949, containing a classified Index of Authors and Subjects/recently published. To subscribers, 17s. 6d. net. To non-subscribers 35s. net. Postage 1s.

LONDON: H. K. LEWIS & Co. Ltd., 136 Gower St., W.C.1
Telephone: EUSton 4282 (7 lines)



Instruments  *for Research and Industry*

The CHRONOTRON

An electronic stopclock for measuring time intervals in the millisecond region. Widely used for timing relays, speeds of vehicles and projectiles, camera shutters and in psychological research. Operated by contacts or photocell.



MODEL 25 A—0 to 1000 milliseconds (lowest range 0—4 mS)

MODEL 25 B—0 to 10 seconds (lowest range 0—40 mS)

MODEL 25 C—0 to 10 milliseconds (lowest range 0—40 μS)

ELECTRONIC INSTRUMENTS LTD

17, PARADISE ROAD · RICHMOND · SURREY · ENGLAND



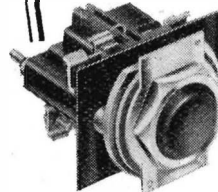

DONOVAN ACCESSORIES— FOR THE ELECTRONIC APPARATUS MANUFACTURER!

TYPE J.96 TERMINAL BLOCKS. Made in 15, 30 and 60 amp. sizes.

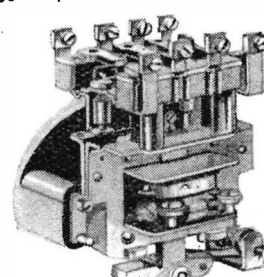

Type C.30 PUSH-BUTTON UNIT arranged for mounting on customers' own cover plate.



Type A.11 A.C. POWER RELAY — 4-pole with N.O. or N.C. contacts.

THE DONOVAN ELECTRICAL CO. LTD.
Safuse Works · Stechford · Birmingham 9

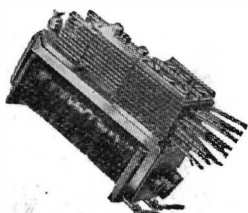

MAGNETIC RELAYS

LARGEST STOCK IN GREAT BRITAIN OF RELAYS, KEY SWITCHES AND UNISELECTORS

Government Contractors

RELAYS P.O. 3000 — 600 — SIEMENS' HIGH SPEED. 400v. A.C. 50cy.

ALL NEW EX-MINISTRY GOODS

JACK DAVIS (Relays) LTD. DEPT. E.E.
36 PERCY STREET, LONDON, W.1.
Phones: MUSEum 7960 LANgham 4821

*Three piece lead wires —
for hard glass seals*

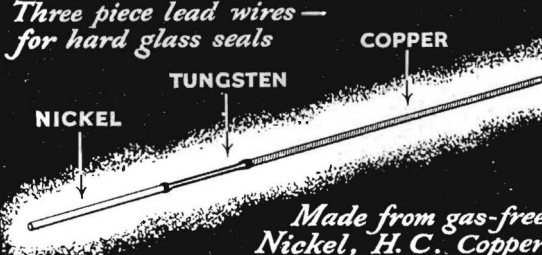

NICKEL
TUNGSTEN
COPPER

*Made from gas-free
Nickel, H. C. Copper
and split-free TUNGSTEN*

 **ELECTRO-ALLOYS LTD** 12 Brunel Rd. London, W.3
Makers of TUNGSTEN and MOLYBDENUM Products

INDEX TO ADVERTISERS

Advance Components Ltd.	30	Drayton Regulator & Instrument Co. Ltd.	52	Muirhead & Co. Ltd.	18
Air Control Installations Ltd.	29	Dubilier Condenser Co. (1925) Ltd.	15	Mullard Ltd.	5 and 28
Airmec Laboratories Ltd.	12	Du Bois Co. Ltd., The	32	Multicore Solders Ltd.	Cover iv
Automatic Coil Winder & Equipment Co. Ltd., The	11	Edison Swan Electric Co. Ltd., The	10	Murex Ltd.	40
Automatic Telephone & Equipment Co. Ltd.	33	Edwards & Co. (London) Ltd., W.	40	Mycalex Co. Ltd.	46
Autoset (Production) Ltd.	48	Egen Electric Ltd.	52	Nagard Ltd.	27
Baldwin Instrument Co. Ltd.	41	Electro-Alloys Ltd.	55	N.S.F. Ltd.	39
Belling & Lee Ltd.	35	Electronic Engineering Monograph	453	Oxley Developments Co. Ltd.	54
Bird & Sons Ltd., Sydney S.	50	Electronic Instruments	55	Panax Equipment Ltd.	47
Bray & Co. Ltd., George	53	E.M.I. Parent Co.	13	Philips Electrical Ltd.	47
British Institute of Engineering Technology	54	English Electric Co. Ltd., The	31	Pitman & Sons Ltd., Sir Isaac	49
British Insulated Callender's Cables Ltd.	Cover i	Evershed & Vignoles Ltd.	22	Radio Resistor Co. Ltd.	38
British Manufactured Bearings Co. Ltd.	Cover iii	Ferranti Ltd.	23	Radiospares Ltd.	8
British Mica Co. Ltd.	55	Fox Ltd., P. X.	44	Ragosine Oil Co. Ltd.	32
British National Radio School, The	53	General Electric Co. Ltd., The	36	Samwell & Hutton	51
British Physical Laboratories Ltd.	53	Henley's Telegraph Works Co. Ltd., W. T.	54	Sankey & Sons Ltd., Joseph	Cover ii
British Thomson-Houston Co. Ltd.	9	Hunt Ltd., A. H.	34	Savage Transformers Ltd.	54
Bullers Ltd.	14	Industrial Electronics	46	Small Ltd., William, H.	50
Chance Bros.	56	Johnson Matthey & Co. Ltd.	3	Southern Instruments Ltd.	43
Chapman & Hall Ltd.	453	"J.B." Service (Bexleyheath) Ltd.	54	Spears Engineering Co. Ltd.	54
Cinema-Television Ltd.	20	Lewis & Co. Ltd., H. K.	55	Spencer, Franklin Ltd.	42
Cohen, Sons & Co. Ltd., George	52	Londex Ltd.	49	Standard Telephones & Cables Ltd.	17 and 21
Cole Ltd., E. K.	5	London Electric Wire Co. & Smiths Ltd.	48	Steatite & Porcelain Products Ltd.	16
Creators Ltd.	49	Lyons Ltd., Claude	19	Sullivan Ltd., H. W.	42
Davis Supplies Ltd., Alec	52	Marconi Instruments	44	Telegraph Construction & Maintenance Co. Ltd., The	45 and 50
Davis (Relays) Ltd., Jack	55	Measuring Instruments (Pullin) Ltd.	41	Transradio Ltd.	49
Donovan Electrical Co. Ltd., The	55	Metropolitan-Vickers Electrical Co. Ltd.	24	Tufnol Ltd.	7
		Mica & Micanite Supplies Ltd.	53	Vitavax Ltd.	45
		Minnesota Mining & Manufacturing Co. Ltd.	25	Vortexion Ltd.	37
				Walter Instruments Ltd.	26
				Webb's Radio	51
				Wells & Co. Ltd., A.	43
				Wilkinson, L.	53

Austinlite 'Fifty'

50 amps at 450 volts A.C. (slow break). 20 amps at 250 volts D.C. (quick break). Also available with 6 or 8-way mechanism for tapping etc.

Austinlite 'Thirty'

30 amps at 250 volts A.C. (slow break). 15 amps at 440 volts A.C. (slow break). 5 amps at 230 volts D.C.

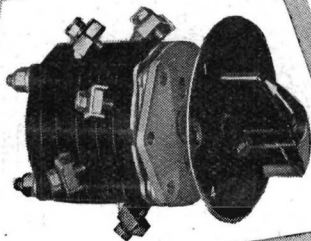
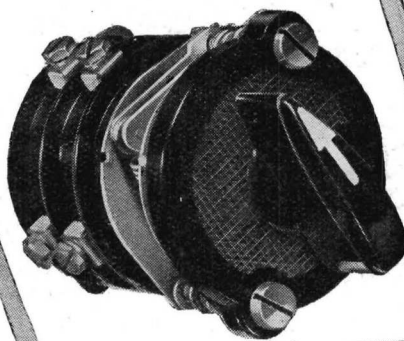

Austinlite switches are built for heavy duty. Their intelligent use for all forms of motor control including reversing, star delta starting and dynamic braking can save the expense of separate contactors or relays. For heater selection, on load transformer tap changing, or change-over switching, they are unrivalled. Why not send us details of *your* switching problem?

Cut your control gear costs

Austinlite switches are used and specified by: The Admiralty; British Electricity Authority; The Air Ministry; British Broadcasting Corporation; General Post Office; Crown Agents for the Colonies; National Physical Laboratory; Royal National Lifeboat Institution and most of the leading electrical manufacturers in Great Britain.

A *Chance* PRODUCT

AUSTINLITE LIMITED (A subsidiary of Chance Brothers Limited)
Dept. A., Lighthouse Works, Smethwick 40, Birmingham. Tel: West Bromwich 1824



We have pleasure in announcing that we are now producing gyro balls and bearings. We are also producing miniature steel balls .003" in diameter in addition to our present range of Grade A25 and Grade A1 balls.

Synthetic sapphire, ruby and agate balls are also produced in similar sizes and grades.

For particulars please apply to our Selling Agents at the following address :

B · M · B (Sales) Ltd

2 BALFOUR PLACE · MOUNT STREET · LONDON W.1

Telephone : GROsvenor 3155. Telegrams : Britmanbea, Audley, London. Cables : Britmanbea, London

All our products are entirely of British manufacture and are fully A.I.D. approved.

Soldering facts which no radio or television manufacturer can afford to ignore

Of the 500 soldered connections in a radio receiver or the 1,000 in a television set, it needs only *one* H.R. or "dry" joint to interfere seriously with reception. Knowing they cannot risk injury to their reputation, leading radio and television manufacturers all over the world rely on Ersin Multicore not only for greater soldering reliability, but also for faster production at lower cost. Here are some of the reasons why Ersin Multicore has attained such world-wide popularity:

- Ersin Multicore is the only solder with three cores of extra-active, non-corrosive Ersin Flux, which ensures quicker, more economical precision soldering. It not only prevents the formation of oxides during soldering, but actually cleans surface oxides.
- Three cores ensure flux continuity. There are no lengths of wire without flux—that means no wastage of solder or time and freedom from "dry" or H.R. joints.
- The correct proportions of flux to solder are always assured—no extra flux is required. Thinner solder walls mean instantaneous melting—an important factor in speeding up production.
- Soldered joints made with Ersin Flux do not corrode even after prolonged exposure to any degree of humidity. This has been tested under climatic conditions ranging from the Arctic to the Tropics.
- Only the finest virgin tin and lead are used in the manufacture of Ersin Multicore, ensuring freedom from impurities.
- Ersin Multicore cuts production costs by soldering more joints in less time, with no wastage. Because every joint is absolutely sound, fewer sets are rejected on test.

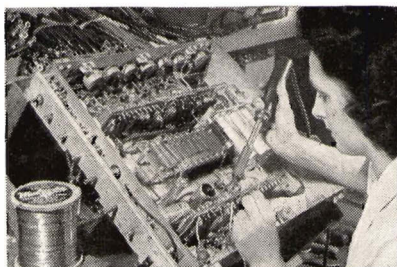

Ersin Multicore Solder being used at H.M.V. radio and television factories, Hayes, Middlesex.



This Pye Television transmitting equipment has more than 3,000 Ersin Multicore soldered joints.

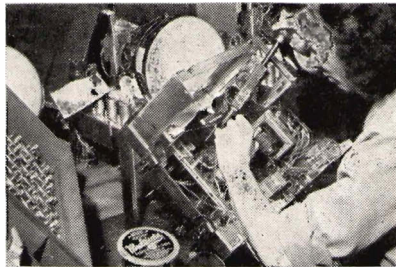

One of hundreds of operatives who assemble Ekco television sets with Ersin Multicore.

We will be pleased to send to manufacturers, without charge, new technical literature and bulk prices. Service engineers and radio enthusiasts can obtain Size 1 cartons, at prices given below, from most radio and electrical shops.

SIZE 1 CARTONS 5/- RETAIL

Catalogue Ref. No.	Alloy Tin/Lead	S.W.G.	Approximate length per carton
C 16014	60/40	14	13 feet
C 16018	60/40	18	37 feet
C 14013	40/60	13	13 feet
C 14016	40/60	16	26 feet

Ersin Multicore Solder

The Finest Cored Solder in the World



7lb. reel for factory use. Size 1 Carton for Service Engineers.

MULTICORE SOLDERS LTD., MELLIER HOUSE, ALBEMARLE STREET, LONDON, W.1 • TEL: REgent 1411