

Harry S. Tuttle

Electronic Engineering

INCORPORATING ELECTRONICS, TELEVISION AND SHORT WAVE WORLD

**PRINCIPAL
CONTENTS**

Land Mine Locators

Nuclear Energy — Part I

Pentodes and Tetrodes operating as Triodes

High Stability Carbon Resistors

21-MAR. 1946

QUARTZ PLATES

for

COMMUNICATION EQUIPMENT

REGD. TRADE MARK

G.E.C. Low Temperature Co-efficient Quartz Crystal Oscillator Plates for Radio Frequency Control purposes are supplied in sealed holders and are suitable for use in all types of transmitter, fixed or mobile. The crystal plate is rigidly clamped in position and the unit will stand a considerable amount of rough usage without damage.

All holder metal work is silver plated and the electrodes are precision ground from high grade stainless steel.

All crystal plates are processed so as to eliminate frequency and activity ageing.

Standard Crystals cover the frequency range 3.5 Mc/s—10 Mc/s but crystals can be supplied for frequencies outside this range and for a wide variety of frequency—temperature characteristics.

Quantities running into hundreds of thousands per annum have been supplied during the war for ground sea and airborne equipment all over the world. The G.E.C. Quartz Crystal Factory is one of the most up to date in existence.

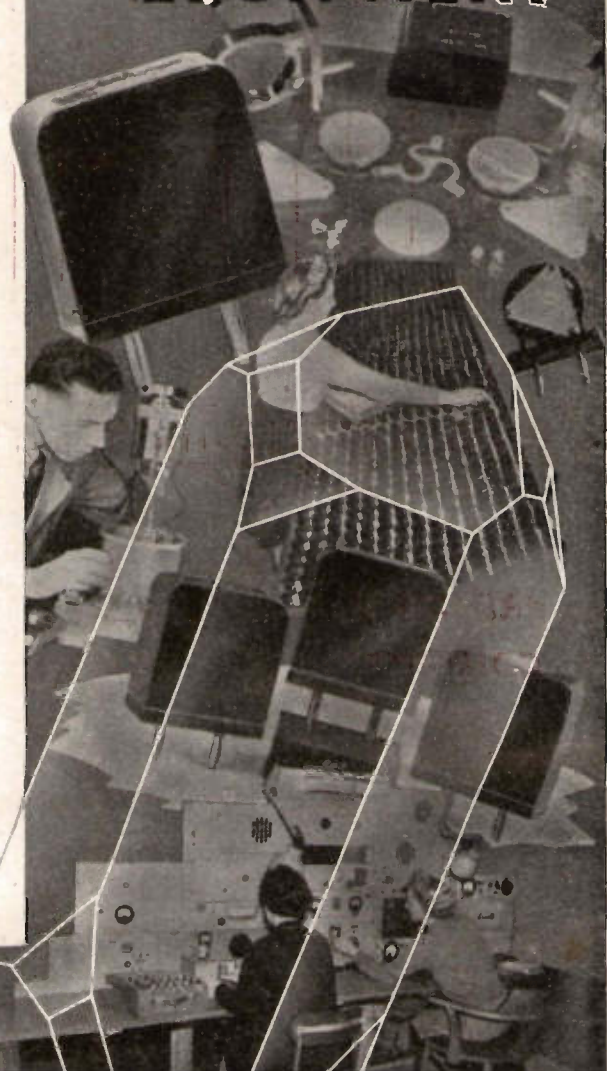

SALFORD ELECTRICAL INSTRUMENTS LTD.

PEEL WORKS, SALFORD, 3. Telephones : BLAckfriars 6688 (6 lines). Telegrams and Cables : "Sparkless, Manchester"

Proprietors: **THE GENERAL ELECTRIC Co. Ltd., of England**

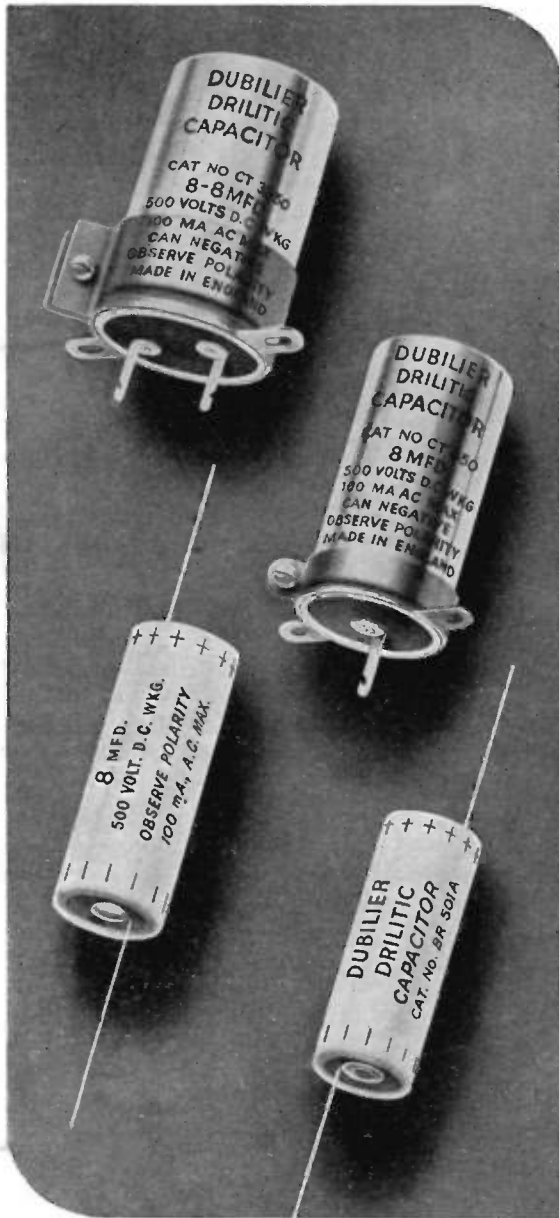

Now!
a full range

"DRILITIC"

ELECTROLYTIC CAPACITORS

Physically small, these B.R. and C.T. capacitors embody many technical advantages and their comprehensive coverage of every electrolytic requirement will be readily appreciated by users. The electrical characteristics of these capacitors are a marked advance in electrolytic design, the leakage current and equivalent series resistance are reduced, the audio and radio frequency impedance improved, breakdown voltage and life expectancy have been increased together with an improvement in temperature characteristics. They are contained in seamless drawn aluminium containers hermetically sealed and the container is always negative.

DUBILIER
CONDENSER CO. (1925) LTD
LONDON. W.3

"DRILITIC" CAPACITORS						
Capacitance	MAXIMUM Working Voltage	SIZE INCHES		MAXIMUM Ripple Current mA.	TYPE Number	RETAIL PRICE EACH
		D.	L.			
50	12	1/4" dia. x 1/2" dia. x 1/2" dia.	1 1/2	55	BR501	2s. 6d.
25	25		1 1/2	75	BR252A	2s. 6d.
50	50		2	190	BR505	3s. 6d.
8	150		1 1/2	110	BR815	2s. 9d.
8	500	2	2	100	BR850	4s. 0d.
8	500	1" dia.	2	100	CT850	4s. 6d.
16	500		2	110	CT1650	6s. 6d.
8-8	500-500		2	* 100-100	CT8850	6s. 6d.
16-8	500-500		2	* 110-100	CT16850	8s. 6d.

Vertical mounting clips supplied with C.T. types. * The total max. ripple current for both sections must not exceed the larger figure.

THE Model 7 Universal AvoMeter is the world's most widely used combination electrical measuring instrument. It provides 50 ranges of readings and is guaranteed accurate to B.S. first-grade limits on D.C. and A.C. from 25 to 100 c/s. It is self-contained, compact and portable, simple to operate, and almost impossible to damage electrically. It is protected by an automatic cut-out against damage through severe overload, and is provided with automatic compensation for variations in ambient temperature.

Write for fully descriptive pamphlet.

Sole Proprietors and Manufacturers:

AUTOMATIC COIL WINDER & ELECTRICAL EQUIPMENT Co. Ltd., Winder House, Douglas Street, London, S.W.1
 Telephone: VICToria 3404/8.



ONE INSTRUMENT

measures:—

- Current, A.C. and D.C. (0 to 10 amps.)
- Voltage, A.C. and D.C. (0 to 1000 v.)
- Resistance (up to 40 megohms)
- Capacity (10 to 20 mfd.)
- Audio-frequency Power Output (0 to 4 watts)
- Decibels (— 25 Db. to + 16 Db.)

The AvoMeter is one of a useful range of "Avo" electrical testing instruments which are maintaining the "Avo" reputation for an unexcelled standard of accuracy and dependability—in fact, a standard by which other instruments are judged.



WRIGHT & WE AIRE LTD

HIGH ROAD • TOTTENHAM • LONDON N17 Tel.: TOTtenham 3847/9
 VIBRATORS • TRANSFORMERS • SWITCHES • COILS

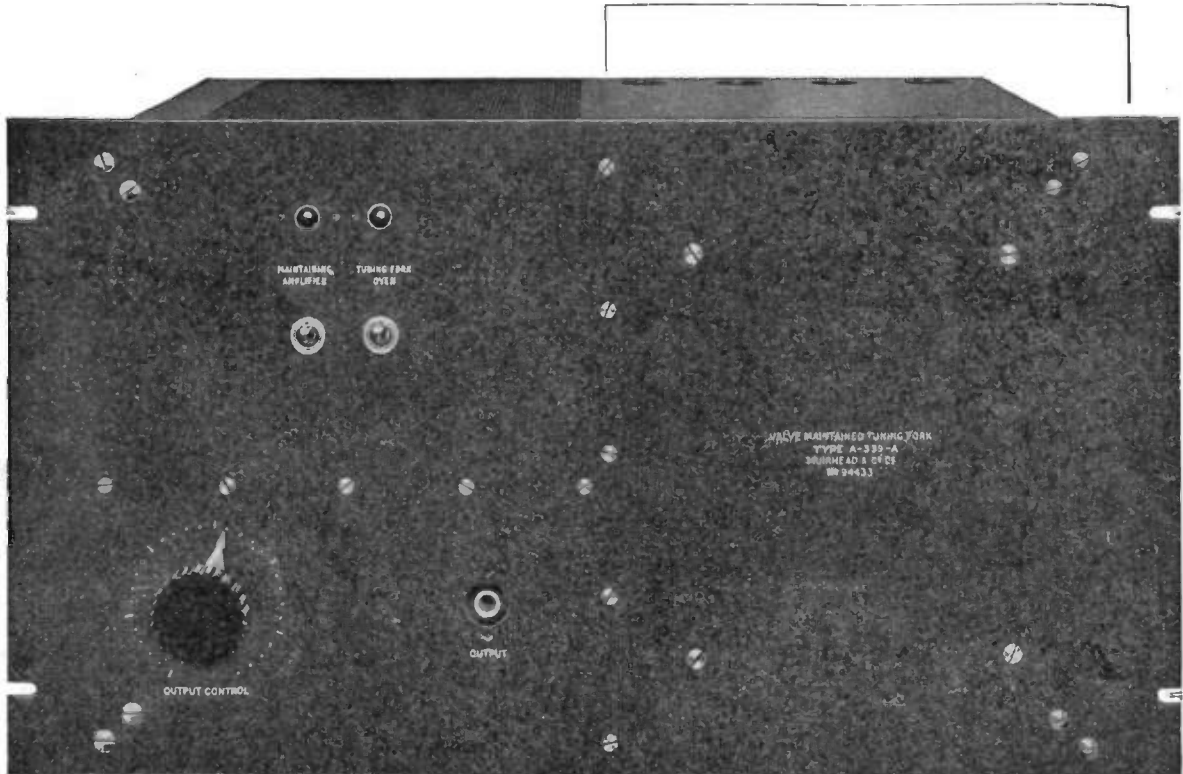

Valve Maintained Tuning Fork Type-A339

(Incorporating our *MINIATURE TUNING FORK*)

An audio-frequency standard of precision accuracy, small dimensions and reasonable price. *Bulletin No. B-522-A, giving full particulars of this instrument will be supplied on request.*

MUIRHEAD

MUIRHEAD & COMPANY LTD., ELMERS END, BECKENHAM, KENT.

Telephone: Beckenham 0041-0012

SPECIFICATION

GENERAL

Elinvar Tuning Fork, hermetically sealed and temperature controlled. Special negative feedback drive circuit.

FREQUENCY

Normally 1000 c.p.s. may be supplied for any frequency between 500 c.p.s. and 5000 c.p.s.

SUPPLIES

Type A-339-A ... A.C. Mains.
Type A-339-B ... Batteries

POWER OUTPUT

Type A-339-A ... 1 watt into 600 ohms for 2% distortion.
Type A-339-B ... ½-watt into 600 ohms for 2% distortion.

DIMENSIONS

Both types ... 19"x10½"x10½" deep.

FOR OVER 60 YEARS DESIGNERS & MAKERS OF PRECISION INSTRUMENTS

C.R.C. 34

DEVELOPMENTS IN MEASUREMENT AND CONTROL

We offer manufacturers and process users a service on problems of measurement and control . . . a service based on scientific method, technical ingenuity and modern production, covering the field of Idea, Prototype and Manufacture.

BALDWIN

INSTRUMENT COMPANY LIMITED
CUMNOR, OXFORD

originators and makers of scientific instruments for
measurement and control

B1

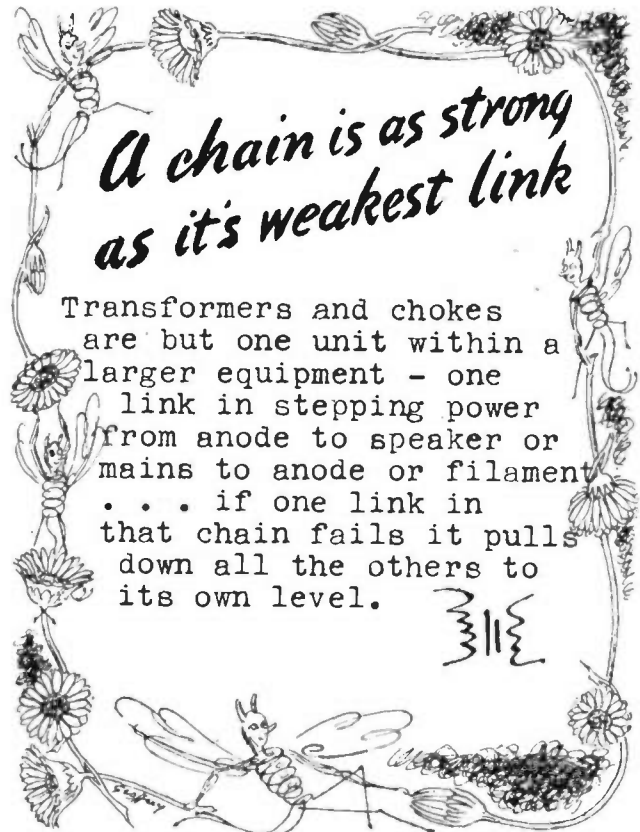

*A chain is as strong
as it's weakest link*

Transformers and chokes are but one unit within a larger equipment - one link in stepping power from anode to speaker or mains to anode or filament . . . if one link in that chain fails it pulls down all the others to its own level.



PARMEKO LTD., LEICESTER
Makers of Transformers

LAMINATED
Electrical
INSULATION

to

DCD WT
1000

Write for
PUBLICATION
No 31

Telephone
GLOUCESTER
4941.

THE NEW INSULATION CO. LTD. BRISTOL RD. GLOUCESTER.

LONDON OFFICE WINDSOR HOUSE, 46 VICTORIA ST, S.W.1 TEL. ABBEY 6494

Telegrams
NICO
GLOUCESTER

Did you see
this exhibit?

WESTINGHOUSE

**METAL RECTIFIERS
& WESTECTORS**
Stand 78, R.C.M.F. EXHIBITION

Westalite & Copper Oxide Units
Double Voltage & Miniature Types
Constant Potential A.C. and D.C.

If not, write for literature to Dept. E.E.,

Westinghouse Brake & Signal Co., Ltd.,
Pew Hill House, Chippingham, Wilts.

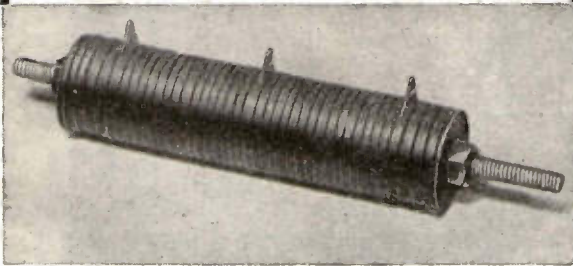

BEAT FREQUENCY OSCILLATORS

**LELAND
INSTRUMENTS LTD**

—for priority requirements only,
at present. Write for particulars
stating frequency range required.

21, JOHN STREET, BEDFORD ROW, LONDON WC1
TELEPHONE: CHANCERY 8763

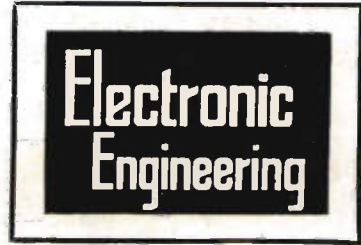

MARCH, 1946

Volume XVIII.

No. 217.

CONTENTS

	PAGE
Editorial—The Origin of the C.R. Tube ...	65
High Stability Carbon Resistors ...	66
By G. V. Planer, M.Sc., A.R.C.S., and F. E. Planer, Ph.D., M.Sc.	
Land Mine Locators ...	69
By S. S. West, M.B.E.	
A Method of Measuring Grid Primary Emission in Thermionic Valves ...	75
By A. H. Hooke.	
Pentodes and Tetrodes Operating as Triodes ...	82
By C. C. McCallum.	
Nuclear Energy—Part I ...	85
By W. D. Oliphant, B.Sc., F.Inst.P.	
H.F. Band-Pass Filters—Part III ...	89
By H. Paul Williams, Ph.D., A.M.I.E.E.	
A Stable Diode Voltmeter ...	94
March Meetings ...	95
Notes from the Industry ...	95
Book Review ...	96
Radio Noise from the Sun ...	98

CONDITIONS OF SALE.—This periodical is sold subject to the following conditions, namely, that it shall not without the written consent of the publishers first given, be lent, re-sold, hired out or otherwise disposed of by way of Trade except at the full retail price of 2/- and that it shall not be lent, re-sold, hired out or otherwise disposed of in a mutilated condition or in any unauthorised cover by way of Trade, or affixed to or as part of any publication or advertising, literary or pictorial matter whatsoever.

THE MOST FAMOUS SET MAKERS ARE AGAIN FITTING

MAZDA

**RADIO VALVES AND
CATHODE RAY TUBES**
because of their
**PERFORMANCE AND
RELIABILITY**

**LOW
"I_f"**

**HIGH
"g_m"**

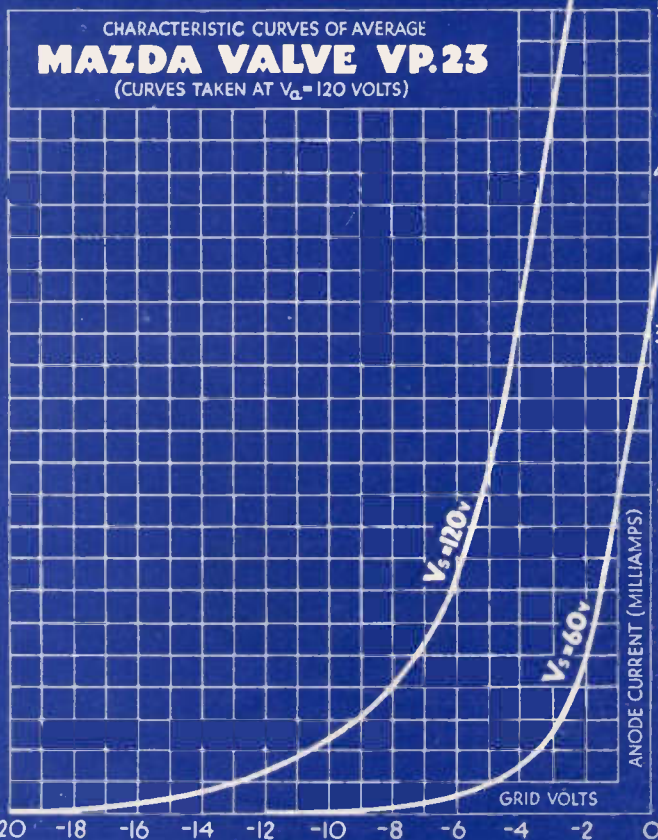

THE FILAMENT CURRENT OF THE MAZDA VP.23 IS EXCEPTIONALLY LOW; IT IS ONLY 50mA.

ITS MUTUAL CONDUCTANCE ($g_m = 1.3mA/V$) IS REMARKABLY HIGH FOR A VALVE HAVING SO LOW A FILAMENT CONSUMPTION.

THIS VALVE MAY BE USED AS A REPLACEMENT IN THE CIVILIAN WAR-TIME RADIO RECEIVER.

THE EDISON SWAN ELECTRIC COMPANY LIMITED



155, CHARING CROSS ROAD, LONDON, W.C.2

PROPRIETORS :

HULTON PRESS, LTD.

Electronic Engineering

MANAGING EDITOR:

G. PARR.

EDITORIAL, ADVERTISING AND PUBLISHING OFFICES, 43-44, SHOE LANE, LONDON, E.C.4

TELEPHONE
CENTRAL 7400

Monthly (published last day of preceding month) 2/- net. Subscription Rates :
Post Paid to any part of the World—
6 months, 13/- ; 12 months, 26/-.
Registered for Transmslson by
Canadian Magazine Post.

TELEGRAMS
HULTONPRES, LUD
LONDON.

The Origin of the Cathode-Ray Tube

IN a recent lecture at the Royal Institution on "The Background of Röntgen's Discovery," DR. ALEX MÜLLER gives an account of the observations of various workers which led to the development of the cathode-ray tube. One of the first mentions of the cathode beam was made by GASSIOT¹ in 1859, in his paper, "On the Stratifications of Electrical Discharges as observed in the Torricellian and other Vacua," and the quotation runs :

"In the tube . . . a discharge appears to emanate from the negative wire, issuing with great intensity from the orifice, and if the wire and the tubing are a little inclined, the discharge will impinge against the side of the vacuum tube, brilliantly illuminating the spot on which it impinges."

The tube in question was constructed with a glass shield round the negative wire, open at the end, and projecting about $\frac{1}{8}$ in. beyond the wire.

Neither GASSIOT nor PLÜCKER, who published a paper in 1858² on the effect of magnets on the electric discharge, seems to have paid much attention to the negative discharge, but the position changed in 1869, when HITTORF³ published his series of papers on the conductivity of

gases. His contribution was mainly concerned with the negative discharge (now called cathode rays), and he noticed the focusing effect of a magnetic field on a beam of the rays and the large potential gradient in the neighbourhood of the cathode. "Considering these achievements,"

comments DR. MÜLLER, "it seems appropriate to call HITTORF the discoverer of cathode rays."

The experiments described by CROOKES⁴ in 1878 had in all essentials been made and described in HITTORF'S first paper in 1869, and HITTORF commented on this in a later paper⁵.

RIECKE in 1881 published calculations on the path of a charged particle in a magnetic field and pointed out that HITTORF'S experiments could be explained by assuming the cathode ray to be a stream of such particles moving with uniform velocity. The idea of atomistic electricity was first announced⁶ by JOHNSTONE STONEY in 1874, and it is to him that we owe the name "electron" for the atom of negative electricity.

A fuller account of DR. MÜLLER'S lecture appears in *Nature* for February 2, 1946, from which the above notes were taken, and it will also appear in the *Proceedings* of the Royal Institution.

REFERENCES

- ¹Gassiot, *Phil. Trans.*, 149, 137 (1850).
²Plücker, *Pogg. Annal. Phys.*, 17 (107), 77 (1859).
³Hittorf, *Pogg. Annal. Phys.*, 16 (136), 1 and 197 (1869).
⁴Crookes, *Proc. Roy. Soc.*, 28, 103 (1878).
⁵Hittorf, *Wied. Annal. Phys.*, 5, 6, 9, 10 (1878-80).
⁶Stoney, *Phil. Mag.*, (v) 11, 881 (1881).

NORTHAMPTON POLYTECHNIC

St. John Street, London, E.C.1.

(nearest station, ANGEL. Underground Northern Line).

A Course of Lectures on

THE CATHODE RAY TUBE AND ITS APPLICATIONS

will be conducted at the Polytechnic
on Monday Evenings at 7 p.m.
commencing 11th March, 1946.

Lecturers :

MR. G. PARR, A.M.I.E.E.

(Editor, "Electronic Engineering")

from 11th March to 15th April.

MR. L. C. JESTY, B.Sc., M.I.E.E.

(G.E.C. Research Laboratories)

from 29th April to 13th May.

Fee for the Course, 15/-.

Admission by ticket, obtainable from
the Secretary, Northampton Polytechnic,
St. John Street, London, E.C.1.

High Stability Carbon Resistors

By G. V. PLANER, M.Sc., A.R.C.S., A.R.I.C., and F. E. PLANER, Ph.D., M.Sc., A.C.G.I.

A NEW component which has become of considerable importance for use in electrical communications equipment during the past few years is the pyrolytic or cracked carbon resistor.

Resistance elements of this type possess important advantages over conventional carbon type resistors. Thus, the carbon used is of a hard and crystalline nature, it is comparatively pure and chemically inert. Its particle size is small, and its conductivity is about 0.33×10^8 , while that of ordinary graphite ranges from 3 to 8×10^3 mho cm.⁻¹ A further advantage is the homogeneity of the conductor, resulting in uniform distribution of electrical potential and temperature over the conducting path.

One of the most important characteristics of this type of resistor is its low temperature coefficient of resistance, which ranges in general from 0.02 to 0.07 per cent. per degree Centigrade. Similarly, the temperature hysteresis and voltage coefficients are low and the noise level is negligible for low values of resistance. For higher values the noise voltages are well below the limiting figures specified by the Inter-Service Committee and given by the expression $2 + \log_{10} (R/1,000)$ μ V per volt, where R is the resistance value in ohms. An important aspect, also, is the ease with which resistors can be made to have pre-assigned values of resistance.

The manufacturing methods for pyrolytic resistors differ appreciably from those used for the older type of carbon resistor, involving the deposition of crystalline carbon on to refractory bases by the thermal decomposition or cracking of hydrocarbon vapours. While the nature of this reaction has been known for some time, it is only comparatively recently that the special properties of electrical resistors made by this method were fully realised, and the resulting new applications, particularly in the electronic industry, have led to a considerable development in the manufacturing technique.

Carbon resistors, in general, may be divided into two main groups, the surface film type and the carbon composition type. In the following,

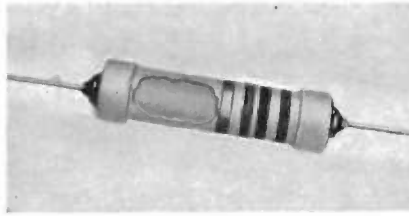

(Above) High stability pyrolytic carbon resistor with the protective lacquer coating partly removed to show the spiral groove.

(Right) High stability resistors protected with plastic sleeving, rated 1 and 1½ watts respectively.

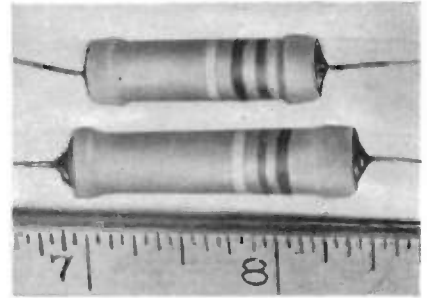

—By courtesy of Dubilier Condensr Co., Ltd.

some of the electrical properties and underlying theoretical considerations, as well as some recently developed manufacturing processes for the two types of resistor will be discussed in more detail.

Carbon Film Resistors

It is well known that "semi-conductors," such as carbon, silicon, zirconium, titanium, etc., possess negative temperature coefficients of resistance at ordinary temperatures. This property was at one time believed to be characteristic of the above type of materials. It has,

however, been shown that in the case of carbon, silicon and similar substances the temperature coefficient of resistance is a function of the particle size.¹ Thus, positive coefficients may be obtained for carbon of sufficiently large grain size. It has further been shown that at higher temperatures the coefficient becomes positive also for ordinary graphite. Fig. 1 shows the types of temperature characteristics obtained for carbons of two different grain sizes. A number of theories have been put forward to explain these phenomena, and according to the one generally accepted these properties are due to the deficiency of free electrons in the surface layer of the individual particles. The crystalline lattice is somewhat wider on the surface of the grains than in the interior, and the boundary layer therefore contains fewer free electrons. As the temperature is raised, the electrons bound to nuclei due to the widening of the lattice are progressively freed, thus producing an initial increase in conductivity. On continued raising of the temperature the conductivity is lowered again owing to the scattering of the free electrons, as is the case in metals. It is therefore evident that the greater the grain size the smaller will be the former effect, since this depends on the surface area of the material.

In the case of surface film type resistors which consist essentially of ceramic rods coated with a thin film of carbon, the overall temperature coefficient is dependent not only on the temperature coefficient of the carbon layer, but also on the thermal expansions of the ceramic carrier and the carbon itself. The latter is of the order of 5×10^{-6} per degree Centigrade. The temperature coefficient

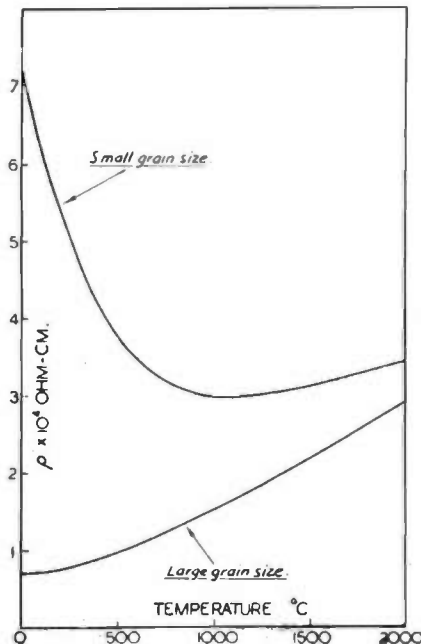

Fig. 1.

of resistance of graphite is of the order of -8×10^{-4} , while that of pyrolytic carbon is only approximately -3×10^{-4} per degree Centigrade.

By the choice of a suitable carrier material it becomes possible, therefore, to construct a pyrolytic carbon resistor in which the negative temperature coefficient is largely compensated by the thermal expansion of the rod.

The conventional methods of manufacture of surface film type resistors consist of coating ceramic bases with a thin layer of finely divided carbon by dipping into, or spraying with, a suspension of carbon and binders. The coated rods are then stoved, provided with suitable end connexions and varnished. The new pyrolytic methods consist, in principle, in depositing carbon on to the ceramic bases by passing a hydrocarbon vapour, for example methane, over the ceramic, in admixture with a larger volume of a neutral gas, such as nitrogen.

Pyrolytic carbon may be of two types, depending on the conditions under which pyrolysis takes place. At temperatures exceeding 600° to 700° C. the carbon deposited is hard and comparatively inert, while at lower temperatures active carbon is obtained, which is more susceptible to oxidation. Pyrolysis is therefore carried out at elevated temperatures, the usual temperature range being between 900° and $1,100^{\circ}$ C.

In addition to the thermal decomposition of the hydrocarbon gas into carbon and hydrogen, a certain amount of polymerisation resulting in the formation of higher hydrocarbons invariably takes place. By correct adjustment of the conditions of pyrolysis this undesirable reaction

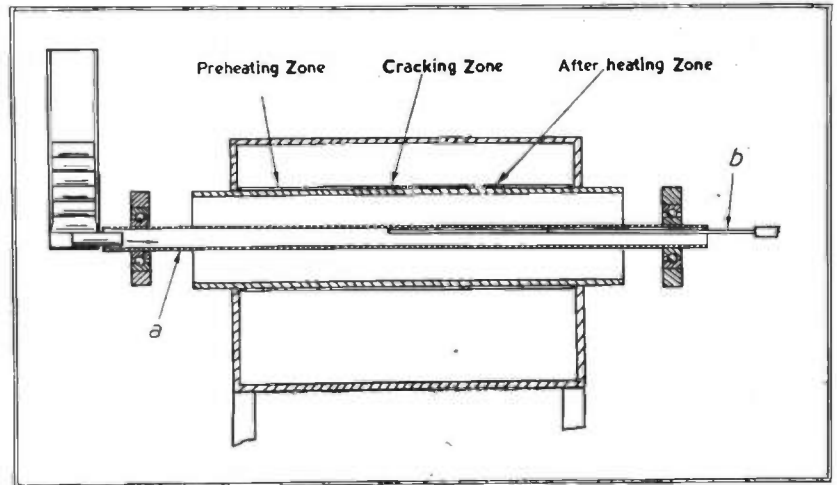

Fig. 2. Automatic furnace for the manufacture of pyrolytic carbon resistors.

can, however, be reduced to a minimum.

Several methods of production have been developed, and one of the most recent² makes use of an apparatus shown diagrammatically in Fig. 2. Rods of refractory, non-porous material, such as steatite or porcelain, are fed from a hopper into the rotating reaction tube, a, which is made of silica. They are then passed through the cracking furnace by means of an automatic feeding mechanism, while rotating continuously by contact with the inner wall of the tube. An even deposit of pyrolytic carbon is ensured by these means. The gas mixture, consisting of a neutral gas and a small proportion of a hydrocarbon, is passed into the reaction tube through a narrow delivery tube, b, consisting of nickel or silica. Owing to the smaller diameter of tube b, the velocity of the gases is too great for the gas mixture to attain the cracking temperature inside the delivery tube.

The cracking furnace comprises separately controlled pre-heating, cracking and after-heating zones. By adjusting the pre-heating temperature to be above that in the cracking zone, the ceramic rods may be made to enter the latter at a higher temperature than that of the reaction tube in that zone, and pyrolysis will therefore take place mainly on the surface of the ceramic rods, the deposit formed on the walls of the silica tube being negligible.

In the case of continuous coating processes, it is general practice to purify the gases before they enter the reaction chamber, since oxygen, water vapour, etc., act as inhibitors of the reaction. A typical absorption train as used, for instance, in the case of methane, comprises towers containing fused calcium chloride or glass beads coated with phosphorus pentoxide, to remove moisture. Wash-bottles containing an ammoniacal

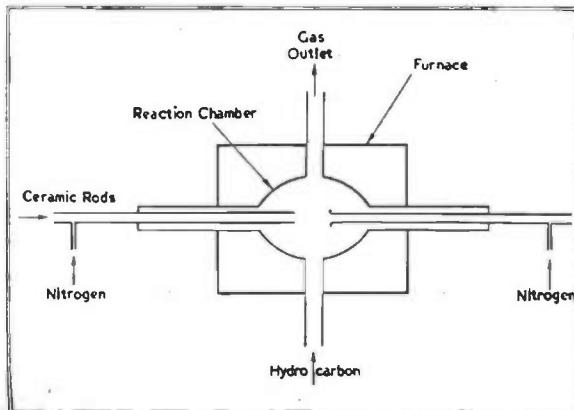

Fig. 3. A second type of automatic coating furnace.

High stability pyrolytic carbon, film type resistor.

—By courtesy of Welwyn Electrical Laboratories, Ltd.



solution of cuprous chloride and an alkaline pyrogallol solution may be used to remove carbon monoxide and oxygen, respectively.

The thickness of the carbon deposit and hence the electrical resistance of the coated rods will depend on the cracking temperature, the hydrocarbon content of the gas mixture, as well as on the time of exposure in the cracking zone, *i.e.*, the speed at which the rods are fed through the furnace, in the case of continuous processes. Adjustment of one or more of these factors allows resistors to be made within relatively close tolerances of pre-assigned values of resistance.

After deposition of the carbon film the rods are generally "spirallised," *i.e.*, their resistance values are increased by the grinding of helical grooves around the rods. This process is found to be necessary owing to the difficulty of depositing a satisfactory carbon film sufficiently thin to give higher values of resistance. Moreover, it is desirable to apply coatings of an appreciable thickness, since the overall temperature coefficient of resistance decreases with the thickness of the deposit.

One of the disadvantages of spirallising is the resulting increase in inductance. It is apparent that with a more intricate grinding machinery the resistive path can be

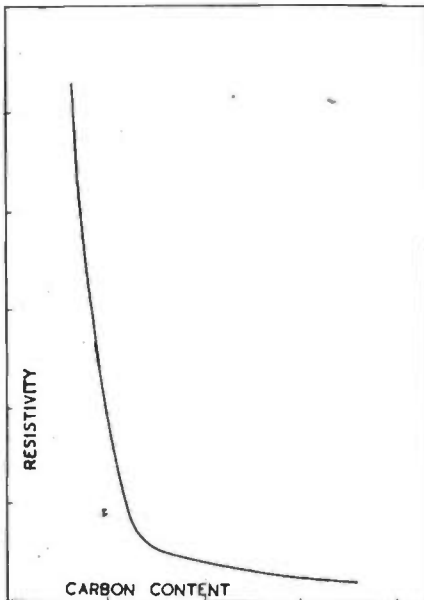

Fig. 4.

arranged in such a way as to result in a substantially non-inductive resistance, *e.g.*, by the grinding of axial instead of helical grooves. An alternative method of effecting an increase in the resistance of the coated rods consists in reducing the thickness of the carbon deposit by grinding with quartz sand in a rotating grinding cylinder. This method, although resulting in resistors of low inductance, suffers from several disadvantages, as will be apparent from the aforesaid.

After adjustment of the resistance value by one of the above methods, connexions are made by means of end-caps, or by fitting tinned copper wire spirals and dipping these in solder. To ensure adequate electrical contact between the rods and the connexions, a low resistance contact material is usually applied to the ends of the rods, before capping. The resistors are finally lacquered, and if additional protection be required, sleeves of flexible insulating material, such as polyvinyl chloride, are fitted. For tropical use the resistors may be sealed in glass envelopes.

An alternative continuous process² for the pyrolytic deposition of carbon makes use of an apparatus shown diagrammatically in Fig. 3. Ceramic rods of a length of about 15 cm. are fed along silica tubes through the reaction chamber, where a short gap in the former allows them to come into contact with the gas mixture.

As previously mentioned, pyrolysis at lower temperatures results in inferior carbon deposits. Precautions have to be taken therefore to confine thermal decomposition to the region within the reaction chamber. In order to avoid deposition on to the rods while these are passing through the silica delivery tubes, a stream of a neutral gas, such as nitrogen or carbonic acid, is passed into the latter as indicated in Fig. 3. After the coating process the ceramic rods are broken up into smaller units and treated as described previously.

A cracking furnace designed for batch production of pyrolytic carbon resistors makes use of a totally enclosed reaction chamber.⁴ The latter is first of all evacuated by means of a pump. Hydrocarbon

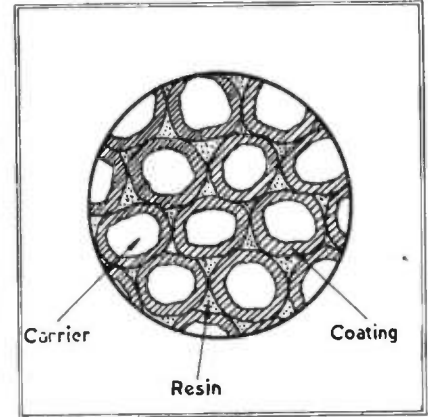

Fig. 5.

vapour is then drawn into the furnace by connecting this to a calibrated bulb containing a liquid hydrocarbon. The temperature of the furnace is maintained at about 800° C. during pyrolysis, and the thickness of the deposit may be controlled by varying the time of exposure, the amount of hydrocarbon admitted, or both.

Non-continuous processes such as that described above are generally less satisfactory than continuous methods, for difficulties are often experienced in obtaining uniform deposits, owing to small local variations in the temperature of the cracking furnace. Also, these methods are usually less economical than the continuous ones.

Finally, mention may be made of an alternative process for the production of pyrolytic carbon film type resistors. This consists in depositing carbon on to plates of refractory materials, usually silica, removing the deposit and applying this with a binder to ceramic bushes or rods.

Carbon Composition Resistors

Resistors of the carbon composition type consist of solid rods made from a mixture of various grades of carbon, a filler and resin binder. The methods employed in the manufacture of this type of resistor consist essentially in preparing mixtures of carbon, a filler such as talc, silica, asbestos, etc., and a resin, for example polystyrene or phenol formaldehyde, by milling, and moulding the powder into rods. End-caps and leads are then applied in the usual manner, and the rods are protected

(Continued on page 97.)

Land Mine Locators

By S. S. WEST, M.B.E.*



Instructing a squad in the use of the mine locator.

At Exhibitions concerned with a display of this country's efforts in the production of munitions, the mine locator, or detector, as it is sometimes called, has always had its share of attention. This is not surprising, because it is remarkable to many people that a device can be provided which permits the accurate detection and location of buried metallic objects. So far as the radio engineer is concerned, he is probably not so mystified for he is equipped to hazard a good guess as to "how it is done." Nevertheless, it is hoped that this first published description of the mine locator will be of interest. It should be pointed out that the locator described first is an early example, but its basic principles are of considerable interest and have been exploited to some extent in later types.

While the main requirement in a mine locator is, naturally, that it shall find mines, it must also be simple to operate, reliable, and, most important, reasonably portable. That in a large measure these requirements were met is revealed by the description of the various types of locator developed. It is of interest to follow the development of these devices and the literature contains one or two references to the subject. In particular HAGUE in his book *Alternating Current Bridge Methods*† describes the employment of a form of "Felici" bridge for the location of unexploded bombs.

Models I, II and III detectors are based upon this bridge principle, and accordingly it is pertinent to consider its operation.

In Fig. 1 the coils L_1 and L_2 are connected respectively to an oscillatory source and an indicating device (for convenience a pair of headphones). If mutual coupling exists between L_1 and L_2 some part of the

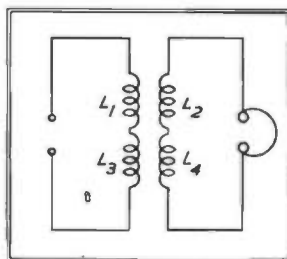
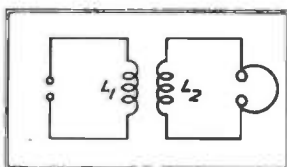

Figs. 1 & 2. Mutually coupled circuits.

signal due to the oscillatory source appears in L_2 and is rendered audible by the headphones. If now a further pair of coils, L_3 and L_4 (Fig. 2), having the same degree of coupling as, but of opposite sign to that between L_1 and L_2 be connected in series with these coils as shown by the figure, then the arrangement is balanced and any signal applied from the oscillatory source from L_1 to L_2 is nullified by an equal and opposite signal applied from L_3 to L_4 and there is no note in the headphones. That is to say, if M_1 is the mutual coupling between L_1 and L_2 and $-M_2$ that between L_3 and L_4 , no note is heard in the headphones when $M_1 = -M_2$. This is the principle of the "Felici" bridge employed for determining the mutual inductance between a pair of coils. Actually, when employed

for this purpose L_3 and L_4 constitute a calibrated mutual inductance standard.

It is apparent that having adjusted $M_1 = -M_2$, any change of M_1 , or $-M_2$ will disturb the balance of the bridge and the headphones will give audible indication of this unbalance. Also that so far as the signal in the headphones is concerned, it is immaterial whether it is M_1 or M_2 , which is changed. That is to say, it is unimportant what phase relationship the signal has; an equal magnitude of change to either M_1 or M_2 will provide exactly the same aural sensation. If M_1 is considered to be positive then it is obvious that M_2 will be negative in sign so that this bridge circuit will provide indications of unbalance due to mutual coupling whose sign is either + or -. Further, it is not difficult to appreciate that even though the bridge be completely balanced for mutual inductance coupling, resistive coupling between the coils will result in unbalance from which, as will be demonstrated later, it may be assumed that most combinations of these types of coupling will unbalance the bridge.

Now it is well known that if a pair of coils physically juxtaposed have a metallic object placed in their proximity, this metallic object will provide a degree of coupling between them. If coupling already is present between the two coils, this existing coupling may be augmented or reduced depending upon its sign and the nature of the metallic object. On the other hand, if the coupling

* Cinema Television, Ltd.
† See pp. 410 and 411. Also *Jour. Frank. Inst.*, Vol. 210, p. 311.

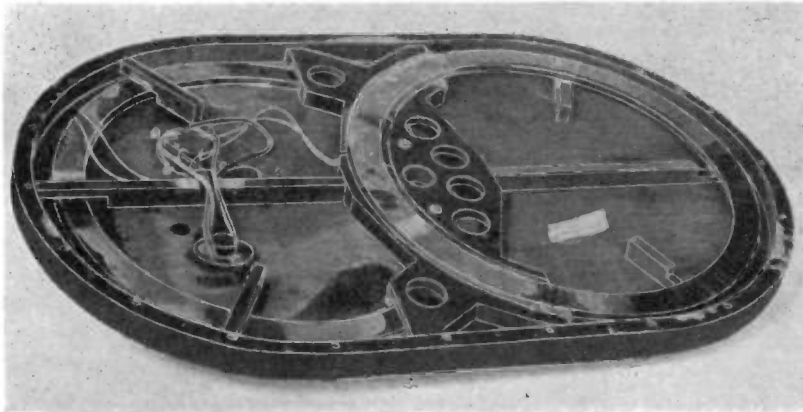

Fig. 3. Search coil box with cover removed, showing overlapping coils.

initially is zero, any coupling due to the proximity of a metallic object is an increment of coupling regardless of its sign as we have seen in considering the Felici bridge.

Measurements of the effect due to the proximity of representative mines show that the mutual coupling resulting therefrom is very small indeed.

TABLE

Type of Mine	Distance (ins.)	Mutual Inductance	R
Teller	12	-23	.062
	10	-47	.130
Anti-personnel	8	-1	.02
"S" Mine	6	-2	.05
	4	-4	.11

The table shows that even in the case of a Teller mine, which was the largest anti-tank mine commonly used by the enemy, the mutual coupling is only .01 per cent. at a distance of 12 in. This implies that either the oscillatory current driving the coils must be large or that an amplifier must be interposed between the coils and the headphones in order to secure reasonable detection sensitivity. If the coil system is initially balanced an amplifier employing small valves can be used since an output of a volt or so is adequate to operate the headphones. Moreover, the proximity of an object is revealed by causing a signal to occur in the headphones and not by a change in amplitude of an already existing signal. It is also to be noted that it is a great deal more efficient to amplify a small increment of signal above zero level than an equally small increment above or below a large signal level. Similarly it is not efficient to attempt to provide a large oscillatory drive current to the coils in an attempt to avoid the use of an amplifier.

Reviewing these arguments it is

seen that the most efficient arrangement will result from the employment of a coil system which has initially zero mutual coupling. There are, of course, several ways of providing such a system, but the particular one employed is perhaps not so well known as most methods. The arrangement may be regarded as providing zero mutual coupling between the coils due to the fact that so far as the field interaction is concerned, the two-coil

system behaves as a four-coil one. From Fig. 3 it will be seen that flat section coils are used which are overlapped, the degree of overlap required being quite critical. That this arrangement will provide zero mutual coupling is evident from the following simple argument.

Consider the coils to be overlapped completely, *i.e.*, the annular windings are coincident. The magnetic field from the driven coil will link with the other coil in a certain direction. If the two coils are now placed side by side in the same plane, the magnetic field from the driven coil links in the opposite direction. That is, there is a complete reversal of polarity between these two conditions of coupling. It follows that at some intermediate position the effective coupling is zero.

Throughout this discussion of the coil system and its conditions for balance the presence of couplings other than those due to mutual inductance have been ignored. However, it is obvious that a complete balance cannot be expected unless they are taken into account and means provided for their neutralisation.

Fig. 4. Amplifier box with self-contained batteries and sub-chassis. The control is in the top right corner.



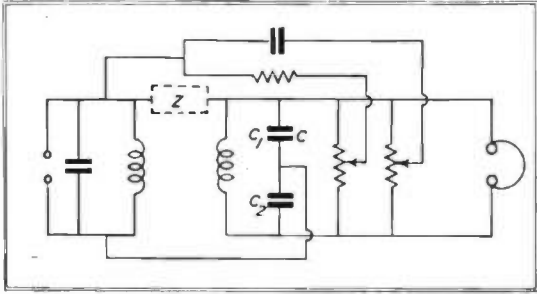
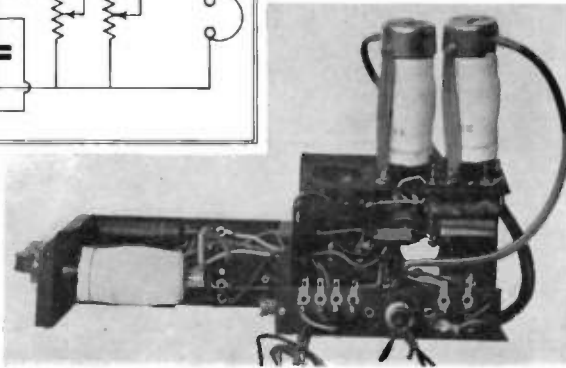

Fig. 5. Diagram of balancing circuit for search coils.

Fig. 6. View of amplifier chassis removed from case.



Stray Coupling

There will be two forms of parasitic coupling present: capacitive and resistive. So far as the first is concerned, the coupling component is in general similar to that due to mutual inductive coupling so that an adjustment of the coil position exists where this coupling is neutralised. It is to be noted that the degree of these couplings is a function of frequency so that the system is only balanced for one frequency. This implies the use of an oscillatory drive whose frequency drift and percentage harmonic content are both small. The resistive coupling can be of either sign depending upon the sense of the coils with respect to one another. It is necessary, therefore, to provide means for balancing out this coupling. In addition, there are couplings between the coils attributable to the essential employment of small metal parts in the coil housing. A suitable frequency of operation for a detector is approximately around 1 kc/s.—a choice dictated by the employment of headphones as the indicating device and by the reduction of undesirable ground capacity effects. At this frequency small metal parts have an almost entirely resistive effect, i.e., their "Q" is approximately unity, so that the resistive balancing control must cater for their effect. We have seen that capacitive coupling can be balanced with correct positioning of the coils, but practically it is convenient to have a fine control of both this and resistive coupling conveniently placed with respect to the operator. The arrangement adopted was simple and is shown in Fig. 5. One terminal for the

oscillatory drive is connected through a capacitor and also through a resistance to the sliders of potentiometers across the pick-up coil only, thus providing two signal components that supplied by the resistive feed being in phase with the oscillatory drive and that by the capacitive feed differing by approximately 90°. This pick-up coil is provided with a centre tap by means of the capacitors C_1, C_2 , which tune the coil to resonance at the operating frequency (as does the tuning capacitor across the drive coil) and, by suitable adjustment of these potentiometers complete balance between the coils can be secured. In effect this is achieved by providing a composite signal whose amplitude and phase is exactly equal and opposite to the signal resulting from the slight unbalance of the coil system and its mounting arrangements.

Model I Mine Locator

The mine locator embodying the principles just described consists of two main parts, the search coil unit and the amplifier-oscillator pack. The amplifier and oscillator operate from self-contained dry batteries fitted in the amplifier case, and are carried in a canvas bag fitted with carrying straps to enable it to be strapped on the back of the operator.

From the case a short length of flexible protected cable connects to the search coil, which is mounted on the end of a bamboo pole approximately 6 ft. long. By swinging the search coil from side to side slowly over the ground while progressing across the area to be searched, the operator hears an unmistakable indication of the presence of the mine or other metal object and, with some ex-

perience, can estimate the depth and extent of the buried objects with considerable accuracy.

The search coil and pole are so designed that the weight of the coil box is largely counterbalanced by the weight of the control box at the opposite end of the pole, and the search coil can be manipulated with one hand if necessary.

Circuit of Locator (Fig. 7.)

The circuit comprises an oscillator valve 2 and two amplifier valves 18 and 27 coupled by the transformer 17. R_3 is a gain control which permits the overall sensitivity to be adjusted.

The oscillator valve has an inductance 1 in its anode circuit and the coil 28B is connected to the anode by the coupling condenser 3 and to the grid by the condenser 5. Condensers 6 and 7 are across the coil. This connexion arrangement provides a Colpitts oscillator.

Coil 28A is fixed in relation to coil 28B and is connected to the transformer 12 through the screened cable.

The input to valve 18 is amplified in the usual way and applied to the gain control R_3 across the secondary winding of the transformer 17. The output valve 27 has a tapped choke 26 in its anode circuit, feeding the headphones through the condenser 29.

Connexion to the filament of the valves is made through the earth lead in the plug and socket connexion, the indicator lamp 33 being in series with the filaments to ensure that the correct operating voltage is applied. An adjusting resistance 34 is across the indicator lamp. The act of connecting the search coil to the amplifier by the plug and socket connexion thus switches on the amplifier.

Balancing Circuit

As previously mentioned, it is necessary to obtain electrical balance of the coil circuit before the set is used for searching. This is done by means of the circuit 15, 16 and 19, 20, which is similar to that of Fig. 5.

The operator does not need to know the actual amount of feedback required, and is instructed to turn both knobs (15 and 19) until minimum sound is heard in the headphones.

Search Coil Unit

The coils shown in Fig 3 are wound with 800 turns of 32 s.w.g. enamelled and silk covered wire and are wax impregnated. During assembly in the box, the correct amount of overlapping having been determined by a special test equipment, they are fixed firmly in position with wax, and the cover plates fastened down.

The electrical characteristics of the coils are adjusted if required by the addition of a resistance of 1-3 megohms and a condenser of 10-50 pF connected across the leads from each coil inside the box.

These leads are soldered to a 7-contact plug mounted on the top plate of the search coil box.

At the other end of the pole is a control box containing the control potentiometers 15, 19, the balancing resistance and condenser 16 and 20. This box is a heavy casting designed partly to counterbalance the weight of the search coil box, and the control knobs are sunk in recesses on the top of the casting. The connexions between the control box and search coil unit are made by a flexible cable passing down the pole and terminating in the 7-contact socket, which fits on to the plug on the search coil box.

Amplifier Unit

The amplifier is housed in a pressed steel box which contains the amplifier and oscillator chassis and L.T. and H.T. dry batteries. The canvas-carrying case also provides room for the headphones and connecting cable.

The gain control and indicator lamp are mounted at the side of the amplifier chassis.

The amplifier is connected to the search coil control box by a short flexible cable which is brought out of the top of the amplifier box. This cable is fitted with a 7-pin socket similar to that on the pole and the insertion of this socket on to the plug on the control box completes the filament circuit and switches the amplifier on.

The fundamental circuit described served as a basis for two early mine locator models, which only differed in mechanical construction as experiments in the field showed the desirability of improvement in the coil box assembly.

An improved form of circuit was then developed in which the output choke (26 of Fig. 7) was tuned and a degree of regeneration was introduced into the amplifier to increase its sensitivity and improve the harmonic rejection. This was done by applying part of the output signal to the suppressor grid of the first amplifying valve.

In spite of these improvements it became apparent that this type of mine locator circuit possessed certain limitations inherent in its funda-

mental circuit and mechanical design.

In addition, mine warfare was becoming increasingly complicated. New detection problems were continually arising which involved the detection of small fuses and, worse still, mines which had been concealed under reinforced road surfaces and ferrous-bearing paving blocks. The circuit previously described was quite indiscriminate in its detection, all metallic objects behaved similarly so far as this detector was concerned so that in the case of a mine buried under a ferrous loaded material, detection was almost impossible for the coupling provided by the concealing medium had already heavily loaded the amplifier with a signal. Development engineers of Cinema Television, Ltd., co-operating with Government engineers had continued to work on the problem of mine detection, and at about this time the author had demonstrated an entirely new mine locator circuit.*

Apart even from these new problems this circuit had shown advantages, but in particular it permitted a simple and very neat solution to the question of discriminatory detection of objects. In addition, a number of other applications have been found for this principle and it is of interest to note that many of the measurements normally utilising

* See pending applications 8086/14984/43 and 12612/45.

bridge circuits can be carried out by employing the regenerative amplifier principle which is the basis of the new British locator. It is proposed to describe briefly the principle employed.

Discriminatory Detection

A coil system similar to that used in the earlier detector is used. One coil is connected to the input circuit, the other to the output circuit of a 3 stage amplifier. This amplifier has negligible phase shift throughout the normal working frequency range, the extent of this range will be apparent later. An input transformer is connected between the input coil and the first stage so that at the resonant frequency for the two coil circuits, at which frequency they can be represented as pure resistances, the output signal is in phase with the input and resistance coupling between input and output circuits having sufficient magnitude will result in the amplifier becoming oscillatory. The coil circuits are so chosen that this oscillation is a convenient audible one (approx. 1,000 c/s.). Thus coupling between the two coils due to an adjacent object which is of such a nature as to simulate resistive coupling between the coils and whose magnitude of coupling is sufficient will cause the amplifier to become oscillatory. Having now considered one set of

Fig. 7. Circuit diagram of mine locator (early models).

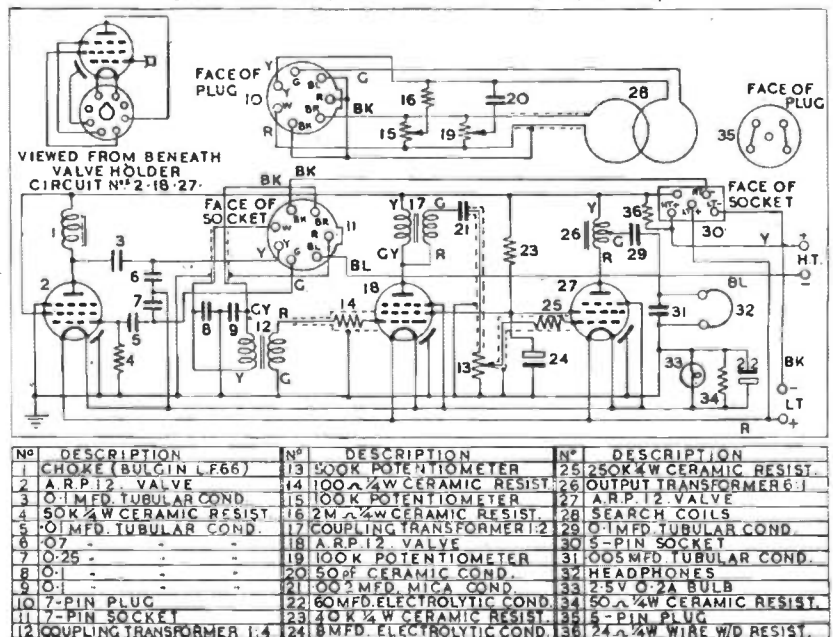

conditions which can produce oscillations it is not difficult to see that couplings of any nature having the requisite magnitude of coupling can cause oscillations. The resistive coupling case assumed that the object was one whose phase angle at the coil resonant frequency was zero. If we consider a ferrous object it is well known that compared with the resistive case the coupling phase angle will differ by 90° . For convenience this is considered to be $+90^\circ$. Similarly an object whose nature of coupling is entirely due to the existence of eddy current losses will provide coupling which for convenience is considered to have a phase angle of -90° . Therefore, the amplifier cannot oscillate due to such couplings unless we either introduce a $\pm 90^\circ$ phase shift in the amplifier or the operating frequency changes so that a total shift of $\pm 90^\circ$ occurs in the two coils' circuits. Since the two coil circuits are identical a total phase shift of $\pm 90^\circ$ for the two circuits is equivalent to a $\pm 45^\circ$ shift in each. The response amplitude at this point is 70 per cent. of that at

resonance, and since there are two circuits the response will be one-half of that at resonance. Thus if a ferrous object having twice the coupling effect of that of a resistive object be placed in proximity to the coils, again the amplifier will oscillate, but not at the resonant frequency of the coil circuits. It will oscillate at the frequency which provides the requisite 45° phase shift in each tuned circuit. It will be obvious that all intermediate conditions of coupling will similarly provide oscillatory conditions.

Now a little reflection will show that any of these types of internal couplings can be simulated within the locator itself; for example, a variable condenser or resistance can be connected between the input and output circuits of the amplifier so that an initial degree of regeneration can be secured. Thus the sensitivity of detection for an object whose phase angle is similar to that provided by the initial coupling due to the manually operated variable device can be made much higher than is the sensitivity for a dissimilar object. In this way discriminatory detection

of objects can be secured. This fact is revealed rather more clearly by the diagrams provided in the Fig. 8. In order to make it possible for capacitive coupling to simulate both $+90^\circ$ and -90° coupling the input circuit is centre tapped so that the capacitive feedback can be applied to either terminal of the input transformer. The diagrams in the figure are based upon the formulæ derived by analysing the coil coupling circuits. For the No. 3 locator the expression

$$e = iZ_c \left(\frac{I}{1 - \omega^2 LC + j\omega CR} \right)^2$$

where L is the search coil inductance, R their resistance, and C the tuning capacity, permits the magnitude of e to be valued in terms of Z_c where Z_c represents the coupling effect due to the mine or other metallic object. In the case of this new circuit, however, ω is not constant. We have already seen that the two practical limiting cases for the variation of ω are such as to permit a total phase shift of $\pm 90^\circ$ in the pair of coil circuits.

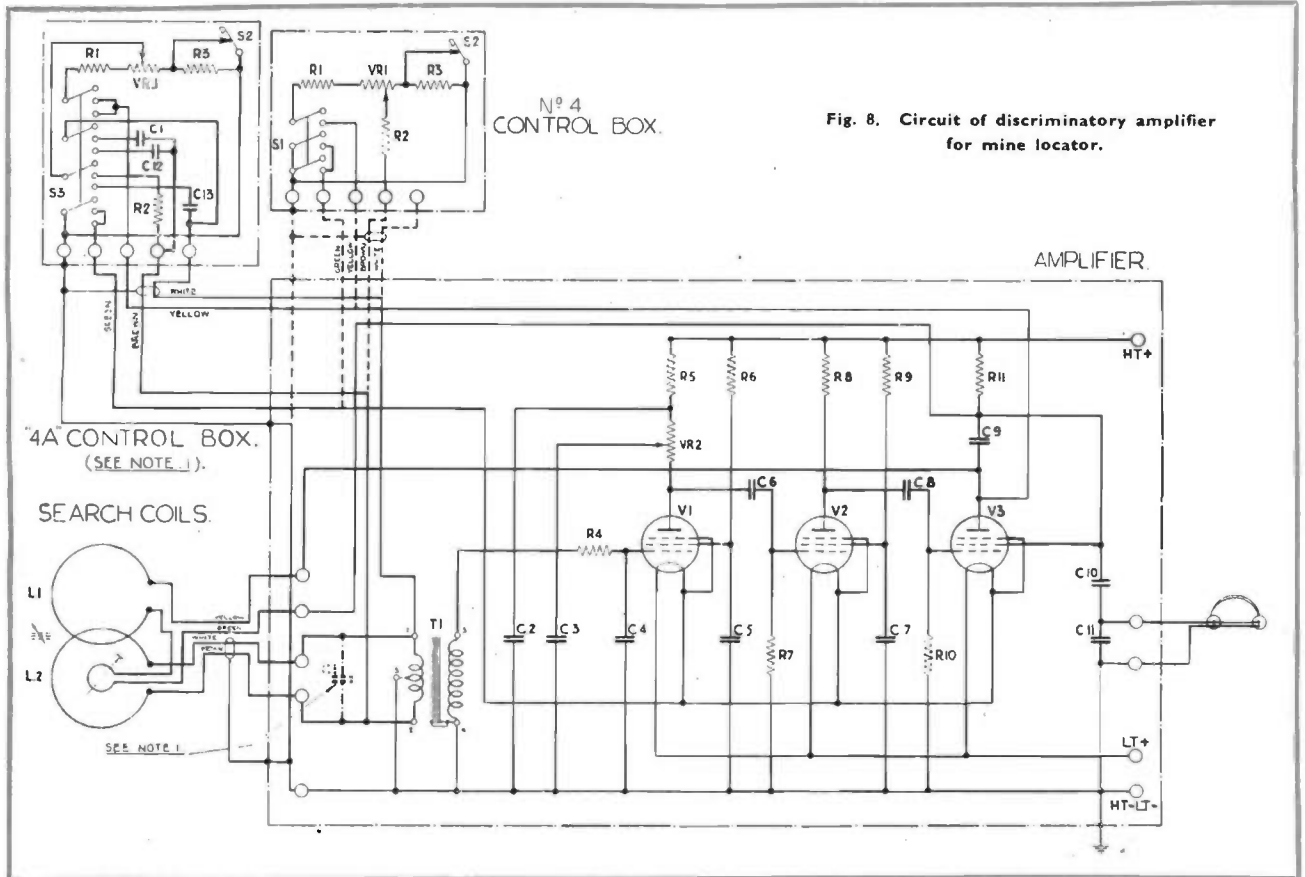

Fig. 8. Circuit of discriminatory amplifier for mine locator.



Fig. 9. Component parts of modern mine locator with cover of amplifier and control box removed.

It is illuminating to draw a polar diagram of the impedance of the two coil circuits plotted on polar coordinates in terms of frequency and phase angles between the limits of ω_1 and ω_2 where ω_1 is the frequency at which the total phase shift is $+90^\circ$ and ω_2 for that of -90° . For this purpose it simplifies the calculation to determine the impedance for one coil circuit only and to plot the square of this value. Similarly the phase angle is twice that of the single circuit.

The general form of such curves is depicted by Fig. 10.

If the operating point moves outside the plotted curve oscillation results. The distance it has to travel to do so is proportional to the coupling which the object to be detected must provide.

It is to be particularly noted that the operation point can be artificially taken near to the boundary curve by means of resistive or capacitive feedback networks inside the amplifier, so that, for example, on the curve B some capacitive feedback has been provided which has taken the operating point so that oscillations are almost starting at the value of f which coincides with the -90° condition. Thus an object whose coupling effect is $+90^\circ$ will need to have sufficient effect to be enabled firstly

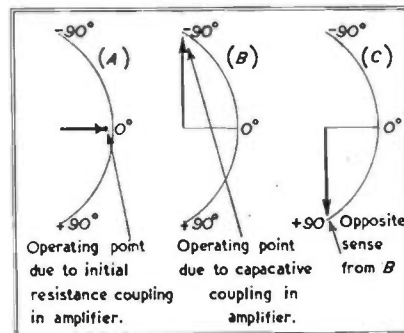

Fig. 10. Polar diagram of coil circuits.

to neutralise the artificial coupling provided by the capacitive feedback and then to take the operating point from the centre to cross the curve at $+90^\circ$.

The circuit of Model 4, shown in Fig. 8, consists of a 3-valve amplifier of the conventional type in which the coil L_2 is connected to the input through the transformer T_1 , and the output is fed to the other coil L_1 . L_1 and L_2 are normally adjusted so that there is no coupling between them and no phase-shift through the circuit.

Alternative control boxes are provided, the one marked "No. 4" for providing discrimination as a function of the feedback network. The

box marked "No. 4A" provides simpler discrimination. If the switch shown is in one position, the arrangement of the control box is identical with that of the No. 4, and in the other position the condenser C_1 is cut out of circuit, thus leaving coil L_2 untuned. An additional phase shift of 90° is introduced by this means which can be either positive or negative, depending on the sense of the coil connexions. The sensitivity of the detector is a maximum for objects having a 90° phase shift, and, depending on the coil connexions, the feedback may be made degenerative for either phase angle. This action is independent of the amplifier gain.

It will be apparent on consideration that these features in the Model IV mine locator have enormously extended its applications and there is little doubt that the British mine detector is the best in the world. A few peace time applications have been found for it and possibly other uses will be found. It has proved to be a useful tool for avoiding damage in saw mills where timber which may have shrapnel embedded in it is handled. Valuable or important lost objects have been found with a great saving of time. It provides, in fact, a successful solution to all variations of the proverbial "needle in the haystack" problem.

A Method of Measuring Grid Primary Emission in Thermionic Valves

By A. H. HOOKE*

Summary

The paper describes equipment designed to measure grid primary emission in thermionic valves under controlled conditions of grid and anode dissipation. An explanation of grid primary emission and an outline of some of the difficulties associated with its measurement are given. These are followed by a description of the circuit of the measuring instrument. The way in which power is applied to the grid and anode of the valve under test allows the operating conditions of the valve to be adjusted as desired. By taking measurements on a valve with first, zero anode dissipation, then any conveniently selected value of anode dissipation, the grid dissipation necessary to produce a given emission current may be calculated for any value of anode dissipation. Examples of measurements are given which indicate the close agreement between measured and calculated values.

Introduction

A PART from those electronic valves in which certain electrodes are designed with a view to utilising their properties as emitters of secondary electrons, emission from any electrode other than the cathode can generally be regarded as detrimental to the efficient performance of a valve. An electrode will emit primary electrons when its temperature is raised sufficiently to overcome the work function of the material of which it is made. The work functions of materials used in the construction of most valve electrodes other than cathodes are high, and if the electrodes are maintained in an uncontaminated condition, it is improbable in most practical cases that the temperature would rise sufficiently for emission to occur to any significant degree.

Unfortunately, it is often extremely difficult during certain processes in valve manufacture involving the generation of considerable temperature within the valve structure, to prevent contamination of electrode surfaces by active materials emanating from such sources as the cathode.

Owing to its proximity to the cathode the control grid in the average valve is often the most subject to contamination, and for the same reason it may tend, under operating conditions, to rise in temperature due to radiant heat from the cathode surface.

Transmitting valves due to their high operating temperatures, are more subject to grid primary emission than are receiving valves, although it is by no means unknown among the latter particularly in closely spaced types.

The determination of grid primary emission is thus a problem in which

* Valve Division, Standard Telephones and Cables, Ltd.

both the valve designer and the circuit engineer are directly interested. Unfortunately the direct measurement of grid primary emission presents some inherent difficulties. The temperature reached by the control grid is often substantially affected by back-heating from other electrodes such as the anode as well as from the cathode. This back-heating will obviously be a function of the power dissipated in the other electrodes so that grid primary emission may be expected to be a maximum under conditions of maximum power dissipation on all electrodes. Unfortunately this condition of maximum power dissipation may be conducive to the release of gas in the envelope, also sometimes due to bombardment by high velocity electrons from the cathode, the grid may emit secondary electrons. These two effects may both result in grid current in the same direction and possibly of the same order of magnitude as the current resulting from primary emission. In normal methods of measurement the grid currents are measured collectively and no discrimination between the amounts due to the three components (primary emission and the two components just mentioned above) is possible. Also when the grid is swinging sufficiently positive, the mean resultant grid current will be in a direction opposite to that of the primary and secondary emission currents so that these will be masked from measurement by normal means. Hence, in order to obtain adequate data regarding the behaviour of grid primary emission it is necessary to have available a device capable of discrimination between this and the other two components mentioned above. As the equipment described in this paper is designed to measure grid primary emission, all following references to

grid emission should be understood to apply to primary emission only unless otherwise stated.

With the apparatus to be described, measurements of grid emission may be made at any desired grid dissipation without danger of damage to the valve. In addition facilities are provided for determining in triode valves the effect on grid emission of back-heating from the anode. Determination of the back-heating effects in tetrodes and pentodes presents difficulties owing to complications that arise, both in the circuit of the instrument and in the calculation of electrode dissipations other than that of the grid. The instrument does not, therefore, permit of measurements on such valves under normal operating conditions but adequate data can, as a rule, be obtained by operating these valves as triodes since heating of the control grid from sources other than the cathode and anode can usually be considered negligible.

The circuit of the instrument is so arranged that the anode and grid of the valve under test are consecutively supplied with heating power followed by a measurement of any grid emission present, these operations being repeated in a cyclic order at a constant repetition frequency. The grid emission is indicated on a suitable meter as an average of the current flowing during the period occupied by an operational cycle. In any one cycle of operation, power is supplied twice to the grid and anode followed by the application to the grid of a high negative voltage sufficient to cut off all anode current. It is during this last period that the grid primary emission is measured.

The heating powers for both anode and grid are derived from the 50 c/s. mains supply through half-wave rectifiers, so that half-cycles of A.C.

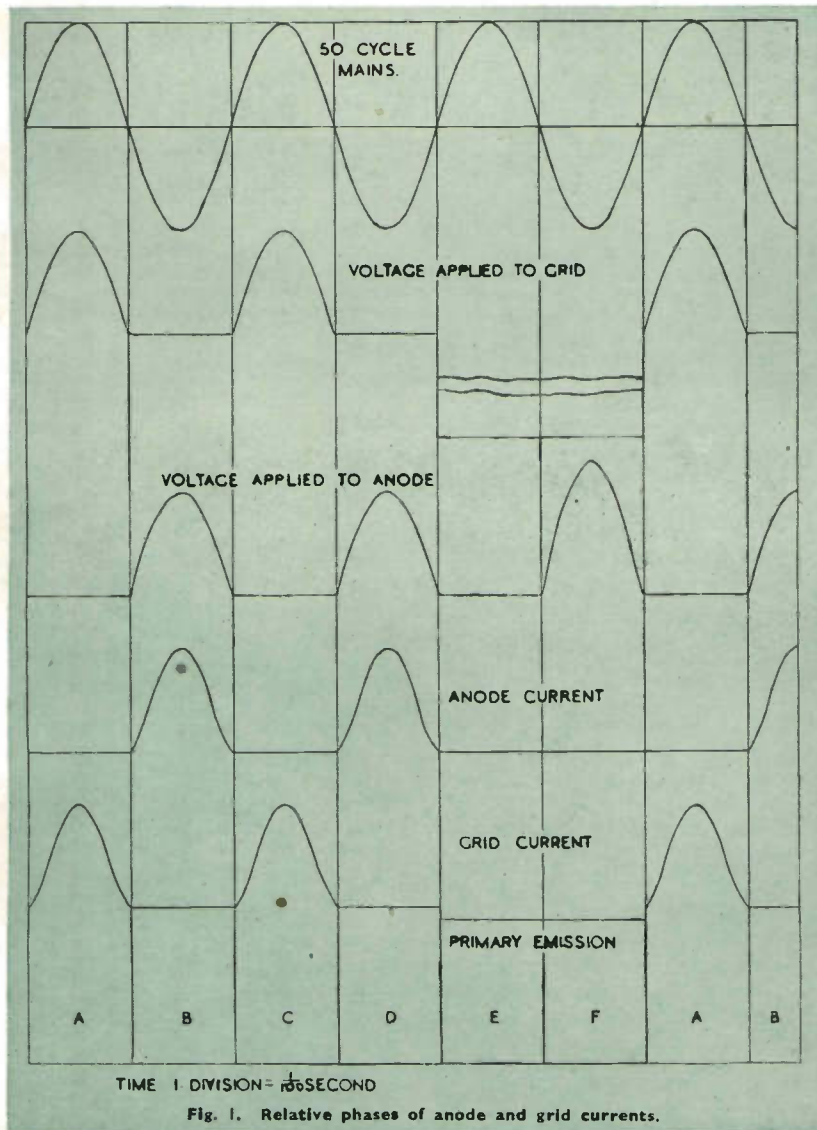

Fig. 1. Relative phases of anode and grid currents.

voltage only are delivered to the valve. A phase difference of 180° exists between the anode and grid supplies thus allowing the anode voltage to be applied during the periods of one half-cycle duration, in which the grid has zero potential. Meters are included in each circuit so that the power input to each electrode may be calculated.

The complete sequence of operations may be seen by reference to Fig. 1, which indicates the relative phases of the anode and grid voltages and currents, together, with a 50 c/s. wave for comparison purposes. For the purpose of explanation, the operational cycle has been divided into six periods of $1/100$ th second (half-cycle intervals at 50 c/s.) which have been labelled A, B, C, D, E

and F. The amplitudes of the various waves shown in Fig. 1 are drawn to an arbitrary scale and are not significant.

To start the analysis of the sequence, let us consider the interval A. During this period the grid of the valve under test is supplied with a half-cycle voltage wave of positive polarity, causing grid current to flow and power to be dissipated, while the anode potential is zero. In the interval B which follows, it is the anode which has a half-cycle wave applied to it, with the grid remaining at zero potential. Interval C is a repetition of A and likewise interval D is the same as B. During the intervals E and F a constant high negative voltage is applied to the grid. The anode is supplied with

zero voltage during E and a positive half-cycle during F, but the negative voltage on the grid is of sufficient magnitude to carry the valve well past anode current cut-off during all of both intervals E and F. Interval F concludes the sequence, following intervals being repetitions of A, B, C, D, E and F.

It will be seen that during the period A, B, C, D, E, F, the grid is supplied with power for two of the $1/100$ second intervals and so is heated for one-third of the period occupied by an operational cycle. If the grid attains a high enough temperature grid emission will occur and the resulting current may be measured in the external circuit during the periods E and F.

It will be noticed that the voltage applied to the anode during interval F is shown as being greater than that in intervals B and D. This is due to the absence of load on the power supply unit and cannot be avoided easily. However, provision has been made to prevent this voltage from affecting the reading of anode dissipation by automatically disconnecting the anode voltmeter during interval F.

Referring to Fig. 1 again, it will be seen that the currents corresponding to the voltages applied to the anode and grid are also indicated in the appropriate intervals. As the instantaneous anode currents are proportional to the instantaneous anode voltages raised to the power of $3/2$, the current pulses, as seen in the figure, will not have the shape of half sine waves.

Circuit and Operation of Instrument

The circuit diagram is shown in Fig. 2. The operation is as follows:

A 50 c/s. supply is fed via a phase adjuster and transformer into a half-wave rectifier (V_{11}). The output from this rectifier, developed across its load resistance R_{13} in the form of a series of half-cycles, is fed to the control electrodes of three gas-filled, cold-cathode, three-electrode valves arranged in a ring counting-circuit (V_6 , V_7 and V_8). One of these valves ionises every time an impulse is received and deionises when the next in the ring is ionised by the succeeding impulse. Hence, any one valve strikes every third impulse received, which in this case is every third half-cycle swing across the load resistance R_{13} , corresponding to every third cycle of the mains supply. One of the valves of the ring is provided with a load resistance (R_6) in its

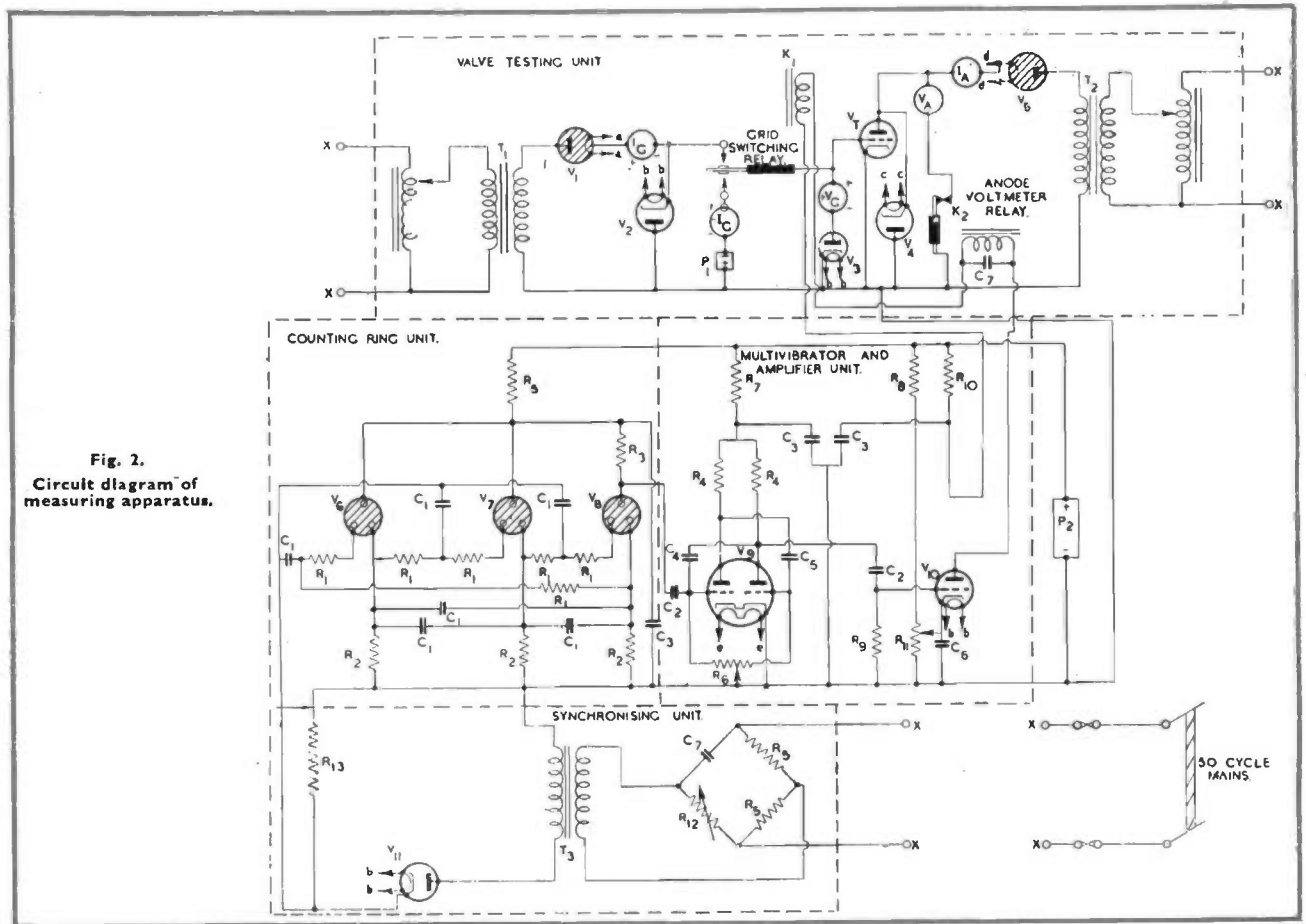

Fig. 2.
Circuit diagram of measuring apparatus.

anode circuit for the purpose of feeding a synchronising signal to a multivibrator (V_6).

The multivibrator provides an asymmetrical output of rectangular form at a frequency of $50/3$ c/s. and is locked to the main 50 c/s. supply in the manner described above. The width of the negative pulse generated by this multivibrator is half that of the positive pulse, the duration of their sum being that of three cycles of mains frequency.

The output from the multivibrator is applied to the grid of a biased amplifier valve (V_{10}) which, in turn, controls two relays, K_1 and K_2 . K_1 switches the grid of the valve under test (V_t) to its appropriate supplies and K_2 switches the anode voltmeter of V_t .

When the multivibrator delivers a positive pulse to the grid of the biased amplifier, current will flow in the anode circuit causing K_1 and K_2 to operate and to remain operated for a period corresponding to the width of the positive pulse. In the operated position K_1 connects the grid of the valve under test (V_t) to the source of

heating power via the rectifier V_1 and the transformer T_1 .

In the unoperated position K_1 connects the grid of V_t to a high negative voltage via a grid current meter which measures the grid primary emission.

Thus when K_1 is operated (for a period corresponding to the positive pulse width of the multivibrator) the grid of V_t is heated by half sine-wave pulses of power from V_1 . K_1 then releases and, with V_t biased well past anode current cut-off by P_1 , any grid primary emission is measured by the grid current meter. When discussing the multivibrator it was seen that the positive pulse lasted for $1/25$ second. This corresponds to intervals A to D on Fig. 1 where it is seen that during this time the grid is supplied with power for a total of two $1/100$ second intervals; for the other two $1/100$ second intervals the grid is at zero potential and it is during these latter intervals that power may be supplied to the anode from a source similar to that used for the grid. Intervals E and F correspond to the period of the nega-

tive pulse of the multivibrator during which K_1 and K_2 are unoperated and primary grid emission is being measured on the grid-current microammeter. This meter will indicate an average of the current flowing during the periods A to F.

The purpose of the anode voltmeter is, in conjunction with the anode current meter, to measure the power supplied to the anode of the valve under test. During intervals E and F no anode current flows in V_t owing to the large negative grid voltage and so no power is delivered to the anode during this period. The relay K_2 is therefore inserted to cut the anode voltmeter out of circuit during intervals E and F. If this were not done the high peak no-load voltage applied during interval F would unnecessarily complicate the interpretation of the voltmeter reading in calculating the heating power applied to the anode.

It can be appreciated that the relays are working under ideal conditions, since they are synchronised with the anode and grid supplies so that there is no current flowing across

the contacts during their operation.

The anode and grid half-wave power supplies are of conventional design and require no explanation.

Synchronisation of the instrument to the mains is effected by means of the phase adjuster at the input. This phase adjuster, being of the single-reactance bridge type delivering a constant voltage output, is very stable and once set rarely requires adjustment.

As an alternative to the method described for the co-ordination of the supplies to the valve under test, a synchronous motor, driving suitable commutators, could be employed. A later model of this equipment has, in fact, been modified in this manner.

Interpretation of Meter Readings

The meters employed throughout the instrument are of the D.C. moving-coil type and therefore register the average values of the waveforms applied. The desired r.m.s. values may, therefore, be obtained by the use of appropriate multiplying factors.

The use of a rectangular waveform for operating the grid switching relay (K_1) simplifies the calculation of the actual grid emission current.

Since the relay is on its back contact for one-third of each cycle of operation (A to F in Fig. 1), the actual emission current meter reading is one-third the true value.

The interpretation of the grid supply meter readings is somewhat different. Here we are interested in the input power rather than the r.m.s. values corresponding to the readings of the individual meters. Hence it is more desirable to apply a single multiplying factor to the product of the grid input voltmeter and ammeter readings in order to arrive at the figure for the average power dissipation. It has been found that the multiplying factor required for this operation is 3.8 (see Appendix I).

As the anode voltmeter is disconnected by K_2 during all F intervals (Fig. 1), the waveforms applied to this meter and to the anode current meter are the same as those applied to the corresponding grid supply meters, so that the multiplying factor is the same as before, i.e., 3.8.

Measurements

The measurement of grid primary emission on valves so far carried out with this instrument has been

directed towards the production of curves showing the effect of varying the grid dissipation for various values of anode dissipation. Complete sets of curves can be taken in this manner by setting up the valve under test in the instrument, selecting the required anode dissipation, and taking readings for varying grid voltage values. The curves obtained are consistent and can be repeated with considerable accuracy.

When a full set of curves is required, it is not necessary, however, to follow this somewhat laborious procedure. It has been argued in a paper by Mourontseff and Kozanowski* that if the assumption is made that all the power dissipated by the grid structure is radiated to the anode, then for any given grid emission, that is to say, grid temperature:

$$W_g = A - kW_a \dots\dots\dots (13)$$

where A and k are constants, and W_g and W_a represent the energies dissipated at the grid and anode respectively. (See Appendix II.)

The use of this principle allows of an appreciable saving in time and

* Mourontseff and Kozanowski, "Grid Temperatures as a Limiting Factor in Vacuum Tube Operation," *Proc. I.R.E.*, March, 1931.

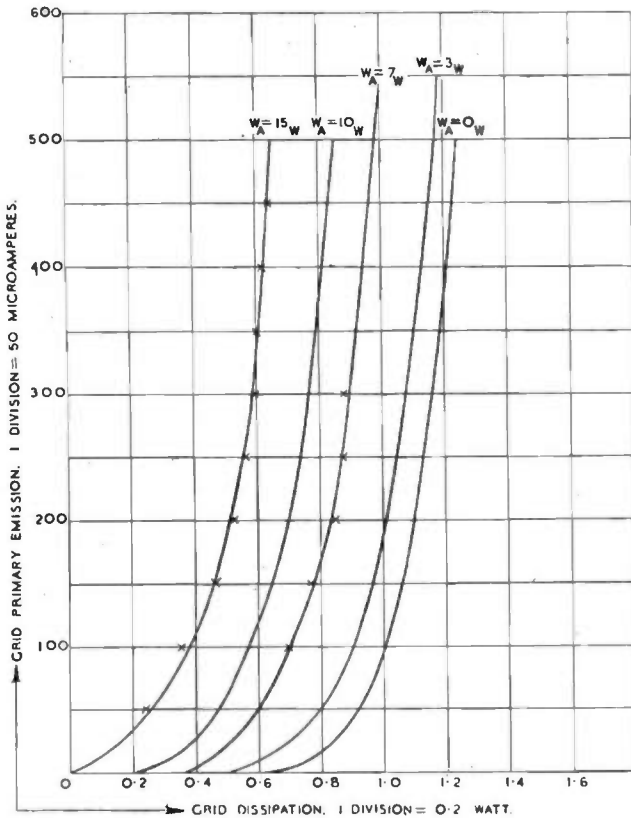
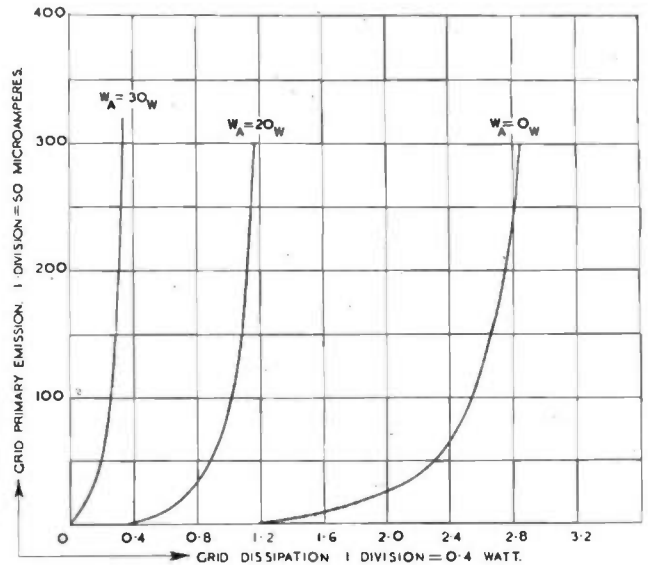

Fig. 3 (left). Grid emission and dissipation for low power output valve.

Fig. 4 (below). Effect of anode power on a close-spaced power valve.



labour, as measurements need only be taken for the plotting of two curves of grid emission versus grid dissipation, the first taken with zero anode dissipation and the second with any convenient anode dissipation. From this information experimentally derived, it is then possible to calculate, for any value of grid emission current under consideration, the necessary grid input power required at any value of anode dissipation.

The above procedure has been utilised to produce many curves, some of which have been experimentally verified to provide a check. In these it has been found that the calculated and measured values show close agreement, a maximum divergence of 5 per cent., with a usual divergence of 2 per cent., from measured values being observed.

Conclusion

The curves taken with this instrument have provided information which has proved of great value, particularly in experiments upon valves involving different materials and methods of construction of the grid assembly. Four typical examples of such curves are shown in Figs. 3-5.

Fig. 3 represents a set of curves taken for a low power output valve. All the drawn curves are experimental and the crosses represent calculated values using the experimental results for zero and 10 watts anode dissipation as a basis. The close agreement between measured and calculated values is apparent.

Fig. 4 gives an indication of the effect of anode power upon a very close-spaced power valve. It is to be noted that for a given grid dissipation the grid emission increases very rapidly with increase of anode power.

Fig. 5 indicates the effect of variation in grid material upon primary grid emission characteristics. It will be noted that the valve employing a tantalum grid will stand appreciably more input to that electrode for a given emission current than will a similar valve in which the grid was constructed from molybdenum.

The author's thanks are due to Standard Telephones & Cables, Ltd., for permission to publish this article.

Appendix I

Determination of Multiplying Factor for the Conversion of the Indicated Voltages and Currents into Mean Powers

Let I_{av} = measured average current and E_{av} = measured average voltage.

Fig. 5. Effect of grid material on emission characteristics.

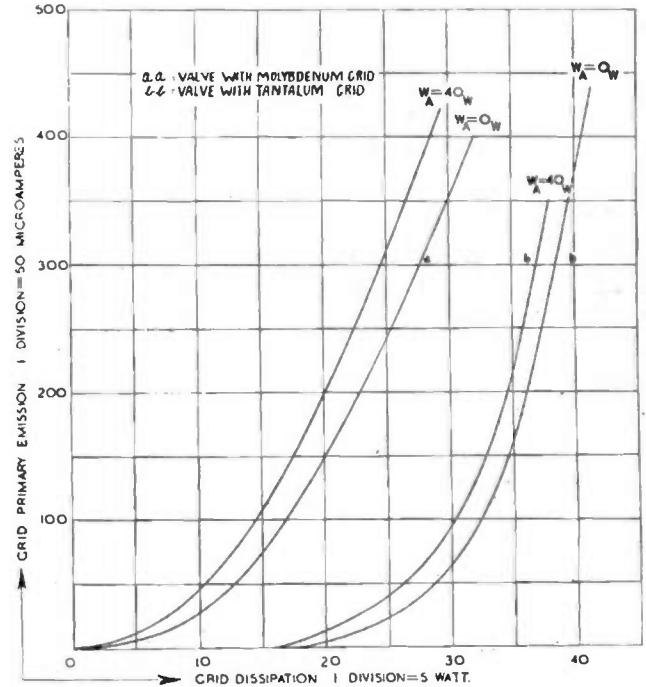

Let the load present a linear impedance,

Then the average current in one half-cycle = $\frac{2}{\pi} I$ peak.

Hence by reference to Fig. 1, measured average current over six half-cycles = I_{av}

$$= \frac{2}{6} \times \frac{2}{\pi} I \text{ peak} = \frac{2}{3\pi} I \text{ peak} \dots (1)$$

$$= \frac{1}{\pi/2} \int_0^{\pi/2} I_m \cos^{3/2} \theta \times E_m \cos \theta d\theta = \frac{I_m E_m}{\pi/2} \int_0^{\pi/2} \cos^{5/2} \theta d\theta \dots (3)$$

Now r.m.s. current in one half-cycle = $\frac{1}{\sqrt{2}} I$ peak = $\frac{1}{\sqrt{2}} \times \frac{3\pi}{2} I_{av}$

Also it follows from this that r.m.s. voltage in one half-cycle

$$= \frac{1}{\sqrt{2}} \times \frac{3\pi}{2} E_{av}$$

∴ Mean power in one half-cycle

$$= \left(\frac{1}{\sqrt{2}} \times \frac{3\pi}{2} \right)^2 E_{av} I_{av}$$

and power in six half-cycles

$$= \frac{2}{6} \left(\frac{1}{\sqrt{2}} \times \frac{3\pi}{2} \right)^2 E_{av} I_{av} = 3.7 E_{av} I_{av} \dots (2)$$

However, the current in a valve does not obey a linear law but is

usually a function of the three-halves power law over most of the operating range.

Let i = instantaneous value of current, I_m = peak current and E_m = peak voltage.

$$i = k E^{3/2}$$

$$\frac{i}{I_m} = \frac{(E_m \cos \theta)^{3/2}}{E_m^{3/2}} = \cos^{3/2} \theta$$

$$\therefore i = I_m \cos^{3/2} \theta$$

Hence mean power over quarter-cycle

$$= \frac{I_m E_m}{\pi/2} \int_0^{\pi/2} \cos^{5/2} \theta d\theta \dots (3)$$

Now it is known that

$$\int_0^{\pi/2} \cos^{m-1} x \sin^{n-1} x dx = \frac{\gamma(\frac{1}{2}m)\gamma(\frac{1}{2}n)}{\gamma(\frac{1}{2}m + \frac{1}{2}n)}$$

which is the same as Equation (3) if $x = \theta$, $n = 1$ and $m = (1 + 5/2) = 7/2$.

Hence mean power in quarter-cycle

$$= \frac{I_m E_m}{\pi/2} \left(\frac{\gamma(\frac{1}{2} \times 7/2)\gamma(\frac{1}{2} \times 1)}{\gamma(\frac{1}{2} \times 7/2 + \frac{1}{2} \times 1)} \right)$$

$$= \frac{I_m E_m}{\pi/2} \left(\frac{\gamma(7/4)\gamma(\frac{1}{2})}{\gamma(9/4)} \right)$$

From table of gamma functions

$$\gamma(7/4) = \gamma(1.75) = 0.9191$$

$$\gamma(1/2) = \frac{1}{\sqrt{\pi}}$$

$$\gamma(9/4) = (9/4 - 1)\gamma(9/4 - 1) = \frac{5}{4} \times 0.9064$$

∴ Mean power in quarter-cycle

$$= \frac{I_m E_m}{\pi/2} \left(\frac{0.9191 \times \sqrt{\pi}}{5/4 \times .9061} \right)$$

$$= \frac{0.7190}{\pi/2} I_m E_m$$

and mean power in one half-cycle

$$= 2 \times 0.7190 \frac{I_m E_m}{\pi} = 0.4576 \frac{I_m E_m}{\pi}$$

Now $i = I_m \cos^{3/2}\theta$ (5)

∴ Average current in one quarter-cycle

$$= \frac{1}{\pi/2} \int_0^{\pi/2} I_m \cos^{3/2}\theta d\theta$$

$$= \frac{I_m}{\pi/2} \int_0^{\pi/2} \frac{\cos^{3/2}\theta d\theta}{\cos^{m-1} \times \sin^{n-1} \times dx}$$

If $n=1, m=(1+3/2)=5/2$ and $x=\theta$

∴ Average current in one quarter-cycle

$$= \frac{I_m}{\pi/2} \left[\frac{\gamma(\frac{1}{2} \times 5/2)\gamma(\frac{1}{2} \times 1)}{\gamma(\frac{1}{2} \times 5/2 + \frac{1}{2} \times 1)} \right]$$

$$= \frac{I_m}{\pi/2} \left[\frac{\gamma(5/4)\gamma(\frac{1}{2})}{\gamma(7/4)} \right]$$

and from table of gamma functions

$$\gamma(5/4) = 0.9064$$

$$\gamma(7/4) = 0.9191$$

$$\gamma(\frac{1}{2}) = \frac{1}{\sqrt{\pi}}$$

∴ Average current in one quarter-cycle

$$= \frac{I_m}{\pi/2} \left[\frac{0.9064 \times \frac{1}{\sqrt{\pi}}}{0.9191} \right]$$

$$= 0.8738 \frac{I_m}{\pi/2}$$

and average current over one half-cycle is obviously the same

$$= \frac{2 \times 0.8738 I_m}{\pi} = 0.5560 I_m$$
 (6)

But measured average current over period of six half-cycles

$$= I_{av} = \frac{2}{6} \times 0.5560 I_m = 0.1853 I_m$$
 (7)

Now we have proved in (5) that mean power in half-cycle

$$= 0.4576 E_m I_m$$

then for I_m we can substitute $\frac{I_{av}}{0.1853}$

and for E_m we can write $\frac{3\pi}{2} E_{av}$

similar to (1).

∴ Mean power in half-cycle

$$= 0.4576 \times \frac{3\pi}{2} E_{av} \times \frac{I_{av}}{0.1853}$$

Hence mean power over six half-cycles

$$= \frac{2}{6} \times \frac{0.4576 \times 3\pi}{2 \times 0.1853} E_{av} I_{av}$$

$$= 3.88 E_{av} I_{av}$$
 (8)

which is higher than the value obtained for a linear law. However, it is realised that the above value would not be so large in practice due to electron scattering, etc., and a figure of $3.8 \times E_{av} I_{av}$ has been taken to represent the mean power.

Appendix II

The Relationship between Anode and Grid Dissipations for a given Grid Primary Emission

Assuming that the total power dissipated in the grid is radiated to the anode

let W_g = grid dissipation, and W_a = anode dissipation

then $W_g = c(T_g^4 - T_a^4)$ (9)

Where c is a constant for a given valve structure, T_g and T_a are grid and anode temperatures.

A similar relationship exists for the radiation from the anode into the surrounding space

$$W_a + W_g = C_1(T_a^4 - T_o^4)$$
 (10)

Where T_o is the temperature of the surrounding medium. We may write:

$$\frac{W_a + W_g}{C_1} = T_a^4 - T_o^4$$

$$\therefore T_a^4 = \frac{W_a + W_g}{C_1} + T_o^4$$
 (11)

∴ substituting for T_a^4 in (9)

$$W_g = C \left(T_g^4 - \frac{W_a + W_g}{C_1} + T_o^4 \right)$$

$$= \frac{CW_a + CW_g}{C_1} + CT_g^4 + CT_o^4$$

$$\therefore W_g + \frac{CW_a + CW_g}{C_1} = CT_g^4 + CT_o^4$$

and

$$W_g \frac{(C_1 + C)}{C_1} = (CT_g^4 - CT_o^4) - \frac{CW_a}{C_1}$$

$$W_g = \frac{(CT_g^4 - CT_o^4) C_1}{C_1 + C} - \frac{CW_a}{(C_1 + C)}$$

then $\frac{dW_g}{dW_a} = \frac{-C}{(C_1 + C)}$ or the rate of

increase of W_g with respect to W_a is constant, which gives a linear relationship.

∴ Equation $W_g = A - kW_a$ may be used. (13)

Improved Molybdenum

The high melting point of molybdenum (4748° F.) renders it difficult to prepare, and it is manufactured by a sintering process similar to that used in tungsten which also has a high melting point.

The powdered metal, obtained from the oxide, is compressed into the desired simple shape and a heavy current is passed through it to raise the temperature of the mass to just below the melting point. The particles of metal then adhere firmly together and form a homogeneous mass.

By a new process the Westinghouse (U.S.A.) engineers have enabled molybdenum to be produced in any desired shape that is capable of being moulded, and the cost per pound has been reduced to approximately 1/3 that of normal. Among the properties of molybdenum which will make it of increasing value are its high wear resistance at high temperature, greater modulus of elasticity and better thermal conductivity than steel, and lower specific heat and thermal expansion.

Its corrosion resistance compares favourably with tantalum, palladium and platinum.

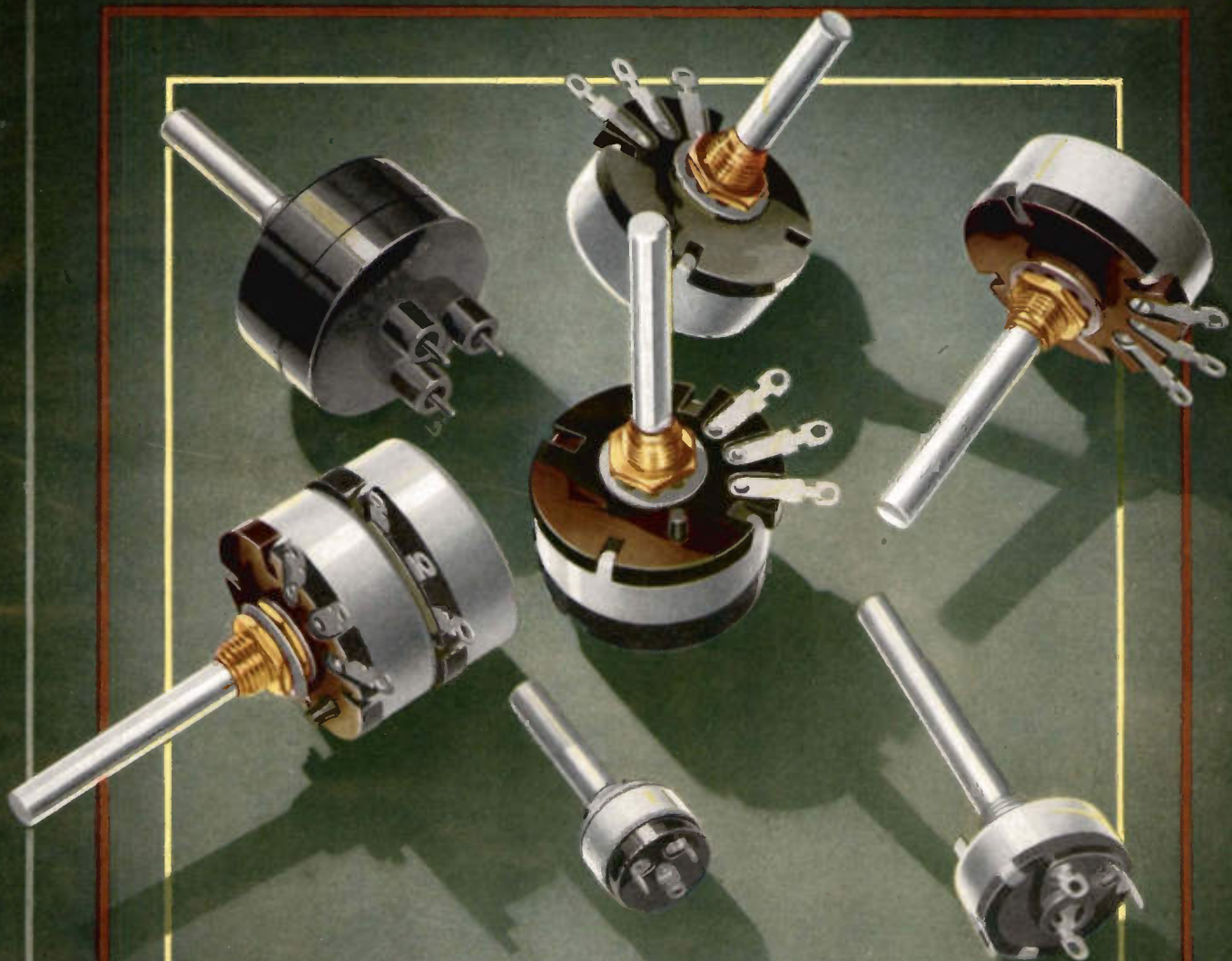

MORGANITE POTENTIOMETERS

A
MORGAN
product

Pentodes and Tetrodes

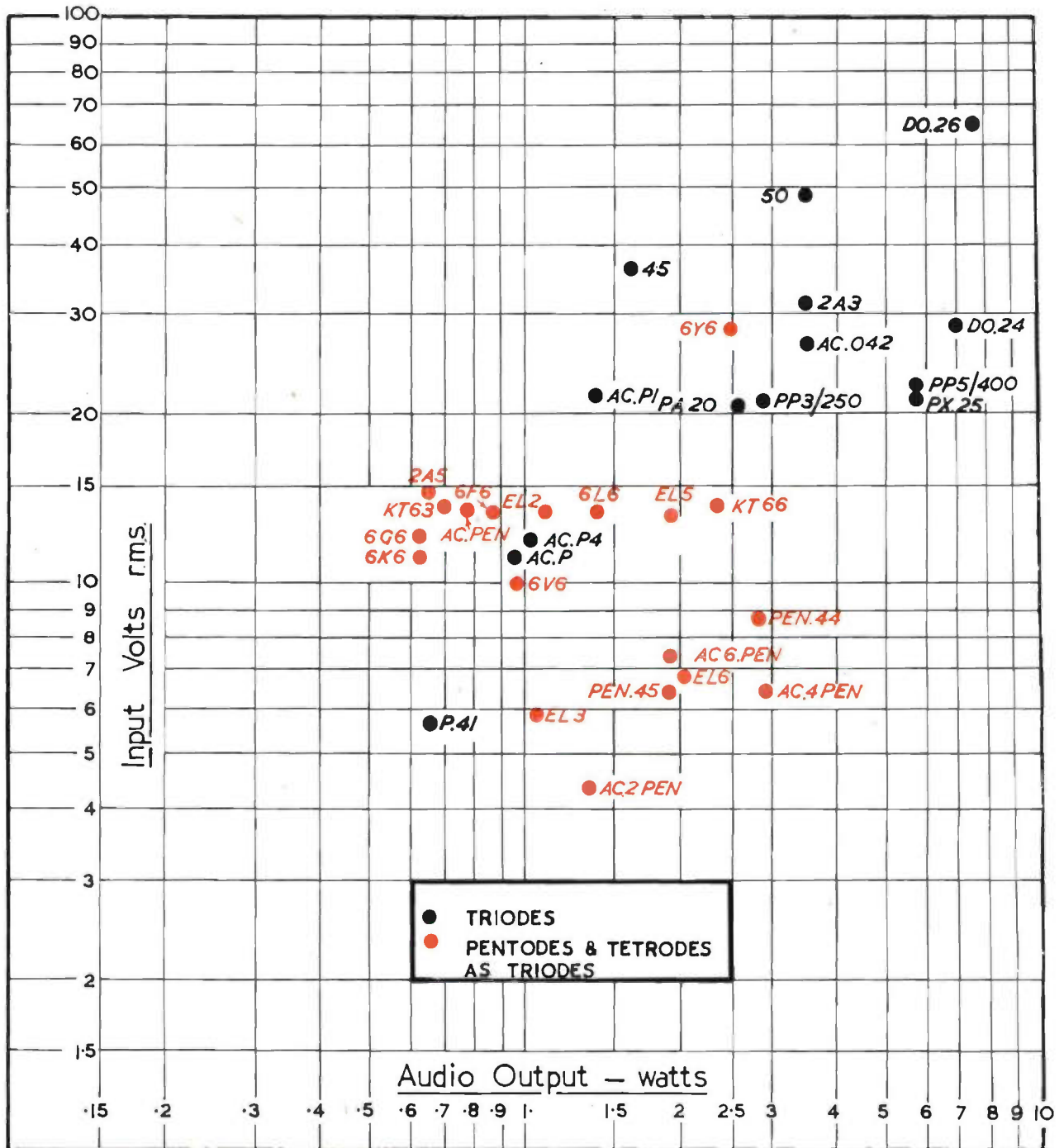

Chart of typical British and American triodes, tetrodes, and pentodes classified according to power output and input voltage swing.

Operating as Triodes

By C. C. McCALLUM*

SINCE commercial radio receiver designers have necessarily to provide a maximum audio power output for a minimum D.C. power input (to reduce cost of H.T. supply equipment) and a minimum audio input swing (to reduce cost of early stages), the pentode and its successor the beam tetrode has been almost universally chosen for the output stage.

The result of this concentration on power efficiency has very naturally caused the valve designers to neglect triodes and to devote their skill to the still further improvement of the pentodes and tetrodes. This can be very readily seen by looking through current catalogues and finding that the old original PX4, PP3/250, PX25, PP5/400, etc., are still the "ultimate" in triodes much as they were over ten years ago.

Now among a large number of quality-conscious enthusiasts triodes are still used extensively because, without wishing to go into the details of the age-old controversy, there are advantages if efficiency is not of paramount importance. This large body of discriminating people are, too, realising that the triode has not progressed to any marked extent for years and they have had to resort to methods not altogether orthodox to produce for themselves more efficient triodes. This they have done by linking electrodes in the pentode and tetrode class and thus evolving for themselves "new" valves having higher mutual conductances (and sometimes anode dissipations) than is possible by using the somewhat restricted range of true triodes.

How far they succeed will be shown later, but before doing so, another point will be touched upon that is causing the growing interest in the use of pentodes and tetrodes as triodes.

The "cathode-follower" as applied to the output stage, where the loud speaker transformer appears in the cathode circuit, is beginning to find

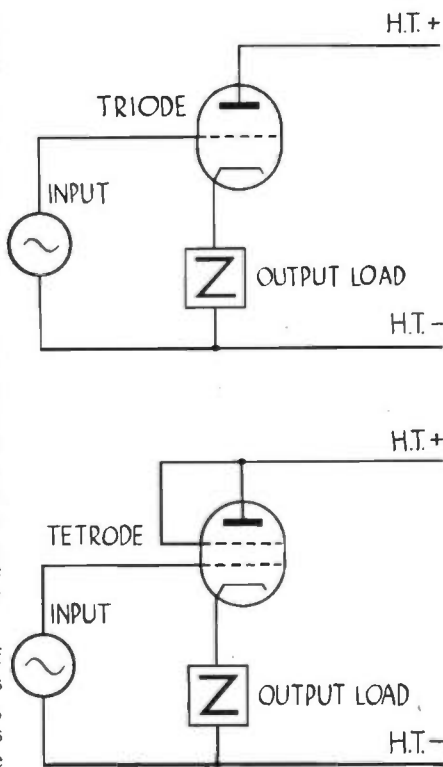

favour because of the damping imposed on the speaker. The important thing about this circuit (from the point of view of this article) is that, whether one employs a triode beam tetrode, or pentode, all function effectively as triodes as will be seen by the diagram. Thus it becomes important to know the triode characteristics of tetrodes and pentodes if one is to assess the desirability of adopting "cathode-follower" circuits.

Unfortunately, the maker's catalogues do not give, except in rare cases, the details wanted and the user will have to "work it out" for himself.

This can be done fairly easily by reference to the catalogues. Taking for example the Mazda A.C.4/Pen valve, the details given in the maker's list are:—

- Anode Current 64 m/a at V_a 250.
- Screen „ 13 m/a at V_a 250.

From this it may be seen that the

screen current is one-fifth of the anode current. This relationship can be assumed to remain substantially constant throughout the ranges of potential in which we are interested and enables the "triode" anode current to be derived by addition of screen and anode current. Where the manufacturer gives a family of anode current-control grid voltage curves for identical anode and screen voltages, the procedure of conversion to anode current-anode voltage curves is simplified. Where the anode current-control grid voltage curves are given for varying anode voltages and fixed screen voltages, interpolation methods will have to be adopted. In the case of a true pentode, as distinct from a beam tetrode, the screen, suppressor grid and anode must all be linked together in making an artificial triode.

The adjoining chart has been prepared to indicate the power output to be expected from a representative range of British and American triodes, pentodes and beam tetrodes, the two latter types connected as triodes. To give the chart greater value the input swing necessary to achieve the power output stated can also be read off from a scale. The figures are in general given with due regard to the maker's maximum dissipation requirements, restriction of second harmonic distortion to a maximum of 5 per cent. of the fundamental, and utilisation of optimum load resistance.

The table may be of value to those who are unable to obtain a particularly old type triode by indicating a pentode which, connected as a triode, will give approximately the same power output.

In addition, the sensitivity of any individual valve appearing on the chart may be simply obtained by dividing the power output by the input voltage swing, thus deriving an expression of milliwatts per volt input. British pentodes and beam tetrodes connected as triodes will be found to be considerably ahead of any other types from the point of view of sensitivity.

* Radio Division, The Edison Swan Electric Co.

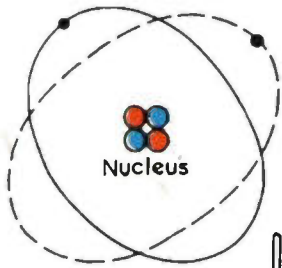

Extra-nuclear Electrons
(Separate elliptical orbits form one group or shell—see 2)

COLOUR CODE	
●	PROTON Charge: +1
●	NEUTRON Charge: 0
●	ELECTRON Charge: -1

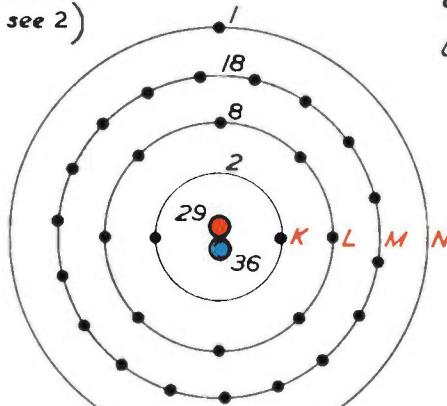
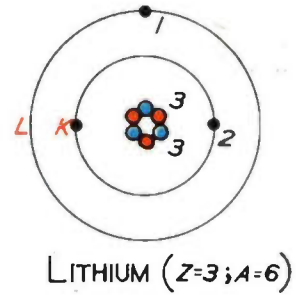
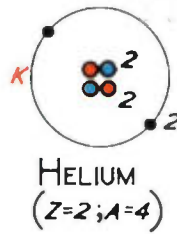
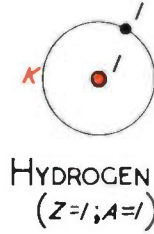

2

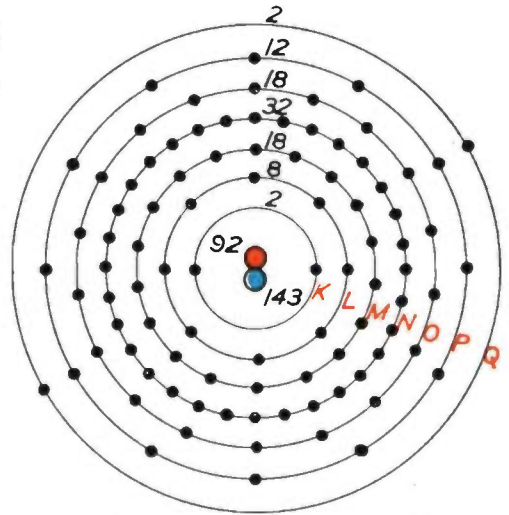

3

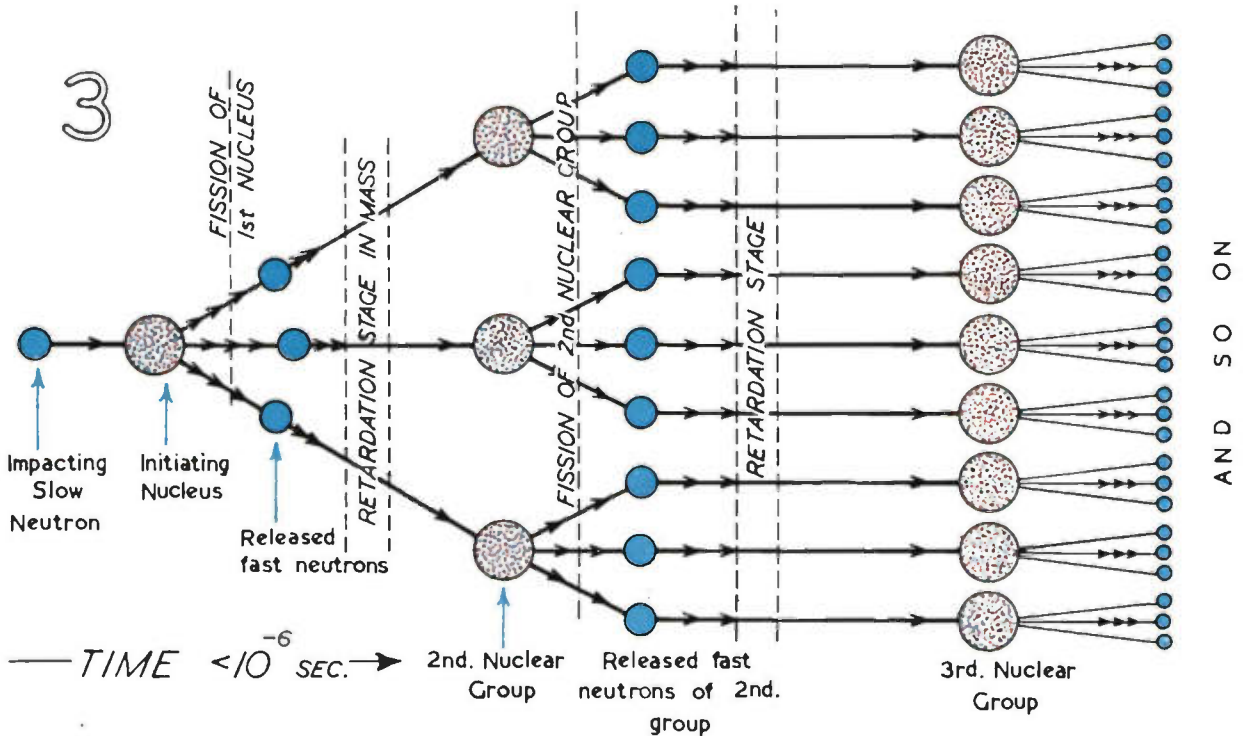

Nuclear Energy

PART I.—Theoretical Considerations

By W. D. OLIPHANT, B.Sc., F.Inst.P.

Introduction

THE history of atomic disintegration has already been outlined in this Journal* and it is the object of this article to investigate the order of energy level which can be expected in a nuclear reaction, and to compare it with such energy levels as are at present encountered in engineering practice.

Current motive-power engineering practice is concerned essentially with the behaviour of *molecules*, that is to say with chemical substances which have been formed by the combination of atoms either of one, or of a number of different species. The heat engine, except in very special circumstances, utilises heat energy derived from an exothermic chemical reaction involving the disintegration of molecules into their atomic components and of their recombination in the presence of oxygen to form the products of combustion. Such a reaction may be called a chemical chain reaction and is dependent on the establishment of a definite temperature, known as the ignition point, for its initiation and continuance. As is well known, the rate at which heat is liberated can be controlled within fine limits in the combustion chamber and just sufficient heat energy to meet the prevailing load requirements of the plant can be generated.

A simple example of an exothermic reaction is the complete combustion of amorphous carbon, the thermochemical equation taking the form:

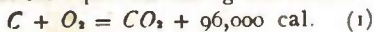

This equation shows that the substances which react (carbon and oxygen) possess more energy than the final product (carbon dioxide) by an amount equivalent to 96 kcal. of heat. (One calorie is the amount of heat required to raise the temperature of 1 gm. of water through 1°C.) The symbols in such an equation represent gram-atoms (in the case of C) or gram-molecules or moles (in the case of O₂ and CO₂), and thus the heat of combustion of 1 gram-atom of carbon

(12 gm.) is 96 kcal., a figure which may be taken as representative of the average energy level obtained in fuel technology. The heat of combustion of hydrogen to form water is of the order of 68 kcal. per mole, or, if aqueous vapour is formed, this figure becomes 58 kcal. per mole.

In the engineering applications of fluid dynamics, the potential and kinetic energies of molecules "in bulk" are utilised in gaseous expansion in the engine cylinder or as a result of the reaction forces set up by a high velocity fluid jet on the blading of a hydraulic turbine runner or of a steam turbine rotor. A recent extension of this application is jet propulsion and its initiation is dependent on the establishment in certain cases of an exothermic chemical reaction of a more instantaneous or explosive nature than that cited for the combustion of carbon.

In the light of recent developments in nuclear physics, it is now evident that the motive-power engineer stands on the threshold of a revolutionary new era and it may not be so very long before he is actively engaged in utilising the enormous energy liberated by the disintegration, or indeed of the combination, not of molecules, but of atomic nuclei. The term "atomic energy" has come suddenly into everyday usage, but it should be realised that this covers electronic energy as well as nuclear energy; in the former category we have such phenomena as are associated with the atomic extra-nuclear or planetary electrons (for example, electronic and photonic emission), while in the latter, we are concerned with the atomic nucleus only. In the applied aspects of the subject, we have electronic engineering covering all matter contained and described up to the present in this journal, and *nuclear engineering*, a subject which is now just making its first bow.

It is necessary at this point to introduce a very important principle in modern physics—the principle of the equivalence of mass and energy.

The Equivalence of Mass and Energy

At the beginning of the present century, the fundamental relation between mass and energy was demonstrated by Einstein as a consequence of his theory of relativity. On this principle, mass and energy are equivalent, and mass must be regarded as a concentrated form of energy. (In a recent issue of a popular pictorial magazine, mass has been rather picturesquely described as congealed energy!)

It can be shown that the relativistic mass (*m*) of a system depends on its translational velocity (*v*) in accordance with the expression:

$$m = \frac{m_0}{\left(1 - \frac{v^2}{c^2}\right)^{\frac{1}{2}}} \quad \dots\dots\dots (2)$$

where *m*₀ is the static or rest mass of the system, and *c* is the velocity of propagation of electromagnetic waves (light, radio waves, etc.) in vacuo being equal to 3 × 10¹⁰ cm. sec⁻¹. This result has had experimental confirmation as the result of researches involving high velocity electrons; the effective mass of an electron has been found to increase rapidly as the velocity of light is approached. In everyday experience the effect of this increase in mass, while present, is not manifest; for example, a car moving at 60 m.p.h. will not have increased in mass by more than one then-thousandth part of one per cent.

If we are prepared to neglect powers of *v* higher than the second, and this can be tolerated in most practical applications, then Equation (2) may be written as:

$$m = m_0 \left(1 + \frac{1}{2} \frac{v^2}{c^2}\right) \quad \dots\dots\dots (3)$$

In Newtonian mechanics, the kinetic energy (*E* ergs.) of a body of mass *m*₀ gm. and translational velocity *v* cm. sec⁻¹, is given by *E* = ½*m*₀*v*², and it follows, therefore, from Equation (3) that:

$$E = (m - m_0)c^2 \quad \dots\dots\dots (4)$$

* Feather, *Electronic Engineering*, September, 1945.

In other words, the energy of a system is proportional to the change in mass, while the proportionality factor is the square of the velocity of light ($c^2 = 9 \times 10^{20}$); c^2 may thus be referred to as the energy equivalent of unit mass.

Arising out of the above theory, we can no longer uphold the law of the conservation of mass (or of matter) as applied to any individual system, but we must replace it by the law of the conservation of energy, at the same time recognising the existence of a new and fundamental entity—*mass energy*. Thus if the energy of a system is decreased, its mass also is decreased and *vice versa*.

When dealing with matter in bulk, such as in the combustion of a fuel, the change in mass between the initial and final substances involved in the reaction is exceedingly minute and quite beyond the possibility of laboratory measurement. Referring back to equation (1) for the combustion of carbon, the heat energy liberated per gram-atom of carbon represents a mass reduction to the system of the order of 10^{-8} gm. The position is very different, however, when dealing with matter in its ultimate form in the realm of atomic magnitudes as will become apparent in the next section.

Nuclear Synthesis

Prior to the discovery of the neutron, atomic nuclei were supposed to be made up of protons and electrons, but there is now considerable experimental evidence in favour of a proton-neutron construction. A proton is the nucleus of a normal hydrogen atom possessing a mass of 1.672×10^{-24} gm. and carrying one positive unit of electric charge equal in magnitude to the electronic charge. The protonic mass, expressed on the physical scale, is 1.008 atomic mass units (a.m.u.) wherein 1 a.m.u. is taken to be 1/16th of the mass of the oxygen isotope of mass number 16, namely 1.660×10^{-24} gm. A neutron possesses no electric charge, but has a mass (slightly greater than the proton) equal to 1.674×10^{-24} gm., or 1.009 a.m.u.

In general, the nuclear charge is given by the product of the *atomic number*, Z , and the electronic charge, the values for Z ranging from 1 for hydrogen to 92 for uranium. The *mass number*, A , of an element (or of a particular isotope thereof) represents the total number of nuclear particles present (protons and neutrons), and it follows that there

must be Z protons and $(A-Z)$ neutrons in a nucleus.

We will now investigate the synthesis of an α -particle which is the nucleus of a helium atom. Helium has an atomic number $Z = 2$ and a mass number $A = 4$; there are thus 2 protons and 2 neutrons in the nucleus. The mass balance sheet is then as follows:—

$$\begin{array}{l} \text{Mass of 2 protons} = 2 \times {}_1H^1 = 2 \times 1.672 \times 10^{-24} = 3.344 \times 10^{-24} \text{ gm.} \\ \text{Mass of 2 neutrons} = 2 \times {}_0n^1 = 2 \times 1.674 \times 10^{-24} = 3.348 \times 10^{-24} \text{ gm.} \\ \text{Sum} \dots\dots\dots 6.692 \times 10^{-24} \text{ gm.} \end{array}$$

$$\begin{array}{l} \text{But the mass of an } \alpha\text{-particle (4.003 a.m.u.)} = 6.640 \times 10^{-24} \text{ gm.} \\ \text{hence loss in mass by difference} = 0.052 \times 10^{-24} \text{ gm.} \end{array}$$

This loss in mass, by equation (4), is equivalent to an amount of liberated energy equal to 4.68×10^{-8} ergs per α -particle.

For one gram-atom of helium (4 gm.), this figure must be multiplied by 6.06×10^{23} which is Avogadro's number and represents the number of nuclei present in one gram-atom of an element. Thus the liberated energy per gram-atom amounts to 2.84×10^{16} ergs.

Joule's mechanical equivalent of heat, J , is equal to 4.2×10^7 ergs per caloric and hence the heat equivalent of the above energy amounts to 6.76×10^8 kcal. Thus, if it were possible to synthesise α -particles in the laboratory, each gram-atom produced would yield 6.76×10^8 kcal. of heat, just about five million times greater than the heat generated by the combustion of 4 gm. of hydrogen.

The amount of energy calculated above represents the *binding energy* of the helium nucleus, and it follows that before the helium nucleus can be split into its component parts, at least this amount of energy would have to be supplied to it from an external source. The α -particle, in common with most other nuclei, is thus a very stable structure.

It is interesting to note as a result of the above calculation that if all the hydrogen atoms contained in one litre of water could be made to combine to form helium atoms, the energy liberated would be approximately the same as that set free in the combustion of 200 tons of coal or 40,000 gallons of petrol—a great thought for these days of fuel rationing and heavy rainfall!

A study of the binding energy per nucleus has been calculated for most

elements and it is found that the elements of mass numbers ranging from about 40 to 100 are most stable, the binding energy decreasing towards both ends of this range. This suggests the possibility of obtaining nuclear energy either by disintegrating the heavy nuclei or by combining the light nuclei. The spontaneous

disintegration of the heavy radioactive nuclei is well known, but unfortunately their half-life periods render them wholly unsuitable as practical sources of energy. Additional proof of future possibilities is to be found in the recent demonstrations of nuclear fission, but as yet no means have been devised whereby the lighter nuclei may be made to combine.

Artificial Nuclear Disintegration

The first attempt to bring about transformation of stable nuclei was made by Rutherford in 1919 and, in the first classical experiment, nitrogen atoms were bombarded by the fast α -particles emitted from Ra.C (radium-C); these particles have a range in air of about 7 cm. The success of the experiment, quite apart from the fact that an atom is mainly empty space, was rendered difficult by the positive charge on the bombarding projectiles which were thus subject to Coulomb (electrostatic) forces when they approached a nucleus; direct hits were few and far between. When, however, a close collision did take place, two new atomic species were formed—oxygen and hydrogen—and the nuclear reaction equation takes the form,



(In such equations, the subscript denotes atomic number and the superscript the mass number of the element or isotope involved.)

Thus, the result of bombarding nitrogen (${}_7N^{14}$) with α -particles (${}_2He^4$) is to produce an isotope of oxygen (${}_8O^{17}$) and a proton (${}_1H^1$), and it is evident that particles emitted during

the radioactive disintegration of the heavy atoms are capable of transmuting the stable nuclei of the lighter elements. This reaction was confirmed and analysed by Blackett who succeeded in photographing the tracks in the Wilson cloud chamber. Later experiments with other elements established the fact that α -particle bombardment gave rise to the production of high velocity protons.

The ranges of the emitted nuclei observed as a result of inelastic collisions between α -particles and the heavier nuclei are dependent not only on the energy of the incident α -particle, but also on the energy involved during the nuclear reaction process; such ranges (as recorded in the cloud chamber photographs) are a measure of the energies involved. In the case of nitrogen disintegration, a change in mass of the order of 0.0014 mass units was observed and confirmed by calculation from a knowledge of the isotopic masses involved, energy in this case has actually been *absorbed* since the isotopic masses of the final nuclear products add up to more than for the reactants.

In 1932 another classical experiment was performed by Cockcroft and Walton who, with the aid of positive ray apparatus operating at high voltage, produced a beam of high energy protons. This beam was allowed to impinge on a lithium target and the following reaction took place,



The lithium isotope of mass 7 was taken and occasionally, as the result of a close collision, a proton entered a lithium nucleus and was captured by it. The resulting nucleus was unstable and disintegrated immediately with explosive violence to produce two α -particles which escaped with high velocity in opposite directions. The kinetic energy liberated was found to be equivalent to 0.017 mass units.

The efficiency of all such reactions was found to increase rapidly with increase in the velocity of the bombarding particles, a two-fold increase in velocity accounting for as much as a ten-fold increase in reaction efficiency. Parallel development in the production of such high velocity ions culminated in the magnetic

resonance accelerator or cyclotron of Lawrence; by this means it was possible either to accelerate the α -particles emitted naturally from radioactive elements or to produce and accelerate artificially such ions within the apparatus by electronic bombardment.

Urey's discovery of the hydrogen isotope of mass 2—known as deuterium—provided yet another high velocity particle in the form of the deuteron (deuterium nucleus, ${}^2\text{H}^2$ or ${}^2\text{D}^2$). If we had bombarded the lithium target with such particles, the reaction would have yielded an additional product in the form of what is now known to be a neutron (n^1), thus,



Neutrons

The classical discovery of the neutron was however obtained as the result of bombarding beryllium with α -particles obtained naturally from polonium in accordance with the relation,

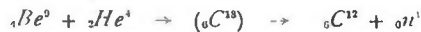

Neutrons are fundamental uncharged particles which possess a unique penetrating power in virtue of the fact that they are unaffected by extra-nuclear electrons and can approach to and collide with nuclei without being subjected to repulsive forces. Neutron absorption is most effective in substances rich in hydrogen, such as paraffin and heavy water, and these substances therefore provide an effective means for slowing down fast neutrons to energy values comparable with thermal agitation velocities. With such a decrease in energy, the cross-section of a nucleus for neutron capture increases from about 10^{-24} to 10^{-20} cm².

It may be mentioned at this point that short-wave photons (γ -rays) have also been employed in nuclear transformations, one example of such a reaction being the conversion of deuterons into protons and neutrons, thus

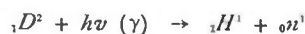

where h is Planck's constant (6.62×10^{-27} erg. sec.) and ν is the frequency in cycles per second. The product $h\nu$ represents the photonic energy of the incident γ -rays

In such nuclear reactions, an energy release may be manifest, but

from the point of view of the practical engineer they do not afford a solution (at least for the present) to the generation of power from the atomic nucleus. They do, however, furnish us with fundamental data and provide a microscopic picture of what may in time become a stable technical process. We now pass from the microscopic to the macroscopic.

Nuclear Fission

As soon as the neutron was discovered, experiments involving neutronic bombardment were actively undertaken and a start was made on the heaviest element—uranium. Uranium possesses three isotopes of mass number (and relative abundance) 238 (99.3 per cent.), 235 (0.7 per cent.) and 234 (less than 0.01 per cent.), and it was found that certain well-defined phenomena occurred.

Uranium 235 (hereafter referred to simply as U.235) was found to be very susceptible to attack by slow neutrons and it was reported by Hahn and Strassmann that, as a result of chemical analysis, one of the disintegration products was an active barium. Now barium possesses an atomic mass of approximately half that of uranium and it was soon apparent that the uranium nucleus had been split into two approximately equal parts—this new phenomenon being called *nuclear fission*. We may thus write down a very simple nuclear reaction equation, bearing in mind the fact that in all such equations conservation of charge (atomic number) and atomic mass (mass number) prevail, thus

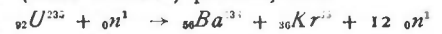

Starting out with the barium clue, the right-hand side of this equation has been built up by incorporating stable isotopes of highest mass number for both barium and krypton and the atomic mass has been balanced by the inclusion of 12 neutrons—a valid addition since experimental evidence has confirmed the emission of such particles. It must be remembered, however, that one of the products of fission was found to be an *active* isotope of barium possessing a mass number necessarily greater than 140. For each increase in the barium mass number by unity, we must take away one neutron from the emitted quantity and insert it in the barium nucleus at the expense of a certain amount of binding energy.

For the present purpose, however, we may regard the above equation as providing us with the order of energy involved in such a fission process. The atomic mass balance sheet may now be drawn up as follows:—

The figures shown are the isotopic masses of the components.

${}_{92}\text{U}^{235}$	=	235.125
${}_{0}\text{n}^1$	=	1.009
		236.134
${}_{56}\text{Ba}^{138}$	=	137.916
${}_{36}\text{Kr}^{92}$	=	85.929
${}_{12}\text{}_{0}\text{n}^1$	=	12.108
		235.953

hence atomic mass difference = 0.181 unit, which is of the order of 1/1,000th part of the mass of the original uranium mass.

Now 1 a.m.u. $\equiv 1.49 \times 10^{-3}$ ergs, and since there are 6.06×10^{23} nuclei in one gram-atom of uranium (235 gm.), this energy works out to be 1.64×10^{20} ergs; equivalent to about 4×10^6 kcal.

Again, since 1 kWh. = 3.6×10^{11} ergs, this energy may be expressed electrically as 4.5×10^6 kWh. per gram-atom; approximately 20,000 kWh. per gram of uranium consumed. A further conversion to practical motive-power thermal units would produce a figure of the order of from 3 to 4×10^{10} B.Th.U. per lb.

This is a stupendous figure, but it must be realised at this juncture that the release takes place in a period of time less than a micro-second, and so to be of any practical value (apart from its use as an explosive) it would require to be very considerably slowed down by the introduction of suitable ballast material such as carbon.

Returning to our basic equation, it is seen that for each nucleus of U.235 disintegrated, there are several neutrons ejected, of which we are probably justified in claiming from 3 to 5 as free. These neutrons, suitably decelerated, are available for attacking other uranium nuclei and so we have the correct conditions for a *divergent chain reaction* in which the whole mass of uranium present will be disintegrated—this is subject to certain conditions governed by

critical mass, configuration and temperature.

Resonance Capture

The fission of the U.235 nucleus by slow neutron bombardment thus constitutes a very potent source of energy but unfortunately it is a relatively rare isotope, occurring in about 0.7 per cent. of the available uranium. It would seem therefore that other nuclei would require investigation to see whether or not fission could be incited. The answer, curiously enough, came from uranium itself, only this time the raw material was the more abundant U.238. If U.238 is bombarded by neutrons possessing a narrowly defined energy value it is found that they are captured by the uranium nucleus without fission taking place—this is known as *resonance capture* and the bombarding neutrons are said to possess resonant energy. The nuclear reaction equation is now much more complicated, being characterised by the emission of β -rays (electrons) and γ -rays (hard X-rays) as follows,

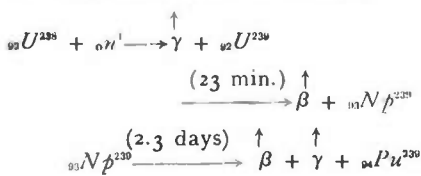

Neptunium

This equation tells us that on bombarding the 238-isotope of uranium with a neutron of resonant energy value, a new isotope of uranium of mass number 239 is formed with the emission of γ -rays. This isotope is unstable (having a half-life period of 23 min.) and emits one electron to become a new element of atomic number 93 and mass number 239—this element is called neptunium. Np.239 is itself unstable (having a half-life period of 2.3 days) and it emits γ -rays and one electron to become another new element of atomic number 94 and mass number 239—this element is called plutonium. Neptunium and plutonium are isobares (same atomic mass but different atomic number); they are true trans-uranic elements which do not occur in nature. Pu.239, like U.235, is susceptible to slow neutrons to produce fission, the resulting release of energy being of the same order of magnitude as for U.235. In

the production of the atomic bomb, the raw uranium (a mixture of U.238 and U.235) may have the 235 isotope separated from it by one of the many well-known methods for isotopic separation, while the remaining U.238 is subjected to resonant neutron bombardment to produce Pu.239. Thus the whole of the uranium may be suitably prepared for slow neutron fission.

In carrying out the transmutation from U.238 to Pu.239, binding energy is liberated and this amounts to about 1,500 kWh. per gm. of plutonium produced. At present this energy is dissipated in circulating cooling water, but it is conceivable that the steam point could be reached if the rate of flow of the water were reduced, and provided the higher working temperature of the plant could be tolerated. It is seen from the equation for the reaction that γ -radiation is present and so adequate steps must be taken to ensure that the operating personnel are not irradiated to the detriment of their health. Furthermore, if we can coin a phrase, the "neutronic combustion" of U.238 produces a very potent "ash" in the form of Pu.239, which, if not removed periodically from the "grate," would attain a certain critical mass and be liable to become triggered-off to the detriment of plant and staff.

The discovery of the nuclear fission of uranium has come as no isolated event, but is the result of patient fundamental research in the physical laboratories of the Universities and Scientific Institutions of the World. With the advent of the war, attention had of necessity to be focused on the production of a suitable offensive weapon and so production methods were investigated at the expense of further fundamental research. With the return of peace it is natural to expect a return to more serviceable research problems which have as their aim the utilisation of nuclear energy in motive-power engineering practice; hereafter the physicist and the engineer must be allowed every facility to pursue the problem to its ultimate solution and there must be no interference from non-scientific and non-technical outsiders (politicians) who are scared of a power *infinitely* greater than their own.



RADIO FREQUENCY CABLES

Callender's RADIO FREQUENCY CABLES

BALANCED TWIN CABLES

Solid Polyethylene Dielectric

These cables are for use in circuits balanced with respect to earth potential. Two selected cores, one black, one white, are twinned up together and filled with polyethylene compound. The small amount of carbon in the black core does not affect the electrical properties of the dielectric.

Unscreened cables are sheathed with black polyethylene compound and flexible screened cables are lapped with metallised paper and braided with tinned or plain copper wire.

In service it has been found that the effective conductor resistance of a flexible screened twin cable at radio frequencies is greatly affected by the contact resistance between the wires of the braiding and, as the cable ages, the attenuation increases many times. On all Callender flexible screened twin cables a layer of metallised paper is lapped round the cable under the braid to eliminate this trouble. Non-flexible screened cables are sheathed with lead alloy.

The dimensions and characteristics of balanced twin cables are given on pages 40 and 41; the average attenuation values and the power ratings in air for a 50 C. temperature rise are shown on pages 42 and 43.

Unscreened twin cables have a large external field and their characteristics are affected by the proximity of metal objects. All characteristics given are for cables in air with no metal within one foot of the cable.



39

38



Have you had a copy of this new book—the first of its kind giving comprehensive technical and catalogue data on radio frequency cables?

Ask for Publication No. 141.E.

BRITISH INSULATED CALLENDER'S CABLES LIMITED
 NORFOLK HOUSE, NORFOLK STREET, LONDON, W.C.2.

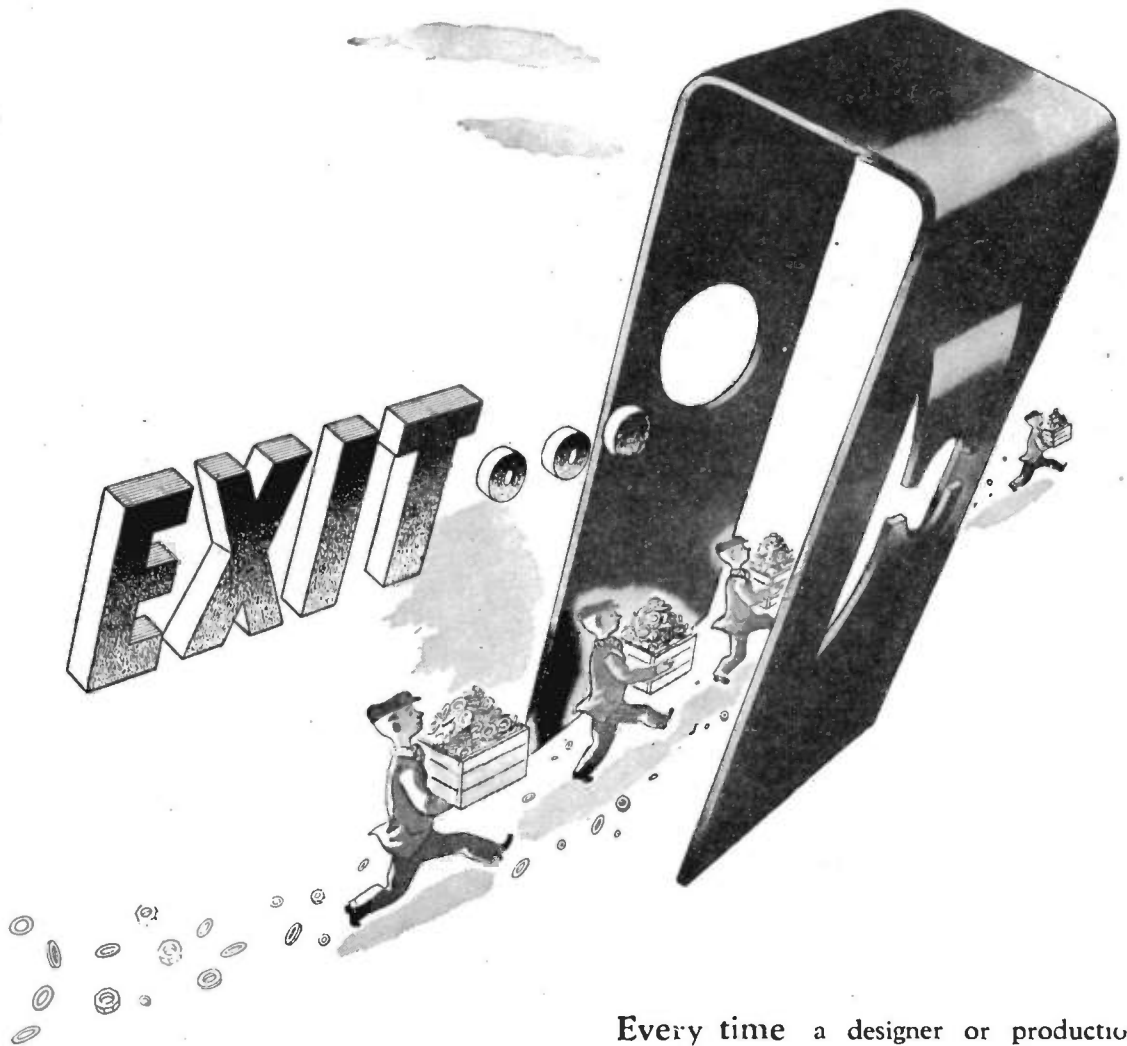

THAT'S Fixed THAT!

Type CA 725.

Fixing knobs to shafts. Sounds simple but if you're a radio manufacturer you know what a headache it can be. The Spire fixing was designed to solve that particular problem. The CA 725 is made to measure for shafts of various diameters. Then it is snapped into position in the hub of the knob and the knob pushed straight on to the shaft.

Don't think of Spire as a 'kind of nut'. It is a great deal more than any nut. It is a simplified and sure method of fixing. Especially awkward fixings!

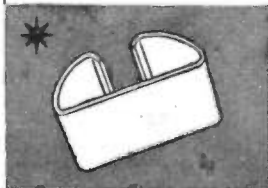

Spire
(Regd.)

Every time a designer or production engineer decides to use some form of Spire fixing, he puts a few thousand (or a few million) nuts and washers out of a job. No more fumbling and holding the bits together with one hand while you get to work with the other. Spire fixing can tackle and simplify most light assembly jobs. The best thing is to send us the job—or the drawings. If a Spire fixing will improve the job we'll design it for you and show it to you in a week or two. Then you can judge for yourself.

* **A BETTER way of fixing**

Simmonds Aerocessories Limited • Great West Road • London • A Company of the Simmonds Group

H.F. Band-Pass Filters

Part III.—Dissimilar Circuits and Miscellaneous Properties

By H. PAUL WILLIAMS, Ph.D., A.M.I.E.E.

2.2 Dissimilar Circuits

2.21 Unequal Damping

Referring to Fig. 10, let us put $R_1 = k^2 R_2$ where k is a numerical constant.

$$\text{Then } Q_1 = \frac{Q_2}{k^2}; \text{ also } q_1 = \frac{q_2}{k^2}$$

Proceeding as for Equation (2), Section 2.12, we find:

$$\frac{V_2}{e} = \frac{-\omega^2 ML}{Z_1 Z_2 + \omega^2 M^2 - \omega^2 ML}$$

$$= \frac{R_1 R_2 (1 + j2q_1)(1 + j2q_2) + \omega^2 M^2}{-\omega^2 ML}$$

In this case we put

$$K = \frac{\omega M}{\sqrt{R_1 R_2}} = \frac{\omega M}{k R_1}$$

$$\left| \frac{V_2}{e} \right| = \sqrt{Q_1 Q_2} \frac{K}{1 + K^2 + 2j(q_1 + q_2) - 4q_1 q_2} = \sqrt{Q_1 Q_2} \frac{K}{(1 + K^2 - 4k^2 q_1^2) + j2q_1(1 + k^2)} \quad \dots (5)$$

Curves of this expression are given in Section 4 for different values of K and k . In Fig. 20 the value of k is 2 for all curves, while in Fig. 21 we have k equal to 4

Inspection of Equation (5) shows that the curve is still symmetrical about $q = 0$ but that the shape is never identical with the equal circuit cases.

All the same, if one compares an equal circuit damping curve with the nearest unequal damping case, one finds that the two shapes are near enough to be considered as being the same from a practical point of view. With unequal damping the values of K required to give a particular shape of response curve are higher than those required in the case of equal damping.

Equation (5) corresponds to Equation (2) of the equal circuit case. Formulae will now be developed from this equation in the same manner as formulae (2a) to (2g) were from their parent formula. At the same time, corresponding formulae will keep the same letter index, e.g., (5b) will correspond to (2b), etc.

The equations so obtained are much more cumbersome than for the (2) series. They have, therefore, been shown graphically in Section 4,

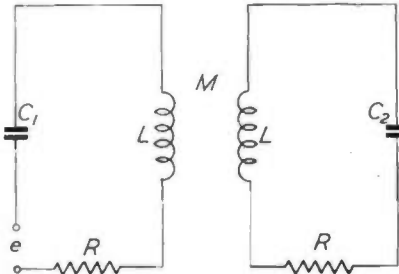

Fig. 11.

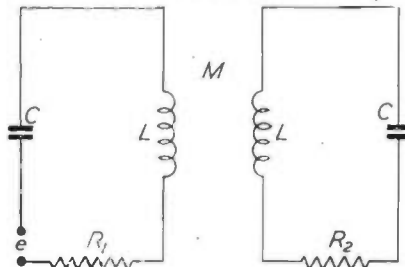
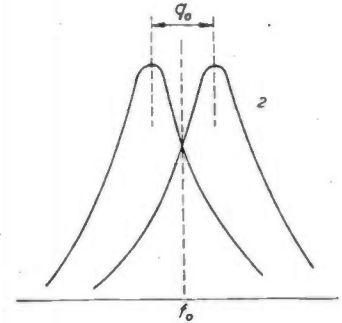

Fig. 10.

Fig. 32, together with the corresponding (2) equations for comparison.

Equation (5) may also be expressed as:

$$\text{Response off tune} \quad \dots (5a)$$

$$\text{Response on tune} = \frac{1 + K^2}{(1 + K^2 - 4k^2 q_1^2) + j2q_1(1 + k^2)}$$

Gain On Tune

Putting q equal to zero we have:

$$\left| \frac{V_2}{e} \right| = \sqrt{Q_1 Q_2} \frac{K}{1 + K^2} \quad \dots (5b)$$

$$= k Q_1 \frac{K}{1 + k^2}$$

Therefore the variations of the gain on tune can be found from Fig. 3 on using an effective Q value of kQ_1 . Perhaps a more useful point to remember is that the effective Q is also equal to Q_2/k , for this is the form we should use if the damping of circuit 1 were increased while that of circuit 2 remained constant.

Position of Peaks

From Equation (5) we see that peaks occur when $(1 + K^2 - 4k^2 q_1^2)^2 + 4q_1^2(1 + k^2)^2$ is a minimum. Proceeding as for the corresponding Equation (2c), we obtain:

$$q_m = \sqrt{\frac{2k^2 K^2 - k^4 - 1}{8k^4}} \quad \dots (5c)$$

This reduces to Equation (2c) when $k = 1$.

Two peaks are formed after q_m exceeds the zero value. With equal circuits the dividing line, i.e., $q_m = 0$, occurs when $K = 1$, but this is not so in the present case. The name "transitional coupling" has been given to the value of K for which two peaks commence in unequally damped circuits (see Aiken, Proc. I.R.E., Feb., 1937). Transitional coupling occurs when $2k^2 K^2 = k^4 + 1$

$$\therefore K = \sqrt{\frac{k^4 + 1}{2k^2}} = \sqrt{\frac{k^2}{2}} \quad \text{when } k^4 \gg 1$$

Maximum Response

Using the value for q_m given in Equation (5c) we have:

$$\frac{V_2}{e} = \sqrt{Q_1 Q_2} \frac{K}{\left[1 + K^2 - \frac{2k^2 K^2 - k^4 - 1}{2k^2} \right] + j2(1 + k^2) \sqrt{\frac{2k^2 K^2 - k^4 - 1}{8k^4}}} \quad (5d)$$

The heights of the peaks are no longer constant as in the equal circuit case. But for a given ratio of peak to valley the curves for the equal and unequal cases are very similar in shape.

The variation of peak heights may be studied by using the curves of Fig. 32 in conjunction with Equation (5b).

Corresponding to (2e) we have:

$$\text{Maximum response} = \frac{1 + K^2}{\left[1 + K^2 - \frac{2k^2 K^2 - k^4 - 1}{2k^2} \right] + j2(1 + k^2) \sqrt{\frac{2k^2 K^2 - k^4 - 1}{8k^4}}} \quad (5e)$$

Graphs of this expression are given in Fig. 32.

When there are two peaks, the response again equals that on tune when:

$$(1 + K^2 - 4k^2 q_1^2)^2 + 4q_1^2 (1 + k^2)^2 = (1 + K^2)^2$$

Giving this value of q the suffix 1 again and dropping the suffix 1 we have:

$$q_0 = \sqrt{\frac{2k^2 K^2 - k^4 - 1}{4k^4}} \quad (5f)$$

= $\sqrt{2} q_m$ (as in the equal circuit case)

N.B.—Here again the value of q is that obtained when referred to the "flatter" of the two circuits.

Rough Plot of Response Curve

As shown in Section 2.12, a rough plot can be obtained from five points. In this case the points are given by (5c), (5e) and (5f). For convenience in working we can use the graphs in Section 4, making interpolations where necessary.

Response Well Off Tune

If $q > \pm 3K$, then a good approximation for V_2/e is given by:

$$\frac{V_2}{e} = \sqrt{Q_1 Q_2} \frac{k}{4k^2 q^2}$$

$$\therefore \frac{V_2}{e} \propto \frac{1}{q^2}$$

Therefore the shape of the skirts of the curve is similar to that obtained by equal circuits.

Separation between Peaks

Separation between peaks = $2q_m$:
= $2q_m \times \text{bandwidth (in kc/s.)}$

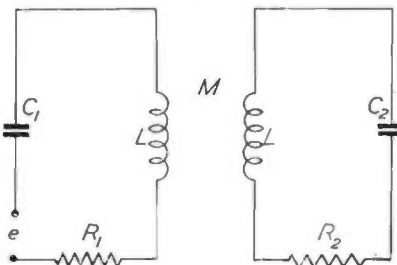

Fig. 12.

$$= 2 \sqrt{\frac{2k^2 K^2 - k^4 - 1}{8k^2}} \frac{R_1}{2\pi L}$$

$$= \frac{R_1}{2\pi L} \sqrt{\frac{K^2 - k^4 + 1}{2k^2}}$$

$$= \frac{1}{2\pi L} \sqrt{\frac{k^2 \omega^2 M^2}{2k^2}} \frac{R_1^2 (k^4 + 1)}{2k^2} \quad (5g)$$

Comparison with Single Circuits

With loosely coupled circuits $K < 1$, and we may neglect K^2 in Equation (5a).

Response off tune

Response on tune

$$\frac{1}{1 - 4k^2 q^2 + j2q(1 + k^2)}$$

$$= \frac{1}{(1 - j2kq)^2 + j2q(1 + k^2) - 2}$$

or $\frac{1}{(1 - j2kq)^2}$ when q is large (say greater than ± 3)

Therefore the response is again similar to that given by two single circuits, except that near tune the

coupled circuits are slightly sharper. The two equivalent single circuits have a Q which is k times the Q of the more highly damped of the two coupled circuits.

2.22 Staggered or Mismatched Circuits

In Fig. 11 we are assuming that the circuits are tuned one to $+q_0/2$ and the other to $-q_0/2$ with respect to a central frequency f_0 (i.e., the separation between the two tuning points is q_0).

If the variable q is still reckoned from f_0 , then the expressions for Z_1 and Z_2 become:

$$Z_1 = R[1 + j2(q - q_0/2)]$$

$$Z_2 = R[1 + j2(q + q_0/2)]$$

With these values of Z_1 and Z_2 we find Equation (2) is modified to

$$\frac{V_2}{e} = \frac{Q}{1 + K^2 + q_0^2 - 4q^2 + j4q} \quad (6)$$

This is exactly like Equation (2) except for the term $(K^2 + q_0^2)$ in place of K^2 . Also all the equations of the (2) series will apply when this substitution is made.

Therefore the shape of the curve is identical with that given by a non-staggered case whose coupling factor equals $\sqrt{K^2 + q_0^2}$. We may put $(K^2 + q_0^2) = K_e^2$ and call K_e the "effective coupling factor."

Although the shapes are identical whether we stagger two coupled circuits by an amount q_0 or whether we increase the coupling to K_e , the outputs obtained in the two cases are not equal.

Taking the on-tune point ($q = 0$) we find that the ratio of the outputs is as follows:

Output of staggered circuits

Output of extra-coupled circuits

$$\frac{K}{K_0} = \frac{K}{\sqrt{K^2 + q_0^2}}$$

Thus there is never any point in staggering circuits so long as the coupling can be increased instead. In particular it should be noted that any inequality in the damping of the two circuits will bring about an unsymmetrical response curve when the circuits are staggered (see Section 2.23).

2.23 Unequal Damping with Staggering

The circuit for this case is shown in Fig. 12. The two meshes are tuned one to $+q_0/2$ and the other to $-q_0/2$ from f_0 . Also the damping is unequal so that $R_1 = k^2 R_2$.

In this case the two circuits will not have the same values for q_0 when referred to their respective circuits. Therefore for circuit number 1 we shall call the staggering $q_{10}/2$ and for circuit number 2, $-q_{20}/2$.

Also we have $q_2 = k^2 q_1$.

Making these modifications in the fundamental formula (see Section 2.12) we obtain:

$$\frac{V_2}{e} = \frac{-\omega M \omega L}{R_1 R_2 \left[1 + j2 \left(q_1 + \frac{q_{10}}{2} \right) \right] \left[1 + j2 \left(q_2 - \frac{q_{20}}{2} \right) \right] - \omega^2 M^2} K = \sqrt{Q_1 Q_2} \frac{\omega M}{(1 + K^2 + k^2 q_0^2) + j q_0 (1 - k^2)} \dots (7)$$

The curve is no longer symmetrical since both the real and imaginary parts have constant terms. It will be noticed also that variations in K , k or q cannot be dealt with one at a time. Therefore the equation cannot be made to resemble the previous cases (i.e., (2), (5) or (6)) in any way.

If $k = 1$, the equation becomes Equation (6).

If $q_0 = 0$, the equation becomes Equation (5).

If we change over the frequencies to which we are tuning the circuits, the curve retains the same shape as before but is reversed on the frequency scale about the point f_0 .

The response curve may also be expressed as:

Response off tune $\frac{V_2}{e} = \frac{\omega M}{(1 + K^2 + k^2 q_0^2) + j q_0 (1 - k^2)}$
 Response on tune $\frac{V_2}{e} = \frac{\omega M}{(1 + K^2 + k^2 q_0^2 - 4k^2 q^2) + j [2q(1 + k^2) + q_0(1 - k^2)]}$ (7a)

In the above equation all q values are those obtained when referred to circuit number 1 (whose series resistance R_1 equals $k^2 R_2$). This convention has been adopted throughout where the circuit resistances (and therefore the q values) are unequal.

Gain On Tune

From Equation (7) we find that when $q = 0$

$$\left| \frac{V_2}{e} \right| = \dots (7b)$$

$$\sqrt{Q_1 Q_2} \frac{\omega M}{(1 + K^2 + k^2 q_0^2) + j q_0 (1 - k^2)}$$

Position of Peaks

To find the positions of the peaks we differentiate the denominator of Equation (7) and equate the result to zero. In previous cases the result was a quadratic in q , for the third solution (which gives the position of the minimum between the peaks) was always $q = 0$. With the present case of both unequal damping and staggering the full cubic equation appears.

The solution is a little tedious but not difficult. A table of some typical results is given below:

K	k	q ₀	q _m		
			(i)	(ii)	(iii)
0.5	2	1	0.500		
		2	1.003	-0.136	-0.865
	4	1	0.500		
		2	1.00	-0.144	-0.857
1	2	1	0.526		
		2	1.025	-0.128	-0.896
	4	1	0.51		
		2	1.005	-0.143	-0.863
2	2	1	0.675	-0.174	-0.50
		2	1.11	-0.106	-1.00
	4	1	0.55		
		2	1.03	-0.135	-0.89

It will be noticed that in many cases only one peak appears and that there is no valley at all (see also the graphs in Section 4). The position of the valley is given by q_m (ii).

Although one normally avoids such curves, they are of interest in view of the fact that while circuits are being trimmed we have curves of this type set up. The staggering is then due to the fact that one circuit may not yet be trimmed, and the uneven damping is a direct result of damping one circuit while trimming the other. Under these conditions we are interested in the accuracy with which the circuit is actually being tuned. In other words, we wish the sharpest peak of the response curve to be at precisely $q_0/2$.

The table given above provides the figures on which Fig. 3 is based (see Section 1.4).

2.24 Unequal L to C Ratios

The circuit illustrating this case is given in Fig. 13. We now cannot assume $R_1(1 + j2q_1) = R_2(1 + j2q_2)$ as in Equation (2), for if $R_1 = R_2$ then $q_1 \neq q_2$ and vice versa. So the method used for unequal damping must be applied.

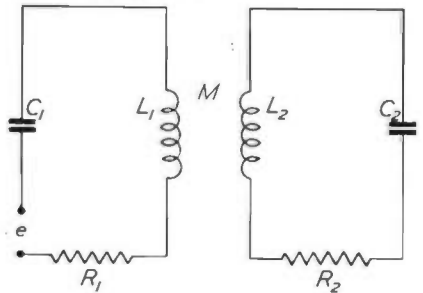

$$L_2 = \rho L_1 \quad C_2 = C_1 / \rho \quad R_1 = k^2 R_2$$

Fig. 13.

Proceeding as before (see Section 2.21):

$$\frac{V_2}{e} = \frac{\omega M \omega L_2}{R_1 R_2 (1 + j2q_1)(1 + j2q_2) + \omega^2 M^2}$$

Using $Q_1 Q_2 = \frac{\omega^2 L_1 L_2}{R_1 R_2}$

we have $\sqrt{Q_1 Q_2} = \frac{\omega L_1}{\sqrt{R_1 R_2}} \sqrt{\frac{L_2}{L_1}}$

Also putting $K = \frac{\omega M}{\sqrt{R_1 R_2}}$ as in 2.21, we have:

$$\left| \frac{V_2}{e} \right| = \sqrt{\frac{L_2}{L_1}} \frac{v Q_1 Q_2}{1 + K^2 - 4k^2 q_1^2 + j2q_1(1 + k^2)} \dots (8)$$

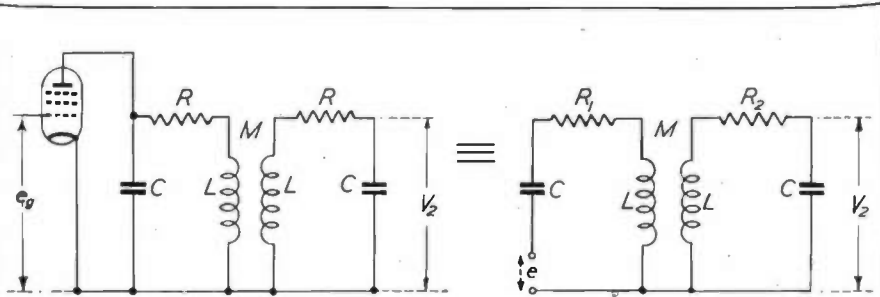

Fig. 14.

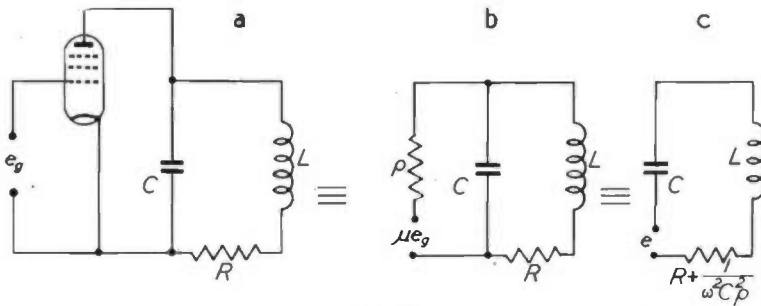

Fig. 15.

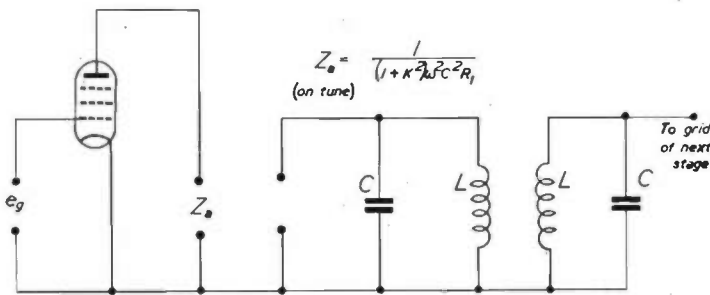

Fig. 16

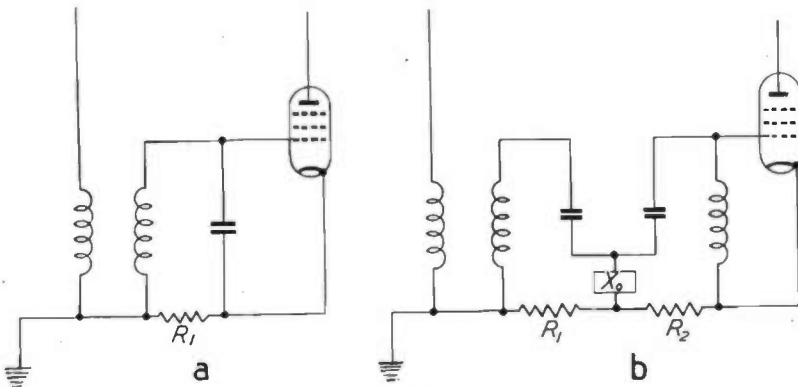

Fig. 17

Therefore the response is similar to that obtained in the unequal damping case, *i.e.*, it is symmetrical but requires tighter coupling than in the equal circuit case for a given ratio of peak to valley.

The gain is, however, different from the simple unequal damping case due to the term $\sqrt{L_2/L_1}$.

We can therefore have a transformer action. But it is important to remember that the effective primary impedance is lowered if we attempt to obtain a voltage step-up. As a result, the overall stage gain with a high impedance value is actually less than that which would be obtained if both circuits had an inductance equal to L_2 .

2.3 Miscellaneous Properties

2.31 Stage Gain

In Fig. 14 the valve is replaced by an equivalent series voltage "e." This voltage is related to the voltage on the grid in the following way:

$$e = g_m e_g \frac{j}{\omega C} \dots (9)$$

$$\text{Also } R_1 = R + \frac{1}{\omega^2 C^2 p}$$

The above result is derived by the application of Thévenin's theorem and the assumption that ρ , the impedance of the valve, is high compared with $\frac{1}{\omega C}$.

This assumption easily applies in circuits using screened grid or pentode valves.

The derivation is as follows:

In Fig. 15(b) we have

$$V = \frac{-\mu e_g Z_p}{\rho + Z_p}$$

(i) where μ = amplification factor
 Z_p = parallel impedance of tuned circuit *excluding* ρ

In Fig 15(c) we have

$$V = \frac{e}{Z_s + j\omega C}$$

(ii) where Z_s = series impedance of tuned circuit *including* the damping due to ρ .

The equivalent series resistance of ρ is $\frac{1}{\omega^2 C^2 p}$ when $\rho \gg \frac{1}{\omega C}$. Therefore

the total series resistance is now $\left(R + \frac{1}{\omega^2 C^2 p} \right)$ and the q values

(see Section 2.11) are altered in the same proportion.

From (i) and (ii) we find:

$$|e| = \frac{\mu e_k Z_p Z_a}{\omega L(\rho + Z_p)}$$

(We may assume $\frac{1}{\omega C} = \omega L$ for these equations.)

Now $Z_p = \frac{\omega^2 L^2}{R(1 + j2q)}$ (provided $\omega L \gg R$)

and $Z_a =$

$$\left(R + \frac{1}{\omega^2 C^2 \rho} \right) \left(1 + j2q \frac{R}{R + \frac{1}{\omega^2 C^2 \rho}} \right)$$

$$\mu e_k \frac{\omega^2 L^2}{R(1 + j2q)} \left\{ \left[R + \frac{1}{\omega^2 C^2 \rho} \right] \left[1 + j2q \left(\frac{R}{R + \frac{1}{\omega^2 C^2 \rho}} \right) \right] \right\}$$

$$\therefore e = \frac{\omega L \left[\rho + \frac{\omega^2 L^2}{R(1 + j2q)} \right]}{\mu e_k \omega L \left[R + \frac{1}{\omega^2 C^2 \rho} + j2qR \right]}$$

$$= \frac{\rho \left[R(1 + j2q) + \frac{\omega^2 L^2}{\rho} \right]}{g_m e_k \omega C} \dots (9a)$$

$$= g_m e_k \frac{1}{\omega C} \dots (9a)$$

In Equation (9) the phasing has been retained while (9a) gives the magnitude relationship only. The phasing relationship shows that "e" is 90° out with respect to e_k. Now in Equations (2), (3), (5), and (6) we see that V₂ is 180° out of phase with respect to e at the on-tune frequency. Hence the output and input voltages (V₂ and e_k respectively) are 90° out of phase at this frequency.

This result has been used to obtain the necessary 90° phase shift in the signal on the vertical antenna of a D.F. system. It is well known that such a phase shift must be produced before we can mix the signal with that from a D.F. loop. Only by doing this can we obtain the cardioid polar pattern which then gives the "sense" of the bearing.

N.B.—When the value for "e" given in Equation (9) or (9a) is used, the damping effect of the valve must be included in the series resistance of the tuned circuit.

The approximation made here lies in assuming $\rho \gg 1/\omega C$ which is quite true ($\rho = 500,000$ ohms, $1/\omega C = 2,000$ ohms in typical cases). If we try to avoid adding ρ to the tuned circuit damping, the modified "e" value has the denominator ($\rho + Z_p$). In the latter case we cannot say $\rho \gg Z_p$, so that the variable part of the denominator could not be neglected.

2.32 Impedances

In the case of pentodes we can consider the valve as a constant current device. Then the plate current will be $g_m e_k$ and is independent of the load.

If e_a is the voltage developed across the effective impedance Z_a of the band-pass, then

$$e_a = Z_a i_p = Z_a g_m e_k$$

In the case of all circuits of reasonably high Q, we can say:

$$Z_a i_p = \frac{i_1}{\omega C} \quad (\text{in magnitude})$$

$$\begin{aligned} \text{Now } i_1 &= \frac{e Z_2}{Z_1 Z_2 + X_o^2} \\ &= \frac{e R_2}{R_1 R_2 + X_o^2} \quad (\text{on tune}) \\ &= \frac{e}{R_1} \times \frac{1}{1 + K^2} \end{aligned}$$

Substituting this value for i₁ in the equation for Z_a:

$$Z_a = \frac{e}{R_1} \times \frac{1}{1 + K^2} \times \frac{1}{g_m e_k \omega C}$$

Also $e = \frac{g_m e_k}{\omega C}$ (see Section 2.31)

$$\therefore Z_a = \frac{1}{R_1(1 + K^2)\omega^2 C^2} \dots (10)$$

$$i.e., Z_a = \frac{\text{Parallel impedance of primary on tune}}{(1 + K^2)} \dots (10a)$$

With very loose coupling this reduces to the normal parallel impedance of the primary tuned circuit. In most band-pass filters K is of the order of unity, so that the impedance is usually about half that of a single circuit.

2.33 Signal-to-Noise Ratios

We may compare the signal-to-noise ratio obtained with a band-pass input circuit to that obtained with a single tuned circuit in the following way:

In Fig. 17, on tune (a) has an impedance of

$$\left| \frac{1}{R_1(\omega L)^2} \right|$$

(b) has an impedance of

$$\frac{1}{R_2(\omega C)^2(1 + K^2)}$$

The case of (b) is simply Equation (12) of the previous section with R₂ substituted for R₁.

Now thermal noise $\propto \sqrt{\text{Grid-to-cathode resistance}}$

$$\begin{aligned} \therefore \frac{\text{Noise (b)}}{\text{Noise (a)}} &= \sqrt{\frac{Z_b}{Z_a}} \\ &= \sqrt{\frac{R_1}{R_2(1 + K^2)}} \end{aligned}$$

$$\begin{aligned} \frac{S/N(b)}{S/N(a)} &= \frac{V_b N_a}{V_a N_b} \\ &= \frac{K}{1 + K^2} \sqrt{\frac{R_1}{R_2}} \sqrt{\frac{R_2(1 + K^2)}{R_1}} \\ \therefore \frac{S/N(b)}{S/N(a)} &= \frac{K}{\sqrt{1 + K^2}} \dots (11) \end{aligned}$$

Equation (11) shows that the loss in signal-to-noise ratio as compared with a single circuit is independent of R₁ and R₂. In the case of critical coupling the loss is 3 db.

(To be continued.)

A Stable Diode Voltmeter

An instrument which does not require zero resetting between ranges and free from "wandering" with mains voltage variations

(Photograph and description supplied by Furzehill Laboratories, Ltd.)

THE basic circuit elements of this instrument are shown on the functional circuit diagram (Fig. 1).

The network $C_1R_1V_1$ constitutes a peaked shunt rectifier system in which C_1 is the reservoir condenser and R_1 the load resistance. When an A.C. input is applied to the probe terminals, the condenser C_1 tends to become charged up to the peak value of this input on the negative half-cycle. The time constant R_1C_1 has been chosen so that C_1 does in fact actually charge up very nearly to the peak value at all frequencies above 50 c/s. The voltage waveform at the cathode of V_1 is the original input A.C. waveform added to a D.C. voltage, positive with respect to earth, equal in magnitude to the peak of the negative half-wave of the A.C. input.

This voltage at the cathode of V_1 is filtered by the components R_2 and C_2 , the time constant R_2C_2 being chosen so that all but a very small proportion of the A.C. component is filtered out for frequencies exceeding 50 c/s. The D.C. voltage so produced across C_2 is applied to the grid of V_2 , which operates as a cathode-follower valve.

The cathode current of this valve all passes through R_3 in the absence of signal input, for the current through R_4 is initially balanced out by adjustment of the potentiometer R_5R_6 connected across the H.T. supply to the valve.

Provided the total resistance in the

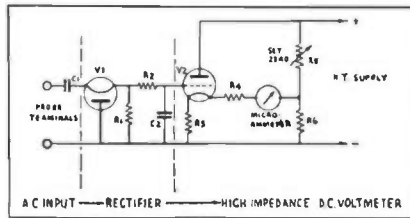
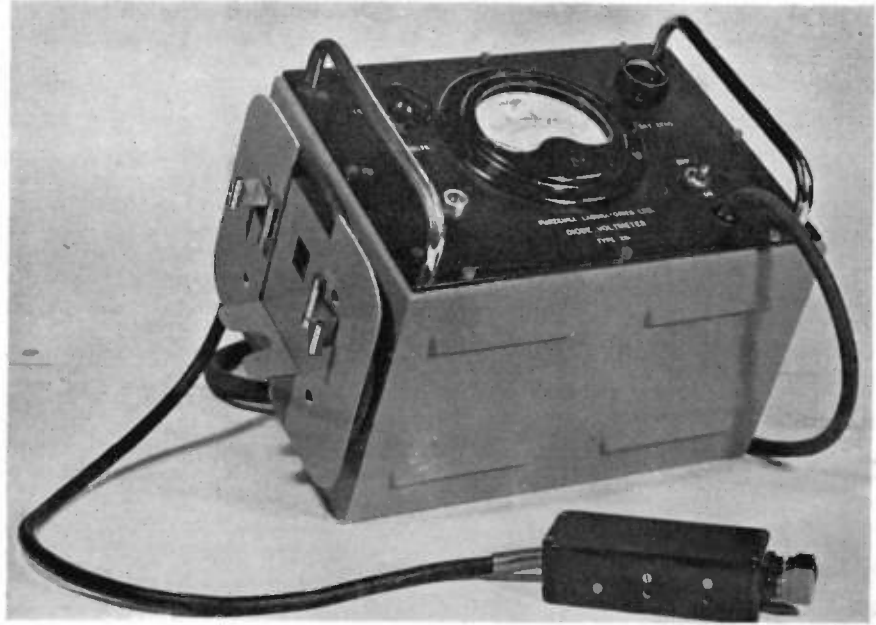

Fig. 1.

cathode circuit of the valve V_2 is maintained high in value compared with the reciprocal of the valve conductance, the signal voltage developed across C_2 will be accompanied by a substantially equal change in voltage across R_3 . This condition is in fact maintained, the function of the valve V_2 being to transfer the signal voltage developed in the high impedance diode rectifier circuit to the much lower impedance microammeter circuit in the cathode of the valve, without appreciably affecting the magnitude of this voltage.

The range of the instrument is adjusted by modification to the value of R_4 . This controls the current which flows into the microammeter for a given signal input.

It will be seen that this is independent of the zero setting control, which is achieved by adjusting the value of the element R_6 of the H.T. potentiometer, so that once the zero has been set on any one range, it remains set on all other ranges. It is also apparent that the valve V_2 , and the resistors R_3 , R_5 and R_6 constitute a bridge circuit in which the H.T. supply is the bridge voltage source and the microammeter the null indicator. Consequently, when the bridge is in balance there is no current in the microammeter. Assuming the valve impedance to behave as a resistance, change of H.T. supply does not affect the balance of the bridge. Thus the zero of the voltmeter is inherently stable against changes of H.T. supply voltage.

Circuit diagram.

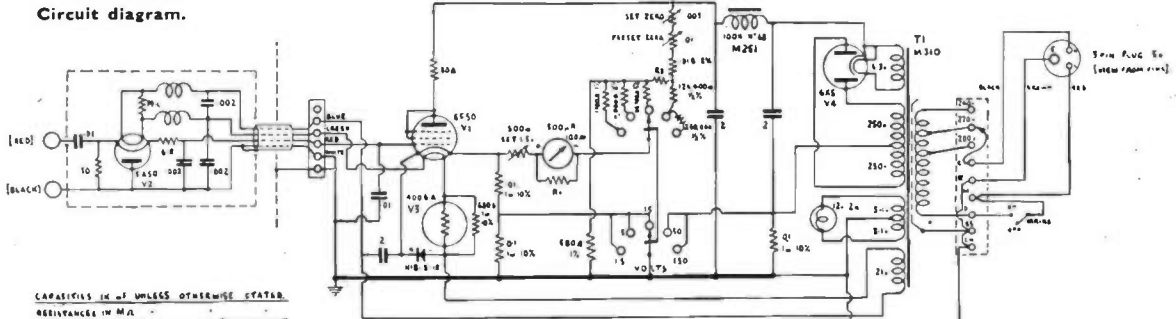

MARCH MEETINGS I.E.E. RADIOLOCATION CONFERENCE

Institution of Electrical Engineers

All meetings of the London Section will be held at The Institution of Electrical Engineers, Savoy Place, Victoria Embankment, London, W.C.2.

Radio Section Radiolocation Conference

Date: March 26. Time: 5.30 p.m.

Lecture:

"The Evolution of Radiolocation."

By:

Sir Robert Watson Watt, C.B., F.R.S.

Date: March 27. Time: 9.30 a.m.

Lecture:

"Aerials."

By:

J. A. Ratcliffe, M.A.

Lecture:

"Waveguides."

By: M. H. L. Pryce, M.A., Ph.D.

Date: March 27. Time: 2.30 p.m.

Lecture:

"Elements of Radio Meteorology."

By: H. G. Booker, Ph.D.

Lecture:

"Experimental Studies of the Propagation of Very Short Waves."

By: E. C. S. Megaw, M.B.E.

Lecture:

"Survey of Cathode-Ray Tube Problems for Service Applications."

By:

G. Bradfield, B.Sc., D. Stewart Watson, B.Sc., and J. G. Bartlett.

Lecture:

"War-time Development in C.R. Tubes for Radar."

By:

H. Moss, Ph.D., B.Sc.(Eng.), R. Puleston, B.Sc., and L. C. Jesty, B.Sc.

Date: March 27. Time: 6.15 p.m.

Lecture: "Precision Radar."

By: W. A. S. Butement, B.Sc.

Date: March 28. Time: 9.30 a.m.

Lecture:

"The Development of Radio Valves."

By: J. H. E. Griffiths, D.Phil.

Date: March 28. Time: 2.30 p.m.

Lecture:

"Radio Measurements and Test Gear."

By: C. W. Oatley, M.A.

Date: March 28. Time: 6.15 p.m.

Lecture:

"Problems in Shipborne Radar."

By: A. W. Ross, M.A.

Date: March 29. Time: 9.30 a.m.

Lecture: "Transmitters."

By: O. L. Ratsey, M.A.

Lecture: "Radar Receivers."

By: W. B. Lewis, F.R.S.

Date: March 29. Time: 2.30 p.m.

Lecture:

"An Introduction to Circuit Techniques for Radiolocation."

By: F. C. Williams, O.B.E.

Date: March 29. Time: 6.15 p.m.

Lecture:

"Radiolocation in Navigation."

By: R. A. Smith, M.A., Ph.D.

For further particulars apply to:

The Secretary:

The Institution of Electrical Engineers, Savoy Place, Victoria Embankment, London, W.C.2.

Cambridge Radio Group

Date: March 12. Time: 6 p.m.

Held at:

Room 301, Cambridgeshire Technical College, Collier Road, Cambridge.

Lecture:

"The Design of Band-Spread Tuned Circuits for Broadcast Receivers."

By: D. H. Hughes, A.M.I.E.E.

Group Secretary:

D. H. Hughes, c/o Pye Ltd., Radio Works, Cambridge.

Institution of Electronics

North-West Branch

Date: March 29. Time: 6.30 p.m.

Held at:

Reynolds Hall, College of Technology, Manchester.

Lecture:

"Recent Advances in Electronics Applied to Medicine."

By: G. Parr, A.M.I.E.E.

Hon. Secretary:

L. F. Berry, 105 Birch Avenue, Chadderton, Lancs.

Brit.I.R.E.

North-Eastern Section

Date: March 13. Time: 6 p.m.

Held at:

Mining Institute, Neville Hall, Westgate Road, Newcastle.

Lecture:

"Carrier Current Protection."

By:

D. H. Towns, B.Sc., and C. Ollernshaw, B.Eng.

Section Secretary:

H. Armstrong, 60 Osborne Road Jesmond, Newcastle-on-Tyne.

NOTES FROM THE INDUSTRY

B.B.C. Television Service

The following appointments to the programme staff at Alexandra Palace have been announced by Mr. Maurice Gorham:—

Programme Director, Denis Johnson.

Programme Organiser, Cecil Madden.

Outside Broadcasts and Film Supervisor, P. H. Dorté.

Senior Producers, G. More O'Ferrall, Mrs. Mary Adams.

Producers, Michael Barry, Eric Fawcett, Fred O'Donovan, A. Miller-Jones, Philip Bate, F. M. Baker-Smith.

Outside Broadcasts Manager, Ian Orr-Ewing.

Film Assistant, G. del Strother.

Design Manager, Peter Bax.

Announcer, Miss Jasmine Bligh.

The appointments to the engineering staff are:—

Superintendent Engineer (Television), D. C. Birkinshaw.

Engineer-in-Charge (Television Station), H. W. Baker.

Mr. G. Windred, A.M.I.E.E.

We learn that Mr. G. Windred, A.M.I.E.E., who has contributed many articles to this journal, is relinquishing his post as research and development engineer with the Sperry Gyroscope Co., Ltd., owing to health considerations, and is making arrangements to engage privately in an advisory capacity.

The Edison Swan Electric Co., Ltd.

Mr. J. W. Ridgeway, O.B.F., manager of the Radio Division of The Edison Swan Electric Co., Ltd., has been appointed a director of the company.

Change of Address

The Reading office of British Insulated Callender's Cables, Ltd., is now at 21 London Street, Reading, Berks. Telephone: Reading 2801.

R.G.D.

The Radio Gramophone Development Co., Ltd., who before the war had works in Birmingham, are now located at Bridgnorth, Shropshire. They have commenced their post-war programme and have in production a new high-quality radiogramophone which will be available this month. Full details and specification of this model will be released when the first deliveries are made.

BOOK REVIEWS

Television Programming and Production

R. Hubbell (Murray Hill Books, Inc., 232, Madison Av., N.Y. 16, N.Y.) Price: \$3.00. 203 pp., 53 photographs.

Why must the only up-to-date book on the television producers' problems come from the U.S.A.?

All too often have I heard people say: "Oh yes, television; it is bound to be a very big thing after the war—I wish I could read something about it; all the books I can find are too terribly technical." This plaint has been made to the reviewer by men who have served in Norway, the Libyan Desert, in Burma, etc., and it has been impossible to advise them, until Richard Hubbell's excellent book arrived a few weeks ago. I can quite honestly say I have not seen a better, or simpler introduction to the peculiar problems which beset the television producer and his team of studio managers, art directors, lighting and studio cameramen, etc. Nor is the "Audio" or sound side forgotten.

The book is really a symposium covering nearly all the aspects of the new medium. There are chapters telling how television works, and I think that the layman will be able to follow them; I know they are easier to understand than the papers I read, and the papers I try to write. There are chapters telling what television does. These are full of interest because several new technical skills are coming into existence, and we are observing incipient counterparts to close-ups and panning shots, while they hardly have their own names; and there are chapters telling what television may become, and they are hopeful and, I certainly think, not extravagant.

An outstanding feature of the book is that at long last due credit is paid to the programme pioneers in Britain. In previous American publications I have read, I have often wondered if the little Baird studios, first at Long Acre, then at the Crystal Palace, the early B.B.C. programme experiments at Savoy Hill, and later in the basement at Broadcasting House (where to name only one of Eustace Robb's gallant experiments, the famous ballerina Adeline Genée gave her farewell performance by television), and in 1936 the coming of high definition and the glorious three years of experiment, co-operation and

friendship at the first public television service in the world, the B.B.C.'s station at Alexandra Palace, London—yes, I have often wondered—was it real or only a dream?

Thank you, Richard Hubbell, for proving in cold print, and with fifty excellent photographs, that it was not even a nightmare. You pay British technicians and programme men and women a well deserved compliment when you say in your introduction: "From the end of 1936 through August, 1939, the British Broadcasting Corporation conducted the first serious effort to develop programme production techniques," and later in the final chapter headed "Television Programming in England": "The art of television programming had its beginning in England. The British Broadcasting Corporation blazed the first trail, and television broadcasters in other countries patterned their early programme efforts after the B.B.C."

For thirteen weeks in 1945 the B.B.C.'s North American Service broadcast a series of talks under the general heading "Television was Fun." In this, members of the B.B.C.'s pre-war television staff were interviewed by leading American radio Press commentators. Richard Hubbell has cleverly edited this thirteen weeks series down to a concise chapter on British television as it was in 1939, and as the B.B.C.'s experts were allowed sufficient scope to prophesy their future aims and aspirations, this chapter alone makes the book worth while for all British readers interested in the medium.

Richard Hubbell is fully qualified to write this book, being a member of the original programme staff of the Columbia Broadcasting System, a staff under that brilliant if erratic "Lively Artiste," Gilbert Seldes, this reviewer had the privilege of advising in the spring of 1939.

Having gathered a wealth of first-

hand experience in the field (C.B.S. experimented on closed-circuit programmes for several years during the war), he established practice as a television consultant and is now production director and television consultant for the Crosley Corporation, Broadcasting Division, Cincinnati, Ohio.

Briefly he carries his readers through the progress of television during the pre-war period, including its technical as well as its still somewhat dark economic aspects, then its distinctly brightening and mostly behind the scenes advances (in America, of course) to early 1945.

Next he takes up the detailed potentialities of the art in a discussion of television versus other individual media of entertainment and education, including theatre, films and sound broadcasting.

From this point attention is centred on "Programming and Production," with chapters on "The Camera, Visual Technique and Theory, the Audio (Sound Broadcasting)," etc.

The illustrations already referred to, together with their extensive captions, provide in themselves a highly valuable course of instruction in the technique of television. Numerous line drawings also illustrate many production principles and problems.

Anyone looking forward to participating in television as "viewer" broadcaster, writer, director, designer, technician, cameraman or student, will, I think, find this new book a "must." I only hope that copies will be readily available in this country, as I cannot think of a better refresher course for the men and women who worked so well for television before the war, blacked out their aspirations, and put up the shutters on the studio side of Alexandra Palace.

To return the compliment paid British programme pioneers, I would like to quote a well-known American writer: "The images will detach themselves from the screen and appear in space before us, with the stature and colours and the voice of life itself."

I don't say any part of it is coming true tomorrow or the day after, but I won't say that any part of it cannot come true.

D. H. MUNRO.

Books reviewed in this
Journal can be obtained
from

H. K. LEWIS & Co. Ltd.
136 Gower Street, W.C.1

If not in stock, they will be obtained
from the Publishers when available

High Stability Carbon Resistors

(Concluded from page 68.)

by coating with varnish or mounting in ceramic tubes. The values of this type of resistor may be controlled to a certain extent by varying the type of carbon used in the mixture; the method more generally employed, however, is that of varying the carbon content of the moulding powder.

A serious difficulty in the manufacture of composition type resistors is the uncertainty in predicting resistance values from a knowledge of the carbon content of the moulding powder and the considerable spread of values obtained on moulding rods from the same sample of powder. Fig. 4 shows the type of curve obtained on plotting the resistivities of the finished resistors against the carbon content of the moulding powders, as confirmed by a number of investigators. It will be apparent that at low carbon percentages the resistivity varies rapidly with the carbon content, the controllability of resistance values being poor. This may be attributed to the fact that in this region the individual carbon particles are separated from each other by the filler and binder. At high carbon contents, *i.e.*, for very low resistance values, the controllability improves, as shown by the reduced slope of the curve, for here the carbon particles are in contact with each other, thus affording a continuous conducting path.

For these reasons, resistors of the composition type are frequently adjusted by the application of copper shorting bands on the surface of the rods. Such bands will be found to occupy occasionally as much as 40 per cent. of the surface of commercial resistors.

In order to overcome these difficulties, methods have been developed for the production of moulding powders in which carbon-to-carbon contacts are maintained also at high values of resistivity. This has been achieved by coating carrier particles with carbon and moulding the powder into rods using a small percentage of resin binder. A coating of this type may, for instance, be applied by suspending first of all the filler in a solution of resin, and evaporating off

the solvent. The resin-coated particles are then added to a carbon suspension, such as "Aquadag," and the carbon is deposited on to the resinified filler by coagulation with acid. The powder is finally filtered, dried and moulded into rods. On the application of pressure and heat in the moulding process, resin is forced into the cavities between the coated particles, acting as binder, as indicated in Fig. 5.

A considerable improvement in the controllability is obtained in this way. as the resistance values may be varied solely by altering the thickness of the carbon coating, the carbon-to-carbon contact being maintained throughout the whole resistance range. In addition, powders prepared by this method are considerably more homogeneous than, for example, milled carbon-resin-filler mixtures, and this tends to decrease further the spread of resistance values obtained with rods moulded from the same stock of powder. The fact that this method has not found extensive application in practice would appear to be due to the relatively complex and time-consuming processes involved.

Recently, pyrolytic methods have been developed for applying uniform carbon coatings to finely divided carrier particles, such as quartz dust or other siliceous materials. According to one of these, the refractory material is contained in a rotating heating chamber into which a hydrocarbon gas is passed, with or without a diluent. Deposits of different thickness may again be obtained by varying the time of exposure, the cracking temperature or the concentration of hydrocarbon in the gas mixture.

One of the properties of powders obtained by this method is a high modulating efficiency. The material has therefore found application in carbon granule microphones.⁶ Other advantages of coatings obtained by this method are the purity and uniformity of the deposit, as well as its heat stability and comparative inertness towards chemical attack.

REFERENCES

- ¹ Nishiyama, Report No. 236, Research Institute for Iron, Steel and Other Metals.
- ² B.P. 668,286.
- ³ U.S.P. 1,098,060.
- ⁴ B.P. 541,241.
- ⁵ U.S.P. 2,161,050.



LOW-LOSS CERAMICS

*Success
through
constant
research*

CAN WE HELP YOU?

TAYLOR TUNNICLIFF

& CO. LTD.

Head Office: Eastwood, Hanley
Staffs, London: 125, High Holborn,
W.C.1. Factories at Hanley, Stone
and Longton, Staffs. Phone: Holborn
1951-2 and Stoke-on-Trent 5272-4.

Radio Noise from the Sun

It has long been accepted that, since the sun emits electromagnetic waves in the form of light and heat, it must also emit radio waves of extremely weak intensity.

It has been recently found by British radio workers that, when there is a big and active sun-spot group on the sun, the solar radio emission can be increased up to 100,000 times in the 1 to 10 metre band; and this radio emission can then be detected by sensitive receivers on the earth's surface. It is natural to assume that these abnormal bursts come, not from the sun's disk as a whole, but from the localised active sun-spot area.

At present there is a large and important group of sun-spots on the sun's disk which can easily be seen by the naked eye, looking through smoked glass. This group, according to the Astronomer-Royal (Sir Harold Spencer Jones) is the largest observed since 1926. Solar noise from it was detected by Mr. J. S. Hey and his colleagues on January 30 on their equipment in Richmond Park. A continuous watch has been maintained and valuable assistance has been given by Army operators, mainly



Sir Edward Appleton at the sun-spot observation equipment.

from A.A. Command. It is believed that this is the first time that the noise phenomenon has been continuously studied in this way.

When sun-spots become active the sequence of events is somewhat as follows:—

First, enhanced "radio noise" or hissing is heard.

The radio noise is usually followed by and associated with short-wave

"fade-outs." These are due to the formation of an absorbing "blanket" underneath the Heavside Layer so that radio waves are strongly absorbed there. This "blanket" is due to a burst of ultra-violet light and causes a fade-out of from half to one hour's duration. Such fade-outs are observed only on the sunlit side of the earth.

The "fade-outs" are followed one to two days later by magnetic storms and, in severe cases, by auroral displays. Both the magnetic storms and auroral displays are supposed to be due to the entry, into the earth's atmosphere, of swarms of electrically charged atoms from the sun. These particles take one to two days to travel from the sun to the earth.

Solar radio noise is of great scientific interest since its existence was not suspected till recently. A new field of scientific research has been opened up and it is expected that scientists the world over will start to look for it during the coming period of sun-spot activity which culminates in 1947-8.

—From a note issued by D.S.I.R.

CASE

by
IMHOF'S
ESTABLISHED 1845

THE HALLMARK OF A GOOD INSTRUMENT

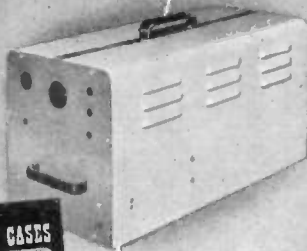

If you are inclined to the view that your instruments deserve a case that is better built and of more attractive and functional design, or you build equipment that needs precision sheet metal work, you will be interested to have this catalogue. A penny stamp and the request on your business letterhead will bring it you.

ALFRED IMHOF LTD. 112-116 NEW OXFORD STREET, LONDON, W.C.1. MUSEUM 5944

PROBLEMS WE HAVE SOLVED—No. 6

THE DINGHY BLOWER

BEFORE the introduction of dinghies inflated by means of a compressed-air bottle, rubber dinghies for life-saving in British aircraft were inflated by means of an ingenious electrically operated blower designed and constructed by S.E.M. research engineers.

A high speed electric blower was developed suitable for operation from a 12-volt battery. The characteristics of the fan and motor were so adjusted that the dinghy was completely inflated in 30 seconds. Incorporated in the outlet of the blower was a special valve which, while offering minimum resistance to the blowing up of the dinghy, provided perfect sealing when it was fully inflated.

One of the chief difficulties in all previous equipments had been the weight problem.

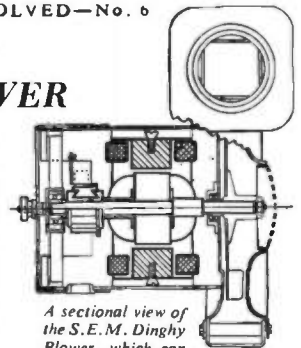

A sectional view of the S.E.M. Dinghy Blower, which can inflate a dinghy in 30 seconds

S.E.M. engineers, however, managed to reduce the weight of the blower to only 3 lb., making a total of only 12 lb. together with the dinghy.

This is only one of the many technical problems that we have been called upon to solve. We specialize in supplying non-standard electrical devices for particular purposes. The resources of our research laboratories are available now to manufacturers who have a special problem.

SMALL ELECTRIC MOTORS LTD.

(A SUBSIDIARY OF BROADCAST RELAY SERVICE LTD.) BECKENHAM · KENT

ERG'S HAVE THE URGE TO GO ABROAD

**SPEAKING
EXPORTLY-**

ERG Resistors have an exceptional electrical specification and performance, with mechanical strength.

High Grade Vitreous Enamels used on our Tropical Resistors give long life, and definitely assist in the trouble-free manufacture and performance of Radio Receivers, Television and Test Equipment.

Processed up to the highest Service Standards at a competitive price.

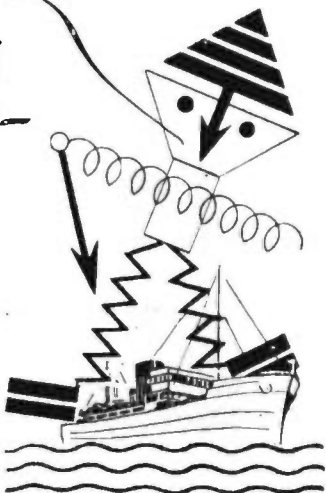

**ERG
RESISTORS LTD**

1021a, FINCHLEY ROAD
LONDON, N.W.11

Phone: Speedwell 6977



**Precision Instruments
of Maintained Accuracy**

Switchboard and Portable
Pattern Microammeters,
Milliammeters, Ammeters,
Voltmeters, Wattmeters
and Testing Sets.



MEASURING INSTRUMENTS (PULLIN) LTD
ELECTRIN WORKS, WINCHESTER ST., LONDON, W.3

War to the

NIFE



SERVING THE COUNTRY
WITH ITS
Life

NIFE All-Steel Alkaline Batteries have been in use wherever the Services required — **MAXIMUM RELIABILITY**. With the return of peace they will soon be available for radio requirements everywhere.

ALL STEEL ALKALINE BATTERIES

NIFE BATTERIES LTD: HUNTING REDDITCH WORCESTERSHIRE

for **HIGH • HIGHER** and
HIGHEST FREQUENCIES!

TENAPLAX
Co-axial Cable



SOME TENAPLAX CABLES HAVE

60% AIR INSULATION
Patented method of construction reduces losses to a minimum.

- Plastic Cover
- Electrical Screening
- Alkathene Sleeve
- Braided Alkathene Filaments
- Conductor

Write for details to :

WORKS : UPPER BASILDON, NEAR PANGBOURNE, BERKS.



EYELETS

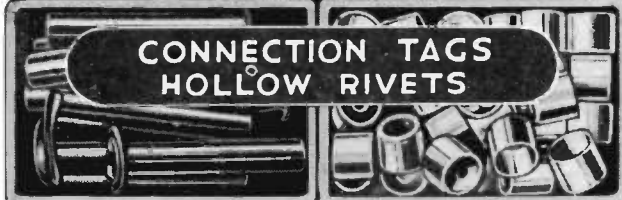

CONNECTION TAGS HOLLOW RIVETS

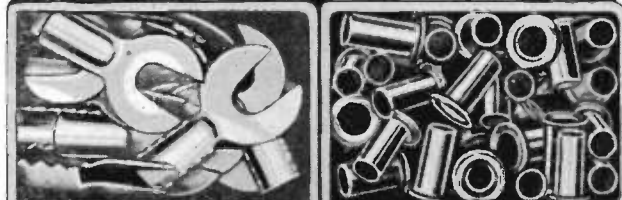
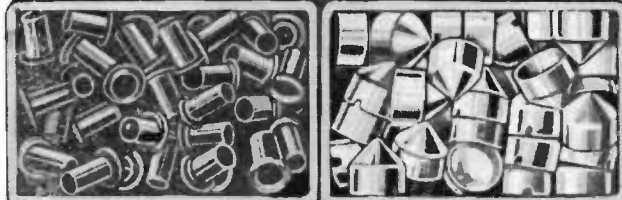
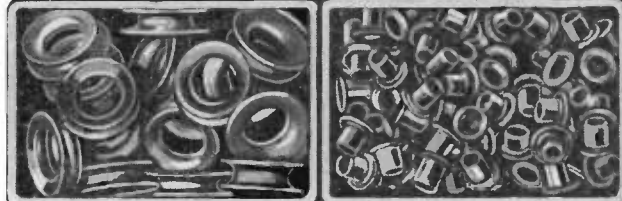
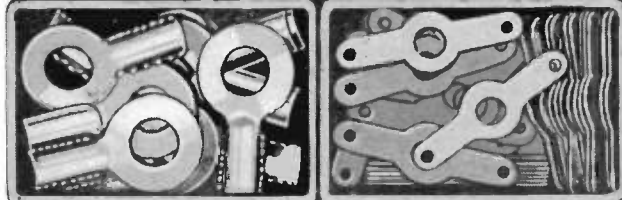

GEO. TUCKER EYELET CO. LTD.
WALSALL ROAD, BIRMINGHAM. 22

Phone: BIRchfields 5024

R.P.555

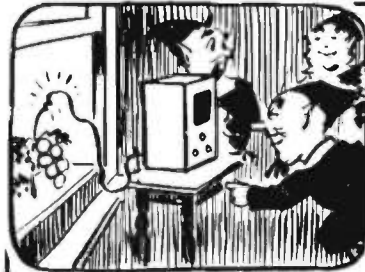

THE "FLUXITE QUINS" AT WORK

"I know this old set
isn't worth
the trouble - but why
all the mirth?"

Said the Jads "Yes, all
right.
It's fixed with FLUXITE,
But tomatoes won't
make a good earth."

For all **SOLDERING** work—you need **FLUXITE**—the paste flux—with which even dirty metals are soldered and "tinned." For the jointing of lead—without solder; and the "running" of white metal bearings—without "tinning" the bearing.

It is suitable for **ALL METALS**—excepting **ALUMINIUM**—and can be used with safety on **ELECTRICAL** and other sensitive apparatus.

With Fluxite joints can be "wiped" successfully, that are impossible by any other method.

Used for over 30 years in Government Works, and by leading Engineers and Manufacturers, OF ALL **IRONMONGERS**—IN TINS—8d., 1/4 and 2/8. Ask to see the **FLUXITE POCKET BLOW-LAMP**, price 2/6d.



The "Flux-
ite Gun"
puts Fluxite
where you
want it by
a simple
pressure.

Price 1/6, or
filled 2/6.

ALL MECHANICS WILL HAVE

FLUXITE

IT SIMPLIFIES ALL SOLDERING

Write for Leaflets on **CASE HARDENING STEEL** and **TEMPERING TOOLS** with **FLUXITE** also on "WIPED JOINTS." Price 1d. each.

FLUXITE LTD. (Dept. T.V.) Bermondsey St., London, S.E.1

"UNO" STENCILS

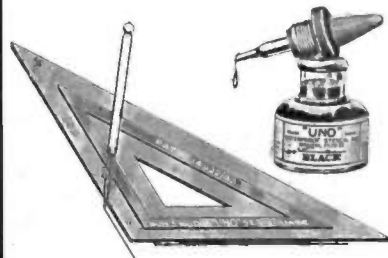

6 Stencils of
Electrical Symbols
6/- each

A. WEST & PARTNERS, LTD 36, BROADWAY
WESTMINSTER, S.W.1



CERAMIC

High Voltage **CAPACITORS**

Outstanding characteristics of U.I.C. Pot and Plate Capacitors are the high break-down strength, low loss factor, and small dimensions. *Working Voltage:* 10 KV D.C. only or 7.5 KV D.C. Peak + A.C. *Working Load R.F.:* Up to 25 KVA according to type. *Max. Current:* Up to 14 AMP. according to type. *Range of Capacitance:* 5 pF to 1200 pF. Tested to Specification K110. Full details on request.

UNITED INSULATOR CO. LTD. 12-22 LAYSTALL STREET, LONDON, E.C.1

Tel.: TERminus 7383 (5 lines) Grams.: Calanel, Smith, London

THE PIONEERS OF LOW LOSS CERAMICS



NEW LOW LEVELS in capacity and attenuation of CO-AX Cables mean new possibilities in electronic equipment design both for the war effort and for the post-war electronic age.

Write for characteristics

BASICALLY BETTER AIR-SPACED

CO-AX LOW LOSS CABLES

TRANSRADIO LTD. 16 THE HIGHWAY-BEACONSFIELD-6-BUCKS.

1073

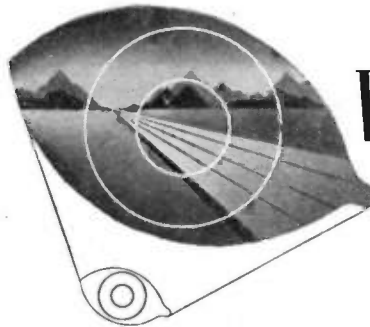

VISION ...

The ability to think ahead and to appreciate the problems of others is innate at Woden, and is visibly evidenced in our own productions as well as in those components we are privileged to build for other manufacturers. If therefore you are looking ahead and would welcome intelligent co-operation in the production of your new or redesigned projects we would like to hear from you.

WODEN TRANSFORMER COMPANY LTD

TRANSFORMERS · AMPLIFIERS · LOUDSPEAKERS
RADIO AND ELECTRONIC COMPONENTS
MCXLEY ROAD · BILSTON · STAFFS
TELEPHONE: BILSTON 41959

Immediate delivery.

SINGLE CHANNEL OSCILLOSCOPE
MODEL EA II. PRICE £30 nett.

RESISTANCE-CAPACITANCE BRIDGE
MODEL EA 20. PRICE £13 nett.



Detailed specifications on request.

ELECTRONICS LTD.
1 KING ST., EXETER, DEVON

LONDEX for RELAYS

A.C. and D.C.

The wide range of Londex Relays covers, especially, the Wireless and Electronic fields.



Ask for details and leaflet 205/E0

Multiple contact Relay LF

LONDEX LTD

MANUFACTURERS OF RELAYS
SHEPHERD WOODS 207 ANKERLY ROAD, LONDON S.E.20 (OVERHAM 6256)

NEW ROMAC RADIO AND ORAL COMMUNICATION COMBINED

25 Watt, model 25/H11

Incorporated Radio Tuning Unit, Provision for Moving Coil or Crystal Microphone and High Impedance Gramophone Pick-up to meet the demand of the present day for High Grade Equipment. Delivery Ex. Stock.

Also our Model 25/H1. Amplifier for Microphone and Gramophone input only, also with high quality output of 25 watts. Delivery Ex. Stock.

Gramophone Playing Desk Unit in attractive case with lid available with either Amplifier.

ROMAC RADIO CORPN. LTD
THE HYDE · HENDON · LONDON, N.W.9

DUAL TESTSCOPE



This New Dual Model indicates 2 to 30 volts and 100-750 volts. Allowance made on old Models. Send for interesting leaflet L24 on "Testing".

RUNBAKEN-MANCHESTER-I

GALPINS

Electrical Stores

408, High St., Lewisham, London, S.E.13

Phone: Lee Green 0309.

TERMS: CASH WITH ORDER. NO C.O.D

Closed half-day Thursday. Open all day Saturday

EX-GOVT. ROTARY CONVERTERS for car radio, etc., 6 to 9 volts, D.C. input, 450 volts, 50/80 M/amps., output complete with automatic regulator, smoothing, consisting of condenser, dropping resistances, etc., and a specially designed gearing operating 3 multi-leaf relays, all mounted on chassis, size 12 in. by 8 in. by 2 1/4 in., weight approx. 16 lb., condition as new, to clear 37/6 each, carriage 2/6. Ditto, same output, but with an input of 12 to 18 volts at 3.3 amps. Price 37/6 each, 2/6 carriage.

EX-GOVT. EIGHT-VALVE CHASSIS, size 12 in. by 8 in. by 2 1/4 in., short wave, comprising of two highly sensitive multi-contact relays, dropping resistances, approx. 36 fixed condensers ranging from 10 P.F. to 1 N.I.F., also approx. 28, 1, 1 and 2 watt resistances. To clear, 18/6 each, 1/6 carriage.

STANDARD TELEPHONE, block condensers, 10 mfd. at 550 volt wkg., 7/6 each. T.C.C. 4 mfd. 300 volt A.C., wkg., 4/6 each. Ditto, 2 mf., 2/6 each. T.C.C. 2,000 mfd., dry electrolytic, condensers, 25 volt wkg., 15/- . Ditto, 500 mfd., 50 volt wkg., 12/6 each. All fully guaranteed.

ELECTRIC LIGHT CHECK METERS, by well-known makers, all electrically guaranteed, for A.C. mains, 200/250 volts, 50 cycles, 1-phase, 5-amp. type, 12/6 each. 10-amp. type, 15/- . 20/25 amps., 17/6 each.

"WESTON" MOVING COIL MILLIAMP. METERS, model 505, 2 in. dial, flush mounting, 0 to 5 m/a, 27/6; 0 to 10, 27/6; 0 to 20, 25/-; 0 to 50, 25/-; 0 to 300, 27/6.

EX-G.P.O. HIGHLY SENSITIVE RELAYS, small type, with multi-contact Q.M.B. action, 5/- each. Also same type, new and unused, 10/- . All fully guaranteed.

All articles advertised sent on approval against cash. Terms: Cash with order.

HILL & CHURCHILL,

Booksellers LTD.

SWANAGE, DORSET

ENGLISH & AMERICAN BOOKS IN STOCK ON

RADIO AND TELECOMMUNICATION

Catalogue on Application

TRANSFORMERS

to customers' specifications or in accordance with standard list.



W. BRYAN SAVAGE LTD.

Westmoreland Road, London, N.W.9. Calindale 7131



Continuous Film Cameras
For Standard Cathode Ray
Tube Photography

AVIMO LTD., TAUNTON (SOM.)

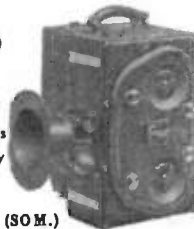

DALY

The **ELECTROLYTIC Specialists**

We specialise and manufacture only **ELECTROLYTICS**



DALY (CONDENSERS) LTD.
West Lodge Works, The Green, Ealing, W5.
Telephone: Ealing 4841

Varley

THERMAL DELAY SWITCHES

★ **PROTECT YOUR RADIO EQUIPMENT** ★

4 VOLT · 5 VOLT or 6.3 VOLT HEATERS
OLIVER PELL CONTROL LTD
CAMBRIDGE ROW · WOOLWICH · S.E.18
TELEPHONE: WOOLWICH · 1422

Introducing

TOM THUMB



A small, compact amplifier, using 6F6's in push-pull, with new linear phase-changing circuit. Output 15 watts with an ordinary magnetic pick-up. Complete in case, 9 x 8 x 6 1/2 inches. Ready to assemble £8 18s. (Carriage and packing, 2/6.)

Write for our Transformer and Component Lists "E.E."

RADIO INSTRUMENT CO.,
294 Broadway, Bexleyheath, Kent.

FOYLES
FOR BOOKS

Nearly 3,000,000 Books in Stock. New and Second-hand Books on Engineering and all other subjects.

Books Bought.
119-125, Charing Cross Road, London, W.C.2
Tel: GERrard 5660 (16 lines). Open 9-6 Inc. Sat.

Double Purpose AERIALS

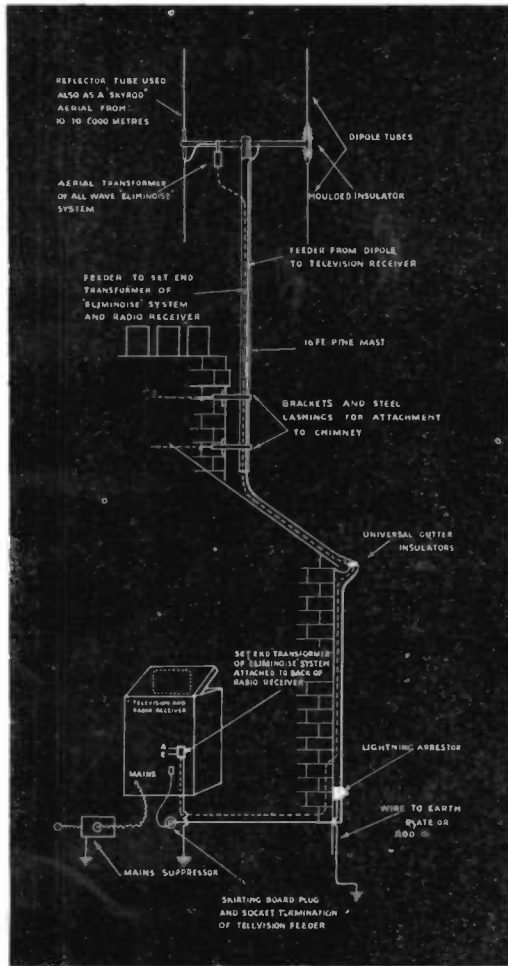

(U.K. Reg. Designs applied for)

IF YOU are erecting an aerial now, you must seriously consider two important facts: *The coming of television and an anti-interference aerial for normal broadcast reception.* You can cover both with a "combined" television and anti-interference aerial. For use when separate aerial and earth terminals are correctly provided for medium and long wave reception.

You will save 25% on the price.

L.502/L and L.392/100 Combined Television and Broadcast Aerials with 100 ft. cable, but without wooden Masts: Price - £13.0.0

L.502/L and L.392/120 Combined Television and Broadcast Aerials with 120 ft. cable, but without wooden Masts: Price - £13.16.0

L.363 Balanced twinfeeder - Price 9d. per yard.

BELLING & LEE LTD
CAMBRIDGE ARTERIAL ROAD, ENFIELD, MIDDX

Constant Voltage

TRANSFORMERS

LINE VOLTAGE VARIATIONS OF $\pm 15\%$ REDUCED TO $\pm 1\%$

TYPICAL SPECIFICATION

Input Voltage ... 190-260 v. 50 c.p.s.

Output Voltage ... 230 v. $\pm 1\%$

Max. load ... 150 watts

Input power factor over 90%

Prices on application. Write for details

ADVANCE COMPONENTS LTD.

BACK RD. SHERNHALL ST. WALTHAMSTOW. E17. PHONE WARKSWOOD 43663

MINIATURE or MIDGET

We specialise in their manufacture

HIVAC

THE SCIENTIFIC VALVE

Originators, designers & manufacturers of Midget Valves

BRITISH MADE

HIVAC LIMITED. Greenhill Crescent, Harrow on the Hill, Middx. Phone: HARROW 0895

CLASSIFIED ANNOUNCEMENTS

The charge for miscellaneous advertisements on this page is 12 words or less, 4/- and 4d. for every additional word. Box numbers count as four words, plus 1/- extra for replies. Remittance should accompany advertisement. Cheques and P.O.'s payable to Hulton Press, Ltd., 43 Shoe Lane, E.C.4. Replies to box numbers should be addressed as above, marked "Elec. Engg." Press date: 15th of month for following issue.

Vacancies advertised in these columns do not relate to men between the ages of 18 and 50 inclusive, or women between the ages of 18 and 40 inclusive, unless they are exempted from the provisions of the Control of Engagements Order, 1945, or the vacancies are for employment excepted from the provisions of that order.

FOR SALE

PHOTO-ELECTRIC CELLS, SeTe on gold-alloy, super-sensitive to light, gasfilled, permanent, operate relay direct or with valve amplifier, perfect reproduction of speech and music, etc., from sound track of films; large tube $3\frac{1}{2}$ in. from glass top to valve pin base, 1 in. dia., 38/-; same type, $2\frac{1}{2}$ in. long, 35/-; small tube, 2 in. from top to terminal base, $\frac{1}{2}$ in. dia., 30/-; miniature cell, 1 in. overall glass top to cap base, $\frac{1}{2}$ in. dia., thin flex leads, 28/-; all cells operate on 40 to 100 volts. Connections diagrams free.

PRECISION OPTICAL SYSTEM, producing fine line of light from any car headlight bulb, for scanning sound track of film direct into photo cell, brass tube 2 in. long, $\frac{1}{4}$ in. dia., $\frac{1}{2}$ in. focus, 52/-; full instructions free, goods by return. Cefa Instruments, 38a, York Street, Twickenham, Middlesex. 'Phone: POPesgrove 6597.

IN STOCK. Rectifiers, Accumulator Chargers, Rotary Converters, P.A. Amplifiers, Mikes, Mains Transformers, Speakers of most types, Test Meters, etc. Special Transformers quoted for.—University Radio, Ltd., 22, Lisle Street, London, W.C.2. GER. 4447.

"COIL" MOVING COIL PICK-UP and transformer, model 7 Avometer, Meico microphone and transformer, Rothermel 0104 microphone. Offers to Box No. 816, "Elec. Engg."

LOUDSPEAKERS

LOUDSPEAKERS—We carry on. Sinclair Speakers, 12, Pembroke Street, N.1.

LOUDSPEAKER repairs, British, American, any make, moderate prices.—Sinclair Speakers, 12, Pembroke Street, N.1.

MISCELLANEOUS

WE WILL BUY at your price used radios, amplifiers, converters, test meters, motors, pick-ups, speakers, etc., radio and electrical accessories. Write, phone or call, University Radio, Ltd., 22, Lisle Street, London, W.C.2. GER. 4447.

WEBB'S Radio Map of the World enables you to locate any station heard. Size 40 in. by 30 in. 2 colour heavy Art Paper, 4/6, post 6d. Limited supply on linen, 10/6, post 6d.—Webb's Radio, 14, Soho Street, London, W.1. 'Phone: GERrard 2089.

MORSE Practice Equipment for Class room or Individual Tuition. Keys, Audio Oscillators for both battery or main operation. Webb's Radio, 14, Soho Street, London, W.1. 'Phone: GERrard 2089.

MECHANICAL ENGINEERS to the Electronic Industry. Precision and Optical Instruments of all types designed and constructed in collaboration with Electronic Engineers. Tecnaphot Ltd., Mile Lane, Coventry.

AMATEUR RADIO PRODUCTS, 50 Glasslyn Road, Crouch End, N.8. Designers and Manufacturers of short-wave radio components and equipment, both for transmitters and receivers. Enquiries invited. Phone: MOUNTview 4745.

WE ARE NOW able to undertake the adjustment of resistors and capacitors over a wide range to within 0.1%. Customers' own apparatus, including audio oscillators and wavemeters, carefully calibrated to any required degree of accuracy. We can supply special precision radio and mechanical components from the small gear or coil to the complete apparatus for the solution of unusual problems. Lydiat Ash Laboratories, Nr. Bromsgrove, Worcs.

BERRY'S (SHORT WAVE) LTD. The House for Quality Radio and Electronic products. Send for our 1946 Catalogue; 3d post paid, 25, High Holborn, London, W.C.1.

EVERYTHING for the Amateur, professional constructor or commercial buyer. So many of our customers tell us that we have the finest display of new radio components in England that we are beginning to believe it ourselves, and by the time this advertisement appears we hope to have on display some quite new and very interesting communications equipment.

If you are building a transmitter, communications receiver, high fidelity audio equipment or test apparatus, come along and see us—we can help you—and supply all the components you want. New catalogue and price list in course of preparation. Tele-Radio (1943) Ltd., 177, Edgware Road, London, W.2. 'Phone: PADddington 6116.

S.A.E. WILL BRING YOU lists of high voltage, high frequency capacitors, components, receiving and transmitting valves, including gear surplus to Government radar requirements. M.O.S., 24, New Road, London, E.1.

MARCONI INSTRUMENTS output power meter, TF340; wavemeter, TF680A/3; high and low-resistance ohmmeters; mains-operated meggers; Mullard measuring bridge; 30 ft. portable telescopic mast with tripod; power supply unit 0-650 volts, .6 amp.; rotary converters, 75 watt 24 volt D.C. to 230 volts A.C.; Westinghouse Noregg input, 230 volts A.C. to 24 volts D.C., 75 watts; Belling & Lee mains suppressors, 15 amp.; thermocouple milliammeters; miscellaneous equipment, plugs, sockets, etc. S.A.E. for details. Box 815, "Elec. Engg."

SITUATIONS VACANT

CHIEF GLASSBLOWER required to take charge of small but expanding glass section of industrial electronic laboratory, 50 miles London. Experience in bench and lathe work, glass-metal seals and high vacuum pump erection essential. Good prospects for a man with skill and initiative. Apply, giving full particulars of experience and salary required.—Box 818, "Elec. Engg."

OPPORTUNITY for laboratory assistant with knowledge of industrial electronics equipment, power oscillators and central circuits. Must be practical. Write, stating qualifications, age and salary required.—Box 797, "Elec. Engg."

OPPORTUNITY for draughtsman with knowledge of radio factory drawing office practice. Write, stating qualifications, age, and salary required.—Box 798, "Elec. Engg."

ELECTRICAL and Mechanical Engineer for varied and interesting duties in small works. Competence and initiative essential. Knowledge of electronics desirable. Good pay to live man under 40, full or part time.—Box No. 466, c/o Dawsons, 31, Craven Street, London, W.C.2.

RADIO TRANSMITTER Design Engineer, with experience of ultra-high frequency wide band width transmitters. Apply, giving full details of academic and practical qualifications to Box 806, "Elec. Engg."

ELECTRONICS ENGINEER, with experience of design and operation of television equipment. Apply, giving full details of academic and practical qualifications to Box 807, "Elec. Engg."

REQUIRED, for new factory near Aberdeen, experienced Radio Testers and Fault Finders. Write fully. Box 809, "Elec. Engg."

V.H.F. DEVELOPMENT WORK. Radio manufacturers have vacancies for two high calibre engineers, fully experienced in V.H.F. receiver design. Good prospects, generous salary and congenial working conditions in well-equipped laboratories are offered. Applicants must be capable of originating design and developing apparatus in detail up to the stage of production; must be well acquainted with current Services technique, tropicalisation requirements, etc.; must also have had similar experience in a senior capacity either in Government establishment or in commercial laboratories of first-class firm. Write, stating in confidence details of pre-war and wartime experience, technical education and qualifications, present salary, age, salary required and date when engagement could start, to Box 810, "Elec. Engg."

DEVELOPMENT ENGINEER required by old-established manufacturers of radio and light electrical components to take charge of the development of paper and mica dielectric capacitors. Applicants must have had experience in a similar capacity and must also be completely familiar with the production processes associated with this type of component. Write, in confidence, stating details of experience, salary required, etc. Our own employees have been advised of this advertisement. Box 812, "Elec. Engg."

A VACANCY OCCURS in a large engineering concern for a man with approximately 5 years' production experience in the radio, electronic, valve, cable, transformer, resistor, small electrical or condenser industries. This experience is essential and further qualifications, as follows, would be advantageous. Some knowledge of elementary electrical measurements of E.C. resistance, capacity, power factor. Also some electrical or chemical qualifications—not unduly academic. Age between 25 and 45 years. Please write in first instance, with full details of qualifications and experience, to Box 814, "Elec. Engg."

BERRY'S (SHORT WAVE) LTD., have vacancies for counter staff (good V.H.F. knowledge), junior clerks and packers. Applicants must live in or near London. State experience, age, salary required, to 25, High Holborn, London, W.C.1.

TECHNICAL DEVELOPMENT man wanted, particularly for aerial design. Must be fully acquainted with design of aerial equipment for radio, television, anti-static equipment and similar. Applicant must be capable of arranging production of equipment testing, etc. North-west area. Full particulars to Box 817, "Elec. Engg."

RADIO ENGINEER required to take charge of receiver development work of an established company. An opportunity for a young man with B.Sc., or equivalent, and possessing knowledge of pre-war receiver design. Write Box 5402, A.K. Advg., 212a, Shaftesbury Avenue, London, W.C.2.

ENGINEER required by well-known company to take charge of their Drawing Office and Mechanical Design. Must have academic qualifications and production experience. Write Box 5403, A.K. Advg., 212a, Shaftesbury Avenue, London, W.C.2.

ELECTRONIC LABORATORY ENGINEER and Research Worker required for experimental and development work on H.F. heating equipment and application of dielectric heating to particular industrial problems. Degree in Physics and Electrical Engineering essential. Box 817, "Elec. Engg."

SITUATIONS WANTED

EX ARMT/ARTIFICER (WIRELESS), W/O II R.E.M.E., age 27, with pre-war experience. Sitting B.I.R.E. examination in November, 1946. Requires position of reasonable prospects with radio and telecommunication firm. Box 813, "Elec. Engg."

YOUNG MAN with C.G. Radio Final, Technical Electricity 2, also London Matric and P.M.G. Telegraph Certificate, released March, desires post in Midlands. Three years' pre-war chemical laboratory experience, 5 years' R.A.F. signals experience. Pleasant manner and ability to handle personnel. Hard work enjoyed but must have opportunity for advancement.—Box 819, "Elec. Engg."

WANTED

WE OFFER cash for good modern Communication and all-wave Receivers.—A.C.S. Radio, 44, Widmore Road, Bromley.

CHARTERED ELECTRICAL ENGINEER, Ph.D., M.Sc., etc., and Partner, having wide experience in electrical measurements, radio and electronic engineering, are prepared to accept work of a consultative nature in these fields. Box 790, "Elec. Engg."

CHARTERED MECHANICAL ENGINEER, wide experience in practical interpretation of electronic requirements, can undertake design and development of components and apparatus. Box 808, "Elec. Engg."

Keen amateur experimenters know Webb's as the centre where the latest developments can be seen, explained and obtained. Expert technicians test and perfect all classes of radio equipment. A courteous and practical staff is ready to help you at our showrooms. That is why Webb's are recognised as Britain's leading specialists in Radio, Television and Electronics.

HIGH GRADE TEST GEAR FOR HOME & LABORATORY

WEBB'S
Radio

OSCILLOGRAPHS

We introduce two instruments of exceptional merit and interest for both laboratory work and home experimentation.

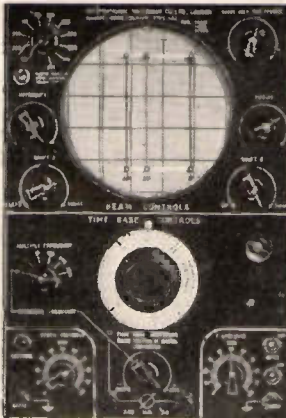

"NAGARD" MODEL 102

Unique in incorporating a high accuracy CALIBRATED TIME BASE, ideally suitable for the quick determination of frequency of periodic electrical or mechanical phenomena.

- FEATURES:**
 Calibrated time base velocity, accuracy ± 1 per cent.
 AUTOMATIC and stable synchronization from 5 to 1,500,000 cycles per second. Highest writing speed 10 millimetres per microsecond.
 Particularly suitable for photographic recording, exposures of one minute or more possible.
 5½ in. C.R. Tube.
 Effects of mains variations on Time Base calibration eliminated.
 Full details on request, demonstrations at Webb's (preferably by appointment).

Price £70. 0. 0.

"RADIO AID" MODEL 1A

An excellent general-purpose 'scope of GUARANTEED RELIABILITY. Portable in size and weight, combining accuracy and flexibility of use for the serious industrial investigator and the amateur. Wave-form can be studied up to 100/150 Kc/s, carrier envelopes, modulation characteristics and frequency comparisons up to 100 Mc/s.

- FEATURES:**
 Overall size of case 12 in. by 7½ in. high by 7 in. wide. Linear time base to 15 Kc/s. "Y" Amplifier responds 5 to 200 Kc/s. Can be used separately and is supplied from independent rectifier circuit, thus avoiding usual troubles found with earthed positive supplies.
 1½ in. C.R. Tube, green trace of medium duration.
 Fitted in attractive smooth grey instrument-finished case, self-contained power supply 200-250 volts A.C.

Price £22. 10. 0.



All the usual controls found on larger and more expensive instruments are incorporated. Reasonable stocks are available at Webb's.

VALVE VOLTMETER



"RADIO AID" MODEL A

Gives high stability, suggesting the performance of a D.C. moving coil instrument. The ranges and probe-unit combine to make the meter of universal application.

- FEATURES:**
 Desk-type steel case, instrument grey, 9 in. by 8 in. by 8 in.
 Miniature H.F. diode rectifier fitted in specialised probe-unit, balanced valve-bridge circuit.
 Stabilised power supply.
 Ranges: 2, 10, 100 and 500 volts.
 The detachable probe-unit allows H.F. measurements to 50 Mc/s., and can be used for comparative work at considerably higher frequencies.

Price £27. 10. 0.

Complete with probe-unit.

The probe-unit is also available as a separate item. Complete with diode, screened lead and 4-pin British plug.
Price £3. 15. 0.

Second printing of our INTERIM CATALOGUE is held up through paper control, etc.—Our apologies to many hundreds eagerly waiting for it. As a temporary measure we are sending details of selected items such as are of interest to the home experimenter.

WRITE, CALL OR TELEPHONE
14 SOHO STREET, LONDON, W.1.
 TELEPHONE: GERRARD 2089

OFFICIAL BUSINESS HOURS: 9 a.m. to 5.30 p.m. SHOP HOURS: 9 a.m. to 5 p.m. (SAT. 9 a.m. to 1 p.m.)

GREAT OAKS FROM LITTLE WHATNAMES GROW

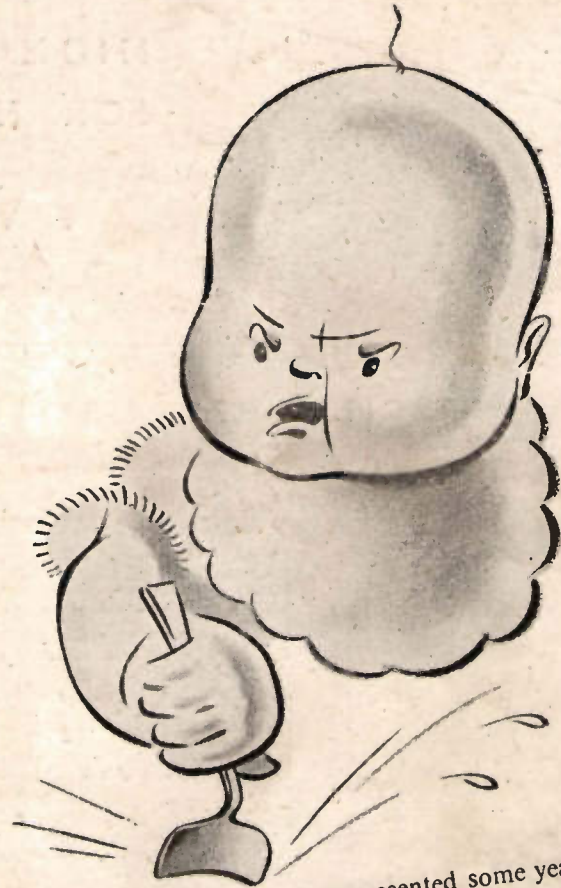

IT IS RECORDED of our Managing Director that on being presented some years ago with a silver spoon and pusher, he remarked: "Damned clumsy contraption"—and continued to shove potato and gravy into his mouth with his fingers. Who could then foresee

that this cuddly bundle of babyhood was already showing the traits that in later years were to revolutionise the design of portable tools? Not his parents, nor his tutor, who rebuked—often with a clothes brush—the child's early efforts to avoid what he regarded as unnecessary labour. Yet here we show you by diagram which even the meanest intellect can follow (*Come, come, apply your mind to it!*) how the shape, size, and weight of light portable tools were changed

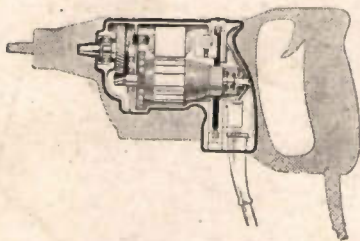

overnight by the appearance of the first Desoutter Tool. The bud had blossomed. The twig had grown from sapling to sturdy tree. The child was father to the man. The early fumbblings of tiny fingers . . . aw, drat the brat!

Specialists in Lightweight, Pneumatic and Electric Portable Tools

DESOUTTER BROS. LTD. (DEPT. U), THE HYDE, HENDON, LONDON, N.W.9.

DESOUTTER

TELEPHONE: COLINDALE 6346-7-8-

C.R.C. 158