

Electronic Engineering

INCORPORATING ELECTRONICS, TELEVISION AND SHORT WAVE WORLD

PRINCIPAL CONTENTS



- The First Stereo-colour Television Picture (Colour Plate)
- The Manufacture of Tungsten and Molybdenum
- A Selective Tuning Fork Circuit
- The Cathode Ray Tube Used Stroboscopically
- Electronics in Medicine and Surgery

2/- AUG. 1942

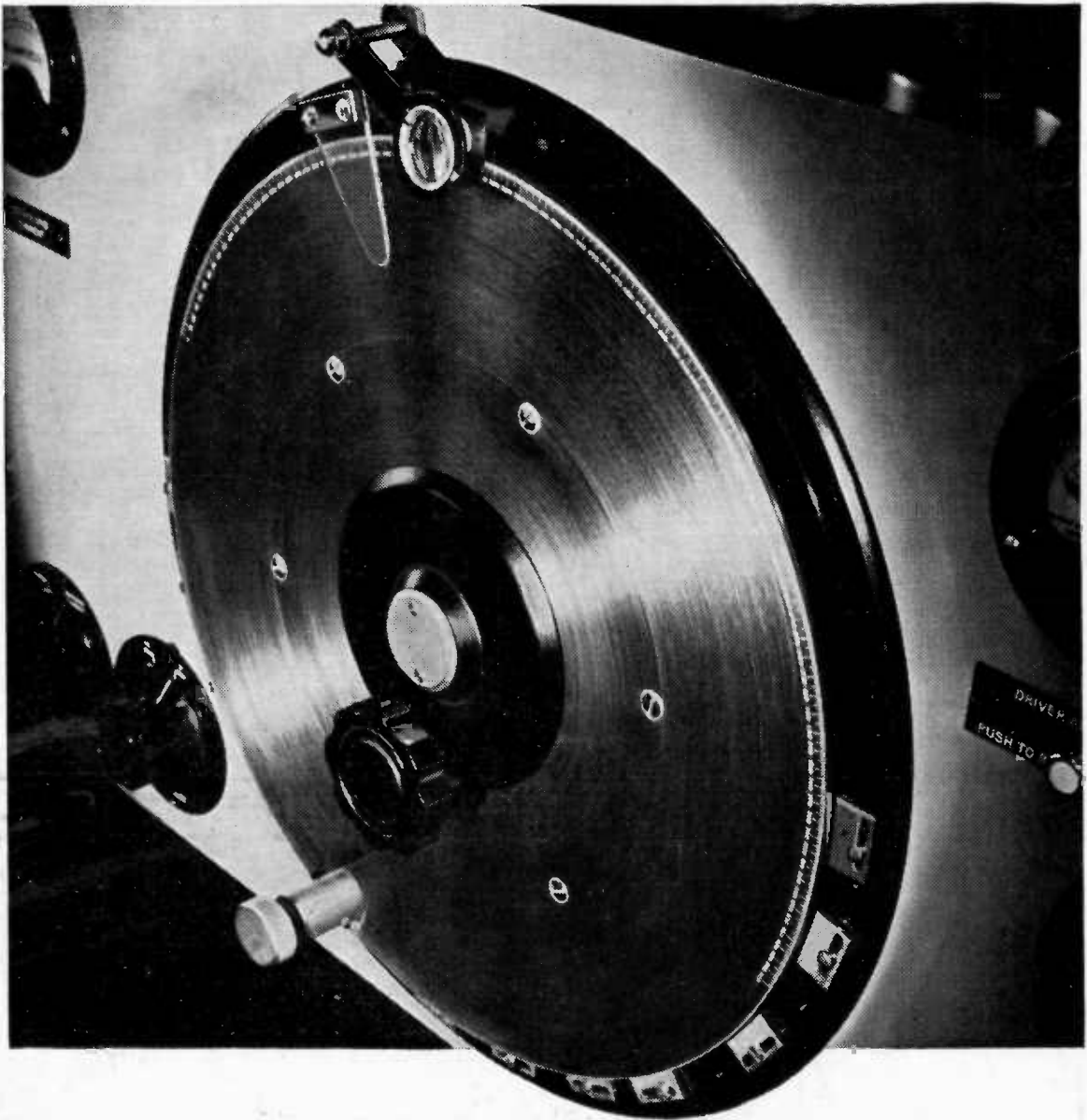

One Hundredth Part of One Degree! The 12" diameter dial is engraved with 900 divisions over an angle of 180°. With the aid of the vernier scale and magnifying glass, readings can be taken to one twentieth of a division, giving an accuracy of $\frac{180}{900 \times 20} = \frac{1}{100}$ of a degree. Just one of the refinements of Rediffusion equipment.

REDIFFUSION LIMITED
A subsidiary of
BROADCAST RELAY SERVICE LIMITED

DESIGNERS AND MANUFACTURERS OF COMMUNICATION EQUIPMENT
VICTORIA STATION HOUSE • VICTORIA STREET • LONDON • S.W.1 (PHONE VICTORIA 8831)

CONDITIONS OF SALE AND SUPPLY—This periodical is sold subject to the following conditions, namely, that it shall not without the written consent of the publishers first given, be lent, re-sold, hired out or otherwise disposed of by way of Trade except at the full retail price of 2/- and that it shall not be lent, re-sold, hired out or otherwise disposed of in a mutilated condition or in any unauthorised cover by way of Trade, or affixed to or as part of any publication or advertising, literary or pictorial matter whatsoever.



With all the Ocean for a Road

. . . . a ship ploughs its way to port. Often contact with the world seems all but lost through fog or gale. But thanks to radio, contact is *never* lost. Each ship, great or small, can receive whatever warnings, whatever orders, whatever news or encouragement its guardians afloat and ashore may send forth. Dubilier are proud to know that they are helping this great work, helping in the equipment which is bringing the ships home.

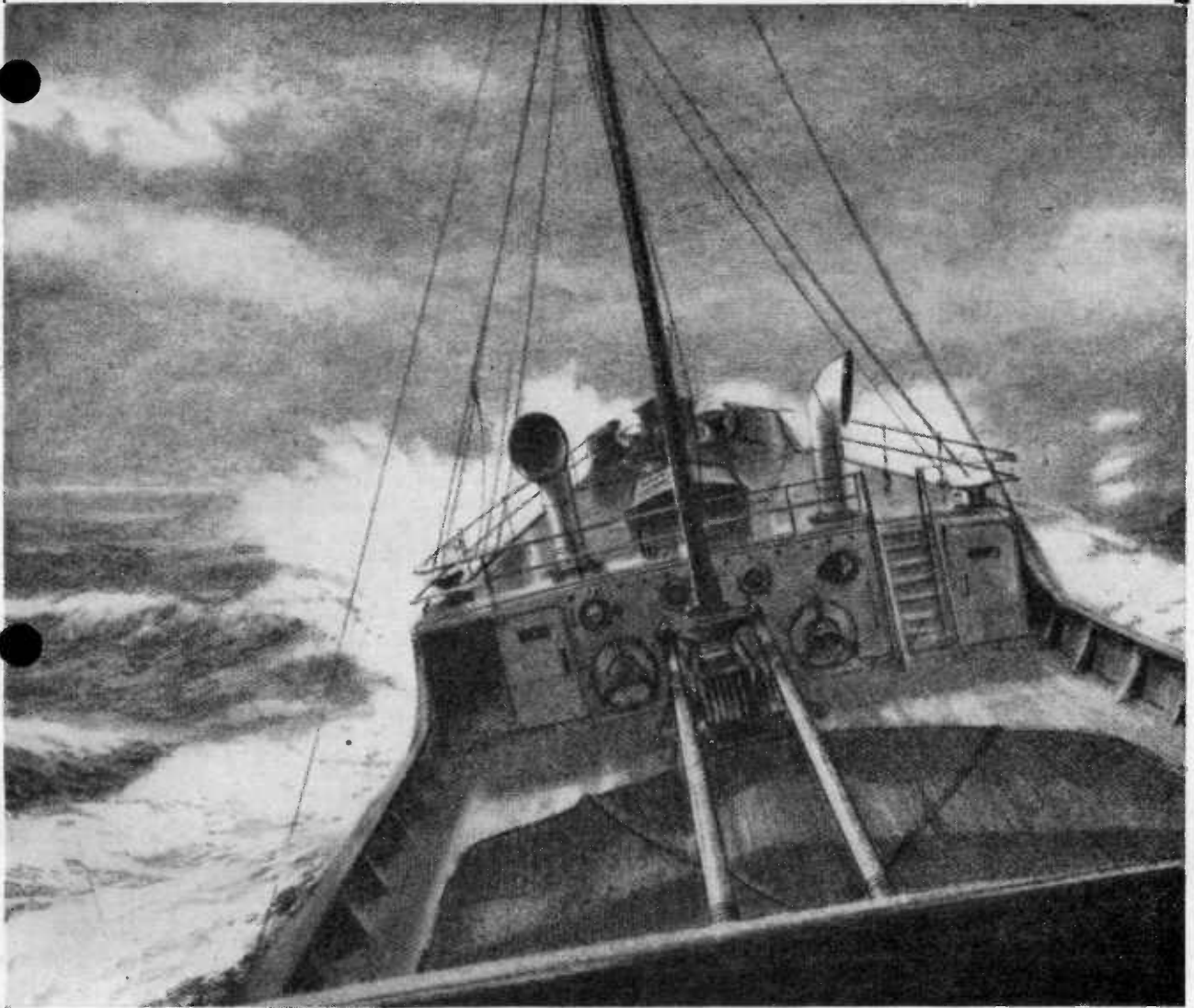

DUBILIER
CONDENSER CO. (1925) LTD.

WEARITE

VIBRATORS *for Dependable Power*

Representing the result of several years research into Vibratory technique, they embody the most recent developments of both British and American Design and are manufactured in this country under "OAK Manufacturing Company's" Patents 460470, etc., etc.

• • •

Our technical staff will be pleased to co-operate in the solution of your Vibratory problems.

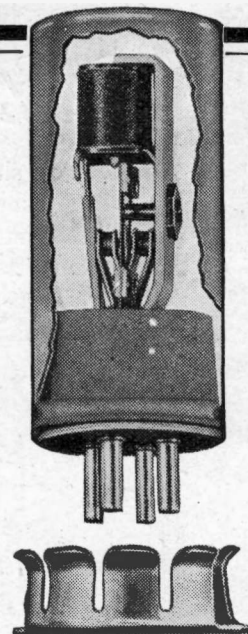

WRIGHT & WEAIRE LTD.

HIGH ROAD, TOTTENHAM, N.17. Telephone: Tottenham 3847-8-9

PHILIPS HIGH VACUUM GAUGE

Range 0.005 – 0.00001 mm. Hg.

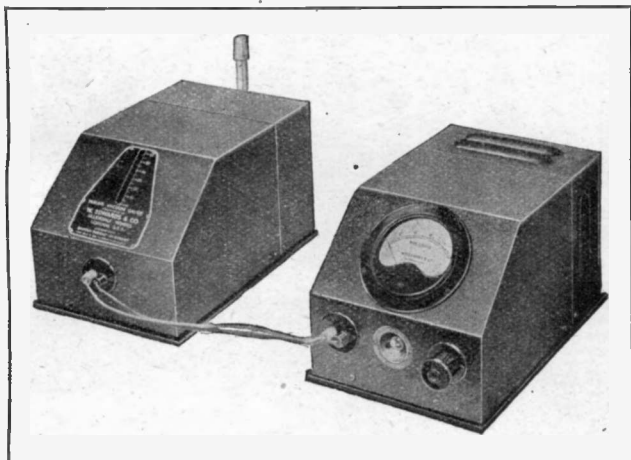

- ★ Electrical direct reading gauge working from A.C. mains.
- ★ Gives instantaneous and direct reading of total pressures.
- ★ Particularly suitable for measuring rapid variations in pressure.
- ★ Ideal for use in the manufacture of radio valves, cathode ray tubes and other thermionic devices.
- ★ Requires no skilled attention.

W. EDWARDS & CO. (London) LTD.,
Southwell Road, London, S.E.5.

Telephone :
BR1xton 1195

Telephone :
Edcohivac, Phone, London.

Going one better

IN COMMUNICATIONS



To-day, wherever Bullers Low Loss Ceramics are used, reception is clearer and better than ever before.

Years of research in Bullers Laboratories have developed these materials to such a high level of efficiency that Dielectric Loss is virtually eliminated. Bullers Ceramics are now playing a vital part in maintaining communications under all conditions.

BULLERS LIMITED

THE HALL, OATLANDS DRIVE, WEYBRIDGE, SURREY

Telephone: Walton-on-Thames 2451

Manchester Office: 196 Deansgate, Manchester

**Made
in Three
Principal
Materials:**

FREQUELEX. An Insulating material of Low Dielectric Loss. For Coil Formers, Aerial Insulators, Valve Holders, etc.

PERMALEX. A High Permittivity Material. For the construction of Condensers of the smallest possible dimensions.

TEMPALEX. A material of medium permittivity. For the construction of Condensers having a constant capacity at all temperatures.

Bullers

LOW LOSS CERAMICS

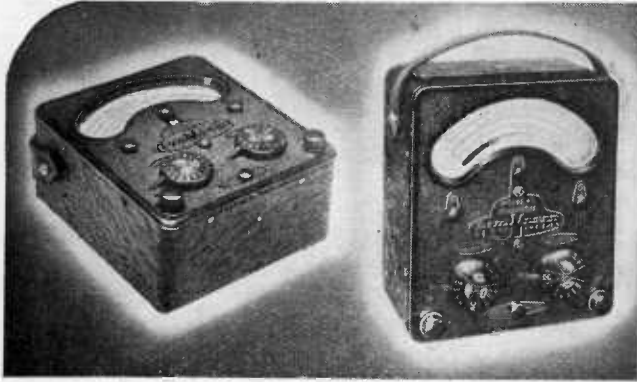

46-range Model 7
Universal AvoMeter

40-range Model 40
Universal AvoMeter



Regd. Trade Mark

ELECTRICAL MEASURING INSTRUMENTS

FROM years of intensive research in the design and manufacture of electrical testing equipment has grown the range of world-famous "AVO" Instruments. To-day, wherever rapid precision testing is demanded, there will be found the meters that matter—"AVO" Meters.

Some delay in delivery of Trade Orders is inevitable, but we shall continue to do our best to fulfil your requirements as promptly as possible.

Write for literature fully descriptive of any "AVO" Instrument in which you are interested.

Sole Proprietors and Manufacturers:

THE AUTOMATIC COIL WINDER & ELECTRICAL EQUIPMENT Co. Ltd.
Winder House, Douglas Street, London, S.W.1 Phone: VICToria 3404-7

Universal AvoMinor

D.C. AvoMinor

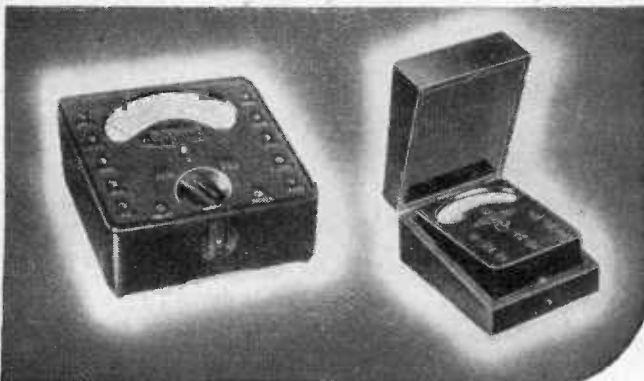

HIVAC
THE SCIENTIFIC
VALVE
BRITISH MADE

Specialists in
**MIDGET
VALVES**

HIVAC LIMITED
Greenhill Crescent,
Harrow on the Hill, Middx.

Telephone: Harrow 0895.

TELCON
CABLES

for
**HIGH
FREQUENCY
TRANSMISSION
and RECEPTION**

Full particulars of all Telcon Products from:
**THE TELEGRAPH CONSTRUCTION
& MAINTENANCE CO. LTD.**
Head Office: 22, Old Broad Street, London, E.C.2
Telephone: London Wall 3141

The sign of
reliability

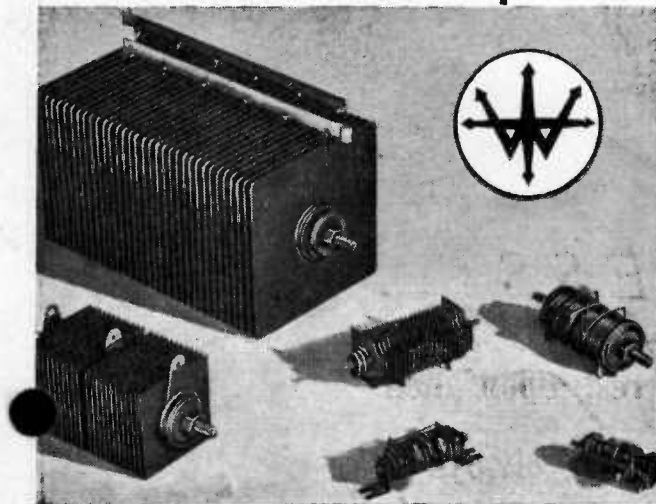

The good reputation, well earned in extensive service over fifteen years, is being maintained by

WESTINGHOUSE RECTIFIERS

Continuous intensive research has resulted in many remarkable developments, which, when normal conditions return, will be made available to our good friends whose needs we are at present unable to meet.

WESTINGHOUSE BRAKE & SIGNAL CO., LTD.
PEW HILL HOUSE, CHIPPENHAM, WILTS.

**A NEW 38 RANGE
TAYLOR METER**

The Sensitivity of this improved Model 90 Universal Meter, is 1,000 ohms per volt on all voltage ranges.

D.C. VOLTS 7 ranges from 0-0.25 to 1,000 v.

A.C. VOLTS 6 ranges from 0-0.25 to 1,000 v.

OUTPUT 5 ranges from 0-2.5 to 500 v.

D.C. CURRENT 5 ranges from 0-1 mA. to 2.5 amps.

A.C. CURRENT 5 ranges from 0-1 mA. to 2.5 amps.

RESISTANCE 3 ranges from 1 ohm to 1 megohm with internal battery.

RESISTANCE 1 range from 1,000 ohms to 10 megohms with external 60-volt battery.

DECIBELS 6 ranges from -22 db to +60 db.

METER 5 Scales covering A.C. and D.C. Measurements and also Ohms and Decibels.

SAFETY SWITCH A Meter safety switch is now incorporated.

SCALE LENGTH Outer scale is 3½ inches long.



£ 11 - 11 - 0

TAYLOR MODEL 90

British made by —

Supplied complete with leads, test prod, internal battery and instruction book.

TAYLOR

ELECTRICAL INSTRUMENTS LTD.
419/422 Montrove Ave, Slough Bucks.
Phone : Slough 21381.

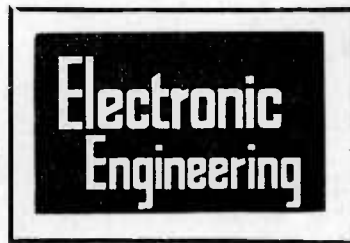

AUGUST, 1942.

Volume XV.

No. 174.

CONTENTS

	PAGE
Stereoscopic Television in Colour (Colour Plate)	95
A Selective Circuit using a Tuning Fork ...	98
The Cathode Ray Tube used Stroboscopically	102
The Manufacture of Tungsten and Molybdenum	104
Data Sheet Supplement—Corrections and Index	109
Electronics in Medicine and Surgery—Part 1	114
Practical Notes on Receiver Design—Part 2	118
Notes from the Industry	124
Abstracts of Electronic Literature	127
Patents Record	128
Correspondence	130



PROGRESS . . .

Never content to rest upon their present best . . . striving always to find new ways to improve what is already as perfect as human minds and hands can devise . . . Thus have Mazda maintained their reputation.



MAZDA
RADIO
VALVES

THE EDISON SWAN  ELECTRIC CO. LTD
155 CHARING CROSS ROAD, LONDON, W.C.2

For full particulars write to Technical Sales Department.

PROPRIETORS :

HULTON PRESS LTD.,

Electronic Engineering

EDITOR

G. PARR.

EDITORIAL, ADVERTISING AND PUBLISHING OFFICES, 43-44, SHOE LANE, LONDON, E.C.4

TELEPHONE :
CENTRAL 7400

Monthly (published last day of preceding month) 2/- net. Subscription Rates : Post Paid to any part of the World— 3 months, 6/6; 6 months, 13/-; 12 months, 26/-. Registered for Transmission by Canadian Magazine Post.

TELEGRAMS :
HULTONPRES LUD
LONDON.

The First Stereoscopic Television Picture in Colour



The photographs shown above were taken from the screen of J. L. Baird's 500-line stereo-colour television receiver. The original picture measures 3" by 4" and is viewed through a rotating colour filter and optical projection device, the viewer seeing the picture directly, without the aid of coloured glasses. Further details are given overleaf.

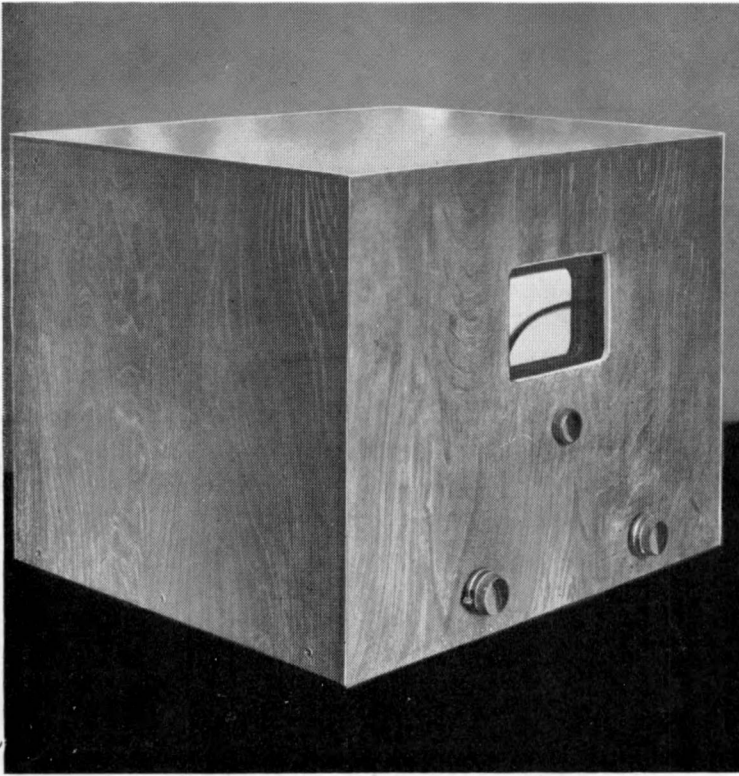

Colour and Stereoscopic Television

Table Receiver for B.B.C. monochrome colour and stereoscopic television using a 5" tube. The controls are Brilliance and Synchronising and the centre knob starts the motor of the rotating colour filter.

The dark line across the screen shows the division between the orange-red and blue-green sectors. Note that on a panchromatic plate the colour distinction is not rendered.

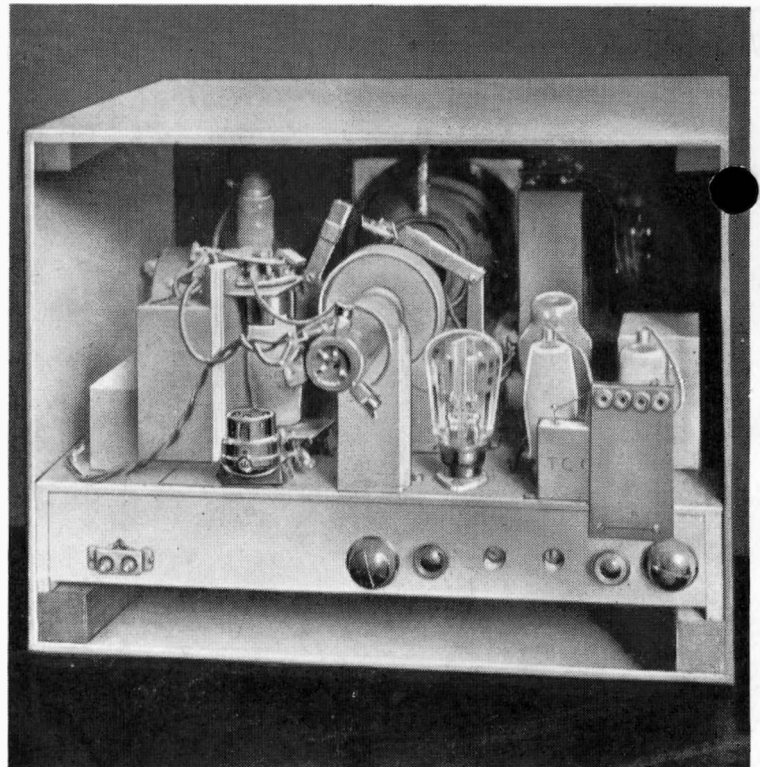

(Right) Interior of cabinet showing preset controls for framing and focusing.

THE most prominent developments of Television during the war years have undoubtedly been in Colour and Stereoscopic. Although colour was shown for the first time by J. L. Baird as far back as 1928¹, it was not until some ten years later that he showed a practical system for high definition Colour Television in the home, when in August, 1939² he showed a 102-line picture using a cathode-ray tube with a revolving colour filter disk. (A 34-line field interlaced three times, alternate fields being coloured blue-green and orange-red.) This system was developed during the war, the 34 lines being increased to 200, thus giving a 600-line picture.³

In the U.S.A. the Columbia Company⁴ and the General Electric Co.⁵ also adopted this system (cathode-ray tube with colour disk) and gave demonstrations in 1940 and 1941.

Baird has developed three-colour television receivers. The first set, an expensive projection model has already been described.⁶ It gives a picture 2 ft. 6 in. wide by 2 ft. high. Two smaller models have also been developed, a medium-priced model (which it is hoped could be marketed round about £30) and a very cheap model at about half this price.

The medium-sized model gives a picture approximately 5 in. by 4 in., and the smaller size a picture 4 in. by 3 in., both models are direct viewing and can receive the B.B.C. monochrome picture in addition to the colour picture.

Stereoscopic Television.

A further interesting and important development and one that is entirely unique to this country is Stereoscopic Television. This phenomenon was first shown by Baird as far back as 1928⁷, but nothing more was seen of it either in this country or abroad until 1941, when Baird produced a 500-line picture in colour and stereoscopic relief. The colour was produced as in his previous colour work by a colour disk revolving in front of a C.R. tube, three colours being used with a 100-line field interlacing 5 times. This, of course, necessitated a wider frequency band than that available through the B.B.C. channels, but the demonstration was regarded partly as an experiment and not put forward as

a commercial proposition. For commercial purposes Baird considered his two-colour, 600-line system to be greatly preferable as it can be sent through the existing television channels. In the stereo-colour system the image was rendered stereoscopic by transmitting left-eye and right-eye images in sequence, as described in a previous article⁷. While it is possible by using suitable shutters to enable more than one person to view the picture, the system has very definite limitations as the viewers must remain in

colour pictures are transmitted from different viewpoints corresponding to the right and left eyes. These images appear on the receiver as slightly displaced superimposed red and blue pictures and the viewer wears glasses with red and blue filters for the right and left eyes. The right eye then sees only the blue (right eye picture) and the left eye sees only the red (left eye picture).

If colour filters are used at the transmitter so that the right-eye image corresponds to blue and the left eye to red, a coloured stereoscopic picture is seen at the receiver. The effect, however, is sometimes not altogether satisfactory, as the right eye sees red only and the left eye blue only, so that the picture tends to appear iridescent. A better stereoscopic result is obtained when a shutter is used at the transmitter and monochrome left and right eye pictures are sent out, the colour at the receiver being employed entirely for left and right eye discrimination.

This system has the unique advantage that any one with a colour receiver can receive stereoscopic pictures with no alteration to the receiver. The transmitter also can be altered readily from one colour to stereoscopic transmission by fixing a beam-splitting device* in front of the transmitting lens so that the programme could readily be arranged to give a short interlude of stereoscopic viewing between the ordinary items.

BIBLIOGRAPHY.

¹ *Nature*, August 18, 1928.

² *Television and Short Wave World*, Vol. 12, No. 139 (Sept.) 1939, p. 541.

³ *Electronics and Television and Short Wave World*, Vol. 14, No. 156 (February) 1941, p. 69.

⁴ *Electronics and Television and Short Wave World*, Vol. 13, No. 152 (October) 1940, p. 465.

⁵ *Electronics*, Vol. 14, No. 1 (January) 1941, p. 87.

⁶ *Television*, Vol. 1, No. 7 (September) 1928, p. 20.

⁷ *Electronic Engineering*, Vol. 14, No. 169 (February) 1942, p. 620.

* See p. 621, Vol. xiv.

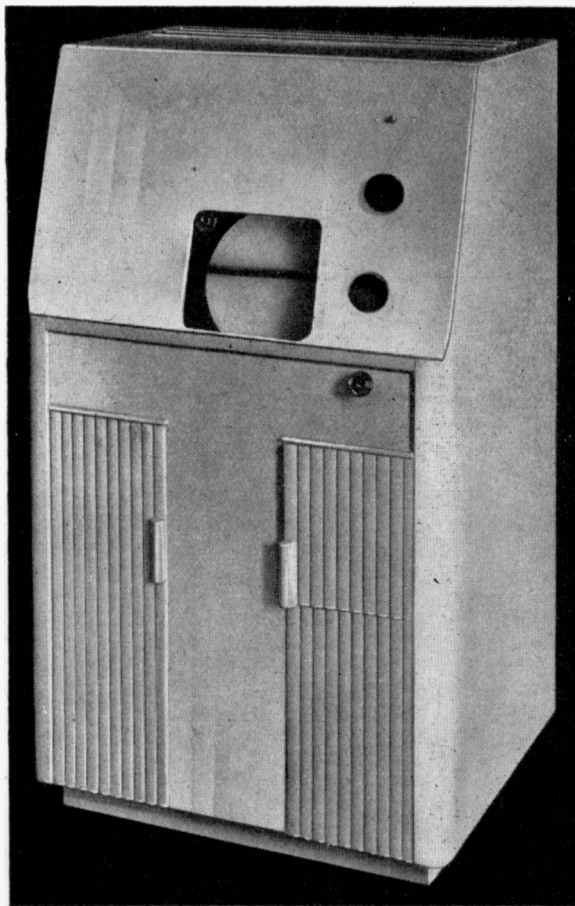

Medium sized cabinet model which can receive B.B.C. stereoscopic and colour television without alteration. The colour filter can be removed if desired, though its presence does not spoil the appearance of a monochrome picture.

a fixed position. The illustration shows a colour photograph taken of the stereoscopic pair. If viewed in a stereoscope this gives an idea of the effect, although much has been lost in taking a somewhat difficult photograph.

Anaglyphic Viewing.

A more practical system shown by Baird⁷ is the application of the anaglyph principle to his 600-line colour system. The red and blue

A Selective Circuit and Frequency Meter using a Tuning Fork

By D. G. TUCKER, B.Sc. (Eng.), A.M.I.E.E.*

The article describes a simple means of utilising a tuning fork as a selective circuit with a very sharp peak, and shows how the principle may be applied to make a frequency meter of extreme sensitivity

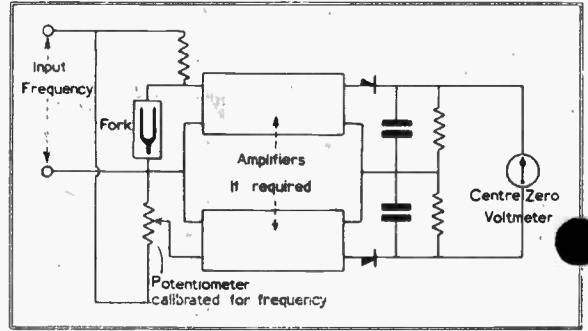
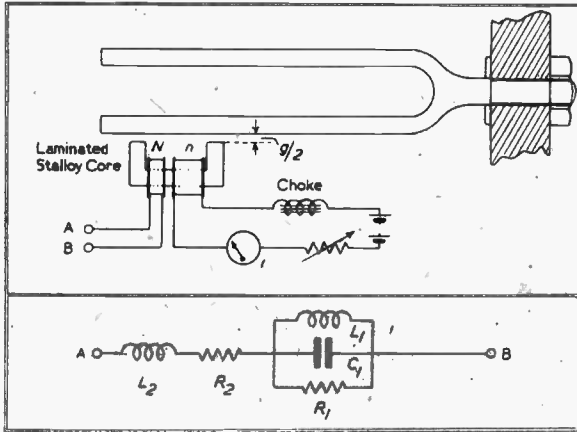

Fig. 1 (Top left) Schematic diagram of Fork Circuit and Fig. 2 (below) the equivalent circuit diagram. Fig. 6 (above) The use of the Fork Circuit as a Frequency Meter.

THE use of a tuning fork as a 4-terminal narrow-band filter is fairly well-known, although very little information seems to have been published on the subject. The method used to obtain the effect of a filter from the fork is to apply the input signal to a winding on a magnetic core clamped fairly close to the fork, arranged so that part of the tines are included in the magnetic circuit; the output signal is obtained from another winding either on the same core or on a separate but similar one. Extreme selectivity, even at very low frequencies can be obtained in this way. Some polarising field is generally necessary.

The use of a tuning fork as a 2-terminal selective circuit is not well-known, however. In this case only one winding is used for the a.c. circuit, and this is utilised more or less as a shunt-tuned circuit. The general arrangement is shown in Fig. 1. A B are the terminals of the selective winding consisting of N turns on the iron core of, say, Stalloy laminations. Another winding of n turns is provided for the d.c. polarising current of i amps, produced by the battery connected via the choke and adjustable resistance. The choke is very necessary to prevent damping of the selective winding by the low resistance of the battery circuit, and in the example described later has an inductance of about 100 henries: this is not a difficult choke to obtain, since with $n = 5,000$, the current used need not be large, and is not likely to exceed

50 mA. The impedance at the terminals A, B is the same as that obtained from an equivalent circuit as shown in Fig. 2 in which L_1 , C_1 and R_1 are the equivalent inductance, capacity and parallel resistance of the fork itself, and L_2 and R_2 are the inductance and series resistance of the coil N . The frequency characteristic of this circuit therefore shows a maximum impedance at the resonance of L_1 and C_1 and a minimum at the resonance of L_2 with the resultant capacitance of L_1 and C_1 above their own resonant frequency. If a high-impedance generator is connected across A and B, then the voltage developed between A and B is nearly proportional to the impedance of the fork circuit, and therefore shows a maximum and a minimum value. The peak at the maximum value is extremely sharp and since the frequencies of maximum and minimum voltage are extremely close to one another, the slope of the voltage-frequency characteristic between these frequencies is extremely great.

Determination of Equivalent Circuit Values

If the mass of the tine (or prong) of the fork is M and the compliance* S ,

* Compliance = $1/\text{stiffness} = dx/dF$ where F is the force and x the deflection it produces.
In simple cases, with no polarising force,

$$\text{Compliance} = \frac{12}{3EI}$$

where l = length, I = moment of inertia of cross-section
i.e., $\frac{\text{width} \times (\text{thickness})^3}{12}$

and E = Young's Modulus.
These must be expressed in cm-dyne units.

and if the velocity of motion at any instant is v , the applied force being F , then, neglecting mechanical resistance,

$$v = \frac{F}{j\omega M - j/\omega S}$$

where $\omega = 2\pi \times$ frequency of vibration.

Now if the current flowing in the driving coil is I and the back e.m.f. is E , then we have:

$$F \propto I, \text{ say } F = K_1 I \dots \dots (1a)$$

and $E \propto$ rate of change of flux

$$\propto v, \text{ say } E = K_2 v \dots \dots (1b)$$

If Z is the equivalent electrical impedance of the fork (without driving coil), then

$$Z = \frac{E}{I} = \frac{K_1 K_2 v}{F} = \frac{K_1 K_2}{j\omega M - j/\omega S}$$

and so Z is equivalent to an inductance L_1 and capacitance C_1 in parallel, where

$$\left. \begin{aligned} L_1 &= K_1 K_2 S \\ C_1 &= M/K_1 K_2 \end{aligned} \right\} \dots \dots (2)$$

Now, to evaluate K_1 and K_2 , assume all the reluctance of the magnetic circuit to be in the air-gaps. Let g cms. be the total length of gaps. Let a sq. cms. be the area of cross-section of each gap.

Let B be the flux density in gap due to alternating current I amps. in N turns.

Let b be the flux density in gap due to the polarising current i amps. in n turns.

Then we have†

† For derivation of these expressions, see standard text-books.

* Post Office Research Station.

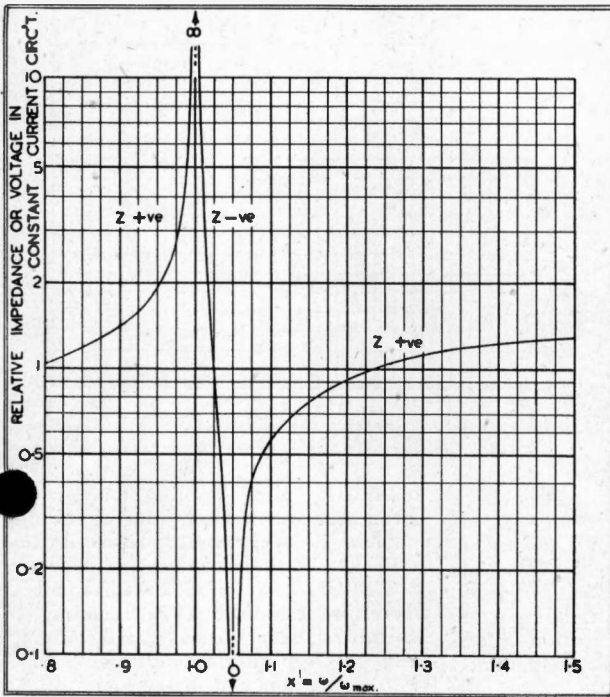

Fig. 3. Theoretical response of Fork Circuit.

$$B = \frac{4\pi}{10} NI/g \text{ and } b = \frac{4\pi}{10} ni/g \quad \dots (3)$$

$$\text{Pull on fork tine} = -\frac{2a}{8\pi} (B + b)^2 \text{ dynes.}$$

$$= -\frac{2a}{8\pi} (B_0 \sin \omega t + b)^2$$

where B_0 is the maximum flux density due to the applied a.c.

$$= \frac{2a}{8\pi} (B_0^2 \sin^2 \omega t + 2 B_0 b \sin \omega t + b^2)$$

$$= \frac{2a}{8\pi} \left(\frac{1}{2} B_0^2 - \frac{1}{2} B_0^2 \cos 2\omega t + 2 B_0 b \sin \omega t + b^2 \right)$$

The only term of this expression which is at the applied angular frequency ω is

$$F = \frac{2a}{8\pi} \times 2 B_0 b \sin \omega t = \frac{2a}{8\pi} \times 2 B b$$

$$= 0.08 \pi \frac{Nn Ii}{g^2} \text{ dynes.}$$

$$\therefore K_1 = 0.08\pi \frac{Nni}{g^2} \text{ from (1a)}$$

Back e.m.f. $E = -Na \frac{db}{dt} \times 10^{-8}$ volts.

being produced by the variation of flux due to the periodic change in the air-gap.

$$\text{Since } b = \frac{4\pi}{10} ni/g, \frac{db}{dt} = \frac{-4\pi}{10} \frac{ni}{g^2} \cdot \frac{dg}{dt}$$

$$\text{Now the velocity of the tine, } v = \frac{dg}{dt}$$

$$\therefore \frac{db}{dt} = \frac{-4\pi}{10} \frac{ni}{g^2} \cdot v$$

$$\text{So } K_2 = 0.4\pi \frac{Nni}{g^2} \cdot a \times 10^{-8} \text{ from (1b)}$$

Thus, from (2), we have

$$L_1 = 0.032 \pi^2 \left(\frac{Nni}{g^2} \right)^2 a S \times 10^{-8} \text{ henries}$$

$$C_1 = M \left/ \left[0.032 \pi^2 \left(\frac{Nni}{g^2} \right)^2 a \times 10^{-8} \right] \text{ F} \right. \quad \dots (4a)$$

Also, since L_2 is the inductance of the driving coil, we have

$$L_2 = 0.4\pi \cdot \frac{N^2 a}{g} \times 10^{-8} \text{ henries} \quad (4b)$$

The resistances R_1 and R_2 are not readily calculated from known data, and are therefore neglected at this stage.

The resonant frequencies of the equivalent circuit, and therefore of the fork circuit, are given by:

$$\text{Maximum point at } \omega_{\max} = \frac{1}{\sqrt{L_1 C_1}}$$

$$\text{Minimum point at } \omega_{\min} = \sqrt{\frac{L_1 + L_2}{C_1 L_1 L_2}}$$

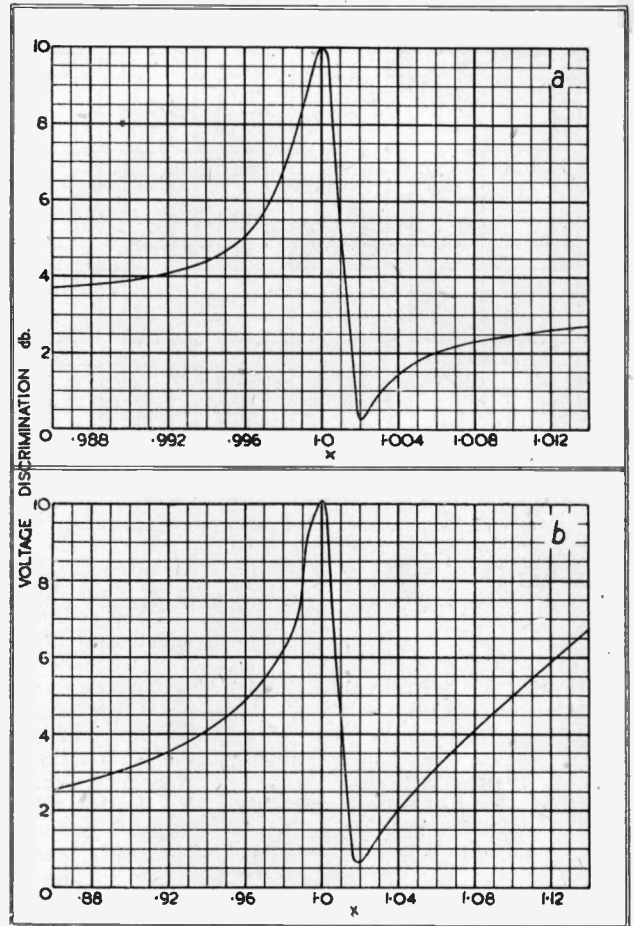

Fig. 4. Measured characteristics of Fork Circuit: (a) with polarising current of 28 mA.; (b) with current of 70 mA. Note that the "x" scales differ in the two cases.

The impedance at any angular frequency ω is

$$Z = \omega L_1 + \frac{\omega L_1}{1 - \omega^2 C_1 L_1}$$

$$= \omega \left(0.4 \pi \frac{N^2 a}{g} + \frac{0.032 \pi^2 \left(\frac{Nni}{g^2} \right)^2 a S}{1 - \omega^2 M S} \right) \times 10^{-8} \text{ ohms} \quad \dots (5)$$

As already stated, if the generator impedance is high, the voltage across the terminals A, B is nearly proportional to Z . A typical theoretical characteristic of the circuit is given in Fig. 3 for the case where

$$a = 1.25 \times 1.25 \text{ cm.}^2$$

$$g = 0.25 \text{ cm.}$$

$$n = 5,000$$

$$i = 0.05 \text{ amp.}$$

$$S = 10^{-7} \text{ cm./dyne units.}$$

$$\text{peak frequency} = \text{about } 50 \text{ c/s.}$$

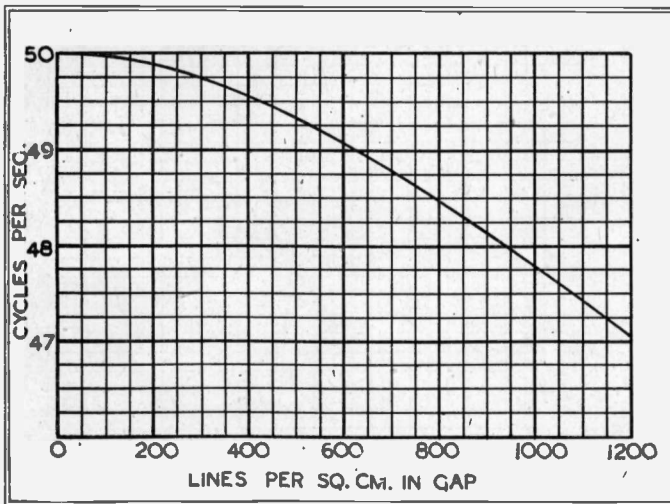

Fig. 5. Change of peak frequency with polarisation.

We have $MS = \frac{I}{\omega^2 \max}$

Let $x = \frac{\omega \max}{\omega}$

Substituting all these values in (5), for this case we obtain

$$Z = 8 N^2 \omega \max \left(x + 0.1 \frac{x}{1 - x^2} \right) \times 10^{-8} \text{ ohms (very nearly).}$$

In the graph of Fig. 3, $\frac{1}{8N^2 \omega \max \times 10^{-8}}$

is plotted against x , without regard to sign. The minimum and maximum points are seen to be very close together, the interval between them being only 5 per cent, of the peak frequency. Had the polarising current been only 0.02 amp., this interval would have been only 0.75 per cent, of the peak frequency. The slope of the curve between the two points is thus remarkably steep.

Measurements Made with a 50 c/s Fork

A series of measurements were made of the characteristics of a nominal 50 c/s fork fitted with a coil as described above. These measurements all confirm the theory reasonably well.

In Fig. 4 is shown the characteristic of the circuit with $N = 430$, $n = 5,000$, $g = 3$ mm., and $a = 1.56$ cm²; curve (a) is for $i = 28$ mA and curve (b) is for $i = 70$ mA. Both curves are plotted in terms of $x = \omega/\omega \max$ in order to give a better comparison. It will be seen that the voltage discrimination of the circuit is not very great (just over 2:1 or 6 db), owing to the effect of the coil inductance in series. To get a good result at all, it is necessary to clamp the base of the fork extremely firmly, and the whole apparatus should be

mounted on a strong steel panel with no "whip."

A very interesting and important effect is that the polarisation affects the frequency of peak impedance. When there is no polarisation, the peak impedance occurs at the natural frequency of vibration of the fork; as the polarisation is increased, the peak frequency decreases. This is due to a change in the compliance of the fork when under the influence of the polarising field.

Fig. 5 shows the change of peak frequency as the polarisation is changed. It will be observed that the change becomes more rapid as the polarisation is increased. An important conclusion is to be drawn from this curve:—In view of the fact that the change of frequency with polarising current may be much greater than the frequency interval between maximum and minimum points on the fork characteristic, it is always essential to maintain the polarisation as constant as possible in a practical job. This is most effectively achieved by using a permanent magnet.

The Use of the Fork Circuit as a Frequency Meter.

The circuit as described above may be used as the basis of a very sensitive frequency meter. This application was described by Mallett in an article entitled "Some Notes on a Fork Frequency Meter" in *World Power*, 1927, p. 133. Some difficulty was experienced in obtaining a low enough value of R_s , however, owing to the fact that the driving coil was placed between the tines in order to get a symmetrical magnetic circuit. This arrangement left very little space for the winding. With the arrangement described in the present article, however, a much lower resistance can be

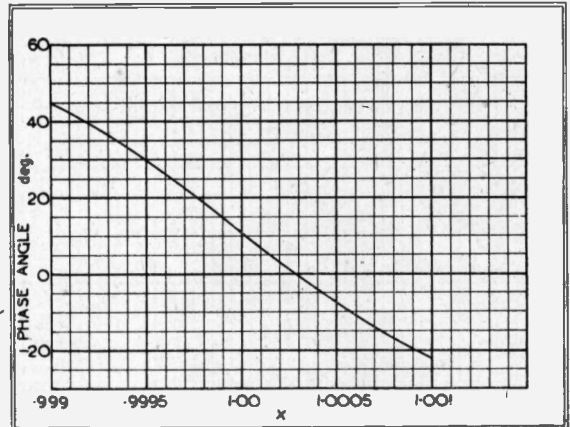

Fig. 7. Phase characteristic of Fork Circuit (example).

obtained, thus giving a much straighter and steeper slope of the impedance characteristic between the maximum and minimum points.

The simplest form of the frequency meter is obtained by connecting a voltmeter across the coil terminals, and by applying a certain voltage whose frequency is to be determined through a comparatively high resistance. If the frequency lies between the maximum and minimum points, the voltmeter can be calibrated to read the actual frequency, and a comparatively large change of voltage may be obtained for a small variation of frequency. The sensitivity and range of frequency can be controlled by means of the polarising current, but since the actual peak frequency will also be changed, it may be necessary to readjust the natural frequency of the fork by means of an added or reduced load on the tines.

The above simple scheme may have errors due to the following causes:

(a) Variation of polarisation. has already been pointed out how sensitive the fork is to small changes of polarising field. It would be desirable to use a permanent magnet field for accurate work; the control of sensitivity and range would then be obtained by variation of the air-gaps.

(b) Variation of temperature. This would change the natural frequency of vibration of the fork through altering the compliance, S . In addition, variations would probably take place in the air-gap, thus producing an additional change of frequency range. For extreme precision, the fork would need to be enclosed in a temperature-controlled oven.

(c) Variation of applied voltage. This difficulty can be almost overcome by using a differential scheme. In its simplest form this consists of connecting the input voltage through a potentiometer and rectifier in opposition to the output voltage from the

fork circuit after rectification. If the potentiometer is adjusted so that there is no resultant voltage in the middle of the frequency range, and a centre-zero voltmeter is used, then variations of applied voltage will tend to balance out, and at the centre of the scale will cause no error at all. A more accurate, though less convenient, method is to adjust the potentiometer for every reading to give zero resultant voltage, and to have the potentiometer calibrated in terms of frequency. This scheme is shown in Fig. 6.

Another method of using the fork circuit to measure frequency is to make use of the steep phase characteristic shown in Fig. 7. If the voltage across the fork circuit is taken through a constant volume device, and then a rotary phasemeter connected in the circuit, it is clear that the phasemeter may be calibrated to read the frequency directly. This method does not, however, offer any great advantage over that previously described. The general principles and construction of the rotary phasemeter are described in an article by Jarvis and Clarke, entitled "Apparatus for the Measurement of Insertion Phase Shift at Radio Frequencies," in the *Post Office Electrical Engineer's Journal*, January, 1941, Vol. 33, p. 162.

Acknowledgment.

The author wishes to acknowledge the help and advice given him in the analysis of the fork circuit by his colleague, Mr. J. O. Ackroyd.

APPENDIX

Change of Peak Frequency with Change of Polarization

We have already stated that the pull on the tine is given by

$$F = \frac{2a}{8\pi} (B + b)^2$$

$$= \frac{2a}{8\pi} \left(\frac{1}{2} B_0^2 - \frac{1}{2} B_0^2 \cos 2\omega t + 2 B_0 b \sin \omega t + b^2 \right)$$

We are concerned only with the steady pull this time, which is

$$F_1 = \frac{2a}{8\pi} \left(\frac{1}{2} B_0^2 + b^2 \right)$$

and for normal polarising fields and small applied a.c. voltages, we can neglect $\frac{1}{2} B_0^2$ compared with b^2 so that

$$F_1 = \frac{2a}{8\pi} b^2 = \frac{2a}{8\pi} \left(\frac{4\pi}{10} \frac{ni}{g} \right)^2 = \frac{4\pi a n^2 i^2}{100 g^2} \text{ dynes}$$

Let S_0 be the compliance of the tine with no polarisation.

Let g_0 be the air-gap (total) with no polarisation.

Let x be the deflection of the tine towards the coil.

$$\text{Then } \frac{g}{2} = \frac{g_0}{2} - x \text{ or } g = g_0 - 2x$$

$$\text{So } F_1 = \frac{4\pi a n^2 i^2}{100} \times \frac{I}{(g_0 - 2x)^2}$$

and the opposing force due to $S_0 = \frac{x}{S_0}$

Therefore resultant force, $F_R = \frac{x}{S_0} - F_1$

$$= \frac{x}{S_0} - \frac{4\pi a n^2 i^2}{100} \times \frac{I}{(g_0 - 2x)^2}$$

Let the new effective compliance be S .

$$\text{By definition } S = \frac{dx}{dF_R} \text{ or } \frac{I}{S} = \frac{dF_R}{dx}$$

$$= \frac{I}{S_0} - \frac{4\pi a n^2 i^2}{100} \left[-2 (g_0 - 2x)^{-3} \right] (-2) = \frac{I}{S_0} - \frac{16\pi a n^2 i^2}{100} \times \frac{I}{(g_0 - 2x)^3}$$

$$\text{Now } (g_0 - 2x)^3 = g_0^3 - 6g_0^2 x + 12g_0 x^2 - 8x^3$$

In a practical case x would be difficult to measure, but is not really small enough to justify neglecting the second term above, although the 3rd and 4th terms can safely be neglected.

$$\text{Therefore } \frac{I}{S} = \frac{I}{S_0} - \frac{0.16\pi a n^2 i^2}{g_0^2 - 6g_0^2 x} \quad (6a)$$

$$\text{and very approximately } \frac{I}{S} = \frac{I}{S_0} - \frac{0.16\pi a n^2 i^2}{g_0^2} \quad (6b)$$

$$\text{It will be seen from (6a) that when } \frac{I}{S} = \frac{I}{S_0} - \frac{0.16\pi a n^2 i^2}{g_0^2 - 6g_0^2 x} \quad (6c)$$

S becomes infinite. This means that the tine immediately clamps up against the pole pieces. Therefore (6c) defines the condition of maximum polarisation.

It is the value of S obtained from (6a) that must be used in equation (4a).

Since the peak frequency is given by
$$\omega_{\max} = \frac{I}{MS}$$

it is now clear that an increase of polarisation, by increasing S , reduces the peak frequency.

Change of Phase Angle of Fork Circuit

Referring to the equivalent circuit of Fig. 2, if we take

$$Q = \frac{R_1}{\omega L_1} \text{ and } x = \frac{\omega}{\omega_{\max}}$$

we have

$$Z = R_2 + j\omega L_2 + \omega L_1 \frac{Q + jQ^2(1-x^2)}{1 + Q^2(1-x^2)^2} = \frac{R_2[1 + Q^2(1-x^2)^2] + \omega L_1 Q + j\{\omega L_2[1 + Q^2(1-x^2)^2] + \omega L_1 Q^2(1-x^2)\}}{1 + Q^2(1-x^2)^2}$$

so that if ϕ is the phase angle of the impedance,

$$\tan \phi = \frac{\omega L_2 [1 + Q^2(1-x^2)^2] + \omega L_1 Q^2(1-x^2)}{R_2 [1 + Q^2(1-x^2)^2] + \omega L_1 Q} \quad (7)$$

To take the example following Eqn. 5 but with $i = 0.02$ amp., and if we neglect R_2 , which has little effect on the change of phase near the peak frequency, we have

$$\tan \phi = \frac{I + 0.015Q^2(1-x^2) + Q^2(1-x^2)^2}{0.015Q}$$

This gives a means of determining the effective resistance of the fork from measurements of the phase angle. If we assume a Q value of 350, which is a reasonable value to obtain for a 50 c/s fork, we get a phase characteristic near the peak frequency as shown in Fig. 7. It will be observed that the change of phase is very rapid for small changes of frequency.

The C.R. Tube Used Stroboscopically

By G. BOCKING *

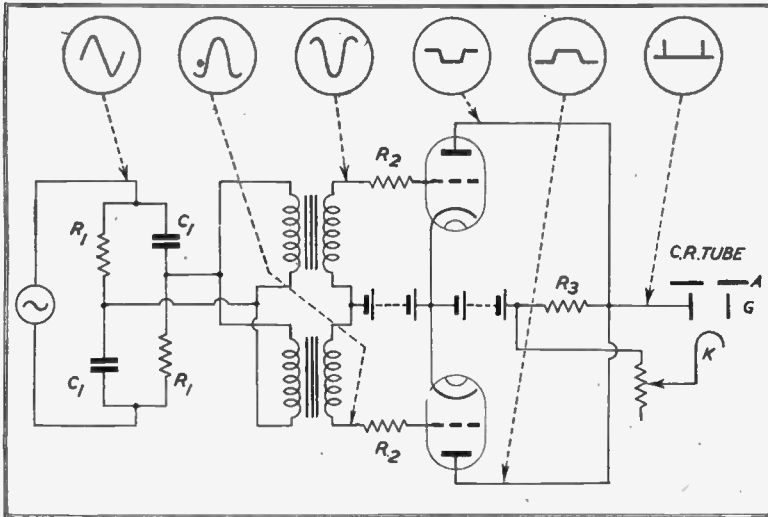

Fig. 1. Time marking circuit after Watson Watt, Herd, and Bainbridge Bell.
 R_1 5,000 ohms, R_2 150,000 ohms, R_3 50,000 ohms
 C_1 4 μ F.

The oscillograms at various points in the circuit are shown in the circles above.

IN the industrial world of to-day the stroboscope is a tool of ever increasing usefulness. In machines where materials are in a state of rapid motion it is generally necessary at some time or another to inspect the deformation to which these materials become subject without interrupting their motion by doing so. The stroboscope makes this possible by providing intense flashes of light of extremely short duration which are allowed to illuminate the material. If this is, for instance, a rotating wheel of rotation time t seconds and a flash of light lasting $1/1,000 t$ seconds illuminates it once every t seconds, the wheel will appear to be stationary; or if illuminated once every $t + 1/100 t$ seconds, will appear to have made one complete revolution in 100 actual revolutions or 100 t seconds. The deformations of the wheel are thus readily made visible.

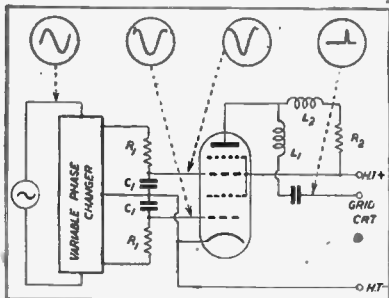

Fig. 2. Modification of Fig. 1 using a hexode. R_1 50,000 ohms, C_1 0.001 μ F., L_1, L_2, R_2 form a wide band filter, the values depending on the valve and C. R. Tube.

* Assoc. Brit. I.R.E.

In the world of moving electrons where the motion may be incomparably more rapid, the cathode ray oscillograph has been of even greater usefulness. In this case, however, stroboscopic viewing of, for instance, a rotating voltage vector is avoided by the established artifice of graphing the voltage amplitude against a time base. Nevertheless, as will be shown, it is equally possible and frequently desirable to view stroboscopically some part of a waveform by quenching the beam at all other parts or to build up a complete picture in a way similar to the mechanical case.

The occasions on which the stroboscopic method possesses advantages over conventional methods are several. One of these, for which the method was originally used¹ is when, owing to the deflexion methods used or for other reasons, that part of the signal which requires inspection appears to be overlapped by some other part occurring at a different instant of time. Another example of the use of this method is the so-called "timebase flyback blackout," where the return stroke of the flyback is suppressed to avoid confusion with the signal delineated during the normal forward stroke. An outstanding case when stroboscopic viewing is a necessity is in conjunction with a spiral timebase whereby an extremely extended time-scale is compressed into the small area of the C-R tube screen. With radial deflexion it almost invariably occurs that the signal overlaps one or more of the other revolutions of the spiral

with consequent confusion. If the time of incidence of the signal is known, the beam may be suppressed at all times except when the signal is present, thereby allowing its deflexion amplitude to be increased while maintaining the advantages of an extended time-scale. If the time of incidence of the signal is not predetermined it may be searched for by varying the point on the time-scale which is made visible, or frequently the signal itself may be arranged to release the beam by a trigger device.

The means of achieving beam release are numerous, but in order to secure accurate register the release impulse is almost invariably derived directly either from the timebase generator or from the signal. A circuit incorporated in the original suggestion¹ is shown in Fig. 1. It will be seen from the oscillograms accompanying the circuit that variation of the point of incidence of the beam release is obtained by varying the phase of the two antiphased grid voltages with reference to the timebase generator. A development of this method is the use of a hexode valve in which nearly antiphased voltages are

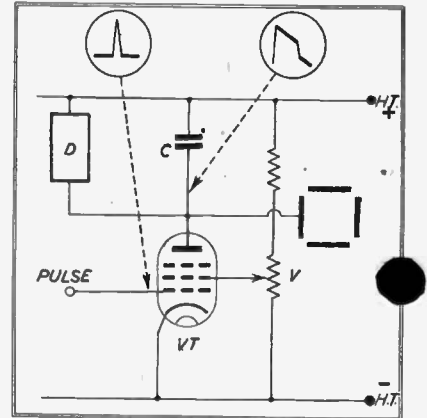

Fig. 5. Use of a pulse to extend the time scale by increasing the conductance of the charging valve VT. C is the condenser and D the discharge device. V: Velocity Control.

applied to its two-control grids as shown in Fig. 2. In this case the valve may be compared to a corridor having a door at each end; only when both doors are open simultaneously is it possible to see right through. Similarly, in the valve only when both grids have a potential within the range of cut-off and zero potential does current flow to the anode. The time of incidence of the beam release may be adjusted in the same way as in the preceding example, but this method has the advantage that, owing to the presence of interposed high-

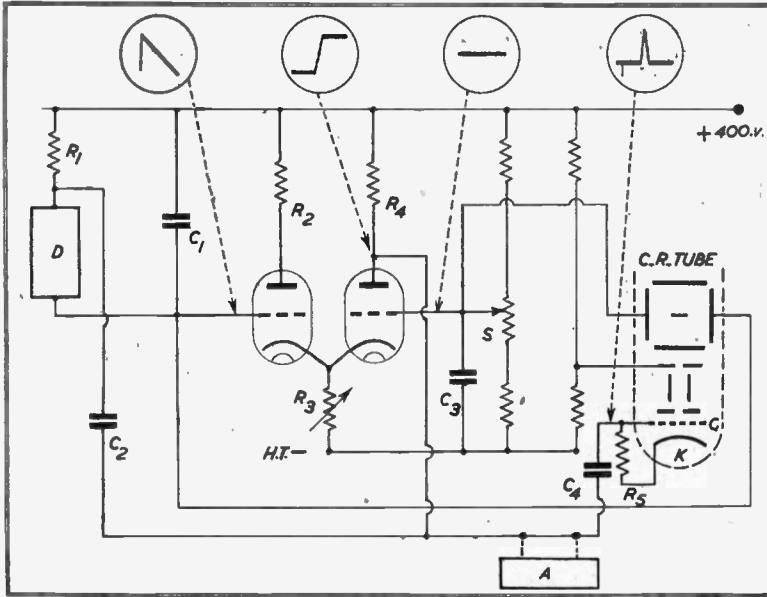

Fig. 3. Circuit for releasing the beam at a fixed point on the screen.
 R_1 100 ohms C_1 Timebase condenser
 R_2, R_3, R_4 50,000 ohms C_2, C_3, C_4 50 pF.
 R_5 10,000 ohms C_4 0.1 μ F.
 D Timebase discharger S X-shift Control A Amplifier

potential screens within the valve the duration of the pulse may be made at least 100 times shorter than the 0.1 msec. quoted, and may be adjusted in width within wide limits by varying the relative phase of the two grid voltages. The above method is valuable when the timebase generator is sinusoidal as is frequently the case when using a spiral timebase.

When using a linear transverse timebase or when the above method is inexpedient it is sometimes convenient to have the beam release at a fixed point on the screen, the signal being moved past it and appearing as if viewed through a window. The circuit arrangement shown in Fig. 3 makes this possible. The normal shift voltage is applied to one grid of a "long-tailed pair" and the timebase voltage is applied to the other. The valve which has its grid at the

fixed grid potential is then either cut-off or fully conducting except about a point where the grid potentials are congruent. If the resultant rapid transition appearing at the anode of this valve is applied through a short time-constant (differentiating) network, either directly to the C-R-O grid or via an amplifier, the beam will be released for a very short interval and will appear on the screen at a fixed point, apparently independent of the shift potential. The signal may then be moved past it by adjustment of the shift control by an amount which, if this control be calibrated, may be determined. Prevention of confusion due to the timebase flyback also, releasing the beam may be avoided by arranging that the C-R-O grid receives also the discharging pulse from the timebase generator.

Reference was made above to the possibility of the signal itself triggering the beam release. Such a device, called the "Beam Trigger," has been a standard feature for several years on oscillographs marketed by Messrs. A. C. Cossor, Ltd. The circuit of the beam trigger is shown in Fig. 4. There are a variety of trigger devices which may be used,² but essentially they all function in a similar manner to that shown.

Stroboscopic viewing may be used to advantage in conjunction with a timebase accelerator. It is frequently desirable to view a selected part of a waveform on an extended time-scale. Where the use of a circular or spiral timebase is inconvenient, this facility is secured by momentarily increasing

the charge rate of the timebase generator condenser. With stroboscopic viewing the beam, releasing pulse may also be used to increase the conductance of the condenser charge valve as shown in Fig. 5, thereby realising the advantages of stroboscopic viewing and an extended time-scale simultaneously. In an equipment used by the author a refinement has been added to this, in which the pulse derived as in Fig. 3 is used to release the beam, accelerate the timebase and increase the gain of a Y-deflexion amplifier, thereby achieving an effect strikingly similar to viewing the screen through a high-power magnifier without the disadvantage of decreased legibility consequent upon such a procedure.

The use of stroboscopic viewing is not, however, restricted to the production of a single spot. For instance, by releasing the beam at several predetermined points an unambiguous comparison of the signal waveform at these points may be made. With a linear timebase sufficient accuracy normally results from using an oscillator of a frequency which is some multiple of the timebase repetition frequency to release the beam. When the signal is viewed against a base other than time, however, the beam must be released, at definite voltage intervals controlled by the base voltage. This may be done by a modification of the circuit shown in Fig. 3. Instead of a fixed potential being applied to one grid of the "long-tailed pair" a scalariform voltage derived as shown in Fig. 6 is applied; the beam will then be released at definite voltage intervals governed by the number of steps and the voltage dimensions of the risers.

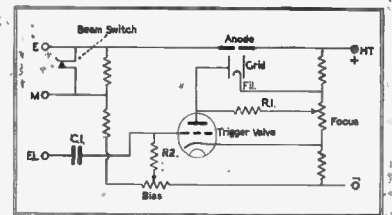

Fig. 4. Simplified diagram of Beam Trigger Circuit. By courtesy of Messrs. A. C. Cossor

The instances given above are but few of the many uses to which the stroboscopic method of viewing may be applied. The examples given are not intended to be exhaustive, but to be indicative of yet one further method of applying the C-R oscillograph to the solution of the problems of electronic engineering.

REFERENCES

- 1 R. A. Watson-Watt, J. F. Herd and L. H. Bainbridge-Bell: *The Cathode-ray Oscillograph in Radio Research*. H.M.S.O. 1933.
- 2 H. J. Reich: "Trigger Circuits." *Electronics*. No. 8, 1939, p. 14.

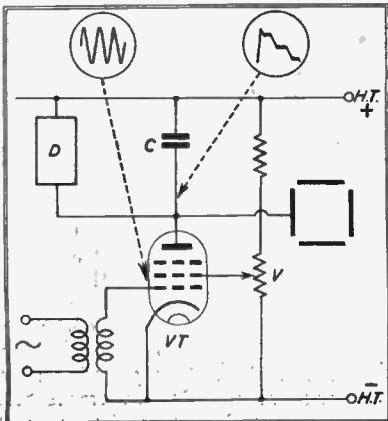

Fig. 6. Use of a scalariform voltage to release the beam at definite intervals. The lettering has the same significance as in Fig. 5.

The Manufacture and Properties of Tungsten and Molybdenum

By G. A. PERCIVAL, A.Inst.P.

AS all readers may not be familiar with the method used in the manufacture of Tungsten and Molybdenum, a brief preliminary description may help in an understanding of the more technical details which are dealt with subsequently in this article.

The process is based on the technique of powder metallurgy, in which metal in a fine state of division is moulded under high pressure to give a coherent mass. In the case of tungsten this is necessary on account of the high melting point, which is over $3,000^{\circ}\text{C}$. As will be understood, there is no refractory capable of holding metal at that temperature. For this reason tungsten powder is pressed into bars before the melting or "sintering" process takes place. Bars may be anything from $9" \times \frac{1}{4}" \times \frac{1}{4}"$ to $2' \times 1" \times 1"$ but immediately after pressing they are in a very fragile condition, necessitating a hardening process to give some mechanical strength. By heating in hydrogen at a temperature of $1,100^{\circ}\text{C}$., and allowing to cool down slowly, sufficient toughness is imparted to enable further handling.

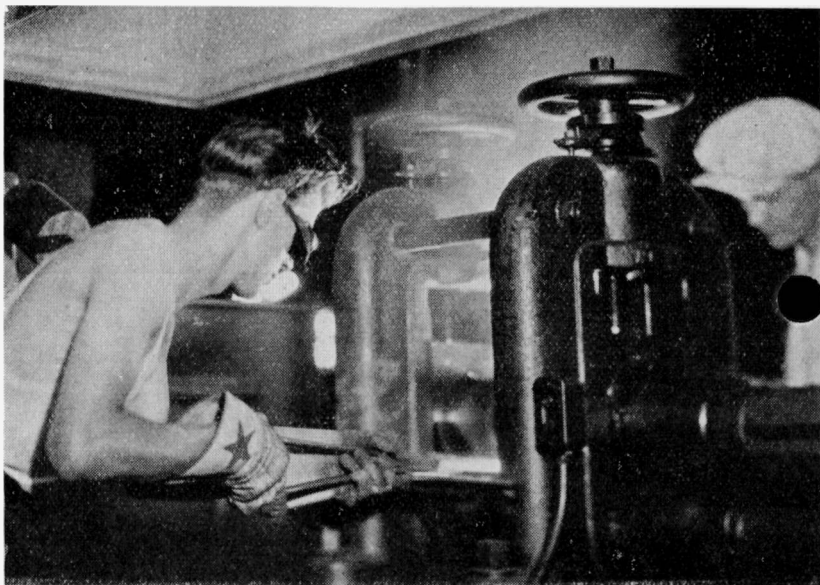
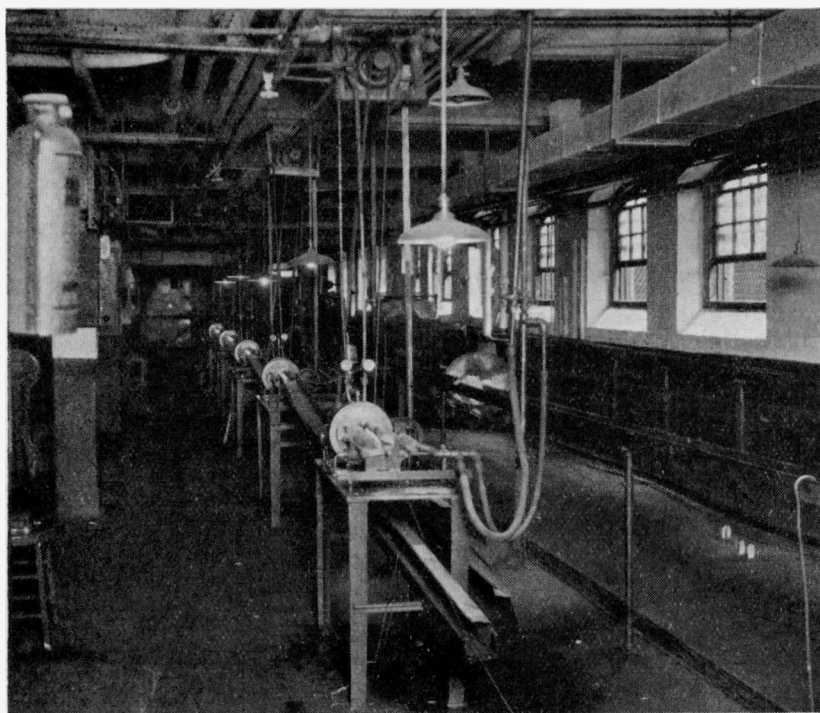

Fig. 6. (Above) Hot rolling of tungsten. By courtesy of Mallory Metallurgical Products Ltd.

Fig. 2. (Below) Light swaging machines. By courtesy of Syrian Wire Co., Inc.



Even at this stage the bars are little more than a piece of sandy material just stuck together, but by passing a current through the bar, any temperature up to that of melting point can be reached with a fritting or "sintering" of the particles. At melting point the circuit is, of course, broken so that in practice the sintering is never taken to the limit but to about 10 per cent. below that required for fusion.

To do this the hardened rod is placed between two heavy solid copper clamps in a vertical position. The top clamp is fixed on a water-cooled support, the bottom clamp floats in a water-cooled mercury bath to allow for the contraction in the rod during sintering. As tungsten readily oxidises, a reducing atmosphere must be maintained during the sintering process. This is accomplished by using a water-cooled metal "bell" which is lowered over the mounted rod and sealed at the bottom from contact with air by a trough, filled with mercury, into which the rim of the bell sinks to a depth of about half an inch. The inside is then flooded with hydrogen for about three minutes before the current is switched on and slowly increased from zero. Until the sintering is completed and the bar once more cold, an ample circulation of both water (to keep the

apparatus from melting) and hydrogen (to maintain a reducing atmosphere) must be maintained, otherwise there are serious risks of explosion.

In a sense the effect is like a glorified electric lamp, in which the filament is the tungsten bar and the bulb a water-cooled metal chamber; but as there is so much metal and a danger of short-circuits, transformed current is used at a pressure of about 20 volts. As the current on a small 9" rod is somewhere in the region of 3,000 amps., it will be realised what an enormous quantity of heat has to be dissipated in order to avoid overheating with the resultant generation of steam in the water system and pulsations of the mercury seal which might allow air to leak into the bell.

As in other manufacturing processes, it is in the small and unexpected details that the sintering operation may break down, and one of the greatest difficulties is that of maintaining exactly the right "springiness" in the clamps which hold the rod. Too heavy a spring will crush the ends. If too light the rods will fall out, probably when just near the end point of sintering. Although tungsten springs are used it is preferable to arrange a balance weight so that the grip remains at constant pressure independently of the temperature changes inside the bell. To avoid sticking and arcing between the jaws of the clamp and the tungsten, a thick piece of molybdenum is recessed into the jaw face so that the rod is in contact with a high melting metal instead of directly touching copper.

Apart from the purely mechanical and electrical details there is the all-important one of gas, i.e., hydrogen, as upon the purity of this depends the quality of wire or sheet in the finished state. In the first place the gas must be absolutely dry. Secondly, it must be free from all traces of hydrocarbons. Commercially this condition of purity is not found, although with the electrolytic gas (made by decomposition of water) hydrocarbons are absent. Where hydrocarbon-free gas is difficult to obtain or where transport is irregular, "cracked" ammonia may be used and even where hydrogen is available cracked ammonia offers certain economies, as apparatus for the cracking or splitting of ammonia into nitrogen and hydrogen, is quite automatic and gives a dry gas.

Perhaps in no part of the world have these details in manufacture of tungsten been watched with greater care than in Germany and Holland. To the English-speaking observer it

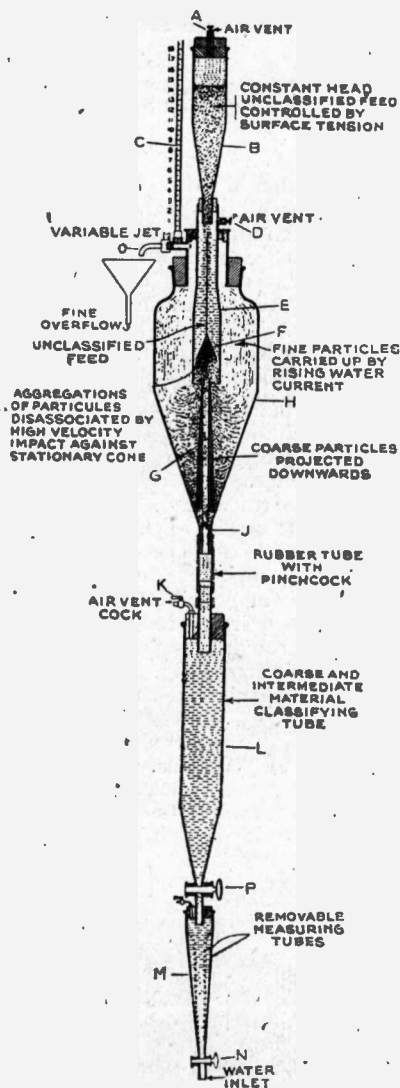

Fig. 1. Andrews Elutriator for grading tungsten powder.
By courtesy of International Combustion Ltd.

appears extreme, yet results have shown the value in the high standards maintained. This applies not only to mechanical and electrical questions but to chemical purity and physical analysis. This may be better understood by considering the variables in the manufacturing process.

Tungstic acid is precipitated by chemical means. The precipitate may be light or heavy. As a result, the metal may be fluffy or hard grey crystals. But, in addition, the sintered rod (or ingot, as it is called after sintering) will vary in crystal structure according to the time-temperature curve of treatment.

With molybdenum the case is slightly different as the base material is of a higher chemical purity.

Further, it is more malleable and allows a wider range of error. Molybdenum requires the greatest care at the end of the process—at least where wire is concerned.

Except for minor differences, tungsten and molybdenum are made by the same general process. Although it is not usual to use tungsten ingots of more than 500 gms., at least one manufacturer on the Continent uses 2,000 gm., molybdenum ingots and sinters six at a time in the same bell. It will be seen, therefore, that it is more simple to generalise than to be specific, as no two factories are likely to have exactly the same conditions. But for the benefit of those interested, though not engaged in actual manufacture, the following data may be of interest:—

Typical Oxide Reduction Treatment		
	° C.	Time (minutes)
1	500	15
	500—800	15
	800	15
	800—1,100	15
	1,100	15
	Cool down.	
2	400—800	20
	800—1,100	20
	1,100	20
		Cool down.
3	400	30
	500	30
	650	30
	750	30
	800	30
	950	60
	Cool down.	

In these experiments the oxide was from the same batch, having been checked for grain size dispersion by means of elutriation. Again checked by the same method after reduction, all the metals were comparable.

As elutriation is the only accurate method of control—on a commercial scale—an illustration is given (Fig. 1) of one type of elutriator which is still available in this country. Space does not permit a detailed description which the manufacturers will be pleased to supply, but the method of operation is reasonably clear. More elaborate apparatus is used for making photographic records.

Referring back to the figures in reduction treatment it will be seen what a wide time-range is permissible, provided the oxide is of the same physical condition. But in experiments 1 and 2 a short time was balanced by a high temperature as compared with that in experiment 3. A high temperature is to be preferred as it helps to eliminate occluded oxygen. In general, the relation of reduction speed to the quality of oxide is as follows:—

Slow Reduction	Oxide	Quick Reduction
Fine Black. Sandy. Grey. Heavy. Fine.	Fine. Medium. Heavy.	Blue-Black. Sandy Grey. Crystalline.

It will be seen that the whole question of powder metallurgy is involved in the preparation of tungsten (and molybdenum), and much of what, a few years ago, was of laboratory interest is now a science of industrial importance. To a large extent the subject developed from the study of tungsten, and it is doubtful if carbide alloys would have reached the present stage of usefulness without the knowledge gained in the manufacture of tungsten wire.

The subject of carbide alloys hardly comes within the scope of this article, but some reference is permissible in view of the fact that carbide dies are so much used in wire drawing, and are made from the same base material.

Tungsten powder "cemented" with carbon (at a temperature of $1,500^{\circ}\text{C}.$), prepared with not more than 6 per cent. of carbon content, is ground to a particle size of not more than 20 microns. Larger particles cause porosity which seriously affects the life of the tool, or die, and the quality of the work produced.

The cemented powder is then subjected to a further treatment of grinding with cobalt, or being re-reduced with a cobalt salt which has been added as solution and dried.

From this it will be seen that the process is initially similar to that by which thoriated wire is made; but after sintering, the material would be too hard to swage and is therefore moulded to the required shape before the final heat treatment.

Returning to the subject of sintering tungsten ingots, the time-temperature curve for any material must be standardised to obtain regularity, and without previous experience this presents some difficulties owing to the peculiar changes in the metal structure. With the same material, numerous effects may be obtained ranging from crystals of the original powder up to those which cover the cross section of the ingot. This will be understood from ordinary examples where on a sintering schedule of $3,200^{\circ}\text{C}.$, reached in 20 minutes, the grain size will be totally different from that in which an ingot is raised to $2,600^{\circ}\text{C}.$, and held for 20 minutes, followed by a rapid rise to $3,200^{\circ}\text{C}.$

The sintering schedule is determined by the purpose for which the tungsten or (molybdenum) is intended, and by the size of ingot, in

which the axis must become hotter than the surface during the sintering process. While it is more usual to allow something like 45 minutes for the ordinary size ingot, one company in America making contact metal completes the sintering in seven minutes; and there is less than 0.02 per cent. of oxygen left.

In swaging, it is usual to work with not more than a reduction of 10 per cent. in diameter at each die, and after elongating to 50 per cent. of the original length, it is re-sintered at 50 per cent. of the original watts. This releases the strain imposed by swaging and encourages crystal growth.

When the ingot has been elongated to a length at which it is difficult to hold in a pair of tongs, it is fed directly through a smaller machine, being pre-heated (Fig. 2) by a high temperature tube furnace at about $1,200^{\circ}\text{C}.$ This does not imply that the rod passing through is at this temperature. Obviously, this is a question of length of heated zone and diameter of tube. It is also important to see that the speed at which the rod passes through the machine synchronises with the hammer-blows,

otherwise an irregular—and often lumpy—surface will result, causing cracked dies and defects in the wire which will be discovered at much later stages. This trouble is aggravated by the fact that swaging dies for tungsten have a much shorter barrel than is the case in dealing with other metals worked in the cold state. It is a necessary characteristic of all dies used, whether for swaging or drawing, and particularly at that point where swaging has to give place to drawing in consequence of the increasing length of the ingot, which after fine swaging is many times the original length.

As the rod is still brittle, ductility is imparted by drawing through carbide dies, usually starting at about 1 mm. This is done for preference on a chain-bench where the tension is maintained in a straight horizontal direction. The resulting flexibility enables the wire to be coiled on drums, which are interchangeable for use on other machines where the speed increases as the diameter decreases.

On the chain-bench, drawing is done at about 10 m. per minute. On the final drawing machine at a diameter of 20 microns the speed is 100 m. per minute.

The three major operations in drawing are heavy, medium and fine. In the first, drums of 12 in. diameter are used (Fig. 3) subsequently followed by an intermediate size (Fig. 4) of

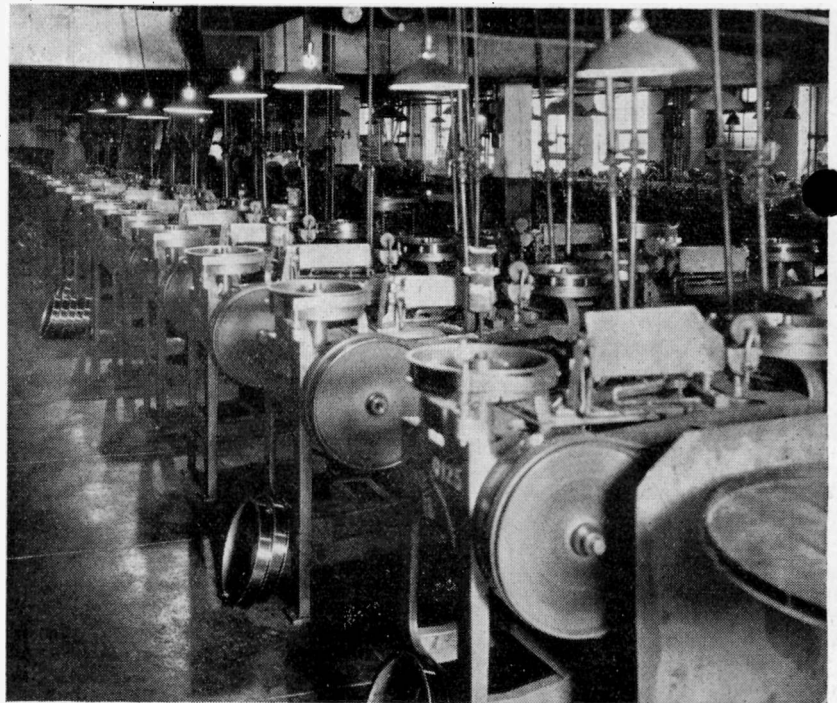

Fig. 3. Heavy drawing machines.

By courtesy of Syrian Wire Co., Inc.

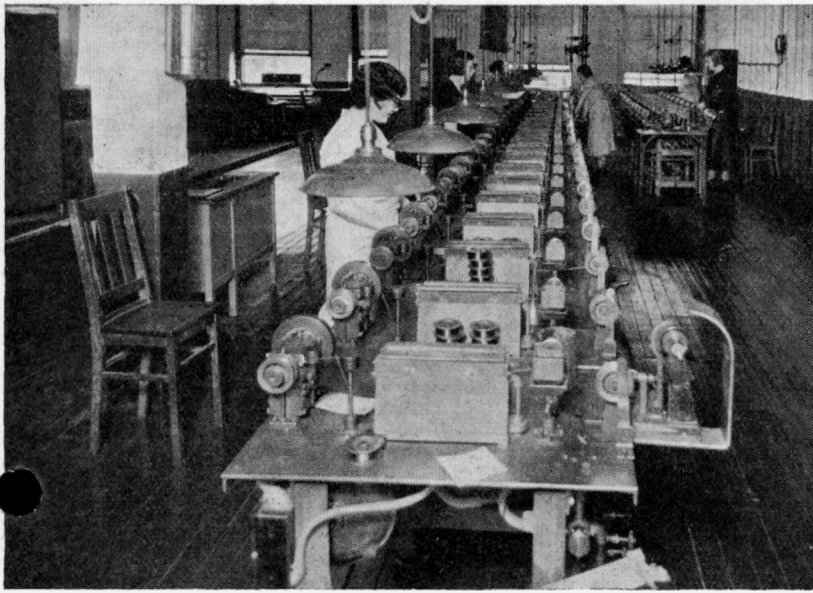

Fig. 4. Medium wire drawing machines.

By courtesy of Syrian Wire Co., Inc.

about 2 in. The wire is finally drawn on spools of 1½ in. diameter, which is a convenient size for all wire below 100 microns. Molybdenum is finished on larger spools of 4 in. to 6 in. diameter as this ties with conditions on most equipment where it is used. It also has the advantage of keeping the wire straight for feeding to the machines.

Down to a size of 150 microns carbide dies are in common use, after which diamonds are essential; but in every case the angle of polishing is different from that in use for other metals. A long barrel always gives rise to excessive wear and causes a characteristic "scratchy" pull on the wire. Although a long barrel is usually associated with long life in drawing copper or steel, a short barrel for hot-worked metals is more than compensated for by the absence of broken wires and increased output. (Fig. 5).

With molybdenum, the process of wire drawing is not quite so critical, and as soon as the rod comes from the chain-bench it can be transferred to "multiple" machines where a series of five or six dies are mounted for a continuous operation which is impossible for tungsten.

At all stages in drawing, both the temperature of the wire and that of the die are of the utmost importance. Too high a temperature will burn the wire; too low a temperature will "pull" the die and over-strain the metal which will ultimately split. In addition, a good film of graphite must be preserved on the wire. Only col-

loidal graphite, or some mixture of it, is suitable for giving a fine, smooth film. Sometimes it is found that the wire tends to have a grey colour, with an absence of that high polished black indicative of graphite. By "oxy-annealing"—or drawing through a gas flame to give a very slight oxide surface—the surface will take, or "wet," again to the lubricant.

In the previous notes some attempt has been made to outline points which are not too well known by those outside the industry. The specific uses of various kinds of material are dealt with below:

So far as tungsten filament is concerned, this may be divided into three groups:

Thoriated tungsten—for valves, although this has been largely replaced by coated wire.

Thoria-silicated tungsten—used chiefly for special types of rough-service lamps.

Silicated tungsten—used for transmitting valves and in gas-filled lamps.

Pure tungsten is rarely made for filament purposes: its chief application is in the manufacture of contacts and alloys.

In calculating the size of filament, neither micrometer nor microscopic methods of determining the diameter are suitable in consequence of the irregular symmetry. This can be seen by heating a small length of wire in hydrogen until brittle, and then examining it under a microscope. Rarely is it found to be a true circle. This often accounts for apparent errors of calculation and certainly

causes failures due to early burn-out in lamps. It is an excellent check on the quality of wire, so far as it indicates the manufacturer's attention to detail.

Actual size is determined by the weight of 200 mm., of straight wire; this applies, of course, to fine wire. As the efficiency of a lamp or valve depends upon regularity in respect of the first calculation, too much attention cannot be given to the accuracy of weighing, and it is not sufficient to accept the figure of a torsion balance as indicated on the dial by calibration from standard weights. This may be proved by weighing 200 mm., of wire, and then 400 mm. In many cases it will be found that the second weight does not correspond with twice the length of the first. It is a very simple check and will cause some unpleasant surprises. It will also account for many inexplicable results.

Whether filament should be cleaned, or not, before use depends on the purpose for which it is intended. In general, as received from the manufacturer it is coated with graphite. For valve purposes this is no disadvantage. In lamps, carbon must be avoided. Even for valves it is preferable to clean and re-treat the wire to a definite stage of carbonisation, where it is required. Whether for lamps or other purposes, loose graphite should be removed. One method is to wind on steel drums of two or three feet diameter and a foot wide, and rotate in a mixture of fine sand and hot caustic soda. Alternatively it may be treated electrolytically in a bath of sodium phosphate.

As coiled filaments are always subjected to a heat treatment before mounting, previous cleaning is not necessary, though desirable. But what appears to be a repeated "literary" error is the reference to cleaning coils in "dry" hydrogen. If graphite is still adhering to the surface, heating will only tend to form a carbide unless water-vapour is present. For this reason the hydrogen used should be wet, and to ensure such a condition is usually bubbled through water to obtain saturation.

Molybdenum wire, being used for different purposes from those of tungsten, requires a different treatment.

Most valve works have experienced the trouble of wire for grids being too hard and springy; and most lamp works have found batches of wire too soft for a smooth feed on the inserting machines. For each set of conditions there are limits in the quality of wire, between which, the best results are obtained. As both the original grain size and the final annealing control

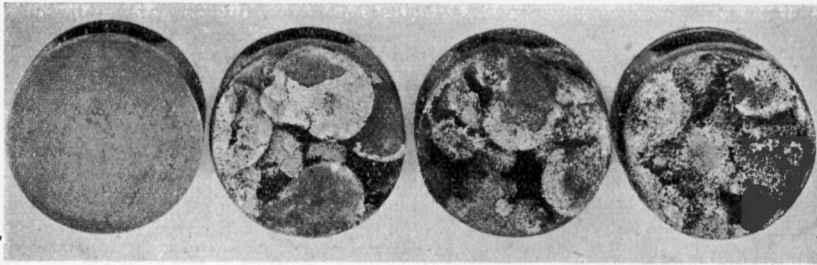

Fig. 7. Photomicrographs of copper-tungsten contacts after varying degrees of use.
By courtesy of Mallory Metallurgical Products, Ltd.

these limits, each is a factor of importance in relation to the other. With only one variable, the control would be as direct as with other metals, but conditions are complicated by the circumstances under which the wire is to be used, *i.e.*, at high temperatures. This will be understood from the fact that the elongation of molybdenum may be anything from 10 per cent. to 20 per cent. at 300° C. For lamp work, wire must be rigid; for valves, soft, yet the tensile strength may vary from 90 to 120 kg. per mm.² in the same batch of wire.

From this it will be appreciated that it is not sufficient just to anneal molybdenum without some data on its condition or method of preparation. In general, however, a certain degree of regularity can be obtained by heating above the re-crystallising point and drawing, all in one operation. After re-crystallising the wire is brittle, and as it would not be commercial to keep it in straight lengths for drawing, by combining the two processes it can be coiled (or spooled) as it leaves the die. From this stage ductility may be increased as desired by reducing and/or increasing the heat according to the speed of the machine. Without such treatment, wire from the same batch is liable to vary. This is not so important in the case of tungsten, apart from the necessity of strain-hardening to develop large crystals when heated. But molybdenum, for the most part, is used in the cold, or at temperatures below that of re-crystallisation.

In annealing either type of wire it must be remembered that the temperature of the furnace is not always directly conveyed to the wire which is moving, and experience has shown that to anneal molybdenum, running at 33 m.p.m., a furnace temperature of 1,500° C., is required, with a hot zone of 12 in. A more positive method for both metals is to heat by passing current through the wire.

When the direct method is used the contacts are preferably made of fine tungsten (filament waste) squeezed into plug, and forming the top and

bottom of a sponge through which the wire is run. This avoids the "flicker" experienced with mercury contacts. During any annealing, all wires are, of course, in an atmosphere of hydrogen.

In the manufacture of sheet tungsten and molybdenum, while the process is fundamentally the same up to a point, swaging is limited to only one or two dies before the ingot is rolled. (Fig. 6). To manipulate an incandescent body at over 1,200 ft. C., and one which is brittle at that temperature, presents difficulties which can only be overcome by great skill and technique. For efficiency, the ingot is made as large as possible, the greater mass holding the heat better while being transferred from the furnace to the rolls.

Where only narrow ribbon is required, wire may be drawn through dies; but this is unsuitable for anything wider than about 5 mm.

With sheet, difficulties increase with the elongation of the ingot, which is in two directions; at that point where the sheet becomes unwieldy it is often "sandwiched" between two sheets of copper (or other metal) for further rolling. Obviously this can only be done at a temperature below that at which the secondary metal melts, and extended annealing must be avoided on account of "creep" from one metal to the other.

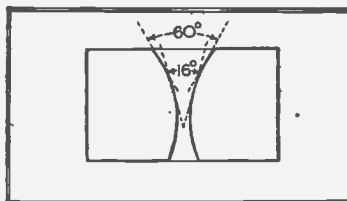

Fig. 5. Sectional sketch of wire drawing die recommended for tungsten.

A simple analogy of this method is the case of "copper-clad" wire used as a platinum substitute for making seals through glass. This wire consists of a nickel-iron core on which is welded, with silver, a sheath of copper. A composite rod of this kind can

be drawn to the finest wire sizes as exemplified in the small flash-lamp bulbs for torches.

As reference has been made to high temperature furnaces in some of the operations, information on these may be useful, not only for the manufacture of the metals referred to, but, for general industrial and laboratory purposes.

No doubt the "molybdenum furnace" is well known as a term though its use is not so general as might be expected. This may be on account of the difficulty in obtaining a really robust apparatus or merely hesitancy on the score of cost. For this reason most people make their own, when perhaps they would prefer to buy them.

There are two factors which make for robustness, heavy gauge wire (necessitating a transformer) and good refractory tubes which will be reasonably free from impurities reducible in hydrogen. The tube must have a high softening point, as distinct from melting point, so that it will carry weight at high temperatures without sagging. Tubes like those of the Morgan Crucible Company, give very satisfactory results, are cheap, and what is more important at the present time, they are obtainable.

Space does not permit much on the subject of tungsten and molybdenum alloys, and so far as contacts are concerned it would be presumptuous to attempt an outline of what has been adequately covered by Windred in "Electrical Contacts"* which deals with the physics of the subject in considerable detail. Of the manufacture, a good deal could be written on the question of control and quality, which, judging from the examination of many samples, is often of a very crude nature. An example of what a high quality contact will endure is illustrated in Fig. 7 which shows reading from left to right:—a new contact, contact after B.S.S. test 116/1937, and the last two, after seventy-one tests at varying currents. Disintegration is negligible and all the contacts are still good for service. This material was copper-tungsten.

Small contacts are usually made from pure tungsten, cut from ground rod by automatic machines and mounted by welding with copper.

Alloy contacts are made by one of several processes; mixing powdered metals and sintering, soaking tungsten ingots in molten copper, and coating tungsten powder by electrolysis. Of these, perhaps the third gives the most regular results.

*Published by Messrs. Macmillan.

Frequency Wavelength and L.C. Product Table*

f	λ	ω	LC	f	λ	ω	LC
100	3000.0	628.32	25330.	300	1000.0	1884.7	2814.5
102.5	2883.2	644.02	24110.	305	983.61	1916.4	2722.9
105	2857.1	659.74	22975.	310	967.74	1947.8	2636.0
107.5	2790.7	675.44	22084.	315	952.38	1979.2	2552.8
110	2727.3	691.15	20934.	320	937.00	2010.6	2473.6
112.5	2630.1	706.86	20014.	325	923.08	2042.0	2398.1
115	2608.7	722.57	19152.	330	909.10	2073.5	2326.0
117.5	2553.2	738.27	18347.	335	895.59	2104.9	2257.1
120	2500.0	753.98	17590.	340	882.45	2136.3	2191.1
122.5	2449.0	769.70	16880.	345	869.56	2167.7	2128.1
125	2400.0	785.40	16218.	350	857.15	2199.1	2067.7
127.5	2352.9	800.11	15582.	355	843.90	2230.5	2009.9
130	2307.7	816.81	14988.	360	833.35	2252.0	1956.5
132.5	2264.1	832.52	14428.	365	821.92	2293.4	1901.3
135	2222.2	848.23	13899.	370	810.80	2324.8	1850.3
137.5	2181.8	863.94	13398.	375	800.00	2356.2	1801.3
140	2142.8	879.65	12923.	380	789.50	2387.6	1754.2
142.5	2105.3	891.65	12475.	385	779.22	2419.0	1708.9
145	2069.0	911.06	12048.	390	769.75	2450.4	1665.4
147.5	2033.9	926.77	11643.	395	759.48	2481.9	1623.4
150	2000.0	942.48	11258.	400	750.00	2513.3	1583.1
152.5	1967.2	958.18	10892.	405	740.73	2544.7	1544.2
155	1935.5	973.89	10544.	410	731.75	2576.1	1506.8
157.5	1904.8	989.60	10211.	415	722.88	2607.5	1470.7
160	1875.0	1005.3	9894.5	420	714.25	2638.9	1440.9
162.5	1846.2	1021.0	9592.6	425	705.88	2670.4	1402.3
165	1818.2	1036.7	9304.0	430	697.70	2701.8	1369.9
167.5	1791.0	1052.4	9028.4	435	689.65	2733.2	1338.6
170	1764.7	1068.1	8764.6	440	681.80	2764.6	1308.4
172.5	1739.1	1083.8	8512.6	445	674.16	2796.0	1278.8
175	1714.3	1099.6	8270.8	450	666.66	2827.4	1250.9
177.5	1690.1	1115.3	8039.8	455	659.34	2858.9	1223.8
180	1666.7	1131.0	7817.9	460	652.15	2880.3	1197.0
182.5	1643.8	1146.7	7624.7	465	645.16	2921.7	1171.5
185	1621.6	1162.4	7401.1	470	638.30	2953.1	1146.6
187.5	1600.0	1178.1	7205.1	475	631.61	2984.5	1122.7
190	1579.0	1193.8	7016.7	480	625.00	3015.9	1099.4
192.5	1558.5	1209.5	6835.6	485	618.56	3047.4	1076.8
195	1538.5	1225.2	6661.5	490	612.25	3078.8	1054.9
197.5	1519.0	1240.9	6493.9	495	606.04	3110.2	1033.7
200	1500.0	1256.6	6332.6	500	600.00	3141.6	1013.6
205	1463.5	1288.1	6027.4	505	594.06	3173.0	993.22
210	1428.5	1319.5	5763.7	510	588.25	3204.4	973.80
215	1395.4	1350.9	5479.6	515	582.51	3235.9	955.24
220	1363.6	1382.3	5233.5	520	576.90	3267.3	936.75
225	1333.3	1413.7	5003.5	525	571.42	3298.7	918.98
230	1304.3	1445.1	4788.0	530	566.00	3330.1	901.70
235	1276.6	1476.5	4586.6	535	560.75	3361.5	884.98
240	1250.0	1508.0	4397.5	540	555.55	3392.9	868.67
245	1224.5	1539.4	4219.8	545	550.45	3424.3	852.76
250	1200.0	1570.8	4054.5	550	545.45	3455.8	837.35
255	1176.5	1602.2	3895.4	555	540.54	3487.2	822.34
260	1153.8	1633.6	3747.0	560	535.70	3508.6	807.67
265	1132.0	1665.0	3606.8	565	530.97	3550.0	793.48
270	1111.1	1696.5	3474.7	570	526.30	3581.4	779.62
275	1090.9	1728.9	3349.4	575	521.74	3612.8	766.10
280	1071.4	1759.3	3230.7	580	517.25	3644.3	752.96
285	1052.6	1790.7	3118.5	585	512.80	3675.7	740.13
290	1034.5	1822.1	3012.0	590	508.50	3707.1	727.67
295	1017.0	1853.5	2910.7	595	504.20	3738.5	715.47

* See Multiplying Table before using

f	λ	ω	LC	f	λ	ω	LC
600	500.00	3769.9	703.62	825	363.64	5183.6	372.16
605	495.86	3801.3	692.00	830	361.44	5215.1	367.67
610	491.80	3832.8	680.72	835	359.27	5246.5	363.37
615	487.80	3864.2	669.68	840	357.12	5277.9	360.22
620	483.85	3895.6	659.00	845	355.02	5309.3	354.74
625	480.00	3927.0	648.44	850	352.94	5340.7	350.62
630	476.19	3958.4	638.20	855	350.87	5372.1	346.57
635	472.44	3989.8	628.19	860	348.85	5393.6	342.42
640	468.50	4021.2	618.40	865	346.82	5435.0	338.52
645	465.11	4052.7	608.85	870	344.87	5466.4	334.65
650	461.54	4084.1	599.52	875	342.85	5497.8	330.82
655	458.01	4115.5	590.40	880	340.90	5529.2	327.10
660	454.55	4136.9	581.50	885	338.98	5560.6	323.41
665	451.13	4178.3	572.79	880	337.08	5589.2	319.70
670	447.79	4209.7	564.25	895	335.20	5623.5	316.22
675	444.45	4241.2	554.66	900	333.33	5654.9	312.72
680	441.22	4272.6	547.77	905	331.50	5686.3	309.26
685	437.96	4303.9	539.82	910	329.67	5717.7	305.95
690	434.78	4335.4	532.02	915	327.87	5749.1	302.54
695	431.66	4366.8	524.41	920	326.07	5780.5	299.25
700	428.57	4398.2	514.92	925	324.32	5812.0	296.04
705	425.53	4429.7	509.62	930	322.58	5843.4	292.87
710	421.95	4461.1	502.47	935	320.86	5874.8	289.74
715	419.57	4492.5	495.46	940	319.15	5906.2	286.65
720	416.67	4523.9	489.12	945	317.46	5937.6	283.64
725	413.79	4555.3	481.89	950	315.80	5969.0	280.67
730	410.96	4586.7	475.32	955	314.14	6000.5	277.74
735	408.17	4618.2	468.87	960	312.50	6021.9	274.85
740	405.40	4649.6	462.57	965	310.88	6063.3	272.00
745	402.68	4681.0	456.36	970	309.28	6094.7	269.20
750	400.00	4712.4	450.32	975	307.70	6126.1	266.46
755	397.35	4743.8	444.36	980	306.17	6157.5	263.72
760	394.75	4765.2	438.55	985	304.56	6189.0	261.06
765	392.15	4806.7	432.82	990	303.02	6220.4	258.42
770	389.61	4838.1	427.22	995	301.50	6251.8	255.86
775	387.10	4869.5	421.73	1000	300.00	6283.2	253.30
780	384.87	4900.9	416.35				
785	382.16	4932.3	411.05				
790	379.74	4963.7	405.85				
795	377.35	4995.1	400.76				
800	375.00	5026.6	395.77				
805	372.67	5058.0	390.87				
810	370.36	5089.4	386.05				
815	368.10	5120.8	381.34				
820	365.87	5152.2	376.70				

MULTIPLYING FACTORS FOR USE WITH THE TABLE

Select the appropriate frequency range in the first column of this table and multiply the figures in the main table by the factors given in the remaining columns.

Example: To find the LC product to tune to 15 Mc/s. The factor in the LC column opposite the frequency range of 10 - 100 Mc/s. is 10^{-20} . The LC product given in the main table is 11,258, for $f=150$ and the actual value of LC in $\mu\text{H} \times \mu\text{F}$ is $11,258 \times 10^{-20}$ or 112.58×10^{-18} , while the wavelength is given by $2,000 \times 10^{-3}$ or 20 metres.

Frequency Range.	Wavelength.	ω	LC Products.
10-100 c.p.s.	10^4	10^{-1}	10^{-8}
100-1,000	10^3	1	10^{-10}
1,000-10,000	10^2	10	10^{-12}
10-100 kc/s.	10	10^2	10^{-14}
100-1,000 kc/s.	1	10^3	10^{-16}
1-10 Mc/s.	10^{-1}	10^4	10^{-18}
10-100 Mc/s.	10^{-2}	10^5	10^{-20}
100-1,000 Mc/s.	10^{-3}	10^6	10^{-22}

CORRECTIONS FOR DATA SHEETS I — XXVIII

contained in Vol. XIV.

DATA SHEETS.	PAGE.	COL.	LINE.	FOR :	READ :
	1	i	12 up	Square root sign in expression for Relative Gain	Square root sign in numerator only.
I, II,	1	i	4 up	The impedance of any frequency . . .	The value of the impedance at any frequency . . .
& III	1	ii	Symbols	$f_0 = \dots$, i.e., the frequency in c.p.s. at which $\omega_0 C R = 1$	\dots , i.e., the frequency in c.p.s. at which $\omega_0 C_T R = 1$
	1	iii	8	. . . Time Delay t.	. . . Time Delay t, where $t = - \left[\frac{\pm \phi}{2\pi f} \right]$
	3		D.S. 2	$t = \text{Time Delay (sec.)} = - \frac{\pm \phi}{360^\circ} f$	$t = \text{Time Delay (sec.)} = - \frac{\pm \phi^\circ}{360^\circ f}$
				$\frac{\pm \phi}{2\pi f}$ radians	$\frac{\pm \phi}{2\pi f}$ (radians)
& V	1	ii	5	. . . electromagnetic waves in low-loss lines electromagnetic waves in low-loss lines with air dielectric . . .
VI, VII & VIII	1	i	below Eq. 5	. . . $\beta l =$ electrical length of line in terms of wavelength λ	. . . $\beta l =$ electrical length of line with 2π representing a wavelength
	1	i	Eq. 6	$E_r = 0$ and $Z_s = Z_0 \tanh pl$ (6) r when α is very small	$E_r = 0$ and $Z_s = Z_0 \tanh pl$ (6) and when α is very small . . .
	1	ii	11	Expressing βl in terms of λ . . .	Expressing l in terms of λ . . .
	1	iii	8	$C = -j/\omega C = -jX$	$C = -j/\omega C = -jX$
	1	iii	Eq. 16	$l = \lambda/2\pi \cdot \tan^{-1}(\lambda/(5.3CZ_0))$ cms.	$l = (\lambda/2\pi) \tan^{-1}[(5.3)\lambda/CZ_0]$ cms.
	1	iii	Eq. 17 & below	$l/\frac{1}{4}\lambda = 2/\pi \tan^{-1}[(\lambda/C) \div 5.3Z_0]$	$l/\frac{1}{4}\lambda = (2/\pi) \tan^{-1}[(5.3/Z_0) \times (\lambda/C)]$
	2 & 3		D.S. 6 & 7	. . . for different values of Z for different values of Z_0 . . .
	4		D.S. 8	$\lambda/2\pi$ (in equation)	$\lambda/2\pi$
	1	i	27	Horizontal scale figures: .2, .3, .4, .5	.11, .12, .13, .14
	1	i	30	$\beta l = a\beta l = c\beta l Le$	$\beta l = a \beta l = c \beta l = e$
	1	ii	6	. . . length $l = \lambda/2$. . . length $l = \lambda/2$
	1	ii	8up	. . . and $l/\frac{1}{4}\lambda = 57\%$. . . and $l/\frac{1}{4}\lambda = 57\%$
	1	iii	Eq. 19	$l/\frac{1}{4}\lambda = 21.6\%$	$l/\frac{1}{4}\lambda = 21.6\%$
	1	iii	Eq. 21	. . . wire of length "l" and diameter "d"	(20) after Equation below Eq. 19. . . wire of length "l" and diameter "d ₁ "
	1	iii	Eq. 23	$L_s = \frac{2D \log_e(2D/d) - 1}{4 \log_e(2D/d)}$	$L_s = \frac{2D [\log_e(4D/d) - 1]}{4 \log_e(2D/d)}$
IX, X, XI	4		D.S. 11	$L_0 \approx .004 \log_e \frac{2D}{r} \left[\dots \text{etc.} \right]$	$L_0 \approx .004 \log_e \frac{2D}{d} \left[\dots \text{etc.} \right]$
	4		D.S. 11	Line joining wire to sheath in figure	Delete.
	4	i	4 up	. . . i.e. very small, $p = j\beta l$ i.e., a very small, $p = j\beta l$. . .
	4	ii	Eq. 30	$l/\frac{1}{4}\lambda = 1/\pi \cot^{-1}(\dots \text{etc.})$	$l/\frac{1}{4}\lambda = 1/\pi \cot^{-1}(\dots \text{etc.})$
	4	iii	Eq. 32	$l/\frac{1}{4}\lambda = 1/\pi \tan^{-1}(5.3\lambda/CZ_0 + \frac{1}{2})$	$l/\frac{1}{4}\lambda = 1/\pi \tan^{-1}(5.3\lambda/CZ_0) + \frac{1}{2}$
XII, XIII & XIV	1	ii	above Eq. 6	. . . of $\Delta L/L$ as a percentage,	. . . of $\Delta L/L_s$ as a percentage,
	1	ii	below Eq. 7	. . . can be plotted with d/l as the variable can be plotted with D/l as the variable
	1	ii	3 up	. . . 10% for a range of d/l values 10% for a range of D/l values . . .
	1	iii	7 up	$S = 0.65 D/l = 1$	$S = 0.65; D/l = 1$
	4		D.S. 14	X (Full Line) = 1.57 K(D/l)	X (Full Line) = 0.0157 K(D/l)
XV, XVI & XVII	1	i	Eq. 11	When $l \frac{1}{4} D$:	When $l < \frac{1}{4} D$:
	1	iii	10	D. Pollack . . . uses Equation (14) . . .	D. Pollack . . . uses Equation (15) . . .
	1	iii	17 up	$D/l = 2$ in Nagaoka's formula	$D/l = 2$ in Nagaoka's formula
XVIII	1	iii	Eq. 10	$3.6 \log_e \left[\frac{p}{2d} + \sqrt{\left(\frac{p}{2d}\right)^2 - 1} \right]$	$3.6 \log_e \left[\frac{p}{d} + \sqrt{\left(\frac{p}{d}\right)^2 - 1} \right]$
XIX	1	i	6 up	. . . low spectrum at other frequencies low frequency spectrum at other
	1	ii	Eq. 9 and on	$R(f) = \frac{1}{2} \div \omega^2 C^2 r = R_{dys} (9)$	$R(f) = 1 \div \omega^2 C^2 r = R_{dys} (9)$
				. . . at the resonant frequency $\omega = 2f_0$ at the resonant frequency $\omega = 2\pi f_0$.

DATA SHEETS.	PAGE.	COL.	LINE.	FOR :	READ :
XX	1	iii	2	Equivalent Noise Resistance " R_{og} "	Equivalent Noise Resistance " R_{oq} "
		iii	Table	Straight Pentodes $I_s \approx \frac{1}{4} I_a$ 0.25	Straight Pentodes } $I_s \approx \frac{1}{4} I_a$ 0.25 - 0.3
				Var. mu Pentodes $I_s \approx I_a$ 0.25 - 0.3	Var. mu Pentodes }
XXI & XXII	1	iii	16 up	... appreciably less than $10K_1$ appreciably less than 10, K_1 ...
XXIII & XXIV	674	iii	Eq. 17	$t = \phi \Delta \omega$ secs.	$t = \phi / \Delta \omega$ secs.
		iii	6 up	$f = f_o$	$f_c = f_o$
& XXV		ii	Eq. 20 & 21		$t = \dots$
	675	i	end	... provided the time delay ordinates are halved provided the time delay ordinates are halved and the K values doubled.

Index to Data Sheets for Vol. XIV.

AMPLIFIERS

Inductance Compensated R.C.C., H.F. Performance of	I, II, and III
Circuit Noise, Thermal Agitation	XIX

COILS

Self Capacity of	XVIII
Short Wave Design Chart	XV
Single Layer Inductance	XVI
Single Turn Inductance	XVII
H.F. Characteristic Impedance of Transmission Line	IV and V

INDUCTANCE.

Compensated Amplifiers—Performance	I, II and III
Per. loop cm. of shielded pair line	XI
Single Layer Solenoids	XII to XVII
Straight wire at H.F.	IX
Short Wave Coil Design	XV
Shot Noise, Calculation of	XX
Shunt Loaded Tuned Anode Circuit, Performance of	XXIII, XXIV, XXV and XXVIII
Skin Effect	XXVI and XXVII
Space Current in Diodes and Triodes	XXI and XXII

TRANSMISSION LINES.

Characteristic Impedance of Lines	IV
,, Thin Parallel strips	IV
,, Thin split cylinder	IV
,, Shielded Pair	V
Resonant Lengths of Capacity Loaded $\frac{1}{4}$ wave line	VI to VIII
Resonant Lengths of Capacity Loaded $\frac{1}{2}$ wave line	X and XI
Tuned Circuit—Performance of Shunt loaded	XXIII to XXV and XXVIII
Wire—A.C. Resistance of a Round	XXVII

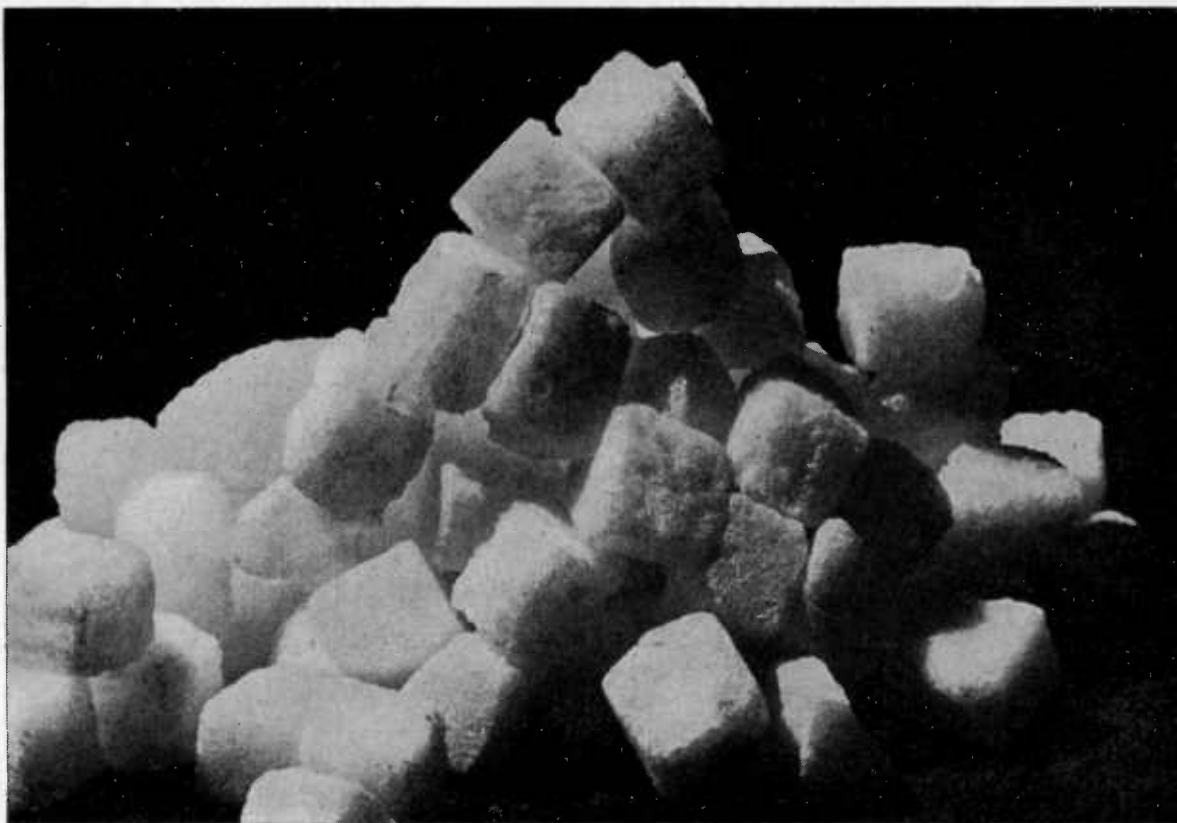

Valves and sugar

To the industrial chemist sugar is a product requiring constant and careful analysis to maintain prescribed standard of quality. One of the tests is to determine its 'ash content', and a method in common use is to compare the electrical conductivity of a prepared solution against a known standard by using a balanced bridge circuit — and there are Mullard Valves for this purpose.

In every branch of industry and research, problems constantly arise demanding more exacting standards of comparison, more sensitive equipment, and closer control of industrial processes.

In many cases the answer is to be found in the application of the radio valve — and that is where Mullard come into the picture with the right valve for the purpose.

MULLARD
THE MASTER VALVE

A Valve for Every Purpose

DOMESTIC · COMMERCIAL · INDUSTRIAL · SCIENTIFIC · MEDICAL · EXPERIMENTAL

THE MULLARD WIRELESS SERVICE COMPANY LIMITED, CENTURY HOUSE, SHAFTESBURY AVENUE, LONDON, W.C.2. (35B)

Electronics in Medicine and Surgery

Part I—Electro-physical Units.

By A. W. LAY, F.Inst.P., A.M.I.E.E.

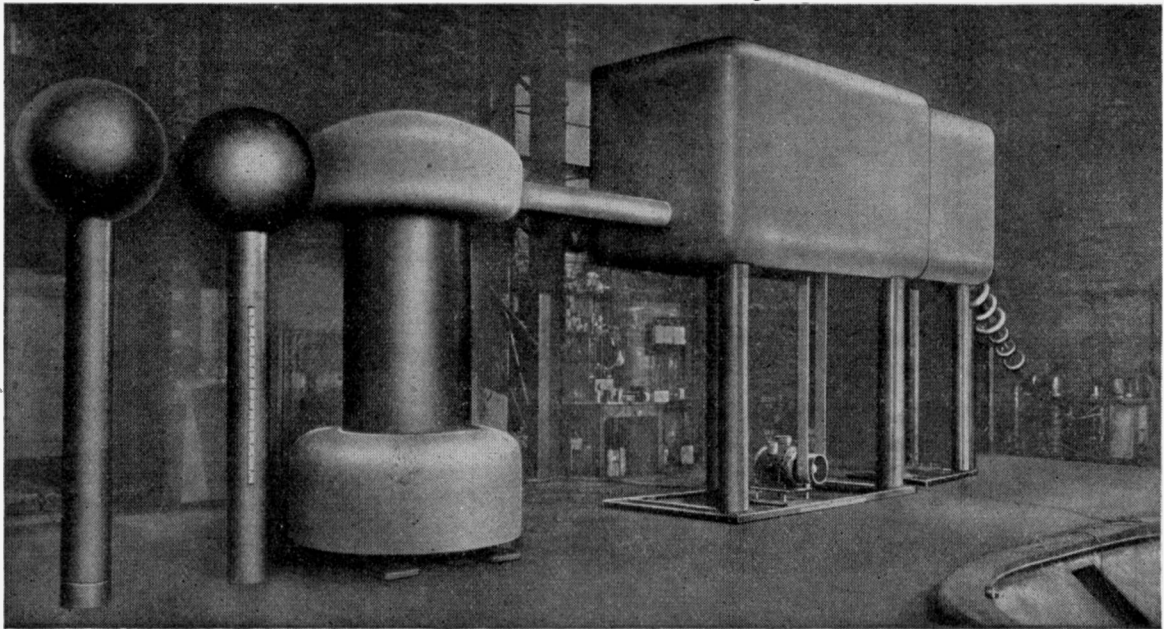

A NEUTRON GENERATOR. The apparatus shown was developed for use in nuclear research problems, although it may easily be adapted to serve as a powerful source of high voltage X-rays. The apparatus was designed for use at King's College, London by a member of the University staff, and constructed by the Research Department of the Metropolitan-Vickers Electrical Co., Ltd.

The components comprise (i) an electrostatic generator capable of supplying about 2 milliamps. at 700 kV. (open circuit voltage approaching 950 kV.), (ii) a source of positive ions (generally protons or deuterons; the latter are used, in conjunction with certain targets, to produce neutrons) which is maintained at a high positive voltage above earth and (iii) a cascade acceleration tube.

The positive ion beam produced by (ii) passes down the acceleration tube until its component particles attain the speed corresponding to the electrostatic voltage. The large electrodes shown in the diagram contain 2 high power rectifier sets, supplied by a belt-driven alternator. One of the sets excites the source, and the other supplies an accurately controllable focusing electrode. The action of the latter is to concentrate the ion beam into the acceleration tube and thus prevent excessive beam diffusion and loss.

The maximum target current reached, to date, is about 180 microamps. at 600-650 kV. This represents a high performance for installations of this kind using electrostatic generators of limited current output.

IN a preliminary survey of medical electronics some difficulty is experienced in assessing the relative importance of the various applications, as progress has been wide, and this extends in terms of physical units across a spectrum from about 0.05\AA ,* the wavelength of gamma rays, to about 500 metres—the longest wavelength of high frequency currents which are used for medical purposes.

However, before proceeding to deal with electronic devices in detail it may be worth while explaining briefly some of the units used as we pass on to an elementary survey of the field of nuclear physics, and the application of these to medical and associated sciences.

Two of these units which are of great importance in electro-physics are the "photon," and the "million

electron volt" the latter being generally abbreviated to M.E.V.

The photon will come into use in dealing with the biological effects of radiation, and we shall be concerned with the M.E.V. when we consider electronic devices for the production of artificial radioactivity by bombarding certain elements with high energy particles.

It should be borne in mind that a static charge of electricity is supposed to have no magnetic field associated with it, but that it is the centre of an electric field; when, however, this charge is set in motion by an accelerating force magnetic lines surround the resulting current in a manner already well known. Readers will also be familiar with the properties of the electron and know that it carries a negative electric charge of 4.8×10^{-10} electrostatic units according to the latest determination¹ that is 1.59×10^{-19} coulombs; its mass when "at rest," or travelling with a very slow

velocity is 9.0×10^{-28} grams approximately.

This is the static unit which is the centre of an electric field without an associated magnetic field, and in free space we may visualise the electric lines radiating all round the charge.

If, however, the electron is accelerated to a high velocity this begins to influence its mass according to Einstein's equation, which is:

$$m_0 = \frac{m}{\sqrt{(1 - \beta^2)}} \quad \dots (1)$$

where $\beta = v/C$; C is the velocity of light.

For practical purposes the value 3×10^{10} cm/sec. is used; v is the velocity to which the electron is accelerated; m_0 is the effective mass, and m is the mass of the electron "at rest."

This is a special case of the universal relativity principle which applies to all matter, but it should be mentioned that the dependence of mass of an electric charge upon its

* \AA signifies Angström unit, which is 10^{-8} cms.

† The full mathematical treatment of the photon involves quantum mechanics which is beyond the scope of this review.

velocity was first deduced by Heaviside² and Thomson.³

From Eqn. (1) it will be observed that the effective mass m_0 of the electron in motion increases with the velocity v , and that if it were possible to accelerate its speed until v reached C , the velocity of light, the effective mass would be infinite. Whilst it is difficult to visualise this speed being attained in practice the fraction v/C is beginning to count in dealing with some applications of high velocity electrons.

In non-mathematical language we may visualise the electromagnetic mass of an electron in motion, or its dynamic mass, as analogous to the hydrodynamic mass of a rubber ball submerged in water and accelerated to a high velocity. The pressure of the water around the ball will not be constant over all its surface, and as the speed is increased this will cause the force antagonistic to motion to increase.

Returning now to the work of Einstein, he deduced that matter and energy are interchangeable—just as various kinds of energy are mutually convertible. This means for example, the conversion of heat into light, or sound into electric currents in considering energy.

In the next step we make use of a well known principle of mechanics, which is that momentum, M , = mass \times velocity or

$$M = mv \quad \dots (2)$$

and if we substitute $v = \beta C$ we get as the momentum of an electron in motion:

$$M = \frac{m_0}{\sqrt{(1-\beta^2)}} \times v$$

$$= \frac{m_0}{\sqrt{(1-\beta^2)}} \times \beta C \quad \dots (3)$$

Before Einstein enunciated the theory of relativity two fundamental laws were recognised in dealing with the conservation of energy. These laws were considered to be mutually independent, and in relating these hitherto independent laws into one law Einstein made a great contribution to mathematical physics.

It is well known from the laws of non-relativity mechanics that the kinetic energy of a particle of mass, m moving with a velocity v is $\frac{1}{2}mv^2$, but this no longer holds according to Einstein's special theory which gives the kinetic energy

$$KE = \frac{m_0 C^2}{\sqrt{(1-v^2/C^2)}} \quad \dots (4)$$

where the symbols have the same significance as in equation (1).

If we now expand the denominator of equation (4) by the binomial

theorem we find that the kinetic energy

$$KE = m_0 C^2 + \frac{m_0 v^2}{2} + \frac{\frac{3}{8} m_0 v^4}{C^2} + \dots \dots \dots (5)$$

from which it is obvious that if v^2/C^2 is very small compared with 1.0 then the third term $\frac{3}{8} m_0 v^4/C^2$, is very small compared with $m_0(v^2/2)$ and may therefore be neglected.

The first term of equation (5) namely $m_0 C^2$ does not contain the velocity v as a factor; but according to the principles of relativity this represents the energy of a mass m_0 "at rest."

We are particularly interested in the term $m_0 C^2$ which is independent of v .

Two other fundamental laws of Nature are of interest; these hold good for light, as well as for electricity, and for matter generally. These are:

$$M = \frac{h}{\lambda} \quad \dots (6)$$

and

$$E = \frac{hC}{\lambda} = h\nu \quad \dots (7)$$

In these equations M signifies momentum; λ the wavelength of radiations in cms. C the velocity of light, E the energy in ergs; ν the frequency of radiations; and h a universal constant named Planck's constant, after its discoverer. Its value is 6.55×10^{-27} ergs, and it plays a fundamental part in modern physics in the field known as quantum mechanics.

We shall be concerned with ν as the frequency of radiation from an atom under bombardment.

It will be clear from equation (7) that the energy radiated is directly proportional to the frequency of radiation, or as the wavelength becomes shorter the energy of radiation increases as h remains constant.

One of the essential features of the quantum theory is that the energy of radiation changes in exact multiples of the frequency ν .

The Photon

We may now define the photon of energy as being equal to $h\nu$.

For example, a photon of radiation of ultra-violet light from the long wave region of 4,000 Å, (or 4.0×10^{-5} cms. wavelength), which corresponds to a frequency of 7.5×10^{14} c.p.s. will have an energy level $h\nu = 6.55 \times 10^{-27} \times 7.5 \times 10^{14} = 4.91 \times 10^{-12}$ ergs of energy.

This is a quantum of energy in the form of light.

As we have already seen the expression $m_0 C^2$ represents the energy equivalent to the mass m_0 "at rest." This can be related to the photon of energy by the equation:

$$m_0 C^2 = h\nu \quad \dots \dots \dots (8)$$

Now the law of Conservation of Energy requires that the energy of an incident photon, $h\nu$, on an atom shall be equal to the sum of the incident energy plus the energy of the recoiling electron which has been liberated from its orbit around its nucleus.

Also the Law of Conservation of Momentum demands that when two bodies are in collision the total momentum of the system must be conserved.

These two laws may be related by equation (8) and thus we have

$$m_0 C = h\nu/C \quad \dots \dots (9)$$

If, therefore, a photon of this momentum is caused to impinge upon an electron "at rest" the electron gains energy and thus gains momentum, whilst the photon loses it, so that the frequency of the photon is diminished as h is a constant; this is what is known as the Compton Effect.

This statement does not at first appear to be in accordance with the laws of classical mechanics. The proof of it would lead us too far as it depends upon relativity transformation from a system considered to be "at rest" to one which is moving along an axis with a velocity.

In simple language it means that we must change our conception of mass in accordance with the principles of relativity in ascribing energy to radiation.

We have seen already that the K.E. of a particle of rest mass m_0 moving with a velocity, v , which is relatively slow compared with C is $\frac{1}{2}m_0 v^2$, and that the corresponding momentum is $m_0 v$.

But radiation is associated with mass which is travelling at the velocity of the radiation, and therefore it cannot then have the same value as the rest mass m_0 .

It can be shown that

$$m_r = E_r/C^2 \quad \dots \dots \dots (9a)$$

where m_r is the radiation mass, and E_r is the energy of radiation, which, according to the Quantum Theory, changes in multiples $h\nu$. The mass m_r of a quantum of radiation is then

$$\frac{h\nu}{C^2} = \frac{h}{\lambda C} \quad \dots (9b)$$

and the corresponding momentum of radiation

$$M_r = m_r C = \frac{E_r}{C} = \frac{h\nu}{C} \quad \dots \dots \dots (9c)$$

Accordingly, the corresponding momentum of the quantum is:

$$\frac{h\nu}{c} = \frac{h}{\lambda C} \dots (9d)$$

We leave the subject of photons bearing in mind that Planck's constant h , is a universal one which is applicable to all radiations, including hard gamma rays of 0.05\AA , and the wavelengths used in radio-communication, but it is not often applied to longer wavelengths than a few microns (the micron being 10^{-4} cms). The relationship $mC^2 = h\nu$ applies throughout nature. For example, the mass of the sun is supposed to change on account of the loss of energy by radiation.

Electron Volt

The next unit is the Electron Volt, from which we derive the M.E.V.

An example of the energy of radiation from the ultra violet region of the visible spectrum has been given, and the result was found to be infinitesimally small, namely, 4.01×10^{-12} ergs per sec.; the erg, therefore, is an inconveniently large unit in dealing with radiations. It is for this reason that the electron volt, and the million electron volt units have been universally adopted in computing these low energy levels.

The electron volt is equal to 1.59×10^{-12} ergs of energy (and it follows that the M.E.V. = 1.59×10^{-6} ergs).

It is derived from first principles by the following considerations: The practical volt is equal to 10^{-8} electromagnetic units, which is built up on the C.G.S. system, and the P.D. between two points is one C.G.S. electromagnetic unit if the energy transformed is one erg when the electromagnetic unit of quantity passes.

Now if e signifies the negative charge of 4.8×10^{-20} E.S.U.s carried by an electron, and V the potential difference in volts between two points in the path of the moving electron, then we can equate the energy of this electron, which is mC^2 , to the energy of the accelerating field, and thus

$$mC^2 = eV \times 10^{-8} \dots (10)$$

As 1.0 ampere = $1/10$ E.M.U., and one E.S.U. = 1.59×10^{-19} coulombs, therefore $C = 1.59 \times 10^{-20}$ E.M.U.s

Thus we have:

$$V = mC^2 / e \times 10^8 = C^2 / (e/m) \times 10^8 \quad (11)$$

Substitution of accepted values of e, m , and C gives:

$$9 \times 10^{20}$$

$$\left(\frac{1.59 \times 10^{-20}}{9.0 \times 10^{-28}} \right) \times 10^8 = 512,000 \text{ v.}$$

or .512 million volts.

From this result we see that the mass of an electron is equivalent in energy to .512 M.E.V. which may be regarded as an energy level = $5.12 \times 10^6 \times 1.59 \times 10^{-12} = 8.13 \times 10^{-7}$ ergs, and therefore the M.E.V. = 0.813 ergs.

It is also convenient to remember for practical purposes that photon energy in electron volts from radiations of which the wavelength is measured in Angstrom units may be computed from the relation that photons of one electron volt correspond to waves of 12,337 A.

We now consider some of the latest discoveries in modern physics, and in particular nuclear physics, which are being applied in biological and associated research, and to some extent in medical practice.

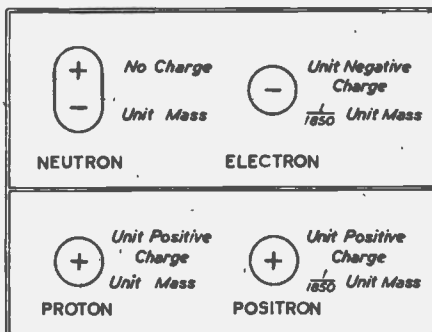

Fig. 2. Diagrammatic representation of the fundamental units with their relative charge and mass.

Early in 1934 Mme. Curie-Joliot and her husband, succeeded in inducing artificial radioactivity in certain elements; they found that if these elements were bombarded by alpha particles they continued to radiate positrons, which are electric charges like those carried by the electron, but of opposite sign. (Fig. 1.)

This artificially produced radioactivity continued for some time after the bombardment had ceased; it was found to decay exponentially with time, as do the natural radioactive materials.

Progress has been so rapid that today artificially excited radioactive materials begin to compare with the natural radium available as the source of beta and gamma rays for physical research and medical application.

Over two hundred radioactive isotopes have now been discovered, but as these are substances of interest to the chemist rather than to the physicist and engineer we pass on to neutrons.

The Neutron

For our purpose the neutron may be considered as a particle of unit mass (actually it is 1.0090); it carries

no electric charge and hence its name.

The neutron and the proton—also of unit mass—form the two essential components in the architecture of nuclear physics, the main difference between them being that the proton carries a positive charge. (Fig. 1.)

Neutrons are ejected from atomic nuclei when the latter are bombarded by high velocity protons, gamma rays, alpha particles, or with deuterons—to be defined later. Radon, or radium emanation, is also a source of neutrons.

Like X-radiation, the neutron is not deflected by a magnetic field; in common with gamma rays neutrons will penetrate heavy substances, but to a far greater extent. This is because gamma rays have electromagnetic properties, and in striking the atom of which all matter is composed, these rays spend their energy in accelerating the electrons which are revolving round their nucleus in the atom and in a fairly short path through a heavy substance the energy of gamma rays is absorbed. This is not the case with the neutron, as it carries no electric charge, and by virtue of this easily passes through a field of electrons.

When however a beam of neutrons passes through a light substance which is rich in hydrogen, such as paraffin wax, the beam is absorbed.

The probable explanation of this is that the mass of hydrogen, like the neutron is practically unity, and we may visualise the collision between the neutron and a hydrogen nucleus as analogous to a collision between two rubber balls when each sheds about half its energy in the collision.

For example, suppose that a neutron is endowed with an energy level of 5 M.E.V. before it strikes an atmosphere of hydrogen, and that during its course through this atmosphere it makes collisions with 20 hydrogen atoms, then it will emerge with its energy level reduced to about 0.1 M.E.V. After neutrons have been so retarded to a low energy level they may be captured by a proton and the resulting combination forms a deuteron, which is readily absorbed.

Paraffin wax, water, and other substances. (Concluded on page 123.)

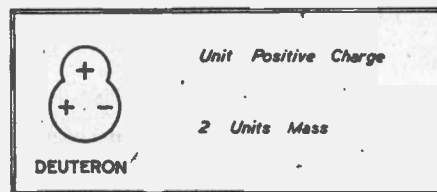

Fig. 3. The deuteron is formed by the combination of neutron and proton.



“Pray, what is the reason of that?”

IT has taken a war and an Act of Parliament to remove the bottom waistcoat button from its traditional idleness. Searching minds are likewise demolishing tradition with the vital question—“Why do we go on doing that?”

In many widely separated fields the application of new products by the Simmonds Organisation has achieved the utmost economy in man-hours and costs. The opportunity is there. Looking forward betimes today will spare the pain of disillusioned retrospection tomorrow.

S I M M O N D S

THE SIMMONDS "WAS" NUT
SIMMONDS-CORSEY CONTROLS
SIMMONDS CONTENTS GAUGES
FOR AIRCRAFT.
SIMMONDS POSITION INDICATORS
SIMMONDS ELECTRIC TEMPERATURE
AND PRESSURE GAUGES
SIMMONDS AIRCRAFT FLOORING



SPIRE "WAS" NUTS
FRAM OIL & ENGINE CLEANER
SIMMONDS INDUSTRIAL AND
MARINE CONTENTS GAUGES
SIMMONDS JOINTING COMPOUND
SIMMONDS CRYSTAL UNITS
SIMMONDS - GOUDIME
NAVIGATIONAL INSTRUMENTS

SIMMONDS AEROCESSORIES LTD

A COMPANY OF THE SIMMONDS GROUP
LONDON · MELBOURNE · PARIS · NEW YORK

Practical Notes on Receiver Design

Part 2—Frequency Changers

By G. T. CLACK

THE input circuit in Fig. 1 (Part 1 of this article) is used to a great extent in the cheaper type of superhet receivers, as with a correctly adjusted primary it will provide sufficient selectivity with good sensitivity. The introduction of a second tuned circuit in the input, such as in a band-pass filter, would naturally provide greater preselection, but the voltage applied to the grid of the first valve would be reduced to one half of that obtained from a single tuned circuit.

The first valve in an average superhet is a combined oscillator-mixer; the function of the mixer is to refer the L.F. modulation, which is present on the input signal, to another frequency that is constant for all signal frequencies. It has been proved by experience that more uniform sensitivity and selectivity is obtained by amplifying at a fixed frequency, and to achieve this, it becomes necessary to beat the signal frequency with a locally generated frequency and produce a "difference" or Intermediate Frequency which contains the modulation characteristics of the signal frequency.

The Triode-hexode is generally considered as the best developed type of electron-coupled frequency changer valves owing to the reduced interaction between the oscillator and mixer sections which assists in maintaining efficient operation at higher frequencies. Originally the I.F. beat was obtained by rectifying a heterodyne between the incoming signal and local oscillator, but with multiplicative mixing as occurs in modern valves, rectification is unnecessary. Briefly, the I.F. is formed because the amount of anode current that flows as a result of signal voltage at the control grid, is dependent upon the oscillator voltage on the injector grid. The extent to which the anode current varies at the I.F. frequency for a given input voltage at the signal grid, is taken as a measure of frequency changing efficiency, and called Conversion Conductance, G_c . In common with all amplifiers, the gain of a frequency changer stage is assessed by $G_m Z$, where G_m is replaced by G_c , Z being the anode circuit impedance.

In Fig. 15 the complete frequency changer stage is shown, but before proceeding with the oscillator and I.F. circuit there is a point worth mentioning about the effect that V_1 has upon the input circuit $L_2 C_2$.

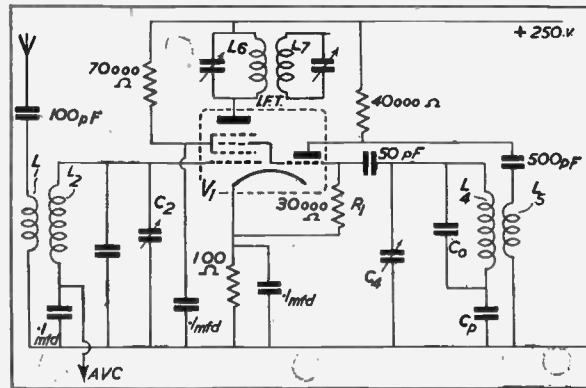

Fig. 15. Typical Frequency changer stage.

At frequencies less than 6 Mc/s., apart from the additional capacity introduced by the valve across $L_2 C_2$, its effective input resistance is negligible, but at higher frequencies the resistance decreases. The reason for the reduction in input resistance is largely due to the grid-anode capacitance which enables the anode impedance to reflect an apparent resistance across the grid-cathode terminals, which can be considered as in parallel with the circuit impedance thus reducing both selectivity and gain. This effect, however, can be tolerated in ordinary broadcast receiver design, but at frequencies about 20 Mc/s., especially so at the ultra-high frequencies, it is advisable to connect the signal grid to a tapping point down the coil. Despite high Q values, the dynamic resistance of a coil is low at high frequencies, and a further shunt resistance across the coil reduces the overall efficiency. In practice, an actual gain can be recorded in most cases when the grid is tapped down the coil.

With frequency changers, the defects present are due to a combination of (1) grid-cathode, grid-anode capacitance, (2) dielectric losses, (3) cathode lead inductance, (4) grid charges bound up with the electron stream and (5) transit time. The whole effect can be proved mathematically, and under working conditions appear as apparent losses in the input circuit.

Oscillator Section

The oscillator requires possibly more attention than most other parts of the receiver. There are two major points to consider (a) operating conditions for optimum efficiency and stability, (b) method of obtaining correct tracking. The first requirements for proper frequency changing are

correct amplitude of heterodyne volts at the injector grid, suppression of parasitic oscillation, and stability. There are several types of circuits, but the most convenient is that illustrated in Fig. 15 for operation over the usual broadcast bands. A 0.1 mA meter should be inserted at the point where R_1 joins the cathode to indicate grid current and peak heterodyne volts are obtained by $1.2 \times IR$.

The overall efficiency of the stage depends upon maintaining the correct oscillator voltage which is indicated by the valve manufacturer for a particular valve, and will be from 6 to 15 volts. The sensitivity does not vary much if it is kept higher than the recommended figure; on short waves too high an oscillator voltage may produce spurious oscillations which introduce erratic operation at one or more points in the range. On the other hand, too low a voltage on any range will adversely affect the sensitivity. For medium and long wave bands, it is a relatively easy matter to adjust and can be achieved in several ways. In the first instance, valve manufacturers supply recommended circuit details, with suitable values of components, which can be accepted without question as a starting line. Very often, the only modifications necessary are minor ones usually connected with the type of coils employed.

The oscillator coupler L_5 , tuned by the stray and coupled circuit capacity, should resonate beyond the H.F. end of the frequency range covered by $L_4 C_4$, otherwise large changes in voltage will occur. This was pointed out in the preceding article in connexion with aerial couplers, where a similar effect can be experienced.

Using the recommended anode

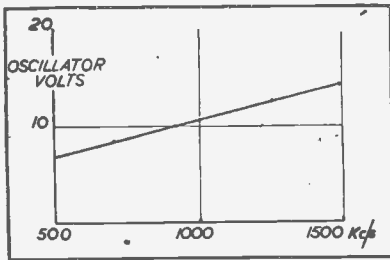

Fig. 16

potentials and circuit values, the coupling between the coils should be adjusted to produce the desired grid current. Under actual working conditions, using a TH4B in the circuit of Fig. 15, a curve was plotted for oscillator voltage over the range 1,500-500 kc/s, Fig. 16.

In this instance, the coupling was arranged to produce 7 volts at the L.F. end of the band with the result that about 14 volts are present at the H.F. end. This is in order on the M.W. band, except that re-radiation may interfere with local receivers. The extent of re-radiation depends upon the coupling between oscillator and aerial coils, which if comparatively high due to insufficient screening, will induce oscillator voltages into the aerial which in turn radiates interference.

When cost is of secondary importance, insertion of resistances in series or in parallel with the oscillator coil will assist in keeping the heterodyne voltage fairly constant, at the same time will prevent spurious oscillation on the S.W. bands. Fig. 17.

Such oscillations will cause an oscillator abruptly to change its frequency, or show up as "kinks" in the heterodyne voltage curve. When introducing resistances into an oscillator circuit, a re-adjustment of the coupling between L_1L_2 may be required, and at the same time it will be necessary to check the frequency range each time an adjustment is made.

At high frequencies, natural losses in the oscillator circuit increase, and it becomes necessary to increase the reaction turns ratio between L_1L_2 to obtain sufficient heterodyne voltage which in turn tends to limit the range. In some cases, say 6-18 Mc/s., it may prove a better proposition to limit it to 6-16 Mc/s, than to reduce the voltage in favour of a slightly longer range. In practice it may not be possible to secure the optimum number of volts, in which case the circuit is adjusted for the maximum obtainable for the required frequency range consistent with reasonable sensitivity. With most valves satisfactory operation is secured up to 16 Mc/s. provided the heterodyne volts do not fall below 50 per cent. of the optimum value

recommended by the valve manufacturer.

A disadvantage, which is not so serious with Triode-hexodes as with other types of frequency changers, is the slight change in capacity that occurs across the oscillator grid circuit when A.V.C. is applied to the signal grid. This is due to the variation in signal-grid bias affecting the density of the space charge in front of the injector grid consequently affecting the oscillator grid capacity in relation to other electrodes. Once again, the effect is small, except at the higher frequencies, where at 15 Mc/s. the amount of mistune would be in the order of 3-6 kc/s. This is partially cured by using a tuned-anode instead of tuned-grid oscillator and would show a mistune of only 1.5 kc/s. for the same conditions, but in which case difficulty may be experienced in obtaining sufficient heterodyne volts at higher frequencies.

The circuit values shown in Fig. 15 are fairly standard and will operate very satisfactorily up to 22 Mc/s. Care must be taken to avoid exceeding the

tem reaches a steady temperature. During this time, changes occur in electrode capacities, which are small but affect S.W. stability. Although this cannot be rectified, the designer must ascertain that the correct heater and anode potentials are not exceeded otherwise the effect is aggravated. The previously mentioned internal coupling between oscillator and control grids when A.V.C. is employed is a defect due to the valve characteristics, the only solution is to avoid using A.V.C. on the frequency-changer at frequencies higher than 6 Mc/s.

The stability of the external circuit depends entirely upon the layout, power supplies and quality of components. Layout should cater for good ventilation around the valves and oscillator circuits, the latter protected against heat by screens, or by keeping power supply transformer, output valve and H.T. dropping resistors, where possible, at the remote end of the chassis. Cabinet ventilation must also be provided by series of large holes in the baseboard immediately

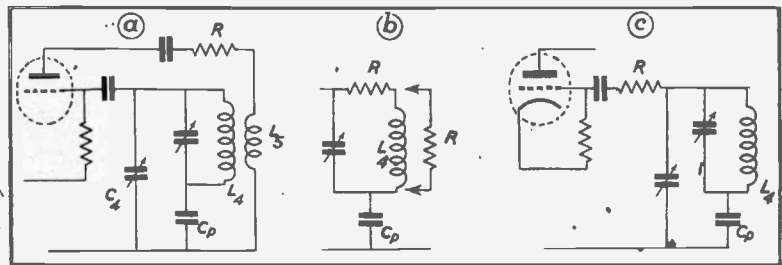

Fig. 17. Use of resistance in oscillator coil to prevent oscillation on short waves.

maximum anode volts on the oscillator anode to produce stronger oscillation, as otherwise the valve will eventually cease to function at the higher frequencies after a while. If it is possible to keep the C_{min} in the oscillator circuit to the lowest possible, then less difficulty will be experienced in obtaining sufficient heterodyne volts at the higher frequencies as tighter coupling between L_1L_2 can be used before the reflected capacitance commences to limit the desired frequency range.

Oscillator Stability

Practically all superhet receivers show frequency drift which in the majority of cases is the result of circuit capacity change with temperature. Provided care is taken in the selection of components this can be reduced to a minimum which is not serious below 6 Mc/s.

The valve cathode will reach a stable operating condition within half a minute, but it takes a longer time before the whole electrode sys-

tem reaches a steady temperature. During this time, changes occur in electrode capacities, which are small but affect S.W. stability. Although this cannot be rectified, the designer must ascertain that the correct heater and anode potentials are not exceeded otherwise the effect is aggravated. The previously mentioned internal coupling between oscillator and control grids when A.V.C. is employed is a defect due to the valve characteristics, the only solution is to avoid using A.V.C. on the frequency-changer at frequencies higher than 6 Mc/s.

The stability of the external circuit depends entirely upon the layout, power supplies and quality of components. Layout should cater for good ventilation around the valves and oscillator circuits, the latter protected against heat by screens, or by keeping power supply transformer, output valve and H.T. dropping resistors, where possible, at the remote end of the chassis. Cabinet ventilation must also be provided by series of large holes in the baseboard immediately

Compression type mica trimmers are subject to slightly higher changes of capacity for varying temperatures, *i.e.*, with a nominal capacity of 100 pF., a change of 0.5 to 2.0 pF. can be experienced. The losses in a silvered mica condenser are very low, due to a negligible resistive component, and in most cases will lower the circuit Q by <1 per cent. at 1,000 kc/s. Similarly, a good grade trimmer will not reduce the circuit Q by more than 3 per cent.

With band-spread and push-button receivers, the tuning circuits require further stabilisation, which is obtained by using one or more condensers with a negative temperature coefficient. As the circuit capacitance normally increases with higher temperatures, the stabilising condenser produces a compensating change which is in the opposite direction and by carrying out a series of tests with different values of compensation a very satisfactory performance can be achieved. Where a drift at 15 Mc/s. would be 15-20 kc/s. without compensation, the introduction of a suitable negative coefficient condenser will reduce it to 3 or 4 kc/s.

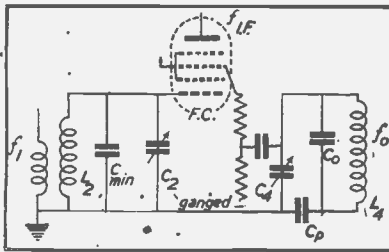

Fig. 18

The small changes that occur in circuit values with increasing temperature are invariably additive and noticeable, more so on the S. W. bands during the first half hour of operation. With comparatively wide band I.F. transformers the effect of drift is minimised, but with sharply peaked I.F.s it is often necessary to retune the oscillator after a short while to obtain the correct beat frequency. As the signal and oscillator tuning condensers are ganged, such adjustments will detune the signal circuit so affecting both sensitivity and selectivity. Thus, to minimise drift without resorting to compensating circuits, the following precautions should be observed; use of silvered mica type condensers for R.F. and oscillator circuits, impregnation of both coil and condensers with high grade wax or varnish, good ventilation, correct operating potentials, and to avoid, where possible, sharply peaked I.F. stages.

Tracking

In a superheterodyne receiver, the

frequency of the oscillator circuit must always differ from that of the R.F. circuits by an amount equal to the intermediate frequency, and to obtain this constant difference with ganged controls, the oscillator is tuned by a condenser with specially shaped vanes or by a condenser identical to that used in the R.F. circuits, but which is made to track by using series and parallel trimmers. The latter method is invariably used for economy reasons.

It can be proved by extensive mathematical manipulation that with a suitable choice of $C_o C_p$ and L_4 , see Fig. 18, that it is possible to obtain the correct frequency difference between oscillator and R.F. circuits at three points over the range to be covered by $L_4 C_4$. For the M.W. band these frequencies are around 1,500, 1,000 and 500 kc/s., as then the mistune of the aerial coil at the intermediate points will be from 3 to 10 kc/s, according to circumstances. With an aerial circuit as shown in Fig. 18, this will not be serious, as the loss in gain is about -3 db. at the most for a properly padded circuit.

For the highest frequency, where C_4 is at minimum and C_p is large compared with C_o , the main tuning capacity will be C_o , which consists of the minimum capacity of C_4 , the trimmer capacity and the circuit strays. An approximation of the inductance of L_4 , for experimental purposes, could be obtained by $L = 1/\omega^2 C_o$; the oscillator frequency, f_o , being $f_1 + f_1.F.$ where f_1 is the frequency to which $L_2 C_2$ is tuned. At the lowest frequency where C_4 is at maximum, C_o is small in comparison to C_4 , and the effective tuning capacity will be the resultant of C_4 and C_p in series, which expressed mathematically becomes

$$\text{Effective } C = C_o + \frac{C_p C_4}{C_p + C_4}$$

$$\text{and } f_{o \text{ min}} = \frac{1}{2\pi \sqrt{L \left(C_o + \frac{C_p C_4}{C_p + C_4} \right)}}$$

Without resorting to a complete analysis, the initial value of L_4 and C_o for the highest frequency can be roughly assessed by assuming C_o to be at least the same as the C_{min} of the aerial circuit, or better still, slightly greater. It then becomes a matter of trial and error, for once approximate values have been checked for tracking, a little experience will soon indicate the direction in which adjustments to L_4 and C_p must be made to secure the intermediate crossover.

Fig. 19 shows the effect of different

values of L_4 on the disposition of the intermediate crossover using the correct capacities, and the effect of different values of trimming capacities using the correct value of inductance.

When carrying out tracking adjustments it is very much quicker to record aerial circuit mistune in terms of gain rather than in kilocycles, by aligning in the first instance at the two extreme ends, and noting whether more or less capacity is required on the trimmer across L_4 at the intermediate points to give an increase in output from the receiver. At a crossover point the gain will be at a maximum, and an increase or decrease in trimmer capacity will show a loss in output. If the maximum change is not more than +3 db. the tracking can be considered satisfactory.

For the M.W. band an average padding capacity would be about 500-550 pF and the inductance of L_4 round about 80 μ H. The padding condenser, C_p , can be an adjustable compression type to facilitate early experimental alignment, and when the correct values of C_p , L_4 have been

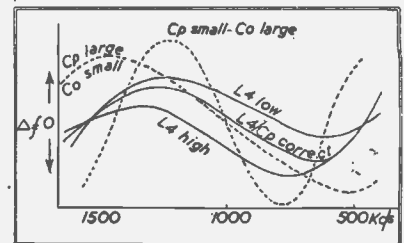
Fig. 19. Effect of varying L_4 of Figure 18.

determined, it should be replaced by a good grade silvered mica condenser. On the L.W. band, the procedure is much the same, except that a small capacity padder is required, about 300 pF., and for the short waves, it is not essential to have a padded circuit, as the oscillator inductance itself can be adjusted to give correct tracking towards the low frequency end, while the parallel trimmer is used towards the H.F. end of the range. S.W. tracking is likely to be less accurate, but as the aerial circuit is comparatively flatly tuned, the overall performance does not suffer too seriously.

I.F. Circuits

The anode current of the frequency changer will contain several components, the most important being the intermediate frequency which will develop a voltage across the impedance offered by the I.F. primary winding, L_4 , and consequently induce a voltage across the grid circuit of the I.F. amplifier. As the impedance of the primary circuit falls sharply on either side of resonance, the remaining com-

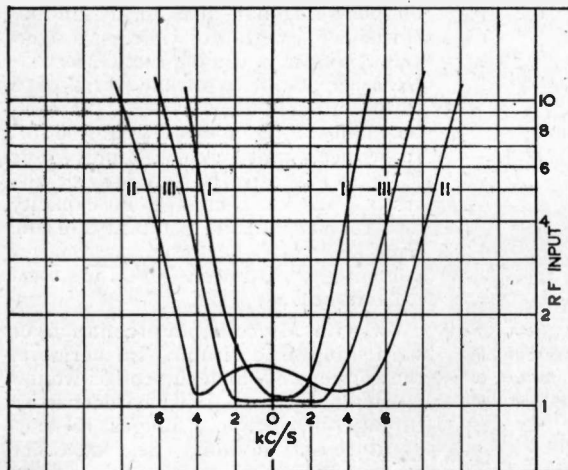

Fig. 20. Effect of coupling on the response curve. Curve III shows critical coupling.

ponents, such as $f_1, f_0, f_0 + f_1, \text{etc.}$, will not appear in the following stages.

It has been pointed out that when mutual inductance exists between two circuits, the impedance of the primary is increased by a reflected impedance, which acts in series and is dependent upon the amount of coupling between the coils, *i.e.*,

$$Z_p = Z_1 + \frac{\omega^2 M^2}{Z_2}$$

In the case of the aerial circuit $L_2 C_2$, already discussed, the expression contains resistive and reactive components, as one circuit only is tuned, but in the case of an I.F. transformer where both primary and secondary are similar in characteristic and resonate at the same frequency, the primary and secondary impedances can be considered as resistive at resonance. The coupled impedance in series with the primary is also resistive and varies with mutual inductance. The effect of coupling on the response above and below resonance is shown in Fig. 20, in which curve 3 is for a condition where the coupling is such that the secondary reflects into the primary a resistance equal to that of the primary. This is termed critical coupling, which induces the maximum current in the secondary circuit, and is achieved when

$$R_p = \frac{\omega^2 M^2}{R_s} \text{ or } \omega M = \sqrt{R_p R_s}$$

In a 3 or 4 valve superhet receiver, where the number of stages are limited, it is advisable to adjust the transformers for critical coupling or just above in order to obtain reasonable I.F. gain.

The amplification given by the frequency changer stage is the product of

the conversion slope and Z_p , where, for critically coupled circuits,

$$Z_p = \frac{1}{2} \sqrt{Z_1 Z_2}$$

and Z_1, Z_2 are the primary and secondary dynamic resistances. The parallel effect of the circuit resistance modifies $Z_1 Z_2$, as the anode resistance R_p of the frequency changer is in shunt with Z_1 , and the input loading of the I.F. amplifier is in shunt with Z_2 Fig. 21.

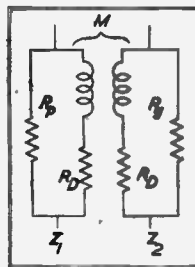

Fig. 21

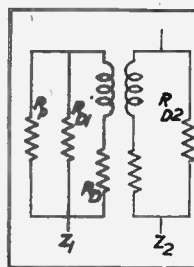

Fig. 23

The dynamic resistances can be obtained by $Q\omega L$, so taking an average transformer at 465 kc/s. where the primary and secondary inductances are in the region of 600 μH and both have a Q of 120, then $R_D \approx 250,000$ ohms. In the case of the primary, R_p varies with different types of valves, but if an average is taken as 750,000 ohms,

$$\text{then } Z_1 = \frac{1}{\frac{1}{R_p} + \frac{1}{R_D}} = 187,000 \text{ ohms.}$$

$$\frac{1}{R_p} + \frac{1}{R_D}$$

For the secondary, the loading may be quite high, but allowing 1 megohm, $Z_2 = 200,000$ ohms. Therefore, $Z_p = \frac{1}{2} \sqrt{187,000 \times 200,000} = 96,700$ ohms, and assuming a conversion slope of 0.65 mA/V., the gain of the frequency changer stage would be in the order of 63 times.

The second I.F. stage consists of a

pentode amplifier with a similar I.F. transformer in the anode circuit. Fig. 22 shows the amplifier and diode circuits which are connected to both primary and secondary windings.

Connexion of the A.V.C. diode to the primary of the transformer must be taken into account when determining the anode load, and is represented as a further shunt resistance, R_{D2} , across the primary in Fig. 23.

The secondary load, R_{12} , due to the signal diode, is comparatively low, especially so if high quality reproduction is required, thus the shunt effects of both diode circuits across the 2nd transformer will result in lower Q and Z_p values than those realised in the 1st I.F. transformer. To obtain a higher efficiency, it would be necessary for the transformer to work into a definite load by tapping the diode circuits down the windings in order to decrease the damping and so obtain a higher effective Q than that obtained without tapped windings.

The A.V.C. diode is biased by the delay voltage, and so the extent of R_{D1} will depend upon the input voltage. At low signal inputs, when the signal voltage is less than the delay voltage, R_{D1} is roughly assessed as equal to the resistance of the diode load, *i.e.*,

$$R_{12} = \frac{1}{\frac{1}{R_s} + \frac{1}{R_a} + \frac{1}{R_t}} \approx 0.3 \text{ meg.}$$

The signal diode damping shown as R_{D2} , also varies with signal input due to the curvature of the characteristics at low inputs, but for experimental purposes can be assumed as 0.1 meg below 1 volt input, and $\frac{1}{2}(R_{12} + R_{D1})$ at higher inputs.

Using a 465 kc/s. transformer adjusted for critical coupling with 0.6 mH coils having Q's of 120 and connected as in Fig. 22 to valve with an anode resistance, R_p , of 1.0 megohm and a slope of 2mA/V., the gain of the second I.F. stage is computed as before.

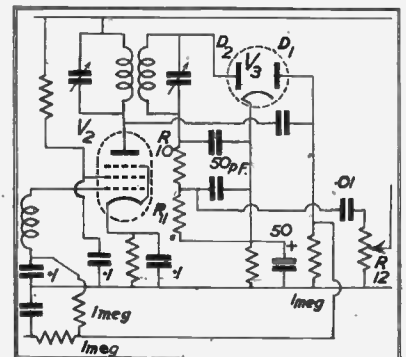

Fig. 22. Amplifier and diode circuits following second I.F. stage.

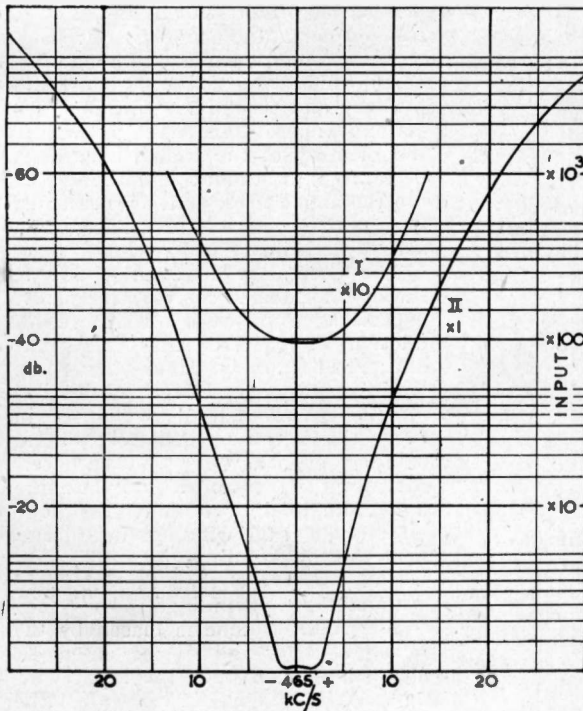

Fig. 24. Average I.F. selectivity curve of typical four valve superhet.

temperature, but also to a gradual shift over a period of time. To overcome this, it is usual practice to fit a fixed capacitance, in the form of a stable silvered mica type, of at least one half of the total C required for resonance, and use a high grade ceramic base trimmer to provide the rest. Thus, any change in capacity due to mechanical instability in the trimmer would represent a smaller percentage variation of the total capacitance.

As with all coils, impregnation or varnishing is desirable, furthermore, the former on which the coil is wound must retain its original characteristics throughout various changes in temperature and humidity. In fact, every mechanical detail must be good before consistent results can be expected.

Selectivity

The side-bands on a broadcast signal are generated as the result of modulating the carrier wave by speech and music frequencies and the limit of usable selectivity is reached when side-band attenuation becomes objectionable. In the more expensive receiver, variable selectivity is often fitted so that the user can vary the side-band attenuation to suit circumstances, but with a cheaper receiver the selectivity is fixed and the result is a compromise between minimum tolerable selectivity and response.

The curves in Fig. 20 indicate the change in response brought about by different values of coupling. As the present spacing between stations is 9 kc/s., any attempt to maintain side-band response beyond 5 kc/s. will result in the reception of the upper side-bands of an adjacent station. The extent of the interference naturally depends upon the relative strengths of both signals and proves objectionable if the desired signal is weaker than the unwanted signal. In the case under discussion, the effect of the aerial circuit L_2C_2 , Fig. 15, upon the overall selectivity, is very slight, amounting to a reduction of only 2 db. at 5,000 cycles, and so it is obvious that the response requirements are chiefly controlled by the I.F. characteristics.

The I.F. selectivity curves in Fig. 24, may be considered as average for a typical 4 valve superheterodyne receiver. The coupling is a little more than critical, and under working conditions has a stage gain of 90, which compares favourably with the gain computed earlier. Curve I is for the 2nd I.F. transformer only, and curve II is the overall selectivity measured from the grid of the frequency changer.

$$Z_1 = \frac{1}{\frac{1}{R_p} + \frac{1}{R_{11}} + \frac{1}{R_1}} = 120,000\Omega$$

$$Z_2 = \frac{R_D R_{D2}}{R_D + R_{D2}} = 71,400\Omega$$

$$\therefore Z_p = \frac{1}{2} \sqrt{120,000 \times 71,400}$$

$$= 46,000\Omega$$

$$\text{Gain} = G_m Z_p = 92.$$

I.F. Coils

When the input circuit consists of a single tuned circuit as in Fig. 15 the initial selectivity is determined by the I.F. amplifier. In this stage, the problem of selectivity is simplified as the circuits are fixed tuned, which permits the designer to use appropriate L/C ratios and Q consistent with gain and stability.

The factor Q can be looked upon as a measure of efficiency of a coil (or condenser), and as an index to the selectivity of a circuit. In both cases, the efficiency and selectivity vary with Q , which means that a higher Q results in an increased tuned circuit efficiency and selectivity, but not necessarily as an overall increase in stage efficiency. For example, with two coils, one of $800\mu\text{H}$ and the other of $500\mu\text{H}$, with Q 's of 140 and 200 respectively, the coil with the lower Q

will give 10 per cent. higher gain under working conditions.

For a given inductance Q depends upon the losses in the coil which are controlled by the type of winding, wire, insulation, sealing wax, and coil former. The I.F. in a commercial receiver uses Litz wire of 9 strands and upwards, in a bank winding; sometimes in two or three sections with a view to reducing C_o , or, in the case of iron cored types, to situate as much as the wire as possible over the iron surface to provide better flux linkage between turns thereby reducing the amount of wire required and consequently H.F. resistance.

Where possible it is advisable to use large screening cans of low resistance, as then the reflected impedance will have less effect upon the efficiency of the coils. The final measured values of L and Q must be taken with the completed I.F. transformer in the screening can, as this may modify the values as found for unscreened conditions. Also it is possible that when the I.F. can is assembled on the chassis, the coil nearest to the chassis will be found to have a slightly lower Q than that of the upper coil.

Frequency Stability

The L/C ratio should not be excessively high, otherwise small changes in C can cause serious mistuning. Trimmers are subject not only to small changes in capacity with increasing

(Continued from page 116.)

stances rich in hydrogen may be used as barriers against neutrons; but heavy materials, such as lead, up to several feet thick, are easily penetrated by a neutron beam.

Another important property of neutrons is that they do not, in general, produce intense ionisation along their path, and therefore the usual devices, such as ionisation chambers and electronic counters, are not applicable directly in detecting and measuring neutron beams, so for these observations we have recourse to the intense ionising effects of collisions between neutrons and protons in a hydrogen medium. This ionising effect is taken as a measure of the neutron field intensity. Similarly, the recoil of the proton resulting from the collision, which is manifested in the form of a track in the ionisation chamber, may be taken as a measure of the velocity of the colliding neutron.

Nuclear physics is becoming of great importance in physical research associated with biology and medicine for the following reasons:

Ionising radiations can be used to produce great changes in living organisms, and furthermore, because radioactive isotopes provide facilities for the study of biological processes. The neutron, by virtue of its properties in passing through biological substances may simultaneously create radioactive atoms by impact with them, and thus produce recoil electrons or other nuclei, or excite gamma rays.

A wide field of opportunity is thus opening up for the application of these discoveries in nuclear physics in the service of man—the possibilities are manifold.

Radioactive isotopes are of great value in medicine, as they have definite therapeutic properties, and they may conveniently be injected into an organ, or part of the body to be treated. Furthermore, there is the possibility that these irradiations may be rendered selective by the choice of suitable isotopes according to the composition of the biological substance composing the organ under treatment. This means, for example; that radioactive phosphorus would be used to treat bone structure, radio-iodine for the thyroid gland, and so on.

In biological research these radioactive materials offer high potentialities, as they may be used as tracers of particular elements through the human system. Again we may mention phosphorus, which plays a vital part in the metabolism of the body.

With further progress in physics and biology it may be found that radioactive materials may thus surpass the microscope in their usefulness to the investigator in his efforts to track down disease.

Space forbids further excursion into biology or bio-physics, and we therefore return to the neutron, and its production.

We have seen that neutrons are ejected from atomic nuclei by bombardment with high velocity projectiles.

If, for example, beryllium is the element under bombardment the following reaction takes place:



In this equation the superscripts symbolise atomic weights, and the subscripts mean atomic numbers, this means that the element beryllium (Be) has atomic weight 9, and atomic number 4, similarly, the neutron (n^1_0) has atomic weight 1.0 and atomic number 0 and so on.

Neutrons are ejected with energies up to 13.7 M.E.V.

To recapitulate, we are aware that a particle carrying an electric charge e of 4.8×10^{-10} E.S.U. has a kinetic energy, $KE = Ve/300$ ergs, where V is in volts, which is the P.D. between two points in its path.

When, however, a neutron, having no charge, has the same kinetic energy, its energy level is one M.E.V. if it falls through a P.D. of one million volts.

Multi-million volt generators for accelerating bombarding projectiles up to 16 million volts are already in use for the production of neutrons and artificial radioactivity, and accelerators up to 30 million volts have been projected. These will form the subject of a later article, before dealing with X-ray equipment.

BIBLIOGRAPHY.

1. J. M. A. Lenihan: The Electron—Recent Progress, *Electronic Engineering*, May 1942, p.764.
2. O. Heaviside, *Electromagnetic Theory*, Vol. 1.
3. J. J. Thomson, *Recent Researches in Electricity and Magnetism*
4. Compton, *X-Rays and Electrons*, Appendix, 1.
5. Curie-Joliot, *A New Type of Radioactivity Comptes Rendus*, 198, 1934, p. 254.

The following have also been consulted:—

“*Mathematical Theory of Electricity and Magnetism.*” Sir J. Jeans.

“*Electricity and Magnetism.*” S. G. Starling.

“*Electron Optics.*” L. M. Myers.



NOT QUITE LIKE THIS

Indeed, we wish our problems could be disposed of so light-heartedly.

But to-day we have not only to find the technical solution but also cope with the steadily increasing demand for our electronic equipment.

We are taking steps to meet this new problem and look forward to being of still greater service to our friends in the industry.

Oscillographs, Amplifiers, Oscillators, Frequency Standards, Pressure Recorders, Vibration Analysers, Speed Measuring Equipment, Clock Timers, etc., etc.



FURZEHILL
LABORATORIES LTD.
BOREHAM WOOD
HERTS
TELEPHONE • ELSTREE 1138

NOTES FROM THE INDUSTRY

Leland Instruments, Ltd.

Since their London premises were destroyed by enemy action last year, Leland Instruments, Limited, have been carrying on their business from temporary offices in Mecklenburgh Square and their Middlesex laboratory. Suitable premises have now been secured and the new address is 21 John Street, Bedford Row, London, W.C.1. The telephone number is once again CHAncery 8765. The Service department and emergency office will remain outside London.

Leland Instruments, Limited, have specialised for many years in instruments and test equipment from the leading American instrument makers and their facilities have been extended to meet the special needs of the American and other Allied Forces now in Great Britain. The requirements of the technical branches for service work on American apparatus, items of special service equipment, and urgent modifications are being met in the Leland laboratories.

National Fire Protection Co.

The above company have recently appointed the undermentioned agents:—

Messrs. Sloan Electrical Co., Ltd., 9 John Street, Bristol, and at 32 Gandy Street, Exeter; and

Messrs. W. R. & F. G. Kirkby, Somerset House, 2 Brazil Street, Manchester 1.

It is stated that these agents will carry good representative stocks of the company's fire extinguishing equipment and will be in a position to give information regarding prices and other details.

Institute of Physics Electronics Group

The third meeting of the Electronics Group was held at the Royal Institution, W.1, on Wednesday, July 8, when a discussion on Cathode-Ray Tubes was opened by Mr. G. Parr.

At the conclusion of the paper a demonstration was given of the Clothier Electronic Switch in conjunction with a Cossor double-beam tube, giving three simultaneous traces. Several novel applications of the tube were mentioned in the ensuing discussion.

Membership of the Electronics Group is open to all supporters of the Institute of Physics, and further particulars may be obtained from the temporary hon. secretary, Dr. Lowery, at the S.W. Essex Technical College, E.17.

Co-Ax Cables

In Co-Ax Cables the theoretically ideal air-insulation is claimed to be closely approached in practice by a special form of mechanical construction. The air insulation is obtained by supporting the inner conductor (see illustration) inside the outer conductor by means of coaxially-shaped hollow insulators ensuring that over 85 per cent. of the dielectric between the two conductors is air. The inner conductor is only in contact with the insulating material at intervals and even here the area of contact is very small. The insulators are moulded of "Megastyrene" low loss dielectric, and fit into each other like a ball and



socket joint so that the cable may be bent with ease. Terminal collars are available.

Electrical characteristics are listed for three groups—low attenuation, medium and low capacity—and a characteristic curve of attenuation/frequency is given for the medium group.

In addition to the usual single cable, double or multiple, parallel or twisted Co-Ax cables are also obtainable. Co-Ax cables can be manufactured to comply with nearly any electrical and mechanical specification.

Details may be obtained upon application to The Telequipment Co., 16 The Highway, Beaconsfield, Bucks.

Cambridge Instrument Company, Ltd.

List No. 139 dealing with Cambridge mechanical recorders.

The measurement of small and rapid mechanical movements has been mostly carried out by apparatus involving the use of reflecting mirrors and photographic recorders. The introduction by the above company of a method of recording which employs a stylus moving over a strip of celluloid has enabled an entirely new series of mechanical recorders to be developed, that are simple in operation, accurate, compact and do not possess the inherent drawbacks of the earlier methods. The frictional errors due to the moving stylus are found to be extremely small and do not invalidate the accuracy of the resulting records.

The theoretical considerations governing this are referred to in detail.

This catalogue is extremely well presented and typical records, photographically enlarged are beautifully reproduced. Further information will be given upon request to the Cambridge Instrument Co., Ltd., 45 Grosvenor Place, London, S.W.1.

Electrical Conductivity of Graphite Films

Supplementary information about screening with graphite coatings formed with colloidal graphite* has been supplied by Messrs. E. G. Acheson, Ltd. This is in the form of a note on electrical characteristics, especially the conductivity, of such coatings.

"One of the difficulties of defining such characteristics is the almost unlimited range of thicknesses of film which can be obtained. If a very dilute solution of "Aquadag" colloidal graphite in water is employed, a microscopically thin film can be obtained which offers a resistance of the order of several megohms. By using a higher concentration or by forming successive films, one upon the other, to form a coating of measurable thickness, a value of a few ohms per centimetre square can be obtained.

One or two examples taken from industry will convey an idea of the magnitude of resistance of graphite films and the effect of either successive film thickness, or polishing. A rough high tension cable sheath was treated with one part of "Aquadag" in one part of distilled water. A single coating gave an ohmic resistance of 27,000 ohms, a second coating brought this down to 400 ohms, and a fourth coating to 110. It is made clear that the conditions were somewhat against the formation of a truly homogeneous graphite film.

When glass is coated, a value of a few ohms per centimetre square can be obtained, and this applies to many other dielectrics treated by this method. Tests carried out by the Research Department of the Institution of the Rubber Industry a few years ago showed that the contact resistance between a coating formed with "Aquadag" and mercury was higher for a contact between two graphite films."

Detailed information can be obtained from the Technical Department of Messrs. E. G. Acheson, Ltd., 9 Gayfere Street, London, S.W.1.

* See Vol. 14, April 1942, page 730.



DISTRENE

(POLYSTYRENE)

REGISTERED

in sheets, rods and tubes ★

THE IDEAL PLASTIC FOR HIGH FREQUENCY ELECTRICAL INSTALLATION

for particulars of sizes and prices apply:—

BX Plastics Ltd., Hale End, London, E.4

LHS/VX/150

ON BRITAIN'S

Lifelines



Eddystone

“358”

COMMUNICATION

RECEIVER

WEBB'S RADIO 14, SOHO ST., LONDON, W.1.

PHONE GER. 2089

ABSTRACTS OF ELECTRONIC LITERATURE

TELEVISION

Simple Television Demonstration System

(J. B. Sherman)

The circuits and apparatus of a simple 150-line television demonstration system are described. The equipment employs the small type 1847 iconoscope as camera tube, remotely operated from the transmitter control panel. The transmitter is connected by cable to receiving equipment of which the principal item is a modified conventional oscilloscope. Some photographs taken of pictures on the oscilloscope screen are shown.

It is shown that the low-frequency characteristic of a video cable driven from an amplifier anode circuit differs considerably from the characteristic of the usual interstage coupling.

—*Proc. I.R.E.*, Vol. 30 (1942), No. 1, p. 8.

Orthicon Portable Television Equipment

(M. A. Trainer)

Recently developed orthicon portable television equipment is described. Because of the greater light sensitivity of the orthicon it is expected that the equipment will fill a need for lightweight equipment to be used under adverse light conditions. Among the novel features of the design are the use of a forced air-cooled transformer in the regulated power-supply unit, an all-electronic synchronising generator, gamma control and keyed diodes for black-level setting.

The units required for a one-camera set up are—camera and tripod, camera control unit, power supply unit, pulse unit, and shaping unit. The total weight, exclusive of camera cable, is 370 lb., and the power required is 1,250 watts.

—*Proc. I.R.E.*, Vol. 30 (1942), No. 1, p. 15.

A Supersonic Cell Fluorometer

(H. B. Briggs)

A method is described for the measurement of the rise and decay of luminescence in phosphors excited by cathode-ray beams. It is particularly suited to the investigation of phosphors classed as fast, i.e., those in which major changes in intensity occur in a few microseconds. The method is based on the use of a supersonic cell arranged to produce the Debye-Sears diffraction effect. High speed shutter action is obtained by modulating the supersonic wave train to produce short steep sided pulses. Light intensities sufficient for direct measurement in terms of photoelectric cell response are obtained by

synchronising the periodic excitation of the phosphor with diffracting wave pulses in the liquid. Time intervals in the decay process are measured in terms of distances traversed by the sound waves in water. Several methods of using the device are described and some results obtained by these methods are shown.

—*Jour. Opt. Soc. Am.*, Vol. 31, No. 8 (1941), page 543.

THERMIONIC DEVICES

Fluorescent Lamps

(L. J. Davies, H. Ruff and W. J. Scott)

The paper is a study of the recent history, principles and physical and electrical characteristics of mains-voltage fluorescent lamps. Reference is made to the luminous efficiency of coloured fluorescent lamps, and to the usefulness of the 80-watt lamp for photographic work. The type sizes in use in America in December, 1941, are tabulated. It is concluded that the 80-watt lamp is fulfilling a present industrial need and is the forerunner of a new series of lamps that will provide a helpful stimulus to the general development of good lighting practice.

—*Jour. I.E.E.*, Vol. 89, Part 1, No. 18, p. 288 (1942). Abstract only.

Electrical Characteristics of Stroboscopic Lamps

(Murphy and Edgerton)

This paper describes the electrical characteristics of gas-filled discharge tubes when flashed by a condenser discharge. The object of the experiments was to determine the effects of tube, dimensions, pressure, voltage, and capacity upon the performance. The results are stated to be of an experimental nature and cover a limited range of values of tubes and circuit constants. An empirical constant called tube resistance is defined and evaluated. This constant is said to be useful in predicting the performance of tubes in electrical circuits.

—*J. App. Phys.*, December, 1941, p. 848.*

CIRCUITS

A 100 c.p.s. Frequency Standard

(Hohnell and Dickerson)

The standard oscillator comprises a General Radio tuning-fork unit adapted for valve drive and a buffer amplifier supplying three outputs: Standard clock, power amplifier and harmonic generator (multivibrator) for measurement purposes. The fork is mounted in a double temperature-controlled enclosure.

The frequency is checked by com-

paring the standard 100 c.p.s. clock against time signals. Voltage supply to the oscillator is stabilised and the line voltage is stabilised against slow variations. Circuit diagram (no values) is given.

—*Communications*, Vol. 22, No. 5 (1942), p. 8.

THEORY

Formulae for the Amplification of Triodes

(B. Salzberg)

Existing formulae for the amplification factor of the three electrode valve implicitly assume, among other things, that the distance between the grid and anode is large compared to the distance between turns of the grid. Formulas are developed here for the calculation of amplification factor for plane and cylindrical structure for which this assumption is not permissible. The results given by the new formulas become identical with those obtained from existing formulas, when the foregoing assumption is legitimate. A satisfactory experimental verification made by determining the amplification factor for an ideal scale model of a plane structure immersed in an electrolytic trough is also presented.

—*Proc. I.R.E.*, Vol. 30 (1942), No. 3, p. 134.

Aerial Characteristics

(N. Wells)

The paper covers vertical aerials and is divided into an Introduction and six other sections. Low aerials are considered in relation to approximate formulae for radiation resistance and for terminal reactance, whilst the importance of the earth system is also examined. Van der Pol's analysis for the radiation resistance (R_r) of vertical aerials, of all heights is discussed, and various curves are given for R_r values likely to be met with in practice. The effect of retardation of current is dealt with briefly, and curves for modified R_r values are given. Vertical polar diagrams are next considered. The knowledge gained is applied to determine the optimum height of anti-fading aerials. Technical details of anti-fading aerial are discussed. Terminal values are considered, while two groups of curves are given for computing terminal resistance and terminal reactance.

—*Jour. I.E.E.*, Vol. 89, Part 3, No. 6 (1942), p. 76.

*Supplied by the courtesy of Metropolitan-Vickers Electrical Co., Ltd., Trafford Park, Manchester.

PATENTS RECORD

The information and illustrations on this page are given with the permission of the Controller of H.M. Stationery Office. Complete copies of the Specifications can be obtained from the Patent Office, 25, Southampton Buildings, London, W.C.2, price 1s. each.

TELEVISION

Improvements in Television Apparatus

The invention consists in television apparatus for producing coloured pictures comprising a Kerr cell device having a polarising prism arranged at one side and a number of different coloured light filters and polarising prisms at the other side arranged to cover different portions of the Kerr cell. The polarising prisms are polarised at different angles so that when different voltages are applied to the Kerr cell, the light passing through it will be directed to pass through a corresponding colour filter and will be cut off from the other filters.—*J. L. Baird. Patent No. 545,462. (See Patent No. 545,491 which also relates.)*

Television Signal-Translating System

The invention relates to television signal-translating systems and particularly to an arrangement for stabilising a video-frequency television signal and controlling the contrast ratio of the repeated signal in a single-valve amplifier circuit. It is especially directed to the provision of an improved background illumination insertion and contrast-adjusting system for television receivers.

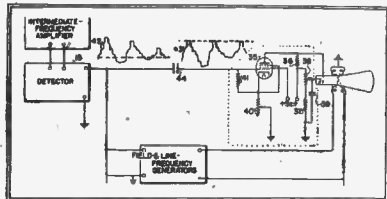

The video-frequency amplifier comprises a valve 35 (Type 1852) having input electrodes coupled to the detector and output electrodes coupled to the cathode-control grid circuit of the tube, through the load resistance R 36 (5,000 ohms). A potential divider including R 37 and R 38 having an adjustable tap is coupled across the anode supply of valve 35, by-pass condenser 39 being connected between the tap on R 38 and earth, the tap being connected directly to the cathode of the tube to provide a bias. An unby-passed cathode resistor R 40 (1,000 ohms) is connected in the common signal-input and signal-output circuits of valve 35 and provides adjustable degeneration to control the stage gain

of the video-frequency amplifier to control the contrast ratio of the reproduced picture.

The input circuit of valve 35 is connected to operate as a peak detector in order to stabilise the translated signals and, for this purpose the grid is coupled to the detector by C 44 (0.1 μF) and is provided with a 2 meg. grid leak R 41.

The wave form 42 corresponds, in general, to the v.f. wave form of conventional television practice with the d.c. component removed. Due to the action of the coupling condenser 44, the unidirectional component of the signal supplied by the detector is lost, if it is present in the output signal derived from detector 15, and the signal tends to centre itself about the zero axis as Curve 42. The grid condenser 44 and leak 41 cause the valve 35 to operate as a peak-grid rectifier, automatically varying the bias of the control grid of valve 35 which, in the absence of a signal, is provided with zero bias. The signal is thus stabilised at the output circuit of valve 35 as shown by curve 43.—*Haseltine Corporation (Assignees of A. V. Loughren). Patent No. 538,220.*

RADIO RECEPTION

Fading Compensation in Radio Receivers

A telecommunication system where intelligence is communicated by means of a radio-frequency carrier, the amplitude of which is modulated by a frequency-modulated sub-carrier. A receiver is adapted to receive the radio frequency carrier and side bands and to extract from the received energy the frequency-modulated sub-carrier. The receiver feeds into two channels to which the sub-carrier is fed in common and a combining circuit where voltages in the two channels are combined. One of the channels is adapted to pass selectively for frequency detection a predetermined harmonic frequency component of the sub-carrier, and to block the sub-carrier frequency component. The other channel is adapted to pass the fundamental frequency component of the sub-carrier and to block the harmonic frequency component.—*Marconi's Wireless Telegraph Co., Ltd. (Assignees of R. E. Mathes). Patent No. 539,793.*

CATHODE-RAY TUBES

Removable Cathode-Ray Tube Screens

In television receivers the screen of the cathode-ray tube is liable to wear out by burning or other causes and the object of the invention is to provide simple and reliable means for replacing a worn-out screen by a fresh one.

As shown in the diagram, the cathode-ray tube is provided with a number of screens in the form of plates 2 arranged in a stack one behind the other. The plates are provided with holes 3 near the bottom edges by which they are threaded on guide rods forming part of a supporting frame 5 securely mounted in the tube. The upper edge of each plate is provided with a notch fitted in alternate plates and staggered. A latching member 7 is pivotally mounted on a rod 8 at the top of the frame and fitted with two magnetic portions 9 arranged one at each side in position to cooperate with electromagnets 10, for rocking the latching member laterally. A spring 12 is arranged between the rearmost plate 2 and the back of the frame 5 to press the plates forward so that the lower edge of the foremost plate is held against turned-down por-

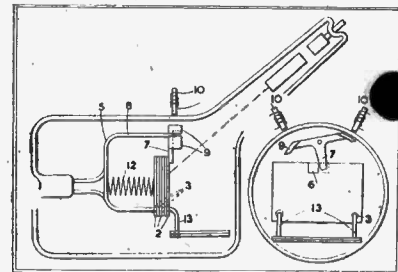

tions 13 of the rods while the upper edge, adjacent to the notch, is engaged by the latching member 7 which has been brought to the required position by energising the appropriate magnet. When the foremost plate has been used up, the opposite magnet is energised to rock the latching member laterally, to register with the notch 6 in the plate and free the upper edge of the plate, thus permitting the spring 12 to push the plate forward so that it will ride over the bent-down ends of the guide rods and fall down upon it to expose the next plate.—*J. L. Baird. Patent No. 544,413.*



AVOID DANGER of H.R. or DRY JOINTS

The experiences of the leading manufacturers of Radio and Electrical Equipment have shown that only by using ERSIN MULTICORE SOLDER WIRE, which contains three cores of non-corrosive Ersin Flux (A.I.D. Approved), and the correct soldering technique, can they ensure that H.R. or Dry Joints are avoided.

If you are engaged on Government Contracts write for Technical information and free samples of Ersin Multicore. For the present, supplies of Ersin Multicore are restricted to such firms, and the Ministries.

MULTICORE SOLDERS LTD.
BUSH HOUSE, LONDON, W.C.2
Tel : 5583/4

IN THE NATIONAL INTEREST. *Even if you do not yet enjoy the advantages of Multicore; in the National interest endeavour to use an alloy containing a lower tin percentage. We are glad to give technical assistance in overcoming difficulties.*

THE Tenaplas Process of Extrusion permits the use of plastics for covering a variety of materials, including wire, rope, etc. If you believe your products will benefit by this process we shall be pleased to advise you.

TENAPLAS LTD.
Extruded Plastics Specialists
Head Office : 7, Park Lane, London, W 1

TENAPLAS

Extruded Plastics



IM UNIT-BUILT AMPLIFYING SYSTEMS

This is an illustration of our standard IM Unit-built 120 watt, central control amplifying master unit incorporating radio, single turntable gramophone, and microphone. Enquiries invited from establishments in any part of the country engaged on essential work. All types of workshops and factories covered, from single unit amplifiers to specially designed multi-purpose apparatus.



INSTRUMENT CASES
Our fully equipped modern factory produces all types of metal instrument cases, radio chassis, panels, brackets, boxes and other metal components.

We invite your enquiries. Priority work only.

IMHOF'S

112-116 NEW OXFORD STREET, LONDON, W.C.1. Museum 5944

CORRESPONDENCE

Input Circuits for Biological Amplifiers

DEAR SIR,—I have read J. D.'s letter with great interest and would like to reply to certain points he raises.

As he states, Fig. 5a in my original article is not identical with that of Offner in *Rev. Sci. Inst.* 1937; it is a practical circuit similar to one which may be seen in *J. Neurophysiol* 1938, Vol. 1, p. 416, except that the H.T. — should, of course, go to earth not to the cathode as in my diagram. As J. D. suggests an apparently similar mistake appears in Offner's diagram of the reinforced feed-back circuit; the figure does not tally with the script and does not seem to work in practice.

With regard to the "in-steps" method of calculation of the gain of V_2 (the grid of V_2 being earthed), this method was used for the benefit of the less mathematically minded reader to reinforce the previous arguments on the working of the Tönnies amplifier; I did not really intend it to be used in practice and the matter of the use of slide rule does not enter into the question.

The discrepancy between the re-

sults of J. D.'s formulae and mine appears to lie in an unjustifiable use of the approximation for formula 6 (see Ref. 11). Whilst

$$E_c = \frac{E R_c}{\frac{1}{g} + R_c}$$

is good enough for circuits in which R_c is relatively small, the formula,

$$E_c = \frac{E R_c}{\frac{1}{g} + R_c \left(1 + \frac{1}{\mu}\right)}$$

should be applied in this case; the small percentage difference introduced by this correction introduces very large errors when E_c is taken from E as J. D. states.

The statement that the "in-steps" method does not permit cross-checking is a little unjust; instead of formula 6 we can use a modification of formula 4, e.g.,

$$E_c = \frac{E \mu R_c}{R_c (\mu + 1) + R_a}$$

and a substitute for formula 5 is not very difficult to arrive at.

The formulae seem to bear the proof of practice; for example, in a circuit used where $V_1 = V_2 = AC/HL$ with anode currents adjusted to be equal,

$$R_{p1} = 0 \Omega$$

$$R_{p2} = 54,000 \Omega$$

$$R_{c3} = 60,000 \Omega$$

$\mu = 35$, $g = 3$ and $R_a = 11,700$ by calculation the gain of V_2 equals 14.3, in practice it was found to be approximately 14.4.

The suggestion that Offner's and Tönnies circuits work on the same principle is interesting, and it seems that the authors arrived at similar circuits independently.

In conclusion, I must apologise for the mistakes appearing and for their not having been corrected in the June issue, and I must thank J. D. for his very interesting letter and formulae, which provide a general method for calculation of gain in push-pull amplifiers, including Tönnies circuit.

—Yours faithfully,

M. G. SAUNDERS.

Manchester.

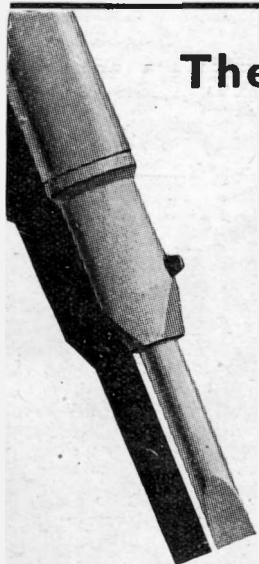

The 65-watt PENCIL BIT SOLON

One of the range of Industrial type SOLONS. Pressure tested 600 volts. to earth for 1 minute. Made for usual standard voltages.

Details of this and other models sent on request.



Supplies of various models are only available for essential war work, of course, and due to heavy demands it is necessary to order well in advance to avoid disappointment in delivery.

W. T. HENLEY'S TELEGRAPH WORKS CO., LTD.,
Engineering Department, Milton Court,
WESTCOTT, DORKING, SURREY.

CO-AX CABLES

FOR HIGH FREQUENCIES
Unequalled
in performance * range of characteristics *

AIR-Insulated
and flexible

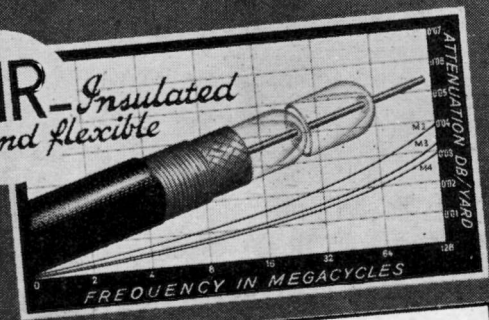

CO-AX Valve Connectors
Very low and constant capacity

TELEQUIPMENT CO.,

16, THE HIGHWAY, BEACONSFIELD, BUCKS.

TRIX

QUALITY
SOUND
EQUIPMENT

Designed and built for reliability and high quality sound amplification



Let us send you full details

Amplifiers
4-400 Watts

Horns
Microphones
Loudspeakers

Equipment available for priority work, factories, etc.

The
TRIX Electrical Co., Ltd.

45 BOLSOVER ST.,
LONDON, W.1

Phone: EUSton 5471/2

Grams: Trixadio, Wesdo London

A GOOD JOB!

through

RADIO SIMPLIFIED

By John Clarricoats. This handbook provides a useful background of fundamental radio knowledge and is by a recognized authority. It has been borne in mind throughout that at the present time it is necessary for many people to obtain their practical instructions of the subject quickly and therefore the minimum of space has been devoted to purely theoretical considerations consistent with a sound basis of knowledge. Fifty-one illustrations. 4s. 6d. net.

SHORT WAVE RADIO

By J. H. Reyner, B.Sc., A.C.G.I., etc. This book gives an account of the tremendous progress which has been made in the field of short-wave radio telegraphy during the last few years, and shows how many of the problems formerly regarded as insuperable have been overcome. Second edition. 10s. 6d. net.

A SIMPLE GUIDE TO TELEVISION

By Sydney A. Moseley and H. J. Barton Chapple. An intensely interesting booklet, written in the simplest of terms and yet giving a comprehensive idea of the growth and principles of television, its experimental stages in the past, its improvements, and its possibilities. 1s. net.

39 Parker St., Kingsway.

A PITMAN BOOK

Transformer Technique

Prints are now available of the paper recently presented by Dr. N. Partridge, to the British Institution of Radio Engineers, on the subject of Harmonic Distortion in Audio-Frequency Transformers.

Copies will be sent free and post free to professional engineers and technicians upon application. The paper is of purely technical interest and the limited supplies will not permit distribution to the general public.

N. PARTRIDGE,
PH.D., B.SC., M.BRIT.I.R.E., A.M.I.E.E.,

King's Buildings,
Dean Stanley Street,
LONDON, — S.W.1

The BIG CHANGEOVER

When that day arrives, when we all must switch from a war effort to a peacetime pursuit you will find R-S prepared. The valuable experience gained in design . . . the new methods . . . the new ideas . . . the new standards . . . all will be available to you coupled with the quality and efficiency you have come to expect from R-S.

R S

Amplifiers Limited

3-4, Highfield Rd., Shepperton, Middlesex
Telephone: Walton-on-Thames 1019

Balanced Perfection

Design, raw materials and human skill in unbalanced trinity will ever fail to attain enduring perfection. Skill may hide for a time shoddy material . . . design may be a cloak for lack of skill . . . but in the end the dross will thrust its ugly way through the gold. Here, at Gardners, we are long experienced in incorporating Balanced Perfection in our products so that when the time comes when you, in your turn, must insist on only the best in Small Power Transformers up to 4 kva, you may order Balanced Perfection in the sure knowledge that you will get it. Of course, priority numbers must be quoted.



GARDNER'S RADIO, LIMITED,
SOMERFORD · CHRISTCHURCH · HANTS.

Q.1



Now he is wondering what his is going to be! But we KNOW—and all of us are striving to hasten his beyond any doubt. When that end comes RELIANCE, with more than 20 years' experience, will again be at your service with that enthusiasm which we are now giving to priority needs of National Requirements. If you have a problem connected with variable resistances for the War Effort, write and tell us about it?

RELIANCE

Manufacturing Co. (Southwark) Ltd.
Sutherland Road, Higham Hill,
Walthamstow. E. 17.

Telephone—Larkwood 3245

GALPINS ELECTRICAL STORES

21 WILLIAM ST., SLOUGH, Bucks.

Telephone: Slough 20855.

Cash or C.O.D.

ELEC. LIGHT CHECK METERS, small, late type, good makers, fine condition, electrically guaranteed, 200/250 volts, 50 cy., 1 ph. A.C. 5 amp., 10/-; 10 amp., 12/6; post 1/-.

D.C. ELEC. LIGHT CHECK METERS, 200/250 v., 5 and 10 amps., 7/6, post 1/-.

AUTO CHARGING CUT OUT AND VOLTAGE REGULATOR, ex-R.A.F., suit any dynamo up to 20 v. at 15 amps., fully adjustable, with wiring instructions, complete in metal case, 3/6, post 9d.

BLOCK CONDENSER, large size. 1 MF., 4,000 v. working, 15/-, carriage 2/-.

2 kw TRANSFORMER, complete with clamps, suitable for rewinding, 25/- carriage forward.

AUTOTRANSFORMER, size 2,000 watts, tapped, common, 100, 200, 220 and 240 volts. As new. Price £6 5 0, carriage paid.

MOTOR BLOWERS, 2" disc outlet, for 110 v. D.C., or will work on 150 volt A.C., small size, Ball Bearing, in perfect working order. Price £2 10 0, carriage paid.

26 volt D.C. COMPOUND WOUND MOTORS, 1/20 H.P., speed 2,000 R.P.M., totally enclosed, Ball Bearing, a really high-class job, in new condition, ampr. 3-75, make good dynamo. Price 30/-, carriage paid.

ROTARY CONVERTOR, D.C. to D.C., Input 220 volts; output 12 volts at 50 amps., D.C., Ball Bearing, condition as new. Price £10, carriage forward, or 17/6 passenger train.

MILLIAMP METERS, by "Weston" and "Turner," 2" dia., moving coil, flush mounting, zero-adjusting, reading 0-50 M/A. £2 10 0, post free.

INSTRUMENT, Metal Rectifiers, small size, 5 M/A rating, price 12/6, post free.

HEADPHONES, 120 ohms, complete with cords, lightweight, 6/- pair, P/F.

TRANSFORMERS

to customers' specifications or in accordance with standard list.



W. BRYAN SAVAGE LTD.

Westmoreland Road, London, N.W.9. Colindale 7131

TECHNICAL BOOKS

English and Foreign Books on Radio and Electrical Engineering supplied from stock or obtained promptly to order.

(Lists post free on application.)

LENDING LIBRARY

Annual Subscription from One Guinea. Details post free on request.

H. K. LEWIS & Co. Ltd.

136 Gower Street, London, W.C.1

Telephone: EUSton 4282 (5 lines)

Great Possibilities for

TECHNICALLY QUALIFIED ENGINEERS KEY MEN IN WARTIME AND AFTERWARDS

The finest posts and the majority of posts in this war are technical and when the war is over, the immense increase in technique and mechanisation created for war purposes will be applied to reconstruction and commerce. An age of great possibilities for qualified engineers is here. Study at home with The T.I.G.B. and take a Recognised Engineering Qualification such as C. & G., A.F.R.Ae.S., A.M.I.Mech.E., A.M.I.E.E., etc. In which examinations T.I.G.B. Students have gained 31 FIRST PLACES and hundreds of passes. Write now for "The Engineer's Guide to Success"—200 Courses—covering all branches—Aeronautical, Tele-communication, Mechanical, Electrical, Chemical, etc. etc.



World's best choice of Courses in Engineering

THE TECHNOLOGICAL INSTITUTE OF GREAT BRITAIN
168, Temple Bar House, London, E.C.4.

Classified Announcements

The charge for miscellaneous advertisements on this page is 12 words or less 3/-. and 3d. for every additional word. Single-column inch rate displayed, £1. All advertisements must be accompanied by remittance. Cheques and Postal Orders should be made payable to Hulton Press, Ltd., and crossed, and should reach this office, 43, Shoe Lane, London, E.C.4, not later than the 15th of the month previous to date of issue.

LOUDSPEAKERS

3,000 SPEAKERS P.M. and energised 4" to 14", including several Epoch 18". Sinclair Speakers, Pulteney Terrace, Copenhagen Street, N.1.

LOUDSPEAKER repairs, British, American, any make, 24-hour service; moderate prices.—Sinclair Speakers, Pulteney Terrace, Copenhagen Street, N.1.

MISCELLANEOUS

BRAND new Motor Generators. Made in U.S.A. Pre-war price. Input 6v. Output 300-400v. 150 milliamps. 55% efficiency. No ripple. Flowerdale Ltd., Fitzroy Square, W.1.

7/6.—Assorted Components contained in attractive permanent box. 9 Assorted Valve Holders, 2 Volume Controls, 12 Assorted Condensers, 6 Resistances, Choke, Wire, Plugs, Circuits, etc. 7/6, postage 7d.

TELSEN Radio Magazines, complete with 4 circuits, gd. post free. Wireless Crystals, 6d. each, 5/- per dozen. Permanent Magnet Speakers, 8", complete with multi-ratio transformer, 22/6. Many other bargains for callers.

SOUTHERN Radio Supply Co., 46, Lisle Street, London, W.C. Gerrard 6653.

MORSE EQUIPMENT

FULL range of Transmitting Keys, practice sets and other equipment for Morse training.—Webb's Radio, 14, Soho Street, London, W.1. Phone: GERrard 2089.

RADIO MAP

WEBB'S Radio Map of the World enables you to locate any station heard. Size 40" by 30" 2 colour heavy Art Paper, 4/6, post 6d. Limited supply on Linen, 10/6, post 6d.—Webb's Radio, 14, Soho Street, London, W.1. Phone: GERrard 2089.

LONDEX BATTERY CUT-OUT

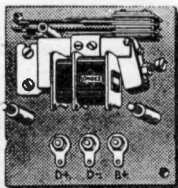

TYPE LF/c

Simple, robust and sensitive. Works in any position. Suitable for ships, vehicles and stationary plants. Heavy silver-to-silver contacts. No mercury.

Ask for Leaflet 98/EO.

LONDEX LTD

MANUFACTURERS OF RELAYS. ANERLEY WORKS 207 ANERLEY LONDON S.E.20 PHONE: SYDNEYHAM 0250/9



Also HOOKS, RINGS, etc. Write for A. J. PRATT & SONS, Ltd. Catalogue E. 7 WOODBRIDGE STREET, E.C.1

ELECTRADIX BARGAINS

FULTOGRAPH. Spare parts, new. Chart Drum and Clips, 5/6. Magnetic Clutch, 6-volt, complete, 25/-, 9 in. Traverse Shaft, 4 in. threaded 120 to inch, with bearings, 12/6. Stylus, with carriage rods and brackets, 7/6. 5-pin plugs, with panel socket and cords, midjet type, 4/6 pair. 14-way Plug and Socket, with cord, 7/6. 1/4 in. Aluminium Panel, drilled 13 in. x 6 1/2 in., 3/-. Bakelite ditto, 7 1/2 in. x 6 1/2 in., 2/3.

TESTERS OR AMPLIFIERS. Portable Mark IV, 3-valve Battery Amplifiers, ex W.D. 9 in. x 9 in. x 6 1/2 in. double doors, mahogany-covered, metal-bound case and handle. Fitted 4 transformers, 5-tap switch rheostat, terminals and sockets, etc. Suitable for conversion for test set, mike amplifier, oscillator, etc., unused, 45/-.

DYNAMOS. Wind drive aero Lucas-Rotax, 6/12 volts, 8 1/2 amps., D.C., 3rd brush size, 8 in. by 4 1/2 in., 11 lb. cost £10, unused, 15/-, postage 2/-. G.E.C. Double-current Dynamos, 6 volts and 600 volts, ball bearing, 17 lb., as new, 25/-. Carr. 2/6 extra. Charging Dynamos, 30 volts, 15 amps., £6 10 0. A.C./D.C. Motor Gen. Chargers. State wants.

PUMPS. Stuart motor pumps in stock.

GALVOS. Circuit testing G.P.O. vertical Galvos, 12/6. Elliott, Army E108, with mov. coil meter 0 to 3A, with glass top, Rheo in lid, 57/6. Sullivan Marine Lab. type Galvo, £9 10 0. Tinsley Ballistic £4 10 0. Please add postage on mail orders and send stamp for replies to enquiries.

ELECTRADIX RADIOS

19, Broughton St., Queenstown Rd., London, W.8. Phone: Macaulay 2159.



EDWARD Wilcox & CO. LTD. Sliding-Interlocking and vibration-proof contacts and comprehensive adaptability are characteristics of interest to designers of unusual schemes in these unusual times. Edward Wilcox & Co., Ltd., Sharston Road, Wythenshawe, Manchester.

Varley

Quality Components

I.F. TRANSFORMERS
WIRE WOUND RESISTANCES
L.F. CHOKES & TRANSFORMERS
MAINS TRANSFORMERS
DELAY SWITCHES

Varley (Prop. Oliver Pell Control Ltd.)
Cambridge Row Woolwich, S.E.18

"COSMOCORD" CRYSTAL PICK-UP

LICENSED BY BRUSH CRYSTAL CO., LTD. under Brit. Pat. Nos. 366,252 and 454,595

FOR CLARITY AND TONE

Retail Price 30/- Plus Tax
Wholesale Trade only supplied.

SOLE SELLING AGENTS
SALE, TILNEY & Co., Ltd.,
3, LLOYD'S AVENUE, LONDON, E.C.3

ROLA

LOUD SPEAKERS

THE WORLD'S FINEST REPRODUCERS

TRANSFORMER LAMINATIONS

Core Widths $\frac{3}{16}$ " to $1\frac{1}{2}$ " (E's and I's.)

EIGHT STOCK SIZES

A Comprehensive Bulletin together with details of Associated Covers and Clamps with design data will be sent to manufacturers on request.

BRITISH ROLA LIMITED

MINERVA ROAD · PARK ROYAL · N.W.10 · WILlesden 4322

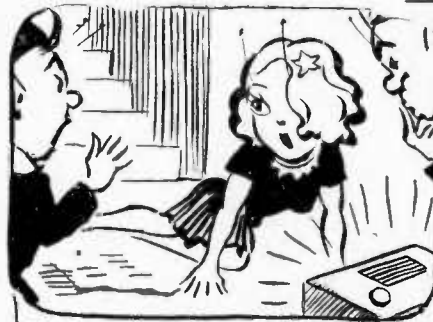

THE "FLUXITE QUINS" AT WORK.

When moving the wireless one day OO tripped down the stairs, sad to say "Are you hurt?" Hollered OI "Not a bit—darling boy" "But that set'll need FLUXITE" growled EH

See that FLUXITE is always by you—in the house—garage—workshop—wherever speedy soldering is needed. Used for 30 years in government works and by leading engineers and manufacturers. Of Ironmongers—in tins, 4d., 8d., 1/4 and 2/8. Ask to see the FLUXITE SMALL-SPACE SOLDERING SET—compact but substantial—complete with full instructions, 7/6. Write for Free Book on the art of "soft" soldering and ask for Leaflet on CASE-HARDENING STEEL and TEMPERING TOOLS with FLUXITE.

To CYCLISTS! Your wheels will NOT keep round and true unless the spokes are tied with fine wire at the crossings and SOLDERED. This makes a much stronger wheel. It's simple—with FLUXITE—but IMPORTANT.

THE FLUXITE GUN puts FLUXITE where you want it by a simple pressure. Price 1/6, or filled 2/6.

FLUXITE LTD. (DEPT. T.V.),
BERMONDSEY ST., S.E.1.

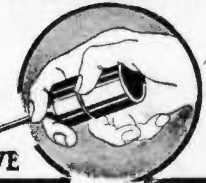

ALL MECHANICS WILL HAVE

FLUXITE

IT SIMPLIFIES ALL SOLDERING

AWKWARD JOBS

Ardux is good at doing awkward jobs in the aircraft, radio and electrical industries. Ardux is unsurpassed for cementing iron dust cores to adjusting screws, for attaching cheek plates to tubes in transformer bobbins, for repairing moulded parts of instruments damaged in service, for fixing fittings to the delicate spindles of moving coil instruments, for cementing ebonite to laminated plastic sheet, for holding metal inserts in plastic mouldings, for building up complicated shapes from laminated sheets, for making hollow mouldings.

AERO RESEARCH LIMITED,
DUXFORD, CAMBRIDGE.

Telephone : Sawston 167-8

"AFTER THE WAR" TELEVISION

With the coming of Peace, and backed by the Technical advances that have resulted from the war years, TELEVISION will again spring to life and offer opportunities, as never before, to the trained man.

Now is the time to prepare for this new "market." Our Home-study "Television" Course is comprehensive, up-to-date and suitable both for the amateur and experienced Radio Engineer.

We definitely guarantee
"SATISFACTION—OR REFUND OF FEE"

You are advised to send 2½d. stamps for (post free) details of this special Television Course and subsequent matter immediately, to investigate its possibilities. Details will also gladly be sent of A.M.I.E.E. and A.M.Brit.I.R.E., Examinations and other courses in all branches of WIRELESS ENGINEERING, including particulars of our special SHORT WAVE and RADIO SERVICING COURSES which are in such demand.

BRITISH INSTITUTE OF ENGINEERING TECHNOLOGY

Principal : Prof. A. M. Low,
337, Shakespeare House, 17/19, Stratford Place, London, W.1.



PANILAX

REGISTERED TRADE MARK

BONDED PAPER INSULATION OF HIGH MECHANICAL STRENGTH AND MOULDED RESIN WITHOUT FILLER. BOTH HAVE EXCELLENT ELECTRICAL PROPERTIES.

The MICANITE & INSULATORS COMPANY LIMITED
WALTHAMSTOW LONDON E.17



Telephone: LARKSWOOD 1044 (Pte. Br. Exch.)

F R E Q U E N T I T E

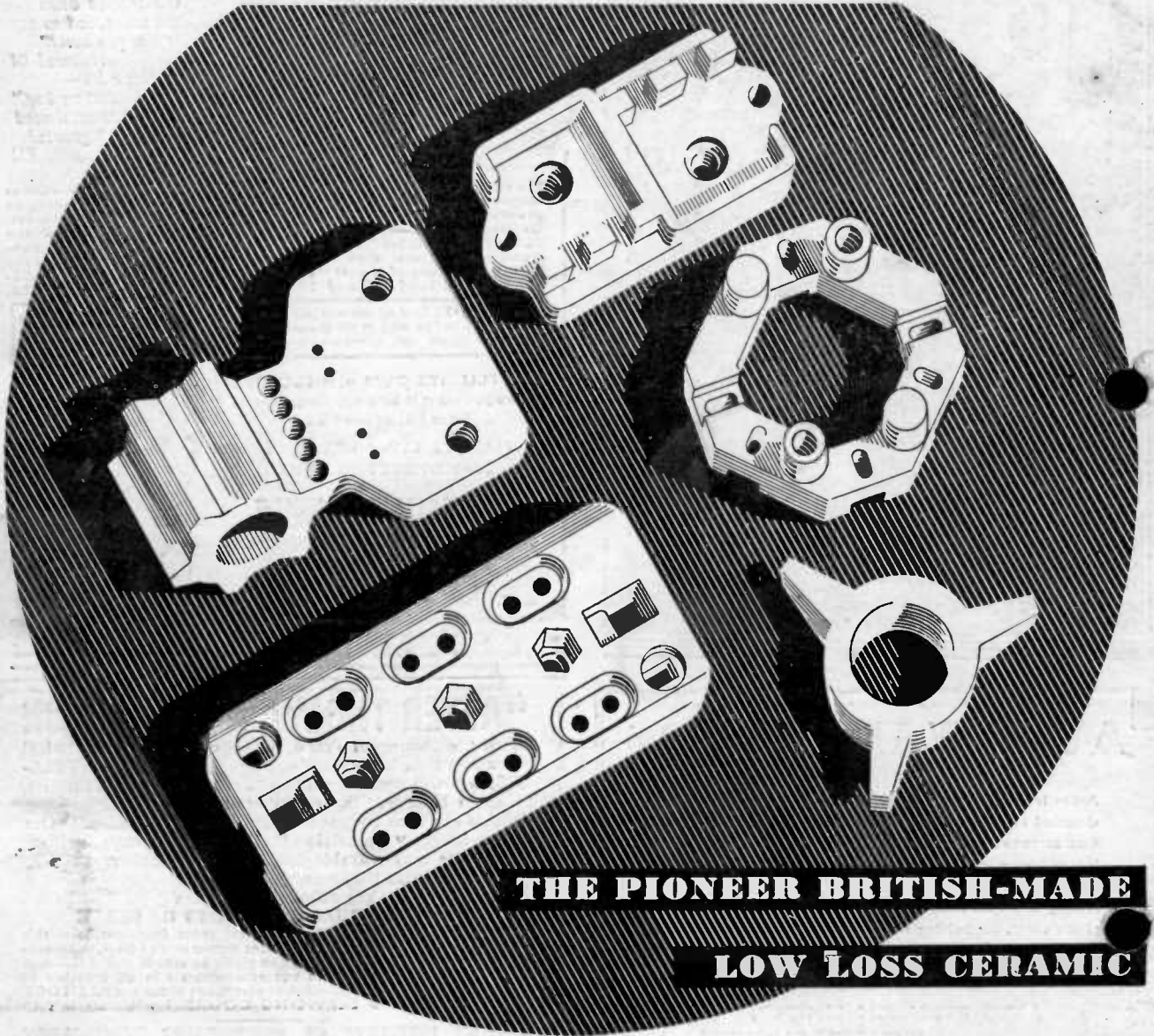

**THE PIONEER BRITISH-MADE
LOW LOSS CERAMIC**

THE outstanding properties of Frequentite—Low Loss and High Mechanical Strength—led to a demand which even before the war severely taxed our productive capacity. The needs of the fighting services have inevitably led to restriction in supplies for general industry, *but we can now meet all requirements promptly.*

Extensions to our plant, the employment of specialised new equipment, and progressive improvements in our manufacturing technique made during the past seven years, now enable manufacturers to obtain bulk supplies of the most intricate designs. Please write for Catalogue No. SP.10.

STEATITE & PORCELAIN PRODUCTS LTD.

Head Office and Works : STOURPORT-ON-SEVERN, WORCS.
Telephone : Stourport 111. Telegrams : Steatint, Stourport.

SP2