

Electronic Engineering

INCORPORATING ELECTRONICS, TELEVISION AND SHORT WAVE WORLD

**PRINCIPAL
CONTENTS**



The Thyatron Time Base
Frequency Modulation—Part V
The Shunt Loaded Tuned Anode Circuit
(Data Sheets, Nos. 23, 24 and 25)
Plastics in the Radio Industry—Part V
Distortion in Radio Receivers

2/- MAR., 1942

Flexible Shaft facts



The S. S. White Company produces each year many millions of feet of Flexible Shaft for purposes almost too numerous to mention. Two of its most common uses are—Torsional Remote Controls for car radio and flexible drives for speedometers. To scientists and designers who require a means of operating an instrument at a distance—perhaps in a different plane or at awkward angles, S. S. White Torsional Remote Control Flexible Shaft is a solution to their problem.

Here are some of the many uses to which S. S. White Flexible Control Shaft is put . . . wireless receivers, precision instruments, engine speed indicators, speedometer drives, windshield wipers, fuel pump controls.

THE TREATISE. This subject is fully described and combined with a mass of technical data and information, in the now well known Treatise upon Flexible Remote Control published by the Company. A copy of this standard work will be sent to all those genuinely able to make use of it. In applying, mention should be made of the name of your concern and your status.

**THE S. S. WHITE COMPANY OF
GREAT BRITAIN LIMITED**

BRITANNIA WORKS,
ST. PANCRAS WAY, CAMDEN TOWN,
LONDON, N.W.1.

Telephone: Euston 4758, 4759, 2033.
Cable Address: Whicodenta.

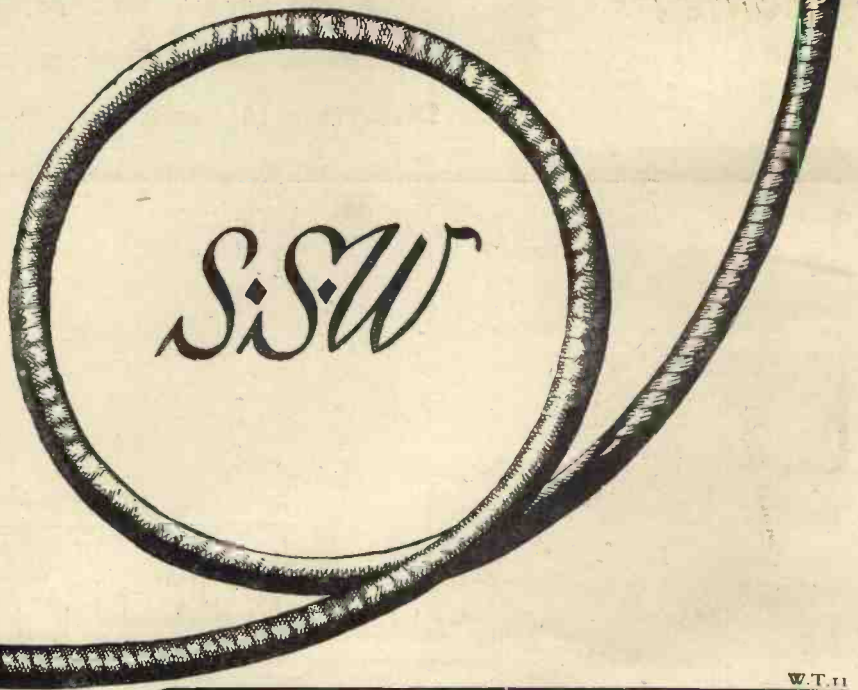

POWER SUPPLY

for

electronic devices

The Westinghouse Metal Rectifier plays an important part in all the spheres of electronic engineering, where its outstanding qualities of high efficiency and long life ensure a reliable power supply. Many examples are to be found in the fields of broadcasting, telephony, impulse generators, etc. and descriptive literature may be obtained on application.

WESTINGHOUSE metal rectifiers

Westinghouse Brake & Signal Co., Ltd.
(Dept. Ec.)
Pew Hill House, Chippenham, Wilts.

CONSTANT VOLTAGE

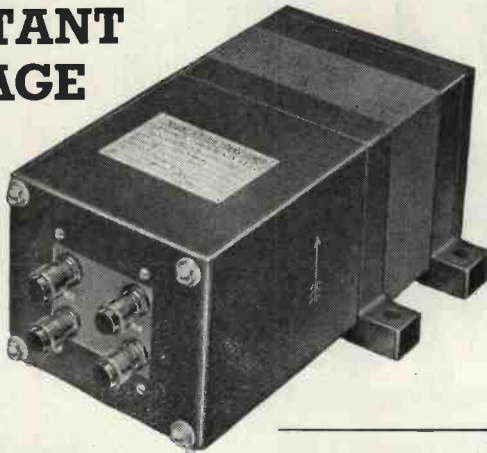

A NEW *ADVANCE* IN TRANSFORMER DESIGN

Line voltage variations of
 $\pm 15\%$ reduced to $\pm 1\%$

Stabilize your Electrical Instruments by using an
"ADVANCE" Constant Voltage Transformer

TYPICAL SPECIFICATION:

Input Voltage: 190-260 v. 50 c.
Output Voltage: 230 v. $\pm 1\%$.
Max. load: 150 watts.
Input power factor over 90%.

Write for details.

Price on application.

ADVANCE COMPONENTS LTD.,

Back Rd., Shernhall St., Walthamstow, London, E 17

Telephone: Larkwood 4366.7

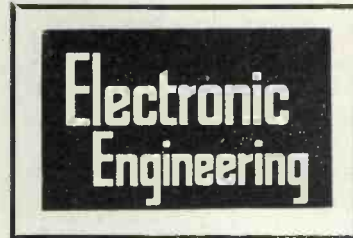

MARCH, 1942.

Volume XIV.

No. 169.

CONTENTS

	PAGE
Editorial	663
The Thyatron Time Base Circuit	664
A Time-Base with D.C. Amplification	666
Plastics in the Radio Industry, V	667
The Shunt Loaded Tuned Anode Circuit	673
Data Sheets Nos. xxiii, xxiv and xxv	677
Frequency Modulation, V	682
Notes from the Industry	685
Distortion in Radio Receivers	686
The Cathode Ray Tube in Industry	692
Abstracts from Electronic Literature	694

SYMBOLS OF PRECISION

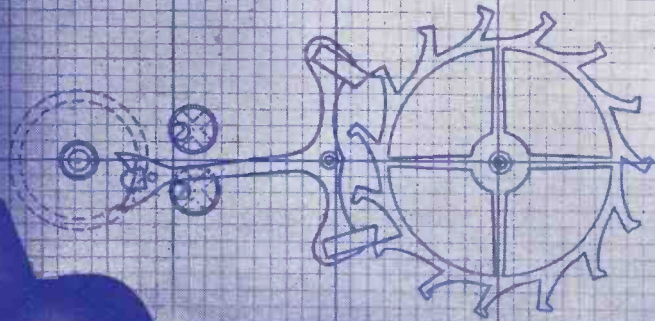

WATCH ESCAPEMENT



MAZDA

RADIO
VALVES

Mazda Radio Valves are manufactured in Gt. Britain for the British Thomson-Houston Co. Ltd., London & Rugby and distributed by

THE EDISON SWAN ELECTRIC CO. LTD.  155 CHARING CROSS RD., LONDON, W.C.2

For full particulars write to Technical Service Department

Electronic Engineering

PROPRIETORS :
HULTON PRESS LTD.,

EDITOR:
G. PARR.

EDITORIAL, ADVERTISING AND PUBLISHING OFFICES, 43-44, SHOE LANE, LONDON, E.C.4

TELEPHONE:
CENTRAL 7400

Monthly (published last day of preceding month) 2/- net. Subscription Rates :
Post Paid to any part of the World—
3 months, 6/6; 6 months, 13/-; 12 months, 26/-. Registered for Transmission by Canadian Magazine Post.

TELEGRAMS :
HULTONPRES LUD
LONDON.

Sponsored

AN article of interest to all those concerned with radio appears in *Advertiser's Weekly* for February 12, written by the advertising manager of Kolynos (Inc.).

He advocates that after the war the Forces wavelength should be allocated to sponsored advertising and quotes impressive figures in support of his claim.

Luxemburg in its heyday had an audience of over 4,000,000; Normandy had 1,229,000, and Lyons over half a million listeners. He adds: "If audiences of the size indicated by the survey could be built up through continental stations of which the reception was by no means uniformly good all over the country, what might not be achieved through the medium of a powerful wavelength operating here?"

It is pointed out that it could hardly be alleged that these commercial broadcasts were inflicted on the public, and with the alternatives of the B.B.C. programmes nobody was obliged to listen against their will.

This seems to be a good point in favour of the use of the Forces wavelength. The money spent in maintaining the programmes (over £500 an hour, according to the author) might well be diverted into this country instead of finding its way to the continent, and the B.B.C. might find themselves in a position to start television programmes earlier than they expected.

And what about sponsored tele-

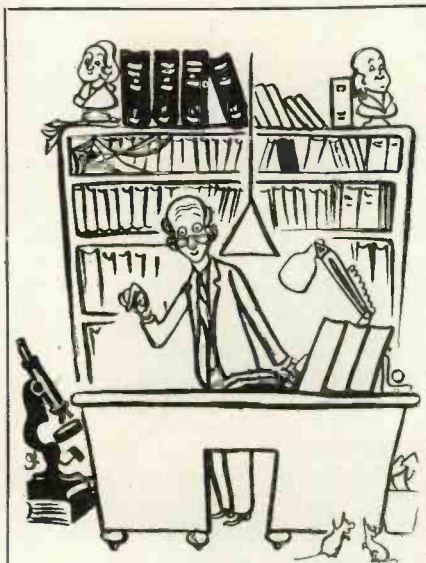

"I've actually made a start!"

HAVE YOU? Have you looked through your old books to see what can be spared for salvage?

There must be dozens of old text books that you have never looked at since your student days.

Obsolete reference books—catalogues of pre-war vintage. They won't be used again, and you will bring the time nearer when you can buy new and up-to-date ones.

But give them now to salvage. Don't put it off another month. Your local Council will collect bulky parcels on request.

Salvage books and paper and shorten the war!

vision programmes? The magazine film, with its judicious mixture of advertisement and information has long been popular, and many of the advertising trailers could have been presented equally well on the television screen.

This is where the author of the article, Mr. L. H. Chevallier, is silent. No doubt he prefers to consider one possibility at a time, but the prospect of sponsoring television programmes is one that will certainly have the support of one section of the community at any rate, if it means an earlier resumption of the service.

The expenditure on radio time by advertisers in the year preceding the war was roughly £1½ million, spread over 200 different products. A quarter of this sum would provide comfortably for television programmes of the duration to which we were accustomed, and it will only be a question of time before the audiences become comparable with those viewing the trailer publicity film.

It is said that the Press would not welcome sponsored programmes, although so far as American experience shows the advertising revenue has not suffered in the long run.

There is no sign that the publicity film has affected the advertisers in the daily Press—in fact, it is generally considered as a useful adjunct. From publicity film to publicity television items is a short step and one that might be well worth taking.

The Thyatron Time-Base Circuit

An Investigation into the Characteristics of a Gas-Discharge Triode used as a Time-Base Discharger Valve

By O. S. PUCKLE, A.M.I.E.E.

The subject matter of this article formed an appendix to a paper which was recently read by the author before the Wireless Section of the Institution of Electrical Engineers.

A book by Mr. Puckle on "Time Bases" is in preparation and will shortly be published by Messrs. Chapman and Hall.

MANY circuits are known in which a gas-discharge triode is employed to discharge a condenser but, from one point of view, all these circuits may be conveniently divided into two classes.

In one class the discharge is extinguished because the condenser behaves as a suppressor to the arc discharge, which is then only maintained so long as the current exceeds a certain minimum. The other class, which will not be considered here, comprises all those circuits in which the discharge is more or less forcibly extinguished by the aid of additional devices which drive the anode or grid negative. The former class is represented by the circuit of Fig. 1 in which the condenser C_1 is charged through a high resistance R_1 and discharged through the triode. The resistances R_2 and R_3 limit the anode and grid current after the discharge has commenced.

The present investigation of this circuit has brought to light some interesting features which become more complex as the repetition frequency is increased. At very low frequencies, however, the behaviour of the circuit is readily predictable from the static anode-current/anode-voltage characteristics of the triode.

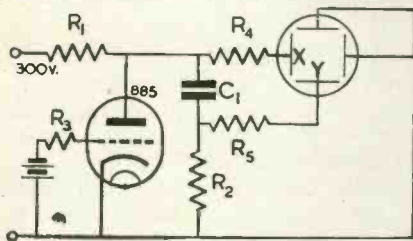

Fig. 1. Time-base circuit.

Fig. 2 shows part of the anode-current/anode-voltage curves for a typical argon-filled triode at various grid-bias voltages applied through a resistance of 50,000 ohms. The lower end of the curves has been omitted except in the curve for zero bias. This curve clearly shows a sharp change of direction where the characteristic may be said to change over from the hard-valve type to the arc type. The anode voltage at the transition point is called the "striking potential," and the valve is said to be in the ionised condition when the anode current is greater than that at the striking point.

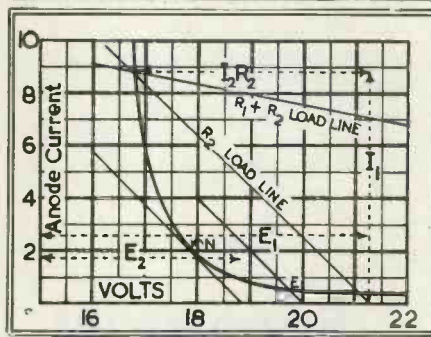

Fig. 3. Static characteristics of R.C.A. 885 gas triode.

The chief effect of negative grid bias is to raise the striking potential by an amount which depends on the control ratio, *i.e.*, the amplification factor. The striking potential is approximately equal to τ times the grid bias, where τ is the control ratio and thus moves considerably to the right as the bias is increased. One consequence of this, which can be seen from Fig. 2, is that an increase in negative bias produces an increase of anode current for a given anode voltage, when in the ionised condition, although the anode voltage increases if the current is held fixed. The slope also becomes less steep, indicating an increased negative resistance.

The effect of grid bias becomes less marked as the anode current is increased, and is practically negligible from about 10 mA upwards. In this region the anode voltage becomes almost independent of both grid bias and anode current and is approximately equal to the ionisation potential of the gas. The steep slope denotes a very low negative resistance.

One reason why the applied grid bias has little effect, except at small anode currents, is that the grid current through R_3 is sufficient to hold the grid potential at about -1 volt regardless of the applied bias voltage.

The choice of bias voltage is, of course, governed by the striking voltage which is desired, but the grid potential after the discharge has commenced is influenced to a limited extent by the value of the resistance R_3 .

Mechanism of a Gas Discharge Time-Base

The mechanism of the time-base circuit as shown in Fig. 1 is best explained by reference to Fig. 3, which shows a number of load lines drawn to intersect the anode characteristic of a typical gas

triode. The condenser slowly charges through the resistance R_1 and, until ionisation takes place, the anode voltage of the valve is the same as the potential across the condenser. When ionisation occurs, and assuming for the moment that the time-constant C_1R_2 is large, the anode current rises to a high value determined by the value of the resistance R_2 and by the difference between the condenser and the anode potentials. The condenser then discharges to a potential, say E_1 , by which time the anode current will have fallen to the value I_1 . In these circumstances the potential drop across the anode load is I_1R_2 , while $E_1 - I_1R_2$ represents the anode voltage of the valve. This situation is indicated by the load line R_2 , corresponding to the condenser potential E_1 . It will be noted that this load line moves to the left as the condenser discharges. Its initial position, at the striking point, may be imagined as parallel to that shown but at a considerably higher condenser potential.

Since the time-constant is large it is permissible to assume that the current in the valve will follow the static curve.

Fig. 3 also shows a load line marked $R_1 + R_2$ which is drawn in such a position that the charging and discharging currents are equal and hence the potential on the condenser will not alter.

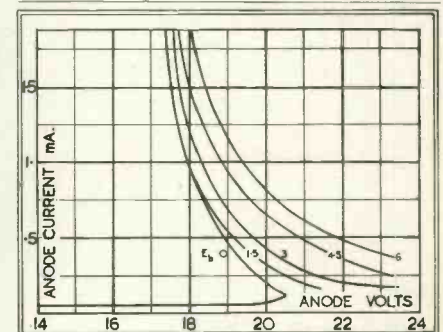

Fig. 2. Static Characteristics of the Cossor G.D.T. 4 B.

This means, in effect, that the discharge through the valve cannot be extinguished in the condition postulated.

In order to enable the discharge current to fall to zero it is essential for the $(R_1 + R_2)$ load line to strike the curve at a point below that at which the R_2 load line becomes tangential to the curve. In this case, when the current has fallen to the tangential point it cannot follow the curve any further, since this requires an increase in the

potential across the condenser, in spite of the fact that the charging current is less than the discharging current. Therefore, since the condenser potential cannot rise, the discharge is suddenly extinguished, leaving the condenser charged to the potential indicated by E_2 . It may therefore be said that extinction occurs at the tangential point where the negative slope resistance of the arc characteristic becomes equal to the positive resistance R_2 .

The above theory has been checked by first making R_2 too small to permit extinction of the discharge current and then gradually increasing it and noting the current at which oscillation commences. With condensers of the order of $0.1 \mu\text{F}$ or larger, reasonable agreement is found between the measured current and the value predicted from the static characteristics. This check was made on several valves, and in each case the resistance R_2 was varied from 500 to 5,000 ohms. If R_2 is made considerably higher, the discharge is apt to extinguish itself at higher currents than would be expected, and it is found that the stray capacitance between anode and cathode is then able to extinguish the discharge before C_1 can do so. Normally, R_2 is only made high enough to limit the peak current to a safe value, of the order of 200 to 500 mA.

So far we have only considered the case where C_1 is rather large, of the order of $0.1 \mu\text{F}$. When a considerably smaller capacitance is used, it is found that the charging current has to be reduced in order to maintain oscillation. In other words, the real extinction point falls below the tangential point on the static characteristic, which now no longer applies.

The extinction current begins to fall almost in proportion to the capacitance when very small condensers are used. Thus the frequency of a gas discharge time-base cannot be indefinitely raised by reducing the capacitance, because the charging current also has to be reduced.

While it is not suggested that this extinction current, determined by static means, is identical with the extinction point when the triode is actually operating as a time-base, it does signify that a time-base which employs a higher charging current than this will not commence to oscillate until it is given a shock.

The existence of a stable equilibrium condition below the tangential point implies that the condenser potential rises when the charging current through R_1 is momentarily reduced below the value of the discharge current through R_2 .

When the condenser is small the variation of potential from the junction of R_1 and R_2 to earth is the same as would be expected without a condenser except that the discharge still extinguishes itself at a point further along the curve. In other words, the small condenser only takes control of the discharge when the current has fallen well

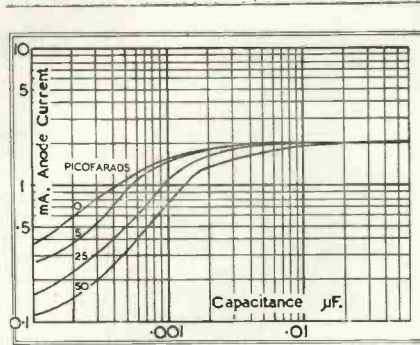

Fig. 4. Characteristics showing minimum current for stable equilibrium with various values of added capacitance between anode and grid.

G.D.T. 4B. with R_2 500Ω and R_3 50,000Ω

below the tangential point. We may then consider that the dynamic slope of the discharge characteristic has become equal to the slope of the R_2 load line at the actual extinction point.

It will thus be seen that for small values of capacitance the charging current must be considerably reduced and therefore, for this reason, apart from any others, the maximum frequency of a time-base of this type is limited.

One reason why the dynamic slope is steeper than the slope of the static characteristic is the presence of stray capacitance between grid and anode. This will cause the grid potential to rise in a positive direction when the anode potential is increasing rapidly. It will be seen from Fig. 2 that this will result in a reduction of anode current and is equivalent to a steepening of the slope.

The effect of this stray capacitance can be enhanced by adding further capacitance across the grid and anode of the valve. This is illustrated in Fig. 4 from which it will be seen that, for small values of the main condenser C_1 , the anode current at the extinction point falls to a greater degree as the

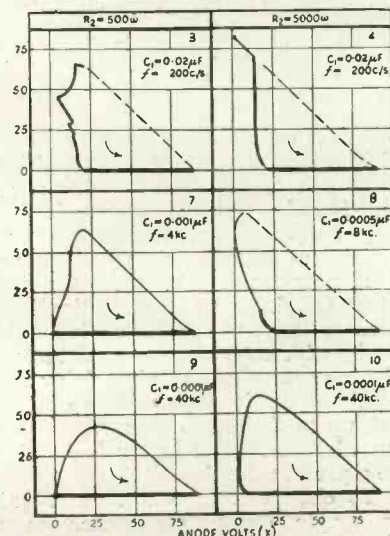

Fig. 5. Time-Base cyclograms.

additional grid/anode capacitance is increased. It is perhaps reasonable to assume that in the absence of any capacitance between anode and grid (including that between the anode and the cloud of ions) the extinction current would remain constant, in this particular case at 1.84 mA.

From the foregoing remarks it would appear to be reasonably certain that the action of the main condenser C_1 in extinguishing the discharge is similar to the effect of a condenser in extinguishing an arc across a pair of contacts.

Some examples of the behaviour of a gas-discharge time-base were obtained by connecting an X-plate of an oscillograph to the anode of the discharge valve, while a Y-plate was connected to indicate the voltage drop across R_2 as shown in Fig. 2. These oscillograms are shown in Fig. 5. As the charging current is very much smaller than the discharge current, the voltage across R_2 is, except for the effects of stray capacitance and inductance, approximately proportional to the anode current only. From the curves it will be noticed that the voltage developed across R_2 appears slightly less than the potential through which the anode has fallen. This is due to the potentiometer effect produced by the presence of resistance and inductance in the condenser C_1 and its leads, together with that produced by the resistance R_1 and the stray capacitance from the Y-plate to earth.

When the condenser C_1 is large the discharge follows the static characteristic down to the anticipated extinction point and then the current falls very rapidly to zero.

The zig-zag effect at the higher current ($R_2 = 500\Omega$) is believed to be due to the glow jumping from point to point. This is often seen when plotting static characteristics at high currents.

During the rapid changes of current at the beginning and end of the discharge, the spot moves across the screen at an angle of approximately 45° because the condenser voltage remains constant during these short intervals and the X- and Y-plates, which are directly across the condenser, therefore undergo equal voltage changes.

When the capacitance of C_1 is reduced, the locus shows a tendency to overshoot or break away from the static characteristic and the anode voltage appears to reach a minimum in the region of zero for a short time.

Sometimes the anode voltage does not merely touch this minimum as shown in (7), (8) and (10), but remains there for a definite short time. This is clearly indicated in cyclogram (9) by the spot at zero anode voltage.

It has been found that the duration of this low-voltage régime may be increased to as much as 20-30 microseconds by connecting an additional condenser directly between anode and cathode. The occurrence of this régime cannot be readily detected by a change

in the appearance of the glow unless the duration of the low anode voltage régime is many times longer than the duration of the ionisation potential régime. A change in the colour and luminosity of the glow can then be easily observed. The normal glow obtained with argon, which may be described as magenta, is replaced by a pale blue glow and the discharge becomes much less brilliant.

The low-voltage régime is found to exist in all the diagrams from Nos. (4) to (10) inclusive and it is believed that it also exists in the first diagram but that, since the repetition frequency is so much lower, it is not visible on the tube. For the same reason the trace from the maximum value of potential across the X-plate to the maximum value of potential across the Y-plate is hardly visible in any of the diagrams from Nos. (3) to (8) inclusive and for this reason they have been shown dotted. Examination of the diagrams (4) and (8) shows the low-voltage régime continuing to exist for progressively longer portions of the cyclogram. This, however, does not mean that the régime lasts for a longer time, since the oscillograms are also progressively more rapid and it is, in fact, probable that the time taken for the potential to change from the neighbourhood of zero to the ionising potential is more or less constant.

If the capacitance is still further reduced below the value of $0.0001 \mu\text{F}$ as shown in diagrams (9) and (10), it will be found that it is impossible to charge the condenser to the same striking potential across the Y deflector plates. This occurs because a certain amount of time is required for the recombination of the remaining ions after the discharge is extinguished. Since the capacitance has been reduced, however, the time available for recombination (or de-ionisation) is reduced because the condenser charges more rapidly. The striking potential, in the presence of a few ions, is lower than when no ions are present and for this reason the discharge is initiated before the small condenser has had an opportunity of charging up to a potential which is as high as that which would be required for a larger condenser. This condition is only reached when the condenser is so small that it is on the point of non-extinction of the discharge and the condition is not, therefore, a very important factor in determining the limitations of the circuit.

The fact that goods made of raw materials in short supply owing to war conditions are advertised in this magazine should not be taken as an indication that they are necessarily available for export.

A Time Base with D.C. Amplification

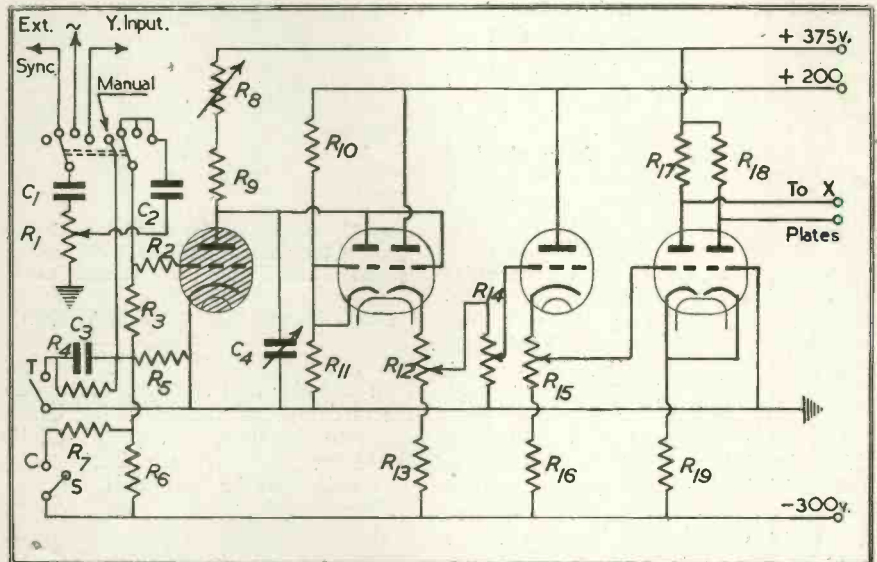

VALUES OF COMPONENTS.

C_1	.25 μF .	R_5	10,000 ohms.	R_{13}	0.25 meg.
C_2	.01 μF .	R_6	.5 meg.	R_{14}	0.5 meg.
C_3	.001 μF .	R_7	.5 meg.	R_{15}	15,000 ohms.
C_4	to suit frequency	R_8	5.0 meg.	R_{16}	0.25 meg.
R_1	5,000 ohms.	R_9	1.0 meg.	R_{17}	0.15 meg.
R_2	10,000 ohms.	R_{10}	.1 meg.	R_{18}	0.15 meg.
R_3	0.1 meg.	R_{11}	75,000 ohms.	R_{19}	0.15 meg.
R_4	20.0 meg.	R_{12}	0.1 meg.		

IN the December issue of *Electronics*, W. A. Geohegan describes a flexible time-base circuit employing direct coupling throughout from the thyatron to the deflector plates. The amplifier consists of one 7F7 valve and has a uniform response from zero to 20,000 c.p.s. with a gain of more than 50. The time-base circuit is also adapted for single sweep operation and the saw-tooth generated can be expanded symmetrically with respect to the centre of the tube.

Referring to the circuit diagram the D.C. component at the cathode end of R_{12} (referred to earth) will change more rapidly than the saw-tooth component as R_{12} is adjusted. It is therefore possible to find a point on R_{12} at which the saw-tooth is symmetrical above earth and is only slightly attenuated. With R_{12} so adjusted a continuous sweep will behave as though the time-base were condenser coupled, but when the circuit is set for single sweep operation it will assume its new conditions instantaneously with no adjustment of the positioning control (R_{13}) and no delay which would occur if condensers were building up to their new charge. Once adjusted R_{12} need not be touched and can be a preset control.

To change from continuous running to single sweep the switch in the thyatron grid circuit is thrown from C to S. When this is done the spot con-

tinues to progress across the screen, but does not fly back when reaching its original limit of travel owing to the increase in ionising potential of the thyatron.

The spot moves off the screen to a position which corresponds to the new ionising potential, but is prevented from reaching this point by the left triode section of the 7F7 in the sweep circuit which tends to draw current as soon as its anode becomes positive with respect to the cathode.

The screen is thus dark until a tripping pulse is applied either manually (Switch T) or through the synchronising circuit, when the spot flies back to its initial position, completes one sweep at the same transit speed and then stays off the screen again until another impulse is applied.

Tripping pulses are selected from any desired source by the double-pole switch shown in the top left corner of the diagram. The value of C_3 and R_{12} are chosen so that the tripping pulse is of shorter duration than the shortest transit time for which the circuit is designed, and only one sweep will be tripped regardless of the time of contact of the switch T.

When the switch is released C_3 discharges through R_4 and the circuit is restored to normal. The linearity of the time base is good at .2 c.p.s. and is quite satisfactory up to 10,000 c.p.s.

Plastics in the Radio Industry

Conclusion :-The Electrical Properties of Plastics

by

E. G. COUZENS, A.R.C.S., B.Sc., and W. G. WEARMOUTH, Ph.D., F.Inst.P.

(Messrs. B. X. Plastics Ltd.)

(Messrs. Hallex Ltd.)

THIS article details the electrical properties of Industrial Plastics, and shows how the study of these properties is beginning to influence the ideas on the molecular structure of these materials and thereby point the way to the development of plastics with not only much improved dielectric properties, but also with greater mechanical strength and with better resistance to conditions of normal usage.

Most plastics are good insulators, but the insulation resistance of those materials which have a propensity for picking up moisture is much affected when such materials are exposed to varying atmospheric conditions. The standard urea-formaldehyde resins are somewhat weak in this respect and

on this account are never used under conditions which are likely to be very humid. The melamine formaldehyde type of resin (as stated in Part II) with a much lower water absorption coefficient has correspondingly improved electrical properties and it is believed that this resin will become of increasing importance in the future.

Despite this apparently adverse comment on the urea formaldehyde resins, one must not overlook their remarkably good anti-tracking qualities. Blakey¹ has described an ingenious way for demonstrating this quality and it is generally conceded that the urea resins are much better than the phenol formaldehyde resins as far as anti-tracking properties are concerned. In order to minimise this surface leakage, moulded

materials are often coated with an alkyl resin solution of the glyptal type.

Table I shows the range of values obtained for the standard resistivity coefficients in the case of plastics. The basic materials are quoted and reference to the table on page 484 in Part I of this series will enable readers to see to which trade material any particular values refer. For convenience, values of the water absorption coefficient are also quoted.

It is clear that polystyrene, polyethylene and polyisobutylene possess the highest electrical resistivity (both for surface and volume resistivity) and in this respect they are much superior to glass, values for which are quoted in the table. These three materials are also practically unaffected by moisture

TABLE I
ELECTRICAL PROPERTIES

Material	Water Absorption (24 hours immersion)	Breakdown Volts/mil.	Volume Resistivity Ohms/cm ²	Surface Resistivity Ohms/cm ²
Polystyrene	0.0	2,600	10 ²⁰	1.3 × 10 ¹⁹
Polyethylene	0.0	600	10 ¹⁷	3 × 10 ¹⁶
Polyisobutylene	0.02	500	10 ¹⁶	2 × 10 ¹⁵
Ethyl Cellulose	1.0	1,500	10 ¹⁵	3 × 10 ¹⁴
Aniline Formaldehyde { Standard ... Laminated	0.05 0.4	400 400	3 × 10 ¹⁵ —	2 × 10 ¹⁵ —
Methyl Methacrylate	0.5	480	7 × 10 ¹⁵	2 × 10 ¹⁴
Urea Formaldehyde	1.3%	300—550	2.4 × 10 ¹³	10 ¹²
Phenol Formaldehyde { Standard ... Mineral Filled Fabric Filled	0.1—0.2% .01—0.3 1.0—1.3	300—500* 250—400 300—450	10 ¹⁰ —10 ¹² 10 ⁹ —10 ¹¹ 0.4 × 10 ¹¹	9 × 10 ¹⁸ 10 ¹⁰ 10 ¹⁰
Do. Laminated Paper	0.3—9.0	500—1,300	1.10 × 10 ¹²	10 ⁹
Do. Laminated Fabric	0.3—9.0	200—600	0.1—1.0 × 10 ¹⁰	10 ⁸
Do. Cast	0.01—0.5	300—450	2 × 10 ⁸	10 ⁷
Vinyl Chloride (filled)	0.2—4.0	400—800	3 × 10 ¹²	2 × 10 ¹¹
Copolymers05—0.15	—	—	—
Cresol Formaldehyde	0.4	400	2 × 10 ¹²	1 × 10 ¹¹
Glass	—	1,500	8 × 10 ¹⁴	10 ¹³
Melamine Formaldehyde	0.2—0.6	300	—	—
Cotton	—	140	—	—
Silk	—	450	—	—
Cellulose Acetate	1.5—3.0	590—1,000	4.5 × 10 ¹⁰	0.5 × 10 ⁷
Cellulose Nitrate	0.6—2.0	300—780	2—30 × 10 ¹⁰	1.8 × 10 ⁸

* At 60 c.p.s.

TABLE II
DIELECTRIC CONSTANT AND
POWER FACTOR AT 60~

Material	Permittivity	Power Factor
Polystyrene	2.5—2.6	.0002
Polyisobutylene ...	2.4	.0005
Polyethylene	2.2	.0006
Steatite	5.5—6.5	0.0002
Polyindene	3	.0004
Ethyl Cellulose	2.7	.007
Laminated ... paper Phenol Formal- dehyde Resin fabric	5 6	.02—.06 .02—.06
Cast do.	9—10	.02—0.2
Phenol Formaldehyde (Standard)	5—6	.05—0.10
Do. Fabric filled ...	9—10	0.08—0.30
Cellulose Acetate ...	3—6	.02—.06
Aniline Formal- dehyde { Resin Lam'n	3—4 4—5	.01—.02 .02—.06
Vinyl Chloride	3.4—4	.02—0.15
Copolymers	3—11	.014
Melamine Formal- dehyde	8.0	0.16
Urea Formaldehyde	7.6—8.6	.05
Cresol Formaldehyde	6.0	.10
Methyl Methacrylate	3—3.1	.06
Mineral-filled Phenol Formaldehyde	6—12	0.10—0.30
Cellulose Nitrate ...	3—4	.06—0.15

(indeed it will be seen that water absorption coefficient for polystyrene is quoted as 0 per cent.) and on this and many other grounds they are attracting the attention of electrical engineers throughout the world.

Strenuous efforts are continually being made to improve these properties in the case of the phenolic formaldehyde resins, and phenolic type mouldings are now on the market which are made from special mineral-filled materials for which excellent anti-tracking properties and improved electrical strength are claimed.

Dielectric Constant and Power Factor

The electrical properties of plastics which are probably of greatest interest to the electronic engineer are no doubt the dielectric constant and power factor, *i.e.*, those properties which enable him to assess the dielectric qualities of the materials. Moreover, a knowledge of the way these two properties vary with frequency and temperature is also of the greatest importance.

Table II gives the values of dielectric constant and power factor for the main plastics at 60 c.p.s. It will be observed that once again polystyrene has the lowest relative power loss, having a power factor of .0002 and a dielectric constant of 2.5—2.6—better than steatite, quartz, or mica.

Clearly, it approaches the ideal dielectric, and it should be noted that it is a purely synthetic material.

Polyethylene and polyisobutylene (artificial rubber) are almost as good, and since these resins are more pliable than the standard polystyrene, they are finding extensive use as flexible coatings for wires intended for low-loss work. Varnished tubing is also being replaced by plastic impregnated cotton sleeving of which "Tenatube" (Tenaplas, Ltd.) is an example.

Ethyl cellulose plastic, a compound prepared from cellulose—is also of excellent quality, and since it is also both tough and flexible it is being put forward for the same purpose.

It will be recalled that in Part II, page 42, mention was made of a modified polystyrene. Styroflex (produced by cold drawing standard polystyrene sheet) which is remarkably tough and flexible even in thin section. The rapid development of this material was undoubtedly influenced by the advent of the tougher dielectrics of excellent quality above described.

It is possible to toughen polystyrene in an entirely different way, namely, by the incorporation of high boiling point plasticisers. Indeed mouldings have been produced with this type of modified polystyrene, and although the finished products are certainly tougher, their electrical properties are generally impaired as a result of the inclusion of plasticiser. Anyone considering the use of polystyrene for important electrical work should take the greatest care to ensure that only the best clear grade is employed. The addition of colouring matter or plasticisers should be avoided. Styroflex, the cold drawn polystyrene, does not suffer from this defect, since its greater toughness is derived from a reorientation of the polystyrene molecules and not from a modification of the chemical composition of the material.

Influence of Molecular Structure

Many people wonder why the synthetic materials, polystyrene and polyethylene, should have electrical properties much superior to those of the other plastics. A comparison of the chemical structures of the various plastics will provide the answer.

It is fairly well known that the power factor and dielectric constant of any material are dependent on:

- The number of ionic changes in the material;
- the number of polar molecules or polar groups in the material.

A highly polar molecule like water (H.OH) has a high dielectric constant and on the other hand, a non-polar molecule like benzene has a low dielectric constant. The (OH) radicle in the water molecule is a highly polar one and excites polar properties in any compound to which it is introduced.

It will be recalled that phenol-formaldehyde resin is prepared by heating together phenol C_6H_5 , OH and formaldehyde H.CH.O. It is to be noted that the phenol is highly polar, because of

the presence of the (OH) radicle. In the network of the resin macromolecule produced by this reaction the polar phenol is "bound" and is therefore not so free to respond to the application of electrical stresses, and it is therefore not surprising that the dielectric constant of the pure phenol-formaldehyde resin is not so high as the original phenol from which it is made (Dielectric constant for the resin is 4.0 as compared with 15 for phenol.)

Water is one of the by-products of the chemical reaction in which the phenol formaldehyde resin is produced. A large proportion of this is removed during the progress of the reaction, but within the network structure of the phenol formaldehyde resin macromolecules there are plenty of spaces for some of the water to be held, and the water, being a polar material, is attracted to the resin because of the polar properties conferred on the resin by the presence of the polar phenol groups. This water is very difficult to remove from the resin, and its presence increases the power factor and dielectric constant of the material. The effect of this water on the electrical properties has been clearly demonstrated by Hartshorn, Megson and Rushton,² who showed that the power factor of a phenol formaldehyde resin could be reduced by as much as 30 per cent. when the material was dried out.

Polymerised Hydrocarbons

Polystyrene, the plastic of excellent dielectric properties, is prepared from styrene, a derivative of benzene (C_6H_6). Benzene is a pure hydrocarbon and is one of the least polar substances known. Its dielectric constant is therefore quite low, approximately 2.2. Styrene or vinyl benzene, $C_6H_5CH=CH_2$, is similarly a pure hydrocarbon is non-polar and has the low dielectric constant of 2.4. Polystyrene is prepared from styrene by the chemical process known as polymerisation, and in this process the molecules of styrene are linked together to give the polystyrene plastic. In contrast to the reaction in which phenol formaldehyde resin is produced, no water is formed during the corresponding polystyrene formation. In this way it is easy to understand why polystyrene is distinctly non-polar and why its dielectric constant and power factor are so low. Impurities in the monomer styrene can have a very serious effect on the electrical properties of the finished polystyrene, and they give rise to one of the chief difficulties in the manufacture of the resin, namely, the purification of the monomer.

Polystyrene, as we have seen, is practically impervious to water and there is no danger of its electrical properties deteriorating when it comes into contact with water.

Polyethylene, produced from the hydrocarbon ethylene $CH_2=CH_2$, is likewise non-polar and on this account has a very low dielectric constant and

TABLE III

VARIATION OF DIELECTRIC CONSTANT AND POWER FACTOR, WITH FREQUENCY, OF SOME PLASTICS

All measurements made at 20° C.

Material	Dielectric Constant	Power Factor	Frequency
Polystyrene	2.6	.0002	60 ~
	2.6	.00018	1 Kc
	2.5	.0002	1 Mc
	2.6	.0002	10 Mc
	2.55	.0002	35 Mc
Polyisobutylene	2.4	.0004	60 ~
	2.5	.0005	1 Kc
Quartz	3.2	.001	60 ~
	3.0	.001	1 Kc
	3.1	.001	1 Mc
	3.0	.0001	10 Mc
Mica	6.5	.002	60 ~
	6.6	.003	1 Kc
	6.8	.003	1 Mc
	7.0	.0002	10 Mc
Ethyl Cellulose	2.7	.007	60 ~
	2.6	.012	1 Kc
	2.0	.015	1 Mc
Phenol Formaldehyde (Laminated) ...	4-6	.02-.05	60 ~
	4-7	.03-.05	1 Kc
	4-8	.03-.06	1 Mc
Phenol Formaldehyde (Cast)	5-10	.025-.02	60 ~
	5-8	.005-.08	1 Kc
	5-8	.01-.04	1 Mc
Cellulose Acetate	3-6	.02-.07	60 ~
	4-6	.03-.08	1 Kc
	4-4.8	.06-.08	1 Mc
	5-5.3	.08	10 Mc
Vinyl Chloride and Copolymers	4-6	.03-.09	60 ~
	4-7	.04-.14	1 Kc
	4.5-6.5	.04-.10	1 Mc
Urea Formaldehyde (Wood Flour filled)	6.6	.03	60 ~
	6.2	.02	1 Kc
	5.5	.03	1 Mc
	5.4	.04	10 Mc
Phenol Formaldehyde (Wood Flour filled)	4.8-11	.04-.03	60 ~
	4-9	.04-.018	1 Kc
	4-8	.035-.012	1 Mc
	5-8	.073	10 Mc
Methyl Methacrylate	3.5	.07	60 ~
	3.5	.05	1 Kc
	3.0	.02	1 Mc
	2.8	.019	10 Mc
Phenol Formaldehyde	6	.058	60 ~
	5.8	.05	1 Kc
	5.8	.05	10 Mc
	5.4	.048	30 Mc
Cellulose Nitrate	7	.06-.15	60 ~
	6.2	.05-.11	1 Kc
	6.5	.06-.15	1 Mc

power factor. In this respect it is very similar to polystyrene, and polyisobutylene, another polymerised non-polar hydrocarbon C₄H₈. The dielectric properties of all the plastics can be similarly explained in terms of their chemical structure. Thus, urea-formaldehyde is not unlike phenol formaldehyde, although the urea ingredient having the less polar formula CO(NH₂)₂, confers rather better electric properties on the resin. Likewise, in the aniline formaldehyde resin we find the improved electrical properties due to the presence of the less polar structure of aniline C₆H₅ NH₂. Cellulose acetate and cellulose nitrate have highly polar structures, and therefore have high dielectric constants and power factors, but ethyl cellulose with its lower polar structure has a correspondingly lower power factor and dielectric constant.

Influence of Test Frequency

When we come to study the variations in the value of the power factor and dielectric constant with frequency we immediately find differences between the various plastics. Table III has been drawn up to illustrate these variations. From these details it will be noted that once again polystyrene is the best dielectric material. It shows practically no change in power factor and dielectric constant as the frequency is varied even over such a wide range as 60 c.p.s. to 35 Mc./s. Thus, besides having very good dielectric properties at low frequency these properties remain practically constant as the frequency is increased. Such is the quality of this synthetic material that it has been rightly described as almost "the ideal dielectric." The constancy of its dielectric properties over a wide frequency range is undoubtedly due to the absence of polar groups within its molecular structure.

In the same way we can understand why some of the plastics show regions of intense dielectric absorption. Generally speaking the curves relating power factor and frequency for plastics contain a number of maxima, and in many cases the maximum is very broad and ill-defined.

Many workers have shown that in all industrial plastics containing a cellulose filler, the "Dielectric constant *v.* frequency" curve shows a maximum at about 10 Mc/s., and this peak has been shown to disappear if the cellulose filler is replaced by a mineral filler such as mica. Many plastics show a low-frequency maximum also, which is attributed to the presence of moisture in the plastic. The introduction of a mineral filler improves the moisture resistance of the plastic, and low-loss plastics which are now commercially available are based on this type of filler. Such fillers tend to eliminate both the high and low frequency maxima, for the reasons stated above and so result in a smoother "Power factor *v.* frequency" curve. The elimination of this

low frequency maximum is also claimed by the users of a plastic containing silica gel, the basic idea being that the silica gel will absorb the moisture and although, in effect, the plastic still contains the same amount of moisture it is believed that in the "absorbed" condition the moisture is in a different "form" and thereby ceases to give rise to fluctuations in the "Dielectric constant $v.$ frequency" curve.

Finally, from the electronic engineer's point of view the variation of the dielectric constant and power factor of plastics with temperature is also of the greatest importance. The ideal dielectric is one with only a small temperature coefficient, and plastics which do not possess this quality have thereby a restricted application.

Table IV and the curves shown in Figs. I, II and III are included to illustrate how the dielectric properties of the several plastics vary with temperature. Once again it is seen (Fig. 1) that polystyrene possesses electrical properties which remain reasonably constant over a fairly wide range of temperature. Actually, from room temperature up to 70° C. there is practically no change in dielectric constant or power factor, and above 70° C. it is not customary to use polystyrene since the material begins to soften, and mouldings made from the material would certainly begin to deform if used under such conditions. It will be recalled that in part II pages 541 and 542 a material consisting of polystyrene with mica filler was described.

This material, as stated on page 542, is used in cases where temperatures higher than 70° C. are likely to be encountered since it has a softening point above 70° C. Moreover, it has been found to possess a constant value for its power factor and dielectric constant up to approximately 85° C., and in this respect it is better than the standard polystyrene. Unfortunately, the introduction of mica to the polystyrene material causes a corresponding increase in the dielectric constant and power factor, and for purposes where the extremely low value of the dielectric constant and power factor of polystyrene are essential, mica distrene cannot be used.*

Other materials which show fairly steady values of dielectric constant and power factor over a useful temperature range are polyisobutylene, polyethylene and some phenol formaldehyde resins. Polyisobutylene and polyethylene we have discussed earlier; they have similar dielectric properties, though not quite so good as polystyrene, but the phenol formaldehyde resins in general have very much larger values for dielectric constant and power factor.

Fig. 1 shows the variation of power factor with temperature at constant frequency for a series of thermoplastic resins investigated by Hartshorn, Megson and Rushton. The curves for

polystyrene and phenol formaldehyde (heat hardened) are included to demonstrate the point mentioned in the foregoing. The peak in each of the other curves for *o* cresol, *p* cresol, phenol and meta cresol) is of great theoretical and practical significance. This maximum value for the power factor at a critical temperature is paralleled by a corresponding rise in the "Dielectric constant $v.$ temperature" curve (Fig. II). It is interesting to note that Moullin and Jackson discovered a similar sort of curve (Fig. III) for chlorinated diphenyl resin and they have shown that these curves can be predicted from purely viscosity measurements on the resin. It is important to note that the position of the peak of the curve depends also on the test frequency, and in the case of Hartshorn, Megson and Rushton's investigation the workers were able to show quite definitely that a secondary rise to a maximum value occurs (Fig. 4) which is independent of frequency. They explain this by saying that it must be considered as a manifestation of normal ionic conductivity in the materials at that temperature.

Future Developments

From the essentially practical point of view all these variations in dielectric properties with frequency and temperature are a serious handicap and much research work is in progress to try and overcome these deficiencies in the resins.

Some improvements on the original materials have undoubtedly been made and a few of these have already been noted together with the probable reasons for their efficacy. Others, without doubt, will become available as work progresses.

On the theoretical side, the plastics chemist and research worker is beginning to appreciate and understand the causes underlying these apparent electrical defects of plastics. Thus, Hartshorn, Megson and Rushton suggest that the fluctuations they observed in the thermoplastic resins are due almost entirely to the presence of (OH)

polar groupings in the resin macromolecules, since the fluctuations are almost directly proportional to the concentration of hydroxyl groups in the resin. These workers believe that the dielectric properties of the resins (and probably of other plastics) are also in some way related to the ordinary mechanical and physical properties of the materials. And in this connexion, it is interesting to recall that Moullin and Jackson were able to predict the "Power factor $v.$ frequency curve" for chlorinated diphenyl resin from measurements on the viscosity of the resin.

It would seem that we are on the threshold of new discoveries of immense importance both to the electrical engineer and to those workers whose primary interest lies in purely constructional materials, in which sound mechanical properties are desired.

The studies of purely mechanical properties and of electrical properties of plastics are rapidly merging into one another and without doubt this transformation will result in benefits to the advantage of both, and will lead to the earlier fulfilment of the condition pictured in that somewhat trite phrase "the production of plastics with predetermined properties."

Acknowledgments

In concluding this series of articles on Plastics in the Radio Industry, the authors wish to thank their respective companies, Messrs. B.X. Plastics and Messrs. Hallex, Ltd., for permission to reproduce the information and photographs contained therein, and also acknowledge with thanks the help that they have received from many friends in the industry. They once more express regrets that several products may have been inadvertently remained unnoted.

* (Errata) In Part II, page 541, Distrene with Mica filler was also described. It should be noted that the mica filler is introduced to improve the heat resistance of the distrene and not, as stated on page 541, to improve the electrical properties.

¹ The Testing of Urea Plastics: W. Blakey, *Chemistry and Industry*, Feb. 1937.

² Plastics and Electrical Insulation: Hartshorn, Megson and Rushton, *I.E.E.* Vol. 83, No. 502, p. 474.

TABLE IV
VARIATION OF DIELECTRIC CONSTANT AND POWER FACTOR OF SOME PLASTICS WITH TEMPERATURE

Material	Dielectric Constant (κ) or Power Factor ($\tan \delta$)		Remarks
Ethyl Cellulose ...	$\kappa = 2.6$ at 20° C.	$\kappa = 2.9$ at 100° C.	Slight increase with temperature
Catalin (American Electric Grade)	$\tan \delta = .017$ at 30° C.	$\tan \delta = 0.20$ at 80° C.	Increases with temperature
Aniline Pure Resin Formaldehyde	$\tan \delta = .005-0.02$ at 20° C.	$\tan \delta = .02-.05$ at 90° C.	Increases with temperature
Polyisobutylene ...	$\tan \delta = .0004$ at 20° C.	$\tan \delta = .0004$ at 85° C.	Constant

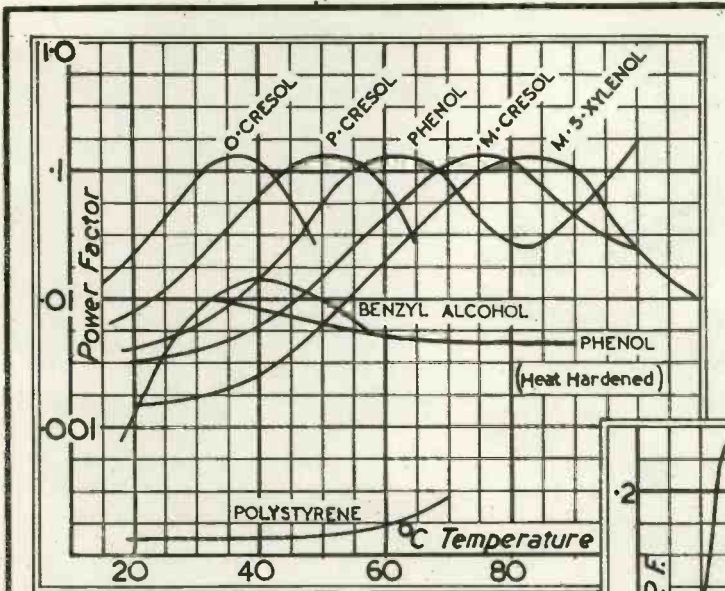
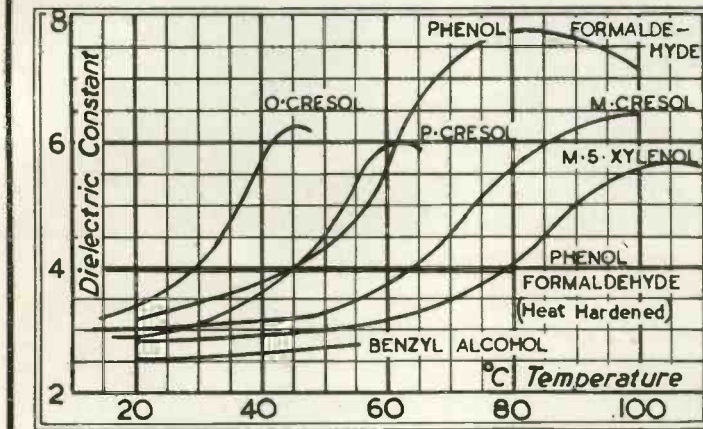
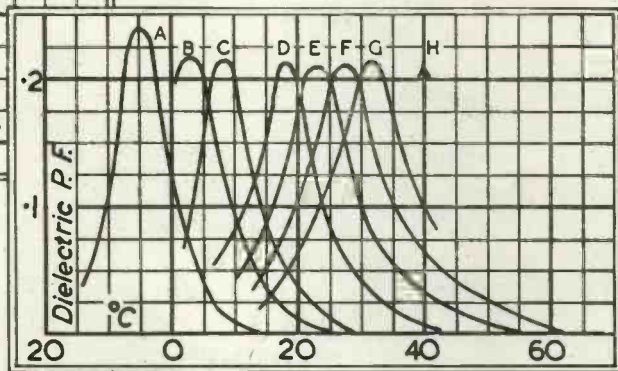

Fig. 1 (left). Variation of Power Factor with Temperature of some thermo-plastic resins. For comparison a curve of heat-hardened phenol-formaldehyde resin is included.
(After Hartshorn, Megson & Rushton)

Fig. 3 (below). Power factor variation with Temperature for a chlorinated diphenyl resin. The effect of varying the frequency is also shown (see chart below curve).
(After Moullin & Jackson)



FREQUENCY VALUES IN C.P.S.

CURVE III		
A	50	E $2.95 \cdot 10^5$
B	10^3	F $9.5 \cdot 10^5$
C	$6 \cdot 10^3$	G $2.75 \cdot 10^6$
D	10^5	H $1.09 \cdot 10^7$

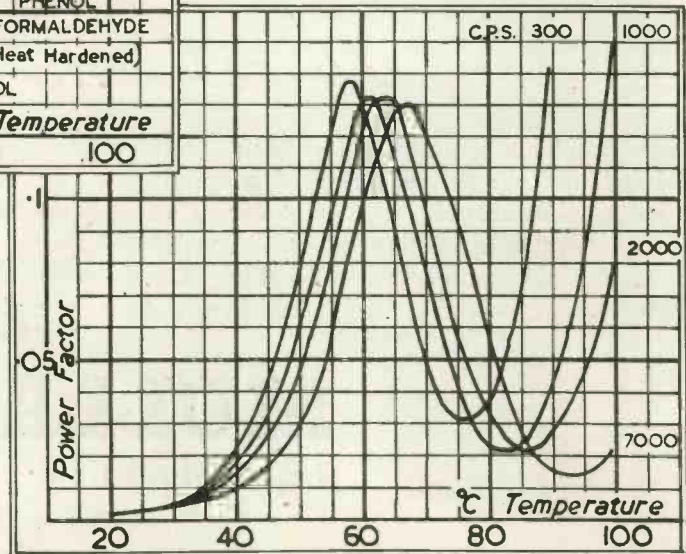
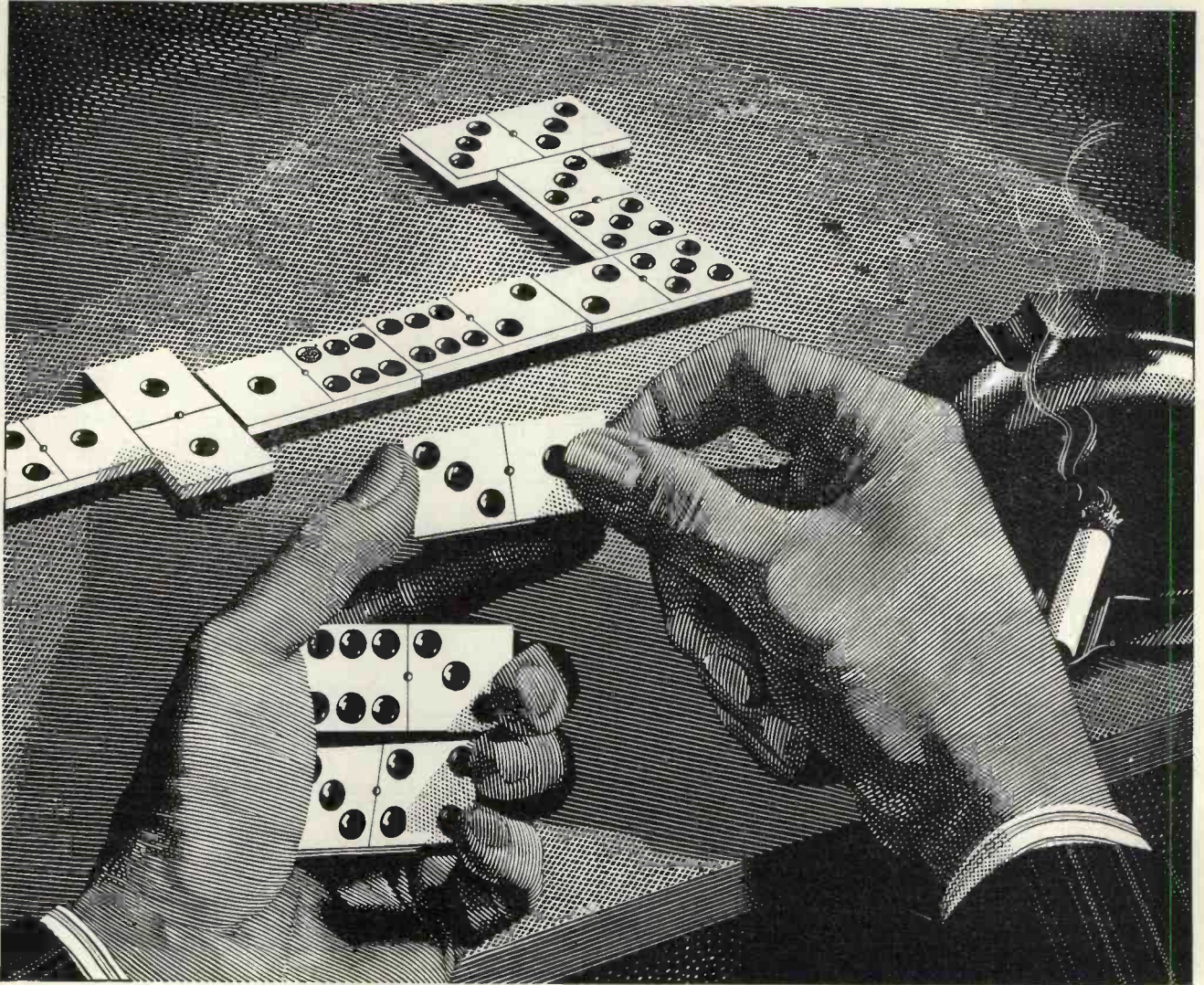

Fig. 2 (above). Variation of Dielectric Constant with Temperature of the resins shown in Fig. 1.
(After Hartshorn, Megson & Rushton)

Fig. 4 (right). The influence of test frequency on the Power-factor Temperature curve for a thermo-plastic resin. Note the rise to a secondary maximum as the temperature increases beyond 80 deg. C.
(After Hartshorn, Megson & Rushton)



Threes and Fives

If the problems of to-day, and their solution, followed the simple sequence of a game of dominoes, life would be comparatively easy. But we move in a bustling world. A world of constant change and ever-quickenning tempo where . . . it isn't all 'threes and fives'. So,

in the unceasing search for new developments, and the restless urge for faster progress, Mullard technicians are overcoming many difficulties . . . and the results of their labours will be truly appreciated in the years which lie ahead.

MULLARD

THE MASTER VALVE

TRANSMITTING AND RECEIVING VALVES FOR COMMUNICATIONS · BROADCASTING
TELEVISION · SOUND AMPLIFICATION · ELECTRO - MEDICAL EQUIPMENT · INDUSTRIAL EQUIPMENT

THE MULLARD WIRELESS SERVICE CO. LTD., CENTURY HOUSE, SHAFTESBURY AVENUE, LONDON, W.C.2.

SUPPLEMENTARY TO DATA SHEETS XXIII—XXV.

The Shunt Loaded Tuned Anode Circuit

By C. E. LOCKHART

A detailed study of the performance of the shunt loaded parallel-tuned circuit in wide band tuned-anode amplifiers

WHILE the tuned transformer type of intervalve coupling for H.F. Amplifiers provides a greater gain with improved stability,¹ the tuned-anode type of coupling is still used extensively due to its simplicity and cheapness (particularly when an amplifier is required to cover a range of wavelengths). It is the object of this article first to analyse the general performance relations governing this type of circuit and then to provide a set of curves from which the performance of any individual circuit may be rapidly obtained. For simplicity the effect of feed-backs (Miller, etc.) will be neglected. Fig. 1 illustrates a typical stage of a wide band tuned-anode amplifier. In practice the tuned circuits of such an amplifier may be all tuned to one frequency or staggered to provide the required response. Fig. 2 shows the equivalent of the anode tuned circuit, where C represents the total tuning capacity including all strays. The resistance R represents the total resistance loading in shunt with the tuned circuit. At high carrier frequencies this will consist largely of the input resistance of the following amplifier. When dealing with wide-band amplifiers it is justifiable to neglect the resistance of the inductance and condenser as both these can be made small in comparison with the required loading effect of R .

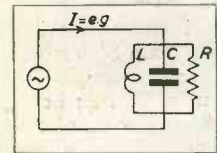

Fig. 2

The impedance Z of the circuit of Fig. 2 is given by

$$Z = \frac{1}{\frac{1}{R} + \frac{1}{j\omega L} + j\omega C} \quad (1)$$

$$= \frac{1}{\frac{1}{R} + j\omega C \left(1 - \frac{1}{\omega^2 LC}\right)}$$

Let $\omega_0^2 = 1/LC$; (2) then:

$$Z = \frac{1}{\frac{1}{R} + j\omega C \left(1 - \frac{\omega_0^2}{\omega^2}\right)} \quad (3)$$

$$= \frac{1}{\frac{1}{R} + j\omega C R^2 \left[1 - \left(\frac{f}{f_0}\right)^2\right]} \quad (4)$$

Now this can be expressed as an impedance of absolute magnitude $|Z|$ and phase angle ϕ

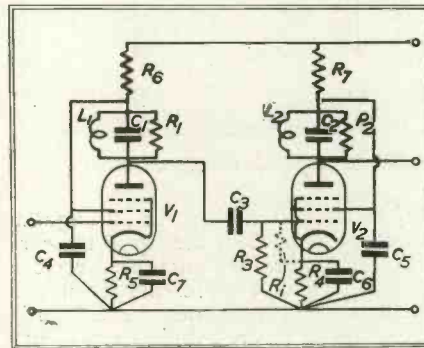

Fig. 1

$$|Z| e^{j\phi} = |Z| (\cos \phi + j \sin \phi) = \frac{R}{\sqrt{1 + \omega^2 C^2 R^2 \left[1 - \left(\frac{f}{f_0}\right)^2\right]^2}} \quad (5)$$

where

$$|Z| = \frac{R}{\sqrt{1 + \omega^2 C^2 R^2 \left[1 - \left(\frac{f}{f_0}\right)^2\right]^2}} \quad (6)$$

$$\text{and } \phi = \tan^{-1} \left\{ -\omega C R \left[1 - \left(\frac{f}{f_0}\right)^2\right] \right\} \quad (7)$$

Now when the applied frequency f is equal to f_0 the resonant frequency.

$|Z| = R$ so that we can conveniently express the performance of the circuit at any frequency f in terms of its performance at the frequency f_0 by the ratio $|Z|/R$. To make the expressions more convenient for computation we establish a new parameter $K = \omega_0 C R$. Then:

$$\frac{|Z|}{R} = \frac{1}{\sqrt{1 + K^2 \left(\frac{f}{f_0}\right)^2 \left[1 - \left(\frac{f}{f_0}\right)^2\right]^2}} \quad (8)$$

$$= \frac{1}{\sqrt{1 + K^2 \left(\frac{f}{f_0} - \frac{f_0}{f}\right)^2}} \quad (9)$$

$$\text{and } \phi = \tan^{-1} \left[-K \left(\frac{f}{f_0} - \frac{f_0}{f}\right) \right] \quad (10)$$

Stage Gain.

In the case of a tuned-anode coupling used in conjunction with a high A.C. anode resistance valve such as a pentode the stage gain will be equal to $g|Z|$ where g is the mutual conductance. We can therefore write down Relative Gain = $|Z|/R$.

$$\text{Relative Gain in db} = 20 \log \frac{|Z|}{R} \quad (11)$$

where $|Z|/R$ is given by equation (8) or (9).

With amplitude modulation we are concerned with a carrier frequency of say f_0 modulated by one or more appreciably lower frequencies. Taking the case of a modulating frequency Δf , there is produced according to normal side-band theory three frequencies, the

carrier frequency (f_0) the upper side-band ($f_0 + \Delta f$) and the lower side-band of frequency ($f_0 - \Delta f$). We can therefore express the side-band frequencies by

$$f = f_0 \pm \Delta f \quad (12)$$

$$f/f_0 = 1 \pm \Delta f/f_0 \quad (13)$$

On Data Sheet No. 24 the Relative gain in db given by Equation (9) has been plotted against both the parameters of Equation (13), for values of K from 1 to 10.

Phase Distortion.

When considering the amplification of transients and pulse-like signals that are encountered in television reception and transmission, it is not sufficient to provide a reasonably level response in order to reproduce the original impulse faithfully, but it is necessary in addition to reduce phase distortion to a minimum.

An impulse signal consists of a large number of harmonically related voltages, the amplitudes and phase angles of which are suitably related to provide on summation the desired shape of impulse. Thus in the case of a rectangular wave the only reason that we get the very steep rise, is that at this instant all the component sine waves forming the resulting pulse are going through their zero amplitude point together and are all rising in amplitude. If the phase relations of the component sine waves is upset for any reason, so that they do not all pass through zero amplitude at the same instant or that at that point they are not all about to rise or fall together, then the sharpness of the pulse will be destroyed and the flat top to the pulse no longer obtained.

From the above it will be seen that in order to pass an impulse without distortion it is essential that all its component frequencies should take an equal amount of time to travel through the amplifier chain. The absolute value of time taken for transit through the amplifier is however immaterial.

Now expressions (7) and (10) give the phase angle of the tuned-anode circuit impedance $|Z|$, where the phase angle expresses the angle by which the current through the circuit leads or lags behind the voltage across the circuit. The current leads the voltage when ϕ is negative and lags when ϕ is positive.

If we consider a carrier frequency f_0 modulated by a frequency Δf then, we can represent the three resultant frequencies by three vectors all rotating in an anticlockwise direction (Fig. 3a).

¹ "Figure of Merit of H.F. Valves," C. E. Lockhart, E. & T.S.W.W., March, 1941.

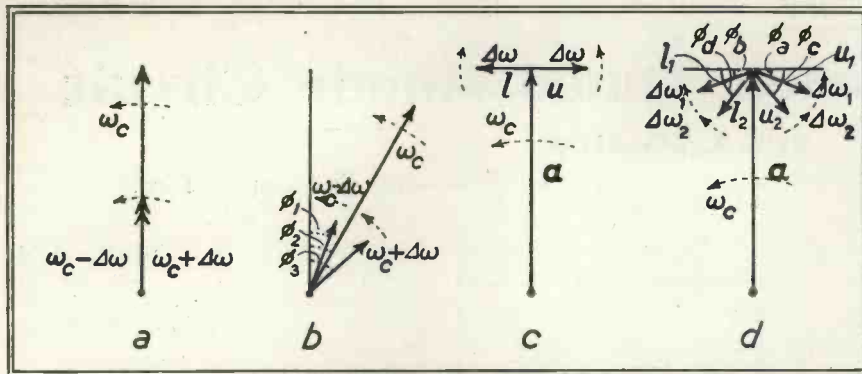

Fig. 3. Vector relations of carrier and sidebands in amplitude modulated wave.

The upper side-band will be rotating at an angular velocity $(\omega_c + \Delta\omega)$ radians per second the carrier at ω radians p.s. and the lower side-band at an angular velocity $(\omega_c - \Delta\omega)$ radians p.s. Consider the instant when at the grid of the amplifier all the three voltage vectors are coincident (peak of carrier envelope): then after passing through the amplifier stage the upper side-band output voltage vector with respect to the anode current may have been displaced by an angle of say $(-\phi_3)^*$ the carrier output voltage vector by $(-\phi_2)$ and the lower side-band output voltage vector by $(-\phi_1)$ where $\phi_1 > \phi_2 > \phi_3$. Fig. (3b). For any frequency $f = \omega/2\pi$ it will take $1/\omega$ seconds for the vector to complete one revolution, so that an angular displacement of φ radians will take

$$t = \phi/\omega = \phi/2\pi f \text{ secs.} \quad \dots \quad (14)$$

In the above example, the upper side-band vector at the output of the amplifier, which has been shifted $(\phi_3 - \phi_2)$ radians with respect to the carrier, will take

$$t = \frac{-(\phi_3 - \phi_2)}{(\omega_c + \Delta\omega) - \omega_c} = \frac{-(\phi_3 - \phi_2)}{\Delta\omega} \text{ seconds} \quad \dots \quad (15)$$

before it catches up and again becomes coincident with the carrier vector. The upper side-band vector is therefore said to have been time-delayed by "t" seconds with respect to the carrier.

Similarly the lower side-band will have been shifted $(\phi_1 - \phi_2)$ radians with respect to the carrier and it will take the carrier vector

$$t = \frac{-(\phi_1 - \phi_2)}{-\Delta\omega} \text{ seconds} \quad \dots \quad (16)$$

to catch up with the lower side-band vector.

A more usual way of illustrating the vector relations discussed above is shown in Fig. 3c. Here we have a carrier vector a rotating in an anti-clockwise direction with an angular velocity

ω_c . Rotating with and at an angular velocity of $\Delta\omega$ about the tip of the carrier vector a are two additional vectors u and l, where u represents the upper side-band which rotates in an anti-clockwise direction, while l represents the lower side-band which rotates in a clockwise direction. The projection on the vertical axis of the summation of the three vectors represents the instantaneous amplitude of the carrier. As in the majority of cases we are only interested in the envelope of the carrier, we can consider the carrier vector as stationary (provided $\omega \gg \Delta\omega$) from the point of view of the summation. In Fig. 3c the position of the side-band vectors represents the instant when all of the infinite number of harmonic components of a rectangular modulating pulse are passing through zero amplitude (the side-bands are neither adding to the height or subtracting from the height of the carrier vector). If we now apply to the input of an amplifier possessing some phase shift the wave shown in Fig. 3c, the output might be of the form shown by the vectors in Fig. 3d. Only four of the side-bands are shown for simplicity and these are produced by two modulating frequencies $\Delta\omega_1$ and $\Delta\omega_2$. The upper and lower side-band vectors u_1 and l_1 produced by the modulating frequency $\Delta\omega_1$ are shown shifted in the amplifier by angles of $(-\phi_a)$ and $(+\phi_b)$ with respect to the carrier.† Similarly the side-bands u_2 and l_2 of the modulation

† Here $-\phi_a$ is equivalent to the $(\phi_3 - \phi_2)$ shift and ϕ_b equivalent to the $(\phi_1 - \phi_2)$ shift in the previous example Fig. 5a.

$\Delta\omega_2$ are shifted by angles of $(-\phi_c)$ and $(+\phi_d)$.

Each of the side-band vectors will take $t = \phi/\Delta\omega$ seconds ... (17)

before it again reaches the horizontal position, and it has therefore been delayed by that time in its transit through the amplifier. Now for distortionless reproduction we require

$$t = \frac{-\phi_a}{\Delta\omega_1} = \frac{+\phi_b}{-\Delta\omega_1} = \frac{-\phi_c}{\Delta\omega_2} = \frac{+\phi_d}{-\Delta\omega_2} = \frac{-\phi_e}{\Delta\omega_3} \quad \dots \quad (18)$$

which implies that ϕ_a must equal ϕ_b and ϕ_2 must equal ϕ_d as well as that

$$\phi_a/\phi_c = \Delta\omega_1/\Delta\omega_2 = \phi_b/\phi_d \quad \dots \quad (19)$$

This last requirement implies that the phase angle must bear a linear relationship to frequency (i.e., the slope of the phase angle versus frequency curve must be a constant which is equal to the time delay). If ϕ_a is not equal to ϕ_b or ϕ_c is not equal to ϕ_d then in addition to distortion, phase modulation of the carrier will be present. The same effect will be introduced if the amplitudes of the upper and lower side-bands are not equal.

The phase angle as given by equation (10) has been plotted on Data Sheet No. 23. The shape of the phase angle-frequency curve is shown in Fig. 4; however, in order to double the scale of the ordinates, the region of negative phase angles (i.e., $+\Delta f$) has been folded back in Data Sheet No. 23.

As it is much easier to observe the presence of phase distortion as a variation in time delay rather than as a deviation from a constant slope of the phase angle-frequency curve, a time delay characteristic has been plotted on Data Sheet No. 25. It will be realised from the preceding discussion that the time delay characteristics (except in the case of constant time delay) must depend on the relative value of the carrier frequency f_c to the resonance frequency f_o . In the case of Data Sheet 23 the condition of $f_c = f_o$ has been taken. Under these conditions the phase-shift of the carrier frequency is zero and equations (15) and (16) may be combined in the following form by the use of (10) (12) and (13).

$$= \frac{\tan^{-1}\{-K(f/f_o - f_o/f)\}}{2\pi(\pm \Delta f)} \quad \dots \quad (20)$$

$$= \frac{\tan^{-1}\{-K[I \pm \Delta f/f_o - (I \pm \Delta f/f_o)^{-1}]\}}{2\pi(\pm \Delta f)} \quad \dots \quad (21)$$

where Δf is given a + sign for the upper side-band and a negative sign for the lower side-band. To make the curves universal we actually plot the function

$$f_o t = \frac{\tan^{-1}\{-K[I \pm \Delta f/f_o - (I \pm \Delta f/f_o)^{-1}]\}}{2\pi(\pm \Delta f/f_o)} \quad \dots \quad (22)$$

* In the case of a pentode the anode current and therefore the current through Z will be in phase with the applied grid voltage.

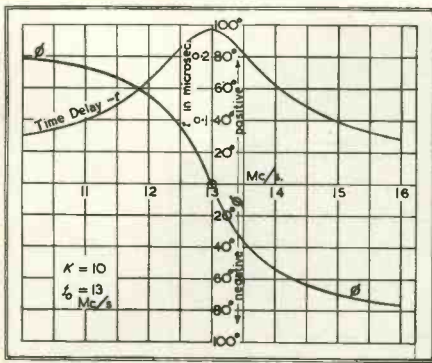

Fig. 4. Phase angle and time-delay characteristics of shunt loaded tuned circuit for a resonant frequency of 13 Mc/s.

which is the expression plotted on Data Sheet No. 25. (If f_c is not equal to f_0 , t would have to be plotted directly from (20) with Δf expressing the frequency deviation from f_c). When $f_0 t$ is negative, t is negative and this represents a time delay. The curves show reasonably constant time delays only for low values of $K = \omega_0 CR$ (unless $\Delta f/f_0$ is kept small), which condition also provides least side-band attenuation. At first sight it might appear that a much higher gain for a given band-width and distortion might be obtainable by the use of a high carrier frequency f_0 (i.e., $\Delta f/f_0$ small). This, however, is not the case as the gain is a direct function of R , so that for a fixed value of R an increase in f_0 will result in a direct increase in K . As a result the gain is almost independent of the value of f_0 (provided $\Delta f/f_0$ is reasonably small). It will be shown in next month's Data Sheet that

$$R = \frac{n}{2\pi C \cdot 2\Delta f}$$

where n is a function of the permissible maximum side-band attenuation ($n = 1$ for -3db) and $2\Delta f$ the total pass band required.

As an example of the use of the Data Sheets curves of Relative gain in db, Phase Angle and Time Delay have been plotted here and on the next page for frequencies of $f_0 = 45 \text{ Mc/s}$ and $f_0 = 13 \text{ Mc/s}$.

It should be realised when comparing these curves that for a given gain the K values on the 13 Mc/s curves, should be compared with $45/13 K = 3.46K$ values on the 45 Mc/s curves. Thus a $K = 1$ curve on the $f_0 = 13 \text{ Mc/s}$ Sheet should be compared with a $K = 3.46$ condition on the $f_0 = 45 \text{ Mc/s}$ Sheet. It should also be noted that in order to obtain a sufficient spacing between the Time Delay curves of the $f_0 = 45 \text{ Mc/s}$ Sheet the t scale has been doubled. The two sets of curves may be used at other resonant frequencies provided the time delay scale is divided by the ratio of the resonant frequency employed. Thus we can double the frequency scale the ordinates on the 13 Mc/s curves making $f_0 = 26 \text{ Mc/s}$ provided the time delay ordinates are halved.

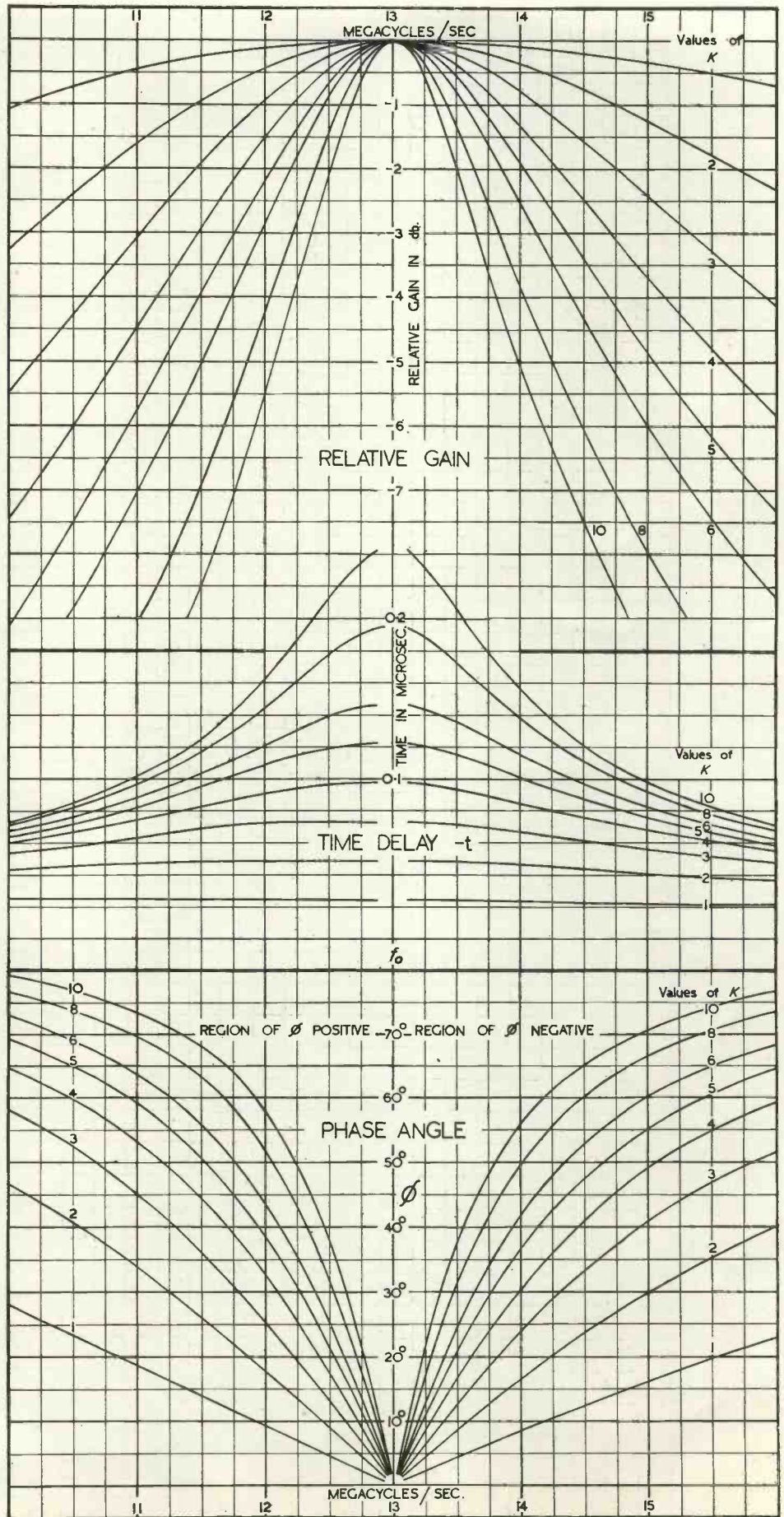

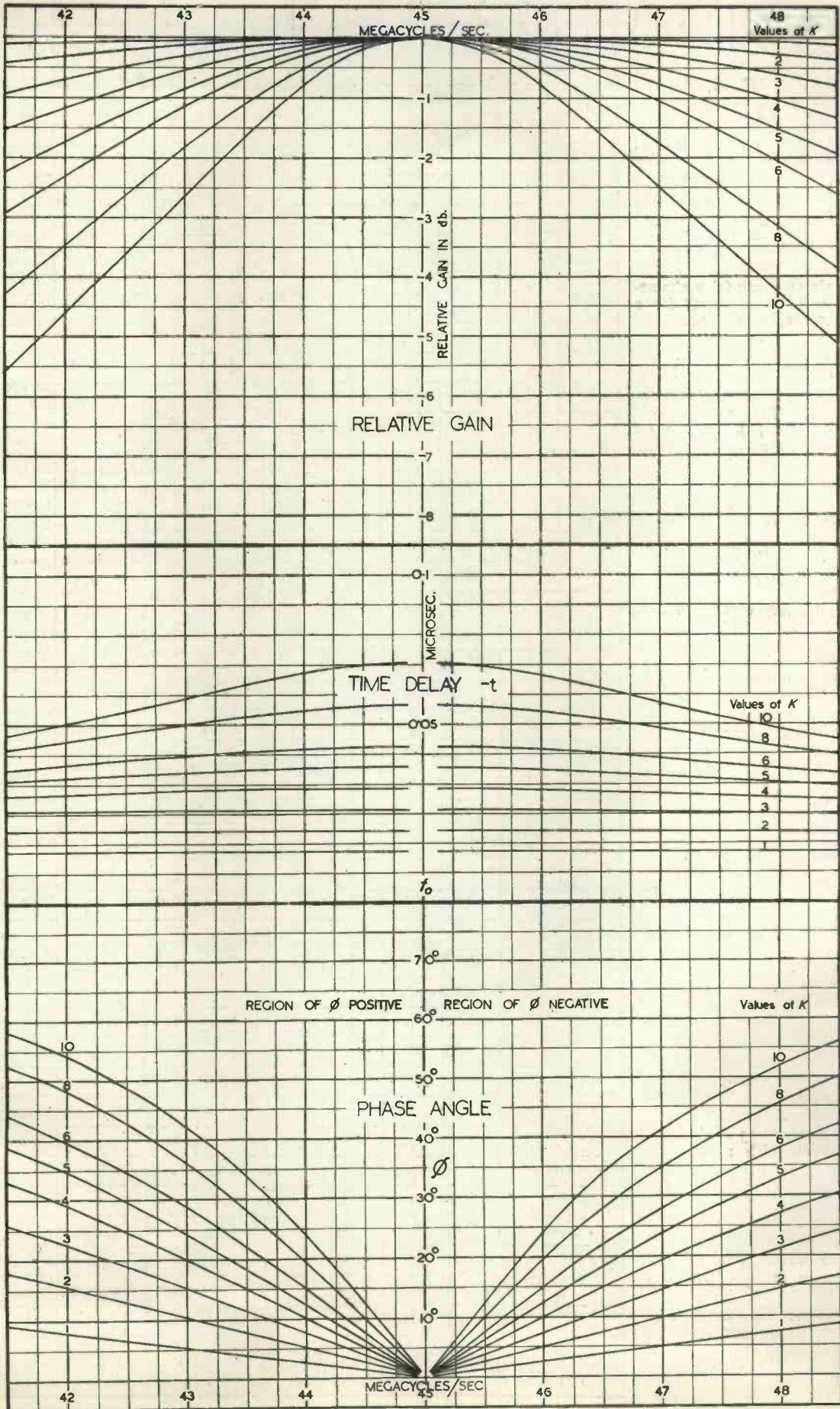

DATA SHEETS XXIII, XXIV and XXV

Performance of the Shunt Loaded Tuned Anode Circuit

SUPPOSE it is desired to investigate the gain obtainable and the shape and magnitude of the phase angle and time delay versus frequency curves for a tuned anode coupled stage consisting of a pentode with a mutual conductance of 8.0 mA/volt and a total capacity across the anode circuit of 30 μ F. A total pass-band ($2\Delta f$) of 2.6 Mc/s is required at a carrier frequency of 13 Mc/s and a maximum attenuation of 3db will be acceptable.

a. Value of R.

From equation (23) we have

$$R = \frac{I}{2\pi C \cdot 2\Delta f} = \frac{I}{2\pi \times 30 \times 10^{-12} \times 2.6 \times 10^6} = 2040 \text{ ohms.}$$

which gives a stage gain of $2040 \times 8 \times 10^{-3} = 16.3 = +24.25\text{db.}$

b. Value of K.

We can get the value of K from either $K = \omega_0 CR$... (1) or from the relation that for a 3db attenuation at the extremities of the pass band :

$$\frac{2\Delta f}{f_0} = \frac{1}{K} \dots (2)$$

using (1) we have

$$K = \frac{2\pi \times 13 \times 10^6 \times 30 \times 10^{-12}}{2.04 \times 10^3} = 5.$$

c. Relative Gain in db.

We can now plot a curve of relative gain against frequency. For this purpose express the applied frequency in terms of either f/f_0 or $\Delta f/f_0$. In the attached table the value of f has been

SYMBOLS

L = Inductance of tuned circuit in henries.

C = Total Capacity of tuned circuit in henries.

R = Total Resistance in parallel with circuit (ohms).

Z = Impedance of circuit
 $= R_1 + jX_1$ where R_1 is the resistive component and X_1 the reactive component of the Impedance.

|Z| = Absolute magnitude of impedance
 $= \sqrt{R_1^2 + X_1^2}$.

ϕ = Phase angle of circuit, i.e., angle by which the current through the circuit leads (ϕ -ve) or lags (ϕ +ve) on the voltage across the circuit
 $= \tan^{-1} \left(\frac{X_1}{R_1} \right)$.

f_0 = Resonant frequency = $\frac{1}{2\pi\sqrt{LC}}$
 $= \frac{\omega_0}{2\pi}$.

f = Applied frequency = $f_0 \pm \Delta f$.

Δf = Frequency deviation of applied frequency from f_0 .

K = $\omega_0 CR = 2\pi f_0 CR$.

-t = Time delay of side band frequency $f_0 \pm \Delta f$ relative to carrier frequency f_0
 $= \frac{\pm \phi \text{ radians}}{2\pi(\pm \Delta f)} = \frac{\pm \phi^\circ}{360^\circ(\pm \Delta f)}$ seconds.

tabulated in the first column, while f/f_0 and $\Delta f/f_0$ are given in the second and third columns respectively. From the values of f/f_0 or $\Delta f/f_0$ it is now possible to read the relative gain from Data Sheet No. 24. The values so obtained are given in the third column.

d. Values of the Phase Angle.

In a similar manner the phase angle ϕ in degrees can be read off Data Sheet No. 23.

e. Values of Time Delay.

To obtain the Time Delay we can either use the expression

$$t = \frac{\phi^\circ}{360^\circ \Delta f} \dots (3)$$

where ϕ and Δf are given their appropriate signs (positive or negative) or alternately read off ($f_0 t$) directly from Data Sheet No. 25 and then obtain t by dividing by $f_0 = 13 \text{ Mc/s}$. All the ordinates of $f_0 t$ in Data Sheet No. 25 are negative, representing a time delay. The values of ($f_0 t$) have been tabulated in the sixth column of the table and the time delay $-t$ expressed in microseconds in the last column.

The value of $f_0 t$ at the carrier frequency f_0 is given by

$$f_0 t = \frac{-K}{\pi} = -2 f_0 CR \dots (4)$$

or $t = -2CR$ seconds ... (5)

The results shown on the Table together with similar calculations for other values of K are shown by the series of curves on the centre spread pages.

If the carrier is not equal to f_0 the time delay characteristics will have to be calculated from the phase curves as discussed in the main part of the article.

TABLE

$f_0 = 13 \text{ Mc/s} \quad K = 5$

f Mc/s	$\frac{f}{f_0}$	$\frac{\Delta f}{f_0}$	Relative gain db	ϕ°	$f_0 t$	Time Delay $-t \mu s$
16.0	1.231	+0.231	-7.3	-64.5°	-0.77	0.059
15.5	1.1925	+0.1925	-6.16	-60.5°	-0.87	0.067
15.0	1.1538	+0.1538	-4.85	-55°	-0.99	0.076
14.5	1.1153	+0.1153	-3.37	-47.5°	-1.15	0.089
14.0	1.0769	+0.0769	-1.92	-36.5°	-1.315	0.101
13.5	1.0385	+0.0385	-0.57	-21°	-1.5	0.115
13.25	1.01925	+0.01925	-0.15	-10.7°	-1.57	0.121
13.0	1.0	0	0	0	-1.59	0.122
12.75	0.98075	-0.01925	-0.16	+11.3°	-1.58	0.121
12.5	0.9615	-0.0385	-0.65	+21°	-1.545	0.119
12.0	0.9231	-0.0769	-2.18	+38.5°	-1.4	0.109
11.5	0.8847	-0.1153	-3.93	+50.7°	-1.23	0.095
11.0	0.8462	-0.1538	-5.76	+59.3°	-1.07	0.082
10.5	0.8075	-0.1925	-7.5	+65°	-0.935	0.072
10.0	0.769	-0.231	-9.15	+69.3°	-0.83	0.064

Electronic Engineering

DATA SHEET

No. 23

THE PHASE ANGLE OF A SHUNT LOADED TUNED CIRCUIT

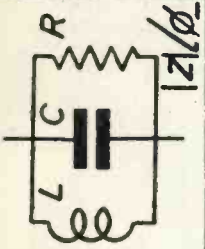

$$\phi = \tan^{-1} \left[-K \left(\frac{f}{f_0} - \frac{f_0}{f} \right) \right]$$

where

$$K = 2\pi f_0 CR$$

$$f_0 = \frac{1}{2\pi\sqrt{LC}}$$

$$f = f_0 + \Delta f$$

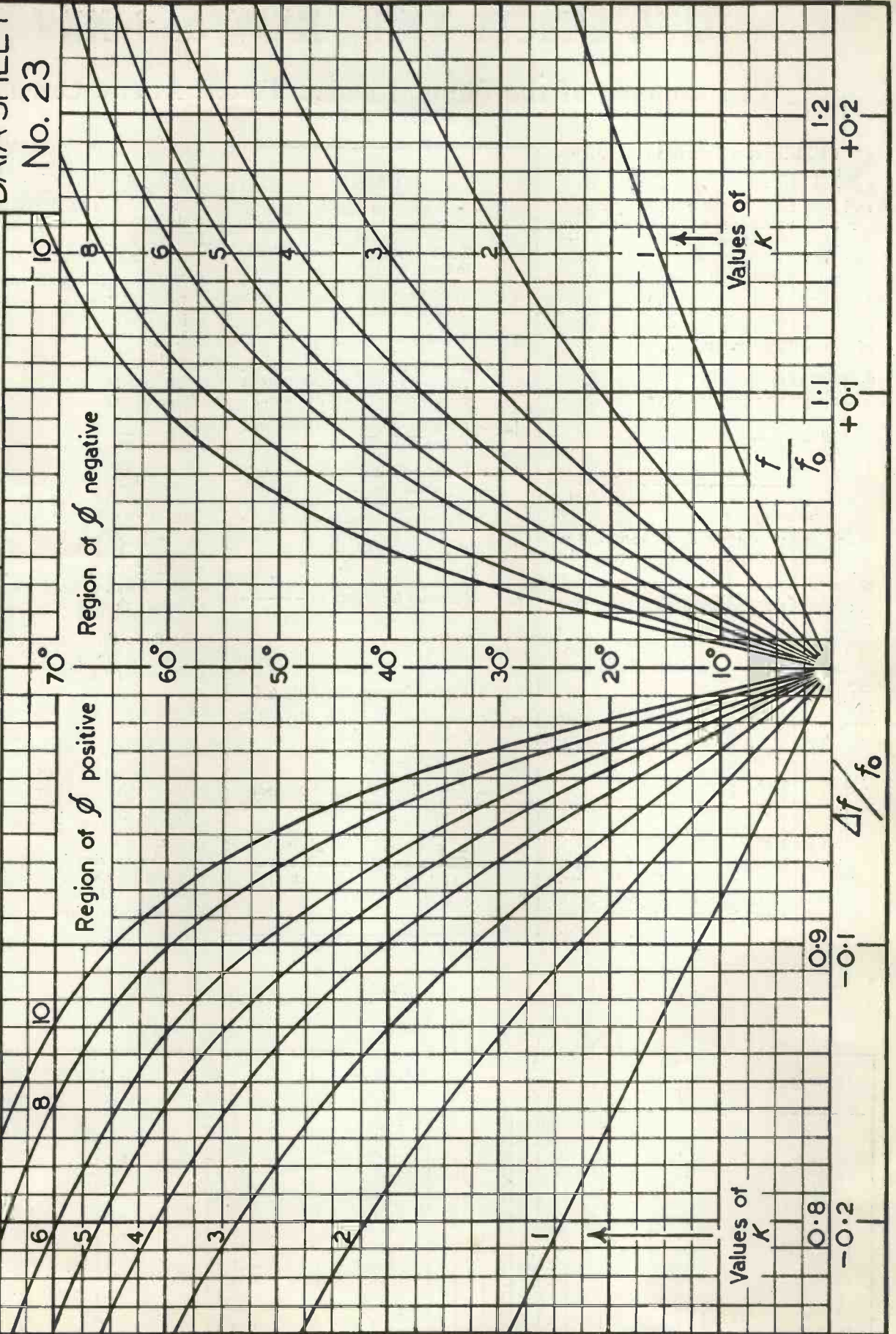

DATA SHEET No 24. THE $|z|/R$ CHARACTERISTICS OF A SHUNT LOADED TUNED CIRCUIT

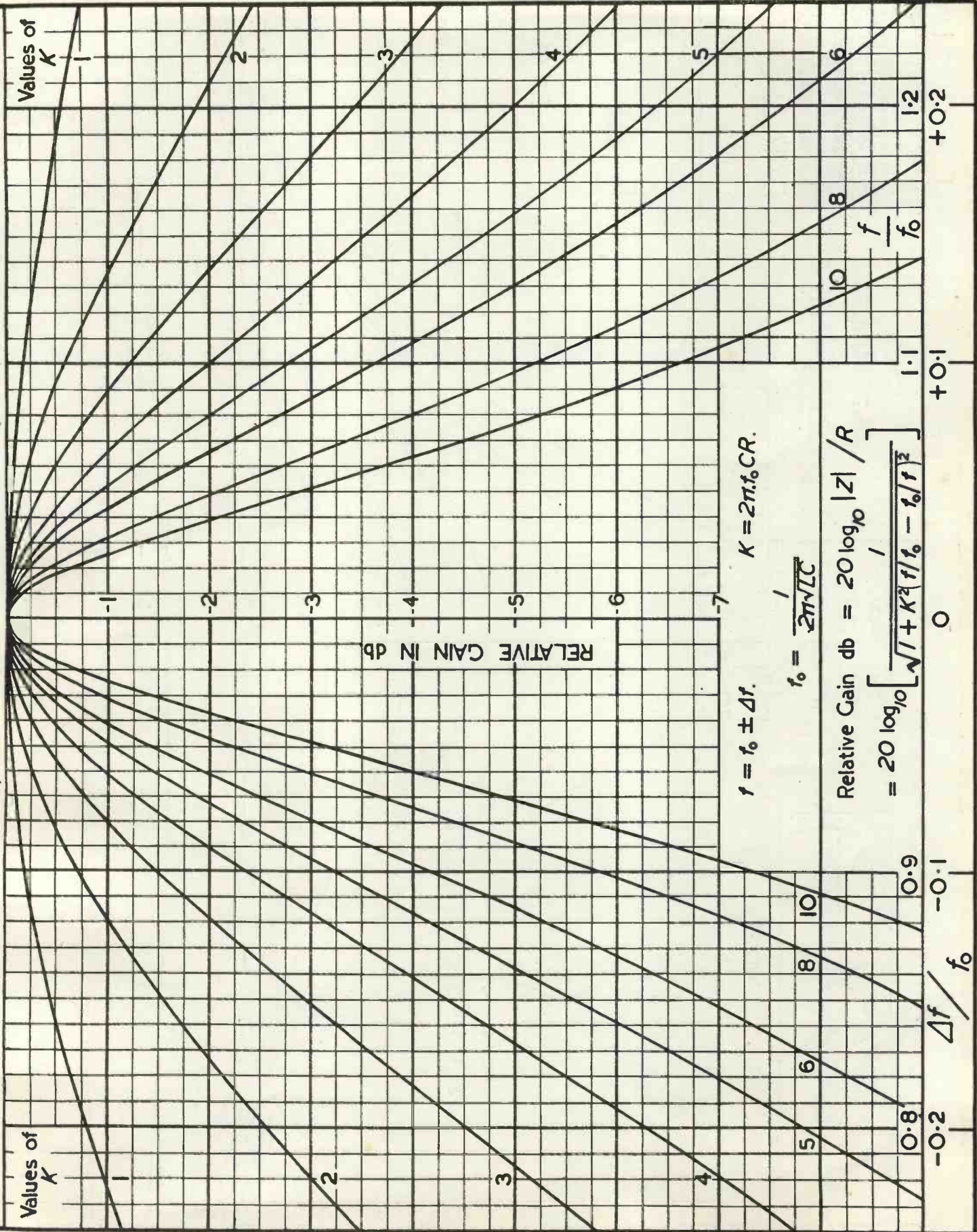

Electronic Engineering

DATA SHEET

No. 25

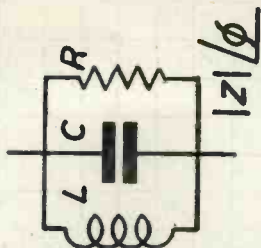

TIME DELAY OF SHUNT LOADED TUNED CIRCUIT

$$f_0 = \frac{1}{2\pi\sqrt{LC}}$$

$$f = f_0 \pm \Delta f$$

$$K = 2\pi_0 CR$$

where

$$f_0 t = \frac{\pm \phi \text{ (radians)}}{2\pi (\Delta f / f_0)} = \frac{\pm \phi}{360 (\Delta f / f_0)}$$

$$f_0 t = \frac{\tan^{-1} \left\{ -K \left(\pm \frac{\Delta f}{f_0} - \frac{1}{\pm \frac{\Delta f}{f_0}} \right) \right\}}{2\pi \left(\pm \frac{\Delta f}{f_0} \right)}$$

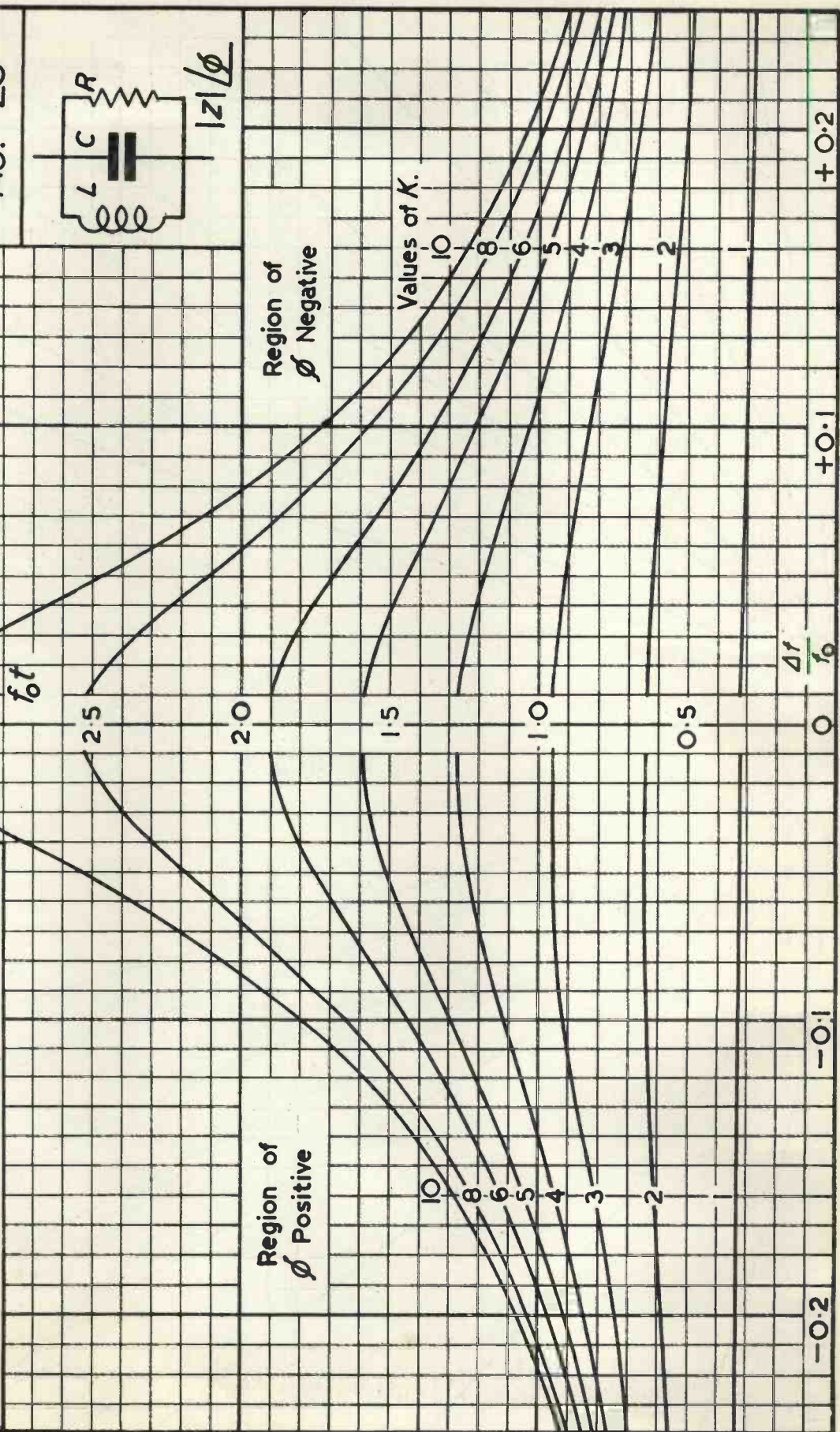

-0.2

-0.1

0

+0.1

+0.2

f_0

$\frac{\Delta f}{f_0}$

Values of K.

Region of ϕ Negative

Region of ϕ Positive



Not Much Progress

THE very pressure under which industry is working to-day renders it sometimes inevitable that methods should persist which, already barely adequate, will prove quite out of date as the war proceeds.

Not later on but now is the time to overhaul those methods, to examine the new and more efficient means of production which are available. In numberless fields of industrial activity the Simmonds Organization, after a careful study of conditions, has evolved a product which specifically solves a vital problem of design or manufacture with the complete success born of highly specialized knowledge and experience.

S I M M O N D S

THE SIMMONDS "WEEB" NUT
 SIMMONDS-CORSEY CONTROLS
 SIMMONDS CONTENTS GAUGES
 FOR AIRCRAFT.
 SIMMONDS POSITION INDICATORS
 SIMMONDS ELECTRIC TEMPERATURE
 AND PRESSURE GAUGES
 SIMMONDS AIRCRAFT FLOORING



SPIRE "WEEB" NUTS
 FRAM OIL & ENGINE CLEANER
 SIMMONDS INDUSTRIAL AND
 MARINE CONTENTS GAUGES
 SIMMONDS JOINTING COMPOUND
 SIMMONDS CRYSTAL UNITS
 SIMMONDS-GOUDIME
 NAVIGATIONAL INSTRUMENTS

SIMMONDS AEROCESSORIES LTD

A COMPANY OF THE SIMMONDS GROUP
 LONDON · MELBOURNE · PARIS · NEW YORK

Frequency Modulation

Part V.—The Frequency Modulation Receiver (Continued)

by K. R. STURLEY, Ph.D., A.M.I.E.E.

IN the previous article we considered the first three stages, the R.F. amplifier, the frequency changer, and the local oscillator, of the frequency modulation receiver and now we will describe the intermediate frequency amplifier and amplitude limiter.

The I.F. Amplifier

The actual value of the intermediate frequency must naturally first be settled. The comparatively wide pass band required (200 kcs) limits the minimum I.F. to 2 Mc/s, but the question is whether a higher value would be preferable. The lowest possible value of I.F. has advantages, greater amplification and selectivity with stability, but the possibility of spurious responses is greater. Spurious responses, generated by the frequency changer, are in order of importance.

(1) the image due to interaction between the local oscillator and an undesired signal at a frequency as much above or below the oscillator frequency as the desired signal is below or above. If image response is only likely to be serious over a given band of frequencies embracing the desired signal, it can be avoided by making the I.F. at least a half of this band, e.g., if we assume frequency modulated transmissions to cover a band from 40 to 50 Mc/s, an I.F. above 5 Mc/s will prevent image interference from transmissions in this band.

(2) oscillator harmonic response due to combinations of oscillator harmonics and undesired signals.

(3) signal harmonic response from interaction of undesired signal frequency harmonics with the oscillator fundamental.

(4) signal and oscillator harmonic combinations. Interaction between equal harmonics of both, e.g., second harmonic of signal and oscillator, is likely to be more serious than unequal harmonics since the former are nearer to the desired signal.

(5) I.F. harmonic response due to the desired signal being close in frequency to an I.F. harmonic. It is usually caused by feedback along the A.V.C. or H.T. line or by stray coupling between the limiter or detector and the aerial.

(6) direct I.F. response due to a signal at the fundamental or sub-multiple of the intermediate frequency, the latter being converted to the I.F. by the frequency changer stage.

(7) interaction between undesired signals separated by the intermediate frequency.

(8) cross modulation.

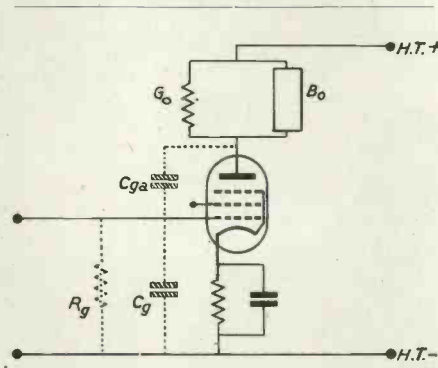

Fig. 1. Equivalent grid input admittance of a valve with grid-anode capacitance feedback.

A high value of intermediate frequency assists in reducing interference from 1, 2, 3, 4, and 7 because it removes the interfering signal further from the desired and allows R.F. selectivity to be more effective. Interference from 5 and 6 is increased by raising the intermediate frequency, but the effect of 5 can be mitigated by adequate I.F. decoupling of the limiter anode circuit, the detector-first A.F. amplifier connexion and A.V.C. line. It is not likely to be serious since the probable maximum value of I.F. (10 Mc/s) requires 4th harmonic feedback to cause interference in the 40-50 Mc/s band. Cross modulation is rarely a serious problem in the amplitude modulation receiver and Wheeler³ states that it has little interference capability in frequency modulated reception.

Since the limiter requires a certain minimum input voltage (from 2 to 5 volts) to remove amplitude variation, the gain of the I.F. amplifier must be sufficient to bring the weakest probable signal up to the limiter input minimum. In general much greater I.F. amplification is required for frequency modulation than for amplitude modulation so that the maximum intermediate frequency must be limited to that value which gives the required overall gain without approaching instability. A value between 4 and 5 Mc/s is a reasonable compromise and in subsequent calculations we shall assume an I.F. of 4.5 Mc/s. There are other methods of reducing spurious responses besides that of a high intermediate frequency: the reduction of input voltage to the frequency changer by A.V.C. on the R.F. stage and increased R.F. selectivity decreases effects from 3 and 4, whilst the reduction of oscillator voltage to the lowest level consistent with satisfactory frequency changing decreases responses from 2 and 4.

The problems to be solved in the design of the I.F. amplifier are therefore to obtain highest overall amplification with freedom from self oscillation, and level pass band with rapid attenuation outside this band. Sources of instability are input-output coupling, common impedance to the intermediate frequency in valve electrode leads normally carrying only D.C. or mains A.C. currents (anode H.T. supply, screen, grid bias, cathode and heaters) and grid-anode interelectrode capacitance. The first two can be reduced to negligible proportions by suitable shielding and decoupling circuits. Common impedance coupling can largely be eliminated by connecting decoupling condensers for each stage to a common earth point as for the R.F. amplifier. Thus we come to the basic fact that grid-anode capacitance feedback sets a limit to maximum overall amplification. This feedback effect is most conveniently specified in terms of grid input admittance and analysis shows that the input admittance is equivalent to a resistance and capacitance in parallel (Fig. 1) the approximate formulæ for which are

$$R_g = \frac{G_o^2 + B_o^2}{g_m B_o \omega C_{ga}} \quad \dots \quad (1)$$

$$\text{and } C_g = C_{ga} \left[1 + \frac{g_m G_o}{G_o^2 + B_o^2} \right] \quad (2)$$

where G_o = the conductance of the anode circuit

where B_o = the susceptance of the anode circuit

and C_{ga} = grid-anode capacitance

It should be noted that the anode susceptance B_o is positive and equal to ωC_o when the anode circuit parallel capacitance is C_o and negative (equal to $-1/\omega L_o$ when the parallel inductance element is L_o ; i.e., regeneration occurs when the anode circuit is inductive and instability is possible, but degeneration results when the anode is capacitive. Now a parallel tuned circuit is inductive at frequencies below resonance and capacitive at frequencies above so that an amplifier having a tuned anode circuit tends to increase the amplitude of frequencies in its grid circuit below its resonant frequency and decrease those above. If, therefore, a similar tuned circuit is supplying the input signal the otherwise symmetrical overall frequency response is given an asymmetrical character with low frequencies "boosted" and high frequencies depressed as shown in Fig. 2. This distortion of the frequency response occurs before the amplifier

reaches an unstable condition and maximum usable amplification is therefore limited to a value very much less than that causing self oscillation. The actual value must be such that the minimum negative resistance component, R_g (min), of the grid input admittance is at least ten times the parallel resistance component of the grid tuned circuit if frequency distortion is to be negligible. The minimum resistance R_g is obtained by differentiating expression (1) with respect to B_o and equating to 0, from which

$$B_o = \pm G_o \dots \dots \dots (3)$$

B_o is treated as the variable since it changes rapidly in the region of resonance, from a high negative value below, through zero at resonance, to a high positive value above. G_o over the same frequency range remains practically constant and equal to the reciprocal of the dynamic impedance ($R_{DO} = \omega_r L_o Q_o$

$= \frac{Q_o}{\omega_r C_o}$, where ω_r is the resonant pulsance) of the anode tuned circuit. Hence the minimum value of resistance is

$$R_g (\text{min}) = \frac{G_o}{g_m \omega C_{ga}} \dots \dots \dots (4)$$

and this must be at least $10 \times R_{DI}$ where R_{DI} is the dynamic impedance of the input tuned circuit. If instead of single tuned circuits, we have double tuned transformers, calculation may be based on the assumption that coupling is never less than critical, and under these conditions one circuit reflects into the other a resistance equal to its initial resistance, i.e., the actual dynamic impedance is half that of one tuned circuit alone and expression 4 becomes

$$R_g (\text{min}) = \frac{2}{g_m \omega C_{ga} R_{DO}} \dots \dots \dots (5)$$

To obtain a flat frequency response over the pass band it is necessary to combine single tuned circuits with over-coupled circuits with double peaked response, the peak of the single circuit filling in the trough of the two over-coupled circuits as shown in Fig. 3.

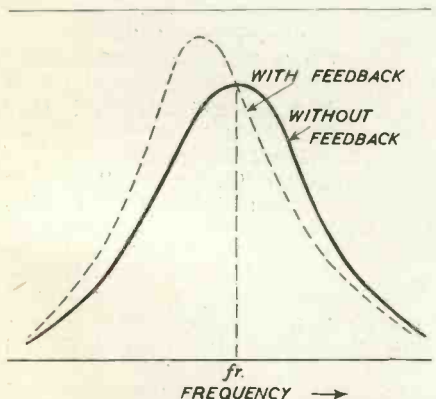

Fig. 2. Effect of grid anode coupling on the overall frequency response of an amplifier with single tuned circuits in grid and anode.

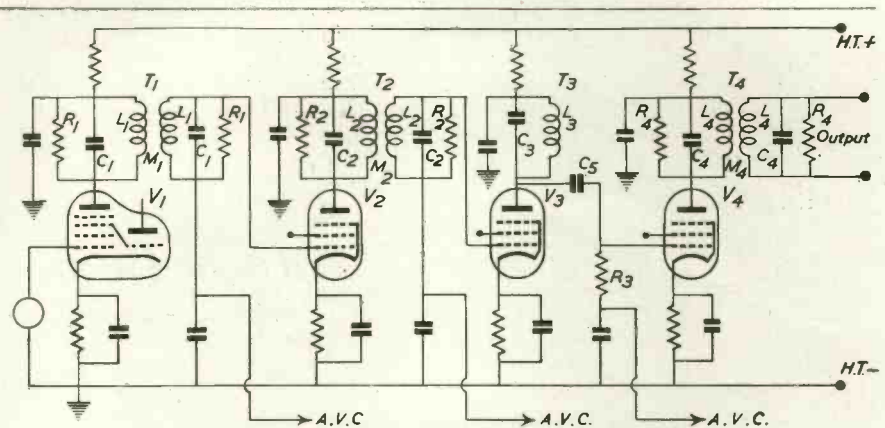

Fig. 4. Circuit diagram for a typical I.F. amplifier.

The combination of a pair of over-coupled circuits with a pair of under or critically coupled circuits with single peaked response has much the same effect and we shall use these principles in the design of the I.F. amplifier, the diagram of which is given in Fig. 4. V_1 , the frequency changer valve has a pair of critically coupled tuned circuits in its anode circuit, the first and third I.F. amplifier valves (V_2 and V_4) a pair of over-coupled circuits and the second (V_3) a single tuned circuit. Three stages of I.F. amplification are employed as this is about the minimum number for adequate gain. By using the generalised curves developed by Beatty¹ for the frequency response of single and double tuned circuits and assuming that the primary and secondary circuits of T_2 and T_4 are identical, we find that an almost flat pass band response can be obtained by combining two pairs of over-coupled circuits (T_2 and T_4) of constant $Q, k = 2$, with one pair of critically coupled circuits (T_1) of $Q, k_1 = 1$, and a single tuned circuit (T_3), where k

is the coupling coefficient ($\frac{M_1}{L_1}$ for T_1 and $\frac{M_2}{L_2}$ and $\frac{M_4}{L_4}$ for T_2 and T_4) and Q is the

magnification of one of the circuits in the absence of coupling from the other. The over-coupled circuits T_2 and T_4

$$\text{have maximum response at } \frac{Q_2 \Delta f}{f_r} = \pm 1.8$$

where Δf is the frequency off tune from f_r , the resonant or trough frequency, and the trough to peak ratio is -2db. By selecting Q_2 to satisfy the above expression when $\Delta f = \pm 100$ kc/s (the maximum frequency deviation of the frequency modulation) we have

$$Q^2 = \frac{1.8 f_r}{2 \Delta f} = \frac{1.8 \times 4.5}{0.2} = 40.5 \dots \dots (6)$$

and the two transformers T_2 and T_4 with this Q value will give a peak at 100 kc/s on either side of the central frequency or trough position, at which there is 4dbs loss. The frequency

response of the two circuits is the dotted curve 2 of Fig. 5. Similarly, if Q_1 and Q_3 are chosen to satisfy the condition

$$Q_1 = Q_3 = \frac{f_r}{2 \Delta f} = 22.5 \dots (7)$$

at $\Delta f = 100$ kc/s, we have the broken and full line curves 1 and 3 with a loss of 3 and 1 db respectively at 100 kc/s off tune, thus exactly counterbalancing the gain of 4 dbs due to T_2 and T_4 . There is not exact compensation at all frequencies in the pass band, but the variation in the overall response curve (4 in Fig. 5) does not exceed 0.7 db. Having determined the Q values of the various circuits we now have to select the L and C values to give a grid input resistance component R_g not less than 10 times the dynamic resistance of the grid circuit. In designing the amplifier we will assume that valves V_2, V_3 and V_4 are identical with $g_m = 2$ mA/volt, $C_{ga} = 0.01 \mu\mu F$ and an internal resistance $R_a \gg R_D$. Hence maximum gain is given by $g_m R_D$ and $g_m R_D/2$ for single and double tuned circuits respectively. Since $R_D = Q \omega L = Q/\omega C$ and Q is fixed by frequency response considera-

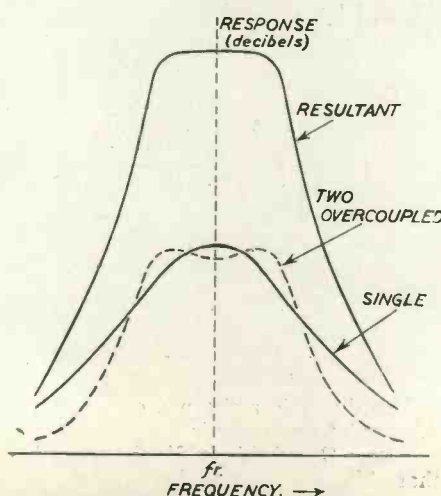

Fig. 3. Addition of the frequency response of a single and two overcoupled circuits to give a flat pass band response.

tions, it is clear that maximum gain per stage requires minimum tuning capacitance (C), which in practice is about $50 \mu\mu\text{F}$. Using this value and starting at the last I.F. amplifier, we find that $C_4 = 50 \mu\mu\text{F}$; $L_4 = 25 \mu\text{H}$, $f_r = 4.5 \text{ Mc/s}$ and from expression 6, $Q_4 = 40.5$ so that $Q_4 k_4 = 1.8$ gives $k_4 = .0445$ and $M_4 = k_4 L_4 = 1.1 \mu\text{H}$.

$$RD_4 = \frac{Q_4}{\omega_r C_4} = \frac{40.5 \times 10^{12}}{6.28 \times 4.5 \times 10^6 \times 50} = 28,700 \Omega.$$

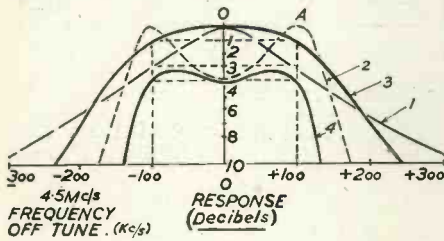

Fig. 5. Frequency response of (1) a single tuned circuit $Q = 22.5$. (2) two overcoupled circuits $Q = 40.5$, $Qk = 2$. (3) Two critically coupled circuits $Q = 22.5$. (4) Overall for (1) + (3) + 2 of (2).

Maximum gain at the frequency response peak (A in Fig. 5) is

$$G_4 (max) = g_m \frac{RD_4}{2} = 28.7$$

Expression 5 gives the minimum input resistance at the grid of V_4 as

$$R_{g4} (min) = \frac{2}{g_m \omega C_{g4} R_{D4}} = \frac{2 \times 10^{-3} \times 6.28 \times 4.5 \times 10^6 \times .01 \times 28,700}{2 \times 10^{12}} = 123,200 \Omega.$$

The dynamic impedance of T_3 must not therefore exceed $12,320 \Omega$ if the frequency response is not to be seriously affected by feedback.

$$\therefore R_{D3} = 12,320 \Omega \text{ and from } 7 Q_3 = 22.5$$

$$\text{and } C_3 = \frac{Q_3}{\omega R_{D3}} = \frac{22.5 \times 10^{12}}{6.28 \times 4.5 \times 10^6 \times 12,320 \mu\mu\text{F}} = 64.5 \mu\mu\text{F}$$

$$L_3 = 19.4 \mu\text{H}$$

$$G_3 (max) = g_m R_D = 24.64.$$

Expression 4 gives

$$R_{g3} (min) = \frac{1}{g_m \omega C_{g3} R_D} = 143,500 \Omega.$$

The dynamic resistance of the transformer T^2 secondary is $R_{D2}/2 = R_{D4}/2 = 14,350 \Omega$ and this fulfils the condition that $\frac{1}{2} R_{D2}$ shall not be greater than $R_{g3}/10 (min)$. All circuit constants are identical with those of T_4 . Hence

$$R_{g2} (min) = R_{g4} (min) = 123,000 \Omega.$$

Transformer T_1 must have a dynamic impedance not exceeding $12,300 \Omega$, i.e., $RD_1 > 24,600 \Omega$. The maximum dynamic impedance is, however, fixed for us because Q_1 is to be 22.5 and C_1 not less than $50 \mu\mu\text{F}$.

$$RD_1 = \frac{Q_1}{\omega C_1} = \frac{22.5 \times 10^{12}}{6.28 \times 4.5 \times 10^6 \times 50} = 15,900 \Omega.$$

This value of RD_1 cannot be exceeded without reducing C_1 , but as it is less than the maximum RD_1 required by feedback considerations it simply means that feedback has even less effect. The constants for T_1 are therefore

$$C_1 = 50 \mu\mu\text{F}, L_1 = 25 \mu\text{H}, Q_1 = 22.5.$$

$$M = \frac{L}{Q} = 1.11 \mu\text{H}. (Q_1 k_1 = 1),$$

$$D_1 = 15,900 \Omega.$$

$$G_1 (max) = g_c \frac{RD_1}{2}$$

where g_c = the conversion conductance of the frequency changer valve V_1 ; a suitable value is 0.3 mA/volt .

$$\therefore G (max) = 0.3 \times 7.95 = 2.385$$

The overall gain of the I.F. amplifier from the grid of V_2 is 28.7 (gain of V_2) $\times 24.6$ (gain of V_3) $\times 28.7$ (gain of V_4) divided by 1.587 (this is the ratio corresponding to the 4 db loss from peak to trough in V_2 and V_4).

$$\therefore \text{Total gain} = 12,800$$

or including the frequency changer, the gain from the grid of V_1 to the output of V_4 is $30,500$.

No attempt has been made to specify the values of the resistances R_1, R_2 , etc., shunting T_1, T_2 , etc., because they will depend on the initial Q of the coils. For example, suppose the Q of the coils of T_1 is 150, the equivalent dynamic resistance of the tuned circuit is

$$R_D = \frac{Q_c}{\omega C} = \frac{150 \times 10^{12}}{6.28 \times 4.5 \times 10^6 \times 50} = 106,000 \Omega.$$

R_1 must be such that when paralleled with $106,000 \Omega$ the total is $15,900 \Omega$.

$$\text{i.e., } R_1 = \frac{106,000 \times 15,900}{106,000 - 15,900} = 18,700 \Omega.$$

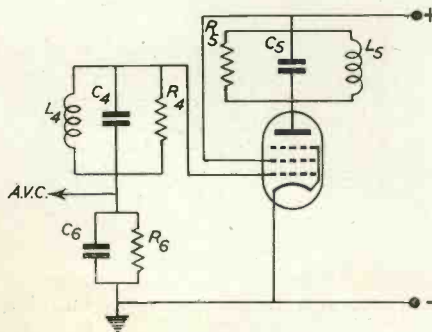

Fig. 6. An amplitude limiter circuit.

Similar procedure can be used to find R_2, R_3 and R_4 . It should be noted that R_3 is the grid leak for V_4 and that the coupling condenser C_5 ($0.001 \mu\text{F}$) is sufficiently large for R_3 to be effectively in parallel with L_5 and C_5 .

The Amplitude Limiter Stage

The limiter stage for reducing any amplitude variation of the frequency modulated carrier to negligible proportions is in essence a saturated device, the amplification of which is automatically decreased as the amplitude is increased and vice-versa so that carrier output amplitude remains practically constant. A typical circuit is shown in Fig. 6; the carrier input is detected by the $I_e E_g$ characteristic of the valve and automatic bias is produced across R_6 . Any change in carrier amplitude causes a corresponding change in bias, e.g., increase of carrier increases the negative

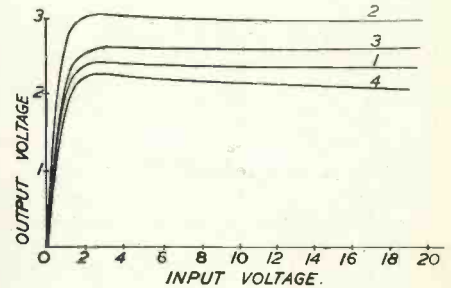

Fig. 7. Typical input-output voltage curves for an amplitude limiter.

bias across R_6 . Provided the gain of the valve to the carrier fundamental frequency is inversely proportional to the grid bias, and the bias voltage is a faithful reproduction of the amplitude modulation envelope, amplitude modulation is absent from the output. This condition can be approached by operating the valve with a low cut-off ($I_a = 0$) bias causing it to act as a Class C amplifier. Hence the valve in Fig. 6 has low voltages on screen and anode (about 40 volts). The resemblance of the limiter stage to a "leaky grid" detector may be noted; it is in fact this type of detector working under saturated conditions, with an anode circuit tuned to the carrier fundamental instead of an aperiodic circuit accepting audio frequencies. In the "leaky grid" detector the time constant of the self bias resistance R_6 and condenser C_6 must allow the bias change to follow exactly the modulation envelope and this also applies to the limiter. A suitable time constant is from 10 to 20 microseconds with $R_6 = 100,000 \Omega$ to $200,000 \Omega$ and $C_6 = 100 \mu\mu\text{F}$. If the time constant is too high the bias variation is not proportional to the amplitude modulation and if it is too low bias change is reduced and gain control compensation in-

adequate. Typical limiter input-output curves are shown in Fig. 7. The output variation is about 2.5 per cent. (curve 1) from 2.4 to 2.34 volts for a 2.0 to 20 input voltage change with $E_a = E_s = 36$ volts. Increasing E_a (curve 2) raises the output level, but does not change the general shape of the curve, whilst increasing E_s (curve 3) moves the point of level output to a higher input voltage (roughly in proportion to the increase in E_s) and tends to greater variation in output voltage. In all cases the output voltage rises to a maximum and then falls slightly as input is increased. This is due to the fact that the valve is distorting the input wave and producing more harmonic and less fundamental. The rate of fall of output is very largely controlled by R_0 , high values of which increase the rate of fall. (Compare curves 1 and 4). The tuned circuit in the anode of the limiter must bypass satisfactorily harmonics of the input voltage without appreciably affecting fundamental amplitude over the pass range from 4.4 to 4.6 Mc/s (4.5 ± 0.1 Mc/s). Reduction of the amplitude of frequencies at the edges of the pass band results in harmonic distortion of the audio frequency output from the frequency-amplitude converter detector. If the reduction is the same at each end of the pass range the distortion consists mainly of odd harmonics (3rd, 5th, etc.). It may be noted that variations of pass band response before the limiter are compensated by its action, but subsequent variations result in harmonic distortion of the audio frequency output. A suitable value of Q for the limiter anode tuned circuit is 4.5 which gives a loss of 0.1 db (representing 1 per cent. change of amplitude) at 4.6 Mc/s and a loss of 19 db (representing a reduction to 1/10 amplitude) at 9 Mc/s the second harmonic frequency. The frequency-amplitude converter circuit which follows, may constitute the anode load of the limiter, or it may have a separate valve amplifier.

Since across R_0 in Fig. 6 there is a negative voltage proportional to carrier amplitude it may be used as a source of A.V.C. for the R.F. and I.F. stages of the receiver. Overloading of the frequency changer can thus be prevented. A.V.C. of the frequency changer stage is not usually employed because of electron coupling between signal and oscillator circuits, any change of which causes oscillator frequency drift.

BIBLIOGRAPHY.

- 1 "Two Element Band Pass Filters," R. T. Beatty, *Wireless Engineer*, October, 1932, p. 546.
- 2 "Variable Selectivity and the I.F. Amplifier." W. T. Cocking, *Wireless Engineer*, March, April and May, 1936, pp. 119, 179 and 237.
- 3 "Two Signal Cross Modulation in a Frequency Modulation Receiver." H. A. Wheeler, *Proc. I.R.E.*, December, 1940, p. 537.

NOTES FROM THE INDUSTRY

X-Ray Analysis in Industry

The Institute of Physics is arranging a conference on X-Ray Analysis in Industry to be held in Cambridge on April 10 and 11 next. The purpose of the conference is to promote the interchange of knowledge and experience among those employing diffraction methods of analysis in their work and to arrange for further collaboration.

The programme includes three discussions and a lecture by Prof. Sir L. Bragg on the history and development of X-Ray analysis. Further particulars can be obtained from the Secretary of the Institute of Physics, The University, Reading, Berks.

Publicity Films

In a note on the advantages of publicity films, our contemporary *Advertiser's Weekly* points out the increasing use which is made of this form of propaganda as the available space in newspapers becomes less. The film's chief asset over the more usual forms of advertising is in its unique method of combining entertainment with good pictorial display of the goods advertised. Many people who avoid looking through the advertising pages of a popular magazine will hardly shut their eyes when an advertising film appears on the screen.

In addition to the Ministry of Information propaganda films on "Building for Victory" and "Fire Prevention" there are several examples of excellent commercial publicity film trailers to be seen—Ford Motors have made five recently and Ediswan have followed their first successful series of lighting films with three more in the "Signs of the Times" magazine film issues. Their publicity department have a high opinion of the value of this form of publicity, a view which will be shared by those who have seen the various ways in which subtle advertising can be introduced by this medium.

Taylor Electrical Instruments, Ltd.

The new address of the Instrument Sales Dept. of this firm is High Street, Slough (phone Slough 21383). It is regretted that the rising costs of materials and labour has necessitated an alteration in current prices of various instruments, and a revised list can be obtained on application. Models 60B, 60U and 60L have been temporarily withdrawn.

Hammans Industries, Ltd.

A further leaflet issued by this company describes heat-resisting rubber covered connecting wire. The covering has a free sulphur content which prolongs the life of the rubber and maintains its insulating properties for several years. Sizes of conductor range from 1/14 to 28/30 and seven colours are available in the coating.

Messrs. Alfred Imhof, Ltd.

We have recently had an opportunity of inspecting a new factory which Messrs. Imhof, the well-known gramophone and radio dealers, have opened in London for the manufacture of small radio components and metal parts.

The consultants responsible for the design and layout of the plant were Messrs. Leland Instruments, Ltd., who, it is rumoured, are contemplating enlarging their own manufacturing and service facilities.

Messrs. Imhof invite inquiries for metal pressings and metal cabinet work, which should be addressed to the company's head office in New Oxford Street, W.C.1.

"Is there an Electrical Basis for Water Divining?"

Those who had hoped to be enlightened on this subject, discussed recently at an informal meeting of the Institute of Electrical Engineers, were disappointed. In a very comprehensive digest of modern literature dealing with this subject, Mr. J. F. Shipley opened the discussion impartially. Apparently at one time or another diviners have claimed power of divination of practically every object known to man, by every possible geometrical arrangement of twig or rod. The complete lack of uniformity in methods, indicating devices, and movement of the indicator renders a scientific approach to the subject very difficult. Research work, has, however, been undertaken by at least one learned association in an endeavour to find an explanation, and the results of such work to date seem to prove beyond a doubt that the faculty of dowsing cannot be tied down to scientific theories or rules.

Why anyone should imagine that there should be any connexion between electrical theory and dowsing is difficult to understand, in the light of the discussion. Perhaps we shall soon be discussing the probability of an electrical basis for the age-long mystery of the homing instinct of the pigeon.

A technical lecture on **Harmonic Distortion in Audio Frequency Transformers** is to be delivered by Mr. N. Partridge, B.Sc., M. Brit. I.R.E., A.M.I.E.E., before the British Institution of Radio Engineers at the Federation of British Industries, 21, Tothill Street, Westminster, London, S.W.1, at 3 p.m. on **Saturday, March 7th.**

The subject matter is to be based entirely upon original research, many of the results of which are to be published for the first time on this occasion.

Professional engineers wishing to attend can obtain tickets (free of charge) from:—**The Secretary, British Institution of Radio Engineers, Duke Street House, Duke Street, London, W.1.**

Distortion in Radio Receivers

A Summary of the Chief Obstacles to Perfect Reproduction

by S. W. AMOS, B.Sc. (Hons.)

MODERN radio receivers are capable of giving a very good illusion of the original performance—good enough, in fact, to permit keen appreciation of music. But radio reproduction has not yet reached the point when it can be truthfully described as indistinguishable from the real thing, and it is the purpose of this article to enumerate the principal reasons why this is so.

All the differences between the reproduced and original performance are covered by the term distortion, which therefore has a very wide connotation, embracing in its scope the well-known effects of frequency and amplitude distortion and the not so familiar phase and scale distortion, volume compression and point source distortion. These topics and other allied phenomena will be treated in turn.

In designing radio receivers for high quality reproduction, as much, if not more, attention has to be paid to the loudspeaker itself as to all the rest of the apparatus. Accordingly distortion due to the receiver alone will be considered first and that caused by the loudspeaker subsequently.

Distortion in Receivers (excluding loudspeakers)

Frequency Distortion.

For theoretically perfect reproduction radio transmitters and receivers and all associated apparatus including microphones, loudspeakers and land-lines should be capable of handling, without appreciable attenuation, the whole of the frequency response of the average human ear, which extends from about 20 c/s in the bass to approximately 20,000 c/s in the treble. It is generally considered that the upper half of the audio-frequency spectrum is less important than the lower half, and accordingly for most apparatus designed for high quality reproduction of speech and music, a range of 30 c/s to 10,000 c/s is considered adequate. Under good conditions the human ear can appreciate a change in aural intensity of about 25 per cent., which corresponds to an increment in the logarithm of intensity of roughly 1/10, known as a decibel. It is important, therefore, to see that the amplification of all notes within this range given by all links in the broadcast chain is constant, if possible, within a decibel. If the response is not independent of frequency, then frequency distortion is present.

There are many sources of frequency distortion in a broadcast receiver: the response curve of a loudspeaker is never a straight line; the low frequency

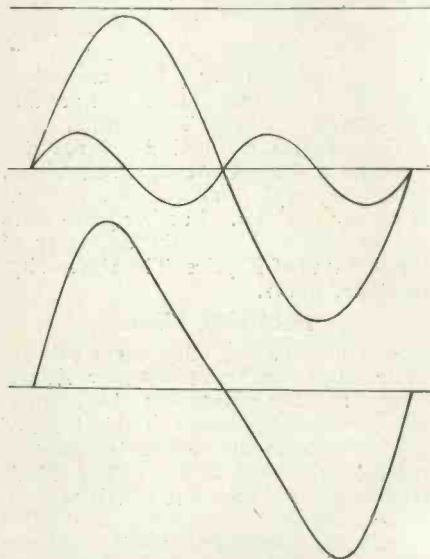

Fig. 1. The upper diagram shows two sine curves in phase, one having double the frequency and one-quarter the amplitude of the other. The lower curve shows the type of waveform obtained by adding these.

amplifier may attenuate the upper or lower register; and—one of the most fertile sources—the response of the tuned circuits in the high or intermediate frequency stages is purposely made peaked to obtain selectivity good enough to permit reasonable reception of a particular station in the congestion of signals found, say, in the medium waveband. The interests of freedom

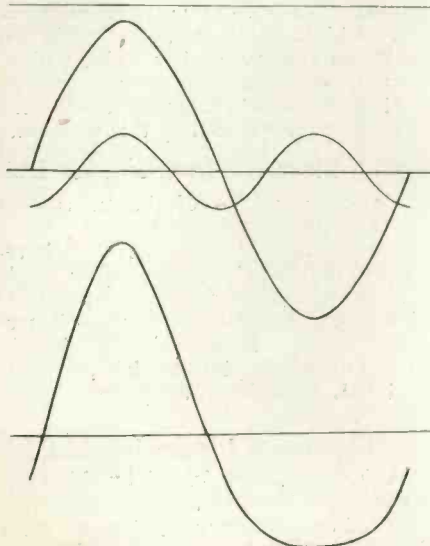

Fig. 2. The upper figure shows the same two sine curves as in Fig. 1, but with a phase difference of 45°. The resultant waveform, shown in the lower diagram, has an entirely different appearance.

from frequency distortion and high selectivity are mutually conflicting and this is the reason for the introduction of variable selectivity.

Phase Distortion.

The upper part of Fig. 1 illustrates a fundamental sine curve together with an additional sine curve of double the frequency and one-quarter the amplitude. If, as in Fig. 1, these two sine curves are in phase, then the resultant function has the appearance shown in the lower curve. If, however, they are not in phase then the resultant waveform may present an entirely different shape as shown in the lower part of Fig. 2, which is drawn for the case when the term of smaller amplitude is 45° behind the other.

If these two lower curves be assumed to represent alternating currents at audio frequencies fed to an (ideal) loudspeaker, then it is found that the human ear is quite unable to detect any difference between the two sound waves so produced. The ear makes a kind of Fourier analysis of a complex waveform, is able to appreciate the relative amplitudes of all the harmonics present, but is quite unable to detect changes in the relative phases of the constituents, provided they do not exceed 360°.

In Fig. 2 let the equation to the fundamental curve be:—

$$I = I_0 \sin \omega t.$$

where

I = instantaneous value of the current at any instant t ,

I_0 = amplitude or peak value of the current,

ω = pulsance (angular velocity of radius vector in radians per second)

= $2\pi f$, f being the frequency of alternation in c/s.

Then the second function has the equation:—

$$I = \frac{1}{4} I_0 \sin 2(\omega t - \frac{1}{4}\pi).$$

$$= \frac{1}{4} I_0 \sin(2\omega t - \frac{1}{2}\pi).$$

$$= -\frac{1}{4} I_0 \cos 2\omega t.$$

and the equation to the complete waveform is:—

$$I = I_0 \sin \omega t - \frac{1}{4} I_0 \cos 2\omega t \dots \quad (1)$$

Amplitude Distortion.

For a triode with a purely resistive load, the dynamic characteristic has a shape similar to that shown in Fig. 3. To represent dynamic characteristics exactly a series of the type.

$$I_a = a_0 + a_1 E_g + a_2 E_g^2 + a_n E_g^n \quad (2)$$

must be used. Here I_a represents the anode current, E_g grid potential, while a_0, a_1, a_2, \dots , are numerical constants, of which a_0 represents the steady anode current for zero grid signal.

The first three terms of this series are



BX DISTRENE

REGISTERED

CAN TAKE IT

The bigger the load, the more marked the superiority of BX Distrene—that's the opinion of electrical engineers who now specify this modern insulating material. Its low loss factor at high frequencies is matched by its remarkably high dielectric strength. The figures below tell most of the story ; we'd just like to add that specific gravity is as near as makes no odds equal to that of water ; 7 tons per square inch is compression strength ; and, taken over 24 hours, water absorption is nil.

Shall we send you working samples of BX Distrene ? We make it in sheets, rods and tubes ; and also in powder form for injection moulding. By the way, owing to its low density, it gives more mouldings per pound of material and has a faster moulding cycle than any other class of injection moulding powder.

Specific Gravity	1.06
Water Absorption	Nil
Coefficient of Linear Expansion0001
Surface Resistivity (24 hours in water)	3 — 106 megohms
Dielectric Constant 60—106 cycles	2.60—2.70
Power Factor up to 100 megacycles0002—.0003

Makers of Plastics since 1877

BX PLASTICS LTD., HALE END LONDON E.4, AND ELSEWHERE

sufficient to represent adequately the dynamic characteristic of a triode, which is accordingly approximately parabolic in shape as shown in Fig. 3, and roughly obeys the quadratic equation:—

$$I_a = a + bE_g + cE_g^2$$

If the grid potential fluctuates in sympathy with a signal, which is a sinusoidal function of time, then the corresponding fluctuation in anode current is seen, from Fig. 3 to be distorted, and its shape is very similar to that of the lower part of Fig. 2, which suggests that a new wave of double the frequency has been introduced.

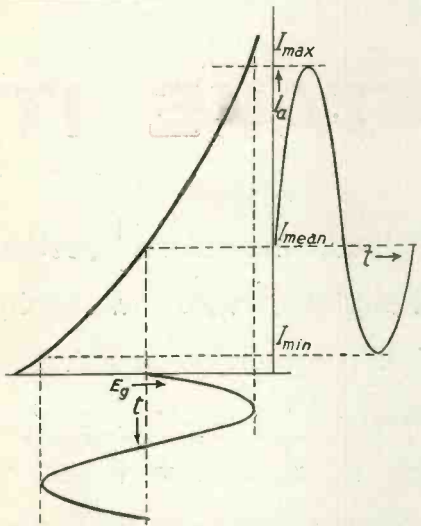

Fig. 3. The dynamic characteristic of a triode with resistive load showing the distortion of the anode current due to 2nd harmonic distortion caused by the parabolic nature of the curve.

The introduction of this unwanted signal constitutes harmonic or amplitude distortion, this particular example being of 2nd harmonic distortion. As most musical notes contain an abundance of overtones or harmonics in addition to the fundamental frequency, it is not obvious how the introduction of this second harmonic can cause audible distortion. The process is actually one of intermodulation and interested readers are referred to an article by A. J. Heins van der Ven.²

The dynamic characteristic of a pentode or tetrode with resistive load has a shape similar to that shown in Fig. 4. It is not even approximately parabolic, and a cubic equation has to be employed to represent it adequately. We thus have:—

$$I_a = a + bE_g + cE_g^2 + dE_g^3$$

and if the grid signal is, as before, given by $E_g = E_0 \sin \omega t$,

$I_a = a + bE_0 \sin \omega t + cE_0^2 \sin^2 \omega t + dE_0^3 \sin^3 \omega t$.
By use of the relationships $\sin^2 \omega t = \frac{1}{2}(1 - \cos 2\omega t)$ and $\sin^3 \omega t = \frac{1}{4}(3\sin \omega t - \sin 3\omega t)$ we obtain the result.—

$$I_a = \left(a + \frac{cE_0^2}{2} \right) + \left(bE_0 + \frac{3dE_0^3}{4} \right) \sin \omega t - \frac{cE_0^2}{2} \cos 2\omega t - \frac{dE_0^3}{4} \sin 3\omega t.$$

$$\sin \omega t - \frac{cE_0^2}{2} \cos 2\omega t - \frac{dE_0^3}{4} \sin 3\omega t.$$

These four terms represent respectively the mean anode current, fundamental alternating component, 2nd harmonic distortion and 3rd harmonic distortion. It would appear from this result that the 3rd harmonic function is 180° out of phase with the fundamental. This is not true, however, as, in practice the constant "d" is negative, so that the functions are actually in phase. It is usually found that "c" is a very small constant, so that there is little 2nd harmonic distortion in the output of a pentode or tetrode. The percentage of 3rd harmonic is usually far from negligible, and its aural effects are more unpleasant than those accompanying 2nd harmonic distortion. From Fig. 4 it is seen that the effect of 3rd harmonic distortion is to flatten the maxima of the fundamental sine curve. This is better illustrated in Fig. 5, where a sine curve has been compounded with another representing 12½ per cent. 3rd harmonic distortion, giving the almost rectangular result shown in the lower diagram. The flattening of the peaks is very evident (p. 601).

Although, as mentioned above, the first two or three terms of the series (2) are sufficient in general to represent approximately the dynamic characteristic of triodes and more complex valves respectively, higher terms, which are present in smaller degrees must be considered in an accurate analysis. In order to see the effect of these, consider the (n+1)th term of the series (2) $a_n E_g^n$.

If $E_g = E_0 \sin \omega t$, then this term gives $a_n E_0^n \sin^n \omega t$.

If $n = 2m$, a typical even number then:—

$$\sin^{2m} \omega t = a_0 + a_1 \cos 2\omega t + a_2 \cos 4\omega t + \dots + a_{m-1} \cos 2(m-1)\omega t + a_m \cos 2m\omega t,$$

where a_0, a_1, a_2, \dots , are numerical constants. This is a series involving even multiples of ωt .

If $n = 2m + 1$, a typical odd number, then:—

$$\sin^{2m+1} \omega t = a_1 \sin \omega t + a_2 \sin 3\omega t + a_3 \sin 5\omega t + \dots + a_m \sin (2m-1)\omega t + a_{m+1} \sin (2m+1)\omega t,$$

a series involving odd multiples of ωt .

The following particular cases occur when $m = 2$,

$$\sin^4 \omega t = \frac{3}{8} - \frac{1}{2} \cos 2\omega t + \frac{1}{8} \cos 4\omega t$$

$$\text{and } \sin^5 \omega t = \frac{5}{16} \sin \omega t - \frac{5}{16} \sin 3\omega t + \frac{1}{16} \sin 5\omega t.$$

From this it is clear that even powers in series (2) yield even harmonics in the anode current, whilst odd powers give odd harmonics. There is reason to suppose that high order harmonics are more prone to cause audible distortion in radio reproduction than the same amount of low order harmonic. For methods of assessing the nuisance value of these harmonics the reader is referred to articles by Harries³ and Bloch⁴.

The effects of harmonic or amplitude distortion are often reduced by the use

of a frequency discriminating network glorified by the name of tone control, which has the additional advantage of limiting the rise in impedance of the loudspeaker with increase in frequency. Such circuits have the effect, if not carefully designed, of introducing frequency distortion by attenuating the upper register. The use of inverse feedback is possibly a better method of reducing amplitude distortion.⁵

Scale Distortion

Assuming that all frequency, phase and amplitude distortions have been reduced to aurally insignificant proportions, there still remains another type of distortion, which can mar reproduction considerably. It is best understood by reference to Fig. 6, which shows the sound intensity in decibels needed to give equal loudness—expressed in phons—to all frequencies in the audio frequency spectrum. From this it can be shown that if a receiver has a perfectly flat frequency response, then for all settings of its volume control, but one, it must inevitably give (frequency) distortion, for really faithful reproduction can only be obtained when the loudspeaker produces the same average sound intensity at the ear, that the original performers give at the microphone. It is assumed here that the frequency response of every link in the broadcasting system is flat. If the average intensity of reproduction is reduced below the level given by this particular setting then a relative loss in bass and treble results: if it is increased then an emphasis of bass and treble occurs. This explains why the balance of reproduced music is so poor at low volumes, and why the male speaking voice contains such a preponderance of bass frequencies at high volumes. This particular variant of frequency distortion has been called scale distortion,⁶ and it is very difficult to avoid if the average intensity of the reproduced sound is required to be different from that produced originally at the micro-

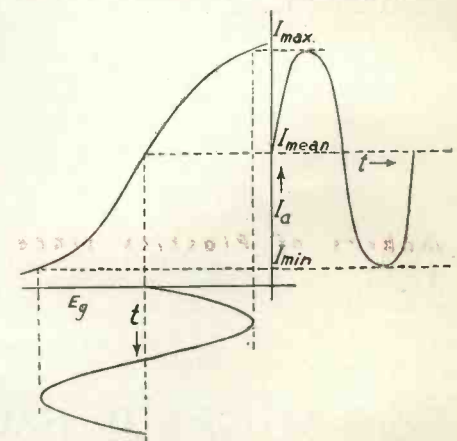
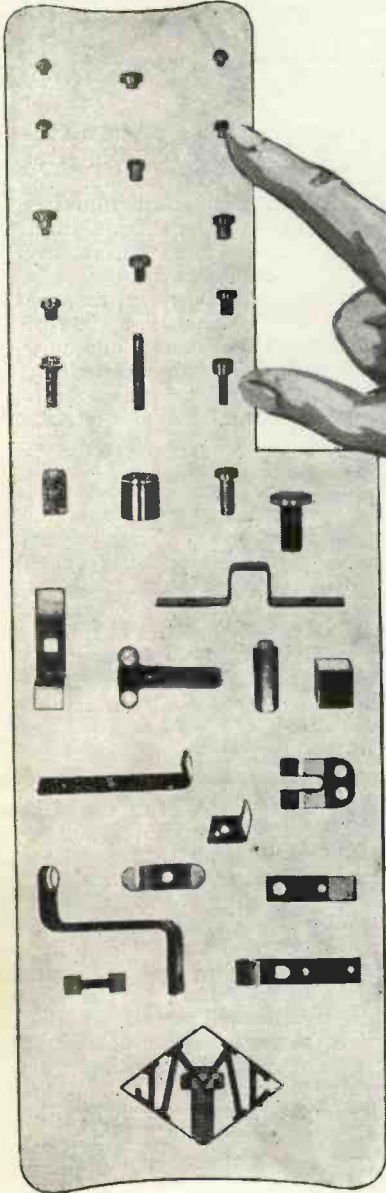

Fig. 4. The dynamic characteristic of a tetrode or pentode with resistive load, showing the distortion of the anode current due to the cubic nature of the curve.

"Just the Contact for the Job"



Write for Booklet 112, giving details of J. M. C. contacts and contact materials.

The selection of suitable contact materials and types of contact, presents problems to designers in all grades of electrical engineering. It is accordingly our keen desire to be of service by presenting the fullest available information and guidance to those who seek assistance in determining the most suitable contact for a specific job. May we assist you?

JOHNSON, MATTHEY & CO. LIMITED

73/83, HATTON GARDEN, LONDON, E.C.1

Telephone: HOLBORN 6989

VACTITE

REGD.

Wires & Tapes

RESISTANCE WIRES TO THE FINEST SIZES

MOLYBDENUM

VAC-STEEL

PLATINUM SHEATHED

GAS-FREE NICKEL

WIRES, TAPES, BARS. MESH & VALVE PARTS

VACTITE WIRE CO. (1919), LTD.

19, QUEEN ANNE'S GATE, WESTMINSTER, S.W.1

TELEPHONE: WHITEHALL 2552

BOONTON

IMMEDIATE DELIVERY

from London Stock of the **Beat Frequency Generator MODEL 140a**

A compact portable two-range instrument generating audio and video frequencies from 20 cycles to 5 megacycles, with direct reading frequency dial and Calibrated Output Attenuator covering 1 millivolt to 32 volts. This instrument is particularly valuable for measuring over a wide frequency range, the transmission characteristics of: Audio frequency stages and amplifiers etc., for determining the frequency characteristics of broadcast and ultra high-frequency transmitters, and as a modulation source for signal generators, both Audio and Video

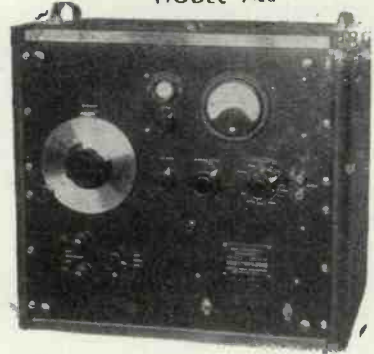

Send for details of this outstanding instrument and of other items available from the ranges of Ferris, Clough-Brengle, Ballantine and Hewlett-Packard equipment.

LELAND INSTRUMENTS LTD

43 MECKLENBURGH SQ. LONDON, W.C.1
TELEPHONE: TERMINUS 5689

Clough-Brengle • Boonton • Ferris • Ballantine • Hewlett-Packard

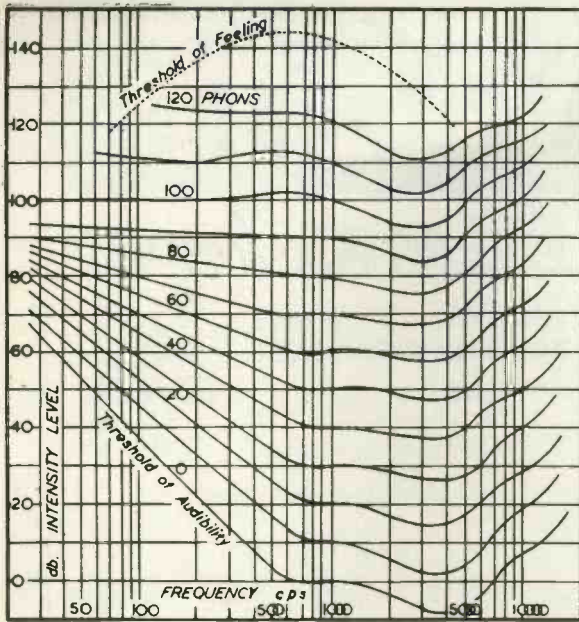

phone Its elimination seems to involve fitting receivers with an extremely flexible tone control capable of modifying the response curve so that the two extremes of the audio frequency scale are boosted at low average intensities and attenuated at very high volume levels in just the right proportion dictated by the equal loudness contours of Fig. 6. Needless to say this is no easy task, although attempts have been made to do it.⁷

Compression of Volume Range

When music with a great volume range is broadcast or recorded, the quiet passages are boosted and the loud ones reduced in intensity. If this were not done, if the fortissimo passages give 100 per cent. modulation, then the pianissimo passages would be drowned in background noise (or needle hiss). If no allowances are made for this volume range compression in radio receivers, then this provides yet another way in which reproduced music can differ from the original. It is generally recommended that the ratio of maximum to minimum power in the reproduction should be improved by 12 decibels to restore the original contrast in the music, although it should be remembered that the compression applied at the transmitter is quite arbitrary. It would be advantageous if this compression were made to accord with a particular law in recordings and broadcasts so that exact reciprocal compensation could be applied in the low frequency amplifiers at the receiving end. Various circuits are available for obtaining expansion of volume range. The simplest employ lamps,⁸ but as these tend to introduce distortion it is preferable perhaps to use variable- μ valves⁹ or a special circuit which provides negative feedback as well.¹⁰

Distortion Introduced by the Loudspeaker

Frequency Distortion.

The loudspeaker is undoubtedly the

weakest link in the receiving chain, for it is no easy matter to design an instrument to reproduce equally well all the audio frequencies between 30 c/s and 10,000 c/s. A rather heavy diaphragm is required to do justice to bass notes, whilst good reproduction of high notes demands a light cone. At first sight it would appear possible to employ two separate loudspeakers to cover this great range, but in practice it is found impossible to dovetail their response curves without introducing irregularities at the changeover frequency. This difficulty is usually overcome by using two concentric cones and in Fig. 7 a copy is given of a response curve of a high quality moving coil loudspeaker designed on this principle. The useful range extends from 30 c/s to 10,000 c/s, and the response does not deviate more than 5 decibels from the average output level.

There are many limitations to this method of assessing performance.* For example, at points off the axis of the instrument the high note response falls off. A degree of evening up can be achieved by the use of small deflecting baffles or diffusers mounted in the loudspeaker opening.

The bass response depends greatly on the size and shape of the baffle used. In fact, the response curve at low frequencies does not mean very much unless full details of the baffle are given. It is well known, of course, that increase of baffle area will in general improve low note radiation, and it has been shown¹² that symmetrical shapes are prone to introduce irregularities in the response curve.

The shape of the room in which the loudspeaker is situated exerts possibly greater effects on its performance than the cabinet. An ordinary brick or plaster wall may be as good a reflector for sound as polished glass is for light,

* A better method was suggested by Brittain and Williams.¹¹

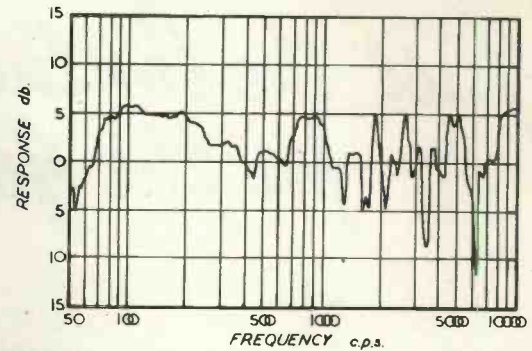

Fig. 6 (left). Curves showing the sound intensity in decibels needed to give equal loudness (in phons) to all notes in the audio frequency range.

Fig. 7 (right). Response curve of high quality moving coil loudspeaker using two concentric cones.

(Courtesy of Messrs. Goodmans Industries)

and accordingly standing sound waves are easily set up. These result in great anomalies in sound distribution. As an example, a note of a particular frequency may be quite inaudible at a certain point in the room yet readily perceived a few inches away.

The furnishings of the room, too, are part of the complex acoustic system of which the loudspeaker is only one unit. This will be readily appreciated by those who have heard the striking difference in the sound of a loudspeaker heard in the same room when it is empty and when normally furnished. Soft furnishings such as curtains, materials and cushions absorb sound and tend to defeat the standing wave.

The response curve of a loudspeaker which is effective when it is in normal use is then a highly complex function not only of the characteristics of the instrument itself, but also of other factors, which include the baffle and the shape, size and furnishings of the room in which it is situated.

Amplitude Distortion

When radiating low notes some loudspeakers, particularly those with straight-sided cones, tend to introduce an additional output at half the applied frequency, known as a subharmonic. This effect, which does not show up on a responsible curve, can be minimised by giving the cone additional rigidity, which is usually done by using an exponentially shaped cone.

Another peculiarity sometimes encountered is cross-modulation of a high note by a low one. This is likely to occur at high volume levels, when the cone is developing a considerable amplitude and so moves out of the region of uniform flux density between the magnetic poles. The use either of a long speech coil and a short magnetic gap or a short speech coil and a long magnetic gap will overcome this trouble. For economic reasons the former of these two alternatives is usually chosen.

Reproduction of Transients.

Some musical notes, such as tympani raps, have waveforms with a sharp rise to a maximum. On resolution by Fourier analysis such shapes give a great number of high order harmonics. The successful reproduction of such notes, termed transients, demands a loudspeaker capable of giving an extended upper register and also, since the waveform represents a sudden blow,

the moving parts which radiate the high notes should have little inertia. Damping, too, should be great otherwise the loudspeaker will continue to radiate after the pulse has passed. This should be achieved by electromagnetic rather than mechanical means, which means a high flux density. 12,000 lines/sq. cm. is a normal figure.

Point Source Distortion.

One is always conscious, when listening to a loudspeaker, that the sound emanates from a point source. This is not the impression given by, say, a large orchestra. It has been suggested that this defect might be overcome by the use of two microphones, placed some distance apart before the orchestra, connected to two entirely separate broadcast transmitters. At the receiving end

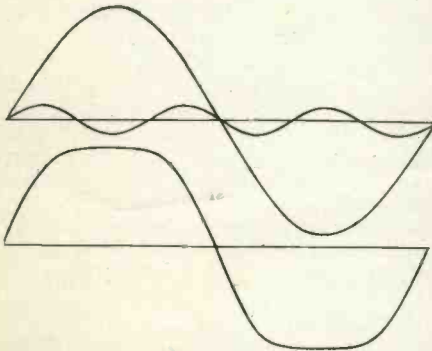

Fig. 5. Curve showing the effect of third harmonic on a pure sinusoidal signal.

two receivers are required, each energising a separate loudspeaker, the two of which are placed some distance apart so as to correspond with the positions of the microphones. Headphones lend themselves particularly well to this type of reproduction, as each phone can be energised from a separate source. The reproduction so obtained is termed stereophonic or binaural, and it is claimed to be very fine, although very little research seems to have been carried out on this subject.*

Conclusion.

From the foregoing it is clear that even very good receivers do not give even approximately perfect reproduction and that great technical strides have yet to be made before it will be possible to create a perfect copy of the original sound. Fortunately, the human ear is very easily deceived—vide its attitude towards phase distortion—and it is therefore possible to derive great satisfaction from reproduction actually very different in frequency range, volume range, harmonic content and average intensity from the sound entering the microphone.

* Some interesting correspondence appears in *The Wireless Engineer*.¹³

BIBLIOGRAPHY.

- 1 "Van der Pol," *Phil. Mag.*, Vol. 7, p. 477, 1929.
- 2 "Output Stage Distortion," A. J. Heins van der Ven, *Wireless Engineer*, p. 383, August, 1939.
- 3 "Amplitude Distortion," Harries, *Wireless Engineer*, p. 63, February, 1937.
- 4 "Distortion in Valves with Resistive Loads," Bloch, *Wireless Engineer*, p. 592, December, 1939.
- 5 "Output Stage Distortion," A. J. Heins van der Ven, *Wireless Engineer*, p. 444, September, 1939.
- 6 "Evolution of the Phon," *Wireless World*, p. 33, 9th July, 1937; "Scale Distortion," *Wireless World*, p. 318, 24th September, 1937; "Loudspeaker v. Orchestra," *Wireless World*, p. 210, 10th March, 1938.
- 7 "American Quality Receiver," *Wireless World*, p. 271, 23rd March, 1939.
- 8 "Simplified Volume Expander," *Wireless World*, p. 404, 24th April, 1936; "Inexpensive Volume Expander," *Wireless World*, p. 507, 22nd May, 1936; "Lamps for Volume Expander," *Wireless World*, p. 146, 14th August, 1936; "Notes on Volume Expander," *Wireless World*, p. 313, 18th September, 1936; "Improving the Volume Expander," *Wireless World*, p. 68, 15th January, 1937.
- 9 "Contrast Amplification," *Wireless World*, p. 636, 18th December, 1936; "Contrast Expansion Unit," *Wireless World*, p. 590, 9th December, 1937; "Correction," *Wireless World*, p. 621, 16th December, 1937.
- 10 "Low Distortion Volume Expansion using Negative Feedback," Stevens, *Wireless Engineer*, p. 143, March, 1938.
- 11 "Loudspeaker Reproduction of Continuous Spectrum Input," Brittain and Williams, *Wireless Engineer*, p. 16, January, 1938.
- 12 "Loudspeaker Baffles," *Wireless World*, p. 508, 22nd May, 1936.
- 13 *Wireless Engineer*, p. 368, July, 1938; *Wireless Engineer*, p. 442, August, 1938.

Met-Vick Research

In a report on recent activities issued by the **Metropolitan-Vickers Co. (Trafford Park)**, mention is made of special apparatus developed for use in crack detection in steel, the curing of resin-treated papers, stress measurements in cutting tools and many other out-of-the-ordinary problems.

A unique type of equipment comprising a positive ion tube with an electrostatic generator and intended for work on atomic disintegration phenomena has been completed during the year 1941. The equipment was designed to be as flexible as possible with a view to its use as a neutron generator or as a source of other radiation.

Acoustics investigations carried out in the period under review have included further work on the noise emitted by large d.c. machines, also work on the damping of the resonances of gear cases, whilst measurements have been made of the noise of a 15,000 kVA shunt reactor which is the first of its kind. A new objective noise meter is now available.



ONE WAY OF DOING IT

Our clients usually know what they want to do but the method of achieving their object may not appear very practicable. For that matter we ourselves are often in the same position, but our wide experience usually enables us to find a solution which falls within the bounds of politics.

Very often a standard piece of equipment may be used to perform the required functions indirectly, and although under present day conditions we cannot carry stocks, our organisation does permit us to meet the calls on our services without too heavy a delay.

Furzehill Stroboscopes, Pressure Amplifiers, Production Testing Equipment and similar instruments are typical examples of apparatus developed to meet individual needs, while we carry a standard range of Signal Generators, Oscillators, Oscilloscopes and Measuring Instruments. In all this equipment equality and performance is the primary consideration.

Our experience is at your service.

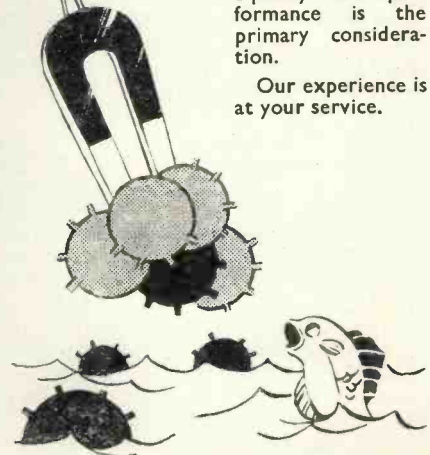

FURZEHILL
 LABORATORIES LTD.
BOREHAM WOOD
 HERTS
 TELEPHONE • ELSTREE 1138

The Cathode-Ray Oscillograph in Industry

By W. WILSON, D. Sc., B. Eng., M.I.E.E. *

The following is an extract from a lecture on "Recent Developments in the Design and Application of the Cathode-Ray Oscillograph," delivered to the members of the British Institution of Radio Engineers on January 10th, 1942:—

THE various applications of the cathode-ray oscillograph can be divided into five classes, as follows:—

- (1) Applications requiring only a single deflection, that is, employing only a single pair of deflector plates.
- (2) Differential applications, in which a similar voltage, current, capacity, pressure, etc., exerts its influence upon each pair of deflector plates, the two being balanced against each other, in very much the same way as weights are balanced in a pair of scales.
- (3) Applications employing a repeating time base, in which a cyclic voltage (or current) is traced as many times as required for the purposes of observation or photography.
- (4) Applications permitting only a single-sweep time base, such as lightning or circuit-breaking transients, where difficulties of observation and photography are a maximum.
- (5) Applications in which the base is any quantity other than time, and therefore in which a curve is plotted connecting the variation of another.

The question might be asked why it is necessary to use an elaborate instrument like the cathode oscillograph when voltmeters and ammeters have been brought to such a high level of efficiency and performance. The answer is that although the performance of D.C. instruments, especially of the moving coil type, is adequate for nearly all purposes, this is not the case with regard to the A.C. instruments, and especially the A.C. voltmeter. Their chief drawback is the considerable amount of volt-amperes required to operate them, especially when small currents and voltages have to be recorded; but they also suffer through possessing an appreciable or excessive frequency error, and insufficient damping. The cathode oscillograph on the other hand gives an almost perfect performance in all these respects.

It would, therefore, be expected that this application would be made chiefly for replacing an A.C. voltmeter, in those cases where high frequency or rapidly fluctuating waves have to be recorded. It is highly suitable, for example, for measuring the output from a mercury arc rectifier, while it is also employed for monitoring wireless broadcasts.

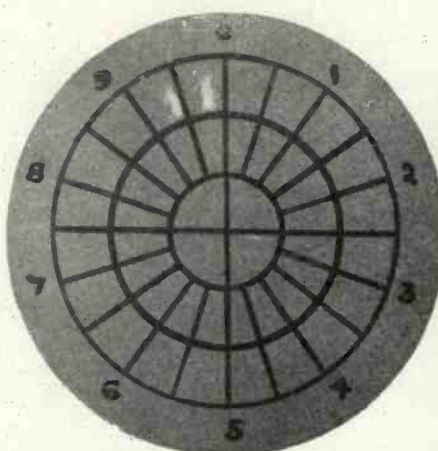

Fig. 1. Test for Distortion in Telegraph Relay Circuit, looking at screen end of Tube. A circular time-base is used, the frequency being first doubled, so that a mark is made on the screen every second revolution for each contact of the doubler throw relay. When there is no distortion, the marks coincide but as shown in the figure, there is 4 per cent. distortion in the test in progress. The scale is naturally invisible in the photograph, and has been drawn in subsequently. The H.T. for the tube is derived from the voltage "kicks" at contact-breaks, stepped up by a transformer. This gives the radial lines shown.

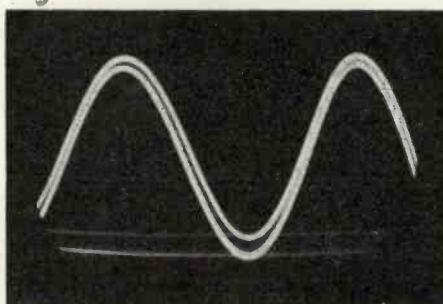

Fig. 2. Test with Double-Beam Tube, comparing the frequency of two oscillating circuits, one of which is a calibrated standard. The lower wave was moving slowly to the right, and the time taken to move from position shown to the next cycle was measured with a stop-watch

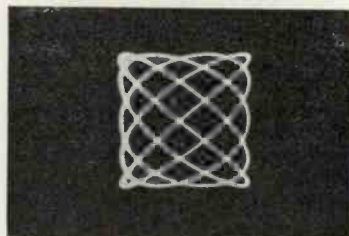

Fig. 3. Typical Lissajous' figure formed by differing frequencies.

Frequencies may be compared by a simple extension of the phase difference rule, by making use of the higher order of Lissajous' figures that will be traced when the ratio between the frequencies is 2 to 1, 3 to 1, 5 to 2, or any other

ratio. (Fig. 3). Although these figures at first sight appear to be complex, they will be found, when one of the frequencies is so adjusted as to create a standing figure, to follow a simple and uniform rule. This is that if the number of loops along a horizontal axis is counted, and similarly the number of loops along one of the vertical axis, then the ratio between the frequencies is equal to the ratio between these numbers of loops.

There are many kinds of test which can be carried out by means of the repeating time base. Probably the most familiar are those for the determination of the wave form of electrical machines, transformers, and rectifiers.

The input and output of stages in a radio set can be compared in accordance with this method by arranging a changeover switch so that the input curve is traced first and the output immediately afterwards. Alternatively, the two can be traced on the one diagram simultaneously by means of a double-beam type of oscillograph. (Fig. 2).

Particularly interesting forms of oscillograph that have been designed quite recently are those which simulate the effect of single-sweep transients, by generating square-fronted waves on a small scale and applying them repeatedly to the circuit under examination. By this means both observation and photography are greatly simplified. Examples are the recurrent surge oscillograph and the restriking voltage indicator due to K. R. J. Wilkinson, which can simulate the effects of lightning surges,

The last group is of considerable importance, as it includes the recording of tests that were beyond the powers of the electro-magnetic oscillograph. They include many which are usually carried out by the slow process of plotting a series of points on squared paper, and which may now be carried out by means of the cathode oscillograph in only a fraction of the time.

One of the most interesting examples of this type of test is the electronic steam engine indicator, in which the fluctuating pressures in the engine cylinder are recorded by the agency of a piezo, carbon resistance, or variable capacity pick-up, the longitudinal travel being obtained by means of a cam type shutter and photo-electric cell mounted at the end of the engine shaft.

The above examples are naturally only representative of what the cathode ray oscillograph has done and is doing to facilitate testing and research work in industrial engineering.

X Make a Note of it!

PUBLICATION C-III-A

**INSTRUMENT DIALS &
CONTROL KNOBS**



Our latest catalogue, Publication No. C-III-A, fully illustrates and describes over 60 different Dials, Drives, Scales, Knobs and Miscellaneous Parts which are of vital interest to designers and manufacturers of electrical instruments.

REMEMBER – PUBLICATION C-III-A

A copy will be supplied on request.



MUIRHEAD & CO. LTD.
ELMERS END, BECKENHAM, KENT
BECKENHAM - 0041-0042

FOR OVER 60 YEARS DESIGNERS AND MAKERS OF PRECISION INSTRUMENTS

ABSTRACTS OF ELECTRONIC LITERATURE

INDUSTRY

Electronic Detector for Pin-holes in Steel

The apparatus described is designed to detect minute pin-holes of about 0.010 inch in diameter in thin gauges of rolled steel strip. The detector is usually mounted on the shearing-line where the continuous coiled strip passes through a series of conveyor rollers and is side trimmed and cut to required size. The elementary units of the detector comprise a dust-tight, force-ventilated steel case containing thirty-three 10-volt exciter lamps with neon-lamp failure indicators, heavy-duty welded photo-tube housing, spring-suspended three-stage resistance-coupled amplifier, and a thyatron and other control panels. The faulty strips may either be marked and removed later, or rejected automatically together with the over and under gauge sheets.

—*Mchy.*, December 11, 1941, page 290.*

Electronic Control for Insulator Leakage Current Tests (Miller)

During the development of insulator conduction glaze it became desirable to study results of long exposure to high leakage currents. The author describes

the test equipment used. The insulator is immersed in salt water to the edge of the top shell. Compressed air, controlled by a thyatron, provides an atomised spray which periodically renews the surface coating conductivity. A high-voltage condenser limits the current to about 50mA when the leakage resistance is small. A capacitance potential divider in parallel with the insulator impresses a 60-cycle voltage on the grid of the thyatron. D.C. plate voltage and grid bias are provided by a rectifier. An additional control circuit limiting the duration of the spray is also included.

—*El. World*, September 6, 1941, page 84.*

Excitation Circuits for Ignitron Rectifiers

(H. C. Myers and J. H. Cox)

Four main types of ignition excitation circuits have been used quite extensively in commercial applications, and the authors classify these as: (1) main anode, (2) capacitor-thyatron, (3) rotating impulse generator, (4) saturating reactor. Details of these are given with circuit diagrams. Other experimental circuits are reviewed.

—*El. Engg.*, October, 1941. p. 943.*

THEORY

Anode Dissipation in Anode-Modulated Class C Amplifiers (R. G. Mitchell)

The effect on anode dissipation of anode modulation is investigated theoretically and also by practical tests. Formulae are developed to facilitate the assessment of the anode dissipation for any depth of modulation. The effect of non-linearity of the amplifier is discussed. An analysis is given showing how the input is distributed between the H.T. and modulator sources.

—*Wireless Engineer*, Vol. 18, No. 218, page 443 (1941).

Transit-Time Phenomena in Electronic Tubes (R. Kompfner)

The equation of motion of electrons, or charged particle generally, are developed mathematically for certain initial conditions and brought into a graphical form in which they yield useful information.

—*Wireless Engineer*, Vol. 19, No. 220 (1942), page 2.

* Supplied by the courtesy of Metropolitan-Vickers Elec. Co., Ltd., Trafford Park, Manchester.

AERO RESEARCH LIMITED

HOW TO USE 'ARDUX 2' FOR FIXING INSERTS..

1. Do not use deep grooves or threads. They should not exceed 1/16th inch.

2. Make the hole of such a size that the insert is a good push fit.

3. Put ARDUX in the hole, and press the insert home.

4. Wipe off excess ARDUX.

5. Then put into an oven at a temperature of 150°C. ARDUX sets quickly at temperatures above 140°C.

6. As an alternative protruding ends of inserts can be screwed into a block of metal (such as the bit of an electric soldering iron) maintained at 150°C. Sufficient heat will be conducted down insert to set the joint.

AERO RESEARCH LIMITED, DUXFORD, CAMBRIDGE. TELEPHONE SANDWICH 1015

Great Possibilities for TECHNICALLY QUALIFIED ENGINEERS KEY MEN IN WARTIME AND AFTERWARDS

The finest posts and the majority of posts in this war are technical and when the war is over, the Immense Increase in technique and mechanisation created for war purposes will be applied to reconstruction and commerce. An age of great possibilities for qualified engineers is here. Study at home with The T.I.G.B. and take a Recognised Engineering Qualification such as C. & G., A.F.R.Ae.S., A.M.I.Mech.E., A.M.I.E.E., etc. in which examinations T.I.G.B. Students have gained 25 FIRST PLACES and hundreds of passes. Write now for "The Engineer's Guide to Success" — 200 Courses — covering all branches — Aeronautical, Tele-communication, Mechanical, Electrical, Chemical, etc. etc.



THE TECHNOLOGICAL INSTITUTE OF GREAT BRITAIN
160, Temple Bar House, London, E.C.4.

THE "FLUXITE QUINS" AT WORK

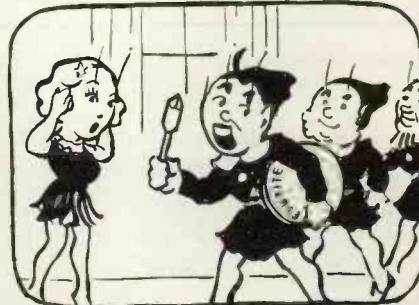

"There's a man shouting awful next door"
Cried OO "Hurry, quick, all you four"
"FLUXITE'S" needed, I'll bet that's his radio set"
Chuckled EE "Here's a job, FLUXITE CORPS"

See that FLUXITE is always by you—in the house—garage—workshop—wherever speedy soldering is needed. Used for 30 years in government works and by leading engineers and manufacturers. Of Ironmongers—in tins, 4d., 8d., 1/4 and 2/8. Ask to see the FLUXITE SMALL-SPACE SOLDERING SET—compact but substantial—complete with full instructions, 7/6. Write for Free Book on the art of "soft" soldering and ask for Leaflet on CASE-HARDENING STEEL and TEMPERING TOOLS with FLUXITE.

To CYCLISTS! Your wheels will NOT keep round and true unless the spokes are tied with fine wire at the crossings and SOLDERED. This makes a much stronger wheel. It's simple—with FLUXITE—but IMPORTANT.

THE FLUXITE GUN puts FLUXITE where you want it by a simple pressure. Price 1/6, or filled 2/6.

FLUXITE LTD. (DEPT. T.V.), BERMONDSEY ST., S.E.1.

ALL MECHANICS WILL HAVE

FLUXITE

IT SIMPLIFIES ALL SOLDERING

A METALASTIK MOUNTING IN TENSION

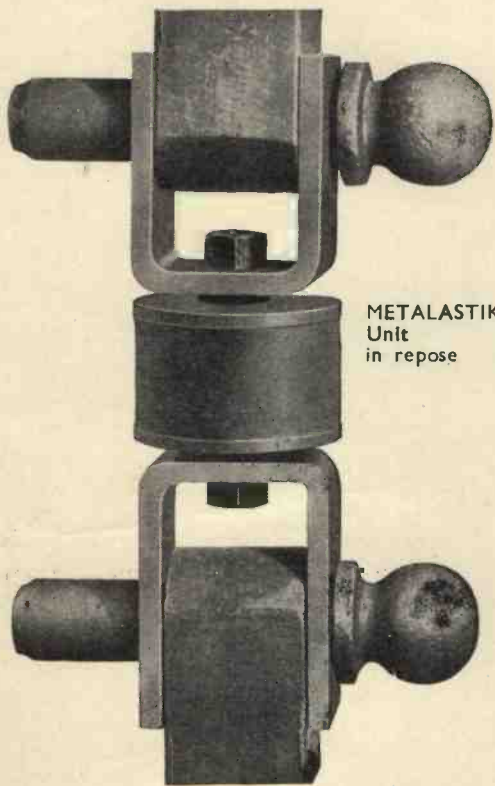

METALASTIK
Unit
in repose



Under
extreme tension
the rubber
shows not
the slightest
tendency
to separate
from the
metal

These illustrations demonstrate a further example of the great strength of Metalastik bonding, in this case applied in *tension*. There is no mechanical connection between the two elements, the strength being entirely in the *Metalastik* 'rubber-to-metal' weld. By eliminating destructive vibration, consider what this remarkable new principal, incorporated in your machines, recording and other delicate instruments can mean in terms of efficiency and reduced maintenance costs.

METALASTIK
ANTI-VIBRATION UNITS

WEBB'S Radio

A WARTIME SERVICE

Since the war short wave radio has become of immense importance and the radio-man very often finds his activities restricted. Nevertheless, Webb's Radio can still provide a great many facilities both to amateurs and priority holders. A few of these services are described here:—

Retail Sales & Mail Order Dept.

Despite staff shortages and other difficulties we are still able to offer practically any component required by the Short-wave enthusiast at our Retail Sales Dept., 14, Soho Street. MAIL ORDER DEPT. If you are unable to call, post your requirements. Though also short-staffed this department provides an efficient and careful service.

Service of Communication Receivers

A restricted service can now be given on all types of Communication Receivers. Please do not despatch instruments without first communicating with us.

Special Products Dept. This department offers very useful facilities for the construction of specialised equipment for transmission and reception. One of its recent productions—a 75 watt, 'phone and C.W. Transmitter is illustrated above.

New lines are continually being introduced and among the latest is an American type Morse Key. This new Key is very light in operation, well balanced and is priced at 8/6. Other lines include a 50 watt audio amplifier and an audio oscillator for Morse practice. This latter instrument, Type OA-1, is entirely operated from A.C. Mains, gives a 1,000 cycle note, and drives two pair of phones. Price £2 5s. od., including two valves.

Bandpass Crystal Filter Units by Simmonds Aerocessories, Ltd.

The retail distribution of these units is being made exclusively through Webb's Radio. Considerable research and experiment have preceded their manufacture. We shall be glad to send a full technical specification and details on request. Bandpass Crystal filter units by Simmonds Aerocessories Ltd. are suitable for use generally with communication type receivers and can be supplied in several band widths.

United Insulator Co., Ltd. A wide range of these well known products which include Silvered Mica fixed Condensers, Silvered Ceramic Fixed Condensers, etc., are also available from stock. Webb's Radio are sole distributors to trade and user.

Ceramic Trimmer Condenser by United Insulator Co. Ltd.



Woden Transformers & Amplifiers

A full range of the stock lines manufactured by the Woden Transformer Co. is carried and arrangements made for rapid delivery of special non-standard items.

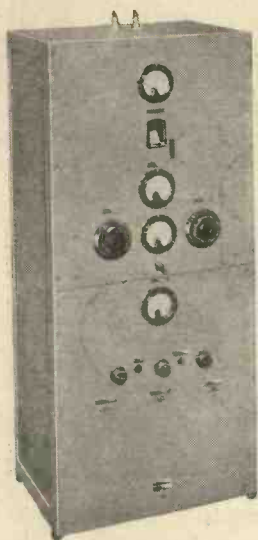

A 75 watt 'phone and C.W. Transmitter constructed in Webb's Special Products Dept.



A new light American type Morse Key, price 8/6.

WEBB'S RADIO, 14 SOHO STREET, OXFORD STREET, LONDON, W.1.

Hours of Business 9 a.m.—5 p.m. Saturdays 9 a.m.—12 noon.

Tel.: GERrard 2089