

GUARANTEED TELEVISOR, EASILY BUILT

Television

and SHORT-WAVE WORLD

APRIL, 1938

No. 122 Vol. xi.

1/-

CHEAPEST TELEVISOR YET!

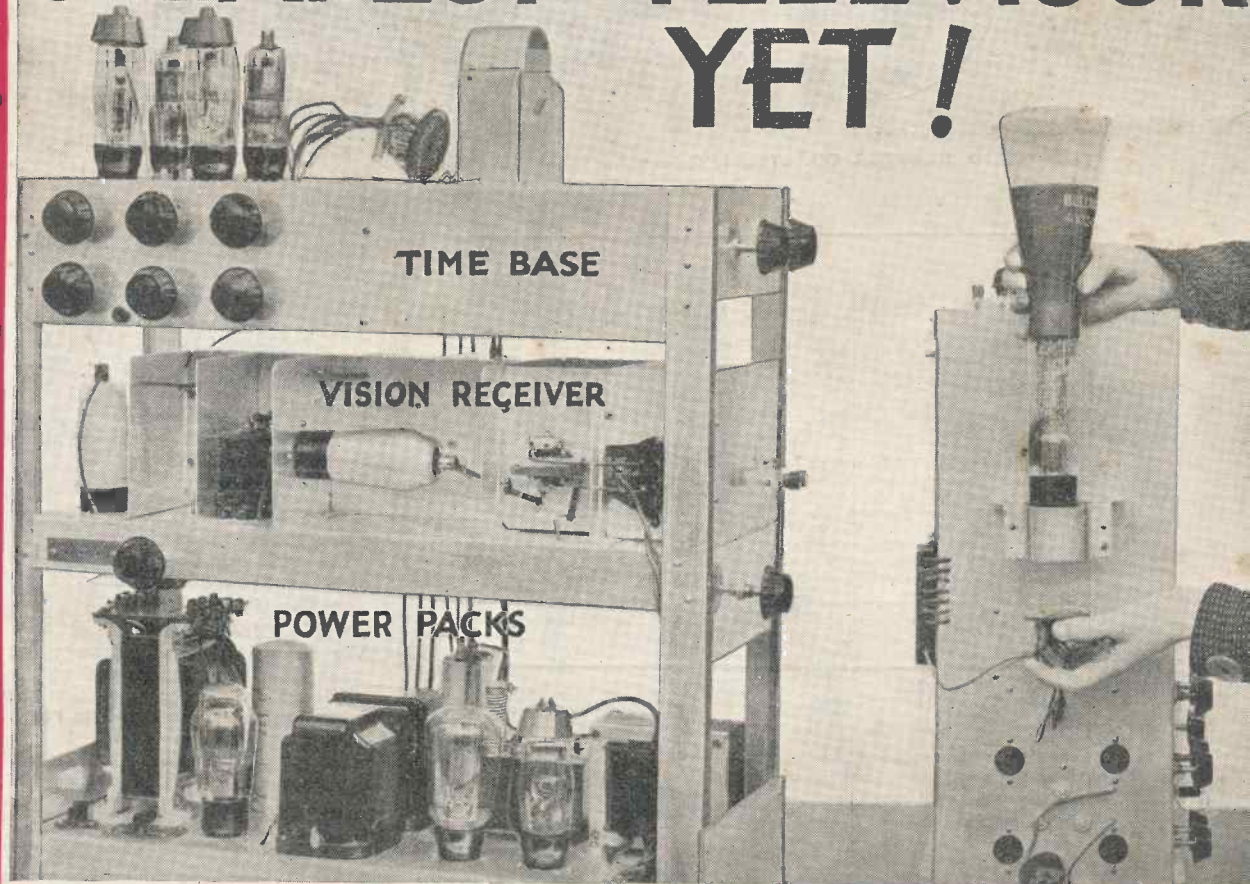

**NEW
METHODS,**

**NEW
APPARATUS,**

**TELEVISION
IN EASY
STAGES**

ETC., ETC.

Fully Illustrated

SHORT WAVES

AMATEUR ALL-WAVE RECEIVER
TRANSMITTING, STEP BY STEP
AMATEUR ACTIVITIES

BERNARD JONES PUBLICATIONS LTD.
CHANSITOR HOUSE, CHANCERY LANE
LONDON W.C.2.

THE FIRST TELEVISION JOURNAL IN THE WORLD

For Reliability use

LAB
TESTED

**TONE & VOLUME
CONTROLS**

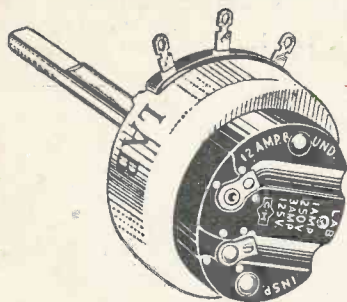

"LAB" TONE & VOLUME CONTROLS are high-class, precision-built components. Their construction is such that they will never develop faults. Each control is individually tested for noise level, contact efficiency, etc. Spindles are 1 1/2 ins. long for cutting to required length.

Without Switch	3/-
With Single-Pole Switch ...	3/6
With Double-Pole Switch ...	5/-

FROM ALL RADIO DEALERS

Write for descriptive leaflet to:
THE RADIO RESISTOR CO. LTD., 1, Golden Sq., LONDON, W.1

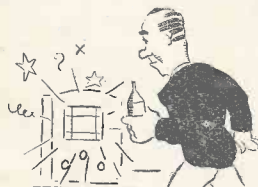

When talk sounds like motors back-firing,
And bands, like a duck that's expiring,
There isn't a doubt
That's your signal to rout
Out the FLUXITE—and see to your wiring.

See that FLUXITE is always by you—in the house—garage—workshop—wherever speedy soldering is needed. Used for 30 years in government works and by leading engineers and manufacturers. Of Ironmongers—in tins, 4d., 8d., 1/4 and 2/8. Ask to see the FLUXITE SMALL-SPACE SOLDERING SET—compact but substantial—complete with full instructions, 7/6. Write for Free Book on the art of "soft" soldering and ask for Leaflet on CASE-HARDENING STEEL and TEMPERING TOOLS with FLUXITE.

To CYCLISTS! Your wheels will NOT keep round and true unless the spokes are tied with fine wire at the crossings and SOLDERED. This makes a much stronger wheel. It's simple—with FLUXITE—but IMPORTANT.

THE FLUXITE GUN

Is always ready to put Fluxite on the soldering job instantly. A little pressure places the right quantity on the right spot and one charging lasts for ages.
Price 1/6.

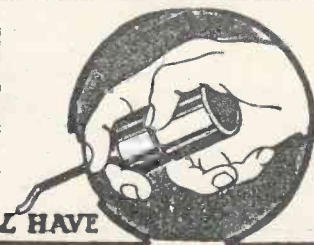

ALL MECHANICS WILL HAVE

FLUXITE

IT SIMPLIFIES ALL SOLDERING

FLUXITE LTD. (Dept. T.V.), DRAGON WORKS, BERMONDSEY ST., S.E.1.

AIDS TO TELEVISION
by "BELLING-LEE"

We have carried out extensive research in connection with television aerials and transmission cable and are in a position to recommend the twin feeder and aerial system listed below as the most efficient for nearly all installations.

● **TWIN FEEDER.**

"Belling-Lee" twin feeder for centre-fed half-wave aerials has three distinct advantages which are; ease of running, very low cost and, most important of all, anti-interference properties.

Theoretically, a coaxial cable should be better for a very long run with a very weak signal and no local sources of interference, but in practice we are still waiting to find such a case; when we do find such a case we will advertise the fact and will market coaxial cable, but in the meantime our experience dictates that we continue to sell only balanced twin feeder. It can be used quite efficiently with a receiver designed for a coaxial feeder, and, even taken down lift shafts, it picks up less interference than expensive coaxial.

Apart from television—as a short wave feeder this "Belling-Lee" twin cable, L.336, has no fibrous covering to absorb moisture and the cable insulation will withstand very severe climatic conditions—ozone, sea air, etc.

The breaking load is 80 lbs., and weight per 100 ft. is 2 lbs. Characteristic impedance in ohms at 45 Mc. 80. Loss in db. per 100 ft.: at 45 Mc. 2.9; at 14 Mc. 1.3. Sold loose as L.336 at 6d. per yard, or on 65 ft. reels as L.344 at 10/6d. per reel.

● **TELEVISION AERIALS.**

The system comprises a centre-fed half-wave aerial consisting of two weather-proof tubings of correct proportions to give maximum reception at 45 Mc. The aerial illustrated is List No. 323 mast-head aerial complete with reflector. Price 65/-. Full particulars upon request.

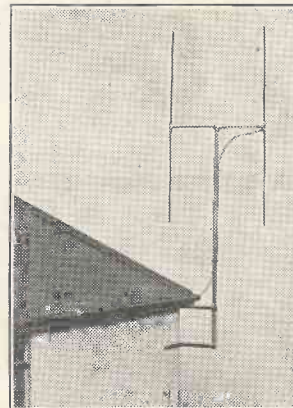

● **TELEVISION SERVICE**

We are prepared to undertake the measurement of field strength on vision and sound channels and on interference, to determine whether reception is practicable and if so at what height and position the receiving aerial will require to be situated.

The nett inclusive fee for this service is from 3 guineas, the figure depending on the actual location. We also undertake complete aerial installations for the trade.

Literature: write for free suppression literature or our manual 'Interference Suppression' 1/8d. post free.

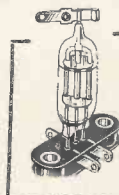

D.I. DIODE VALVE HOLDER
SPECIALLY made for the new type of Mazda Diode Valve for use in multi-valve receivers for rectification and A.V.C. No. 357, Price, each, 1s. No. 357/H (H.V., Type), Price, each, 1s. 6d.

BELLING & LEE LTD
CAMBRIDGE, ARTURIAL ROAD, ENFIELD, MIDDY

APRIL, 1938

For ACCURATE testing you need
The **AVOMINOR**

Regd. Trade Mark

Only precision instruments enable you to test accurately and trace radio faults efficiently. The AVOMINOR is outstanding for precision. There are two models; they are the outcome of an effort to provide amateur enthusiasts with instruments of high accuracy and maximum utility at a moderate cost.

Write for fully descriptive pamphlet of all "AVO" testing instruments.

Sole Proprietors & Manufacturers:
AUTOMATIC COIL WINDER & ELECTRICAL EQUIPMENT CO., LTD.
Winder House, Douglas St., London, S.W.1
Telephone: VICTORIA 3404/7



The D.C. AVOMINOR

13 precision meters in One. This accurate moving-coil instrument has 13 ranges . . . voltage ranges sufficient for measuring H.T., L.T., Grid Bias, Mains and Eliminator voltages; milliamp. ranges for testing all receiving valves and radio apparatus; resistance ranges for all resistance tests. In case, complete with testing prods, crocodile clips, leads and instruction booklet **45/-**

Deferred Terms if desired



The UNIVERSAL AVOMINOR

This compact precision moving-coil instrument covers all A.C. and D.C. testing. It has 22 ranges for measuring A.C. voltage, D.C. voltage, current and resistance. All readings are direct. No calculations. The high total resistance of the instrument—200,000 ohms—ensures accurate readings. Complete with testing prods, crocodile clips, leads and instruction booklet **£5 10s.**

LEATHER CARRYING CASE 10/-
Deferred Terms if desired

MAKE IT BRITISH!

The safe and sure method of converting your 110 Volt AMERICAN Receiver Gramophone Motor or Loudspeaker for operation on 210, 220 or 250 Volt mains, is to "Step-down" your mains supply by using a "Sound Sales" Auto-Transformer.

This method cuts out the waste occasioned by the use of voltage dropping resistance leads

The "Sound Sales" Auto-Transformer also enables you to "Step-up" from 110 volts to 250, if desired.

The 60-watt model will be found suitable for use with the majority of American apparatus.

Full details of these models and the range of "Sound Sales" Chokes-Mains Transformers—Power Supply Units—Microphone Transformers—Public Address Amplifiers, etc., are given in our new 56 page catalogue. 6d. Post free.



60-WATT Type 15/- 100-WATT Type 22/-

SOUND SALES LTD.

Marlborough Road, Upper Holloway, London, N.19
Phone: Archway 1661-2-3 (Contractors to G.P.O., etc.)

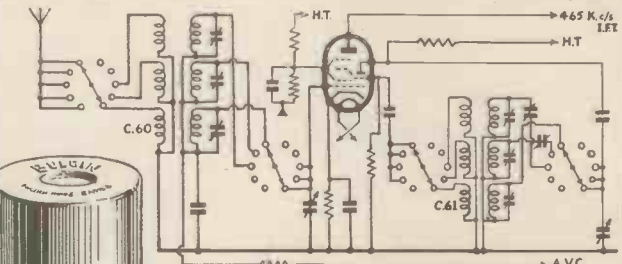

3-RANGE COILS

LONG, MEDIUM & SHORT-WAVE BANDS

Built for constructors and experimenters, as well as for manufacturers, the above Three-Range Coils are an interesting example of what can be done by Bulgin Precision Winding. The circuit diagram shown completely covers the vitally important Frequency Changing Stage of a highly modern "all-wave" Superhet. The coils cover bands of 18-55, 200-550 and 1,000-2,100 metres, and are tuned by untracked 2-gang .0005- μ F condensers. Accurate tracking assured by trimmers, and low-loss switching by Bulgin Rotary 5-way H.F. switches. Write for Instruction Sheets.

List No. C.60 ... 9/6
List No. C.61 ... 15/6

BULGIN

Send 3d. stamps for 120-Page Catalogue No. 157 M.I.
Fully illustrated. 1,200 components described.

ADVT. of A. F. BULGIN & Co., Ltd., ABBEY RD., BARKING, ESSEX

NEW MAZDA

● Each month this page will contain data on special television valves developed by MAZDA engineers for use with EDISWAN Cathode Ray Tubes.

TELEVISION VALVES

TYPE D.I. DIODE

The MAZDA D.I. is a single diode specially developed for use in video receivers both as a detector and D.C. restorer. Its self-capacity has been reduced to a minimum by the use of short pins sealed through the glass bulb to which the electrodes are joined. Connecting wires must not be soldered direct to the pins, and special holders are available from component manufacturers.

CHARACTERISTICS

Heater Volts	-	-	-	-	4.0
Heater Current	-	-	-	-	0.2
Max Peak Anode Current	-	-	-	50mA	
Peak Reverse Voltage	-	-	-	500	
Overall Length (max.)	-	-	-	46mm	
Overall Diameter	-	-	-	12mm	

TYPICAL OPERATING CONDITIONS

As vision signal detector.					
Anode Load	-	-	-	-	3700 ohms
Compensating Inductance	-	-	-	-	140μH
As D.C. restorer in Cathode Ray Tube circuit.					
Load Resistance	-	-	-	-	1 megohm
Coupling Condenser	-	-	-	-	.005μf

INTER-ELECTRODE CAPACITY

Anode—Cathode	-	-	-	-	1.35μμf
Anode—Heater	-	-	-	-	0.45μμf
Cathode—Heater	-	-	-	-	2.4μμf

Price 10/6

Mazda Radio Valves are manufactured in Great Britain for The British Thomson-Houston Co. Ltd., London and Rugby

EDISWAN CATHODE RAY TUBES

EDISWAN CATHODE RAY TUBES are used by leading set makers and home constructors on account of their exceptional efficiency and brilliance.

The full range now includes 9" and 12" tubes electrostatically and magnetically focussed. Write for full particulars to the Technical Service Department, 155 Charing Cross Road, W.C.2.

THE EDISON SWAN ELECTRIC CO. LTD., 155 CHARING CROSS ROAD, LONDON, W.C.2

R.M.329



TELEVISION

and SHORT-WAVE WORLD

Special Features

	PAGE
The Phasmojector	197
The Simplest Home-built Televisor	199
Colloidal Graphite Light Relays ...	205
Testing Electron Lenses	207
How Vision Signals are Received ...	211
Easily made Di-pole Aerial	219
Wide-band Television-Amplifiers ...	219
Cossor Television	221
Finding and Remedying Receivers	
Faults	225
Dual Purpose Communication Receivers	227
"Q" Aerial System	231
Crystal Oscillator	235
Single-stage Transmitter	237
Making a Side-Contact Key	245
National Oscilloscope	247
Controlled Carrier Modulation ...	247

TELEVISION AND SHORT-WAVE WORLD

Proprietors:

BERNARD JONES PUBLICATIONS, LTD.

Editor-in-Chief:

BERNARD E. JONES.

Editor:

H. CORBISHLEY, F.T.S.

Short-Wave Editor: KENNETH JOWERS

Editorial, Advertising and Publishing Offices:

Chansitor House, 38, Chancery Lane,
London, W.C.2.

Telephones: Holborn 6158, 6159.

Telegrams: Beejapee, Holb., London.

Subscription Rates: Post paid to any
part of the world—3 months, 3/6;
6 months, 6/9; 12 months, 13/6.

Published Monthly—1/- net.
On the first day of the month).

Contributions are invited and will be promptly considered. Correspondence should be addressed according to its nature, to the Editor, the Advertisement Manager, or the Publisher, "Television and Short-wave World," Chansitor House, Chancery Lane, London, W.C.2.

IMPORTANT

"Television and Short-wave World" is registered at the General Post Office, London, for transmission to Canada and Newfoundland by Magazine Post. Entered as Second-class mail matter, Boston, Mass.

COMMENT OF THE MONTH

A Promising Outlook

SEVERAL events have transpired during the past month which should do much to quicken the progress of television towards its principal objective of providing a new form of home entertainment. Of major importance was the announcement by the Postmaster-General that it had been decided to allocate 8 per cent. of the net radio licence revenue, or in all a sum of £295,000, for television. This should go far towards providing a more efficient service, which will undoubtedly be an important inducement to the public to buy receivers. It was noteworthy that in the debate that followed this announcement the only serious criticisms were regarding the lack of television facilities in the Provinces.

Secondly, the B.B.C. in their annual report stated that the year's experience is felt to have justified that confidence in the future of television which led to the establishment of the station at Alexandra Palace. The service, the B.B.C. stated, has been vigorously developed in the face of considerable difficulties, and it remains the only public service in the world to reach viewers in their homes. It can be assumed, therefore, that the B.B.C. no longer regard television as the Cinderella of broadcasting and that the service will be developed as rapidly as circumstances will allow.

Thirdly, a television sub-committee has been appointed by the Radio Manufacturers' Association for the purpose of furthering television development and providing means of interesting the public in this new form of entertainment. This committee will act as a liaison instrument between the B.B.C. and television manufacturing interests and being representative of the trade should be capable of some very valuable propaganda work.

Clearly, these developments are of paramount importance and indicate a desire on the part of all the authorities concerned, including the Government, to advance television with all practicable speed; they should result in the clearing away of a good deal of misconception that has existed and giving the public the assurance that a worth-while new form of entertainment has come to stay.

Six reasons why you should build our New Televisor:—

It has been specially designed for home construction ■ Its cost is the minimum ■ It is as simple to construct as an ordinary wireless set ■ It is guaranteed to give excellent pictures ■ Its construction will provide you with valuable knowledge and experience ■ It is quite safe to use.

THE PHASMAJECTOR

A NEW SOURCE OF VIDEO SIGNALS FOR TESTING CATHODE-RAY TUBES AND TELEVISION RECEIVER PERFORMANCE

BY means of a new type of tube developed by the DuMont Laboratories, New Jersey, the experimenter, designer and tester are now entirely independent of outside transmitters previously depended upon for video signals.

The Phasmajector (Greek for image emitter) as the tube is called, provides a uniform television test signal with relatively inexpensive associated apparatus. It is a modified form of cathode-ray tube and is the latest achievement of the Allen B. DuMont Laboratories, Inc., of Upper Montclair, N.J.

In place of the usual fluorescent screen there is in the Phasmajector a metallic plate on which is printed the desired picture or test pattern. Also, the tube includes a collector electrode as well as the conventional cathode-ray tube gun and deflecting elec-

trodes. When used with suitable sweep circuits and amplifiers, the picture printed on the metallic plate can be readily scanned and transmitted to a receiver for reproduction on a standard television cathode-ray tube. It is also possible to use standard oscillograph cathode-ray tubes for viewing.

trodes. When used with suitable sweep circuits and amplifiers, the picture printed on the metallic plate can be readily scanned and transmitted to a receiver for reproduction on a standard television cathode-ray tube. It is also possible to use standard oscillograph cathode-ray tubes for viewing.

by the collector electrode and fed to the grid of the video amplifier. This signal, it is stated, is very stable and of much better quality than can be obtained from a photo-electric mosaic pick-up tube because of the absence of capacity effects. The amplitude of the signal may be as high as 10 volts with high-impedance coupling and is able to modulate a television viewing tube directly without any video amplifier. The signal is 0.2 volt across a 10,000-ohm load.

For a simple television demonstration, two standard oscillographs such as are used by radio servicemen, can be used, one equipped with a Phasmajector tube in place of the usual cathode-ray tube, and the other with its usual tube. Certain slight modifications are required, but the oscillographs can still be used for their normal purposes when desired.

With such a simple, inexpensive arrangement all the principles of a complete television system can be readily demonstrated. Either horizontal or vertical scanning of any desired number of lines and any interlacing arrangement can be used.

The circuit and principles involved in this simple television demonstration equipment are part of the DuMont simplified high-definition television system, which has been completed and tested in the DuMont Laboratories. Field tests for this system are to be made provided an experimental licence can be obtained, application for which has been made. This radically different method of television uses no synchronising or blanking impulses at either transmitter or receiver, and has no sweep circuits at the receiving end. This makes possible the simplification of



A photograph of a picture transmitted by the phasmajector.

the receiver. It is claimed that the receiver need consist of little more than a high-grade short-wave receiver with a cathode-ray tube in place of the usual loudspeaker. Furthermore, the DuMont method, it is said, requires a much narrower frequency band than that now needed for usual television transmission. Four transmitters can be operated where only one can operate at present. If this is proved to be correct it means that television can be transmitted on somewhat higher wavelengths or lower frequencies, thereby greatly extending the service area covered by a given transmitting power.

The Phasmajector, Type 1, has the same operating voltages as the DuMont 34-XH 3 in. cathode-ray tube. It has two additional electrodes, however, the collector electrode and the image plate. The collector is operated several hundred volts positive with respect to the anode, and feeds into the grid of the amplifier tube. (The image plate is normally grounded to the anode.)

The Phasmajector now available to experimenters and others has on its plate a line drawing of Abraham Lincoln. In the demonstrations staged at the DuMont Laboratories, the drawing was first scanned with a half-dozen lines or less, yet the coarse image reproduced could be at least identified. Increasing the scan to about 100 lines and adjusting the intensity and focusing controls, an excellent image was obtained. The individual luminous lines were observed to disappear as they overlapped and blended together. Interesting distortion could be produced at will, such as by horizontal expansion of the image. The price of the tube is \$40.000.

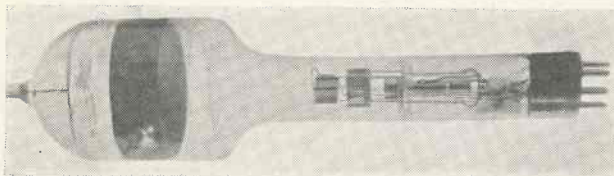

The Phasmajector tube: note the image on metallic plate for transmission.

For the Du Mont simplified television system referred to previously it is claimed that by transmitting the wave-forms of the transmitter scanning voltages, it is possible to send pictures interlaced four-to-one, with flickerless reception at 15 frames per second, and as a consequence, the band width is only one-half as great.

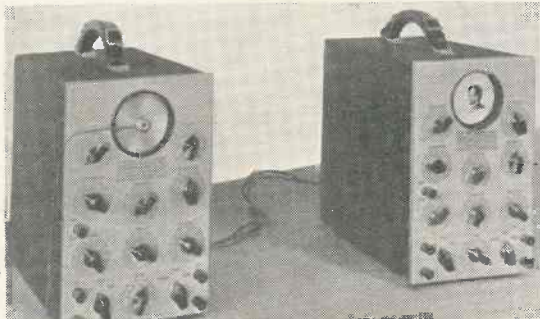

Two oscilloscopes being used as transmitter and receiver and providing a very simple arrangement for test purposes.

Reduction in picture frequency introduces a high degree of flicker unless special means are taken to prevent it. The means taken in this case is a high interlace ratio, four-to-one as compared with two-to-one at present. The "field frequency" (the number of times the picture area is fractionally scanned) thus remains

the same, 60 per second, in the new system as in the conventional system the only difference being that each interlaced "fractional" frame contains one-half as many lines as formerly. The number of lines, 441 (American standard), and the number of picture elements per line, $\frac{4}{3} \times 441$ for 4-to-3 aspect ratio, remain

the same. Consequently, a flickerless 441-line image is produced, even though there are only 15 complete frames per second.

A 4-to-1 interlace ratio seems impossible to accomplish when the conventional method of transmitting sync. pulses is used. In the conventional system, separate sweep-voltage

generators are employed at transmitter and receiver, and sync. pulses are transmitted to maintain synchronism between them. To produce a properly interlaced picture by this method, the sync. pulses must maintain a time accuracy of less than a microsecond, even when the interlace ratio is only two to one. When an interlace ratio of only four to one is attempted, the degree of accuracy required is so great that the sync. signal method is useless. In the Du Mont system, however, all this is taken care of by eliminating the sync signals altogether. Only one sweep voltage generator (producing horizontal and vertical scanning) is employed, that at the transmitter. The wave-forms of the vertical and horizontal scanning voltages, produced by this generator, are used as modulating signals on an auxiliary carrier. After demodulation and amplification at the receiver the wave-form is then used directly as a sweep voltage for the receiving cathode-ray tube. The receiver is thereby considerably simplified, in principle at least. No amplitude-operated sync.-signal separation circuit is necessary, and no sweep-voltage generators are required.

Columbia's Television Transmitter

THE Columbia Broadcasting System's new television transmitter is now practically ready.

When completed the transmitter is to be shipped to New York for installation on the 73rd and 74th floors of the Chrysler Building. There it will provide television programmes from the nearby Grand Central Station studios now being built by Columbia and it is expected that they will be picked up within a radius of approximately 40 miles over a total area of about 4,800 square miles of a thickly populated area.

Columbia's new transmitter really consists of two complete units almost identical in construction. One of these will be used to transmit high fidelity sound and the other produces for pictures. There is only a slight difference in design of the two despite the fact that the sound transmission will cover a frequency range of up to 10,000 cycles while the wave band needed to reproduce high frequency 441 line interlaced pictures extends to 2,500,000 cycles.

Twenty-four water-cooled valves

ranging in length from ten inches to about four feet, have been especially designed for use in the two transmitters. Each of the latter has a 7,500-watt output with 30,000-watt peak modulation. Due to the fact that tremendous heat will be generated a complete air conditioning unit has been built to cool the 120 gallons of water per minute used to reduce the temperature of the valves and other parts of the equipment. In addition, 1,000 gallons of oil are needed to cool the ten transformers used.

The main power units, consisting of the transformers and motor generators, will be housed in fireproof vaults on the 73rd floor of the Chrysler Building, while the transmitter itself is to be housed on the 74th floor. The latter will be connected with a power distribution panel 16 ft. long by 7 ft. high and a transmitter panel 46 ft. long, the right-hand half of which will be devoted to sound, and the left to vision. There is to be a control desk in the centre of the transmitter panel from which operation of the whole set can be checked.

The entire assembly will be finished in chrome and satin steel.

Every safety precaution has been taken in designing Columbia's new television station. The steel structure of the Chrysler Building floors is being strengthened to bear the additional weight. The control panel is equipped with lights which indicate failure of operation at any part of the equipment. A second series of controls and lamps is installed at the back of this panel so that in an emergency the transmitter can be controlled from there. Interlocking automatic circuits have been arranged so that power will be cut off and signal lamps lighted the instant a door leading to the high tension wiring is opened.

The 74th floor also contains a room where all input circuits from the adjacent Grand Central Station studios enter and another where power from the public utility company is introduced.

When all of this equipment is ready for installation, it will be necessary to construct special rigging to lift it from the 71st floor, where the elevator service ends, to the floors above.

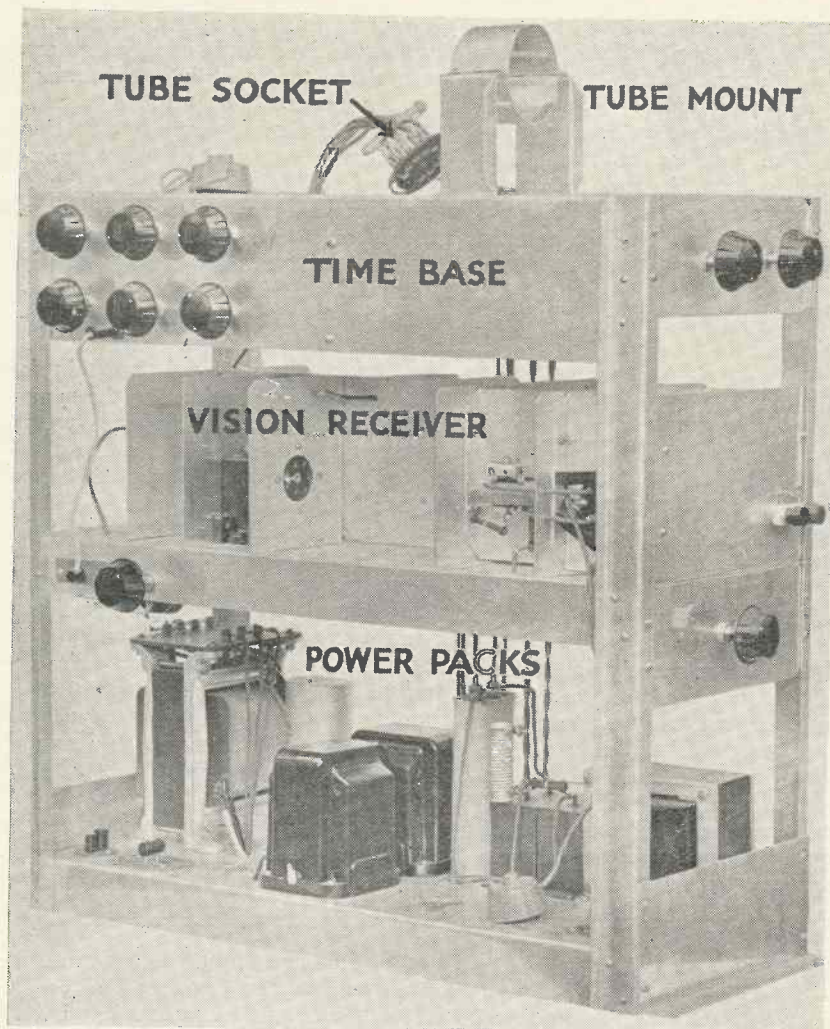

THE SIMPLEST HOME-BUILT TELEVISOR

Designed by S. West

COMPLETE WORKING
INSTRUCTIONS FOR
BUILDING A SMALL-
SCREEN VISION RE-
CEIVER THAT WILL
PROVIDE A HIGH
STANDARD OF PIC-
TURE QUALITY AT A
MINIMUM COST

PART II.—MORE ABOUT THE VISION UNIT AND CON- STRUCTIONAL DETAILS OF THE TIME BASE

LAST month an outline of the complete simple home-built televisor was given, including all the circuits, list of components and photographs. Sufficient information was given to enable any experienced constructor to complete the work, though obviously in the space available it was not possible to enter into much detail. Part of this detail is furnished in this article and diagrams are given showing the exact wiring of the vision unit and these are followed by detailed instructions on the construction of the time base.

Normally, when a television receiver is in course of construction, the amateur approaches the time base with some temerity for he has had impressed on his mind that here is a piece of apparatus which does not comply with his acquired conception of normal radio. Fortunately, in the case of this receiver the time base is so extremely simple that it is unlikely that difficulties of any nature will be encountered.

The complete time base employs four valves only

and the arrangement adopted for these results in considerable simplification.

The layout adopted is a little unusual but it has the advantage of improving the subsequent handling of the unit. It is sufficiently compact to permit the C.R. tube with its associated smoothing and potential network to occupy the same deck, thereby reducing the length and number of the various inter-connecting leads.

Before considering further the practical construction of the unit, let us first briefly review the circuits for the time bases and C.R. tube network.

On p. 202 these circuits are shown in schematic form. The two valves shown to the left of this diagram are responsible for developing the line scan. The remaining two valves develop the frame scan. The connections to the C.R. tube socket are shown at the extreme right.

A knowledge of the manner in which a time base works is very desirable for it is not easy to arrive at

**WIRING DETAILS
OF VISION UNIT.**

The letter references on the photograph correspond to those on the drawings given on this and the following pages.

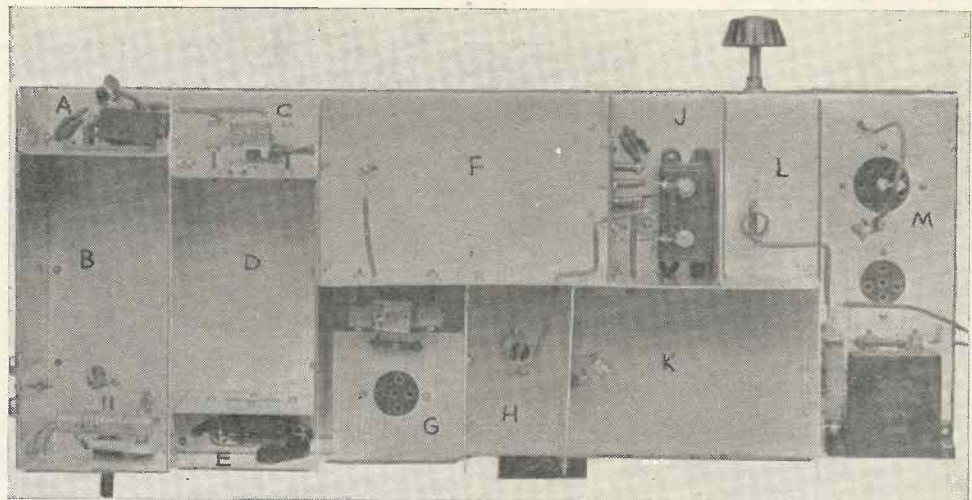

THE TIME BASE

List of components with values and makes for the time base.

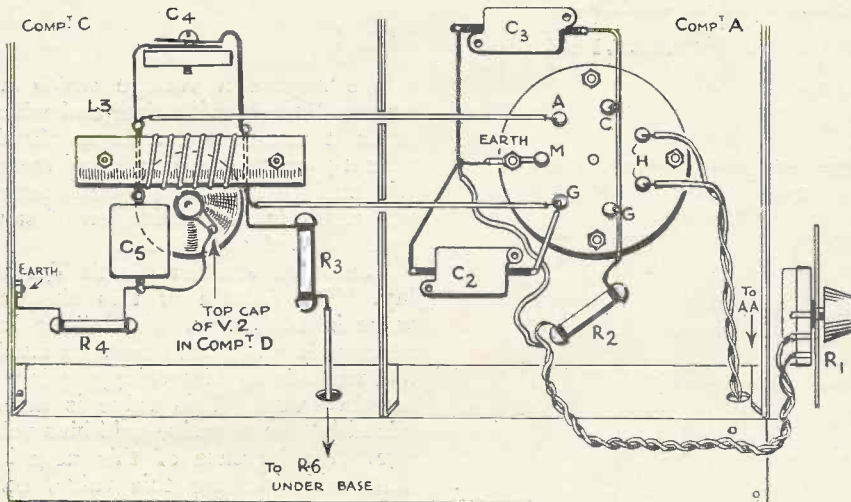

The drawings above give the wiring details of compartments C and A of the vision unit.

CONDENSERS

- C19 0.001-mfd. (Dubilier type 670).
- C20 50-mfds. 12 v. (Dubilier type 402)
- C21 0.001-mfd. (Dubilier type 670).
- C22 0.001-mfd. (Dubilier type 670).
- C23 0.005-mfd. (Dubilier type 670).
- C24 20-mfds. 50 v. (Dubilier).
- C25 0.1-mfd. (Dubilier type 4603/S).
- C26 0.002-mfd. (Dubilier type 670).
- C27 50-mfd. 12 v. (Dubilier type 402).
- C28 0.5-mfd. (Dubilier type 4608/S).
- C29 0.1-mfd. (Dubilier type 4603/S).
- C30 0.1-mfd. (Dubilier type 4603/S).
- C31 50-mfds. 50 v. (Dubilier type 3004).
- C32 2-mfds. 1,000 v. (Dubilier type 950).
- C33 Optional see text.

RESISTANCES.

- R19 50,000-ohms potentiometer (Reliance).
- R20 150,000-ohms 1/2 watt (Dubilier).
- R21 500,000-ohms 1 watt (Dubilier).
- R22 500,000-ohms potentiometer (Reliance).
- R23 50,000-ohms potentiometer (Reliance).
- R24 1,000-ohms 1/2 watt (Dubilier).
- R25 1-megohm 1/2 watt (Erie).
- R26 100,000-ohms 2 watts (Erie).
- R27 5,000-ohms 1/2 watt (Erie).
- R28 50,000-ohms potentiometer (Reliance).
- R29 20,000-ohms 1/2 watt (Dubilier).
- R30 2-megohms potentiometer (Reliance).
- R31 500,000-ohms 1 watt (Erie).
- R32 1,000 ohms 1/2 watt (Erie).
- R33 500,000-ohms 1/2 watt (Erie).
- R34 2,000 ohms potentiometer (Reliance).
- R35 8,000-ohms 1/2 watt (Erie).
- R36 200,000-ohms 2 watts (Erie).
- R37 1-megohm 1/2 watt (Erie).
- R38 1-megohm 1/2 watt (Erie).
- R39 50,000-ohms 1 watt (Erie).
- R40 500,00-ohms 1 watt (Erie).
- R41 500,000-ohms potentiometer (Reliance).
- R42 50,000-ohms potentiometer (Reliance).
- R43 Optional see text.

SUNDRIES.

- 2—High-voltage valve caps (Bulgin).
- 4—5-pin valve holders (Belling-Lee type 1136/9).
- 2—10-way connecting blocks (Bryce).
- 1—4-way connecting block (Bryce).
- 1—5-way group board (Bulgin type C31).
- 2—9-in. lengths 1/2 in. diameter steel or brass rod.
- 2—Shaft couplers (Bulgin type 2005).
- 2—Panel bushes (Bulgin type 1048).
- 1—3-way terminal strip (Belling-Lee type 1253).
- 1—Wander plug (Belling-Lee type 1290).
- 1—Banana plug and socket (Belling-Lee type 1078).

VALVES, TUBES AND CHASSIS.

- V8 & V10 Mazda type T3.
- V9 and V11-Mazda type AC/P.
- Mullard C.R. Tube type A41-4 (white) or A41-G4 (green)
- Chassis, nuts and bolts and wire, etc. (Mervyn)

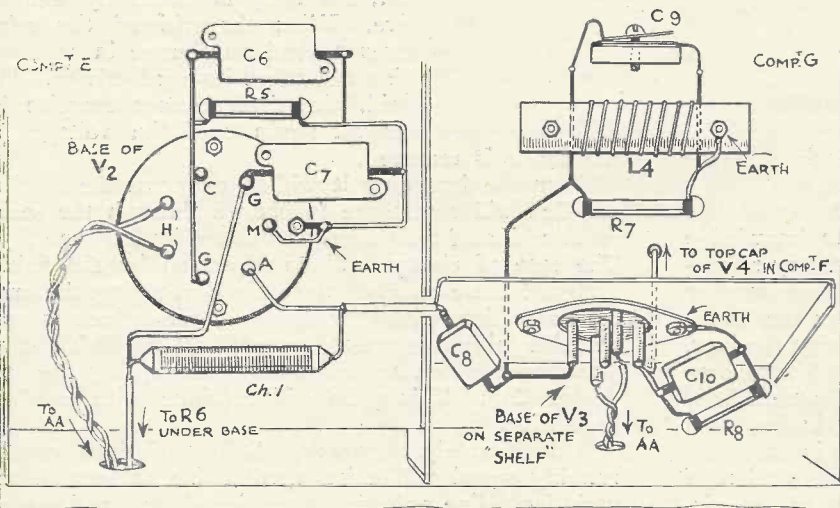

These two drawings show the wiring details of compartments E and G.

HOW THE TIME BASE FUNCTIONS

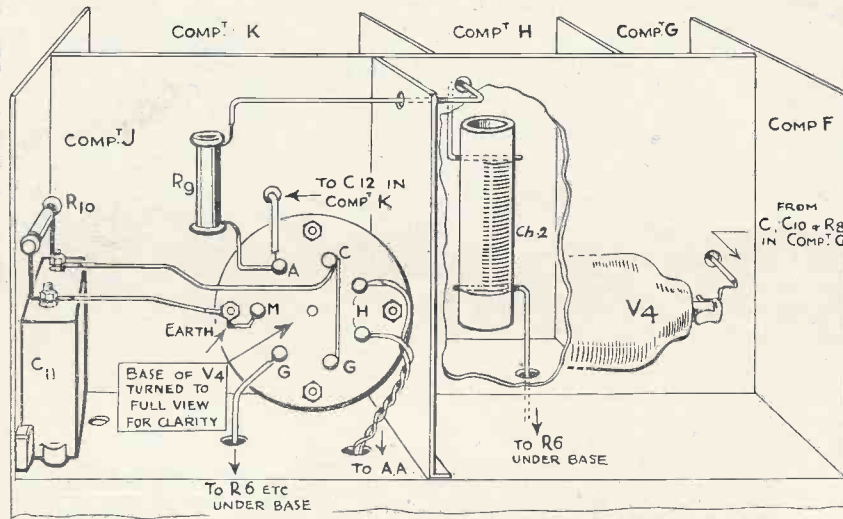

Details of compartments J, F and B.

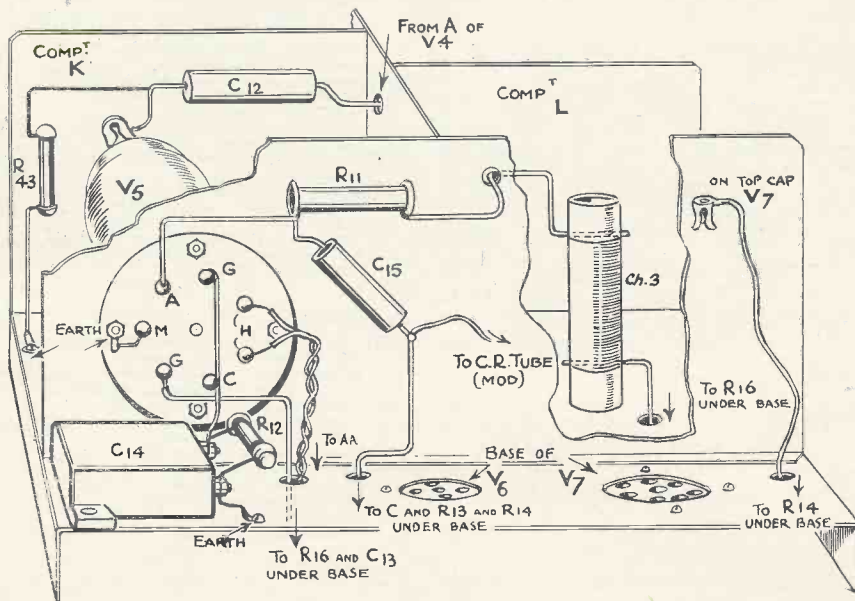
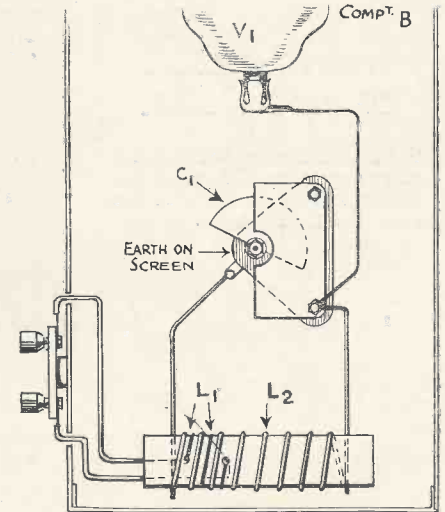

Details of compart M.

We require a voltage which increases linearly with time and which when it attains a certain amplitude abruptly returns to a zero mean. Obviously a repetition of this action will result in the production of saw-tooth shaped oscillations.

The valve V10 is a Mazda T31 relay. The feature of this class of valve is as follows. An infinite impedance is presented across its anode and cathode to any voltage below a certain value. This value is determined by the negative grid bias voltage. An increase of this negative bias will increase this value, conversely a reduction will reduce it.

For any voltage across the relay exceeding the critical value there is presented a very low impedance path, i.e., the relay is effectively conductive. When the grid of the relay loses control no change in value of bias will affect its conductivity. The grid, therefore, cannot exercise its control again until the voltage at

the anode is removed.

From the foregoing it will be apparent the condenser C28 will commence to charge through the series combination of resistances comprised by R30 and R31. The rate of charge will be governed by the values assigned these components. Upon reaching the critical value determined by the grid bias which is controllable with the potentiometer R34, the relay valve V10 becomes conductive rapidly discharging the condenser C28. This cycle will continue with excellent regularity.

Unfortunately, however, slight variations of the running speed will exist, attributable to temperature variations, line voltage fluctuations, etc., and we require to arrange some form of accurate control to ensure the time bases operate in sympathy with the transmitter arrangements. This is simply contrived

the correct settings with haphazard alterations of the various controls.

Most readers will be familiar with the theory of time bases and will already have the requisite knowledge enabling them easily to carry out the necessary adjustments. However, it is believed that a large number of amateurs comparatively new to television and therefore unfamiliar with this section of a television receiver, will undertake its construction on account of its reasonable cost. It is felt they at least will welcome a brief description of the manner in which a time base works. Accordingly the following brief treatment is provided.

It will suit our purpose to consider one section of the time base only for with the exception of the circuit constants the bases are identical. It is convenient to refer to the frame base which is comprised of the valves V10 and V11.

THE TIME BASE CIRCUIT

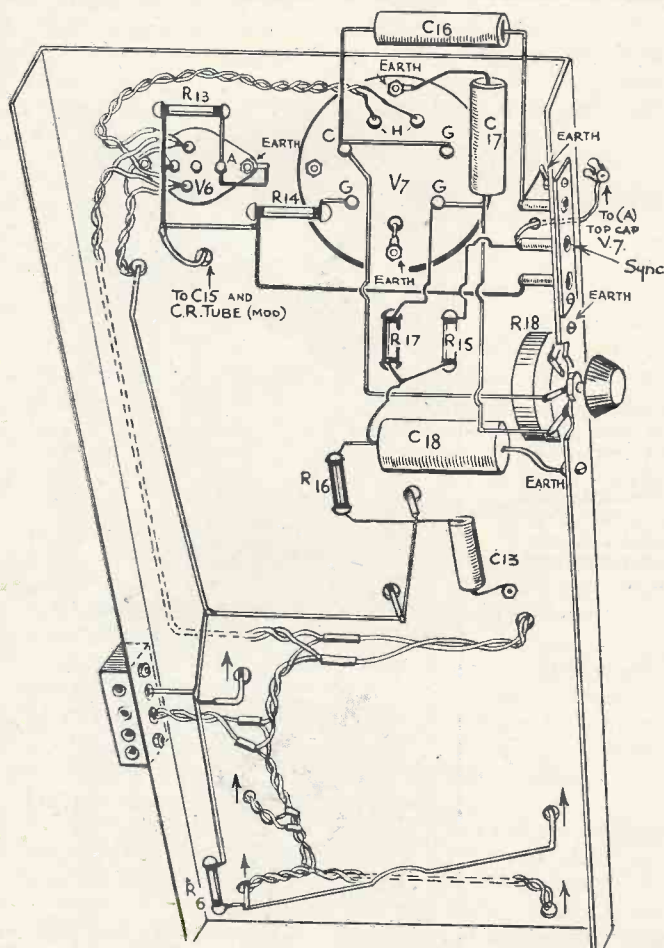

This drawing gives the component assembly and wiring of the underside of the vision unit.

and the point is dealt with later.

It is important to appreciate from the foregoing the following facts. Assuming a fixed value for C28, the rate of oscillations is controlled by the value for the charge resistances R31 and R30. The latter resistance

is variable, it follows then the rate of the oscillations may be varied.

The amplitude for the oscillations is controllable with the value of grid bias present at the grid of the relay valve. For a higher negative bias the amplitude is greater.

Now observe an important point. If the amplitude of the oscillation is greater with an increased bias it follows, as the sweep is linear with respect to time, that the frequency of oscillation is reduced, for a longer period is required to attain the new critical amplitude. Naturally the converse is equally true.

In brief the adjustments to the variable resistances R30 and R34 are to a great extent interdependent, but there will always exist an optimum setting for each. This fact must be borne in mind when the final adjustments are made.

Now to return to the question of ensuring that the correct operating frequency is maintained in step with the transmitter. It would be possible manually to hold a time base at the correct frequency to resolve the transmitted picture. This would entail unusual skill and is unnecessary.

At the end of each line or frame the transmitted carrier is suppressed. (This statement is not strictly true, but a clearer appreciation of what happens is conveyed by this description.) With a suitable circuit this effect may be resolved to provide positive synchronizing pulses.

If we now feed these pulses through suitable amplitude and frequency filters to the grids of the frame and line relay valves we can anticipate the normal free running conduction time because these positive pulses will reduce the relay valve's bias voltage.

Obviously then the firing frequency of the time bases is controlled by the transmitter and correct synchronism results.

The application network comprises C19, R19 and R20 for the line time base. Frequency discrimination is sufficiently provided for hereby the condenser C19 which has a capacity of 0.001-mfd. and consequently offers considerable opposition to the low-frequency frame sync. pulses. The resistance R20 serves to

This is the circuit of the time base which is of a particularly simple type and employs four valves only.

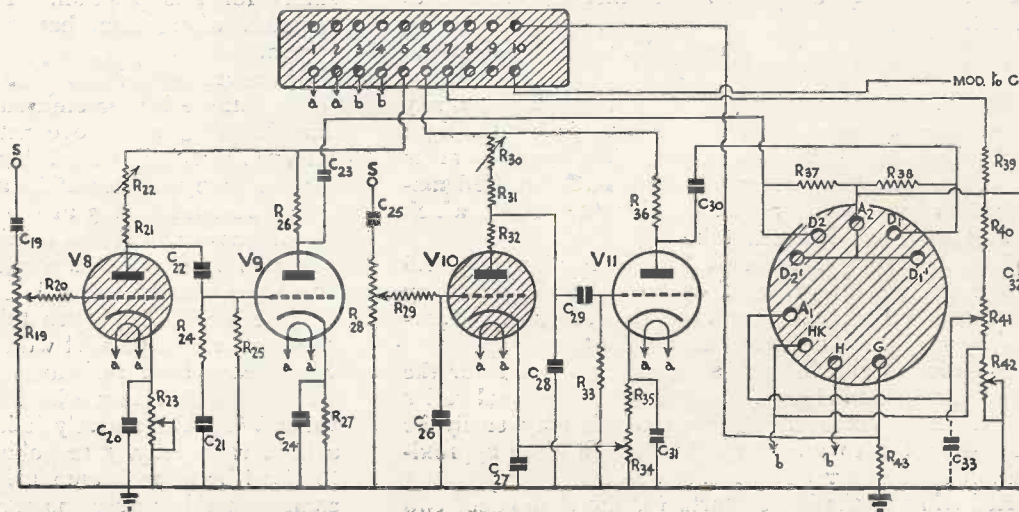

BUILDING THE TIME BASE

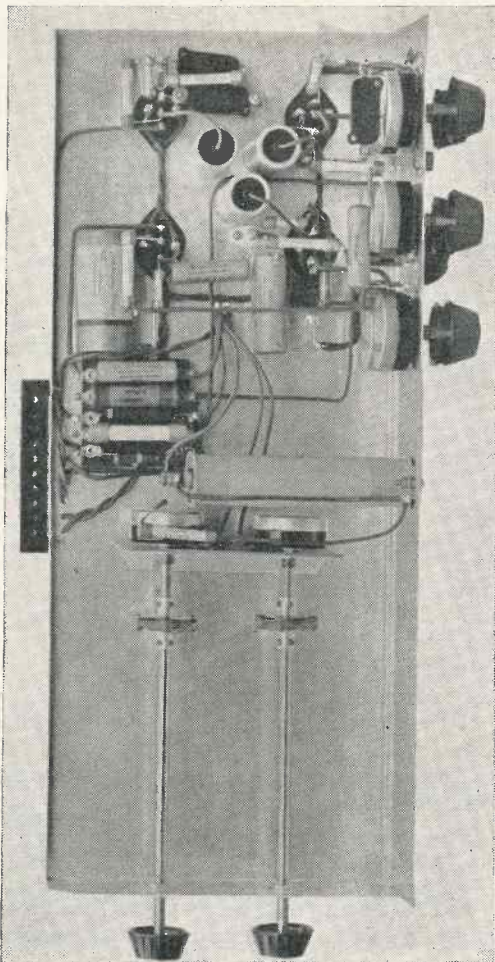

These two photographs show the under and upper sides of the time base respectively. It will be noted that the component assembly and wiring is particularly simple and only calls for ordinary wireless constructional practice.

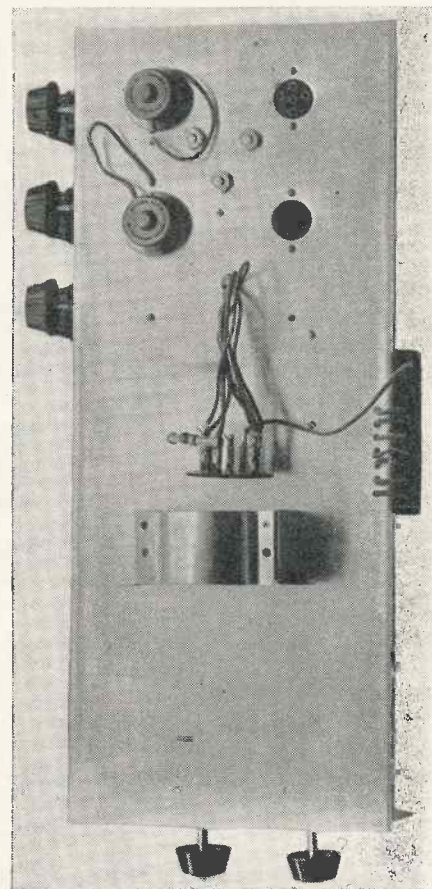

limit the peak positive pulses applied to the relay grid.

The application network for the frame time base is substantially similar. An additional condenser is included (C26), which has a capacity of 0.002-mfd. and will consequently present a low impedance path to earth for the line sync. pulses.

Simple discriminating networks such as these perform remarkably well and are furthermore simple to adjust.

Up to the present the valve V11 has received no mention.

The oscillations generated by a relay valve rarely have sufficient amplitude adequately to deflect the light spot across a C.R. tube screen. The valve V11 is therefore included. It is a simple R.C. coupled amplifying stage having a gain of about 10 times, which is ample for the Mullard tube.

The foregoing will, it is hoped, furnish a useful introduction to the mode of operation of the gas relay type of time base. An understanding of this will enormously facilitate the correct adjustment.

In order to simplify the correct adjustments for the time base, the final article of this constructional series will describe some simple tests which may easily be made in order to adjust the bases to a close approximation of the correct operating speeds.

Referring to the list of parts for the time base; two items are shown as optional, namely, C33 and R43.

For certain cases a condenser will be required between the slider of R41 and earth. A condenser having a capacity of 1 or 2 mfds. will be entirely suitable, and it should be able to withstand 500-600 volts. Similarly a condenser may be needed between the tube cathode (HK in the diagram) and earth. A condenser tested to withstand 200 volts has an ample margin of safety for this position. These condensers are only required where hum bands are troublesome on the screen.

If the diagram is referred to it will be seen that if the resistance R43 is omitted the C.R. tube grid is un-biased. This will prove detrimental to tube life. If the grid circuit is traced, however, it will be seen that for the complete assembly a return circuit is formed by the resistance R13 of the vision unit.

For cases where the original arrangement is to be departed from, or if separate tests for the time base unit are contemplated, it is strongly recommended that R43 be included. When this is so it will be seen to be effectively in parallel with R13 of the vision unit, in which case both resistances should have a value of 2 megohms to retain a load of 1 megohm for the diode valve V6. Alternatively it is satisfactory to give R43 a high value, say, 5 megohms. This will only reduce the load by a small amount. Actually it will then become something over 800,000 ohms, which is a reasonable value.

APRIL, 1938

Let us now examine the practical arrangement of the top deck. To the left, mounted on the flap, are the various controls for the time bases.

Approximately midway along the underside of the deck is mounted a paxolin panel which carries the brilliance and the focus controls (R₄₂ and R₄₁). Eddystone extension spindles continue these controls to the front of the receiver.

Mounted on the shallow right-hand flap is the Bryce 10-way connecting block. Eight terminals only of this are required to complete the connections. The correct order is preferably observed as this will make the inter-connecting leads neater.

Note especially the junction No. 10. Without a brief description some confusion may result concerning the purpose of this. A lead from the top of this, clear of other connections, yet at the same time as short as possible, is taken direct to the C.R. tube grid socket. Another lead continues from the bottom of the connection and is taken direct to the junction of C₁₅ and R₁₄ on the vision chassis. This is plainly revealed by the photograph in the right-hand corner of p. 140 of last month's issue. There is no need for this lead to be located at the connecting block, but it will be found convenient to make the connection in this way. Also it is simpler to keep the lead clear of others when this is done.

The actual wiring of the deck will be found straightforward. Adherence to the original layout as revealed by the various illustrations is advisable and in view of the comparatively high voltages existing for tube excitation care is desirable in wiring the apparatus associated with the potentials network.

The blocking condensers feeding the sweep voltages to the deflector plates, C₂₃ and C₃₀ in the diagram, and also the load resistances for the triode amplifiers V₉ and V₁₁, are mounted on the Bulgin group board. This permits convenient grouping of leads and also

serves as a junction board for some of the tube socket leads.

The remainder of the assembly is adequately revealed by the various illustrations.

A Belling-Lee banana plug and socket serve to feed the sync. pulses from the vision chassis.

The tube support bracket is constructed of aluminium. A snug fit to the neck of the C.R. tube is made by packing with sponge rubber. This bracket performs no screening function and the method employed for tube support is therefore optional.

Many constructors will prefer to contrive some form of wooden support and there is no objection whatever to this.

It will be seen from the photographs of the complete receiver that aluminium right angle section uprights hold the three units in position.

In connection with these it is recommended that no holes be drilled in the actual units, until the final assembly is undertaken. It will prove very much simpler to drill the uprights first when, with the units held in position, drilling points can be marked from the outside. This will ensure greater accuracy. Two bolts for the units at each upright are ample to ensure rigidity.

It is regretted that two errors occurred in last month's article. In the theoretical circuit for the vision unit, the inductance shown between the anode of V₁ and R₃ is L₃. The inductance shown in this diagram as L₃ should read L₄.

In the list of parts the item, 1 banana plug and socket (Belling-Lee, type 1078) should be included with the parts for the time base assembly and not as shown with the parts for the vision section.

In next month's issue the final unit of the complete receiver, namely, the power packs, will be fully described.

WORLD'S LARGEST CATHODE-RAY TUBE

MR. I. G. MALOFF, of the Radio Corporation of America laboratories, in Camden, N.J., has completed what is undoubtedly the largest cathode-ray tube ever built. The tube is 4½ ft. long, and 31 in. in diameter. The cone of the tube is made of ¼-in welded steel, while the end consists of special glass, 2 in. thick. The glass end is attached to the steel tube by means of special gaskets.

The picture is 18 by 24 in., and appears on a flat glass plate, made of glass of a thickness of ¾ millimetre. This thin glass plate, placed within the tube carries the fluorescent screen.

It is necessary continually to exhaust this gigantic tube when in use in order to preserve the high vacuum. Incidentally, this vacuum causes a pressure of 5½ tons on the 2-in. glass end of the tube. The sturdy construction of the tube makes it possible to use a 10,000 volt electron gun.

Never before has there been the problem of a picture being too bright. In Mr. Maloff's tube the

brightness is such that it is too intense for a darkened room. The picture can be viewed in a brightly lighted room, or in daylight, with ease.



COLLOIDAL GRAPHITE

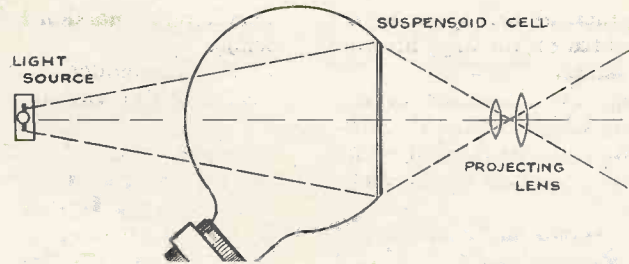

LIGHT RELAYS

By A. H. Stuart, Ph.D., B.Sc.

In view of the great amount of interest that is centred round the possibility of using colloidal solutions for light relay systems this article which deals with the physical properties of these solutions is of particular value.

IN the December, 1937, issue of TELEVISION there appeared, on page 716, an article by Mr. W. H. Stevens, entitled "An Electronic Light Relay for Large Pictures," and on page 731 of the same issue, an

"dag" colloidal graphite under the influence of magnetic and electric fields, and the transmission of light has been measured under a great variety of conditions for a number of media. It is hoped that some of the results of this experimental work will be helpful to those who are experimenting on electronic light relays by giving them exact data of the properties of the material they are using which are not readily available in the literature of the subject.

(which may be called the axis of the crystal).

These facts would suggest that the electrical and magnetic properties of graphite would be anisotropic, that is, they would differ according to the direction within the crystal in which they were measured, and such has been found to be the case.

Graphite has for many years been known to be diamagnetic, that is, in a magnetic field it tends to put the longest axis of any given susceptibility at right angles to the direction of the field instead of tending to lie along the field like the paramagnetic substances of which iron is the best example. Recent work has shown,

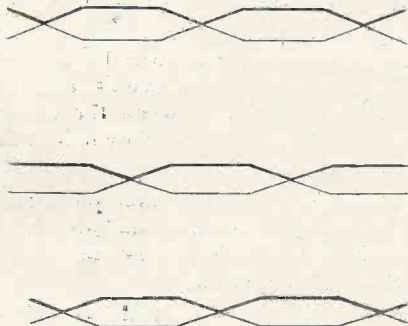

Fig. 1. Diagram showing the atomic arrangement of the carbon atoms of graphite.

Graphite Crystals

Graphite has long been known as a crystalline form of carbon shaped as flat hexagonal plates. X-ray and electron diffraction records have more recently proved that the crystal of graphite consists of carbon atoms arranged in plane hexagonal networks, these planes being parallel to each other and superimposed so that the centres of the hexagons in one plane are vertically over carbon atoms in the plane below. Fig. 1 shows a diagram of the arrangement in which an attempt at a scale drawing has been made, for electron diffraction analysis has shown that the distance between neighbouring carbon atoms in any one plane is $0.14 \text{ m}\mu$, while the distance between any two planes is $0.34 \text{ m}\mu$ (one $\text{m}\mu$ is a millionth of a millimetre).

These relative distances are important since they are responsible for the more interesting properties of the graphite crystal. The carbon atoms in any one plane are held together by "close" linkages, while the atoms in different planes are controlled by what physicists call "metallic" linkages. The result of this is that electrons are free to move along paths parallel to the planes (that is, the basal plane of the crystal) and not at right angles to this plane

abstract was given of a Patent (No. 470,347), by Baird Television, Ltd., for the same purpose, which depends upon a similar principle. In both cases the electron stream, instead of impinging on to a fluorescent screen, falls on a "crystal electrode," which consists of a cell containing a colloidal solution which is normally more or less opaque, but becomes relatively transparent under the action of the electron stream.

It will be at once appreciated that if such a scheme could be developed into a workable proposition it would revolutionise television, since the picture could be projected like a lantern slide and there would be no limit to its brilliance, and its size would only be limited by the definition.

In Mr. Stevens' account the cell was made up of a solution in a suitable oil of Acheson's "Oildag," which is an oil dispersion of colloidal graphite. For the past three years the writer has been conducting an investigation into the behaviour of

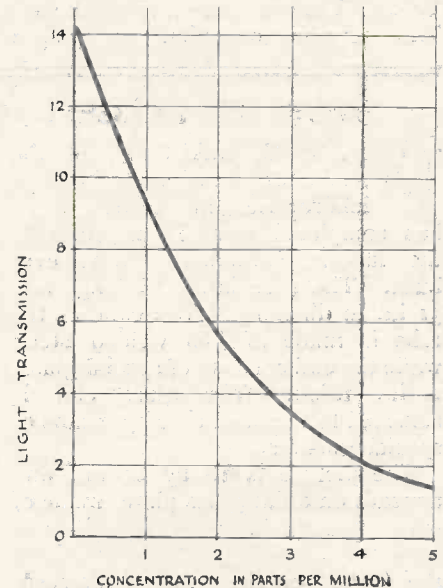

Fig. 2. Graph showing the proportion of light transmitted by solutions of colloidal graphite when acted on by a magnetic field.

however, that the diamagnetic susceptibility of graphite along the hexagonal axis is over fifty times that in a direction in the basal plane. (This

APRIL, 1938

is a characteristic property of the natural mineral graphite, and the writer has developed a method of utilising it as a test of the so-called artificial graphites.

Colloidal Graphite

The graphite in "Oildag" is made from selected carbon and is of a degree of purity far beyond that of the best natural product. Moreover, it is colloidalised, which reduces the dimensions of the particles to the order of 10 m μ , which is so small that the particles will remain in suspension in media such as distilled water and suitable oil over very long periods. These tiny particles are, of course, black and quite opaque, and they have the power of reducing the transmission of light to a very remarkable degree. Fig. 2 shows a graph indicating the amount of light transmitted through a column of distilled water 8 cm. high when "dag" colloidal graphite is present in very small amount. From this it will be observed that the presence of the graphite to the extent of only 5 parts in a million (say, 1 oz. of graphite to 5 $\frac{1}{2}$ tons of water) reduced the trans-

mission of light to one-tenth of its value through clear water.

Now if this column of water carrying these minute traces of graphite is surrounded by a coil of wire through which an electric current may be passed, the magnetic field produced in the liquid causes these very small crystals of graphite to place themselves with their basal planes parallel to the lines of force of the magnetic field and, consequently, less light is absorbed. To give readers some idea of magnitude the following table refers to the water dispersion used in the experiment giving the results shown in Fig. 2.

Concentration of graphite in parts per million.	Increase per cent. of light transmitted when magnetic field operated.
1	13 $\frac{1}{2}$
2	21
3	32 $\frac{1}{2}$

These effects have been produced hundreds of times under a great variety of conditions, from columns 8 cm. high as in the case just given, down to films one-thousandth of an inch thick. A great variety of media have been employed in addition to water. Oils of different viscosity and

a number of special liquids such as a mixture of carbon tetrachloride and bromoform which has a specific gravity equal to that of graphite.

In addition to a magnetic field the phenomenon may be produced in an electrostatic field, as Mr. Stevens pointed out in the article above-mentioned. It is, however, not quite so easy to arrange an electrostatic field parallel to the incident light, as was the case with a magnetic field, and the experimental work, therefore, presents more difficulty.

It is not suggested that the results of these experiments solve the problem of the electronic light relay for the worker in television. It would, however, appear that colloidal graphite possesses a very valuable property which is capable of development. Much work remains to be done; for example, what is the best medium, what is the most efficient thickness of the film, what is the best method of imposing the orientation forces? About all these and a number of similar matters we at present know very little, and since the initial work at any rate does not require elaborate apparatus, the writer suggests that it is within the capacity of many amateurs.

PICTURE RETENTION

WE have received from Mr. T. de Nemes, research engineer of the Hungarian Post Office, the following particulars of a method of cathode-ray tube construction which it is claimed will enable the picture to be retained on the screen during the whole period of a complete scan.

The principle is illustrated in the diagram and it will be seen that the scanning beam is caused to scan a grid mosaic which is placed in front of a semi-transparent photo-emissive surface K.

The construction of the grid is shown by the small diagram and it consists of small metallic elements separated by insulating material, the plain circles in the drawing representing holes and the black parts metal, the remaining part consisting of insulating material separating the units of the metal mosaic. A steady source of light B is caused to fall on the surface of K.

In operation it is claimed that the

mosaic units will acquire charges according to the intensity of the electron beam which is caused to scan them and will control the emission from the cathode which will continue at the same value until they are again

scanned by the beam. An electron lens system enables the image to be projected on to the fluorescent screen.

The chief claims made for the system are greater freedom from flicker, as the picture is retained during the whole period of each scan, and increased brightness, as the entire picture, it is stated, is retained during the period of each scan.

Schematic diagram of the Nemes tube for picture retention during the whole period of scan.

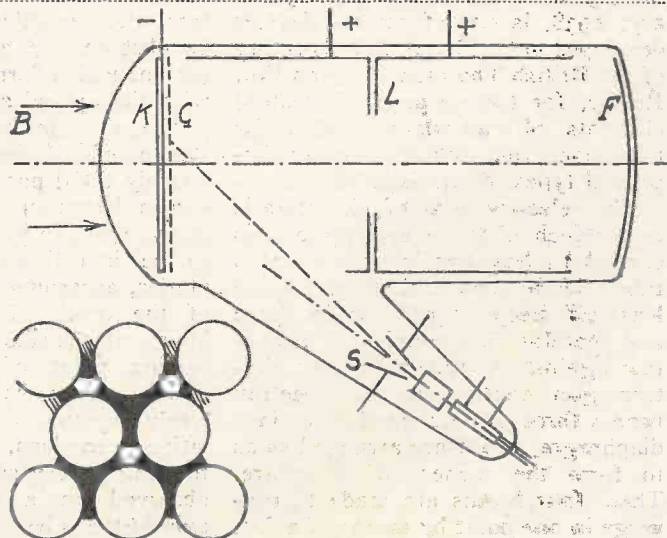

TESTING ELECTRON LENSES

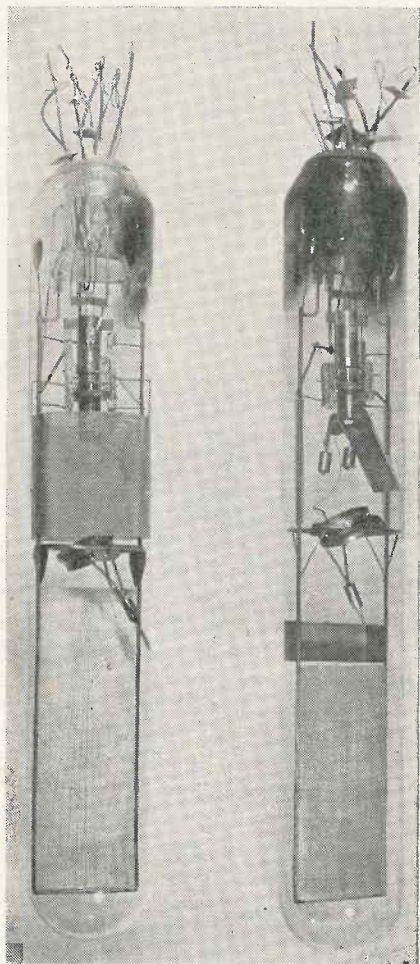
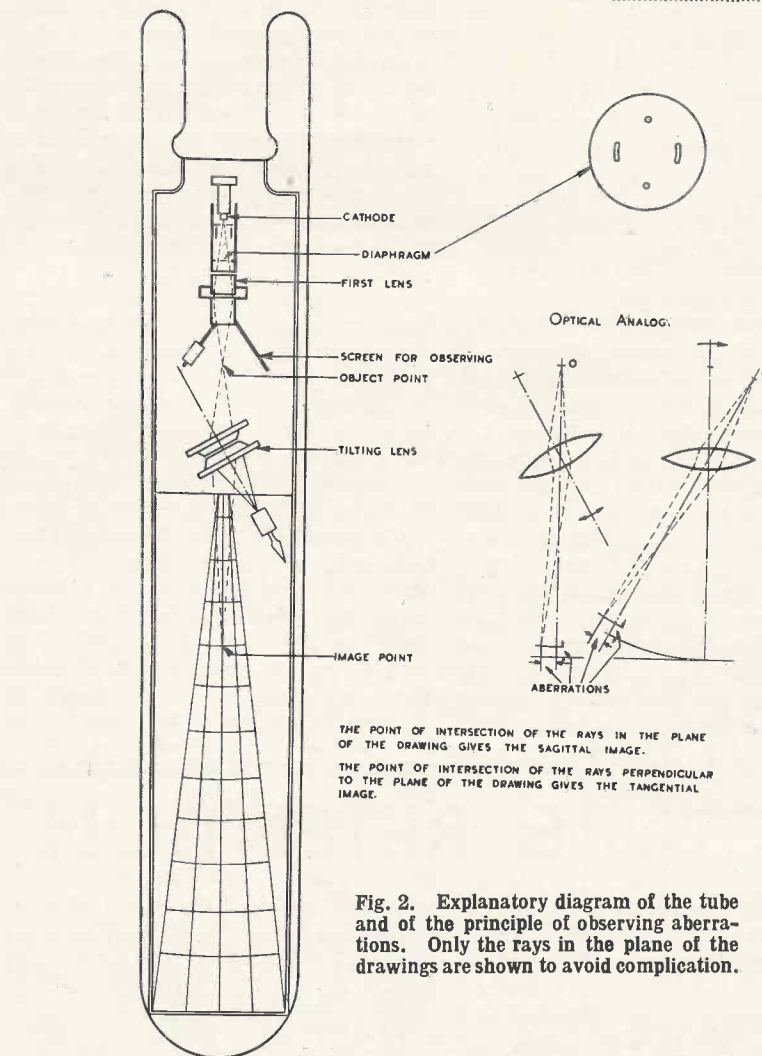

Fig. 1. Photograph of two tubes. In the tube at the right the swivelling lens and the screen for the location of the object point can be clearly seen. In the tube at the left the space between the two lenses is shielded from wall charges by a gauze, which covers the tilting screen from view.

THIS apparatus, which was shown at the annual exhibition of the Physical and Optical Society in South Kensington, January, 1938, is one of several devices developed in the Research Laboratory of the British Thomson-Houston Co., Rugby, for the purpose of testing elements of cathode-ray tubes for television, and for developing improved types of television tubes.

The electron lens of electrostatic type which is to be investigated is carried by bearings in an evacuated tube. If the whole tube is tilted, the lens will keep its position in space and therefore will change its inclination against the tube axis. An electron gun emits four thin electron beams through four small holes in a diaphragm, which are arranged so as to form the corners of a square. These four beams are made to converge in one point by means of a first



THE POINT OF INTERSECTION OF THE RAYS IN THE PLANE OF THE DRAWING GIVES THE SAGITTAL IMAGE.
THE POINT OF INTERSECTION OF THE RAYS PERPENDICULAR TO THE PLANE OF THE DRAWING GIVES THE TANGENTIAL IMAGE.

Fig. 2. Explanatory diagram of the tube and of the principle of observing aberrations. Only the rays in the plane of the drawings are shown to avoid complication.

lens. (The position of this point can be observed on a tilting fluorescent screen, which forms a grazing angle with the optical axis.

The electron beams will hit the screen only if the tube is in an extremely tilted position, otherwise the screen keeps out of their way and allows them to pass through the lens to be investigated, under variable angles, according to the tilting angle of the tube. This lens forms an image of the above-mentioned intersection point of the four beams, which serves as an object point, freely movable in two dimensions relative to the lens. (The image can be forming a very small angle with the observed on a fluorescent screen, axis of the tube. The position of the

image point can be located in a system of polar co-ordinates, ruled on the screen.

In this way it is possible to find the image corresponding to any position of the object point, and to any voltage ratio that may be applied to the lens. Moreover it is possible to measure the aberrations of the lens, i.e., its departure from ideal behaviour, especially at large inclination angles of the object. The aberrations, called image distortion, field curvature, astigmatism and coma can be observed one by one, and the data so obtained can be utilised for the construction of improved lenses.

Dr.—Ing. D. Gabor,
Research Laboratory,
British Thomson-Houston Co. Ltd., Rugby.

Telegossip

A Causerie of Fact, Comment and Criticism

By L. Marsland Gander

I WALKED into Mr. Gerald Cock's room at Alexandra Palace the other day to find the Director of Television in even more optimistic mood than usual. His office resembles a glass-fronted conning tower from which he surveys the roof-tops of London stretching away in the valley below Alexandra Park—a great territory to be conquered for television.

Mr. Cock held a handful of postcards, delivered by the last post in answer to the microphone appeals made during the week. It has been a long-standing dilemma of regular viewers that if they switched on their television sets at 9 p.m. they missed the National news bulletin.

Now that programmes are being extended after 10 o'clock so frequently, viewers also run the risk of missing the Regional bulletin as well. So Mr. Cock proposed to record the 9 o'clock news and broadcast it at the end of the television programme on the ultra-short wavelength. Accordingly, for several consecutive nights, he had broadcast to viewers a request to express their opinions on this innovation.

He told me that the results had been surprising and vastly encouraging. Anybody who has experience of broadcasting or newspaper work knows that it is extremely difficult to persuade people to write unless you are offering them something tangible or you have made a mistake.

"Postcards are coming in from all points of the compass," he said. "Even places outside the normal service area, such as Eastbourne, Colchester, Southend, Sittingbourne, and Cambridge are represented. We know now that we have a great circle of viewers spreading through Essex, Kent, Hertford, Surrey, Sussex, and even extending to Hampshire."

Mr. Cock had not had time to analyse the correspondence and was speaking from memory. It was also only the second day after the first appeal. The demand for a recorded version of the news was overwhelming, and by the time these notes appear the wish of the majority will have been granted.

"What pleases me most," said Mr. Cock, "is that there is not a single unfriendly communication in the whole lot. Many have taken the

opportunity of writing a constructive commentary on the programmes as a whole, and I warmly welcome such expressions of opinion.

"This ballot has shown me conclusively that we have an audience of 'fans.' That people who have television sets use them night after night."

Yes, Mr. Cock, you and all who have helped to launch television in London if you have done nothing else, have created a definite and a growing demand. But you have also shown that British pioneer effort can still lead the way and wrest success from a morass of difficulty while all the world hesitates and watches.

The "Big Push"

Last month I urged the B.B.C. to speed-up their work of preparation for longer and better programmes. Now, fully aware of the obstacles and the reasons for delay I repeat the admonition with all the vehemence I can.

It was a great disappointment to find at Alexandra Palace that no start had yet been made on the conversion of the old theatre. The Postmaster-General has now declared that a further 8 per cent. of the B.B.C.'s total licence revenue will be granted for television expenditure.

The old difficulty arises that this is income and there is no provision for capital expenditure. But nevertheless the announcement removes doubts which, we were told, were the principal reason for delaying television's Big Push.

I understand that the position now is this. Plans have been prepared for the adaptation of the theatre and are in process of being approved. Orders have actually been placed for the alteration and re-equipment of the No. 2 studio.

But I see no reason to revise my estimate that it will take a year before the theatre is converted into a studio. The idea is to have four cameras in No. 2 studio and another six camera units in the theatre, which will become Studio No. 3. This makes an impressive total of fourteen cameras in all. It is proposed that the glass-panelled two-storeyed structure in No. 2 shall now be converted into a

central control room, from which transmissions in all three studios can be controlled.

Central Control

Some such central control is essential. The producers have long laboured under the handicap that when No. 1 studio was in use it was impossible to hold a camera rehearsal in No. 2. All rehearsing for an evening show has to be crammed in between 5.30 and 9 p.m. With a centralised control-room it will be possible to make full use of all studios simultaneously. Thus extension of the evening programme will be facilitated.

The most immediate improvement will be that all the existing Emitron cameras are to be replaced with the new "long-gun" type. I understand that these cameras are not so sensitive as the super-Emitrons, but they are easier to manufacture and will give finer detail than ordinary types. Viewers must have noticed that one or two of the cameras at present in use are nearly worn-out, and replacements are overdue.

O.B.'s

In the corridors at Alexandra Palace I ran into Mr. Philip Dorté, the energetic chief of the Outside Broadcasting section. He expects the second outside televising unit, complete with three cameras, to be ready for action in July. Should it be available in time it will enable him to improve upon the very elaborate plans which he had made for televising the Oval Test Match.

I, personally, am looking forward to the cricket televising more than any other future broadcast. Mr. Dorté tells me that he intends to have one camera behind the bowler's arm, and another behind the opposing wicket. Viewers will thus be able to see the bowler take his run and deliver the ball. Then they will see the ball travelling towards the batsman. He proposes to have one camera mounted on the roof of the Pavilion and the other on a special rostrum behind the mound stand.

The Oval Test Match is the last of the series and, if the Rubber is undecided, will be a fight to a finish of

indefinite duration. Another camera will range over the crowd. Telephoto lenses which, by the way, do not seem to have been used since Armistice Day, will be very necessary for the Test cricket. I understand that one reason for the restricted use of the telephoto lens in television is that at present rapid panning is impossible. If it were not for this drawback a considerable improvement could have been effected in the televising of the University Sports from the White City.

I wonder if viewers have noticed that Mr. Dorté has adopted a signature tune for each type of sporting broadcast? Thus, for the University Sports it was "I'm Young and Healthy." For rowing it will be the Eton Boating Song; for boxing, "I Saw Stars." Any suggestions?

An amusing programme of the near future will be a Sunday obstacle race by Old Crocks at Hurlingham, arranged by the Veteran Car Club. The ancient vehicles will have to go round or over obstacles such as small walls, but the principal trial of the drivers will be to stop and start their groaning engines. I expect about eight cars will be in the race.

Another light-hearted programme which should raise a laugh is the one with which Sunday programmes are to be inaugurated on April 3, the day after the Boat Race. A review of boat races from 1829 to 1938 sounds a serious and ambitious undertaking but it will not be as solemn as all that. Mr. G. Drinkwater is to give the commentary, and one of the star turns will be an illustration of the days when Blues raced in top hats, each oarsman having a slice of lemon tied to the thwart.

The B.B.C. intend to re-enact the historic scene when the stroke of one crew lost his topper overboard and it was handed back with old world courtesy by No. 2—"Your hat, sir."

Zeebrugge

For the Zeebrugge epic, to be reproduced in the lake of Alexandra Park on St. George's Day, Mr. Michael Ellison, M.C., of Harrogate, is making a most impressive fleet of models. His ingenuity is remarkable. For instance, a cruiser has holes covered with oil-silk. When the ship is torpedoed a firework touched off by electrical contact explodes inside, blowing out the silk and letting in the water with a rush.

This is a list of the vessels which will be seen: Belgian fishing trawlers, the *Vindictive*, the *Iris*, the *Daffodil*, three block ships, two submarines, a destroyer flotilla led by the cruiser *Warwick*, and motorboats laying a smoke-screen. The Admiralty has given special permission for the transmission and sections of film will add to the realism.

The Copyright Question

One of the most important events during the month has been the sudden issue by the B.B.C. of the notice before certain sporting broadcasts banning reproduction in public. The notice ran: "The reproduction in any form of the outside broadcast which follows, including projection in places of public entertainment, is strictly prohibited." This action was taken largely because the promoters of the Len Harvey-Jock MacAvoy fight insisted that before permission would be granted for televising the contest some protection must be given against the possibility of free reproduction in cinemas.

Now while I have every sympathy with the motives of the fight promoters who naturally must protect their own interests, the need for some protection for those firms which have spent thousands of pounds on the development of big screen television is also imperative.

The B.B.C. cannot put down a bar to progress. After all it has been the loudest to complain when obstacles have been put in the way of broadcasting. So Dictators permitting, and if the Government can spare the time amid the more pressing problems of the moment I would suggest that some clear ruling must be given on the legal aspects of big-screen television. Some way must be found of utilising the results achieved by time, effort and money spent over a long period of years. When achievement is near it is futile and wrong-headed to raise artificial obstruction. Rather must some way be sought out of an apparent impasse, some way of applying big-screen television to the profit of all parties—the programme providers, the public, the B.B.C. and the manufacturers. It is not impossible.

Please mention "Television and Short-wave World" when corresponding with advertisers.

And now, my coat off for programme criticism. Among programmes which I liked least of all during the month I would mention the film "Tell Me if It Hurts," and the play "The Cup that Cheers." The former portrayed in an amateur imitation of the Russian impressionist school a visit to a dentist. Intended to be lightly satirical, I liked it rather less than the toothache. The censor banned it and for once the worthy censor was right, but for the wrong reasons. He thought that it held up the profession of dentistry to ridicule; I thought that it was satirical and unpleasant. Added to all this the reproduction on my screen was not good.

V. C. Clinton-Baddeley's play, "The Cup that Cheers," went all wrong. The impression of a typical suburban family at breakfast was depressingly accurate, and not a bit funny. But why have a pantomime dame as the mother? Finally, by a desperate twist, came a tragi-comic ending when mother assassinates a second pantomime dame who came in to criticise. The sketch somehow didn't seem to hang together at all.

Best among the offerings of the month I think I liked the Yeats' play "The Words Upon the Window Pane." Mr. Eric Crozier is a producer who knows his medium. His portrayal of a spiritualist séance was sympathetic and effective. He built up atmosphere most ingeniously, and preserved perfect continuity though he never had more than two or three characters on the screen at a time.

The performance of Beatrice Wilson as the medium was a *tour de force*, Terence de Marney (Count of Monte Cristo) was well cast for the young undergraduate, and William Devlin made a dramatic impression as the spirit of Swift.

A New Raymart Catalogue.

Over 200 components are listed in the new Raymart catalogue which is priced at 1½d. Some of the new items listed include chassis, panels, feed-through bushes, special mica condensers, heavy duty morse keys, neutralising condensers and a whole host of receivers.

This catalogue should be of particular interest to short-wave listeners and the constructing short-wave transmitting amateur. We advise all who operate on short waves to write to Raymart Manufacturing Co., 44 Holloway Head, Birmingham, 1, for this catalogue.

A CROWD ALWAYS ASSEMBLES TO WITNESS DEMONSTRATIONS ON BAIRD RECEIVERS.

WHY?

BECAUSE EACH MODEL IN THE RANGE REPRESENTS THE HIGH WATER-MARK OF ACHIEVEMENT.

Among the factors contributing to the first-class performance of all Baird Television receivers are brilliant pictures, freedom from distortion, excellent detail, wide angle of vision, extremely simple operation, high fidelity sound and all-wave radio. Each television receiver incorporates a Baird "Cathovisor" Cathode Ray Tube which has the outstanding advantage of being completely electro-magnetic in operation. These tubes can be supplied separately with the necessary scan-



ning equipment where desired. Apart from manufacturing processes, stringent tests are made for electrical emission, tube characteristics, filament rating, and screen quality, and following normal picture reconstitution under service conditions, every Baird Cathode Ray Tube, on completion, is subjected to a very high external pressure test. Baird "Cathovisor" Cathode Ray Tubes are the ideal solution for high quality television pictures. Write for details.

★ ★ ★

A small section of the daily crowd which assembled at the B.I.F. to see demonstrations on Baird receivers.

★ ★ ★

See television at its best by witnessing Baird receivers in operation at the Ideal Home Exhibition, Olympia, 5th to 30th April.

BAIRD TELEVISION LTD.

Head Office :

Laboratories :

**Greener House, 66, Haymarket,
LONDON, S.W.1**

**Crystal Palace, Anerley Road,
LONDON, S.E. 19.**

'Phone: Whitehall 5454

'Phone : Sydenham 6030

ELECTRON RAY

TUNING INDICATORS



G.E.C.

'TUNERAY'

TYPES Y63 AND Y64

are intended for visual indication of the correct tuning point in a receiver, or for any circuit where small change in current is required to be indicated visually. They consist of a fluorescent target and an indirectly heated cathode to provide a source of electrons which on striking the target cause a glow to appear. The glow area is controlled by a third electrode internally connected to a triode amplifier.

Points to note with the G.E.C. 'Tuneray' :

- (1) The indication is positive and clear cut, being provided by a single sector of shadow in a field of brilliant fluorescence.
- (2) The introduction of a "limiting" electrode results in improved uniformity of the glow, and the maintenance of a clear screen free from "patchiness."
- (3) A "variable-mu" characteristic to the triode grid enables the exact maximum of strong signals to be indicated without "overlap" of shadow angle, and at the same time there is increased sensitivity on very weak signals.

Available in Two Types :

- (4) **TYPE Y63**
for A.C. sets and all normal purposes where 250 volts are obtainable for Anode and target voltages.
TYPE Y64
for D.C. and D.C./A.C. sets where the supply voltage may be limited. The new Type Y64 gives adequate brilliance of glow even down to 90 volts.
- (5) G.E.C. 'Tunerays' are fitted with the self-locating "International" Octal base.

TYPES Y63 AND Y64

Heater voltage.....6.3 A.C. or D.C.
Heater current.....0.3 amps.
Anode voltage.....250 max.
Target voltage.....250 max.
Triode grid voltage for 0° shadow angle
—22 volts approx.

PRICE 10/6 EACH

Write for technical leaflets and full details

TELEVISION IN EASY STAGES.—II

HOW THE VISION SIGNALS ARE RECEIVED

This article fully describes the difference between a receiver for vision as compared with the conventional short-wave super-het receiver.

WE have described the composition of a typical television receiver but many readers will wonder just what is the difference between a radio receiver designed for short-wave reception and the multi-valve vision receiver.

This is very simply explained, but it is as well to know just why the vision receiver has so many more

Next follows the intermediate-frequency amplifier which operates in most receivers at a frequency of 465 kc. This frequency gives ample selectivity and high gain but does not amplify too many second channel beats which cannot be removed. The final two valves are the second detector, usually a triode or diode triode and the output pentode.

This simply means having H.F. and L.F. couplings that will pass this narrow band of frequencies.

It is quite a different matter, however, with vision signals for if full definition is required the receiver must be capable of passing a band of frequencies no less than 2.5 to 3.0 million cycles wide. This has to be compared with 12,000 cycles on the radio set.

That is the problem that has to be solved and accounts for the extra valves used in the receiver designed to pick up vision signals.

The usual way to increase the band width of a receiver is to tightly couple the coils together which reduces the selectivity of the stage. If this is done in every section and carried to extreme limits it will cover about half of the frequencies sent out by the vision transmitter.

So to increase the band width of the receiver still further low-value resistances are connected across the primary and secondary of the coupling coils. The value of these resistors depends on the amount of broadening that has to be done and the amount of stage gain available.

In some instances the coils themselves are wound with resistance wire as in the case with the first television receiver we published. In this system the band width can be made very broad, but it also decreases the stage gain to such an extent that many more valves are needed to bring it back to the level of the ordinary short-wave receiver of normal band width.

That is the secret of the extra valves. As the band width is



A good example of vision receiver design.

valves than the ordinary sound receiver.

Most constructors interested in television will have some knowledge of radio reception and know that the average short-wave receiver is made up of about 5 valves.

Of these the first is the H.F. stage at signal frequency which is generally sharply tuned to obtain the best possible selectivity before the first detector stage. This detector stage uses either a pentode or screen grid valve into which is injected the oscillation generated by the local oscillator. The local oscillator can be in the same bulb as that of the first detector and can either be electronically coupled or externally coupled.

That is the valve line up of the typical short-wave receiver and it does not matter whether it is operated on 7 or 70 metres, it will give all-round results.

The natural query is then, "Why have all these extra valves in the vision receiver if five will do for ordinary broadcasting?"

This brings us to a point we have not so far raised. In the radio receiver although we have a need for selectivity, the problem of quality, or more accurately, band width does not arise.

With sound broadcasting, to pick-up all the frequencies transmitted both on speech and music less than a 12,000 cycle band width is required.

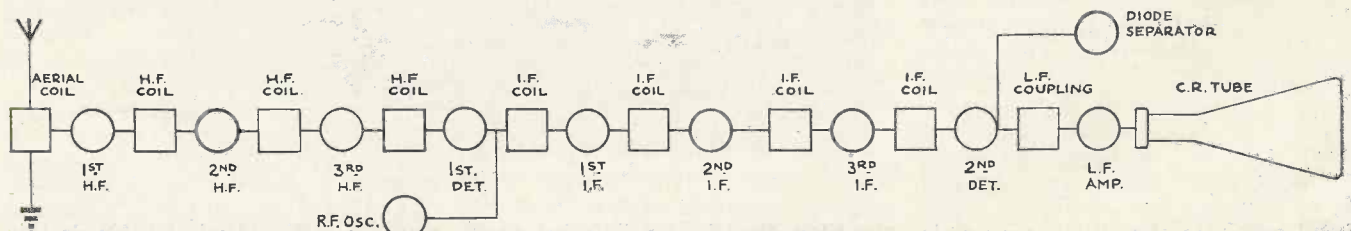

This schematic diagram gives a very clear idea of the valve and coil line up in a typical vision receiver.

COUPLING :: THE VIDEO STAGE

widened, particularly as the resistance values are reduced, the stage gain drops alarmingly. In fact where one high-frequency stage would do in an ordinary receiver no less than three stages are required when the band width is increased to 2 million cycles.

Next comes the problem of the intermediate-frequency stages. In the average receiver where the I.F. stages have a frequency of 465 kc. quite a high gain can be obtained with one stage. As this frequency and degree of selectivity would be

scope of action as with coil couplings.

The second detector is always a diode in which all stray capacity has been eliminated. The slightest capacity across the circuit tends to attenuate the higher frequencies very rapidly. For example the standard output triode with ebonite base and conventional base connection will reduce the top note response by as much as 500,000 cycles without any other matter being taken into consideration.

That is why wherever possible the grid contact is brought out to the

without cause. The main reason for not having more low-frequency stages is due to the trouble experienced in filtering the residual 100 cycle from the power supply.

While on the subject of the low-frequency amplifier it is well to mention that the name low-frequency is still the old name taken from the speech amplifiers in conventional radio receivers. In such receivers the speech frequencies passed were quite low in comparison with the high frequency band. With vision receivers where the final amplifier has to handle frequencies up to 3 mc. it is better to use the more modern name of video amplifier.

That gives a good idea why the vision receiver uses so many valves, but it does not explain how these receivers are so easy to make as compared with a radio set having a similar number of valves.

With the normal radio set having two high-gain stages it is very difficult entirely to eliminate instability in the high-frequency stages. Constructors feel that if two stages are unstable in a radio set, what is going to happen with three or four stages in a vision receiver?

The solution again lies in the band width. As the band width is so great, the stage gain is reduced to a fraction of the former value. Consequently there is no more trouble in stabilising three H.F. stages in a vision receiver than there would be with one stage in an ordinary radio set.

It can be assumed that the vision

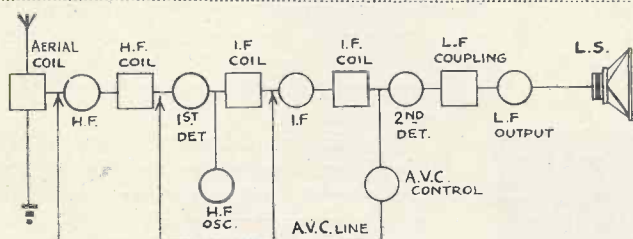

Although there are many less valves in this sound receiver the system is the same as for the vision receiver.

too high for television reception the coupling between coils is brought to maximum and across both primary and secondary low-value resistors are connected as with the H.F. transformers.

This reduces the gain from a figure nearer 200 otherwise to a figure not exceeding 10. Consequently the number of stages has to be increased. That is why some commercial receivers use as many as five stages of I.F. amplification.

Many old ideas, long discarded as useless, have been brought into use with television receivers. It has been discovered that the old tuned-anode system gives a very broad tuning curve and on the lines of what is wanted for vision reception. Many receivers use this scheme with success and find that three stages of tuned anode H.F. amplification and three stages of I.F. amplification will provide sufficient gain for most areas.

With tuned anode couplings the lay-out can be made very simple and as the number of coils is reduced by half, the final trimming and ganging is greatly simplified. This point should be borne in mind by constructors.

Although at first glance it may not seem possible to apply the same methods to low-frequency couplings it so happens that obtaining high-band width in the L.F. stages is quite a problem that has not the same

top cap so reducing interelectrode capacity and also grid to earth capacity.

All resistance values have to be modified in order to obtain the maximum gain, but as it is not advisable to increase the number of low-frequency stages the valves have been improved and made specially for television amplifiers.

Modern television valves have the high slopes of 9 and 10 mA. per volt in order to obtain the maximum stage gain without additional valves.

Also in the low-frequency stages if



This super-het receiver is designed for all-wave reception and should be compared with the vision chassis illustrated on the preceding page.

another stage were added this would cause a negative picture and, although not much of a difficulty, there is no need to complicate the receiver

receiver is fundamentally the same as a radio set except that it must pass a very wide band width. To do this the number of valves must be in-

APRIL, 1938

creased. The type of couplings are the same, the system is similar, the valve types are of the same pattern but of greater efficiency so that the first change comes with the cathode-ray tube which for the purpose of comparison takes the place of the loudspeaker.

Constructors who have used the normal super-het. receiver below 10 metres will have noticed that most of these sets suffer from frequency drift. By that we mean that when a station has been tuned in the tuning is inclined to change on its own.

This problem has also been auto-

matically solved with the vision receiver. As the band width is great and the tuning so flat, small variation in oscillator setting which would cause the so-called frequency drift are not noticed because they do not wander outside the band covered by the receiver.

HOW THE SIGNALS ARE FED TO THE TUBE

Paradoxically, one of the best methods of feeding the signal to the grid of the cathode-ray tube is by omitting the video amplifier altogether and connecting the diode direct to the grid.

In previous articles we have seen that the only way in which the D.C.

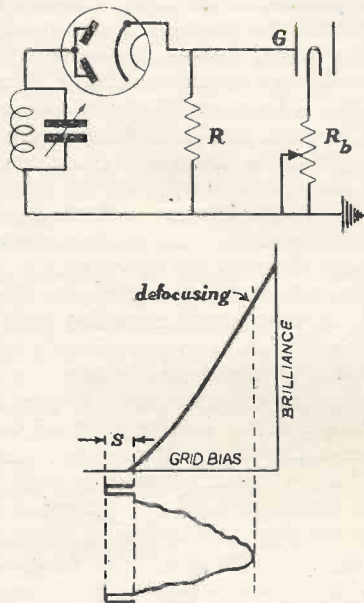

Fig. 1 The tube can be directly connected to the diode as shown, if sufficient voltage is available.

component can be maintained at the tube terminals is by direct connection to the preceding valves or by the use of a diode to restore the brightness level. The load resistance of the diode detector contains the D.C. and A.C. currents after rectification and thus by connecting the grid of the tube directly to the load resistance we shall automatically take care of the brightness level.

Fig. 1 shows the circuit in which this can be done. The output from the last radio frequency tuned circuit is rectified by the diode and this rectified current flows through the load resistance R. The grid of the tube is connected to the top of R and the

bias of the grid is obtained from the cathode resistance R_b . This is adjusted so that the beam current is just cut off when there is no picture signal. If we suppose that a "black" signal is being radiated before the start of the transmission the rectified voltage across R will be proportional to the amplitude of the synchronising pulse and we can adjust the bias of the tube so that the beam is not visible on the screen with this value of potential applied to the grid. This is shown in the lower diagram as "S," and it will be seen that with the bias adjusted to the correct position the amplitude of S is insufficient to start the flow of beam current. Now suppose the picture signal starts. The rectified voltage across R will rise and will be of such a polarity that it wipes out the negative bias on the tube grid. The beam current will flow and the brightness of the screen will vary according to the lower curve. We shall have to take care that the brilliance does not increase beyond the point marked "defocusing" as at this point the beam current is excessive and the spot will be blurred.

Output Voltage Required

If we assume that the voltage developed across the diode load is sufficient to swing the grid of the tube to the full extent shown by the lower

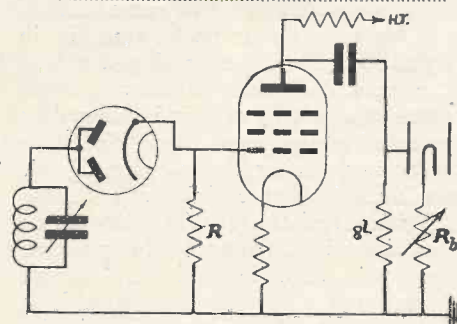

Fig. 2. The addition of a single video stage results in reversed polarity if no alteration is made.

curve we can estimate the value from the "modulation sensitivity" of the tube. This is always specified by the makers and may be, for example, 20 volts. Now in the total signal voltage, only 70 per cent. corresponds to vision and the remaining 30 per cent. is allocated to the synchronising. For 20 volts of "picture" the total voltage developed across the load resistance of the diode is therefore about 30, and unless the diode can develop

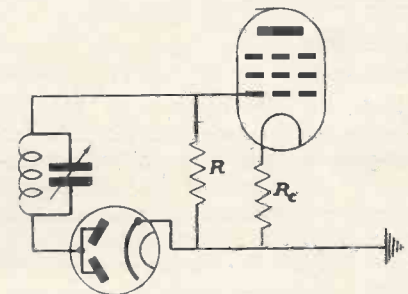

Fig. 3. How the polarity of voltage across R can be altered.

this value from the radio frequency input the tube is not going to be fully modulated.

As a general rule, in the simpler types of television receiving circuit it is not possible to obtain this value of voltage without a large number of radio frequency amplifying stages, and we are therefore forced to use an extra amplifying stage after the diode—the video amplifier.

Inserting a Video Amplifier

Fig. 2 shows a single stage of video amplification inserted after the diode. The leads have been disconnected from the tube and connected directly to the grid of the pentode. (The connections to the other electrodes have been omitted for clearness.) As soon as we connect the video amplifier stage in circuit we must isolate the grid of the tube from the H.T. supply by the condenser

NEGATIVE AND POSITIVE PICTURES

shown, but the loss of D.C. component does not worry us as we already know how to restore it.* What will worry us far more is that on switching on we shall get a negative picture in which the whites and blacks are reversed!

The reason for this will be seen on looking again at the curve of Fig. 1 and imagining it to represent the anode current of the video valve. The grid of the valve is biased by the cathode resistance shown, and the signal voltage will increase the anode current in exactly the same way as it increased the brightness of the tube. These variations in anode current will be handed on to the grid of the tube through the coupling condenser, but instead of producing a decrease in bias they will be of such a polarity that they increase the bias. The inclusion of the video valve without any modification has therefore resulted in a reversal of polarity.

Reverse Polarity

How can the reversal of polarity be cured? One method would be to add yet another stage of video frequency amplification, as the signal undergoes successive reversals in polarity as it goes through each stage. Two stages after the diode would therefore bring the polarity right again. This method is not always desirable; however, both on economical grounds and because of the excessive gain, resulting in poor detector efficiency.

Reasoning backwards from the argument in the previous paragraph, we can see that if we reversed the polarity of the signal applied to the grid of the valve we should obtain a correct polarity of signal on the tube. We can reverse the signal polarity on the load resistance of the diode by reversing the connections, and this is shown in Fig. 3. It will be seen that the resistance R is now virtually in the anode circuit of the diode instead of the cathode circuit and the top end will therefore become more negative as the rectified current increases. The grid of the video amplifier will thus be driven more negative with an increase of signal and the grid of the tube will correspondingly be driven more positive, which is what we require.

At the same time we must make

* See page 156, March issue.

one important alteration to the operating conditions of the valve, as it is already biased to a negative value. The increase of negative potential on the grid would therefore have no effect and the last state would be worse than the first with no signal on the tube at all!

To overcome this difficulty we reduce the bias on the valve to a very low value—actually just sufficient to prevent the flow of grid current. The application of an increasing negative potential then reduces the anode current, the variations due to the signal then appearing as in Fig.

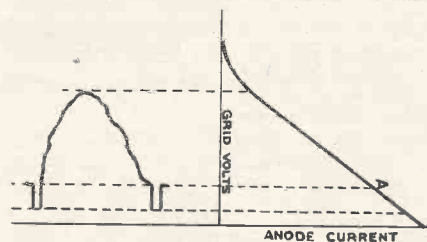

Fig. 4. The working characteristics of the video amplifier with low bias.

4. This should also be compared with Fig. 1 of last month's article.

It will be noted from Fig. 4 that the first few milliamperes change in anode current are due to the voltage developed by the synchronising signal, and this suggests a neat method of separating the synchronising impulse from the video signal. The method has been used by Murphy Radio in their television receivers.

The value of the bias resistance is chosen so that the change in anode current produced by the synchronising signal gives a potential of, say, 10 volts across the resistance. Another diode is connected across the bias resistance with its cathode joined to a potential divider across the H.T. supply. The cathode can thus be made positive with respect to earth by any desired value of potential.

This potential is such that it is equal to the voltage developed across the bias resistance when a certain value of anode current is flowing. Any value of current less than this, such as occurs during the picture signal, produces less potential drop across the bias resistance. The anode of the diode is therefore less positive than the cathode and no current flows.

As soon as the current exceeds the value the anode of the diode becomes more positive than the cath-

ode, and when the bias is reduced to zero during the synchronising pulses the anode voltage is 10 volts positive and the diode passes current. The synchronising signals thus produce pulses of potential across the resistance in the diode circuit, and these pulses cease as soon as the picture signal reduces the anode current of the valve.

The R.M.A. Television Sub-Committee

THE Radio Manufacturers' Association has recently appointed a sub-committee to discuss and provide means of developing television. The first meeting has already been held and a decision was reached to tackle the problem under the following divisions:—

- (a) Liaison with the B.B.C. and the Television Advisory Committee to secure development of programmes, both as regards time and quality.
- (b) Regular contact with the Press.
- (c) Discussion of common technical and trading problems.

The sub-committee will meet regularly at fortnightly intervals.

The R.M.A. sub-committee of the technical advisory committee on receiving set problems at its first meeting considered interference of television reception by short-wave sound receiving sets. Interference is caused not only by one television set with another and by sound receivers tuning down to the television sound channel, but also through harmonics arising from short-wave receivers which are not actually tuned to television sound.

A Receiver for Television Sound

READERS who are interested in picking up the television sound broadcasts as a preliminary to buying a television receiver should make a note that the new Invicta receiver, Model 310, is suitable for this purpose.

This receiver which covers all wavelengths from 6.5 to 17 metres, 16.5 to 52 metres, and the usual medium and long wavelengths, is priced at £13 19s. 6d. It uses five valves in a super-het circuit and will pick up the television sound programmes at quite long distances.

Full details can be obtained from Invicta Radio, Ltd., Radio Works, Parkhurst Road, London, N.7.

Scannings and Reflections



TELEVISION THE BOAT RACE

THE finish of the Oxford and Cambridge Boat Race on April 2 will be televised from the Middlesex bank at Mortlake. One camera, fitted with telephoto lens, will be installed opposite the winning post to show the crews finishing the race. Two other cameras will be operated in the enclosures of the Quintin and Ibis Rowing Clubs respectively to show the crews afloat immediately after the race and in close-up as they bring in their boats.

During the first part of the race, viewers will be able to watch the progress of the boats on an animated chart. The sound commentary to be given on the National wavelengths by John Snagge, with Edgar Tomlin and Tom Brocklebank, will accompany the television broadcast until the finish at Mortlake, when a special television commentary will be given by Howard Marshall.

TELEVISION FOR SCHOOLS

One of the first television installations in schools is that at Leigh Hall College, Westcliff, near Southend. It appears probable that this step marks the inauguration of a new aid to education which will doubtless be followed at other schools and colleges.

THE NEW TELEVISION ANNOUNCER

Mr. David Hofman has been appointed announcer in place of Mr. Leslie Mitchell, who resigned to become a news-reel commentator. Mr. Hofman commenced his duties on March 7. He is thirty years of age, has had ten years' experience on the stage and in films, including eight years in Canada and the United States. He has also been a radio announcer at Station CFCF Montreal.

On his return to England two years ago he appeared in *Parnell* at the Gate Theatre, and has since worked with the Sheffield Repertory Company besides appearing in touring productions.

CRAZY PROGRAMME

Following the amusement caused by his Crazy Cabaret last year, in which the compère was seen throughout in his bath, Cecil Madden is once more devising a presentation which he is calling "Nice Work," an even crazier programme, which follows a general theme. This is to be given on April 1.

Joan Miller will be seen as Cleopatra in a skit on the producers' 100 per cent. Broadway programmes, with Guy Glover as Hyman Kaplan Anthony in a new sketch "You Can't Take Your Needle With You, Cleo!" specially authored for the occasion by Shakespeare and the producer.

There will be burlesques on aspects of television programmes from American Travelogue films in which Charles Heslop and Cyril Fletcher will appear. Others taking part will be the Bashful Boys, the Three Pirates, the Three Romps, and the Narkover Gang, Campbell Rogerson, George and Frank Dormonde.

MORE FILM TELEVISION

The B.B.C. is to extend its activities in the televising of films and work is proceeding in the making of stock films which will assist in studio productions, the idea being to have a film library which can be drawn upon as occasion demands. The possibility of using amateur-made films is not being overlooked and inquiries are being made in America and on the Continent with the object of securing films in which the question of television copyright does not arise.

£295,000 FOR TELEVISION

Major Tryon, Postmaster-General, in the House of Commons on March 9 submitted a supplementary estimate of £360,000 for the B.B.C. He said that it was expected that by the end of March 8,540,000 licences would have been issued, whereas the original estimate was 8,400,000.

It was proposed that 8 per cent. of the net licence revenue should in future go to the B.B.C. for television.

Expenditure would be necessary

for additional studio accommodation at the Alexandra Palace, and £295,000 would be the amount of the additional grant for television.

TELEVISION IN THE COMMONS

During the debate on the B.B.C. supplementary estimate several M.P.'s criticised the conduct of the television service.

Mr. H. Morrison (Soc., S. Hackney) described television as "indeed a wonder of the age," and said he did not think it right that a national service of this kind should be monopolised by London. He would, he said, like some indication as to when television would be available for the larger centres of the country, the provinces, Wales, and Scotland.

Mr. Graham White (Birkenhead, E., L.) said that it was important that the cost of television should be reduced and that the service should be brought within the range of a very much larger number of people.

Mr. Simmonds (Birmingham, Duddeston, U.) said that television had not yet been developed either geographically or technically, and it was clear that the B.B.C. was not using its most expensive artists, as compared with broadcasting, which meant that television had an air of amateurism. Perhaps that was one reason why more television receivers had not been sold. He urged that regional developments should be carried out with the least possible delay.

Mr. Magnay (Gateshead, L. Nat.) congratulated the Postmaster-General and the B.B.C. on their new venture in television.

Mr. H. Morrison (Hackney, S., Lab.) asked what effort had been made to get television made more readily available to people of limited means? At present television was limited to a great extent to London and the Home Counties. It was not right that a national service of this kind should be monopolised by London, and he hoped that it would be extended to the provinces, to Scotland, and to Wales.

MORE SCANNINGS

PROHIBITION OF PUBLIC SHOWS

The B.B.C. has placed a ban upon the showing of its television programmes in public. The announcement of this was made visually before the televising of the Oxford and Cambridge sports from the White City when the following notice appeared on the screens of television receivers. "The reproduction in any form of the outside broadcast which follows, including projection in places of public entertainment, is strictly prohibited."

This decision was the outcome of the arrangement to televise the fight between Jock McAvoy and Len Harvey for the light-heavyweight championship of Britain from the Harringay Arena on April 7. The promoters of this fight made it a condition of their contract with the B.B.C. that reproduction in cinemas should be prohibited.

The question of copyright in the B.B.C. television programmes has never been raised, but obviously it exists and sooner or later the position will have to be defined. At present it appears that the ban is directed against reproduction in cinemas and public halls and if it is upheld it will create a difficult situation in respect of big-screen television unless the cinema interests were prepared to make their own transmissions by cable. A short time ago the matter was raised in Parliament, but as up to that time only experimental transmissions had been made to places of public amusement it was not considered necessary that the position should be clarified.

SHORT-WAVE RECEPTION FROM AMERICA

At the present time it is interesting to find that the average commercial all-wave receiver will bring in quite a number of programmes radiated by the popular stations such as Boundbrook, Pittsburg and Schenectady. This is rather unusual for we are at present in the middle of a period which should be rather bad for general short-wave reception.

When conditions are good it is possible to pick up some excellent programmes which are comparable with local programmes. This is mainly due to the efficiency of the transmitters and the use of beam aerials, for receivers built three or

four years ago are still capable of picking up these long distance programmes.

Conditions at the present time are so good that it is quite usual to hear simultaneously American broadcasters on 19, 25 and 31 metres.

TELEVISION IN AUSTRALIA

That something is to be done about television in Australia seems evident. Tests have been conducted on television wavelengths with a transmitter operating from the heart of Sydney, and observations have been made for a range of approximately 15 miles.

PITCAIRN ISLAND

One amateur broadcasting station has been in operation at Pitcairn Island since the first week in March, but now short-wave listeners have discovered that there is a second Pitcairn station in operation using the call-sign VR6AY. This station uses a wavelength of approximately 21 metres and is perhaps one of the most out-of-the-way stations that listeners in this country can hear. Although mail boats to Pitcairn are very few and far between messages are now being sent by radio so that this lonely island can be kept in constant touch with the rest of the world.

TELEVISION AT THE IDEAL HOME EXHIBITION

Television is to be shown all day and every day between April 5 and April 30 to visitors at the Ideal Home Exhibition. Most of the transmissions will be on a closed circuit, but several items are to be televised actually from a studio at the Exhibition and radiated for the benefit of ordinary viewers. A great number of interesting personalities have promised to be televised so making this period a very interesting one for all who are watching the rapid progress of television.

THE HARVEY-McAVOY FIGHT

Viewers were looking forward with extreme interest to the relay of the Harvey-McAvoy fight from the Harringay Stadium. This relay was to have been the most ambitious yet attempted by the B.B.C. television engineers and it was unfortunate that Harvey should have damaged his hand and so called the fight off.

However, the fight is to be relayed on April 7 for a full 15 rounds and there is every indication that anyone who can look-in on that evening will do so. Broadcasts of this kind will make broadcast listeners realise just what they are missing by not having a vision receiver.

The recent exhibition of "Catch-as-catch-can" wrestling between McCready and Foster gave quite a good indication of the possibilities of the Harvey-McAvoy fight relay being a most successful one.

THIRTY RECEIVERS AT THE IDEAL HOME

At least thirty television receivers supplied by Marconiphone, Baird, G.E.C., Cossor, H.M.V., Murphy, and many others, will be in operation from 11 a.m. to 10 p.m. for the duration of the Ideal Home Exhibition. Visitors will also be able to walk round three sides of a glass-walled studio and watch the television scenes being acted. On the opening day Mr. Gilbert Frankau will make an afternoon speech from the studio and at 8.30 p.m. two well-known actors, Mr. Robertson Hare and Mr. Alfred Drayton will be televised.

FAMOUS ARTISTS TO BE TELEVISED

Many famous artists are to be televised between April 5 and 30, and these will include Miss Kay Cavendish, Mr. Lupino Lane, Sir Hugh Walpole, Dr. A. J. Cronin and the well-known author, Mr. Rafael Sabatini. Amongst the sporting personalities to be televised are Tom Webster, Miss Kay Stammers and Mr. Stanley Doust.

A fashion show is to be televised and the compère will be Miss Enid Stamp-Taylor, the well-known actress, while Mr. Leslie Howard, who is at present filming in *Pygmalion*, will also appear before the television camera.

Several London night clubs and theatres are to supply artists and extracts from stage shows and these will include the Coliseum, London Casino, and the Prince of Wales Theatre.

London Films will loan some of their artists from Pinewood and Denham, amongst those expected will be Mr. Robert Donat, Mr. Clive Brook, Mr. Leslie Banks, Mr. Rex Harrison, Mr. Raymond Massey,

AND MORE REFLECTIONS

Mr. Ralph Richardson, Miss Margareta Scott, Miss Vivian Lee and Miss Valerie Hobson.

AEROPLANES AND TELEVISION

Low-flying aircraft certainly do interfere with television reception and in some instances interference has been noticed even when the planes have been at a high altitude.

This is rather extraordinary for the electrical system in the average aeroplane is completely screened with all leads bonded in order to prevent interference to radio apparatus installed in the plane. In view of the number of complaints made by viewers regarding interference from aeroplane engines, it appears that the ignition systems are only sufficiently screened to prevent interference on the wavelength at which the aeroplane receiver is being operated. This allows interference to be radiated on much lower wavelengths so interfering with television reception.

NEWS BULLETINS AND
TELEVISION VIEWERS

By this time most viewers will have heard the News Bulletin broadcast at the completion of each evening's programme. This News Bulletin is actually a recorded version of the nine o'clock bulletin broadcast on the National wavelength. No vision accompanies this transmission although for the period an announcement is left on the screen and in the corner of the announcement board is shown an electric clock. This gives the correct time very accurately for the large second-hand can clearly be seen.

SPECIAL OUTSIDE BROADCASTS

The television engineers at Alexandra Palace, and particularly those in charge of the outside broadcasting van, deserve congratulating on the excellence of their transmissions despite many difficulties. The relay of the women's hockey from Kennington Oval, the Varsity sports from the White City, and the International Rugby from Twickenham were three of the most interesting events. However, these will be very much put in the shade by the televising of the Boat Race and the F.A. Cup Final from Wembley Stadium. Viewers have seen enough of the outside broadcasts to realise that they will be able to follow the action of all these broadcasts quite comfortably.

The interference noticed by viewers

on the outside broadcasts last year seems to have stopped, although there was a slight trace of this trouble during the Rugby International relay.

TELEVISION PROGRAMMES FOR
CINEMAS

Although the B.B.C. specifically bans the showing of television in public places, there is a scheme on hand fostered by cinema proprietors to install large screen television equipment and to produce their own programmes in a central studio which could be connected by line to the various cinemas interested. This idea seems to be quite a good one, but it seems that there will probably be some difficulty in maintaining the standard of entertainment. Most viewers seem to appreciate the unusual programmes such as the relay of the Cup Final, rather than a normal type of entertainment that can be seen in any cinema or theatre.

ENGLAND v. SCOTLAND

On April 9 the mobile television unit will be installed at Wembley Stadium to show viewers the International Soccer match between England and Scotland. This relay is by permission of the Football Association and Wembley Stadium, Ltd., who are also granting facilities for televising of the Cup Final at Wembley on April 30.

THE FIRST SUNDAY PROGRAMME

The first Sunday evening television programme on April 3 will include a special version of Clemence Dane's

great biographical play, "Will Shakespeare," with Henry Oscar in the name part. When the play was first presented at the Shaftesbury Theatre in 1921, John Galsworthy described it as "the richest, most imaginative blank verse we have had since Shakespeare's own day."

In a series of dramatic vignettes, the play takes us from Stratford, where Shakespeare is estranged from Ann Hathaway, to London, where the dramatist falls in love with Mary Fitton, produces plays, meets the Queen, makes merry at Deptford with Kit Marlowe, quarrels with him, and becomes involved in a tragedy which may or may not have an historical basis.

Margaret Rawlings will be seen as Mary Fitton, and Esmond Knight as Marlowe. The cast also includes Catherine Lacey as Ann, and Barbara Everest as Mrs. Hathaway.

George More O'Ferrall, who is producing "Will Shakespeare," considers that the play should be ideal for television. It will be televised again on April 8.

TELEVISION DRAMA

Another biographical play, "Wren of St. Paul's," by a young English playwright, Christine Hahlo, will be seen on April 4 and 9. Sean O'Casey's comedy, "The End of the Beginning," is another highlight scheduled for April 5 and 13. "The Seventh Man," a play by Michael Redgrave, based on the story of "Q," will be televised in the evening on April 8 and repeated on April 11.



A scene in the R.C.A. television studios.

AN EASILY-MADE DIPOLE AERIAL

THE dipole television aerial described below was constructed at short notice with materials that are readily available, and it probably represents the cheapest construction that is possible.

As will be seen from the sketch, it is made chiefly of wood, the actual aerial consisting of two lengths of 14-gauge copper wire, which are supported on two Bulgin stand-off insulators (type 110), which cost eight-pence each.

The wooden framework consists of two lengths of 1-in. square deal, each 4 ft. 9 in. long, screwed to another piece 2 ft. 2 in. long, 2 in. wide, and 1 in. thick. This allows an overlap at each end of the aerial supports of 4 in. and provides for the support of two lengths of wire each 5 ft. 4 in. long with a space of 2 in. between the inner ends.

At the two extreme ends of the aerial framework the stand-off insulators are mounted on two small squares of oak which are previously screwed to the ends of the 1-in. pieces. The necessity for these small pads is because the bases of the stand-off insulators are a larger diameter than the frame arms, and it is not desirable to increase the weight by using thicker wood.

The centre stand-off insulators are mounted on a piece of wood $2\frac{1}{2}$ in.

wide at one end and tapered off to 1 in. at the other. This piece of wood is 2 ft. 6 in. long and serves the double purpose of providing a

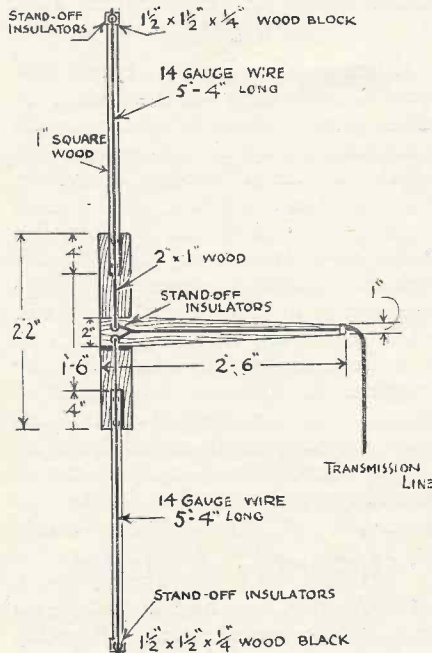

The construction of the aerial will be clear from this dimensioned drawing.

mount for the stand-off insulators at approximately the same level as the outer ones, and also a support for the down lead.

The assembly, as described, provides supports for two lengths of 14-gauge copper wire, each 5 ft. 4 in. long, and with a space of 2 in. between the inner ends. This measurement of wire length is important, and it represents a quarter wavelength in each case.

Clamping screws are provided on the stand-off insulators, and loops are accordingly made at the ends of the wires to take these. At the inner ends it was thought desirable to further ensure a good and permanent connection by soldering the wire to the screws after the lead-in had been attached.

The lead-in, as will be seen, is carried along the horizontal arm, being secured to the outer end by a porcelain cleat. In the first instance, ordinary twisted flex was tried for the lead-in, but it was obvious that the greatest efficiency was not being obtained and in its place the new Belling-Lee 80-ohm transmission line was used. This is a recent production which it is claimed has negligible losses at 7 metres and the results obtained after its installation certainly bore out this claim, for there was a general all-round improvement in picture quality; further, it has the advantage that it cannot become water logged, and it is practically impervious to weather.

The Yorkshire Television Association

THE annual general meeting of the Yorkshire Television Association was recently held at the Regent Picture House, Leeds, when there was a full gathering of members.

In presenting his annual report, the secretary remarked on the excellent financial position of the association considering that quite a large sum had been expended in transmitting equipment. He recalled the many well attended meetings held during the year, and also a day tour which would be difficult to better and one which will long be remembered by those who took part. This was a visit to the works of Messrs. A. C. Cossor, Ltd., at Highbury Grove, a tour of the Alexandra Palace television station, an inspection of the large screen television gear erected by Mr. Baird at the Dominion Theatre, London, and also a visit to the Phoenix Theatre, London, to hear the first demonstrations of "Mirrophonic" sound.

Prospective members are requested to get in touch with the secretary, Mr. A. Buckley, 110 Finkle Lane, Gildersome, near Leeds.

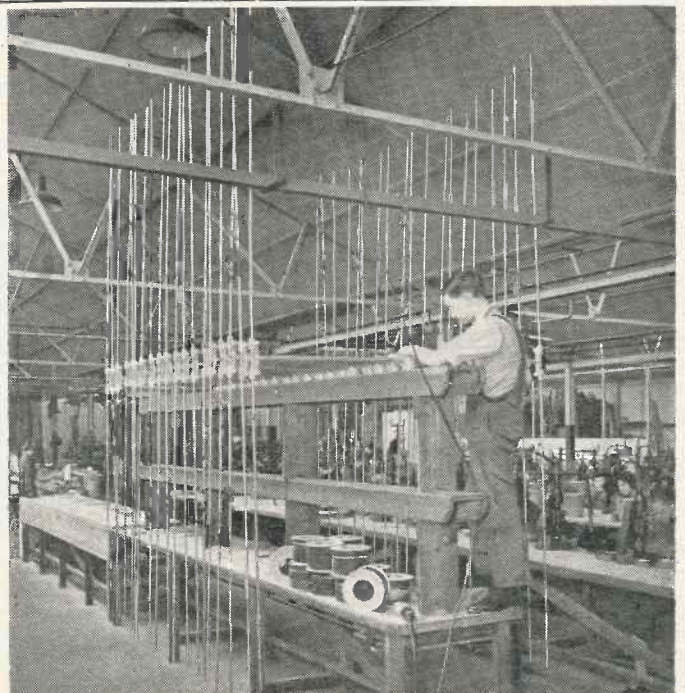

A batch of dipole aerials in course of construction at the Belling Lee works

WIDE-BAND TELEVISION AMPLIFIERS

The following article is an abbreviated form of one which appeared under the same title in "Electronics." It is by F. A. Everest, of the Oregon State College, and gives an outline of the theory underlying the frequency range of television amplifiers.

IT seems probable that the newly-developed electron multipliers will eventually supplant the resistance-coupled amplifier on account of the very high gain obtainable at very low noise level. In the meantime the resistance-capacity coupled amplifier can be made to serve very well for video-frequency amplification until it

If the capacities C' and C'' are added to form the equivalent capacity C_e , we can simplify the circuit of Fig. 1b into that of Fig. 1c, as shown.

Effect of High Frequencies

At high frequencies the reactance of the capacity C is very low and it

this effect depends on the amplification factor of the valve and the grid-anode capacity, it is possible to reduce the shunting capacity by lowering the latter.

This is done in the screen-grid valve, and thus we should expect to obtain much better results by using screened pentodes in the amplifying

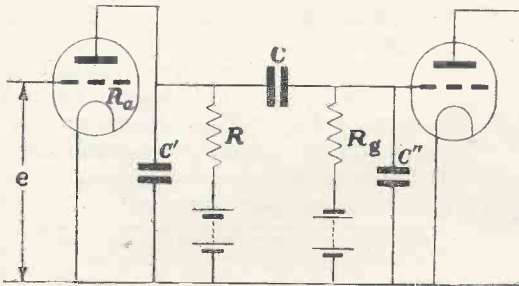

Fig. 1a. Circuit of R.C. coupled stage showing shunt capacities.

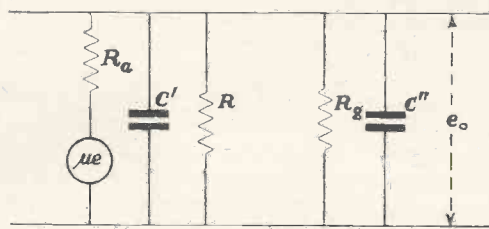

Fig. 1b. The same circuit without valves showing capacities and resistances effectively in parallel.

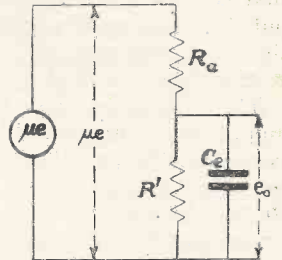

Fig. 1c. A further simplification showing how the stray capacities shunt the output voltage.

is supplanted, and the object of this paper is to show how it can be adapted to the handling of the high frequencies present in television.

The circuit of the resistance-capacity amplifier is shown in Fig. 1a, and the equivalent circuit for high frequencies is shown in 1b. At these frequencies the reactance of the

forms a shunt across the resistance R' , lowering the proportion of the voltage μe which appears across it. As the stage gain is equal to the ratio of the output voltage e_0 across R' to the input voltage μe , the gain will steadily decrease as the frequency rises.

The first step towards improving the stage gain is to minimise the shunting effect of the capacity C_e . If the value of the grid leak R is high in comparison with R_g (as it would be in practice) the value of R is the main factor in determining the effective impedance across the output. Values were calculated for a fixed value of grid leak of 1 megohm and various anode resistances from 50,000 to 1,000 ohms and it was seen that the frequency response increased with decreasing values of R . With 50,000 ohms a stage gain of 11 is obtained with a type '56 valve and the response curve is flat to 100 kc. With 5,000 ohms, however, the response is flat to 300 kc., but the gain is reduced to 5. It is clear that the selection of the value of the coupling resistance is governed by the compromise between gain and frequency response.

The above considerations do not take into account the Miller effect, which causes the total shunting capacity to be considerably larger. Since

stage. As an example of the reduction in capacity obtained, the figure for a triode type 56 is 57.8 $\mu\mu\text{f.}$ while that of the acorn pentode is only 11 $\mu\mu\text{f.}$

With an anode resistance of 10,000 ohms and the same value of grid leak, the stage gain is raised to 11 in the case of the acorn pentode,

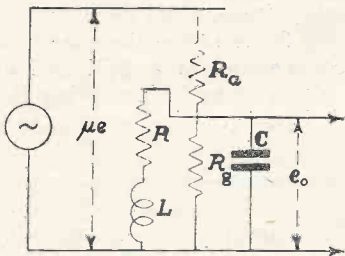

Fig. 2. The addition of an inductance L to the equivalent circuit of Fig. 1c.

coupling condenser C is negligible. C' represents the output capacity of the first valve and C'' the input capacity of the second valve. The signal voltage e applied to the first grid can be considered as a voltage equal to μe acting in the anode circuit in series with the valve impedance R .

The anode resistance R and the grid leak R_g are effectively in parallel and can thus be replaced by an equivalent resistance R' which is given by $\frac{RR_g}{R+R_g}$.

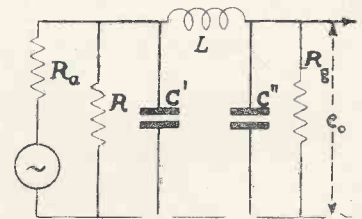

Fig. 3. The equivalent circuit of a filter coupled amplifier corresponding to Fig. 1b.

with a flat frequency response to nearly 1 megacycle.

Use of Inductance

A favourite method of neutralising the effects of the shunt capacity is by the introduction of a small inductance in series with the anode resistance R . This actually forms a resonant circuit, but the resonant frequency is higher than the highest

frequency it is desired to amplify. Fig. 2 shows the equivalent circuit of the amplifier with the addition of an inductance in series and the resulting response curves show that for an inductance of 1.1 millihenry the impedance across the output terminals actually exceeds the value at the middle range of frequencies and a greater proportion of the input voltage μe appears across the output.

This means that the stage gain is increased above 300 kc. and this effect may be used to compensate for a falling off in other parts of the circuit. Care must be taken, however, that the peaking of the voltage output does not reach such a value that the amplifier oscillates at the high frequencies.

The calculation of the response of amplifiers including inductance is involved as the impedance of the combined choke and resistance must be found for each frequency value required.

This equivalent impedance is then substituted in the formula for stage gain.

Filter-coupled Amplifiers

The use of filter circuits in amplifiers has been described by Beardsall* and the following table gives some results calculated for the filter-coupled stage shown in Fig. 3.

Cut-off freq.	C ($\mu\mu f.$)	L (mH.)	R	Approx. Gain.
2	6	2.105	13,220	14.5
3	6	.935	8,830	9.7
4	6	.526	6,620	7.3
6	6	.234	4,410	4.9
8	6	.132	3,320	3.7
4	12	.262	3,320	3.7
6	12	.117	2,200	2.4
8	12	.066	1,650	1.8

The frequency is in megacycles, and $C_1 = C_2 = C$.

The value of the cut-off frequency selected should be 2-10 times the

maximum frequency desired to amplify. It should be noted that the value of the grid leak R is exceptionally low, and it is in fact the characteristic impedance of the filter.

Phase Shift

The phase shift accompanying the amplification of the signal may assume important proportions as its effect is a displacement of the picture element from its proper position.

For a 300-line 24 pictures/sec. transmission on a screen 10 in. wide a phase shift of 450 results in a displacement of .009 in. at certain low frequencies.

The phase shift of the inductance compensated circuit described above is appreciable with inductances of 0.5 mH and over and this is an important factor in determining the final value of inductance to use.

* The original paper referred to appeared in T. & S. W. W. for February 1936, p.95.

AMERICAN TELEVISION

The Studio

THE Grand Central Studio across the street from the Chrysler Building was chosen by Columbia because it is easily accessible, cen-

trally located and near the transmitter. This will make programme production easier as well as assure power transmission with the least possible loss or distortion. The problem of power transmission is further simplified by the fact that the aerial for the new station is located just under the stainless steel needle of the building, only 90 ft. from the transmitter.

and is 40 ft. high, 230 ft. long and 60 ft. wide. In addition to dressing rooms, laboratories, etc., there is room for two large studios, but only one is to be constructed immediately. The television cameras are now being given final tests at Camden. They

are mounted on counterweighted "dollies" so they can be moved about easily and raised and lowered at will. Each is connected to its control equipment by a flexible cable 1½ in. thick which contains a total of 32 circuits, four of which are coaxial.

Experiments now are going on in Camden to determine the type of aerial best suited for the transmitter and also for the Chrysler pinnacle around which it is to be constructed. A complete "electrical reproduction" of the top floors of the skyscraper has been constructed in a field and different kinds of aerial are being built and tried out on this structure.

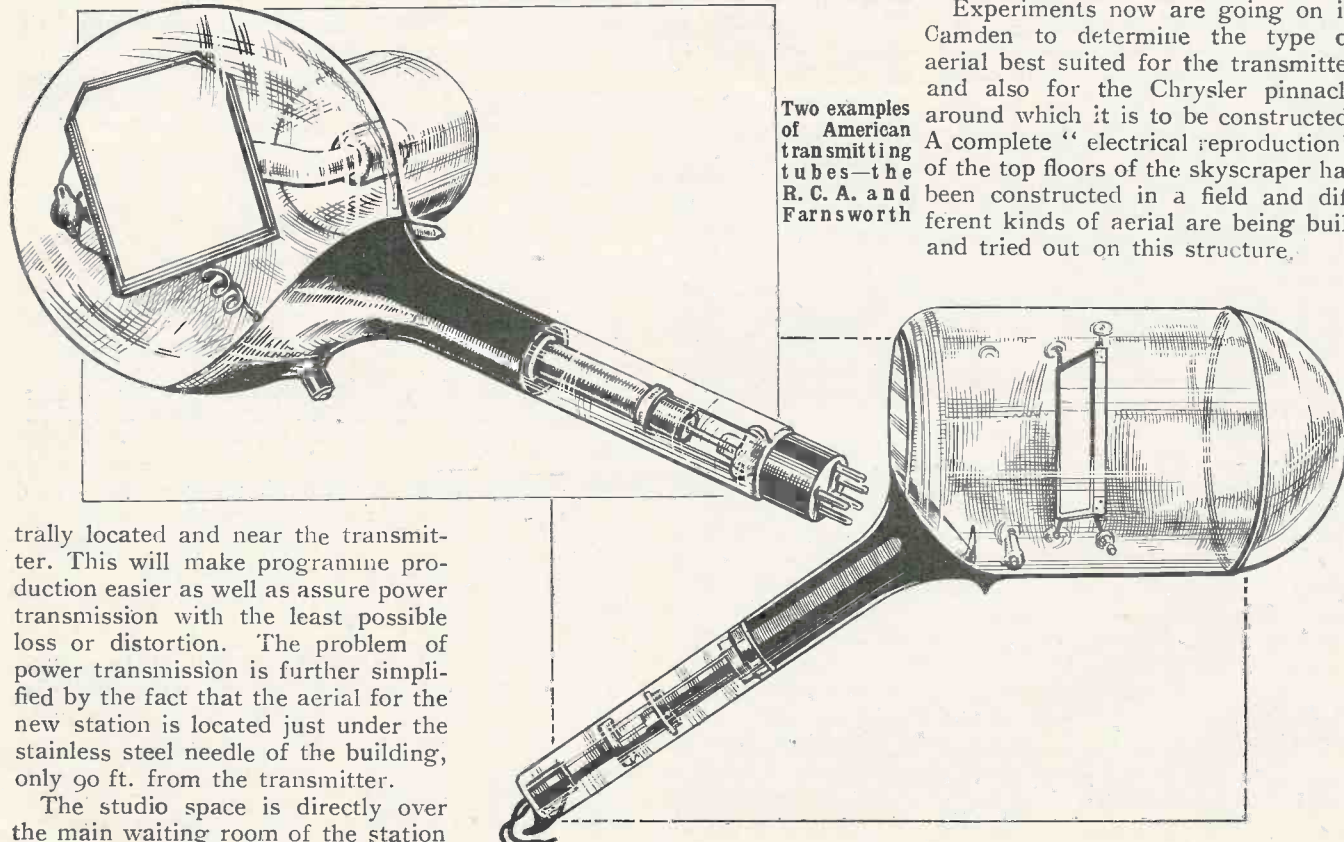

Two examples of American transmitting tubes—the R. C. A. and Farnsworth

trally located and near the transmitter. This will make programme production easier as well as assure power transmission with the least possible loss or distortion. The problem of power transmission is further simplified by the fact that the aerial for the new station is located just under the stainless steel needle of the building, only 90 ft. from the transmitter.

The studio space is directly over the main waiting room of the station

COSSOR TELEVISION

The results of our laboratory and practical tests on the Cossor television receivers are given in this short review.

A. C. COSSOR, LTD., have produced three different types of television receiver all of which give a bright black and white picture which is viewed directly on the front of the tube face.

The two larger models first produced a little over 12 months ago have not been modified since they were first introduced which speaks well for the design in the first instance.

The receiver which should be of

width in order to obtain increased gain.

Contrary to the usual practice in the cheaper instruments two distinct receiver chassis are used, one for vision signals and the other for sound reception.

Both of the aerial inputs are fed from a common aerial in rather an unusual manner. Between the input of each receiver and the common 80-ohm feed line is a rather unconventional $\frac{1}{4}$ -wave matching stub. In

A single video stage is used followed by one double-anode valve for synchronising and four valves in the time bases, three straightforward rectifiers and five valves in sound receiver making a total of 20 valves in all.

The sound receiver has a single H.F. stage in front of the mixer with a single I.F. stage, a double-diode-triode second detector and an output pentode in the final stage.

With this 437T receiver there are five controls and one switch on the front of the cabinet with seven additional pre-set controls at the back of the cabinet out of the way.

It has been our experience that the receiver is easier to operate than the average all-wave receiver for most of the controls remain untouched for long periods.

The main controls on the front of the panel are, on-off switch, sound volume, trimmer for sound receiver, brightness, focus and contrast.

It is not really necessary to touch any of these controls with the exception of the switch, once they have been set. The more important controls, which are at the back of the cabinet, are pre-set when the receiver is installed and need not be touched.

These controls are for adjusting the width and height of the picture, the horizontal synchronising, the

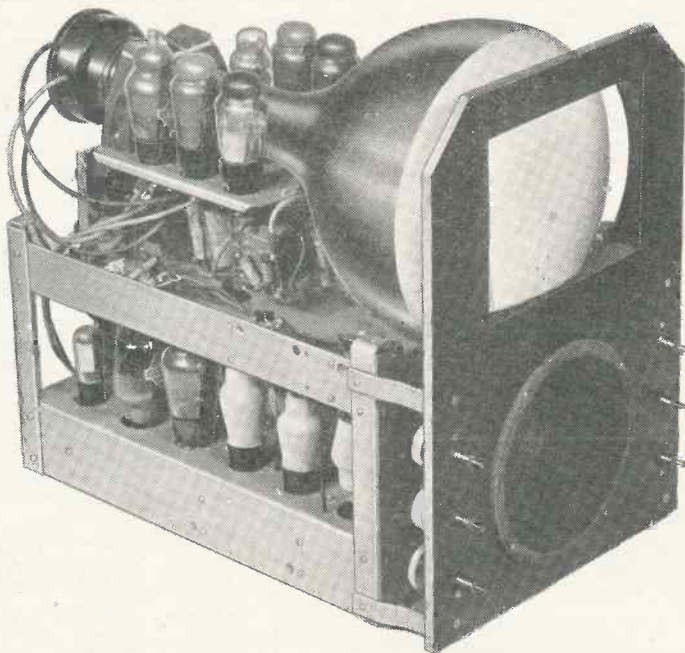

A view of the fine chassis of the Cossor television receiver model 437T.

particular interest to our readers is the smaller table model 437T, priced at 45 guineas. This receiver has one of the largest pictures available in what is generally known as the cheaper models.

The sensitivity of this instrument on both sound and vision is practically the same as with the larger models which are priced at 70, 80 and 90 guineas.

We have been testing the model 437T under very bad local conditions where the field strength is so low that only the most sensitive receiver will provide a picture of any kind.

Despite this handicap the picture received is a definite black and white with ample contrast. The sensitivity of the receiver is such that there has not been any need to peak the radio units for vision or to reduce the band

this way the two frequencies are adjusted in such a way that they reflect into almost an infinite load so that both receiver units can be fed from the common aerial without loss.

Super-het. receivers are used in both cases which is rather better than having one or two stages in the vision receiver fulfilling a double purpose.

In the vision receiver there are two high-frequency stages before the mixer which is a triode-hexode of high conversion conductance.

Following the mixer are but two intermediate-frequency stages feeding a double-diode-triode of special design having a very low inter-electrode capacity. This is, of course, essential in order to prevent possible attenuation of the very high frequencies handled.

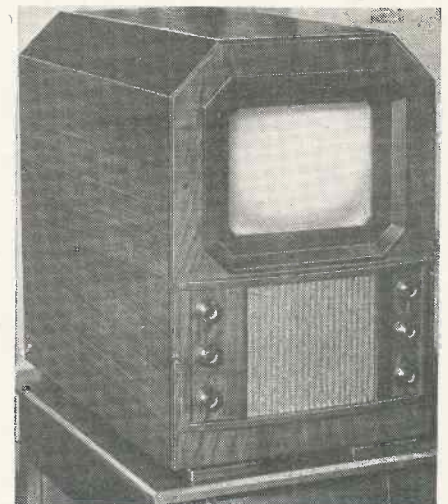

The external appearance of the 437T receiver giving an 8 $\frac{1}{2}$ -in. by 6 $\frac{1}{2}$ -in. picture.

vertical synchronising and interlacing.

Once the receiver has been ad-

20 VALVES

::

A COMPLETE INSTRUMENT

justed the picture remains quite steady and interlaces perfectly. It is advisable to have the contrast control retarded as much as possible in order to use the receiver with minimum stage gain. Interference from motor-car ignition systems can be troublesome if the receiver is used in a bad location or if too high a degree of sensitivity is used.

This interference will make itself

be obtained, the price of which is 3 guineas.

For those who need a combined television and radio instrument there is the model 137T, which has been designed for reception of the normal broadcast stations on 200-2,000 metres.

This instrument gives high fidelity reproduction and a high output in addition to a large picture size of

Both the 137T and 237T have a special switch which receives the T.V. sound without the picture. This is a most useful device in that such items as the News Bulletins may be received without wasting the extra wattage consumed by the tube.

Full information on these receivers can be obtained from A. C. Cossor, Ltd., Cossor House, Highbury Grove, N.5.

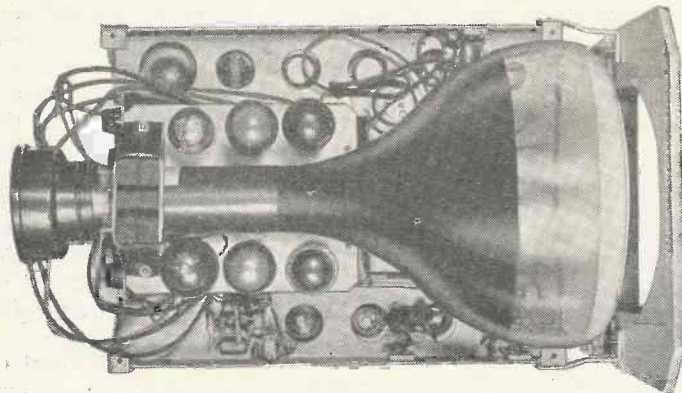

This is a plan view of the Cossor small receiver. Notice the compact lay-out.

noticeable by a number of white spots appearing on the screen. This interference can be cured in all but the most distant areas in which case a small unit can be fitted which has the effect of converting the white spots into black ones. This "spotter" or phase reversing unit costs an additional 25s., including fitting.

The picture size of this Cossor receiver is about 8½ in. by 6½ in., which is ample for the average home. In addition, as the definition is so good a number of people can view at the same time. For example upwards of a dozen people viewed the relay of International Hockey from Kennington Oval and the same number saw the Varsity sports from the White City.

The size of picture was ample fully to appreciate the action going on while some of the camera work in the hockey relay was extremely fine. In many instances the ball was followed in flight from the moment of impact.

We have found this receiver quite trouble free, in fact, less troublesome than the average multi-valve receiver. Many readers with a receiver of this kind will find that the only control to be used is the main switch.

The standard cabinet is of grained walnut 22½ in. high, 14½ in. wide and 25 in. from back to front. A table on which to mount this receiver can also

10 in. by 8 in. This instrument complete with the special aerial, installed and adjusted, costs 70 guineas, which includes a guarantee and maintenance for twelve months.

For those who require all that

Book Review

Principles of Radio, by Keith Henney (Chapman & Hall, 17s. 6d.). Good text-books suitable for the student and the advanced constructor interested in the working of circuits built are all too few. This is one of the reasons that we were so pleased to find that KEITH HENNEY, the well-known editor of *Electronics*, had issued a third edition of his "Principles of Radio."

This book gives a simple explanation of most radio problems in a direct manner while at the same time the technical aspect is not overlooked. The chapters include Ohm's Law, Capacity, the Valve as an Amplifier, Low-frequency Amplifiers, and several chapters on transmission, aerials and oscillators.

Each chapter is complete in itself and

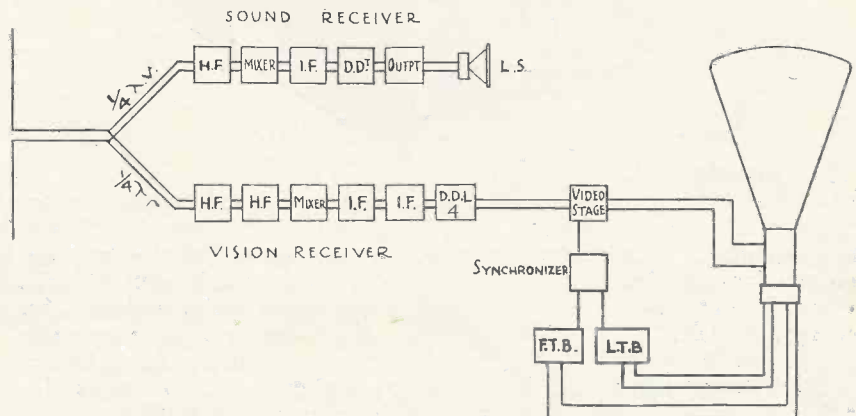

This schematic diagram gives a very good idea of the valve line-up in the small Cossor receiver.

radio and television can offer there is a special receiver, model number 237T, which provides a large black and white picture, broadcast reception with high fidelity reproduction and a gramophone pick-up with a fully automatic record changer.

This instrument costs 90 guineas and is a very fine complete home entertainer.

although a certain amount of formulæ is essential none has been included without fulfilling some definite purpose. It is also very interesting to have the American point of view on several problems which are common to engineers in both countries. This book fills a want and is one of the most concise books of its kind available. It is to be strongly recommended to all interested in the principles of radio.

RECENT TELEVISION DEVELOPMENTS

A RECORD OF PATENTS AND PROGRESS *Specially Compiled for this Journal*

Patentees: Baird Television Ltd., L. R. Merdler and A. H. Gilbert :: Telefunken Ges. für drahtlose Telegraphie m.b.h. :: N. V. Philips Gloelampenfabrieken :: M. J. Goddard and I. M. K. Syndicate Ltd. :: Zeiss Ikon Akt. :: Baird Television Ltd. and D. M. Johnstone :: F. W. Cackett

Line and Frame Impulses (Patent No. 475,046.)

LINE-synchronising signals usually consist of rapid "dips" below a datum line V-V of uniform voltage, the frame-synchronising signals F being of similar form

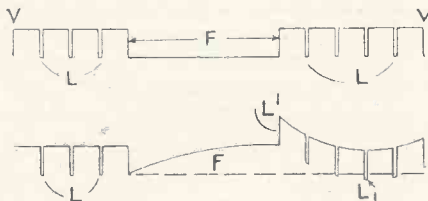

Obviating a synchronising defect.
Patent No. 475,046.

though longer in duration. It is found that at the end of each framing impulse, there is a tendency for the line impulses to acquire an undesirable variation in amplitude, as shown for instance at L₁ in the lower curve.

The effect is said to be due to the setting-up of forced oscillations in the line-scanning oscillator by the sudden change of voltage at the end of each framing impulse.

According to the invention, this defect is corrected by suitably coupling the valve that separates the picture from the synchronising signals to the oscillator valve producing the line-scanning oscillations. The coupling transfers an impulse which neutralises the voltage "kick" shown at L₁ in the figure.—*Baird Television, Ltd., L. R. Merdler, and A. H. Gilbert.*

Synchronising Systems (Patent No. 475,189.)

In order to secure accurate synchronisation of the "line" and "frame" impulses, the latter are divided into two parts, the first serving to prepare the way for the second, which actually "triggers" the timing valve.

Both the line and frame impulses are applied to a pair of discharge valves. The line impulses actuate

one valve in the ordinary way, and simultaneously build-up a voltage which blocks the grid of the second valve. This blocking voltage is removed by the first or preliminary part of the "framing" impulse leaving the valve ready to respond to the second or operative part of the impulse.

During the transmission of the two-part framing impulse no line signals are transmitted.—*Telefunken Ges. für drahtlose Telegraphie m.b.h.*

Cathode-ray Tubes (Patent No. 475,772.)

In order to produce a "white" light from a fluorescent screen, it is usual to use a mixture containing zinc or cadmium sulphide. It is found, however, that this tends to shorten the life of the tube, because in the course of time such screens liberate "free" sulphur which attacks and "poisons" the oxide coating of the cathode.

According to the invention a part of the wall of the tube, between the cathode and the screen, is coated with a layer of an alkaline earth metal. This absorbs any free sulphur that may be emitted from the fluorescent screen, and so prevents it from damaging the cathode.—*N. V. Philips' Gloelampenfabrieken.*

Light Valves (Patent No. 475,971.)

Relates to known forms of light valve in which the refractive medium is subjected to high-frequency mechanical vibrations from a piezo-electric crystal, and in which a number of image points are thrown on to the viewing-screen simultaneously so as to form a line or strip of light.

The arrangement is now modified by using a number of piezo-electric crystals to produce two or more parallel trains of vibrations through the medium, thus forming two or

more different strips of picture-points, separated by intervals corresponding to one or more scanning lines. These are projected simultaneously on to the viewing-screen in their correct relative positions.—*M. J. Goddard and I.M.K. Syndicate, Ltd.*

Image Dissectors (Patent No. 475,995.)

The signalling currents produced in a television transmitter of the "dissector" type are intensified by

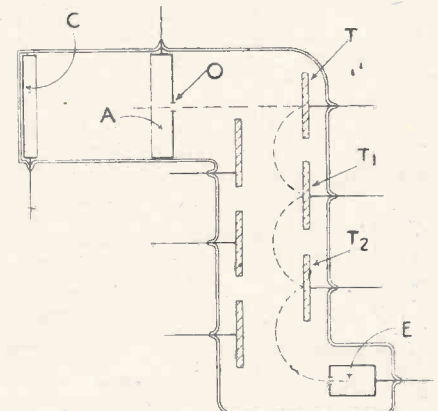

Image dissector, Patent No. 475,995.

secondary emission before being used to modulate the outgoing carrier-wave.

As shown in the drawing, the picture to be televised is first focused upon a sensitive electrode C, and the electrons so liberated are moved past a scanning aperture O in the anode A by suitable deflecting electrodes (not shown).

The emerging stream falls directly on to a "target" electrode T where it produces secondary electrons. These are thrown, by combined electric and magnetic fields, in turn against similar target electrodes T₁, T₂, as shown by the dotted lines. At each impact the stream is further intensified by secondary emission, until it reaches the output collector E, where it is converted into a signalling current.—*Zeiss Ikon Akt.*

"Television and Short-wave World" circulates in all parts of the world.

Intensifying Picture Signals
(Patent No. 476,233.)

In a cathode-ray television receiver, the incoming signals are first reproduced on a fluorescent screen F by the electron stream from the cathode C in the usual way. The light from the far side of the screen F then falls upon a photo-sensitive electrode S of the "mosaic" type, consisting of a large number of photo-electric particles set in a plate of insulating material. The fluorescent light sets up

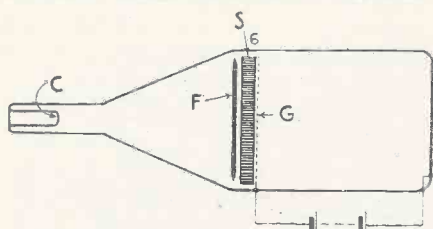

Tube for increasing picture intensity.
Patent No. 476,233.

charges on each of the mosaic cells at the side nearest to the screen F. Meanwhile a steady illumination acts upon the opposite face of the electrode S, so that each individual cell is discharged in a period of time equal to that required to complete the scanning of one picture-frame.

The electrons emitted, as each cell discharges, first pass through a grid G, and are then focused and accelerated on to a second fluorescent screen K, where they form an intensified image of the original picture.—*Baird Television, Ltd.*, and *D. M. Johnstone*.

Generating Saw-toothed Oscillations

(Patent No. 476,336.)

Saw-toothed oscillations, suitable for scanning, are produced in a circuit of which the inductance is formed by the deflecting coils of the cathode-ray tube, and the capacity is the inherent capacity across the windings of the same coils.

The deflecting coils, shunted by a biased rectifier, are included in the plate circuit of a valve, and the arrangement is such that the current taken from the valve is reduced to a minimum for the work it has to do.—*F. W. Cackett*.

Summary of Other Television Patents

(Patent No. 475,047.)

Cathode-ray tube provided with a storage grid backed by a parallel high-potential grid, and with a cath-

ode emitting a wide homogeneous electron beam, for scanning.—*Baird Television, Ltd.*, *V. Jones*, and *P. W. Willans*.

(Patent No. 475,100.)

Electron discharge device fitted with a photo-electric cathode, consisting of silver telluride coated with tellurium, and a photo-sensitive material.—*Baird Television, Ltd.*, and *A. K. Denisoff*.

(Patent No. 475,715.)

Electron tube containing a transparent "mesh" anode and a high-resistance photo-electric screen or target, backed by a parallel scanning-member.—*Electrical Research Products Inc.*

(Patent No. 475,807.)

Photo-electric cell of the evacuated type, in which a funnel-shaped "control" electrode is inserted between the cathode and anode.—*Baird Television, Ltd.*, and *E. B. King*.

(Patent No. 475,928.)

Television transmitter in which the picture signals are intensified by secondary emission from a mosaic-cell electrode.—*Electric and Musical Industries, Ltd.*, and *H. G. Lubszynski*.

(Patent No. 475,999.)

Optical multiplying system for use with a mirror scanning-drum.—*R. G. Wilson* and *W. D. Silver*.

(Patent No. 476,181.)

Scanning a continuously-moving film by an "interlaced" line-group method.—*Radio Akt. D. S. Loewe*.

(Patent No. 476,256.)

Composite H.F. inductance for a television transmitter designed to show high damping-losses.—*Baird Television, Ltd.*, and *D. W. Pugh*.

(Patent No. 477,433.)

Means for preventing the electron beam in a cathode-ray tube from burning-out the fluorescent screen.—*Philco Radio and Television Corpn.*

G.E.C. Secondary-emission Photo Cells

RECENT research work on photo-electric cells at the laboratories of the G.E.C. has been directed almost entirely to work on secondary emission cells of the single and multiple stage types. The progress achieved in the development of the former has led to the production

of secondary emission cells of the cathode-on-wall type, known as the CWS₂₄. A smaller size, type CWS₈, similar in dimensions to the well known CMG₈ is also available. With regard to the multiple-stage secondary-emission cells, experience has been gained with their use in the development of a television transmitter used for test purposes, but they are not yet available for the general market.

The CWS₂₄ secondary-emission cell consists of a primary cathode, a target and a collector. When light falls upon the primary cathode, photo-electrons are emitted. These electrons are accelerated by means of a suitable electric field towards the target, where, upon impact, they release secondary electrons. The ratio of the number of secondary electrons emitted to the number of primary electrons incident upon the target in unit time, is a function of the impact

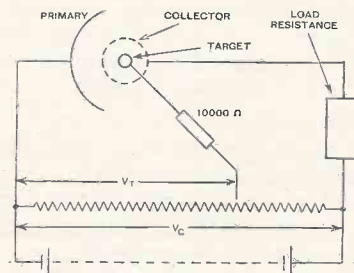

Circuit diagram of CWS₂₄ secondary emission cell.

velocity and the target surface. For targets employing the complex caesium cathode, the ratio may be as much as ten times.

The secondary electrons are attracted towards a collector, which plays the same part as the anode in the ordinary photo-cell, and it follows that the collector current can be several times greater than the original photo-electric current.

In the CWS₂₄ and the CWS₈, the primary cathode is formed upon the inner wall of a glass bulb, the target on a silver tube in the middle of the bulb and the collector is a wire helix coaxial with and surrounding the target.

The circuit recommended for use with these cells is shown here. The following values should be noted:—

$V_T = 75$ per cent. of V_C .

Recommended value for $V_C = 400$ volts but may be between 100 and 800 volts.

Potentiometer current—1 milliamp.

FINDING AND REMEDYING TELEVISION RECEIVER FAULTS—III

By S. West

The two preceding articles in this short series dealt with the location of faults in the vision receiver and time base. This article, in conclusion, deals with picture distortion and faults in the power unit.

WE will now assume that the raster is obtained and picture modulation is applied. The resulting picture is synchronised and has good detail. Unfortunately, however, aspect distortion occurs, the picture tending to compress at one edge.

This is invariably due to asymmetrical deflection voltages. In isolated cases the tube itself may be to blame or the saw-tooth wave shape may be poor.

With the feed to the grid of the paraphase valve completely cut down for each time base, the picture will have a certain reduced size.

Now the important point is this. When the picture is increased in size with alteration to these paraphase feed potentiometers, symmetrical deflection is obtained only when the picture is approximately twice this reduced size. This is perhaps not strictly true, but it is sufficiently true for our purpose. It is seen, therefore, that the operating conditions of the relay valve will require to be fairly accurately determined. These operating conditions will control also the accuracy of shape for the saw-tooth oscillation.

For the actual relay valve, we are concerned with two variable factors, which control the periodicity of ignition. It is here assumed that the other concerned constants are correct. These are the time constant for the charge device, i.e., the charge resistance and its associated condenser and the control voltage at the grid of the relay valve.

To retain the correct operating frequency and picture size these two factors will require to be varied inversely. However, the amplitude the charge voltage can reach, and therefore the picture size, is directly controllable with the voltage at the grid of the relay valve.

Obviously then, we are able to control the picture size when we incorporate a variable charge resistance in addition to an arrangement which will permit variation of the bias voltage of the control grid.

Similarly, an understanding of the manner in which a condenser acquires a charge will show that these constants will require to be correct for good saw-tooth waveform.

In the "Low Cost" Television Receiver to which these notes are primarily referred, for each time base fixed charge resistances are included. A number of excellent reasons governed the decision to adopt this arrangement when the receiver was designed but, with some operating experience gained, there is no reason why the refinement of variable charge resistances should not be included. This course is recommended where it has been found impossible to avoid aspect distortion.

The Power Unit

We come now to the final link of the complete receiver, the 4,000 volts power unit.

The tests applicable here are strictly limited to those that can be carried out with the unit disconnected from the mains, for amateurs having meters suitable for checking such high voltages are in a minority. There is a way in which it can be ascertained that the voltage is present, but it cannot be too strongly emphasised that extreme care is required.

A screwdriver having a long well insulated handle is required for this check. The blade of this is placed in proximity to a high voltage point, when a light discharge will indicate the presence of high voltage.

A few puzzling faults that often are extremely difficult to locate result where insufficient attention has been paid to the insulation requirements of the high-voltage leads. Also the writer has had personal experience of condensers which are handling a high voltage, developing an internal leak which no normal test will reveal.

Fortunately the fault is usually revealed as a definite pattern on the screen of the cathode-ray tube.

Other leakages are revealed as intermittent flashes not unlike heavy ignition interference. It can be borne in mind that very light discharges can produce a field which is picked up by the vision unit, when it is amplified and passed on to modulate the grid of the C.R. tube.

For those with normally developed olfactory senses the characteristic odour of ozone is an excellent indication of an electrical discharge taking place somewhere. Its location should not prove difficult to find in a well-darkened room.

In the writer's experience certain types of potentiometer can be guilty of an intermittent internal brush discharge which will mar the picture; also rubber-covered cable, no matter how heavily insulated, must always be regarded with suspicion unless the rubber is of excellent quality and in good condition.

Whilst the information given in this article has necessarily been in condensed form, it is hoped that sufficient information has been provided to enable the majority of faults that can occur rapidly to be located.

Useful Data on Light Intensities.

Source of Light	Approx. Intrinsic Brightness Candles per sq. cm.
Carbon Filament	20
Tungsten Filament (Gasfilled Lamps)	350 to 1,650
Sodium Lamps	c. 10
High Pressure Mercury 1 atmosphere, 230 volt	160
High Pressure Mercury 125 Watt. Pearl Bulb*	50
Brightness of column alone*	1,000
Mercury Water Cooled.	
400 watts/cm., 400 Volts/cm.*	30,000
Mercury Water Cooled.	
800 Watts/cm., 400 Volts/cm.*	60,000
Ordinary Carbon Arc	13,000 to 17,000
High Current Density Carbon Arc.	50,000 to 80,000

* Starting volts double running volts.

Dr. C. C. Paterson G.E.C. Research Laboratories.

Our Readers' Views

Correspondence is invited. The Editor does not necessarily agree with views expressed by readers which are published on this page.

Mr. A. F. Bulgin's Opinion of the Television Outlook

MY own experience, over a period exceeding 15 months of daily reception of the B.B.C. vision and sound transmissions, is more than encouraging. It is a confirmation of my belief that television is a steady, reliable contribution to civilised amenities, long past the laboratory or experimental stage. The only breaks in our reception were occasioned, not by any trouble with either the B.B.C. transmissions or our televisor, but simply by our own experimenting with various types of aerial. The installation has not been touched now for six months, however, as we have found our L.16 television aerial kit entirely satisfactory.

It is simply a matter of switching on at the appropriate times each day. There is never any disappointment, and the quality of the pictures has remained extraordinarily good. Although the receiver (which is a perfectly normal and unaltered commercial model) is situated in a room next to the big machine shops, with numbers of electric motors and miles of wiring in its vicinity, the problem of interference has not arisen since the first few days of reception, when the use of a suitable transmission line from the di-pole aerial and a few condensers effectually removed the last trace of interference on both sound and vision frequencies.

The Years Ahead

The installation now seems a permanent fixture in the works. It has aroused the keen interest, not only of the technical staff, but of the other employees, to whom "viewing"—or whatever word is to be used in the future—is a fascinating entertainment eagerly enjoyed whenever opportunity is offered.

We are authoritatively assured that the present system of transmission will be employed for a long time to come, so that there is no question of our receiver, although it is already nearly two years "old," becoming obsolete for years to come. This, combined with the promised exten-

sion of hours of transmission and the exploration of wider and wider fields for choice of programme material, makes us feel that the initial outlay is entirely justified.

Lower Prices Unlikely

We are not greatly surprised to gather that the prices of televisors will remain very much at their present level for the next few years at least. We know something of the work and material that has to be put into efficient vision receivers and our surprise is rather that prices are as low as they are. Experienced technicians know that quality in materials and reception cost money; this is more true of television than of sound reception. For our part, we are entirely satisfied that any purchaser of a modern televisor will not regret the expenditure and to put off buying one hoping for prices to fall considerably is to miss excellent entertainment for the whole family.

Mr. A. F. Bulgin is Governing Director of A. F. Bulgin & Co. Ltd., the well-known radio component manufacturers.—ED.

Radio Service Employment

SIR,

In view of the interest inspired by recent articles in various organs on the subject of service and the engineer, we, the undersigned, although recognising the good intentions of bodies now in existence, incline to the opinion that radio-service engineers stand in urgent need of an organisation, formed and equipped by themselves, to give collective voice to the immediate and overdue necessity for the regulation and control of hours, wages and status in the retail radio industry, and empowered to negotiate to that desirable end.

We also believe that a general shortening of hours and the stabilisation of service conditions would be welcomed by many dealer-employers.

With a view to obtaining the opinions of fellow engineers on the

formation of such a body we invite all interested to write to A.J.B., c/o 86 Myddleton Avenue, Enfield, Middlesex.—Yours faithfully,

F. EDMONDS, D. A. GRIFFIN, H. FITZGIBBON, E. V. RUSSELL, H. WATSON, L. J. OSBORN, H. JAMES, A. WALKER, G. F. JESSUP, J. HOLDEN, L. LEADER.

An Open Letter to Radio Societies and Short-wave Amateurs.

THE British section of the International Short-wave Club has devised a plan to affiliate all radio clubs and societies with The International Short-wave Club with a view to increasing the benefits obtained by the members.

It is hoped to create a powerful national body which would elect a central committee of officers to represent radio amateurs and listeners on the numerous councils and commissions.

The International Short-wave Club receives the full support of the G.P.O., the radio manufacturers and radio amateurs and is strictly a non-commercial organisation.

A body representative of all the amateurs in this country would be able to approach the proper quarters with a view to obtaining legislation regarding the suppression of interference to radio and television.

Affiliated societies could exchange views with regard to current radio topics while lines of research would be indicated by the main committee.

The International Short-wave Club has many thousands of members in 140 different countries and invites all short-wave listeners and radio amateurs to join its ranks. Membership costs 5s. per year from the time of joining, and all members receive the club publications "International Short-wave Radio" and the Short-wave News Letter which keeps amateurs in all parts of the world in constant touch with each other.

Local Chapters where members can meet are open in various parts of the country and more Chapters are being organised in various centres where the need arises.

The London Chapter meets every Friday at 80 Theobalds Road, W.C.1. The club have their own transmitter, while morse instruction is given to members. Readers desirous of further information should write to the Secretary, International Short-wave Club, 100 Adams Gardens Estate, London, S.E.16.

Ensure obtaining "Television and Short-wave World" regularly by placing an order with your newsagent.

This is a fine front view of the receiver showing the controls, the



tuner and the modern type of loudspeaker grille.

A Dual-purpose Communication Receiver

RADIO receivers are slowly being divided into three distinct classes which are easily defined. The most popular set is the five- or six-valve all-waver suitable for broadcast reception from about 12 to 2,000 metres without any frills such as a beat-frequency oscillator. This type of instrument is being used by the keen broadcast listener at the present time, but before long will be the usual type of home receiver.

In the second class is the communication receiver used by the short-wave listener and the transmitting amateur who are only interested in long-distance short-wave reception. This type of receiver is generally expensive, uses up to 14 valves and includes all the refinements required by the amateur.

In the third range is the type of receiver that is being more generally used by the average amateur. This is the semi-communication type of receiver with a moderate number of valves, suitable for serious short-wave reception, has only the refinements which are essential for short-wave reception, is a good family broadcast receiver when so required and despite all these features is no more expensive than the normal broadcast receiver.

This third type of receiver is in great demand at the present time amongst the short-wave listeners in addition to transmitting amateurs who cannot afford the high price of the multi-valve communication receiver.

For many months we have been working on a receiver which the amateur would find suitable for his requirements in every respect. At the same time we did not lose sight of the fact that the receiver would have to be

This six-valve communication receiver has been designed for amateur and general broadcast reception by R. K. BUDGE and KENNETH JOWERS. It has a very good performance on 10-metres and the cost is rather less than that of the average broadcast receiver with a similar number of valves.

adaptable for family use and to be handled by non-technical listeners.

Points to Note

Before going into the theoretical aspects of the design of such a receiver we compiled a list of points that would have to be embodied.

1. Coverage of the most important amateur wavebands.

2. High sensitivity on the short-wave bands.
3. Maximum results on 10 metres.
4. A built-in B.F.O. unit.
5. Switchable A.V.C.
6. Built-in loudspeaker.
7. Phone jack plus loudspeaker silencing switch.
8. Efficient medium and longwave reception.
9. No residual hum level on headphone reception.
10. Maximum price of £12 for a ready-built receiver.

This is a most formidable list which at first sight seemed to be out of the question owing to the low-price level we had set.

Our first idea was to have switchable coils but in view of the switching troubles and the difficulties amateurs

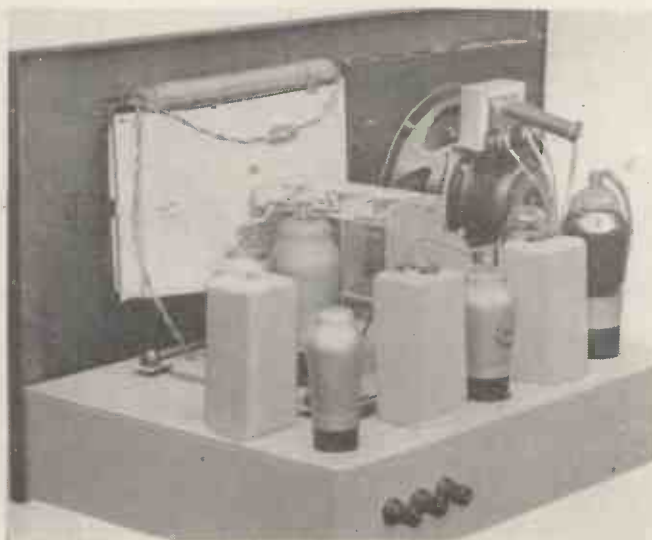

The lay-out is quite clean and the receiver can be tested out of the cabinet as the loudspeaker is mounted on the front panel.

Built-in Loudspeaker

the speech watts output would drop to quite a low figure.

By using an energised loudspeaker we saved a few shillings on the smoothing choke and still obtained ample filtering after the correct lay-out of components had been found.

The other refinements in our original list were then included but added to

B.F.O. Switch

A switch is provided to bring the B.F.O. into circuit, which at the same time shorts out the A.V.C. action.

Though the B.F.O. coil is pre-set tuned to 465 kc. the trimming condenser in the top of the coil can should be adjusted to give the correct setting. This

The main switch was then made a part of the low-frequency volume control and arranged so that when the A.C. supply is switched on the L.F. gain is at minimum. This makes quite sure that maximum volume will not be obtained unless actually required.

Stand-by Switch

A similar idea was used for the "send-receive" switch which is part of the R.F. gain control. If the R.F. gain control is rotated a little beyond minimum volume, that is in an anti-clockwise direction, a switch comes into action which breaks the high-tension supply but leaves the valve heaters in circuit.

This feature will be appreciated by the transmitting amateur who wishes to silence the receiver but still to be in a position to receive signals without any time lag. Some amateurs short circuit the loudspeaker, but this leaves the H.T. voltage still applied to the receiver and is inclined to overload the output valve.

With the scheme we have used the receiver is quite out of action in the "send" position as the centre tap of the high-voltage secondary winding on the mains transformer is not returned to earth. In this way H.T. voltage is only applied when the receiver is actually picking up signals.

That is a bare outline of the receiver, but it will serve to indicate that the receiver is really suitable and in fact has been designed for amateur use.

The theoretical circuit, which off-hand may look complicated, is quite straightforward for the first half of the set is already wired.

Valve Line Up

In the first stage is a high-slope pentode with a top cap grid connection followed by a triode-hexode frequency

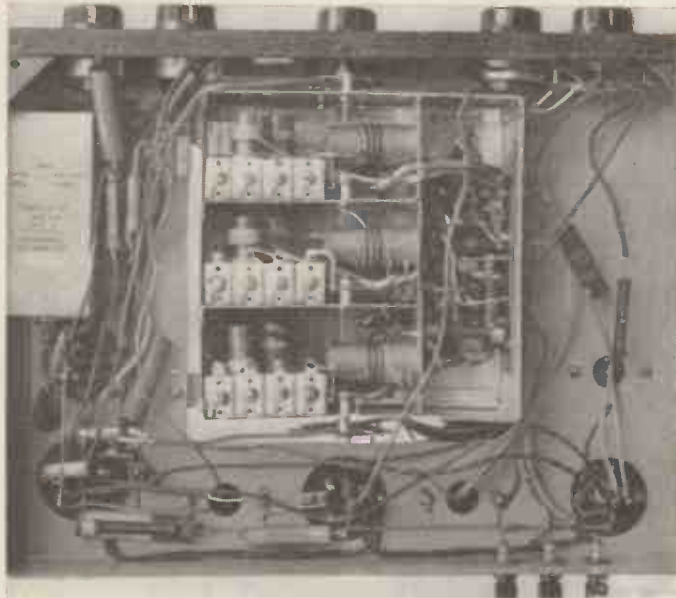

This is the underside of the receiver showing the fully wired tuner.

this list was a variable tone control, "send-receive" switch and the B.F.O. switch. By the time these features were all included the front panel was a mass of controls which would possibly frighten the average non-technical user.

However, the receiver was tested at this stage on all wavelengths. It says much for the theoretical design that we found the performance almost up to the required standard. Faults were, however, too strong a signal from the beat-frequency oscillator, slight instability on the lowest waveband and rather too much A.V.C. action on 20 metres.

These faults were soon taken care of in the following way. The B.F.O. unit was originally coupled to the second detector by means of a small fixed capacity. As even the smallest condenser was too large we discarded this arrangement altogether and in place used a short length of wire twisted at one end around the A.V.C. lead to the second intermediate-frequency transformer. The other lead to the "beat-frequency oscillator" is joined directly to the grid of the HL4+. It should be appreciated at this point that the I.F. end of the B.F.O. lead is not actually connected. Coupling is obtained by means of the capacity gained by twisting the two wires together. In practice this scheme works very well indeed.

adjusting should be done with an insulated screwdriver after which it need not again be touched.

This same combination switch enables the B.F.O. to be cut out of circuit and if the switch is left in the central position the A.V.C. is also cut out. This is sometimes of advantage on the very short waves when maximum gain is required. We also find that very often when reporting on the signal strength of long-distance stations no indication of fading can be given unless the A.V.C. is out of circuit.

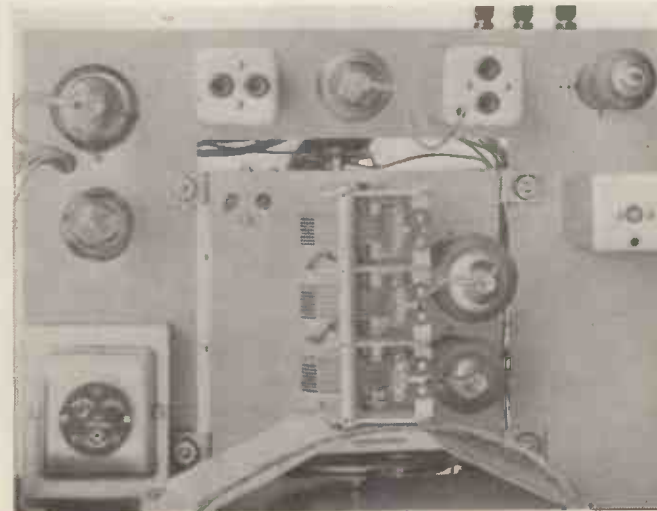

Very few components are mounted on top of the chassis as can be seen from this illustration.

B.F.O. Send-receive Switch

changer that has been specially designed for ultra short-wave working.

This valve only became available after we had completed most of our experiments, but we found that it was very suitable in the circuit chosen. This valve puts up a fine performance and accounts, to a certain extent, for



The finished instrument presents a very commercial appearance and is an asset to any radio room.

of mounting suggested must be adhered to.

Component values in the tuner are not given for these will not interest the constructor. The other values are all marked and must be strictly followed. We have arranged for maximum gain on every waveband so that should the

covered, the 10, 20 and 40-metre amateur bands plus all the medium and long-wave stations.

The tuning dial is calibrated in station names both on broadcast and short-wave bands, so removing one of the main troubles with amateur built receivers. For amateur use the four scales are also marked in wavelengths.

Although no provision has been made for band spreading as the lowest waveband is marked on the outside edge of the dial, the distance travelled by the cursor is very great, so making short-wave reception simple.

The knob on the tuner is marked with four different coloured spots to line up with the coloured scales used and in this way it is easy to tell on which band the receiver is tuned.

It is essential when connecting up to use heavy gauge wire, well insulated, for all the small components are fixed in the wiring. There should also be one solid connecting wire from the tuner chassis to the main chassis for the common earth connection.

Dipole Aerial

Provision has been made for a dipole input circuit so that amateurs interested in short-wave reception can take advantage of the better results given by the di-pole which is cut to wavelength.

When the receiver is used with the conventional Marconi aerial plus earth connection the terminal marked A₂ should be connected to the terminal marked E.

the high gain on 10 metres.

In the intermediate-frequency stage is another VP4B pentode with top-cap grid connection and it will be noticed that the first gain control operates on both H.F. pentodes.

Following this is the double-diode pentode with one diode acting as a rectifier, the second diode supplying the A.V.C. voltage.

In the grid circuit of the output pentode is the low-frequency volume control which has a value of 250,000 ohms and is quite a conventional arrangement.

We have given the original chassis to Messrs. Peto-Scott, who are making arrangements to supply it in steel ready drilled with all the holes so that constructors will merely have to assemble the components in the correct positions as shown by the many photographs.

Mounting the Tuner

It is essential, however, that the tuner be carefully mounted so that the metal chassis of it does not touch the main chassis. The tuner is supplied with rubber grommets and lugs so that the tuner can be mounted quite firmly but without actually making electrical contact with the main chassis.

If this point is ignored microphony will be noticed on the shorter wavebands and no amount of condenser juggling will counteract this. In some receivers the use of variable condensers with tied plates often prevents microphony, but with this receiver, due partly to the extreme gain, the method

values be varied the gain will go down or instability may occur.

Wavebands Covered

We have not mentioned the wavelength covered by the receiver. A stage of radio-frequency amplification is in circuit on each band covering most channels from 10 to 2,000 metres. Band number one covers slightly under 10 metres to 25 metres. On band number

Components for A HIGH GAIN 4-BAND RECEIVER

CHASSIS AND CABINET.

- 1—Steel chassis finished grey with all holes cut and fitted with terminal strips (Peto-Scott).
- 1—Steel cabinet finished black with all holes cut (Peto-Scott).

CONDENSERS, FIXED.

- 2—.1-mfd. type tubular (Dubilier).
- 3—.0002-mfd. type tubular (Dubilier).
- 1—.01-mfd. type tubular (Dubilier).
- 2—.05-mfd. type tubular (Dubilier).
- 1—.006-mfd. type tubular (Dubilier).
- 1—.8-mfd. type electrolytic 500-volt (Dubilier).
- 1—25-volt 25-mfd. (Dubilier).

COIL UNITS.

- 1—4-band tuner complete with dial (Peto-Scott).
- 1—B.F.O. unit complete type I.F.A. (B.T.S.).

HOLDERS, VALVE.

- 2—4-pin type VI chassis mounting less terminals (Clix).
- 2—7-pin type VI chassis mounting less terminals (Clix).

HEADPHONES.

- 1—Pair Super Sensitive (Ericsson).

LOUDSPEAKER.

- 1—D.C. type 2,500-ohm field (Rola).

PLUGS, TERMINALS, etc.

- 4—Plug top connectors (Bulgin).
- 1—Jack type P66 (B.T.S.).

RESISTANCES, FIXED.

- 1—50-ohm type ½-watt (Erie).
- 1—100-ohm type 1-watt (Erie).

RESISTANCES, VARIABLE.

- 1—150-ohm type 1-watt (Erie).
- 1—10,000-ohm type ½-watt (Erie).
- 1—20,000-ohm type ½-watt (Erie).
- 3—5-meg-ohm type ½-watt (Erie).
- 1—1-meg-ohm type ½-watt (Erie).
- 1—150-ohm type 1-watt (Erie).

POTENTIOMETERS, VARIABLE.

- 1—10,000-ohm potentiometer with switch type J (Dubilier).
- 1—100,000-ohm type potentiometer (Dubilier).
- 1—25 meg-ohm type J with switch (Dubilier).

SWITCH.

- 1 Complete assembly type 143 (B.T.S.)

SUNDRIES.

- 1—Loudspeaker baffle board.
- 1—Mains cord.
- 1—Mains plug type 29 (Clix).

TRANSFORMERS.

- 2—Type 465 Kc with trimmers (B.T.S.).

TRANSFORMERS, MAINS

- 1—Special type with wire ends model S/1 (New Times Sales, Limited).

VALVES.

- 1—VP4B met (Tungsram).
- 1—DDPP4B (Tungsram).
- 1—HL4+ met (Tungsram).
- 1—APV4 (Tungsram).
- 1—VP4B met (Tungsram).
- 1—TH4A met (Tungsram).

We have made arrangements for a completely wired and tested receiver to be available from Messrs. Peto-Scott, Limited, at a cost of 11½ gns.

two the coverage is 25 to 65 metres, band number three 200 to 550 metres, and the final band 800 to 2,000 metres.

It can be seen from this that all commercial short-wave channels can be

covered. No blue-print is being made for this receiver for we feel that the average amateur will be able to construct from the circuit plus the numerous photographs.

APRIL, 1938

The "Q" Antenna System

This interesting article on the "Q" antenna system is by
H. W. STEWART, G2CY and E. W. PICKARD, G6VA.

IN view of the interest taken by experimenters in new antenna systems it seems that at last the average amateur is beginning to realise that the most important part of his installation is the antenna.

Many low-powered stations are being heard in every part of the globe with great consistency and often better than some of the high powered stations. In such circumstances it will generally be found that the antenna used is an efficient one, with low losses, correct termination and angle of radiation.

The correct position of an antenna depends on which part of the globe is of most interest to the amateur concerned, but low losses and correct ter-

mination are generally part of the antenna design. of the directional applications of the "Q" should be chosen. The most simple as well as one of the most effective uses is the harmonic radiator sometimes known as the "long wire" antenna. The "Q" may be used with this type of antenna in any combination from 2 to 26 half wavelengths at the operating frequency. Radiation is concentrated in four major lobes at angles with the axis of the antenna varying with the length. As the length of the antenna increases, the nearer these lobes approach the axis of the antenna, the more narrow they become (indicating a greater degree of directivity), and the more power gain is obtained.

Excellent directional results are ob-

suspended from adjacent horizontal sections, and connected together at the bottom. The "Q" matching section may be attached in the centre of any of the horizontal sections. This antenna is directional broadside, the amount of directivity and gain depending on the number of horizontal half-wave sections used.

In the use of directional antenna systems, extreme care should be used in determining the direction of the points which it is desired to favour. This should be done by means of a globe or by means of spherical trigonometry, never from an ordinary map.

The "Q" is as outstanding where used as a receiving aerial as it is in



mination are generally part of the antenna design.

The Johnson "Q" antenna has achieved outstanding success in high-frequency transmitters throughout the world because of its high efficiency. The special aluminum tubing quarter wave matching section accurately matches line and antenna impedances and power is transferred with practically no losses even with very long lines. Consequently the Type "Q" will radiate a much higher percentage of input power than will the common non-matched antenna-feeder system. The result is usually a greater increase in radiated power than could be obtained by materially increasing the power of the transmitter alone, as well as effecting a corresponding saving in operating costs. To the average amateur, the "Q" affords the least expensive method of greatly increasing the signal strength of his station.

To the amateur who is limited to low power the use of the "Q" often enables him to accomplish results quite superior to those obtained with a more powerful transmitter and less efficient antenna system.

Excellent results are obtained when using the Johnson "Q" with a half-wave doublet. High efficiency is secured and although the system is moderately directional broadside, good general coverage is obtained. For equal signal strength in all directions the "Q" may be mounted vertically, in which case the centre should be at least half wave length above ground.

For the amateur who desires reliable communication in certain directions, one

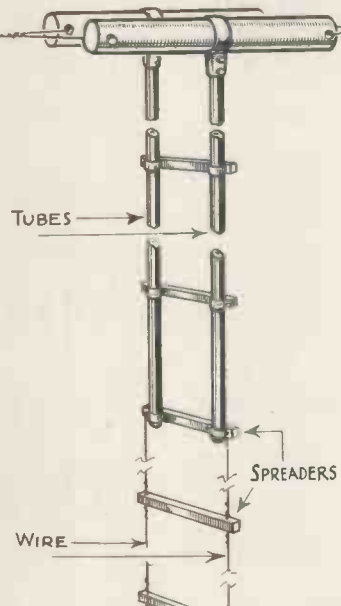

How the "Q" matching system is fed into a half-wave antenna.

tained with antennas as short as 3 half wavelengths. A compromise between results and convenience of installation is reached between lengths of 5 and 9 half-waves.

When using harmonic radiators the "Q" matching section should be attached at a point an odd number of quarter-waves from either end.

Another directional system easily applied to the "Q" is that commonly known as "half waves in phase." This is constructed by "folding back" alternate half-waves, i.e., suspending a series of half-waves horizontally with an insulator between each, and connecting adjacent sections by means of two wires each quarter-wave long separated 6 in.,

transmitting. All the directional effects will be noted and the high efficiency will be evidenced by an extremely high signal to noise ratio. An ideal arrangement is a provision for relay shifting of the antenna from transmitter to receiver and vice versa. Just as efficient but less convenient is a double pole-double throw switch similarly connected.

The Johnson "Q" is supplied in kit form for all bands 5 to 80 metres inclusive, and is complete except for end insulators and transmission line equipment. The transmission line may be any standard open wire line of 400 to 600 ohms impedance.

Some amateurs are still under the impression that the "Q" arrangement is difficult to use, and must be part of the Johnson antenna. Actually the "Q" can be used with any antenna having a radiation resistance of between 72 and 172 ohms. Generally, however, it is used with horizontal and vertical doublets and harmonic radiators up to 13 wavelengths.

It can be used to replace any existing antenna system without changes in mast location while the feeder can be up to several hundred feet in length without noticeable loss on the higher frequencies.

Antenna height has a great bearing on antenna efficiency so that the "Q" should always be at least quarter wavelength above earth. This will allow the "Q" bars easily to clear the ground, but in case of difficulty the tubing may make a gradual bend so as to be kept away from the ground. Such a bend, however, should always be at right

The "Q" Antenna System

angles to the flat top section of the antenna.

Antenna Length. The overall length of the flat-top between end insulators depends upon the working frequency, and is determined by the simple rule: Length in feet equals $(k - 0.5)$ times 492 divided by the frequency in megacycles (mc.). Here "k" is the number of half-wavelengths in the flat-top. Thus, the length of a half-wave doublet for 7.2 mc. (or 7,200 kc.) is $1 - 0.05$ (or 0.95) times 492 divided by 7.2, which is 65 feet. If several frequencies are used in the same band, the antenna may be cut for the average frequency, or may be made the correct length for centre band operation. A doublet antenna may be operated on any odd harmonic. The recommended harmonic radiator is one which is an odd number of half-waves long, with the tubing section suspended at the centre. Less desirable is one any number (odd or even) of half-wavelengths long fed an odd multiple of a quarter-wavelength from one end.

Length of Quarter Waves Tubes. The length, in feet, from the point of connection to the bottom of the quarter wave tubes, is 234 divided by the frequency in megacycles. Thus, the length for 7,200 kc. is 234 divided by 7.2, or 32.5 feet. Two such tubes $\frac{1}{2}$ in. in diameter are required.

Type of Main Transmission Line

Either a transposed line or an ordinary non-transposed open wire line may be used with the Type "Q" Antenna System. It should be well insulated to avoid power losses. The length of the antenna and the wire size and spacing of the line determine the separation of the tubing section, and the following tables give the correct relation of these factors. Table 1 gives the Characteristic Impedance in ohms of common transmis-

sion lines. Table 2 gives the correct centre to centre spacing of the tubing (to nearest $\frac{1}{16}$ in.) for matching any of the lines listed in Table 1 to flat-tops up to five half-waves in length. Thus, to match a 440 ohm line to a half-wave doublet, the centre to centre spacing of the tubing must be $1\frac{1}{8}$ in. The figure under the antenna length is the antenna resistance in ohms at a point an odd multiple of quarter-wave from either end of the antenna.

TABLE 1.—LINE IMPEDANCE (Z_L).

Wire Size.	8	10	12	14	16
Line Spacing					
$1\frac{1}{2}$ "	380	410	440	465	495
2"	410	440	465	495	525
4"	495	525	550	575	600
6"	550	575	600	625	645

TABLE 2.—SPACING OF TUBING (CENTRE TO CENTRE).

Antenna Length.	1 Half-Wave (75)	Full-Waves (91)	3 Half-Waves (100)	2 Full-Waves (109)	5 Half-Waves (116)
Z_1	1	1-3/16	1-1/4	1-3/8	1-7/16
380	1	1-3/16	1-1/4	1-3/8	1-7/16
410	1-1/16	1-1/4	1-3/8	1-7/16	1-9/16
440	1-1/8	1-5/16	1-7/16	1-9/16	1-5/8
465	1-3/16	1-3/8	1-1/2	1-5/8	1-11/16
495	1-1/4	1-7/16	1-9/16	1-3/4	1-7/8
525	1-5/16	1-9/16	1-11/16	1-7/8	1-15/16
550	1-3/8	1-5/8	1-3/4	1-15/16	2-1/16
575	1-7/16	1-11/16	1-7/8	2	2-3/16
600	1-7/16	1-3/4	1-15/16	2-1/8	2-1/4
625	1-1/2	1-13/16	2	2-1/4	2-3/8
645	1-9/16	1-7/8	2-1/16	2-5/16	2-7/16



A typical Collins phone transmitter complete with power packs and modulator.

Collins Transmitting Equipment

Some very fine commercial transmitting equipment is now available in this country. The Collins transmitters are particularly suitable for amateur use.

HOW many amateurs who have used the Collins aerial coupler realise that it was first produced by the Collins Radio Co. of America, who are so well known for their ultra-modern transmitting equipment? This coupler was designed in the first case so that it could be incorporated in the Collins transmitters making them suitable for use with all types of aerial.

However, their main interest at the present time is the production of efficient transmitters of all ratings up to 1 kW for amateur use and almost any power

for commercial use. One of the most interesting transmitters suitable for the amateur is the model 32-G which is quite self-contained and provides an input of 30 watts on both C.W. and telephony.

By the use of plug-in coils the transmitter will cover all frequencies from 1,600 kc. to 1,500 kc. so covering four of the amateur bands. The valve line-up is C100A crystal oscillator, 6L6 doubler and two 6L6's in parallel in the final stage.

The power amplifiers are modulated

in the anode circuit by two 6L6 valves in Class A-B push-pull. These two valves are driven by a 6C5 with an octal base 6J7 in the first stage.

Two separate power packs are used while the gain of the speech amplifier is such that a crystal microphone can be plugged into circuit without any pre-amplification.

The dimensions of this transmitter are 20 in. by 16 in. by $10\frac{1}{2}$ in. so that it is very compact being complete ready to go on the air with the addition of the microphone.

Another interesting transmitter is the model 45A which as an output on telephony of 45 watts which can be increased to 125 watts on C.W. These outputs can both be increased by at least 20 per cent. if required.

(Continued on page 234.)



The Somerset station G6BW uses an input of 50 watts. The complete recording equipment can be seen in this illustration of the station.

With the Amateurs

Any Radio Society with news of general interest is asked to supply the information for inclusion in this page. A new W.A.C. record is mentioned in this article.

By G5ZJ

morning at 07.10 G.M.T., so here is a chance to effect a contact with this new station.

I have just found some new transmitting condensers which solve many problems. Most amateurs have at some time or another required a high capacity wide-gap condenser. Premier Supply Stores have now introduced some condensers in capacities of 15, 40 and 160 mmfds., with double spacing. The prices range from 2s. 9d. to 4s. 6d. The same condensers, but with single spacing and capacities from 15 to 250-mmfd. are priced at 1s. 6d. to 2s. 6d. All these condensers have the

DOROTHY HALL, W21XY, is doing some fine work on 5 metres hooking up foreign amateurs via her 20-metre phone circuit. During a period of 85 minutes she picked up and worked two-way phone with F8DC, ON4BG, G12CC, FAoMZ, VK2IQ, and G8MA. These stations were then relayed on 5 metres to W2TNJ. The replies from W2TNJ were then picked up on 5 metres and re-broadcast on 20 metres.

At one time a G station being worked on 20 metres was relayed to W2DKJ on 5 metres when 2DKJ was in an aeroplane 10,000 ft. above New York.

Pitcairn Station

Many stations have reported the reception of VR6A in Pitcairn, who has been worked by several "G" stations on phone. This interesting station uses an input of about 80 watts and is being heard all over the world. His receiver seems to be up to the mark for he gives very good reports to most stations. Incidentally a diamond aerial is being used for reception.

I hear that several unpleasant suggestions have been put forward at the Cairo Conference. One country which received plenty of support, put forward the idea that the 56- and 28-mc. amateur bands should be used for experimental commercial work. However, at the moment this is only a suggestion.

G8MX is still proving what an efficient transmitter can do on low power. With his 25 watts input, which I have actually checked, he is still doing better than most amateurs in his country. Just recently, working two-way phone, he contacted Shanghai, French Indo-China, Burma, all South American countries, several W6's in addition to keeping up a regular schedule with a whole host of South Africans. Two aeriels are used, one being a two-section W8JK beam and the other the conventional two half-waves in phase.

Another interesting station which is well heard in most parts of the world is G6BW, and on 10 metres at the moment a very high percentage of the

American phones seem to be calling "Ben."

The photograph at the top of this page shows the equipment used, which includes a complete recorder on the left-hand side, and RME-69 and DB-20 in the centre, and the transmitter on the right.

The maximum input used in 50 watts with class-B modulation with a crystal microphone. He is W.A.C. on 20- and



F3JD has worked all continents at once. These are the cards obtained through this contact and they all check up for times and dates. F3JD has slipped a little with his English but amateurs will realise his meaning.

10-metre phone, W.B.E., and has worked 45 stations on phone.

Home Recording

Amateur transmissions have been recorded from most countries including Australia, India, Bermuda, Cuba, Costa Rica, Malay Straits, Egypt, and Canada.

A W.A.C. Record

F3JD, who is doing so well with his low input of 25 watts, tells me that he is now claiming 40 zones on two-way phone. In this page is a photograph he has had taken showing the cards obtained from his six continent QSO last year. He holds the record for W.A.C. speed for he had all continents contacted at the same time.

He also tells me that VR6A, who generally works on 14,280 kc., has a regular schedule with W1DR each

Trolitule insulation which, according to N.P.L. figures, is at least as good as most ceramic materials, if not better.

Another interesting departure for Premier is the production of a number of standard panels and chassis finished

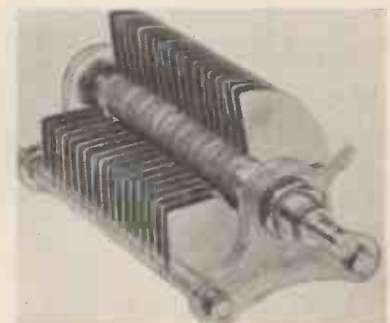

This is one of the new high capacity wide gap transmitting condensers produced by Premier Supply Stores.

The I.S.W.C. :: A 4-band Tuner

black steel, which are suitable for amateur transmitters. The panels fit the standard relay racks and range in price from 2s. upwards.

A complete 66 in. rack complete with panels and chassis costs well under £4, so it is cheaper than most racks of this class.

At the annual dinner of the I.S.W.C. held this year at Maison-Lyons, Shaftesbury Avenue, on March 5, I met many old friends. Amongst those present were the French Consul, who was the

guest of honour, Ralph Stranger, Fred Bate of the National Broadcasting Corporation, E. Repath and over 80 guests.

My own district of the R.S.G.B.—number 12—are holding a dinner at the Salisbury Hotel, Barnet, on April 22. The tickets cost 3s. each and can be obtained from G2AI, who has organised the affair, or from G6CL and other members of the R.S.G.B. A number of prizes are to be won and it is hoped that over 90 amateurs will attend.

The Radio Clubs

The radio societies have been very active during the past few weeks while several functions have been scheduled for the near future.

month and details can always be obtained from G5UM. The next meeting is at the QRA of G5ZJ, 85 Cowslip Hill, Letchworth, and any amateurs who can attend will be very welcome.

During the past month *The Exeter and District Wireless Society* has held several meetings. Amongst the lecturers were D. R. Barber, B.Sc., F.R.A.S., who talked about "Radio and Stars," Mr. V. C. Regan who spoke on "Measurement in Radio," and Mr. R. C. Lawes who gave a description of the Hammond organ.

This live society meets each Monday at 8 p.m., and the Secretary is Mr. E. Ching, 9 Sivell Place, Heavitree, Exeter, from whom all information can be obtained.

"Collins Transmitting Equipment"

(Continued from page 232)

The entire transmitter only takes up a little more space than the average communication type receiver, and can be fitted on to the operating table alongside the receiver.

For the radio-frequency stage the valve line-up is C-100 crystal oscillator followed by a 46 doubler, RK-23 amplifier, C-830B amplifier and C-211D output triode.

In the audio section the amplifier has a total gain of 60 db and is designed for crystal microphone input. The valve line-up is 57 with triode connection, a second 57 as intermediate amplifier and 2A3 modulator.

Control grid modulation is used while a new system of inductive neutralising enables the transmitter to have the advantages of pentode valves with none of the disadvantages.

These Collins transmitters are quite suitable for amateurs and are actually available in this country.



Over 80 guests assembled at the annual dinner of the I.S.W.C.

A New Map

W. & G. Foyle, Ltd., the booksellers, have produced a most interesting true-bearing map. It is intended for the use of all-wave listeners, but as it gives the location of most amateur zones it is a most useful map. The true direction of any station calculated with London as the focal point can be found without calculations.

Should a short-wave amateur wish to erect an aerial to radiate in a given point or to cover a certain area this map will give the true bearing. It is priced at 1s. 6d. or 1s. 8d. post free. The address of Foyles, Ltd., is 119-125 Charing Cross Road, W.C.2.

A 4-band Tuner

It is rather a problem for the amateur who needs a multi-valve receiver to know whether he is capable of building one or whether it would be cheaper to buy.

I have been experimenting with a new tuner designed by The B.T.S. Co. which seems to eliminate most of the snags from multi-valve set building. This tuner covers amateur bands down to 10 metres and is complete with H.F. stage on all bands plus a triode-hexode frequency changer.

As it is lined up after manufacture, the constructor merely has to add the I.F., detector and low frequency stages, which should be well within his capa-

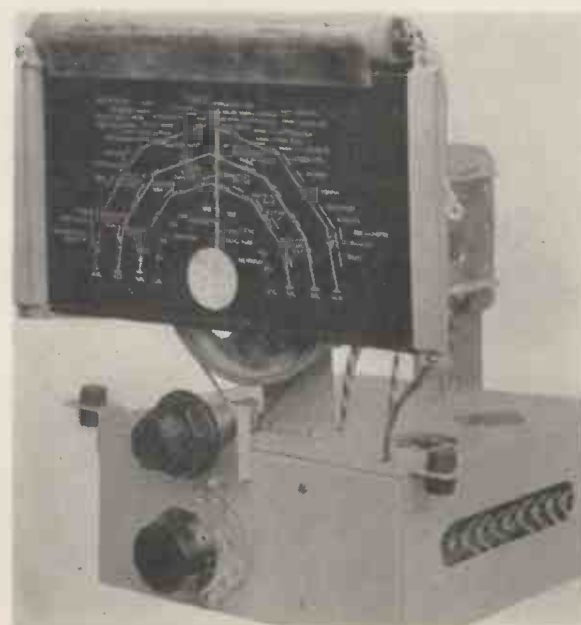

The 10-metre band is covered by this 4-band all-wave tuner designed by B.T.S. It is complete with H.F. detector and oscillator stages.

TRANSMITTING STEP-BY-STEP

A CRYSTAL OSCILLATOR AND FREQUENCY MULTIPLIER

This article is the first of a series describing the design of a multi-stage transmitter. It will, however, be built so that amateurs of all types will be able to use certain sections of it. The designers are KENNETH JOWERS G5ZJ and MALCOLM HARVEY B.R.S. 1636.

WE intend during the next few months to publish the complete constructional details of a high-powered transmitter of modern design using the latest valves and circuit.

So that the transmitter will appeal to all types of amateur both in this country and abroad it will be published in stages, each stage being complete in itself. The transmitter, although still in the laboratory, has passed most of the tests except that we are still in two minds about the output stage.

However, the valve line-up will be provisionally a 6L6 Tri-tet oscillator, TZ-20 buffer or frequency multiplier, a T-40 sub-amplifier followed by two T-55's in the final stage.

350-Watts

Tests show that the final valves will supply a carrier power in excess of 350 watts, but we are still experimenting with a single ended stage using an Eimac 100-TH, for many amateurs still lean towards straightforward stages as against the possible troubles of the push-pull stage.

However, the idea of this transmitter is to interest all of our readers with some really up-to-date equipment no matter what licence restriction they may have as regards input

The first stage consists of a 6L6 crys-

tal oscillator in a Tri-tet circuit which can be operated with either a 40-metre or 160-metre crystal. This oscillator stage is so flexible that almost any coil

in itself which can be used to provide a carrier power of up to 25 watts if required. The valve although not strictly intended for use as a final power

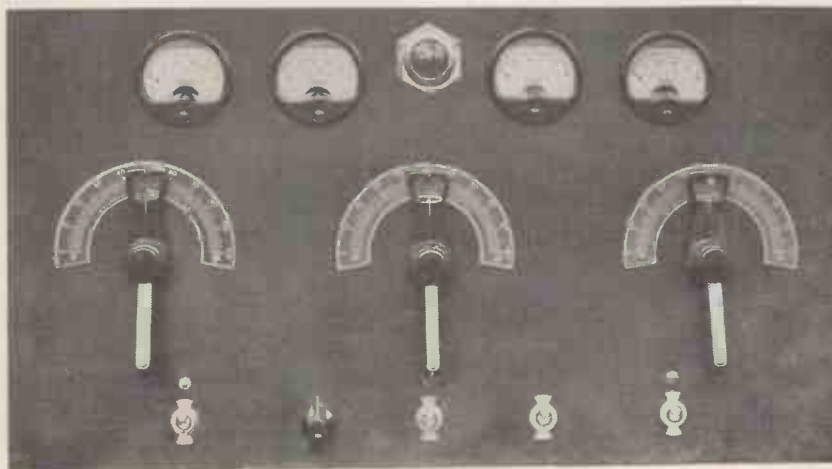

The panel lay-out of the first section has a very professional appearance. It uses the new type of Johnson control handle.

combination can be used so that with three stages most amateur bands can be covered.

Complete Transmitter

However, refer to the circuit of the first unit. It is a complete transmitter

amplifier works excellently in this circuit, but if the constructor has no intention of going beyond the first stage then it will be better to substitute a T-20 for the TZ-20 shown.

The whole transmitter will finally be housed in a special rack made for us by The Premier Supply Stores, which will consist of six panels and chassis of a standard size in a steel frame approximately 65 in. high.

For those who are only going to build the first part of the transmitter then a smaller rack will be available to take the number of chassis and panels required.

Tri-tet Circuit

Notice that in the Tri-tet circuit the crystal goes between the grid and cathode which is in turn above earth potential. Bias is obtained automatically by means of a resistance of 50,000 ohms between grid and chassis. We did experiment with a 400-ohm cathode bias resistance and although this did give

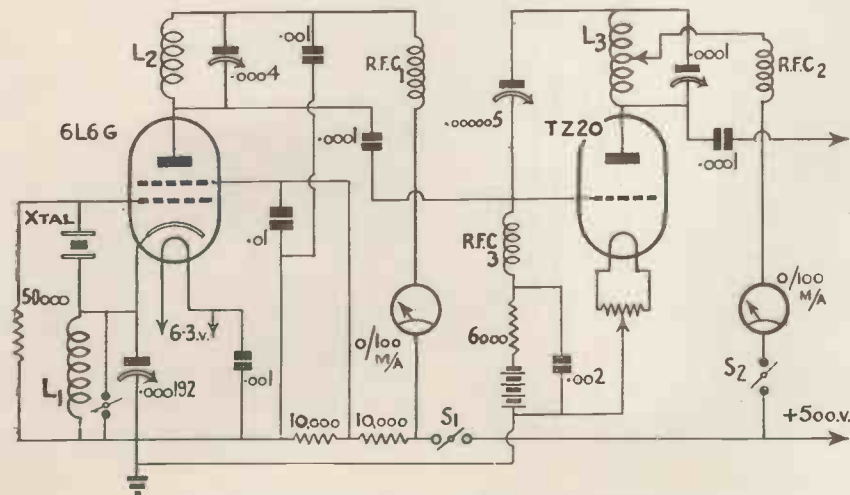

This is the circuit of the crystal oscillator and doubler stages.

Tuning :: Bias Valves

a greatly reduced crystal current we could not obtain the full degree of efficiency without introducing a small amount of feed-back. This we have no wish to do in case the transmitter is built by a real beginner without knowledge of this type of circuit which would probably cause troubles.

The cathode coil L₁ is the conventional arrangement except that we have connected across it a toggle switch for straight-through operation. Without this switch it would be better to use a valve such as the 6V6 or 6F6 in order to have lower crystal current.

With the voltages and component values suggested we do not feel that amateurs will have any difficulty with the circuit using the 6L6 throughout.

The Condensers

In order to obtain maximum R.F. output with stability use a high capacity across the cathode coil and a small capacity across the anode coil. In this way the R.F. output on harmonics will be greatly increased.

Notice also the small coupling condenser between the first and second stages. This, however, is quite large enough and has the advantage that tuning the anode circuit of the TZ-20 does not affect the tuning of the crystal anode circuit. Consequently the crystal circuit can be uned right up for maximum output without troubling about the circuit freely oscillating.

We have noticed that constructors are doubtful about using the 6L6 tetrode for they fear high crystal current and possible crystal fracture. We should like to mention again that the latest type of 6L6 is quite free from troubles and is one of the best crystal oscillators of its kind. Providing the screen voltage does rise beyond 275 volts the crystal current will be very low, in fact lower than that obtained with many triode oscillators. However, if the voltage rises above 300 volts then the crystal current will rise to a very high value and probably cause damage to the crystal or at least cause frequency drift.

Screen Voltage

In the circuit shown we have provided a high current potentiometer of fixed value so that the screen voltage will not rise above 250 volts, in which case no troubles will arise from the 6L6. The potentiometer must have a value of 20,000 ohms having the screen tapped into the centre point. Although it is possible to increase the R.F. output by reducing the value of one of the resistors in the circuit we do not advise this unless constructors are familiar

with the operation of the Tri-tet circuit with this particular valve.

While on the topic of screen voltage and current notice that the screen is by-passed to earth by means of a .01-mfd. condenser. It is advisable to connect this condenser as close to the screen terminal on the valve holder as possible otherwise there may be trouble from instability. The same remarks apply to the by-pass condenser in the filament circuit.

The meter in the C.O. circuit reads the anode current which will be about 100 mA. off tune, but this should fall to less than 20 mA. when the circuit is correctly tuned to resonance.

If the current does not fall the correct amount it shows that the circuit is not as efficient as it should be. It is then advisable to make sure that there are sufficient turns on the anode coil in this stage.

Increase the number of turns used until the lowest capacity is required. This should make quite a big difference to the amount of current drop. Another component which should be checked is the grid resistor which although it should want a value of 50,000 ohms, may need adjusting to suit the particular valve in use. With some valves that have been slightly off their published figure we have had to reduce the grid resistor to 10,000 ohms and

in another case increase the value to 100,000 ohms.

Bias Values

In the doubler stage bias is obtained by means of the 6,000-ohm resistor plus a dry battery. The valve should be biased to double cut-off if used as a multiplier or to cut-off if used as a straight amplifier.

Merely increase the bias from the battery until the anode current drops to zero and this is Class-B or cut-off bias. For Class-C or double cut-off twice the amount of bias will be required.

If for example 50 volts of bias are required to produce cut-off conditions then 100 volts will be required for Class-C. This is not strictly accurate for it omits to take into consideration the effect of the bias resistor when in Class-C working conditions. However, it is quite near enough particularly for the beginner who needs some rule of thumb.

In an efficient circuit the anode current in the doubler stage is at least 100 mA. off tune so that it must be returned very quickly when the current will fall to under 10 mA. We have been able to reduce this resonant current to an unreadable value when particular care has been taken with the construction.

These details will enable the constructor to go ahead with the building of the transmitter, and in the next issue we will show the finished CO FD and temporary PA stages complete with all voltages at different points, and the grid and anode current values under working conditions.

THE CUP FINAL

The F.A. Cup Final to be played at Wembley Stadium on April 30 is to be televised so being the first F.A. match to be seen by viewers.

Components for

A CRYSTAL OSCILLATOR AND FREQUENCY MULTIPLIER

CHASSIS AND PANEL

- 1—Steel chassis, finished black, standard size (Premier Supply Stores).
- 1—Steel panel 10½ in. high, standard width, finished black (Premier Supply Stores).

CONDENSERS, FIXED.

- 1—.001 mfd. type 690W (Dubilier).
- 1—.01 mfd. type 691 (Dubilier).
- 1—.001-mfd. type 620 (Dubilier).
- 2—.0001 mfd. type SW82 (Bulgin).
- 1—.002-mfd. type 690W (Dubilier).

CONDENSERS, VARIABLE.

- 1—Type 940/180 (Eddystone).
- 1—Type 900/40 (Eddystone).
- 1—Low capacity neutralising condenser type 1028 (Eddystone).
- 1—.00016-mfd. type double-spaced (Premier Supply Stores).

COIL FORMS.

- 3—4-pin threaded coil forms type CT4 (Raymart)

CHOKES, HIGH FREQUENCY.

- 2—Type 1022 (Eddystone).
- 1—Type SW69 (Bulgin).

DIALS.

- 3—Type direct drive Johnson handles and scales (Webbs Radio).

HOLDERS COIL.

- 3—4-pin holders, chassis type, less terminals, type VI (Clix).

HOLDERS, VALVE.

- 1—Type ceramic octal (Premier Supply Stores).

- 1—Type 4-pin American ceramic (Premier Supply Stores).

METERS.

- 2—Type 0-100 mA. (Ferranti).

PLUGS, TERMINALS, ETC.

- 2—Insulated sockets type 11 (Clix).
- 2—Johnson feed-through insulators (Webbs Radio).

- 2—Jacks, type J2 (Bulgin).

RESISTANCES, FIXED.

- 1—50,000-ohm type 1-watt (Erie).
- 2—10,000-ohm type PR11 (Bulgin).
- 1—6,000-ohm type PR35 (Bulgin).
- 1—Tapped humdinger (Premier Supply Stores).

SUNDRIES.

- 1—Dial light, type D9 (Bulgin).
- 1—Anode connector for TZ20 (Bulgin).
- 36—4 B.A. round-head bolts with nuts and washers (Bulgin).
- ½ lb.—14 gauge tinned copper wire (Webbs Radio).
- ½ lb.—18-gauge enamelled covered wire (Webbs Radio).

SWITCHES.

- 3—Toggle type S80T (Bulgin).

TRANSFORMER FILAMENT.

- 1—6.3-volt with wire ends (Premier Supply Stores).

VALVES.

- 1—6L6 (Webbs Radio).
- 1—TZ20 (Webbs Radio).

A Single stage 10-watt Transmitter

This single stage exciter is suitable for the beginner who later wishes to build a large transmitter. It will provide a comfortable 10-watts of carrier power.

The left-hand condenser tunes the cathode while the right-hand controls is for the anode coil. The second condenser must be isolated from the metal chassis.



screen voltage. In practice the R.F. current through the crystal remains at quite a low value until the screen voltage rises to above 275 volts. After that figure has been reached, the crystal current goes up from an average of 75 mA. to nearly 200 mA. which will probably cause crystal heating.

High R.F. Output

It can be taken for granted, however, that with a low screen voltage the crystal will be quite safe under all operating conditions even with a high R.F. output of 10 to 15 watts.

The screen should be by-passed to earth with one side of the heater by a condenser of .01-mfd. and this condenser should be connected actually at the screen pin on the valve holder.

The same remarks apply to the fila-

TRANSMISSION on short-waves is a most interesting hobby, although a very expensive one unless the equipment is carefully designed in the first instance. Many amateurs build their first transmitter without any thought for the future and totally forget that the initial equipment may be quite useless for use in conjunction with gear of higher power.

I must confess that at one time I was rather prone to this fault myself so in the circumstances it was not surprising that before long a large stock of almost useless components was accumulated.

10-watt Licence

Most amateurs when first licensed are permitted to use a power of 10 watts to the final valve. As transmitters are crystal controlled the first transmitter should be the exciter providing 8-10-watts of carrier power on 2 or 3 wavebands.

Since the 6L6 valves were first introduced it has become apparent that a single valve transmitter is ample for the beginner. Such apparatus is simple to build and has the virtue that at a later date it can be the first section of a higher powered transmitter without making any fundamental alterations.

In this way both cost and labour are kept to a minimum, while components can be obtained a few at a time as required.

The Tri-Tet

For the beginner the Tri-tet oscillator circuit is most satisfactory for it provides a high R.F. output on the crystal frequency, a good output on the second harmonic, and enough output on the third harmonic to drive a steep slope final valve. This enables the constructor to have a transmitter suitable for three-band operation with the minimum amount of trouble.

The circuit of the oscillator is shown in this page. It consists of a tetrode valve as a crystal oscillator with tuned cathode and anode coils. When used

at crystal frequency the cathode coil is short circuited merely tuning the anode coil to resonate to crystal frequency.

Component values are not very critical, but the best average values are shown in the circuit. The grid of the 6L6 is tied down to earth via a resistance of 50,000 ohms to provide a certain amount of grid bias.

In the normal crystal oscillator circuit the crystal is connected between grid and earth, but in the tri-tet circuit it is connected between grid and cathode with the cathode above earth.

In series with the cathode is L₁ tuned by a high-capacity condenser in parallel with it.



In the foreground can be seen the two insulators connected to L₃. These can either be joined to a second stage or directly to the aerial via the correct tuning system.

In the anode circuit is L₂ parallel tuned with a small capacity in order to produce the maximum R.F. output on the harmonics. The most important components are the two resistances making up the screen-voltage network.

Power Supply

With 400 volts applied, the voltage actually on the screen is 200-volts which is slightly less than optimum value. With the tetrodes, however, it is not advisable to use optimum screen voltage until the circuit has been finally tuned and completely mastered.

When the 6L6 was first introduced into this country many amateurs fractured crystals owing to the use of a high

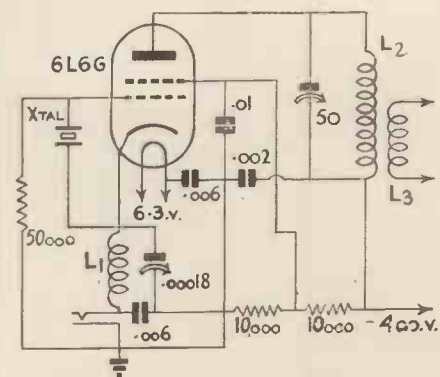

The straightforward tri-tet circuit used which gives a good output on three bands.

Working on 3 Wavebands

ment and anode by-passing, so make a point of connecting the condensers with the shortest amount of wire on the "hot" side.

Coil Data

Assuming that constructors will use a 40-metre crystal the following coil data

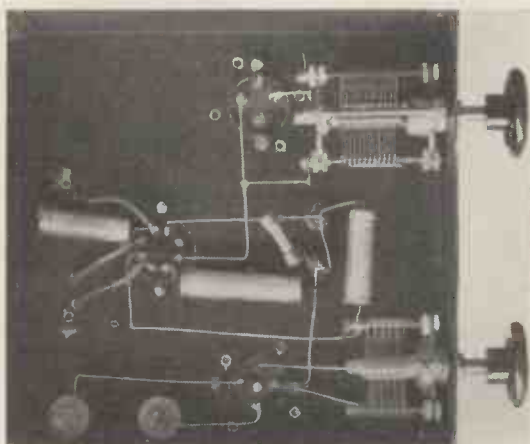

Some idea as to the component layout can be obtained from this sub-chassis view. It is advisable to connect the high wattage resistors in the power pack.

will apply only if that crystal is used with the specified tuning condensers across L₁ and L₂.

For 40-metre operation short circuit L₁ and use 20 turns of number 18 gauge enamelled wire spaced to cover 1½ in. On 20-metres L₁ is made up of 7 turns number 18 gauge wire spaced 1¼ in. L₂ for this wavelength requires 9 turns of the same gauge wire spaced to cover 1½ in.

Although the output on 10 metres is too low should the constructor wish to use the unit as a complete transmitter, it is ample to drive a valve of the RK-25 or RK-39 type. In such circumstances the constructor will have a complete three-band transmitter with only two valves.

The coils for 10 metres are as follows:—L₁ 4 turns number 18 gauge enamelled spaced to cover 1½ in. The anode coil L₂ should be wound with 4 turns number 18 gauge wire spaced 1½ in.

In every case L₃ is merely a link coil connected to the following stage, and consists of one complete turn close to the H.T. end of the anode coil.

If L₃ is to be coupled to an aerial it should have more turns and be almost identical with L₂, although the gap between L₂ and L₃ will have to be found by experiment.

The power pack should be capable of giving 400 volts at 125 mA. as a minimum for the 6L6 when off tune will take well over 100 mA.

For guidance, without any load coupled to L₃ the anode current when L₁ and L₂ are in resonance should be

under 20 mA. or lower if possible. Variations in valves will effect to a certain extent, so for this reason the grid resistance value may have to be altered to give the correct bias for the particular valve in use.

Variation can also be tried with the coils L₁ and L₂ for the way in which the unit is wired will have some effect on

the coil sizes. L₁ should be adjusted so that the resonant point is found with a high value of capacity, that is with the condenser plates well in mesh. With L₂, however, the coil should have a high inductance so that the resonant point is found with the tuning condenser almost completely out of mesh.

This transmitter is most suited for C.W. operation, in which case the key can be connected either in series with the jack provided for the meter or between the centre tap of the heater and earth. In both cases the usual key click filter should be used.

A filter of this kind should consist of a 400-ohm pre-set type resistance in series with a condenser of about .5-mfd. capacity. This filter is then connected in parallel across the key. To prevent every trace of click a further component is needed. Connect a low-frequency choke in series with the key with a 10,000 variable resistor across it. Then adjust both resistors until the best setting is found that prevents the clicks, but does not introduce a tail on the note.

For phone use both screen and anode should be modulated, but it is not advisable to modulate on the harmonics for this generally causes frequency modulation.

This little transmitter is ideal for the beginner, but it should be remembered that a licence must be obtained before construction is contemplated. Details of this licence can be obtained from the General Post Office, the Office of the Engineer-in-Chief, Radio Section, Armour House, Aldersgate Street, London.

Components for A SINGLE STAGE 10-WATT TRANSMITTER

CHASSIS.

1—Steel chassis 6 × 6 × 2 in., finished black (Premier Supply Stores).

CONDENSERS, FIXED.

1—.002-mfd., type 620, 500 volt working (Dubilier).

1—.006-mfd., type 620, 250-volt working (Dubilier).

1—.006-mfd., type B770, 500-volt working (Dubilier).

1—.01-mfd., type 691 (Dubilier).

CONDENSERS, VARIABLE.

1—50 mmfd., type Apex (Webbs Radio).

1—Type 942/180 (Eddystone).

COIL, FORMS.

2—4-pin low-loss, type CT4 (Raymart).

HOLDERS, COIL.

2—4-pin, less terminals, type V1 (Clix).

HOLDERS, VALVE.

1—Type octal, less terminals (Clix).

1—4-pin, less terminals, type V1 (Clix)

PLUGS, TERMINALS, ETC.

1—4-way terminal strip (Eddystone).

1—4-pin plug, type P3 (Bulgin).

1—Jack, type J2 (Bulgin).

RESISTANCES, FIXED.

2—10,000-ohm, type R45 (Bulgin).

1—50,000-ohm, type 1-watt (Eric).

SUNDRIES.

1—Valve, screen, type VS (Peto-Scott).

½ lb.—Tinned copper wire, 14-gauge (Webbs Radio).

1—40-metre Crystal, type Valpey (Webbs Radio).

VALVE.

1—Type 6LG6 (Premier Supply Stores).

Complete kits of parts or ready-built units can be obtained from Messrs. Peto-Scott, Ltd., Messrs. Premier Supply Stores, Webbs Radio, Ltd., and Messrs. Scott-Sessions, Ltd.

New Radio Centre for America

Very shortly there is to be a new radio shop for amateurs in London where they will be able to buy all manner of short-wave components both of British and American manufacture. It is hoped to produce a full range of components on the best American principles but at greatly reduced prices. This will enable the British amateur to build stations on American commercial lines.

The Cairo Conference

We have just heard that the possibility of British amateurs losing the right to work on the 5- and 10-metre bands is now very remote. It seems more than likely that these bands will be used only by the amateurs in the Americas and Great Britain with the rest of the world using these bands for commercial meteorological work.

However, the British amateurs will probably lose a few hundred kc. off the top end of the 10-metre to be used by the Government, but otherwise the bands will remain the same.

NOW READY

Premier 1938 New enlarged Illustrated Catalogue, Handbook and Valve Manual! Send 6d. in stamps for 90 pages of Valve Data, Technical Articles, Circuits and Premier 1938 Radio.

PREMIER

SUPPLY STORES

Manufacturers of

TRANSMITTERS, RECEIVERS, MODULATORS, AMPLIFIERS, COMPONENTS

POST ORDERS

Jubilee Works,
167, Lower
Clapton Rd.,
London, E.5.
Amherst 4723

CALLERS

50, High Street,
Clapham, S.W.4
Macaulay 2381
165 & 165a
Fleet Street, E.C.4.
Central 2833.



SHORT WAVE COILS

Low-loss interchangeable coils, 4- or 6-pin standard and other fittings.

12-26 metres 1/9 41- 94 metres
22-47 metres each 78-170 metres
Other wavebands up to 2,000 metres from 2/-.
S.W. Coil Formers as used in above coils, 2½ in. long 1½ in. diameter, 4-, 6- or 7-pin fitting. Plain or threaded, 1/- each.
S.W. Chokes, 10-100 metres, 9d.; screened 1/6.
Pie-Wound S.W. Chokes, 2/-.

PREMIER HIGH-FIDELITY AMPLIFIERS AND MODULATORS

Premier, 1938, Super 3-Watt Amplifier for A.C. or A.C./D.C. mains. 2-stage, high-gain circuit. Complete Kit, with metal chassis, all parts and 3 matched Valves, 40/-. Wired and tested £2 15s.
Premier, 1938, 8-Watt Amplifier for A.C./D.C. mains. 3-stage, high-gain, with Push-Pull output. Complete Kit, with metal chassis, all parts and 5 matched Valves, £4 4s. Wired and tested, £5 5s.
Premier, 1938, A.C. mains 12-Watt P.A. Amplifier or modulator. 2-Beam Power tubes in Push-Pull output, phase inversion high-gain, distortionless output. Complete chassis-built Kit, with 5 matched Valves, £5 5s. Wired and tested, £7 7s.



SHORT WAVE CONDENSERS

TROLITUL insulation. Certified superior to ceramic. All-brass construction. Easily ganged.

15 m.mfd.	1/6	Double-Spaced
25 m.mfd.	1/9	Transmitting
40 m.mfd.	1/9	Types.
100 m.mfd.	2/-	15 m.mfd. 2/9
160 m.mfd.	2/3	40 m.mfd. 3/6
250 m.mfd.	2/6	160 m.mfd. 4/6
All-brass slow-motion Condensers, 150 m.mfd., Tuning, 4/3; Reaction, 3/9.		

10 watt A.C./D.C. C.W. Transmitter.
Pentode Crystal Oscillator. Low crystal current. Minimum frequency drift. Price, complete with Valves, Crystal and Key, £4 4s.

3 NEW PREMIER TRANSMITTERS
10-watt 'Phone Transmitter (as illustrated) 6L6G exciter. Regenerative Crystal Oscillator Doubler. 802 Pentode Amplifier with Suppressor Grid Modulation. Price complete with 4 Tubes and Crystal, £15.

25-watt 'Phone Transmitter. 6L6G exciter. Regenerative Crystal Oscillator Doubler. 801 Triode Amplifier. Grid neutralised grid and anode meters. Price complete with 6 Tubes and Crystal, £21.

AMERICAN VALVES

We hold the largest stocks of U.S.A. tubes in this country and are sole British Distributors for TRIAD High-Grade American Valves. All Conceivable types in stock. Standard types, 5/6 each. All the new Metal-Glass Octal Base tubes at 6/6 each, 210 and 250, 8/6 each. 4-, 5-, 6- and 7-pin U.S.A. chassis mounting valveholders, 6d. each. Octal Bases 9d. each.



EUROPA MAINS VALVES

4 v. A.C. Types, A.C./H.L., A.C./L., A.C./S.G., A.C./V.M.S.G., A.C./H.P., A.C./V.H.P., A.C./P., and 1 watt D.H. Pentodes, all 4/6 each. A.C./Pens. I.H., 5/6; A.C./P.X. 4, 6/6; Oct. Freq. changers, 8/6; Double Diode Triodes, 7/6; Triode H. ex. Freq. Ch., 8/6. Tri. Grid. Pen., 10/6; 3½ watt I.H. Triode, 7/6.

UNIVERSAL TYPES, 20 v., 18 amps., S.G., Var.-Mu. S.G., Power, H.F. Pens., Var.-Mu. H.F. Pens., 4/6 each.

13 v., 2 amps. gen. Purpose Triodes, 5/6; H.F. Pens. and Var.-Mu. H.F. Pens. Double Diode Triodes, Oct. Freq. Changers, 7/6 each. Full-Wave and Half-Wave Rectifiers, 5/9 each.

BATTERY VALVES, 2 volts, H.F., L.F., 2/3. Power, Super-Power, 2/9. Var.-Mu.-S.G., 4- or 5-Pin Pentodes, H.F. Pens., V-mu.-H.F. Pens., 5/-. Class B, 5/-. Freq. Changers, 7/6.

POWER PACKS

Completely assembled on steel chassis. Finest components.

Outputs:

120 volts 20 m/A.	25/-	Westinghouse Rectification.
150 volts 30 m/A.	27/6	" "
250 volts 60 m/A.	33/-	" "
300 volts 60 m/A.	37/6	" "
150 volts 30 m/A.	17/6	Valve Rectification.
350 volts 120 m/A.	40/-	" "
500 volts 200 m/A.	65/-	" "

Larger Models to Order.

Premier Mains Transformers.—Screened primaries 200-250 volts. Guaranteed 1 year. Wire end types.

HT8 + 9 or HT10 with 4 volts 4 amp., C.T., and 4 v. 1 a., C.T., 10/-. 250-250 v. 60 m/A. or 300-300 v. 60 m/A., with 4 v. 1-2 a., 4 v. 2-3 a., 4 v. 3-4 a., all C.T., 10/-. 350-350 v. 150 m/A., 4 v. 1 a., 4 v. 2 a., 4 v. 4 a., all C.T., 13/-. 350-350 v. 150 m/A., 5 v. 2 a., 6.3 v. 2 a., 6.3 v. 2 a., all C.T., 13/6. Fitted with Panel and Terminals, 1/6 extra. 500-500 volts 150 m/A., 4 v. 2-3 a., 4 v. 2-3 a., 4 v. 2-3 a., 4 v. 5 a., all C.T., 21/-. 500-500 v. 200 m/A., 5 v. 3 a., 6.3 v. 3 a., 2.5 v. 5 a. or 7.5 v. 3 a., all C.T., 25/-. 500-500 v. 150 m/A., 15/-. 1,000-1,000 v. 250 m/A., 21/-. 1,500-1,500 v. 200 m/A., 50/-. 2,000-2,000 v. 150 m/A., 57/6. Fitted with Panel and Terminals, 2/- extra.

Premier Filament Transformers. Primary 200-250 volts, 1,000 insulation test. 2.5 volt 8 a. C.T., 8/6; 4 v. 5 a. C.T. 9/6; 5 v. 3 a. C.T., 8/6; 6 v. 3 a. C.T., 8/6; 6.3 v. 3 a. C.T. 8/6; 7.5 v. 3 a. C.T., 8/6; 10 v. 3-4 a. C.T., 11/6.

PREMIER METERS.—Moving Coil 0-1 m/A., full scale, resistance 100 ohms, 3½ in. diameter, flush mounting, 22/6. Multipliers, 1/- each. Tapped shunts: —10, —50, —100, —200 m/A., 4/- each. Moving Iron Meters, 2½ in. diameter, flush fitting. Read A.C. or D.C. All readings from 0-10 m/A. to 0-10 amps., 5/9 each. 0-6 volts 0-16 volts, 5/9 each. 0-250 volts, 8/6. Telsen Multimeters. Read A.C. or D.C., 0-6 volts, 0-16 volts, 0-250 volts; 0-30 m/A., 0-300 m/A., 8/6 each.

Premier Battery Chargers. Westinghouse Rectification. Complete, ready for use. To charge 2 volts at ½ amp., 10/-; 6 volts at ½ amp., 16/6; 6 volts at 1 amp., 19/6; 12 volts at 1 amp., 21/-; 6 volts at 2 amps., 32/6; 30 volts at 1 amp., 39/6.

TWO NEW MODELS completely enclosed. To charge 6 volts at 4 amps., £3/19/6. To charge 6 or 12 volts at 2 amps., £3/19/6.

New Premier, 1938, S.W. 59.3 Kit, 14 to 170 metres. Pentode H.F., Detector and Pentode Output. Complete Kit of Parts with 3 matched valves 59/6 Metal Cabinet 7/6 extra.



Premier Short-Wave Kits

NEW 1938 1-VALVE SHORT-WAVE RECEIVER OR ADAPTOR KIT, 13 to 86 metres without coil changing. Complete Kit and Circuit, 12/6. VALVE GIVEN FREE

DE LUXE MODEL, 14 to 150 metres, complete Kit with Chassis, 4 Coils and all parts, 17/6.

1937 SUPERHET CONVERTER KIT, 15/-.
DE LUXE MODEL, 20/-.

S.W. SUPERHET CONVERTER, for A.C. Mains Receivers, 22/6. A.C. Valve given FREE!

NEW 1938 2-VALVE S.W. KIT, 13 to 86 metres without coil changing. Complete Kit and Circuit, 19/6. VALVES GIVEN FREE.

DE LUXE MODEL, 14 to 150 metres, complete Kit and Chassis, 4 Coils and all parts, 25/-. VALVES GIVEN FREE.

MODULATION TRANSFORMERS

Primary and secondary impedance to your requirements.

10 watts	14/-
25 watts	18/6
50 watts	26/6

TAYLOR TRANSMITTING TUBES

T.20	17/6	203A	72/-
T.55	45/-	203B	72/-
825	27/6	866	11/6
841A	40/-	866B	17/6
		866JR	7/6

A 203-Z Modulator Stage

This modulator stage uses the new zero bias high-mu triodes type 203-Z. This simple unit can be driven by a small speech amplifier.

VERY few amateurs appear to appreciate the value of class-B amplification for modulation work with transmitting equipment. It is possible with this system to obtain quite high-audio outputs with low voltages and small-type output valves.

A good example of this is the type-10 triode which will give at least 60 to 70 watts of audio without undue stress. From observations we have made it seems that the difficulty with class-B systems, as far as the amateur is concerned, is the trouble of obtaining a steady bias source.

300 Watts

However, at the special request of many amateurs, we publish first the 203-Z output stage, which gives 300 watts output with the minimum number of components and with the low drive power of 7 watts.

Amateurs will see from this that the output stage can be driven by any existing amplifier giving this audio output without going to the expense of building a completely new amplifier.

Tests show that a PP5/400, two 6L6's in class-A or two 6AC5's in class-A,

from which it can be seen that the arrangement is very simple and can be built up with its own power pack if required on a separate chassis and used for either modulation or public address work.

The output can be varied to suit special requirements by altering the load into which the two valves work or by lowering the applied anode voltage. The examples in the table will illustrate this point.

The table below gives proper class-B audio operating conditions for various outputs at different plate voltages. The

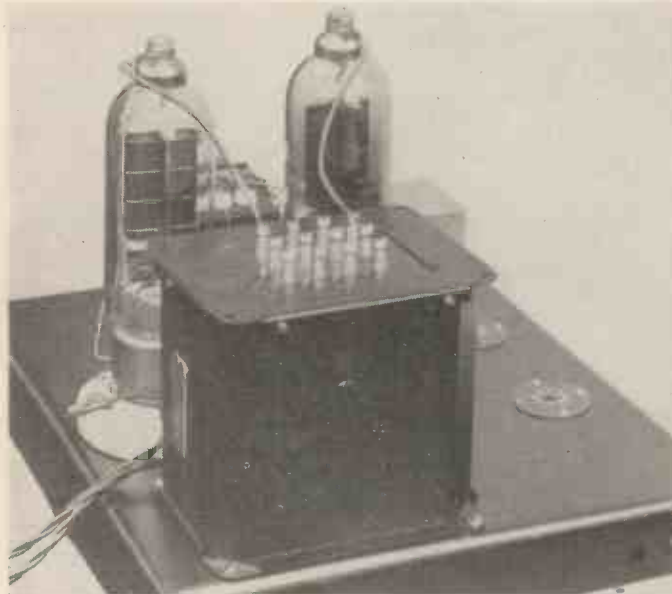

Supply Voltage	150	200	260	300	Audio Watts Output
1250	.175 15,800	.233 11,800	.306 9,000	.350 7,900	Max. Av. Ip Load Impedance plate to plate
1100	.204 11,600	.272 8,750	.352 6,700		Max. Av. Ip Load Impedance plate to plate
1000	.225 9,300	.306 6,900			Max. Av. Ip Load Impedance plate to plate
900	.258 7,200	.345 5,400			Max. Av. Ip Load Impedance plate to plate

A small chassis of this type will accommodate all the components for the output stage in addition to a complete speech amplifier.

As in class-B audio the anode current of the class-B valves swings from a low standing current to a very high value on peaks so it is impossible to use automatic bias of any kind as the bias applied would fluctuate with the anode current.

For this reason those amateurs who are using class-B seem to favour battery bias in the final stage or else use a well filtered mains unit of the type suitable for broadcast receivers.

We have been experimenting with some new triode valves suitable for class-B operation which are of the zero-bias type with a high impedance. These valves remove all the troubles from class-B operation and allow the amateur without knowledge of this type of amplifier to obtain satisfactory results with the minimum trouble.

We have designed a series of amplifiers using the TZ-20, TZ-40, and 203-Z types of valve, which give approximately 70, 170 and 300 watts of audio output.

will drive the 203-Z's quite well. The circuit of the output stage is given

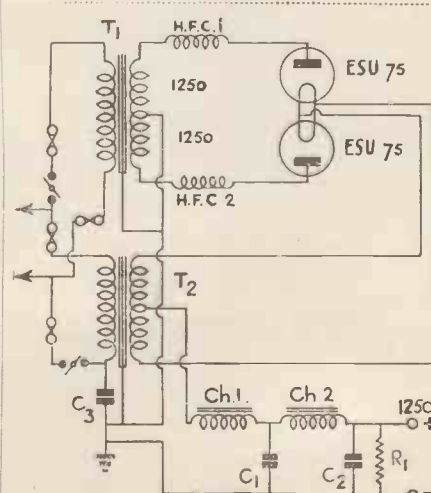

This is the circuit of the power pack for the output stage. The components are discussed in the text.

most important value is the reflected load impedance which is given for the entire primary or plate to plate. The current value is the maximum average value as would be indicated on the plate current meter with sine wave input. For the same peak output with voice input the maximum average plate current will be approximately 50 per cent. to 60 per cent. of this value.

These high-gain triodes have top-cap anode connections so that high anode voltages can be used without fear of breakdown. The average anode dissipation is 65 watts and at this dissipation the anode should be almost cold.

Operating Conditions

The no-signal anode current is about 35 mA. per valve at 1,000 volts H.T., rising to 45 mA. at the maximum of 1,250 volts. As the grid starts to take current immediately the valve is driven the input transformer need not be of the usual complicated design as used in the normal class-B circuits, so consequently the speech quality is almost as good as with class-A.

We have chosen, however, the U.T.C. PA-53-AX, which has been designed for use with this type of circuit and has a tapped primary for use with two small triodes or tetrodes in push-pull operation. This is an interesting point for the driver stage can use quite small valves with a maximum H.T. of 250 volts.

Very few amateurs can afford to build a complete high-power modula-

WEBB'S OFFICIALLY APPOINTED DISTRIBUTORS IN
GREAT BRITAIN BY—
**HALLICRAFTERS
RME, & HARVEY**

Taylor Tubes

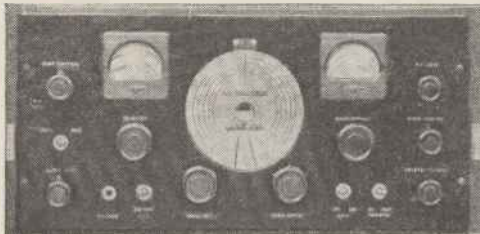

**EVERY HALLICRAFTER
RECEIVER IN STOCK**

1938 Super Skyrider. The finest 5 to 550 metre Superhet calibrated "R" meter. 1,000 degree band spread. Accurate calibration all bands. Crystal gate model complete, 230 volt mains, £32.

**HALLICRAFTER SKY
CHALLENGER II**

New Improved Model of the 1937 Challenger. Incorporates 1,000 degree band spread, crystal gate, "R" meter terminals. Price complete. £25. Available from stock March 1st.

TWO MORE NEW MODELS

Announced by Hallicrafter, release date April 4th. New Improved Sky Buddy at £9. New 7 tube (1 R.F.) "SKY CHAMPION" £12 10s. 0.

**THE PICK OF THE WORLD'S
COMPONENTS**

Every worth while TUBE—and COMPONENT of British or American manufacture is carried in stock at WEBB'S LONDON and BIRMINGHAM Depot. Stocks include full range Eddystone, Raytheon, Taylor, Eimac and Johnson products.

Communication Type Receivers. RME-69, DB-20, all Nationals and Hallicrafters always in stock.

Transmitters. Complete built transmitters, including Temco and Harvey.

NEW RME-501 X U.H.F.
Frequency Expander. Frequency coverage 27.8 to 70 megacycles. Built-in Power Pack. Overall sensitivity less than one microvolt. Accurately calibrated. Release date—April 10th.



RADIO AMATEURS' GLOBE, 12 inch diameter, full colour, continental boundaries, produced by Webb's: Post Free 27/6

GREAT CIRCLE MAP of the World, 30 inches by 40 inches, full colour, every international prefix plainly marked. time zones, continental boundaries.

On heavy paper ... 4/6
On linen, with rollers ... 10/6

NATIONAL CRM 1" OSCILLOSCOPE. See review in this issue. Complete Instrument for 230 v. operation, with 913 tube and rectifier. Price complete £6 0. 0.



NEW T.40. TZ40. IN STOCK.

First consignment in England came into our depot March 31st. Price 24/-



T.20 . . . TZ20.
Now 16/-
866 Rectifier 10/-
866 Junior 7/-
T.55 45/-
203Z 52/6
845 65/-

WRITE FOR TAYLOR MANUAL
New edition 6d. post free

Johnson Q Antennas.

All types in Stock
5 metre Q complete, 26/6
10 " Q " 25/6
20 " Q " 35/6
Johnson Freed Thru' Insulators
1" 8d., 1 1/2" 10d.
Johnson Feeder Spreaders,
6", 9d.
Tuning Handles, 4" 3/6, 6" 5/-

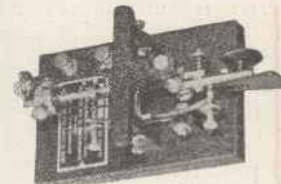
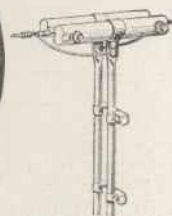

ALL McELROY KEYS REDUCED IN PRICE. Famous McElroy Standard "Bug" reduced from 38/- to 27/6.

1938 Model de Luxe Bug, 50/- reduced to 38/-.
New Junior Bug, reduced from 22/6 to 17/6.
McElroy Straight Key, latest model, heavy cast base, large contact. Reduced from 10/- to 7/6.
McElroy Hummer, 1,000 cycle, mechanical oscillator for Morse practice, again available from stock, 10/-.

SEE THE NEW HARVEY UHX-10 TRANSMITTER

(Reviewed in February issue)

10 watt R.F. output all bands. 5 to 160 metres inclusive. Transmitter complete, two band operation, £19. 230 volt A.C. Power Pack, £6 10s. 6 volt Gene Motor, £9 16s.

WEBB'S RADIO

(C. WEBB, LTD.)

14, SOHO STREET, OXFORD STREET, LONDON, W.1

Phone: GERRARD 2089

MIDLAND DEPOT: 41, CARRS LANE, BIRMINGHAM.

Phone: MIDLAND 3771

Power Pack Considerations

tor, although many will be in a position to add this single stage to their existing speech amplifier. The output transformer is a U.T.C. VM-3, which is large enough for most purposes except to handle the maximum output from the 203-Z's. If amateurs should wish to use the full 300 watts then a

fed into a special swinging choke having an inductance of between 5 and 25 henries.

Low-resistance Chokes

The smoothing choke must be wound with heavy-gauge wire so that the D.C. resistance is not more than 20 ohms.

frequency chokes in the anode circuit of the valves as close to the anode pin as possible.

These chokes are home made and consists of 50 turns of 20-gauge double-cotton covered wire wound on a thick blue pencil and left self-supporting. These chokes can be made the connecting leads between the anodes and the

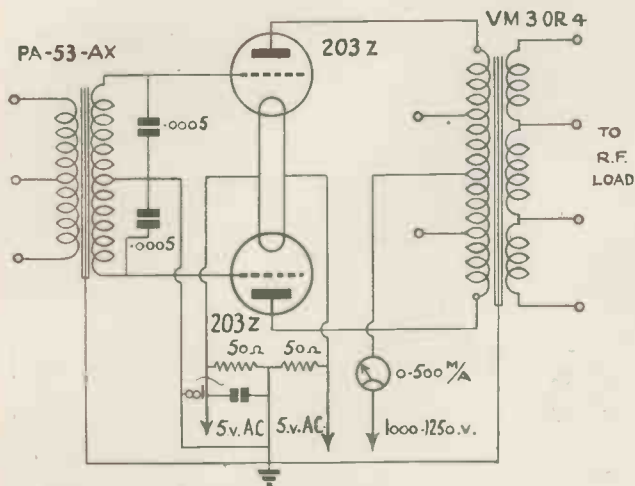

The very minimum of components are required for the modulator unit. Both transformers are of a special type.

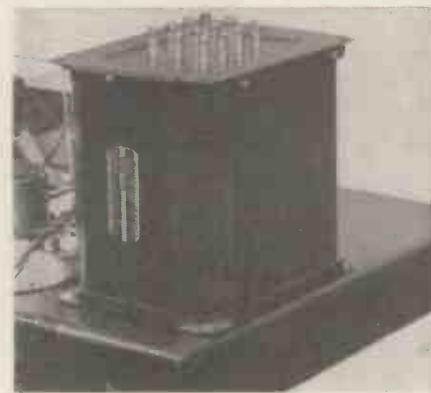

The special U.T.C. output transformer for the 203-Z valves.

type VM-4 transformer will be required. The VM-3, however, will handle up to 150 watts and as this will modulate a 300-watt carrier is suitable for most amateurs in this country.

The secondary of this transformer is tapped to suit all working impedances and at the same time will stand the full current of the modulated stage.

The power pack for this unit calls for some comment for it must be free from fluctuation with the swinging anode current.

Current Swing

Under optimum working conditions the modulator anode current will swing from 00 mA., standing current, to a peak current of 300 mA. If there is a high resistance component in the power pack, such as a smoothing choke the voltage will automatically swing as the current varies.

This cannot be tolerated in any circumstances and if amateurs will remember this point much of the bad quality attributed to class-B will be eliminated. The H.T. voltage must not swing more than 10 per cent. of the total value so for this reason there are several important points to be noticed in the power pack.

First of all the transformer must be capable of delivering a full 300 mA. at 1,250 volts. Secondly, the input circuit cannot be of the condenser type owing to the bad regulation of this system. The output from the rectifiers must be

To prevent voltage surges when the load is removed from the power pack for any reason a resistance of 50,000 ohms has to be connected across the full output.

As most rectifiers cause slight interference on the short waves and will be picked up by the receiving set, it is advisable to connect two small high-

high voltage secondary winding on the mains transformer.

The illustration of the output stage is actually the beginning of the final model of the complete 300-watt modulator which will be described at a later date. If, however, amateurs require some advance information we will be glad to supply some further details as to the driver stages.

Components for A 203-Z MODULATOR STAGE

CHASSIS AND PANEL.

- 1—Standard steel chassis, finished black (Premier Supply Stores).
- 1—Standard 10½-in. panel, finished black (Premier Supply Stores).

CONDENSERS, FIXED.

- 2—.0005-mfd. type 620/500-volt (Dubilier).
- 1—.001-mfd. type 620/250 (Dubilier).

HOLDERS, VALVE.

- 2—Type 50-watt (Johnson-Webbs Radio).

PLUGS, TERMINALS, ETC.

- 2—Feed-through insulators (Johnson-Webbs Radio).
- 1—4-way plug and socket (Bulgin).

METER.

- 1—Type 0-500 m/A. (Ferranti).

RESISTANCES, FIXED.

- 2—50-ohm type 1-watt (Bulgin).

SUNDRIES.

- 2—Top-cap connectors for 203-Z (Bulgin).
- 1—Dial light, type D9 (Bulgin).

TRANSFORMER DRIVE.

- 1—Type PA-53-AX (Premier Supply Stores).

TRANSFORMER OUTPUT.

- 1—Type VM3 or VM4 (U.T.C. Webbs Radio).

VALVES.

- 2—Type 203-Z (Webbs Radio).

POWER PACK SECTION.

CHASSIS AND PANEL.

- 1—Standard chassis, finished black (Premier Supply Stores).
- 1—Standard panel 10½ in. high, finished black (Premier Supply Stores).

CONDENSERS, FIXED.

- 2—4-mfd., type 951B (Dubilier).
- 1—.005-mfd., type 620, 250-volt (Dubilier).

CHOKES, HIGH FREQUENCY.

- 2—Home-built to specification.

CHOKES, LOW FREQUENCY.

- 1—Swinging choke, 300 m/A. (Webbs Radio).
- 1—Smoothing choke, 300 m/A. (Webbs Radio).

HOLDERS, VALVE.

- 2—Type porcelain screw (Premier Supply Stores).

RESISTANCE, FIXED.

- 1—50,000 ohm, type PR41 (Bulgin).

SUNDRIES.

- 4—Fuseholders, type F12 (Bulgin).
- 2—Type Johnson feed-through insulators (Webbs Radio).

SWITCHES.

- 2—Type S80 toggle (Bulgin).

TRANSFORMER, MAINS.

- 1—Special, to give 1,250-0-1,250 300 m/A. (Webbs Radio).
- 1—Special, to give 1-0-1V 16A and 5-0-5V 8A (Premier Supply Stores).

VALVES.

- 2—Type ESU 75 (Mazda).

SUNDRIES, EXTRA.

- 1—Mains connector, type 3-way (Clix).



... **WORLD'S RECORD LOG**
secured with a **TROPHY** SHORT WAVE
RECEIVER

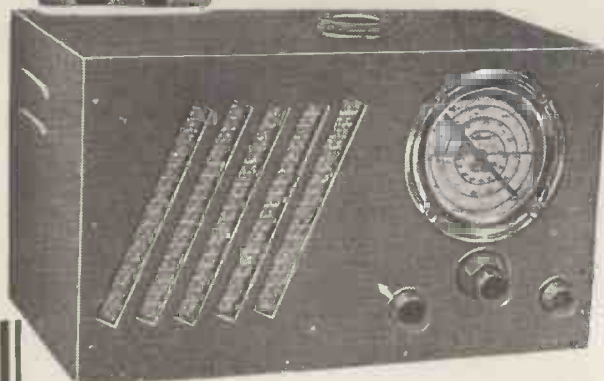

Reviewed in this issue

In putting before you details of the wonderful Trophy Receivers, B.T.S. are proud to sponsor a series of Short Wave Receivers that so amply support the claims of the designers. . . . Based on the circuit design used by the World's Champion Short Wave Station "logger." Three models to choose from . . . the Trophy 2, a duplicate of the set used by the designer, who secured 247 stations for his Trophy record. The Trophy 3 in two versions, A.C. Mains Model and Battery Model. . . . Designed for the reception of the World's Broadcasts on the Moving-Coil Speaker incorporated. Supplied complete with all valves and two B.T.S. One-shot Inductors covering 12-52 metres. Housed in beautiful black crystalline finished steel cabinet.

SPECIFIED for the DUAL PURPOSE COMMUNICATION RECEIVER

Described in this issue

B.T.S. 4-BAND TUNER. 10-2,000 metres.

Supplied complete with two matched B.V.A. Valves, Frequency Changer and H.F. Amplifier.

Comprising a completely assembled H.F. and Frequency Changer Unit embodying all tuning and decoupling for four wavebands . . . 10-2,000 metres . . . New type Duplex Epicyclic dial, with dual-ratio slow-motion drive giving reductions of 9-1 and 80-1 and extra large plate-glass dial with engraved station names and in-direct lighting. **£5 : 15 : 0**

B.T.S. ONE-SHOT INDUCTORS for the TROPHY 3

Type SL/1 (6-13 metres), (for Television) 3/3. Type SL/2 (12-26 metres), 3/-. Type SL/3 (26-52 metres), 3/-. Type SL/4 (40-96 metres) 3/-. Type SL/5 (70-200 metres), 3/3. Type SL/6 (150-350 metres), 3/6. Type SL/7 (300-550 metres), 3/9.

TROPHY 2

Supplied complete with 2 specially matched valves, light-weight head-phones, and 2 One-shot Inductors. Not illustrated.

£4 : 15 : 0
or 7/6 down and 12 monthly payments of 8/3.

TROPHY 3 BATTERY MODEL

Supplied complete with 3 matched valves, 2 B.T.S. One-shot Inductors and speaker, housed in cabinet as illustrated less Batteries.

£5 : 15 : 0
or 9/6 down and 12 monthly payments of 9/11.

TROPHY 3 A.C. MODEL

Supplied complete with 2 matched valves and rectifier, 2 B.T.S. One-shot Inductors and housed in cabinet as illustrated. 200/250v. 40/100 cycles

£6 : 6 : 0
or 10/- down and 12 monthly payments of 10/9.

BRITISH TELEVISION SUPPLIES Ltd.

Faraday House, T.2, 8/10 Charing Cross Road, LONDON, W.C.1. Telephone : Temple Bar 0134

WANTED— THE GREATEST AMPLIFICATION WITH THE LEAST NUMBER OF VALVES

The set—a Dual Purpose Communication Receiver. Required—as much amplification as possible with as few valves as possible.

And specified by the Television and Short Wave World were—Tungram Valves. Recommended

because Tungram Valves do all that a good valve should do, well. The valves specified were VP4B, DDPP4B, HL4+ and APV4. There is a Tungram valve for every circuit, and the Tungram range includes both English and American types (pin and octal bases).

AND THE CHOICE WAS— TUNSGRAM

The valve with the name behind it!

Making a Side-contact Key

THE semi-automatic key, used almost universally in America, is rapidly gaining favour among amateurs in England. The chief reason that it is not still more widely

Many amateurs have asked how they can build a side contact key. This article, by R. C. FROST, 2AXM, gives all the details required.

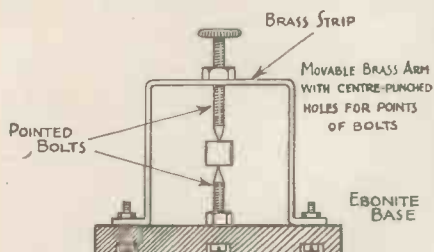

Fig. 1. How the pivot frame is constructed.

used lies in the price, as a good-quality and reliable key of this type is rather expensive to buy.

A serviceable side contact key can be made easily at a very low cost by anyone possessing a few tools and the ability to use them with average skill.

This type of key is operated in a horizontal direction from side to side. When pressed to the left a continuous dash is produced as long as the pressure is maintained and when pressed to the right a series of dots, the frequency of which can be easily adjusted to any speed within certain limits is sent out.

Making the Key

The accompanying diagrams are self-explanatory, but all parts must be strongly and rigidly made and moving parts should be able freely to pivot. It is better to use fairly heavy materials, as a very light key feels flimsy and is rather tricky to operate at high speed.

The base of the key consists of a piece of fairly heavy ebonite about 6 in. by 3 in. wide, and the movable arm is a 3 in. length of $\frac{1}{4}$ in. square brass rod. A pivot frame is made for this arm as shown in Fig. 1 by means of a strip of $\frac{1}{8}$ in. heavy gauge brass bent to the shape indicated and bolted to the ebonite base. Two bolts have their ends filed to a point and are fixed to form the pivot as shown. The points of these bolts engage with centre-punched holes of the centre of the brass arm, the upper bolt being fitted in a tapped hole in the pivot frame, with a lock-nut, so that the pressure on the arm is easily regulated.

A vertical hacksaw cut is made for $\frac{1}{2}$ in. at one end of the arm, a hole being drilled horizontally through the arm at the same point. The hacksaw cut takes the small piece of thin ebonite by means of which the key is operated, and this is fixed in position by a bolt passed through the hole drilled in the arm.

At the other end of the arm, a similar

cut and hole are made to take the vibrating part of the arm, which is fixed in the same way by means of a nut and bolt.

The vibrating portion consists of a short strip of springy metal such as a piece of thin phosphor-bronze.

At the far end of this strip is a length of thin steel rod split and bolted in position in the same manner as described for fixing the ebonite handle. The bolt also carries a short length of light watch-spring bent as shown in Fig. 2, which forms the movable half of the dot-making contact.

A small adjustable weight, which may be a telephone-type terminal with the shank removed, is slipped on the steel

rod. The position of this weight on the rod regulates the speed of the dots produced.

Two small coil-springs are soldered to the end of the brass arm remote from the ebonite handle. The other ends of these springs are bolted to the ebonite base in such a way as to hold the arm central and to bring it back to the central position after it has been pressed to one side or the other.

It now remains to provide dot and dash contacts and stops. These are made by bolting small brass angle-brackets to the base in the positions indicated in Fig. 2, and tapping them to take adjustable bolts which can be fixed with lock-nuts. These contacts and stops are adjusted in the following way when the key has been completed.

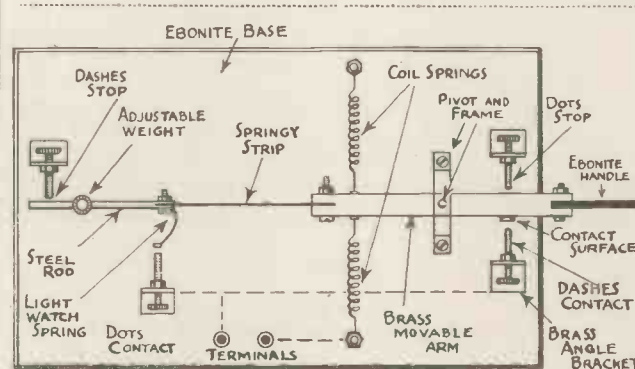

Fig. 2. The lay-out of the key showing the tension springs.

rod. The position of this weight on the rod regulates the speed of the dots produced.

Two small coil-springs are soldered to the end of the brass arm remote from the ebonite handle. The other ends of these springs are bolted to the ebonite base in such a way as to hold the arm central and to bring it back to the central position after it has been pressed to one side or the other.

It now remains to provide dot and dash contacts and stops. These are made by bolting small brass angle-brackets to the base in the positions indicated in Fig. 2, and tapping them to take adjustable bolts which can be fixed with lock-nuts. These contacts and stops are adjusted in the following way when the key has been completed.

The dots stop is set so that the arm can be moved a short distance (say 1-2 mm.) before making contact with it. The lock-nut is then tightened up. The dots contact is then adjusted so that, when the arm is up against the stop, the watch-spring contact on the arm vibrates smoothly and evenly against the end of the bolt of the contact fixed to the ebonite base.

Next, the dashes contact is set so that

contacts are joined together and connected to the second terminal.

If fairly heavy currents are to be broken by the key, small pieces of silver should be fixed to the contact surfaces to prevent too rapid burning away of the points.

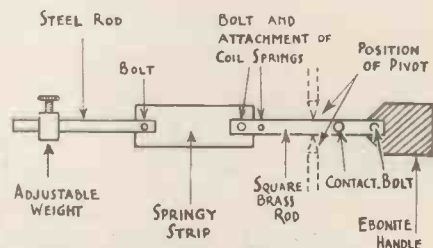
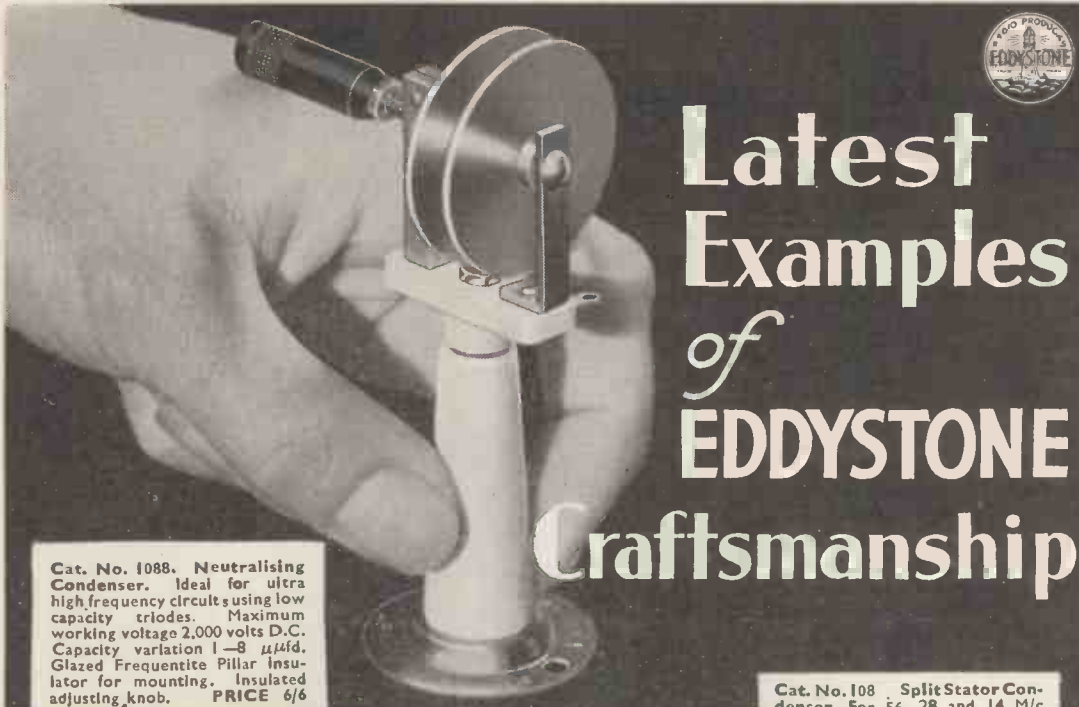

Fig. 3. A side view of the key movement showing the make-up of the movement.

Proficiency in operating the key is quite easily obtained and, after a certain amount of practice, very high speeds can be reached. A mistake which one often hears over the air is the setting of too fast a dots speed relative to the actual speed at which the letters are being formed.



Latest Examples of EDDYSTONE Craftsmanship

Cat. No. 1088. Neutralising Condenser. Ideal for ultra high frequency circuits using low capacity triodes. Maximum working voltage 2,000 volts D.C. Capacity variation 1—8 μfd . Glazed Frequentite Pillar Insulator for mounting. Insulated adjusting knob. PRICE 6/6

Cat. No. 108. Split Stator Condenser. For 56, 28 and 14 Mc Transmitters with Inputs up to 150 watts. Solid brass construction Frequentite insulation, maximum working voltage 2,750 volts D.C. Capacity of each section 6—27 μfd . in parallel 12—54 μfd . In series 1—10.5 μfd . PRICE 15/-

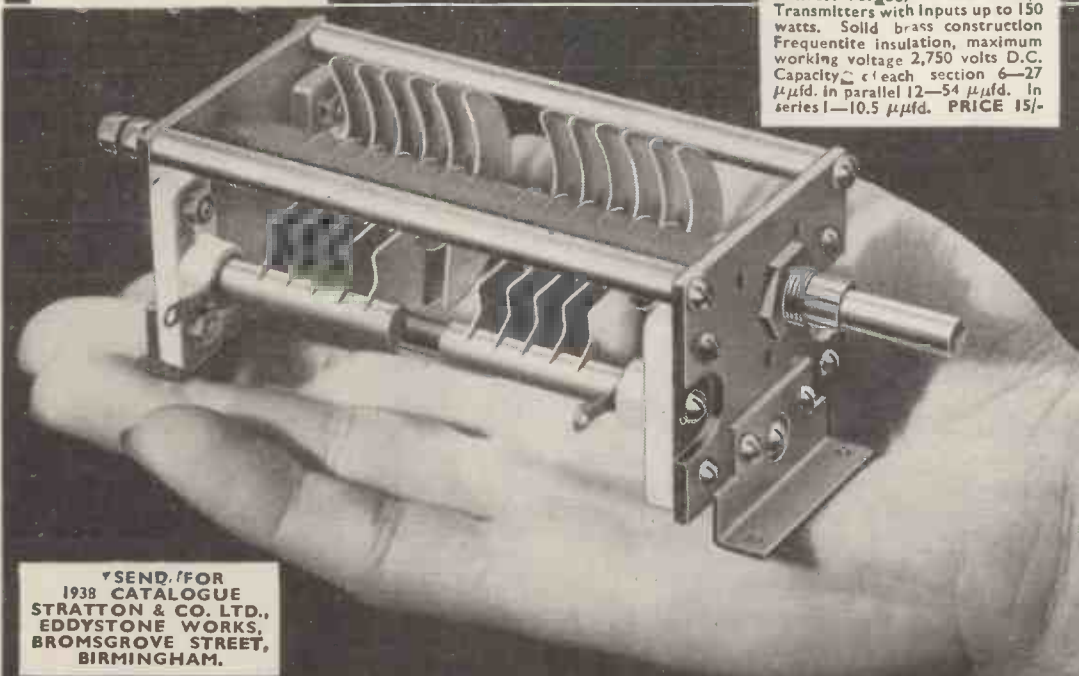

SEND FOR
1938 CATALOGUE
STRATTON & CO. LTD.,
EDDYSTONE WORKS,
BROMSGROVE STREET,
BIRMINGHAM.

EDDYSTONE SHORT WAVE COMPONENTS

LONDON SERVICE; WEBB'S RADIO, 18 SOHO STREET, OXFORD ST., W.1

The National Oscilloscope

THE new National Oscilloscope, a photograph of which appears below, is one of the neatest instruments we have tested for a long time and it cannot fail to make an immediate appeal to the amateur transmitter and research worker.

As the photograph shows, it contains an R.C.A. 1 in. type 913 tube together with the necessary H.T. supply and a 50-cycle potential for the horizontal sweep. An H.T. voltage of 500 is obtained from a type 6Z5 rectifier operating in half-wave and the supply potentials are derived from the usual potential divider chain. Part of the transformer winding is connected to a potential divider R₂ through an on-off switch S₂. This is located at the top right-hand corner of the panel and one of the horizontal deflector plate terminals is connected through it to the potentiometer or left free. The operation of freeing the plate terminal applies the 50 cycle-sweep to the plate itself, the amplitude being adjusted by means of R₂.

The vertical deflector plate is connected to earth through a 5-megohm fixed resistance which will not appreciably load the input circuit.

The plates are brought out to two terminal strips mounted one on each side of the case. One terminal of each pair is marked "G," denoting its connection to earth.

The controls on the front panel are as follows:—

- Top left—Input potentiometer R₂.
- Bottom left—Focus.
- Bottom right—Brilliance.
- Top right—Switch S₂.

Internal Construction

Access to the interior of the case is obtained by removing the screw at the back which holds the cover in place. The tube socket is mounted on a swivelling bracket by which the angle can be altered and the socket can also

be rotated to align the trace in the horizontal plane.

The transformer is remarkably compact, measuring only 2½ in. square by 3¼ in. deep. As will be seen in the diagram supplied, only a single condenser is used for smoothing the supply.

Operation

The supply is switched on by the switch on the front of the panel. The makers say that the brilliance and focus controls should be turned as far anticlockwise as possible before switching on the tube, and the switch S₂ turned to the left. After 15 seconds the con-



This small oscilloscope can be used for measuring modulation percentage with either a transmitter or on received signals.

controls can be turned up to focus the trace on the screen. The usual precautions should be observed regarding the presence of a stationary spot on the screen. The thickness of the trace is said to be 1/32 in. when correctly focused.

A booklet provided with the tube gives some suggestions for its use in

checking modulation in receivers and transmitters together with sketches of typical figures obtained.

Test Results

The instrument when connected to 110-volt mains consumed approximately 200 mA. At this supply voltage the tube anode was 425 volts, which dropped to 375 volts at 100 volts input. In both cases the sharpness and brilliancy of the trace were excellent and it could be seen in broad daylight. There was no trace of A.C. interference from the transformer. The approximate sensitivity measured with an A.C. deflecting potential was 0.3 mm. per volt r.m.s.

It is understood that the 110-volt model only is available at present, but most amateurs will have an auto-transformer which can be used to step down the British mains voltage to this value.

At a price of £5 the instrument is very good value for the money and will give long and trouble-free service.

A Linear Time Base for the Oscilloscope

In the issue of TELEVISION AND SHORT-WAVE WORLD for August, 1937, appeared a description of a linear time base which will be found of use with the National Oscilloscope described above. This unit is housed in a "Magnum" steel box measuring 6½ in. cube and is self-contained with the exception of the power supply.

The H.T. required is 250-350 volts, which can be obtained from a standard power pack circuit, with the addition of 4.0 volts for the valve heaters. The input to the unit is from a 4-pin socket mounted at the side of the box, the following connections being used: Filament pins, 4.0 volts A.C. Anode pin H.T. +, Grid pin H.T. -, and earth. Copies of the issue containing the description of the unit are available from this office, price 2s. 2d.

Subscription rates for "Television and Short-wave World" post paid to any part of the world are : 3 months, 3/6 ; 6 months, 6/9 ; 12 months, 13/6.

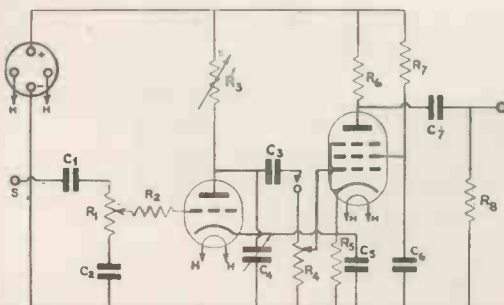

The circuit diagram of the linear time base attachment.

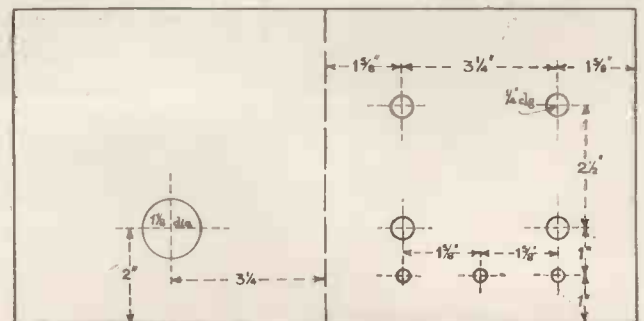

Drilling dimensions showing the side of the cabinet to the left and the face to the right.

DUAL PURPOSE COMMUNICATION RECEIVER

10-2000 metres



Described
in this
issue.

Assembled Receiver exactly to Authors' specification, including B.T.S. All Wave Tuner. Complete in steel cabinet with all valves and speaker fitted—rigidly tested and accurately aligned before dispatch.

H.P. Terms : Deposit 21/- and
12 monthly payments of 20/3

PRICE:
11 1/2 GN S

Send
NOW
for Full
Lists.

PETO-SCOTT CO. LTD.
77 (T.3.), CITY RD., LONDON, E.C.1
62 (T.3.), HIGH HOLBORN, LONDON, W.C.1

Est. 1919

Protection and Control

CLIX Completely Insulated All-in-Terminal gives protection against short circuits and shocks under all conditions of use.

CLIX ALL-IN-TERMINAL

Is supplied engraved : Aerial, Earth, **6d. ea.**
+, -. Input, Output.

ClIx Control Panel is designed to prevent sudden cessation of load on the output valve. In the case of a Pentode it can be very disastrous since the voltage on the auxiliary grid will build up and seriously impair the emission of the valve. This ClIx fitting gives instantaneous switching in or out of Headphones or Extension Speaker and the Internal Speaker can also be left in or out of circuit. A movement of the Twin Plug to left or right operates the switch.

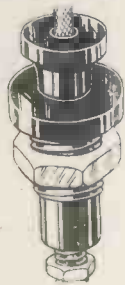

The following ClIx components are specified for apparatus described in this issue :—

VALVEHOLDERS

Type VI.	4-pln 5d., 7-pin 9d.
	(without terminals)
Octal Type	10d.
Loudspeaker Control Panel	1/-
Insulated Sockets Type II	2½d. ea.
Mains Plug, Type "M" 2-pin	6d.

You will often find ClIx Illustrated Folders "T.S." useful to you. Why not send for copies now ?

CONTROL PANEL
1/- Complete.

BRITISH MECHANICAL PRODUCTIONS LTD.

79a Rochester Row,
London, S.W.1.



Fundamentals of RADIO

By **FREDERICK EMMONS TERMAN**

Professor of Electrical Engineering, Stanford University

458 pages, 9 × 6, 278 illustrations, 21s. net

WHILE this book is essentially an abridged version of the author's well-known *RADIO ENGINEERING*, it is by no means merely a truncated edition of the larger book, but constitutes a carefully unified and almost wholly new text at a more elementary level.

The simplification consists largely in confining the treatment more closely to fundamental principles. This policy has been followed in the belief that the most satisfactory method of presenting a subject in an elementary course is to concentrate on the fundamental concepts, and to avoid diverting attention from these by too much consideration of all the possible consequences, applications, and implications of these principles.

VIBRATION AND SOUND

By **PHILIP M. MORSE**

Associate Professor of Physics, Massachusetts Institute of Technology

351 pages, 9 × 6, illustrated, 24s. net

BECAUSE the rapid growth of atomic physics in the past ten years has induced a complete reorganisation of the science of acoustics, this book on the theory of vibrations and sound will be of particular interest to workers in the field of acoustics and to communications engineers. The book aims to give a general introduction to the theory of vibration and sound, emphasising newer applications and the more recent points of view and to give a series of examples in the method of theoretical physics—how a theoretical physicist attacks a problem and how he finds its solution.

During the recent rapid change in the science of sound, certain parts of the subject have gained and other parts have lost importance. The present book attempts to follow this change in emphasis and to discuss the new developments as well as those portions of the older theory which are still of importance.

COMMUNICATION ENGINEERING

By **W. L. EVERITT**

Professor of Electrical Engineering, The Ohio State University

New Second Edition, 727 pages, 9 × 6, 411 illustrations, 30s. net

IN the second edition of this widely known book every chapter has been enlarged with new material which is of importance to the radio and telephone engineer. There is a new chapter on equalisers. The chapter on electro-mechanical-coupling has been entirely rewritten to show the use of mechanical impedance methods of analysing vibrating systems. A general method of analysing loudspeakers, microphones and telephone receivers is demonstrated. The chapter on radiation has been extended to include computations of antenna arrays and the propagation of waves over an earth of known conductivity.

McGraw-Hill Publishing Co., Ltd.
Aldwych House London, W.C.2

Points in Receiver Design

SMALL variations in the design of a modern radio set can often be made by the experimenter and very easily by the amateur designer when the set is in the early stages of construction.

The R.C.A. Manufacturing Co. of New Jersey have collated some data on various features and problems which often confront set designers, and some of these points are dealt with in this article.

The A.V.C. Circuit

(a) When separate diodes are used in A.V.C. and second-detector circuits, it may be desirable to feed the A.V.C. diode from the primary, rather than from the secondary, of the last I.F. transformer. With this connection, advantage is taken of the difference in selectivity between the input and output terminals of this transformer. The primary connection facilitates tuning and provides better quality when the receiver is detuned slightly. The voltage-frequency curve taken across the primary of the usual I.F. transformer is broader than that taken across the secondary. Thus, when the A.V.C. diode is fed from the primary, the A.V.C. voltage does not fall rapidly as the receiver is detuned slightly. Because of this characteristic, the high audio frequencies are not over-emphasised for slight detuning.

(b) In many radio receivers, the distortion present in the output at low signal levels increases rapidly with the degree of modulation of a signal. The results of a number of tests show that most of this distortion originates in the second-detector circuit, and that it can be minimised by changing some of the circuit constants. In order that a diode will rectify a high-percentage modulated signal with little distortion, the A.C. and D.C. diode load impedances should be nearly equal. Practically, this condition can be fulfilled by making the value of the first A.V.C. filter resistor high in comparison to the resistance of the D.C. diode load. This practice should supplement the now-established procedure of using an L.F. grid resistor which has a value high in comparison to the resistance of that portion of the D.C. diode load across which the A.F. grid resistor effectively connects.

Multi-purpose Valves

(c) A receiver which uses a multi-purpose valve as diode second-detector and first L.F. amplifier may have some L.F. output when the volume control is set in the zero-output position. It has been found that this output is often due to a small amount of capacitive coupling between the diode plates and the output-plate of the valve; when the signal is

These facts about receiver design should be of particular interest to advanced set constructors. The data on the Magic Eye is of particular value.

strong enough, rectification takes place in the grid circuit of the following valve. To reduce this zero-setting output, a capacitance of about 200 $\mu\mu\text{f}$. should be connected from the output-plate of the multi-purpose valve to ground. The effect of this condenser is to decrease the R.F. impedance of the output-plate circuit to a small value.

(d) The output of a receiver which uses a multi-purpose valve as diode second-detector and first A.F. amplifier may be severely distorted at some definite low setting of the volume control. This distortion is probably due to a



No experimenter should be without accurate test equipment. This Universal Avometer tests voltage, capacity and resistance etc. with great accuracy.

small amount of capacitive coupling between the diode plates and the control grid of the valve. When the signal is strong enough, rectification takes place; the resulting A.F. output is out of phase with the output due to rectification in the diode circuit. The per cent. distortion is, therefore, increased. Since the impedance in the grid circuit determines to some extent the R.F. voltage developed across grid and cathode, and since the output is most distorted when the two A.F. voltages are equal in magnitude, the distortion is maximum at a certain low setting of the volume control. The remedy is to reduce the impedance of the grid circuit to radio-frequency voltages by connecting a capacitance of about 200 $\mu\mu\text{f}$. from grid to earth.

(e) The cause of dead spots in the tuning range of many receivers has been

traced to absorption of energy from the active tuned circuit by an adjacent unused circuit. This condition is prevalent in three-band receivers that have three R.F. coils inside a single shield-can. Usually two of the unused coils are connected in series and short circuited. The larger of the two unused coils acts as an R.F. choke in parallel with the small coil; the small coil is then free to absorb energy from the tuned circuit in use. The remedy in this case is to short-circuit the unused coils individually.

Rectifier Valve Shields

(f) Shields for glass rectifier valves usually have a number of holes to provide ventilation for the valve. Increase in the size or number of holes decreases the operating temperature of the valve, but at the same time reduces the shielding action. We have found that black paint on the inside and outside of the shield increases heat radiation to such an extent that fewer holes are necessary to provide bulb cooling.

The 6E5 Magic Eye

(g) When the 6E5 is used as a tuning indicator, its grid is connected to the A.F. diode through an A.F. filter which consists of a series resistor and a shunt condenser. The time constant of this filter is important in determining the rate at which the target shadow increases or decreases. If the time constant is small and the dial is turned rapidly through resonance, the fluorescent area overshoots the value corresponding to slow tuning; if the time constant is too large and the dial is turned rapidly through resonance, the change in area will be less than that corresponding to slow tuning. In either case, it may be difficult to tune to resonance. In general, the time constant of this circuit should be about the same as that of the A.V.C. system, so that the voltage applied to the grid of the 6E5 follows the A.V.C. voltage.

A Multi-purpose All-stage Valve

Experimenters will find the Hivac all-stage valve of particular interest. It was originally created by thermionic expert Harries, and enables constructors to build complicated multi-valve receivers with only one valve type. A demonstration of a receiver on these lines was surprisingly effective for the performance was good and the noise level considerably lower than the average set having a similar number of stages.

Keep your pictures steady



H.T.16 for H.T. supply to vision and sound receivers and time bases



W.X.6
Westector



H. and J. Type rectifiers for H.T. Supply to cathode ray tubes

Steady bright pictures necessitate a constant unfailing H.T. Supply. The only way to ensure this is by the use of Westinghouse Metal Rectifiers for sound and vision receivers, time base and the tube itself. Full details are given in "The All Metal Way, 1938." Send 3d. to Dept. T for your copy.



METAL RECTIFIERS

Westinghouse Brake & Signal Co. Ltd., 82, York Way, King's Cross, London, N.1.

Selected and Specified for the

DUAL PURPOSE COMMUNICATION RECEIVER



Three Resistances—one price: 120, 2,000 and 4,000 ohms.

15/-



SUPER SENSITIVE TELEPHONES

No wonder the designer of this Dual Purpose Communication Receiver featured in this issue chose Ericsson Telephones as indispensable. They are simply perfect for the 100 per cent. functioning of this set.

Wonderfully sensitive, comfortable in wear and very pure in tone, they have come to be regarded as standard for the keen short-wave enthusiast's equipment.

Use them with your Dual Purpose Communication Receiver.

At all good radio dealers. If you have any difficulty in procuring, write direct to:

ERICSSON TELEPHONES, LTD., 22, Lincoln's Inn Fields, London, W.C.2

Telephones : 6396 HOLborn

The Short-wave Radio World

ONE of the most interesting developments we have noticed in some of the new American receivers is an image rejection circuit that completely eliminates all traces of a second-channel interference. The new Hallicrafter receiver, designed by Karl Milles and J. L. A. McLaughlin, embodies such principles, and in a recent paper they have fully described the arrangement used.

The fundamental circuit is shown in Fig. 1 where there is a primary coil L_1 coupled to L_3 by the mutual coupling M , and the capacity C_3 . In addition

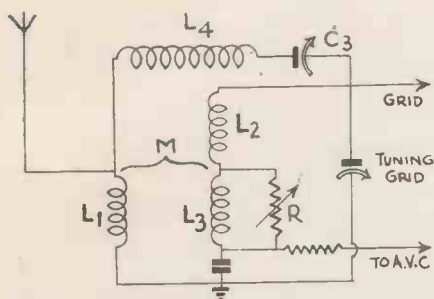

Fig. 1. The fundamental image rejection circuit.

A Review of the Most Important Features of the World's Short-wave Developments

tion L_2 and L_3 together form the signal frequency tuning coil, while L_1 and L_4 make up the image-rejection circuit. The coupling between the aerial input and the grid circuit is the product of M and C_3 . The signal-frequency circuit behaves in very much the same manner as a straight inductively coupled stage with a small capacity coupling at the high-potential side. For the image frequency the voltage through C_3 equals the voltage induced in the mutual coupling M and being of opposite phase cancels out.

To make the null infinite the power-factor correction R is required, for with proper power factor correction no coupling exists at the image frequency. In practice owing to stray coupling or through direct pick-up in a section of the circuit beyond the rejector stage some image signal may leak through, but with careful design the signal-to-image ratio can be made better than 100,000 at frequencies as high as 36 mc. According to the designers experi-

mental work has been carried out on single stage application and on two standard receivers. In one instance in which the rejector circuit was inserted in the mixer circuit of a receiver having no R.F. stage, image ratios of over 2,000 were achieved at frequencies as high as 16 mc. Stray coupling by bypassing the rejector circuit prevented more efficient rejection.

These figures give some idea as to the effectiveness of the rejector circuit, because an image ratio of 2,000 at 16 mc. is higher than can be obtained in quite a good receiver embodying two or even three stages of pre-selection in front of the mixer.

The following practical data is also given so that amateurs can make the most of this unique Hallicrafter innovation. To make the rejector circuit work effectively pick out a band where there are known images such as around 13 mc. Tune over this band until an image of some 14 mc. amateur phone is picked up, then peak up the circuits by means of C_2 and C_4 . Slowly turn the rejector condenser C_3 until a spot is found where the phone drops out or is greatly attenuated. Finally, adjust the resistance R_2 for maximum attenuation. Between 14 and 30 mc. the rejector

HALLICRAFTER'S NEW MODELS



NEW CHALLENGER, SX18

Latest American release, possessing many new features, including guaranteed "Infinite Image Rejection," 1,000 degree band spread, "S" meter terminals. Wave range 7.9 to 545 metres, crystal gate, universal A.C. input voltage. Price complete, £25.

Six other Hallicrafter models cover every demand. These include the new SKY BUDDY at £9, the new CHAMPION at £12 10s, and the Super Skyrider, £32.

WEBBS CARRY EVERY WORTH-WHILE COMMUNICATION TYPE RECEIVER IN STOCK.

WRITE FOR LIST T.R.

WEBBS RADIO

(C. WEBB, LTD.)
14, SOHO STREET, OXFORD STREET, LONDON, W.1.
Telephone: Gerrard 2089
Midland Depot:—41, Carrs Lane Birmingham.
All Post Orders to London.

STABILOVOLT
THE SOLUTION TO UNSTABLE SUPPLY VOLTAGE

The Stabilovolt tube is a voltage dividing potentiometer and voltage regulator. The voltages tapped are independent to a precision of about .1% from the supply voltage variations, 1-2% from the varying current intensities, .01% from one another. Currents up to 200 mA, voltages of unlimited values subdivided into parts of 70 volts each. Light weight, small size, simple and safe in operation. Stabilovolt tubes from £1.16.0. to £62.10s. to £1.7.6. Full particulars from:—

MARCONI'S
WIRELESS TELEGRAPH CO. LTD.
Electra House, Victoria
Embarkment, London, W.C.2.

S.3b

STANDARD BOOKS ON TELEVISION

TELEVISION : THEORY AND PRACTICE

By J. H. REYNER, B.Sc. (Hons.), A.M.I.E.E., M.Inst. R.E.

"The issue of the second edition of this well-informed text indicates that it is meeting a growing demand for accurate particulars of modern television practice. Needless to say, the author has brought the information up-to-date with respect to the latest technique, which seems to have become stable, at least for a few years."—*The Electrician*.
Second Edition, Revised and enlarged. Demy 8vo., 235 pages, 126 illustrations, including 24 half-tone plates. 12s. 6d. net.

TELEVISION RECEPTION

Construction and Operation of a Cathode-Ray Tube Receiver for the Reception of Ultra Short-Wave Television Broadcasting

By MANFRED Von ARDENNE
Translated by O.S. PUCKLE, A.M.I.E.E.,
Research Department A.C. Cossor, Ltd.

"This book supplies a real need, particularly as it has been adapted to English requirements to a very large extent."—*Television and Short-Wave World*.
Demy 8vo., 140 pages, 96 illustrations, including 44 half-tone plates. 10s. 6d. net.

TELEVISION CYCLOPAEDIA

By ALFRED T. WITTS, A.M.I.E.E.

"The author wisely does not confine himself merely to definitions, and except in the simplest cases they are amplified by some description of the mode of operation of the circuit or apparatus."—*The Wireless World*.
Demy 8vo., 151 pages, 97 illustrations, 7s. 6d. net.

THE LOW VOLTAGE CATHODE-RAY TUBE AND ITS APPLICATIONS

By G. PARR.

"Can be confidently recommended to all users of cathode-ray tubes and we hope that it will meet the response that it deserves."—*Television and Short-Wave World*.
Demy 8vo., 187 pages, 76 plates and figures. 10s. 6d. net.

A List of Standard Books on Wireless and Television, may be had post free, on application

CHAPMAN & HALL LTD.
11, HENRIETTA STREET, LONDON, W.C.2

COMMUNICATION RECEIVERS



THE HALLCRAFTER'S SUPER SKYRIDER SX16 illustrated above, is Hallcrafters' finest receiver to date and incorporates many features not found in other sets. Chief among these may be mentioned the extended wave range from 550 to 5 meters, expander control giving variable selectivity, 1,000 degrees of band-spread, signal meter, and large undistorted output (13 watts). Crystal model £32

THE HALLCRAFTER'S SKY CHALLENGER II, SX18, similar in appearance to the Super Skyrider is fitted with an amazing image rejector control, with which it is possible to tune out annoying second channel signal on the higher frequencies. Other features that will make this a favourite are the spiral band-spread, crystal filter and signal meter terminals. Crystal model £25.

Write, call or phone for full descriptions of these and all our other receivers to

A.C.S. RADIO, Technical Manager G2NK

52-4 Widmore Road, Bromley, Kent
Ravensbourne 0156-7

Cheap Day Return to Bromley North, 1/6. (20 minutes from Town)
Open until 8 p.m. (except Weds., 1 p.m.)

TELCON CABLES

for

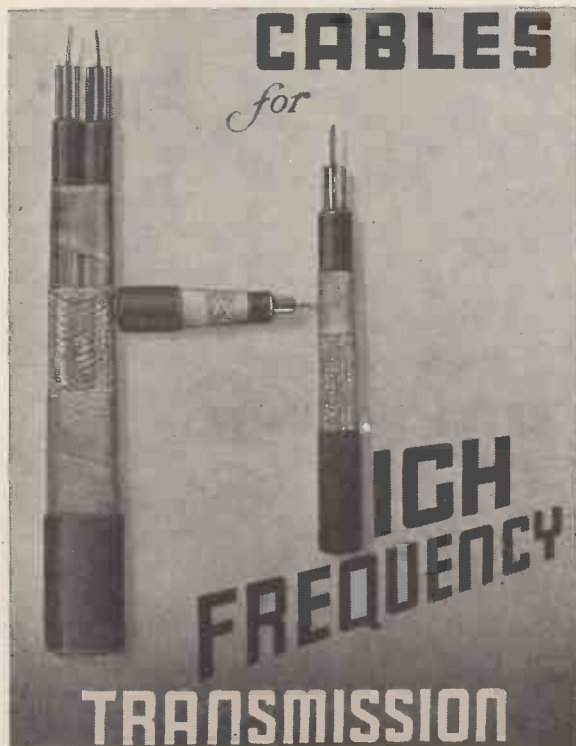

Full particulars of all TELCON PRODUCTS from:
THE TELEGRAPH CONSTRUCTION & MAINTENANCE CO., LTD.
Head Office: 22, OLD BROAD STREET, E.C.2.
Telephone: LONDON Wall 3141.
Works: Greenwich, S.E.10. Telephone: GREenwich 1040.

**A Career in Television—
Your Big Chance**

Already there is a shortage of men with sound knowledge of television. Its popularity has emphasised this shortage, but provides a golden opportunity for ambitious men. Television as a career offers good pay, interesting work, and the advantage of getting early into a rapidly expanding industry.

Here is your opportunity. Grasp it. Men with trained practical knowledge are wanted urgently by manufacturers and for servicing.

The International Correspondence Schools **TELEVISION COURSE** (including Sound Picture Recording and Projection) enables students to gain comprehensive knowledge of the subject in the shortest possible time. It is fully described in a forty-page illustrated prospectus. Details are also given of Radio Engineering, Complete Radio, Radio Service & Sales, Radio Servicemen's and I.E.E., I.W.T., C. & G., and P.M.G. Certificate Examination Courses. This prospectus will gladly be sent free and without obligation. Write for a copy now.

International Correspondence Schools Ltd.
Dept. 62, International Buildings, Kingsway, London, W.C.2.



Founded 47 years ago—860,000 British students—400 Courses of Instruction for every industry, trade, and profession—1,000 text books specially written by I.C.S. for postal tuition—80 Specialist Instructors—branches in all parts of the world—officially recognised by Government Departments at home and overseas.

RADIOMART

THE SHORT-WAVE SPECIALISTS

We are Sole Distributors for
**BLILEY, THORDARSON, TAYLOR TUBES,
RME, BASSETT CONCENTRIC CABLE, HOYT
METERS, &c.** We are also Authorised Distributors
for **NATIONAL**. Send us your enquiries
Large stocks carried.

G5NI's 66 PAGE MANUAL

the greatest value and most
comprehensive manual ever
published in this country.

Post Free for 7½d.

The Contents include —

- COMPLETE RECEIVING AND TRANSMITTING TUBE CHART OF CHARACTERISTICS.
- 16 TRANSMITTER CIRCUITS FROM SINGLE VALVE CW TO HIGH POWER PHONE.
- CLASS B MODULATORS FROM 8-WATTS TO 250-WATTS (INCLUDING 6L6).
- TRANSMITTING ANTENNAE, INCLUDING DATA FOR JOHNSON Q, BASSETT, DOUBLET, MATCHED IMPEDANCE AND SINGLE WIRE FED.
- CATHODE RAY OSCILLOGRAPH CIRCUITS AND INSTRUCTIONS, HIGH FREQUENCY CONVERTERS (INCLUDING 10-METRES), PRE-SELECTORS 5-METRE TRANSCIEVERS AND TRANSMITTERS.
- METRE/KC CONVERSION CHARTS, AMATEUR PREFIXES, LIST OF SHORT-WAVE BROADCAST STATIONS, Q CODE AND REPORTING SYSTEMS.
- INFORMATION ON MICROPHONES, NEUTRALISATION, CHECKING FOR PARASITICS AND FEED-BACK.
- DOZENS OF HINTS AND TIPS.
- THE GREATEST VALUE AND MOST COMPREHENSIVE MANUAL EVER PUBLISHED IN THIS COUNTRY.

OUR NEW CATALOGUE shows dozens of New Short-Wave Components and is yours for 1½d. post free.

Raymart Coil Forms
Specified in this issue
Type CT4 (4-pin threaded) 1/8 ea.

RADIOMART

G5NI (Birmingham) Ltd.

44, HOLLOWAY HEAD, BIRMINGHAM, 1
Telephone: Mid. 3254.



16 PAGE CATALOGUE

1½d.
2
POST
FREE

NOW READY. The Fifth Edition of our Catalogue. Useful Information on Q.C.C. Piezo Quartz Crystals and a wide range of Short-wave Transmitting Apparatus. Numerous NATIONAL products are included and illustrated.

Write Dept. "T.S." for a copy now.

THE QUARTZ CRYSTAL CO., LTD.
63 & 71, Kingston Road, New Malden, Surrey
Telephone: MALDEN 0334.

Service for the Modern Receiver

With the modern multi-valve receivers it is not advisable for the listener to try and carry out his own service work even though he may have some knowledge of radio technique.

The biggest problem is finding a reliable service agent who will carry out the work for the correct cost. We have found Messrs. G. Scott-Sessions & Co. particularly good and quick so should any reader be in trouble with a receiver or need a kit built up, we suggest writing to this company for a quotation.

capacity, C_3 , ranges from a fraction of a mmfd. to a few mmfd. Resistor R is variable between 250 and 1,500 ohms. On higher frequencies a lower value of resistance will be required. The following values, however, will serve as a good indication for intending constructors, who wish to embody this circuit in a pre-selector. C_3 for 7 and 14 mc., 15-mfd., and for 28 mc. 10-mmf. L_1 for 7 and 14 mc., 4½ turns of No. 34 d.s.c. ¾ in. in diameter. 28 mc. 2½ turns No. 34 d.s.c. and the same diameter. L_2 is 10½ turns of No. 22 d.s.c. of the same diameter and is suitable for 7 and 14 mc. On 28 mc. use No. 20 d.s.c. and two complete turns. L_3 is made up of 3 turns of No. 22 d.s.c., diameter ¾ in. and is suitable for both 7 and 14 mc. On 28 mc. use

R_5 100 ohms.

$R_6, 7$ 20,000 ohms.

Very full data on this pre-selector can be found in the March issue of the American publication *Q.S.T.*

An Eye Opener

It is possible to increase the shadow angle sensitivity of the Magic Eye tuning indicator by increasing the maximum shadow angle from the usual value of 90 degrees to almost 180 degrees. This improvement is obtained by using a separate triode in a new circuit introduced by R.C.A. to control the action of the ray-control electrode in the tuning indicator valve.

The circuit for obtaining wide-angle tuning is shown in Fig. 3. When a

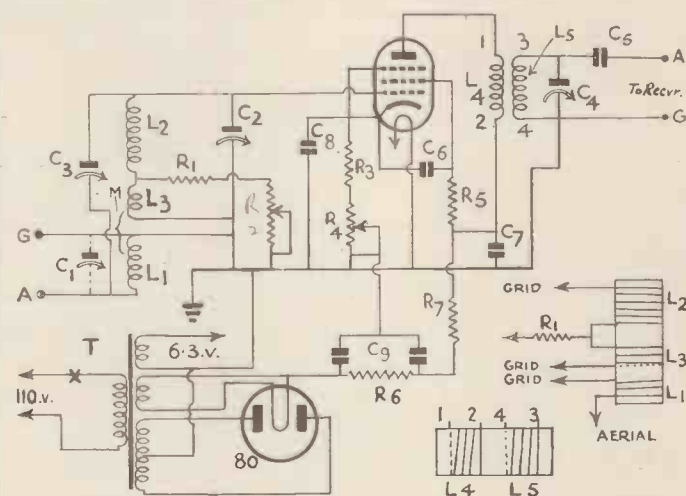

Fig. 2. An efficient pre-selector embodying infinite rejection. Component values are given in the text.

two turns of No. 20 d.s.c., with a diameter ¾ in. Finally, L_4 requires 15 turns of 34 d.s.c. for both 7 and 14 mc. with a diameter of ¾ in. and 8 turns of the same wire and diameter for 28 mc. The resistance R should have a total value of 2,000 ohms.

Still further to aid the constructor we have shown in Fig. 2 the recommended circuit for a pre-selector embodying the Hallicrafter image rejector together with the actual constructional data of the 5 inductances. The values are as follows:—

- L_1 10 turns No. 34.
- L_2 5 turns No. 20.
- L_3 3 turns No. 20.
- L_4 15 turns No. 36.
- L_5 5 turns No. 20.
- C_1 .0001-mfd.
- C_2 .0001-mfd.
- C_3 .00002-mfd.
- C_4 .00015-mfd.
- C_5 .0002-mfd.
- $C_6, 7, 8$.05-mfd.
- C_9 double 8-mfd.
- R_1 600 ohms.
- R_2 100 ohms variable.
- R_3 500 ohms.
- R_4 10,000 ohms.

high negative bias is applied to T the anode current of T is nearly zero and the voltage drop across T is also down to zero. Under these conditions the shadow angle is zero.

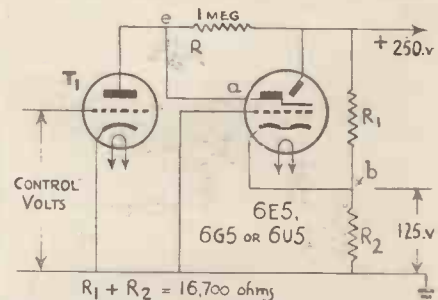

Fig. 4. The magic eye-tuner is a very useful component but its usefulness is increased when the shadow can be increased 180 degrees. How this is done is mentioned in the text.

When the grid of T is at zero potential the anode current of T is high and the potential of point (a) is nearly minus 125 volts with respect to the cathode of the 6E5. The shadow angle under these conditions is approximately 180 degrees.

Controlled Carrier Modulation

It is hoped that this description of simple controlled carrier modulation by the UNITED TRANSFORMER CORP. of New York will interest phone users on the crowded amateur bands. The controlled carrier system helps to reduce interference between stations and lowers transmitter running costs.

CONTROLLED carrier modulation is to the R.F. end of a modern transmitter what class-B is to the audio end. In addition to the advantages of increased power efficiency, ex-

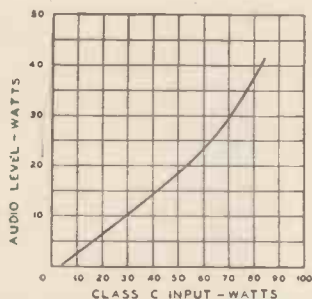

Fig. 1. Class C input vs. audio level in a controlled carrier transmitter.

tended valve life and the use of smaller valves for high power output, controlled carrier modulation reduces interference between stations and increases effective working range of transmission.

The data and explanations which follow will readily substantiate these facts to those who are interested in the theoretical side of transmitter design.

Controlled carrier modulation can be defined as a method of modulation in which the average carrier output varies with the audio level, instead of remaining constant as in conventional modulation systems. Fig. 1 illustrates the relation of R.F. power to A.F. power in a typical transmitter using the first really practical system of controlled carrier modulation. The advantages of this controlled carrier modulation and the effects which produce these advantages can be enumerated in the following way.

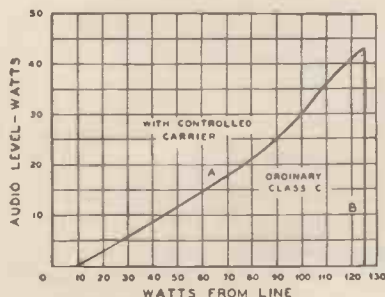

Fig. 2. Comparison between ordinary class C and controlled carrier class C as referred to the variation of power consumption from the mains vs. audio power.

Reduction in Power Consumption and Operating Costs

Fig. 2 illustrates the relationship of power measured at the primary of the anode transformer for the final as compared to different audio levels. Every amateur who has watched the wiggling of the anode current meter in a class-B amplifier, or by means of an oscillograph used to check percentage modulation, realises that speech and music are not of continuous level, but consist of a series of valleys and peaks representing different audio levels. Tests have indicated that if these valleys and peaks are integrated over a period of time, the average audio output is less than 20 per cent. of the amplifier peak power handling ability. This is particularly true of the amateur phone sta-

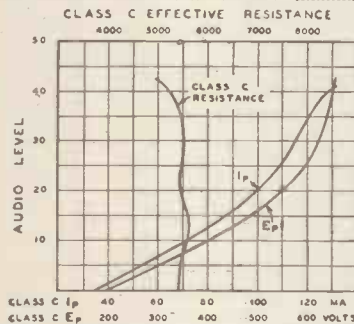

Fig. 3. Relation of class C operating characteristics to modulator level in controlled carrier transmitter.

tion, because silent periods of short duration are extremely frequent. An approximate check taken on three stations indicated that the effective audio power was less than 10 per cent. of maximum for 90 per cent. of the time.

Using this approximate check, the audio power taken 90 per cent. of the time on the transmitter described above would be below 4½ watts. In an ordinary transmitter using 801's for the final, curve B, Fig. 2 would indicate that a constant power of 125 watts would be taken from the line by the final anode transformer. Considering this with respect to curve A, Fig. 2, this means that for 90 per cent. of the time the power taken from the line will be reduced to less than 24 watts. Furthermore, for a very considerable portion of the time the power taken from the line by the final anodes will be only 10 watts. This saving in power is tremendous. If duplex operation is used,

RADIO CLEARANCE

63, High Holborn, W.C.1

'Phone: Holborn 4631

LARGEST COMPREHENSIVE STOCK OF COMPONENTS IN GT. BRITAIN

Huge Purchase P.M.M.C. Speakers, by well-known manufacturer, 7½" cone, latest type magnet, fitted Universal Transformer, with terminals. Suitable for P.P., Class B, Power or Pentode, 9/11 each.

VOLUME CONTROLS. Special offer.

1 Meg. with Switch, 1/6.
500,000, less Switch, 1/3.
100,000 Miniature type, less Switch, 1/-.
5,000 with Switch, 2/-.

CENTRALAB VOLUME CONTROLS, Long Spindle, fitted with Switch, Brand New. 1,000 5,000: 10,000: 25,000: 50,000: 250,000: 500,000: 2/6.

Limited quantity Centralab 5,000, with Switch, 1/- each.

RESISTANCES. Special offer.

1 gross assorted ½, ¼ and 1 watt Polar N.S.F. Resistances, all good sizes, 4/- gross. Our selection.
1 Watt Resistances, well-known make, all sizes, 3½d. each, 2/9 dozen.
2 Watt Polar N.S.F. Resistances, following sizes: 100: 160: 400: 600: 2,500: 3,000: 5,000: 40,000: 50,000: 100,000: 120,000: ohms, and 1 meg., 6d. each.

VARIABLE CONDENSERS.

Plessey 3-gang Midget Condenser, three .0005 sections, straight unscreened, trimmers, 2/6 each.

Plessey 2-gang two .0005 sections, straight, fully screened, top trimmers, 2/6.

Plessey 3-gang Geared, three .0005 sections, unscreened, straight, 2/11.

FIXED CONDENSERS.

Electrolytic Can Type, well-known manufacturer.

8 Mfd., 450 volt working, 2/6.

4 Mfd., 450 volt working, 2/6.

8 Mfd., 500 volt working, 3/-.

Cardboard Type. 450 v. working.

8 plus 8 Mfd., 450 volt working, 3/-.

4 plus 4 Mfd., 2/9.

6 plus 4 Mfd., 2/9.

8 plus 4 Mfd., 2/11.

SPECIAL OFFER. PHILLIPS Wet, Can type, Electrolytics.

8 Mfd., 450 volt working, 1/6.

16 plus 8 Mfd., 450 v., 2/-.

16 Mfd., 320 v., 1/6.

25 Mfd., 320 volt working, 1/6.

50 Mfd., 32 volt working, 1/6.

Special offer Cardboard Electrolytic 10 Mfd., 250 volt working, 8d.

SPECIAL OFFER, Polar N.S.F. Electrolytics, Can type

8 Mfd., 400 volt, 1/6.

8 Mfd., 250 volt, 1/3.

8 Mfd., 150 volt, 1/3.

Cardboard type, 8 Mfd., plus 8 Mfd., 380 volt, 2/-.

1 Mfd. plus 4 Mfd. plus 12 Mfd. plus 12 Mfd., 380

volt, 2/-.

25 Mfd., 50 volt, 9d.

TUBULAR CONDENSERS, well-known manufacturer,

all sizes up to 0.1, 4½d. each, 4/- dozen.

Special offer. 1 dozen Assorted Polar N.S.F. Tubular

Condensers, all good sizes, 1/6 dozen. Our selection

Muirhead 1 Mfd. Tubular Condensers, 350 volt working

10d.

0.1 ditto, 3d. each, 2/9 dozen.

BRYCE MAINS TRANSFORMERS, standard for the

season. These Transformers are British made, and are

fully guaranteed for 6 months.

350-0-350, 150 m.a., 2-0-2 volts 2.5 amp., 2-0-2 volts 5 amp.,

2-0-2 volts, 2 amp., 11/6 each.

500-0-500, 150 m.a., 2-0-2 volts 2.5 amp., 2-0-2 volts

5 amp., 2-0-2 volts 2 amp., 2-0-2 volts 2 amp., 17/6.

All Windings centre tapped.

Special offer Transformers, ex Aerodyne, 300-0-300, 100

m.a., 4-volt 2 amp., 4 volt 4 amp. 5/-.

BRYCE MAINS CHOKES.

30 Hys., 40 m.a. 500 ohms, 4/6.

40 Hys., 60 m.a. 500 ohms, 6/-.

40 Hys., 150 m.a. 400 ohms, 10/6.

80 Hys., 60 m.a., 2,500 ohms for speaker replacement,

etc., 6/6 each.

SPECIAL OFFER.

QUARTZ PIEZO CRYSTALS, 125 k.c.

A unique opportunity at a fraction of the original price.

Ideal for Wave Meters, Standard Frequency Test or

could be re-ground for other frequencies. Unrepeatable

price, 4/6 each.

QUARTZ PIEZO CRYSTALS and 125 k.c. I.F.

TRANSFORMER as a complete Unit, fully screened

Ideal combination for Single Signal Superhet or

Crystal Gate Receivers, 7/11 complete, 14/- per pair

HUGE PURCHASE—RELAYS, made by well-known

manufacturer, Resistance 3,300 ohms, cost 25/- each

our price, 5/- each.

ALL ORDERS 5/- AND OVER POST
FREE. UNDER 5/- POSTAGE EXTRA
Enquiries 1½d. stamp

the operating cost is reduced still further, as negligible anode power is taken by the final during receiving periods.

Increase in Valve Life

Referring again to Fig. 1, it is seen that at low-audio levels the class-C input is very low. This is shown still more clearly in Fig. 3. It is seen from this latter curve that at zero audio input the class-C anode current is only 36 milliamperes total, and the corresponding anode voltage 195 volts. The increased valve life at this low anode power is obvious. Using the previous approximation of 10 per cent. audio

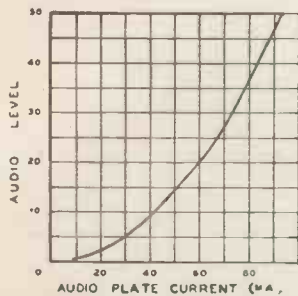

Fig. 4. Relation of anode current to watts in a typical class B amplifier.

level for 90 per cent. of the time, the class-C input to this pair of 801's is found to be less than 15 per cent. its maximum value for most of the time. The resultant reduction in anode dissipation should increase the valve life many times over.

Use of Smaller Valves for High Output

Most amateurs are familiar with the theory of class-B amplification and realise why class-B audio amplification made possible greater power from audio valves. This is easily seen on the curve for anode current vs. power output of a class-B system as in Fig. 4. Because the anode current swings through a wide range, the average effective anode

current is much less than that at maximum output. An examination of Fig. 3 will show a striking similarity between the class-C anode current vs. audio level and the class-B anode current vs. audio level of Fig. 4. The effect of the curves is almost identical and consequently it is found that the available power output from a given pair of valves used with controlled carrier modulation can be increased greatly over the output available from the same valves in a normal class-C amplifier. Tests conducted so far seem to indicate that an increase of almost 100 per cent. can be obtained.

Reduction of QRM

Because the carrier magnitude is reduced for the greater part of the time, interference between stations is greatly reduced. To the amateur this is of importance, using controlled carrier modulation the best note between stations is reduced for a major part of the time.

Increased Working Range

One of the first fundamentals in phone transmission is the formula which states that the carrier power required for a given field coverage varies inversely as the square of the modulation percentage. Assuming for ordinary speech a percentage modulation of 10 per cent. for 90 per cent. of the time, we find the following peculiar fact; since

$$\text{Power A} \quad \% B^2$$

$$\text{Power B} \quad \% A^2$$

and assuming 50 per cent. for "A" (controlled carrier) and 1.58 per cent. for "B" (regular class-C): (See Fig. 8):

$$\frac{\text{Power A} \quad .25}{\text{Power B} \quad .00025} = 1,000$$

This means that at 10 per cent. audio level the same coverage (distance) could be obtained from a 10 watt transmitter using controlled carrier as from

a very much larger transmitter using normal class-C. This does not apply to the maximum audio level; at which well-designed transmitters of both types should give 100 per cent. modulation. However, as previously stated, the average audio power is far below the maximum audio power. In this respect it might be remembered that broadcast stations have found that the minimum audio power range for good fidelity must be at least 30 Db. This represents a minimum audio power equal to .1 per cent. maximum audio power which is a much greater change in percentage modulation in the ordinary transmitter than in any of the examples referred to above.

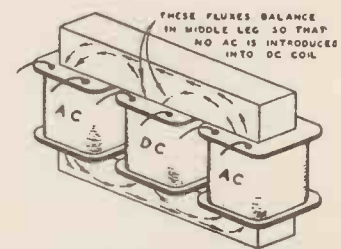

Fig. 5. This is a typical saturable reactor.

Increased Fidelity

Broadcast stations have found it necessary to increase the range of audio levels they transmit very appreciably to take care of modern high fidelity requirements. Massa, of R.C.A., claims that a range of 70 Db in audio level is required for real high fidelity. One of the greatest stumbling blocks in the progress of broadcasting in this respect has been the fact that due to the decrease in modulation percentage, the corresponding effective coverage is reduced in accordance with a square law. However, using controlled carrier modulation, the major part of this effect can be eliminated and a much greater range in audio level can be obtained with the same maximum power output and the same coverage. Another

LOUDSPEAKER 24-HOUR SERVICE

(BRITISH AND AMERICAN)

TRANSFORMERS DESIGNED AND REPAIRED.

NEW SPEAKERS 3" to 18" P.M. and MAINS ENERGISED.

SPEAKERS OF ALL KINDS FROM 10/6.

SINCLAIR SPEAKERS

ALMA GROVE, COPENHAGEN STREET, LONDON, N.I. TER 4355

TELEVISION.

A NEW COURSE OF INSTRUCTION,

We have pleasure in announcing that our new "Television" Course has met with remarkable success. The enormous demand for the Course has shown, beyond any shadow of doubt, that it fills that long-felt need which we anticipated when we went to such trouble and expense in its preparation.

We shall be happy to send full details of this special "Television" Course on request. Particulars are also available of other Courses in all branches of Wireless, Television, Talking Picture Engineering, etc., and of the easiest way in which to prepare for the A.M.I.E.E., A.M.I.W.T., A.M.I.R.E., etc., Examinations.

We teach by correspondence, and guarantee "NO PASS—NO FEE." Our Technical Consultant is Professor A. M. Low.

Send for full particulars to-day. Free and without obligation.

THE BRITISH INSTITUTE OF ENGINEERING TECHNOLOGY
337, SHAKESPEARE HOUSE, 17/19, STRATFORD PLACE, LONDON, W.1.

APRIL, 1938

important factor in fidelity is the tendency prevalent among broadcast stations and amateurs to over-modulate. If controlled carrier modulation is used, when the audio level rises to the point of normal over-modulation, the class-C input is automatically increased sufficiently to minimise the effect.

Circuit Details

The basis for control in variator controlled carrier modulation is the fact that as shown in Fig. 4 the anode current in a class-B audio amplifier varies practically linearly with the power output. The anode current is used to saturate a control reactor which in turn controls the anode supply of the class-C final. If a class-A modulator is used, other means of obtaining this control current are possible.

Fig. 5 illustrates the general nature of a saturable reactor. A shell type laminated core of somewhat different proportions than that in an ordinary transformer is used for the magnetic circuit. Three coils are placed on the respective legs of this core, the outer

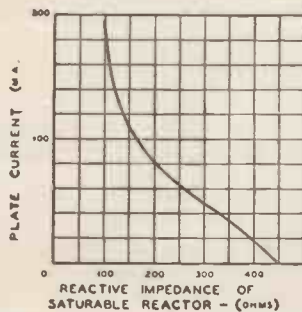

Fig. 6. This curve shows the change in reactance of the AC coils in a saturable reactor as the DC is increased.

two being connected in series with the AC line and so related in polarity that their respective magnetic fluxes are in accordance with the arrows shown. It is seen that the MMF's of the two AC magnetic circuits are opposite in direction in the middle leg and tend to neutralise each other. If the coils and magnetic circuit are perfectly balanced, these fluxes will be perfectly balanced and no AC flux will traverse the middle leg of the laminations. The control coil is placed on this middle leg and the anode current of the class-B modulator is passed through it.

All radio men are familiar with the fact that as the DC current is increased in a filter choke, its inductance decreases. Exactly the same effect is produced here, except that by proper design a fairly linear relation and a wide range in inductance can be obtained. Fig. 6 illustrates this relation of saturating DC to AC impedance in the experimental reactor used in the trans-

GALPINS ELECTRICAL STORES

75, LEE HIGH ROAD, LEWISHAM, LONDON, S.E.13

Telephone: LEE GREEN 5240.

Terms: CASH WITH ORDER OR C.O.D

EX-G.P.O. PEDESTAL TYPE TELEPHONE, with Automatic Dials.—Reading 0 to 9, 8/6. Wall type ditto, 10/6 each. Microphone Transformers, ratio 80 to 1, 2/-. Bell Boxes, consisting of A.C. Bell, Mike Transformer, 2 mf. Condenser, 4/- each. G.P.O. Automatic Dials, 0 to 9, 3/6 each. Hand Sets, Earphone and Microphone combined, 4/6 each. Weston Electric Highly Sensitive Microphones, 2/6 each.

SLIDER MAINS RESISTANCES, 2,500 ohms, carry 300 m/amps, worm wheel type, 17/6; 1,000 ohms 1/2 amp., 12/6; 350 ohms 2 1/2 amps., 15/-, etc. Dimmer Resistances, 1 kilowatt, 20/-; 2 kilowatts, 30/-.

ROTARY CONVERTORS by well-known makers. D.C. to A.C. 220 volt D.C. to 200 volt A.C., 150 watts, 50/- Ditto, 220 volts D.C. to 200 volts A.C., 650 watts, 70/- Ditto, 100 D.C. to 80 volts A.C., 1 1/2 kilowatt, 80/- Transformer to suit, 20/- Ditto, 220 volts D.C. to 200 volts A.C. 400 watts, 70/- Ditto, 440 volts D.C. to 285 volts A.C., 2 kilowatts, £6. Ditto, 100 volts D.C. to 65 volts A.C., 1 1/2 kilowatts, 80/- Ditto, 230 volts D.C. to 150 volts A.C., 150 watts, 50/-.

WESTINGHOUSE RECTIFIERS (second-hand), in guaranteed working order. 500 volts, 250 milliamps, in voltage doubler circuit with transformer to suit, 35/- the pair; or Rectifier 22/6, Transformer 17/6.

AERODYNE 6-VALVE SUPERHET CHASSIS, in new condition. Less valve and dial with relay for remote control. Valves used in this chassis are 1W4/350. FC4, PEN4A, 2 ACVPI, 2D4, 25/- Carriage, 1/6. Goodman Mains Energised Moving Coil Speakers, with Pentode Transformer, 2,500 ohm field, in new condition, 6/9 each.

PHILIPS' MAINS TRANSFORMER, input 200/250 volts, 2,000/0/2,000 volts, 150 m/A., 1 1/2 volts 2 1/2 amps. and 4 volts 8 amps. output, 26/- C/F. 40 henry 250 m/A. Smoothing Choke, 12/6. C/F.

KOLSTER BRANDES MAINS TRANSFORMERS, input 200/250 volts, output 250/0/250 volts; also 4 volts 2 amps. and 4 volts 1 amp., 3/6 each. Philips 1 mf. 4,000-volt working Condensers, 7/6 each. Muirhead 2 mf. 375 volts working, 1/- each. Dублиer Block Condensers, 350 volt working, 10 mf. tapped, 4 x 4 x 2 mf., 3/- Ditto, 8 mf. tapped, 4 x 2 x 2 mf., 2/6.

MAINS TRANSFORMERS, 200,250 volt input. Low voltage at approx. 50/75 amps. output, 8/6, C/F. Transformers with unknown windings, 6/6 each; approx. 500 watts.

LARGE MAINS TRANSFORMERS, input 200/250 volts, output 4,000 volts, 1/2 amp. twice, 70/- Smoothing Choke, 12 henrys to suit, 30/-.

WESTON MOVING COIL MILLIAMP METERS, fully guaranteed. 2 in. and 2 1/2 in. dials, 0 to 3, 17/6; 0 to 5, 15/-; 0 to 25, 0 to 50, 14/-; 0 to 150, 0 to 200, 12/6 each. Everett Edgcombe, 0 to 500 m/A., 12/6 each. Moving Coil Meter Movements for recalibrating into multirange meters, approx. 10 m/A., 5/-. Ditto, 4 in. dial, 6/6. Post 9d. A few only, need slight repair, 2/6 each.

ELECTRIC LIGHT CHECK METERS, 200/250 volt 1 ph. 50 cycles, 5 and 10 amp., 5/- each. Post free. G.P.O. Glass Top Relays, approx. 1 m/A., 7/6. Smoothing Chokes, 30 henrys 150 m/A., 5/-. Visual Wavemeters, 1,000 to 9,000 metres, 5/-. Power Packs, consisting of 2 x 20 henrys 60 m/A. Chokes and 2-2 mf. Condensers at 3/6 each.

STEEL CABINETS for transmitting racks, etc. Size 40 in. by 24 in. by 17 in., 10/- each, C/F. X-Ray Spark Coils, 100 to 200 volts primary, 8 in., 27/6; 10 in., 35/6; 12 in., 45/6; 16 in., 60/6. Fluorescent Screens, 12 x 9, 30/6. Brand new X-Ray Tube, 7 in., 15/- C/F. Packing free. X-Ray Transformer, 100 volt input, 40,000 volt 12 m/A. output, in new condition, £5.

LARGE MAINS TRANSFORMERS FOR REWINDING, 1kW. 15/500 watt, 7/6, 250 watt, 5/-, 150 watt, 3/6, each.

MAINS TRANSFORMERS by well-known makers. Input 200/250 volt 50 cycle 1 phase, 6 and 30 volt out at 15-20 amp., 17/6. Another, 3-5-8 volt at 20-30 amp., 17/6. Another, 10 volt 5 amp., 10/6. Another with 3-4 volt 3 amp. tappings all C.T., 7/6.

TELEGRAPH MORSE INKERS with Sounder, in good condition, 30/-. Ex-R.A.F. 7-valve Receiver Amplifiers, wave-length not known, 7/6 c/p. Radiogoniometers by "Marconi," etc., 15/- "Sullivan," .0005 mfd. Transmitting Variable Condensers, 10/6. Cosor 2-volt general purpose Valves, 3 for 2/6, as new. 2 mfd. 250 volt working Condensers, 9d. each. Single Earphones, 1,000 ohms, 9d. Bobbins, 1,000 ohms, per pair 6d. Microphone Buttons, 9d. 1/2 mfd. 350 volt working Condensers, 9d. each. Volume Controls, 1,000, 25,000, 100,000 ohms, 1/- each. Bulgin Toggle Switches, s.p.c.o., 9d. Ex-Naval Short-Wave Aerial Insulators, 8 in. long, 1/- per pair. Resistance Mats wound with Eureka wire, 600 ohms, carry 1/2 amp., size 24 x 24 in., 4/- each.

MOTOR BLOWERS, fitted 1/2 h.p. 110 volt motor D.C. Series wound, ball-bearing, 4-in. inlet and outlet, 35/- c/f.

"VIBRO" MESSAGE MACHINE, fitted 1/2 h.p. motor 100/250 volt D.C., complete in carrying case, 30/-.

X-RAY BARGAIN for the Experimenter. A brand new 12-in. Coil, complete in teak case, with tube and meter holders, discharge rods, complete with 7-in. Tube Fluorescent Screen, Mercury motor-driven break, Moving Coil m/A. Meter, 2 reading, 0 to 5 and 25 m/A. The lot, all fully guaranteed, packing free, carriage forward, £6 10s. 0d.

DOUBLE OUTPUT GENERATOR shunt wound, ball-bearing, output 2,500 volts 160 m/A., also 16 volts at 14 amp. D.C. Can also be used as Rotary Converter, 20 to 24 volt input, full H.T. output, 70/- c/f.

EPOCH PUBLIC ADDRESS MOVING COIL SPEAKERS, Handle 20 watts 15 ohm and 1,000 ohm; Speech Coils, 15 in. cone, 6-volt Field, 45/-.

COPPER SCREENED BASE BOARDS, 17 1/2 x 7 in. undrilled, 2/6. 4-valve metal chassis, 18 x 6 1/2 x 3 1/2, drilled, 1/6.

STUD SWITCHARMS with studs, very smooth action 1/6. Quartz Tubes, 10 x 3/16 in., 5/- per doz.

ROTARY CONVERTERS, 12 volt D.C. input, 1,500 volt 150 m/A. output, 35/- Ditto, 750 volt, 100 m/A. output, 25/- A few only to clear, 6 to 12 volt input, 750 volt, 100 m/A. output. Need slight overhaul, 12/6 each.

SWITCHBOARD VOLT AND AMP. METERS, 4, 6, 8-in. dial, by well-known makers, 0 to 120 volts, 12/6. 0 to 250 volts, 17/6. 0 to 40 volts, 8/6. 0 to 10, 0, 50, 100, 150 amps., 12/6. All m/coil, hot wire for A.C., 0 to 120 volt, 12/6. 0 to 250 volts, 17/6. Ampermeters as above for A.C. or D.C., 12/6 each.

EX-R.A.F. WAVEMETERS, 200 to 550 metres, visual type, 3/- 300 to 2,500 metres, valve type, 7/6 each, with valves. Post free.

CHARGING DYNAMOS, all shunt wound, fully guaranteed, 15 volt 12 amp., 22/6. 12 volt 8 amp., 17/6. 25 volt 8 amp., 32/6. 50/75 volt 10 amp., 60/-, 100 volt 15 amp., 80/- Regulators to suit any of these Dynamos, 12/6 each.

C.A.V. AUTOMATIC CHARGING CUT-OUTS. Any voltage, amps. up to 10 amp. Please state voltage. 7/6 each. Post 6d.

EX-R.A.F. VISUAL WAVEMETER with valve 1,000 to 9,000 metres, 5/-. Ex-naval heterodyne detector unit 3-valve 15 to 200 metres, less valves, very useful to the experimenter, 25/- C/F. Enamelled copper instrument wire, 20 gauge, 4 lb. reel new and unused, 6/- Ex-G.P.O. Morse tapping keys, three contact type, long-brass bar, 5/6 each.

MERCURY VAPOUR LAMP PEDESTAL fully adjustable 3,000 candle power (less burner), condition as new, for A.C. mains, £5 0s. 0d., for D.C., 75/-.

"WESTON" MOVING COIL VOLTMETER 7-in. dial reading 0 to 4 and 0 to 4, 3,500 ohms per volt reading on coil is 6,000 ohm 1/2 milliamp. full scale, 45/-.

ALL GOODS ARE FULLY GUARANTEED unless otherwise stated, sent on 3 days approval against cash.

mitter previously referred to. The linearity of this curve is increased still further in the larger variactors.

The saturable reactor is placed in series with the primary of the final anode transformer. It is seen from Fig. 6 that with no audio signal (minimum DC) the reactance of this reactor is quite high (450 ohms). This effects a great voltage drop to the primary of the anode transformer, as the effective impedance of this primary is quite low. However, as the saturating DC is increased, the reactance is decreased, and the consequent voltage drop is decreased. The primary voltage rises in accordance with this, and with proper design reaches almost maximum at normal maximum audio output.

Even with the reactor practically saturated, a small reactance and consequent voltage drop exists. To com-

pensate for this, an auto-transformer is used on the line side of the reactor which increases the total impressed voltage. This auto-transformer does not have to be used if the anode transformer primary is wound or tapped for the reduced voltage obtained after the reactor drop. In either case, this voltage drop does not represent a power or efficiency loss, as the drop is almost entirely reactive and results primarily in a change of power factor; i.e., the ratio of VA/watts increases only.

It is apparent, on examining the circuit of Fig. 7, which shows a typical application of this reactor type controlled carrier modulation to an already existing transmitter, that the actual application of this reactor type con-

present in the modulator), no additional equipment is necessary. The circuit changes are extremely simple. The DC coil of the reactor is connected in series with the H.T. plus lead of the modulator. The auto-transformer primary is connected to the line and the primary of the class-C anode transformer is connected across the output side of the auto-transformer with the AC coils of the reactor in series. That is all there is to obtaining controlled

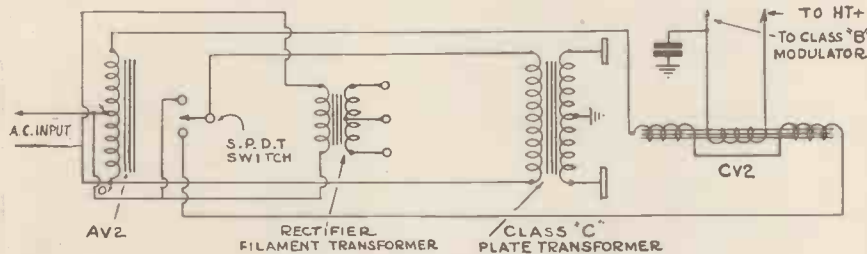

Fig. 7. Circuit of controlled carrier transmitter.

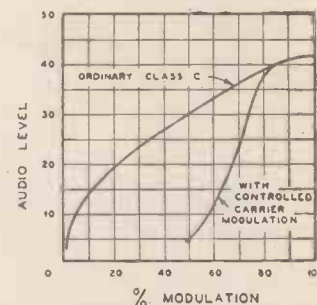

Fig. 8. Percentage of modulation in ordinary and controlled carrier transmitters at various audio levels.

carrier modulation from an existing transmitter. A simple switch, as indicated in Fig. 7, permits instantaneous change-over from standard to controlled carrier.

"HOW TO BECOME A RADIO AMATEUR"

is the title of a

NEW R.S.G.B. PUBLICATION

Contents :—

WHAT IS AMATEUR RADIO ? — MORSE CODE — INTERNATIONAL PREFIXES AND ABBREVIATIONS — THE Q CODE — SIGNAL CODES — THE A.A. LICENCE — THE FULL LICENCE — SELECTED FORMULAE AND DATA — THE PRIVILEGES OF R.S.G.B. MEMBERSHIP.

If you missed the 5th edition of "A Guide to Amateur Radio" get this booklet and learn :—

"HOW TO BECOME A RADIO AMATEUR"

Price **4^D** Post Free

Write to

The Secretary,

R.S.G.B. 53 Victoria Street, LONDON, S.W.1



TELEVISION DEVELOPMENTS

Are you keeping abreast of modern television developments? Whether amateur or professional you *must* be in touch with the latest trend of research.

The Television Society enables you to meet fellow workers in the field of television, both in this country and abroad.

Founded some 10 years ago **The Television Society** provides a scientific and non-partisan platform for discussion on all aspects of the subject. Meetings are held monthly during the session (October-June) and are reported in full in the Society's Journal which is sent free to all members.

The Society's activities are shortly being enlarged to meet the growing interest in the subject and members will have a unique opportunity of furthering their knowledge by contact with well-known television engineers.

Full particulars of membership qualifications may be had from the Hon. General Secretary—J. J. Denton, 25, Lisburne Road, Hampstead, London, N.W.3.

THE TELEVISION SOCIETY

(Founded 1927)

President: Sir AMBROSE FLEMING, M.A., D.Sc., F.R.S.

OPPORTUNITIES SECTION

BUSINESS :: EQUIPMENT :: EMPLOYMENT :: MISCELLANEOUS

The charge for miscellaneous advertisements on this page is 12 words or less 2/-, and 2d. for every additional word. Single-column inch rate displayed, 12/6. All advertisements must be accompanied by remittance. Cheques and Postal Orders should be made payable to Bernard Jones Publications Ltd., and crossed, and should reach this office not later than the 15th of the month previous to date of issue.

INDEX TO ADVERTISERS

A.C.S., Ltd.	251
Automatic Coil Winder & Electrical Equipment Co., Ltd.	193
Baird Television, Ltd.	209
Belling & Lee, Ltd.	Cover ii
British Institute of Engineering Technology ...	254
British Mechanical Productions, Ltd.	247
British Television Supplies, Ltd.	243
Bulzin, A. F., & Co., Ltd.	193
Chapman & Hall, Ltd.	251
Clix ...	247
Edison Swan Electric Co., Ltd.	194
Ericsson Telephones, Ltd.	249
Fluxite, Ltd.	Cover ii
Foyles, Ltd.	Cover iii
G5KA ...	Cover iii
Galpin's ...	255
General Electric Co., Ltd.	210
International Correspondence Schools ...	251
Marconi Wireless Telegraph Co., Ltd.	250
McGraw Hill Publishing Co.	247
Mullard Wireless Service Co., Ltd.	Cover iv
Peto-Scott Co., Ltd.	247
Premier Supply Stores ...	239
Quartz Crystal Co., Ltd.	252
Radio Clearance ...	253
Radiomart ...	252
Radio Resistor Co., Ltd.	Cover ii
Radio Society of Great Britain ...	256
Sanders, H. E., & Co.	Cover iii
Scott-Sessions, G., & Co.	Cover iii
Sinclair Speakers ...	254
Sound Sales, Ltd.	193
Stratton & Co., Ltd.	245
Technological Institute of Gt. Britain ...	Cover iii
Telegraph Construction & Maintenance Co., Ltd. ...	251
Television Society, The ...	256
Tungsram Electric Lamp Works (Gt. Britain), Ltd. ...	243

Mechanical Television at Last

We can supply a new Scanning System for High Definition giving a small Picture. Light relay. Lenses, High Speed Scanner, Motors, etc., at low cost, details and prices available.
CHASSIS FOR VISION RECEIVER. Complete with Nuts and Bolts. Price, 25/-.
LENS for small Cathode Ray Tubes 6" Plano Convex, Non-distorting, Price, 13/6.
HIGH VOLTAGE CONDENSERS. 1 mf. 1,000 wkg, 6/-, 2 mf. 1,000 v. wkg, 8/3, 1 mf. 2,000, 10/-, 2 mf. 2,000, 15/-, Kerr Cells, Neons, Lenses, Cathode Ray Tubes, etc., always in stock.
 Send your enquiries to us
H. E. SANDERS & CO., 4, Grays Inn Road, LONDON, W.C.1. Telephone: Chancery, 8778.

SCOTT-SESSIONS & Co.
EXCHANGE WORKS
MUSWELL HILL, N.10
 TUDOR 4101-2

All "T. & S.W.W." sets and kits. Servicing to all U.S. and British Sets. Exceptional facilities. Free quotations

Motor Tuning in Ekco Receivers

Press-button motor-tuning is now being incorporated in Ekco receivers. This system of tuning which is already sweeping America enables the operator to tune any selected station by merely pressing a button.

Tuning is carried out by means of a small motor while the station is accurately tuned-in by means of an automatic frequency control circuit.

The most interesting Ekco receiver using this system of tuning is the model PB199, which is a 10-stage instrument priced at 18½ guineas.

Mention of "Television and Short-wave World" when corresponding with advertisers will ensure prompt attention.

MISCELLANEOUS

OLIVERS offer 1-watt resistances, 3½d. each, 3/-dozen, 2/6d. dozen in 3 dozen lots.
CENTRALAB Volume Controls, with Switch, all values, 2/- each.
CHASSIS Mounting Valve Holders, 7-pin 3½d.; 5-pin 2½d.; Americans and Octals, 6d.
ALUMINIUM Chassis, 16" x 10" x 3", 18 gauge 5/3d.; 16 gauge 7/6d. Undrilled. Panels, Chassis to any specifications, etc., write for quotations.
SPEAKER Transformers, Power/Pen.; Universal 3/3d. each. Push-back, Red or Brown, 9 yards, 6d.
ROLA G.12. Speakers, 2,500 ohms or 1,250 ohms field. Push-pull. Triode or Pentode Transformer. Fully guaranteed, £2 19s. od. P.M. model £3 12s. 6d.
ALL non-ringing and American type valves offered at lowest prices. Lists and quotations upon receipt enquiries.
OLIVERS, 676, Christchurch Road, Boscombe, Hants. Please send 1½d. stamp for lists. Orders under 5/6d. postage extra; C.O.D. extra.
MAGNIFICENTLY constructed television Cabinets, extra heavy walnut, overall sizes 42 in. high, 25 in. wide, 20 in. back to front, fitted with ¼ in. plate glass first grade mirror in lid, size 20 in. x 16 in., ideal for radio gramophone cabinets; 45/- each; send for photograph, linen cover, wool lined, 3/6 extra. Please send for list of Dubilier high-voltage transmitting condensers and other Television components.
CARRIAGE extra.—Samson Radio, 4, Praed St., Paddington, W.2. Phone: Padd. 7851.
 Save 50% on your 1938 Radio Requisites. Valves, Speakers, Chassis, Components all brand new and boxed. ½d. S.A.E. for catalogue.
 Conlphone Radio, Ormskirk, Lancs.

TEN INCH CATHODE TUBES. New condition £5 Bargain. Cabinets for do. 30/- Furzehill Laboratories, Boreham Wood.

WANTED. Nicols, and double image prisms, White Line Lamp, Ti-lamp, etc. Box 22.

EXCHANGE Pathé Home Talkie Complete, for Television Receiver or will sell £40. Write full details, "CASQUETS," KINGS DRIVE, SHOREHAM, SUSSEX.

PATENT AND TRADE MARK AGENTS

GEE & CO., patents and trade marks throughout the world (H. T. P. Gee, Mem. R.S.G.B., A.M.I.R.E., etc.). Estab. 1905. 51-52, Chancery Lane, London, W.C.2 (2 doors from Government Patent Office). Phone: Holborn 4547 and 4548. Handbook free.

KINGS PATENT AGENCY LTD. (B. T. King, Patent Agent) 146a, Queen Victoria Street, London, E.C.4. **ADVICE,** Handbook and Consultations free. Phone City 6161.

A Cheap All-wave Radiogram

We are interested in the new Murphy all-wave radiogramophone which has just been released. It is priced at £20 for the A.C. model and £22 for the D.C. model. This is one of the cheapest receivers of its kind to include all-wave tuning and if it is to the normal Murphy standard is good value for the money. There are no less than 12 new Murphy receivers now available and we advise readers to write to Murphy Radio, Ltd., Broadwater Foad, Welwyn Garden City, for further details.

THE HAMS' BOOKSHOP (G5KA)

RADIO AMATEUR CALLBOOKS. Spring issue now on sale. Thousands of new QRAs. The Callbook is essential to every ham and short-wave listener. Price, 6/-.

JONES RADIO HANDBOOK. The 1938 edition of this famous handbook contains over 500 pages and is a library in itself. This edition is brand new, having been completely revised and re-written. Price, 7/-.

TELEPHONY HANDBOOK. An essential book for all hams interested in getting on 'phone. Price, 3/6d.

LOG BOOKS. The A.R.R.L. Log Book provides space for all facts pertaining to transmitting or receiving. There are 38 ruled pages with an equal number of blank pages for notes. Price, 1/8d.—3 for 4/3d.

All the above prices include postage.

G5KA. 41, Kinfauns Road, Goodmayes, Ilford, Essex. Dept. "T 4."

FOYLES

BOOKSELLERS TO THE WORLD

Enrolments taken for the Scientific Book Club

119-125 Charing Cross Rd., London, W.C.2. Telephone: Gerrard 5660 (14 lines)

Engineers' Guide

Shows how to qualify in Television, Sound Recording, Radio Engineering and Servicing, Wireless Communications, etc., by studying at home with The T.I.C.B. Write to-day for this Great Guide containing world's widest choice of engineering courses and which alone gives the Regulations for A.M.I.E.E., A.M.I.R.E., A.M.I.T.E., etc.

Free!

THE TECHNOLOGICAL INSTITUTE OF GREAT BRITAIN
 160 Temple Bar House, London, E.C.4
 (Founded 1917. 20,000 Successes)



To SUCCESS

200 Courses

Mullard introduce a new type of Cathode Ray Tube



TYPE A.41-G4

THIS NEW TYPE of Mullard Cathode Ray Tube has been specially designed to permit the pair of plates nearer the screen to be used with a non-symmetrical deflection circuit, thus considerably reducing the cost of the associated apparatus.

The design of the focusing electrodes enables an exceptionally small spot size to be obtained over the entire screen area.

Price £6 15s.

COMPLETE WITH SPECIAL SOCKET

ABRIDGED SPECIFICATION

Screen Diameter - 4 ins. (approx.)
Heater - - 4 volts, 1.2 amperes
Maximum Final } - 1,200 volts
Anode Voltage }
Deflection - Double Electrostatic
Focusing - - - - Electrostatic

FLUORESCENT COLOUR

A.41-4	- - - - -	White
A.41-G4	- - - - -	Green
A.41-B4	- - - - -	Blue

Full technical information from
THE MULLARD WIRELESS SERVICE CO. LTD.
Cathode Ray Tube Department,
225 Tottenham Court Road, London, W.1