

# TELEVISION

THE FIRST TELEVISION JOURNAL IN THE WORLD

*Special Features in  
This Issue:*

***Building a Double Time  
Base for Cathode Rays***

• •

***Modern High-Definition  
Transmission***

• •

***Holding the Picture  
Steady***

• •

***Fluorescent Lamps***

• •

***Section for Beginners***

DECEMBER



1934. No. 82

MONTHLY

Bernard Jones Publications Ltd., 58-61, Fetter Lane, E.C.4

## A 10-METRE

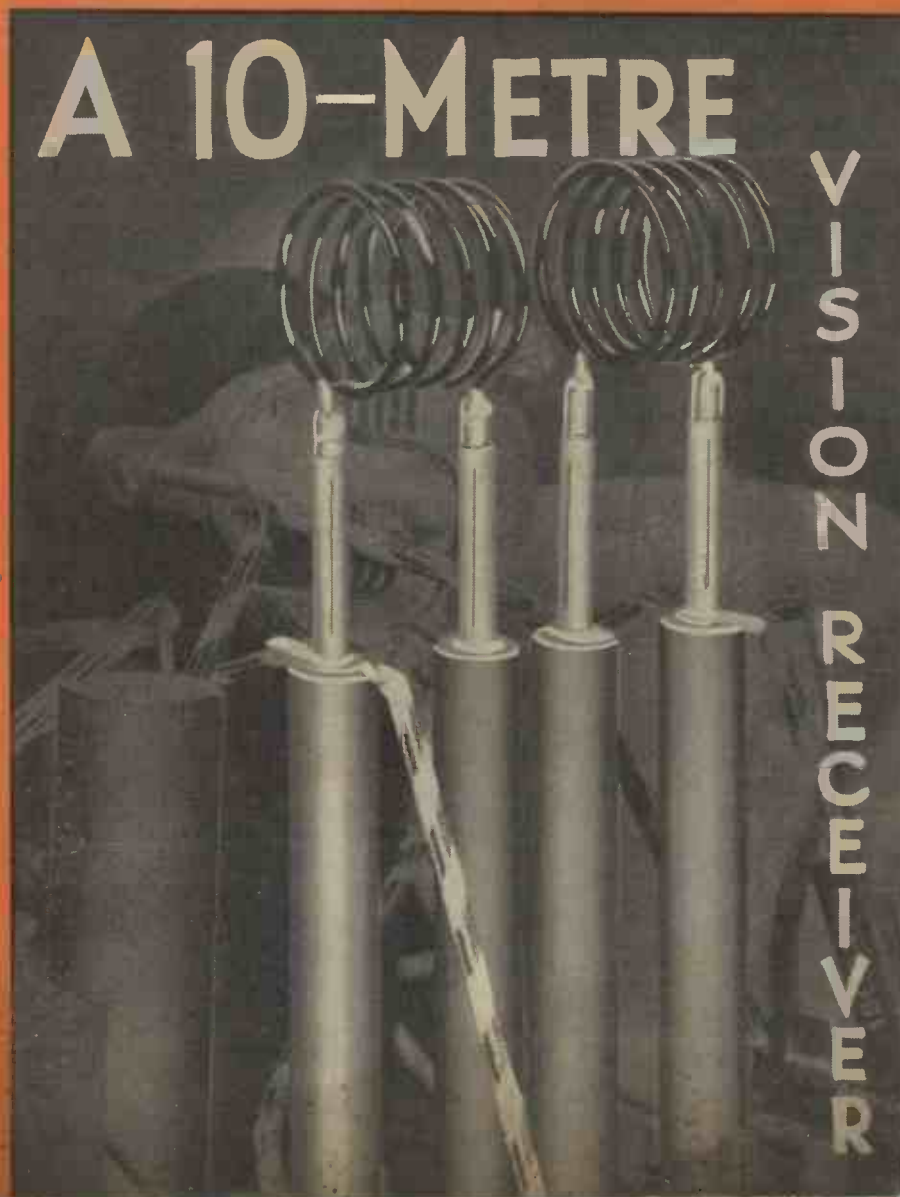

VIS-I-O-N R E C E I V E R

# ANNOUNCEMENT SCOPHONY LIMITED

*Sound and Picture Communications*

SCOPHONY LIMITED wish to announce that they are now ready to undertake the manufacture of high definition television film transmitters for experimental purposes. These incorporate their special optical patents, which make it possible to obtain adequate light on the photo cell, using only a small filament lamp as light source.

SCOPHONY LIMITED, DEAN HOUSE, 2, DEAN STREET, LONDON, W.1.

GERrad 1228



## The Cry of the "Bitten"

THIS IS NOT a story of Bulldogs and pants, but of the many disillusioned builders of apparatus who plead with us to take their "not to specification" components in part exchange for a

### SOUND SALES PRODUCT

WE HATE to be disoblging, but what can we do with them? The designer chose certain components to give him the results he aimed at and so successfully achieved. Those unfortunate people who depart from specifications are now realising their error. Hence—*The Cry of the "Bitten."*

A COMPREHENSIVE catalogue with special reference to Quality Amplifiers is now being prepared; it gives full details of the 4-12 watt Sound Sales "Wireless World Quality Amplifier." This will be available when this advertisement appears. If you are contemplating building an amplifier yourself, may we send you our latest catalogue of transformers and chokes?

You must have  
This New  
Catalogue "V"

Specified by

the Experts

**SOUND SALES**

SOUND SALES Ltd.  
Phone: Archway 1661-2



Tremlett Grove,  
Highgate, London, N.19

# THE LAMP

for TELEVISION



Regd.  
Design  
792,977  
BRITISH MADE

25A

## THE MOST BRILLIANT TELEVISION LAMP YET PRODUCED.

Adaptable to ALL modulated lamp systems. Can be used for direct viewing or projection.

CAN PROJECT A PICTURE ON A SCREEN THROUGH A DISC.

Many well-known consultants and experimenters agree that the "Ti" lamp is the most powerful light source available and the only lamp that can project a picture through a disc with results equal to most expensive systems.

A customer writes:—  
"I take this opportunity of congratulating you on the performance of your tube."

TELEVISION INSTRUMENTS LIMITED  
323, CITY ROAD, E.C.1

Telephones : Clerkenwell 4494 & 0686.

It helps us if you mention "Television."



**EP20  
MAINS TRANSFORMER**

BLOOMFIELD RD., WOOLWICH, S.E.18. Tel. : WOOLWICH 2345

**FOR YOUR TELEVISION SET**

Use Varley Components for your television set. Remember that thirty-six years experience in specialised electrical engineering goes into the production of every Varley product.

Write for free catalogue.

- Mains Transformers.
- Volume Controls.
- Heavy Duty Smoothing and Output Chokes.
- Nicore Flat-Gang Units.
- High Inductive Chokes.
- Duo-Nicore Coils.
- Resistances. All types.
- Junior H.F. Chokes.
- Power Potentiometers.
- Nicore H.F. Chokes.



**THE DIX-ONEMETER**



**FOR ALL TESTING PURPOSES**

TWO CLEAR SCALES WITH MIRROR ARC ON THE DIX-ONEMETER

The Dix-onemeter with only 6 Terminals, but 50 Ranges, is a valuable instrument for laboratory work; it is of portable size to go in the pocket, but big enough to cover the whole range of D.C. electrical measurements, 50 microamps. to 150 amps. and 20 millivolts to 2,000 volts. What other instrument to Brit. Elec. Standard Asscn. Standard of Accuracy for First Grade meters is available at the price? None! Each range has its Independent multiplier, and a safety button controls the moving coil.

DIX-ONEMETERS are now 55/- only. This is a remarkably small price for a meter worth £10 in comparison with others. Latest Model. Mirror Double Scale. Moulded Base. The finest Precision Multi-Measuring instrument is the DIX-ONEMETER. A.C. models are 3-range multiples, each 6/6.

We carry a wide range of Moving Coil and Moving Iron Meters. Send for Folder "B.R."

**LESLIE DIXON & CO.,**  
218, Upper Thames Street, E.C.4

Telephone: Central 4611.

**NEGATIVE  
TO  
POSITIVE  
PICTURE  
at will!**

The Television enthusiast is often faced with the problem of converting his pictures from negative to positive.

There is only one method of conveniently effecting such a change, and . . . it's done in a moment.

Use a WX Westector as your detector, thus getting linear rectification with distortionless pictures, and just reverse the Westector to alter the phase at a moment's notice. Simple . . . but effective.



**WESTECTORS**

The Westinghouse Brake & Saxby Signal Co., Ltd., 82, York Road, King's Cross, London, N.1.

Mention of "Television" will ensure prompt attention

for Xmas

# MERVYN for RELIABLE TELEVISION COMPONENTS and SOUND APPARATUS

Here's Entertainment—Scientific Instruction, and a new avenue for your future career!



**Relay Tube.**  
The MR/ACI Mercury Gas discharge relay for time base units — specified in this issue.

**£1/15/0**



**The "Nu-Glo" Crater Lamp**  
for Mirror drums and lens discs provides an intense spot of light inside the lamp, and is easily modulated — no optical concentration necessary. Striking at 200-220 volts.

**37/6**



**Line of Light Lamp.**  
Mercury and rare gas filling introduced January, 1934 — specified for Mirror screws, direct viewing with disc and disc projection experiments. Blush - white colour.

**21/-**



**The New Mervyn Duplex NU-GLO Lamp.**  
as announced last month. Striking voltage 180-200 volts: gives excellent pictures on only 17 milliamperes. Can be used up to 55 milliamperes. NU-GLO rich yellow-orange colour.

**12/6**



**Double Gun Cathode Ray**  
The only hard double gun Cathode Ray available — suitable for high or low definition as specified in this issue. Delivery from stock.

**£8/8/0**



**The Unisphere Mirror Drum.**  
Perfectly turned spherical main casting, 30 compensated curved carriers, mirrors, etc. : ONE SCREW fixing and adjusting — a really perfect system. Serves the dual purpose of transmitting or receiving scanner. Patented.

**Mirror Kit £2/15/0**

## FARADAY ALLWAVE RADIO

The world-wide known "FARADAY ALLWAVE" Receiver is a set of universal appeal both for home and abroad. It has four wavebands covering 15 to 2,000 metres: tuning is by one actual control, and every instrument has to receive American broadcasts in daylight before being passed by the test department: built by Mervyn.

Booklet containing full details and short wave information free.

**MERVYN Popular Television Kit**

**60/- ONLY**

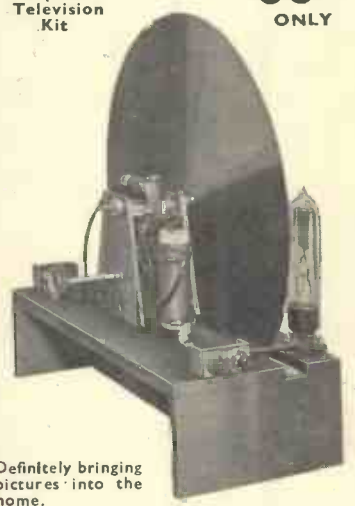

Definitely bringing pictures into the home. Although offered at a low price, the set of parts includes the famous "NU-GLO" lamp. Here is a great opportunity for the enthusiast to obtain a set of tested parts that will definitely bring pictures into the home. Price 60/- only.

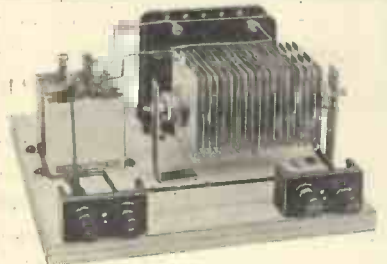

**Exciter Unit.**  
Fitted with Westinghouse rectifier. Universal for A.C. or D.C. 200-250 volts, output 200-250 volts D.C. 25 milliamperes.

**£2/5/0**

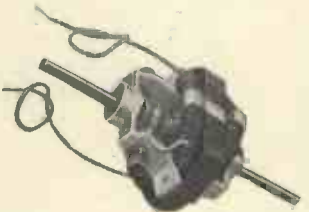

**Mervyn Motor Type BM3.**  
Die-cast frame, tapped for phonic synchronizing gear,  $\frac{3}{8}$ " ground spindle  $1\frac{1}{2}$ " overhang at each end, self-lubricating bearings. The best motor; suitable for driving Mervyn BD4 and UNISPHERE Mirror drum. Prices: Mains model — 20/-; 6 volt Battery model —

**20/-**

**CATHODE RAY UNIT Complete Set of Parts**  
for the Cathode Ray receiver and the 7 meter receiver can be supplied. Full details on request.



**Angle Mirror.**

Stand of entirely new design giving positive setting for directing the light-beam in projection work or direct viewing: mirror size,  $2\frac{1}{2} \times 2\frac{1}{2}$ ".  
Price 6/-



**The 8 pole Laminated Wheel.**

(2" diameter) interchangeable with standard synchronizing gear — will keep the motor steady on 50 cycles. For transmitters.  
Price 7/6



**Variable Resistance.**  
Large diameter — efficient heat dissipation — scientific ventilation — micro-control of speed with perfect smoothness now possible. When working the control has such a low temperature that the hand can be placed on it. Resistance, 150 ohms.  
Price 7/8



**Transformer.**

The 12 volt 100 watt Transformer — originally introduced by Mervyn for supplying current from A.C. mains to projection lamps, for Kerr cells and transmitter scanners.  
Price 25/-

**A Photo Cell Caesium on Silver.**

The most ideal for professional and amateur transmitter pick-up: has an enormous light-sensitive surface in comparison with ordinary cells.  $4\frac{1}{2} \times 3\frac{1}{2}$ " sensitive surface. 140 microamps per lumen — gas-filled — frequency response good up to 90 k/c. The cell with the biggest output. A cell with a sensitive area of  $1\frac{1}{2} \times 1\frac{1}{2}$ " with the same characteristics is available. If you are interested in transmitting sound films, etc., ask for details.



**Lens and Holder.**

A superfine flat-field highly polished 4" diameter Lens for increasing the size of images received.  
Price 4/8  
Clip-in lens-holder for above, 1/-.

**Scanning Discs.**

The finest available from stock:  
BD3. 16" — 8 spokes 7/6  
BD4. 15 1/2" — plain 6/-  
AS1. 20" — 8 spokes 12/6

All Television Lamps and Cathode Ray tubes are vision tested before Sale. Your dealer can supply you with Mervyn Apparatus. In difficulty, send dealer's name with your order to

## MERVYN SOUND & VISION CO., LTD.

4, HOLBORN PLACE - LONDON, W.C.1

Managing Director: W. J. Nobbs. Telephones: Holborn 6332 and 7709. French Office: 8 Square, Henri-Delormel, Paris, 14e.

**Fixed Resistance**

With mounting feet and sliding link adjustment for coarse control. 700 ohms 4/-

# TELEVISION

THE FIRST TELEVISION JOURNAL IN THE WORLD

*Special Features in  
this Issue*

	PAGE
Synchronising from the Mains ...	524
Building a Double Time Base ...	525
Modern High-definition Transmission	529
Whither Television? ...	532
Holding the Picture Steady ...	533
The Reason for Multiple Pictures ...	536
Studio and Screen ...	537
A 10-metre Vision Receiver ...	539
A Television Service for Germany ...	542
Modern Physics and Television Research	543
Recent Developments ...	546
The Ashdown Rotoscope ...	549
Meters for the Laboratory ...	552
Fluorescent Lamps ...	554
New Ideas for High-definition Reception	555
Questions Beginners Ask ...	560
Reception Schemes ...	562

## TELEVISION

*Proprietors:*

BERNARD JONES PUBLICATIONS, LTD.

*Editor-in-Chief:*

BERNARD E. JONES.

*Editor:*

H. CORBISHLEY.

*Editorial, Advertising and Publishing  
Offices:*

58-61, Fetter Lane, London, E.C.4.

Telephone: Central 4341 (four lines).

Telegrams: Beejapee, Fleet, London.

*Subscription Rates:* Post paid to any  
part of the world—3 months, 3/6;  
6 months, 6/9; 12 months, 13/6.

Published Monthly—1/- net.

(Last Wednesday in every month for  
following month).

Contributions are invited and will be  
promptly considered. Correspondence  
should be addressed according to its  
nature, to the Editor, the Advertisement  
Manager, or the Publisher, "Tele-  
vision," 58-61, Fetter Lane, London,  
E.C.4.

## COMMENT OF THE MONTH

*Progress in 1934.*

THE year just drawing to a close has been of outstanding importance for the development of television. It has seen the commencement of a co-ordinated effort to place the new science on a standard basis and it has witnessed proof that practical high-definition television of full entertainment value is an accomplished fact. This latter has been amply demonstrated both in this country and Germany, and its importance cannot be overestimated for there now remains no question of the ultimate development and practicability of television. Of equal importance is the proof that has been afforded that the difficulties of transmission and reception upon the ultra-short waves have been surmounted. Though possibly some of these developments have not gone much further than the laboratory stage, there does not seem any real reason why the placing of them on a commercial basis should not follow with very little delay. It is well known that several concerns in this country are awaiting the decision of the Postmaster-General's Committee and some programme of policy before placing home receivers before the public. At no previous time has the outlook been so promising.

There has been very little incentive during the year for the intensive development of low-definition systems, but progress has by no means been at a standstill. Though nothing radically new has been forthcoming, a considerable amount of research work has been carried on which has resulted in detail improvement. Probably this has been more noticeable in transmission technique than at the receiving end, and the experience that has been obtained will prove invaluable for more ambitious systems. Most research work during the year has been concentrated upon cathode-ray systems as offering the more obvious solution of high-definition problems, but mechanical systems are not being neglected and there is every promise of equal success.

Considerable work has been devoted to the development of light sources which are capable of modulation and the securing of greater efficiency from light cells employing the Kerr effect. In both cases some very real improvements have been effected. Development of the intermediate film system with the object of obtaining large screen pictures is generally associated with Germany, but recently apparatus of a similar type has been constructed here.

A feature of the year has been the greatly increased public interest and the attitude of the lay Press towards television; the scepticism which prevailed but a matter of twelve months ago has disappeared and the practicality of television is now taken for granted.

PRACTICAL INSTRUCTIONS FOR

# SYNCHRONISING FROM THE MAINS

*In response to numerous requests for detailed information on synchronising from the mains we give the following working instructions.*

**N**OW that time-controlled 50-cycle alternating-current mains are becoming general, it has been appreciated that a method of controlling the speeds of scanning devices within fairly accurate limits is made possible. The obvious way would seem to be to design a synchronous motor which would operate at the desired speed, but there are difficulties in doing this, particularly with the fractional horse-power motors which are used for television purposes.

The problem can be tackled in a much simpler way which will permit the use of practically any type of motor. Briefly this is to use the 50-cycle alternating current as an independent control, the current for driving purposes being entirely separate. This method, it should be remarked, does not completely solve the prob-

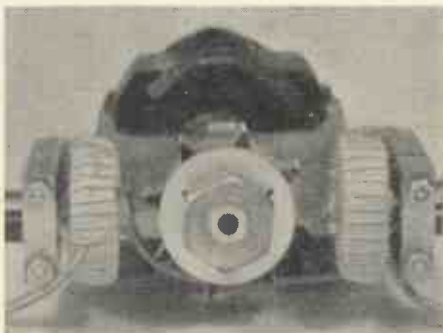

*This photograph shows a complete synchroniser fitted with an 8-tooth phonic wheel.*

thirty-tooth phonic wheel, one with only eight teeth is employed and the synchronising coils are fed with current from the mains instead of the radio signal impulses. The complete gear is shown by the photograph and details are given by Fig. 1. The phonic wheel is 2 ins. in diameter and

$\frac{1}{2}$  in. wide. The coils consist of approximately 3,000 turns of 36-gauge enamelled copper wire. The coil pole pieces are of  $\frac{1}{2}$  in. section and both wheel and pole pieces are preferably made up of laminations. All these components and also the pole piece yoke are available from The Mervyn Sound and Vision Co., Ltd., and it should be noted that the wheel is interchangeable with the standard 30-tooth wheel.

As mentioned before, the coils are fed with current from the mains, but it is necessary to interpose a res-

istance in series to prevent too much current passing. A resistance of 1,400 ohms will be suitable for mains of from 200 to 240 volts, the connections being as shown in Fig. 2.

When using this type of control it will be found an advantage to adjust the speed of the motor so that it is a little in excess of the required 750

revolutions per minute and this can be gauged by the appearance of the teeth of the phonic wheel when viewed by light, preferably a neon, obtained from the same mains, which will appear to slowly drift. When the mains current is switched on to the synchronising coils this will then take charge and hold the speed steady over fairly wide variations of mains supply to the motor.

Reception speed in relation to an independent transmitter will depend upon the dead frequency of the mains and as this seldom obtains it is probable that the picture will drift either up or down. This trouble may be obviated to some extent by employing the ordinary synchronising gear in addition to the mains control and in this case it will be found necessary to adjust the value of the current fed to the mains synchronising coils; this must not be too heavy or otherwise the radio impulses will not have sufficient power to overcome the pull on the eight-tooth wheel.

Two magnetic systems are, of course, necessary in this case, but as a rule there is no difficulty in fitting these as most television motors have extensions of the shaft at both sides.

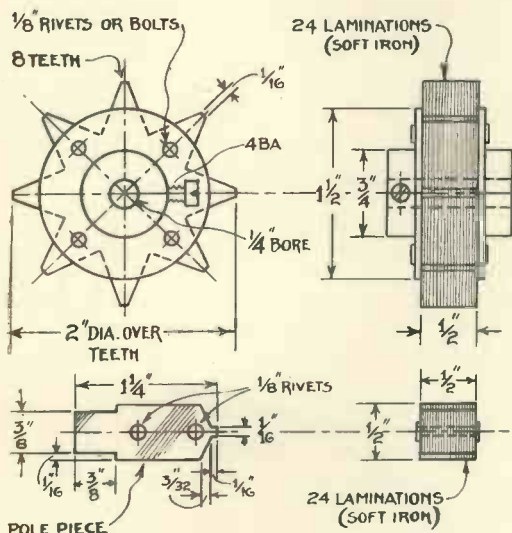

*Fig. 1.—Constructional details of the 8-tooth phonic wheel and the magnet pole pieces.*

lem of synchronism when receiving the B.B.C. transmissions, though it will be found a very great help; for holding motors at synchronous speed, however, when both transmitting and receiving motor are operated from the same mains it is ideal.

The scheme uses the ordinary synchronising device, but in place of the

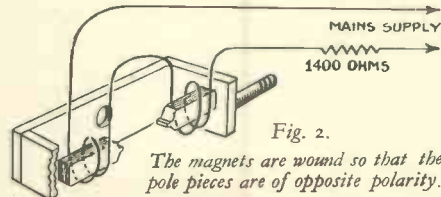

Providing that the normal speed of the motor is a little fast when the mains control is in operation there is another way by which it can be brought down to a speed corresponding to that of the transmitter; this is by means of a simple and constant friction device which will just compensate for the difference.

There is one further point in connection with this type of synchroniser which is of interest. If a speed of 1,500 revolutions per minute is required, as in the case of a picture frequency of 25 per second, then it is only necessary to remove four alternate teeth from the phonic wheels.

# THE SIMPLEST CATHODE-RAY RECEIVER

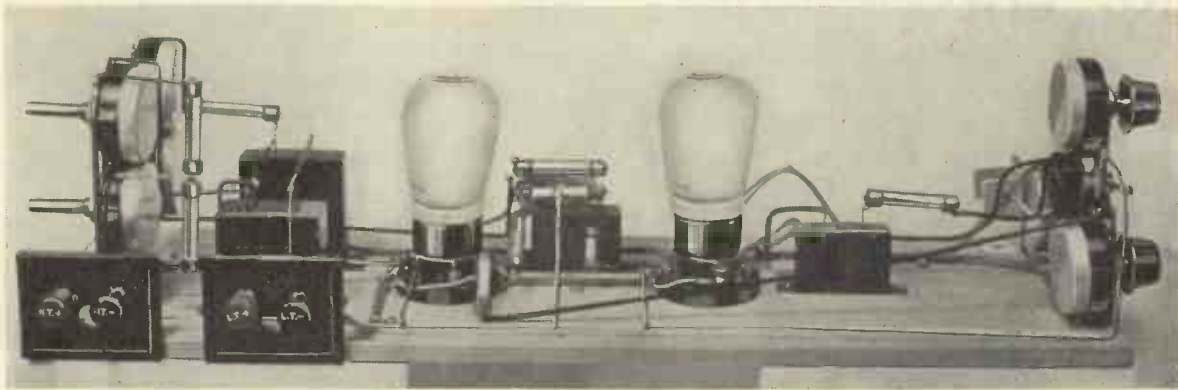

## BUILDING THE TIME-BASES

*This article gives instructions for building the double time-base for the cathode-ray receiver which was described last month. In the complete design a special feature of simplicity has been made. It is the first published design of a self-contained equipment.*

THOSE readers who have not hitherto had any experience of cathode-ray television are strongly recommended to read the articles on the subject which have appeared in the issues for February, March, and August, 1934, which will give them an insight into the theory underlying the choice of the circuit illustrated in this article. As we are now dealing with the construction, further theory would be out of place, but the uses of each component will be touched on as the construction proceeds.

### High Voltage

First of all, before undertaking any assembling of the components, look at the theoretical circuit and

realise that the voltage applied to it is 1,000, a much higher value than we are used to dealing with in ordinary constructional sets. And when we come to the wiring of the tube itself the voltage will be nearer 2,000, which is higher still! There is no reason why these high voltages should scare you at the start, but they are mentioned here so that the job will receive that little extra care which they warrant. For example—it is a risky thing to run flexible leads next to a metal frame if they are at 1,000 volts potential above the frame. Flex is not guaranteed to stand up to 1,000 volts, although it will probably do so. However, don't risk it.

Ordinary systoflex will not safely stand 1,000 volts, so don't rely on it implicitly. It is much safer, if it is used, to thread one length inside another and make a double thickness. Use stiff wire, not 20 gauge, but 18. Components keep in place better and there is no risk of their flopping about. We have helped you as much as possible by giving ample room in the set and baseboards and avoiding metal in the construction, so that if the wiring is done with just that little extra trouble to see everything is clear and firmly soldered, the set will work well and there will be no trouble afterwards.

### The Controls

In a cathode-ray receiver the utmost flexibility is had by making all the controls adjustable. This means that the scanning circuit can be altered to suit any type of television without pulling the circuit to bits. However, too many knobs would be required for this arrangement, and, realising that the receiver would be

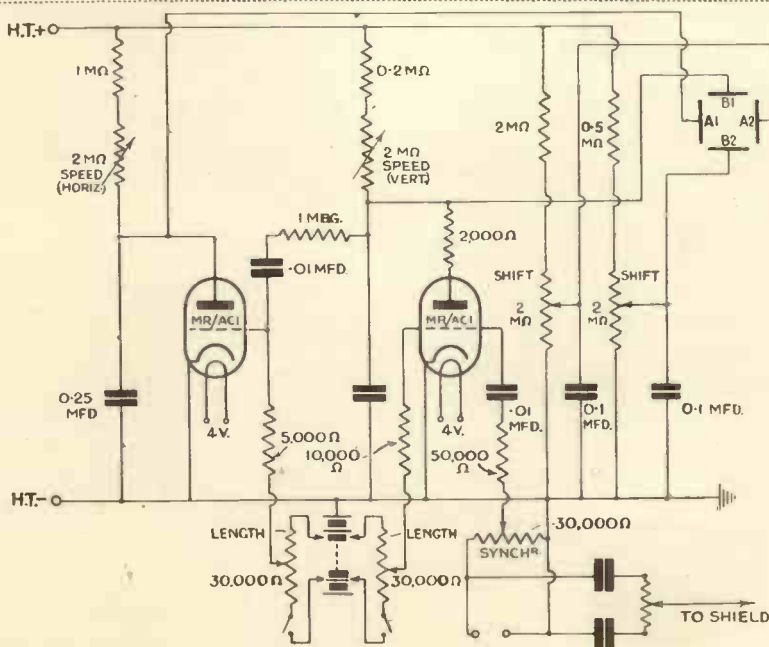

*The circuit of the double time-base.*

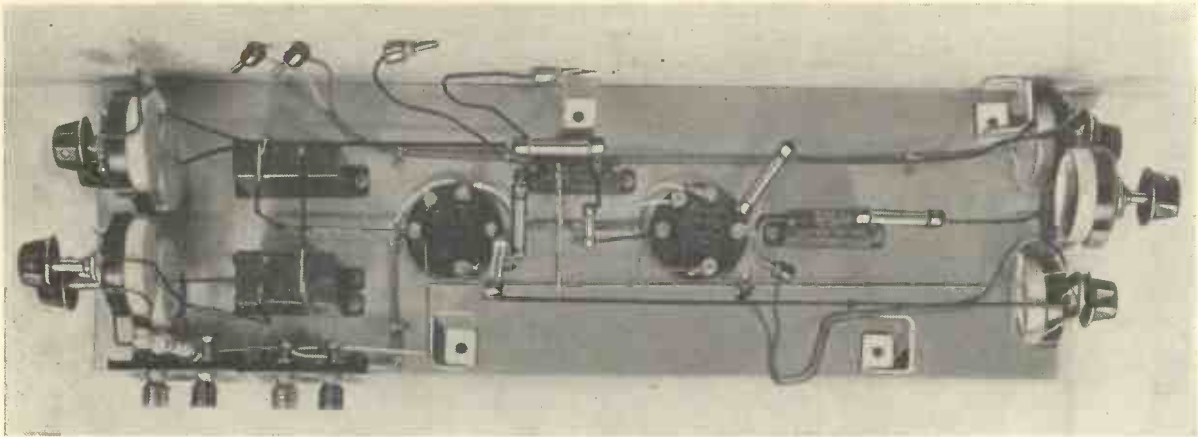

This photograph is a plan view and it will be found useful for comparison with the layout and wiring diagram below.

used on 30-line transmission for the present, a compromise has been made, and some of the controls have been pre-set. The principal adjustments can then be made from the front while the set is operating, but the scanning circuit requires "tuning up" before being shut into its cabinet.

The controls available in the scanning circuit are as follows:

- (1) Speed of travel of the beam in the vertical plane.
- (2) Speed of travel in the horizontal plane (picture frequency).
- (3) Length of travel of the beam vertically.
- (4) Length of travel of the beam horizontally.
- (5) Centralising of the beam travel to occupy the centre of the screen of the tube.
- (6) A similar adjustment for up and down movement.
- (7) Synchronising impulse applied to the scanning circuit.
- (8) Modulation of the beam intensity by the applied signal from the receiver.

Now consider the 30-line transmissions. The speed of the vertical scan (375 per second) and that of the horizontal scan ( $12\frac{1}{2}$  per second) is fixed. The only variation which will occur is in the scanning circuit itself, owing to variations in the mains voltage, etc. Therefore it is sufficient to pre-set the speed adjustment to give the required rate of travel and control it from time to time as required. Now the time-base circuit described has one peculiarity, which was mentioned as a disadvantage previously: the length adjuster which alters the travel of the beam also affects the speed to a slight extent. In the set under construction this is turned to advantage, and the variation

of speed is carried out by slightly altering the length of travel of the beam. True, the picture may not be exactly the right proportion in all cases, but the amount taken off the length or breadth is so slight that it is not noticed in the actual reception of the image.

Once the line screen has been formed on the tube, the centralising controls can be used to bring it symmetrically in the centre of the fluorescent screen, and thereafter can be left without alteration. This is, therefore, another case of initial adjustment which need not be touched again.

This enables the following disposition to be made:

On the front panel, for accessibility, are mounted the two potentiometers controlling the length of the lines (and to a lesser extent the speed of traverse of the beam) and the potentiometer controlling the synchronising impulse.

At the back of the receiver, so that they can be reached by removing the back panel, are the "shift" knobs for centralising the image, and the "speed" knobs for initial adjustment of speed. The reader will probably say "But how can I make adjustments at the back of the set, and crane my neck to see the screen at the same time?" The image on a cathode-ray screen can be viewed from either the back or the front of the tube, so the answer is "Look at the screen from the back."

### Tube Controls

No mention has been made of the controls for the tube itself. These are:

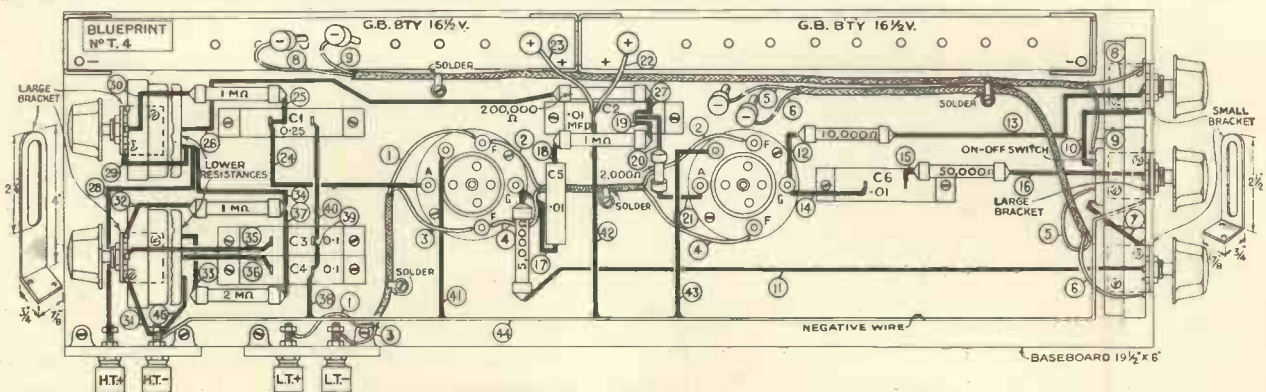

The layout and wiring diagrams of the double time-base. A full-size blueprint is available, price 1/-.



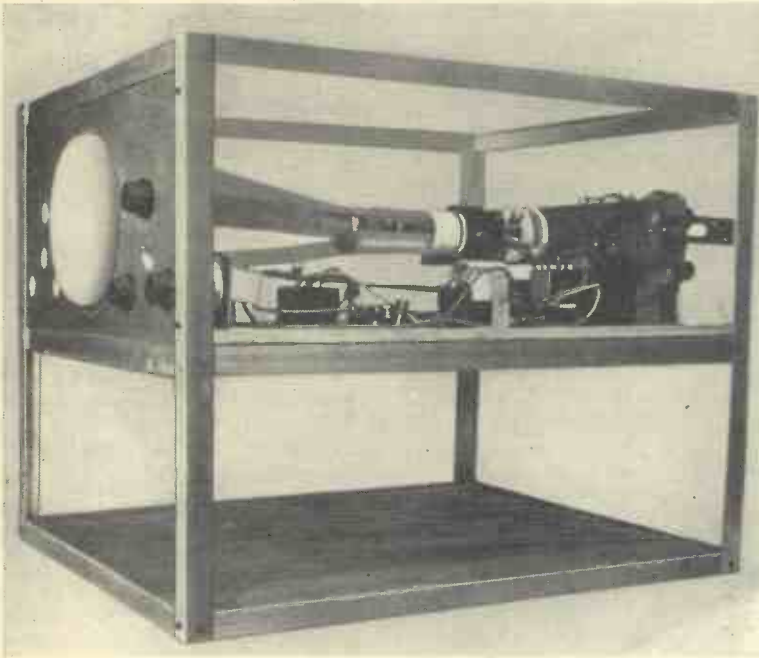

View of the receiver chassis with the double time-base in position.

Cathode current.

Focusing.

Modulating signal applied to the tube.

They will be dealt with in turn under the construction of the exciter unit for the tube, but in the meantime, note that the knobs will be symmetrically arranged on the opposite side of the panel to the time-base, and will be three in number—focusing (2) and modulation. The cathode current can be pre-set in the way described above.

### Lay-out of the Scanning Circuit

The scanning circuit is occupying the right-hand side panel looking from the front of the receiver. The dimensions of the baseboard have already been given, so that the assembly of the components can be done right away. For the front of the baseboard (right-hand side of the layout) one large and two small component brackets are screwed on to the baseboard at the positions shown. Fix the two 30,000-ohm potentiometers on the small brackets, and on the large one fix the Bulgin double-pole switch, and above it, the other 30,000-ohm potentiometer for the synchronising control. The soldering tags on the two side potentiometers are mounted pointing upwards, while those on the centre one are mounted downwards, care being taken that they are clear of the switch body.

The actual mounting distances of the components are shown in the wiring diagram. At the opposite end of the baseboard are fixed two more large brackets about 1 in. in from the edge of the wood so that the knobs of the potentiometers will not foul the back of the cabinet. Before the brackets are fastened down it may be necessary to lengthen the slots in them so that the two potentiometers may fit one above the other.

The four 2-megohm potentiometers are then fastened

### COMPONENTS

#### BASEBOARD.

1—5-ply 19½ in. by 6 in.

#### CONDENSERS, FIXED

1—T.C.C. .01-mfd., type tubular.

2—T.C.C. .01-mfd., type 87.

2—T.C.C. .1-mfd., type 95.

1—T.C.C. .25-mfd., type 95.

#### HOLDERS, VALVE

2—W.B. 5-pin, type baseboard mounting.

#### PLUGS, TERMINALS, ETC.

5—Clix wander plugs, marked: G.B. -1, G.B. -2, G.B. -3, G.B. -4, G.B. (two).

4—Clix terminals, marked: L.T.-, L.T.+, H.T.-, H.T. +.

#### RESISTANCES, FIXED

1—Dubilier 2,000-ohm.

1—Dubilier 5,000-ohm.

1—Dubilier 10,000-ohm.

1—Dubilier 50,000-ohm.

1—Dubilier 200,000-ohm.

1—Dubilier .5-megohm.

2—Dubilier 1-megohm.

1—Dubilier 2-megohm.

#### RESISTANCES, VARIABLE

3—Reliance 30,000-ohm.

4—Reliance 2-megohm.

#### SUNDRIES

3—4 in. metal mounting brackets (B.T.S.).

2—2 in. metal mounting brackets (B.T.S.).

1—Yd. twin screened sleeving (Goltone).

2—Terminal mounts (B.T.S.).

2 pairs Bulgin G.B. battery clips, type No. 1.

2 yds. thin flex (Goltone).

Connecting wire and sleeving (Goltone).

#### SWITCH

1—Bulgin double-pole on-ox, type S 104.

on the brackets, with their soldering tags turned upwards and downwards to allow easy access for soldering. Then fasten down the fixed condensers, valve-holders and terminal blocks.

It will be seen that the wiring is so spaced that every wire is clear of its neighbour and there is no overlapping. This will avoid any risk in the use of the high voltage on the time-base, but make sure at the same time that there is no risk of loose wires touching if the set is roughly handled.

### Wiring

The heaters of the mercury relays have been wired in metal braided flex, as the drawing shows. This is not absolutely necessary, but makes a neat job, and may avoid any stray interference which will affect the tube when operating. The braided wire is fixed to the baseboard by screws passed through soldering tags, which are bent over to grip the braid firmly and held in place with a dab of solder. Don't leave the iron too long on the joint when this is being done as the rubber underneath may be damaged and the flex short-circuited to the metal braid. A quick touch with a very hot iron is the best way of soldering these. The wiring of the heaters is straightforward: L.T.+ terminal to F on the first valve-holder (wire No. 1) and to F on the second valve-holder (wire No. 2). Then the L.T.- to the other F terminal (wire No. 3) and on to the F terminal on the second holder (wire No. 4).

The remainder of the braided cable is used in connecting the potentiometers to the taps on the bias battery. These tapping points will be separated by 3 volt steps on the battery and the position of the plugs will be found on making the adjustments for the length of the scanning lines.

Cut a piece of flex about 10 ins. long and cut away the braid from each end to a distance of two inches. Attach two black wander plugs to the wires at one end (marked Nos. 5 and 6, in the diagram). Clip the braid

down with a soldering tag as shown, and join wire No. 5 to one tag of the double-pole switch. The other switch connection goes to the outer tag of the potentiometer (wire No. 7) and the end of wire No. 6 goes to the other outer tag on the potentiometer. The switch thus disconnects the potentiometer from the battery when it is "off."

For the other grid bias connection, proceed in a similar manner, cutting a length of braided wire 18 ins. long, and baring the ends as before. The connections are then:

Outer tag of potentiometer—wire No. 8 from the wander plug.

Switch—wire No. 9 from the wander plug.

Wire No. 10—from switch to potentiometer.

### Synchronising Input

The grids of each of the mercury relays can be joined to their respective bias potentiometers. Wire No. 11 is joined to the centre tap of the potentiometer nearest the lower edge of the baseboard in the plan and is connected through a 5,000-ohm resistance to the grid terminal of the valve-holder. Let this wire slope upwards clear of the board as shown in the photograph. Now join the other grid terminal on the valve-holder through a 10,000-ohm resistance to the other potentiometer tap (wire No. 12). The synchronising impulse will be applied to this grid, which is that governing the line frequency (375 per second). For this purpose the grid terminal is also connected through a fixed condenser of .01 mfd. (C.6) and a resistance of 50,000 ohms to the centre tag of the centre potentiometer. The wiring is 13, from grid terminal to condenser, 14, from condenser to resistance, and 15 from resistance to potentiometer. Leave the other connections to the potentiometer for the time being until the negative lead is ready for soldering on.

### Coupling between Relays

The grid of the slow speed relay (horizontal deflection), is coupled to the anode of the "vertical" relay by a 1-megohm resistance and .01 mfd. tubular con-

denser. This is to ensure that the two relays are interlocked and thus keep the correct relative speed when they have been adjusted. The wiring for these components is as follows:

Wire No. 16—from grid terminal of left-hand valve-holder to the tubular condenser C5.

Wire No. 17—from condenser to 1-megohm resistance.

Wire No. 18—from resistance to soldering tag of C2 condenser. This same tag is connected to the anode terminal of the right-hand valve-holder through

Wire No. 19—a 2,000-ohms resistance and,

Wire No. 20.

To the other tag of the .01 fixed condenser are soldered two small pieces of flex terminating in red wander plugs to be connected to the positive sockets of the grid bias batteries. These are shown as wires Nos. 21 and 22 in the diagram. Condenser C1 (.25 mfd.) has one wire taken from it to corresponding tags on C3 and C4 (No. 23). The other soldering tag is joined to the anode terminal of the left-hand valve-holder (wire No. 24).

### Speed Control Resistances

These resistances are two, 2-megohms mounted on the upper large bracket shown in the layout diagram. Viewed from the back of the set, they will be on the left-hand side. Commence by soldering a wire to the centre tag of the lower resistance and taking this out clear of the .25 mfd. condenser in the direction of condenser C2. This wire is referred to in the diagram as No. 25. Care should be taken that it is bent so as to keep clear of both the condensers and the grid bias battery. The end of the wire is soldered to a resistance of .2-megohm and thence through wire No. 26 to the soldering tag of the condenser C2. Care should be taken that the 200,000-ohm resistance is kept quite clear of the condenser, and the braided covering of the grid bias leads which run alongside.

Returning to the variable 2-megohm resistance, loop the right-hand tag (looking from the back) to the cor-

(Continued on page 568.)

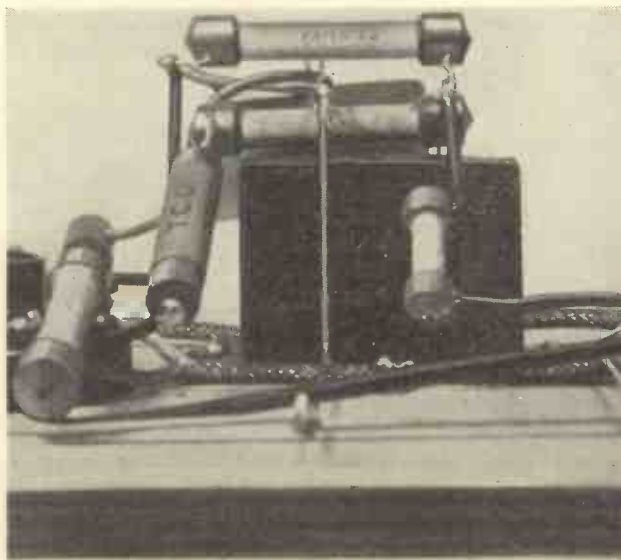

Photograph showing the connections of the resistances to the small charging condenser.

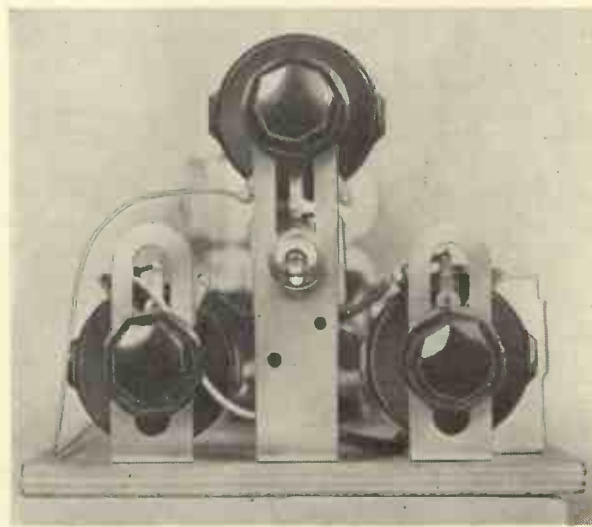

Controls on front panel. The two lower controls alter the length of the picture; the upper control is for synchronising.

# MODERN HIGH- DEFINITION TRANSMISSION

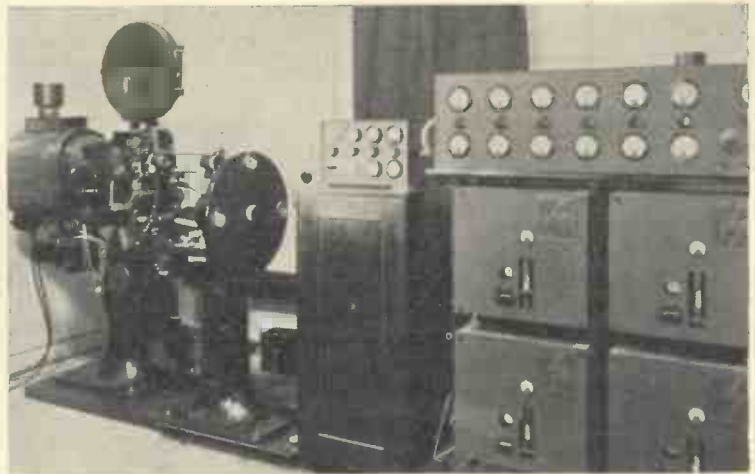

*This article is an authoritative explanation of the methods now being employed in the transmission of films in high-definition systems. The writer has been engaged in this class of research work for a considerable time and it will be appreciated therefore that the information is no mere generalisation but is a clear exposition of the problems involved and their solutions.*

By G. Baldwin Banks, B.Sc.  
(Late of the Baird Laboratories)

THE system of film transmission to be described in this article is one which is in fairly general use, not only in this country but also in America and Germany. Of course, individual organisations have developed their own modifications, but the general principles underlying these systems are the same.

Before going further it would be as well, perhaps, to define what is meant by "high-definition" transmission. It will be understood that there is no absolute border line between low-, medium- and high-definition, but for the sake of simplicity, transmissions may be divided into three arbitrary groups, as follows:—

- (a) Low-definition.—Systems using up to 45 lines, which can be radiated by transmitters satisfying normal broadcasting requirements, viz., 10 kilocycle side band.
- (b) Medium-definition.—Systems using from 45 to 100 scanning lines, suitable for transmission on short waves.
- (c) High-definition.—Systems using over 100 scanning lines, utilising side bands of 500 kilocycles or more,

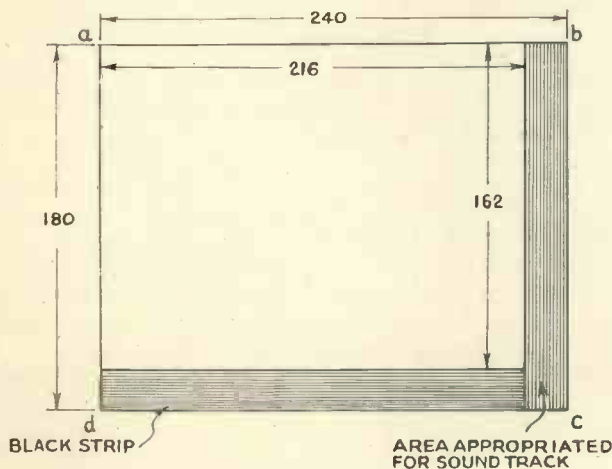

Fig. 1.—This diagram explains the picture standards employed.

necessitating for transmission ultra-short wavelengths with carrier frequencies of over 30 megacycles.

There are many practical limitations to the number of lines, or to be more exact, the number of elements

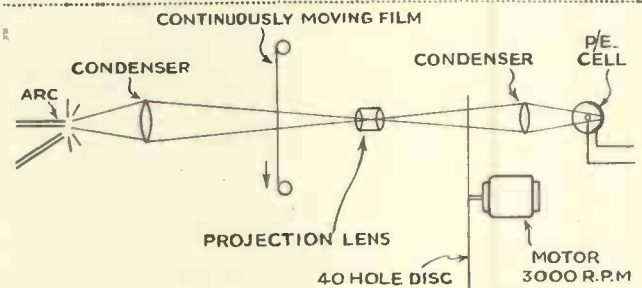

Fig. 2.—Schematic layout of the optical system used for high-definition film transmission.

into which the picture can be divided. To begin with, there is a practical limit to the size of disc which can be used and with a large number of holes the size of these holes becomes very small indeed and not only is it very difficult to punch them satisfactorily but very little light can pass through them and the resulting photo-electric currents may be so minute that they are swamped by parasitics. Another limit is set by the frequency range of the amplifiers and transmission channels. The frequency band required for a transmission is proportional to the square of the number of lines used, providing that the picture ratio is unchanged.

Because of these limiting factors it is generally accepted that at the present stage of television technique 180 lines represents the highest practical limit, and the writer proposes to describe apparatus used for this degree of definition.

## The Picture Standards

In the old "silent" films, the picture frame was very nearly in the proportion of 3 × 4 and is represented in Fig. 1 by the area a b c d. For purposes of con-

## HOW THE SYNCHRONISING IMPULSE IS PROVIDED

venience this is shown as being 180 units  $\times$  240 units, which is the same proportion. On the advent of sound films, roughly 10 per cent. of the frame was appropriated to accommodate the sound track at the side, leaving a more or less square area for the picture. This shape of picture did not fit in very well with existing cinema screens and at a later date it was decided to return to the 3  $\times$  4 ratio by taking a corresponding slice off the height. This can be seen as a black strip between individual frames on a length of film. Curiously enough this cutting off of a portion of the picture is very useful to television technicians.

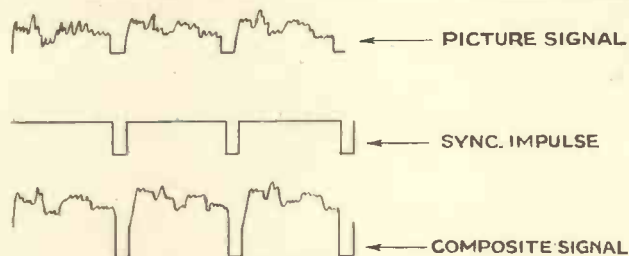

Fig. 3.—Diagram explaining the method of superimposing the synchronising impulse.

Almost without exception these high-definition transmissions are received on a cathode-ray tube screen and it so happens that in practice it takes about 10 per cent. of the scanning period to return the electron beam to the starting point of the scan. Furthermore, this period, when no picture is being scanned, may be used to take a synchronising impulse in a manner which will be described later.

Using 180 lines it will be seen that our film frame is divided into  $180 \times 240 = 43,200$  picture points. Of these only about 35,000 are used for the actual picture the rest being sacrificed for the purposes mentioned.

### The Tele-cine Projector

The projector is a modified form of the standard cinema projector in which the usual jerky motion is eliminated, allowing the film to move *continuously* through the gate at the rate of 25 frames per second. The picture is projected on to the disc so that it is scanned horizontally, i.e., at right angles to the direction of its own motion.

The disc differs from ordinary television discs inasmuch that the radially-spaced holes are all at the same distance from the centre, the picture traverse being effected entirely by the motion of the film itself. It is usual to use a disc with only 90 holes revolving twice per frame in order to keep the size of disc down to reasonable limits (a disc with 180 holes would be very cumbersome). A 90-hole disc of this type with the holes 9 ins. from the centre would have holes  $2\frac{1}{2}$  thousandths of an inch in diameter, spaced from each other by a distance of .63 in.

It may be imagined that the manufacture of such a disc is a very difficult matter and special machinery has had to be evolved for this purpose. It is usual to

make the discs with small circular inserts of very thin platinum, the holes being punched in these inserts; the punching process is carried out under a microscope. The optical system of the projector is so arranged that the projected picture occupies less than the distance between two holes, giving a 10 per cent. underlap.

The light passing through the holes is collected by a photo-cell. It is usual to interpose a condensing lens between disc and photo-cell in order to concentrate the light on to a limited area of the photo-sensitive material in this way eliminating fluctuations due to varying sensitivity.

### Synchronising Impulses

By means of 90 fine slits on the disc and an arrangement of lamp and photo-cell a synchronising impulse is generated which is injected into the picture signal at the end of each scan, occupying the short period which occurs when no picture is being scanned. This is clearly shown in Fig. 3. A similar procedure is adopted between every picture frame, in this case a local 25-cycle impulse generator being used. Special phasing arrangements are embodied so that the synchronising impulses fit correctly into their allotted places in the picture signal.

It will be seen that the ultimate output signal is composed of

- a. The picture signal.
- b. A 4,500-cycle synchronising signal.
- c. A 25-cycle synchronising signal.

Special filters are used at the receiving end in order to separate these components. These will be described in a later article dealing with high-definition television receivers.

### Amplifiers

In designing amplifiers for a television system it is first essential to determine the frequency range which the amplifiers have to deal with. It is generally ac-



Fig. 4.—Aperture attenuation—conditions when aperture gives no response.

cepted that the lowest component is the repetition or picture frequency—in this case 25 cycles per second. Strictly speaking, this is only true when each of the series of pictures are identical. This is rarely the case and the amplifier should be capable of dealing with even lower frequencies.

In determining the highest useful component it is necessary to consider signal attenuation due to the finite size of the scanning aperture. It will be readily understood that an aperture of finite size will not respond so well to the finer detail as it does to the coarse. This is equivalent to stating that the higher frequencies are attenuated—the finer the detail the less the response will be—until a certain frequency is reached which will not be reproduced at all.

If we consider a scanning strip with alternate black and white areas half the width of the scanning spot,

## TRANSMISSION AMPLIFIER DESIGN

it will be seen from Fig. 4 that whatever the position of the spot may be it will always represent the same amount of light, and no signal will result from its passage along the strip. This represents one cycle per picture point and this critical frequency will be the product of the number of picture points  $\times$  number of pictures per second. In the case under consideration this is roughly one million cycles.

The drop in response due to aperture attenuation may be compensated for to a certain extent, the practical limit being reached when response has fallen about 15 decibels. Taking into account the loss at both transmitter and receiver, this occurs when the fineness of detail represents about 750,000 cycles.

From the foregoing considerations it will be seen that the amplifier must give equal amplification, without undue phase distortion, to all frequencies from 10 to 750,000 cycles. Fig. 5 depicts a circuit which has proved very satisfactory. It is in two sections between which a filter is interposed. The characteristics of this

tain high-frequency response. The photo-cell is always of the caesium-vacuum type. Gasfilled cells are much more sensitive but their characteristics show a rapid drop above 10 kc.

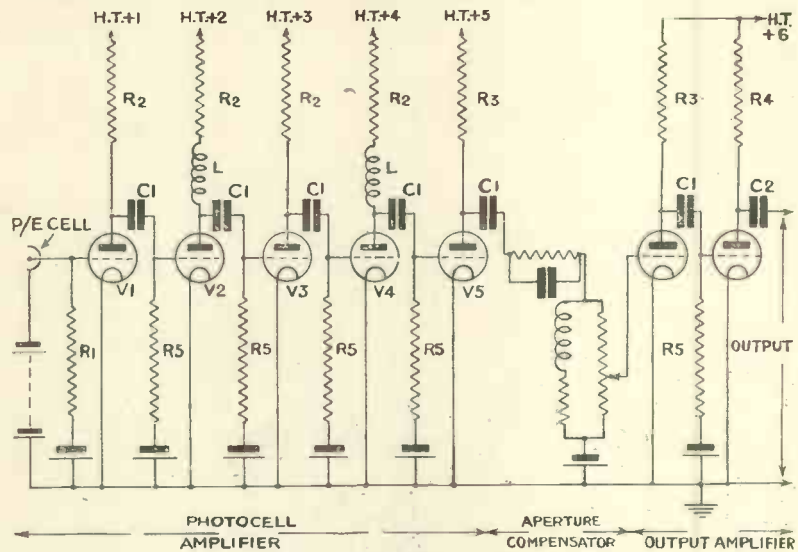
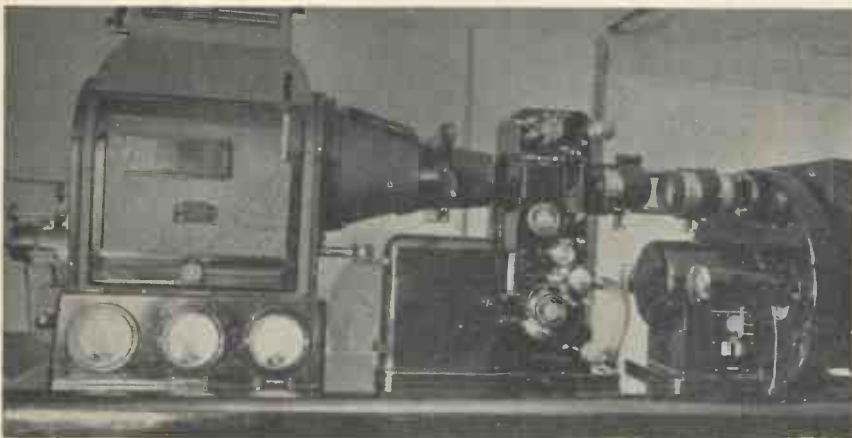

Fig. 5.—A transmission amplifier circuit which has proved successful.



The Fernseh A.G. 180-line sound film transmitter.

filter circuit are such that the amplitude of the lower frequencies is greatly diminished in order to compensate for aperture attenuation.

The first section of the amplifier which accommodates the photo-cell, consists of five low-gain stages, while the second section of two stages makes up for the loss in the filter and provides a suitable output. Care is taken to eliminate mechanical and electrical interference, each section being contained in metal boxes complete with batteries.

In order to eliminate the necessity for decoupling, each stage has its own H.T. battery. Very low values of anode and grid resistances are used in order to keep down the loss of higher frequencies due to valve and stray capacities. The inductances in the anode circuits of the second and fourth stages also help to main-

Screen electrode valves are favoured by some designers because of the greater stage gain obtainable, due to the low grid-anode capacity and high magnification factor. On the other hand, these valves have a much higher grid-earth capacity than triodes and owing to the very close electrode arrangement tend to be noisy.

The output of the amplifier is taken through a short line to the radio transmitter. A suitable line takes the form of an earthed lead tube about 1 in. in diameter down the centre of which a copper wire runs. In order to keep down the capacity paper insulation is used.

It is common practice to erect the radio transmitter in the close vicinity of the television apparatus, keeping the line very short. The radio frequency currents are carried to the aerial by suitable feeders. Recently great strides have been made in this direction and well-designed feeders will carry the R.F. currents over quite appreciable distances without undue loss of efficiency. As an example, the Baird ultra-short wave transmitter at the Crystal Palace is connected to the aerial at the top of the South Tower by a feeder over 200 feet long.

The two short-wave transmitters in Berlin reserved for television are now carrying out experimental broadcasts at the following times: G.M.T. 08.00-11.00 daily except Fridays and Sundays. G.M.T. 19.30-21.00, Tuesdays and Thursdays. Sound on 6.985 metres; vision on 6.67 metres.

# Whither Television ?

*Author's Foreword: It being now possible, in this Age of Marvels, to write in the future, I do so. I write this in November, 1936.*

HERE is a flagstone in the Quai d'Orsay in Paris which is different from its fellows. It is cracked. It became cracked in this manner:

Mr. Prettyman Timbermere has a reinforced concrete villa on a slope

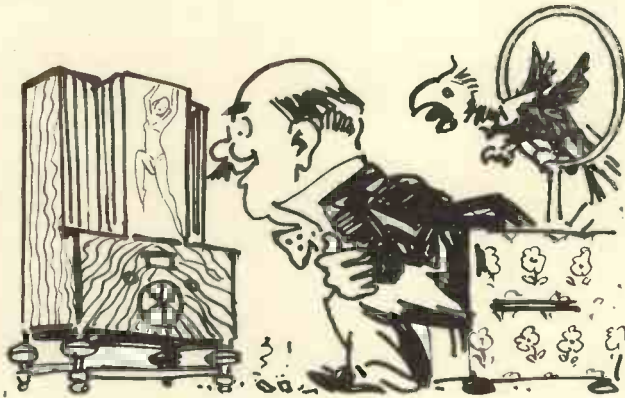

*... he sat down to look-in in a censorious silence.*

of Sussex. In it are his wife, his daughter, Marigold, his son, and a television set. The set was installed last week, on a Monday.

On the Monday night, the clan Timbermere settled to a good play round at television. Son got London. Mr. got Athlone. Mrs. got bored. But it was Marigold who got Paris.

"Ah!" said Mr., "We must look in to this"—which he thought very passable word-play (as indeed do I, who record it). "You remember how we did Paris in '20, my dear?"

"Yes," said Mrs. Timbermere, "I'd a frightful snuffly cold, hadn't I?"

"Always romantic, mother, wasn't she," said Marigold, "What's this announcer saying?"

Mr. didn't know without his "French For Fifty Occasions." In fact, nobody knew—but son caught just two magic words, to which he battened and said nothing. They were "Folies Bergères." The foreign programmes in the paper fur-

ther confirmed his delighted guess—this was a television relay from that haunt of beauty.

Well, when Mr. had cleared the whole of his family out of the room he sat down to look-in in a censorious silence. When it was over he got

out writing things and sent a letter in sextuplicate to the chief morning papers and to the Home Secretary. It went:

"This (Monday) evening my eyes have been affronted by a spectacle which, by reason of its impropriety and lack of decorum, should not be tolerated in this country for one moment. I

refer to the television relay, via Radio Paris, of scenes from the 'Folies Bergères.'

"Am I, a ratepayer and the father of a family, to have my home invaded in this infamous manner? The thing must be nipped in the bud ere the rising generation is corrupted beyond redemption!"

Nothing much happened about the letters though, and the following Monday—the Monday of this week—son was agreeably surprised to find that another Folies relay was programmed.

"Must have a weekly contract," he said, but to himself, and saw to it that at 10 p.m. the Timbermere set was tuned on Paris.

The next morning, Mr. packed his grip and left for Paris—Direct Action in every swing of his umbrella. He

reached the Quai d'Orsay at 4.30, just in time for tea with the French Foreign Minister, who was sympathetic with Mr. Timbermere—so far as language would permit—and by no means backward with his lump sugar.

But he just couldn't get Prettyman's drift. "You ask me to put down my foot with a firm hand?" he said. "But why? We of France do not ask you of England to look over at our programmes. And as to scandalising your nation, is it not your nation that comes in huge hordes to attend our music-halls?—that makes them pay?"

"That is not the point," said Prettyman, "I saw them in '20. But that is not to say that all my countrymen—and women—should see them at the turn of a switch."

The argument became tangled as the moments passed, and references to Waterloo, and even Agincourt, were dragged in. Then it became warm. Then heated. Finally, it boiled over. And at this point it was that the flagstone in the Quai d'Orsay became cracked, due to the precipi-



*Mr. packed his grip and left for Paris.*

tate arrival thereon of Mr. Timbermere from a third-floor window of the French Foreign Office.

The visit might therefore be described as rather moribund, but—and this is the point—*It may very well have to be repeated.*

THE WHOLE PROBLEM OF SYNCHRONISING—II

# METHODS OF HOLDING THE PICTURE STEADY

By T. S. Roberts



*This is the second of two articles dealing with the problem of synchronising. The first one published last month explained the requirements and here are details of several practicable schemes.*

**L**AST month it was shown how the present semi-automatic synchronising system works; also why it is not always successful. After perhaps a little adverse criticism, an easy thing to do with most things, we should examine what alternatives are offered to us.

The obviously best method is to use the same A.C. mains that drive the transmitter, the mains at Broadcasting House, according to various sources of information, are those of the Marylebone Borough, and anyone living in the London district should inquire if their

along the time base and may appear divided by the synchronising signal, the bottom of the picture appearing on the top, with the top of the picture underneath.

This effect may also happen if the load in the district suddenly becomes more or less inductive or capacitive, though this is not a very likely occurrence in an average residential district. It must be mentioned, however, that though an A.C. grid system is advocated to cure all the problems of synchronisation in television, it is doubtful if it will be suitable for high-definition pictures.

Suppose mechanical reception of, say, 180-line pictures was attempted, which would mean one line would equal two degrees of rotation, the limit of "hunting"

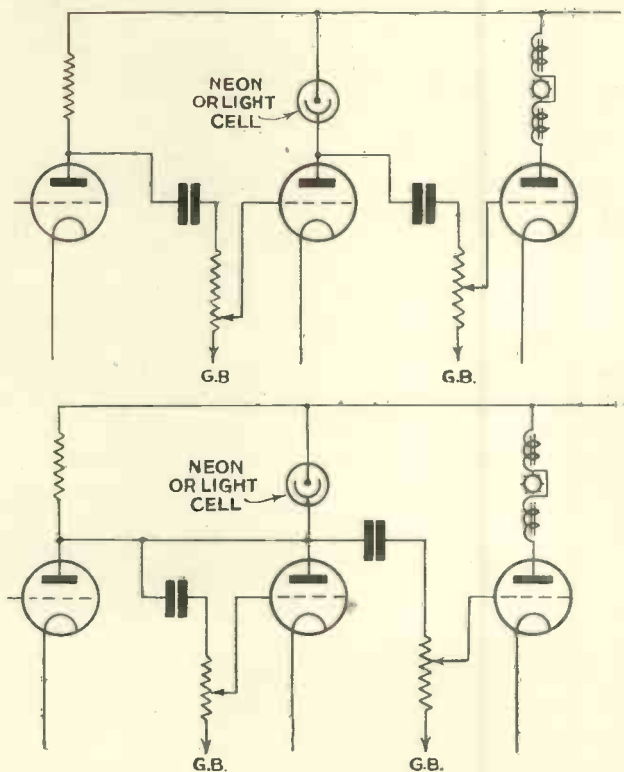
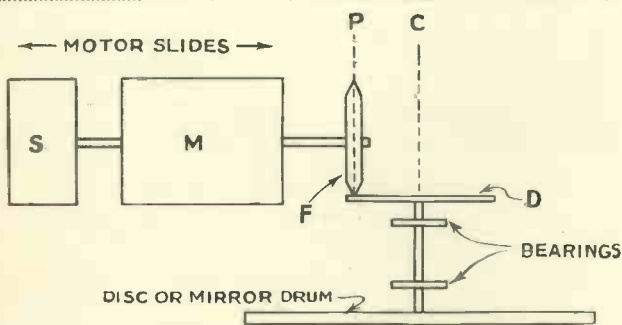

*Fig. 2.—It is desirable to have separate volume controls on the output valves for feeding the synchroniser.*

would have to be .1 to equal .75 degree, the limit on a thirty-line picture, though to offset this a correspondingly greater number of pulses are available to govern the receiver.

## Mains Synchronising

Most mains nowadays are frequency controlled A.C., and though not interlocked with those used at the



*Fig. 1.—An effective variable speed device for the motor.*

mains are connected with those of Marylebone, as so many systems are now interlocked in the grid scheme.

If so, it is plain sailing; all that is required is a synchronous motor to run at the required 750 revolutions per minute. With such a motor it will be advisable to mount it so that the whole motor can be rotated, otherwise there may be some trouble in getting the pictures in frame; also, as pointed out last month, when the view point of the transmitter is altered, the whole picture has either been advanced or retarded

## SYNCHRONISING FROM THE SIGNAL

transmitter, are in themselves quite steady enough to be used to run a receiver, though one must be prepared for a slow acceleration or retardation.

Such variations will be very slow, and, of course, may happen at either the transmitting or receiving end. To overcome the difference in frequency of the two mains an ingenious system has recently been put on the market by the Plew Television Co.

It consists, see Fig. 1, of an ordinary universal motor

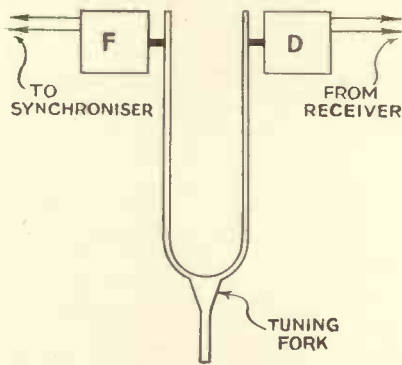

Fig. 3.—A scheme using a tuning fork for supplying the 375-cycle impulses.

M, which is fitted to an 8-tooth wheel and pole-pieces, S, very similar to the 30-toothed synchroniser. On the other side of the synchronising unit is a fibre bevelled wheel, F, which makes a frictional contact on D at the point P, the movement of rotation is transferred to D, which is mounted on the same shaft

as the disc or mirror drum.

Now if the diameter of F is equal to twice the radius of PC, D and F will rotate at the same speed, on the other hand an increase or decrease of the radius of PC will either cause D to run faster or slower.

To effect the alteration of the radius PC, the driving motor is on sliders, and its position can be adjusted. Thus though the speed of F is controlled by the A.C. mains by S, the final speed of D can be adjusted to that of the transmitter.

Of course M could be a synchronous motor, though it is not easy to build a single-phase, self-starting motor, of small dimensions and power.

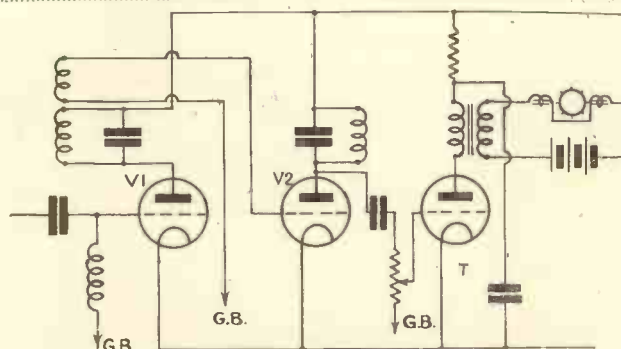

Fig. 4.—A circuit employing a valve oscillator for providing the correct synchronising frequency.

Those readers who are commencing television reception and have frequency-controller A.C. mains are advised to try using the mains for synchronisation.

### Synchronous Motors

It should also be noted that there are a few makes of synchronous motor on the market in the form of

gramophone mechanisms, which, though they generally run at 1,500 r.p.m., could be quite easily adapted to the system developed by the Plew Company.

Turning again to the system of synchronising from the signal itself, let us investigate how we can improve the results.

First of all we must not forget that the average driving motor requires some 25 watts to operate it, while we rarely get as much as 2 watts A.C. output for the synchroniser.

The driving motor should be designed to run at constant speed of about 800 r.p.m. Only too often a motor designed to run at about 4,000 r.p.m. is used, current being supplied through a resistance which gradually changes its value according to its temperature, the result is a varying voltage across the motor windings and in consequence varying speed. Mains supply for driving the motor is not ideal as there are large areas where the voltage variation is in excess of the Board of Trade limits, and even these are too wide for really satisfactory results. In all cases an accumulator is best. The motor should be shunt wound, the manual control being by means of a rheostat in the field winding.

### Signal Synchronising

With regard to feeding the strip or synchronising frequency into the synchroniser, this should always be done from a separate valve (or valves) other than that, which is modulating the light source, as considerably more power is required in the synchroniser. Also it is advisable to have separate volume controls on the two groups of output valves (see Fig. 2).

As explained last month the reliability of the 30-tooth wheel synchroniser really depends on the characteris-

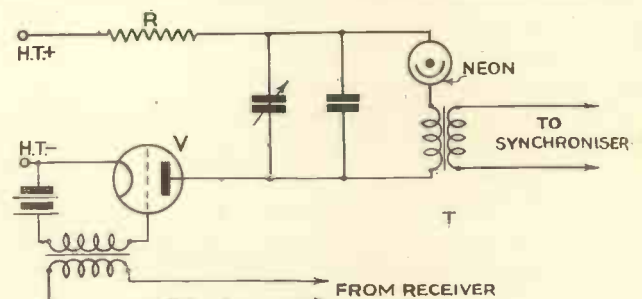

Fig. 5.—Circuit of relaxed oscillator.

tics of the television signal and various experimenters have displayed a certain amount of ingenuity in trying to overcome these varying factors.

### Tuning-fork Control

One method which can be used with a fair amount of success is that of using a mechanical buffer or filter which will only allow the necessary 375 cycles to pass. Fig. 3 is the elementary circuit of such a device. The signal is applied to the driving coil D which drives the tuning fork, which is tuned to 375; this in its turn, either by a "make-and-break" or magnetic system,



## VALVE SYNCHRONISING SYSTEMS

produces a signal in F, which is duly amplified and applied to the synchroniser.

The effect of the fork is to vibrate at the strip frequency, its (the fork's) natural frequency; owing to its inertia it ignores any secondary synchronous impulse, and therefore only passes a pure synchronising impulse. The impulses produced at F from a "make-and-break" are to be preferred, as they are more like

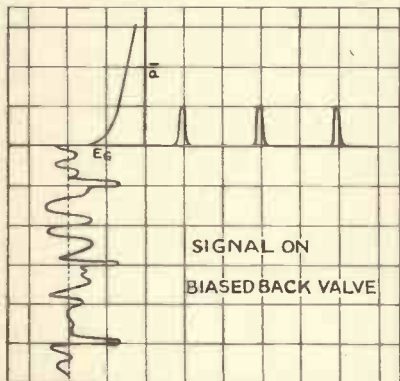

Fig 7.—Signal on back-biased valve.

the original impulses, for which the toothed wheel is designed.

The fact that the strip frequency may slightly vary, according to the periodicity of the mains driving the transmitters, can be accommodated as the variation is likely to be so slight that the fork will follow them.

### Valve Control

Another method is by substituting a valve oscillator for the tuning fork (see Fig. 4). (K. S. Davies, B.Sc., and E. C. C. White, B.A., TELEVISION, December, 1933.) V<sub>1</sub> is a simple valve oscillator with the anode tuned to 375 cycles. The television signal is applied to the top of the grid coil, this driving the oscillator at the exact frequency. The output is taken from a coil coupled to the anode coil, and applied to the grid of V<sub>2</sub> which is a tuned amplifier, the output of which triggers a thyatron T. Thus regular impulses are applied to the synchroniser, which is best wound to a lower impedance and fed via a transformer of suitable ratio.

This device could also be made to give impulses of the desired frequency and of fairly suitable wave-form by using an ordinary triode, biased back, in the place of T, though in this case the impulse to the synchroniser would vary somewhat in power according to the input signal, which is undesirable, as the basis of good synchronising is a control of constant power.

Another rather similar device, very familiar to cathode-ray receivers, is that of the relaxed oscillator. The theoretical circuit is shown by Fig. 5. It will be

at once realised that it is our old friend the "popping" neon—with additions. The values of R and C are chosen to give a popping frequency of, say, 370, something a little less than 375, with the bias on valve V so adjusted as almost to cut off any anode current. Along comes the synchronising impulse which is applied to the valve V, lowering its impedance, the voltage very rapidly rising across the condenser, which discharges through the neon via transformer T.

Actually the input to V can be filtered or, as previously described, fed through an oscillator. It is a cheap circuit to try out compared with that using a mercury vapour relay. It may, of course, be desirable to amplify the output of T. Unfortunately there is no device which may not be influenced by secondary synchronising impulses.

Obviously the best method would be to insert a signal at the end of each strip of a definite power, which would be so arranged as always to be higher than the picture signal. Such a signal would appear something like Fig. 6 in the case of the broadcast 30-line system.

Such a method has been used in America (see Proceedings of the Institute of Engineers, December, 1933) though with the addition of an impulse between each picture as well as between each strip.

The method of filtering the required impulse from a signal such as Fig. 6 is a valve biased back, followed by the necessary amplification. One objection to such a system is that when one comes to modulating a car-

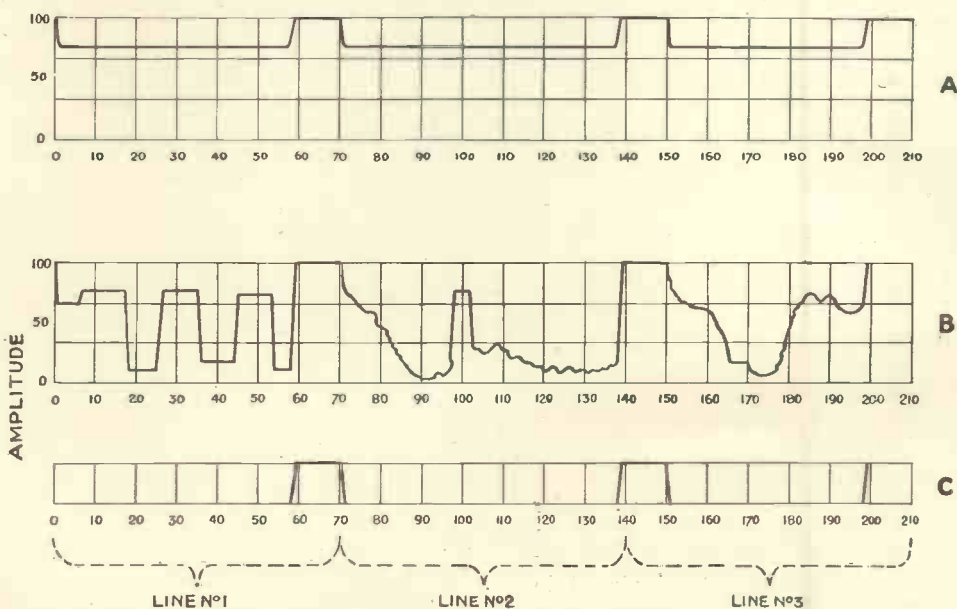

Fig. 6.—(A) Three lines of white blank screen with synchronising impulse. (B) Line 1, series of black and white lines; Line 2, a high light on a dark background; Line 3, top and bottom high lights with dark space between. (C) A and B after passing through a back-biased valve.

rier, the picture signal will not cause very deep modulation owing to the more excessive modulation of the synchronising impulse.

# THE REASON FOR MULTIPLE PICTURES

*An explanation of the curious effects sometimes produced on the television screen.*

IT appears that some lookers-in have been somewhat puzzled by receiving more than one face of a lovely lady—in fact the sole act has become a twin or even quadruplet one. This freakish reception is due to the receiver running at half the speed of the transmitter. Let us see

to left. This is because the line traverse is in that direction, the spot moving from the bottom to the top of the picture. Fig. 2 is that of a receiving screen, the section B being the bottom half and U the upper.

Now we will assume that both transmitting and receiving scanning spot begin to scan line "1" together, but as the receiver is going only half as fast as the transmitter, it will only have reached as far as 35, while the transmitter will have done 70 and while the receiving spot travels from 35 to 70 the transmitting spot has travelled along line No. 2 and therefore line 1 of the receiver receives the signal from lines 1 and 2 of the transmitter, with the obvious curtailment of size of the received image in the vertical direction.

### How the Multiple Pictures are Produced

Note that the two synchronising bars on the receiver screen are half

the height of that of the transmitter. It is not till we get to the sixth line of the transmitter that we start to transmit the letter "T," which, if we follow things out, will be found to be produced on the upper half of line 3 in the receiver, while it is not until line 4 that any T appears in the bottom, which is, of course, produced by line 7 at the transmitter.

The whole action can be quickly followed by the aid of the figures on the top of the upper and bottom of the bottom halves, marked transmitter, these numbers, of course, repeating themselves for the lines 16 to 30.

It will be noticed that the vertical section of the T is four lines wide in the transmitter, while in the received picture it is only two. With a very little thought the reason for this will be obvious.

In Fig. 2 the quadruplet effect is shown, the twin act appearing when the framing is such as to have two T's side by side in the middle, with the upper halves of two T's below and the bottom halves above them.

The letter T was chosen as a simple design. Those who wish can work out any pattern on squared paper with ease. In conclusion, the multiplying effect is increased at speeds of  $\frac{1}{3}$ ,  $\frac{1}{4}$  and so on.

The Kerr cell was named after its inventor Kerr, who was an English teacher in a technical school in 1875. He discovered that when polarised light passed through nitro-benzine or other highly refractive material when under an electric pressure, the plane of polarisation was twisted. Kerr took little notice of this effect (known then as the Kerr effect). It was left to Röntgen, the well-known X-ray scientist, and Quinche, a physicist, to develop the idea. Later it was used by Karolus for his picture telegraphy experiments.

The Ministry of Communications at Tokio has decided to open an experimental laboratory with a view to the study of the various television systems. Later, it is hoped to establish a regular service in connection with the broadcasting stations.

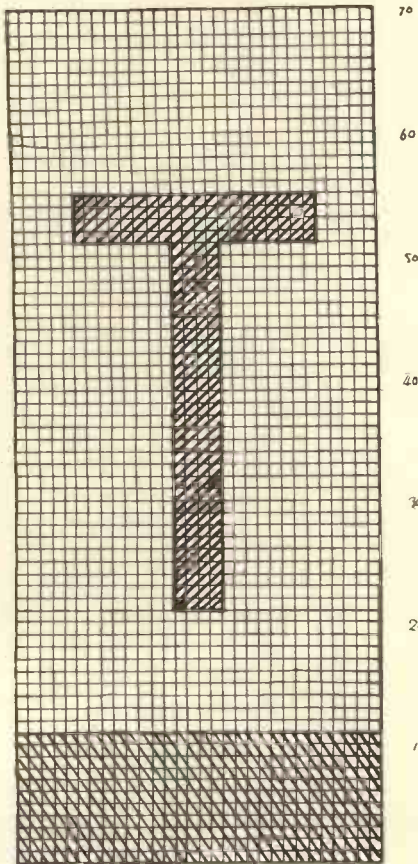

Fig. 1.—The transmission of a simple image showing the order and direction of scanning.

the whys and wherefores of this multiplying effect.

In Fig. 1, which, like Fig. 2, has been drawn on squared paper in order to make the explanation easier to understand, we have the transmitting screen with a letter "T" placed in the centre; the synchronising black-out bar is also included. The Baird picture ratio is 7 by 3, but as this includes the synchronising signal the actual picture is approximately 5.9 by 3.

It will be noted that the scanning lines—30 in number—read from right

70  
60  
50  
40  
30

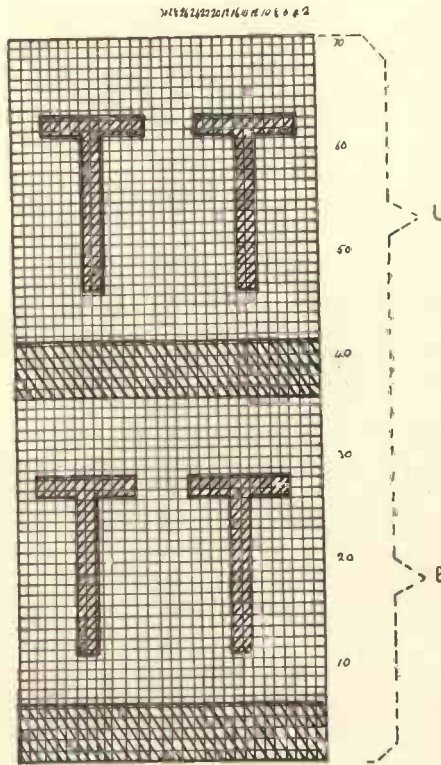

Fig. 2.—Diagram showing the production of multiple images on the receiving screen.



## REVIEWS OF THE PROGRAMMES AND RECEPTION REPORTS

SOME weeks ago the B.B.C. received notice that direct current could no longer be supplied to the building which houses the studio. Broadcasting House and other premises around had long been supplied with the alternating variety and number sixteen Portland Place must at last change over. The difficulty was that the arc in the projector would not stand up to the ripple which A.C. would produce, so the engineers have installed a motor generator in the basement. Power is taken from three-phase A.C. and the plant generates D.C. at 110 volts for the arc and all lamps in studio and control room. It was first used for the programme on November 17. A controlling rheostat is part of the equipment and the motor in the basement can be started or stopped from a desk beside the projector by pressing green or red buttons.

While at Broadcasting House the arc drew its power from the emer-

gency lighting batteries which are part of the permanent equipment of the building.

Another development of the month was the introduction of a revolving caption machine, by which twelve pictures can be scanned in turn by the miniature transmitter. This piece of equipment resembles the ammunition drum of a Lewis machine gun and it is rotated by hand when drawings and captions have been dropped into its twelve exterior slots. Its speed is regulated to suit the programme and I thought that it was most effectively used on the Japanese night when we watched a passing panorama of temples, houses and trees, while Gounoske Komai talked. No such smooth sequence would have been possible with the old system, which worked on the double frame principle used in magic lanterns. Facilities for presenting more drawings produces a demand for pictures of this kind and I expect to see a good

deal more of this cinematic effect again.

\* \* \*

By the way, have you noticed that whenever one dancer leaps on to another the beam is always focused on the stationary figure? At rehearsal the other day the producer tried swinging the beam across the studio following Juanita as she leapt upon Juan. This method was not so effective. She arrived before the light.

\* \* \*

Mrs. Mulberry and Mrs. Big Wood, to use the English equivalents of their Japanese names, made charming studies in their native dress, and it was interesting to hear their songs, but a little of the samisens, that doleful guitar-like instrument, went a very long way with me. Yeichi Nimura danced with tremendous verve and the whole programme was remarkable for its novelty.

\* \* \*

It is clear that the flickering shaft of light does not illuminate all that there is to see in the television studio. Cupid has evidently been darting about *behind* the lens, for my visor has given no hint of the romance which is now made public. Jean Bartlett and H. Thornton Bridgewater were married one Saturday in November. It was their work in the studio that brought assistant producer and television engineer together and lookers will join me in wishing them every happiness and the best of luck.

Mr. Bridgewater is already back at the scanner and, though Miss Bartlett has left the B.B.C., I hope that she will find time to visit the studio. In the producer's absence she has presented many successful pro-



*A Scene from the "Gods Go A-Begging" ballet which was repeated last month.*

grammes and we shall miss the feminine touch which has been invaluable in matters of costume and make-up.

Robin Whitworth, producer in the North Region, is coming to town to assist Eustace Robb in the new year.

\* \* \*

Scenes on the backscreen are usually painted boldly in black and pictures in my visor have sometimes suffered in definition as the result of an over-elaborate design. The backcloth itself has made an excellent picture; but images have become slightly confused as figures have moved about in front of it. It was so in the earlier performance of *The Gods Go A-Begging* ballet, which was repeated during the month. For the last performance the backcloth had been repainted in green as an experiment. With this treatment the scene appeared on the screen as a grey background against which the costumes of the cast were seen quite vividly.

They were trying to locate beams in the ceiling of the studio when I arrived for rehearsal yesterday. Harold Scott is singing "The Man on the Flying Trapeze," and with any luck we shall see him "float through the air with the greatest of ease" while he gives the number. Harold Scott has often sung this old favourite which was as popular around 1870 as it is now, though many listeners mistake the song for a new number. I hope that beam is strong enough to carry the trapeze.

\* \* \*

Eustace Robb made one of his rare appearances before the projector in order to introduce John Hendrik, who was taking the place of Maurice Elwin. The producer makes a good picture and I wish that he could be persuaded to work more often in the beam. This time he was there to tell the story of *Kleine Möwe*, a song about seagulls which John Hendrik was to sing. Eustace Robb heard the number in the Winter

Garden Theatre during his recent visit to Berlin and the result was this performance. After the programme both Tessa Deane and a music publisher who was listening for Maurice Elwin, rang up to congratulate singer and producer on the song.

\* \* \*

Eddie Windsor's fall down the stairs on his skates was a trifle too quick to be fully effective on my screen; but with Eric Barker dressed as a maid singing "Miss Otis Regrets," and Gordon Little, the new radio star, televising for the first time, I count this one of the best light programmes of the month. Another bright show was given one Saturday when Eve Becke and Iris Kirkwhite came along. Iris is one of the most graceful "popular" dancers who appear in the studio. It was bad luck that she hurt her leg in Australia while playing Claire Luce's part in *Gay Divorce*, and I was glad to find her dancing as well as ever.

## THE TELEVISION COMMITTEE IN GERMANY

REPRESENTATIVES of the Postmaster-General's Committee, including Mr. O. F. Brown (Dept. of Scientific and Industrial Research), Mr. A. J. Gill (G.P.O. Engineering Dept.), Mr. H. L. Kirke

(representing the B.B.C.), and Mr. G. Varley Roberts (the secretary of the Television Committee) arrived in Berlin on Monday, November 5, in order to study development in Germany. They were received on Tues-

day by Ministerial-direktor Giess, well-known in international post office circles as head of the German delegation to the Madrid, Lucerne and Lisbon conferences.

On Wednesday morning they visited the television laboratories of the German Post Office and under the guidance of Postrat Dr. Banneitz they were shown the television film scanner and the twin ultra-short wave television transmitters for sight and sound broadcasting.

The remaining period of their stay was occupied by visits to the television department of the Reichs-Rundfunk-Gesellschaft (the German broadcasting company) and to the various German firms interested in the development of television.

Mr. O. F. Brown expressed his and his colleagues' great appreciation of the manner in which they had been received by official and private persons in Germany. He also remarked on the orderliness and efficiency of the German laboratories. He pointed out to our representative that the technical problems of television were much the same on both sides of the Channel. He remarked that German television had, in his eyes, reached a very high standard, but was unable to make any statements regarding equivalent values in Britain and Germany.



Representatives of the Postmaster General's Committee visit the German Post Offices laboratories.

# A 10-METRE VISION RECEIVER

*This article describes the construction of an ultra-short wave receiver with which the experimental high-definition transmissions can be picked up.*

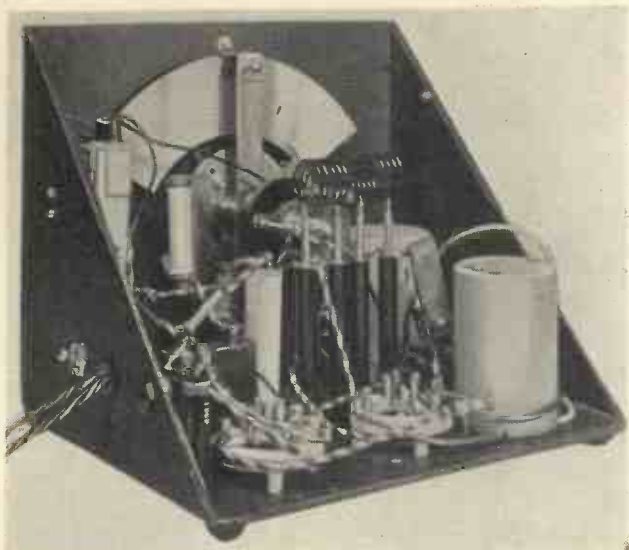

*The construction of the receiver is unique as this photograph shows*

UNTIL quite recently the most popular receiver for ultra-short or quasi-optical waves has been the super-regenerative type. This does, however, suffer from serious defects and except for Morse reception is not really worth considering.

Experience has proved the super-het is more suitable and would be very much more popular than the super-regenerative, except for the fact that the few amateurs who have tried their hand at it have not been very successful.

Admittedly, the super-regenerative is the most simple set for the ultra-shorts if you are not very particular about the results obtained. A high pitched whistle, limited range and poor quality are only a few of the defects.

The super can be arranged to give reasonably good frequency response, without going to extremes with the intermediate-frequency and the number of stages used.

To try to use the conventional 126 or 110 kilocycles is asking for trouble. The gain will be high but as a general rule stabilising will take away most of it.

As it seemed rather a waste of space, time and money to have three separate receivers for the 5, 7.5 and 10 metre bands, it was decided to use three sets of coils to cover these bands. These were obtained from Stratton's.

The results exceeded expectations. The three bands were received more or less in the centre of the tuning scale and could be covered with the greatest of ease. This meant that

the receiver could be used by amateurs on the five and ten bands or for the experimental television transmissions which are now being sent out. The Baird vision transmissions from the Crystal Palace take place at all odd times of the day and night on a wavelength of about six metres.

## **Building the Receiver**

Well, take a look at the receiver. There is not a blueprint, for anyone who is interested in the ultra-shorts will be able to make it up from the theoretical circuit and the photographs and large-scale drawing.

First of all do keep to the layout. You may be able to make it look more pretty, but the best layout for the maximum efficiency is the one used.

The metal box, obtained from Stratton's, is already drilled to take the tuning drive and escutcheon. There are two other holes on the front but as the metal is so soft you can easily drill them.

All the components, except for a few condensers and resistances, are bolted to the baseplate. There is no need to

use a baseboard. You will have considerable difficulty in getting all of the components in the proper place unless you start in the right order, then you will be surprised how simple it all is.

First of all clamp down the tuning drive and on to its spindle the insulated coupler. This coupler is of the semi-flexible type and very useful too, for if your drilling is a little out, the error can be taken up with this.

Then fix the bracket for the tuning condenser. This bracket has a metal fixing plate but is itself made of ebonite. The chassis is not relied upon for the earth connection.

Make quite sure that the condenser fits snugly but do not leave it in position at this stage for it takes up too much room. Next comes the coil mount. This is fitted close to the end of the condenser so the grid wire is short. Before fitting perman-

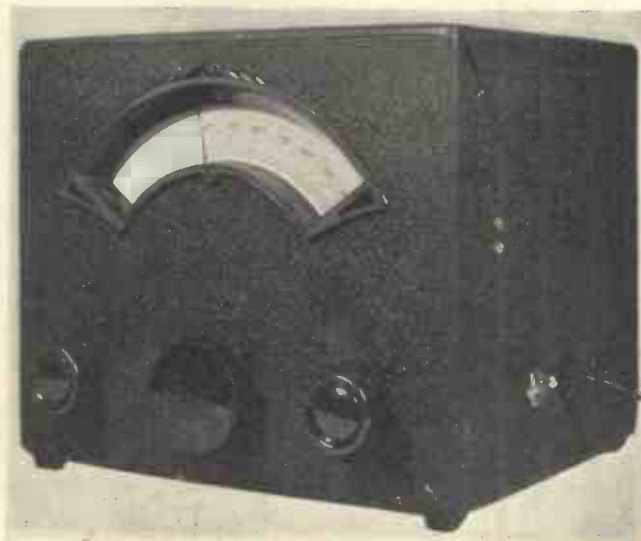

*A photograph of the complete receiver; the case is entirely metal.*

ently make sure that you have left room for the detector-oscillator valve-holder, *with the valve in it*. You may have trouble here for the back of the cabinet slopes, so be careful to check up on this.

It is an easy matter to drill the holes for the oscillator condenser and the variable resistance in the anode

sure the lid does fit without touching any of the valves.

## Wiring

Wiring is simple enough, but do it in some sort of order. Start off with the components on the panel for they will be hard to get at later. Then tackle the coil connections followed

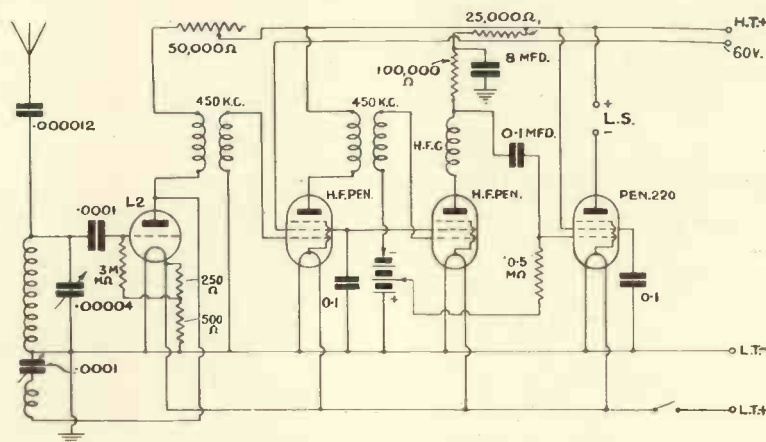

The circuit of the 10-metre receiver.

of the first valve. These components should be mounted next. You will want a small bracket for the grid-bias battery. It just fits in on the right-hand side of the cabinet above the second detector valve.

After that most of the ticklish jobs have been done. Try your hand on the second detector valve-holder and the intermediate-frequency coil that feeds into it. These are quite easy to get at. Make quite sure the blue lead of the second coil comes out facing the intermediate-frequency valve, this makes the wiring neater.

The cabinet must be carefully scraped free of all coating before the earth terminal is fixed. This is the only contact that relies on the case for connection.

Go over to the other side of the cabinet and drill the holes for the loud-speaker jack, on-off switch and bush for the battery leads. The coupling condenser between the detector and pentode valve should also be fixed.

There remains only the detector-oscillator, pentode valve-holder and the first intermediate-frequency coil. Please yourself how you put these in. It is perhaps a good idea to leave them for a while and do a little of the internal wiring first. The volume control is hard to get at when everything is in place. Put all the valves in their proper sockets and make

by the second detector valve-holder and associated wiring.

Connecting the intermediate-frequency coils is easy for they are fitted with flexible wires. The blue ones go to the anode of the preceding valves while the red goes to high-tension. Both white wires are connected to the grid of the valves following; the negative side of the coils are coloured black.

Make sure the decoupling condenser in the anode circuit of the second detector valve is connected the right way round. This is an electrolytic of a new type and is rated to work with up to 150 volts high-tension. The negative side, of course, goes to earth while the positive is joined to the junction of the 100,000-ohm anode and 25,000-ohm decoupling resistances.

So that you can get the hang of

## CABINET

1—Eddystone, type 974

## CHOKE, HIGH-FREQUENCY

1—Eddystone, type 947

## COILS

1—Set Eddystone, type 977 with stand

## CONDENSERS, FIXED

1—Eddystone .000012-mfd., type 922

1—T.C.C. .0001-mfd., type tubular

1—T.C.C. .1-mfd., type 95

2—Franklin .1-mfd., type tubular

1—T.C.C. 8-mfd., 150-volt working, type electrolytic

## CONDENSERS, VARIABLE

1—Eddystone .00004-mfd., type 900.

## DIAL, SLOW-MOTION

1—Eddystone, type 970W

## HOLDERS, VALVE

1—Eddystone, 4-pin, type 949

1—Eddystone, 5-pin, type 950

2—W.B., 7-pin, type baseboard mounting

## PLUGS, TERMINALS, ETC.

6—Clix, wander plugs, marked: H.T.+1, H.T.+2,

H.T.—, G.B.—1, G.B.—2, G.B.+

1—Metal terminal 4BA (Peto Scott)

2—Clix spade terminals, marked L.T.+ , L.T.—

1—Igranic single open circuit jack

1—Clix all-in-one socket and plug, marked: Aerial

1—Igranic phone plug

## RESISTANCES, FIXED

1—Franklin 250-ohm, type 1/2-watt

1—Franklin 750-ohm, type 1/2-watt

1—Franklin 20,000 ohm, type 1/2-watt

1—Franklin 100,000-ohm, type 1-watt

1—Franklin 1/2-megohm, type 1/2-watt

1—Franklin 3-megohm, type 1/2-watt

## RESISTANCE, VARIABLE

1—Erie 100,000-ohm

## SUNDRIES.

1—Eddystone insulated bracket, type 971

4—Clix top cap connectors

4—Yards thin flex (Goltone)

Connecting wire and sleeving (Goltone)

## SWITCH

1—Bulgin on-off, type S80

## TRANSFORMERS, Intermediate-Frequency

2—Eddystone, type 974

## VALVES

1—Mazda L2

2—Mazda SP215

1—Mazda Pen 220

the whys and wherefores, here are a few details about the circuit. The aerial is fed into the grid of a triode valve through a minute fixed conden-

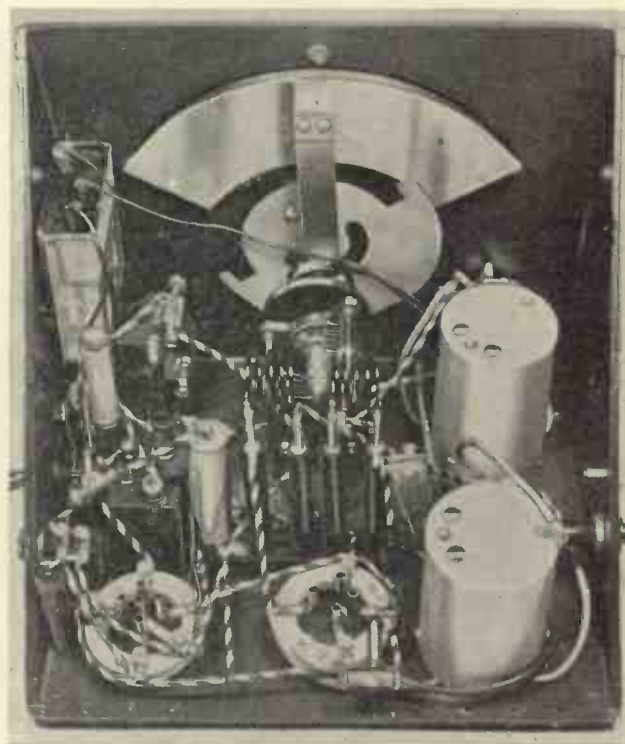

This rear view shows the central construction.

ser of .00012 micro-microfarads which effectively removed any damping the aerial might impose on the grid of the detector-oscillator.

This detector-oscillator works as an autodyne of conventional design and feeds into a bandpass intermediate-frequency coil with a tuned primary and secondary. The fundamental frequency of this coil is 450 kilocycles.

This frequency is just about right to give stability, stage gain and a wide band width. A higher frequency would be better if higher definition is wanted, but this would mean a second intermediate-frequency stage to make up for the loss in stage gain.

The valve in this stage is a high-frequency pentode giving enormous amplification. A second valve of this type is in the second detector stage. It works as an anode-bend detector and is resistance-capacity-coupled to the output pentode so gives good quality with maximum volume.

Although a small pentode in the output stage is specified, if you want to use a loud-speaker, a valve

such as the Mazda Pen 220A can be substituted, but remember that the grid bias will have to be increased to about 16 volts.

This type of valve should not be wanted, for the small pentode will modulate a cathode-ray tube quite nicely. If you want to use mirror-drum equipment the output should be a triode valve and fed into a large amplifier.

### The Coils

Buy the Eddystone coils and you cannot be in doubt as to the wavelengths covered. If you make the coils be careful about the diameter and spacing. Use this as a basis for them. Both coils must be wound on a former that will give a diameter of  $\frac{3}{4}$  in. when the coils are allowed to spring off.

For the grid coil wind on five turns of 18 gauge wire and solder the ends on to two Clix plugs. The gap between the turns should be about  $\frac{1}{8}$  in. The reaction coil is identical except that the spacing between turns is re-

duced to  $\frac{3}{32}$  in. That is for the five-metre coils.

For the 7.5 metre band increase the diameter to  $1\frac{1}{2}$  ins. On ten metres use  $1\frac{1}{2}$  in. coils but nine turns for the grid coil and seven for reaction.

The quickest way to calibrate the receiver is to pick up the harmonic of a 20-metre station which can be obtained from the usual short-wave super. This will give exactly 10 metres. The same methods can be adopted for the two other bands.

As regards the required voltages. Apply 150 to the maximum tapping and 60-90 to the screen tap. The voltage on the first-detector anode is very critical but this can be obtained by using the variable resistance in the anode circuit of that valve. Finally, you will find the grid bias to the anode-bend second detector is critical. The correct value will cause the volume to rise very appreciably.

A word about the aerial to use. If you slip up here the receiver will be useless. The most satisfactory is a conventional di-pole. This should be roughly tuned to the band you wish to work, but as in this case there are three bands a different system has to be employed.

Tune the aerial to 5 metres. Make each half of the tap about 16 ft. 3 ins. with down leads of about the same length.

On the 5-metre band it will work as a full-wave aerial while on the 10-metre band it will be half-wave.

Now about the 7.5 band. It is quite a sound scheme to tune the feeders with a small .0005 condenser which can be cut out of circuit when not required.

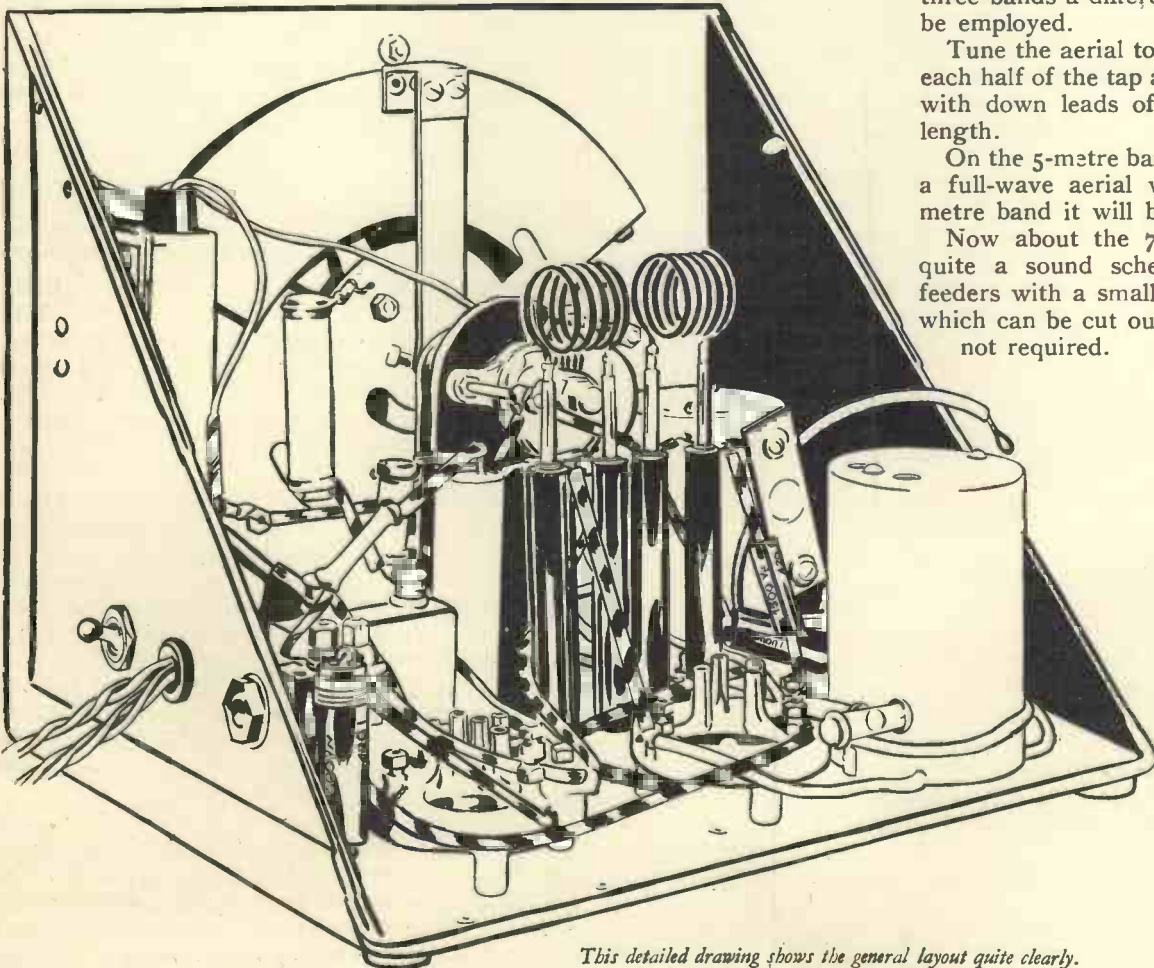

*This detailed drawing shows the general layout quite clearly.*

# A TELEVISION SERVICE FOR GERMANY

FIRST AUTHENTIC DETAILS—  
EXCLUSIVE TO THIS JOURNAL

**I**N view of a number of conflicting and exaggerated statements in the daily Press the German Post Office has issued an official communiqué regarding the present television position in Germany.

The Post Office laboratories, under Dr. Banneitz, have made experiments to determine the range of the Berlin ultra short-wave sight and sound transmissions. It has been possible to receive these at sufficient strength on the summit of the Brocken in the Harz mountains, that is to say, a distance of about 140 miles (200 kilometres), from Berlin. Reception on the Brocken is sufficient to provide modulation for a second ultra short-wave transmitter which could be erected there. Taking the height of the position into consideration, an ultra short-wave transmitter on the Brocken would have a range of from 100 to 150 kilometres and could thus provide important towns such as Hanover, Braunschweig, Magdeburg, Kassel and Erfurt with television reception.

The Post Office has ordered a transportable television transmitter which will first be put into operation on the summit of the mountain next summer.

## Line

### Transmission

Experiments with an entirely new type of cable are about to be made. A short length of cable is at present being laid in Berlin for practical tests. If these prove successful it would be possible to connect television transmitters by cable. It would also be possible to provide two-way television communication between two cities such as Munich and Berlin. As the cost of such a cable would at present be 8 million marks there is no possibility of such a service being opened for some years to come.

So far the official communiqué. Our German correspondent has been able to obtain independent information as regards the position in Berlin.

He interviewed Dr. Kirschstein, the head of the television department of the German Broadcasting Company. Dr. Kirschstein, who had just received the visit of the members of the British Television Committee, who were in Berlin at the time, told him that the morning and afternoon sight and sound television broadcasts would continue to be provided by the Post-Office as they were purely experimental and mainly intended for the laboratories.

A period of one hour in the evening from 9 to 10 p.m. is to be reserved for an experimental service intended for a larger public. It will be necessary for programmes with definite entertainment value to be provided for this. The R.R.G. intend supplying these as, in all probability, the future development of television will be closely connected to broadcasting and therefore it is expedient that the broadcasting company should take up television.

Dr. Kirschstein pointed out that at the present moment it was difficult to see exactly when the evening television programmes would commence. There were a certain number of technical and organisation difficulties to be overcome. He briefly outlined the programme policy for the experimental service. The one hour in the evening will be taken up by 10 minutes special broadcast, then broadcasts of excerpts from the news reels supplied by film companies and of a shortened version of a popular film. At the present moment negotiations between the film companies and the R.R.G. are not quite complete, but it is hoped to reach some mutually satisfactory arrangement within a short time.

The 10 minutes special programme will be filmed by the broadcasters. A small news reel car of the ordinary



The ultra-short wave aerials on top of the Berlin Funkturm tower.

sound film type will be specially built for the R.R.G. and a second car will be provided for the necessary artificial light apparatus. This team of two cars will accompany the "Echo of the Day" car on its daily round and what will be called a "Mirror of the Day" will be produced for the television programme. A film taken in the normal manner will be processed in the normal manner and broadcast or rather televised in the evening.

Big events such as Hitler speeches will be handled by the special television van first shown at the Berlin Exhibition. In this case television will take place within a few seconds of the actual event.

## Studio in Berlin

At the Berlin Broadcasting House a studio is being provided where the intermediate-film television transmitter contained in the big van can be installed for the televising of short variety or dramatic scenes. But this possibility is very much of the future, as for the present it will be less expensive and equally entertaining to draw upon existing films as far as the entertainment part of the programme is concerned.

To recapitulate then: Berlin will shortly have an experimental sight and sound, high-definition, ultra-short-wave television service. Technical development will continue and

(Continued at foot of page 545.)



## THE TELEVISION ENGINEER

## MODERN PHYSICS

By J. C. Wilson,  
of the Baird Laboratories.

## AND TELEVISION RESEARCH

*Although the television engineer is not primarily concerned with pure physics, except in so far as the phenomena which constitute its subject-matter are of direct utility in his work, it has nevertheless been suggested to the writer partly from observation and partly by personal experience, that in technical matters to possess a wider physical outlook than is at the moment necessary for the job in hand is often a great advantage. This is especially so in dealing with new problems, for a very hopeful line of research may often be suggested by analogy. The value of the analogic method lies in its suggesting the probable line of finding the truth, and those with the greatest background of knowledge of physics, constituting as it were their framework of reference, are most likely to succeed.*

**I**N introducing into the following notes the discussion of relativity, quantum theory and wave-mechanics, it is not intended to convey the impression that the television engineer need consider refinements of his ordinary formulæ to take into account, for example, the additional deflection voltages required due to the "relativistic" increase of mass of the electrons in a cathode-ray tube receiver, or the possibility of no light passing through some holes of his scanning discs due to the non-divisibility of the quantum of light. There is no such direct connection between modern theory and current practice contemplated here, nor will such direct applications of these theories become necessary, at least until very much higher electron-velocities or very much more minute holes are used.

### Tendencies in Modern Physics

During the last fifty years the most remarkable changes have taken place in the outlook of physicists generally, and in that of mathematical physicists in particular. It is hard to realise now that in 1884, when Paul Nipkow was taking out his German patent for the first complete scanning disc television system, the world of physics was mechanistic to the core. The whole of all-pervading space, to use Jeans' expression, was filled many times over with aethers, the properties of which, mechanistic though their description was, were sufficiently incredible to amaze any respectable engineer.

An alternative view, it is true, was provided by Kelvin's suggestion of a contractile aether, but in this case the universe would be allied to a spider's web in that it would require a framework outside it to keep it from diminishing to a point and vanishing. The main point is, however, that there were aethers for psychic phenomena, luminiferous aethers, and aethers for the transmission of gravitational force; the physical mind—at least the English representatives of it—seemed obsessed with mechanical analogies, with the engineering outlook, and correspondingly incapable of envisaging action at a distance without some intervening medium.

Typical examples are Clerk-Maxwell and Faraday (whose "lines of force" and "tubes of electro-magnetic induction" are well-known in classical text-book

language), Kelvin (who confessed that he could not himself believe in a theory of which he could not construct a mechanical model) and Rankine (whose particular bias towards the thermodynamics of heat engines and the laws of fluid-motion perhaps makes it unfair to call him a typical physicist); Larmor alone seems to have been uninterested in whether the ether of space had a more concrete existence than merely to provide "a nominative to the verb to undulate."

Elsewhere, however, the "engineering analogue" blinkers were much less in fashion, especially on the Continent\* where such men as Gauss, Reimann and Minkowski were speculating brilliantly and developing the properties of non-Euclidian geometries entirely without reference to "intuitive" ideas about the so-called axiomatic conceptions, such as time and space. Mention must also be made of Mach, to whom reference was continually made by Einstein in his earlier writings but whose influence seems nowadays to have been more or less overlooked.

In a different sphere of physics also events were occurring which were destined to lead to drastic changes in the conception of the nature of things. The principle of the predetermination of events from initial conditions was being questioned. At the end of last century, as Sir Arthur Eddington has aptly put it,† the casual machine was running smoothly; then some mischievous person threw a bit of grit in, and the machine developed a wobble. Heisenberg has since measured the wobble one way and the wobble the other and so determined the size of the piece of grit, which turned out to be Planck's constant, about which we shall have more to say in a later article.

### The Reality of the Ether?

The main point is that serious doubts have been cast not only upon the reality of the ether but also upon the purely wave-like nature of light and, most serious of all, upon the calculability of a subsequent state of a system when everything is known about its present state. To the older type of physicist, this may seem

\* The contrast between the "engineering" and the more meta-physical types of physicist is well brought out by Jeans in his address to the Institution of Electrical Engineers (Vol. 63, 1925, pp. 483.)

† Meeting of the Physical Society, June 17, 1932.

## THE TELEVISION ENGINEER

as much of a heresy as to say that the position in a minute's time of a railway train, known to be travelling at constant speed in a straight line, cannot be calculated when its speed is known.

Heresy or not, however, the tendency in physics has increasingly since that time been to treat problems, even in pure mechanics, as statistical ones, and to give the answer to a calculation as a probability (an overwhelming probability in the case of railway trains, fortunately!) instead of an inevitable prophecy.

### Decline of the Ether; the Germ of the Newer Physics

Towards the close of the century, in America, the mine was being loaded which has since exploded with such disastrous results to classical physics. I refer to the experiment—or series of experiments, rather—carried out between 1887 and 1905 on Mount Wilson, and now known collectively as the Michelson-Morley experiment.\* Since it is with ramifications of the newer physical conception of the universe, of which this experiment was the somewhat unwelcome herald, that we have to deal in these articles, it will be as well if we take some little trouble together here at the outset to discover what was the purpose and nature of the experiment and to what conclusions it led.

The object of the Michelson-Morley experiment was to detect and, if possible, measure the absolute velocity of the earth in the universe, on the assumption that the ether of space had a real existence and was, on the whole, stationary. Now it will be clear that if light is a real wave-motion in a real medium, in the same sense as sound is a wave-motion in a real medium such as air, then the time taken by a light-wave to pass between two points on the earth's surface will depend upon the velocity of the earth through the ether (or, as some thought, the velocity of the ether through the earth). This is analogous to the time of passage of a sound wave between two points with a high wind blowing along or across the direction joining them.

In order to avoid troublesome experiments involving the actual measurement of the velocity of light in two directions (for example, radial and tangential to the earth's orbit) a clever experiment was devised to give the difference in time of travel of a light-wave in two directions at right angles without bothering to measure the actual time. The principle of this is roughly analogous to that of a swimming experiment of the following kind: a man sets out to swim across a river and back and simultaneously another man swims upstream and downstream, again an equal distance; without taking the individual times of the swimmers, but assuming that they move through the water at exactly the same rate, the velocity of the river can be calculated from the width of the river, the speed of the swimmers and the interval which elapses between their separate arrivals back.

### The Velocity of the Earth

The actual experiment was conducted with a most elaborately constructed and mounted interferometer, a

simplified sketch of which is given in Fig. 1. Light from a source passes through a slit at A and strikes an inclined surface at B, which allows part of the light to go straight through to a mirror at D and reflects part of it at right angles on to a similar mirror at C. Light returning from C is partially reflected to B again

Fig. 1.—The scheme of the Michelson-Morley experiment to measure the absolute velocity of the earth in the universe.

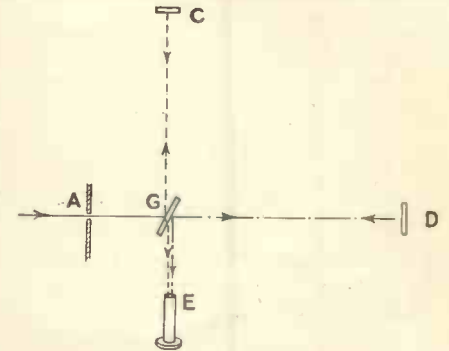

(this part going out towards A and disappearing from the system) and partially transmitted to an eyepiece for an observer at E; similarly, light returning from D is partially transmitted towards A and partially reflected into the same eyepiece.

Now the optical distances BC and BD are very carefully measured, and the interference pattern\* produced in E is aligned on a suitable scale so that motion of the fringes, indicating relative change of the time of passage of light from B to C and back and from B to D and back, can be checked and measured.

The whole system was mounted on a sandstone block and floated in mercury, and the experimental accuracy and sensitivity were such (especially in the later experiments) that the effect of a relative velocity of the earth and the ether, very much smaller than the orbital velocity of the earth (let alone the known translational velocity of the solar system with reference to the fixed stars), would have been clearly observable by turning the block through a right angle in the mercury.

### No Result

Absolutely no effect (within the limits of observational error) could be seen, however.

So startling was this result that several more or less fantastic explanations were suggested; amongst them, one by Fitzgerald, that if the ether could percolate through matter, it might give rise to a contraction in the length of the arm BD of just the right amount to nullify any effect which might otherwise have been observed, this was passed over without much attention. It is true that at the time this suggestion seemed a purely *ad hoc* supposition, not even plausible mechanically; moreover, when the experiment was repeated with wooden arms instead of a sandstone block (with the same result), it looked as though, if substances as widely different as pine and rock contracted by the same amount, the whole of Nature were engaged in a

\* For a description of this type of interferometer and of the nature of interference fringes see, for example, Preston's "Theory of Light."

\* Phil. Mag. December, 1887.

**THE TELEVISION ENGINEER**

kind of conspiracy of magic to ensure that no-one could measure true velocities!

This hypothesis, when worked out (see Appendix hereto), showed that all bodies ought to contract in the ratio of  $1:\sqrt{1-v^2/c^2}$ , where  $v$  is the velocity of the body and  $c$  is the velocity of light. In the succeeding article of this series it will be shown that this is not just a Puckishly artful contrivance, but part of and fully explained by a much bigger theory which con-

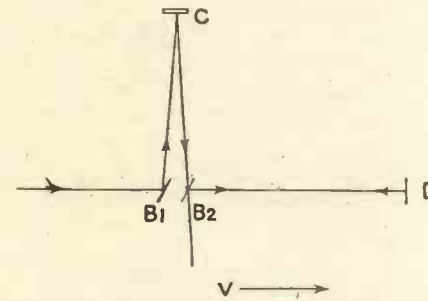

Fig. 2.—Diagram explaining the hypothesis upon which the Michelson-Morley experiment is based.

stitutes an entirely new view of Nature and of the Universe. This is, of course, the view partially contained in the Lorentz-Larmor electron theory of matter, and beautifully generalised into the Principle of Relativity by Einstein.

This preliminary discussion has of necessity been somewhat dry, and its bearing on modern physics perhaps hard to see, yet it will be apparent that it is not only difficult, but dangerous to jump into the middle of later developments before a foundation has been laid.

**“A Television Service for Germany”**

(Continued from page 542.)

next summer a second ultra-short-wave transmitter will be erected on the Brocken mountain which will receive its modulation by wireless link from Berlin. The technical development remains in the hands or rather under the guidance of the Post-Office whereas the R.R.G. will now begin to provide programmes (out of ordinary broadcast listeners' money as long as the service remains experimental). The Post-Office have decided to install public looking-in posts at various points in Berlin. The first of these, at the Reichspostmuseum in the centre of the town, will shortly be opened. The exact date of the opening of the television service is not fixed at the time of writing, but it certainly will be before the end of the winter.

Radio Löwe is at present in a position to supply cathode-ray tube receivers at the remarkably low price

of RM. 600; these receivers will be available to the general public the moment the experimental programme service commences.

**Scophony Transmitters**

Low Power and High Efficiency for Experimental Work

**R**EALISING the need for transmitting apparatus of an efficient type suitable for research purposes, Scophony, Ltd., of Dean House, Dean Street, London, W.1, announce that they can now supply high-definition film transmitters.

A special feature of the design is the low power required. Present film television transmitters available to laboratories require large arc lamps as the source of illumination and in addition the Nipkow disc is usually employed. This is a very precise and costly affair, which has to run in a vacuum and the transmitter necessarily is very cumbersome and expen-

sive. Also owing to the inefficiency of the Nipkow disc on high-definition work, the light available after passing through the film, is very small and requires a large amount of amplification. In the Scophony transmitter only a 32 watt incandescent lamp is used as the source of illumination, and the light obtainable is considerably greater than that obtained with the Nipkow disc-arc combination. This means, of course, that less magnification in the amplifier gear is required with resultant increase in performance.

Research workers and clubs should find these transmitters of particular interest; full particulars will be sent on mention of this journal.

Leybold und von Ardenne, of Koln-Bayental, Bonner Strasse 500, have taken over the manufacture of the cathode-ray oscillograph of Manfred von Ardenne.

**Appendix:**

Let  $x$  be the length of the arms (assumed equal for simplicity: see Fig. 2).

Then time taken from  $B_1$  to  $c$  and back to  $B_2$  is:—

$$T_1 = \frac{2x}{(c^2 - v^2)^{\frac{1}{2}}}$$

But time which would normally be taken from  $B_1$  to  $D$  and back to  $B_2$ , assuming translational velocity  $v$  is:—\*

$$T_2 = \frac{x}{c - v} + \frac{x}{c + v}$$

If now we assume a contraction in  $BD$  of amount  $hx$  due to the velocity, such that  $T_1 = T_2$  we must have:

$$\frac{2x}{(c^2 - v^2)^{\frac{1}{2}}} = \frac{x - hx}{c - v} + \frac{x + hx}{c + v}$$

$$\frac{2}{(c^2 - v^2)^{\frac{1}{2}}} = \frac{(x - hx)(c + v) + (x + hx)(c - v)}{c^2 - v^2}$$

$$\frac{2}{(c^2 - v^2)^{\frac{1}{2}}} = \frac{c(1 - h)}{1 - \frac{v^2}{c^2}}$$

$$1 - h = \frac{\sqrt{1 - \frac{v^2}{c^2}}}{1 - \frac{v^2}{c^2}}$$

Hence bodies must contract in the ratio:—

$$1 : \frac{\sqrt{1 - \frac{v^2}{c^2}}}{1 - \frac{v^2}{c^2}}$$

is usually written  $\beta$ .

\* For a complete consideration, taking into account the fact that the light-wave-front is reflected from a moving surface and showing that the rays combined in the eyepiece have actually the same direction, see Cunningham's "Principle of Relativity," pp. 19-20.

# RECENT DEVELOPMENTS

## A RECORD OF PATENTS AND PROGRESS Specially Compiled for this Journal

Mirror-Drum Construction :: Crystal Scanning :: Film Television :: Cathode-ray Synchronising :: Cathode-ray Tube Construction :: Cathode-ray Transmitters.

### Mirror Adjustments (Patent No. 415,404.)

In a mirror drum or similar scanning device comprising a number of lenses or mirrors, the accurate setting

For instance, in Fig. 1A, the mirrors A are held in a spheroidal groove by radial springs C. The edge of a thin disc D serves as a fulcrum about which each mirror is adjusted by hand; it is then locked in place by

in a television scanning system as an alternative to the usual rotating disc, or cathode-ray tube. As shown in the figure, a series of tourmaline crystals C are connected together and to electrodes marked T, to which a saw-toothed voltage is applied from an oscillation-generator O. The modulated rays of light from a neon lamp N, are concentrated by a lens L, on to the crystal prism formed by the group of tourmaline crystals. Owing to the effect of the voltages applied from O, the emerging ray is swung rapidly up and down the viewing screen from A to B. At the same time, the lines are traversed laterally across the screen by an interposed mirror (not shown).—(Akt. Tekade.)

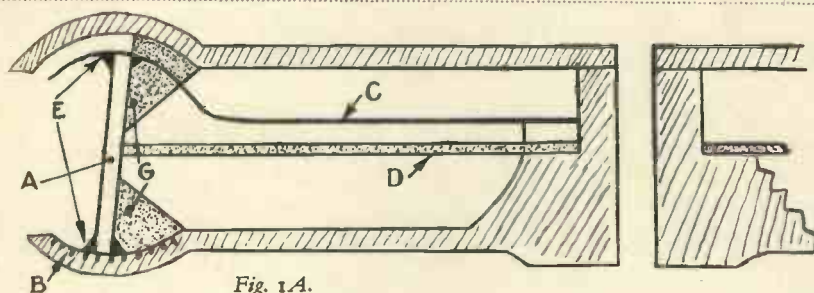

Fig. 1A.

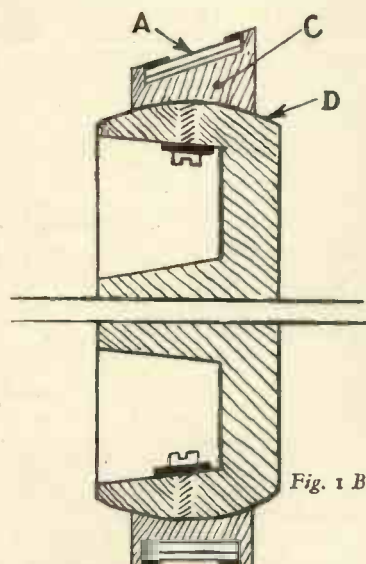

Fig. 1 B.

Methods of mounting the mirrors of mirror-drums.  
Patent No. 415,404.

of each component is often a matter of difficulty. The operation is facilitated, according to this invention, by mounting each of the scanning elements on a spherically-curved surface (which allows free movement) and cementing the mirror in position after the correct adjustment has been found.

the setting of cement E in grooves formed in the surface B. A backing G serves to resist pressure when the mirror is being cleaned. In Fig. 1B, the mirrors A are fitted in carriers C, which can be moved freely over the spherical rim of the drum D.—(D. H. Byron.)

### Scanning by Crystals (Patent No. 416,286.)

Certain crystals, such as tourmaline, change their refractive index when subjected to an electric field of force, and therefore alter the direction of a beam of light passing through them. This effect is utilised

### Television from Films (Patent No. 416,298.)

One method of televising out-of-door events "on the spot" is to take a cinematograph record by means of a camera and to pass the resulting film, after it has been rapidly fixed and half-dried, through a scanning apparatus. In this way a scene can be televised within a few seconds of its actual occurrence. At the same time it frequently happens that awkward intervals occur, between one event and the next, say, at races or other sporting fixtures for which this type of apparatus is chiefly intended. The invention consists in fitting extra

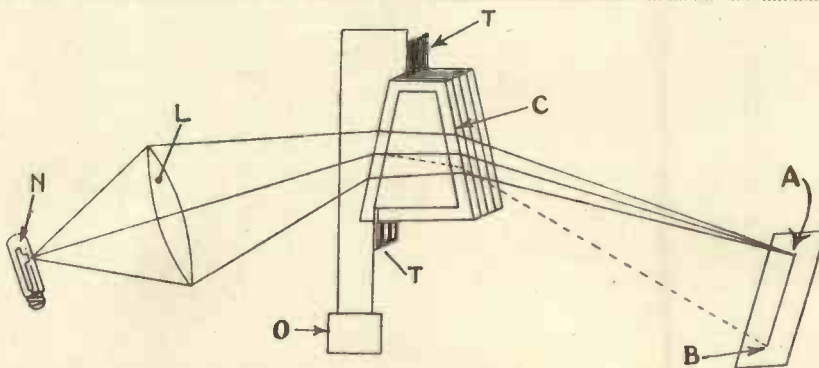

A method of scanning by the change of the refractive index of crystals. Patent No. 416,286.

chambers to take already-prepared cinema reels, which are then transmitted at otherwise quiet intervals in order to maintain a continual programme of transmission.—(*Fernseh Akt.*)

**Synchronising**

(Patent No. 416,720.)

In some systems of synchronising it is usual at the transmitting end to superpose both the rapid line-scan-

vents undesired reaction.—(*Electric and Musical Industries, Ltd., M. B. Manifold and E. C. Cork.*)

**Cathode-ray Tubes**

(Patent No. 416,043.)

In order to produce a rigid structure, not liable to be damaged in transport, the cathode is made of a thin disc D, of nickel covered with a layer of electron-emitting material. The disc is spot-welded to the top

plied to the filament. It also allows the two heating wires to be mounted so close together that the magnetic field due to the current flowing in one limb is counterbalanced by the current flowing in the opposite direction in the other. This prevents any distortion of the cathode stream by the heating current.—(*British Thomson-Houston Co., Ltd., and J. A. V. Fairbrother.*)

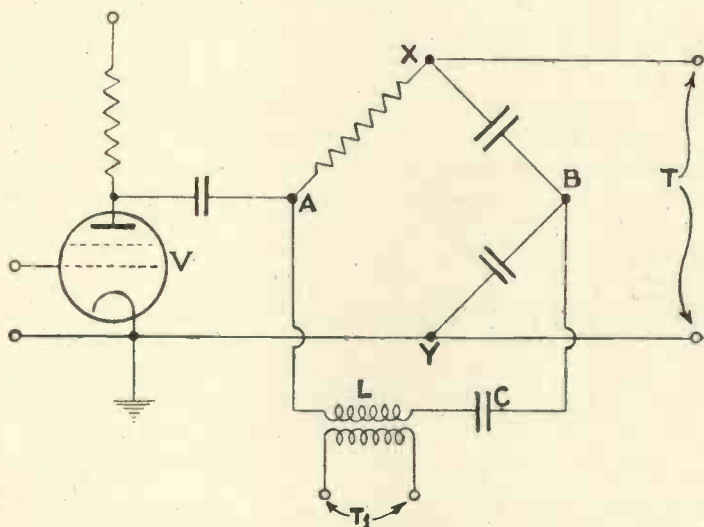

Method of synchronising cathode-ray tube receiver. Patent No. 416,720.

ning frequency (2,400 cycles) and the slower framing frequency (24 cycles) on the same carrier-wave. At the receiving end the two frequencies are separated out and applied through different saw-toothed oscillators to the two scanning-electrodes of a cathode-ray tube. In order to maintain strict synchronism it is important that there should be no back-coupling between the two saw-toothed oscillators and the common circuit from which both of the scanning frequencies are derived.

To ensure this the incoming carrier wave, containing both frequencies, is applied to the input of a valve V, the output circuit of which is arranged in the form of a balanced Wheatstone bridge. The high line-scanning frequency is filtered out across one diagonal AB of the bridge through an inductance L, and capacity C, forming a circuit tuned to that frequency, and is taken off from the terminals T<sub>1</sub>. The lower frequency is developed across the opposite diagonal XY, and tapped off at the terminals T. Each circuit attenuates the unwanted frequency, whilst the bridge arrangement pre-

vents undesired reaction.—(*Electric and Musical Industries, Ltd., M. B. Manifold and E. C. Cork.*)

loop of a nickel heating-filament F, which passes through two holes bored in a steatite insulator S, as shown in Fig. 1A. The whole assembly is

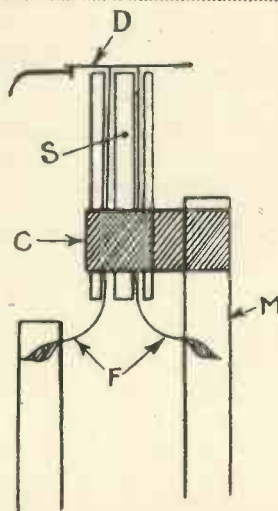

Detail of construction of cathode-ray tube. Patent No. 416,043.

then tightly clamped by a metal collar C, to a rigid support M, mounted in the stub of the tube. The steatite insulator conserves the heat sup-

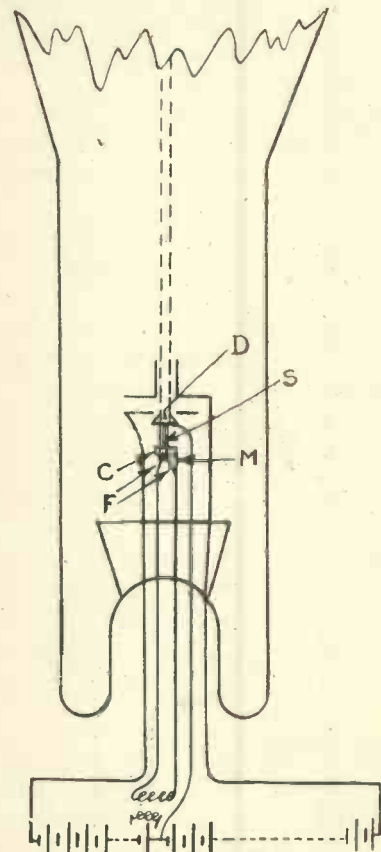

Patent No. 416,043.

**Cathode-ray Transmitters**

(Patent No. 416,848.)

The large end of the cathode-ray tube contains a wire-gauze screen, which is biased positively and an adjacent photo-sensitive anode. The picture to be transmitted is focused upon the anode through the fine mesh of the screen, and causes the emission of electrons in proportion to the light-and-shade values of the incident light. The liberated electrons are attracted by the positively-charged gauze screen, and move towards it through the cathode-ray tube.

The result is that the main scanning-ray projected from the "gun" part of the tube traverses this cloud of electrons, and is impeded to a de-

gree which depends upon their density, and therefore upon the varying light values of the original picture. This gives rise to voltage fluctuations across a resistance in the external anode-cathode circuit of the tube, which are used to modulate the outgoing carrier wave.—(Marconi's Wireless Telegraph Co., Ltd., H. M. Dowsett and R. Cadzow.)

#### Summary of Other Television Patents

(Patent No. 415,118.)

Method of transmitting synchronising signals which can be delayed or advanced relatively to the picture signals.—(Electric and Musical Industries, Ltd., and C. O. Browne.)

(Patent No. 415,155.)

Push-pull amplifiers for use with a Kerr cell or similar light valve.—(P. V. Reveley and Baird Television, Ltd.)

(Patent No. 415,589.)

Producing saw-toothed voltages for cathode-ray scanning by means of a tetrode or pentode valve which serves as a combined oscillator and short-circuiting device for the charging condenser.—(T. Nakashima, K. Takayanagi and A. Yamashita.)

(Patent No. 415,744.)

Improvements in spot-light scanning systems.—(J. L. Baird and Baird Television, Ltd.)

(Patent No. 415,771.)

Photo-electric amplifier, suitable for use in television, having a high resistance to fluctuating currents and a low resistance to steady currents.—(Marconi's Wireless Telegraph Co., Ltd., and E. W. B. Gill.)

(Patent No. 415,796.)

Amplifier having a variable-frequency characteristic for correcting relative attenuation in the frequencies used in television systems.—(J. C. Wilson and Baird Television, Ltd.)

(Patent No. 416,703.)

Improvements in the manufacture of photo-electric cells.—(General Electric Co., Ltd., and C. H. Sims.)

(Patent No. 416,723.)

Scanning and synchronising systems particularly adapted for televising from photographic films.—(Electrical and Musical Industries, Ltd., and C. O. Browne.)

(Patent No. 416,834.)

Method for magnifying the image produced on the viewing-screen of a cathode-ray receiver.—(A. C. Cossor, Ltd.)

#### For the Looker's Diary

*Saturday, December 1, in the afternoon.*—Roy Royston, musical comedy juvenile; Mabel Marks, songs and dances; Scott Courtnay with Peggy and Sylvia, stepping in hot rhythm; Jack Day, banjo wizard; Renita Kramer and Sydney Jerome's quintet.

Miss Kramer's half-and-half dance is a sensation of the current Crazy Show at the London Palladium. Dressed partly as a man and partly as a woman, she dances with herself and television should enhance the illusion of a couple embracing.

*Wednesday, December 5, at night.*—Leila Megan, Welsh mezzo-soprano from Covent Garden; Esme Haynes; and Susette Morfield and Hugh Laing, two dancers from the Ballet Club.

*Saturday, December 8.*—A repeat of "Vignettes of Vienna," just to persuade lookers who complained that Schubert and dances from *The Gypsy Princess* do not make a high-brow programme.

A strong cast, including John Hendrik, Harriet Bennett, Dimitri Vetter, Doris Sonne and John Byron.

*December 15.*—Maurice Elwin, recording star, whose earlier appearance was postponed on account of a cold.

## Electrical and Musical Industries TELEVISION

**S**PEAKING at the third ordinary general meeting of Electrical and Musical Industries, Ltd., on November 16, Mr. Alfred Clark, the chairman, in the course of his speech, said: Such action as the Postmaster-General may take as a result of the Committee's report will presumably be followed by the equipment of transmitting stations and the sale of receiving sets to the public.

The research engineers of your company have developed and demonstrated a complete and entirely successful system of high-definition television of undoubted entertainment value. This system includes both transmission, or broadcasting, and reception by sets suitable for use in the home. These sets can be placed before the public at a reasonable cost.

In view of the large experience of Marconi's Wireless Telegraph Co. in the field of radio transmission and the rights they have retained in that field, arrangements were entered into with them resulting in the formation of the Marconi-E.M.I. Television Co., Ltd.,

in which both companies have contributed their interests in the transmission of television of high-definition.

The main business of the new undertaking will be to supply transmission apparatus to the broadcasting authorities, both here and in certain foreign countries.

Your company has, of course, retained all of its rights in the field of television receiving sets, and hopes that this may become a profitable feature of its business once television broadcasting has begun and a public demand created.

It now remains for the Postmaster-General to decide under what conditions the broadcasting of television will be carried out and, of course, until this decision is known there can be no commercial progress. In the meantime the research engineers are actively engaged and the satisfactory results so far obtained are of such a nature as to indicate that the story of television, like that of the broadcasting of sound, will be one of constant and sure advance.

#### The Television Committee in U.S.A.

In the course of an interview which an American correspondent obtained with Lord Selsdon, chairman of the Postmaster-General's Committee, during the recent visit of a section of the Committee to U.S.A., to make a study of American conditions, Lord Selsdon is reported to have expressed the belief that he considered television's major problems financial rather than merely mechanical. He stated that he considered the British and Continental method of radio licences more advantageous than the American advertising system for television's advancement.

New York's principal television laboratories were visited. Lord Selsdon, when interviewed, was about to leave for Philadelphia to see the Farnsworth equipment and the Philco Radio and Television Corp. experiments.

# THE ASHDOWN ROTOSCOPE

## —AN INTERESTING DEVELOPMENT OF THE STROBOSCOPE

*Though the Rotoscope described in this article has no direct application to television it employs principles with which all television experimenters are familiar and shows an interesting development of the simple stroboscope.*

THE Rotoscope has for its purpose the obtaining of slow-motion vision of machines or objects which are in high-speed motion, and at the same time an instant record of their speed. It is a development of the stroboscope. The stroboscope dates back to Plateau (1801-1883), who used a disc, having a number of narrow slits in it, which could be made to rotate at the frequency of the observed object—giving the latter the appearance of standing still.

The feature required in a satisfactory form of stroboscope can best be made clear by a short study of the action of an elementary pattern of the device consisting of a stationary disc A, Fig. 1, and a rotary disc B, each having an equal-sized radial aperture in it. With the two discs mounted co-axially and B set rotating, we may take as our object of ob-

servation a rotating disc or blank wheel C, one portion of the surface of which is distinguished by a mark.

Once during each revolution of B, vision will be permitted through the slots in the two plates. The period of vision will begin when the slot in B is in the position indicated at D, and will end when it is at E. Quantitatively it will occupy the time taken by B to turn through the angle twice as great as  $\theta$ , the angle subtended by the slot. During this period the area of the visual aperture will increase from zero to a maximum equal to the full area of either slot, and thereafter will fall again to zero.

The observation of the object C is affected by three principal factors: (a) the size of the visual aperture; (b) the duration of the period from its opening to its closing; and (c) the number of times it opens per minute. The size of the aperture determines

the amount of illumination reaching the observer's eye from the object being studied. From this aspect considered by itself, the aperture provided ought to be as large as possible.

The duration of the period of opening affects the definition of the observational mark. If the period is in any way prolonged, the chalk mark will be drawn out by the rotation of the object C into a band form, and at the successive glimpses will appear ill-defined and distended. If, however, the duration of the period for which the aperture is open is short relatively to the speed of the object, the distance moved by the chalk mark during the period will be very small and successive glimpses will reveal it sharply defined and practically undistended.

### Aperture and Period

These two desiderata, a large aperture and a short glimpse period, are conflicting. It is obvious that the larger the aperture the greater must be the speed of the moving plate in order to secure a glimpse period of given duration. Constructional considerations limit the speed at which the disc B may be rotated. If the requirements to be met necessitate this limit being surpassed, the obvious course to follow is to rotate the plates A and B in opposite directions and at half the speed required with the single rotating plate stroboscope.

The glimpse period beginning in the position indicated at F and ending in that shown at G is accomplished during an angular movement of  $\theta$  instead of  $2\theta$ , and, as the rotary speed has been halved, therefore occupies the same time as before. It should be noted that with this arrangement the slots will permit vision at every half revolution instead of every complete revolution. The intermediate glimpses are, however, useless for observational purposes unless the diameter of the discs is so small that, without moving the head,

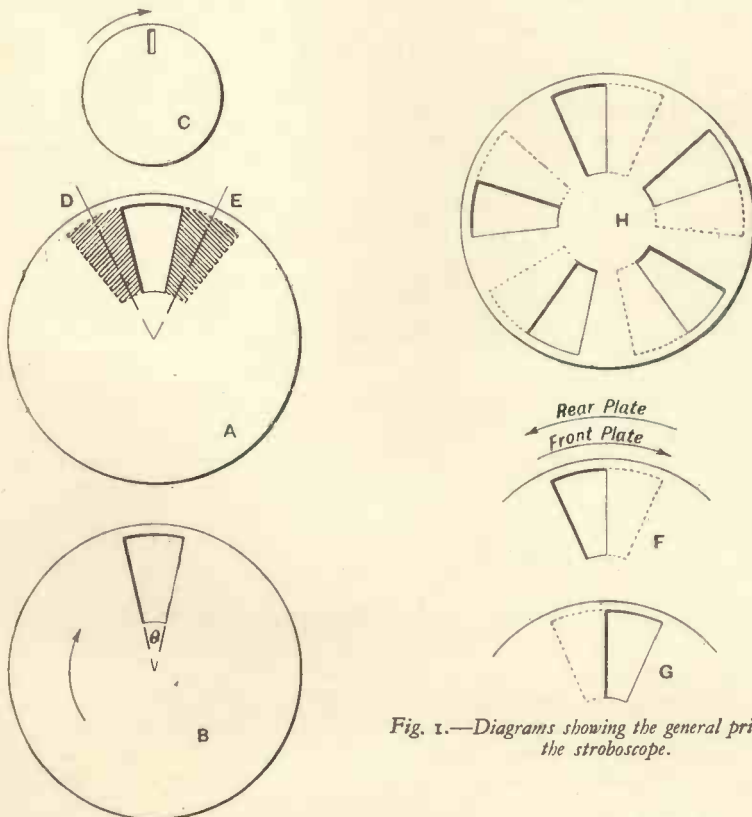

Fig. 1.—Diagrams showing the general principle of the stroboscope.

## OBSERVING 40,000 MOVEMENTS PER MINUTE

one eye can be employed on one glimpse position and the other eye on the other position. In general, however, the disc type of stroboscope is much too large in diameter to permit of binocular vision.

plates are driven. It will be understood that observation is made through only one out of the five pairs of slots.

The operation of the stroboscope depends upon the observer's power

glimpses, it will again appear stationary, intermediate speeds as before being represented by a clockwise or anti-clockwise movement. It follows, therefore, that when the mark appears stationary, the speed

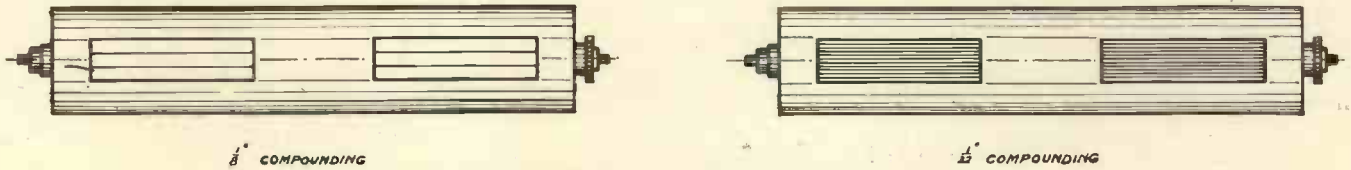

Fig. 2.—Two types of Rotoscope shutter in low and high compounding.

### Glimpse Rate

The third main factor affecting the observation of the object C is, as previously stated, the number of glimpses afforded per minute. With the plates A and B, one fixed and one moving, the number of glimpses per minute is simply the number of revolutions made per minute by the plate B. This number will be halved by adopting the arrangement F G, since the speed of the plates is halved and

to vary the number of glimpses per minute over a considerable range. Let us take, for example, its use as a means of determining the speed of the rotating object C. With the speed of B set at some random value, the mark will in general occupy a different position at each successive glimpse, and as a result of the persistence of vision it will appear to possess a slow rotary motion.

If in the interval between two successive glimpses the mark executes a natural movement through something less than 180 deg., it will appear through the stroboscope to be rotating in its normal direction—clockwise in our example. If, however, the natural movement during the period of eclipse of vision is something between 180 deg. and 360 deg., the mark will appear to rotate anti-clockwise as seen through the stroboscope. If the movement is exactly 180 deg., it will seem to dance vertically from top to bottom of the disc C, and if it is exactly 360 deg. the mark will appear to be stationary. If, then, the speed of B is adjusted until the mark appears to be stationary, the speed of the object C can be determined. In the example the speed of C will be simply the same as the speed of B, which we are to suppose is fitted with a speed indicator.

### Reduced Size

In the Ashdown rotoscope the objection and difficulties presented by the large slotted plates have been completely overcome. The Plateau discs give place to little metal cylinders about  $4\frac{1}{4}$  in. long by 1 in. in diameter (see Fig. 2). These—being light, dynamically balanced, and running in jewelled bearings—are capable of being driven at extremely high speeds; in some special instances to give as high a glimpse frequency as 3,000 per second. Two slots,  $\frac{3}{8}$  in. wide and  $1\frac{1}{4}$  in. long, pierce the cylinder. These slots are situated about  $2\frac{1}{4}$  in. apart, centre to centre, to suit the distance between the observer's eyes.

It will be gathered that a peripheral movement of the shutter amounting to  $\frac{3}{8}$  in.—corresponding to an angular rotation of about 43 deg.—causes the aperture for vision through the slots to open and close. Thin plates are, however, inserted horizontally in the slots with the result that while the area of vision at full aperture is but slightly reduced, the angle of rotation required to open and close the aperture is very much lessened (Fig. 3). Thus, with two plates—distance  $\frac{1}{8}$  in.—a movement through 14 deg. opens and closes the aperture, while with ten plates— $1/32$  in. compounding—the required angular movement is only about  $3\frac{1}{2}$  deg., or, say, one-hundredth of a complete turn.

It will be noted that two glimpses through the apertures are obtained

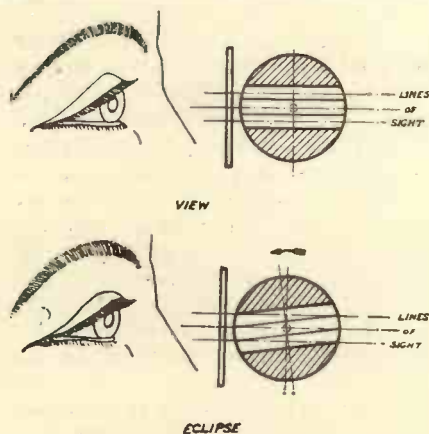

Fig. 3.—Diagrams showing the principle of the bladed shutter.

since the intermediate glimpses at 180 deg. are per minute, keeping all the other factors the same, non-effective. To increase the number of glimpses the disc may be formed with multiple slots. Thus, with the arrangement shown at H, the number of glimpses per minute will be either five or two and a half as many as with the arrangement A B, according as but one plate or both the

### Multiple Speeds

There is an interesting complication, however, in the matter. Obviously, if the object C makes not one, but two or more exact turns during the period between two successive



per revolution of the shutter. Accordingly, to obtain 12,000 glimpses per minute the shutter speed will be 6,000 revolutions per minute. At this speed the time period of vision at each glimpse will be one ten-thousandth second. The extraordinary rapidity of the shutter will be better appreciated if it is mentioned

value that the time of exposure does to the total time. In other words, if the light is admitted to the eye and cut off very rapidly with long periods between glimpses, the period of darkness can be as much as 100 times that of the light period, in which case the average intensity becomes only one-hundredth of the normal inten-

ordinary rapidity of the mechanical shutter of the Ashdown rotoscope is the flash-lamp apparatus, in which neon tubes are used. It should be remembered, however, that in the first there must be a relative extinguishing of the existing lighting; the second utilises all the light available to its full purpose.

## Television Screens

WHEN it comes to providing a screen, either for a mirror drum receiver or one of the disc projection type, one almost instinctively assumes that a sheet of ground glass is the most suitable material to use. Actually, however, ground glass, though being very convenient, possesses certain disadvantages. The greatest of these is that the angle of vision is rather small and this means that those viewing the image must be almost directly in front if it is to be seen to the best advantage. Obviously this imposes a limit to the number of people who can see the picture at any one time unless some of them are a considerable distance away, which again is unsatisfactory.

This matter of viewing angle quickly becomes apparent. Viewed from a position directly in front, illumination may be all that can be desired, whereas from a position a very little to one side or other the picture appears to have lost all its brilliancy and may even prove a disappointment to those members of the audience who are not in a favourable position. There are other materials of which screens may be made with which this effect is very considerably reduced, for instance, oiled paper makes a very good screen and upon the texture and thickness of the paper will depend the viewing angle that may be used and also the brilliancy of the picture.

Waxed paper is also very suitable. Paraffin wax should be melted in a shallow vessel and carefully heated. When thoroughly melted the paper should be floated in it and when impregnated with the wax should be lifted out quickly and allowed to drain whilst still held over the heated vessel. The heat should then gradually be reduced, as otherwise the paper will be unevenly coated with the wax. When cool great care must be taken in handling the screen for it marks easily. Tracing paper and cloth make good screens and they have the advantage that the opacity is very even.

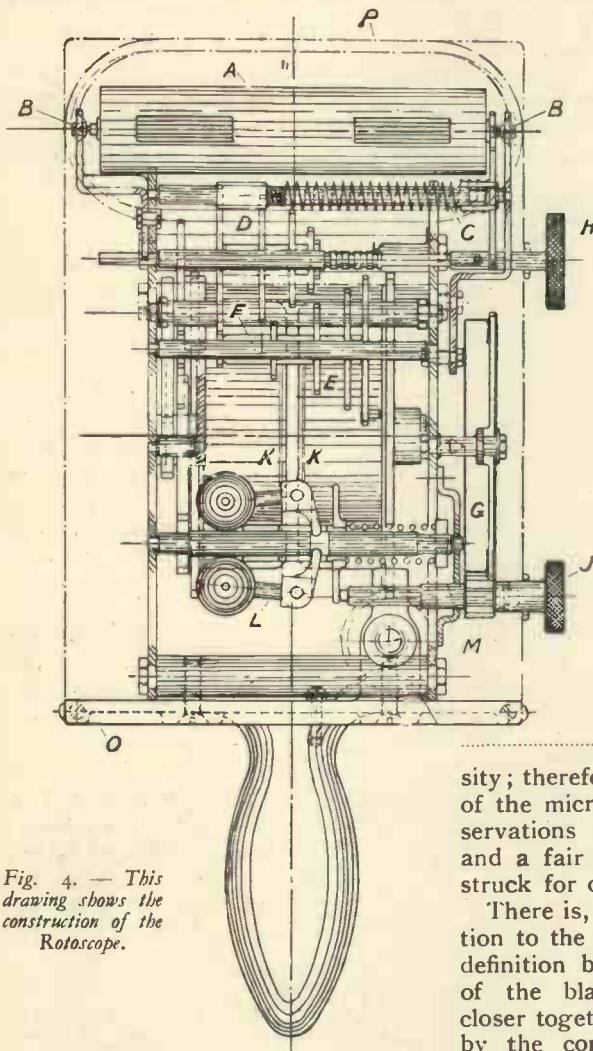

References :—

- A = Shutter.
- B = Jewel bearings.
- C = Equaliser.
- D = 3rd motion gear.
- E = 5 Speed gear change.
- F = 2nd motion gear.
- G = Speed indicator.
- H = Primary.
- J = Controller.
- K = Spring unit.
- L = Governor.
- M = Automatic.
- N = Winder.
- O = Base.

Fig. 4. — This drawing shows the construction of the Rotoscope.

that with a time interval between the glimpses equal to the shutter speed, over a quarter of a million separate views of the object would be seen in one minute.

There is, however, a difficulty in using a very highly compounded shutter in the matter of light, just as there is in using a very high-powered objective in the microscope. By what is known as "Talbot's Law," the average intensity of the light which reaches the eye through any stroboscope when the glimpses are of sufficient frequency to blend together into a continuous appearance bears the same ratio to its normal intensity

sity; therefore—as in the case, again, of the microscope—more critical observations require more lighting, and a fair medium value has to be struck for ordinary application.

There is, however, a further objection to the method of increasing the definition by increasing the number of the blades—or crowding them closer together—i.e., the loss of light by the combined thickness of the blades obstructing the vision slot. This difficulty has been overcome by a second form of shutter, known as the heteroptic.

This shutter consists of two concentric cylinders, the outer of which has the same dimensions, 4 in. long by 1 in. diameter, as the original bladed type of shutter. Both cylinders are pierced with openings in each wall. The openings may subtend an angle of 20 deg. at the centre, and, as in the original type, twin apertures are provided for binocular vision. The outer cylinder is arranged to rotate at a considerably faster speed than the inner.

The only serious rival to the extra-

## THE AMATEUR TELEVISION EXPERIMENTER

## METERS FOR THE LABORATORY

*This is the third of a very comprehensive series of articles on the equipment of a television laboratory. The articles are based on the personal experiences of two research engineers and will form a complete guide to the investigation of television problems.*

WE now come to the important matter of equipping the laboratory with measuring instruments and apparatus which will definitely be of use in all branches of experimental television. Necessarily there will be some apparatus which can be made up to suit the research in hand, and this will be dealt with in its turn. The following equipment, however, is designed to be of general use, and can be considered to be essential for serious experimental work.



*The Avominor—a useful multi-purpose instrument.*

In selecting instruments the cost is, of course, the deciding factor. For this reason the following list should be taken as a guide and followed only so far as funds will permit. The instruments named are in order of importance.

First, a universal testing instrument similar to the "Avominor." Although this may represent a considerable outlay to some, it is a good investment for experimental work on account of its flexibility and the numerous ranges available. Similar instruments of this type are the "Dix-onometer" and the "Pifco," and the user will be left to judge which is the one to suit his particular case best. It is true that a universal tester can be built up from a single range meter by the addition of shunts and resistances, but the labour involved is considerable and it is barely worth the time and trouble spent. It is easy to add a single range to an existing meter, but it is more difficult to design and fit a series of ranges to agree among themselves, and this job is best left to the professional instrument maker.

A first-quality voltmeter will also be needed with a resistance of at least 1,000 ohms per volt. This is invaluable for checking operating conditions in circuits, and the high resistance avoids errors due to the current taken by the meter itself. A cheap moving-iron meter

is worse than useless and should never be used except as an indicator. To digress, a large number of instruments on the market (and the second-hand market) are called measuring instruments, but are little more than indicators, i.e., they show that the voltage is applied to the circuit, but are quite incapable of measuring the voltage to an accuracy of 1 per cent. or so. There is no objection to their use provided that their limitations are realised and that they are not used for accurate work. For those who are unfamiliar with meter types, it is sufficient to see that the scale is marked "B.S. 1st grade," which implies that the accuracy of the meter conforms to the standards laid down by the British Standards Institution.

A good low range ammeter, or rather, milliammeter is needed, and it is suggested that 0-1 ma. is the most suitable range. This will then read 100 microamperes or lower and will probably give a useful indication in a grid circuit.

A microammeter is expensive and will not always be found of use, whereas the milliammeter can be provided more easily with shunts to enlarge its range, and is more robust.

A cheap milliammeter of, say, 0-50 ma. is useful for checking distortion in valve circuits, and it should be selected with this in view. Generally speaking, the lightly damped type of meter which has the pointer swinging all over the place is ideal for the job.

### Cathode-ray Measurements

If any work is to be done in cathode-ray circuits an electrostatic voltmeter will be required having a range of 1,000 to 2,000 volts maximum. Probably the lower range is better, since it would read 600 volts with ease, and could be used on higher voltages by the addition of a potential divider of several megohms resistance. Series resistances are, of course, useless on electrostatic



*Fig. 1.—Photograph showing the recommended method of mounting ordinary measuring instruments.*



*The Dix-onometer is a particularly useful instrument for general test work; it has very many applications for television research work.*

instruments, and the best way of increasing their range is by connecting two resistances of 2 megohms each across the H.T. to be measured and joining the meter across one of them. The voltage applied to the meter will then be halved if the two resistances are equal.

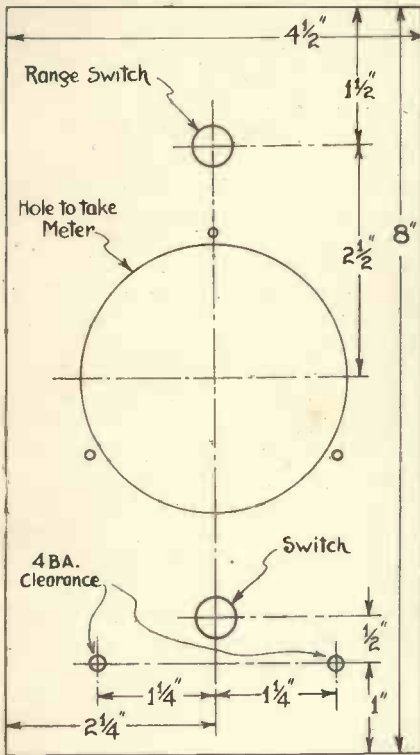

Fig. 2 (left) — Dimensional details of meter panel.

It is convenient at this stage to attempt to standardize as far as possible the mounting of various components and apparatus so that the panels shall be interchangeable if required and the layout can conform to standard dimensions.

The standard width of panel proposed is 22 ins., which is the width of panel racks in most of the "talkie" and P.O. apparatus. The height of the panel will vary with the job, but a minimum of 8 ins. will be found suitable to accommodate valves and ordinary screened coils on a baseboard. A special form of

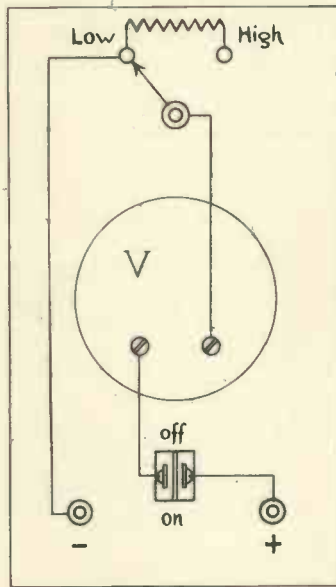
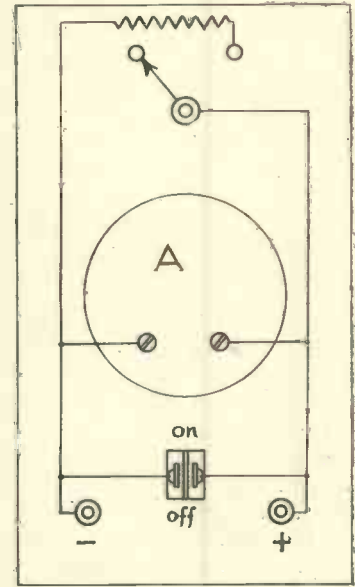

Fig. 4.—Circuit arrangements of voltmeter and ammeter panels.



Now as to the fitting of the test bench. Some experimenters prefer to have their meters portable, and provide them with wooden stands. There is a slight objection to this method in a limited space—the meters are usually below eye-level and are difficult to read without peering. Also there is always a possibility of their being swept off the bench. After carefully weighing up the advantages and disadvantages of various arrangements the writers have come to the conclusion that the most satisfactory arrangement for small meters in a limited space is to mount them in a rack on the back of the test bench at eye-level, leaving terminals at the front to connect them to the job in hand. This method has the advantage that they are never in the way, are easy to read, and that the leads can be kept clear of the connections on the bench. The only disadvantage is that long leads to the meters may cause instability in some valve circuits, but this can usually be avoided by using screened cable for the connections.

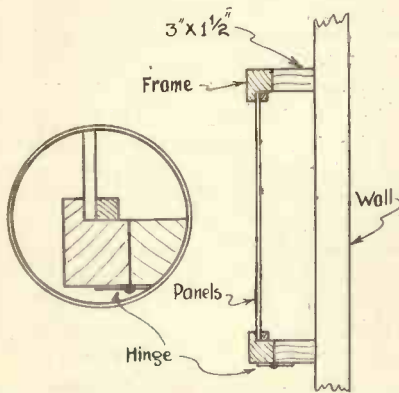

Fig. 3.—Diagram showing the suggested method of fixing the meter panels.

screening for amplifiers, designed by one of the writers, will be mentioned later.

To accommodate the meters on a standard rack, each meter is mounted on a panel of ebonite measuring 4 1/2 ins. by 8 ins. high. Five of these panels side by side will exceed the standard by 1/2 in., which can be allowed for by recessing the frame in which they are held, or by lopping a bit off the end panels of the row. The photograph of Fig. 1 shows one of the panels holding a voltmeter. Above the meter is mounted a range-changing switch for doubling the range, and below is a switch for cutting the meter out of circuit if required. In the case of milliammeters the switch will be used to short-circuit the meter, and this plan is very useful when dealing with unknown circuits. The drilling dimensions of the panel are given in Fig. 2, it being understood that the size of the hole for the meter is varied to suit its dimensions.

When all five racks have been made (and it is not necessary to mount five meters all at once) the framework for holding them can be made from ordinary picture frame moulding with a 1/4 in. rebate. The racks are then held in position with a thin strip of metal screwed through the ebonite into the frame.

If the back of the test bench is of wood, this frame can then be mounted on it, spaced off the back by two battens. The frame should be hinged to the lower batten, as shown in the sketch of Fig. 3, enabling the rack to be dropped down to give access to the backs of the meters. The wiring should be carried out in screened cable for the reasons given above.

Fig. 4 shows the wiring for a voltmeter and milliammeter with one extra range controlled by a switch.

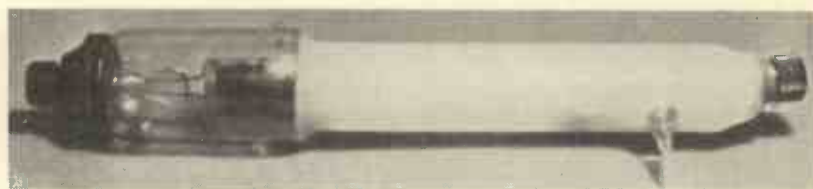

# FLUORESCENT LAMPS

By W. J. Nobbs, F.T.S.

*A new development of far-reaching importance is described in this article. It concerns glass that contains substances that fluoresce under the action of light both in the visible and invisible spectrum.*

IT is a known fact that by the addition of uranium compounds to glass the glass under certain conditions will emit light, but the fluorescence is green and therefore limited to this colour.

However, the addition of certain alkali sulphides or zinc sulphide to glass results in visible radiations of different colours. But it was found necessary to combine with the glass-sulphide mixture a small proportion of heavy metal.

It is interesting to note that the writer was shown some years ago an advertising device consisting of a sheet coated with sulphide of antimony. On exposure to light it would glow, and continue to do so for a short period. Many attempts were made to produce the coating substance, but without success. It was pointed out that foreign matter, not identified, mixed with the sulphide was responsible for the results. This fact is mentioned to illustrate that it is more than probable that the impurity was metallic.

By suitable mixtures of glass and sulphide, taking care to include the correct metallic additions, many different emitted colours or combined colours can now be produced.

It is a fairly simple matter to make up fluorescent or phosphorescent mixtures to coat material, but extremely complicated and difficult to incorporate a mixture as a constituent of the actual glass.

Correct procedure and methods are known, and it can be stated that the combination of the metal-sulphide can take place during the melting or by known reduction methods, the sulphide being formed in the glass itself.

Radiation can be caused by rays striking the exterior of the glass or from light produced inside a lamp made of the glass, such as a mercury discharge tube.

This last fact shows an application

for television purposes. Not only can fluorescence be produced, but by suitable control during manufacture of the glass, afterglow (phosphorescence) takes place. This afterglow can be of very short duration or last several minutes, depending on the type of mixture.

This points to the application of the system for the cathode-ray tubes—giving fluorescence with the desired degree of afterglow *without* coating the glass in any way. We can, therefore, produce visible light, controllable after-glow and colour with

these sulphide content are found to produce a pale orange or yellow-orange glow. Calcium-rubidium sulphide colour is what may be termed red-orange.

A violet colour is a little more difficult, but is accomplished with a mixture of bismuth-calcium and thallium sulphides.

It will be readily understood that, given the desired colour fluorescence of the glass (yellow-orange), combined with radiation of the actual discharge of a mercury tube, an almost perfectly white light can be obtained.

It should be noticed that an addition to the light, compared with the use of an ordinary glass bulb for the mercury tube, is obtained as the *ultra-violet* radiations of the mercury discharge cause additional fluorescence of the mixture in the new glass.

Present tubes, especially those for television purposes (mercury and rare gas), are inclined to have a stronger blue response, resulting in a pale bluish colour which is considerably nearer to white than the bluish discharge of mercury. It is possible by suitable filtering of the strong blue lines of the mercury discharge to produce a real white light.

The photograph shows a tube made from the new glass, and a brief description of the construction and results will be given.

It is, of course, of the positive-column type, filled with a mixture of mercury and rare gas which gives a relatively low striking potential. No difficulty is experienced in causing the discharge to start, and in practice the voltage drop across the lamp terminals is 250 volts approximately. Tubes with a voltage drop of 180-200 volts can be produced, but their characteristics and luminous response are not ideal for television purposes.

The tube illustrated has given excellent results with a current of 20

(Continued on page 568.)

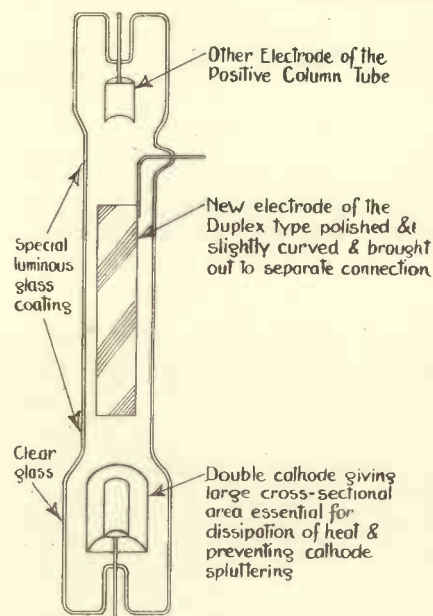

Diagram showing the construction of the new fluorescent lamp.

no risk of burning out the screen.

In some cases it is necessary to diffuse or mask the source of light or radiation causing the fluorescence, and this is quite simply accomplished by the addition of suitable fluorides as the media.

Zinc sulphide and a small mangan-



has a frequency of 4,000 kilocycles and is tuned across primary and secondary.

Then comes three stages of intermediate-frequency amplification in which I use high-frequency pentodes, but, of course, screen-grid valves can be used equally as well. There is, however, an appreciable decrease in gain when using screen-grid valves. As a second detector you must use a high-frequency pentode if you want the best results. As an anode-bend detector with an external resistance of 100,000 ohms the stage gain is colossal.

There is room for experiment in the low-frequency stages. Although

the third, a critical one, feeds the anode of the 1C6 pentagrid.

For tuning condensers use Stratton type 900, with a capacity of about 20 micro-microfarads and fitted with a good slow-motion drive. Jacksons have just brought out a new one that will do excellently. In series with the aerial lead-in wire you want a very small capacity, otherwise the receiver may not oscillate. A good condenser for the job is the small Stratton variable which has a maximum capacity of 7 micro-microfarads. As a makeshift cut the lead-in wire about a foot from the receiver and twist the two ends together for a distance of about a foot. Don't make

can obtain between each turn. Fix the ends very tightly, leave a gap of  $\frac{3}{8}$  in. in the centre and wind on another coil as near a twin brother as you can to the first one, all windings in the same direction.

Then in both ends of the former mount a small preset condenser such as you get from British Radiophone, which is already mounted on steatite. The first coil is then connected across one trimmer and the second coil across the other trimmer. Mount the whole coil assembly in a copper can of about 3 in. diameter and bring out four connections, two from each trimmer. The holes through which these connections come must be bushed so that they do not touch the can.

That's all there is about it, as all the coils and intermediate can be home-made, the cost is reduced very considerably, while five out of the seven valves will probably be on hand.

The best way to trim up on the intermediate-frequency coils is to tune in any sort of signal and adjust the trimmers with a wooden screwdriver until you get maximum volume. Of course, you start with the condenser across the primary of the first coil, finishing with the one across the coil that feeds into the grid of the second detector. If you can't find a signal or you don't quite know to what part of the band you are tuned, pick up the second harmonic from your short-wave superhet. Use a wavelength of either 14 or 20 metres, that will give you 10 and 7 metres.

If made up to run from the mains there should not be any complications, although in view of the greater amplification probably two intermediate-frequency stages will be sufficient. Anyway there is the basis of the idea and it will act as a guide to your experiments and you will be able to find out other points quite easily.

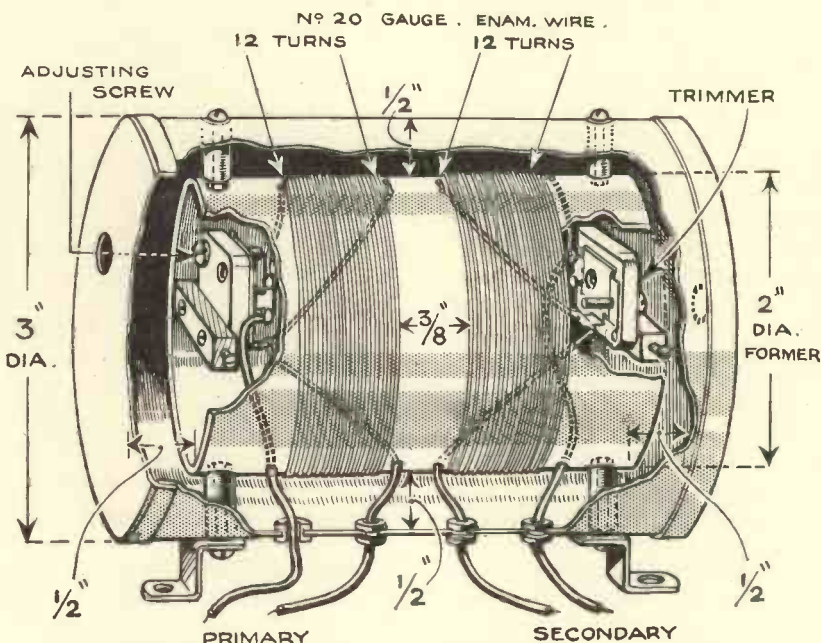

*Suggested design for the intermediate-frequency coils. Primary and secondary are both tuned and the whole is screened.*

I have used two low-frequency amplifiers you may find that a parallel-coupled transformer-coupled stage with pentode output and no tone correction will give sufficient output, but so far I haven't tried it. I do think, however, that it is better to have two low-gain stages rather than one highly efficient stage.

Use a good low-frequency choke and a large condenser in the output stage, otherwise results from the cathode-ray tube are likely to be unsatisfactory.

There are only three high-tension tappings, one applying the maximum available voltages to all the valve anodes except that of the pentagrid, the second is for the screen voltage of the high-frequency pentodes, while

any actual electrical connections between them and then you will have what is virtually a very small condenser.

### The I.F. Coils

I have left until last one of the most important points—the intermediate-frequency coils. These are quite simple to make and it does not matter if in the windings you go astray, for the trimmers will take up all the little errors.

Take a length of 2-in. paxolin or ebonite former and on it wind twelve turns of 20-gauge enamelled-covered wire with the smallest spacing you

### NEXT MONTH'S ISSUE

Owing to the Christmas Holidays the January issue of "Television" will be on sale on

Wednesday, December 19



# Correspondence

Correspondence is invited. The Editor does not necessarily agree with views expressed by readers which are published on this page.

**Can You Explain This? :: Non-sequential Scanning**

**Displaced Scanning :: The Optical Efficiency of Lenses**

**Can You Explain This?**

SIR,

Some little time ago I was experimenting with television apparatus—a general hook-up it was—and I managed to get a rather distorted image of a dancer *off the screen some two feet away*.

I have not quite finished analysing the cause of the phenomenon but wondered whether any other experimenter has had similar results.

Although the results were crude it may be another of those early "accidents" which eventually turn out to be modern commonplace—a glimmer of the future? Shall we in years to come have complete ethereal images dancing on our home stage? Who knows?

The only disappointing thing is that I find difficulty in repeating the phenomenon. Meanwhile, however, I would point out the possibility of effecting television without a screen—there may be something in it.

I had two television sets working displaced at an angle of about 60°, and the focus of the two was about two feet away from the system.

Were stationary waves produced which became slightly visible?

Did they use the eye as a screen and, as minute as the eye picture was, produce a sensation of the image being two two feet from the source? *Did they use a shower of cosmic rays as a screen?*

I don't know, but I shall not rest until I do.

ALBERT PARSONS, F.R.A., F.T.S.  
(Portsmouth).

(We shall be glad to have readers' comments upon this curious occurrence.—Ed.)

\* \* \*

### Non-sequential Scanning

SIR,

You publish in your November issue a letter from Baird Television, Ltd., referring to an article in your October issue, in which non-sequential scanning of the strips of a picture was mentioned. This feature

was described in British Patent No. 218,766 in the name of Walton and another, dated the 18th of April, 1923, with particular reference to Fig. 13 and its accompanying description.

The benefits of non-sequential scanning are not due to a particular form of scanning device, but to the general principle.

SCOPHONY, LTD. (London, W.1.)

\* \* \*

### Displaced Scanning

SIR,

I have been inspired to write concerning the two articles appearing in TELEVISION for November, 1934, "Displaced Multiple Scanning," by Robert I. Rosenfelder, and "The Whole Problem of Synchronising," by T. S. Roberts.

It has always been my contention that the 30-line transmissions by the B.B.C. (very good though they are) are far from being the best possible, taking into consideration, of course, the limitation of the 9 kc. waveband.

Referring to the article by Robert I. Rosenfelder, I, myself (although I do not claim priority), anticipated a somewhat similar scanning system using "hole-overlap" as a means of improving the "grain" and brilliance of the image. My experiments in this direction have shown that the field of light is greatly improved.

Turning to the problem of synchronising, the graph (b) on page 494, by T. S. Roberts, illustrates how a secondary impulse is introduced into the synchronising coils, causing the picture to hunt. To overcome this defect, I make the suggestion that the scanning lines should not be adjacent, as at present, but, widely spaced, for example, strips No. 1, 10, 20, then 2, 11, 21, and so on. This method would eliminate a severe fall of current existing for 4 or 5 lines duration.

Why cannot the B.B.C. try out variations of the 30-line system in addition to the present broadcasts? Films are cheap and suitable for such

purposes, and valuable data would be obtained through co-operation with the public. *Now B.B.C., how about it?* Thanking TELEVISION for its up-to-date technical articles.

G.E.C. (Folkestone).

\* \* \*

### Optical Efficiency of Lenses

SIR,

In my article, to which your correspondent M. Turpin takes exception, I was not, of course, considering aberrations, because the type of system the television engineer has chiefly in mind, and to which I led up at the end of the article, is the condenser system in a scanning layout. The principal aberrations are, with their order, as follows:—

Aberration.	Order.
Spherical aberration	$O^3/f^3$
Coma	$O^2/f^2 \tan \beta$
Curvature of the field	} $O/f \tan^2 \beta$
Astigmatism	
Distortion	$\tan^3 \beta$

where  $O$  is the radius of entrance pupil and  $\beta$  the angular distance of the element considered from the field-centre.

These are known as the third order aberrations in thin lenses (there are no second order terms, by symmetry), and I think M. Turpin will be the first to admit that they play no important part in the luminous efficiency of condenser systems, and particularly in an axial system of the fixed-aperture type referred to.

However, since my remarks about efficiency have a more general bearing than simply upon the condenser system I then had in mind, I think it will be as well to point out that each of the above aberrations may be either avoided or diminished to negligible proportions in a simple lens without stopping it down at all. Since M. Turpin has concentrated upon astigmatism (though precisely why is not quite clear), I suppose it is of interest to examine this one particularly:

The astigmatic difference,  $q^1 - p^1$  in the diagram, is not easy to work with, but using the difference of the reciprocals in the form obtained by putting  $n/p = P$ ,  $n^1/p^1 = P^1$ ,  $n/q = Q$  and  $n^1/q^1 = Q^1$ , we have:

$$Q^1 - Q = P^1 \cos^2 \alpha^1 - P \cos^2 \alpha = D$$

where the magnitudes in capital letters, taking the metre as unit, are dioptres. The astigmatism is measured by  $(P^1 - Q^1)$ . If the bundle of rays is homocentric (i.e.,  $Q = P$ ) the astigmatism will be:—

$$P^1 - Q^1 = P^1 \sin^2 \alpha^1 - P \sin^2 \alpha$$

Accordingly, astigmatism vanishes if  $Q = P$  and  $P^1 \sin^2 \alpha^1 - P \sin^2 \alpha = 0$ ,

which may be made to obtain in either of two well-known ways. Thus, if the simple lens happens to be made for conjugates other than equal image and object distances, the maximum efficiency condition given by M. Turpin will not be obtained.

The remaining these of M. Turpin fall into three parts, viz. :—

- (i) The optical efficiency of a simple lens system comprises the ratio of output to input luminous fluxes.
- (ii) The intrinsic brilliancy of the image is always less than that of the object, in the ratio given by the above definition.
- (iii) The maximum flux is not obtained in a fixed-aperture scanning system when the source is juxtaposed to the aperture.

All three may be clearly shown to be wrong. Taking them *seriatim* :

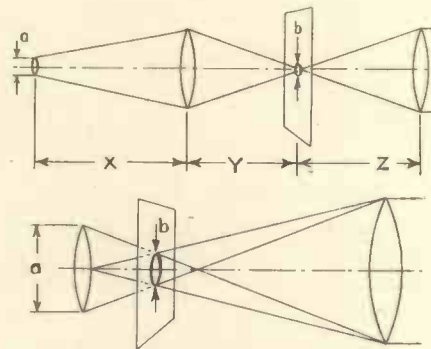

Three diagrams illustrating Mr. J. C. Wilson's views on the optical efficiency of lenses.

(i) This statement is true in the same sense and to the same extent as one may say, the efficiency of an internal combustion engine is equal to the ratio of the amount of petrol poured into the tank to the amount poured out of the can (allowing, that is, for some to be spilt on the ground). In other words, a highly intelligent observation but useless as data for the designer of the engine.

(ii) The intrinsic brilliancy is defined by M. Turpin implicitly as the flux per unit area per unit solid angle in the image; but this quantity, though a useful one where the cone of light from an image has to pass through some arbitrarily limited area, such as that of the projector lens or a mirror in a scanning system, is totally erroneous as a definition of the brightness of the image where its actinic effect, for example on a photographic plate or photoelectric surface, is required, or simply its visual brightness on a diffusing screen. Actually

we must take the total luminous flux through the image area divided by the area as a measure of intrinsic brilliancy, and using M. Turpin's own notation we have :—

Flux caught by lens:  $\phi_1 = b_1 s_1 \pi R^2/x^2$   
 If loss is  $k$ , then output flux =  $k\phi_1 = k b_1 s_1 \pi R^2/x^2$ .

All of this goes into the image, of which the area is  $s_2$ , so that the intrinsic brilliancy is:

$$b_2 = k\phi_1/s_2 = k b_1 s_1 \pi R^2/s_2 x^2 = k b_1 \pi R^2/y^2$$

$$= k b_1 \cdot \frac{\pi}{4} \cdot \frac{1}{P^2} \cdot \frac{1}{(m+1)^2}$$

which corresponds with the formula given in my article.

(iii) It is hard to see how M. Turpin can maintain this view, since on his own admission the so-called brilliancy of the image measured by the flux per unit area per unit solid angle can never equal that of the source, while if the source is juxtaposed to the aperture, no one but a hardened controversialist could say the aperture does not exhibit the brilliancy of the source itself. However, to leave no

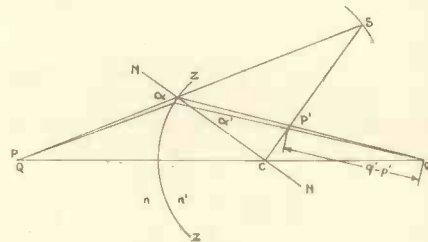

obscurity in the matter, it is best to resort to algebra again :—

The optical system in the figure is designed to fill a projector lens of diameter  $D$  with light from an aperture of diameter  $b$  on which is focused an image of an arc-crater of diameter  $a$  and brilliancy  $B$  by a conductor of diameter  $d$  and focal length  $f$ .

Flux through condenser aperture  $\phi_2 = k B \pi a^2 \pi d^2/16 x^2$ .

But  $x = f(1 + a/b)$ .  
 Hence flux through aperture  $\phi_2 = k B \frac{\pi^2 d^2}{16 f^2} \frac{a^2 b^2}{(a+b)^2}$

where  $k$  is the transmission of the condenser and  $B$  the arc-brilliance.

Now under the most efficient conditions, when  $d/y$  is made equal to  $D/Z$ , this formula gives a maximum useful light-flux upon the projector lens of:

$$\phi_2 = k B \frac{\pi^2}{16} \cdot \frac{b^2}{Z^2} \cdot \frac{D^2}{Z^2}$$

But with the juxtaposed arrangement, provided we make  $a$  as large as the value  $b(1+2dD/Z)$  or, in the limiting case of unity value for  $D/Z$ , as large as  $b(1+2d)$ , we have complete flash in the projector and the useful light flux passing through the aperture and falling on the projector lens is:

$$\phi_3 = B \pi b^2 \pi D^2/16Z^2 = B \frac{\pi^2}{16} \cdot \frac{b^2}{Z^2} \cdot \frac{D^2}{Z^2}$$

showing that the condenser system is less efficient by the factor  $k$ , as previously stated.

I have already\* given some practical measurements of the ratio of efficiencies of condenser lens and juxtaposed systems, which bear out this rough algebraic result entirely:

As a matter of fact, I suspect that the origin of the idea of maximum efficiency being given by equal conjugates lies in an analysis of a system in which both object and image are very much larger than the lens, in which case to obtain the light collected by the lens an integral has to be taken over the surface of the object, and the directional propagation of the object plays a large part. For axial or nearly axial systems, however, the results given in my article are approximately valid.

My apologies are due for trespassing on your space to this extent, but the matter is of some interest to me, and, I hope, also to your readers.

J. C. WILSON (London).

\*Journal, Television Society, Series

\* \* \*

### What Type of Apparatus?

SIR,  
 As there seems to be little hope of the findings of the Television Committee coming along for some time yet, it would be rather interesting to have the views of your readers on the relative merits of disc, mirror drum, and cathode-ray apparatus.

I am thinking of getting together some vision apparatus, but I am still in doubt as to what to buy. On one side I hear that in view of the fact that no good transmissions will be available for several years, there will be no advantage in getting anything better than a mirror drum. On the other hand I hear that high-definition television might soon be expected from the B.B.C., in which case it will be worth while going in for more expensive gear.

I have read that the mirror drum system is still the most effective, as some people tell me that any economi-



cal system is bound to be a failure on anything over sixty lines. It does seem to me that an electrical system should be more satisfactory.

Perhaps some of your readers will oblige with their opinions?

J.L. (Letchworth).

\* \* \*

“Still” Television

SIR,

An ingenious suggestion is contained in a letter over the signature D’Orsay Bell, which appeared recently in your contemporary, *Wireless World*. I cannot do better than quote part of the letter, and it will be interesting to have readers’ views upon the subject for in my opinion it opens up some excellent possibilities. The writer says,

“For the moment this screen is dark, but in a few seconds, as I watch, it begins to glow, and in another second it is fully lit up with the scene, in all its natural colours, at which the audio item has arrived. The picture is ‘held’ for a moment or two and then fades away; but in another 20 seconds or so the glow again appears and develops into the next picture.

“Such, sir, is ‘Still’ television—as I picture it—described in less than a hundred words. It is not an accomplished fact—because no one has thought of it and therefore no one has tried to accomplish it. But there is no fundamental difficulty in its way, as there is in the way of ‘moving’ television. By having a framing fre-

quency of 1/20 instead of 25 we divide the necessary width of wave-band by 500 at one stroke. We do not need such an enormous reduction factor, so we can use, if we wish, a fifth of it to give us our colours, leaving still a factor of 100. With this factor at our disposal, an excellent picture quality would be possible. There are, of course, a lot of points that require working out. Presumably the scene would be filmed on an ‘intermediate-film’ equipment of special design. . . . The building-up and retention of the *visio* transmission in the receiver, ready for illumination at the end of the 20 seconds, is more difficult, involving as it does some new retentive screen or some magnetic, photographic or other ‘storage’ process.”

Such a scheme may not be immediately possible, but in my opinion it could be made possible in the near future and it would provide another stepping stone on the path to perfected television. What do your readers say?

R.B. (Brighton).

The Television Society Questionnaire

*It will be recollected that in May we issued a Questionnaire and as a result were able to obtain a large amount of valuable information which since has been placed before the Postmaster General’s Committee. Shortly afterwards the Television Society also issued a questionnaire the results of which were published in the Journal. As the information is of considerable interest we publish it here.*

REPLIES.

1. Are you interested in Television reception primarily from (a) the entertainment, or (b) the experimental viewpoint?
2. Subject to your answers to the questions hereunder, do you consider that the B.B.C. should be solely responsible for the provision of television transmissions in this country?
3. Do you favour the continuance by the B.B.C. of the present 30 line transmissions on ordinary broadcast wavelengths, pending the complete development of a practical system providing higher quality of vision? . . . . .
4. Do you advocate the extension of the present style of 30 line transmissions (a) during programme hours, (b) outside normal programme hours? . . . . .
5. Do you advocate the transmission of high definition television on shorter wavelengths (a) as alternative to, or (b) in addition to the present 30 line transmissions, having regard to the present state of development of the former? . . . . .
6. Do you consider that television transmissions during the daytime serve a useful purpose (a) from the viewpoint of the private user, (b) for the popularisation of television through the retail trade? . . . . .
7. Bearing in mind the cost to the B.B.C. (or other body undertaking television transmission) of providing the entertainment and of occupying two transmission channels, would you welcome the transmission of (a) actual scenes without sound, (b) films with sound, (c) silent films, to supplement the present television programmes? . . . . .
8. Would you welcome additional 30 line experimental transmissions, outside normal programme hours, if the subject matter of such transmissions were limited, for instance, to moving mechanical objects, arranged primarily for experimental purposes, and not accompanied by sound? . . . . .
9. Do you consider desirable the licensing of private concerns for the transmission of television (a) unconditionally, except for normal P.M.G.’s regulations as to wavelengths, etc., (b) conditionally upon the provision of a specified minimum regular transmission, for a specified minimum period? . . . . .
10. Do you consider that the reception of high definition television on ultra short waves is at present practicable for the average amateur experimenter and home constructor?

Percentages of Votes.

(a) only, 18%  
(b) only, 55%  
both, 27%

Yes 38%  
No 57%

Yes 92%  
No 5%

(a) only, 56%  
(b) only, 20%  
both, 17%  
neither, 7%

(a) 14%  
(b) 84%

(a) 37%  
(b) 80%

(a) 50%  
(b) 70%  
(c) 54%

Yes 66%  
No 29%

(a) 24%  
(b) 62%

Yes 31%  
No 66%

Marconi and Television

The Marchese Marconi, on his recent arrival in this country, is reported as having said: “Television across the Atlantic is now not merely a possibility. It is a certainty. I can tell you quite definitely that there is now no doubt whatever as to the possibility of such a development.

“Television has now reached a stage when one may say there is but one link in the chain required to make it suitable for ordinary everyday public entertainment. The forging of that missing link cannot be far away.”

Recently, at the opening of a new Italian radio station, he hinted that it might be possible to use television to illustrate a wireless talk which he is to broadcast shortly to the United States from Italy.

*Radio Round the World*, by A. W. Haslett (Cambridge University Press). This book is a popular treatise on the why and wherefore of wireless. Its history is traced and simple explanations given of many phenomena. One chapter is devoted to television. The book will be found useful to those who require a general survey of wireless in simple language. The price is 5s.

## Questions The Beginner Asks

### Reception Schemes

# Television Made Easy



Without any knowledge of television, but with a general knowledge of wireless, should I have any difficulty in obtaining pictures from the B.B.C. transmissions?

Providing that you make a start with simple apparatus, such as the disc, you will have no difficulty whatever and you can be practically certain of receiving the pictures at your first attempt. The requisites are a scanning disc, motor, neon lamp and a wireless set capable of receiving London. National at good loudspeaker strength.

Is a mains supply necessary for television?

Mains supply is by no means necessary, though it is desirable for the high-tension demands are rather considerable. Also it is a convenience to be able to drive the scanning motor from the mains, though actually a battery driven motor will run more steadily provided that the current supply is adequate.

Is it correct that cathode-ray apparatus is easily adaptable for any scanning-line frequency?

This is one of the great advantages of the cathode-ray system, that with a little modification it can be made to scan any number of lines within reason and also any picture frequency. Mechanical systems are difficult to

modify in these respects and for a large number of lines alteration of some mechanical scanners would not be practicable owing to the necessarily increased size of the scanner.

What are the relative costs of different types of receiving apparatus?

A disc receiver can be built for as little as 50s., but in addition an ordinary wireless set must be available. A mirror-screw receiver would cost approximately £4 exclusive of the wireless set. A complete mirror-drum receiver cannot be built for less than £25 but this would include a powerful amplifier which it is necessary to use in conjunction with this type of apparatus. Cathode-ray apparatus would probably cost slightly less than this and would include the cathode-ray tube, the exciter unit and time bases.

I am not sure what each class of apparatus comprises to form a complete equipment.

Taking the simplest apparatus first—the disc, the apparatus which is absolutely essential consists of a scanning disc, motor and neon lamp; then a wireless set is necessary in order to receive the vision signals and it must be capable of receiving London National at good loudspeaker

strength. In some cases it will be necessary to increase the voltage of the high-tension supply as a minimum of 185 volts is required. A separate receiver must be available if it is desired to receive the sound part of the programmes.

The requirements of mirror-screw apparatus are practically the same, the mirror-screw taking the place of the disc.

There are different classes of mirror-drum apparatus, the chief difference being in the light source employed. The simplest uses a crater-point neon lamp which is modulated directly, in other words the varying values of light necessary are obtained in the lamp itself by variation of the intensity of the light produced. Of a similar type is the mercury-vapour lamp of the recording type. The other type employs a constant source of light and this is modulated at some point in its path to the screen by passing it through a special light valve termed a Kerr cell. This slightly increases the complication and the cost of the apparatus, but the system possesses the advantage that rather more light is available for the production of the picture on the screen. In addition to the mirror-drum and associated apparatus a wireless receiver and amplifier are required which will provide an output of approximately four watts at four to five hundred volts. The amplifier usually employs four valves, three of which are used

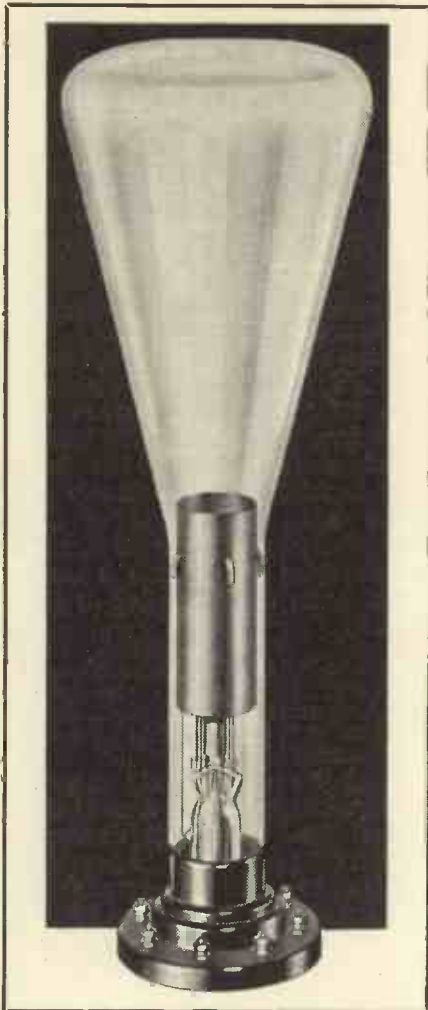

# A.C. COSSOR LTD<sup>TD</sup>

MANUFACTURERS OF

VALVES • CATHODE RAY  
TUBES AND EQUIPMENT •  
PORTABLE OSCILLOGRAPHS  
TELEVISION EQUIPMENT  
KITS AND RECEIVERS •  
RADIOGRAMS • ELECTRO-  
MEDICAL APPARATUS •

*Full details of Cossor Products may be had on application to:*

**A. C. COSSOR LTD.,**

Head Office:

Cossor Works, Highbury Grove, London, N.5

\*Phone: Canonbury 1234 (20 lines).

\*Grams: Amplifiers, Phone, London

### WORKS:

**COSSOR WORKS:**

Highbury Grove, N.5.  
Cossor Valves

**ABERDEEN WORKS:**

Aberdeen Lane, N.5.  
Electric Lamps and Signs

**KELVIN WORKS:**

Kelvin Road, N.5.  
Cossor Radio Receivers

**MELODY WORKS:**

Highbury Grove, N.5.  
Cossor Kits and Components

### DISTRIBUTING AND SERVICE DEPOTS AT:

**BIRMINGHAM**

14/16 Carrs Lane (4) Tel. Midland 1627/8

**BRISTOL**

14 Bath Street (1) -- Tel. Bristol 20271/2

**GLASGOW**

21 Waterloo St. (C.2) Tel. Central 4446/7

**LEEDS**

17 Wellington St. (1) - Tel. Leeds 21581/2

**LIVERPOOL**

42 Paradise St. (1) -- Tel. Central 1877/8

**MANCHESTER**

6, 8 & 10 Cannon Street (3)  
Tel. Blackfriars 9777/8/9

**NEWCASTLE**

3 St. Nicholas Buildings (1)  
Tel. Newcastle 23154/5

**SHEFFIELD**

3 Porter Street, Moorhead (1)  
Tel. Sheffield 23103/4

**CARDIFF**

4 Park Lane - - - - - Tel. Cardiff 3377

**DUBLIN**

47b Fleet St. (Parliament Row)  
Tel. Dublin 22471

**BELFAST**

47 Queen Street - - - - - Tel. Belfast 7979



for the modulation of the light and the other for synchronising. The type of receiver depends upon the situation but usually it consists of a 2 H.F. and Det. combination. As with the other classes of apparatus a separate receiver must be available for the reception of the sound side of the programmes.

Cathode-ray apparatus is entirely non-mechanical. The complete equipment for the reception of vision comprises a cathode-ray tube, the exciter unit for the provision of high-tension, two time bases for producing the scanning movement of the electron beam and a wireless receiver for the reception of the vision signals. Operation can be either from batteries or mains, the former being the more simple and entailing less cost; mains operation, however, reduces maintenance troubles to the minimum.

Should the resistance be removed from the base of the ordinary Osclim neon lamp?

For television purposes it is probably better to remove the resistance as the current which is available is too small to harm the lamp; it will function, however, either with or without the resistance. The simplest way of removing it is to saw through the thin brass cap when it will be found that the metal can be torn away.

What signal strength is required for the reception of the television programmes using a cathode-ray tube?

The modulation of a cathode-ray tube can be accomplished with a signal strength which ordinarily would give good headphone reception.

What is the extreme range at which the B.B.C. television broadcasts can be received?

We have reports of reliable reception at distances up to three hundred miles though at long range a certain amount of fading is apparent and conditions generally are more exacting. Good loudspeaker reception of the London National station is a good criterion to base the possibilities on.

What are the possibilities of recording the television programmes or, alternatively, are any records of this type available?

Records have been made of television transmissions but on the whole they are not satisfactory on account of the difficulty of recording the very high frequencies necessary. It is, however, possible to reproduce a picture by this means though a certain amount of detail is lacking.

Is it possible for an amateur to adjust the mirrors to the correct angles on a mirror drum?

It is quite possible though the task calls for the construction of a certain amount of auxiliary apparatus. For example, it is almost essential to make

a large wooden disc which is divided into thirty equal parts and mount this on the spindle of the drum. This, used in conjunction with a pointer, will allow the positions of the mirrors to be determined accurately. A plotted screen is also required so that the correct angular setting of the mirrors can be made. Full instructions for carrying out the work were given in the February issue of this year.

Is there any objection to driving a disc scanner by means of a belt?

None whatever, in fact, indirect drive of this nature has certain advantages in that slight variations of motor speed are not so readily transmitted to the scanner. The belt must be jointless and preferably of rubber which will permit of the mechanical filtering action mentioned. Synchronising gear, if any is used, should be on the same shaft as the scanner.

I am using the minimum of current through the neon as I am operating my receiver from batteries. What effect is this likely to have on the picture?

When the value of the current passing through the neon is small the pictures have very large contrasts between light and shade. The addition of a little extra voltage would not only remedy these contrasting effects but also make for a brighter picture.

## RECEPTION SCHEMES

Many people who contemplate taking up television are unaware of the requirements of different systems, and more particularly the amount of apparatus necessary. In order to give some idea of this a few schematic drawings have been prepared which, it should be understood, are a mere outline.

Roughly, it may be taken as an axiom that the larger the picture, the

more elaborate must the apparatus be. The simplest receiver of all, of course, is the disc and it is usually practicable to work this from an average three valve set, the only essential being that there must be ample high-tension which must approximate 185 volts as a minimum. Given adequate high-tension supply the lamp of the disc visor can be connected direct to the receiver.

A short time ago we described in this journal a method of obtaining screen pictures with an ordinary disc machine by means of the addition of a simple optical unit and the use of a special lamp. The requirements in this case are slightly greater than those of the simple disc, for sufficient light has to be provided to illuminate a much larger area. This calls for a still higher value of high tension, the figure being round about 235 volts and a current of about 25 milliamps. Otherwise the scheme is the same as for simple reception with the disc.

The mirror screw receiver will operate under almost the same conditions as the disc but here again the area of the picture is greater and it is therefore desirable to have a greater value of high-tension current—say 20 to 25 milliamps; the voltage, however, need only be the same as that

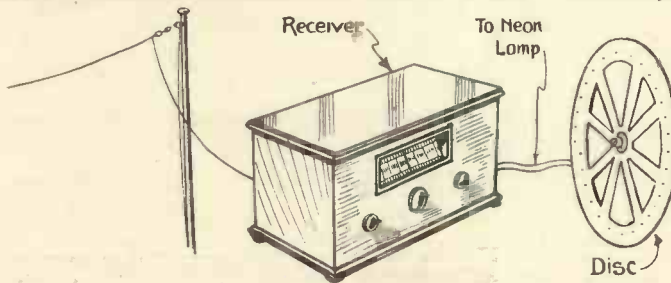

The disc receiver is the simplest of all; this drawing shows the elements.

# EVERYTHING YOU NEED in TELEVISION

## from PETO-SCOTT - CASH - C.O.D. - H.P.

PETO-SCOTT will supply you IMMEDIATELY with all your Television needs. Nowhere else will you obtain such prompt execution of your order, lower prices, or easier terms. Miscellaneous Television Components, Parts, Kits, or Accessories for Cash, C.O.D. or H.P. on our own system of easy payments. Send a list of your wants. We will quote you by return. C.O.D. orders value over 10/- sent carriage and post charges paid (GREAT BRITAIN ONLY), OVERSEAS CUSTOMERS CAN SEND TO US WITH CONFIDENCE. We carry a special export staff and save all delay. We pay half-carriage packed—free. Send full value, plus sufficient for half-carriage. Any surplus refunded. HIRE PURCHASE TERMS ARE NOT AVAILABLE TO IRISH OR OVERSEAS CUSTOMERS.

We undertake to construct all kinds of Television Apparatus to customers' specifications. Special staff of Television Experts. Send full particulars with drawings for detailed quotation

### PETO-SCOTT UNIVERSAL TELEVISION MOTOR



The Best Television Motor on the Market.

Specially designed for Television and built to stand hard usage, yet runs with the perfect precision so essential to Television;  $\frac{1}{4}$  in. diam.

spindle extended  $1\frac{1}{2}$  in. each side. Each end bearing screwed for synchronising gear. Heavy cast aluminium frame ensures freedom from vibration and noise. Self-oiling bearings provide even running. Armature and field coils accurately wound. Absolutely Universal for A.C. or D.C. Mains. 200-240 volts and A.C. 40 to 60 cycles. Cash or C.O.D. Post free, 30/-; 6-volt (Battery type), 35/-

**5/-**

**DOWN**

and 6 Monthly Payments of 4/9

All models, with stand, 2/6 extra.

**PETO-SCOTT UNIVERSAL MOTOR RESISTANCES** for use with above. Baseboard Fixed Type. Total Resistance 1,600 ohms. Variable (Panel Mounting) Type wound to 150 ohms. PER PAIR, CASH or C.O.D., 11/6 Post free.

**B.T.S. TELEVISION MOTOR.** Complete with Resistances. Cash or C.O.D. Carriage Paid £2/7/- or 5/- deposit and 9 monthly payments of 5/3.

### PETO-SCOTT 75/- DISC TELEVISION KIT

ASSEMBLED IN 30 MINUTES.

Peto-Scott, Pioneers in Television since 1927, have, after considerable research, produced this "up-to-the-minute" Disc Television Receiver Kit, of which Efficiency and Economy are the keynotes.



YOURS FOR **10/-**

and 11 monthly payments of 6/6

**NO SPECIAL TOOLS REQUIRED.** Designed to work from any 3-valve battery or mains set, the Peto-Scott 75/- Disc Television Receiver is supplied in Kit form, and comprises Peto-Scott Universal Television Motor and stand; controlling resistances; laminated and ready assembled chassis; Stroboscopic 16 in. scanning disc; lens and lens-holder; Neon Lamp and holder; together with sundry small parts. It is absolutely complete down to the last screw and piece of wire. Full-size Blueprint with assembly, wiring and operating instructions included with every Kit. Cash or C.O.D. Carriage paid, 75/-

### B.T.S. INDIRECT DRIVE DISC TELEVISION KIT

Comprises EVERY PART for instant assembly. Including B.T.S. Universal Ball-bearing Television Motor for Mains or Battery operation; resistances; laminated and ready assembled chassis with all component fixing holes marked. 16 in. Scanning disc and stand; lens and holder; improved type TELELUX NEON Lamp and Holder, FULL-SIZE BLUE-PRINT WITH ASSEMBLY, WIRING AND OPERATING INSTRUCTIONS WITH EVERY KIT.

TYPE K12 for A.C. (40-60 cycles) and D.C. Mains. Cash or C.O.D., Carriage Paid, 84/-; TYPE K13 for 6-volt Battery. Cash or C.O.D., Carriage Paid, 78/-, or 10/- deposit and 11 monthly payments of 6/9.

Yours for

**10/-**

and 11 monthly payments of 7/6

TELELUX the NEW Television Neon Lamp. Gives Brighter Pictures. Postage 6d. extra. **6/6**

### EDISWAN CATHODE RAY TUBES

As specified for the CASH or C.O.D. CATHODE RAY RECEIVER. Carriage paid **£5/6/0**

### 5-10 METRE SUPER-HET

COMPLETE KIT of first specified parts, including Eddystone two-piece metal cabinet and set of 4 Mazda Valves. Cash or C.O.D. Carriage paid, £7/11/- Balance in 11 monthly payments of 13/9. 1 Set of 4 Specified Mazda Valves ... **£2/6/-**

**PETO-SCOTT Co. Ltd.**

77, CITY ROAD, LONDON, E.C.1. (T-12) Telephone: Clerk. 9406-7. West End Show-rooms: 62, High Holborn, W.C.1.

## FERRANTI

### A.C.-D.C. CIRCUIT TESTER



**RANGES:**  
A.C. VOLTS: 0-15, 0-150, 0-300, 0-450, 0-600.

A.C. MILLIAMPS: 0-1.

D.C. VOLTS: 0-3, 0-15, 0-150, 0-300, 0-450, 0-600.

D.C. MILLIAMPS: 0-1, 0-7.5, 0-30, 0-150, 0-750.

**RESISTANCE:** 0-50,000 ohms self-contained and up to 30 megohms with external 1600 volt supply.

An 0.5 mfd. plug-in Condenser Unit can be supplied (Price 5/-) to enable the instrument to be used directly to measure output voltages.

Write for Leaflet Wb 529/D.

for the measurement of

**A.C. VOLTAGE D.C. VOLTAGE  
D.C. MILLIAMPS AND RESISTANCE**

Complete with External Resistance to give voltage ranges up to 600 volts.

Price

**£5-15-0**

**FERRANTI LTD., HOLLINWOOD, LANGS.**  
London: Bush House, Aldwych, W.C.2.

## Osram

### GAS FILLED RELAY TYPE G.T.1.

For Television Receivers

MADE IN ENGLAND

**NOW REDUCED IN PRICE**

Old Price	NEW PRICE
50/-	40/-

### Improved Characteristics

Peak current increased to:—  
1.0 ampere.

This means still greater reliability.

**REDUCED IN PRICE  
IMPROVED IN QUALITY.**



Advt. of The General Electric Co. Ltd., Magnet House, Kingsway, London, W.O.2

necessary with the disc receiver—a minimum of 185 volts.

The mirror-drum receiver is much more exacting in its requirements. The screen area is approximately 9 in. × 4 in. and the amount of modulated light necessary is much in

The cathode-ray receiver is also of a complicated nature and requires a considerable amount of accessory apparatus. Taking this in sequence there is first the wireless receiver which in this case need only be capable of a moderate output; in fact good

mentioned that the cathode-ray tube permits of television reception in an economical manner with all the power derived from batteries as the actual current consumption is very small. Finally, of course, there is the special tube.

The foregoing only outlines the schemes which find most favour and are generally in use. There is, however, a considerable amount of latitude possible and a very wide field for the experimenter. For example, there is a variation of the disc receiver which uses lenses in place of the usual holes, by which means it is possible to project pictures on to a screen. Naturally, such apparatus is more complicated, for it calls for accurate setting of the lenses and the provision of a brighter light source because of the increased area of the picture.

With all systems there are many alternative methods possible for pro-

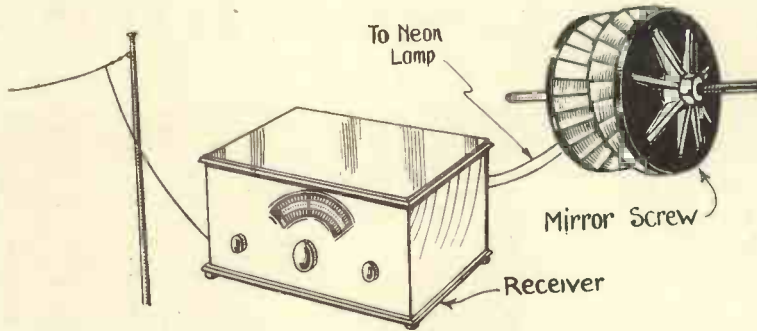

Mirror-screw reception is upon lines which are as simple as the disc though the current requirements are a little greater.

excess of that required by the receivers so far mentioned. In the first place it is essential to use a good-class three valve set for the reception of the signals and this must be followed by a powerful amplifier with an output of 4 to 5 watts at 400 volts. Both receiver and amplifier must be above reproach if good pictures, free from distortion, are to be obtained.

An outline of the system is given by the drawing and it will be seen that the vision signals are fed to the amplifier and the output from this is fed to the light cell or the special type of lamp which can be used as an alternative.

headphone reception is a sufficiently high standard. Next there is the

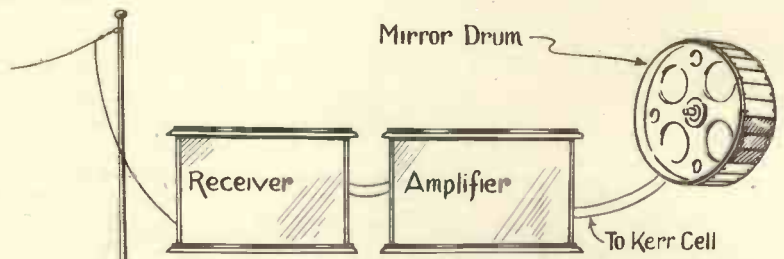

The mirror-drum demands considerably more power than any other type of receiver and the apparatus is rather elaborate.

double time base which is for the purpose of providing the screen. The arrangement of this will be clear from the drawing. It will be seen that there is one unit, which is for the purpose of supplying the tube, with the high voltage necessary for its operation. The type of unit there is the ordinary bunched filament lamp, the light from which is to be modulated on its way to the screen.

viding the light source. Roughly these comprise the flat plate neon, the crater point neon (which provides a highly concentrated point of light), the mercury vapour, and the mercury vapour recording tube. All these can be directly modulated. Additionally, there is the ordinary bunched filament lamp, the light from which is to be modulated on its way to the screen.

# 1935 EDDYSTONE SHORT WAVE MANUAL



Fully illustrated with constructional details for building Battery and Mains S.W. Receivers — 6v. S.W. Super-het with A.V.C. — All Wave Wave-metre — 5-metre Receiver — Simple 5-metre Transmitter — Cross-feeder Aerial System — Battery and Mains S.W. Converters — Amateur Bands Receiver — 100 watt Transmitter — Eliminators, etc.

Compiled by the Leading Short Wave Specialists  
 Obtainable from your radio dealer, W. H. Smith, or in case of difficulty, direct from  
**STRATTON & CO., LTD.,** (Dept. 20), Bromsgrove Street, Birmingham.  
 London Service Depot:—Webb's, 14 Soho St., W.1

PRICE 1/6

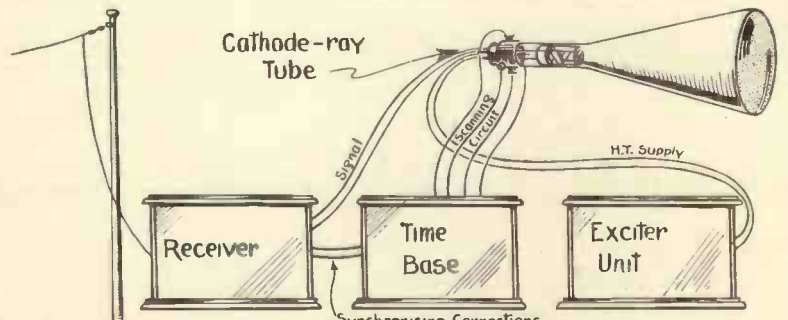

The cathode-ray system also calls for a fair amount of apparatus but the power requirements are small.



A corner of Paul Tyers' well-equipped laboratories where the original "W.M." Stenodes were developed.

### IS A TRANSPORTABLE STENODE POSSIBLE ?

Following the publication of constructional details of the "Wireless Magazine" battery and A.C. Stenodes, a number of readers have asked for completely self-contained models. Here are extracts from an article by Paul Tyers, the designer, in an answer to the above query that appears in the December "W.M.":

Now, the answer to this question is, of course, from first principles, very decidedly yes. Whether it is possible to design a transportable set which can satisfactorily be built by the home constructor is an entirely different matter.

\* \* \*

... as far as I am aware, there exists on the market no tuning pack which consists of a frame aerial inductance and an oscillator inductance tuned by a double-gang condenser. This means that it would appear necessary for the home constructor to make a special frame aerial.

\* \* \*

If we use a frame aerial instead of the ordinary outside type ... it is obvious that we must, by some means or other, increase the overall gain of the set. There are two ways of doing this ...

\* \* \*

Actual experiments are being made with both the suggested systems, and it is quite possible that the simple arrangement without the additional valve may give good programme strength from a sufficiently large number of stations. ...

\* \* \*

It must be remembered that the selectivity and sensitivity of the Stenode which I designed some months ago is such that it is by no means difficult to receive seventy to eighty stations.

\* \* \*

... it is impossible for me to say whether a satisfactory transportable Stenode can be built until the experiments referred to have actually been completed. These experiments are now being made in my laboratory.

# WIRELESS MAGAZINE

for December . . . . Price 1/-  
Special Christmas Number

# STENODE COUPLERS

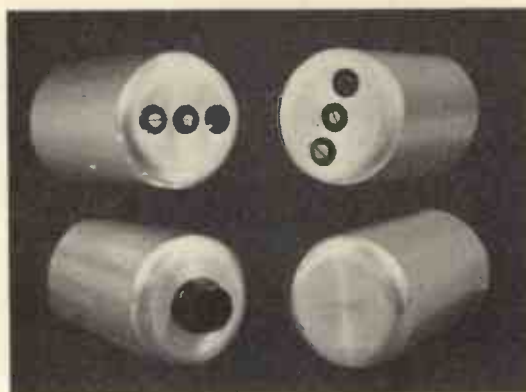

Set of 4 Couplers . . . . . Price 65/-  
Separate Couplers . . . . . each 16/6

USUAL Belling-Lee workmanship, quality and finish, has been put into the manufacture of these stenode couplers to the specification of the British Radiostat Corporation.

They comply in every way with the requirements of the inventor Dr. James Robinson, and the designer of the Wireless Magazine Stenode Receivers—Mr. Paul D. Tyers.



## BELLING-LEE

CAMBRIDGE ARTERIAL RD., ENFIELD, MIDDX

Advertisers like to know you saw it in "Television"

## "COILED-COIL" LAMPS

The Edison Swan Electric Co., Ltd., have sent us the following note regarding their new development in gasfilled lamps:—

The "coiled-coil" filament lamp is the latest development in the lamp making industry, and represents a considerable improvement in lighting efficiency.

The name originates from the fact that the filament of a standard gas-filled lamp is coiled twice instead of once.

As will be seen from the photograph, the filament wire is first wound in a spiral on a mandrel, and then the coil so formed is again wound on a mandrel of a larger diameter.

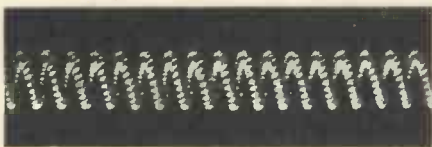

Section of filament of coiled-coil lamp.

As is well-known, the filament of a gasfilled lamp is cooled by heat conduction through the gas, and the rate of loss of heat depends on the area of the filament surface presented to the gas. For this reason the filament is coiled in a spiral of as large a diameter as possible in order to present the minimum surface area for cooling purposes.

The practical limitation to the diameter of the coil is that of mechanical stability, but if the coil is again wound in the form of a spiral, increased rigidity is obtained coupled with the advantage of further decrease in surface area.

The "coiled-coil" has the further advantage in that less filament supports are required, and that therefore there are less points along the surface of the coil where cooling can take place by conduction down the support. As a result, the "coiled-coil" 40-watt lamp is about 20 per cent. more efficient than an ordinary gasfilled lamp of the same rating.

### The Television Society.

The next meeting of the Society will be held on Wednesday, December 12, at University College, Gower Street, when a paper will be read by Dr. L. C. Martin on Electron Optics.

## THE PRIESS SYSTEM

*The following is a personal description by the inventor of the Priess system which according to a correspondent is being developed in U.S.A. We publish it just as received.*

The light is caused to strike a mirror and is reflected from that mirror to the screen as a spot. The spot is caused to move horizontally by vibrating the mirror in a vertical plane and simultaneously the lines produced by the vertical vibration are caused to travel up and down by a slower horizontal vibration of the same mirror. The mirror is a metal mirror  $\frac{1}{4}$  in. square and  $\frac{1}{32}$  in. thick. It is spot welded to a steel wire 3 ins. long. One end of the wire is welded into a frame. The other end terminates into a thinned-out section that is gripped by adjustable jaws to provide tuning.

The natural frequency, as determined by the elasticity and moment of inertia of this system, is 5,000 cycles a second and it requires a power of only  $\frac{1}{2}$  watt to attain a  $15^\circ$  light angle. The torsional vibration of the mirror rod system scans the line. This line system is welded to a steel rod  $\frac{5}{32}$  in. in diameter and 3 ins. long whose axis is at right angles to the first rod and crosses the plane of the mirror. It likewise contains a tuning adjustment.

The second vibrating frequency is the picture frequency and serves to sweep the scanned line from the top of the picture to the bottom and then back again to the top. The picture frequency is a resonant system and is 24 double frames a second and the motion is obtained with but .1 watt.

As the driving powers are low, they are obtained from the receiving amplifier by a pulse that is sent over the air. This ensures the exact synchronisation of the receiving scanners with the transmitting scanner.

Miss Ruth Jebb, of the Lyth, Elmere, Salop, will be glad to hear from other members of the Constructor's Circle in this district.

FOR  
DISC AND MIRROR DRUM SYSTEMS  
"BAIRD" and "MERYN"  
KITS AND COMPONENTS  
L. LEAMAN, 97, Northfield Avenue,  
W. Ealing, W.13.  
Phone—EALING 5394

## AMERICAN TELEVISION STATIONS

1,600-1,700 kc. 176.5-187.5 m.  
W2XR—Long Island City, N.Y.  
W8XAN—Jackson, Mich.

2,000-2,100 kc. 142.9-150 m.  
W9XAO—Chicago, Ill.  
W6XAH—Bakersville, Cal.  
W9XK—Iowa City, Iowa.

2,100-2,200 kc. 136.4-142.9 m.  
W2XBS—New York, N.Y.  
W6XS—Los Angeles, Calif.  
W9XAP—Chicago, Ill.  
W9XAK—Manhattan, Kans.

2,200-2,300 kc. 130.4-136.4 m.  
W9XAL—Kansas City, Mo.

2,750-2,850 kc. 105.3-109.1 m.  
W9XG—W. Lafayette, Ind.

43,000-46,000 kc. 6.52-5.98 m.  
48,500-50,300 kc. 6.00-6.20 m.  
60,000-80,000 kc. 3.75-5.00 m.

W9XD—Milwaukee, Wis.  
W9XE—Marion, Ind.  
W8XF—Pontiac, Mich.  
W3XAD—Camden, N.J.  
W2XR—Long Island City, N.Y.  
W9XAT—Portable.  
W2XF—New York, N.Y.  
W6XAO—Los Angeles, Calif.  
W3XE—Philadelphia, Pa.  
W2XAK—New York, N.Y.  
W10XX—Portable and Mobile.  
W8XAN—Jackson, Mich.  
W8XL—Cuyahoga, Heights, Ohio.

Readers in the Hampshire area may be glad to know that fortnightly meetings of the Portsmouth and District Wireless and Television Society are held in the Municipal College Wireless Room.

Application for membership is invited and full particulars can be obtained from the Chairman, Mr. Albert Parsons, F.R.A., F.T.S., The Radio Section, Municipal College, Portsmouth. At an early date it is hoped to open a research station.



# See at once what's wrong!

A sudden silence in your set . . . or a baffling, aggravating noise! What is it? With the AvoMinor you can find out at once.

This ingenious scientific instrument is actually TEN testing instruments in one, giving ten different ranges of readings in milliamps, volts and ohms. It enables you to make every conceivable test with the ease and precision of the electrical engineer, but without his specialised knowledge and skill.

Supplied in handsome case with pair of leads, interchangeable crocodile clips and testing prods, and booklet of instructions showing diagrammatically how to make every test.



**40%**

Deferred terms if desired.

- CURRENT.**  
 0-6 m/amps.  
 0-30 "  
 0-120 "  
**VOLTAGE.**  
 0-6 volts.  
 0-120 volts.  
 0-300 volts.  
**RESISTANCE**  
 0-10,000 ohms.  
 0-60,000 "  
 0-1,200,000 "  
 0-3 megohms.

**"RADIO SERVICING SIMPLIFIED"**

Everyone should have this invaluable book. It explains every phase of fault-tracing step by step in non-technical language. The comprehensive information and numerous diagrams render testing and servicing a matter of straightforward procedure.

2/6  
 or post free, 2/9.

THE D.C. **AVOMINOR** REGD. TRADE MARK  
**T E L L S T H E W H O L E T R U T H**

The testing of valves and valve circuits is no longer a tiresome business with your fingers getting in the way. The AvoDapter enables you to make every test with ease, under actual working conditions, but externally on the bench instead of grovelling about inside the set, and without having to sever any connections. You simply plug the valve under test into the AvoDapter base and insert the AvoDapter plug in the valve-holder in your set. Supplied with comprehensive instruction book. Adaptable for 4-pin, 5-pin, or 7-pin valves.

The **AVODAPTER . . .**

Fully descriptive Folders Post free from:—

**AUTOMATIC COIL WINDER & ELECTRICAL EQUIPMENT CO., LTD.**  
 Winder House, Douglas Street, London, S.W.1. Victoria 3404-7.

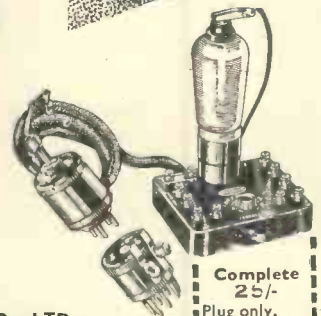

Complete 25/-  
 Plug only, with 6-way lead 7/6

**The Journal of the Television Society**

Principal Contents of Vol. I, Part XI  
 (Sept. 1934)

**NOW READY**

**E. H. Traub :**

Television at the 1934 Berlin Radio Exhibition.

**H. R. Ruff :**

Recent Developments in Photo-electric Cells and their Applications.

**E. B. Kurtz.**

Teaching by Television.

Review of current literature and instruments, Notes, etc.

**The Journal of the Television Society**

is published three times a year. All members are entitled to a copy ; and it is also sold to Non-Members, at an annual subscription of 15/- post free; single copies 5/-.

Forms of proposal for Membership, and further information regarding the Society, may be obtained on application to the Business Secretary, J.J.Denton, 25, Lisburne Road, Hampstead, London, N.W.3.

# RESILIENCE

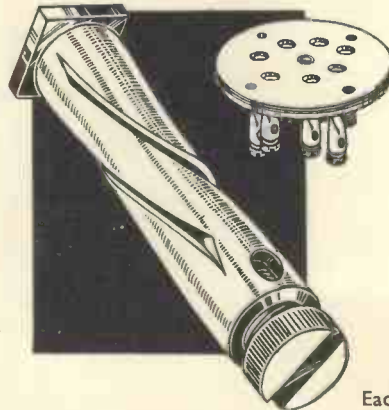

*CLIX  
 Points of  
 Advantage*

**FOR YOUR LABORATORY**

There are numerous Clix perfect contact components which, though small, are extremely useful for all experimental work. The technical staff of "Television" use them.

Each individual socket in Clix Chassis Mounting Valveholders is formed with a definite waist which, in conjunction with the helical slots, affords unique resilience and gives perfect contact with every type of valve pin without possibility of collapse.

Folder "F" Free.

**CLIX LECTRO LINX LTD.**  
 79a Rochester Row, London, S.W.1

Better service results from mentioning "Television" when writing to advertisers

## "Building the Time-Bases."

(Continued from page 528.)

responding right-hand tag of the upper resistance (wire No. 27), and take a connection from either of the tags to the H.T. + terminal (wire No. 28).

### "Shift"

#### Potentiometer

The other two 2-megohm potentiometers on the right-hand side of the baseboard, looking from the back of the set, are for the purpose of centring the line screen on the end of the cathode-ray tube. These are connected in parallel across the H.T. supply, each one having a series resistance. The right-hand side soldering tags of both upper and lower potentiometers should be looped together as before and connected to H.T. - (wires Nos. 29 and 30). The left-hand side soldering tag of the lower resistance is joined to a 2-megohm fixed resistance by means of wire No. 31. The left-hand side soldering tag of the upper resistance is joined to a 1-megohm resistance by wire No. 32. The other ends of the two resistances are joined together (wire No. 33) and are connected to H.T. + (wire No. 34).

As usual take care that these resistances are kept well clear of the components and that the wires do not touch the metal brackets or the covers of the resistances themselves.

Finally, the centre tags of each variable resistance are joined through wires Nos. 35 and 36 to the soldering tags on condenser C<sub>3</sub> and C<sub>4</sub>. Flexible leads will later be taken from these tags to the deflector plates of the tube, but all these flexible connections can be left until the tube is actually ready to be put into place.

## Negative Wire

The final connections are then made from various points on the layout to the negative H.T. wire. If the wiring is carried out exactly as in the diagram, there is no reason why it should not be done with bare copper wire tacked to the board with fine pins to hold it in place.

Commencing at the H.T. - terminal, lay a length of wire (No. 37 in the diagram) the full length of the baseboard, bending it clear of the bias battery and finally soldering it to the right-hand tag of the centre potentiometer viewed from the front. Connections can now be made to this wire along its length as follows:

Wire No. 38—from C<sub>3</sub> and C<sub>4</sub>.

Wire No. 39—from the cathode terminal of the valve-holder. Where this wire passes between the anode terminal it must be carefully insulated with a short double length of systoflex tubing to avoid possible short-circuiting.

Wire No. 40—from soldering tag of C<sub>2</sub> condenser. Where this wire passes over the braid covering, a touch of solder can be put to earth the braiding to the H.T. -. The same applies to the braid which passes under the wire near the L.T. - terminal (near wires Nos. 1 and 3 in the diagram).

Wire No. 41—is from the cathode terminal of the second valve-holder, and the same care must be taken where it passes near the anode terminal.

This now completes the wiring with the exception of one or two flexible leads, which can be left until the whole assembly is ready to be put in the cabinet.

## "Fluorescent Lamps"

(Continued from page 554.)

mA passing through it. A valve with an output of 1 to 1½ watts undistorted output gives an extremely good modulation at this current value. The positive anode is made much larger, and is necessary for effective operation and long life. This same lamp has been operated at 60 mA and modulated with a valve of the PX25 and DO24 type. At this current value the brilliance is ex-

ceedingly high and the modulation character of the discharge slightly better.

It will be noticed that the centre of the tube has a milky appearance, which is, of course, due to the opaque medium introduced; it provides an even light field, at the same time masking the actual form of the mercury discharge.

The diagram shows a logical development of this type of tube. There is introduced a third electrode, and this is highly polished, resulting in a

scientific light reflection due to its position and shape.

Without doubt, these developments will have far-reaching applications in television and similar subjects, and it is only necessary to envisage a screen of the glass in projectors. Further experimental work is being undertaken, and the results will undoubtedly prove interesting.

## A New American Company

America's newest television company to announce operations is the National Television Corp. of New York. This new concern will transmit programmes as well as sell receiving sets. The results of more than two years' intensive research will be demonstrated when the new company begins commercial operations, probably in January, 1935. The firm is a subsidiary of the Sirian Lamp Co., which is also affiliated with other manufacturing companies, including Arcturus Radio Tube Co. and World Bestos Corp.

Mechanical scanning of the 60-line mirror drum type will be used. Later it is expected to advance to 120 lines.



**PHOTO CELLS  
FOR  
TELEVISION  
AND  
ALL OTHER PURPOSES**

The Oxford X.41 Photo Cell is specially constructed and extensively used for television transmissions. Not only is it more sensitive than any other cell of similar type, but it is less expensive. Full details of all Photo Cells and Photo Relays will be sent on request.

**OXFORD INSTRUMENT CO. Ltd.**  
Keble Road, Oxford.

**THE CONSTRUCTORS' CIRCLE**

Application for Membership

To be filled in and sent with a stamped envelope for reply to the Editor, "Television," 58-61, Fetter Lane, London, E.C.4.

(1) I already subscribe to your journal at the address below.

(2) I have placed a regular order for TELEVISION with my booksellers, Messrs.....

.....  
 .....  
 and desire to be enrolled as a member of the TELEVISION "Constructors' Circle."

Please send membership badge free of charge to

Name (in block letters) .....

Address .....

\*Strike out lines not applicable.

**ENGLISH PROGRAMMES**  
 from  
**CONTINENTAL STATIONS**

Every week RADIO PICTORIAL gives full details of the English-speaking programmes from Continental stations for the coming week.

These programmes are exclusive to RADIO PICTORIAL.

RADIO PICTORIAL appears every Friday, and is sold by all newsagents and bookstalls—price 3d.

**"TELEVISION" COUPON**

FOR FREE INQUIRY SERVICE

Name .....

Address .....

December, 1934.

**H. E. SANDERS & Co**

Supply all Up-to-date Apparatus

USE A "MERYVN" DUPLEX NU-GLO 16" LAMP AND A SANDERS 4" NON-DISTORTING LENS AND GET MORE BRILLIANT AND LARGER PICTURES.

DUPLEX LAMP AND LENS. Price 17/6 post free.

SUPER LENS 5" will give extra Large Picture. Price 7/6, post 6d.

WHITE LINE LAMP giving 12 to 60 times brightness of a Neon Lamp can be definitely used for Discs, Mirror Screws and Projector Systems. Length of White Strip, 2½" x 4 mm. diam. Containing Mercury and Neon. Price 25/- post free.

VARIABLE RESISTANCE, 2000 ohms. for all Neon Tube Control. Best Workmanship. Price 4/6, post 3d.

DISC RECEIVER KIT, including Nu-Glo Lamp and Baseboard Fittings. Price 60/- HANDBOOK "EASY LESSONS IN TELEVISION." 2/- post free.

Send for Latest Illustrated List

**H. E. SANDERS & Co**  
 4, GRAYS INN ROAD, LONDON, W.C.1

Telephone : Chancery 8778



**TELEVISION CHRISTMAS PRESENTS**

70/-; 75/6; 5 gns.

ANOTHER GENEROUS BENNETT KIT, 70/- COMPRISES baseboard ready for use, fitted with metal legs and terminals. A.C./D.C. Television type Motor (or 6 volt) Scanning Disc. Motor Brackets. Tapped Resistance. Variable Resistance. Mercury-neon Lamp (flat electrode) and holder. BICONVEX 4½" LENS AND VIEWING TUNNEL. COMPLETE RECEIVER, 70/-. VISION TESTED. The above set is also supplied with two lensed enclosed type VIEWING TUNNEL unit. COMPLETE RECEIVER, 75/6. VISION TESTED. Same receiver incorporating SYNCHRONISING GEAR. COMPLETE RECEIVER, 5 gns. DISC PROJECTION KIT. Including "T1" LAMP (but less lens system only), 72/- complete. Projection Lens, 2½" fc., 4/6; Biconvex 4" diam., 12" fc., 4/6. Lensholder with rails, 2/6. Send for Television Components List, Free. All apparatus sent post free over 10/- or C.O.D.

PRACTICAL TELEVISION HANDBOOK, 1/- BENNETT TELEVISION Co. REDHILL

Additional Members of the Constructors' Circle.

S. A. Morley, 22 Old Farleigh Road, Selsdon, South Croydon, Surrey; R. N. Stevens, 38 High Street, Oakham, Rutland; J. S. Austin, Alcutha, Sandwich, Kent; A. Blackburn, 26 Peasey Hills Road, Malton, Yorks; R. Hall, 32 Church Road, Willesden, N.W.10; E. R. Grant, 80 Trafalgar Street, Norwich; G. P. Astill, 22 Humberstone Drive, Leicester; W. J. Bird, 50 Baker Street, Brixton, S.W.9; L. Goding, 31 Horsenden Crescent, Greenford, Middlesex; D. L. Johnston, 64 Glisson Road, Cambridge; S. N. Carrington, 78 Charles Street, Milford Haven, Pembrokeshire; Filtenborg, Fona Radio Rosengrns Alle, V. Copenhagen, Denmark; Miss Ruth Jebb, The Lyth, Ellesmere, Salop.

It helps us if you mention "Television"

**MISCELLANEOUS ADVERTISEMENTS**

The charge for advertisements in these columns is 12 words or less 2/-, and 2d. for every additional word. All advertisements must be accompanied by remittance. Cheques and Postal Orders should be made payable to Bernard Jones Publications Ltd., and crossed, and should reach this office not later than the 15th of the month previous to date of issue.

A. MATHISEN, Chartered Patent Agent. Patents' Designs and Trade Marks.—First Avenue House, High Holborn, W.C.1. Holborn 8950. Telegrams: "Patam" Holb., London.

KINGSTONE Manufactured Components "Nu-Vu" Television Kit, 42/-; motors, double-ended, 19/-; synchronised, 30/-; complete synchroniser, 14/6; toothed wheel, 4/8; synchroniser coils, 4/- pair; Kerr cell, 10/-. Poss, Mirror Drums, etc. Stamp for illustrated list.—Kingstone & Co., 372, Essex Road, N.1.

(CHESHIRE) Baird Motor and Synchroniser, speed and phase control, cost over £6. Perfect, only run two hours. £3/10/-.—Broadlands, Motcombe Grove, Gately, Cheshire.

TELEVISION components at greatly reduced prices. Bankrupt stock of double-ended motors 200/250, AC/DC bargain, 14/9; variable resistance, 3/6. Illustrated lists, synchronising gear, mirrors, etc., free. Ancel Cine Television Co., 18, Highbury Terrace, Nr. Highbury Station.

MANUFACTURERS Design and Production Engineer. F.T.S., M.O.R.E., etc.—Radio or Television—initiative and ability—ready for your consideration. 16, Lyndhurst Avenue, North Finchley, N.12. (A. R. Turiss.)

GENUINE Baird Telesivisor, £6/10/-, or near offer.—Marshall, 25, Harrington Drive, Nottingham.

PATENTS, Trade Marks, Advice. Handbook and Consultations Free.—B. T. King, Patent Agents, G.B., U.S.A. and Canada, 146a, Queen Victoria Street, London. 48 year's references. Phone: City 6161.

GRAMOPHONE MOTOR.—Triple Spring, auto-stop. Plays six 10" records, one winding. Nicke plated, 12" turntable, perfect condition, 25/- Val. 3421.

BRITISH ISLES TELEVISION CLUB keeps you in touch by post. Open to all Television enthusiasts. Inter-communication secured. Information bureau free. Send stamped envelope for details from Secretary, B.I.T.C., Jesmond House, Redstone Copse, Redhill.

**INDEX TO ADVERTISERS**

Automatic Coil Winder Co. Ltd.	..	567
British Television Supplies, Ltd.		Cover iv
Belling & Lee, Ltd.	..	565
Bennett Television, Ltd.	..	Cover iii
Cossor, A. C. & Co.	..	561
Electradix	..	521
Ferranti, Ltd.	..	563
General Electric Co., Ltd.	..	563
Leaman	..	566
Lectro Linx, Ltd.	..	567
Mervyn Sound & Vision Co., Ltd.	..	522
Oxford Instrument Co.	..	568
Peto-Scott, Ltd.	..	563
Sanders, H. E., & Co.	..	Cover iii
Scophony, Ltd.	..	Cover ii
Sound Sales	..	Cover ii
Stratton & Co. Ltd.	..	564
Television Instruments, Ltd.	..	Cover ii
Television Society	..	567
Varley	..	521
Wireless Magazine	..	565
Westinghouse Brake & Saxby Signal Co., Ltd.	..	521

# LONGER TELEVISION PROGRAMMES

ENJOY THEM WITH THE  
**B.T.S. INDIRECT DRIVE DISC TELEVISION KIT**

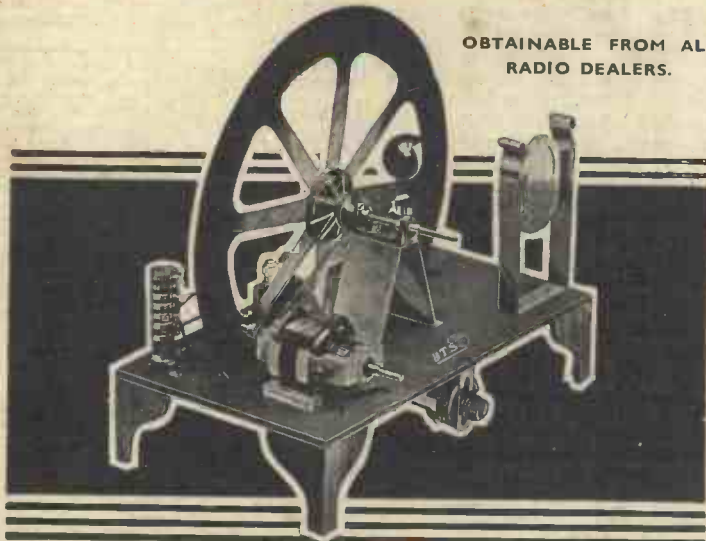

OBTAINABLE FROM ALL  
RADIO DEALERS.

## TELELUX FOR BRIGHTER PICTURES

Invented to Perfect Disc Television.—The process of manufacturing TELELUX is one of the latest Television patents, and results in a very highly-developed lamp essential to perfect Disc Television reception.



**6/6**

Due to the special opaque external coating, "glare" and "beehive" lines are entirely eliminated. Bright, clear and well-defined images result from the concentration of light at the picture aperture by a special light-collecting medium. Designed for use with 16 in. and 20 in. discs, TELELUX lights at 180 volts, and operates with only 18m/a passing through it

Obtainable from all Radio Dealers

**T**HE B.T.S. DISC TELEVISION KIT comprises EVERY PART for instant assembly, including B.T.S. Universal Ball-Bearing Television Motor for either Mains or Battery operation as required; controlling resistances; laminated and ready-assembled chassis, with all component fixing holes marked. Stroboscopic 16 in. Scanning disc and stand; lens and lens-holder; improved type TELELUX Neon Lamp and Holder. **FULL-SIZE BLUE PRINT WITH ASSEMBLY WIRING AND OPERATING INSTRUCTIONS WITH EVERY KIT.**

**TYPE K12 for A.C. (40-60 cycles) and D.C. Mains**  
**84/-**

**TYPE K13 for 6-volt Battery, 78/-**  
If required with B.T.S. Synchronising Gear, 27/6 extra.



## B.T.S. TELEVISION COMPONENTS

Obtainable from all Radio Dealers

### B.T.S. TELEVISION MOTOR



Runs with perfect precision. Heavy cast aluminium frame ensures freedom from mechanical vibration and absence of noise. Ball bearings provide even running. Suitable for both 16 in. and 20 in. Scanning Discs. Cat. No. M/1 Universal A.C. or D.C. Mains, 200-240 volts. A.C. 40-60 cycles or Battery Model. Cat. No. M/2 6-volt. Price **35/-**

B.T.S. Motor Stand 2/6

**B.T.S. FIXED RESISTANCE.** Cat. No. R/9. **6/6**

**VARIABLE RESISTANCE.** Cat. No. R/10. **5/6**

### B.T.S. SCANNING DISCS



Light gauge aluminium. Centre-boss is an 8-ribbed black Bakelite moulding faced white to give true Stroboscopic effect, and thereby visual speed indication. Scanning holes perfectly punched to secure uniform scanning without preventable lines. Made in 2 sizes and ready for immediate use. 16 in. diam. Cat. No. D/3. 20 in. diam. Cat. No. D/4, 12/6. **7/6**

### B.T.S. SYNCHRONISING GEAR KIT



Perfect synchronisation, with floating images reduced to a minimum. Expertly designed and constructed. Quickly and easily assembled. For mounting on either end of B.T.S. Universal Motor.

In carton with assembly instructions. Complete Kit. **27/6**  
Cat. No. S/8.

### SEND FOR LISTS OF B.T.S. TELEVISION & SHORT WAVE APPARATUS

All parts for the needs of the Constructor and the serious Experimenter. Write to-day.

# B.T.S.

● **MANUFACTURERS of TELEVISION APPARATUS** ●

**BRITISH TELEVISION SUPPLIES LTD. BUSH HOUSE, LONDON, W.C.2**

Telephone: **TEMPLE BAR 0134**

**WHOLESALE STOCKISTS:**

Boynnton's & Co., Ltd., 65-8, Stafford Street, Birmingham.

& Co., Ltd., 3, 4 & 5, Castle Street, Hull.

Frank Riddiough & Son, Slimes Street, Westgate, Bradford. J. Dyson & Co., Godwin Street, Bradford. Samuel Gratrix, Jr., & Bros., Ltd., Alport Works, Quay Street, Deansgate, Manchester. Nottingham Radio Supplies, Sherwood Buildings, Sherwood Street, Nottingham. T. Beadle & Co., Ltd., 241, Park Road, Aston, Birmingham.

Telegrams: **TELEVIEW, BUSH, LONDON**