

TELEVISION
August, 1932

RADIO EXHIBITION NUMBER

TELEVISION

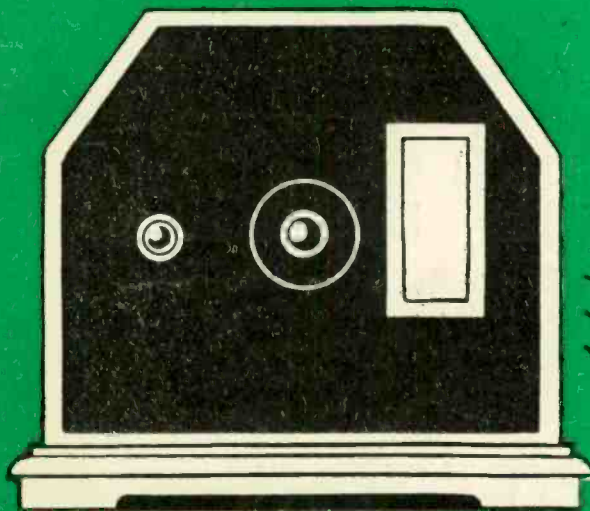

AUGUST 1932

New B.B.C. Broadcasts :
Official Date

The Future of
Radio Drama

If Lindbergh
had been Televised

All About "Radio City"

Vol. 5

No. 54

1
NET.

THE FIRST TELEVISION JOURNAL IN THE WORLD

LOOK IN

AT THE

LEWCOS

REGD.

STAND N° 153 OLYMPIA

AND SEE

WE ARE EXHIBITING AT

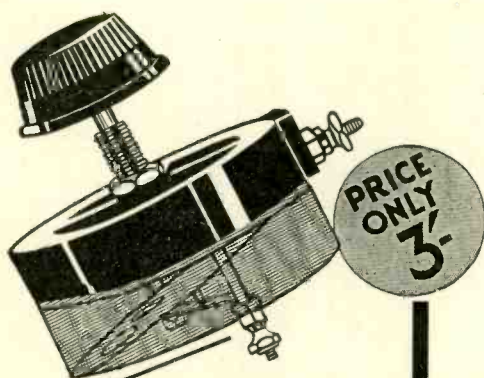

The following are some of the reasons for the popularity of the LEWCOS

POTENTIOMETER

- 1 It is dead silent in operation.
- 2 Perfect contact is made by an eccentric rocking plate.
- 3 The rocking plate is constructed to prevent friction on the wires.
- 4 It is wire wound and dust-proof, being enclosed by a non-inflammable transparent cover
- 5 Obtainable in the following values: 1,000, 5,000, 10,000, 25,000 and 50,000 ohms.

the latest Lewcos lines in Radio Components—especially those suitable for Television Sets. At Stand No. 153 will be on view all the latest developments which help so much to bring you better reception, including the new

LEWCOS REGD. POTENTIOMETER

which costs only 3/-, yet will make all the difference to your set by enabling you accurately to control your output to suit varying conditions. It definitely clarifies reception by giving a far higher degree of efficiency which will improve your set enormously.

A large model of the Lewcos Potentiometer, illustrating its various advantages, will be on view at Stand No. 153, in addition to other famous Lewcos Products.

Other Lewcos Products which have been specially recommended for Television Sets by experts of this Journal are GLAZITE Wire, LEWCOS Spaghetti Resistances and Twin Flex.

Manufacturers
are reminded that Lewcos are particularly well-equipped for manufacturing Radio Components to definite specifications.

LEWCOS RADIO PRODUCTS FOR BETTER RECEPTION

THE LONDON ELECTRIC WIRE COMPANY AND SMITHS LIMITED, CHURCH ROAD, LEYTON, LONDON, E.10

GENEROUS HIGH-TENSION NEVER FAILING, NEVER FLUCTUATING

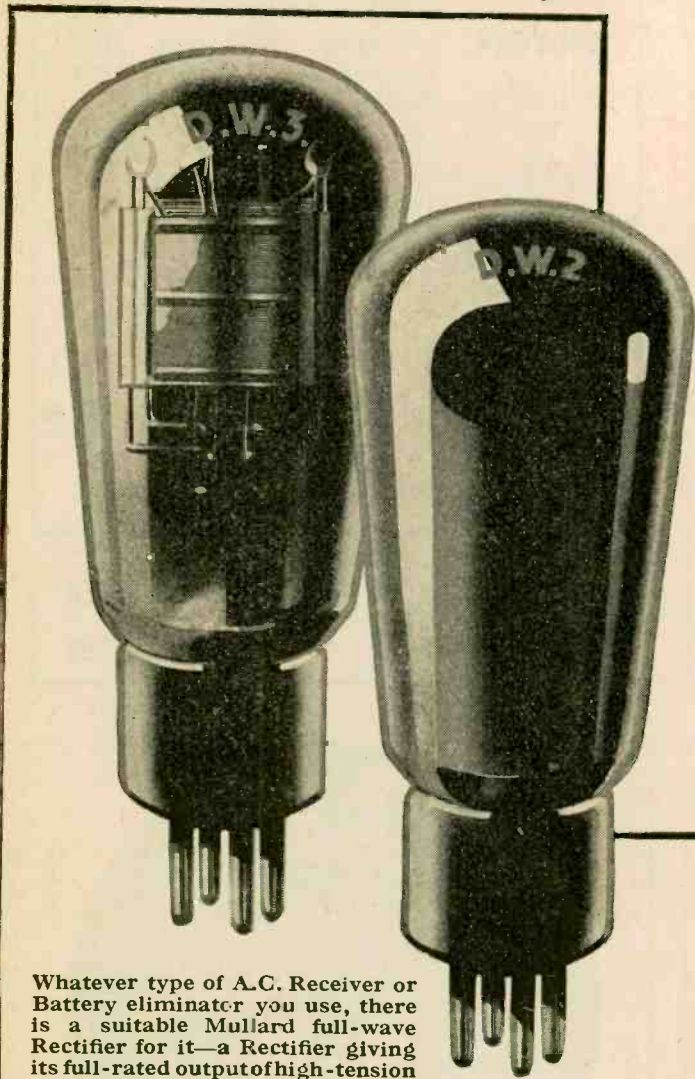

Whatever type of A.C. Receiver or Battery eliminator you use, there is a suitable Mullard full-wave Rectifier for it—a Rectifier giving its full-rated output of high-tension current, week in, week out. Constant voltage, generous ever-available output—and that consistent performance which you have learnt to expect from every Mullard valve.

The D.W.4 is specified for the eliminator for the "Tele-Radio" receiver described in this issue.

from

MULLARD FULL-WAVE RECTIFIERS

Type D.W.2. Output 60 mA. at 250 volts]	Reduced price	12/6
Type D.W.3. Output 120 mA. at 350 volts	Reduced price	15/-
Type D.W.4. Output 120 mA. at 500 volts	Reduced price	20/-

MADE IN ENGLAND

Mullard

THE · MASTER · VALVE

Advt. The Mullard Wireless Service Co., Ltd., Mullard House, Charing Cross Road, London, W.C.2.

ARKS

TELEVISION for August, 1932

193

P.P.M. gives 'PRICELESS' REPRODUCTION

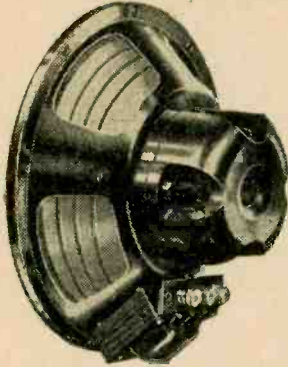

Realism—quality of tone—know what real radio reproduction is by hearing a Celestion P.P.M. Permanent Magnet, Moving Coil Speaker—once you have heard it you will have no other—insist upon your local dealer giving you a demonstration.

47/6

**INCLUDING
TRANSFORMER**

The P.P.M. incorporates an impregnated diaphragm, and a scientifically designed twin suspension. The new patented cobalt content steel magnet produces a very high flux density. Housed in a strong metal chassis.

Please state whether pentode or standard transformer required. Supplied fitted to baffle as illustrated. Easy payment terms: 10/- down and 6 monthly payments of 8/-.

CELESTION
The Very Soul of Music
LOUD-SPEAKERS

Celestion Ltd., London Road, Kingston-on-Thames. London Showrooms: 106 Victoria Street, S.W.1

PROGRESS

Radio and Television technique are constantly advancing . . . there is no finality . . .

COLVERN

Whatever advances are made, Colvern Coils will be available . . .

COILS

COLVERN COILS are specified for the "VISIONETTE."

1 Type RM1S. 8s. 6d. each.
1 Type RM3S. 8s. 6d. each.

2 Screens and Bases, type C.C.S. . . . 3s. 6d. each.

1 10,000 ohm variable Colverstat, type S.T.10. 5s. 6d. each.

● Send for a copy of the Colvern Booklet No. 10. ●

Stand No. 245, Radio Exhibition, Olympia.

COLVERN LIMITED
MAWNEYS ROAD, ROMFORD, ESSEX

A FAMOUS VALVEHOLDER

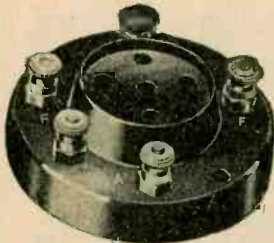

W.B. 4- or 5-pin VALVE-HOLDERS FOR A.C. Valves. (Patent No. 320460.)

Diam. 2 ins. Used in the test rooms and laboratories of leading valve manufacturers. Expanding nickel-silver sockets make it equally suitable for Banana or solid valve pins **10d.**

**FOUR
ARE
SPECIFIED
IN THIS ISSUE**

of "Television"

for the
"VISIONETTE"

Made by the Makers of the famous "W.B."
Moving-Coil Speakers

*Write for the new lists
of new season's models*

Whiteley Electrical Radio Co., Ltd.,
Nottingham Road, Mansfield, Notts.

Irish Free State Distributors:
Kelly & Shiel, Ltd., 47 Fleet Street, Dublin

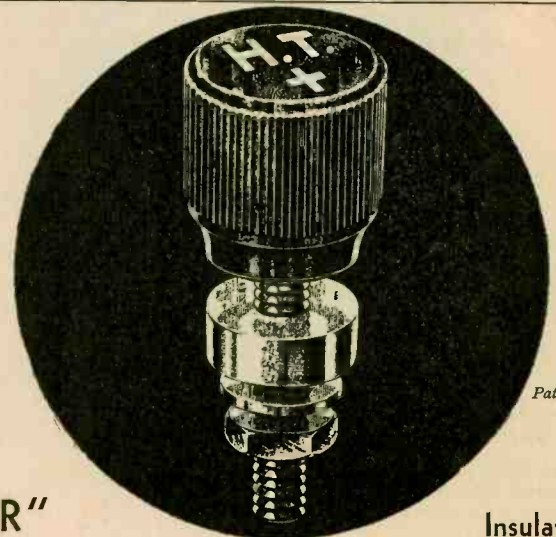

"R"

Type
Terminal

REDUCED

2 1/2

PRICE

Insulated
non-remov-
able head

BELLING-LEE
FOR EVERY RADIO CONNECTION

Advertisement of Belling & Lee, Ltd., Cambridge Arterial Road, Enfield, Middlesex.



and be sure to visit

STAND 281

reserved by the publishers of

“TELEVISION”

For the benefit of subscribers and the general public the special apparatus designed by the Technical Editor, Mr. H. J. Barton Chapple, Wh.Sch., B.Sc., A.C.G.I., D.I.C., A.M.I.E.E., and by Mr. William J. Richardson will be on view, enabling every visitor to Olympia to see the actual sets described in recent issues of TELEVISION. These issues will be on sale at the stand, so that the constructor can immediately obtain full details and working diagrams showing how to make similar sets for home use.



Throughout the week technical advice will be given gratis to interested enquirers, who will thus have the opportunity of obtaining first-hand hints on the construction of vision apparatus and on the problems of television generally.

EXHIBITS WILL INCLUDE THE “VISIONETTE” AND ALSO THE SPECIAL POWER UNITS FOR THE “TELE-RADIO RECEIVER” DESIGNED AND DESCRIBED EXCLUSIVELY IN “TELEVISION.”

Make a note of the number now—

STAND 281

AUGUST 19th–27th (except Sunday), 10 a.m.—10 p.m.

THE FOLLOWING DEALERS ARE WILLING TO DEMONSTRATE TELEVISION

"TELEVISORS" • KIT SETS • COMPONENTS

AMERSFOORT (Holland)
BAGSHOT
BEDFORD
BEDWORTH
BEXLEY HEATH
BICESTER
BIRMINGHAM
BIRMINGHAM
BIRMINGHAM
BISHOPS STORTFORD
BOURNEMOUTH
BRACKNELL
BRAINTREE
BRIDGEND
BURTON-ON-TRENT
CAERPHILLY
CHALVEY
CHESTERFIELD
CHIPPERFIELD
COLCHESTER
COULSDON
COVENTRY
COVENTRY
DARLINGTON
DEAL
DEWSBURY
DOVER
EASTBOURNE
EASTBOURNE
ERDINGTON
FELIXSTOWE
FOLKESTONE
GERRARDS CROSS
GODALMING
GRAYS (ESSEX)
KIRKCALDY
LEIGHTON BUZZARD
LLANDUDNO

LONDON :

BATTERSEA
BAYSWATER
BRIXTON
BROMLEY
CLAPHAM COMMON
CRICKLEWOOD BROADWAY
EALING
EALING (WEST)
EARLSFIELD
EAST BARNET
EDGWARE
EDGWARE
FULHAM PALACE ROAD
HAMMERSMITH
HOLLOWAY
HOUNSLOW
KINGSTON
KNIGHTSBRIDGE
KNIGHTSBRIDGE
MUSWELL HILL
NEW BOND STREET
OXFORD STREET
PECKHAM
PIMLICO
WEST NORWOOD
WIGMORE STREET, W.
WOOD GREEN
LUTON
NEWCASTLE
NEW MALDEN (SURREY)
NORWICH
PERRY BAR
PLYMOUTH
RAMSGATE
RAMSGATE
ROCHDALE
ROCHESTER
SLOUGH
STAINES
TONBRIDGE
WALLINGTON
WALLINGTON
WEST BYFLEET
WEST DRAYTON
WITLEY (SURREY)
WORTHING

WILLEN VAN LOON
LINDFIELDS GARAGE
JEAKINGS & SON
T. H. RUSSELL
J. SPENCER (LONDON) LTD.
LAMBOURNE BROS.
C. WEBB LTD.
SHANNON & CAPENER
H. R. MOORE LTD.
J. E. BEALE LTD.
DRAKE & MOUNT LTD.
COX'S GARAGE
WRIGHT & ASHWORTH
RADIO & CY-KAR MART
L. PRITCHARD
J. D. HALLIDAY
G. KENNINGTON (CHESTERFIELD) LTD.
A. C. GEORGE
SHROSBURY & BAKEWELL CO., LTD.
THE "VIC" WIRELESS STORES
MAX. A. BUCH
PARKER'S RADIO SERVICES
C. SHARP
G. CLOUT
BICKERS LTD.
DOVER RADIO STORES
A. BODKIN & CO., LTD.
OWEN H. RELLY
STANLEY'S RADIO
L. E. PULFORD
BOBBY & CO. LTD.
R. F. CHIPPS
H. J. CHALLEN
GRAYS WIRELESS CO. (H. W. FRANKLIN)
GIBB & WATSON
GRIFFIN BROS.
EVANS & EVANS

E. F. KELLY
HOPE, NORMAN & CO.
QUIN & AXTENS
UNIVERSAL ENGINEERS
DEMPSEY & CO.
HARDEN & CO.
KEEN WIRELESS CO.
L. LEAMAN
H. HOLLIER & SONS
EAST BARNET WIRELESS STORES
A. ALDERTON
J. F. WISSON
"ECONOMIC"
W. H. OATES
JONES BROS. (HOLLOWAY) LTD.
SANDERS ELECTRIC & RADIO SUPPLIES
BENTALLS LTD.
BROMPTON RADIO CO.
HARRODS LTD.
VICTOR RADIO SERVICES
KEITH PROWSE LTD.
SELFRIDGE & CO., LTD.
HAVIL RADIO
F. DOVE & SONS
E. SHELDRIK
WIGMORE RADIO SERVICE
DISTRICT SUPPLIES LTD.
R. J. STEARN & CO.
PAYNE & HORNSBY LTD.
ACORN SERVICE STATION LTD.
E. A. PRIEST & CO.
WELLINGTON RADIO & ELECTRICAL DEPOT
W. H. AXWORTHY & CO.
J. CARMAN
E. COVENEY & SONS
BANNISTER & FITTON
A. F. SMITH & SONS, LTD.
G. CASE & SONS
V. & D. KEALE
A. T. LANGTON
W. BELDING
BULLOUGH BROS.
A. LONG
SPRATLEY BROS.
G. WOOTON
E. LAMB

Stationsstraat 32B
Surrey
Mill Street
Tram Terminus, Coventry Rd.
127 The Broadway
47 Market Square
41 Carrs Lane
13 Aston Road North
Northgate End
Hants
Berks
Rayne Road
Kings Bldgs., Adair Street
Cross Street
73 Princes Avenue
Nr. Slough
Victor Lane
The Common
73 Crouch Street
21 Chipstead Valley Road
143 Lower Ford Street
3 Holyhead Road
321 North Street
Electrical Engrs.
The Galleries
4 Townwall Street
11 Cornfield Road
"Gavinwood," Willingdon
191 High Street
141 Hamilton Road
48 Sandgate Road
6 Oak End Way
12 Church Street
Clarence Road
270 High Street
11 High Street
29 Mostyn Ave., Craig-y-Don

5 Park Road
85 Westbourne Grove
Brixton Road
1 Chatterton Road
69 South Side
99 Cricklewood Broadway
1 Dare Road
97 Northfield Avenue
422 Garratt Lane
3 Park Parade
8 Bank Parade, High Street
2 Cheapside, Deans Lane
24 Fulham Palace Road
195 Hammersmith Road
Holloway Road
119 Staines Road
Surrey
20 Brompton Arcade
S.W.
8 Firs Parade
159 New Bond Street
W.I.
30 High Street
77 Pimlico Road
493 Norwood Road
36/38 Wigmore Street
43 High Road
7 Manchester Street
7 St. Andrew's Buildings
Kingston By-pass Road
28 St. George's Road
303 Birchfield Road
106 Tavistock Road
65 King Street
20 Belle Vue Road
27 Millrow Road
215 High Street
2 Grove Parade, High Street
Kingston Road
High Street
9 The Parade, 320 Stafford Rd.
34 Woodcote Road
1 Byfleet Corner
Station Road
Northfields
Franklin Road, Durrington

• GIVE YOUR LOCAL DEALER A CALL TO-DAY •

"BUILT TO SPECIFICATION"

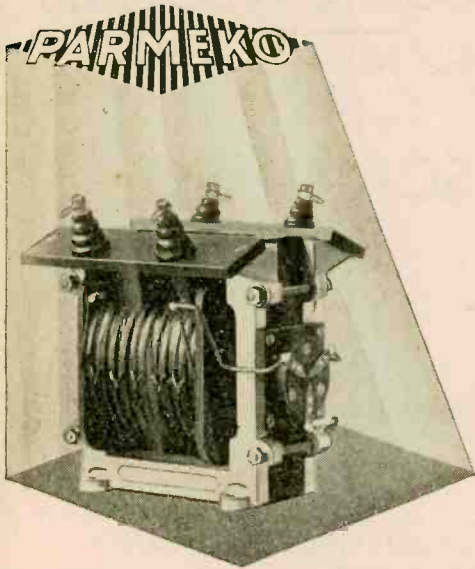

Sooner or later you—if you take your television seriously—will find that you want a transformer or a choke which is not made in stock models. Make a note now, that when the occasion arises you can get apparatus made to your own specification by "PARMEKO"—and at very little more, if any, than the usual stock prices. Probably there is not a reader of "Television" who is unaware of the superiority of "PARMEKO" components, and for this reason there is no need to say more than that our "to specification" models are made with precisely the same care and precision as our stock models, and fully uphold the tradition of "the best—regardless." Estimates and specifications prepared free and without obligation. Write to us if in any difficulty.

Price list A (Transformers, Chokes and Eliminators) on request.

LEICESTER
AYLESTONE 487

PARTRIDGE & MEE LTD.

74 New Oxford Street
LONDON, W.C.1
MUSEUM 5070



The only
TRANSFORMER
that is good
enough for
TELEVISION

Type AF5. Price 30/-
Ratio 1/3.5. Inductance 120/170 Henries

Every Ferranti Transformer is guaranteed to give a performance within 5% of the published curve, AND within 5% of every other Ferranti Transformer of the same type. Ferranti are the only transformers so guaranteed.

FERRANTI
TRANSFORMERS

FERRANTI Ltd., HOLLINWOOD, LANCS. London: Bush House, Aldwych, W.C.2

TO OBTAIN THE
BEST

out of your
TELEVISOR

build with

DUBILIER CONDENSERS AND GRID LEAKS



TYPE B.B.

There is no excuse for using anything else but Dubilier—for at their new season's prices, Dubilier Condensers and Grid Leaks are in many cases *actually cheaper* than components of doubtful origin and still more doubtful performance.



TYPE 670

Top left is the Dubilier type B.B. Paper Condenser, a high efficiency Condenser in bakelite case. Capacities from .09 mf. to 4.0 mf. Prices from 1/9.

Above is the Dubilier type 670 Condenser, designed to fill the demand for a high-quality, low-priced Condenser. In all popular capacities, at prices from 6d. to 1/6.

On the left is the Dubilier Grid Leak, the last word in strength, permanence and efficiency. Its price is 1/-.



DUBILIER CONDENSER CO. (1925) LTD.
Ducon Works, Victoria Road, North Acton, W.3

★ SPECIAL EXHIBITION OFFER

DURING THE RUN OF THE RADIO EXHIBITION ONLY, the price of our specially constructed

SCANNING DISCS

IS BEING REDUCED TO

10/6

STANDARD 20½ inch
ALUMINIUM 30 square holes
BRASS-BUSHED

S. LEE BAPTY

60, CRAVEN PARK ROAD, N.W.10

When ordering, please remit sufficient to cover postage (9d.); also please state size of motor spindle.

TRADE INQUIRIES WELCOMED

Willesden 7084.

'MERVYN'

TELEVISION COMPONENTS ARE COMING

They include Scanning Discs, Mirror Drums, Lenses, Phonic Motors, All-Mains A.C. Receivers for sound and vision.

Write for further details of
MERVYN SOUND & VISION
BOX 22, c/o "TELEVISION"
Bouverie House, Fleet Street, London, E.C.4

Telegrams :
Benbrolish Fleet
London

TELEVISION

Telephone :
City 0244
(10 lines)

Proprietors : BENN BROTHERS LTD.

Established 1880

Editorial, Advertisement and Publishing Offices :

Bouverie House, Fleet Street, London, E.C.4

(Closed on Saturdays)

SUBSCRIPTION RATES
13/6 PER ANNUM, POST FREE.
6/9 SIX MONTHS, POST FREE.
AMERICAN RATE:
\$4.50 PER ANNUM, POST FREE.
\$2.25 SIX MONTHS, POST FREE.

MS. AND OTHER MATERIAL
FOR EDITORIAL CONSIDERATION
SHOULD BE ACCOMPANIED BY A
STAMPED ADDRESSED ENVELOPE,
AND SHOULD PREFERABLY BE
TYPEWRITTEN.

Contents August 1932

	PAGE
NOTES OF THE MONTH	201
"TELEVISION" AT OLYMPIA: AUGUST 19th—27th	202
B.B.C. AND TELEVISION: OFFICIAL ANNOUNCEMENT	203
HAS TELEVISION ARRIVED?: A REPLY AND A CHALLENGE	203
"VISION AND SOUND ON ONE WAVE"	204
THE COMPLETE "VISIONETTE"	205
NEWS FROM ABROAD: GERMANY AND THE UNITED STATES	211
RADIO CITY	213
IF LINDBERGH HAD BEEN TELEVISED	215
RETAINING HIGHER FREQUENCIES	218
FROM MY NOTEBOOK	221
THE NEW "TELEVISOR"	223
LETTERS TO THE EDITOR	224
THE FUTURE OF RADIO DRAMA	226
POINTS FROM THE PRESS: "A REAL ADVANCE"	227
THE ENTHUSIAST SEES IT THROUGH	229
REPORTS ON APPARATUS TESTED	232

Index to Advertisements

Baird Television Ltd.	200	London Electric Wire Co. & Smiths Ltd.	ii
Bapty, S. Lee	198	Mervyn Sound & Vision	198
Belling & Lee, Ltd.	194	Microfuses, Ltd.	—
Benn Ltd., Ernest	iii	Miscellaneous Announcements	iii
British Institute of Engineering Technology	—	Mullard Wireless Service Co., Ltd.	193
Celestion Ltd.	194	Oates, W. H.	—
Classified Television Dealers	196	Partridge & Mee, Ltd.	197
Colvern Ltd.	194	Pitman & Sons, Ltd., Sir Isaac	—
Dossett Studio	iii	Rotax Ltd.	iv
Dubilier Condenser Co. (1925) Ltd.	198	Salter, J.	iii
Ferranti Ltd.	197	Westinghouse Brake & Saxby Signal Co.	—
Lambert, H.	iii	Whiteley Electrical Radio Co., Ltd.	194
Leaman, L.	iii		

Praised by the Press . . .

The New Baird model home "Televisor" receiver was exhibited last week in the Baird laboratories at Long Acre. The most important advantage of the new instrument is that the image is reproduced on a screen 9 in. high by 4 in. broad, so that it can be seen by a room full of people. In the older model, in which the image was produced in a lens, not more than four people could see it at any one time.—*The Times*.

Improvements on the former television apparatus include:

An image which can be seen by a roomful of people simultaneously, instead of by only three or four persons.

Sufficient brightness of the image to make it visible in a room electrically lit, so that it is not necessary to put the room in darkness.

Compactness of the apparatus, which measures 1 ft. 6 in. long by 8 in. wide and 13 in. high. The screen is 4 in. wide and 9 in. high.—*The Daily Telegraph*.

A new home—"Televisor" receiver which was demonstrated to me at the Baird Company's headquarters in Long Acre yesterday gave results of a quality and brilliance considerably in advance of any form of television I have seen.—*News-Chronicle*.

Television has arrived!

This is no wild statement, for yesterday I saw a practical and convincing demonstration of moving images on a screen that can be seen from any angle by any number of people.—*Daily Mirror*.

The quality of the black and white image is very much better than the reddish picture produced by previous "Televisor" receivers. These preliminaries were followed by a cartoonist, who did some quick-action cartoons on large sheets of paper in view of the audience. Here again the results were remarkably clear.—*Amateur Wireless*.

The image can be viewed without putting the room in total darkness. The new machine measures, when closed, 1 ft. 6 in. in length by 8 in. wide and 13 in. high. From the distance at which we viewed it the image appeared quite clear, the undesirable line effect not being noticeable.—*Electrician*.

Probably the most convincing television demonstration yet given in this country was staged by the Baird Television Company at their headquarters in Long Acre, London, W.C.2, on Thursday, June 30th, when *The Wireless World* was able to witness the new home "Televisor" receiver in action. Although the actual trans-

mission was carried out on a short line between two rooms, it was obvious that if comparable results could be obtained by wireless the new instrument could guarantee genuine entertainment value.—*Wireless World*.

We were considerably impressed by the "Televisor" receiver, the images being clear, and of the real entertainment value. The usual flicker does not seem to be

quite so noticeable, while the up and down "float" of the image is slight. A great improvement lies in the fact that the "line" effect obtained with the old scanning disc model is entirely absent.—*Wireless and Gramophone Trader*.

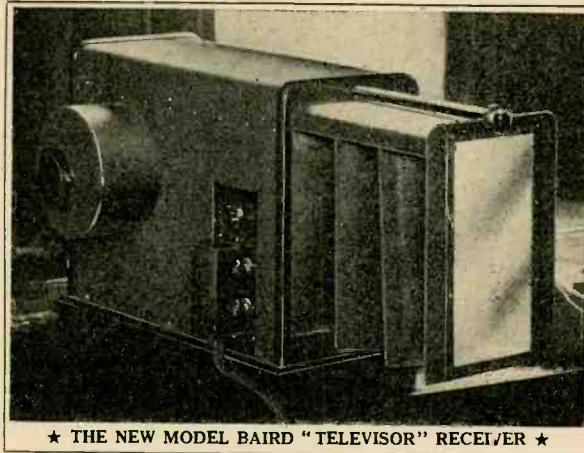

★ THE NEW MODEL BAIRD "TELEVISOR" RECEIVER ★

Yesterday the Baird Company demonstrated to "The Cinema" a new type of home "Televisor" receiver which is a notable advance on anything they have yet shown. . . . This, coupled with the fact that from next month and for at least two years the B.B.C. are to broadcast, per week, four half-hour television broadcasts

in ordinary programme hours, suggests a counter-attraction that may very well divert further money from the cinema. The new Baird model is a remarkably fine piece of work.—*To day's Cinema*.

The announcement that the B.B.C. are shortly to take over the broadcast television programmes hitherto provided by the Baird Company, and are to transmit a new series of half-hour transmissions on four nights a week at 11 p.m., has coincided very opportunely with the perfection of the new home "Televisor" receiver by the Baird Company.

Our impressions of the new "Televisor" receiver, as we stated last week, were very favourable, and it certainly marks an outstanding advance on the earlier model.

Programmes can now be seen in comfort by a number of people at a time, and in black and white. . . . When we apply the acid test as to whether we ourselves would, at least for the time being, be satisfied with the results, the answer is in the affirmative.—*The Wireless and Gramophone Trader*.

I feel convinced that a real step forward has been made with the new apparatus.—*Wireless Magazine*

ADVT. OF **BAIRD TELEVISION, LTD.**

133, LONG ACRE, LONDON, W.C.2

'Phone:
Temple Bar
5401

TELEVISION

The First Television Journal in the World

Publishers : BENN BROTHERS, LTD. Technical Editor : H. J. BARTON CHAPPLE, WH.SCH., B.Sc.
Offices : BOUVERIE HOUSE, FLEET STREET, LONDON, E.C.4

VOL. V. No. 54]

AUGUST 1932

[IS. NET

Notes of the Month

THIS issue is published at a moment of exceptional interest in the history of television. On Monday next (August 22nd) the B.B.C. is to begin the new transmissions, which will be given regularly from Broadcasting House; the same week will see the Radio Exhibition in full swing, when the latest developments in television will be known to the public. It is expected that vision sets will be shown by several manufacturers, but the greatest secrecy is being maintained before the Exhibition opens. TELEVISION has reserved Stand No. 281, where readers will be able to see some of the special apparatus designed by our technical editor and to obtain advice on their constructional problems.

The B.B.C. transmissions will inaugurate a new era for television, as the public is assured of being able to look-in at regular hours, and hence to pursue experiments seriously. There was general disappointment that the date originally announced was not adhered to, as the new programmes were expected to begin in the middle of July. No



Olympia gets ready for the Radio Exhibition.

announcement of the delay was made, and the *Radio Times* of July 15th and 22nd gave no reference whatever to television. There was evidently a lack of staff work, and in consequence many experimenters who were eagerly awaiting television's "first night" were unaware of the delay. It appears, however, that the apparatus took longer to install than had been expected, and of course the B.B.C. had to make sure of giving adequate transmissions from the outset. The delay was very regrettable, but now that the programmes are to begin in earnest, the television public can look forward to a period of increasing interest and activity.

In future issues we shall publish regular reviews of the new B.B.C. broadcasts. In order to make the criticisms as comprehensive as possible, we shall welcome the co-operation of readers, who are invited to submit their comments on the programmes. A number of these letters will be published, and each month the correspondent who sends the best criticism will receive a year's subscription to TELEVISION free of charge. Where a prizewinner is already a subscriber, his existing subscription will be extended for a further year. Now that television is to be transmitted regularly, we believe that representative views on the subject-matter and the technical quality of the programmes will be of considerable interest, especially during the early stages.

What is the television equivalent to the word "listener"? The obvious term is "observer," but that is hardly distinctive enough, as it is now generally associated with aviation. For want of a better word, we have used the word "looker-in," but it is not very pretty. Some American writers have suggested "radio spectator," and even "televisioner," but neither term is likely to appeal to the British public. We are glad to see that the *Wireless World* has drawn attention to this problem, and we join our contemporary in asking whether any reader can suggest a word that is both expressive and pleasant to use.

"Television" at Olympia

Surprise Exhibits

THE proprietors of TELEVISION have reserved Stand No. 281 at the National Radio Exhibition, which will be held at Olympia from August 19th to 27th. The accompanying plan shows the position of the stand, which is in the gallery just above the main staircase on the north side of the Grand Hall.

Free Technical Advice

To assist those who are new to television and to enable radio enthusiasts to develop their experiments, TELEVISION has arranged for free technical advice to be available at the Stand, where visitors will be able to discuss their television problems with expert attendants. For the benefit of readers who have constructed the special sets described in recent issues, a selection of this apparatus will be exhibited, including the latest model "Visionette." With the extension of television facilities by the B.B.C., this latter set has been modified by the designer, Mr. William J. Richardson, in order to give a greater range for reception. On another page this month the complete model is described, enabling readers to begin its construction at once or to bring the existing set up to date. Copies of the current issue of TELEVISION and back numbers will be on sale at Stand No. 281.

This year the Radio Exhibition is associated with

almost as much "hush-hush" as is usually attached to the Motor Show. Surprises are promised by some of the biggest firms, and it is expected (though not definitely confirmed) that several vision receivers will be shown to the public for the first time. There are rumours of a new model that will go one better than the radio-gramophone by including a vision receiver as well. It would, in fact, provide the complete home entertainment, and whether available this month or not, it is certain to be a development of the near future. Following the demonstration to the Press in July, Baird Television, Ltd., have been in negotiation with leading radio manufacturers, and probably the latest "Televisor" will be shown by one of the big exhibitors. Here again, however, the plans are not officially disclosed, and the public must wait until the opening day to learn whether the new model has been completed in time for the Show.

The Exhibition will be twice the size it was last year, and will thus reflect the remarkable growth of radio in this country during the past twelve months, the turnover in 1931 being no less than £30,000,000. As yet of course, television accounts for only a small part of the total, but it is adding a valuable margin, which is growing all the time and will increase greatly within the next few years. It is estimated that there are already between five and ten thousand vision sets in use throughout the country, and the more enterprising wireless manufacturers, already profiting by this new market, are taking steps to meet the requirements of the television constructor.

Olympia is decorated in silver and blue, a colour scheme intended to suggest coolness in the summer-hot days. But the organisers are taking no chances with the clerk of the weather, and a special flood-lighting arrangement has therefore been devised, so that the silver may be gilded and the blue turned into blood-red — a crimson-and-gold effect suggestive of warmth!

A report of the exhibits will be given in the next issue of TELEVISION; meanwhile the publishers extend a warm welcome to all readers and friends to visit Stand No. 281.

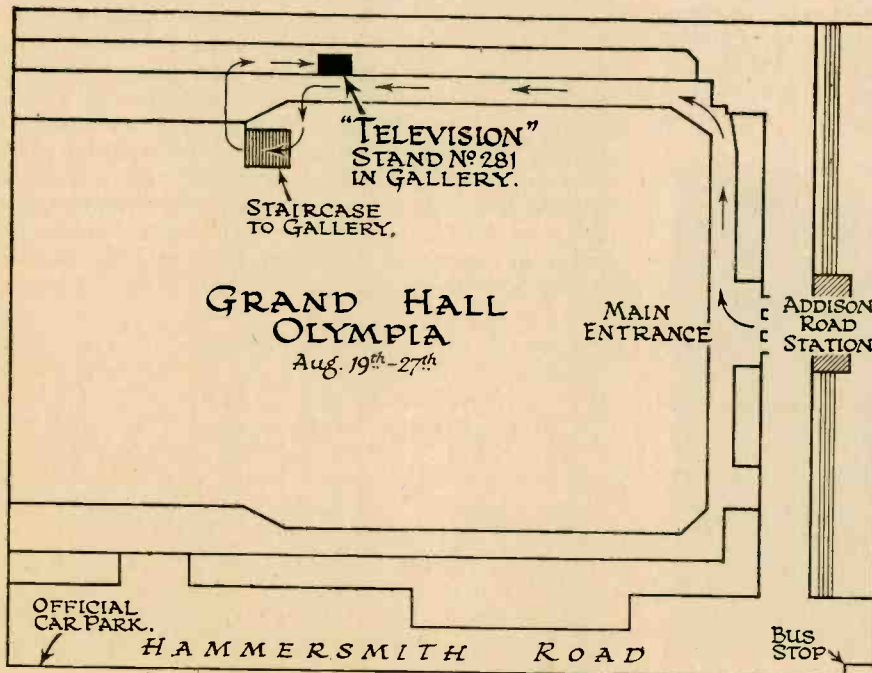

Has Television Arrived?

A Reply and a Challenge

IN reply to the article published in our July issue, *Popular Wireless* of August 6th again explained its attitude to television. We had expected a more prompt reply, but our contemporary has so little to say that the delay is hardly surprising. After paying a compliment to the "earnest investigator and experimenter," for there is nothing it would like better than to see the "dawn of television for the masses," the journal proceeds to give an "impartial and reasoned reply to those 'publicity-mongers' who insist on maintaining that television in the home is an accomplished fact."

We are entirely in agreement with our contemporary in objecting to "exaggerated and over-optimistic statements" about this science. We object to exaggeration of every kind and believe it is as dishonest to ignore or withhold facts as to overstate them. That is where we differ from a controversialist who constantly draws attention to the difficulties of television but seldom encourages those who are working to overcome them. A typical quotation from the journal recently illustrates its attitude towards television. The suggestion was made in the *Newspaper World* that television notes should be given by the wireless correspondents of the daily Press. "What," says *Popular Wireless*, "would be the attraction in that, when not one

newspaper reader in 10,000 will be practically interested in the subject for *years to come*."

Our contemporary cannot have it both ways. If it seriously wants "television for the masses," it cannot at the same time object to the newspapers giving space to the science, and thus helping to make it more widely known to the public.

Three points are selected from the July issue of **TELEVISION** for "impartial and reasoned reply."

(1) The first is our statement that "television in the home is already an actual achievement." *Popular Wireless* says that this may be "a matter of opinion," but adds that presumably "radio in the home was achieved when Marconi first experimented with his crude coils in his garden in Italy over thirty years ago!"

To compare television to-day with radio in 1900 is, however, quite inaccurate, when there are hundreds of vision sets in use, both in this country and abroad, and when the science has already reached the stage that merits the serious attention of the B.B.C.

Our contemporary quotes a recent lecturer to the Television Society who said that "television has not yet arrived" and that the "Baird method had reached its practical limits." As against this opinion, there are others of equal authority who take another view. Mr. Alan Hunter, the well-known radio critic, says that the images obtained with the latest "Televisor" have "real entertainment value," and that the stage has been reached when big things may happen any day now in television.

As for the Baird method, it is the only one that has so far been brought into practical use in this country, and hence is engaging the major attention of television experimenters. Time alone can show whether it will improve still further, but no less an authority than the Marchese Marconi believes that television (by whatever method) has "a very important future."

(2) "The B.B.C. programmes are the present criterion by which to judge television in the home." In objecting to this statement our contemporary quotes a recent editorial article from the *Radio Times*, which said that "many difficulties strew the path ahead of television, not the least of which is that of the present congestion of the ether."

Because there are difficulties to be overcome, the television enthusiast welcomes the interest of the B.B.C., and believes that, just as has been the case with radio, the technique of television will gradually be improved and perfected under its auspices. It seems likely that the congestion of the ether will be eventually solved, so far as television is concerned,

B.B.C. and Television

The Editor of TELEVISION has received the following statement from the B.B.C.:—

DURING the past few weeks Baird television apparatus has been installed in Broadcasting House. Television transmissions will be carried out on Mondays, Tuesdays, Wednesdays, and Fridays from 11 to 11.30 p.m. Vision will be transmitted from Brookman's Park on 261.3 metres, and the accompanying sound will be transmitted from Daventry on 398.9 metres. The first of these transmissions will be on Monday, August 22nd.

"An earlier announcement by the B.B.C., published in the June number of **TELEVISION**, stated that the new transmissions were expected to begin between July 15th and 20th. It was, however, found that the installation of the necessary equipment in Broadcasting House required more time than had been anticipated. The television programmes will be in charge of Mr. E. F. Robb, under the direction of Mr. Val Gielgud."

by the use of ultra-short waves, and here again, with the aid of the B.B.C., the future is in the best possible hands.

(3) The last point in our article to which objection is taken is as follows: "Only a few years ago the broadcasting of sound and music was also rather crude and quite as complex as television. We question whether vision apparatus is any more difficult to construct than the early wireless receivers."

This sentence our contemporary calls "a pure gem" (much as a small boy, for want of a better reply, might say "funny face"), and it adds that two radio receivers, a television instrument, and power mains are needed for television, whereas at "the very beginning of broadcasting the programmes could be received on a simple crystal set."

We do not claim that "television for the masses" is here in the sense that the crystal set brought radio to the million; but we repeat that a vision receiver can be constructed without difficulty by any experimenter who is familiar with radio technique. Apart from the dozens of amateurs who have dealt with their work in letters to TELEVISION, we would again refer to the article in *World Radio* of June 24th, which described how a vision set was made for a few pounds. Television is still a fairly expensive hobby, but it is not necessary, as *Popular Wireless* suggests, to spend "fifty pounds" on the necessary equipment to enjoy experimental "looking-in."

Our contemporary concludes by saying that the public is even now being told that "anything and

everything can be televised, and is led to believe that good moving pictures by radio can already be accomplished." We also protest against over-statements of this kind, and would repeat (with that "amazing candour" which *Popular Wireless* finds so surprising in others) that television is in its infancy, and that the images are still rather crude. It is, however, a vigorous and growing branch of radio which has made remarkable headway and shows every promise of further improvement in the near future.

Meanwhile, there are several recent achievements which our contemporary conveniently ignores; for example, the fact that experimenters throughout the country succeeded this year in "looking-in" to the Derby, even at such a great distance as Newcastle, and under conditions which were far from perfect.

In its refusal to face the facts and to recognise the progress already made by television, the attitude of *Popular Wireless* is not very different, at the other extreme, from that of the "publicity-mongers" to which it rightly objects. The journal is widely respected—it claims to have the "largest radio circulation in the world"—and has a real responsibility to its readers in this matter. It is completely inaccurate to say that "television in the home appears to be as far away from practical politics as it did one year or even ten years ago," and in the interests of that impartiality to which *Popular Wireless* rightly attaches importance, we again challenge it to prove or withdraw this statement.

"Vision and Sound on One Wave"

UNDER this title the *Broadcaster* publishes an interesting report from New York, dated July 15th, stating that the Columbia Broadcasting System, one of America's largest broadcasting firms, is attracting wide attention for its newest engineering feat, the transmission of a television picture and voice simultaneously on one wavelength. The equipment at one transmitter is now being altered to give regular television programmes, beginning on July 21st. The launching of the new system will mark the first anniversary of the Columbia television station. At the receiving end only one instrument is needed.

Double Modulation

Mr. William B. Lodge, Columbia development engineer, told the *Broadcaster* representative that double modulation was the term which best describes the new principle.

"When a receiver is receiving a given transmitter," he added, "the set is tuned to a particular carrier frequency. The signal which reaches the set consists of this carrier frequency, combined with the frequencies of speech or music.

"The first step in the new system is to modulate a carrier of 45 kilocycles with the microphone signal.

"The television signal such as will be emitted by Columbia's W2XAB transmitter consists of frequencies up to 40 kilocycles. In the operation of the sound and picture broadcast, the television signal, up to 40 kilocycles, and the modulated 45-kilocycle carrier are combined and transmitted together.

"At the receiving station the set is tuned to the frequency of the transmitting station, and then detects and reproduces the above signal. Frequencies up to 40 kilocycles are applied to the terminals of a neon tube and reproduce the television picture. As previously stated, the 45-kilocycle modulated carrier wave contains the sound signal, and a receiver tuned to that frequency can be used to obtain the original sound.

"In the television receiver, therefore, it is only necessary to insert a simple filter at the terminals of the neon tube to prevent the 45-kilocycle voice carrier from interfering with the picture, and to add a second detector with a circuit tuned to 45 kilocycles to obtain the audio signal.

"It may be interesting to note that a sound programme may also be detected by a conventional selective receiver tuned to a frequency of 45 kilocycles either higher or lower than that of the transmitting station's carrier, or, in the case of W2XAB, either 2,755 or 2,845 kilocycles."

The Complete "Visionette"

By William J. Richardson

AS I indicated last month, the original "Visionette" receiver described in the April and May issues of TELEVISION has been subjected to numerous tests, in an endeavour to fall in with the wishes of some readers who desired greater range and even greater selectivity.

It is felt unnecessary to go into every detail that has been tried out, but in its somewhat modified form the set does undoubtedly meet the demands just stated. If any constructors of the original set desire to make the alterations, they will find that these can be effected without much trouble, for in the main the original layout has been adhered to.

On the other hand, for the benefit of those who will be building the set for the first time, a completely new theoretical diagram and wiring plans have been prepared. Furthermore, since this issue of TELEVISION will come into the hands of hundreds of readers for the first time as a result of making its acquaintance at the Radio Exhibition at Olympia, it was felt appropriate to treat the design as a new one and go into its details thoroughly.

The substance of sections of previous articles on this set will therefore be repeated, and this will save readers having to refer to back issues for information. In essence the modified "Visionette" is an attempt to provide an all mains fed

three-valve receiver which will bring in the television signals within a reasonable range of the Brookman's Park transmitter, which is the B.B.C.'s vehicle for broadcasting them. It is quite simple to handle, and can be used for the reception of sound, if desired, on those occasions when vision signals are not on the air.

Every effort has been made to give the best quality of reproduction, as distortion of the signal in television is a factor which must be carefully guarded against.

The three mains valves chosen are a screen-grid high-frequency, an anode-bend detector, and a pentode output, a double rectifying valve providing the necessary rectified H.T.

The Theoretical Circuit

The first consideration is the coils, indicated as L_1 , L_2 , L_3 , and L_4 in Fig. 1. These coils are both of the dual range type, being known as RM1S and RM3S and manufactured by Colvern, Ltd. The first-named is the aerial coil, and the rotor L_1 is used as a variable aerial coupling on the broadcast wave range, while a tapping on the tuned winding compensates for the increased coupling required on the long-wave band. No reaction winding is included,

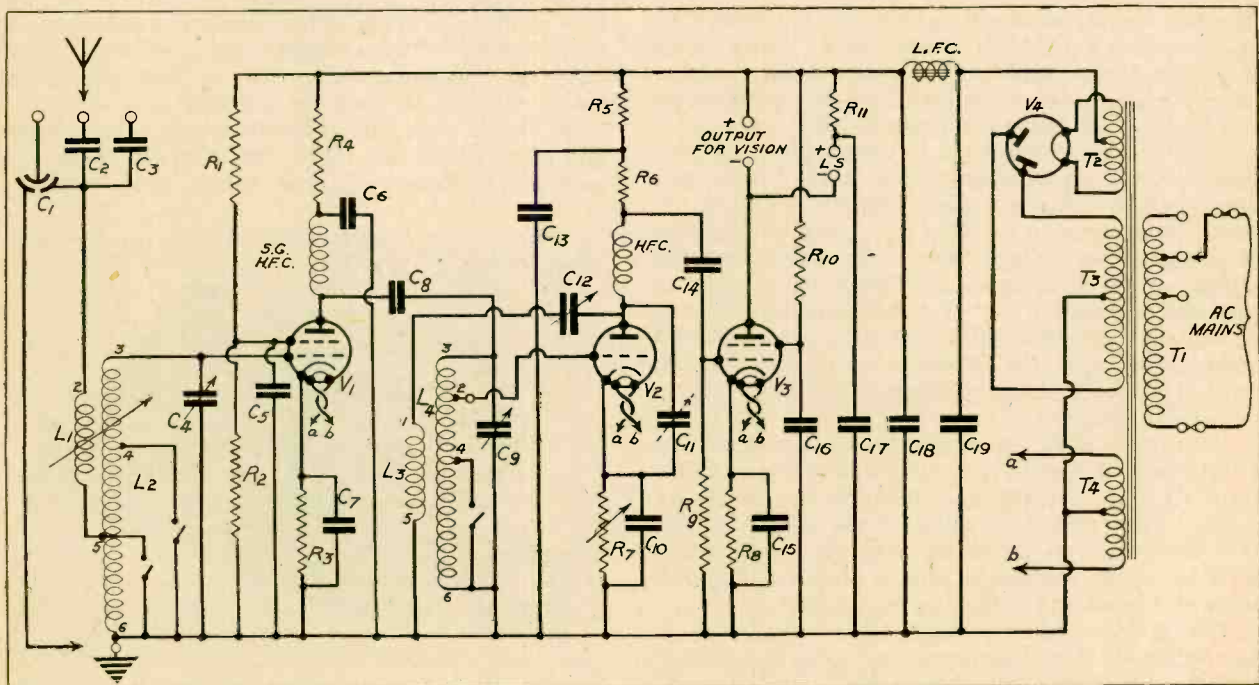
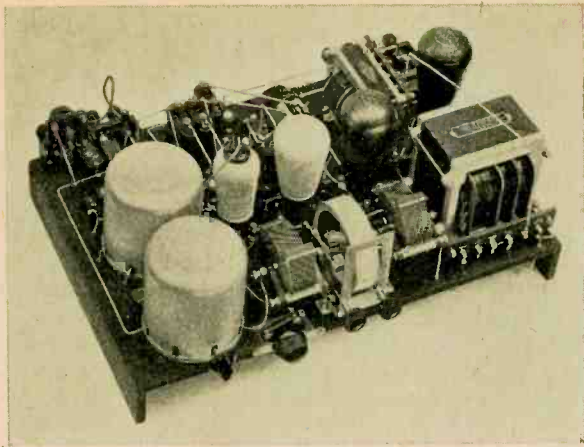

Fig. 1.—Circuit diagram of the "Visionette" as finally modified.



The apparatus is here shown ready for test, with the valves in position.

but by means of the rotor coil the aerial load can be adjusted to give maximum signal voltage across the tuned circuit $L_2 C_4$.

With the movement of a double-contact switch fitted in the base, the degree of aerial coupling is increased by the amount required to maintain maximum signal strength when tuning on the long waves. A correct aerial tuning results from the adjustment of angle and height of the coupling coil, which may be of 20, 40, or 60 turns.

Selectivity

In addition to altering the position of this aerial coil, varying degrees of selectivity are given through the medium of the three condensers, C_1 , C_2 and C_3 . The last two are of fixed capacity, but the first one acts as both a volume control and selectivity device. The moving plates of this condenser are connected to the aerial π terminal. One set of fixed plates now joins the terminal π of the aerial coil, and the other set passes to a short length of flex terminating in a Belling-Lee spade connector marked "earth."

With the spade connector left free, the condenser functions as an ordinary series aerial feed condenser, and when the spade connector is clipped on to the earth terminal we have the condenser working as an effective volume control by regulating the signal feed into the coil L_1 . This scheme, together with the alternative pair of aerial fixed condensers, C_2 and C_3 , of .0002 mfd. and .005 mfd. capacity respectively, and the movable aerial coil should provide sufficient varying degrees of selectivity to meet most situations.

The tuned H.F. signals pass to the grid of V_{12} , a metal-coated Mazda A.C. mains screen-grid valve, type AC/SG, having an amplification factor of 1,200. The resistance values of the associated circuit have been so calculated that the valve works with an anode voltage of 200, a screen voltage of 80, and a grid-bias voltage of 2 (approx.).

The anode current under these conditions is approximately 7 milliamperes, and since the voltage at the extremities of the single H.T. feed is about 400, it is easy to see how the values of $R_1 =$

80,000 ohms, $R_2 = 20,000$ ohms, $R_3 = 300$ ohms, and $R_4 = 30,000$ ohms, were arrived at. The resistance R_3 and the fixed condenser C_7 give the automatic bias to the valve, C_5 and C_6 being the usual decoupling condensers.

It should be noted that, by using this single high-tension feed, the voltage dropping resistances become the decoupling resistances, and function very satisfactorily.

Choke Feeding

Choke feeding into the tuned grid circuit of the detector valve has been chosen, a fixed condenser C_8 of .001 mfd. capacity passing the signals to the second coil $L_3 L_4$. This is known as a dual-range H.F. intervalve coupling coil, complete with a reaction winding and wave-change switch. This switch is ganged to operate in conjunction with the first coil L_1 and L_2 , while the coil itself consists of a solenoid inductance with a section-wound long-wave coil.

In addition, it should be noted that the pair of coils are tuned by a ganged condenser (C_4 and C_9), whose stator plates for C_4 can be separately adjusted so as to allow for any inaccuracies which might creep in owing to the presence of the aerial.

Passing to the second valve V_2 , this is made to function as an anode bend-detector, and is a Mazda AC/HL. Calculations here have been based on an anode voltage of 200 and an anode current of 1 milliampere. This makes $R_5 = 80,000$ ohms and $R_6 = 100,000$ ohms, and although theoretically R_7 should be 6,000 ohms, I have used a variable resistance (actually a potentiometer) of 10,000 ohms for this position. My tests have proved to me the value of this departure, for it enables the valve to be adjusted with great delicacy to work at its best bias setting for efficient rectification to suit varying signal inputs. This resistance must, of course, have no "off" position, otherwise it will break the complete anode to filament circuit.

An H.F. choke is included in the plate circuit, and from here we take the connection to the reaction condenser C_{12} of .0003 mfd. capacity.

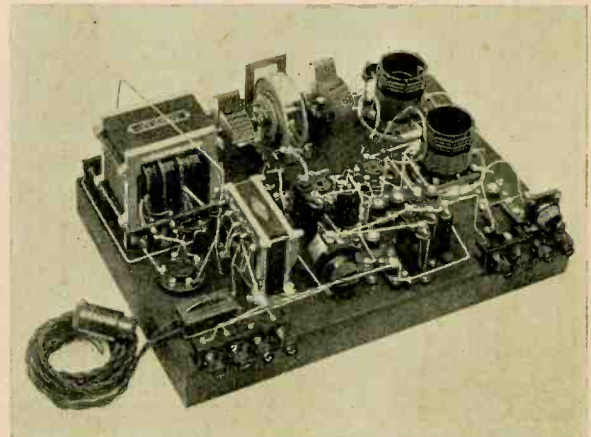

The constructor should study this view in conjunction with the photograph opposite.

⊗ ⊗ ⊗

To obtain satisfactory reception, the arrangement of the components and wiring should be followed carefully.

⊗ ⊗ ⊗

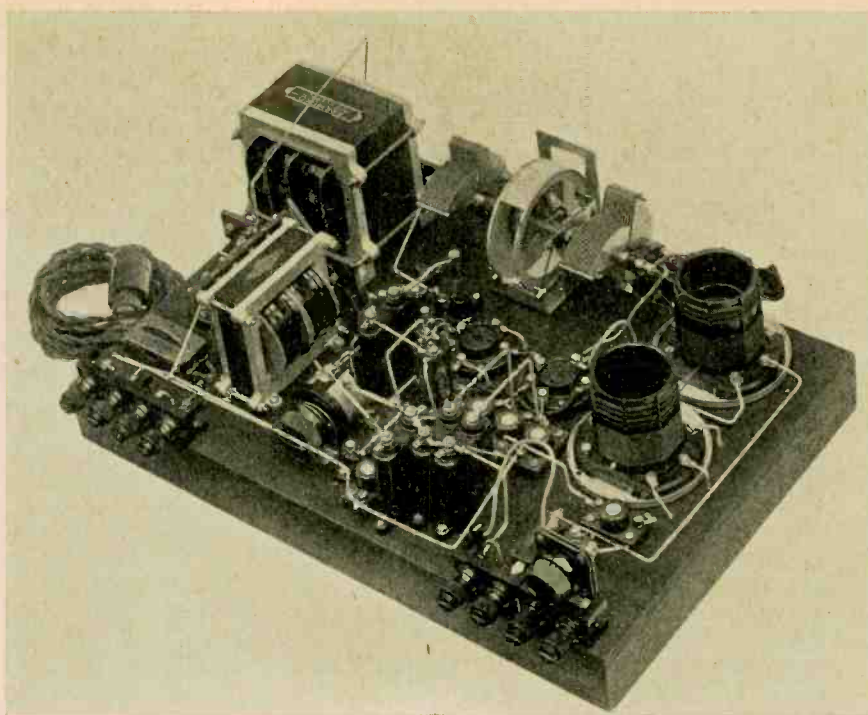

This in turn links with the reaction winding L_0 . Furthermore, there is a semi-variable condenser of .001 mfd. maximum capacity shunting between valve plate and cathode.

The exact value of this capacity must be ascertained on site, stability of operation under working conditions being one of the prime factors here.

Output Stage

The detector stage is resistance-capacity coupled to the pentode output stage—an Osram MPT4 valve. The chosen value of the capacity of the mica coupling condenser C_{14} is .1 mfd., as this gives very good results for vision purposes. As in the previous stages, the usual decoupling precautions have been taken. The approximate operating data furnished by the makers is: anode volts 250, screen-grid volts 200, and negative grid bias of 11. Under these conditions an average anode current of 32 milliamperes will pass, with a screen-grid current of 5 milliamperes.

This valve, in addition to having a rated amplification factor of 100, gives a maximum undistorted output of 2 watts, and there is thus a good reserve for all vision requirements when operating.

Now, it is not always fully appreciated by users of this type of mains pentode valve that damage to the valve is quite likely to occur if the anode circuit is broken while the screen voltage is applied. The temptation for the user to switch over from the L.S. to vision and vice versa has been counteracted, therefore, by omitting a simple change-over switch and fitting terminals. Then the operator will remember to switch off his set before he carries out any changes from aural to vision reproduction and vice versa.

High tension is derived from a double-wave rectifying valve V_4 , connected up to a mains transformer in the usual manner. Here the valve is a Mullard DW4, which has a maximum output of 500 volts, 120 milliamperes. This is too high for our purpose, so the mains transformer specially made by Partridge & Mee, Ltd., has a centre-tapped secondary winding, T_3 giving 425 volts at 60 milliamperes. This gives a very conservative rating for the whole circuit. For safety a pair of 1 ampere rating fuses is included in the input circuit.

The rectified A.C. passes through a high-quality L.F. choke, on each side of which is a pair of 4-mfd. smoothing condensers, C_{18} and C_{19} .

So much, then, for the theoretical side, and attention must now be turned to construction. A complete list of the components required is specified, together with the manufacturers' names and the numbered letter representing them in both the theoretical and wiring diagrams.

Full List of Components

Two dual-range coils Types RM1S and RM3S, L_1 , L_2 and L_3 , L_4 , complete with screening covers and bases. (Colvern, Ltd.)

One dual-gang variable condenser, .0005 mfd. capacity, C_4 and C_5 . (Formo, Ltd.)

Four 5-pin A.C. valveholders. (Whiteley Electrical Radio Co., Ltd.)

One centre-tapped iron-cored H.F. choke, HFC_2 . (Wright & Weaire, Ltd.)

Two screen-grid anode connectors. (Belling & Lee, Ltd.)

One .0001 mfd. differential compact condenser, C_1 . (Wingrove & Rogers, Ltd.)

One .0002 mfd. mica condenser C_2 . (Ward & Goldstone, Ltd.)
 One .005 mfd. mica condenser C_{17} , Type 670. (Dubilier Condenser Co. (1925) Ltd.)
 One 0.1 mfd. mica condenser, Type B775, C_{14} . (Dubilier Condenser Co. (1925), Ltd.)
 Two 1.0 mfd. fixed condensers, Type BB, C_5 and C_{10} . (Dubilier Condenser Co. (1925), Ltd.)
 One 0.1 mfd. fixed condenser, Type BB, C_7 . (Dubilier Condenser Co. (1925), Ltd.)
 One Polar pre-set condenser, .001 mfd. max. capacity, C_{11} . (Wingrove & Rogers, Ltd.)
 Two 1.0 mfd. metal-case mains condensers, C_6 and C_{13} . (Formo Co.)
 Two 4.0 mfd. metal-case condensers, C_{18} and C_{19} . (Formo Co.)
 Three 2.0 mfd. Type C_2 fixed condensers, C_{15} , C_{16} and C_{17} . (Ferranti, Ltd.)
 One low-frequency choke, Type No. 2, LFC. (Partridge & Mee, Ltd.)
 One special mains transformer, to specification T_1 , T_2 , T_3 and T_4 . (Partridge & Mee, Ltd.)
 One 6,000-ohm 10-watt resistance, R_{11} . (Ferranti, Ltd.)
 One .25 megohm grid leak and vertical holder, R_9 . (Dubilier Condenser Co. (1925), Ltd.)
 Two 80,000-ohm wire-wound resistances, R_1 and R_2 . (Watmel Wireless Co., Ltd.)
 Two 300-ohm wire-wound resistances, R_3 and R_8 . (Watmel Wireless Co., Ltd.)
 One 20,000-ohm wire-wound resistance, R_4 . (Watmel Wireless Co., Ltd.)

One 30,000-ohm wire-wound resistance, R_5 . (Watmel Wireless Co., Ltd.)
 One 100,000-ohm wire-wound resistance, R_6 . (Watmel Wireless Co., Ltd.)
 One 10,000-ohm wire-wound potentiometer, R_7 . (Colvern, Ltd.)
 One .001 mfd. mica condenser, Type 610, C_8 . (Dubilier Condenser Co. (1925), Ltd.)
 One .0003 mfd. reaction condenser, compact type, C_{12} . (Wingrove & Rogers, Ltd.)
 One S.G. H.F. choke, HCF₁. (L. McMichael, Ltd.)
 One 40,000-ohm wire-wound resistance, R_{10} . (Watmel Wireless Co., Ltd.)
 Eight insulated terminals, Type B (aerial 1, aerial 2, aerial 3, earth, output +, output -, L.S. +, and L.S. -). (Belling & Lee, Ltd.)
 Four terminal holders. (Belling & Lee, Ltd.)
 One twin baseboard fuseholder, complete with 1-amp. fuses. (Belling & Lee, Ltd.)
 One combined wall plug and adapter. (Ward & Goldstone, Ltd.)
 One A.C. mains S.G. valve, Type AC/SG, metallised, Mazda, V_1 . (Edison Swan Electric Co., Ltd.)
 One A.C. mains detector valve, Type AC/HL, metallised, Mazda, V_2 . (Edison Swan Electric Co., Ltd.)
 One A.C. mains pentode valve, Type MPT4, Osram, V_3 . (General Electric Co., Ltd.)
 One double-wave rectifying valve, Type DW4, V_4 . (Mullard Wireless Service Co., Ltd.)

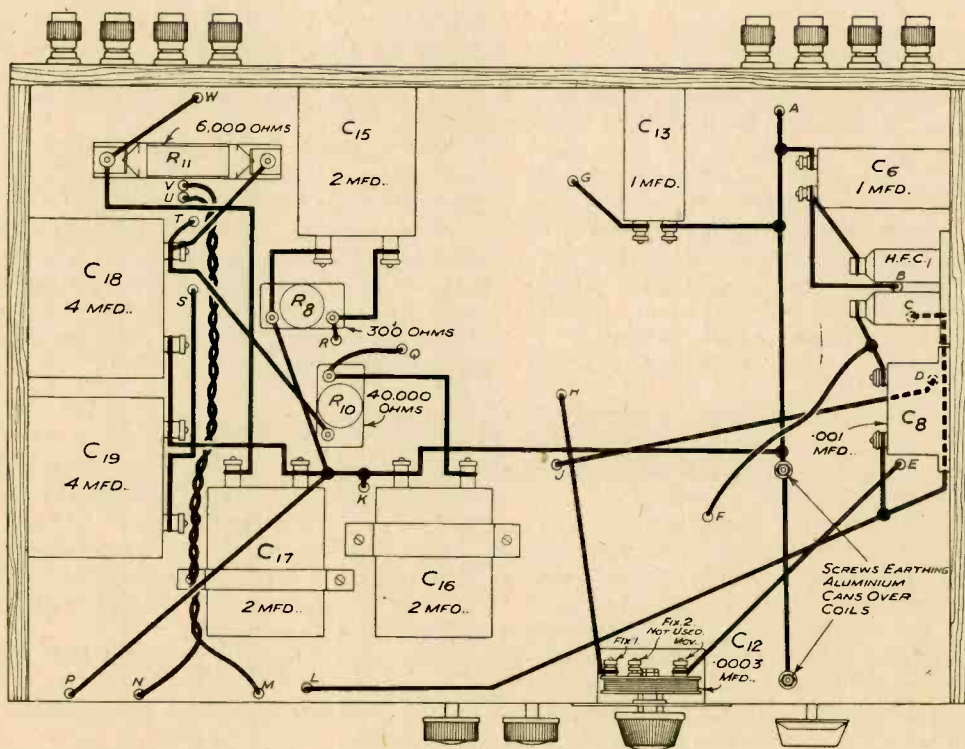

Fig. 3.—Wiring diagram of the "Visionette," in which the components are indicated by number to assist the constructor.

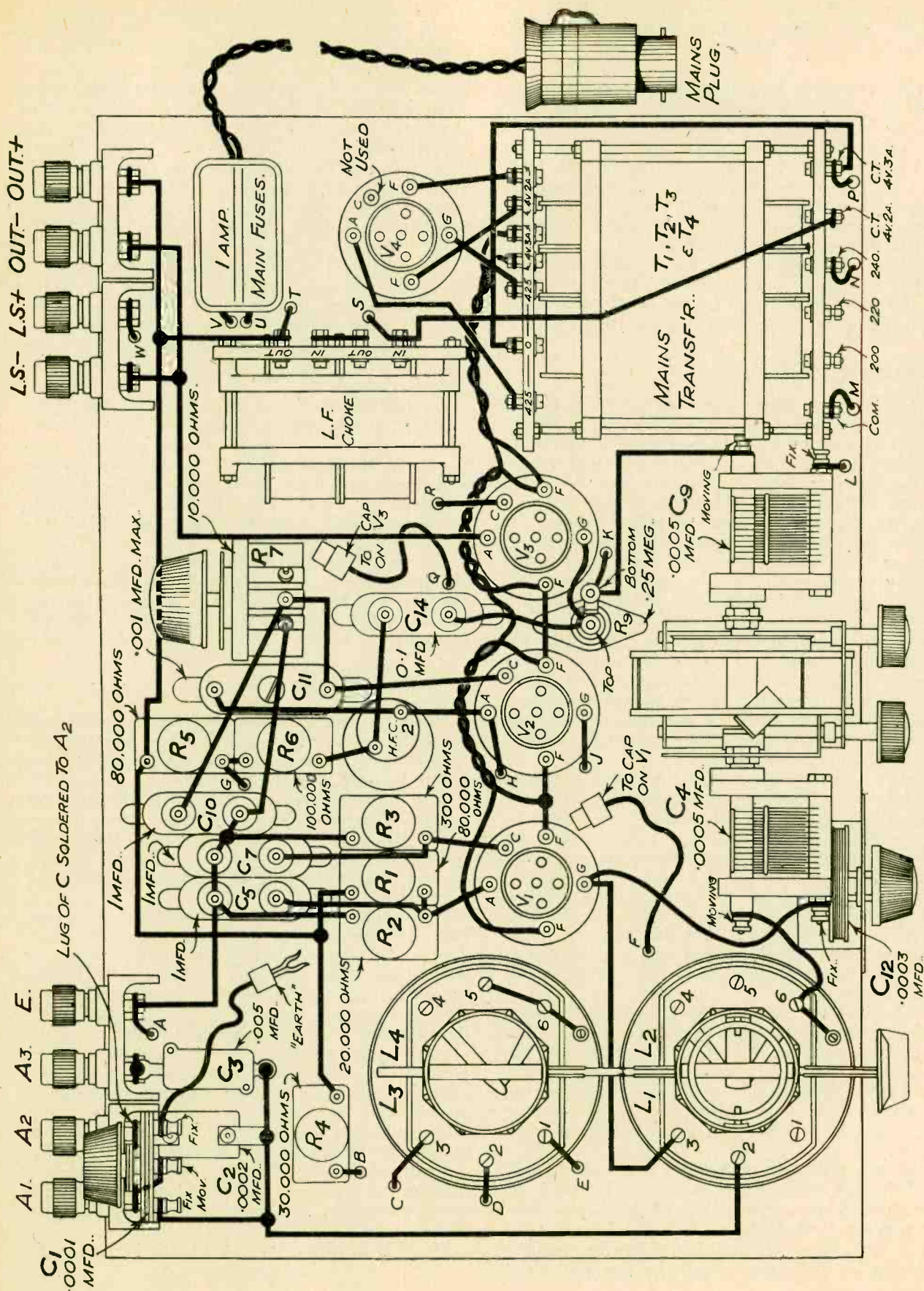

Fig. 2.—Above baseboard wiring diagram, showing how the wiring is effected.

Quantity of Lewcos Glazite wire and flex.
One oak cabinet and baseboard (see text).
(Peto-Scott & Co., Ltd.)

The cabinet has been made up specially to specification by the Company mentioned, while the baseboard consists of a $\frac{3}{4}$ -in. plywood base 18 in. by 12 in., secured to three battens, two of which run underneath the side edges and one at the back. This raises the underside of the baseboard $1\frac{1}{2}$ in., and enables certain of the components to be mounted very conveniently underneath, so as not to cramp unduly the lay-out above baseboard.

Furthermore, the cabinet has a solid oak front, with a central cut-out to take the moulded "dial" of the gang condenser. In this way the set can slide in from the back and has a clip on the back.

Component Assembly

Assemble the components exactly as indicated in the two wiring diagrams. Place the gang condenser exactly in the centre of the baseboard at the front, and since ultimately this condenser will be held rigid by the four screws passing right through the central cut-out in the cabinet front, it can be held down on the baseboard by a screw on either side of its bottom framework, the top of each screw exerting pressure on a small metal strip passing across the framework and resting on the aluminium base.

Pay very careful attention to the positioning of the pair of Colvern coils. The aluminium bases must be included, and the coils so aligned that the wave-change switch rod is at right angles to the baseboard edge. If desired, the makers will supply the coils with the switches ready ganged, but failing that, use must be made of the link to gang the switching of the coils and enable both to be switched from one knob movement.

Since the components are held in place both above and below the baseboard, it is incumbent upon the constructor to see that when holes are drilled in the baseboard to allow wires to pass through, the drill itself must clear the components and not cause damage.

It will be noticed that the fixed condensers below the baseboard are held against the side battens, except in the case of two. For this pair, aluminium straps were made to pass round each condenser case, two screws passing into the baseboard to secure them in position.

The aerial series condenser C_1 is mounted conveniently on a small right-angled bracket, as also is the potentiometer R_1 , while to accommodate the reaction condenser C_{12} it is necessary to cut away a small rectangular section of the baseboard at the front, and hold the condenser with its one-hole fixing nut on a thin brass strap screwed to the baseboard edge.

The next task to be undertaken is the wiring, and the following points must be noted. First of all, wire up the filament connections of the valves. For this purpose I employed good-quality Lewcos twin flex, it being borne in mind that each valve requires a current of 1 ampere. Tuck the flex round the

valveholders as indicated, keeping it on the baseboard, since it carries raw A.C. The two fixed condensers, C_2 and C_3 , are soldered direct to the aerial terminal tags. When making connections to the pair of coils, remember that screening covers have to be put on, and the wires passing from the numbered terminals must be positioned to keep central with the slots in the covers.

It is advisable to keep strictly to the wiring runs shown in the two diagrams and portrayed in perspective in the photographs. In this way there is less likelihood of any mistakes being made, and also make your leads with neat right-angled bends.

Two Belling-Lee S.G. anode connectors serve to make connections to the terminal at the top of the S.G. valves and the terminal at the side of the pentode valve. This is preferable to bare wire, for when removing valves no bare ends of live wires will be inside the set, with the likelihood of causing damage.

In addition to using a short length of flex to the top cap of the vertical grid-leak holder, use flex wire to the two terminals on the left-hand condenser of the twin gang. This condenser has an adjustment to move its fixed plates through an angle of about 30 degrees, and if the connections are made with solid wire, movement, and hence the trimming adjustment, is prevented.

Do not fail to include the earth wires to each of the metal coil bases. The short lengths for this purpose will be seen in Fig. 2, each lead passing from terminal 6 to a screw making electrical contact with the base.

The First Test

When the wiring is completed, check it over once carefully to see that no lead has been omitted, and then proceed to connect up the set for its trial run before housing it in the cabinet.

For the first test join the aerial lead-in to the terminal "aerial 1," and the earth to its proper point. It is advisable to assimilate the simple operating details in conjunction with a loud speaker, so join this to the pair of terminals included for the purpose.

Place on the pair of coil-screening covers, making quite sure that none of the wires to the coils touch the covers, but project through the centre of the slots provided. Insert each valve in its holder, not forgetting to add the two connectors to the S.G. and pentode valves; add the fuse-box cover with its pair of 1-amp. fuses, and finally insert the mains plug into the house electric-supply socket.

With the wave-change switch knob set to give either the medium or long waveband, whichever covers your local station, switch on the mains. After waiting a few seconds for the valves to heat up, proceed to tune in your local station by rotating the pair of moving plates of the gang condenser through the agency of the right-hand knob on the centre panel inset, the reaction condenser being set at zero.

If all is in order, the constructor is sure to be

(Continued on page 214)

News from Abroad

From Our Own Correspondents

Germany

DETAILS are now available of an entirely new type of modulated light source, developed by the Osram company in conjunction with the engineers of Fernseh A.G., the company sponsoring Baird television in Germany. When it was found that the brightness of the ordinary neon glow lamp could not be increased any further, it was decided to investigate on entirely new lines.

Glowing Electrodes

It is known that the brightness of a gas discharge lamp can be increased considerably if one utilises the positive column. The drawback of these lamps was, up to now, the very high voltages that had to be employed with them. However, by using glowing electrodes, it is possible to construct such lamps which will work with mains voltages, i.e. about 220 volts. As such values exist in the output stage of an ordinary mains receiver, lamps using oxide electrodes can be used directly after the output valve.

Now, when such a lamp is filled with Sodium, the discharge becomes extremely bright and of a yellowish-white colour. In order that the lamp can be used with ordinary voltages, it is placed in a metal box which is heated directly from the mains. Thus very bright images are obtained at relatively low voltages. Photometrically measured, the brightness was found to be 126 candles. At maximum operating conditions the illumination was 10 lux, or 3.55 Hefner candles per sq. cm., compared to the ordinary neon lamp's 0.04 Hefner candles per sq. cm. As Fig. 1 shows, the lamp is U-shaped. In order to obtain even illumination over the whole of the surface of the image, a ground-glass screen is placed over the front of the heating chamber (Fig. 2).

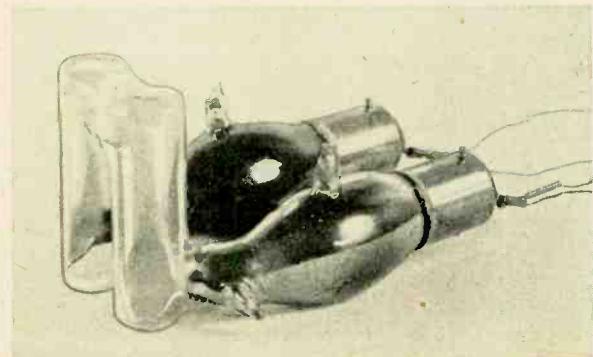

Fig. 1.—View of the new U-shaped lamp filled with Sodium, which gives an extremely bright discharge.

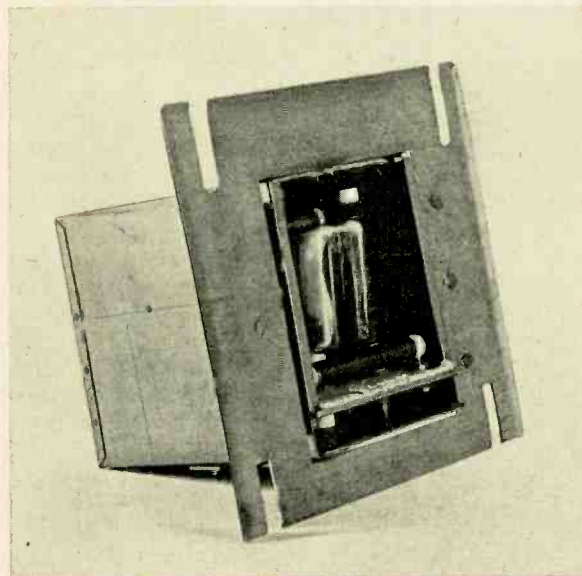
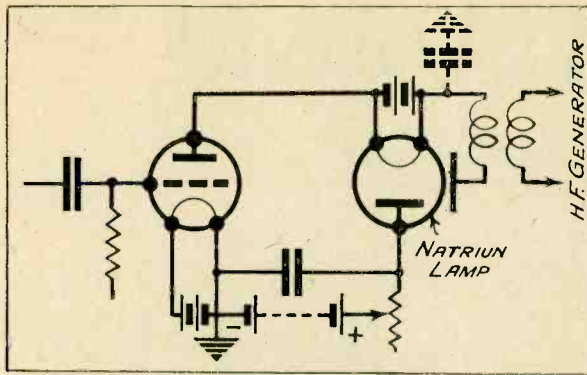

Fig. 2.—Heating chamber, with ground-glass screen.

A great advantage of this lamp is, moreover, that it has absolutely no lag, which is of extreme importance owing to the very high frequencies that occur in modern good-detailed television images. The bright yellow light is very pleasant to look at, as the images appear somewhat white. The lamp shown in the photograph illuminates a surface area of about 1 in. by 2 in. In order to keep the high temperature of the heating elements away from the vision apparatus itself, the chamber with the lamp is attached to the outside of the back wall of the cabinet.

It was found that in order to avoid the formation of black streaks in the images, the lamp should be slightly "tickled" with high-frequency current, and the accompanying circuit shows how the lamp is connected up. The necessary high frequency is taken from a small valve generator, which is not itself indicated. The end of the coupling coil is connected at the one end to the cathode of the lamp, and at the other end to a metal screen placed a few millimetres away from the lamp, so that the high frequency is fed capacitatively.

The optimum operating temperature was found to be 180° C. The characteristic of the lamp is then absolutely flat from 10–100 milliamperes at 160 volts. The optimum brightness is obtained between 30 and 60 milliamperes. The power needed to modulate the lamp is anything between 1 and 14 watts, according to the brightness that is desired. The writer has had the opportunity of seeing some



How the new lamp is wired.

very bright images using an output of only 4 watts. The images obtained in conjunction with this new Natrium lamp are so bright that 120-line images can be comfortably viewed in an undarkened room. Moreover, projection is possible using an ordinary scanning disc (not a lens disc) with 60 holes. The results were superior to those obtained with a mirror drum and crater neon under similar operating conditions.

The United States

By A. P. Peck

A survey of television "in the home" is given by Mr. A. P. Peck, an associate editor of the *Scientific American*, from which we reproduce the following article by special permission. It is the most complete statement that has so far appeared on the position in the United States at the present time:—

"Television is here," says the technician; and the public looks around for a television "machine" with which it can see stage presentations, boxing matches, horse and automobile races, and all the other interesting events that go to make up our complicated national life. But the public looks in vain. Here is a vision apparatus that shows a picture the size of a postage stamp; here is one which gives an image, somewhat distorted by a huge magnifying glass, apparently about 6 in. square. But the images in these receivers show only head or head-and-shoulder views, of one or at the most two persons, and to see even these limited pictures the spectator must be very nearly in a direct line with the apparatus.

Where, then, is the kind of television that will give



Mr. William Hoyt Peck with his vision receiver which gives an image about one foot high.

us in our own home the equivalent of a motion picture with sound accompaniment? Quite frankly it is not yet available in the United States. We can to-day go to an up-to-date radio shop and purchase a vision receiver that will actually operate, but it will have all of the limitations briefly expressed above. Thus television has or has not arrived, according to the standards which each person sets for such entertainment in the home.

Workers in the television field may be divided into two general classes—those who are doing something and telling the world about it, and those who are doing something and saying nothing. Both groups can justify their attitudes. The former is giving the public a new plaything—crude though it is; the latter is working towards a more or less definite end, and prefers to withhold the details of results until television on a scale acceptable to the majority can be made available.

A brief survey of the activities of some of the workers in the first of these two groups will give a general idea of what the present offers.

The engineers of the Jenkins Television Corporation have developed a line of television receivers and reproducers, a console model of which is shown. The image is viewed through a modified shadow box mounted in the console, being projected on to a translucent glass screen so that it can be watched by a small group of people. This company reports that it is experimenting with a transmitter operating in the neighbourhood of 5 metres. In this region congestion is at a minimum and the carrier wave can be held steady enough for satisfactory transmission.

Jenkins' engineers also talk of a new type of "camera" or television pick-up for use in theatres and out of doors, and of a new method of increasing detail in a received image. So far this development is all in the future, and the receiver with a small image, lacking in detail, is all the public can have at this time.

In one of the models put out by the Freed Radio and Television Corporation, a crater-type neon lamp supplies the light which is modulated by the incoming signal. This light is projected through a series of lenses arranged in a spiral on the usual scanning disc. This lens system serves to enlarge the image as it is projected on a screen, and so to make it visible by several persons at one time. On the front of the cabinet is a hinged arrangement which serves as a shadow box, and which may be closed to cover the screen when the set is not in use.

The latest development at the time of writing is the lens-mirror disc of William Hoyt Peck (no relative of the writer). In this system, a scanning disc about 1 ft. in diameter gives an image projected on a screen, about

1 ft. long. Arranged in a circle around the edge of the disc are 60 lens-mirrors (or the proper number according to the number of units used at the transmitter). Light from a crater-type neon lamp is focused through a lens system on to the lens-mirrors, which are individually tilted so that a scanning effect is obtained. The designer claims that far more efficiency is obtained from the neon lamp with his system than is possible with any other system in which only part of the light is used at any one instant.

In a demonstration of the Peck system, the writer noted fair definition, but insufficient illumination on the foot-long screen. This was explained as being due to the lack of a satisfactory light source, which, however, is being developed. The best feature of the apparatus was the fact that a large group of persons could view the image from various angles, and did not have to be directly in front of the screen. This factor is one which is stressed below as being highly desirable in a satisfactory vision receiver. Peck's invention is not as yet on the market, but licences are being arranged for manufacture in the very near future.

Statements from a few of the workers in the second group mentioned above—the silent, hard workers—will indicate to some extent what may be expected in the future. John V. L. Hogan, of Radio Pictures, Inc., who for some years has been engaged in intensive development work on television problems, recently told the writer of some of the features that television must possess before it can be considered an important factor in our daily life. "The image," said Mr. Hogan, "should be at least six inches square with detail sufficient to show recognisable features of persons in close-ups and recognisable action in scenes which take in more area. The large magnifying glass for enlarging the image is definitely out. The image may be viewed directly as formed or projected upon a screen. In any event, the image must be such that it can be seen by a group of people seated as they would be in a home living-room, and not by only one or two directly in front of the television receiver. The apparatus must be simple enough in operation to require no more attention from the user than is needed by the present-day broadcast receiver.

"I do not believe that the scanning disc or drum, as such, will be a part of the really successful television receiver of the future. By this I do not mean that mechanical methods of scanning and reproducing will be discarded in favour of some such electrical method as the cathode-ray tube, but the bulky scanning disc must go. Its inherent, undesirable features cannot be countenanced in a radio vision receiver that is to be used by the general public."

Mention was made of the use of motion picture film for television transmission as opposed to direct scanning of actual figures or scenes. Mr. Hogan expressed himself as follows: "When experimenting with television as we are, and as others are doing to-day, it is essential that all available factors be eliminated or stabilised as far as possible. Scanning a film does just this with one part of the transmitting equipment. All other factors being equal, we know that the transmission to-morrow will be the same as it is to-day, using the same film, and thus we are able to check differences in operation that would be more obscure if direct scanning were employed. When television becomes an accepted fact for the general public. I believe that films will furnish the bulk of the programmes. Their use will make possible a far wider range of television entertainment than could be attained by direct scanning, although the latter will be of great value for 'spot pick-up' of news events and the like."

In the United States to-day, then, television seems to boil down to just this: If you will be content to see pictures that are not even comparable with the earliest movies, or if you are experimentally inclined, you can have television in your own home and can "look-in" on programmes which are available at more or less regular intervals. If, however, you want some-

thing that will compare favourably with your home movie equipment in quality of image, you cannot have television to-day, and you probably will not have it for some time to come.



In the foreground is the Jenkins television "camera," used to pick up visual programmes.

Radio City

RADIO CITY forms part of a new group of buildings which are being erected in the heart of New York by Mr. John D. Rockefeller, Jr. As soon as the project definitely took form, American business interests rallied enthusiastically to its support. Mr. Owen D. Young, chairman of the General Electric Co., at once took long leases for four great companies in which he has a guiding hand—the R.C.A., the National Broadcasting Co., Radio-Keith-Orpheum Corporation, and R.C.A. Telephone, Inc.

Radio City will include the first television theatre in the United States. American business interests are backing television. Mr. Samuel L. Rothafel, the entertainment magnate who has been styled "Mayor of Radio City," said: "Television is not perfect yet. We do not want to start it on a big scale until it is. That was the mistake made over sound films. But all our stages and studios are being built for television purposes. The time will soon come when

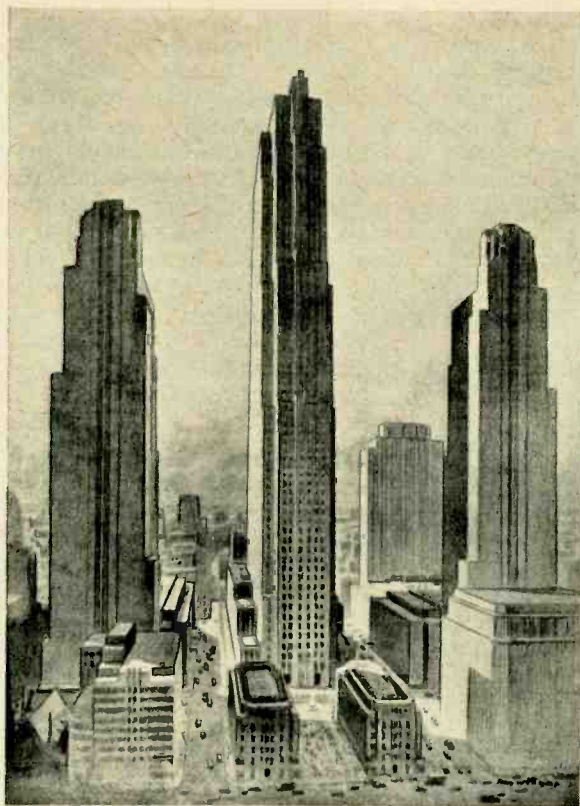

Architect's drawing of the new Rockefeller buildings, with the giant radio skyscraper in the centre.

London will look-in to Radio City's plays, operas, and films."

The whole group of buildings will be known as the "Rockefeller Center," and the founder is himself spending several millions on the project. In the founder's words, it is a monument "to symbolise the spirit of co-operation and brotherhood among all nations, upon which enduring peace and prosperity can be built." The enthusiasm in New York is reflected in an illustrated brochure which we have just received from America:

"New York already has its famous landmarks—the soaring beauty of the Woolworth Building, the needle-like towers of the financial district downtown, the cool stark majesty of the Empire State Building. But these are isolated and devoted to business alone. Uptown the Cathedral of St. John Divine crowns Morningside Park, the tower of Riverside Church leaps up to its inspiring heights, and in midtown Fifth Avenue stand the twin spires of St. Patrick's Cathedral."

It is claimed that the Rockefeller Center will meet every requirement of business, and at the same time it will create an atmosphere of harmony and peace. Huge buildings have sprung up all over New York. A great number obscure the individuality of all except the tallest.

Aiming at buildings of individuality and of lasting importance, the architects of the Rockefeller Center have perfected plans for two relatively low buildings of studied proportion. These will be known as the British Empire Building and the Palais de France.

Last month Lord Southborough laid the foundation-stone of the British building, which forms the right-hand side of the gateway to the Center. Here will be exhibited the finest products of the Empire, with examples of our works of art, antiques, and jewellery. Information will also be available about travel facilities. The left-hand side of the gateway has been secured by the French Government to house in similar fashion all the finest products of France. Both Italy and Germany are also to be fully represented. The German Government are making arrangements to secure a building at the corner of Fifty-first Street and Fifth Avenue. When the Italian Government heard of the project, they at once approached Mr. Rockefeller with a strong request to be allowed to participate.

Radio City will include a seventy-story skyscraper and other buildings, which will form the principal entertainment centre of New York—an opera house, a sound theatre, the television theatre, and vaudeville and drama theatres, together with offices for the big radio corporations.

The land on which Rockefeller Center will stand, with its frontage on Fifth Avenue, is probably the most valuable site in the whole American continent.

The "Visionette"

(Concluded from page 210)

impressed with the quality of reproduction (assuming a high-class model speaker is in use), and the complete absence of any mains hum. Selectivity and one form of volume control is provided through the differential condenser C_1 at the back, while the second condenser knob on the left at the centre panel inset acts as a trimmer, and enables the station to be tuned in accurately.

Note that the potentiometer R_1 should be set at approximately its mid-position to start with, and should be adjusted carefully after the station is tuned in to give the best rectification for the signal strength then available. Adjustment should also be made on site to the pre-set condenser, C_{11} , although this is done best in conjunction with the reaction control.

Searching for stations is carried out in the usual manner with the set brought to its most sensitive condition just off oscillation point, and I am sure readers will find that the receiver fulfils adequately the quite modest claims made for its performance.

Unfortunately, up to the time of writing the promised transmission of television signals by the B.B.C. has not materialised, so that it has not been possible to test out this modified version of the "Visionette" in conjunction with vision apparatus. This is a pleasure which must be deferred for a few days, but will be dealt with in full in next month's issue.

In conclusion, may I thank those vigilant readers who pointed out the little error in the skeleton decoupling arrangement shown as Fig. 2 on page 179 of the July issue. Of course, R_x and R_7 and R_7 and R_8 should be interchanged.

If Lindbergh had been Televised

By Orrin E. Dunlap, Jr., B.Sc.

A fascinating future is foreshadowed in the writer's new book, "The Outlook for Television," just published by Harper & Brothers, New York. We have acquired the serial rights of several chapters, the first of which gives a picture of the famous flight across the Atlantic as it might have been watched by television. Mr. Dunlap also deals with the future of exploration and politics as likely to be influenced by this new science.

TO reveal the thrilling possibilities of television let us go back a bit, into the land of what-might-have-been, where the imagination links the future with the past. Charles A. Lindbergh is at Curtiss Field ready to begin his famous flight to Paris, on May 20th, 1927. The electric cameras with their all-seeing eyes and sensitive lenses are on duty to snap the scene.

It is two o'clock in the morning. Television screens depict a murky, dreary scene. Puddles caused by a thunderstorm's deluge around midnight glare like tiny lakes in the flood of the electric lights that are now illuminating the television scene. The silver nose of the *Spirit of St. Louis* glistens through the hangar door upon which a television camera is focused. Word has been broadcast that "Lindy" is preparing to go. Crowds are collecting. Automobiles line the roads around the field, and on the television screen the Nassau county police are seen rushing about to keep the mob off the flying field.

Wisps of fog blow across the field and the televisions catch them. It is a dismal scene, but nevertheless a dramatic one for the millions who are forsaking slumber to watch an historic event. They hear the chatter and comment of the crowds, the shouts of the police, complaints of the wet field. Microphones alongside the radio camera pick up words that come from the crowd. Someone says it is the height of folly for any plane to take off, even on a short flight. A spectator at the field looks skywards and holds out the palm of his hand. He says it is raining again. But someone runs out of the hangar and reports the sky to the north is clearing. Apparently the threatening conditions are only local.

Outward Bound

A policeman's motor-cycle roars across the television screen. He is clearing a path through the crowd for the pilot. It has stopped raining. The big doors of the hangar swing open revealing a graceful plane. A truck backs up to the doorway. The *Spirit of St. Louis* is turned around. The tail is lifted up by careful hands and is made secure with ropes. Every precaution is taken to avoid strain before it gets into the air. It is bound on a long journey on an uncharted pathway along the Great Circle Route that links two continents.

The television screens of all America are illuminated with activity. Motor-cycle policemen are

seen to surround the truck, and the silver bird is pulled ignominiously along tail first across the field, as a corps of television photographers follow with their electric eyes and microphones. Mechanics are seen to stoop occasionally as they walk along to feel the wheel bearings for fear they might heat up under the load of 200 gallons of fuel already pumped into the tanks.

It is five o'clock. The rain is sprinkling. The truck moves slowly towards the runway so that the plane will ride tenderly over the rough spots and puddles that dot the field. The grass is wet and the ground soggy.

The Sun comes Up

The television scene is becoming a bit clearer. The clouds in the east are breaking and the first faint streaks of light appear. Soon the radio men will not need the artificial spotlights and flares to illuminate the scene. At last the nose of the *Spirit of St. Louis*, with a canvas cap over the motor, is at the head of the runway.

The ship is facing the rising sun. A closed car approaches. A youth in army breeches and a tight woollen sweater steps out. Men standing on the nose of the plane are pouring in the petrol. Fellow aviators realise this flier will soon be off, and they are shaking hands and wishing him good luck. The spectators on the field and at the television sets are excited and anxious. Those at the field have wet feet. Those watching by television are comfortable at home, many of them in night clothes. They wonder if there is any bottom to those hungry petrol tanks. Finally they see the men climbing down from the plane. They hear a mechanic tell the flier that there are 451 gallons in the tanks, 150 more than the plane ever lifted. It is a dramatic moment.

A mechanic turns over the motor. There is a terrific roar on the television screens as the associated loud speakers reproduce the noise. The birdman is seen donning his fur-lined flying suit. His helmet is shoved back and the goggles rest high on the forehead. He gazes off into space. He is the most unperturbed man on the field. He climbs into the pilot's seat and warms up the motor. The throttle is open and the great man-made bird roars and flutters. The television eyes are not missing a thing.

Someone runs up excitedly and asks him if he has

forgotten his rations. The microphones on duty pick up his answer. The electric cameras point at him.

"I have five sandwiches. That's enough. If I get to Paris I won't need any more, and if I don't get to Paris I won't need any more, either."

"How is it?" asks the pilot.

"She sounds good to me," replies the mechanic.

"Well, then I might as well go."

It is exactly 7.52 a.m. "So long," he calls from the tiny window of the plane as he waves to the crowd.

Moments of Excitement

The blocks are pulled from beneath the wheels. The motor roars. Television eyes located all down the field watch the heavily burdened plane lurch slowly down the runway. The wheels find it difficult to travel over the bumps and soggy field. She does not seem to get up flying speed, at least not enough to rise with the load. The television spectators groan. So do those at the field. The plane looks nose heavy and as if it might plunge over on its nose at any moment. It must lift quickly or strike a gully at the end of the runway. Suddenly it hits a bump which throws it upwards on the television panorama. But the wheels come back to earth. It has not enough flying speed. It looks as if the craft is too heavy. Suddenly, as if some unseen force were lifting the wings, they leave the ground and the plane just skims over a tractor which is directly in its path and near the last television camera.

The camera-man turns his lens towards the plane. It is seen to clear the electric wires by barely twenty feet. But it doesn't seem to rise high. There are trees ahead. Lindbergh apparently sees them through his periscope. He turns a little to the right and selects the point where the foliage is lowest. The silver wings sweep by and the machine begins to climb. The sun creeps out from behind the clouds and smiles on the *Spirit of St. Louis* as it

dips off over the horizon. It is just a mere speck in the television picture now.

A fleeting bird is flying across Long Island Sound on a course that leads to Rhode Island and over Massachusetts Bay to Nova Scotia and on to Paris, 3,610 miles away. "Lindy" is out of sight. It is time for the television audience in the East to go to work. Californians may catch a few hours' more sleep. The next scene will come from Le Bourget flying field in France. It is almost midnight in Paris 33½ hours later, when the landing lights flash across the sky and 100,000 pairs of eyes are on the watch for Lindbergh's arrival.

How could it be done? How could the earth's population be spectators at such history-making events? Television will be the answer. It is the wizardry of the age.

Aviation offers other possibilities for television. The bird's-eye view will take on a new meaning. An electric eye linked with a radio camera from a lofty perch can photograph a scene and flash it to earth by short waves. On the ground it will be intercepted, recorded on a film and rebroadcast throughout the country by television. Californians may see what the aviator over Manhattan sees as he flies above the skyscrapers. The entire nation may be taken for a television tour across the Grand Canyon, down the St. Lawrence, or see Broadway's "Great White Way" converted into a nocturnal fairyland of electrical glow. Spectators at home may see how their city looks when scrutinised from the sky.

Airplanes will carry television monacles which will enable the pilots to see through fog and darkness so that they may land safely. And ships at sea, like the serpents in the story books, will see far across the waves, far across the horizon and the curvature of the globe.

Adventure and exploration linked with television cameras give the imagination an opportunity to function. It will be recalled that the members of the Byrd Antarctic Expedition were thrilled by familiar voices broadcast specially to them from



"How could the earth's population be spectators of such history-making events as the excited scene before Lindbergh's Atlantic flight? Television will be the answer. It is the wizardry of the age."

Pittsburgh and Schenectady. Out of the darkness of the long winter night, through various climes and a mixture of weather, came voices the identities of which were faithfully preserved, and the ring of the voice was true, despite the long flight across land and sea, across jungles and mountains, across the Tropic of Cancer, the Equator, and the Tropic of Capricorn, finally to strike a slender target of copper antenna wire stretched between two masts reaching up from the ice.

If all that is possible—and it has been done—why should radio not carry sight to and from the far distant points of the earth? Isn't it feasible to believe that some day an explorer will soar over the South Pole with a television camera, just as the plane *Floyd Bennett* carried a motion picture eye? Then,

instead of waiting for a ship to bring the films to civilisation and to theatres throughout the land, radio will flash the scene around the globe so that many millions will see exactly what the aviator views and at the instant he is seeing it. The fact that messages have travelled back and forth from the isolated regions leads those who have faith in science to believe that as the ear hears so shall the eye see.

Television in Politics

Travelling presidential candidates may be rare by 1940. The day is likely to come when they will make personal appearances before the voters by television. But there may be a danger lurking in those screen appearances if the radio waves carry them beyond the Mississippi.

Hughes toured the West in 1916. More than half the states west of the Mississippi voted against him. The sages say that he would have been President had he remained in the East. In 1884, Grover Cleveland chose to be a mystery man, so far as the great open spaces were concerned. He stayed in the East. He won. In 1910, William Howard Taft delivered what was called a poor tariff speech in Minnesota. That state and others surrounding it went strongly Democratic. In 1919, Woodrow Wilson went into the West to champion the League of Nations. He collapsed in Colorado and returned to the national capital broken in health. President Harding made a Western tour and died in San Francisco.

Some of the wise men say that Alfred E. Smith should have remained in the East. But he went West in person, as candidates may do by television in years to come. Smith lost. The brown derby



"In 1928 the nation tuned-in to Hoover. When television enters the political campaign, it will be more realistic than a mere radio battle of words."

did not charm the West. Hoover made personal appearances and speeches in Omaha, Oklahoma City, Helena, Minneapolis, Milwaukee, and Rochester. Ten years ago only the people in those cities attending the political mass meetings would have heard him. But in 1928 the nation tuned-in.

Hoover spoke in New Jersey and they heard him in California. He fired the opening gun of his campaign at Palo Alto and was heard in Maine. Radio in 1928 made the presidential race a national affair within the home circle and took it away from the front porch.

Possibly when television enters the campaign, "red fire" and bunting will come back. Gestures will be in order. The campaign will be more realistic than a mere radio battle of words. But

the election bulletin boards in front of the newspaper offices are likely to disappear as the returns are flashed on television screens.

Images of statesmen and their friendly gestures will mingle among the nations. Television will usher in a new era of friendly intercourse between the nations of the earth. Current conceptions of foreign countries will be changed. Television will perform in this respect in much the way that Lindbergh saw aviation creating new friendships when he said to the Japanese in Tokyo:

"We have come to Japan for an opportunity of meeting your people and learning a little more of the country which in our schooldays was known to us in America as being on the other side of the world. When we were children, we thought of Japan as a land filled with people who were different from us as though they lived on another planet. We marvelled at their ability to walk upside down and that they kept from falling off the earth altogether."

And so television will enable the inhabitants of the earth, who do not have the opportunities of travel, to see how their fellow-men live on the other side of the globe. They will learn to enjoy their music, drama, and national scenes. Suspicions will be obliterated. New friendships will result.

When the Japanese Premier, the late Hamaguchi, broadcast the first message of good-will to listeners in the United States his voice was remarkably clear despite its long flight by short wave across the broad Pacific to the Californian shore. He opened a new era in international relations between the United States and the East. Then the airplane of Lindbergh flew over for a visit. The next link in the chain may be television—when Japan will see America and Americans will see the Japanese.

Retaining Higher Frequencies

I.—*The Band-pass Filter*

By E. G. Bowen, M.Sc.

THE television amateur is well acquainted with the fact that the frequencies in television signals are higher than those met with in ordinary broadcast reception. Speech and music consist mainly of frequencies up to 5,000 cycles a second, and excellent quality is obtained if a wireless set is capable of reproducing these frequencies. But television signals may have a frequency as high as 10,000 cycles a second, and a receiver which gives good results on speech and music will not always be satisfactory for vision reception.

Particular care must be taken of these higher frequencies in their passage through a wireless set if they are to appear undistorted and at sufficient strength in the output to give detail to the television images. Much has already been written of the precautions necessary to prevent loss of higher frequencies in the audio-frequency amplifier and the output stages, but little has been said about the losses in the early stages of a receiver—in the tuning circuits which pick up the signals in the first place. Tuning circuits can cause considerable loss of high frequencies, and in an ordinary receiver no provision is made to balance out or return this loss.

How the High Frequencies are Lost

The resonance curve of a simple tuning circuit tuned to a frequency of 1,000 kc./sec. (a wavelength of 300 metres) is shown in Fig. 1. This curve shows to what extent the circuit responds to radio frequencies in the neighbourhood of 300 metres, and assuming the sideband theory, it will also show to what extent it responds to audio-frequencies which are superimposed on a carrier frequency of 1,000 kc./sec. For instance, an audio-frequency of 5,000 cycles a second (i.e. 5 kc./sec.) superimposed on the resonance frequency of 1,000 kc./sec. gives rise to two sideband frequencies of 995 and 1,005 kc./sec., which would be received at only 30 per cent. of their proper strength, i.e. a note of 5,000 cycles a second would only be received at about one-third of the strength of a low note of, say, 100 cycles a second. Evidently such a circuit is responsible for a considerable high-note loss.

Examination of the figure shows that the frequencies of about 10,000 cycles a second found in television signals would be cut down to but 15 per cent. of their proper strength. Such a loss is far greater than any which may occur in subsequent stages of a receiver, and it would be well to consider how it can be eliminated or at least cut down to a minimum.

A tuning circuit made up of a poor coil and condenser is heavily damped and has a wide resonance curve, as shown dotted in Fig. 1. There is now

reasonable response to sideband frequencies up to 10,000 cycles, and in this respect a poor, heavily damped circuit is to be preferred to a carefully made, lightly damped tuning circuit. But the poor circuit will respond equally well to the transmissions of other wireless stations working on a wavelength near the one being received. It is not a selective circuit, and must therefore be ruled out.

The Ideal Resonance Curve

What is required is a resonance curve having the nearly flat top of the heavily damped circuit with sharp steep sides, so that there is no response to outside frequencies. The ideal resonance curve then is a rectangle, as shown in full line in Fig. 2. (In this and subsequent figures, no particular resonance frequency is specified. The curves are drawn about a zero line, on either side of which is a scale of kilocycles off resonance. This is a more convenient method of drawing curves than the method of Fig. 1, since it shows immediately the width of the band of frequencies covered by any particular resonance curve.)

This rectangular resonance curve shows equal response to all frequencies up to 10,000 cycles a second, and no response to frequencies outside. It

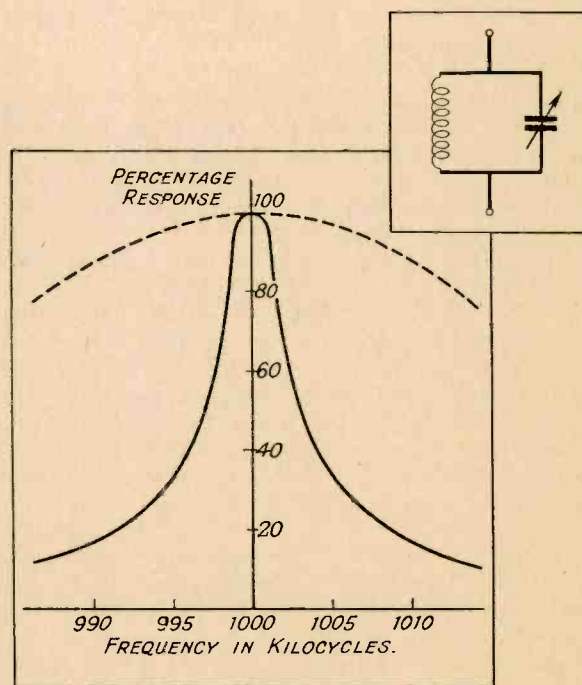

Fig. 1.—The response curve of a simple tuning circuit at 1,000 kc./sec., or 300 metres.

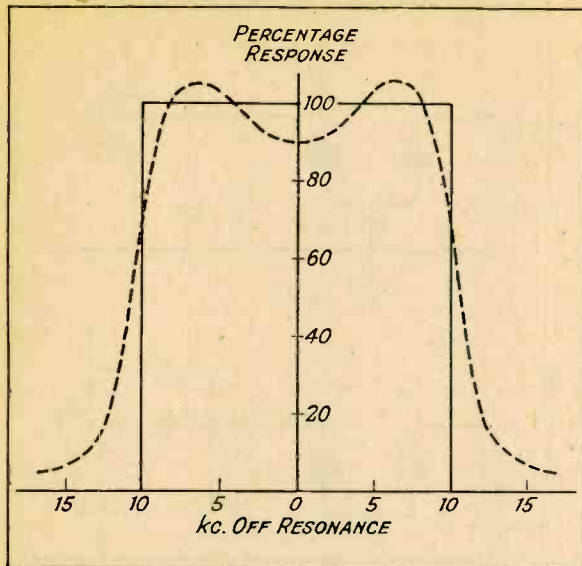

Fig. 2.—An ideal rectangular resonance curve. The response of a band-pass filter is shown dotted.

would therefore be ideal for the reception of television signals. It remains to find a tuning circuit which has such a resonance curve.

The Band-pass Filter

As might well be imagined, it is impossible to design a circuit having this ideal shape, but something very similar can be obtained by using a band-pass filter, which as its name implies passes a band of frequencies to the exclusion of all others. The filter has the double-humped resonance curve shown dotted in Fig. 2, which approximates closely to the ideal rectangular form required.

A band-pass filter is made up by combining two simple tuning circuits. This does not mean using two distinct circuits, separated by a valve, perhaps, as in a conventional H.F. amplifier, but using two circuits coupled together, so that signals in one are fed directly into the other and then on to the valves. Three types of filter are shown in Fig. 3, in which coupling is by:

- (a) mutual inductance between the coils;
- (b) inductance coupling through a small coil common to both circuits;
- (c) capacity coupling by a fixed condenser common to both circuits.

Fig. 3.—Band-pass filters in which coupling is by (a) mutual inductance (M) between the coils, (b) inductance coupling through inductance (L_m), (c) capacity coupling by fixed condenser (C_m).

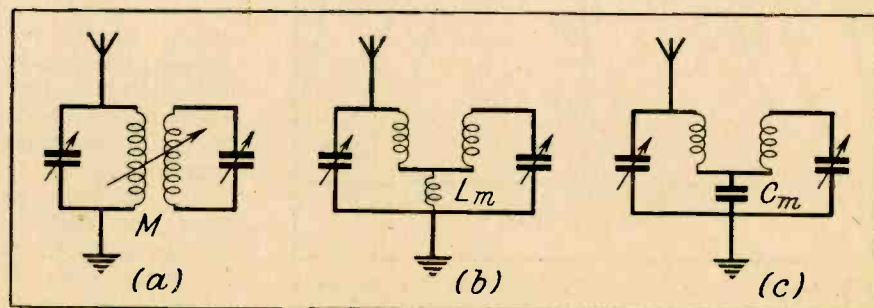

The first is the familiar loose-coupled tuner used some years ago in wireless receivers. Its unique properties were not universally recognised in those days, and it was only used as a circuit whose selectivity could be varied by varying the coupling between the coils. The second circuit is very similar, but there is fixed coupling by means of the small coil L_m . To prevent unwanted interaction between the tuning coils, it is usual to place a screen between them, or to use completely screened coils. The capacity-coupled filter (c) is again similar to (b), but a coupling condenser C_m is used to feed energy from one circuit to the other.

As the properties of all three are similar, they will not be dealt with separately. Instead, only the capacity-coupled filter will be considered, as it is perhaps the most convenient for ordinary use; with reservations, its properties may be taken as characteristic of all three.

The Capacity-coupled Filter

Fig. 3c was drawn to show how the capacity-coupled filter compares with the others, but this is not the most convenient way of connecting it up in practice. The more usual method is shown in Fig. 4, which gives in addition a set of resonance curves for wavelengths of 200, 350, and 500 metres when the coupling capacity is .008 mfd.

It is evident that as the wavelength increases the peaks become more pronounced and the distance between them increases. The peak separation increases from 7 kc. at 200 metres to 25 kc. at 500 metres. At 350 metres the peak separation is a little under 20 kc., and the response to frequencies up to 10 kc. off tune is greater than the response at resonance, i.e. at 350 metres the higher audio-frequencies up to 10,000 cycles a second are received at greater strength than a low note of, say, 100 cycles. Such an accentuation of the higher frequencies would be extremely useful in a television receiver in compensating for the inevitable losses which occur in the low-frequency stages.

We have just seen that the peak separation increases with increasing wavelength. It can be shown that for any one wavelength the peak separation will increase as the capacity of the coupling condenser is decreased—a small coupling condenser gives widely spaced peaks, while a larger one draws

them together. The actual peak separation is given by the formula:

$$\text{Peak separation (in cycles)} = \frac{\sqrt{\frac{I}{\omega^2 C_m^2 - r^2}}}{2\pi L}$$

where $\omega = 2\pi \times \text{frequency in cycles.}$

$L = \text{inductance of either coil in henries.}$

$r = \text{equivalent series resistance of one tuned circuit in ohms.}$

$C_m = \text{coupling capacity in farads.}$

Using this formula, we can calculate the capacity of the coupling-condensers which would be required for the reception of television signals from the London Regional station on a wavelength of 356 metres. Assuming the tuning coils each have an inductance of 200 microhenries, and the series resistance of each tuned circuit is 10 ohms, the calculation leads to a coupling capacity of .008-mfd. It was this capacity which was chosen for drawing the curves of Fig. 4. It can be seen that the curve at 350 metres is one which gives excellent response to side-band frequencies up to 10,000 cycles with sharp cut-off above this frequency.

Using the Band-pass Filter

Having now found the coupling capacity which gives the necessary response curve, we can go on to consider briefly some practical details.

It is essential that the coils of a band-pass tuner should be accurately matched and that the condensers

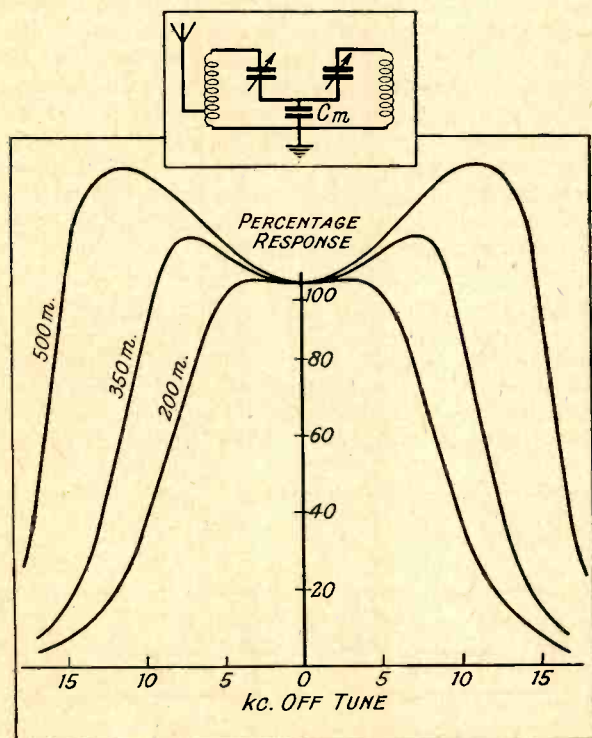

Fig. 4.—Resonance curves of a band-pass filter having a coupling condenser of .008 mfd. at 200, 350, and 500 metres.

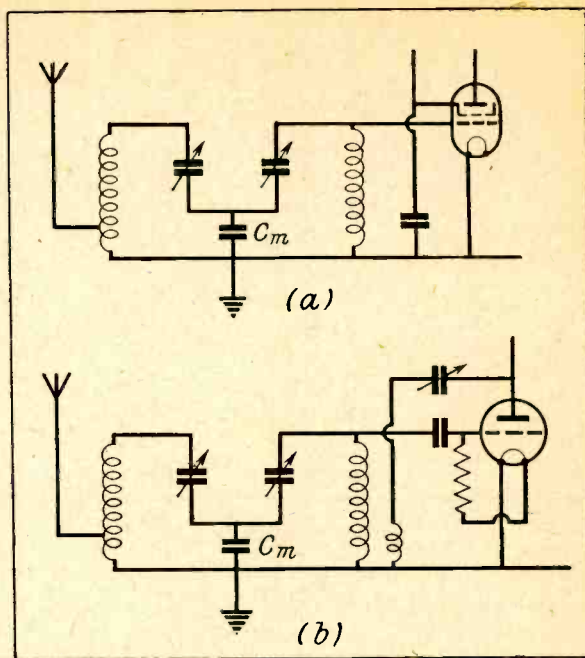

Fig. 5.—Connecting a band-pass filter before (a) a screened-grid valve, (b) a triode detector valve.

should be ganged. There are quite a number of such coils now on the market, matched and completely screened, and there are also many excellent two-gang condensers which are suitable.

For the filter are required a pair of screened coils, a twin-gang condenser, the capacity of each section being the usual .0005-mfd., and a non-inductive coupling condenser of .008-mfd. The filter might be connected directly in front of a screened-grid valve as in Fig 5 a, but in this case, subsequent tuning circuits themselves cause a loss of high frequencies. Perhaps the tuner would be at its best in a receiver employing no H.F. stages. It would then be connected in the grid circuit of the detector as in Fig. 5 b. Reaction could be applied to increase the signal strength if required.

Those who try out this form of tuning circuit are reminded that while the band-pass filters at present on the market are perfectly suited for the reception of broadcasting, they do not respond to a sufficiently broad band of frequencies to be of the greatest value in a receiver designed for vision reception. The type of filter described above with its coupling condenser of .008-mfd., having an unusually broad response curve, is ideal for the reception of television signals, but it is unsuitable for ordinary broadcast reception. For satisfaction its use should be confined to the reception of vision signals from the London Regional station when there are no powerful transmissions working on a neighbouring wavelength.

In the second part of this article I hope to discuss, not methods of preventing loss of higher frequencies, but methods of compensating for the losses which do occur in the simple tuning circuits of an ordinary receiver.

From My Notebook

By the Technical Editor

A D.F. Field Day

ANY activities undertaken by radio societies to keep their numbers together during the summer months call for special commendation. I was therefore very pleased to hear of the success which attended the direction-finding competition organised by the Golders Green & Hendon Radio & Scientific Society. As in previous years, I was appointed a judge, but important business unfortunately prevented my attendance. The competition was the most successful held so far, and over eighty competitors were in the "field," including a contingent from the Pye Radio Society of Cambridge.

Several modifications were made to the scheme as compared with previous years, the most important being that it was divided into two parts. For the first part the transmitting station was mobile, and the object was to locate its direction, but for the second part it was stationary and concealed in a field near Ridge Church, and the object was to discover it exactly.

A second transmitting station (5RD), the exact position of which was known to all, was used as a reference or check station. This proved of the greatest value, as it was quickly discovered that errors due to local conditions were by no means constant even in a small area. By means of this station, not only was it possible to check the apparatus in use, but the errors just mentioned could be compensated. The use of such a station seems

to be of the highest importance in this type of work. The groups were located in an area about twelve miles away from the mobile and hidden transmitting station.

It is interesting to note that the equipment of the transmitting station was essentially mobile. An ML rotary transformer, type L.E.H., supplied the necessary high tension, the power developed being about 8 watts, and the various groups reported excellent signal strength.

Mansfield Rotary Club

A week or two ago I made a journey to Mansfield, Notts, and spent a most enjoyable day. First of all I gave an address on television to the Mansfield Rotary Club. After explaining the principles of transmission and reception, I suggested about a dozen applications of television to home and business life. The ensuing discussion was most illuminating, and proved that the Midlands are fully alive to the vast potentialities of the wonderful science to which this journal is devoted.

After this, Mr. A. H. Whiteley, the genial and popular managing director of Whiteley Electrical Radio Co., Ltd., took me round his works. I was amazed to find how this firm had grown as a result of its policy in giving the public a "sound" deal (need I mention that their speciality is loud speakers?). In any case, they are planning to move to larger premises within the next month. I was privileged to hear the new "hush-hush" speaker, which will be ready in time for the Radio Exhibition, and I was delighted with its performance, a conclusion which readers can substantiate for themselves when they visit the Show.

A New Photo-electric Cell

The value of photo-electric cells is not confined to television, and development in this work is most important and full of possibilities. I was therefore interested to see that the Westinghouse Company have now put a special type on the market. I saw the first model early in the year, but refrained from talking about it, as supplies were then not available.

The cell consists simply of a disc of copper oxidised on one side by a special treatment to cuprous oxide. When light radiations impinge on the oxide surface, photo-electrons are liberated from within the body of the oxide and move towards the copper. Thus, if an electrical circuit is made by contacts on the copper and oxide faces, on illumination a current flows round the circuit from the oxide to the copper. The direction of the current within the cell is, of course, in the reverse direction

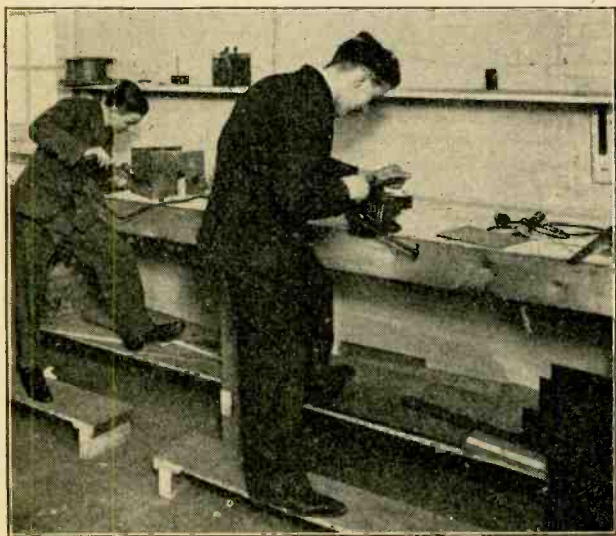

Television constructors will be interested in a recipe for cold solder, which is given on page 230.

to that of the electron flow. It is claimed by the makers that the current so generated is relatively large, and can be measured on a galvanometer or micro-ammeter even with small illuminations.

Amplification

To give the maximum power output for a given illumination, the circuit must be arranged so that the external resistance is equal to the internal resistance of the cell. This latter resistance may be taken as 1,800 ohms, but naturally varies slightly with individual cells. The current generated by the cell through a fixed resistance is directly proportional to the quantity of light radiation falling upon it, provided that the quality of the light remains the same.

The output of the cell can be easily amplified by making use of the following property. When a current is passed through the cell from an external source in the same direction as the generated photocurrent—that is to say, when the positive terminal of the external battery is connected to the negative terminal of the cell—then, on illumination, the resistance of the cell decreases and more current passes. Then the change in current for a given quantity of light is very much greater than the normal generated current, and when translated into a change of voltage drop across a high resistance (say 10,000 ohms) in series with the cell and battery, is easily amplified by means of valves.

The makers state that the current passed through the cell should not exceed 4 or 5 milliamperes.

A Vexing Question

The London Electric Wire Co., manufacturers of "Lewcos" radio products, have for some time past taken a serious view of conditions existing in the wireless trade to-day. They assert that the cutting of legitimate retail prices can ultimately have only one effect—that of a general lowering of quality and a growing paucity of dealer-service to the buying public. This company therefore resolved on a bold policy. They have decided to limit strictly the number of manufacturers and wholesalers with whom they will do business, and will refuse quite definitely to have any dealings with firms suspected of, or known to be, price-cutting. These efforts will naturally receive the strongest support from the Radio Manufacturers' Association and other trade organisations which are fully in accord with their ideals.

Behind the Scenes

The successful televising of the Derby and its projection on a large screen at the Metropole Cinema, Victoria, received so much publicity in the Press, that it rather pushed into the background the daily transmissions of television which were effected between the Baird studios at Long Acre and the cinema. Actually, these played an important part in the whole week's work, and as it was part of my duties to be "behind the scenes"

I am sure readers would like to hear a little more of what happened. The television interlude had, of course, to work to a definite time schedule in order to fit in with the normal picture performance, and a few minutes before the "tabs" were due to be drawn the cinema organist played popular music. As the transmitters had been set running in the Baird studios just previously, the engineers behind the stage switched on the amplifiers, struck the arc, set the motor running which revolved the mirror drum, and projected the flying spot of light on to the screen.

The announcer took his place before the transmitter, and in this way acted as a subject for framing and phasing the image; that is, getting everything into perfect synchronism at the receiving end. The microphone circuit was then tested, and those persons present in the studio were told to watch for the red light to appear, when absolute silence had to be observed except by the individual who was being televised.

Two Transmitters

Two transmitters were in use, the familiar spotlight disc one being used for close-ups and some semi-extended scenes, and the newer mirror-drum one for the remainder of the semi-extended subjects and for all the extended scenes. Change over from one to the other was reduced to the mere turning of two knobs on the control panels.

After the announcer had explained from the stage what was represented by this demonstration of television, the curtains parted and the image of Mr. Bridgewater, the announcer in the Baird studios, appeared on the screen. He in turn made a short introductory speech, but before concluding was interrupted by a telephone call from the stage, in order to prove that the performance was a genuine portrayal of television. At the suggestion of the manager, members of the audience made requests which were passed on to Mr. Bridgewater, who carried them out in a genial fashion. Only on one occasion was he really perturbed, and that was when he was asked to black his face. Unfortunately for him, an artist in the studio had a tube of black paint in her bag, and amid laughter from the audience he proceeded to smear over his face a liberal quantity of the paint which was squeezed into his hand.

Set Testing

To a designer and service engineer the question of testing radio sets looms large on the horizon; in fact, to anyone who has the welfare of his home receiver at heart, fault finding and testing is of extreme importance. I was therefore glad to see that the new edition of *Testing Radio Sets* (published by Chapman & Hall) has been extended and revised to bring it into line with modern knowledge and practice. It contains a considerable amount of practical data, and will form a very useful addition to the library of any wireless and television enthusiast.

The New "Televisor"

FURTHER details are now available of the new Baird "Televisor," which was briefly described in TELEVISION last month.

The scheme of this ingenious apparatus is shown in the accompanying diagram. The beam of light from a metal-filament projection lamp (located at the back of the instrument and on the base) is passed through a lens and then concentrated on a pair of nicol prisms, between which is placed a Baird grid cell. This is one of the most important parts of the instrument.

A New Grid Cell

As is well known, a beam of light consists of vibrations in two directions at right angles to one another. The action of a nicol prism is to extinguish the vibrations in one direction, or, in other words, to plane polarise it. If no cell was interposed and the second nicol prism was arranged to polarise the light in the opposite plane, the net result would be that no light would get through the combination.

The new Baird grid cell, consisting principally of small condenser plates immersed in a liquid called nitro-benzine, has the effect of turning the plane of polarisation through an angle, with the result that the extinction of the light is not complete and a certain proportion of the light from the lamp passes through the second nicol.

This particular cell has no inertia, and the amount of rotation of the plane of polarisation varies exactly with the strength of the signal applied to the plates of the grid cell. Furthermore, it has the enormous advantage that it will work at voltages such as are available in any good wireless set.

By applying the received television signals to this

cell, therefore, the amount of light passing out of the second nicol prism seen in the diagram is proportional to the magnitude of the signal strength, and in this way we secure a light variation which is proportional to the reflected light picked up at the transmitting end when exploring the subject.

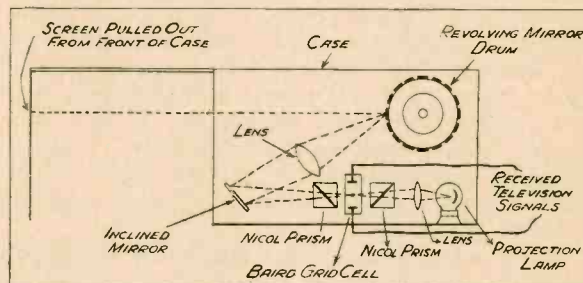

On passing from the nicol-prism grid-cell combination, the light reaches an inclined mirror, is then turned through an angle, and finally passes through another lens to be focused on to a revolving mirror drum.

The mirror drum merely replaces the light perforated disc employed in the simple models of television apparatus. The drum is made from aluminium and purposely lightened by having sections cut away, and 30 mirrors are positioned round the edge. Each mirror is inclined at a slightly different angle from its immediate neighbour, with the result that as the drum revolves the light projected on to each mirror is thrown as a spot on to any screen placed in its path, and this spot is made to move vertically from the bottom of the screen to the top. As each mirror takes charge of the spot of light, it is made to create a strip of light, these individual strips joining together to produce a total light area of approximately 9 in. high by 4 in. wide.

On the case of the new "Televisor" are two switches which control respectively the mains feed to the motor and the mains feed to the filament lamp, while a knob just above is linked to a rheostat for adjusting the motor speed.

When the motor is switched on, the drum is run up to its normal speed of 750 revolutions per minute, and since the familiar Baird automatic synchroniser is incorporated, this pulls the drum into step with the transmitter motor. For framing and phasing the image, a large knob is provided at the side of the instrument near the back. This rotates the carcass of the motor and will move the image up or down; by turning it through the requisite number of degrees, the image can be moved to right or to left according to the number of light strips that it may be out of phase. The resultant images are quite brilliant and are black and white.

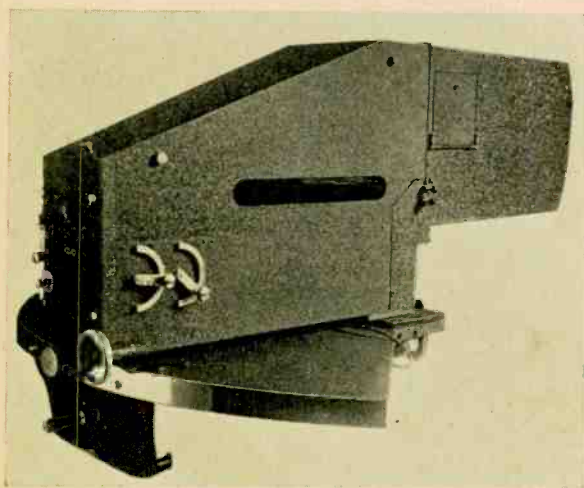

The new Baird television transmitter, which has been installed in Broadcasting House for the B.B.C. programmes beginning on August 22nd.

Letters to the Editor

TWO-WAY TELEVISION

To the Editor of TELEVISION

SIR,—I was interested to see your reference to the two-way television system of the American Telephone & Telegraph Co., as I had a first-hand experience of this apparatus in New York recently.

It is the longest wired-television system in the world, and my brother and I had a television talk across these wires. We were actually three miles apart, and yet we could see and talk to each other as easily as we could across a tea table. Later we compared notes and found that the details of our experience were exactly similar. This is what happened to me.

A chic young lady ushered me into a lovely oak-panelled room. It looked, with its gay cretonnes and bowls of fresh flowers, just like a drawing-room in Grosvenor Square. After a five-minute wait the young lady returned and escorted me to the television booth. It is a little larger than a telephone booth and contains a swivel chair and elaborate apparatus on the back wall. I am instructed not to talk longer than three minutes and not before I see a red light on the screen. The door is then shut and locked.

For a moment there is silence and darkness. Then, with a noise like whirring dynamos the red light appears. As the colour fades my brother's features are focused on the screen. The image flickers badly at first, but gradually clears. My brother smiles and greets me. His voice is clear and natural, but his words do not quite synchronise with the movements of his lips. He has deep shadows around his eyes and mouth. He makes the same observations at his end, and remarks with brotherly candour that I look "fifty years old."

Soon after this a voice interrupts our talk with "the time is now up. Please conclude your conversation." I watch my brother stand up and reach for his hat. Then the picture fades and the lights go on.

When I stepped out of the booth I found a guide waiting to take me through the research laboratories. He was very courteous and answered most of my questions, but was not revealing. We both knew that all the patents and valuable ideas lay behind doors marked "Strictly Private." I saw enough, however, to realise what infinite pains are being taken to make television as simple and effective as the telephone.

In a very real and personal sense, television should rob distance of some of its terror. The lover and his sweetheart, and mother and her child, the man and his business, all dislike the anxiety and uncertainty of separation. When, however, they are able to *see* as well as talk to each other, they should not fret about the miles that lie between them.

The international value of television should become equally great. Wireless, aviation, and the cinema have shrunk the world to a considerable degree. Television will reduce it still further, and may even accomplish what all the conferences in Europe have failed to accomplish, namely, the breakdown of national and racial barriers. If this be too much to hope for, then let us content ourselves that it is at least a step in the right direction.

Yours faithfully,

MARY NEWELL MARDEN.

43 BELSIZE AVENUE,
N.W.3.

"NEWS" BY TELEVISION

To the Editor of TELEVISION

SIR,—With reference to the article in your July issue headed "News by Television," we would like to point out that a similar device was in regular operation in connection with our broadcast programmes, and was described in TELEVISION for November 1930, under the heading "Studio Topics," a continuous message being broadcast by means of a tape pulled past the scanned area at a low speed, thus giving an effect at the receiver similar to the news bulletin electric signs which exist in London and elsewhere.

It might interest your readers to know that an apparatus of this type was built by us with a view to being used in Siam to transmit Siamese characters by telegraphy, and also as a form of television tape machine, ordinary printed tape being transmitted.

The apparatus gives a very rapid method of transmitting visual printed matter, but it is questionable whether it can compete with the ordinary tape machine, which is already developed to a high degree of efficiency, and gives a permanent record.

We may say that the apparatus is described in British Patent No. 324,029.

Yours faithfully,

BAIRD TELEVISION LIMITED,

R. E. LAYZELLE,

Acting Secretary.

133 LONG ACRE, W.C.2,
July 18th, 1932.

The Editor forwarded the above to the contributor of the article, Mr. H. M. Dowsett, M.I.E.E., F.Inst.P., who writes:

The Marconi Television "News" transmitter which I described in the July number is designed solely for the purpose of transmitting one particular type of picture, a long strip of transparent tape which fills the whole of the frame, and this is the central feature which controls the mechanical design

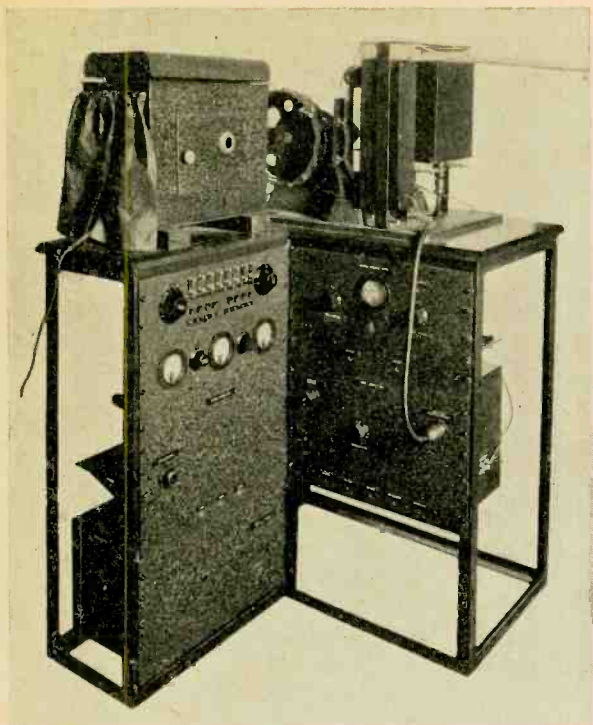

The latest model of the Marconi News Transmitter.

of the apparatus. The electrical design is based fundamentally on the frequency band available for the television transmission, and this determines the length of the frame for a given picture frequency and number of scan lines per picture. The object in view is to transmit the maximum amount of intelligence possible in a given picture area determined in this way, and this results in the use of straight-line scanning, preferably along the length of the picture.

Special apparatus of this kind, designed solely for the purpose of transmitting news, has many features which differ from apparatus used for "head-and-shoulders" pictures. This last-mentioned apparatus can, of course, be employed to transmit a scan of any suitable object, such as a succession of letters or a still picture, or even a cinematograph film, but where the sole requirement is the efficient transmission of news, no one would employ such apparatus, as the same frequency band which would be sufficient to enable a message to be transmitted and read at the receiver at a rate of 120 w.p.m. when employed with "head-and-shoulders" apparatus would only allow a few letters to be scanned at a time on the screen. This, in turn, would necessitate a low message speed for intelligibility, and, further, the curved scan lines of the disc transmitter mentioned in TELEVISION "Studio Topics" for November 1930 would introduce distortion of the type which it is preferable to avoid.

The above arguments apply equally to the new model, of which a photograph is enclosed. It differs from the apparatus described in the July TELEVISION by employing a lens drum and simplified

optical system in place of the aperture drum with separate projector lens. This increases the optical efficiency and allows the apparatus to be made up in a more compact form.

The Marconi apparatus described is covered by British Patent No. 373,288.

GRAMOPHONE RECORDING

To the Editor of TELEVISION

SIR,—A few months ago one of your readers asked whether anyone had succeeded in making gramophone records of television.

At present I am experimenting recording the Berlin (Königswusterhausen) cinema transmissions and have met with fair success. Among the reproductions are the following:

(1) The words *Pause* and *Ende* (reproduced from right to left and backwards).

(2) A blonde and brunette who are apparently laughing and talking.

(3) A man shaving.

I have not yet been able to record the London transmissions owing to their removing to Broadcasting House, but I expect good results, and would be delighted to loan or give any successful records to readers for experimental purposes.

Surely there is a future for this? We have the Blattnerphone-Still system for programme recording; why not for "bottled" television programmes?

Yours faithfully,

F. G. R. PALMER.

ST. THOMAS STREET,
SUNDERLAND.

ORIGIN OF THE WORD TELEVISION

To the Editor of TELEVISION

SIR,—Looking for a reference in back numbers of TELEVISION, I have just noticed a short note published on page 93 for May 1931, dealing with the origin of the word "Television." It is stated that, failing another claimant, the distinction of having coined the word *television* belongs to Dr. Alfred Gradenwitz, a well-known German technical writer, whose priority is stated by an article published in 1909.

The statement must be corrected, because, in fact, there is another claimant whose priority dates back as far as 1900; that is to say nine years before Dr. Gradenwitz's. This claimant is Mr. Constantin Perskyi, who presented at the Congrès International d'Electricité held in Paris from August 18th to 25th, 1900, a report on the researches and present status of television at that period. The word *television* is commonly employed in this report.

It is not only to correct an historical point that I am addressing you, but also for the opportunity of giving to those interested in television a biblio-

graphical reference that I think is not generally known even by television experts. Mr. Perskyi's report was published in the work entitled *Congrès International d'Electricité—Paris, 18-25. Août, 1900. Annexes publiés par les soins de M. H. Hospitalier* (Paris, Gauthier-Villars (Publishers), 1903). The author mentions the television apparatus invented by Nipkow, Kachmetiew, Szczepanik, Schöffler, and Poloumordvinow.

Very truly yours,

FEDERICO S. BASSOLI.

VIA CASTEL MARALDO 2,
MODENA, ITALY.

The Future of Radio Drama

BROADCASTING has developed a new technique in drama which is likely to be further affected by television. As a general rule, plays written for the stage are not satisfactory for the wireless, and in the absence of the visual element it has become necessary to write special plays for the broadcast programmes. This new technique is now highly developed, and although originated in order to compensate for the absence of sight, the wireless play has gradually become a distinct form of art which is highly interesting in itself.

The perfection of television will introduce a new factor in the matter. When it becomes possible to broadcast large scenes, the stage will once more rival the film in its influence, for thousands of people will be able to look-in to the best plays of the day, just as they now listen-in to the great orchestras and singers. Whether the present "radio drama" will still have a following will depend on the extent to which its individuality is preserved and developed. From an artistic standpoint, there need be no conflict between the radio and the television play, as some writers seem to imagine. Even the *Radio Times*, which recently discussed the problem in a leading article, to some extent confuses the issue in its anxiety to defend the present form of broadcast play.

"During the past ten years," this journal stated, "radio drama has become accustomed to 'blindness,' and is now on the way to creating a sound-play technique that is both original and stimulating. Once restore its sight and you are faced with a problem of another calibre, the presentation of a sound-and-sight drama that, for obvious reasons, must lack the authenticity of the stage and the mobility of the screen."

This statement is obviously true, but instead of making the simple point that "sightless" drama is a separate art, it implies that it is actually superior to the televised play. Naturally, this opinion did not pass unchallenged, and Mr. Dallas Bower, a leading sound-technician and author of radio plays, wrote to the *Radio Times* about it. He classed radio with the film as possessing "the great common factor

of physical freedom"; while the stage is cramped and confined by its three walls, radio and the cinema can rove far and wide, taking their audiences with them. "The fact of the matter is," he concluded, "that television, as an exclusive art, will possess the same basic constituents as the cinema. I think its use, when it is technically perfected, will, apart from the broadcasting of news and topical events, be mainly seen in the 'transport' of sound films to cinema halls, and, eventually perhaps, to the home."

In reply the *Radio Times* pointed out that, while Mr. Bower may have prophesied accurately the future of television as a vehicle of drama, he had completely missed the point of the argument. The reply continued:

"When we referred to 'a drama that must lack the authenticity of the stage and the mobility of the screen' we were envisaging the employment of television, not as the medium for transmitting film-plays, but as the medium for transmitting a television drama produced in its own studios and using the facilities of sound-and-sight at first hand. In this event, the broadcast play, on the visual side at least, would be almost as limited as the stage play, for the studio, or studios, would become virtually a theatre in which the physical action involved must be confined to the amount of scenery which can be set up at any one time. This limitation on the visual side would also, to a large extent, immobilise the aural side of the production. The sound-play of the present day is happily free from such limitations.

Magical Quality

"Television, when it comes to perfection, will be a novelty of magical quality. As such it will attract wide interest, particularly among that section of the radio audience which has found imaginative difficulty in listening to plays of sound alone, and which will therefore insist upon its use in the broadcasting of drama. Our point here, like the point of the statement to which Mr. Bower took exception, is not so much that television will inevitably destroy radio drama as a medium of scope and interest (it may even be that ingenious minds will devise means whereby the discreet and partial use of vision will *enhance* the appeal of the broadcast play), but that the introduction of the visual element will not, as those who decry 'blind' drama to suggest, either immediately or necessarily add to the attractions of listening to a play transmitted by wireless."

It may be some while before television is able to transmit a full-sized stage, but when that becomes possible the interest in the "legitimate drama" will certainly be increased. The public must hope that the B.B.C., in preserving the present form of broadcast drama, will not allow it to hinder the even newer development of the televised play.

Certainly the facilities available at Broadcasting House should help the development of radio drama. The television broadcasts will be transmitted under ideal conditions, and it is likely that many subjects hitherto regarded as too ambitious for television will be included in the new programmes.

Points from the Press

"A Real Advance"

TELEVISION continues to attract wide public interest, and further comments have appeared in the newspapers during the past few weeks. Some writers take a cautious view of the future, others look forward to big developments in television.

This division of opinion is referred to by the *Newcastle Evening Chronicle* in connection with the B.B.C. television broadcasts. "It will be interesting to watch the reaction of the small but influential section of the wireless Press, which has persistently belittled British television, to the new era which begins next week. Up to the present television critics have been divided into two schools—those who claim that Mr. Baird and his engineers have made astonishing progress, and those who have persisted in speaking of television as being very unsatisfactory and still in its infancy. When the Derby was televised recently we gave examples of these two schools, both of whom saw the same demonstration and differed violently not on theories but on eye evidence."

"For the first time the images have real entertainment value," states Mr. Alan Hunter in the *Liverpool Echo*, referring to the new "Televisor" described in the July issue of TELEVISION. When you see a face on the screen you can instantly recognise who is at the other end. When a cartoonist gets busy you can laugh at his sketches because the outlines are clearly visible on the screen. I saw a very similar sort of Baird machine demonstrated some weeks ago on the roof of a well-known store in Oxford Street, London. Then the images were sent over a special 6-metre transmitter erected at Long Acre, a mile or so away.

Any Day Now

"The combined effect of these two recent demonstrations, the first to show the practicability of ultra short waves for television images and the second to show off the improved Televisor, is to lead one to conclude that television has now reached a stage when big things may happen any day.

"Almost insuperable technical troubles appear to have been overcome to produce the present encouraging results, although as a matter of fact the several features of the new Baird television system have been known for years. The old scanning discs have been replaced by mirror drums. The neon lamp has given way to a modulated bunched filament light source—hence the black-and-white effect. In a word, the Baird people are now making use of all the best features of the television systems of the world.

"An experimental 6-metre transmitter is testing out the possibilities of short-wave television at Long

Acre, the Baird laboratories. And not far away the B.B.C. is testing its 7-metre transmitter on the top of Broadcasting House. Link up these facts with the successful demonstrations of the new Baird Televisor and you have a working hypothesis that television is getting nearer. . . .

"The immediate possibilities, as I see the situation, are considerably more exciting than they have ever been in the past. For, if the new Televisors are marketed at a reasonable price and listeners can be assured of an extensive service, there is going to be a rapid spread of the 'looking-in' habit."

The Other View

On the other hand, a delay of "a year or two at least," is anticipated by "Tuner" in the *Yorkshire Observer*, who discusses the progress of television since he saw a first demonstration some years ago. His remarks seem to suggest that he has not personally seen the latest apparatus, but in any case "Tuner" looks forward to television screens at least 1 ft. square in size.

"We are all eagerly awaiting its coming; we are longing for the day when, in the comfort of our own homes, we shall be able to see and hear the artists who perform for us. But don't let enthusiasm run away with us. Despite the time which the B.B.C. is proposing to devote to it, despite the years of labour which have been spent upon it, television to-day has not yet definitely reached the stage of being of entertainment value. It is still merely a novelty, and rather an expensive one at that."

Referring to the latest demonstration, "Tuner" continues: "The progress made was demonstrated in London last week, when images were reproduced on a screen measuring 4 in. by 9 in. The early demonstration showed the image in black and orange, but the latest revealed that black-and-white images are now possible. The results were fairly stable and could be seen comfortably by a room full of people.

"That, I believe, is the extent of the progress made in this country as revealed by official reports. I have reason to believe that experiments made by the Marconi people have met with even greater success, but the trouble is in making the models at such a price as to make them worth while.

"In Germany and America equally rapid strides have been made following absolutely independent lines of thought. In America images have been projected on to a screen 6 ft. square, while in Germany more attention has been paid to detail and the reproduction of better images.

"Thus, despite all this progress—very commendable progress—I still maintain that television has not yet reached the entertainment stage, nor is it likely

to do so for a year or two at least. When that time arrives we should have a screen measuring at least 1 ft. square, on to which an image is thrown as good as we are accustomed to seeing at the cinema."

The B.B.C.

"This time I think there has been a real advance," states *Amateur Wireless*. "For one thing, the picture is much bigger. More important, the tone is very much better, the images being in black and white.

"Added to the success of this demonstration is the increased activity on the part of the B.B.C. It is significant of the new importance that is being attached to television at Portland Place that television broadcasts are shortly to be given four evenings a week. What is not so generally understood is that these broadcasts are being conducted entirely by the B.B.C. engineers. Correctly described, these should be called B.B.C. television broadcasts—by the Baird process. This procedure is not a mere quibble, for it means that the B.B.C. is open to try, if not immediately to broadcast, any other system of television that may happen along.

"Some sort of guarantee to purchasers of the Baird apparatus is obviously only fair, and the B.B.C. has made quite a long-term promise to stand by the Baird system of television transmission. No one can pretend that the present owners of Baird Televisors enjoy anything like a television service, so that if at some future time a really foolproof television system were developed and made commercially practicable, it is not likely that existing apparatus would get a great deal of consideration.

"Meanwhile the main hope of television seems to rest in short-wave transmission around the 7-metre band. The 1½-kW transmitter is now testing on top of Broadcasting House, and there is no knowing when the B.B.C. may attempt to broadcast its television on 7 metres. Real success in this direction would mean a considerable speeding up of a nationwide participation in television, because the cost and maintenance of these ultra-short wave stations is quite small. Moreover, the service area of each such station is limited to about twelve miles, so there would be no interference."

Towards Perfection

"There is certain to be a steady increase in the perfection and in the practical application of television. Many avenues of progress will be opened up within the coming twelve months," states the *North Western Daily Mail*.

"Educational, commercial, and entertainment uses of television are already being planned.

"The cost of equipment and apparatus presents the principal obstacle in the way of progress, but this will be overcome in the same way as it has been in the radio business. In the meantime we should study the theory and practice of television

which offers infinite scope for anyone with a scientific turn of mind.

"First, I believe, it is essential to develop the correct mental attitude towards 'seeing in.' Radio broadcasting, in its early days, seemed incredible to imaginative people. We are no longer awed by listening-in, but none can fail to be deeply impressed by television even in this sophisticated age. And the more profound our first impressions, the greater will be our interest and enthusiasm for this new science. The person who just accepts television as a new mechanical device cannot hope to assist in using it intelligently and usefully."

"Television Boom Soon"

With this heading the *North Mail*, Newcastle, prints an interview with Mr. Thomas Payne, the first director of the Newcastle B.B.C. station and a keen television experimenter. "With regular transmissions from the B.B.C. headquarters for the next two years, there will be a great incentive to the wireless enthusiast to experiment with television just as he did in the early days of sound broadcasting. The men who built their own sets and were constantly improving on them are the men who will make their own Televisors for a mere £2 or £3, whereas if they buy Televisors, the cost will be about £30. Given a good receiver of, say, four valves, and a 220-volt electric supply, there is nothing to stop them.

"In the past experimenters have not been encouraged, because television transmissions were during the day and not at fixed times. Big strides have been made in the Baird process, so that the old country is leading the world. It is possible now to receive a black-and-white picture in the light to a size of 9 in. by 4 in.

Many Inquiries

"Within recent months Tyneside wireless dealers have received hundreds of inquiries from radio enthusiasts on the possibility of television reception in their homes. They have had to be advised of the difficulties consequent on the unfixed times for transmissions and have been content to wait until the B.B.C. could announce a definite programme of transmissions. Now," said Mr. Payne, "it is coming, and within a few months you will see a wonderful interest manifested in television. Experiments are taking place at the North Regional Station at Moorside Edge with a view to relaying the television transmissions, and if they succeed, there will be further encouragement to 'lookers-in' in the north-East."

This view is supported by the *Daily Dispatch*, Manchester. "The small but keen band of Northern television enthusiasts are awaiting with interest the new series of sight-and-sound programmes which are expected to begin next week. . . . Now that the B.B.C. are to sponsor television, it is anticipated that thousands of English homes in the near future will be equipped with televisors."



The Enthusiast Sees it Through

THE real enthusiast is always with us, at least that is our conclusion from the correspondence that reaches the Editor every month. We are naturally delighted to hear from previous contributors to these columns, and trust that others who have not written to us for some time will take this hint. In addition, as many new readers will be making a start with television reception, now that the B.B.C. are to broadcast vision signals in the evenings, may we take this opportunity of extending to them an invitation to write and tell us their experiences. Share with your fellow readers the "ups and downs" you encounter, and you will encourage others to further effort!

An Invitation

We may perhaps repeat what we said a few months ago on the birthday of TELEVISION. This magazine is now in its fifth year and is still able to report the progress of those readers who are interested in the constructional side of television. This is indeed a triumph, and it is to be hoped that for many years to come we shall still be able to boast of their support.

One of the most useful ways in which readers can assist other television workers is by their continued interest in this Enthusiast series. It is impossible for us to hear too often from amateur constructors. A monthly contribution would be acceptable should the writer have anything new to report in so short a time. Occasionally we have had to write to old enthusiasts to discover what they are doing, and we usually receive valuable material in reply. Don't wait until you are asked! Write when the spirit moves you, and make full use of the space which is always open to you!

News from Cambridge

Mr. J. Forster Cooper, of Toll Bar, Barton Road, Cambridge, is one of our old stalwarts, and his work in building vision apparatus to receive both the English and German transmissions shows that he is still as keen as ever.

"As can be seen from the photographs," he writes, "my new apparatus is of the same shape as that manufactured commercially. It differs, however, from the Baird 'Televisor,' in the possession of a sound receiving set, of provision for the reception of German transmissions, and of a loud speaker.

"The first photograph shows the front view of the apparatus and the various controls. These are: tuning and reaction for the set; two switches for the neons; motor switch and speed resistances; racking knob; meter; fuse and the two viewing

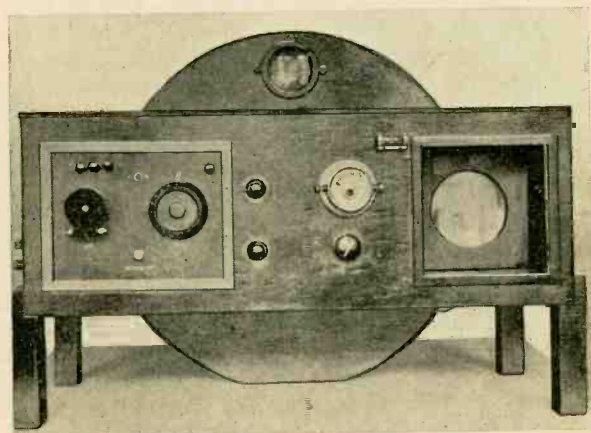

Front view of Mr. Forster Cooper's vision receiver.

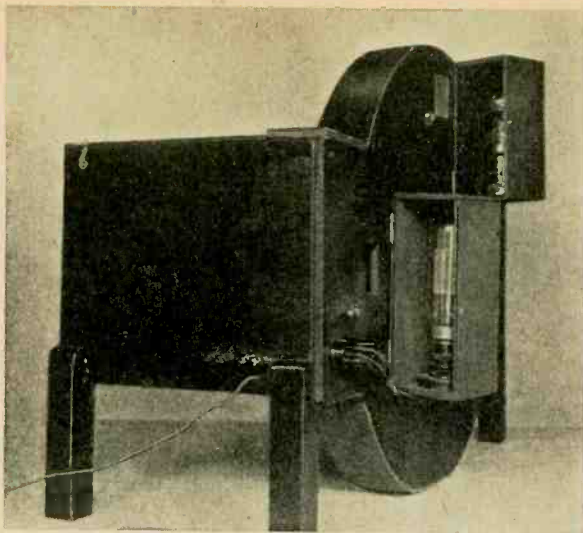

Back view of the apparatus; the two neons in their boxes have been swung back for inspection.

tunnels. The back of the machine may be seen clearly in the second photograph. The two neons in their boxes have been swung back for inspection. For vertically scanned transmissions I use a Baird neon, while for the others a standard beehive lamp behind ground-glass is quite satisfactory. The third photograph is a view of the inside.

"In order to make the transmissions seem more realistic, I am using the viewing tunnel as the loud-speaker baffle. This makes the sound appear to come from the image, as in the cinema, and the result, in my opinion, is much better than with a separate loud speaker.

"I am using a Baird disc and synchronising coils. In order to cut out motor interference, which affected the sound much more than the vision, I have connected two 2-mfd. fixed condensers across the motor brushes, and taken their centre point to the motor carcass. This has improved matters considerably, in spite of the fact that I am still worried with a miserable 90-cycle supply. This is to be changed soon, and will, I hope, permit me to obtain better results and a steadier image.

"It must be noted that if German transmissions are to be received correctly, the disc must be reversed, because the Germans scan in a clockwise direction. This means that if the neon and lens be mounted at the top, the pictures will be the right way up, but reversed. This last, however, does not matter much. The set used for sound is a small 2-valve detector and L.F. power battery-operated receiver, which is coupled straight to the viewing tunnel and loud speaker.

"I am looking forward to the new series of transmissions from Broadcasting House, but I wish that some other wavelength was available for vision. Even in Cambridge, only fifty-eight miles from Brookman's Park, the difference between London National and London Regional is very noticeable at times." Mr. Forster Cooper concludes by giving a recipe for cold solder, which he thinks will in-

terest other readers of TELEVISION. "All that is required is to mix aluminium powder, amyl acetate, and acetone into a thick paste. This may be applied to any wiring connections simply with the fingers, and sets hard in about five minutes. No heat or soldering iron is required."

Watching the Derby

Another earlier contributor to this Enthusiast series, Mr. N. M. Button, of 9 Richmond Avenue, Breaston, nr. Derby, has made many improvements to his apparatus since he wrote to us last year. With the wireless receiver and home-made vision apparatus now in use, he experienced a real Derby "thrill" by watching the race at home instead of mingling with the crowds at Epsom. Hearty congratulations, Mr. Button, and more power to your arm in the coming months! In the course of two letters he says:

"It was in the November 1931 issue that you published photographs of my first television receiver, and since that time I have been making steady headway. I am now sending you a photograph of my new apparatus.

"After trying several old D.C. motors on the 250-volts A.C. mains without any success, a Baird universal motor together with the necessary resistances was finally decided upon. As can be seen from the photograph, the complete set is built on similar lines to the Baird model. The outside casing is made of oak-faced plywood, with a metal well cover to protect the scanning disc.

"A plywood cradle holds the motor, a Meccano cogwheel and spindle are used for rotating the motor, and coils are used for the usual framing device. At first terrible interference was given from the motor, and earthing the centre point of two 2-mfd. condensers added more interference. After earthing the centre point to the motor carcass, the trouble was almost eliminated.

"The neon is a Philips double-spiral type (with resistance removed), which gives a uniformly illuminated surface over the whole of the lens. The voltage from the 250-volts Heayberd eliminator is dropped by a 5,500-ohms heavy-duty resistance to the neon. This lights the neon to its correct brilliancy, and it is then modulated by the output signal pulses in the orthodox manner. I can now

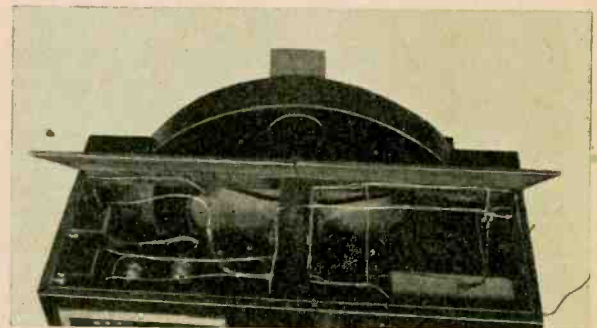

Interior view of Mr. Cooper's receiver.

guarantee a correctly shaded picture with every detail showing.

“Although the London National transmitter is not received here half so well as the London Regional, the broadcast on Derby day was received with success! The parade of the horses was clearly seen, and although it was impossible to distinguish individually one horse from another, the whole experiment provided a thrilling half-hour.”

In his second letter Mr. Button explains that he has made a few alterations to the receiver, and replaced the neon with one of the Baird flat-plate type, with which he hopes to obtain even better results when the regular transmissions begin. “My last neon has worked wonderfully well, but to pass sufficient current through in order to hold the picture, there was a tendency to make the neon too bright and lose all detail. As already explained, my receiver has four valves, which are battery fed and take about 26 to 30 milliamperes; the set and neon can therefore be worked off one eliminator. When worked in this manner the neon has to be fed

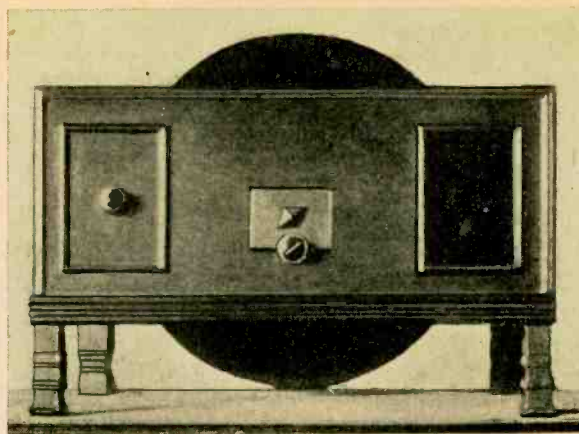

Vision receiver constructed by Mr. N. M. Button.

whenever the receiver is in use, in order to keep the voltage of the eliminator from rising.” Details of the receiver are shown in the diagram.

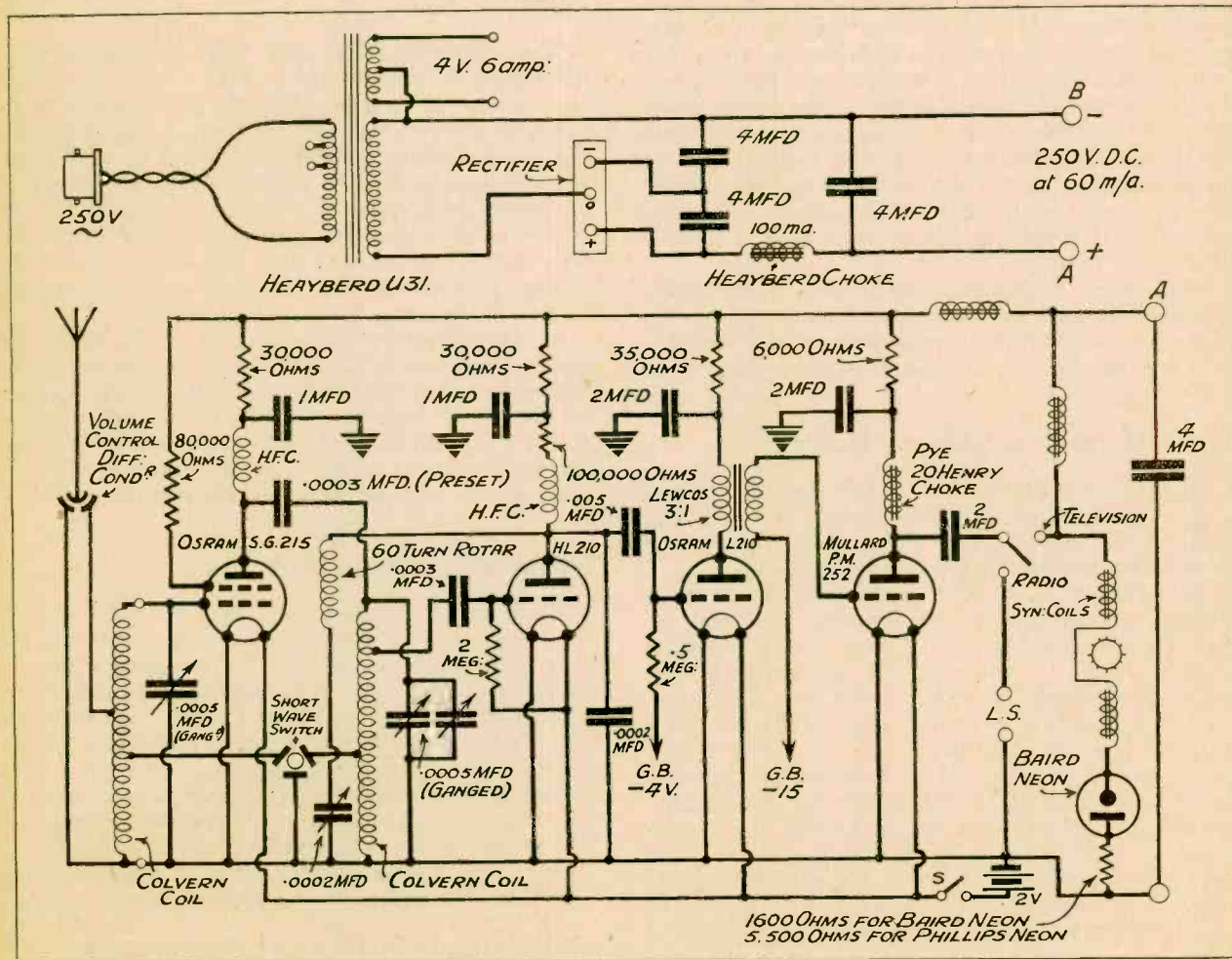

Circuit diagram giving details of Mr. Button's home-made receiver.

Apparatus Tested

The Technical Editor of TELEVISION will be pleased to receive apparatus, components, etc., from manufacturers for test and, if found suitable, for review in these columns.

New Lewcos Potentiometer

A potentiometer is an indispensable component with modern set design, but unfortunately many of these products fail to perform their normal function satisfactorily, the principal objections being that they are both erratic and noisy in operation.

The new Lewcos model, however, has undoubtedly been carefully designed, and is obtainable in the following values—1,000, 5,000, 10,000, 25,000 and 50,000 ohms. Its construction is certainly very novel. First of all the wire-wound resistance is held in a cylindrical moulding, and this with the contact are completely dustproof, since they are enclosed in a non-inflammable transparent cover.

The usual rubbing-arm contact, unless special precautions are taken, is prone to be "noisy" in use, so Lewcos make their contact with the resistance strip by means of an eccentric rotating plate. The spindle terminates in a small brass collar with an eccentric hole. A small "axle" holding the plate engages in this hole at one end, and at the other is a metal cross strip. Pressure is applied by a double-leaf spring, and rotation of the knob causes the plate to make pressure contact at different sections of the winding. With this method there is no friction on the wires and hence no wear, while the component is quite silent in operation, as we proved to our satisfaction in tests with a sample model.

The rated resistance value was substantially correct, and we unhesitatingly recommend this very neat and workmanlike component to our readers. It is well finished, and is sold at the low price of 3s.

D.C. Mains Variable- μ Valve

THE new Osram V.DS valve—a variable- μ type for use with D.C. mains—is fitted with the standard type of 0.25-amp. 16-volt filament heater and indirectly heated cathode.

In common with those valves employed with alternating current, the characteristic has been designed to give a linear control of volume by variation of grid bias. In addition, the maximum mutual conductance at minimum bias is of a very high order, leading to sensitive reception where it is necessary to use only a single stage of H.F. or L.F. Where two or more stages of H.F. amplification are employed, any tendency to instability due to the high mutual conductance can be checked in the "variable- μ " type of valve by the simple method of an increase in the fixed portion of the grid-bias resistance. The value of this fixed portion of resistance will limit the maximum conductance to any desired value.

This valve is designed with a maximum mutual

conductance of 2.4 milliamperes per volt, and a grid bias of approximately 40 volts; that is to say by an increase in grid bias to 40 volts the mutual conductance can be reduced to approximately 0.005 mA/volt, thus giving ample range of volume control. According to the makers' figures, the rated characteristics are as follows:

Filament Voltage	16
Filament Current	0.25 amp.
Anode Volts	200 max.
Screen Volts	80 max.
Mutual Conductance	2.4 mA/volt
(measured at $E_a=200$, $E_{sg}=80$, $E_g=0.5$)	
Mutual Conductance	1.1 mA/volt
(measured at $E_{sg}=80$, $E_g=5$, or $E_{sg}=50$, $E_g=2$)	
Mutual Conductance	0.005 mA/volt app.
(measured at $E_g=40$)	
Anode-grid inter-electrode capacity	0.0025 m.mfd.
Fixed portion of grid-bias resistance	100 ohms approx.*

In a sample we tested the figures given were found to be substantially correct, and readers who have a direct-current mains supply in their home are strongly recommended to use this valve when considering the question of H.F. amplification and smooth volume control. The price is 19s.

New Kit Sets

The popularity of kit sets remains unabated, and the reason is very simple. The home constructor finds a real joy in assembling the parts which go to make up a receiving set. He finds it instructive so far as elementary wireless technique is concerned. He learns to know just what is in his set, what relationship each component bears to others, and in the event of a fault at any time in the future he feels competent to go over his set to make the necessary adjustments or replacements without the fear of doing some irreparable damage.

It was therefore interesting to have details of two new kit sets which are being marketed for the coming season. Reference is made to the Cossor All-Electric "Melody Maker," Model 337, retailed at £11 15s., and to the G.E.C. Thirty-three "Music Magnet," retailed at £9 9s., According to advance information, both sets seem excellent propositions.

Celestion Loud Speakers

Although it has not yet been possible to test samples of the new season's Celestion products, we have been privileged to hear the complete range of these in operation at the company's works. Undoubtedly the new models are in the highest class for lifelike tone, sensitivity and ability to handle powers more than adequate for normal use. The special Hyflex diaphragm is partly responsible for this, coupled with new forms of permanent magnets. The midget with the loud voice is the PPM Soundex, sold at 27s. 6d. in chassis form or 50s. complete in cabinet. Complete test reports will be given later.

* Depending on screen volts. The value of the fixed portion of bias resistance will restrict maximum mutual conductance to any desired value.

A Selection of

**WIRELESS, TELEPHONY &
ELECTRICAL ENGINEERING
BOOKS**

RADIO ENGINEERING

J. H. REYNER, B.Sc., A.C.G.I.

VOL. III. of the ELECTRICAL ENGINEERS' DATA BOOKS, prepared under the editorship of E. B. WEDMORE, M.I.E.E., Director of the British Electrical and Allied Industries Research Association.

484 pages, 314 illustrations, 111 tables. Net 7s.

PRACTICAL TELEVISION

E. T. LARNER.

In this book the early history and development of the attempts to transmit sight by radio are collected and discussed, with descriptions of all the principal apparatus. Mr. J. L. Baird has written a foreword to the book.

Demy 8vo. Fully illustrated. Net 10s. 6d.

A complete Catalogue will be sent upon application to:

ERNEST BENN LIMITED

Bouverie House, Fleet St., London, E.C.4

MISCELLANEOUS ANNOUNCEMENTS

Readers wishing to sell secondhand apparatus and components, books, etc., are invited to make use of this advertisement section at the rate of 3d. per word (minimum, 36 words).

RADIO Vision Receptors (Television). Parts for Experimenters supplied by **JOHN SALTER** (Established 1896), Experimental and Radio Engineer, 13 Featherstone Buildings, High Holborn, London, W.C.1. Telephone—Chancery 7408.

- LAYOUTS.
- ARRANGEMENTS.
- MODERN IDEAS.
- BLUE PRINTS.
- ELECTRICAL DESIGNS.
- RADIO DIAGRAMS.
- TELEVISION INVENTIONS.

**D
R
A
W
I
N
G
S**

Lambert.
8, COUNTY ROAD,
THORNTON HEATH,
SURREY.

PHONE
HOLBORN
8638

**DOSSSET
STUDIO**

TECHNICAL DRAWINGS/
RADIO DIAGRAMS/
MODERN IDEAS/
ILLUSTRATIONS/

HAZLITT H^E SOUTHAMPTON B^LDG^S
CHANCERY LANE LONDON W.C. 2

L. LEAMAN

97, NORTHFIELD AVENUE
WEST EALING, LONDON, W.13

For Radio and Television

DEMONSTRATIONS DURING TELEVISION TRANSMISSIONS

Baird Components Supplied

PHONE: EALING 5394 (MEMBER, TELEVISION SOCIETY)

"TELEVISION"

COUPON

FOR FREE INQUIRY SERVICE

Name

Address

Enclose with this coupon a stamped addressed envelope.
Readers writing from abroad should use the Universal
Stamp Coupon, obtainable from most post offices.

August 1932

Smooth H.T. Supply is essential for TELEVISION !

The high efficiency and dependability of "M-L" Power Plant assures users of smooth H.T. from any convenient current supply.

"M-L" Power Plant is extensively used by the Baird Television Co. Ltd.

Write now for an interesting Technical Booklet.

ROTAX LTD., RADIO DEPT. 13, WILLESDEN, N.W.10



**RADIO & TELEVISION
POWER PLANT**

Used and

Recommended by

Mr. H. J. BARTON-CHAPPLE, Wh. Sch., B.Sc. (Hons.)
(Technical Editor of "TELEVISION")

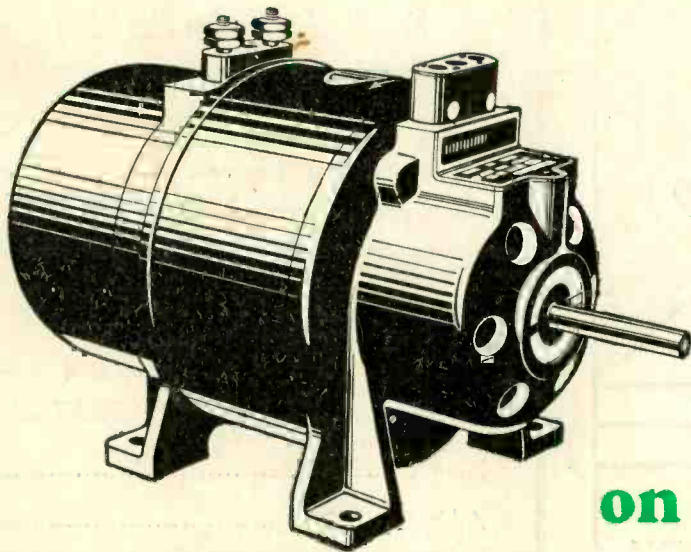

FOR

★ The Operation of an A.C. MAINS DRIVEN TELEVISOR from D.C. MAINS or an L.T. BATTERY.

OR

★ The supply of H.T. Current of 100, 150 or 200 m.a. at 400v., 500v. or 600v. D.C. . . . when your mains are D.C. or when you have no supply except a 12v. Accumulator.

**OLYMPIA
on STAND 246**

ADVT. OF ROTAX LTD.