

# TAPE

RECORDING MAGAZINE

MAY 1963

1/6



*FIRST AND FOREMOST IN THIS FIELD*

AUDIO FAIR  
SUPPLEMENT  
STAND-BY-STAND SURVEY

TELEFUNKEN have more than a quarter century research experience behind their name. Experience built into every machine. Select the recording that suits your requirements—there are nine models all full of exclusive features and great TELEFUNKEN quality. It's fine on its own, or coupled with your Stereo or Hi-fi equipment, to produce an integrated recording system. You will find TELEFUNKEN has sound quality taped!



See us on  
**BOOTH No. 58**  
 Demonstration—Room 31  
 Office—Room 326  
 at the **AUDIO FAIR**

## CLEAR THE DECKS FOR TELEFUNKEN



### MAGNETOPHON 85 DE LUXE

New look, new magic-eye recording level indicator, new mixing facilities. Two speeds— $7\frac{1}{2}$  and  $3\frac{1}{2}$  ips. **83 GNS**

### MAGNETOPHON 96

Four-track plus full controls for trick recording, superimposing, intertrack transcription. **69 GNS**

### MAGNETOPHON 97 STEREO

Four-track recording and playback. Additional speaker in lid. **95 GNS**

### MAGNETOPHON 95

Twin-track. Three-speed. Easy operation. **59 GNS**

### MAGNETOPHON AUTOMATIC

Eliminates most controls to make this a truly automatic machine. **50 GNS**



### MAGNETOPHON 98 STEREO

Twin-track Stereo;  
 High-quality trick facilities.

**95 GNS**



### MAGNETOPHON 75K-15

6-hour playing time on  $5\frac{3}{4}$ " double-play tape.  
**50 GNS**

And now, for high performance, top fidelity recording

### TELEFUNKEN introduce MAGNETOPHON M26KL & MAGNETOPHON M24KL

These two machines bridge the gap between home and studio quality tape recorders. Extremely low wow and flutter on all speeds! The machines are identical in appearance, differing only in speeds. Separate record and playback amplifiers. **M26KL 246 GNS M24KL 209 GNS**

*All prices excluding microphone*



# TELEFUNKEN

WORLD'S FIRST TAPE RECORDER

Write now for full details and new TELEFUNKEN brochure to

**DEPT. T1 WELMEC CORPORATION LTD, 147/8 STRAND, LONDON WC2**

7011



The outstanding  
**NEW RESLO**  
**STUDIO**  
**MICROPHONE**  
type SR1

The new Reslo "Studio" professional ribbon microphone has been specially developed for studio use by broadcasting authorities and professional recording companies throughout the world and is manufactured to the highest possible standards.

The overall frequency response which covers a range of 30 c/s-20,000 c/s is outstandingly smooth and straight giving a very clean and natural quality of reproduction.

The Reslo SR1 is ideal for general studio musical use, due to excellent transient response and freedom from non-linear distortion. It is also ideal for orchestral recording.

Features of the design are the very low hum pick-up and the ability to alter the response characteristic for high quality speech announcing. Each microphone which is individually checked to within 2 dB of the publicised response curve, is supplied complete in a padded instrument case together with a set of mounting adaptors and 6yds. of screened cable.

*Send for literature and price list of the complete range of Reslo microphones and loudspeakers.*



RESLOSOUND LIMITED, 24, UPPER BROOK STREET, LONDON, W.1.

Telephone: HYDE PARK 2291/2/3

**THIS IS A REVOX . . . from above**

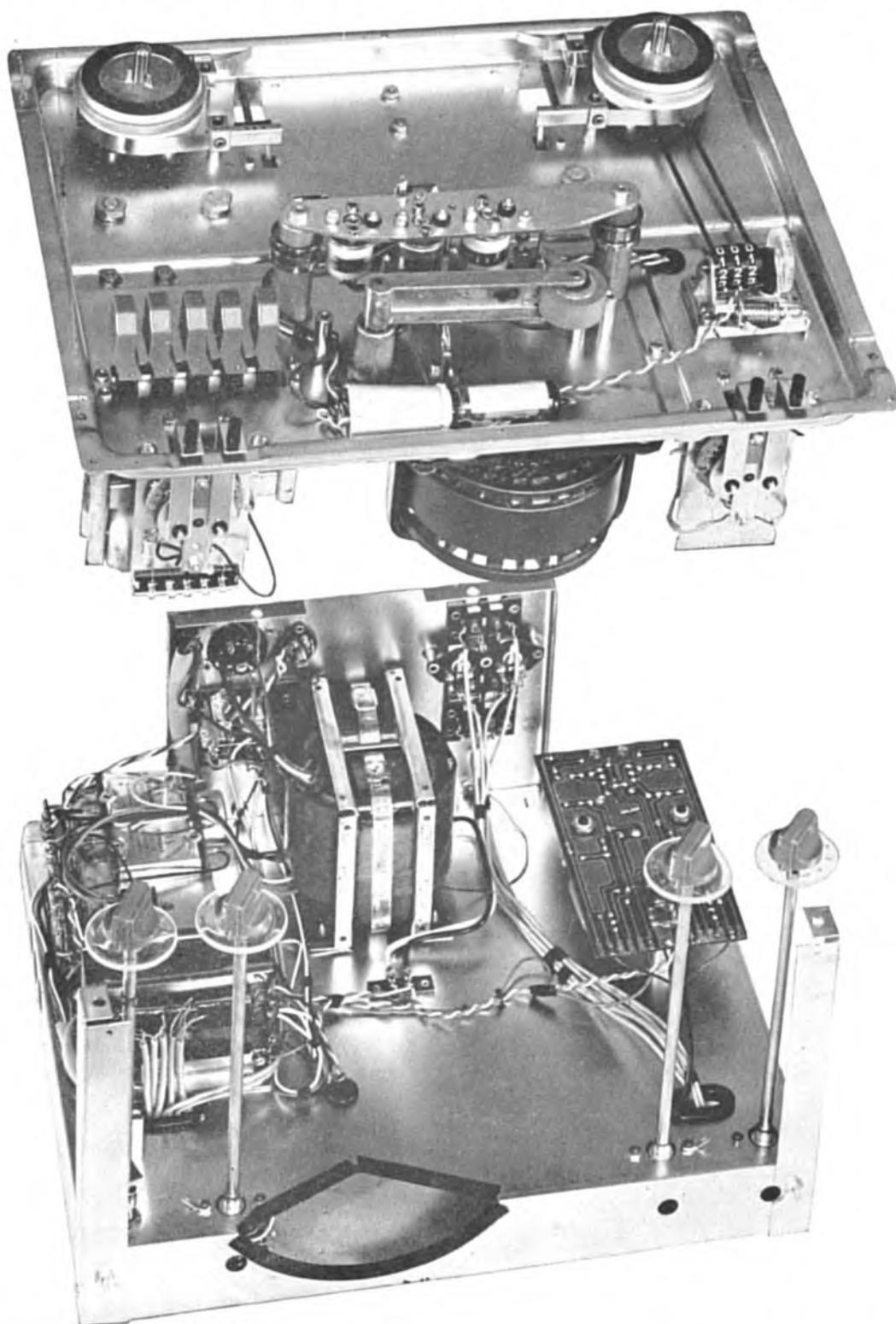

**REVOX - YOU CAN'T BUY**

# THIS IS A REVOX . . . from below

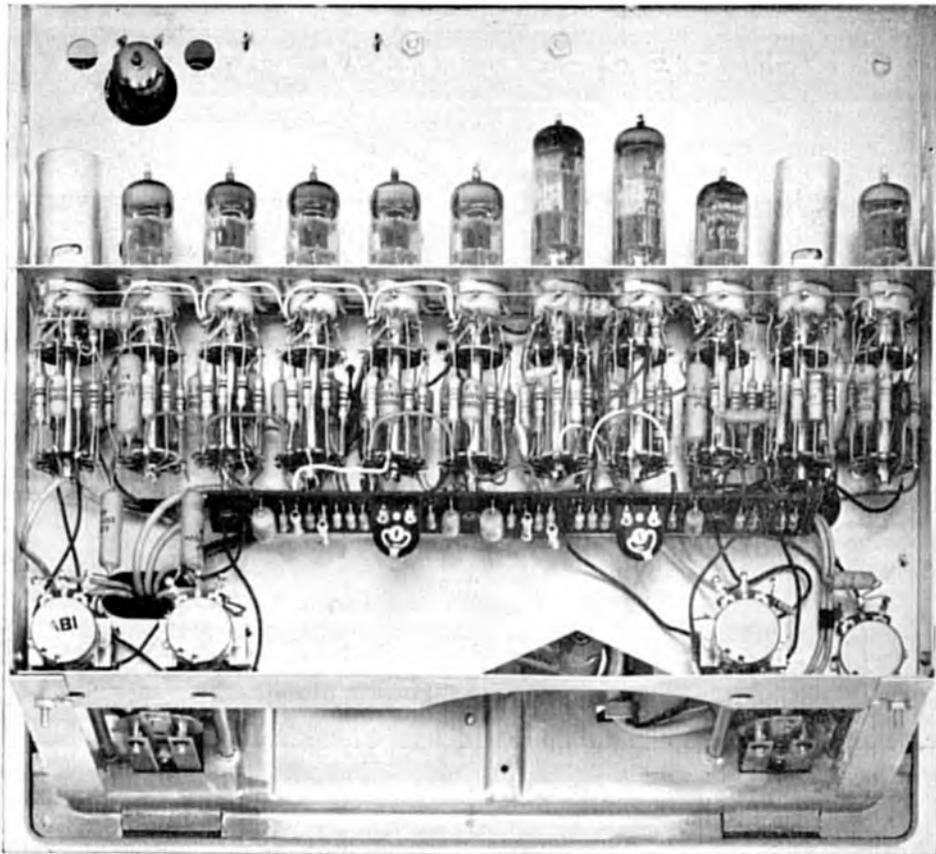

## and these are the facts and the figures

- ★ Three Papst. Motors.
- ★ Heavy flywheel balanced with capstan.
- ★ Direct motor to flywheel drive with anti-flutter transmission damping.
- ★ Spool carriers run on ball races.
- ★ Solenoid start permitting remote control.
- ★ End-of-tape-stop on all functions without foil.
- ★ High Speed wind, 2,400 ft. in 80 seconds.
- ★ No pressure pads or tensioning pins.
- ★ Mu-metal head case and face shield.
- ★ Separate records and playback heads and amplifiers.
- ★ DC heated first stages.
- ★ 6 watt push-pull monitor amplifier.
- ★ Twin channel magic eye.
- ★ 13 valves with 26 functions.
- ★ Wide mixing facilities.
- ★ Echo and multiplay facilities.

PRICE: 112 gns. in portable case.  
107 gns. Chassis only.  
VISIT US AT THE AUDIO FAIR  
Room No. 217 & Booth 62

## BETTER ONLY DEARER

### Specifications

Tape Speed:  $3\frac{3}{8}$  and  $7\frac{1}{2}$  ips. pole-switching capstan motor, direct drive (move may be switched off, if the recorder is used as an amplifier).

Flutter and wow: Below  $\pm 0.1\%$  at  $7\frac{1}{2}$  ips.

Max reel diameter: 25 cm (10in.), i.e., 3,300ft. long play tape.

Frequency response:  $40-15,000$  cycles at  $7\frac{1}{2}$  ips }  $+2/3 = db$   
 $40-12,000$  cycles at  $3\frac{3}{8}$  ips

Equalisation: In accordance with Din standards. 70 micro-seconds at  $7\frac{1}{2}$  ips. 140 micro-seconds at  $3\frac{3}{8}$  ips.

Signal to noise ratio: Better than 50 db at peak record level (Thd.=3%) (Thd.=total harmonic distortion).

Crosstalk: Mono 55 db, stereo 40 db.

Oscillator-bias frequency: 70,000 cycles, push-pull oscillator.

Inputs per channel: 1. Microphone,  $R_i=1$  Megohm, 3 mV.

2. Radio,  $R_i=1$  Megohm, 50 mV.

3. Diode,  $R_i=47$  K'Ohms 3-50 mV, adjustable.

Outputs: 2 cathode-follower outputs, impedance = 5,000 Ohms (input impedance of amplifier to be connected should be higher than 100,000 Ohms. Output voltage=0.7 Volts).

Power requirements: Approximately 120 watt, 110-240 volts 50 cycles.

Please send details of Revox F36, and Local stockists to:

Mr. ....

Address .....

REVOX (U.K. Concessionaires) Ltd.  
296 Kensington High St., London, W.14. Western 4342.



LOEWE OPTA

# Hi-Fi Tape Recorders

**FOR PERFECTION IN SOUND**

## THE LATEST ADDITION TO THE OPTACORD RANGE

### OPTACORD 414

With the first-ever high frequency motor ensuring long life and constant speeds. Unsurpassed for a portable tape recorder. For use on mains, batteries and car batteries.

**47 Gns.**

Ask our Representative to call, or see the complete range at our Showrooms

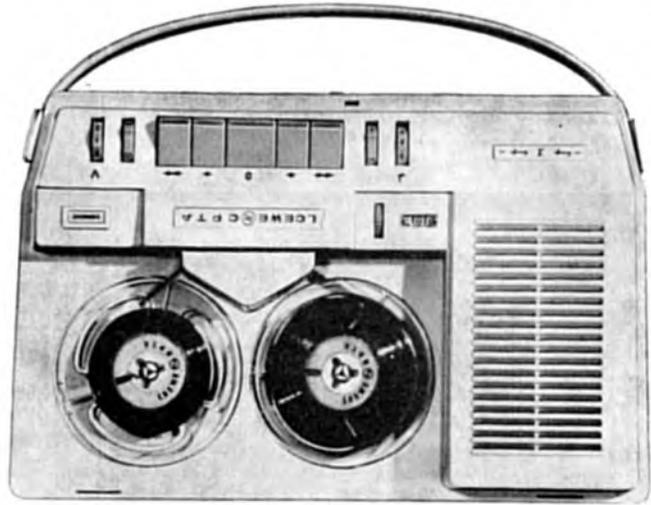

## HIGHGATE ACOUSTICS

71/73, GT. PORTLAND STREET, LONDON, W.1 Telephone: MUSEUM 2901/6

# THE RECORDER CO.

*for best machines on advantageous terms*

	Deposit	12 Monthly	Cash	
	£ s. d.	Payments	Price	
		£ s. d.	£ s. d.	Gns.
<b>4-TRACK STEREO/MONAUROL</b>				
Akai M6 ...	13 13 0	10 4 9	130	
Sony 521 ...	13 2 0	9 15 2	124	
Grundig TK46 ...	10 12 0	7 15 7	99	
Telefunken 97 ...	10 0 0	7 9 7	95	
Sony 464CS ...	10 0 0	7 7 10	94	
Philips EL3534 ...	9 16 0	7 4 8	92	
<b>2-TRACK STEREO/MONAUROL</b>				
Telefunken 98 ...	10 0 0	7 9 7	95	
<b>MAINS TWIN TRACK</b>				
Simon SP5 ...	9 16 0	7 6 5	93	
Brenell 5 Type "M" ...	9 5 0	6 18 7	88	
Telefunken 85 ...	8 15 0	6 10 8	83	
Akai Model 69 ...	8 6 0	6 4 5	79	
Grundig TK41 ...	8 0 0	5 17 11	75	
Brenell 5/2 (Meter) ...	7 15 6	5 16 7	74	
Brenell 5/2 ...	7 5 0	5 8 8	69	
Reps R10 ...	6 4 0	4 12 11	59	
Telefunken 95 ...	6 4 0	4 12 11	59	
Truvox R82 ...	5 15 6	4 6 8	55	
Truvox R62 ...	4 2 0	3 1 5	39	
Grundig TK18 ...	4 2 0	3 1 5	39	
Grundig TK14 ...	3 13 6	2 15 2	35	
Wyndor Trident ...	3 10 0	2 11 11	33	
Elizabethan LZ30 ...	3 7 3	2 10 5	32	
Ferguson 3200 ...	2 16 6	2 0 10	26	
<b>FOUR-TRACK MONAUROL</b>				
Akai Model 69 ...	8 6 0	6 4 5	79	
Grundig TK40 ...	8 0 0	5 17 11	75	

	Deposit	12 Monthly	Cash	
	£ s. d.	Payments	Price	
		£ s. d.	£ s. d.	Gns.
Reps R10 ...	7 5 0	5 8 8	69	
International ...	7 5 0	5 8 8	69	
Philips EL3549 ...	6 12 0	4 17 6	62	
Truvox R84 ...	6 4 0	4 12 11	59	
Grundig TK23 ...	4 15 0	3 10 10	45	
Truvox R64 ...	4 2 0	3 1 5	39	
Elizabethan LZ29 ...	3 15 8	2 16 9	36	
Philips EL3541 ...	3 15 8	2 16 9	36	
Ferguson 3202 ...	3 10 0	2 11 11	33	
Philips "Star Maker" ...	2 16 9	2 2 7	27	
<b>BATTERY</b>				
Uher 4000 ...	9 16 0	7 6 5	93	
Ficord 202 ...	7 0 0	5 3 10	66	
Butoba MT5 ...	7 0 0	5 3 10	66	
Stuzzi Magnette ...	6 4 0	4 12 11	59	
Optacord 412 Bat./Mains ...	4 19 0	3 14 0	47	
Stella ST470 ...	2 15 0	1 19 2	25	
Philips EL3585 ...	2 10 5	1 17 10	24	
<b>TRUVOX HI-FI TAPE UNITS</b>				
<b>TWIN-TRACK</b>				
PD82 Standard ...	4 4 0	3 3 0	42	
PD87 Stereo ...	6 6 0	4 14 6	63	
<b>FOUR-TRACK</b>				
PD84 Standard ...	4 12 0	3 9 0	46	
PD86 Stereo ...	6 6 0	4 14 6	63	

H.P. also over 18 and 24 months

Open Saturday 6 p.m.—Friday 6-30 p.m.

If unable to call, write for free brochure or send deposit now for quick delivery

Agents for:- FERROGRAPH, VORTEXION, REFLECTOGRAPH, TANDBERG, SONY, GOODMAN, etc.

**INTEREST FREE TERMS · FREE DELIVERY · PART EXCHANGE**



**GRUNDIG  
TK.46  
Price  
99 gns.**



Fully Stereo/Mono; Separate recording and playback amplifiers; 3 heads; Superimposition facilities; Direct tape monitoring; Reverberation control; 2 output stages; 2 Loudspeakers

We will be pleased to demonstrate this remarkable model. Send for full details.

**THE RECORDER CO.**  
(Dept. T) 188, WEST END LANE,  
WEST HAMPSTEAD, LONDON, N.W.6  
Telephone: SW1 4977  
Nearest station: West Hampstead, Bakerloo Line



## BULL FIGHTER'S PANTS CAPTURED

by momentous Carmen · Butterfly hits ceiling undistorted · Snippets from 'The Barber' the whole world of sound faithfully recorded on

# Mastertape

## MAGNETIC RECORDING TAPE

Send for free full colour brochure of the prices and tape recording accessories



**British Mastertape Makes Sound Sense**

MSS RECORDING CO LTD COLNBROOK BUCKS Tel: Colnbrook 2451

A MEMBER OF THE **BICC** GROUP OF COMPANIES

See us at the International Audio Festival & Fair  
**BOOTH No. 5.**—Come and hear "This is Your  
 Tape" in **DEMONSTRATION ROOM 234.**

Pick of the **WORLD'S** best!..  
**The leading portable  
 TAPE RECORDERS**



**BUTOBA MT7 & MT7R**

**Battery operated with Mains performance**

If you're looking for a multi-purpose tape recorder buy a "Butoba." This range of battery operated machines is outstanding for purity of reproduction and is ideal for recording music, speech and bird-song. Easily transportable, "Butoba" will help to make your holiday memorable. You can have the music of your choice wherever you go and, together with your camera, you can bring home tapes which have captured forever the sounds and scenes you have selected to record. The "Butoba" is truly economical on batteries and there is a mains converter available for home use. High Fidelity range 6 in. oval speaker. Good output. (1 watt.) The MT7R is available with remote control facilities, ideal for dictation in office or car.

*The prices of the range are attractive*

Model MT7 44 gns. MT7R 49 gns. MT5 66 gns.

Please send me details of BUTOBA Tape Recorders.

I am interested in Model No.....

Name.....

Address .....



**DENHAM & MORLEY LTD.**

Denmore House, 173-175 Cleveland Street,  
 London, W.1. Tel.: EUSton 3656-7

*Introducing*  
**THE WHARFEDALE  
 BOOKSHELF 2**

Where space is limited or where mobile external speakers are required for use with a mono or stereo Tape Recorder or Record Player, the "Bookshelf 2" gives a remarkable performance judged on a size, price, mobility basis. Its outstanding performance is due mainly to the efficiency of its modern 10in. unit (with the very low resonance of 25/30 c/s) and is fitted with flexible roll surround and polystyrene diaphragm to improve the bass and act as an acoustic filter. The special 5in. treble unit is fitted with a volume control so that H.F. response can be adjusted to suit listening room conditions and position of speaker. Two of these handy speakers give very good results on stereo.

SIZE 19in. x 11in. x 6 1/2in. deep. IMPEDANCE: 8-16 ohms.  
 UNITS: Specially designed 10in. WEIGHT: 18 lb.  
 and 5in. Speakers are fitted with Wharfedale Silver Magnets  
 12,500 lines flux density.

Polished walnut, oak or mahogany veneers **£16.10.0**

Unpolished **£15.15.0**

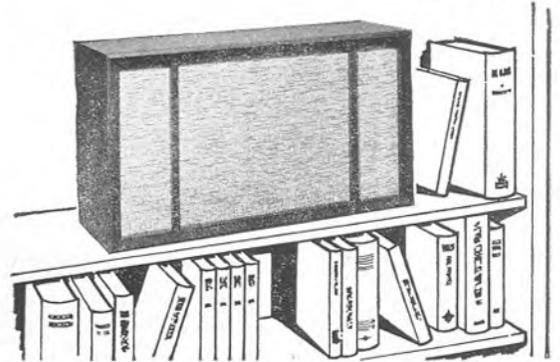

The clean low-frequency performance is clearly illustrated by the wave form oscillograms taken with an input power of 3 watts.

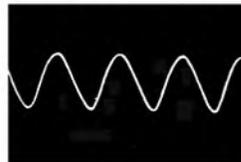

50 c/s

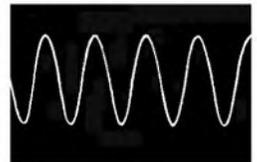

60 c/s

**LOAD MATCHING:**

When used with a set or tape recorder with small output at 2/3 ohms a WMT. 1 transformer is worth fitting for optimum results.

Free leaflet on request



**WHARFEDALE WIRELESS WORKS LTD.**

Idle, Bradford, Yorkshire Telephone: Idle 1235-6

Telegrams: 'Wharfedel', Idle, Bradford



## HEAR **ALL** MAKES

See all makes. Dozens of different models, by all well-known makers. They are *all* at the Tape Recorder Centre—the country's leading specialists in tape recording. At the Tape Recorder Centre you can see all makes, hear all makes, compare all makes, on the spot. Experts are on hand with informed advice, based on the wealth of Tape Recorder Centre experience, to make sure you choose the model that is best suited for you (and for your pocket). You will find everything you need for tape recording, office dictation and hi-fi at the Tape Recorder Centre, plus excellent HP terms. Hear all makes, see all makes, at

**THE**  
**T C R** **TAPE**  
**RECORDER**  
**CENTRE**

**Philips**  
**Elizabethan**  
**Grundig**  
**Ferrograph**  
**Stella**  
**Vortexion**  
**Brenell**  
**Ampex**  
**Tandberg**  
**etc**

82 High Holborn, London WC1. Tel: CHA 7401 ● 75 Grand Parade, Harringay, London N4. Tel: FIT 2316



## Alive to every sound

Like the ears of a wary fox, the Grampian DP4 microphone is sensitive to an extremely wide range of sounds. With its uniform frequency response from 50 to 15,000 c/s, the reliable, medium-priced DP4 will greatly improve the standard of your recordings.



### Grampian DP4

—also for broadcasting, public address and call systems

Low Impedance microphone complete with connector and 18 ft. screened lead **£8.0.0**

Medium and high impedance models **£9.0.0**

A complete range of stands, swivel holders and other accessories is available.

**GRAMPIAN—sounds like the real thing!**

Write or phone for illustrated leaflets:

**GRAMPIAN REPRODUCERS LTD**

Hanworth Trading Estate, Fritham, Middlesex. Fritham 2657

FOR ALL MUSIC LOVERS AND HI-FI ENTHUSIASTS

## TAPE RECORDER COVERS



Smart, waterproof cover to give complete protection to your tape recorder. Made from rubberised canvas in navy, wine, tan, grey and bottle green with white contrasting pipings, reinforced base, handy zip microphone pocket and name panel.

Cosser 1602	...	57/6
.. 1601	...	63/-
Stella ST455	...	63/-
.. ST454	...	57/6
Saja MK.5	...	57/6
Stuzzi Tricolor	...	58/-
Saba	...	63/-
Wyndor Viscount	...	55/-*
.. Victor	...	60/-*
Elizabethan Princess	...	60/-
.. Avon	...	60/-
.. Escort	...	57/6*
.. Major	...	63/-
.. FT.1	...	66/-
.. FT.3	...	...
Fi-Cord	...	52/6
Korting (4 track stereo)	...	63/-
Harting Stereo	...	66/-
Fidelity Argyle	...	55/-*
Walter 101	...	55/-
Simon SP4	...	63/-*
Clarion (complete with strap)	...	52/6
Brenell Mk.5	...	77/-
.. 3 star	...	69/-
Minivox	...	...

\* Without pocket

† Price to be announced

**A. BROWN & SONS LTD.**

24-28, GEORGE STREET, HULL

Tel: 25413, 25412

We offer a wide range of over 50 different models



including: Radios, Speakers, Amplifiers and Test Instruments.



TA-IS

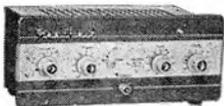

S-33

### Save Money Building Your own Equipment!

**TAPE AMPLIFIER UNITS:** Models TA-IM and TA-IS. The mono version, TA-IM, can be modified to the stereo version, TA-IS, by the modification kit TA-IC. Special features include bias level control, recording level indicators, printed circuit boards.

TA-IC £6.15.0. TA-IM £19.2.6. TA-IS £24.10.0.

**HI-FI STEREO 6 W AMPLIFIER Model S-33** Only 0.3% distortion at 2½ w/chl. £13.7.6.

**DE-LUXE STEREO AMPLIFIER Model S-33H**

De-luxe version of the S-33 with two tone grey perspex panel. With higher sensitivity necessary to accept the Decca Deram pick up. £15.17.6.

**HI-FI STEREO 18W AMPLIFIER Model S-99** Within its power rating, this handsome looking amplifier is the finest available. U/L push-pull output. Printed circuit board construction. £27.19.6.

**HI-FI FM TUNER Model FM-4U** Available in two units. Tuning unit (FMT-4U £2.15.0 incl. P.T.). I.F.-amplifier (FMA-4U £12.6.0). Printed circuit for I.F. Amplifier and Ratio detector own built-in power supply, 7 valves. Tuning range, 88-108 Mc/s. Total price £15.1.0.

**HI-FI AM/FM TUNER. Model AFM-1.** Also available in two units as above: Tuning heart (AFM-T1 £4.13.6 incl. P.T.) and I.F. amplifier (AFM-A1 £20.13.0.). Total £25.6.6.



S-99



AM/FM TUNER

We guarantee that without any previous experience—you can build any of our models.



MALVERN

#### EQUIPMENT CABINETS

A range of equipment cabinets is available including kits, ready assembled cabinets or assembled and fully finished cabinets. Why not send for full details free of any obligation?

Prices from £6.19.6. to £29.8.0.

**TRUVOX TAPE DECKS.**

Models D-83-D84

High quality mono/stereo Tape

Decks.

D83 2 track for higher fidelity

£31.10.0.

D84 (identical presentation) 4

track. £29.8.0.



TRUVOX D83

#### COTSWOLD & MFS SPEAKER SYSTEMS

The "Cotswold" is an acoustically designed enclosure 26" x 23" x 14½" with 3 speakers covering the full frequency range 30-20,000 c/s. The "Cotswold" MFS. A minimum floor space model size 36" high x 16½" x 14" deep. Price either model £23.4.0.

**COLLARO "STUDIO" TAPE DECK**

This stylish tape transcriber is by far the best "buy" in its price range, with 3 speeds 1½, 3½, 7½ i.p.s. £17.10.0.



STUDIO



COTSWOLD

Without obligation please send me

**FREE BRITISH HEATHKIT CATALOGUE**

Full details of Model(s) .....

Name .....

Address .....

(Block capitals please) .....

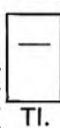

All prices include free delivery in the UK. Deferred terms available on orders over £10.

**ALL MODELS AVAILABLE ASSEMBLED—PRICES ON REQUEST**

**DAYSTROM LTD.**

Dept. T1  
Gloucester, England.

# BRITAIN'S LARGEST PART EXCHANGE

## SPECIALISTS

- ★ OFFER THE BEST POSSIBLE ALLOWANCE ON YOUR TAPE RECORDER, RECORD PLAYER, RADIO, HI-FI ETC.
- ★ LARGE STOCKS OF MOST UP-TO-DATE MACHINES, 300 TAPE RECORDERS TO CHOOSE FROM

APPOINTED AGENTS FOR:

FERROGRAPH, PHILIPS, BRENELL, REVOX, REPS, AMPEX, SONY, SIMON, AKAI, BUTOBA, COSSOR, ELIZABETHAN, GRUNDIG, REFLECTOGRAPH, TANDBERG, TRUVOX, TELEFUNKEN, UHER, FI-CORD, ROBUX, FERGUSON, VORTEXION, etc.



**ALL GOODS AVAILABLE ON OUR FAMOUS  
NO INTEREST TERMS**

10% deposit balance 12 months, 18-24 months terms available  
OUR MAIL ORDER DEPARTMENT COVERS THE WHOLE COUNTRY. FREE DELIVERY. WRITE, PHONE OR CALL FOR A QUOTATION ON YOUR MACHINE. LARGE SELECTION OF USED TAPE RECORDERS

**REW EARLSFIELD Ltd.** Telephone: BALHAM 7710  
266 UPPER TOOTING RD., LONDON, S.W.17.

## USE YOUR TAPE RECORDER FROM ANY D.C. SUPPLY

You can operate your recorder from a car, caravan or boat battery, or from any D.C. mains supply with a VALRADIO D.C. CONVERTER. These D.C. converters enable you to operate TAPE RECORDERS, etc., for play-back music, telephone conversations and reports whilst on long journeys, in addition to making outside recordings.

Electronic types of converters are also available for 200/250 D.C. with outputs up to 200 watts 50 c/s. from ships' supply or D.C. mains.

Available for practically all makes of recorders, record players, radiograms, amplifiers, etc. with prices ranging from £7 3s. 0d., VALRADIO D.C. CONVERTERS add versatility to your equipment.

Valradio and Stereosonoscope are the registered trade marks of Valradio Ltd.



For further details just post coupon below to:

**Valradio**

LIMITED  
Browells Lane,  
Feltham, Middlesex.  
Tel.: Feltham 4242-4837.



Please send me fully descriptive leaflet, ref: TRM on D.C. CONVERTERS for tape recorders and other equipment

Name .....

Address .....

Make and type of equipment: .....

D.C. volts in: ..... A.C. watts out: .....



for the connoisseur

# IRISH

You prefer Brittany to Brighton. Höck to highball. Van Gogh to Velasquez. You're choosy as well as selective. Irish is your tape. Irish professional tape has connoisseur advantages precision-engineered into its mirror-smooth surface. The unique Ferrosheen process, by which this microscopically fine surface is obtained, provides exceptional high frequency response due to intimacy of contact between tape and heads . . . head wear is at minimum . . . makes for freedom from head contamination by oxide build-up, considerable reduction in background noise, minimum drop-out. Only Irish tapes have free 'signature binding' kit for authentic library-style filing—simulated Moroccan leather with 23-carat gold foil for simple 'tooling' of title. People like Tandberg recommend Irish. And every Irish tape carries a 100% unconditional guarantee. Your Irish Tape stockist, and other details including technical data, from: A. C. Farnell Ltd., Hereford House, Vicar Lane, Leeds 2. Tel: Leeds 35111.

'IRISH', 'FERROSHEEN' and 'Signature Binding' are registered trade marks of Orradio Industries Inc., Opelika, Alabama.

# BRITAIN'S FINEST TAPE DECK

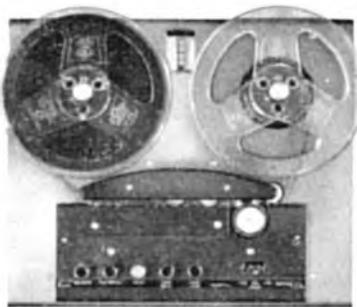

This is not merely our claim—it is the considered judgment of many leading experts. And now, under our 1963 production programme, there will be more PLANET tape decks available.

- ★ The UI deck has been designed to give a long trouble-free life and exceptional performance. That is why it is used by many professional studios and why it is the ideal deck for the serious amateur.
- ★ Now we introduce the UI/15, which is identical to the UI except that it operates at 3 $\frac{3}{4}$ , 7 $\frac{1}{2}$  and 15 ips. Improved production facilities at our new factory enable us now to accept orders for early delivery.

Write for illustrated brochure and independent test reports to:

## PLANET PROJECTS LTD.

Goodman Works, Belvue Road, Northolt, Mddx.

# Lee Electronics

TAPE RECORDER & HI-FI AUDIO SPECIALISTS



At last a 4-channel transistorized microphone mixer at a reasonable price.

Four high impedance inputs, e.g. four mics or two mics, one gram and one radio. Output gain approximately 6dB. Inputs, standard jack sockets. Battery PP3.

Price complete with PP3 circuit diagram

**£3 - 19 - 6**

TRADE SUPPLIED

400 Edgware Road, Paddington PAD 5521

# FRANCIS OF STREATHAM

Akai M6 Stereo ...	30 gns.	*Telefunken 85KL de	82 gns.
Akai M69 ...	79 gns.	luxe ...	59 gns.
*Brenell Mk. V. Model M	88 gns.	*Telefunken 95 ...	59 gns.
*Brenell Mk. V ...	64 gns.	*Telefunken 96 4 Tr.	69 gns.
Cossor 4 Tr. 1602 ...	38 gns.	*Telefunken 97 Stereo ...	95 gns.
Cossor 4 Tr. 1605 ...	62 gns.	*Telefunken 98 Stereo ...	95 gns.
Cossor 4 Tr. 1603 ...	28 gns.	Truvox Series 60, $\frac{1}{2}$ & $\frac{3}{4}$ Tr.	39 gns.
Elizabethan Popular ...	24 gns.	Truvox Series 80/2 Tr.	55 gns.
Elizabethan LZ. 30 ...	32 gns.	Truvox Series 80/4 Tr.	59 gns.
Ferguson 3200 ...	26 gns.	Uher Universal ...	82 gns.
Ferguson 3202 2Sp 4Tr	33 gns.	*Vortexion WVA ...	£93.13.0
*Ferrograph Series V ...	85 gns.	*Vortexion WVW ...	£110.3.0
*Ferrograph 422 or 424 ...	110 gns.	*Vortexion C Stereo ...	£148.10.0
Fidelity Argyll Minor ...	22 gns.	*Vortexion CBL ...	£160
Grundig TK14 ...	35 gns.	*Wyndor International	69 gns.
Grundig TK23 ...	45 gns.		
Grundig TK40 ...	75 gns.		
Grundig TK41 ...	75 gns.		
Grundig TK46 Stereo ...	99 gns.		
Loewe Opta 403 2Sp ...	45 gns.		
Loewe Opta 404 ...	53 gns.		
Philips 4 Tr. 3514 ...	27 gns.		
Philips 4 Tr. 3541 ...	36 gns.		
Philips 4 Tr. 3549 ...	62 gns.		
Philips new 4 Tr. Stereo	92 gns.		
*Reflectograph 'A' $\frac{1}{2}$ Tr.	105 gns.		
Robuk ...	36 gns.		
*Simon SP5 ...	93 gns.		
Sony Stereo 464 ...	75 gns.		
Sony $\frac{1}{2}$ and $\frac{3}{4}$ Track 521 ...	124 gns.		
Stellaphon 4 Tr. 456 ...	28 gns.		
Stellaphon 4 Tr. 454 ...	38 gns.		
Stellaphon 4 Tr. 459 ...	62 gns.		
Stuzzi 4 Tr. Junior ...	26 gns.		
*Tandberg Series VI			
Stereo $\frac{1}{2}$ or $\frac{3}{4}$ Tr.	110 gns.		
*Tandberg Series 7 ...	93 gns.		

### BATTERY PORTABLES

Philips Portable ...	24 gns.
*Butoba ...	66 gns.
Grundig TK1 ...	29 gns.
Clarion Phonotrix ...	39 gns.
Fi-Cord 202 ...	66 gns.
Stella ...	25 gns.
Stuzzi Memo-Cord ...	25 gns.
Optacord 412 Batt/Mains	47 gns.
Uher 4000 ...	93 gns.
Cossor ...	25 gns.

\*Microphone extra

Mains Power Pack for  
Philips or Stella ... £5.0.0

TRUVOX Decks with Pre-Amps  
PD 82—Standard Twin Tr. £42.0.0  
PD 85—Professional 4 Tr. £52.10.0  
PD 86—Professional 4 Tr.  
Stereo ... £63.0.0  
Decks also Brenell and Wearite

## LEADING STOCKISTS OF EQUIPMENT FOR TAPE and HI-FI

... and NO EXTRA FOR CREDIT TERMS

- ★ Minimum Deposit
- ★ No Interest or Service Charges on H.P. up to 18 months
- ★ Free Service during Guarantee Period

Prices subject to alteration as announced  
by manufacturers

- Grampian Reflector... £5.15.0
- MICROPHONES & MIXERS  
Grampian Ribbon GR102 £10.15.0  
Grampian DP/4 Dynamic £8.0.0  
Lustraphone VR/70 Mini-  
ature Ribbon ... 10 gns.  
Lustraphone Ribbon ... £7.17.6  
Lustraphone LFV/59  
Dynamic ... £8.18.6  
Simon 'Cadenza' Ribbon £10.10.0  
Reslo Ribbon or Dynamic £1.12.6  
Reslo Cardioid ... £9.12.6  
Reslo Pencil Ribbon ... £8.0.0  
A.K.G. Stereo D.88 ... £19.19.0  
A.K.G. K.50 Headphones £7.10.0  
Grundig Mixer ... £16.16.0  
Microphones by ACOS, and  
TELEFUNKEN All Walgain  
Products. Brenell and Philips  
mixers.

- TAPES & ACCESSORIES  
Standard, Double Play, Long Play and  
Triple Play in all sizes by all leading  
makers.

- Pre-recorded Tapes by Columbia,  
H.M.V., Saga, Music on Tape, etc.  
Bib, Bond and Romagna splicers.  
Matching transformers. Plugs,  
sockets, etc.

- Defluxers by Walgain, Wearite.

### HI-FI DEPT.

- STEREO AND MONO  
AMPLIFIERS by  
Quad Scott Chapman  
Tripletone Walgain Leak  
Rogers Armstrong B. & O.

- TUNERS by  
Quad Rogers Chapman  
Leak Armstrong Pye

- LOUDSPEAKERS by  
Quad Philips  
W.B. Wharfedale  
Goodmans Tannoy  
Leak Lowther  
Kef

- MOTORS, PICKUPS, by  
Garrard Tannoy  
Goldring-Lenco Connoisseur  
Shure Decca'Deram'  
Stereo Ronette  
Philips SME  
B & O Thorens  
Ortofon

All types of Diamond and Sapphire  
stylis, stereo and mono. Microlifts,  
Garrard SPG3, Acos Dust Bag.

- CABINETS Record Housing  
Design Furniture

Please note our only address as below

169-173 STREATHAM HIGH ROAD, LONDON, S.W. 16

Between St. Leonard's Church  
and Streatham Station

STReatham 0446/0192

# PROFESSIONAL TAPES BY



DIVISION OF

## COLUMBIA BROADCASTING SYSTEM

see these tapes demonstrated at the

# AUDIO FAIR

## STAND N° 13

### DEMONSTRATION ROOM 333

Extended frequency range of tapes for 2 and 4 track operating

C.B.S. E.R.A. Tapes were developed and perfected to accept a wider frequency range of sound than ever possible before . . . to faithfully retain and reproduce harmonic detail, time after time, without reduction or loss of sensitivity.

		5"	5 $\frac{3}{4}$ "	7"
STANDARD	1 $\frac{1}{2}$ Mil	600' 17/6	900' 23/-	1200' 27/6
LONG PLAY	1 Mil	900' 21/-	1200' 25/-	1800' 35/-
DOUBLE PLAY	$\frac{1}{2}$ Mil	1200' 34/-	1800' 45/-	2400' 56/-
STANDARD MYLAR		600' 21/-	900' 28/-	1200' 35/-
LONG PLAY MYLAR		900' 25/-	1200' 32/-	1800' 47/-
DOUBLE PLAY MYLAR (Tensilised)		1200' 42/-	1800' 55/-	2400' 68/-

## BETTER QUALITY FOR LESS COST

### DESMOND BURGESS & CO. LTD.

12-16 WATLING STREET, LONDON, E.C.4  
Telephone: CITY 2238



Vol. 7

No. 5

May 1963

### IN THIS ISSUE

The Editorial View . . .	14
The World of Tape	15
<i>A news digest</i>	
1963 International Audio Festival and Fair	16
<i>A special 8-page feature</i>	
Making a Contest tape	26
<i>Ronald P. Guttridge</i>	
Tape Talk	28
<i>Alan Edward Beeby</i>	
Service Bureau	29
<i>Harry Mack</i>	
Popular music on tape	30
<i>Don Wedge</i>	
Test Bench	31
<i>Ultra 6200</i>	
New Products	34
News from the clubs	37
Tape Exchanges	41

*COVER PHOTOGRAPH: Recording the day-to-day experiences of the family is just another of the many uses of a tape recorder. This charming study came from the Grundig factory in Germany. For the full range of the Grundig recorders available in this country, see Stand 17 at the Audio Festival.*

"TAPE Recording Magazine" is published on the third Wednesday in the month, by Print and Press Services Ltd., from 7, Tudor Street, London, E.C.4.

"TAPE Recording Magazine" is available by a postal subscription of 20s. per annum (U.S.A. \$3.50) including postage, or it can be obtained at newsagents, bookstalls and radio and music dealers. In the event of difficulty, write to the Publishers at 7, Tudor Street, London, E.C.4.

Back numbers, if still in print, are available at 2s. 6d. per copy for issues up to November 1959, and 2s. per copy for later numbers.

Address all communications

7 TUDOR STREET, LONDON, E.C.4

FLE 1455

**EDITORIAL**

**ADVERTISING**

Editor,  
R. DOUGLAS BROWN

Advertisement Manager,  
MISS PAMELA DURHAM

Assistant Editor, FRED CHANDLER

# THE EDITORIAL VIEW

ONE doesn't often hear of an entirely new use for the tape recorder—most things have been tried in the last few years. But in the United States they have now discovered that it can have great therapeutic value if used with delinquent teenagers.

All they do, in fact, is to talk into the recorder. Unburden themselves. Empty their minds.

The project was started by a Harvard professor five years ago, so that the evidence is sufficient to justify conclusions. And the view is that an important new method of treatment of delinquency has been found.

The subjects talk into a tape recorder for two or three hours each week for about nine months. They are paid a dollar an hour. At first, they think it is easy money. But after a few weeks the superficial talk was displaced by comment which drew even more deeply on their personal feelings.

And that is about it. After a period of years the statistics show that those

who took part in the experiment were markedly less likely to commit new offences than was the average young delinquent.

Feeling frustrated? Feeling aggressive? Feeling anti-social? Get talking into that tape recorder.

\* \* \*

**OCTOGENARIAN** conductor Leopold Stokowski has been making my hair stand on end with a suggestion in an interview he has given to our American contemporary, *Audio Times*. He announced that he had been experimenting with four-track stereo—playback through four speakers positioned in the four corners of a room—and he added that this development isn't far off now, in terms of the popular market.

Stokowski ought to know what he's talking about, too. He did a lot of pioneer work with stereo recording in the professional studios—his music for the film *Fantasia* was the first stereo recording ever made with a major orchestra.

Now he says that a new four-track technique would call on the listener to "re-orient his thinking," and on an orchestra to adapt positioning. And what, I wonder, will it call for on the part of audio equipment designers—and of advertising and copy-writing salesmen?

No doubt we all want to see, as soon as possible, the best possible reproduction of sound. But, for my part, I'm pretty happy with the best current standards and I think I could rest content with them for quite a long while if it meant that the tape recording industry got down to further standardisation. The great thing now is to persuade the man-in-the-street that we have a first-rate product and that he can go ahead and buy without fearing that new technical development will out-date his equipment in a few months.

As I've said before, I'd like to see us forge ahead with 3½ ips two-track as the popular standard with 7½ ips—single and double-track—available for the near-professional enthusiasts.

\* \* \*

**T**APE recording seems to be making steady progress on the other side of the Atlantic—but the problems there seem to be identical with those in this country. They have a Magnetic Recording Industry Association over there, but it doesn't seem yet to have taken the active role one might expect. Basic statistics about the growth of the hobby in the USA seem as difficult to come by as they are here.

The latest problem over there, it seems, is unsatisfactory after-sales service from dealers. It sounds familiar.

From what I hear, we may soon be able to give the Americans some useful lessons. Watch this column!

\* \* \*

**P**OSTSCRIPTS: Are there really so few readers who would like to go with the Editor to the International Recording Study Week in Switzerland in July?

Don't miss the first of the new series of BBC "Sound" programmes on Sunday, April 21, at 3.10 p.m. It will report on this year's Audio Festival.

THE EDITOR.

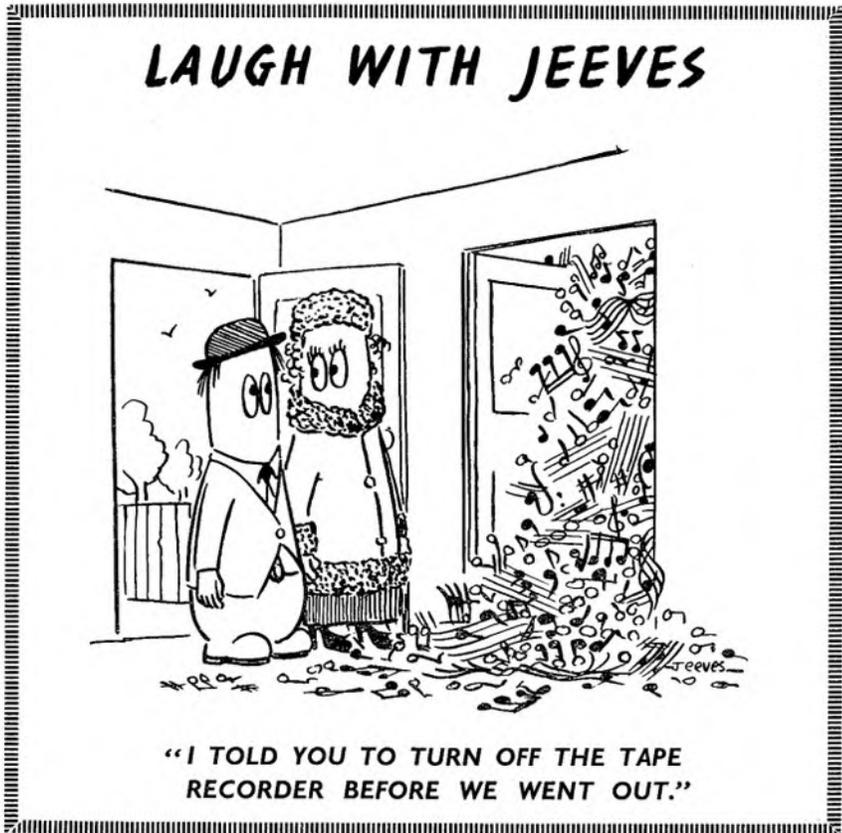

## ADD-ON UNIT FOR DUPLICATING TAPES

NEW YORK—Home tape recording took another step forward last month when Bell Sound introduced a portable machine, which in addition to having the usual facilities of a "professional" unit, adds that of duplicating.

The latter feature comes from a special adaptor available as an accessory, consisting of motors and reels which attach to the sides of the main unit.

The machine is both portable and self-contained. Two 9 x 6 inch elliptical speaker units—housed in cabinets—are part of the carrying case. These are optionally detachable for both playing and recording. The stereo amplifiers have a high rating for a portable—eight watts.

The machine has the usual facilities—recording, playback and dictating, and there are separate erase record and playback heads. By special circuits the three heads allow for recording material from one track on to another. It also makes possible an echo effect as well as sound-on-sound recording.

The basic machine costs £161 and it is highly competitive in its field. What puts it ahead of the others is, of course, the duplicating facility. This extra costs only £18.

Bell sees its future in a very good light. Home enthusiasts can use it for recording, say, a child's first cry and make instant copies for distribution among the family. Business executives can use it for circulating colleagues and clients with verbal statements.

There could be a growing home market among the enthusiasts, too, for duplicating friends' work.

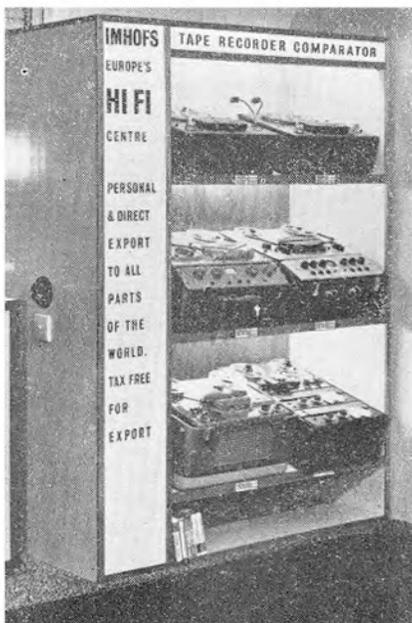

A tape comparator which, at the click of a dial, enables stereo and mono tape recorders to be heard through the widest possible range of loudspeakers, has been installed at Imhof's Ltd., 112-116 New Oxford Street, London, W.C.1.

## PORTABLE VIDEO-TAPE RECORDER



This portable television tape recorder was shown in London last month by Ampex Great Britain Ltd. Costing under £5,000 and weighing approx. 130 lb. it features a single control switch for all operating modes including record, replay, and fast rewind. It has a tape speed of 5 ips, and records 64 minutes programme on a single 8-inch reel of standard two-inch videotape. Designed for closed circuit applications, the VR-1500 will be available for delivery later this year.

## THE WORLD OF TAPE • A NEWS ROUND-UP

A TAPE recording of English lessons made at schools at Greenwich's twin-town, Maribor, in Yugoslavia, has arrived in Greenwich. It was brought to England by the Mayor of Maribor who came here for hospital treatment. The Mayor also brought with him an album of photographs made up by the Maribor children.

Greenwich Council are to present the album to Kidbrooke School and to Sherrington School, Charlton, who together produced a tape recording which was sent to Maribor last year.

\* \* \*

A NEW use for tape has been explored for the first time by Aberdeen education authority who have issued three tapes: "Office work for girls," "Work in the Retail Trade for boys and girls" and "The Interview." Produced by the senior youth employment officer in Aberdeen, Mr. Ross Henderson, and Mr. David Haggart, the tapes include interviews with office and shop managers and with girls and boys who speak of their hopes for jobs, of jobs already held, and what other school-leavers should have in the way of qualifications.

Only recently completed, the tapes are complementary to the Employment Officer's normal school visits. Pupils and staff of Hilton Secondary School co-operated in the making of the tapes, which are believed to be the first ever devised by an education authority. Copies of the tapes have been sent on request to the Scottish Council for Commercial Education.

The Youth Employment Office also has 26 edited tapes of recent careers talks for Senior Secondary pupils.

\* \* \*

NEW YORK—RCA-Victor has introduced a new tape, called Red Seal STM-6A, which gets nearly an hour of playing time on to a 3½-inch reel (at 3½ ips, two-track).

It uses Dupont's tensilised mylar coating, the standard quarter-inch wide. The 3½-inch reel will accommodate 600 feet of the tape.

## WALKIE-TALKIE

WHEN Irish playwright Brendan Behan agreed to write his autobiography, following a request from American publishers, Bernard Geis, he decided the task could be accomplished more easily if he dictated his thoughts into a tape recorder. Accordingly, he asked one of his friends, Mrs. Rae Jeffs, Publicity Manager of the Hutchinsons Group, for assistance.

Mrs. Jeffs, experienced in working for Behan, whose writing habits can best be described as intermittent, has now travelled to America to join Behan and begin her task. She hopes to tape about 50,000 to 100,000 words in bars or wherever else he cares to talk. The tape will then be transcribed and he will revise it.

TOKYO—A workable method of recording on paper has been developed here. Called Nakavision, its essential principles are similar to tape recording.

It records and reproduces sound on a specially treated paper which costs about one shilling a sheet and contains five minutes of material. Information about what has been recorded can be written on one side. The paper can also be folded.

The recorder playback machine fits into a small briefcase. A transistorised unit, it sells at about £32.

\* \* \*

AMERICAN university student Frank Howard, aged 25 from Alabama, sent a gold ring and a tape recording to his sweetheart in England asking her to marry him. In March 21-year-old trainee teacher Janet Moore of Earl Shilton, Leicester, said "I will" on a tape she sent back. The couple met in Paris last summer.

# 1963 INTERNATIONAL AUDIO FESTIVAL & FAIR

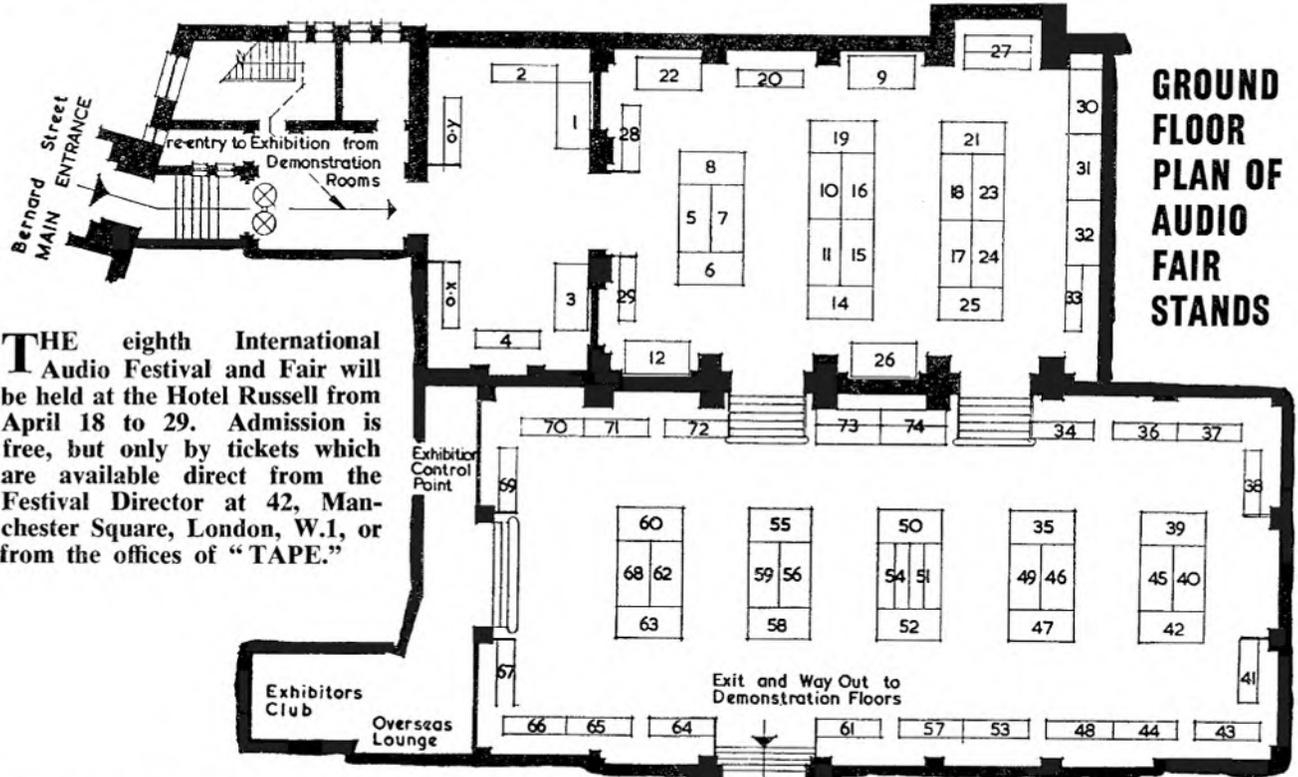

**T**HE eighth International Audio Festival and Fair will be held at the Hotel Russell from April 18 to 29. Admission is free, but only by tickets which are available direct from the Festival Director at 42, Manchester Square, London, W.1, or from the offices of "TAPE."

**ACOS (Stand 57, Demonstration Room 204).**

*Cosmocord Limited, Eleanor Cross Road, Waltham Cross, Hertfordshire.*

Two new microphones will be shown for the first time by this company. These are the Microphone 60, a hand microphone described as having a high sensitivity and a smooth, wide range response. The Microphone 60 is designed for use with high quality domestic recorders and is ideal for interviewing and recording speech or music. The second new unit is the Microphone 55. This is a small lapel microphone incorporating a crystal insert. Prices have still to be announced.

The familiar live show, comparing live music directly with recordings made using the Acos microphones will also be featured in their demonstration room.



**A.K.G. (Stand 39, Demonstration Room 112).**

*Politechna Limited, 3, Percy Street, London, W.1.*

Two of the new microphones that Politechna will be showing on behalf of the Austrian firm of A.K.G. will be the D77A dynamic stereo microphone and the C12A condenser microphone.

The first unit permits XY and AB stereo pick-up of speech and music, has a frequency range of 80-13,000 cps, cardioid directional characteristics and a discrimination of approx. 13 dB. The upper and lower half of the D77A, illustrated

right, are detachable for AB use. Both valves have degree calibrations for altering the basis angle of the stereophonic pick-up. It costs £15 10s.

The C12A, also illustrated, although outside the scope of the amateur, is well worth a visit to appreciate its maximum flexibility as a microphone. It is designed to give the sound engineer maximum quality control. This is achieved using the remote control unit (N12A) which can be located up to 300 ft. from the microphone. By adjusting the control button it is possible to select the most suitable pick-up pattern for each part of the programme being recorded. The exceptionally flat frequency response extends beyond the limits of human audibility, and is combined with a high front to back ratio in the cardioid pattern. The C12A uses the pressure-gradient principle, and a twin diaphragm system. Oh, yes, and the price is £139.

In addition AKG will be exhibiting their wide range of dynamic, and condenser microphones, microphone accessories, including stands, and their K50 stereo/mono lightweight headphones.



**AMPEX (Stand 63, Demonstration Room 417).**

*Ampex Great Britain Limited, Arkwright Road, Reading, Berkshire.*  
Ampex will be displaying a represen-

tative selection of equipment from their comprehensive range of professional and domestic tape recorders manufactured by Ampex Electronics Ltd. in this country, and Ampex Corporation in America. Among the recorders to be shown will be the Universal 351 series and the unchanged domestic 1200 series of four-track machines. Stereo and mono demonstra-



**The AKG 277A dynamic stereo microphone.**

# STAND-BY-STAND SURVEY

tion will given, and it is hoped to include a three-channel stereo demonstration using the 300-3 master recorder.

The Ampex range of domestic and professional recording tape will also be exhibited, and we understand that, subject to preparations now in hand Ampex will be showing two recorders not seen before in this country.



## ARMSTRONG (Stand 34, Demonstration Room 347).

*Armstrong Audio Limited, Warlters Road, Holloway, London, N.7.*

The tuners, pre-amplifiers, and power amplifiers range to be shown by Armstrong will have no new items this year.

On show will be the A20 stereo power amplifier (£23 12s. 6d.), and the PCU25 (£21), and PCU (£28 10s.) stereo pre-amplifiers. The familiar T4B VHF tuner (£20 8s.) with case, and T4C (£17 19s.) without will also feature on their stand.

Two tuner/amplifier chassis will be shown. These are the Stereo 12 Mk2 (£40 5s.), and the Stereo 55 (£29 18s.). The former is described as the most complete chassis ever produced, combining AM and FM tuners, a comprehensive control unit, and two high fidelity amplifiers in one compact unit. Every kind of mono and stereo sound source is provided for, and the output on each channel will match virtually any loudspeaker available.



## AUDIO PIONEER (Stand 65, Demonstration Room 114).

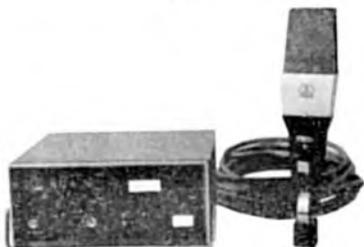

The AKG C12A condenser microphone with power supply unit N12A.



## BASF (Stand 36, Demonstration Room 118).

*BASF Chemicals Limited, 5a, Gillespie Road, London, N.5.*

Education applications of magnetic tape will be one of the feature attractions at the stand of BASF. In their demonstration room a four-position Language Laboratory will be installed. Visitors will be invited to take a seat in one of the booths, to receive a lesson from the Control Console, taped of course.

BASF will also be showing a new correspondence tape weighing less than 1½ ounces complete in mailing carton with 150 ft. of long-play tape. Facilities

will be available for sending a free tape message from the Audio Fair to a friend or relative. Appointments for recording messages can be made at the stand in the main hall.



## BRENELL (Stand 53, Demonstration Room 236).

*Brenell Engineering Co. Limited, 1a, Doughty Street, London, W.C.1.*

A new version of the Brenell Mark 5 recorder, the Mark 5 Series 2, will be shown at stand 53. Among the modifications on the new machine are narrower gapped heads. Also on show will be the Mark 5 "M" recorder, a mono machine fitted with separate recording and replay amplifiers to enable monitoring to be carried out. For the stereo enthusiast the STBI, to be shown for the first time, will be worth a visit. This unit, designed for use with existing hi-fi installations, comprises a four-speed deck and twin recording and replay amplifiers mounted in a portable wooden cabinet.

The Mark 5 Series 2 deck and amplifier are available as separate items, and the Mark 510 Series 2 deck, capable of accommodating reels up to 10½ inches in diameter will no doubt appeal to the professional recordists.



## BUTOBA (Stand 8, Demonstration Room 421).

*Denham and Morley Limited, 173-5, Cleveland Street, London, W.1.*

The two established battery/mains recorders will be shown again on the Butoba stand. These are the MT5, a two-speed, 3½ and 1½ ips, machine which will accommodate a five-inch reel of tape (1,200 ft. double play), and costs £69 4s., and the MT7, introduced at last year's show. The MT7, which retails at 44 guineas, operates on four U2 batteries, an external car battery, a rechargeable battery, or AC mains (50 or 60 cycles). It has an average running time of twelve hours per set of batteries, and, accommodating three-inch spools, provides a playing time of 32 minutes per track using double-play tape at 1½ ips.

A remote control version of this recorder, the MT7R, will also be on show.

In addition to the Butoba range. Denham and Morley will also be exhibiting the Norwegian Siemens, a four-track, stereo tape recorder. (See page 35.)



## CBS (Stand 13, Demonstration Room 333).

*Desmond Burgess and Co., 190, Palace Chambers, Bridge Street, London, S.W.1.*

A new range of magnetic recording tape, available in four grades and five spool sizes, are promised by the agents for the Columbia Broadcasting System of USA. Precise details are not available at the time of going to press.



The Chapman 306 stereo amplifier.

## CHAPMAN (Stand 69, Demonstration Room 315).

*Chapman Ultrasonic Ltd., 24, Upper Brook Street, London, W.1.*

A completely new range of Chapman domestic hi-fi equipment will be on view and will be demonstrated. This will include the first of the new "1,000" series of tuners, the FM1000 and the FM1005. The first is a VHF FM only self-powered unit, with high sensitivity—87.5—108 Mc/s. The second new unit provides complete international AM coverage on long, medium, intermediate, and short wavebands and 87.5-108 Mc/s. It is also self-powered.

Exhibited also will be re-styled and improved Mark II versions of the six-stage bandspread feeder unit AM model S6BS and AM/FM model S6BS/FM.

The latest in Chapman stereo performance will be demonstrated by the entirely new integrated 8 + 8 watts amplifier and control unit model 306 (illustrated), in a single newly styled cabinet. Total harmonic distortion is less than 0.1 per cent at full power with 15 dB of feedback.



## CLAIRTONE (Stand 18, Demonstration Room 215).

*Argelane Limited, 251, Brompton Road, London, S.W.3.*

Clairtone will be exhibiting three of the high-fidelity installations. These include the Signature, the Empress and the Princess. The stereophonic Signature unit, 81½(L) x 19(D) x 26¼(H), contains a tuner, recorder changer, tape recorder and associated equipment. It costs £401 1s. 3d. The Empress, 62(L) x 18(D) x 27½(H), costs £233 8s. 3d.; and the Princess, 58(L) x 19(D) x 28¼(H), costs £202 5s. 6d.

A feature of this stand will be the "Silent Listening" demonstrations, incorporated on all the Clairtone sets. The secret is stereophonic earphones which plug into a socket on the control panel of the hi-fi installation.

On the same stand will be the Braun exhibits. These include the Audio 1, the first fully transistorised feeder unit, the PC 5 stereo record player; the CSV 13, stereo amplifier; CET 15 tuner; and the L50 and L60 loudspeakers. Both the PC 5 and CER 15 are new models in this country.

(Continued on page 18)

# Lounge for tape clubs—tape deck for battery recorders

## CLARKE & SMITH (Stand 46, Demonstration Room 221).

Clarke and Smith Manufacturing Co. Limited, Melbourne Works, Wallington, Surrey.

Clarke and Smith have introduced a "New Look" AM/FM Tuner for the Audio Fair. The unit, Model 658, has a substantially similar specification to its predecessor (Model 558), is self-powered, and is styled in silver and black to match the other components: Integrated stereo amplifier Model 655, stereo pre-amplifier (656) and stereo power amplifier (657). All will be on display and will be demonstrated with the E.M.I. pick-up EPU100, and Clarke and Smith's new transistor tape recorders TR634 and 635 in Room 221.

Designed for education, industrial and commercial users in addition to their obvious domestic application, these two machines show a departure from conventional design in both appearance and performance. Each model is housed in a contemporary light oak lockable carrying case with a removable lid. The amplifiers, which are common to both machines, are fully transistorised and deliver an output of ten watts at minimum distortion. Mixing, superimposition, monitoring and "straight-through" amplification facilities are provided.

In addition to the hi-fi components and tape recorders, some of the Clarke and Smith Sound Division products including specialist rack frame, P.A. equipment, loudspeakers, and radio receivers will be seen.



## CONNOISSEUR (Stand 15, Demonstration Room 337).



## DECCA (Stand 31, Demonstration Room 402).

The Decca Radio and TV Limited, Ingate Place, Queenstown Road, London, S.W.8.

Harmony in the home will be emphasised on this stand, where visitors will be able to examine and have demonstrated the Decca Stereo Decola Separates which

comprise units designed to match in appearance (for the wife) and performance (for the husband). Starting from the record "end" the Decola Separates range consists of a turntable unit with the Garrard 301 transcription motor, Decca fss pick-up with a Mark 1 head, and Decca Microlift (58 gns.); a stereo control unit with maximum simplicity of operation (22 gns.); a twenty-four watt power amplifier, with a frequency response flat from 30-25,000 cps (36 gns.), or in a smart wood and expanded metal box if required (5 gns.); a wide range VHF radio tuner (19 gns.); and the unique Decola multi-speaker system—a seven-speaker unit—its standard housing being a fine Regency reproduction corner piece (51 gns.).

Also to be shown will be the Decca "Professional" pick-up with a Mark II head, a development from the fss pick-up (32 gns.); and the Decca Deram ceramic pick-up head (4½ gns.).



## E.M.I. (Stand 55, Demonstration Room 411).

E.M.I. Limited, Hayes, Middlesex.

The E.M.I. Group of companies will display a full range of professional tape recorders, a new stereo domestic tape recorder with general purpose loud-speaker enclosures, professional loudspeakers and Emitape.

The stereo domestic recorder is the Emicorder, the stereo version of the Voicemaster, a two-speed (7½, 3½ ips) four-track recorder. Among its features are a clock-type tape counter, recording level meter (calibrated in decibels), pause control, safety erase lock and inter-track switching providing multiple superimposition.

Among the professional equipment being shown will be the TR 90 studio recorder. This is constructed in two parts, a mechanical unit and the amplifier. They are available in a form suitable for vertical mounting on standard 19-inch racks, or housed together in a console cabinet. There is also a stereo version.

The battery portable RE 321 will be shown, and other professional models will include the RE 301 and TR/52/2.



Left: The G.K.D. "Chiltern." This equipment cabinet will accommodate any type of tape recorder or deck. It is 54 inches wide, 20 inches deep, and 25 inches high (on legs). Designed to match with the Leak Sandwich speaker, it costs 37 guineas. It can be seen on Stand 52.

## FI-CORD (Stand 9, Demonstration Room 212).

Fi-Cord International, 40a, Dover Street, London, W.1.

A programme of recordings made in various parts of the world by the well-known broadcaster and commentator Bob Danvers-Walker will be featured on the Fi-Cord stand. In addition visitors can hear tapes of unusual musical instruments and frequent live recording demonstrations.

Their 202 battery/mains portable tape recorder will be the main attraction.



## FEDERATION OF BRITISH TAPE RECORDING CLUBS (Lounge 233).

Federation of British Tape Recording Clubs, 211, Melfort Road, Thornton Heath, Surrey.

The programme for the second-floor lounge 233 will be a joint effort by the FBTRC and Stereo International. Officials of both organisations will be available throughout the day to advise tape enthusiasts and answer any queries. There will also be demonstrations of amateur-made tape recordings—thirty-minute programmes alternating between stereo and mono recordings. The mono tapes to be played will include all the past winners of the British Amateur Tape Recording Contest since the Contest's inauguration in 1957 plus some tapes from the Federation's library of recordings. Stereo tapes to be played will be the work of members of Stereo International, a world-wide tape exchange organisation whose members are particularly interested in stereo recording.

The equipment to be used is loaned by Messrs. H. J. Leak, chosen after each of the other exhibitors had offered to cooperate and loan equipment.

On the Saturday morning, the Exhibitors' Club will be used by the Federation from 11.30 a.m. to 1 p.m. for their Annual General Meeting.



## FERROGRAPH (Stand 48, Demonstration Room 442).



## GARRARD (Stand 38, Demonstration Room 222).

Garrard Engineering and Manufacturing Co. Limited, P.O. Box 4, New-castle Street, Wiltshire.

The new two-track magazine-loading tape deck, designed for use on battery-operated tape recorders will be the main attraction for tape users on this stand. Also to be featured will be the established magazine-loading deck for mains machines, supplied in half- or quarter-track versions; and an automatic tape deck suitable for continuous background music, guide commentaries and telephone answering systems.

Garrard will also be exhibiting their wide range of sound reproducing equipment including turntables, record players and changers. Pick-ups and styli will complete their display.

# New G K D range—Grampian transistorised mixer unit

## GEVAERT (Stand 40, Demonstration Room 311).

*Gevaert Limited, Great West Road, Brentford, Middlesex.*

Gevaert will be showing their full range of Gevasonor magnetic recording tape which has now been increased by the recent addition of 8½-inch spools in standard-play (Acetate) and long-play (Acetate and Polyester).



## G.K.D. (Stand 52, Demonstration Room 414).

*G.K.D. Limited, King Street, Houghton Regis, Bedfordshire.*

The latest addition to the G.K.D. range of equipment cabinets will be shown for the first time on stand 52. This is the Huntingdon designed in close collaboration with the manufacturers of the Quad equipment.

Also on show will be the cabinets designed for the Leak equipment. This includes the "Southdown," and the "Chiltern," illustrated opposite. As is standard with all their cabinets, all controls are concealed from view, yet readily accessible via the hinged front panel.

The Chiltern will accommodate any type of tape recorder or deck, and the largest transcription motor available. The cabinet measures 54(w) x 20(d) x 25 (h-on legs). It is designed to match with the Leak Sandwich speaker. Available in a choice of Sapele Mahogany or Dark Australian Walnut finish it costs 37 guineas, plus two guineas for the Deluxe version in teak.



## GOLDRING (Stand 44, Demonstration Room 202).

*Goldring Manufacturing Co., 486, High Road, London, E.11.*

A wide range of transcription equipment will be shown by this company. Latest addition to their range is the G88, designed for use with any pick-up arm, which has an 8 lb. non-ferrous turntable, infinitely variable speed adjustment, and neon indicator light. The Model GL70, for mono or stereo use, introduced last year, will also be shown.

Pick-up arms will include a new unit which can be dynamically balanced in all planes irrespective of which pick-up cartridge is fitted; the Goldring G60, with its unique sliding platform, and the L70 arm.



## GOODMANS (Stand 24, Demonstration Room 448).

*Goodmans Industries Limited, Axiom Works, Wembley, Middlesex.*

The new Eleganzia extra-slim, high fidelity reproducer will be demonstrated for the first time in room 448. This unit, which sets a new standard in high definition sound reproduction in a total depth

of only 6½ inches, has a generous power handling capacity of 15 watts. The impedance is 15/16 ohms, it measures 27 inches high by 20 inches wide.

On their ground-floor stand Goodmans will show a representative selection of their speaker units and enclosures. The new 1963 High Fidelity Manual, including enclosure designs, advice for beginners, and a stereo section, as well as full details of the range of units will be available on this stand.



## THE GRAMOPHONE (Lounge 444).



## GRAMPIAN Stand 68, Demonstration Room 242).

*Grampian Reproducers Limited, Hanworth Trading Estate, Feltham, Middlesex.*

Among the new units to be shown by Grampian are a battery-operated reverb unit, for amateur or professional use; and an all-transistor pre-amplifier mixer. This latter unit has three independently controlled inputs, two medium and one high impedance, variable bass and treble controls, ample gain, and exceptionally low noise level. The standard output is 600 ohms but any other impedance can be supplied to order.

Among the microphones to be shown will be the popular DP4 moving coil, which will be shown with a full range of stands, swivel holders, parabolic reflectors, and other accessories. The smaller DP6 model can also be seen.

Two models of the Grampian ribbon microphone will be shown. The GR1 having a reduced back sensitivity and the GR2 with the usual "Figure-of-eight" sensitivity pattern.

**Right: The Record Housing "Quarter-wave" loudspeaker being shown at the Audio Fair for the first time. It costs 36 guineas, and was designed after consultation with Ralph West. It has a claimed frequency response of 30-20,000 cps. Also illustrated is the Grampian ribbon microphone shown with switch unit and desk stand. This microphone, available in two versions, "Figure-of-eight" or reduced back sensitivity, can be seen on Stand 68.**

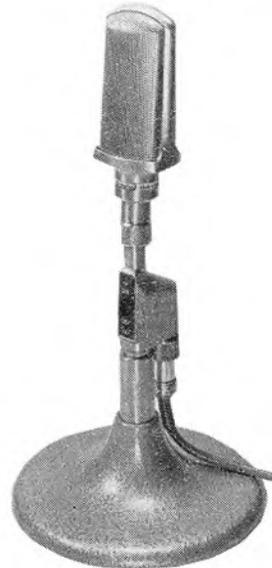
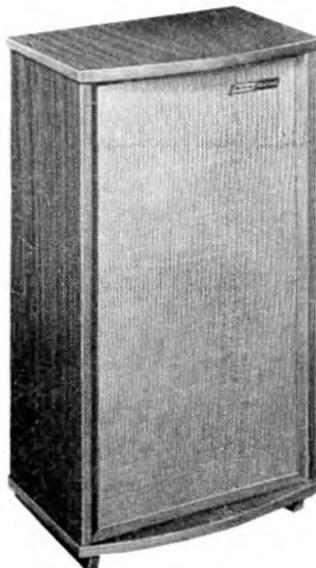

## GRUNDIG (Stand 17, Demonstration Room 237).

*Grundig (Great Britain) Limited, 40, Newlands Park, Sydenham, S.E.26.*

Their full range of Grundig recorders, the TK 14, 18, 23, 40, 41, and 46, and the tape deck TM45 will be shown.

The latest addition is the TK18, the fully automatic "Magic-ear" recorder, described fully in our March issue. This is a 39-guinea, two-track, single-speed machine. Four guineas cheaper is the TK14, again with only the 3½ ips speed, and with the same quoted frequency response of 60-12,000 cps. As with the TK18 the power output is 2½ watts.

Among their accessories for use with these machines will be the recently introduced Stereo mixer Type 608, also described in our March issue.

In room 237 the Grundig hi-fi installations incorporating their stereo units will be shown. These consist of tuners with control units, stereo amplifiers and Superphon loudspeakers.



## HANOVER PRESS LTD. (Stand 54, Lounge 346).



## HANSOM BOOKS LTD. (Stand 26).



## HI-FI NEWS (Stand 41).



## ILIFFE ELECTRICAL PUBLICATIONS LTD. (Stand 12).



## INSTRUMATIC (Stand 43, Demonstration Room 220).

*Instrumatic Limited, Grove Works, Elmgrove Road, Weybridge, Surrey.*

The Worden articulated pick-up arm will be making its first appearance at the show. Manufactured, under exclusive licence, by Instrumatic Ltd., this unit is described as producing an audible improvement in cartridge performance, particularly toward ends of records sides.

(Continued on page 20)

# New Philips recorder — film on manufacture of tape

## K.E.F. (Stand 66, Demonstration Room 413).

*K.E.F. Electronics Limited, Tovil, Maidstone, Kent.*

Their full range of complete speaker systems from the small Celeste to the 8 cu. ft. Lockwood/K1 system will be demonstrated by K.E.F. These cover all domestic and professional requirements. Since pioneering the first British all plastic speaker K.E.F. have concentrated on developing the techniques necessary to deal with these new materials. The 0.4 cu. ft. Celeste, first shown last year, is now in full production.

For those who can accommodate larger speakers there is a choice between the Slimline and the conventionally styled K22. This model, being shown for the first time, employs a 13 × 9 inch flat piston bass driver and a one-and-half-inch hemispherical dome radiator.

For professional users, the 4 cu. ft. Monitor, and the Lockwood LE1 are both fitted with standard K1 three-speaker systems. Constructional details will be available for a variety of enclosures.



## LEAK (Stand 29, Demonstration Room 248).

*H. J. Leak & Co., Ltd., Brunel Road, Westway Factory Estate, London, W.3.*

The famous "Point One" range of amplifiers will be on show with the Trough-Line 11 FM tuner and the "Sandwich" loudspeaker.

Also to be seen will be the two new equipment cabinets designed by G.K.D., see also report on their stand, page 19. The "Southdown" cabinet houses the Leak power amplifier, pre-amplifier, tuner and gramophone unit; and the "Chiltern" houses all these and a tape recorder.



## LOCKWOOD (Stand 11, Demonstration Room 412).

*Lockwood & Co., Ltd., 67, Lowlands Road, Harrow, Middlesex.*

In addition to the range of high quality reproducers for professional studio monitoring, Lockwood will be demonstrating the whole range of their slim reproducers. This is the Academy range which comprises the small Mini-Slim, the medium-sized Minor-Slim, and the large Major-Slim. All these are free-standing enclosures which can be supplied in a large variety of polished or waxed veneered finishes, with many types and combinations of well-known loudspeaker units. Some of the Lockwood equipment can be seen on the Ampex stand (63) where they are being used to give demonstrations of three-track stereo. During the period of the Audio Fair, Lockwood will also be giving special demonstrations at Alfred Imhof Ltd., 112-116, New Oxford Street, W.1, and Nusound Recording Co., 35, Craven Street, W.C.2.

## LONG-PLAYING RECORD LIBRARY (Lounge 344).



## LONGACRE PRESS LTD. (Stand 22).



## LOEWE-OPTA (Stand 7, Demonstration Room 121).

*Highgate Acoustics Ltd., 72, Great Portland Street, London, W.1.*

Two tape recorders, the Optacord 404 and 414 will be shown by the UK agents for the West German manufacturers.

The first model is a four-track, two speed (3 $\frac{3}{4}$ , 1 $\frac{1}{2}$  ips) recorder with a quoted frequency response of 40-16,000 cps at the top speed. Among its many features is the facility which permits simultaneous listening on one track while recording on another, as well as synchronous trick records on second track. It sells at 53 guineas.

The 414, described in our April issue, is an improved version of the earlier Optacord 412. The new machine, designed for mains/battery operation, incorporates a meter recording level indicator instead of a magic eye. It employs one speed, 3 $\frac{1}{2}$  ips, and accommodates 4 $\frac{1}{2}$ -inch spools.

In addition to these new models, Loewe-Opta will be showing some of their range of high fidelity stereo radiograms, in particular the Nordkap Stereo, the Paloma Stereo, and the Premiere Stereo, all of which have facilities for incorporating tape recorders.



## LOWTHER (Stand 64, Demonstration Room 144).



## LUSTRAPHONE (Stand 60, Demonstration Room 247).



## LYREA (Stand 20, Demonstration Room 317).



## MORDAUNT (Stand 74, Demonstration Room 312).



## M.S.S. (Stand 5, Demonstration Room 234).

*M.S.S. Recording Co., Ltd., Poyle Trading Estate, Colnbrook, Buckinghamshire.*

M.S.S. will be introducing a new quarter-track head which has now been developed fully. They will also be presenting a demonstration film entitled "This is your tape" which describes the more important processes in the manufacture of tape, and also offers a guide as to how best to judge tape performance.

Their full range of Mastertape magnetic recording tape will be shown in new-style boxes. Strongly constructed and elegantly designed, the boxes still incorporate the distinctive colour coding that has been featured for some years.

## MULLARD (Stand 1, Demonstration Room 211).

*Mullard Ltd., Torrington Place, London, W.C.1.*

A range of transistors, valves and capacitors for audio applications together with audio circuit information will be available on the Mullard stand.

Among the transistors being shown will be the AD140 power transistor intended for use as matched pairs in class B amplifiers giving outputs of up to 15 watts, or as class A amplifiers in car radio output stages delivering up to three watts. At the other end of the scale is the AC107 low-noise junction transistor, which is particularly suitable for the input stages of audio amplifiers.

Among their "World Series" of audio valves will be the ECL86, a triode-pentode with an output of four watts and a sensitivity three times greater than that of the ECL82; and the EM87, a recording level indicator for tape recorders. A feature of the latter is its short grid base of only —10 volts.

Examples of polyester, miniature foil and miniature electrolytic capacitors will also be shown. Their features include close tolerance and small physical size.

Leaflets giving the design information and performance figures on Mullard circuits for stereophonic amplifiers, tape recorders, and servicing oscilloscope together with details of "Mullard Circuits for Audio Amplifiers" (price 8s. 6d.) and the "Mullard Reference Manual of Transistor Circuits" (price 12s. 6d.) will be available free to visitors.



## ORTOFON (Stand 4, Demonstration Room 113).

*Metro-Sound (Sales) Ltd., 19a, Buckingham Road, London, N.1.*

The wide range of the Danish-manufactured Ortofon equipment will be shown by Metro-Sound, the sole UK agents. This range includes pick-up cartridges, arms, amplifiers, speakers, and pick-up arm controls. The Ortofon KS601 stereo amplifier, designed for music lovers, has two push-pull outputs each of 15 watts giving ample volume for undistorted reproduction. Five stereo inputs for tape, FM, microphone, etc., are incorporated. The quoted frequency range is 20-80,000 cps, crosstalk figures are given as better than 30 dB at 10,000 cps. It features a continuously variable rumble filter.

On the same stand Metro-Sound will be displaying the range of Swiss-manufactured Thorens transcription motors, turntables, units and pick-up arms.



## PHILIPS (Stand 10, Demonstration Room 336).

*Philips Electrical Ltd., Century House, Shaftesbury Avenue, London, W.C.2.*

A de-luxe version of Philips family recorder model EL3541 will be making its first appearance at the Hotel Russell. The new version, Model EL3541/H, illustrated opposite, is to sell at 42 gns.

The current range of five models will also be shown. These include the battery "Starmaker" (27 gns.), the "Family" portable EL3585 (24 gns.), the EL3514,

model (36 gns.), the newest model, the four-speed EL3549 (62 gns.), and the EL3534 stereo machine (92 gns.).

Philips wide range of tape recording accessories can also be seen. These include the recently introduced tape splicing kit, triple play tape, mixing boxes, connecting boxes, headphones, foot-switch, and the mains supply unit which converts the battery portable machine into a battery/mains model for five guineas.

Another first appearance at the Fair is to be their new pre-amplifier, model EL3787, designed specifically for the new all-transistorised mains machines. This will not be in the shops until June. The pre-amplifier allows stereo replay on the EL3549, and also makes possible the Duoplay and Multiplay features when used with headphones.

The Philips AG1016 record player will be demonstrated, showing how the recorders can be used as amplifiers. This hi-fi auto/single player is a low-priced unit selling at 12 guineas.



Above, the new de-luxe version of the Philips family tape recorder. The EL3541/H sells at 42 guineas.



**RECORD HOUSING (Stand 51, Demonstration Room 111).**

*N. & S. B. Field & Co., Ltd., Brook Road, Wood Green, London, N.22.*

Three new models in their range of equipment cabinets will be shown by this company. First is the Walton, 50(L) × 21(D) × 16(H) plus 9-inch legs. It will house almost every turntable and pick-up, tuner, controls, and stereo amplifiers plus about fifty records, all concealed behind a pair of tambour doors. The price is 28 guineas.

The Bartok cabinet measures 36(L) × 18(D) × 18(H), plus 12-inch legs. It costs 19 guineas, and will house any turntable, tuner, controls and stereo amplifiers all concealed behind a drop flap.

The centrepiece of their demonstration will be the "Quarterwave" loudspeaker (illustrated on page 19).

Selling at 36 guineas, this, their first complete loudspeaker, was designed in consultation with Ralph West. It is based on the Voight folded horn patent, whereby the bass is produced by a moving column of air, and only indirectly by the flapping of the speaker cone. A wide frequency range (30-20,000 cps) is claimed, with a minimum of colouration and distortion.

# Radio-controlled tape recorder —American tuners range

**PLANET (Stand 33, Demonstration Room 318).**

*Planet Projects Ltd., Goodmans Works, Belvue Road, Northolt, Middlesex.*

Planet will be showing one of the most unique pieces of equipment seen at the Fair, a radio-controlled tape recorder.

The Planet U1 deck, right, introduced last year, is the basis for this recorder. It features two speeds, 7½ and 3¼ ips, has wow and flutter figures rated at better than 0.8 and 0.15 per cent respectively, and incorporates a single Papst hysteresis synchronous motor, driving a 2¼ lb. brass flywheel. The remote-controlled version, the U1 Remote, is available in three versions. For stop/start remote control only; for remote stop, start, fast left, fast right and amplifier control; and the first-ever remote radio control. Operative up to five miles, line of sight, the recorder is solenoid-operated and is controlled by four push-buttons on a small hand-held box.

All of the above variations to the Planet U1 are also available on the Planet U1-15, which has a speed of 15 ips, in addition to the Planet U1's 7½ and 3¼ ips. The basic deck with half-track mono heads costs £44 10s., with quarter-track heads, £50, and with half-track stereo heads, £51 10s. Prices are not yet available for the remote-controlled versions.

Another feature of the Planet stand will be the CCI, a continuous cassette-loaded tape recorder for background music. It will hold up to 600 ft. of tape. Prices are available on application.



**PLANT NEWS (Stand 72).**



**PYE (Stand 59, Demonstration Room 218).**



**QUAD (Stand 49, Demonstration Room 447).**

*Acoustical Manufacturing Co., Ltd., Huntingdon, Hertfordshire.*

All the established units in the famous Quad range will be exhibited, including their electrostatic loudspeaker, power amplifier, control unit, and AMII and FM tuners.

No new units are announced or expected.



**RADFORD (Stand 30, Demonstration Room 320).**



**RECORD RETAILER (Lounge 154).**



**REVOX (Stand 62, Demonstration Room 217).**

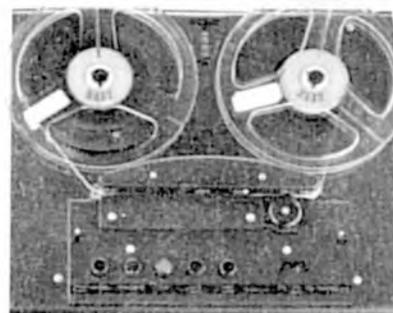

**ROGERS (Stand 71, Demonstration Room 149).**



**ROLA CELESTION (Stand 47, Demonstration Room 302).**



**SCOTCH (Stand 45, Demonstration Room 334).**



**SCOTT (Stand 2A).**

*Elstone Electronics Ltd., Edward Street, Leeds 2.*

The American Scott range of tuners and amplifiers will be shown for the first time at the Audio Fair this year. Among the items to be seen will be the 350B wide-band and the 333 AM/FM Multiplex stereo tuners. These will be exhibited as examples of outstanding American designs, they are not expected to be available for sale until the BBC FM Multiplex service commences regular programmes.

The third Scott unit to be seen is the 299c stereo amplifier, described as the most-widely used, highly respected amplifier in America. It delivers a full forty-watts per channel (IHF power band rating) over the entire audio range. It also incorporates a number of features including individual bass and treble controls, and special tape monitoring facilities. The price is 136 guineas.

Tandberg Series 6 and 7 tape recorders will be demonstrated with the Scott 299c amplifier. (See also Tandberg on page 24).



**SIEMENS (Stand 19, Demonstration Room 422).**

*Denham and Morley, Denmore House, 173, Cleveland Street, London, W.1. See Butoba stand on page 17.*



**SHERWOOD (Stand 6, Demonstration Room 420).**



**SHURE (Stand 67, Demonstration Room 418).**

(Continued on page 24)

**ANNOUNCING**

**TWO NEW TAPE**

## For Stereo—**THE STB1**



This new stereo tape recorder from Brenell contains many new features which will appeal to the discriminating amateur and professional alike. It is beautifully designed both mechanically and electrically and incorporates twin recording and twin replay pre-amplifiers, designed for use with existing high fidelity amplifying equipment. Some idea of the versatility of this new machine will be gathered from this very brief specification:—

4 speeds,  $1\frac{7}{8}$ ,  $3\frac{3}{4}$ ,  $7\frac{1}{2}$  and 15 ips—mixing—superimposing—sound-on-sound—immediate comparison of original and recorded signals—2 edgewise meters—replay facilities for  $\frac{1}{2}$ ,  $2/2$ ,  $\frac{1}{2}$  and  $2/4$  track pre-recorded tapes.

**The cost £120**

## and we continue the **MARK 5 Type M**

A high-class semi-professional machine, the Type M has earned itself an enviable reputation for quality and reliability. Its superb finish and performance will match any high fidelity equipment which is available to-day—just consider this brief specification:—

4 speeds  $1\frac{7}{8}$ ,  $3\frac{3}{4}$ ,  $7\frac{1}{2}$  and 15 ips—separate record and replay heads and amplifiers—reels up to 8 $\frac{1}{2}$  in. dia.—fast rewind (1200ft. in 45 seconds)—mixing—superimposing—recording level meter—adjustable rotary tape guide.

**The cost 88gns**



**BRENELL ENGINEERING COMPANY LIMITED**

**Brenell**

---

# RECORDERS FROM BRENELL

---

## For Mono—THE MARK 5 Series 2



This new machine replaces the MARK 5 and offers a number of improvements both in appearance and electrically. The cabinet is finished in dark grey with chrome trim and the deck and amplifier have light grey masks giving the whole machine a very pleasing appearance. The amplifier has been redesigned to give an improved frequency response at all speeds on both record and playback. The output remains the same at 4 watts.

#### Specification

4 speeds,  $1\frac{7}{8}$ ,  $3\frac{3}{4}$ ,  $7\frac{1}{2}$  and 15 ips—3 independent motors (synchronous drive to capstan motor)—instant stop without spillage—pause control—monitoring—superimposing—up to  $8\frac{1}{4}$  in. reels—fast rewind (1200ft. in 45 seconds).

### The cost 69gns

The MARK 5 Series 2 Deck at 31gns

MARK 510 Series 2 Deck at 12gns extra  
(for  $10\frac{1}{2}$ " NAB and standard spools)

The MARK 5 Series 2 Amplifier at £26  
(metered version £31.5.0)

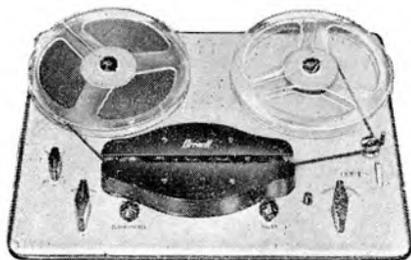

All this equipment can be seen and heard  
at The Audio Festival and Fair

Booth No. 53, Demonstration Room 236

**Brenell**

1a Doughty Street, London, W.C.1. HOLborn 7356 (3 lines)

# Two new Sony recorders— Language Laboratory by Stuzzi

## S.M.E. (Stand 37).

*S.M.E. Limited, Steyning, Sussex.*

New this year by S.M.E., showing their precision pick-up arms, is an ultra light-weight shell weighing only six grammes. With its companion balance weight it will form an accessory to the standard arm and is of special value for cartridges having a compliance of twenty and upwards. Made throughout in aluminium alloy with nearly 120 perforations, it is the lightest interchangeable shell available. Packed with balance weight, the S2 costs 52s. 6d.



## SONY (Stand 73, Demonstration Room 321).

*Tellux Ltd., Avenue Works, Gallows Corner, Romford, Essex.*

The very latest in miniature portable recorders will be shown on the Sony Stand. This is the recently-introduced Sony 801 battery/mains unit illustrated below. Two speeds,  $3\frac{1}{2}$  and  $1\frac{7}{8}$  ips, are employed, and it will accommodate 5-inch spools, providing a playing time of 64 minutes per track at the slower speed using standard-play tape.



The Sony 801.

Suitable for office or field, this instrument is equipped with many "easy-to-use" extras, including a tape counter, recording level/battery indicator, pause control, and back-space facility, and an earphone for private listening. Weighing only 13 lb., the 801 travels in a leather shoulder-case. It measures 13 x 4 x 8 inches. The price is 89 guineas.

Another newcomer to the Sony range is the TC464CS, also illustrated, selling at 94 guineas. This is a completely self-contained stereo system with two microphones, two speakers and with features including sound-on-sound recording push-button channel selection. Other facilities include dual recording level indicators,

automatic tape lifters, digital rev. counter, pause control and FM stereo recording inputs.

Four-track recording and playback is available at speeds of  $7\frac{1}{2}$  and  $3\frac{3}{4}$  ips. The quoted frequency response is 40-15,000 cps at the top speed. Harmonic distortion is rated at less than 0.2 per cent at 3dB below the rated output of three watts. Contained in a strongly-constructed case, the 464 CS measures 23 x 15 x 8 inches and weighs  $37\frac{1}{2}$  lb.



## SYMPHONY (Stand 23, Demonstration Room 213).



## S.T.C. (Stand 14).

*Standard Telephones and Cables Limited, Connaught House, 63, Aldwych, London, W.C.2.*

S.T.C. will show prototype models of stereo headphones and two new microphones. One of the microphones is a medium-priced ribbon unit with a cardioid response; the other is a low-priced high quality moving coil unit.

The headphones mark a breakthrough for S.T.C. who, although Britain's biggest manufacturer of headphones for the telephone industry, have never before designed units specifically for "hi-fi" listening. These new products are in addition to the complete range of S.T.C. high quality microphones which will form the bulk of their display.



## STUZZI (Stand 25, Demonstration Room 313).

*Recording Devices Limited, 44, Southern Row, Kensington, London, W.10.*

Their five standard tape recorders, including the battery-operated portable Magnette, will be shown again by Stuzzi. The 401, introduced at last year's show will again be displayed. The special features of this two-speed, four-track recorder are facilities for inter-track transfer, and a built-in mixer. The quoted frequency range is 40-14,000 cps at the top speed of  $7\frac{1}{2}$  ips. It will accommodate seven-inch spools providing a playing time of 64 minutes per track using standard-play tape at  $3\frac{1}{2}$  ips. The price is 59 guineas.

Highlight of the stand will be the master and student track educational

recorder (MASTER), Recording Devices' own language laboratory. This will be demonstrated in conjunction with BASF Chemicals Ltd., who will be giving free German lessons in Room 118.



## TANDBERG (Stand 2, Demonstration Room 122).

*Elstone Electronics Ltd., Edward Street, Leeds 2.*

The Tandberg exhibits will include their Series 6 recorders, the Model 64, which is a four-track version of the semi-professional Model 62. They are both stereo record and playback decks with cathode follower outputs, and require the addition of hi-fi amplifiers and speakers. A three-head system is employed, and three speeds,  $7\frac{1}{2}$ ,  $3\frac{3}{4}$ ,  $1\frac{7}{8}$  ips, are incorporated. The price is 110 guineas for either.

The more recently-introduced Series 7 recorders, also in two and four-track versions are the Model 74 and 72. These are complete stereo record and playback systems with two 3-watt outputs, and two monitor speakers. Two heads are employed, with the same three speeds. The price is 93 guineas.

To be shown for the first time ever is the Tandberg Language Laboratory equipment. This will be a world preview of a Student's booth with a transistorised amplifier and special 821L tape recorder. The laboratory also includes a control centre for 24 students.

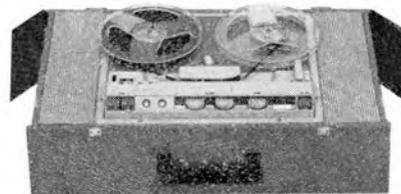

The TC464CS, latest in the Sony range of stereo recorders.



## TANNOY (Stand 16, Demonstration Room 349).

*Tannoy Products Limited, Norwood Road, West Norwood, London, S.E.27.*

The "Slendalyne" ribbon velocity microphone exhibited in prototype form last year is now in production and will be shown by Tannoy, together with the rectangular versions of the York Bass Reflex Cabinet and G.R.F. horn-loaded enclosures.

Also on display and demonstrated will be their range of pick-ups, and the dual concentric loudspeaker units.

THE WALD-MAG, head demagnetiser, long nylon covered probes £2 10s. 0d. WAL GAIN transistorised pre-amplifiers, Mono £5 10s., Stereo £7 10s. and Hi-Gain (latter CCIR equalised) £7 16s. THE WAL BULK Eraser - £7 18s. 6. Available from all leading dealers. (Wholesalers include A. C. Farnell, Leeds; Harris & Russell, London).

WELLINGTON ACOUSTIC

LABORATORIES LTD., Farnham, Surrey (Fnhm 6461)



## TAPE RECORDING AND HI-FI

By the Editor of TAPE Recording Magazine

The best available introductory guide  
160 pages, 40 illustrations. 13s. 3d. (including postage)  
from Tape, 7, Tudor Street, London, E.C.4

## TAPE RECORDING MAGAZINE (Lounge 153).

Print and Press Services Limited, 7, Tudor Street, London, E.C.4.

The Editor and Staff of *TAPE Recording Magazine* will be present in a special lounge to welcome readers.



## TELEFUNKEN (Stand 58, Demonstration Room 314).



## TEPPAZ (Stand 50, Demonstration Room 322).



## THORENS (Stand 4A).

*Metro-Sound (Sales) Co., 19a, Buckingham Road, London, N.1.*

The Thorens range of equipment will be on show and demonstrated in conjunction with the Ortofon equipment, see page 20.



## TRUVOX (Stand 61, Demonstration Room 304).

*Truvox Ltd., Neasden Lane, London, N.W.10.*

Although no new products are promised by this company, Truvox will be highlighting the vastly improved mechanical performance of their Series 80 tape units. These are stereo tape units for easy connection to any existing stereo set-up, and are available in two versions, four-track (PD86), and two-track (PD87).

Either mono or stereo facilities are available on these self-powered units which record independently but play back through conventional reproduction equipment.

So successful is their present range that they are making apologies regarding the delivery schedule. For the R62, R64, R82, and R84 tape recorders there is a delay of two and three weeks respectively; for the Mono PD82 and 85 tape units, delivery is two weeks, and for the stereo PD86 and 87 ten to twelve weeks.



## VITAVOX (Stand 35, Demonstration Room 115).



## VORTEXION (Stand 27, Demonstration Room 342).

*Vortexion Ltd., 257, The Broadway, Wimbledon, S.W.19.*

The CBL in-line stereo tape recorder, introduced at last year's show, will be one of the three recorders shown by Vortexion. Incorporating all the usual features of the established WVA and WVB recorders, also to be shown, the

# Visit us in lounge 153— new Wharfedale loudspeakers

CBL includes facilities for "before and after" monitoring, and for multiple superimposition. This two-track instrument enables the user to record a programme from track one to track two, and at the same time to mix in two separate additional inputs.



The Vortexion CBL stereo tape recorder.

A variety of mixer units will also be on show. There is a choice between a three-channel unit with an accurate within-1-dB-peak-programme meter, or four-, twelve- and double-five channel stereo mixer units. All feature long life without attention tropical controls, built-in screened supplies, balanced line inputs, and ½-volt or alternative 1 mW, 600 ohm balanced, unbalanced or floating outputs.

Two amplifiers, the 30/50 watt and the 120/200 watt, complete their intended display.



## WAVERLEY RECORDS (Stand 3).



## WHARFEDALE (Stand 70, Demonstration Room 147).

*Wharfedale Wireless Works Ltd., Idle, Bradford, Yorkshire.*

A new loudspeaker unit, the "Bookshelf 2," will be shown for the first time by Wharfedale. This is an ultra compact two-speaker system with a wide frequency response. It measures 19 x 11 x 6½ inches, weighs 18 lb. and costs £16 10s. It incorporates specially-designed five-inch and ten-inch speakers each fitted with silver magnets.

The remainder of their high-quality loudspeaker units, including the familiar "Slimline 2," suitable for floor, wall or table mounting, and costing £22 10s., will also be shown. The slimline measures 25 x 20 x 7 inches and weighs 32 lb.

## WHITELEY (Stand 42, Demonstration Room 415).

*Whiteley Electrical Radio Co. Limited, Radio Works, Victoria Street, Mansfield, Nottinghamshire.*

The wide range of Whiteley loudspeakers, enclosures, amplifiers and tuners will be displayed on Stand 42.

Their loudspeakers, ranging in size from 1½ inches up to 18 inches in diameter, are available with a variety of cone construction, speech coil impedance and magnet strength to suit all requirements. The universal speech coil is fitted on the 8 and 10-inch units and this is of great value in providing satisfactory matching to most systems.

The HF 1216 and HF 1016 Major loudspeakers have suspension systems which enable them to be used in the more compact type of cabinet.

A range of enclosures suitable for use with various loudspeakers will be on display and demonstrated. These "break-down" bass reflex cabinets can be assembled with the aid of a screwdriver.

The amplifiers and complementary tuners have been redesigned. The heart of the system is the improved WB 12 amplifier has a control unit with facilities for stereo and single-channel reproduction enabling either tape, disc or radio inputs to be coupled to the main amplifier system.

To cater for potential stereo radio reception requirements a switched VHF tuner gives instant choice of Third, Home or Light programmes. It also incorporates AFC system ensuring accurate station tuning and an output is available for Multiplex stereo when this becomes available.



## WILLIMAN (Lounge 246).

*K. H. Williman & Co. Limited, Blackford House, Sutton, Surrey.*

As specialists in the export of audio equipment, K. H. Williman will be making a special welcome to overseas visitors to the show. Information will be available on everything related to the export sale of hi-fi equipment manufactured by five of the companies they represent. These are Armstrong Audio Ltd., E.M.I. Ltd., Stanley Kelly, Rogers Developments (Electronics) Ltd., and Planet Projects Ltd. Their unique experience will be at the disposal of any manufacturer or importer interested in British Audio Equipment in which they exclusively deal, and on which they cover every aspect from start to finish.

# THE TRUVOX TOUCH

*starts where the specification leaves off*

SEE AND HEAR US AT  
**AUDIO FAIR**  
BOOTH NO. 61  
ROOM NO. 304



# ELECTRONIC WORLD

is by far the cheapest  
HIGH QUALITY TAPE  
on the market

★ ACCLAIMED BY EXPERTS  
Reprints of reviews available.

★ Guaranteed.

POST COUPON NOW!

<b>STANDARD PLAY (Acetate Base)</b>		
3in.	175ft. 4 for 18/- or 48/- per doz.	<input type="checkbox"/>
4in.	300ft. 4 for 26/-	<input type="checkbox"/>
5in.	600ft. 2 for 26/-	<input type="checkbox"/>
5½in.	850ft. 16/-	<input type="checkbox"/>
7in.	1,200ft. 19/-	<input type="checkbox"/>
<b>ARCHIVE GRADE (SP Polyester)</b>		
7in.	1,200ft. 22/6	<input type="checkbox"/>
<b>LONG PLAY (Acetate Base)</b>		
7in.	1,800ft. 28/-	<input type="checkbox"/>
<b>LONG PLAY (Polyester Base).</b>		
3in.	225ft. 4 for 22/- or 60/- per doz.	<input type="checkbox"/>
4in.	450ft. 2 for 21/-	<input type="checkbox"/>
5in.	900ft. 2 for 35/-	<input type="checkbox"/>
5½in.	1,200ft. 24/-	<input type="checkbox"/>
7in.	1,800ft. 31/-	<input type="checkbox"/>
<b>DOUBLE PLAY (Special polyester base).</b>		
3in.	375ft. 4 for 40/- or 108/- per doz.	<input type="checkbox"/>
4in.	600ft. 2 for 30/-	<input type="checkbox"/>
5in.	1,150ft. 27/-	<input type="checkbox"/>
5½in.	1,750ft. 35/-	<input type="checkbox"/>
7in.	2,400ft. 45/-	<input type="checkbox"/>
<b>DE VILLIERS (Electronic World) Ltd.</b> 18D STRUTTON GROUND, London, S.W.1.		
I enclose remittance for £ s. d. Post Free.		
NAME.....		
ADDRESS .....		
<b>BLOCK LETTERS. Cash with order.</b>		

## 3" TAPE SPOOLS

If you use large quantities, may we quote you?  
We are the actual manufacturers and can offer the best prices to bulk users.

**MOUNTAIN FILMS LTD.**  
(Dept. TRM),  
1, NEW BURLINGTON ST.,  
LONDON, W.1.

When writing to manufacturers for information about new products, please mention that you saw it in "TAPE Recording Magazine."

"TIME ALONE WILL TELL"

# The story of a documentary

AT 15s. per lb. for excess baggage, the small Fi-Cord and necessary accessories, likely to cost me £10 to take to Sierra Leone, were nearly left behind. I filled my pockets with batteries, microphones and leads, and hoped that the recorder would pass as a not-too-large camera. Fortunately this scheme worked, and I arrived in Sierra Leone on November 8, 1960, complete with the aforementioned equipment.

Within a month I was up-country in the middle of the Bush at a Trading Station, which I was to run during my eighteen-month stay in this small West African Country.

I soon settled down in the rather strange surroundings, and the Fi-Cord was a regular companion on my commercial forays into the African bush villages.

My first big opportunity came at the Independence Celebrations in April 1961. Sir Milton Margai, the Prime Minister of Sierra Leone had suggested that a suitable showpiece for the country to its guests would be an assembly of Traditional, Colourful Dances and Music. As a result over a thousand dancers and musicians had been assembled and rehearsed for the birth of this New Nation. Some seven examples were selected from the principal Tribes and Societies and, together with an assortment of masked devils, these formed the programme.

Most African tribal music is percussive, any suitable sounding tin drum or box being used to give the necessary rhythm. For my collection I chose The Bundu Society music as being representative of this type of music. They employ one bass drum and a number of "conga" drums. The women shake gourds mounted on a short handle in a large meshed net on the strings of which are thousands of tiny beads. This gives a sound similar to maraccas, and while shaking this instrument they sing chorus songs.

The dancers are young girls aged between eight and 13 years who go to secret rendezvous in the Bush once between these ages when they learn housewifery. Part of their training, probably the only education that they are ever likely to receive, consists of the traditional Bundu dance routines portraying such everyday actions as cooking or minding the baby. The recordings were made with only one microphone, the Grampian DP/4. This was used in the open air with the drummers to one side of the bead-shaking women. With this arrangement a good balance was obtained between the various sound components.

The next group recorded were from the Susu Tribe. These girls are older, between 16 and about 20, and they have become well known following pretty full Press cover during the later Royal Visit of The Queen and the Duke of Edinburgh. Their musicians play Balanjis, a locally made xylophone of wood with hollowed out gourds forming the sounding chambers. There were three in the group recorded, three drummers playing



Fiddles, flutes and calabashes. Foulas musicians and dances in the Sierra Leone, April 1961.

**RONALD GUTTRIDGE**  
describes the production of  
the tape which won the Docu-  
mentary Section of the 1962  
British Amateur Tape Record-  
ing Contest.

what looked like very large Bongoes and two others playing metallic instruments. These were simply pieces of iron held on a chord and struck with steel rings worn on the fingers.

The first recordings were then played back to the performers on the Fi-Cord's tiny speaker. As a result of this I was invited to return that afternoon to their compound to record various items not in the dancing demonstration, and a useful, valuable collection it turned out to be. This special performance was directly attributable to the Fi-Cord's playback characteristic. A day or two earlier, a newsreel company covering the Celebrations had filmed and recorded some of the performance. Their playback capabilities were it seems, somewhat restricted. On being able to hear themselves louder and clearer on my machine the performer's offer allowed an amateur to steal a march on the professional, and as a result obtain some otherwise-never-recorded material, some of which is now in the BBC's Permanent Record Library.

Next was an all male group—The Foulas—a nomadic cattle rearing tribe. They perform acrobatic dances to a fiddle, flute and calabash band. The fiddles and flutes are all locally made and are simple but melodic. The rhythm is obtained from metal rings worn on the fingers striking the calabash (a giant, hollowed out gourd cut in half and dried hard in the sun). There are also a number of conga-like drums carried round the neck. At the front of this drum is a small piece of flattened corrugated iron, to which hundreds of tiny pieces of wire are affixed loosely, and these "sing" like a cymbal as the drums are struck.

The drums play on one side of the field, giving the beat to which the acrobats perform, and the fiddle, flute and calabash band with a singer on the other side of the field act as a sort of accompaniment to the entertainment. They come together at the end of the performance, and this exciting finale has been captured on the tape, together with the excited urging of the watching crowd.

The Madingo and Gambian examples were recorded during the Royal Visit to Sierra Leone. They came to the country as a combined group, and were brought to the Eastern Province as part of the entertainment to be provided on the day that the Queen and Prince Philip visited Kenema in that Province.

The Madingo group consisted of three guitars and two attractive women singers with extremely powerful, and to our ears, harsh voices. There was the problem of balance, so I held the microphone about two feet from the guitars and about ten feet from the singers. The resulting balance was quite acceptable, with the inevitable background of chattering crickets clearly heard on the tape. At the end of each song I recorded a trans-



Ronald P. Guttridge plays back some of his recordings to an African and his family during his visit to Sierra Leone where the tape described in this article was produced.

lation given by an interpreter, and this translation is used on the finished tape. During the final stages of my production a stop watch was the most useful accessory, as my commentary, introducing the translation, had to finish in time to allow my previously recorded interview (incorporating the translation) to follow on naturally. After three takes it did!

The two Gambians played Koras, like a small primitive harp. These again were built on hollowed-out gourds across the top of which was drawn a skin. From the side of the gourd a stick rose some eighteen inches and to this were attached about 25 strings drawn down onto the gourd and the stretched skin. A small metal sheet with wire strips, described earlier, is attached to the front of the instrument, giving the same cymbal-like effect when the strings are "stroked" by the performers. The players also sang, although with a little less power than the Madingoes, and satisfactory balance was obtained by holding the microphone just below and about nine inches from the koras, and about four feet from the singers' mouths.

This then was the music—but now to put it together. A golden rule I had learnt in conversations and discussions with BBC Talks Producer Jack Singleton told me that any commentary had to amplify (please excuse the unintentional pun!) the sound picture not describe it. After several rough drafts a final script was prepared and timed. The script without the sound was colourless, but with it it had life, likewise the sound had added colour when linked with the narrative—this, I believe should be an acid test for sound documentaries.

A whole weekend, during which my wife operated the recorders and mixer while I concentrated on the stop-watch and script, and the seven sections were completed. A further afternoon editing these sections together and the tape was completed.

**AMERICA'S ONLY  
TAPE RECORDING  
MAGAZINE**

Since 1953, this magazine has totally been devoted to tape recording. In addition to its timely articles, our columns also feature:

- Tape Reviews
- New Products
- Industry News
- Questions and Answers
- Feedback (letters from readers)
- Crosstalk (an editorial)
- Club News (tape correspondence clubs)
- Tape in Education
- Book Reviews

A one year subscription, including overseas postage, \$4.75

**TAPE RECORDING**

SEVERNA PARK,  
MARYLAND, U.S.A.

**Tape-to-Disc  
Services**

**RAPID  
Recording Service**

78s and L.P.s. from your own tapes. (48 hour service). Master Discs and pressings. Recording Studio. Mobile Recording Van. Associated Company—

**EDUCATIONAL RECORDINGS LTD.**

Specialists in Sleep-learning and Audio Learning. Tapes on Mind Management; Positive Personality; Memory Training; How to Pass Examinations. Manufacturers of the "Sleep-o-matic Unit" to be used with our Sleep-learning tape. Foreign language courses available for sleep-learning.

Brochures on request from:—

RAPID RECORDING SERVICE (Dept. TRG)  
21 Bishops Close, Walthamstow E.17 COP 3889

**IF QUALITY AND DURABILITY MATTER**

(especially with L.P.s from your precious tape recordings) consult Britain's oldest transfer service.

If minimum 20 identical copies are required, we can manufacture hard-wearing commercial pressings with your own labels. (Excellent fund-raiser.)

... also consult Audio Supply Association for unbiased information on reliable recording and reproduction equipment to suit your specific requirements. Members receive information on latest products and also benefit from special bulk purchases of tapes, equipment, accessories. (Membership 7s. 6d. p.a.). Please specify requirements for first free consultation.

**SOUND NEWS PRODUCTIONS**

10, Clifford Street, New Bond Street, London, W.1. REG 2745.



ALAN EDWARD BEEBY'S

## TAPE TALK

I'VE been asking Mr. R. N. White, the General Marketing Manager of E.M.I., about the possibility of HMV extending the range of their recently-issued "FX" sound effects series. He told me: "We are certainly not averse to increasing our sound effects library, but so far, the demand for effects other than those already available is very small. Perhaps your readers would care to suggest some effects that are really needed, and which are likely to be of interest to the majority of recording enthusiasts." Well? Which items would you like to see issued?

Mr. White added, however: "Whilst we would be pleased to receive suggestions for new effects, there can be no guarantee of production. As you will appreciate we are still a commercial company, and have to assess the sales-potential of each record we issue very carefully." So there it is. Seems we're in the minority as customers. Mind you, if it was "Twist" discs we were after. . . .

Incidentally, whilst on the subject of the HMV effects—have any of my readers had a really close listen to the "rain" item? Roughly half a minute after the start, there's the unmistakable sound of—a wolf-whistle! One of the lads on the location-unit unable to keep his mind on the job in hand. . . .?

\*\*\*\*\*  
"WHAT THE DEVIL. . .!" DEPARTMENT: "S'cuse me," said the man at the door, "but I understand you're summat to do wi' tape recorders." I admitted my guilt, and he swung an ancient Philips in my direction. "Gone wrong," he explained. "Can't get it to light up nor nothing. And the wheels" (I winched) "won't go round neither. Would you have a look at it for me?"

So I had a look at it. In fact, I had TWO looks at it—because I couldn't believe it the first time! Underneath the deck-plate, a treasure-trove indeed! Two hair-pins, one drawing-pin, tea-leaves, three pearl beads, an old ball-pen refill, strands of loose wire, and the broken shaft of a small screwdriver! Explanation? "Well, you know what kids are. I s'pect they've had a bit of a game with it, like. . . ."

For me, legislation in the form of compulsory "driving-tests" for prospective tape recorder-owners can't possibly come too soon!

\*\*\*\*\*  
I CAN offer a gleam of hope to the U.N. pessimists. If the working parts of Comrade Khrushchev's multi-megaton firecrackers are as reliable in performance as the average Russian tape recorder, we have little to worry about.

An acquaintance of mine visited Moscow some time ago, and brought one of these machines home with him. Following is a brief chronicle of its short, undistinguished period of service:

First week: Carrying-strap split in half. Second week: Selector-knob cracked open. Third week: Recording-level indicator started telling lies. Fourth week: Drive-belt snapped. Fifth week: Mains-lead obtained divorce from chassis. Sixth week: Loud hum evident alongside recorded signal. Seventh week: No trace of hum any more—or recorded signal! Eighth week: You want me to go on. . . .?

NOTE: Can state categorically, no truth whatever in rumour Kennedy and Macmillan forming Recorder-Manufacturing Company based in West Berlin!

\*\*\*\*\*  
"GUNPOWDER, TREASON. . . OR WHAT?" I accept no responsibility whatsoever for passing on the following comment. It was put to me recently by someone quite well known in recording circles, but who has asked that his name be withheld. (The front-windows of his house measure roughly 36 x 36 inches, and cost £2 each to replace!)

He said—and I quote: "Tape recording's not nearly so popular as some people try to make out, you know. Nor are tape clubs. Three-quarters of 'em got so committee-conscious, they voted themselves out of existence; the rest simply struggle on with a hard core of genuine enthusiasts, just to keep up appearances. Seventy-five per cent of lone enthusiasts spend half the time blowing 'explosions' down the mike, and playing it back to Aunt Ethel to show her how clever they are, and the other twenty-five still have the original tape which came with the machine, containing nothing but snatches of, 'Testing. . . 1-2-3-4' and one or two ancient 'pops' recorded from the radio—via microphone, of course!"

Well, don't look at me—I didn't say it!

\*\*\*\*\*  
I PURCHASED a small three-inch "self-mailer" tape the other day, the carton of which carried the following inscription: "This box contains a reel of magnetic recording tape with a recorded message. May be opened for postal-inspection."

Now, I know, of course, that any letter or parcel despatched through the mail is subject to search, with or without the sender's permission. But for someone completely outside the Post Office Authority to take the liberty of offering my personal tapes for official checking has a nasty smell about it.

Kindly turn this little lark in!

VERY few things happen at the right time, and the rest do not happen at all. So, it is reputed, Herodotus observed, about twenty-two centuries ago. He went on to hint that historians would probably put this temporal defect right, but he might as well have been talking about the tape recorder addict, who has an inbuilt sense of time.

Getting things to happen at the right time is largely a matter of cueing. Anyone who has been fortunate enough to pay a visit to a professional film editing room, or the cutting and dubbing department of a television studio, will have seen that the secret is accurate, well-tabulated measurement. It is all very fine getting Cousin Joe to watch your down-swinging finger; but if Cousin Joe stutters or is too busy swigging his ale to follow your cue, you are left with the problem of editing.

A problem which is exceedingly onerous without a trustworthy tape position indicator.

This subject has been raised by several readers, among them T. B. L. of Dover, and V. W. of Launceston, who both ask: "What is the best sort of tape position indicator?" It may not at first seem the duty of the Service Bureau to attempt an answer, but if the ideal can be defined as one which "gives an exact indication of tape position at any moment," it will be seen that a lot depends on how the information is to be obtained, and what is likely to go wrong with any device that does this job.

Some of the older machines had a scale marked on the top-plate; one spool overlapped the scale so that it was possible to observe the amount of tape on the spool by looking directly downwards and noting where the circumference of the last turn "cut" the scale.

Such a method can only be approximate. So much depends on the angle of observation, and what might be called "parallax error" can make a difference of a couple of turns. At the loaded part of the scale, this could mean a variation of two or three seconds in playing time, which is quite intolerable to the poor chap who has to do the tape editing.

A development of this idea, was the scale which was read off by a moving finger. This finger was pivoted to a lever which rested against the outer edge of the tape on the spool, and was lightly sprung to maintain the pressure. Such a device would be quite simple to construct, but is subject to a serious error, as before. The problem is that spooling is not always constant, especially if the tape has been rewound at a faster speed. Some decks, in fact, are notorious for their loose spooling during fast forward or reverse winding. Under these circumstances, the tongue would cause the lever to give an indication erring on the plus side.

Moreover, with tape as thin as it is today, the amount of lever movement

# GETTING THE MEASURE!

HARRY MACK offers more advice and answers readers queries.

for one turn of tape (which is more than twenty inches on a fully loaded seven-inch spool) could be less than the thickness of the indicator itself.

Many spools have footage engraved along the radius of a flange, providing a handy indication of the amount of tape seen through the transparent material of the spool. As with deck-scales, this can only be an indication, and refers only to the particular make of tape originally provided on that type of spool—when wound on at the correct tension.

A method of producing this scale on one's own spools has been requested by T. J. of Leeds, who says that all he needs is a rough indication of "the quarters and halves." Reference to Fig. 1 may help him.

Here we have a sector of a spool, with a line drawn along the radius of the flange, passing through the centre, O. (The actual construction can be done on paper, taking measurements from the spool. Only a ruler and a compass is required).

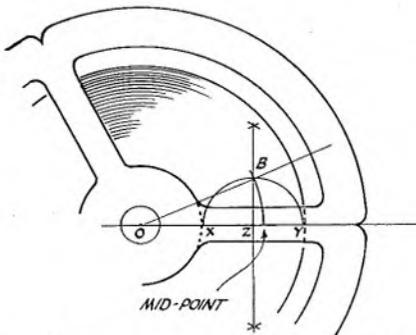

Fig. 1. Footage engraved on the tape spool.

On this line, first mark off the distance from the centre of the spool hub to the beginning of the tape; call this point X. Then measure and mark to the outer turn of tape on the fully loaded spool; call this Y. Bisect XY and call the mid-point Z. On this point, describe a semi-circle and produce the bisector from Z to cut the semi-circle at B. Now, with the true centre O and the length OB as radius, describe an arc to cut the XY line. This is the mid-point of the tape footage.

Further points can be obtained by bisecting XC and CY in the same manner. A scale thus drawn can be glued to the flange for approximate measurement.

The types of tape position indicator in general use are those which act as revolution counters. There are two principal types: the "clock" counter, of which a good example is the Smiths clock as supplied as an accessory to the Garrard Magazine Deck, for mounting on the hub of the take-up spool; and the digital rev. counter, as used on many machines in various forms.

Both clock and digital counters can be belt driven, with very light mechanical loading, and gears calculated to indicate one digit per foot, or even less. In personal reply to T.B.L. and V.W., I would say that I favour the clock indicator as giving a more direct at-a-glance indication of tape usage, particularly when fast winding and watching for a cue-point. However, the fitting of a tape position indicator depends principally on the space available, and the degree of neatness one expects. In this respect, the digital type scores, needing only a couple of slots at right angles, for the zeroing disc and the "window."

A rough sketch of a typical digital counter is given at Fig. 2. This is a three-digit type; some machines have a finer accuracy and employ a four-digit, but the principal remains the same. The belt, B, drives the pulley, P, which turns the worm drive cog W. This engages the primary drive cog C, which turns the first numbered disc, either directly or through a further reduction gear. One face of each disc is toothed, the other bears a trigger T. When the trigger reaches the rocker R, it trips and moves the adjacent numbered disc one digit.

Thus, one complete revolution of the left-hand disc in Fig. 2 results in the movement by one digit of the second disc, and one complete revolution of the second disc trips the third disc one digit. As each disc is numbered from 0 to 9, the total numbering available is 000 to 999. The final, milled disc on the right is used to zero the discs by ratchet action.

The first point to note is that the drive depends on the belt, which should be sufficiently tense to obviate slipping, but not impose too great a load on the drum, spindle or pulley on which it is looped. The usual arrangement is a loop on either feed or take-up spool drum. This means that the rate of progress of the numbered indication from empty to full decreases, as each revolution of the spool takes on slightly more tape, due to the increasing radius. Variations in tension, such as are inevitable when rewinding quickly, then replaying, cause further errors in the readings.

The answer, one reader suggested, is to drive the tape position indicator from the capstan pulley. But he has overlooked one important factor. The tape is not driven by the capstan during fast winding, and thus would have to be re-zeroed and calculated each time the tape is rewound. This is less practicable than allowing for the small errors or progressive variations of the spool drive system.

There are two alternatives. One is to construct a form of drive such as is used in the Stuzzi, where the main drive turns a gear and worm drive assembly, moving a pointer along a track scale right across the width of the machine, the track drawn to allow for the varia-

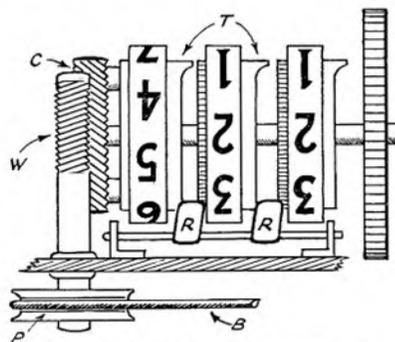

Fig. 2. Typical digital counter.

tion. The other is to add a pulley, driven by the tape, or capstan, and drive the position indicator pulley from this. Such an arrangement imposes a further loading on the tape transport system, and can lead to wow, although this is less likely if the indicator's prime pulley is mounted after the capstan and before the take-up spool.

Undoubtedly, the ideal method, exact indication and no load at all, is that suggested by a writer of light-hearted trade comment, in an electronic magazine. He suggested a marking on the glossy side of each tape, at one-inch intervals, scanned by a photo-electric eye, whose signal feeds an electronic counter. He tactfully shied away from the problem of costs—and perhaps as well, for both tape and tape-decks cost us quite sufficient already.

From the point of view of servicing, tape position indicators are not particularly troublesome. There are occasions when belts break or cogs chip and subsequently miss a beat, but these are faults cured by replacement. The sort of trouble that T.T.L. of Barnes has, "a persistent ticking" can be one of the less obvious faults. Its source is simply proved—remove the drive and note if the ticking stops. Then, switch the machine off and with the belt removed, turn the pulley by hand. This will prove whether the belt is causing the fault: a common enough "teaser" on some of the older machines.

Beware the makeshift belt. It may be too taut. Although giving a fine indicator action, such a device also puts too much load on the spool drum from which the driving torque is derived. If it is too slack, besides the erratic drive to the indicator, which is obvious, there may be excess of friction at the spool during light loaded periods, i.e., as spool nears empty condition.

If the drive is correct, check the cleanliness of the ratchet components. Quite a small piece of grit in the centre spindle channel can interfere with the light plastic cogs of the trip mechanism. The only point at which grease might be applied with good effect is at the bearing through which the worm drive passes. Similar procedure applies on clockdrive mechanisms, with the additional point that cogs and ratchets are usually metallic, and a light oil on pivot points can be of some help after a long period of use.

## NEW POPULAR MUSIC ON TAPE



By DON WEDGE

of "New Musical Express"

**DAKOTA.** Dakota Staton. World Record Club (TTP 222), 3½ ips, mono. (Introductory offer only.)

It is worth joining WRC just to get this record. It is magnificent. It is pop singing (and playing) at its highest level.

It is not hard to enthuse over the work of Frank Sinatra, Peggy Lee, Nat Cole, Ella Fitzgerald and a few others who can be heard on tape. They and their records are well known and rarely fail to please.

Dakota Staton does not have the reputation of these greats. But on this record she can stand alongside them. Most of her songs are fresh and unswayed by having been over-recorded. Several are blues. Only two *Pick Yourself up* and *I'll Close my Eyes* are very familiar.

*Meet Me at no Special Place* is the highlight for me. It is done with a fervour that only Lena Horne could equal.

The backings of all the songs is in perfect sympathy with the singer. WRC does a great disservice to those responsible for the scores by not naming them.

There is no finer ten-shillings-worth of pop music on the market. I understand that unfortunately existing WRC members cannot obtain the record. They should get a non-member friend to join. It would be well worth it.

\* \* \*

**GEORGE SHEARING WITH DAKOTA STATON.** World Record Club (TTP 196), 3½ ips, mono. (Introductory offer only.)

Primarily a showcase for George Shearing with varying groups, this does not show off Dakota Staton to quite the same advantage.

Her two numbers are blues—*Confessin' the Blues* and *Blues in my Heart*. On both she has a disconcerting tendency to shout. Although this is permissible, it hardly matches the smooth, velvety sounds that are the Shearing trademark.

The British-born piano star is heard in some of his more famous specialties—*Autumn in New York*, *Yesterdays* and *Cuban Carnival*, for instance. The best of the traditional Shearing sound is *Goodnight My Love*, but most unusual is the blend with Jean Thielmans' harmonica in *The Man I Love*.

\* \* \*

**GIGI and FUNNY FACE.** Ian Wallace, Maggie Fitzgibbon, Laurie Payne, etc. World Record Club (TT 191), 3½ ips, mono.

Here WRC provides a concert version of two highly successful musicals. "Gigi," featuring Ian Wallace, Maggie Fitzgibbon, Laurie Payne and others, is the most vulnerable as the actual original film soundtrack is available on tape with

such performers as Maurice Chevalier and Hermione Gingold.

It's asking a lot to match the quality of the original. As this is comparatively recent, there is nothing to be gained in the way of modernisation.

"Funny Face" is much different and has a lot to recommend it, especially Scott Peters, a Sinatra-type singer who is particularly effective in *He Loves and She Loves*, a George and Ira Gershwin song which could well be heard more frequently.

Once again, one of the best things on this record is the arrangements written and conducted by Bobby Richards.

\* \* \*

**MARIAN'S MOODS.** The Marian McPartland Trio. World Record Club (TT 192), 3½ ips, mono.

Britain's contributions to jazz are minor compared with America's. Nevertheless, few dispute that we have provided the world's finest girl pianist, Marian McPartland—although she had to go to the USA to be recognised.

Her strident keyboard approach is show cased on the twelve titles of this album. Most are standards such as *I Hear Music*, *Lush Life* and *Skylark*. This makes it a dual purpose record—something good to listen to and excellent background music as well.

Most unusual sound is on *I've Told Every Little Star* when Marian's trio is joined by cellist Joe Keutzen.

\* \* \*

**MUTINY ON THE BOUNTY.** Original sound track recording by an orchestra conducted by Robert Armbruster. M.G.M. (TA-M.G.M.-C 913), 3½ ips, mono.

Bronislaw Kaper's score for this epic film is worth listening to as a record. The theme in particular has a haunting memorable quality.

The love song from the picture ("Follow Me") is given in two versions—the native Tahitian and by an English-speaking choir.

Some of the Tahitian native music is among the record's most interesting aspects.

\* \* \*

**"OUT OF THE SHADOWS."** The Shadows. Columbia (TA-33SX 1458), 3½ ips, mono.

Britain's most popular instrumental group demonstrates in this recent album

(Continued on page 33)

# THE ULTRA 6200

BY

## JOHN BORWICK

**T**HIS new tape recorder is the first to be produced by a firm whose name is already well-known and respected in the TV and Radio fields. The machine is completely new, that is, it does not use one of the existing deck units but has been designed from scratch.

The specification shows this to be a very versatile little recorder, and the range of facilities so exactly fits the modern tape user's requirements that Ultra have evidently conducted a careful market research beforehand. The two speeds—3½ ips for acceptable musical quality; 1½ ips for economy—are what the majority of domestic users want. The four-track system gives further economy and allows you to play a number of useful tape tricks—particularly when the track switching is done as it is here.

A pair of buttons is used. When the 1-4 button is depressed, you record or playback on Track 1 (or Track 4 when the tape spools are swapped over). Similarly, you depress the 2-3 button to record or playback Track 2 or 3. The beauty of this two-button system, compared with the usual changeover switch, is that you can depress both buttons on playback and so reproduce Tracks 1 and 3 (or 4 and 2) simultaneously. This allows you to add background music or a spoken commentary to a previous recording, while keeping the two items separate and intact.

The ordinary superimposing facility is also included. Pressing a button marked "A" during recording cuts out the erase current, so that you can automatically superimpose one recording on another without wiping the first. But don't do what I did. With the microphone plugged in ready to record, and the volume control wound up to an average setting, I pressed button "A." The result was an almighty howl.

## BORROW YOUR RECORDS BY POST

TED HEATH, BILLY VAUGHN, DAVE BRUBECK, ERROLL GARNER, GEORGE SHEARING, COUNT BASIE, DUKE ELLINGTON, NAT KING COLE, FRANK SINATRA, ELLA FITZGERALD, PEGGY LEE, MANTOVANI, SOUTH PACIFIC, Etc., Send names of artists in whom you are interested with 5s. postal order for loan of 1 LP for 4 days (6d. a day hire charge plus 3s. postage), or 9s. for 3 LPs. Do you have stereo equipment?

LP DEPT, 1, BURFORD AVENUE, STOCKTON-ON-TEES

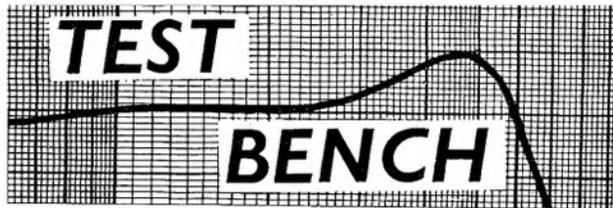
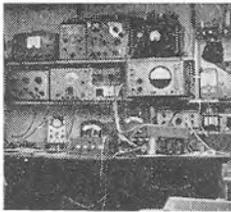

The normal function of the "A" button is to turn the tape recorder into a straight-through amplifier, for broadcasting announcements in a large room or boosting the output of a radio tuner, gramophone pickup or telephone adaptor over the loudspeaker. So my terrific howl (or should I say "howler") was due to my switching to "Amplifier" with the microphone too near the loudspeaker. Once I switched to "Record," however, all was well and I found that commentating over music was child's play, the level of the music being only slightly reduced by being recorded over.

An unusual facility provided on this machine is the remote "on/off" slider switch fitted on top of the microphone. Judging by the ingenious methods I have heard of amateurs using to fit remote control to their machines, this is a much-needed facility and a strong point in the Ultra's favour. Switching the microphone switch off, causes the pressure roller to move a fraction of an inch away from the spinning capstan, so that the tape comes to rest immediately. Switching on again gives a very quick start indeed, most useful for recording dictation or cueing in music or sound effects on playback.

By the way, the Ultra is one of the

two luminescent bands then overlap and give a clear indication. The three-digit position indicator has a re-set zero button. This may seem a small refinement, but since the user can re-set to zero in a single movement as he starts a recording, I believe he will be encouraged to use the indicator more frequently.

Automatic stop is fitted, but once again Ultra have refined the process. Not only does the machine switch itself off when it comes to the end of a tape during "Record" or "Playback" (provided the tape carries a piece of metal stop-foil), but it does so on fast winding or re-winding also.

#### TECHNICAL TESTS

The satisfactory listening quality obtained on various random recordings and a selection of tape records was confirmed by a series of frequency response tests, recording through each of the three input sockets (microphone, pickup and radio) and measuring the playback response at both the radio and external loudspeaker output sockets. The results took the form of the accompanying graphs, showing that the claimed frequency range is maintained and demonstrating also that

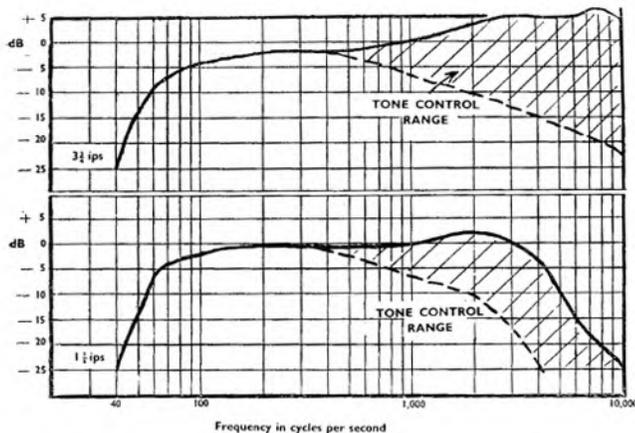

The record/play-back frequency response of the Ultra 6200 tape recorder. Top at 3 1/2 ips, and bottom at 1 7/8 ips.

decks in which the motor (and capstan) run continuously as soon as the mains is applied to the machine. This has the advantage of quick starting, and is standard to heavy duty professional recorders, but does mean that a slight rumbling noise can be heard even when you are not recording or playing back. The noise is more noticeable when the speed selector switch is at 3 1/2 ips and of course if you stand the recorder on a wooden table.

The recording level and tape position indicators are very satisfactory. The former is a magic eye type and although it flickers very rapidly, the overloaded condition is infallibly shown because the

tone control gives both boost and cut off high frequencies. The setting for a flat response is about the half-way mark, but may be adjusted to taste.

The fast wind and rewind times were three minutes ten seconds and three minutes five seconds respectively for the reel of tape supplied.

#### ANY COMPLAINTS?

It seems slightly niggling that whereas the Operating Instructions list the playing times for 5 1/2-inch spools (1,255 feet and 1,700 feet of Long Play and Double Play tape respectively), the quoted fast wind



times are for 850 feet—the length of tape which is actually supplied with the machine "loaded on a 5 1/2-inch spool."

I have no complaints about the facilities incorporated in this recorder which are bang-up-to-date and make the machine as versatile as one could wish. The technical performance too, is well up to specification.

The price is 33 gns.

#### MANUFACTURER'S SPECIFICATION

Tape Speed: 3 1/2 and 1 7/8 ips.

Maximum Spool Size: 5 1/2-inches diameter.

Playing Time (four tracks): Long Play (1255 ft.) four hours at 3 1/2 ips, eight hours at 1 7/8 ips. Double Play (1700 ft.) six hours at 3 1/2 ips, twelve hours at 1 7/8 ips.

Magnetic Heads: Standard quarter-track. One Record/Play, one Erase.

Tape Position Indicator: Digital Type with reset button.

Fast Wind Time: 2 1/2 minutes in either direction for 850 feet of tape.

Power Supply: 200-250 volts AC, 50 cps.

Power Consumption: 60 watts.

Audio Output Power: Three watts.

Frequency Range: 60-10,000 cps (3 1/2 ips), 60-6,000 cps (1 7/8 ips).

Input Sockets: Microphone (MIC) 1.5 mV into 10 M ohms; Radio (RAD) 1.5 mV into 22K ohms; Pick-up (PU) 75 mV into 1 M ohm.

Output Sockets: Low level (RAD) 500 mV at 22 K ohms. External Loudspeaker, three watts at three ohms. Note: When this socket is used, the internal loudspeaker is automatically muted.

Accessories Socket: 30 Volts DC (50 mA). Remote Pause. Radio Output (1.5 mV into 22 K ohms). Record Output (without bias). Head Winding (track not in use).

Dimensions: 14 x 12 1/2 x 7 inches.

Weight: 19 lb.

Loudspeaker: 7 x 3 1/2-inches permanent magnet elliptical.

Manufacturers: Ultra Radio and Television, Television House, Eastcote, Ruislip, Middlesex.

## Tape Reviews by Don Wedge

(Continued from page 30)

just why it holds the title. The Shadows are not just an accompanying act to Cliff Richard. They have a lot of merit of their own.

Five of the thirteen tracks were written by one or more members of the group. A sixth, *Some are Lonely*, came from its featured singer Cliff Richard. The contrast between the numbers demonstrates a high degree of versatility.

The group sings as well as plays the Mike Carr-Jimmy Kennedy standard *Bandit*, Elias McDaniels *Bo Diddley* and—here it sounds as if Cliff Richard helps them—*Are They All Like You*.

Instrumental titles range from *Tales of a Raggy Tramline* to an exciting *The Rumble*. The Spanish *Perfidia* gets a freshening up when the Shadows' "sound" is applied.

Brian Bennett's feature, *Little "B"*, is exciting and far more interesting than most drummers' solos.

But the track that appeals to me most is *Cosy*, which is just what it says it is and far removed from the general impression of raucous sounds being essential for a guitar group. This is quite erroneous and "Cosy" should finally dispel it.

\* \* \*

**SARAH VAUGHAN SINGS ALL-TIME FAVOURITES.** World Record Club (TIP 230), 3½ ips, mono. (Introductory offer only.)

What sounds to be a collection of old Sarah Vaughan singles is not the best showcase for the outstanding singer that we know her to be from her current disc albums.

Although these recordings sounds dated, Sarah Vaughan herself seems younger on her more recent albums.

There is none the less much that is worthwhile and, after all, the record only costs ten shillings. She is moving in *If I Loved You*, swings tremendously on *It's de-Lovely* and ventures into the country field with *I've got a New Heartache*, during which she is multi-tracked—singing with herself.

Again the arrangers and conductors are not named. But in this case it avoids apportionment of the blame for the weaker numbers.

\* \* \*

**STRANGER ON THE SHORE.** Mr. Acker Bilk with the Leon Young String Chorale, Columbia (TA-33SX 1407), 3½ ips, mono.

Disc-jockey David Jacobs, when leaving "Pick of the Pops" at the end of last year, said that he was glad because it would mean not having to play "Telstar" ever again.

The tapes reviewed this month are available from the following addresses:—

"Columbia," "HMV," and "MGM" from E.M.I. Records Ltd., 20, Manchester Square, London, W.1.

World Record Club, Box 11, Parkbridge House, The Little Green, Richmond, Surrey.

This was the tune that dominated the singles chart at the end of 1962. But the tune that was leader throughout the year was Mr. Bilk's "Stranger." Despite its great familiarity, I have never heard anyone complaining about it even in the mildest way.

Bilk's single record of it has sold more than two million copies throughout the world. Throw in sales of this album and the total would near three million. Certainly it will reach that mark one day.

Here then on tape and without too much delay is the outstanding tune of last year, performed by the artist who made it popular.

It is coupled with a lot of well-known tunes, none as melodically strong as "Stranger" but all getting the same treatment of Mr. Bilk's slow, thoughtful (but only occasionally inventive) clarinet, backed by Leon Young's interesting arrangements for strings and rhythm section.

Although I prefer Bilk with his Paramount Jazz Band, it was a pleasurable experience listening to him string-shrouded. Most of the tunes are familiar—*Sentimental Journey*, *Deep Purple* and *Carolina Moon*—and there are some interesting arrangements of such traditional (in the folk sense) airs as *Greensleeves* and the spiritual *Nobody Knows*.

\* \* \*

**"WEST SIDE STORY."** By Ferrante and Teicher and their Orchestra. H.M.V. (TA-CLP 1505), 3½ ips, mono. 35s.

Only the first track is from "West Side Story." For the second, the famous American piano duetists recall famous songs from other films.

The music is performed rather more lightly than Melachrino handles his similar material: throughout it is dominated by the pianists' frothy keyboard techniques, but it is far more pleasant to listen to and is admirably recorded.

Hi-Fi HARRY by rich



"I like your first attempt at synchronising sound with your films, but I'm sure that cow shouldn't tweet!"

## YOUR LOCAL DEALER

# LONDON

## HI-FI CENTRE

Branch of KINGS ELECTRONICS

178, HIGH STREET, E.17

Walthamstow's Leading Stockist of all makes of

## TAPE RECORDERS

AMPLIFIERS, TUNERS, etc.

Free Demonstration in the comfort of your own home

'PHONE AMH 6242 or COP 4488

## Lee Electronics

THE TAPE RECORDER & HI-FI AUDIO SPECIALISTS

400, EDGWARE ROAD, LONDON, W.2

London's leading Stockists of High-Fidelity and Audio Equipment. Many Bargains in new and reconditioned Equipment

SEND FOR FREE LISTS OF RECORDING TAPES, RECORDERS, AMPLIFIERS, ETC

All Machines demonstrated for performance on Record and Playback. All leading makes of Hi-Fi equipment from stock

PADDINGTON 5521

- ★ TAPE RECORDER HIRE
- ★ TAPE TO DISC 78 & LP
- ★ RECORDING STUDIO
- ★ TAPE RECORDER REPAIRS
- ★ SALES—EXCHANGES

## MAGNEGRAPH

1, Hanway Place, London, W.1.  
Tel.: LANgham 2156

Leonard G. Francis presents—

## SHEEN

TAPE RECORDER CENTRE LTD.

Specialists in Tape Recorders and Accessories etc.

—THE CENTRE FOR—

FRIENDLY HELP — SALES — SERVICE  
HOME DEMONSTRATIONS ANYTIME  
— MODELS FROM 19 GNS.—  
PRE-RECORDED TAPE: LANGUAGES  
DANCE . CLASSICS . JAZZ

CALL—WRITE—PHONE

8 Station Parade, Sheen Lane, Sheen, London, S.W.14 (next to Mortlake Station, S.R.)  
Showrooms: PROSPECT 0985 10 a.m.—7 p.m.

## YOUR LOCAL DEALER

### MIDLANDS

#### Audio Electronics (Midlands) Ltd.

Specialists in Dictation Mcs., Tape  
Recorders, Inter-Com., Tapes and  
Accessories

Full After Sales Service on all Equipment

PHILIPS, GRUNDIG, TRUVOX,  
ELIZABETHAN, ETC.

203 STAFFORD STREET,  
WALSALL. Tel.: 21086

### SOUND BUSINESS

Specialists in  
Sound Reproducing Equipment  
Stockists of Butoba, Grundig,  
Sony, Tandberg, Vortexion, etc.

Backed by a  
First-Class Service Department

### TYSONIC

W. M. Tyson, M.Brit.I.R.E.

41 Russell St., Leamington Spa  
phone 24935

### THE NORTH

#### CUSSINS & LIGHT LTD.

YORK'S LEADING RADIO  
TV & ELECTRICAL STORE

Visit our First Floor  
TAPE RECORDER  
CENTRE

LARGEST RANGE  
OF RECORDERS  
& ACCESSORIES  
IN THE NORTH

KING'S SQ.  
YORK



#### TAPE RECORDER CENTRE (Halifax)

stock all the best tape re-  
corders and hi-fi equipment.  
Agents for Revox, Tandberg,  
Ferrograph, etc. Demon-  
strations by expert staff.  
Two years' free service on  
recorders over £35.

30 King Cross St., Halifax. Phone 66832

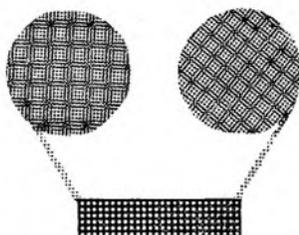

## NEW PRODUCTS

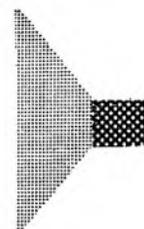

### NEW STEREO RECORDER

A NEW stereo tape recorder has been introduced into the Uher range. This is the Uher Royal Stereo, illustrated below, a four-speed, four-track machine.

The quoted frequency response at each of the four speeds is as follows: 50-20,000 cps at 7½ ips, with the top range being decreased to 16,000 cps at 3½, to 8,000 cps at 1½ ips, and to 4,000 at 15/16 ips. Wow and flutter is rated at 0.15 per cent at 7½ ips, and cross-talk at 50 dB.

It will accommodate up to seven-inch spools, providing a playing time of over 32 minutes per run, using standard play tape at 7½ ips when recording or playing stereo, or 32 minutes per track when used monaurally.

Among the many features is a built-in two-channel mixer unit, for mono or stereo use, and an impulse transmitter for fully automatic slide control, or electrical equipment controlled by impulses. Facilities for monitoring mono

control, and an interlocking pause control.

Inputs are provided for three low impedance microphones, radio, and pick-up. Outputs are provided for headphones, two extension speakers, and for remote control. There is also a double 2 watts push-pull output stage.

The power supply is 110/130/150/220/240/250 volts, 50 cycles. Conversion to 60 cps is possible. Rated consumption is thirty watts.

The Uher Royal measures 14½ x 13½ x 7 inches, and weighs 23 lb. The price is £141 15s.

Bosch Limited, 205, Great Portland Street, London, W.1.

### MUSIC ON TAPE

TAPE Recordings (London) Limited announce they have discontinued the distribution of Recotape and Esoteric tape records, orders for which should now be sent to Esoteric Productions Ltd., 22, Coastal Chambers, Buckingham Palace Road, London, S.W.1.

Tape Recordings London are now concentrating on the presentation and distribution of Music on Tape, which they can still supply on a same-day delivery basis.

The entire Music on Tape range is in the process of being reboxed in eye-catching coloured boxes, and there will be news shortly about impressive future releases including the Scroll series of classical music.

Tape Recording London Limited, 188, Vauxhall Bridge Road, London, S.W.1.

### CORRECTION

ON page 17 of the April issue a photograph of the Ferguson 3202 tape recorder was published above details of the 3200 tape recorder. In fact, the 3202 model has two speeds, 3½ ips, and 1½, and costs 33 guineas. We apologise for any confusion this may have caused.



and stereo recordings both before and after the recording are also available. Other features include echo facilities, multiplay, public address, combined volume/tone control, balance remote

## NEWS FROM THE TRADE

OSMABET LTD., announce an increase in price for their "Instant" bulk eraser. As from April 1 this will sell at £1 15s.

Osmabet Ltd., 46, Kenilworth Road, Edgware, Middlesex.

A PRICE reduction in the recorded sound effects "Tapesounds", is announced by Sound Recordings. Owing to the increased demand for "Tapesounds", they are now able to offer them at 9s. 6d. per catalogue item, instead of the original production price of 12s. 6d.

"Tapesounds" are ideal for dramatic and cinema productions. Full details and a catalogue are available from the producers.

Sound Recordings Stratford-upon-Avon, 14, Hathaway Hamlet, Shuttery, Stratford-upon-Avon, Warwickshire.

A LIQUID, designated Rocket WD-40, described as an organic liquid that displaces moisture in contact with metals and provides a moisture barrier is announced by Suntester Ltd.

Corrosion and rust prevention, penetration, and

lubrication are other claims for the chemical compound which affords complete corrosion control of electronic motors and systems without the costly process of dis-assembly and re-assembly.

Further details regarding price and application are available from the manufacturers.

Suntester Ltd., Rippleside Commercial Estate, Ripple Road, Barking, Essex.

LOCKWOOD & Co. (Woodworkers) Ltd., announce that they are no longer representing Fisher Radio International Inc., and all inquiries for Fisher products should now be addressed to 21-21, Forty Fourth Drive, Long Island City 1, New York, USA.

TECHNICAL SUPPLIERS LTD. announce that they are now in a position to supply from stock drive belts for all models of the Körting tape recorder. The drive belts, which until now have been imported from Germany, are now being moulded by a British manufacturer for T.S.L.

Technical Suppliers Ltd., 63, Goldhawk Road, Shepherd's Bush, London, W.12.

# STEREO RECORDER FROM NORWAY

**A**N all-transistorised printed circuit tape recorder manufactured in Norway is announced by Denham & Morley.

The new machine, Siemens stereo Model 10 is a three-speed, four-track model. The quoted frequency responses all  $\pm 2$  dB are 50-18,000 cps at  $7\frac{1}{2}$  ips, 50-11,000 cps at  $3\frac{1}{2}$  ips, and 50-7,000 cps at  $1\frac{7}{8}$  ips. Wow and flutter is given as less than 0.1, 0.13, and 0.15 per cent rms respectively. The signal-to-noise ratio is given as 52dB unweighted.

Up to seven-inch spools can be accommodated, providing a stereo playing time of 64 minutes at  $3\frac{1}{2}$  ips using standard-play tape, or double this for mono recording.

Among the features are digital rev. counter, pause control, separate bass and treble tone controls, automatic tape end stop by using stop foil, and facilities for remote control. This is achieved by an internal relay activating the stop/start mechanism which can be operated as a push button on the microphone, or a foot control. Two V.U. recording level meters are incorporated.

Other facilities include the ability to transfer a stereo recording into mono during playback by connecting the two amplifier channels in parallel; and three heads for record/playback and erase.

Inputs are provided for two microphones (1mV into 5 K ohms), or one stereo microphone (two  $\times$  1mV into 5 K ohms), radio (two  $\times$  10 mV—25 K ohms), pick-up (two  $\times$  300 mV into 680 K ohms), and mixing for three inputs.

Outputs include low level (two  $\times$  0.5 V—2 K ohms), headphones (two  $\times$  100-

2,000 ohms), and loudspeakers (two  $\times$   $2\frac{1}{2}$  watts—4). Distortion figures are given as pre-amplifiers fully driven 0.5 per cent, third harmonics; and power amplifiers 1.5 per cent, third harmonics at two  $\times$   $2\frac{1}{2}$  watts.

Sixteen transistors and four diodes are used. These are two AC151 low noise, six AC151, two AC121, six TF78/30, and four RL31. The circuit also includes one B30C100 rectifier.

The mains voltage is 110-240 volts, 50 cycles, AC. 60 cycles models are available on request. Power consumption is rated at 50 watts.

The Siemens Model 10 measures  $15 \times 14 \times 7$  inches, and weighs 26 lb. It is available in three versions. Model 10 with one internal speaker costs 89 guineas, Model 12 with two internal speakers costs 93 guineas, and Model 14, with two internal speakers, and housed in a teak cabinet costs 87 guineas.

Denham & Morley Ltd., Denmore House, 173-175, Cleveland Street, London, W.1.

## DANSETTE ANNOUNCE BATTERY PORTABLE

**T**HE first battery tape recorder to incorporate the Garrard magazine loading deck is announced by Dansette who have introduced their Cadet.

This is a fully transistorised two-track two-speed machine,  $3\frac{1}{2}$  and  $1\frac{7}{8}$  ips, which accommodates a four-inch cassette, providing a total playing time of one hour using standard play tape at the slower



The Dansette Cadet

speed. The quoted frequency response is up to 5,500 cps at  $3\frac{1}{2}$  ips, and up to 3,000 cps at  $1\frac{7}{8}$  ips. Wow and flutter is rated at 0.2 and 0.3 per cent rms respectively.

Six U2 batteries provide an approximate playing time of fifty hours. Other features include a magic eye record level indicator, five transistors, combined tone control, and inputs for microphone and radio/pick-up.

The Cadet measures  $11\frac{1}{2} \times 5\frac{5}{8} \times 12$  inches, and weighs 10 lb. The price is 26 guineas.

Dansette Products Limited, 112-116, Old Street, Clerkenwell, London, E.C.1.

**YOUR LOCAL DEALER**

## THE SOUTH

### HAMILTON ELECTRONICS

HIGH FIDELITY TAPE RECORDERS

35 LONDON ROAD SOUTHAMPTON

TELEPHONE 28622

### PORTSMOUTH and SOUTHAMPTON

Tape Recorder Specialists

APPROVED AGENTS FOR:— PHILIPS - GRUNDIG - FERROGRAPH VORTEXION, ETC.

- ALL MAKES OF TAPE RECORDERS SUPPLIED
- ACCESSORIES AND HI-FI EQUIPMENT
- PART EXCHANGES AND SECOND-HAND MACHINES
- PROMPT AND SKILLED SERVICING

**RECORDING MACHINES LTD.**

299 Commercial Road, Portsmouth Telephone: 23097  
4 New Road, Southampton Telephone: 27092

## ELECTRONIC WORLD TAPE

**P**RIce changes for the list of Electronic World magnetic tapes is announced. The new prices are as follows:

**Standard-play** (Acetate base): Three-inch reel (175 ft.) 4s. 6d.; 4-inch (300 ft.) 6s. 6d.; 5-inch (600 ft.) 13s.;  $5\frac{1}{2}$ -inch (850 ft.) 16s.; and 7-inch (1,200 ft.) 19s. A seven-inch reel of polyester-based standard-play tape (1,200 ft.) costs 22s. 6d.

**Long-play** (Polyester base, Three-inch reel (225 ft.) 5s. 6d.; 4-inch (450 ft.) 10s. 6d.; 5-inch (900 ft.) 17s. 6d.;  $5\frac{1}{2}$ -inch (1,200 ft.) 24s.; and 7-inch (1,800 ft.) 31s. A seven-inch reel of acetate-based long-play tape (1,800 ft.) costs 28s.

**Double-play** (Special polyester base): Three-inch (375 ft.) 10s.; 4-inch (600 ft.) 15s.; 5-inch (1,150 ft.) 27s.;  $5\frac{1}{2}$ -inch (1,750 ft.) 35s.; and 7-inch (2,400 ft.) 45s.

De Villiers (Electronic World) Ltd., 16/20, Strutton Ground, London, S.W.1.

## MINIFLUX ELECTRONICS

**A** NEW range of low-loss Ferrite cored erase heads for quarter-inch tape is announced by Miniflux Electronics Ltd. The new range which uses the double-gap system, supersedes the earlier types as standard components. The professional three field types will now only be available by special order.

The heads cover half-track mono and stereo, and quarter-track stereo systems. A new type, designated LF60 is now included for use as an oscillator coil in a transistor bias oscillator circuit. All these new types show improved characteristics against the earlier issues, and the standardisation has resulted in a lowering of prices.

Miniflux Electronics Ltd., 8, Hale Lane, London, N.W.1.

## TAPE RECORDERS

(Bournemouth) LTD (Exeter)



Southern England's Biggest Centres for

PHILIPS . FERROGRAPH

GRUNDIG . TELEFUNKEN

BRENNEL . AND ALL LEADING MAKES

Accessories by return Call, write or phone

**THE TAPE RECORDER PEOPLE**

874 Christchurch Rd., BOURNEMOUTH Tel. 45096  
3 Seamoor Road, WESTBOURNE Tel. 64292  
1 Sidwell Street, EXETER Tel. 75779

## SCOTLAND

### GLASGOW

Tape Recorder Specialists

APPROVED AGENTS FOR:—

PHILIPS - GRUNDIG - FERROGRAPH VORTEXION, ETC.

- ALL MAKES OF TAPE RECORDERS SUPPLIED
- ACCESSORIES AND HI-FI EQUIPMENT
- PART EXCHANGES AND SECOND-HAND MACHINES
- PROMPT AND SKILLED SERVICING

**RECORDING MACHINES LTD.**

60 ST. VINCENT STREET, GLASGOW, C.2  
Telephone: City 3847/8

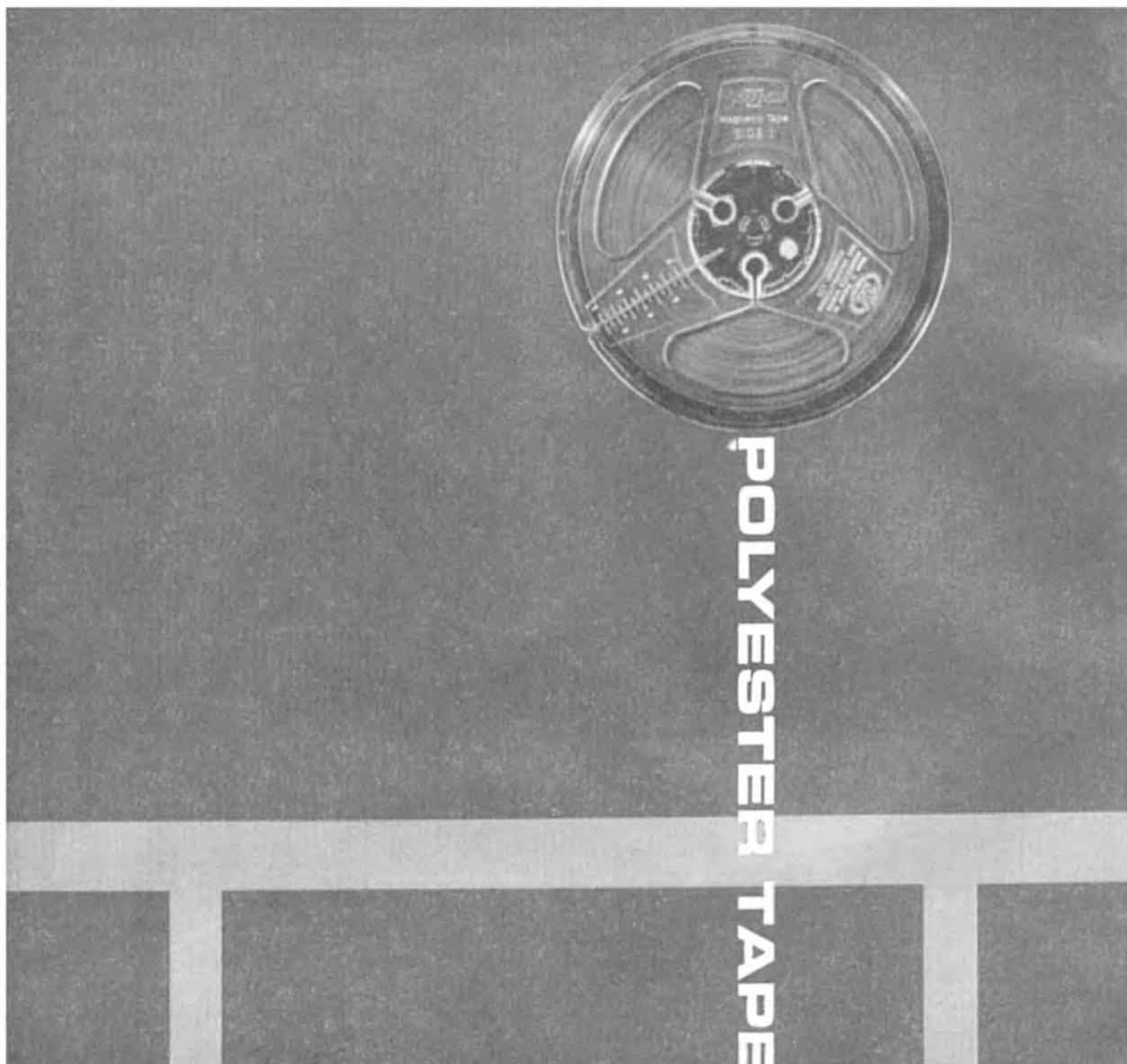

## A winner for the backing

You can't lose on Polyester backed "SCOTCH" Magnetic Tape. It's the great tensile strength of Polyester that makes the going good for extra stability and lasting high-quality reproduction.

Even experts agree to that. "SCOTCH" Magnetic Tapes — sound, video, instrumentation and computer — are their first choice every time. Leading disc makers use

them for cutting masters, while more than 90% of the world's taped T.V. programmes are recorded on "SCOTCH" Video Tape No. 379 with polyester backing. But "SCOTCH" Magnetic Tapes are far from reserved for experts. To professional and enthusiastic amateur alike, "SCOTCH" Polyester-backed Magnetic Tapes give everything to play for.

Trade Mark  
**Scotch Magnetic Tape**

POLYESTER RANGE: NO. 102 STANDARD PLAY. 150 EXTRA PLAY. 200 DOUBLE PLAY

**3M** MINNESOTA MINING AND MANUFACTURING CO., LTD. 3M HOUSE, WIGMORE STREET, LONDON, W.1. TELEPHONE: HUNter 5522

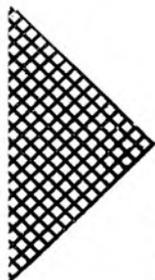

# News from the Clubs

## BOSTON

Two evenings of "sonic splendour" were staged by members of the Boston Soundhunters during February. Audiences of over 300 attended demonstrations of high-quality sound reproduction which were supported by six local dealers. Following an ingenious overture of popular signature tunes the two-hour programme was launched with a dialogue edited on the Jack Jackson lines. Stereo (and pseudo-stereo) was used both across the stage, and from front to back of the hall, sometimes together. Philip Towell compered the show, assisted by Les Brumpton, with his amusing script punctuated with various sound effects. These were produced dead on cue with a remote control made from an American bomb-release button—a disclosure which, when immediately followed by the whistle and crash of a bomb, evoked spontaneous applause.

The demonstrations were made using Tandberg 64 and Sony 521 stereo recorders, together with Avantic amplifiers and Tannoy and CQ speakers. The disc equipment included Ortofon pick-ups with a Garrard 301 turntable.

Future activities include a visit by B.A.S.F. Chemicals Ltd. (April 23), and the production of material in response to a BBC request.

Secretary Phil Towell was recently awarded the Federation of British Tape Recording Clubs' quarterly competition medalion for his documentary and reportage entry on French boys' impressions of Boston.

Secretary: Philip Towell, 107 Spilsby Road, Boston, Lincolnshire.

## BOURNEMOUTH

A series of "Know your machine" lectures has been started by members of Bournemouth club. The more technically-minded have been recruited to give talks, passing on information on various types of machines.

Cliff Rees started the series with a talk at one of the February meetings. He dealt with the transport system using diagrams and drawings to illustrate his talk. During the latter part of the evening Mrs. E. Phillips played a tape of the winning entries in last year's British Amateur Tape Recording Contest. This led to a talk on sound effects, and the following meeting on March 5 saw members attempting to capture correct sound effects. Later in the meeting Mr. F. Slack demonstrated an American battery portable recorder.

Secretary: Mrs. D. L. Robertson, 62, Branksome Hill Road, Bournemouth, Hampshire.

## BRITWELL

New meetings dates for the Britwell club of Slough are announced. The members now meet on alternate Wednesdays at the Methodist Church Hall, Wentworth Avenue, Britwell, Slough, Buckinghamshire. Their next meeting is on April 17.

Secretary: B. J. Jackson, The Meads, Park Road, Stoke Poges, Slough, Buckinghamshire.

## HOYLAKE

A new club has been formed in Hoylake. Details of the club, formed in February by a local dealer, may be obtained from the secretary, L. Wright. Mr. Wright, the chairman and the treasurer are holding office until after the first April meeting when it is hoped to have attracted an increased membership from which can be selected a permanent committee.

Secretary: L. Wright, 128-130, Market Street, Hoylake, Cheshire.

## NORTH LONDON

The North London members have been causing great interest with their fortnightly newstape for blind people in Enfield. The forty-five-minute programme is heard by thirty elderly blind and housebound persons, and it is hoped to treble this figure by the end of the year.

When Miss Molly White, a local welfare officer, recently made the draw which raised funds for further machines for this programme, she congratulated the club on the venture. Six Elizabethan 200's and two Simon Cymbal recorders are now used by the service. The programme includes local news, quizzes, and such features as interviews with local notables. The most recent programme included a three-part feature about the controversial local

re-development plan with interviews by councillors and other interested parties.

Sound effects have played an important part in the club recently. Effects for three local amateur group productions have been recorded and played back during the past three months, the most recent being the thriller *By a Hand Unknown* in February. In order to be prepared for last-minute calls of this kind members are collecting more than 100 varied sound effects for a club sound library.

An instructive microphone positioning session was held recently at the rehearsal rooms of a twelve-piece band. Winner of the club's latest competition—*A Visit to Mars*—was treasurer Patricia Allbutt, who entered the tense short story of a man lost in space.

Organisation of the club's whole-room exhibit at the three-day Hobbies Exhibition in Cheshunt Grammar School from April 4-6, occupied a substantial part of members' time recently. And following an invitation, members are planning a demonstration of tape recording at Enfield's Over-21 Club.

Secretary: Richard Collinson, 30 Ridler Road, Forty Hill, Enfield, Middlesex.

## PLYMOUTH

A change of secretary is also announced for the Plymouth club following the resignation of William Cardew. The post is now filled by Mr. M. A. Glendinning.

Secretary: Mr. M. A. Glendinning, of 44, Budshhead Road, Ernesettle, Plymouth, Devon.

## R.A.F. TAPE SOCIETY

Pete Rogers, former secretary of the R.A.F. Tape Recording Society, has returned to this country after two years serving in Aden. He plans to ask tape clubs throughout the U.K. to help trace relatives of servicemen and women in Aden. Taped messages and record requests will be passed to the Aden Forces Broadcasting Association, an amateur radio station run by servicemen and their families. Peter was a member of A.F.B.A. during his service abroad and prepared many taped interviews, record request programmes and musical shows.

He can be contacted via his home address at 2 Marmora Road, Cambridge.

## ROTHERHAM

Owing to lack of accommodation the Rotherham club is not meeting at present. Persons interested, or wishing to assist in the search for clubrooms are invited to contact the secretary.

Secretary: J. R. Freeman, 12 The Grove, Wickersley, Rotherham, Yorkshire.

## RUGBY

Members of the Coventry club were guests at the February 14 meeting of the Rugby society, and they provided the evenings entertainment. Chairman Peter Warden opened the meeting by playing back the sole entry for the host's inter-club contest tape. The tape had previously been listened to by the Coventry committee, and their comments on it were then read. The Coventry chairman then presented a Cup, donated by Terry Davis, plus four 3-inch tapes to the producers of the tape, Mr. and Mrs. John Bannister.

Other tapes heard during the evening included some of the Coventry club member's contest entries. Tom Bagley's "This was my life" purported to describe his career as a professional soldier, while Roy Reynolds' "Music of my choice" dissected a popular song and gave an appropriate comment on each piece. Roy Reynolds also demonstrated

his "Bulk Listening Machine" by which he concentrated eight minutes programme into a few seconds.

Peter Warden then played part of a tape entitled "This is Voicespence" by Robert Coote, which included examples from other tape exchange correspondents, and advice on how not to make up a tape.

At the following meeting on February 28 members welcomed a Mrs. M. Taylor who presented a slide show on a holiday in Spain.

Secretary: Mike Brown, 219, Clifton Road, Rugby, Warwickshire.

## SOLENT

A club which draws its membership from the Solent areas of Portsmouth, Southsea, Cosham, Porchester, Fareham, Gosport and Lec-on-Solent has recently reported its past activities. Inaugurated last summer, the club meets every Thursday at the Gosport Community Centre, Bury House, Bury Road, Gosport. Membership opened with a total of 25, grew to 40, and is now back to a hard core of 23. These members provide tape programmes for the Old Folks Homes in the area, and have also supplied sound effects for two local dramatic groups.

Several other commitments have been successfully undertaken, including outdoor recording sessions to cover the opening of the Harvest Fayre and of a Hospital and of instrumental and vocal artistes. The members hope to stage a southern region Audio Fair after the London show has closed.

Visits from manufacturers are a feature of the club meetings. To date they have welcomed representatives of Truvox, BASF, Fi-Cord, Akai and others. A tape competition is held every month and judged on the final Thursday. Other clubs are to be asked to judge these contests in future.

A regular series of programmes is held within the club, with the first and third Thursdays being devoted to talks and demonstrations with a question and answer period. The club also has a cine group who add the visual element to any of the more important sound features produced.

The members welcome comments and suggestions from other tape clubs in the hope of establishing regular inter-club contacts. As a start, they point out that many of the members have travelled considerably in Europe, Canada and Asia, and have many interesting tapes made in far-off lands. These may be borrowed, on request, by any club interested.

Secretary: David Lolley, 25, Beaufort Avenue, Fareham, Hampshire.

## SOUTH DEVON

A record that other tape enthusiasts will be hard pushed to beat has been set up by a member of the South Devon club. Larry Seeny is responsible, for he recently recorded a chat with the oldest person to be interviewed on tape. His interview was with Miss Helen Dart, of Paignton, who recently celebrated her 108th birthday, and every word she uttered is described as being perfectly clear.

Larry Seeny has also been responsible for another tape, the like of which, we must surely all hope, is never met again. During the recent bad weather he roamed abroad with a recorder collecting material for a tape to be entitled "The Big Freeze-up of 1963."

The club recently held their first annual supper, social and dance. Club President, Donald Aldous, of *Audio Record Review*, was unable to attend, but instead sent his after-supper speech on tape. At a later meeting members from other local clubs were invited to submit teams for a knock-out quiz contest. Teams had to identify sounds and musical items. Jack Stockman then presented a programme of tape records, using his Tandberg Series 6 tape recorder and a Tandberg Series 7 tape deck. At an even more recent meeting chairman Gordon Furneaux described experiments on microphone placing for his programme "Excursion in stereo." He illustrated his talk with various recordings, including a cabaret arranged for a local Home for the Blind, a multi-track recording of a guitar and numerous sound effects.

At the next March meeting David Pletts introduced his short Victorian melodrama, which kept members busy behind the scenes and playing some of the parts. One of the sound effects required was a torture chamber. Jangling chains were produced by reducing the speed of a recording of rattling keys.

Secretary: M. L. Wright, 12, Sherwell Hill, Chelston, Torquay.

## Lecture / Demonstrations

CLUBS wishing to invite demonstrations and/or lectures are invited to contact the following companies who have offered their services:—

BASF Chemicals Ltd., 5a Gillespie Road, London, N.5.

Fi-Cord Ltd., 40a, Dover Street, London, W.1.

Grundig (Great Britain) Ltd., Newlands Park, Sydenham, S.E.26.

Lustraphone Ltd., St. George's Works, Regent's Park Road, London, N.W.1.

Truvox Ltd., Neasden Lane, London, N.W.10.

Further names will be added as received.

## Invitation to Sound Reality

With the finest in High Fidelity Sound Equipment  
Tape

Disc

Radio

plus a varied selection of furniture to house your choice and the accessories which go to complete the tailor-made set of equipment.

Specialist in High Fidelity Sound.

**H. D. KIRK**

*Stereolectrics*

LIMITED

Phone: 23093

150 HIGHER BRIDGE STREET

**BOLTON**

## BINDERS

Special binders for *TAPE Recording Magazine* designed to hold a year's supply are now available.

No more torn covers and dog-eared edges ★ No more hunting for those mislaid copies ★ Each copy is inserted as received to form a completely bound volume for permanent reference ★ All pages open flat and effect secure binding with steel bars from first to last copy ★ Strong board binders covered with rexine with the title printed in gold on spine.

**PRICE 14s. 6d. (post free)**

From: 7, Tudor Street, London, E.C.4

## The Berean Forward Movement

(NON-SECTARIAN  
NON-DENOMINATIONAL)

Loan of over 700 reliable expositions of the Bible available on tape (3¼ ips) for cost of postage only (free to the blind and infirm). Invaluable to all Christians, from teachers to tyros; for Bible Study groups or private meditation. Supporting literature also available. Send for free, complete list of tapes and literature to *B.F.M. "Eastgrove," Marsham Way, Gerrards Cross, Bucks.*

## AUTOMATED SLEEP-SUGGESTION

- WHAT IS SLEEP-SUGGESTION?
- HOW DOES IT WORK?
- HOW CAN IT BENEFIT YOU?

SEND NOW for FREE BROCHURE for up-to-the-minute information on this vital subject

**EDUCATIONAL RECORDINGS LTD.**  
Dept. B, 21 Bishop's Close,  
Church Lane, London, E.17

## GRUNDIG TK60



S  
T  
E  
R  
E  
O

## SPECIAL OFFER!!

We have a number of the fabulous TK60 STEREO TAPE RECORDERS available at the fantastic price of 89 gns. This recorder is listed at £134 and at the price offered shows a saving of over £40! Absolutely complete in the last detail with two superb detachable acoustically designed speakers, 9 watts output, Frequency response 50-16,000 c/s Bass and Treble controls, automatic tape stops, etc. Superb value and an absolutely unrepeatable offer, BRAND NEW in sealed cartons with full makers' guarantee. Hire Purchase terms available. We specialize in mail order. Write to our HEAD OFFICE at Stratford—address below.

- ★ HIGHEST PART-EXCHANGE ALLOWANCES
- ★ OVER 250 NEW & S/H RECORDERS ON DISPLAY
- ★ H.P. TERMS OVER 9-24 MONTHS
- ★ FREE HOME DEMONSTRATIONS
- ★ TAPE RECORDER REPAIR SPECIALISTS
- ★ FREE DELIVERY, FREE TECHNICAL ADVICE

NOTE—OUR CITY SHOP CLOSED SAT. OPEN MON.-FRI. 9-6 p.m. SUN. 9-2 p.m.

## CITY & ESSEX TAPE RECORDER CENTRES

228 BISHOPSGATE, E.C.2 (opp. Liverpool St. Station) BIS 2609  
2 MARYLAND STATION, STRATFORD, E.15 (adj. station) MAR 5879  
205 HIGH STREET NORTH, E.6 (opp. East Ham Station) GRA 6543

for Professional Performance... **Tandberg**

**SERIES 6**

**STEREO TAPE DECK**



**3 SPEEDS**  
**3 HEADS**  
**4 AMPLIFIERS**  
**\*4 TRACK and 2 TRACK**

- High and low level mixer inputs and cathode follower outputs.
- "On and off the Tape" monitoring.
- Sound-on-Sound simultaneous record and playback.

**110 gns**

Booklet of Technical Reviews on request.

**SERIES 7**

**STEREO TAPE RECORDER**



**3 SPEEDS**  
**2 HEADS**  
 and 2 Power Amplifiers

- Two Indicators.
- Two Monitor Speakers.
- Two outputs for additional speakers or Hi-Fi.

**\*4 TRACK and 2 TRACK**  
 Send for leaflet.  
**BUILD-IT-IN OR CARRY-IT-AROUND!**

4 track model 74  
 2 track model 72  
**93 gns**  
 (Luggage type carrying case. £7 1s 8d. extra).

**Tandberg GB** ELSTONE ELECTRONICS LIMITED,  
 Edward St., Templar St., Leeds 2.  
 Telephone: Leeds 3-5111 (7 lines)

**TAPE RECORDING YEARBOOK 1962-63**

**T**HE latest edition of the "TAPE RECORDING YEARBOOK" is now on the bookstalls. This fifth edition contains the popular "at-a-glance" comparison charts of every currently available tape recorder, microphone, tape deck, and mixer unit together with illustrations, and a valuable miscellaneous accessory guide and magnetic tape price list.

Other contents include a full review of tape developments during the past year; advice on choosing—and using—a tape recorder; tape and cine; copyright; tape records; and a full directory of manufacturers, agents, and tape club addresses.

Simply presented in non-technical language, and including speed and frequency response charts.

POST NOW to : 7, Tudor Street, E.C.4

Please send me.....copy(ies) of Tape Recording Yearbook 1962-63 at 7s. 6d. a copy (including postage), I enclose remittance herewith.

Name .....

Address .....

*Also available*

**TAPE RECORDING HANDBOOKS**

**ADVICE ON BUYING A TAPE RECORDER**

J. F. Ling  
 2/- (2/6 inc. postage)

**INTRODUCTION TO THE TAPE RECORDER**

Charles Langton  
 3/6 (post free)

**HI-FI FOR THE MUSIC LOVER**

Edward Greenfield  
 3/- (post free)

**TAPE AND CINE**

John Aldred  
 3/- (post free)

**HOW TO RECORD WEDDINGS**

Paul Addinsell  
 3/- (post free)

**ORDER TO NEWSAGENT FOR  
"TAPE RECORDING MAGAZINE"**

Published on the third Wednesday  
in every month. Price 1s. 6d.

To .....

(Newsagent's name and address)

Please deliver me one copy of  
"TAPE Recording Magazine"  
each month until further notice.

(Signed) .....

Address .....

TAPE Recording Magazine is published by  
Print & Press Services Ltd., 7, Tudor Street,  
London, E.C.4, and distributed by Trans-World  
Circulation Co., Park Royal Road, N.W.10.

**ORDER FOR ANNUAL  
SUBSCRIPTION TO  
"TAPE RECORDING  
MAGAZINE"**

Please post me one copy of  
"TAPE Recording Magazine"  
monthly for one year. I enclose  
£1 in payment.

(Signed) .....

Address .....

**REQUEST FOR  
IMPROVED  
DISTRIBUTION**

Will you please contact the  
newsagent(s) named below, who  
report difficulty in obtaining  
copies of "TAPE Recording Maga-  
zine" for sale.

(Name of newsagent(s)) .....

(Name of informant) .....

**CLASSIFIED ADVERTISEMENTS**

Rate—Sixpence per word (minimum 5s.); Trade,  
ninience per word (minimum 10s.); box numbers,  
one shilling extra. Payment with copy. Copy should  
be sent to Advertising Department, "Tape Record-  
ing Magazine," 7, Tudor Street, London, E.C.4.

**MISCELLANEOUS**

8mm. Home Movies. Send 1s. for fully illustrated  
catalogue. (Dept. 31), Mountain Films Ltd., 1,  
New Burlington Street, London, W.1.

Good cash prices for tape recorders—Tel: Mary-  
land 5879. (See page 38).

Recorder need repairing? Then let City and  
Essex Tape Recorder Centres do it for you expertly  
and economically. (See page 38).

SLEEP LEARNING. Of fascination to all T.R.  
enthusiasts. Send 6s. 6d. for book. Refund  
guarantee. York House, Huddersfield.

**YOUR TAPES FOR  
BROADCASTING**

**WE NEED YOUR TAPE REPORT-  
AGES OR GOOD SOUND RECORD-  
INGS FOR USE IN RADIO PRO-  
GRAMMES. CONTRIBUTIONS  
FROM OVERSEAS ARE PARTIC-  
ULARLY WELCOME. IF YOU HAVE  
SOMETHING TO OFFER OR ARE  
KEEN TO MAKE YOUR HOBBY  
PROFITABLE PLEASE WRITE FOR  
FULL DETAILS TO DEPT. AMPT,  
RADIO FREE EUROPE, WARNER-  
PATHE HOUSE, 135, WARDOUR  
STREET, LONDON, W.1.**

**NEW EQUIPMENT**

FERROGRAPH 422, 424 and 5A/N always in  
stock ready for immediate delivery and demonstra-  
tion.—City and Essex Tape Recorder Centres. See  
page 38.

REVOX LATEST F36, TELEFUNKEN SERIES  
75, 85 and 95 AND TRUVOX SERIES 80  
(LATEST 3 SPEED VERSIONS) always  
on demonstration and for immediate delivery at the  
hi-fi tape specialists. 48 hours' service for pro-  
fessional Tape Copying. N.R.S., 16, Kings College  
Road, London, N.W.3. PRI 3314.

TAPE RECORDERS. SAVE FROM 30 per  
cent to 60 per cent on the original price. Large  
stocks of second-hand, new, shop soiled machines.  
All guaranteed. Obtainable on our **NO INTEREST  
TERMS**. Best part exchange allowances on your  
existing equipment. CALL, WRITE, PHONE to-  
day for free list. Quotation and details. Our Mail  
Order covers the whole Country.—R. E. W.  
Earlsfield Ltd., 266, Upper Tooting Road, London,  
S.W.17. Balham 7710.

**TAPE TO DISC**

JOHN HASSELL RECORDINGS. Tape to Disc.  
50-minute LPs—Lowest prices. Studio and mobile  
services.—21, Nassau Road, London, S.W.13.  
Riverside 7150.

**TAPE TO DISC RECORDING**

Reduced prices. Finest professional quality. 10-inch  
LP—35s. (32 mins.), 12-inch LP—40s. (45 mins.),  
7-inch EP—17s. 6d.

**48-HOUR POSTAL SERVICE**

S.a.e for leaflet to Deroy Sound Service, 52, Hest  
Bank Lane, Hest Bank, Lancaster. Tel.: H.B. 2444.

TAPE-TO-DISC RECORDING SERVICE. All  
speeds. 50-minute LPs. Photographic sleeves with  
all recordings.—E.R.S., 162, Shirland Road, Lon-  
don, W.9.

**FOR SALE**

L.P. TAPE. Guaranteed. 5½ in. x 1,200 ft.  
18s. 6d.; 5 in. x 900 ft. 13s. 6d. 18, Brook  
Street, Stourbridge, Worcs.

FOR SALE: SIMON SP4. Little used—as  
new. Also "Cadenza" Microphone. £53 or  
offer. Telephone ENTerprise 1796 after 6 p.m.

Many 7 in. tapes giving 30 hours' popular music;  
also microphone. Ring D. Rowe, MAN 3477.

**TAPE RECORDS**

FOREIGN LANGUAGES ON TAPE from  
38s. 6d. French, Italian, Spanish, German, Russian.  
Full money-back guarantee. — Details from  
Visaphone Co. Ltd., 28, Brookland Hill, London,  
N.W.11.

PRE-RECORDED TAPES. Unique complete  
catalogue listing all makes, Mono, Stereo, 7½ and  
3½ ips, including World Record Club tapes. Call  
for FREE copy or send 1s. mailing fee.—Dept.  
T.R.I., Teletape Ltd., 33, Edgware Road, W.2.  
PAD 1942.

TAPE RECORDINGS. World-famous hypnotist  
and Harley Street Psychoanalyst, W. J. Ousby  
(Instructional Recordings). Relaxation and self  
hypnosis for increasing confidence, overcoming in-  
feriorities, lessening nervous tension. Send name  
and address for list of Mr. Ousby's tape record-  
ings. Details sent in plain envelope without obli-  
gation. W. J. Ousby, Home Farm Estate, North-  
church, Berkhamsted, Herts.

**TAPE EXCHANGES**

FRIENDLY FOLK ASSOCIATION, Torquay  
(Est. 1943). Social introductions, Pen-friends, Book-  
lovers, Stamps, Photography, Tapesponding. Mem-  
bers 100 Countries.

"From Down Under" the Australian Tape  
Recordists' Association invites you to become a  
member of their World-Wide organisation. For  
details write The Sec., P.O. Box 67, Eastwood,  
N.S.W., Australia.

Make interesting new friends UK and overseas,  
all ages. Join Victory Club, 34, Honeywell Road,  
London, S.W.11. Details free. Established 20 years.

**MAGNETIC TAPE**

HIGH QUALITY RECORDING TAPE AT  
LOW PRICES. Long Play: 5 in. 900 ft. 12s. 6d.;  
5½ in. 1,200 ft. 16s.; 7 in. 1,800 ft. 22s. 6d.; Double  
Play: 5 in. 1,200 ft. 20s.; 5½ in. 1,800 ft. 28s.; 7 in.  
2,400 ft. 36s. All post paid. Satisfaction or re-  
fund in full. M.S. Recording Tapes, 21, Hoyle  
Street, Radcliffe, Manchester.

TAPE BARGAINS IN ALL SIZES. Example:  
Top Brand 5½ in., 1,200 ft., 19s. 6d., P. & P.,  
1s. 3d. S.A.E. for list. Large choice of new and  
used recorders.—E. C. Kingsley & Co., 132, Totten-  
ham Court Road, London, W.1. EUS 6500.

**Index to Advertisers**

	Page
A. Brown & Sons Ltd. ....	10
Audio Electronics (Midlands) Ltd. ....	34
B.A.S.F. Chemicals Ltd. ....	Back cover
Berean Forward Movement .....	38
Brenell Engineering Co. Ltd. ....	22 and 23
C.B.S. International Ltd. ....	31
City & Essex Tape Recorder Centres .....	38
Cussins & Light Ltd. ....	34
Daystrom Ltd. ....	10
Denham & Morley Ltd. ....	8
De Villiers (Electronic World) Ltd. ....	26
Educational Recordings Ltd. ....	38
Elstone Electronics Ltd. ....	39
E.M.I. Tape Ltd. ....	32
A. C. Farnell Ltd. ....	11
Francis of Streatham .....	12
Grampian Reproducers Ltd. ....	10
Hamilton Electronics .....	35
Hi-Fi Centre Ltd. ....	33
Highgate Acoustics .....	6
Howard Tape Recorders .....	43
Lee Electronics .....	12 and 33
Locksley .....	30
Lockwood & Co. ....	43
Magnagraph .....	33
Minnesota Mining & Manufacturing Co. Ltd. ....	36
Mountain Films Ltd. ....	26
M.S.S. Recording Co. Ltd. ....	7
Multicore Solders Ltd. ....	43
Planet Projects Ltd. ....	12
Rapid Recording Service .....	27
Recording Machines Ltd. ....	35
Resolosund Ltd. ....	3
Revox (Concessionaires) Ltd. ....	4 and 5
R.E.W. Earlsfield Ltd. ....	11
Sheen Tape Recorder Centre Ltd. ....	33
Sound News Productions .....	27
Stereoelectrics Ltd. ....	38
Tape Recorders (Bournemouth) Ltd. ....	35
Tape Recorder Centre Ltd. ....	9
Tape Recorder Centre (Halifax) .....	34
The Recorder Co. Ltd. ....	6
Truvox Ltd. ....	25
Tysonic .....	34
Valradio Ltd. ....	11
Wellington Acoustic Laboratories .....	24
Welmece Corporation Ltd. ....	2
Wharfedale Wireless Works Ltd. ....	8



# Tape Exchanges

(Continued from page 41)

**Harmer, Richard** (64). Middleton Hall Road, Kings Norton, Birmingham 30, Warwicks. Photography, records. 7½, 3½, 1½ ips. 7-inch spool. Elizabethan Princess. Male contacts only, no letters please.

**Healy, Padraig** (23). Castle Street, Ardee, Colouth, Eire. Sport, Scottish music. 7½, 3½ ips. 7-inch spool. Philips four-track, Grundig portable.

**Highazony, Arnold** (50). 45b, Clarence Road, Gosport, Hants. Photography, people, jazz. 7½, 3½ ips. 7-inch spool. Akai M5.—Stereo four-track.

**Hills, G.** (48). Aldern Bridge, Newbury, Berks. Live recording, stereo, gardening. 7½, 3½ ips. 5-inch spool. Sony 521, stereo four-track, Collaro Winston. **USA, Australia, Canada.**

**Hodges, Mrs. L. E.** (48). Post Bag 9158, Fort Victoria, Southern Rhodesia. History, traditions, psychology, art. 3½ ips. 5-inch spool. Clarion and Walter. **Jersey, Italy, Malta, USA.**

**Hunt, Derek Leslie** (32). 64, Middleton Hall Road, Kings Norton, Birmingham 30. Photography, radio, discs. 7½, 3½, 1½ ips. 7-inch spool. Elizabethan Princess. Male contacts only, no letters please.

**Hutton, G. A. L.** (50). Beech Leaves, Fulmer Drive, Gerrards Cross, Buckinghamshire. Photography, travel, light music. 7½, 3½, 1½ ips. 7-inch spool. Cossor four-track. **Overseas.**

**Kleinmann, Henk** (35). P.O. Box 425, Curacao, Netherland Antilles. Photography, travel, sleep-learning, unusual sounds. 7½, 3½, 1½ ips. 7-inch spool. Akai stereo two- and four-track. English, German and Dutch spoken.

**Kramer, Graham** (23). 45, Greenhill Road, Greenside, Johannesburg, South Africa. Hi-fi, photography, jazz. 3½ ips. 7-inch spool. Philips EL3541, four-track.

**Lake, Gerald** (28). 114, Cloverhall Crescent, Belfield, Rochdale, Lancs. Unusual sounds, all music. 7½, 3½ ips. 7-inch spool. Philips EL3542, four-track. Letters first please.

**Leonard, John** (35). 19, Rylett Road, Shepherds Bush, London, W.12. Photography, French language, theatre, humour, poetry. 7½, 3½, 1½ ips. 7-inch spools. Philips EL3541 and EL3542. **France.**

**Rees, Llewellyn** (40). 1, Bronhaul, Talbot Green, Glamorgan, South Wales. Folksongs, Scottish ballads, hillbilly music. 3½ ips. 5½-inch spools. Elizabethan Avon, Sound Prince. **UK, USA, Europe, Canada.**

**Lockie, Miss Fiona** (30). 4, Maryfield Place, Bonnyrigg, Midlothian, Scotland. Germology, reading, music. 3½ ips. 5-inch spool. Philips portable. **Channel Islands, Canada.**

**Marshall, Eric** (30). 33, Bertram Road, Enfield, Middlesex. Football, reading. 7½, 3½, 1½, 15/16 ips. 7-inch spool. Stella ST459, four-track. **New Zealand.**

**Mason, Frank** (42). 175, Cuckmere Way, Brighton, Sussex. Electronic organs. 3½ ips. 7-inch spool. Stellaphone.

**McCoy, Terry** (25). 1, Ballater Street, Manchester 8, Lancashire. Humour, jazz. 7½, 3½ ips. 7-inch spool. Brenell M5, Elizabethan, Carousel. **USA, Germany, Canada.**

**McLean, Barry** (23). 32, Westmouth Street, Beeston, Leeds 11, Yorkshire. Do-it-yourself, humour, pop music. 7½, 3½, 1½ ips. 7-inch spool. R.G.D. Mk 103, Motek deck.

**Megainey, Derek R.** (28). "Sundial," 18, Hamilton Road, Tiddington, Stratford-on-Avon, Warwickshire. Ballet, theatre, travel, music—not pop. 15, 7½, 3½, 1½ ips. 7-inch spool. Wyndors Viscount, Gainsborough Mk 1.

**Metcalfe, E. Allan** (32). 54, Morley Street, Rochdale, Lancashire. Photography, travel, pop music. 3½ ips. 5½-inch spool. Grundig TK23. Argyll Fidelity. Male contacts only.

**Mills, Roy** (22). 83, Kensal Road, Kensington, London, W.10. Photography, theatre, camping, c & w music. 3½ ips. 7-inch spool. Philips EL3541, four-track. **UK and Ireland.**

**Milner, Ernest** (30). Baptist Chapel House, High Street, Normanton, Yorkshire. Photography, music—not classical. 7½, 3½, 1½ ips. 7-inch spool. Stellaphone, two-track. **Italy, Germany, Austria.**

**Morgan, Brian Arthur** (24). 56, Briset Road, Eltham, London, S.E.9. Electrical engineering, aviation, physics, judo, music. 3½ ips. 7-inch spool. Stella ST454, stereo four-track. **UK, USA, South America, Europe, Far East, esp. Japan.**

**Payne, Derek** (31). Box 612, Picton, Ontario, Canada. Car rallying, modern and trad. jazz. 7½, 3½, 1½ ips. 7-inch spool. Philips EL3536A, two- and four-track.

**Panasci, Joseph A.** (29). 84-11, 87th Street, Woodhaven 21, New York, USA. Photography, humour, opera and dixieland jazz. 7½, 3½ ips. 7-inch spool. Voice-of-Music recorder, Model 750.

**Purfield, Joseph M.** (24). 12, Wolsey Street, S.C. Road, Dublin 8, Eire. Short-wave radio, most music. 7½, 3½, 1½ ips. 7-inch spool. Philips EL3515, and EL 3542. No letter required.

FLAP B

SECOND FOLD HERE

NO POSTAGE  
STAMP  
NECESSARY  
IF POSTED  
IN GREAT  
BRITAIN OR  
NORTHERN  
IRELAND

BUSINESS REPLY FOLDER  
Licence No. ND 922

TAPE RECORDING MAGAZINE  
7 TUDOR STREET,  
LONDON, E.C.4.

THIRD FOLD HERE

FLAP A

FIRST FOLD ALONG THIS LINE

Fold along lines as indicated and then tuck Flap A into Flap B.

CUT ALONG DOTTED LINES

# LOCKWOOD

BOOTH No. 11  
ROOM No. 412

HEAR THE NEW LOCKWOOD ACADEMY  
REPRODUCERS AT THE AUDIO FAIR

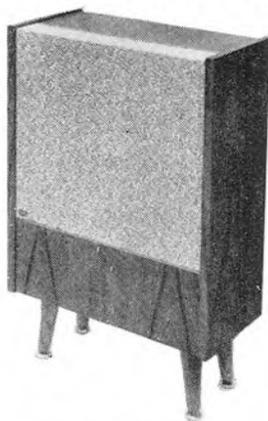

ACADEMY  
MINI-SLIM  
FIGURED TEAK

DEMONSTRATIONS AT:

ALFRED IMHOF LTD. NUSOUND RECORDING CO.  
112/116 NEW OXFORD ST. ● 35 CRAVEN ST.  
LONDON W.1 LONDON W.C.2

► SOUND TO REMEMBER ◀

LOCKWOOD & CO. 67 LOWLANDS ROAD  
HARROW MIDDX. Tel. BYR 3704/0768

# BUY A Bib

## THE PROFESSIONAL TAPE SPLICER

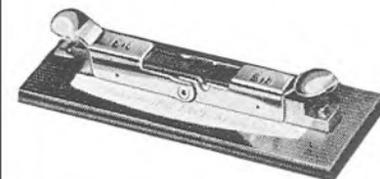

—The most reliable and easy to use.

All metal—beautifully plated—compact in size—mounted on flock covered base. Easily and permanently attached to your tape recorder. Ferrograph, Vortexion, Reflectograph and Wearite decks already have fixing holes for the Bib splicer.

Complete with  
razor cutter  
only 18/6

Clamps hold the magnetic or leader tapes in the precision cut channel—no danger of damaging the edges—most important with 4 track recordings. Right angle and oblique cutting slots are provided to facilitate editing to a syllable.

The Bib tape splicer saves tape and makes editing a fascinating hobby.

More Bib splicers have been sold in recent years than any other make. It is incorporated in the "Scotch" Tape Accessory Kit and is used by recording studios and broadcasting organisations.

**MULTICORE SOLDERS LTD.**

MULTICORE WORKS, HEMEL HEMPSTEAD, HERTFORDSHIRE



# 500 at 218

We stock and sell more Tape Recorders than any other Specialist  
in the British Isles. Wherever you live, it will pay you too, to buy from us.

# HOWARD

FIND OUT WHY—WRITE,  
PHONE OR CALL:

218, HIGH STREET,  
BROMLEY, KENT

(RA Vensbourne 4000 & 4477)

## NOW THEY CAN REALLY "HEAR" FROM YOU WITH BASF LETTER-TAPE

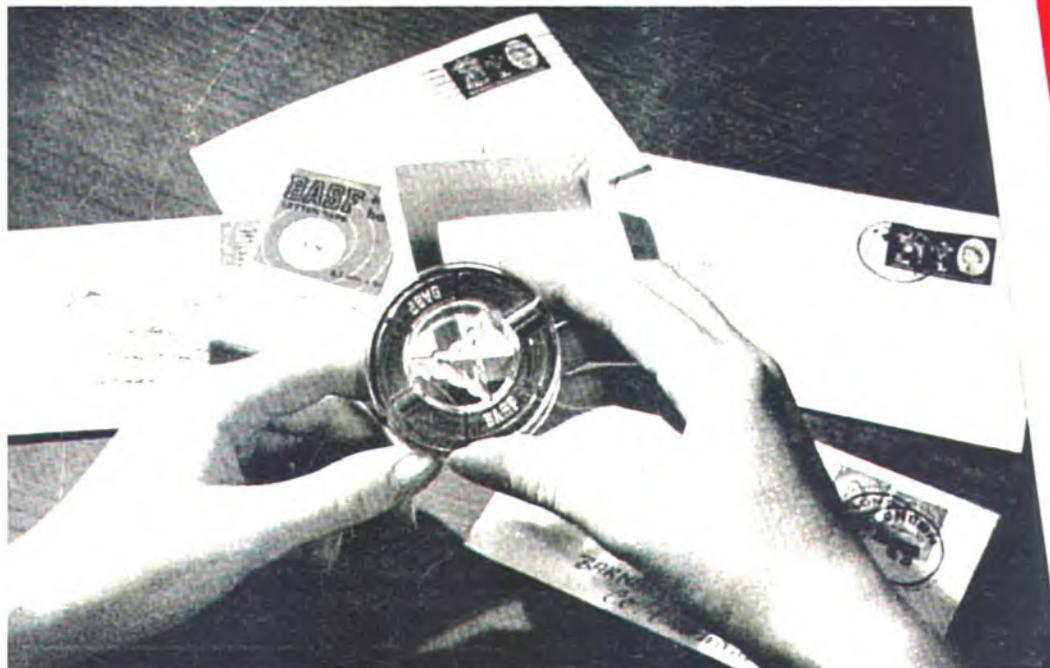

What could be more pleasant than receiving mail actually recorded on a BASF LETTER-TAPE. There is nothing quite so intimate as the sound of a voice; nothing conveys the nuances of meaning like the spoken word. BASF LETTER-TAPES make sending and receiving mail extra personal. A LETTER-TAPE has 150 ft. of long play tape, but weighs under 1½ ozs. including the mailing carton.

**FREE: A letter-tape and the facilities to record on it are yours at the Audio Fair from April 18th to 21st at Room 118, Russell Hotel, London. We are also showing one of the latest educational aids—magnetic recording tape for language classes.**



—SYMBOL OF  
AUTHENTIC SOUND

BASF CHEMICALS LIMITED, 5a GILLESPIE ROAD, LONDON, N.5. TEL: CANONBURY 2011

