

MAY
1958

1'6

TAPE RECORDING

& HIGH FIDELITY REPRODUCTION
MAGAZINE



Everybody uses

EMITAPE

— the magnetic tape for all recorders

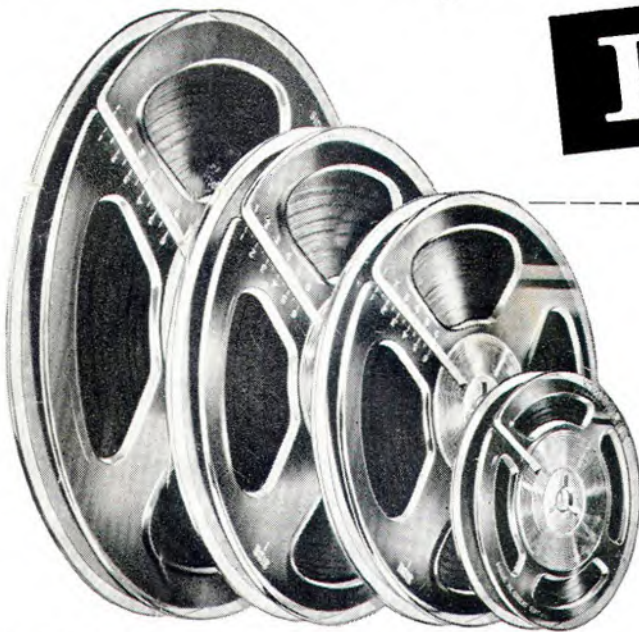

EMITAPE **88**
General Purpose

EMITAPE **99**
Long Play,
giving 50% increased playing time

- * 4 SPOOL SIZES
- * HIGHEST TECHNICAL STANDARDS
High sensitivity · Low noise level · Low print-through factor · Freedom from curl and stretch
Anti-static · Low head wear

- * EMICASE
Solves storage problems · Protects spools from dust · Allows easy identification of leader tapes



EMITAPE *the world's finest recording tape*

SEE US AT THE AUDIO FAIR

Full details from your local dealer, or from:

E.M.I. SALES & SERVICE LTD (Recording Materials Division) **HAYES · MIDDLESEX**

ES171



**SPECIAL AUDIO FAIR
NUMBER — 56 PAGES**



HERALDING.....

The Wyndsor Dauphin

**CONSOLE TAPE RECORDER
AND REPRODUCER**



Here at last is a complete, self-contained transportable hi-fi unit. Now you can obtain superb reproduction with a single piece of equipment instead of having to connect up two or three separate items. The Wyndsor Dauphin console has been designed and developed as one instrument in which all the parts work together perfectly: the handsome bass reflex cabinet and 3 speaker assembly, professional type tape deck, and the high quality amplifiers.

**WYNSOR RECORDING
COMPANY LIMITED**

2 BELLEVUE ROAD
FRIERN BARNET, N.11
Telephone: ENTerprise 2226/7

The Wyndsor Dauphin costs no more than you would pay for a high class portable tape recorder alone, but see all the extra features you get:—

- i. Handsome Bass reflex speaker cabinet.
- ii. 3 matched speakers (10" circular, 9" x 5" elliptical and 4" tweeter.)
- iii. Famous Harting tape deck with third head added.
- iv. Full tape monitoring through third head.
- v. Independent Record and Playback amplifiers and controls.
- vi. Bass and Treble boost and cut controls.
- vii. High and Low Gain inputs.
- viii. Provision for straight through amplification.
- ix. Attractive oak stand in contemporary design.
- x. A 1200' tape.
- xi. A high quality crystal microphone with gilt stand.

The Wyndsor Dauphin is a logical and up-to-date approach to the problem of getting hi-fi performance without the usual hi-fi paraphernalia. Be sure to see the Wyndsor Dauphin before you invest in a tape recorder. We'll be pleased to send you a leaflet giving you full particulars.

BRIEF TECHNICAL DATA :

Tape speeds	7½ & 3½ ips
Frequency response	...	{	50—15 000 c/s ± 3dB @ 7½ ips 50— 8,000 c/s ± 3dB @ 3½ ips
Wow and Flutter	better than 0.1 of 1%
Signal/Noise Ratio	better than 40dB unweighted
Output	3 watts ultra-linear at 15 ohm

Magic Eye recording level indicator. Counter type position indicator

89 GNS.

**Complete including Stand,
Microphone and Tape**

**TWO FULL SYMPHONIES
AND THREE CONCERTOS
ON ONE 7" SPOOL**

WITH THE NEW

GRUNDIG

POLYESTER L.P.*

Grundig Polyester L.P. gives 50% increase in recording time
with enhanced high frequency performance.

It is stronger than standard tape, completely free from curl, ensuring perfect contact with recorder heads, is unaffected by changes over a wide temperature range, has a perfect surface, is exceptionally hardwearing and free from joins throughout its entire length.

* Made from material supplied by I.C.I. called 'Melinex'.

PRICE { 5 3/4" ... 1200 ft. ... 35/-
7" ... 1800 ft. ... 50/-

GET THE MOST OUT OF TAPE

GET

GRUNDIG

POLYESTER L.P.

GRUNDIG (Gt. Britain) LTD.

GS 101

Advertising & Showrooms: 39/41 NEW OXFORD ST., W.C.1
Trade Enquiries to: KIDBROOKE PARK ROAD, LONDON, S.E.3
(Electronics Division, Gas Purification & Chemical Co. Ltd.)



a new sound engineering conception!

• simon



The lid is detachable. Both case and lid are covered with genuine Rexine in attractive dual tone colours. Styling: Peter Bell, M.S.I.A.

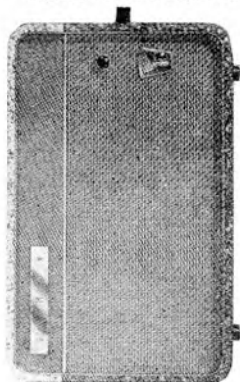

To convince yourself that the new Simon SP.4 has been designed and built for the connoisseur, take a look at the list of features incorporated in this truly outstanding tape recorder—more features than have ever before been gathered into any portable recorder, and several of them exclusive to the Simon SP.4.

The Simon Automatic Deck, designed and manufactured entirely by ourselves, incorporates automatic tape reversal for continuous recording or replay—without button pressing or transposition of spools. It is fully 'push-button-controlled' and is altogether the perfect complement to the superb 10-watt output ultra-linear amplifier.

Technical excellence is matched by elegant styling, and the entire instrument is made even more attractive by the price—for by careful design and manufacture this exceptional recorder can be offered at a price which gives real value for money.

If you really appreciate authentic sound, you will be thrilled to hear the Simon SP.4.

Send this coupon now for literature on the Simon SP.4

SP. 4

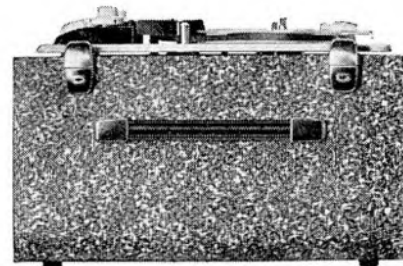

high fidelity **TAPE RECORDER**

incorporating the new Simon fully automatic tape deck

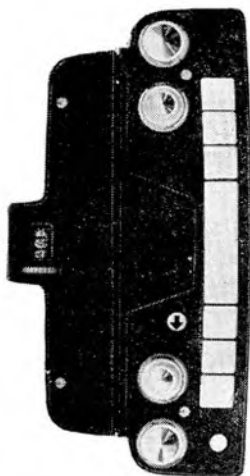

- SIMON AUTOMATIC DECK**
 fully 'push-button-controlled'
- BASS AND TREBLE LIFT AND CUT**
 with independent controls
- AUTOMATIC TAPE REVERSAL**
*without button pressing
 or spool transposing*
- ACCIDENTAL ERASURE PREVENTION**
 by special record 'safety button'
- 3-WAY MIXING FACILITIES**
 on both record and playback
- SYNCHRONOUS MOTOR**
 mains frequency controlled for accurate speed
- 10 WATTS OUTPUT**
 from ultra-linear push-pull amplifier
- ACCURATE TAPE POSITION INDICATOR**
 based on linear tape scale
- PUSH-PULL OSCILLATOR**
 reduces noise and hum to minimum
- CATHODE RAY MAGIC EYE**
 for 'pin-point' modulation

95 GNS

Cadenza
REGD

ribbon microphone

... to do justice to the excellence of the SP.4. Dual impedance head: output sensibly flat between 50-12000 cps.

In handsome presentation case:
 head only 8½ gns
 with tripod desk stand 10 gns



Styling:
 Peter Bell, M.S.I.A.

<p>To Simon Sound Service Ltd 46-50 George Street, Portman Square, London W.1</p> <p>Please send me literature on the Simon SP.4</p> <p>NAME</p> <p>ADDRESS</p>	<p><i>My nearest dealer is</i></p> <p>NAME</p> <p>ADDRESS</p>
E5	

RECORDING TAPE

RETURN OF POST SERVICE

All the following items are normally kept in stock for delivery by return of post. In the event of supplies being held up from the makers we advise delivery position by return.

BASF

Standard PVC Base. 150ft. (3") 8/-. 300ft. (4") 13/6d. 600ft. (5") 21/-. 850ft. (5½") 28/-. 1,200ft. (7") 35/-.
LONG PLAY. P.V.C. Base. 210ft. (3") 9/-. 850ft. (5") 28/-. 1,200ft. (5½") 35/-. 1,700ft. (7") 50/-.
On Hublock Reels. 200ft. (3½") 12/6d. 600ft. (5") 26/9d. 1,200ft. (7") 45/-. 1,750ft. (8½") 63/-.
"88" PVC Base. Message 175ft. (3") 7/6d. Junior 600ft. (5") 21/-. Continental 850ft. (5½") 28/-. Standard 1,200ft. (7") 35/-. Professional 1,800ft. (8½") 57/6d.
"99" LONG PLAY. PVC Base. Message 250ft. (3") 9/6d. Junior 850ft. (5") 28/-. Continental 1,200ft. (5½") 35/-. Standard 1,800ft. (7") 50/-. Professional 2,400ft. (8½") 72/6d.

BRITISH FERROGRAPH

On Hublock Reels. 200ft. (3½") 12/6d. 600ft. (5") 26/9d. 1,200ft. (7") 45/-. 1,750ft. (8½") 63/-.
"88" PVC Base. Message 175ft. (3") 7/6d. Junior 600ft. (5") 21/-. Continental 850ft. (5½") 28/-. Standard 1,200ft. (7") 35/-. Professional 1,800ft. (8½") 57/6d.
"99" LONG PLAY. PVC Base. Message 250ft. (3") 9/6d. Junior 850ft. (5") 28/-. Continental 1,200ft. (5½") 35/-. Standard 1,800ft. (7") 50/-. Professional 2,400ft. (8½") 72/6d.

EMITAPE

"88" PVC Base. Message 175ft. (3") 7/6d. Junior 600ft. (5") 21/-. Continental 850ft. (5½") 28/-. Standard 1,200ft. (7") 35/-. Professional 1,800ft. (8½") 57/6d.
"99" LONG PLAY. PVC Base. Message 250ft. (3") 9/6d. Junior 850ft. (5") 28/-. Continental 1,200ft. (5½") 35/-. Standard 1,800ft. (7") 50/-. Professional 2,400ft. (8½") 72/6d.

EMITAPE IN EMICASES

Emitape packed in the new plastic containers.
"88" Junior 600ft. (5") 23/6d. Continental 850ft. (5½") 30/6d. Standard 1,200ft. (7") 37/6d.
"99" LONG PLAY. Junior 850ft. (5") 30/6d. Continental 1,200ft. (5½") 37/6d. Standard 1,800ft. (7") 52/6d.

GELOSO

3" Spools. Standard 12/-. Long Play 16/-.
T4. 120ft. (3") 7/9d. T2. 850ft. (5½") 27/6d. T3. 1,200ft. (7") 35/-. Long Play. TLP1. 1,200ft. (5½") 35/-. TLP2. 1,700ft. (7") 50/-.
"88" PVC Base. Message 175ft. (3") 7/6d. Junior 600ft. (5") 21/-. Continental 850ft. (5½") 28/-. Standard 1,200ft. (7") 35/-. Professional 1,800ft. (8½") 57/6d.
"99" LONG PLAY. PVC Base. Message 250ft. (3") 9/6d. Junior 850ft. (5") 28/-. Continental 1,200ft. (5½") 35/-. Standard 1,800ft. (7") 50/-. Professional 2,400ft. (8½") 72/6d.

GRUNDIG

T4. 120ft. (3") 7/9d. T2. 850ft. (5½") 27/6d. T3. 1,200ft. (7") 35/-. Long Play. TLP1. 1,200ft. (5½") 35/-. TLP2. 1,700ft. (7") 50/-.
"88" PVC Base. Message 175ft. (3") 7/6d. Junior 600ft. (5") 21/-. Continental 850ft. (5½") 28/-. Standard 1,200ft. (7") 35/-. Professional 1,800ft. (8½") 57/6d.
"99" LONG PLAY. PVC Base. Message 250ft. (3") 9/6d. Junior 850ft. (5") 28/-. Continental 1,200ft. (5½") 35/-. Standard 1,800ft. (7") 50/-. Professional 2,400ft. (8½") 72/6d.

MSS MASTERTAPE

PM/15. 150ft. (3") 5/6d. 300ft. (4") 10/6d. 600ft. (5") 20/-. 850ft. (5½") 27/6d. 1,200ft. (7") 35/-. 1,750ft. (8½") 55/-.
LONG PLAY. 225ft. (3") 8/6d. 450ft. (4") 14/6d. 850ft. (5") 28/-. 12,000ft. (5½") 35/-. 1,800ft. (7") 50/-. 2,400ft. (8½") 75/-.
"88" PVC Base. Message 175ft. (3") 7/6d. Junior 600ft. (5") 21/-. Continental 850ft. (5½") 28/-. Standard 1,200ft. (7") 35/-. Professional 1,800ft. (8½") 57/6d.
"99" LONG PLAY. PVC Base. Message 250ft. (3") 9/6d. Junior 850ft. (5") 28/-. Continental 1,200ft. (5½") 35/-. Standard 1,800ft. (7") 50/-. Professional 2,400ft. (8½") 72/6d.

PHILIPS

300ft. (4") 13/6d. 600ft. (5") 21/-. 1,200ft. (7") 35/-.
LONG PLAY. 850ft. (5") 28/-. 1,800ft. (7") 50/-.
No. 111A. Acetate Base. 200ft. (3") 6/3d. 600ft. (5") 16/-. 850ft. (5½") 22/-. 1,200ft. (7") 27/-.
No. 150. LONG PLAY. Polyester Base. 300ft. (3") 9/6d. 900ft. (5") 28/-. 1,275ft. (5½") 35/-. 1,800ft. (7") 50/-.
No. 120 High Output. Acetate Base. 600ft. (5") 23/-. 850ft. (5½") 31/-. 1,200ft. (7") 39/-.
No. 111V. Super Base. PVC Base. 200ft. (3") 7/6d. 600ft. (5") 21/-. 850ft. (5½") 28/-. 1,200ft. (7") 35/-.
"88" PVC Base. Message 175ft. (3") 7/6d. Junior 600ft. (5") 21/-. Continental 850ft. (5½") 28/-. Standard 1,200ft. (7") 35/-. Professional 1,800ft. (8½") 57/6d.
"99" LONG PLAY. PVC Base. Message 250ft. (3") 9/6d. Junior 850ft. (5") 28/-. Continental 1,200ft. (5½") 35/-. Standard 1,800ft. (7") 50/-. Professional 2,400ft. (8½") 72/6d.

SCOTCH BOY

No. 111A. Acetate Base. 200ft. (3") 6/3d. 600ft. (5") 16/-. 850ft. (5½") 22/-. 1,200ft. (7") 27/-.
No. 150. LONG PLAY. Polyester Base. 300ft. (3") 9/6d. 900ft. (5") 28/-. 1,275ft. (5½") 35/-. 1,800ft. (7") 50/-.
No. 120 High Output. Acetate Base. 600ft. (5") 23/-. 850ft. (5½") 31/-. 1,200ft. (7") 39/-.
No. 111V. Super Base. PVC Base. 200ft. (3") 7/6d. 600ft. (5") 21/-. 850ft. (5½") 28/-. 1,200ft. (7") 35/-.
"88" PVC Base. Message 175ft. (3") 7/6d. Junior 600ft. (5") 21/-. Continental 850ft. (5½") 28/-. Standard 1,200ft. (7") 35/-. Professional 1,800ft. (8½") 57/6d.
"99" LONG PLAY. PVC Base. Message 250ft. (3") 9/6d. Junior 850ft. (5") 28/-. Continental 1,200ft. (5½") 35/-. Standard 1,800ft. (7") 50/-. Professional 2,400ft. (8½") 72/6d.

SOUNDRITE

150ft. (3") 5/6d. 300ft. (4") 10/6d. 600ft. (5") 20/-. 850ft. (5½") 27/6. 1,200ft. (7") 35/-. 1,750ft. (8½") 55/-.
LONG PLAY. 225ft. (3") 8/6d. 450ft. (4") 14/6d. 850ft. (5") 28/-. 1,200ft. (5½") 35/-. 1,800ft. (7") 50/-. 2,400ft. (8½") 75/-.
"88" PVC Base. Message 175ft. (3") 7/6d. Junior 600ft. (5") 21/-. Continental 850ft. (5½") 28/-. Standard 1,200ft. (7") 35/-. Professional 1,800ft. (8½") 57/6d.
"99" LONG PLAY. PVC Base. Message 250ft. (3") 9/6d. Junior 850ft. (5") 28/-. Continental 1,200ft. (5½") 35/-. Standard 1,800ft. (7") 50/-. Professional 2,400ft. (8½") 72/6d.

TELEFUNKEN

EXTRA PLAY TAPE. Supplied on 5" reels only. These contain TWICE the length of standard tape. 1,200ft. on 5" spool 35/-.
NOTE.—All Tapes are Standard Play except where shown as Long Play.

Wide range of Tapes Accessories in stock. Detailed list free on request

TERMS OF BUSINESS.—Cash with order or C.O.D. All tape is post free, but postage is extra on orders under £3 for accessories. C.O.D. fees are charged on C.O.D. orders under £5.

CREDIT TERMS are available on orders of Tape and Accessories over £5 in value. Send for details.

WATTS RADIO (MAIL ORDER) LTD.

54 Church Street, Weybridge, Surrey
Telephone WEYBRIDGE 4556

PLEASE NOTE—Post orders only to the above address

IDEAL FOR STEREO

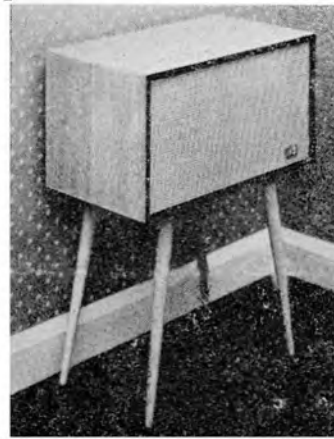

C.Q. Standard Speaker at 13gns.

Senior—17½gns.

The entire range of C.Q. products including:

NEW Amplifier

NEW F.M. Tuner

NEW "Q-Flex"

Loudspeaker for home construction may be seen and heard at C.Q.'s own

FESTIVAL OF SOUND

April 18, 19, 21 and 22 from 11 to 9-30 p.m. daily at the

ALDWYCH BRASSERIE

Few moments from Waldorf Hotel

Tickets free on request.

C.Q. AUDIO LTD.

2, SARNESFIELD ROAD, ENFIELD, MIDDLESEX

Phone: ENField 8262

LUSTRAPHONE MICROPHONES

British in Design, Materials and Manufacture

FOR RECORDERS OF ALL TYPES

THE quality of reproduction from your recorder is dependent completely upon the quality of the microphone used with it. To obtain the best that a recorder will give, always specify a LUSTRAPHONE MICROPHONE. There is a wide range of models available as well as stands, instruments and accessories, all fully described in the 32-page illustrated brochure obtainable free on request from LUSTRAPHONE.

Showing at the Audio Fair

LUSTRAPHONE Ltd.,

ST. GEORGE'S WORKS,
REGENTS PARK ROAD,
LONDON, N.W.1

Telephone: PRImrose 8844





***Elizabethan* PLAYS A LIQUID NOTE**

The tranquil ripple of the Water Music, or the splash as this flautist founders in the pond. The classiest classic, or the squiffiest skiffle. Record *any* sound on the Elizabethan and it will play back all of it, and nothing but. All the facility, fun and economy of a good tape recorder, plus Elizabethan extras, hi-fi quality, handsome looks and excellent value, with even the Essex only 75 gns. Sturdy, reliable, the Elizabethan never dips its oar, and if you go to your dealer to inspect it, you too will go overboard for the Elizabethan.



The Elizabethan Essex



Elizabethan FOR SOUND, NATURALLY

For FREE illustrated literature, please let us have your name and address

E.A.P. (TAPE RECORDERS) LTD Oldchurch Road, Romford, Essex Tel: Romford 62366/7

THERE CAN BE NO DOUBT WHATEVER that "Symphony" Tape Recorders represent the greatest value for money on the market today in spite of the fact that we do not give away coupons with our machines nor offer any other artificial inducement to buy our make. A demonstration will prove to you that both our Table Model and our Portable Model will outclass in quality of reproduction, ease and silence of operation any other make of comparable price on the market. All this is combined with **sheer long-term reliability**—a rare feature indeed among Domestic Recorders today!

HOW IS ALL THIS POSSIBLE? We are not subsidised by the State or other body. It is possible because we **SUPPLY DIRECT TO THE PUBLIC** and give you what would otherwise be a discount to the trade. **The time to consult us is before you sink your money.** Even in the case of makes of recorders other than our own, we submit that **THE PROTECTION AFFORDED BY OUR TECHNICAL RESOURCES IS WORTH A GOOD DEAL MORE** (both before you buy and after) **THAN ANY OF THESE SO-CALLED "SPECIAL TERMS OFFERS."**

Again we have decided to hold our **AUDIO FAIR** at our own showrooms in **Swiss Cottage**, where we feel the conditions for careful consideration and trial of apparatus will be better than at the **Waldorf**. Do not fail to visit us, therefore—we shall be demonstrating continuously from **9 a.m.—6 p.m.** daily on the **18th, 19th, 20th, 21st April.**

SYMPHONY " DE-LUXE TAPE RECORDERS



PORTABLE MODEL

Very high quality reproduction. Two-speed, twin track taking up to 7" reels. Fast wind and re-wind. Very low motor noise. Instant temporary stop/start. Inputs for Microphone, Radio and Gramophone. Outputs for internal speaker, external speaker, and external amplifier. Handsome cabinet, 20" wide x 14" high x 14 1/2" deep. Available in Standard, Medium Walnut, Light Oak or Mahogany. High-grade elliptical speaker.

Portable Model specification as above, but housed in strongly-built De-Luxe, Rexine covered cabinet with locks. Special acoustic properties, including Bass Reflex Action (result of original research)—gives audio impression of much larger cabinet speaker.



TABLE MODEL



THE "SYMPHONY" CONCERT GRAND REPRODUCER

- No. 2 Symphony Amplifier with Remote Control plus extra Tuner power £21 0 0
 - Lenco GL50 Transcription Unit with transcription quality pickup cartridge..... £21 17 6
 - F.M. Tuner £15 15 0
 - Truvox Mark IV Tape Deck with revolution counter..... £30 9 0
 - Truvox Tape Amplifier..... £17 17 0
 - Concert Grand Cabinet with pneumatic lid-stay in sapele mahogany, walnut or oak... £19 0 0
 - Lorenz Triple Cone Loudspeaker with condenser..... £15 4 6
 - Symphony 12" Bass Reflex Cabinet in matching veneer and contemporary style £11 10 0
- Items available singly. Outfit can be built up gradually.

NORTHERN RADIO SERVICES

11, Kings College Road (off Adelaide Road), London, N.W.3.
It is essential to mention this Journal when replying. Telephone: PR1mrose 3314

WE HAVE THE

LARGEST SALES IN ENGLAND!

WHY? BECAUSE WE GIVE YOU THE BEST TERMS

Space is too small to list all our amazing offers, but they include * 2s. 6d. in £ deposit, balance of retail price only, by 9 monthly instalments with **NO INTEREST CHARGES** * H.P. over 2 years * Special cash terms—most makes * Free delivery anywhere in U.K. (we are the biggest Mail Order Specialists with thousands of sales over the whole country) * free demonstrations in your own home, etc., etc.

25 machines on permanent demonstration in our showrooms. * Open all day Saturday. * Credit purchases completed on the spot * all accessories in stock or sent by mail-order. *

You may purchase from us by post, in complete confidence.



HOWARD PHOTOGRAPHIC

WRITE, PHONE OR CALL FOR FREE BROCHURES AND DETAILS OF OUR TERMS

190, HIGH ST. • BROMLEY • KENT • RA V 4477
(Dept. T.) (30 MINUTES FROM THE HEART OF LONDON)



42 gns? - impossible

yes 42 gns. & it's all British



FIRST TIME EVER . . .

a genuine **HI-FI** tape recorder at a price all can afford.
The star-studded **Verdik SI** tape recorder made to very high standards with particular emphasis on trouble-free long term stability.

★ ★ ★ ★ ★

FIVE STAR FEATURE separate record and playback amplifier and 3 head system allows playback of tape as you record. No more ruined recordings — you hear it as you record it.

- **TAPE SPEEDS 3½"/SEC, 7½"/SEC.**
 - **SEPARATE RECORD AND PLAYBACK AMPLIFIERS.**
 - **FIVE VALVES PLUS MAGIC EYE LEVEL INDICATOR.**
 - **TWIN SPEAKERS.**
 - **FREQUENCY RANGE 40 C/S TO 12 KCS.**
 - **HI-FI OUTPUT WITH C.C.I.R. CORRECTION TO PLAYBACK THROUGH YOUR HI-FI AMPLIFIER.**
 - **PROVISION FOR USE OF EXTERNAL SPEAKER.**
 - **SUPPLIED COMPLETE WITH 1200FT. TAPE AND MICROPHONE.**

*From your dealer or if in difficulty
write direct to manufacturers:-*



VERDIK SALES LIMITED 139/143 Sydenham Road, London, S.E.26. Sydenham 3118/9



This superlative all British Deck with three-speed control knob is designed to allow easy fitment and simplicity of operation.

The new MOTTEK-K9 TAPE DECK

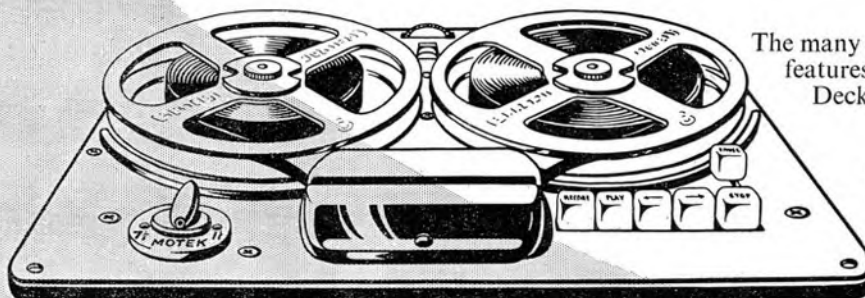

The many outstanding features place this Deck in a class alone.

Details on request
Patents pending

List **21** gns.

MODERN TECHNIQUES

Wedmore Street, London, N.19. Tel: ARChway 3114



TELETAPE

The right advice can be obtained from the Specialist

Speediest Mail Order Delivery

Machine	Deposit	Nine Payments	Cash
Walter 303	5 3 6	3 19 6	39 gns.*
Philips A.G.8109	5 3 6	3 19 6	39 gns.*
Veritone Type V.....	6 16 6	5 6 2	52 gns.*
Grundig T.K.5	6 19 0	5 8 3	53 gns.*
Elizabethan 56	7 1 9	5 10 3	54 gns.*
Wyndsoer Regent	7 1 9	5 10 3	54 gns.*
Veritone D.S.2.....	7 4 0	5 12 4	55 gns.*
Sound	7 4 0	5 12 4	55 gns.*
Brenell.....	7 3 0	5 11 2	£57 3s.†
Elon J.C.20	8 2 9	6 6 7	62 gns.*

*Including Microphone.

Machine	Deposit	Nine Payments	Cash
Philips A.G.8108	8 2 9	6 6 7	62 gns.*
Telefunken KL.65/KS ...	8 5 6	6 8 8	63 gns.*
Baird	8 16 0	6 16 10	67 gns.*
Winston Thoroughbred	8 10 3	6 12 9	65 gns.*
Truvox	9 0 0	7 1 0	69 gns.*
Elizabethan Essex	9 17 0	7 13 2	75 gns.*
Harting	10 15 3	8 7 5	82 gns.†
Grundig T.K.8	9 9 0	7 7 0	72 gns.†
Grundig T.K.830/3D	13 2 6	10 4 2	100 gns.†

No Interest or Charges

†Less Microphone.

Largest stock of tape recorders on display at our branches. Demonstrations daily, open until 6 p.m. Saturdays. *Phone or write to ascertain the nearest branch to you, or send your order to:—

TELETAPE—Britain's Largest Tape Recorder Specialists

230, Hertford Road, Enfield Highway, Enfield, Middlesex

Tel: HOWard 1799

from Pianissimo to...



FORTISSIMO

THE *Spectone* TAPE RECORDER

GIVES THE LIVING TRUTH IN SOUND

An instrument of professional quality for the high-fidelity conscious, achieving a truly high standard of recording and playback at a remarkably moderate price. Automatic equalisation of output at each speed ensures perfect reproduction. Incorporating the new Collaro Tape Transcriptor, upper and lower track recordings can be made in quick succession without spool reversal while a safety device prevents accidental erasure. Three speeds: $3\frac{3}{4}$ ", $7\frac{1}{2}$ " and 15" per second.

76gms

With microphone

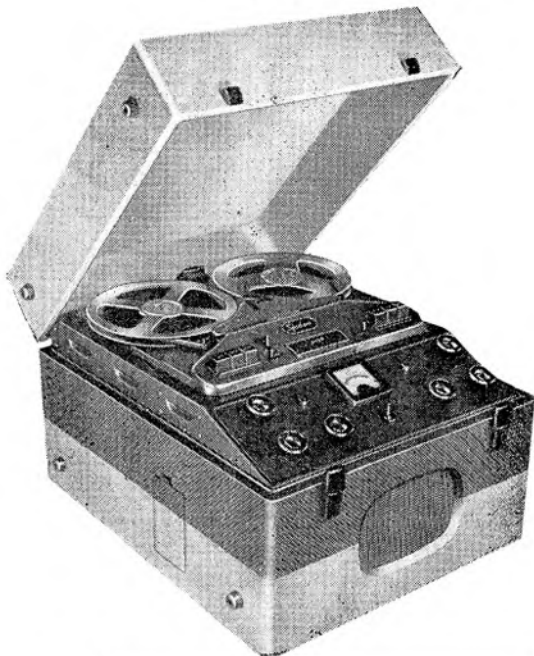

Specto

LIMITED

Vale Road : Windsor : Berks

AUDIO FAIR SENSATION!



PHENOMENAL VALUE!

This completely new model uses our famous high-quality "Adaptatape," directly coupled to a pre-amp. and main amplifier. The lower part of the cabinet is an insulated, tuned port, acoustic chamber, and three first grade speakers are fitted. The latest Mark IV Collaro deck is used and the circuitry embodies nine valves. The cabinet is walnut finish, baize lined lid.

Price only **70 guineas**

Little more than the usual portable ! !

**FOR STAR QUALITY
MAKE YOUR WAY TO**

STAND No. 53

AUDIO FAIR SENSATION!

From The House of SONOMAG

THE NEW SONOMAG "46"

Never before this value! Latest design from Sonomag, using the new Motek three-speed deck, five-valve circuitry of advanced design with our own new push-pull oscillator, Acos microphone. Cabinet is choice of grey and green or grey and maroon. No portable of this quality is on the market at the rock-bottom price of

46 guineas

complete with tape and mike

Only Sonomag's unrivalled manufacturing facilities makes this price possible.



SONOMAG

2 ST. MICHAEL'S ROAD, STOCKWELL, S.W.9

Tele: BRI 5441



How true?

We believe in truth in advertising as well as truth in sound reproduction and this Collaro Sonomag Tape Recorder has, we believe, the best specification of any tape recorder at its price.

Send for the specification, compare the performance and advantages with any other recorder at a similar price and you will be surprised—agreeably surprised—and what is more it is available in chassis form for use with other High Fidelity equipment.

Available from stock now.

Complete at **52 gns.**
or in Chassis form **38 gns.**

SPECIAL OFFER : TAPE RECORDERS

- Easy Terms without interest charges, 6 months' credit.
- Credit sale and Hire Purchase terms with *Free Insurance, Free Technical Advice and Free Delivery.*
- All prices include *Free Tape and Spool.*

Send deposit with order for immediate attention. Proposal form and Agreement by return. All without "Red Tape." Send now for full technical details.

Write now to

CLASSIC

ELECTRICAL COMPANY LIMITED

Britain's Leading Hi-Fi Specialists

352-4, Lower Addiscombe Road, Croydon, Surrey. Tel. ADD 6061/2. Grams.: Classifi, Croydon, Addiscombe. Buses 12, 54, 727. Stations, East Croydon, Addiscombe, Woodside.

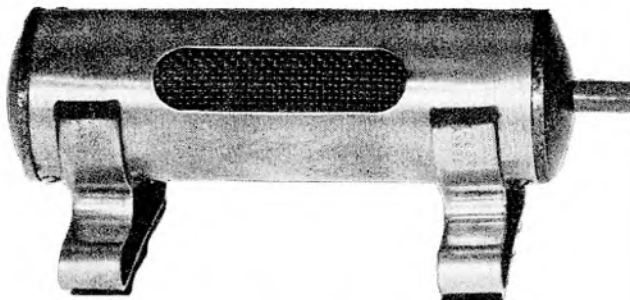

RIBBON MICROPHONE M.9.

In this new Microphone—

Our popular assembly is used mounted in a more economical manner.

The magnet system is very generous and comprises three substantial U magnets to provide the high field necessary for good frequency response and efficiency.

The ribbon is of specially formed aluminium alloy 0.0001" thick.

Price £6. 12. 6.

FILM INDUSTRIES LTD.

90 Belsize Lane, London, N.W.3

HAM 9632-3

Telegrams: Troosound Haver

VERY SPECIAL OFFER!

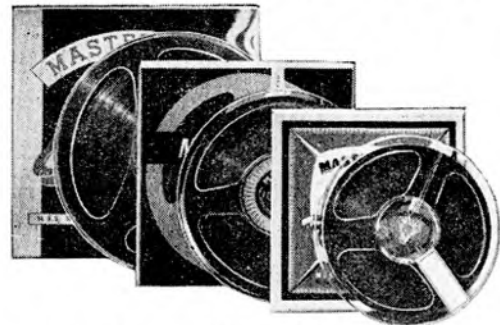

M.S.S. MASTERTAPE

P.V.C. Magnetic Recording Tape on latest type plastics spools. Not surplus but brand new, perfect and boxed. Will work with any Recorder. Satisfaction or money back guaranteed.

1,200 ft. Standard on 7" spool, List 35s.	Lasky's Price	21/-
850 ft. Standard on 5½" Continental spool, List. 26s.	Lasky's Price	16/6
400 ft. Standard on 5" spool, List 21s.	Lasky's Price	12/6
1,200 ft. Long Play on 5½" Continental spool, 35s.	Lasky's Price	22/6
859 ft. Long Play on 5" spool, List 28s.	Lasky's Price	16/6

Post. 1 spool 1s. 6d., Orders over £3/10/0 post free

LASKY'S RADIO (Dept. T.R.)

LASKY'S (HARROW RD.) LTD.

42, TOTTENHAM COURT ROAD, W.1. MUSeum 2605.
370, HARROW ROAD, PADDINGTON, W.9. LAD 4075 & CUN 1979
Open all day SATURDAY. Half-day Thursday.
PLEASE ADDRESS ALL MAIL ORDERS TO HARROW ROAD.

New!

EDITING SOUND TAPE BY BASF you can write on the back

For the first time you can edit sound . . . on the tape itself.
No need now for stick-on labels. The new BASF tape has a specially roughened back to take your ink or pencil comments.
The tape is the only one of its kind on the market . . . its recording and spooling qualities are excellent.
Available on 4" spools in 395' lengths only at 25/- each.



ASK YOUR DEALER FOR BASF EDITING SOUND TAPE

the tape you can write on

In case of difficulty in obtaining supplies please write to:

F. A. HUGHES & CO. LTD DEVONSHIRE HOUSE PICCADILLY LONDON W1

MAYfair 8867



HEAR THE NEW **HARTING** HIGH FIDELITY TAPE RECORDER AT DICKINSONS

BUILT TO PROFESSIONAL BROADCASTING STANDARDS

FULLY DESCRIPTIVE BROCHURE GLADLY SENT ON REQUEST

- **No Interest. Easy Terms.** £14 2s. Deposit. 8 monthly payments of £9
- **We give full demonstrations and we invite you to make "On-the-Spot" recordings**

The Harting Tape RECORDER is recognised as the ultimate standard in tape recorders irrespective of price. It is manufactured by the Wilhelm Harting Co. of Western Germany in a new factory devoted exclusively to the production of this instrument. For many years this Company has been building equipment for the German broadcasting services

VISITORS TO THE AUDIO FAIR ARE MOST WELCOME. WE ARE ONLY A FEW MINUTES' WALK FROM TRAFALGAR SQUARE

DICKINSONS OF PALL MALL LTD.

11 ROYAL OPERA ARCADE, PALL MALL, LONDON, S.W.1

Telephone: TRAfalgar 2881

THE ROYAL OPERA ARCADE LIES JUST BEHIND HER MAJESTY'S THEATRE IN HAYMARKET. ENTRANCES IN CHARLES II STREET AND PALL MALL

- Widest frequency response
50 c/s to 15 Kc/s at $7\frac{1}{2}$ I.P.S.
50 c/s to 9 Kc/s at $3\frac{3}{4}$ I.P.S.
Within ± 3 DB
- Total of Wow and Flutter better than .1 of 1%
- High Fidelity Amplifier designed to Professional Standards, 4-watt output (6-watt peak)
- Very robust construction
- Foolproof mechanical and electronic mechanisms
- Signal to noise ratio better than 52 DB unweighted

Price 82 guineas
(excluding Microphone)

Moving Coil Studio Microphone
9½ guineas

Crystal Microphone **5 guineas**

Jason

AT THE AUDIO FAIR

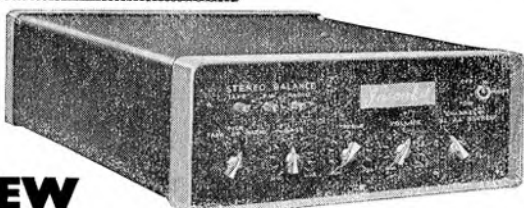

NEW STEREOPHONIC KITS and EQUIPMENT

Two designs are offered. The first, Model J.4-4 is for the more experienced constructor to build, and as well as providing for microphones, disc, etc., it has sufficient gain to play off a tape head. As designed by Mr. H. Lewis York, of Cape Electroponics, and described in *Hi-Fi News*. Model J.2-2 is a somewhat simpler version of the original design, and less complicated to build. A special amplifier is also to be made available, the Jason J.2-10. This is virtually the original J.10 converted to stereo, and like the J.10 is intended for shelf mounting and will cost £37 10s.

JASON STEREO PRE-AMP. J.4-4

All parts, complete with punched and drilled chassis, nuts, bolts, wire, etc., and full instructions. Without 8 valves required

£16 0 0

JASON STEREO PRE-AMP. J.2-2

All parts complete with punched and drilled chassis, nuts, bolts, wire, etc., and full instructions. Without 4 valves required.

£12 18 0

JASON J.2-2 built and tested, complete £18 18s.

Information sheets gladly sent on request.

THE JASON MOTOR & ELECTRONIC CO.

3-4 (K) GREAT CHAPEL ST., OXFORD ST., LONDON, W.1
(Between Tottenham Ct. Rd. & Oxford Circus Und. Stns. Phone: GER. 0273/4)

Catalogue

ALL LEADING TAPE RECORDERS

- NO interest charges
- NO insurance charges
- NO delivery charges
- NO extras

Will you call to see all the best-known makes of Tape Recorders to compare them, listen to them, get full details about them—or would you like us to send you our **FREE comprehensive fully illustrated 20-page catalogue?** You can buy the recorder that is just right for you at the most attractive terms available anywhere at the **nett cash price**, over 9, 12 or 18 months. We repair and service all makes of Tape Recorder. Ferrograph and Vortexion in stock. Please call, write or phone



GRUNDIG TK5

Sypha Sound Sales Ltd. (Dept. T.)

THE TAPE RECORDER CENTRE

75 Grand Parade (nr. Harringay Arena), London, N.4. Tel: STAmford Hill 1146

or call?

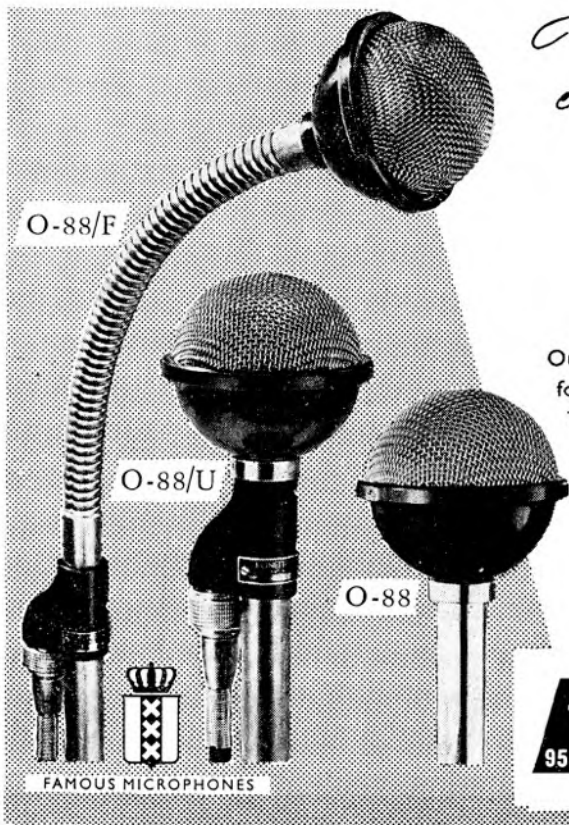

Three popular microphones by **Ronette**

series
O-88

Our O-88 series has been especially developed for use with magnetic recording equipment. These microphones are equally sensitive to sound reaching it from all directions. They are obtainable with different voltage/frequency response curves, to suit your special requirements.

Ask for leaflet Nr. 508 describing our patented cartridges.

Sole distributors for Gt. Britain

TRIANON ELECTRIC Ltd. LONDON NW10
95, Cobbold Rd., Willesden Telephone Willesden 2116

Masterpiece...

The liquid arpeggio from the fingers of an inspired virtuoso... that almost tangible feeling of grace and movement accompanying an impeccable performance... Capture the precious beauty of immortal music at its finest moments, flawlessly, permanently on Mastertape.

Mastertape

MAGNETIC RECORDING TAPE BY
MSS RECORDING CO. LTD. Colnbrook, Bucks.
Telephone: Colnbrook 2431.



Made with a new improved lacquer, anti-static and free from curl, Mastertape is more than ever the choice of expert and connoisseur.

a complete Tape Recorder Service

Grundig, Gelo, Telefunken, Truvox, Elizabethan, Wyndsor, Simon, Phonotrix, Tutor, etc.

TAPE DECKS by Truvox and Collaro.

MICROPHONES AND STANDS. Grundig, Cadenza, Gelo, Cosmocord, Lustraphone, Reslo, etc.

TAPES. Grundig, B.A.S.F., Emitape, Scotch Boy.

JOINTING AND EDITING ACCESSORIES. Mixers, Tuners, Amplifiers, Converters, Speakers, Record Transcription Units.

SPARES

★ **No Interest Terms** ★ **Free Delivery**

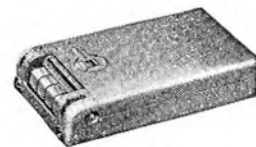

also the

minifon

One of the world's smallest wire recorders

NEW WATERPROOF COVERS TO PROTECT YOUR VALUABLE RECORDERS.

Choice of colours: navy blue, brown, grey and maroon with white piping. Specials made to order. Full range to suit popular models in preparation.

TK5 Cover complete with microphone pocket
42/-

A. BROWN & SON LTD.

TAPE RECORDING DEPT.
24-28 George Street, Hull, E. YORKS
Telephone: 15412, 15413

For the best of reasons

- ★ Perfect Reproduction
- ★ Ease and simplicity of operation
- ★ "Know-how" in manufacture

—buy TRUVOX—and you buy all three. The Truvox R2 Recorder, with its improved circuitry and styling, embodies all the experience of 7 years specialising in the design, development and manufacture of Tape Decks and Tape Recording Amplifiers. There are no last minute "mods"—every stage has been tested and tested again to ensure that it lives up to the reputation enjoyed by the name it bears.

The result is a high fidelity instrument that will give you endless hours of enjoyment producing and replaying your own recordings as well as providing perfect reproduction of pre-recorded tapes with all those finer gradations of tone that are there for those who can hear the difference.

Additional applications of this machine, with accessories, include dictation and transcription, radio reception, telephone conversation recording, AM or FM Tuner amplification, etc.

When you buy TRUVOX you buy a better recorder—produced for those who can hear the difference.

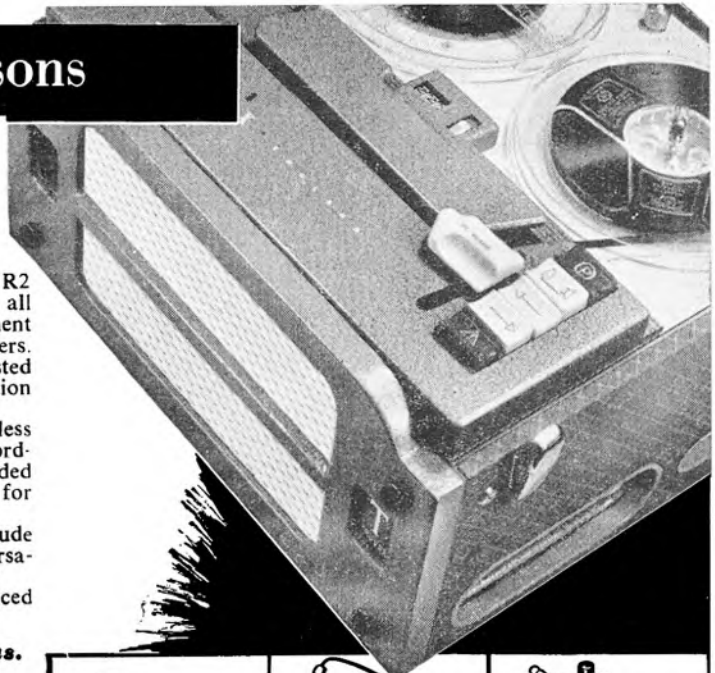

TRUVOX Models from 66 gns.
Tape Recorders



Full details, including accessories available on request from the manufacturers

TRUVOX LIMITED, 15 LYON ROAD, HARROW, MIDDX. Telephone Harrow 9282

EVERYTHING . . .

SOUND

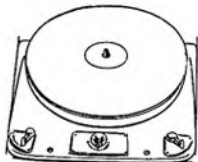

GARRARD 301
TRANSCRIPTION
UNIT



SOUND 777

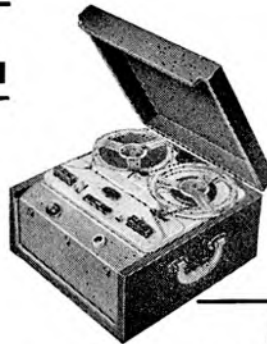

GRUNDIG TK5



LENCO GL56
TRANSCRIPTION UNIT

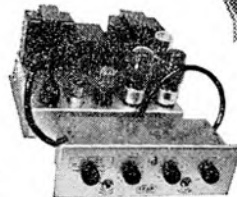

LEAK TL/10
AMPLIFIER



WB HF1214
LOUDSPEAKER



GOLDRING No. 500
CARTRIDGE

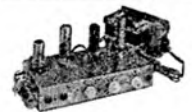

TRUVOX
AMPLIFIER

... IN HIGH FIDELITY

Just a small selection from our stock of Hi-Fi and Tape Recording Equipment. All are available on easy payment terms. Special export service. If you are unable to call please write to our Mail Order Department—speedy service—complete satisfaction.



The E & G RADIO CENTRE Ltd.
HIGH FIDELITY AND TAPE RECORDER SPECIALISTS

SPECIAL BARGAIN OFFERS TO CALLERS
33 Tottenham Court Road, London, W.1
Tel. MUSeum 6667

NOW AVAILABLE



**TAPE RECORDER
for only 44 gns!**

And what do you get for your 44 gns? A really "Sound" job, from one of the most up-to-date Tape Recorder factories in the country, craftsman built with looks you'll be proud of. Features galore! 3 speeds, 3 hours playing time, 3 watts output. The latest Collaro Tape Transcriber with push-button control and digital footage indicator. Pause control, instantaneous track change . . . plays all pre-recorded tapes.

Mr. QUALITY

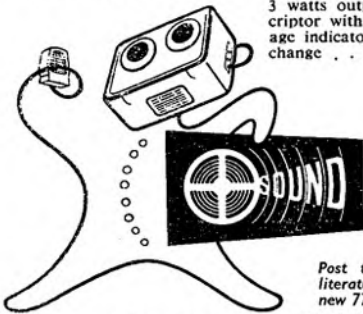

... the sign of a  product

Post the coupon now for illustrated literature giving the full story of the new 777.

777 Piezo-electric desk mic. 55/- extra



TAPE RECORDERS (Electronics) LTD.
784/788, High Road, Tottenham, N.17

Name

Address.....

.....TR/5/58

STEREO and a new service...

The advent of stereo opens up a whole new world of high fidelity sound reproduction. It is dangerous to use the word "ultimate" in relation to Hi-Fi, but certainly for a three dimensional realism in sound, stereo is a "must."

A new service is the Q.M. Tape Library. If your tape recorder can handle 7" reels this is going to interest you! There is a large variety of serious and not so serious recorded music available including an increasing library of stereo tapes.

TANDBERG

The new Tandberg de luxe recorder also reproduces the new commercially recorded stereo tapes. It is a three speed recorder— $7\frac{1}{2}$, $3\frac{3}{4}$ and $1\frac{3}{4}$ i.p.s. on 7" reels and has a precision place indicator. It is housed in a polished, veneered cabinet and there is a pigskin leathercloth carrying case. Price 114 gns.

For stereo reproduction, two external speakers are required—Q.M. can supply suitable models from 12 gns.



HARTING

The Harting Portable tape recorder is a two speed model— $7\frac{1}{2}$ / $3\frac{3}{4}$ i.p.s. It gives exceptionally good quality and is very simple to operate. Its handsome appearance and magnificent performance add up to one of the finest recorders available. Price 82 gns.

Quality Mart

8 DARTMOUTH PARK AVENUE, LONDON, N.W.5. GULLIVER 1131

Our showroom is open for demonstrations daily 9.30-6. Friday 1.30-9. Closed Monday.

Only 20 minutes from Charing Cross by Northern Underground or Bus 27, 134, 137 to Tufnell Park Station.

The Magnafon MI

Here is the perfect light portable tape recorder. The result of seven years' experience. In a modern cabinet designed for maximum acoustic efficiency.

Equalised so that commercially pre-recorded tapes will be reproduced correctly. The lowest speed, $1\frac{1}{8}$ inches per second, giving a maximum playing time of two hours per track with standard tape, that is four hours per spool. With long playing tape this time is extended to six hours per spool.

Extremely low wow and flutter, less than 0.2 per cent. Fast rewind 45 secs. positive spool locks.

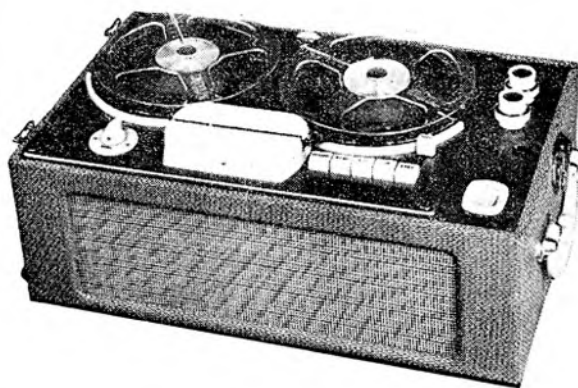

The Magnafon Pre Amplifier
Price 40 gns with meter 50 gns

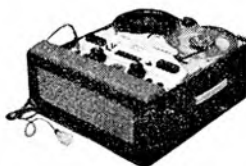

The Magnafon '58'
Price including mic. and tape 62 gns

* You can hear these in our new demonstration room.

MAGNAFON

for details please write to

Magnafon Limited, 3, Baggally Street, London, E.3.

Tel.: ADV. 3112.

The JC20 Plus . . .

AS REVIEWED IN THIS ISSUE

DESIGNED back in 1956 for educational use, the JC20 is available in three different models using the new Mark 4 ★ tape transcriptor.

JC20 standard model still 62 gns

JC30 as standard but with record level meter 66 gns

JC40 ultra linear push/pull output with meter 70 gns

ALL MODELS

Separate bass and treble controls.

Tape mechanism suspended on neoprene to reduce mechanical vibration.

$4\frac{1}{2}$ watts output into 15 ohm load (ultra linear 7 watts).

Automatic frequency compensation at all speeds.

Supplied complete with acos 39/1 microphone, stand, screened jack plug, and 1,200 ft. of PVC Tape.

★The Mark 4 is the latest and more expensive tape transcriptor by Collaro embodying lighter and very silent high torque motors, micro on/off motor switch and greatly improved tape tension and rewind mechanism.

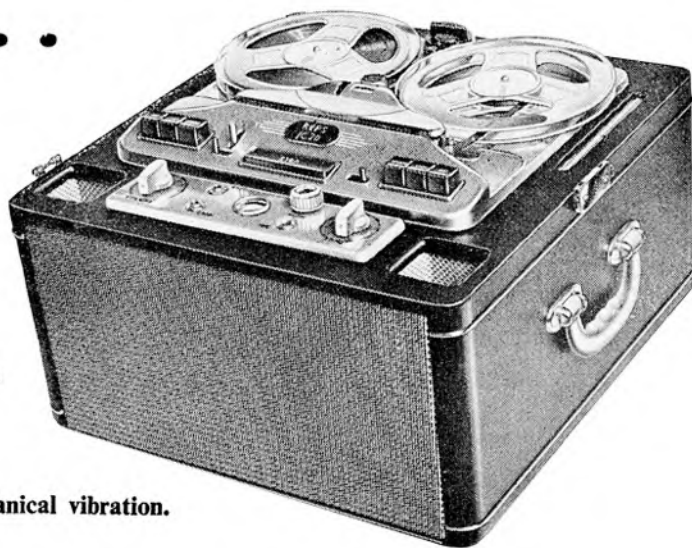

For illustrated leaflet write to **Reps (Tape Recorders) Ltd**

118 Park Road North, South Acton, London W3 Tel: Acorn 4141

Brenell TAPE RECORDING EQUIPMENT

The Connoisseur's Choice

Why are so many tape recording experts turning to the Brenell Deck? Is it because they want precision engineering, greater speed stability, the best value for money, freedom from troublesome gadgets, high quality materials, multiple speeds?

All these features are combined in Brenell Equipment, you can buy Brenell and know you have bought "the Connoisseur's Choice."

Brenell have control during manufacture of all the essential parts—they are not merely "assemblers," and every part must conform to a critically high standard. Skilful design is followed up by a high degree of craftsmanship in manufacture, resulting in equipment which is rightly held in the highest esteem throughout the world.

In the Mark 5 Tape Deck, all the proved features which have given Brenell its great reputation are retained, and new features make available TODAY the Deck of the FUTURE.



BRENELL '3 STAR' PORTABLE TAPE RECORDER

This attractive tape recorder combines a deck and amplifier of outstanding quality with a large loudspeaker in a modern styled cabinet; delightful performance and appearance will make this recorder one of the most popular types available.

Salient Features

- Push button deck control
- Interlocked switching
- Pause control
- 3 speeds $1\frac{7}{8}$, $3\frac{3}{4}$ and $7\frac{1}{2}$ i.p.s.
- Switched frequency correction
- Digital rev. counter

PRINTED CIRCUIT AMPLIFIER

Separate Bass and Treble Controls
Cathode Ray Type Recording Level Indicator
Extension loudspeaker socket
Monitoring facilities

BRENELL MARK 5 TAPE DECK

4 speeds $1\frac{7}{8}$, $3\frac{3}{4}$, $7\frac{1}{2}$, 15 i.p.s.
3 Motors
Up to $8\frac{1}{4}$ in. dia. spools
Provision for Extra Heads (up to 4 in all)

Pause Control
Interlocked Switching
Fast Wind and Rewind
Digital Revolution Counter

Safety Switch to Prevent
Accidental Erasure

BRENELL MARK 5 TAPE RECORDER

Incorporating the Mark 5 Four Speed Amplifier and Hi-Fi Speaker, in portable Tape Deck with High Fidelity Record Play-Back cabinet.

TAPE PRE-AMPLIFIER T.P.2

Designed to suit any Brenell Deck, incorporates all the best features of the modern tape pre-amplifier.

Frequency correction for $3\frac{3}{4}$, $7\frac{1}{2}$ and 15 i.p.s.

Monitoring facilities via headphones.

Monitoring facilities via main amplifier equipment.

Head DE-MAGNETISING facilities.

Frequency response:

$3\frac{3}{4}$ i.p.s. 60 c/s—6,000 \pm 3 dB $7\frac{1}{2}$ i.p.s. 60 c/s—10,000 \pm 3dB 15 i.p.s.
50 c/s—14,000 \pm 3 dB.

Output to main equipment approximately 1v at 50,000 ohms.

Valves: EF86, ECC83, EL84, EM81.

Power requirements: 300v at 40 milliamps. H.T. Supply. 6.3v at 1.5 amps.

Heater.



Detailed information available from :

Sole Manufacturers :

BRENELL ENGINEERING CO. LTD.

1a DOUGHTY STREET, LONDON, W.C.1

Tel: HOL 7358 and CHA 5809

MORE

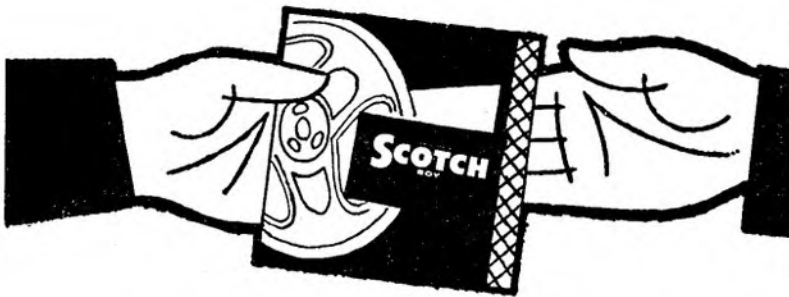

AND MORE



AND MORE



BIGGEST range

Acetate, PVC and Polyester; all silicone lubricated to increase the life of your tape-recorder and assure continued perfect clarity.

FINEST quality

High sensitivity and freedom from distortion guaranteed by scientific production control.

BEST value

Possible only because of 3M research and large scale production.

**BRITAIN'S LOWEST PRICED
RECORDING TAPE**

111A—STANDARD ACETATE

3" —————	200ft.	6/3
5" —————	600ft.	16/-
5 ³ / ₄ " —————	850ft.	22/-
7" —————	1200ft.	27/-

**A POLYESTER TAPE—AT
A P.V.C. PRICE**

150 — EXTRA PLAY POLYESTER

3" —————	300ft.	9/6
5" —————	900ft.	28/-
5 ³ / ₄ " —————	1275ft.	35/-
7" —————	1800ft.	50/-

**Recordists are buying
Scotch Boy Magnetic Tapes
for HIGHER FI at LOWER prices**

Scotch TRADE MARK
BOY **MAGNETIC TAPE**
DOES THE JOB BETTER!



MINNESOTA MINING & MANUFACTURING COMPANY LIMITED
3M HOUSE • WIGMORE STREET • LONDON W.1 AND BIRMINGHAM • MANCHESTER • GLASGOW
WORLD'S LARGEST MANUFACTURERS OF MAGNETIC TAPES

Associate Editors:

IAN ARNISON
R. BROWN

Technical Advisory Editor:

E. SWAIN
A.M.I.E.E., A.M.Brit. I.R.E.

Advertisement Department:

1, Crane Court, Fleet St.,
London, E.C.4
Telephone: FLEet Street 0197

American Representative:

WILLIAM FARQUHAR,
P.O. Box 1290, Grand
Central Station, New York
City 17, N.Y., U.S.A.



Published on the 20th of each month from 426, Camden
Road, London, N.7. Telephone: NORth 3419

CONTENTS

THE EDITORS' VIEW

TAPE RECORDING TRENDS

A review of recent progress, by
R. E. B. Hickman, M.B.K.S.,
M.T.S. Pages 24 & 25

HOMO TAPIENS

Page 26

AUDIO FAIR SUPPLEMENT

Pages 31 to 39

POPS ON SPOOLS

Reviews by Stanley P. White
Page 40

IDEAS POOL

Page 41

TAPE NEWS DIGEST

Page 44

TAPE AND THE PUPPET
THEATRE

by George Rutherford
Page 46

REMOTE CONTROL FOR THE
COLLARO DECK

Page 47

NEWS FROM
MANUFACTURERS

Page 48

REVIEWS OF PRODUCTS

Page 49

Taking stock

THE AUDIO FAIR, so firmly established as a major event in the year for tape enthusiasts, is the natural time at which to take stock of progress made. So far as the efforts of the industry are concerned, the record is impressive, as articles elsewhere in this issue make clear. The organisers of the Audio Fair deserve praise for the manner in which, so rapidly, they have built up this event. Cyril Rex-Hassan, F.R.S.A., has made a niche for himself in the history of these adventurous years in the world of hi-fi.

Tape Recording Magazine marks this year's Fair with another step forward. This is the largest and most ambitious issue we have yet produced, and we present it as an indication of the standards which we set ourselves for the coming year. Since we increased the size of the magazine five months ago, we have welcomed a host of new readers. We thank all our readers, old and new, for their support.

We intend to give more attention to equipment used in conjunction with tape recorders—microphones, amplifiers, speakers, tuners, turntables and so on. We shall work to the same policy we have applied to tape; that is, we shall seek always the lively, straightforward approach, using language readily understood by the thousands of enthusiasts who do not claim to be electronic wisecracks. At the same time, we shall speak with authority, and our contributors will include names which stand foremost in the field. The next issue will contain the first of a regular series of articles intended for the newcomer to high-fidelity. They will show how, from modest beginnings, an enthusiast can develop his equipment along logical lines.

In our second year, we shall step up the activities which we have developed side by side with the magazine, as a service to the industry and to those who use tape. The British Amateur Tape Recording Contest, when it reaches its climax this autumn, will be recognised as the biggest thing in the calendar to stimulate public interest in the subject. At the same time, it provides positive encouragement to individuals to improve their standards, and to youngsters to acquire an early interest in the medium.

The *Tape Recording Year Book*, to be published this year, will provide the long-awaited guide to the subject that is needed by those who are without previous experience of high-fidelity matters.

And, in the development of the club movement, we are anxious to play a full part. We are now recognised by all the clubs formed in this country as their natural mouthpiece, and we shall seek to work in the closest partnership with them all. The news now reaching us makes it clear that we are at the beginning of a spectacular growth of local clubs in towns and cities throughout the country. Nothing can be more important for the future of the industry than sound organisation of this movement at this stage.

All the portents are encouraging. We go forward with faith and with optimism. It will be shared, we know, by all who visit the London Audio Fair this month.

TAPE RECORDING TRENDS

R. E. B. Hickman, M.B.K.S., M.T.S., discusses recent progress and describes likely future developments

LIKE most other years since the war, 1957 was a year of continued expansion in the field of tape recorders.

The year has been notable in several ways: a number of new entrants have appeared in the lists; there has been an appreciable influx of new machines from the Continent; there has been an increasing interest in stereophonic reproduction.

A further trend of importance has been the growing appreciation by manufacturers that the tape recorder is no longer in its infancy.

Now it is not sufficient to provide the bare essentials in the way of a simple amplifier connected to a small loudspeaker and hope to be able to sell such an equipment on its novelty value.

To compete with the present enormous interest and demand for gramophone discs and recorder playing equipment tape recorder manufacturers have realised that their amplifiers must be high fidelity as well and must be as smartly styled, as reliable and as simple to operate as disc reproducers.

Most of the new models introduced during the year have emphasised this trend. The average machine continues to sell around 60 to 80 guineas—there are a number of cheaper ones and also more expensive ones—but in general terms you probably get more for your money this year than last.

* * *

STYLING has received a lot of attention—such machines as the Grundig TK 830-3D and the Truvox R2 are fine examples of high performance equipments which are also handsome to look at. Equally so there are other machines, let them be nameless, which whilst still capable of good quality performance, could sadly do with a face lift!

For some reason which is not at all clear to the writer there often appears to be a sense of good taste and good style about imported articles that is too often missing in the equivalent home produced item. One has only to think of Scandinavian furniture and Italian glasswork. This *je ne sais quoi* is typified by the German made Harting decks which are now being used in a number of British built recorders. The Telefunken units (again from Germany) imported by Welmec have the same well bred appearance.

Of course it will be said that appearance is not everything, but this is an argument which must not be pushed too far as any retailer of high fidelity equipment for the home will be aware.

Although a number of manufacturers have provided input sockets so that the internal amplifier may be used

as a gramophone amplifier it is not thought that this will prove a great attraction. It is still probably true to say that most people buy a recorder *after* having equipped themselves with record playing equipment and in consequence already have a good quality amplifier. It is therefore of more interest that the tape recorder should have facilities to allow it to play-back through the owner's high fidelity amplifier and loudspeaker. Most recorders nowadays provide an output to feed into an extension speaker but it is believed that many could with advantage provide facilities for taking off the relatively low level signal to feed into the input of a good quality amplifier system.

* * *

HAVING made the above point, it should be realised of course that some of the more elaborate and hence unfortunately more expensive recorders, can provide extremely pleasing reproduction from their own inbuilt loudspeakers. The new Winston Thoroughbred has an ultra-linear amplifier working into a 7 in. × 4 in. elliptical speaker plus two 3 in. electrostatic tweeters. Grundig was one of the first firms to do something about improving the inbuilt loudspeaker assembly and their model TK 830-3D uses three 7 in. elliptical loudspeakers fed from a six watt amplifier. The output of the Ferrograph Model 3 A/N is only rated at three watts but its 10 in. × 7 in. loudspeaker gives an excellent quality of reproduction.

The importations from the Continent which have been introduced during the year have, of course, been conditioned by the competition they would have to face from this country's own manufacturers. In general two main types have been brought over. There has been the good quality unit offering excellent facilities, good styling and high fidelity sound and selling in the higher price brackets, and there has also been the small (and indeed in some cases, the very small) portable often with battery operated amplifier and clockwork driven motor.

Of particular interest amongst the imported models have been the very smallest units. Mostly these have been designed to replay through an external amplifier and loudspeaker.

The Telefunken model KL 65/TS which operates at $3\frac{3}{4}$ or $1\frac{7}{8}$ ips has no power output stage or loudspeaker and hence its weight has been kept down to 14 lbs only. It is very attractively styled and is fully automatic in operation.

The Butoba TS6 recorder is the only completely transistorised battery operated recorder at present on the market using 5 in. spools. The amplifier works from four flash-lamp type dry cells and has an output of 500 mW

into a 7 in. elliptical loudspeaker. The tape transport is driven by a clockwork motor and at $3\frac{1}{2}$ ips or $1\frac{1}{2}$ ips, recording times of 20 or 40 minutes respectively are obtained. The complete equipment weighs less than 20 lbs.

Probably the smallest tape machine we have yet seen (there is however an even smaller unit available from E.M.I. but this uses a wire medium) is the transistorised miniature G.B.C. equipment, known as the Phonotrix. This unit is fully transistorised and is operated from four 1.5 v. U2 batteries. Operating at $1\frac{1}{2}$ ips its twin track tape gives 70 minutes play time. The unit in its carrying case measures only $6\frac{1}{2}$ in. by $4\frac{1}{2}$ ins. by $3\frac{1}{2}$ ins. and weighs no more than $8\frac{1}{2}$ lbs.

Apart from recorders themselves there have also been some significant introductions to the lists of accessories.

The Polyester plastic based recording tapes which have been available in the U.S.A. for some time have now been introduced to the U.K. market. Polyester tape is much stronger than standard acetate tape, it is less inclined to curl, and it retains its plastic qualities over a much wider range of temperature and humidity. Taking advantage of these qualities it is now possible to get 1,800 ft. on a 7 in. reel and with enhanced high frequency response. (The Polyester base is known as Mylar in the U.S.A. and is supplied by I.C.I. in this country as Melinex).

British Ferrograph have introduced a "Brief Stop" mechanism which allows the motion of the tape to be halted, either during recording or playback for editing purposes, without having to switch off the motor.

Of interest to the person who looks for other facilities than entertainment from his recorder are the language courses on tape which can be obtained from the Tutor Tape Company. French, German, Spanish, etc. courses are all available, whilst foreigners wishing to learn the English language are also catered for.

* * *

SO much for the year 1957. What may we expect from the current year.

It seems fairly evident that stereophonic reproduction will come much more to the fore this year. There is the promise of stereo discs in the latter part of the year and this is bound to lead to a corresponding surge of interest in stereo tapes. It should be remembered that stereo on tape has been available for several years now—it has been tried and proved and most of the technical troubles such as intermodulation inherent in a stereo set-up are much less troublesome when dealing with stereo tape than with stereo-disc.

Already the tape enthusiast who wishes to install stereo equipment has a choice of several makes. G.E.C. showed some superb equipment at the 1957 Radio Show (but omitted to show how to find the £400 odd to pay for it!)

British Ferrograph have two equipments—their models 3S and 88. These are described in the Audio Fair section.

Specto Ltd. offer stereo reproduction in their model 123 which employs a special Reflectograph tape deck.

It is likely that other firms will enter the field. A very attractive idea was the "add-on" stereo converter shown by RCA at the 1957 Radio Show. This was an attractively styled tape recorder which was suitable for independent use

R. E. B. Hickman, M.B.K.S., M.T.S., is the author of the "Magnetic Recording Handbook." He is a foremost authority on the theory, practice and servicing of domestic and professional tape and wire recorders.



as a single channel recorder or reproducer but in conjunction with an RCA record player became a stereo player for tapes.

Interest in stereo reproduction, which of course, is high fidelity at its present peak, will probably encourage the production of more tape decks with pre-amplifiers suitable for feeding into existing high fidelity systems. It is also thought possible that more tape recorders suitable for playing either monaural or stereo tapes will be produced incorporating a console type loudspeaker. The Wyndson Dauphin and the M.S.S. Model CMR/DE are examples of this type of instrument. (Incidentally no less an authority than G. A. Briggs has put forward the opinion that two dissimilar loudspeakers can be used and still give satisfactory stereo working).

There is also likely to be an increase of interest in the very small battery operated portables such as the G.B.C. and we are likely to see more of these imported. These will probably sell around the 20-25 guinea mark and will be ideal "beginners" instruments.

A long standing hope, but probably not due for fulfilment this year is for some genius to develop a system whereby a reel of tape can be loaded on to a machine and played as easily as can a gramophone record. Tape cassettes have been used for various specialised applications—talking books for the blind for instance—but little real attempt has been made to adapt them to the normal domestic type recorder. This tape handling bogey is still a major issue with a lot of would-be users and must be solved sooner or later.

Finally, with the increasing use of polyester tapes and the continuous development of methods of processing tapes, we cannot be far away from the day when $3\frac{1}{2}$ ips and even $1\frac{1}{2}$ ips or lower will provide reproduction of musical performances of a quality to satisfy even the most critical ear.

Next month's issue will be published as usual on the 20th of the month. Watch out for the first of two important features on "Learning languages with a tape recorder"

Have you got enough tape?

ACCORDING to a *Financial Times* correspondent (and that is good enough for me) the tape recording industry expects to sell 80,000 machines in 1958, worth £4 million. This is 10,000 more than last year; and it is interesting to note, too, that it is double the number sold in 1954.

And, if you are interested in such things, the *Financial Times* breakdown of the cost of a £50 recorder shows the electronic parts and the mechanism each accounting for £15 and the case for £3. The retailer's margin is given as £15, and the maker's margin as only £2.

Something that interested me quite as much as these figures was the estimate that the average tape recorder owner will probably have ten tapes by the time he has had his machine for two years.

Averages can be very deceptive, of course; in some cases, where special uses are involved, one tape is possibly sufficient for the job, which would permit others to have considerably more. I am tempted to think, however, that most of us are understocked with tape most of the time—and to no very great financial advantage.

Sooner or later our permanent library will grow and more tapes will have to be bought for casual recording. By delaying the purchase we deprive ourselves of the use of these tapes in dozens of different ways. How often do you find yourself sacrificing some very entertaining recordings much earlier than you would wish, simply because your stock of tape is not equal to the strain?

Time tells

MY advice is to keep your stock several spools ahead of your apparent immediate needs. For one thing, this will give you a much better chance of applying the test of time to borderline recordings.

I have, myself, wiped off several choice pieces in the fond belief that what I was going to record would be far, far better than what I had done before—and it definitely was not. Some of the choice collector's items do not appear in their true light until the original circumstances have become a thing of the past.

We still talk at my home of a croakily-rendered country song contributed by a friend a year ago—a thing of great character and strange charm. It went, together with several other items, because I wanted to record something of passing significance from the radio—and I was "short of tape." What I now realise was a little masterpiece can never be re-created.

Typing with tape

PEOPLE who own so many tape recorders and pieces of hi-fi equipment that they can't afford a typewriter are faced, from time to time, with a job of

work involving typing. Not only authors and would-be writers, but people who prepare long letters, bulletins, and so forth.

They will be glad to hear that there are a few organisations geared to do typing from normal tape, so that it is possible to dictate into your own machine, post off the tape and receive the typed material back within a few days (or probably by return of post, in the case of short items).

If you wanted to use your own machine for dictating and for playback by a typist there would be the great handicap, in most cases, of having no foot-control and backspacing arrangements; most machines, however, can be used satisfactorily for the dictating part of the process, especially if there is a pause control, and so the postal method achieves the best of both worlds.

HOMO TAPIENS

by

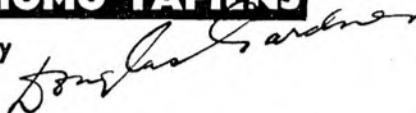

I have been talking to Miss E. M. Foster who started such a service on her own in London about three years ago. Now her Tape-Typing Secretarial Service has a staff of ten typists. She chooses intelligent, well-educated people for the job, because typing from the voices of strangers on strange, often very out-of-the-way, subjects can be much more difficult than copy-typing from bad handwriting.

Much of their work is handling correspondence for London firms; they collect and deliver in the London area so that it can be completed the same day; but they also work for authors and similar people.

Though they usually use Stenorettes, they are equipped to type from 5½ and 7-in. spools if necessary, and at speeds of 3½ ips and 7½ ips. The charges are 8s. 6d. per hour typing time, or 9s. 6d. per hour for French or German work.

Double talk

ANSWERING a question about the value of the tape recorder in his sphere of operation, an authority on elocution indicated the other day, that he did not think its use was as helpful as listening carefully to people who speak well.

This contradiction in terms is, of course, typical of the unimaginative attitude of many people towards the tape recorder. He was taking it for granted, apparently, that all a tape recorder owner can do is listen to himself.

If listening to good speech is the most important element of voice training then it is hard to think of a better way of putting this ideal into practice than by

means of a tape recorder. Passages of correctly-spoken English played over and over again on tape must surely produce the effect required more surely than any other method.

And, having come so far, I cannot believe that there could fail to be a further advantage in hearing oneself—on tape—contrasted against the perfect passage.

I would suggest that a simple way of helping oneself to better speech would be to take from the radio a tape of Sir John Gielgud, or other speaker of English as it should be spoken, and use it as a tutor by playing it back and recording one's own attempts at approximately every other sentence.

To elaborate, when Sir John has completed his first sentence, on replay, you switch to record and record that sentence yourself. Then you return to playback and stop again at the end of the next completed sentence further along the tape and record your next effort, disregarding the tail-end of the sentence partly erased by your first recording. The lack of continuity does not matter, and your aim will be, by re-recording your own sentences time and again, to achieve the nearest possible approximation to the "correct" one.

Tape Types, too

THE usefulness of the tape recorder is beginning to be appreciated by all kinds of clubs and groups not primarily concerned with sound. There is little direct connection, for example, between sound recording and motor cycles, and yet there is at least one motor cycle club—the Triumph Owners' Motor Cycle Club—in which tape has come to play a very important part.

It began, I am told by Mr. Harold Booty, one of the club's officials, two years ago. Stimulated by two London recorder-owning members, the club began to exchange correspondence tapes with branches at home and overseas. Then a tape recording sub-committee began to produce feature tapes likely to interest all members, and before long two portable recorders were in use to help their reporters to cover trials and other events—one powered by a motor-cycle battery and the other by a hand generator.

A six-channel mixer is now used to complete the editing of a 15-minute master tape from which dubbings are made for branches who send clean tapes for the purpose.

A recent development is a feature tape contest between branches. And, says Mr. Booty, "the club is only on the threshold of tape recording; the potentialities are unlimited."

The word "unlimited" seems to apply, too, to the number and kind of organisations which could well benefit from the use of tape recorders, and if you know of such a group a word in their ear, and perhaps an offer to pilot an experiment, might be a valuable service to them.

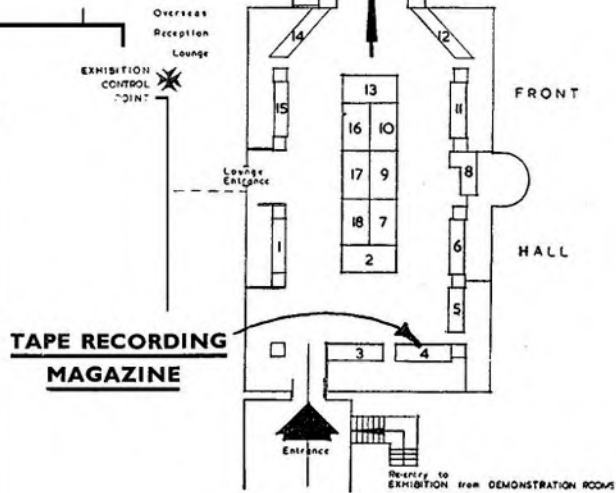
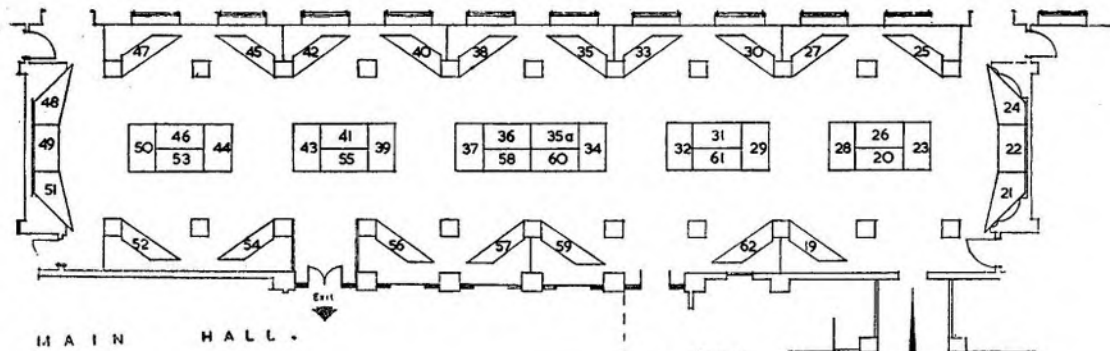

AUDIO FAIR 1958

The third London Audio Fair will be the biggest, and the most significant, so far. How significant may not be appreciated until after the event, but the trends are clear, and they are encouraging.

The thousands of enthusiasts who visit the Waldorf Hotel will see many new features incorporated in the latest equipment. Manufacturers have now adopted the timing of the Audio Fair as a guide to their development plans, and the laboratory efforts of the past year now come to fruition in a truly impressive display of equipment.

The accent on stereo, first discerned last year, is now more pronounced. Not only the tape recorders, but the range of associated equipment, recognise that this is the direction in which things are moving.

A new trend is towards console models of tape recorder-reproducers. At least three manufacturers are in the vanguard with them, and they should have a bright future.

Several new decks will be seen for the first time at the Fair. One of them is already proving of great value in helping to hold prices down. Others incorporate valuable refinements, such as automatic reversal of tape from one track to another on one model and variable—speed fast rewind on another.

There are signs of a conscious effort to meet two distinct demands, by producing one range of recorders and equipment for those who must practice economy, and another range for those who must have quality and are prepared to meet the cost. This is healthy; it avoids the danger of falling between two stools and, taking a long view, the cheaper equipment is bound to benefit from the more uninhibited progress that is possible in the higher price ranges.

Where to find them

Trade Name	Booth No.	Dem. Room No.	Trade Name	Booth No.	Dem. Room No.
Acoustical	18	341	Lustraphone	56	—
A.K.G.	60	331	M.S.S.	19	242
Altobass	13	127	Scotch Boy	48	231
Armstrong	30	317	Mullard	32	245
Astronic	5	117	Reflectograph	39	128
Audiomaster	50	124	Pamphonic	24	224
Avantic	41	241	Philco	29	204
Brenell	35	308	Pilot	27	206
B.B.C.	35a	—	Pye	57	327
B.S.R.A.	Mezzanine	Mezz.	Pye Records	58	122
	Floor	Floor	R.G.D.	17	149
Burne-Jones	44	130	R.C.A.	49	109
Champion	51	240	Rogers	45	141
Chapman	12	145	Rola Celestion	61	247
Collaro	7	148	Simon	47	227
Cosmocord	36	125	Sonomag	53	222
Dulci	62	107	Sound Sales	28	209
Dynatron	16	144	Spectone	22	101
Elizabethan	54	140	Sugden	25	248
E.M.I.	21	309	Tannoy	43	104
El'onic Reprod'ers	9	330			
Garrard	59	131	<i>Tape Recording Magazine</i>	4	—
G.E.C.	55	142	Trix	37	244
The Gramophone	—	220	Truvox	14	249
Goldring	33	340	Vitavox	31	225
Goodmans	20	106	Vortexion	26	217
Goodsell	38	230	Westrex	10	115
Gramophone Record Review	40	218	Wharfedale	34	324
Gramplan	23	325	Whiteley	3	306
Grundig	15	208	Harting	11	228
Hi Fi News	52	320	<i>Wireless World</i>		
Jason	1	108	<i>Electronic</i>	46	—
K-B	2	307	Wright and Weaire	8	201
Leak	6	328	Press Office		121
Lowther	42	315	Exhibition Office		119
			Committee Suite		120

What to look for at the Audio Fair

RESTYLED REFLECTOGRAPH

Multimusic Ltd., Wood Lane End, Hemel Hempstead, Herts.

☆ The re-styled Reflectograph professional recorders, previously made by Rudman Darlington (Electronics) Ltd., will be on show for the first time, together with a prototype of a Reflectograph stereophonic reproducer. These will be demonstrated continuously each day in the Reflectograph Demonstration Suite.

The Reflectograph tape recorder and reproducer will be shown in two models: the 500, priced at 94 gns., and the 400 at 84 gns.

Reflectograph 500 is self-contained, in portable duo-tone case. The tape deck, finished in "hammered gold" and cream, accommodates up to 8½ in. spools, and has three heads with separate record and replay amplifiers, so that instant comparison may be made between the signal being recorded and the signal on the tape. Variable speed is provided between 8 ips and 3½ ips, and a stroboscope, illuminated by neon lamp, shows precise speeds of 7½ and 3½ ips.

Other features include easy tape threading into a straight slot; lever deck controls, providing variable speed wind forward and back from extra fast to inching for editing; sound available for editing if required; instant stop and start; peak level recording meter; push-button record-playback controls with record safety latch; clock-type tape position in-

dicator; three Garrard motors; two matched loudspeakers; three watts undistorted output; two input and two output sockets; Bib tape splicer on deck.

The Reflectograph 400 is supplied in three units for incorporation in furniture, comprising the Reflectograph deck mounted on a stand, combined record amplifier and playback pre-amplifier, and the power pack. The units, with interconnecting leads, have been designed for operation in conjunction with high fidelity amplifiers. The specification is similar to that of Model 500, but excludes the three watts output as it does not contain the output amplifier or the two loudspeakers. Additional facilities include sockets for radio and pick-up; socket for microphone on instrument panel, where an additional switch provides instant selection of microphone, radio or pick-up.

There is provision for conversion of either model to stereo reproduction, whilst retaining monaural recording and reproduction facilities.

Also on show will be the Reflectograph Continuous Player, a heavy-duty machine specifically designed for continuous use. The standard model 80/70/75 operates at 3½ ips and provides for up to four hours sixteen minutes of recording to be repeated indefinitely, using each track in turn and reversing automatically.



The new Model 500 Reflectograph



Wilhelm Harting, Hudson House, 63 Goldhawk Road, London, W.12.

☆ The Tandberg Stereo Recorder, described in the April issue of *Tape Recording Magazine*, will attract a large share of attention. Interest will also be taken in the latest version (above) of the Harting High Fidelity Recorder, known as Model HM. Considerably smaller than its predecessor, it measures 12½ in. x 15½ in. x 8½ in., plus 2 in. with closed lid. It has one speaker, a Lorenz 8½ in. x 6 in. High Fidelity unit, and shows an improved performance, the frequency response claimed for the HM being 30 c/s to 16,000 c/s within 1½ db at 7½ ips, and 30 c/s to 10,000 c/s within 1½ db at 3½ ips. The price is the same as that of the HM6, 82 gns. excluding microphone.

Another new product is the TSL International Model Mark III FM Tuner. The tuner can be installed confidently up to 125 miles from any normal VHF transmitter.

Grundig (Gt. Britain) Ltd., 39-41, New Oxford Street, London, W.C.1.

☆ Prominent among the Grundig exhibits will be the TK-830/3D, with its impressive specification including three speakers, three tone controls, erase cut-out button and frequency response extending to 15kc/s within 3db limits at 7½ ips.

Also on display will be the smaller TK-8/3D and the TK-5 recorders; the GMU-3 four channel electronic mixer unit, arranged for three microphone inputs and one higher level input; and the new long-playing polyester tape.

Wright and Weaire Ltd., 131, Sloane Street, London, S.W.1.

☆ Interest will centre here on the new Ferrograph approach to the problem of stereo reproduction, the makers of this famous recorder having decided to rationalise the instruments offered for use in this field.

Model Stereo 88 (stereophonic recorder and reproducer) is continued in its present form, but the Model 77 Ferrograph will now be omitted in favour of a new model designated Series 3S. The latter will comprise a standard type 3A/N or 3A/NH recorder giving the usual monaural recording and reproduction facilities, to which is added a stereo inline head connected only to the rear unused socket provided on every Ferrograph.

In addition, the Ferrodaptor add-on unit will become available for use with this portable recorder, and by plugging into the socket referred to, conversion is made to the standard 3A instrument whereby stereo can be reproduced. The add-on unit or Ferrodaptor will consist of two matched pre-amplifiers (one for each stereo channel) and a single channel amplifier giving 2½ watts output.

The effect of plugging in will be to bring into use the 2½ watts power amplifier already in the Ferrograph 3A in order to provide the second channel of amplification. Thus with the Ferrodaptor used in conjunction with the new instrument it will be possible to have 5 watts of stereo reproduction available for external speaker usage.

Model 3S/N is priced at 89 gns., and Model 3S/H at 96 gns. The Ferrodaptor suitable for either of the above is 30 gns.

An announcement is expected shortly giving details of the method and cost of converting all series 3A Ferrographs to comply with the new stereo requirements.

E.A.P. (Tape Recorders) Ltd., Bridge Close, Oldchurch Road, Romford, Essex.

☆ In addition to displaying the Elizabethan Essex and Elizabethan F.M. tuner, E.A.P. expect to include a veneered table version, the Essex Mayfair and a tape recorder in the cheaper price range—the Elizabethan Escort, at 45 guineas.



TWO NEW BRENELLS

Brenell Engineering Co. Ltd., 1a, Doughty Street, London, W.C.1.

☆ A new deck for the connoisseur and a new compact tape recorder in the lower price-range will be the principal objects of attention on the Brenell stand. The new recorder, the Three Star, is a three-speed model giving 7½, 3½ and 1½ ips. It uses a printed circuit and incorporates the unit method of construction that is a feature of all Brenell equipment. Deck operation is by push-button, interlocked to prevent accidental erasure and breakage.

Frequency correction according to tape speed is effective on record and playback, and separate bass and treble controls operate on playback. On record, the peak level is shown on cathode ray indicator. The internal speaker is 8 in. x 5 in., 15 ohms, and the claimed frequency range is 60 c/s to 10,000 c/s. A monitor socket for high impedance headphones, and an extension speaker socket are also provided. Other features include a pause control, digital counter, and provision for recording from radio, microphone or pickup. Spools up to 7 ins. dia. can be used.

The Brenell Mark V Tape Deck has a specification which indicates high quality

The new Brenell Three Star

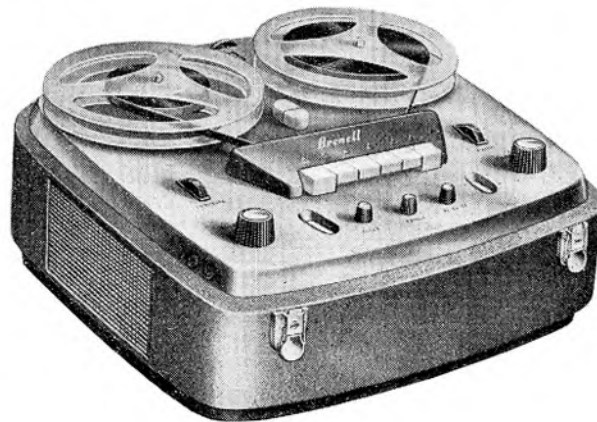

Collaro Ltd., Ripple Works, By-Pass Road, Barking, Essex.

☆ Close interest will be taken in the Tape Transcriptor Mark IV which incorporates several modifications to the previous design.

Among the new features are the inter-connected micro switch and fly-wheel brake. By means of these improvements both motors can be switched off and the fly-wheel instantaneously stopped when

combined with considerable adaptability. It has four speeds, 15, 7½, 3½ and 1½ ips, and facilities for mounting extra heads. Normally the deck is fitted with one erase and one record/playback head, to international standards, and extra heads can be mounted for monitoring (one extra record/playback head); dual track recording (one extra record/playback head and one extra erase head); staggered stereophonic (one of each); and stacked stereophonic (one stacked playback head).

Record, playback, wind and rewind are effected by two switches, and the rewind and record/playback switches are fitted with extended shafts to enable extra wafers to be added for individual requirements. Three B.T.H. shaded pole motors are employed, and a large flywheel ensures speed stability. Other features include digital rev. counter and pause control. Spool sizes up to 8½ dia. can be used.

the "stop" button is operated. Any one of the six smaller knobs will then start the machine in either direction without subjecting the motors to excessive loading. These factors, combined with the new lower wattage input, are in the interests of cooler and quieter running of the motors. Added to these advantages is a more active re-wind, due to larger diameter of the motor pulleys and new type re-wind pulleys with new springing arrangements.

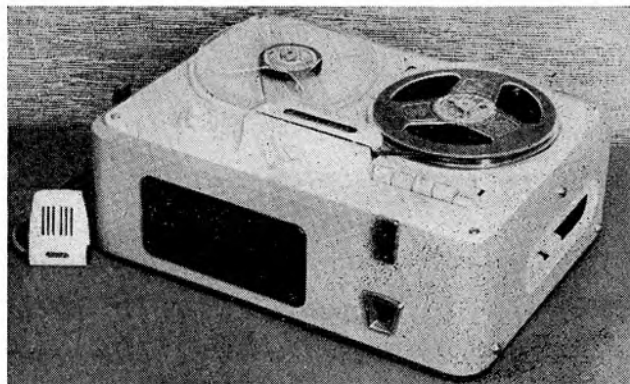

Left: *The Essex Mayfair, available with or without legs. Right: The new Elizabethan Escort*

SONOMAG MAKE A NEW CONSOLE

Sonomag Ltd., 2, St. Michael's Road, Stockwell, S.W.9.

☆ In keeping with the growing tendency to produce tape recorders that provide an alternative to the long-popular radiogram, Sonomag are showing a new walnut-finished console model embodying an Adaptatape with the Mark IV Collaro deck. The recorder incorporates nine valves and there are three speakers in an acoustic chamber. The price is 70 gns. complete.

Other innovations to be seen on the Sonomag stand are a model using the Motek deck, priced at 46 gns, complete with tape and mike, and a "new-look" Elon portable.

The latter introduction follows the news that Elon tape recorders are now being manufactured by Sonomag Ltd.

Beam-Echo Ltd., Parion House, Witham, Essex.

☆ Beam-Echo will be showing an impressive range of amplifiers, pre-amplifiers, tuners, loudspeakers and cabinets. The Avantic SPL 12-D21 Stereophonic combined amplifier and control unit provides 20 watts peak power output on each channel, and the frequency response claimed is 10 c/s to 30,000 c/s within 1 db. The Avantic PL6-21 combined control unit and power amplifier, for monaural use, also has 20 watts peak output and a claimed frequency response of 10 c/s to 30,000 c/s within 1 db. The 7-position selector includes tape equalisation at 3½ and 7½ ips. The SPL 12 stereophonic pre-amplifier is designed to operate with two DL7-35 main amplifiers.

The Avantic VHF-FM/AM-MW tuner, type 612, has continuously variable automatic frequency control, Foster-Seeley discriminator and a claimed frequency response of 20 c/s to 20,000 c/s.

The Beam-Echo Avantic Model PXD 33 15 in. loudspeaker has a 3 in. voice coil, foam suspension and a frequency response of 20 c/s to 5,000 c/s. The recommended crossover frequency is 400 c/s. Avantic speaker enclosure Mark VI is a forward facing reflex corner enclosure using the PXD 33, a middle unit and a pressure unit. Mark IV uses a 12 in. speaker, type BEA 12, bass unit, a middle unit and a pressure unit.

Jason Motor & Electronic Co. Ltd., 328, Cricklewood Lane, London, N.W.2.

☆ Jason show a range of equipment for converting an existing set-up into a stereo one. Those making a fresh start, for instance, can have one channel at first and add a second one later.

There are two kit pre-amplifier designs. Model J4-4, for the more experienced constructor, employs four valves in each channel. This has sufficient gain to play direct from a tape head, and may also be used for discs and radio, either channel or stereo; or if all the equipment for playing stereo is installed, a single source may be played through both channels in parallel giving some improvement over the performance of a conventional single channel. The volume, treble and bass controls are all ganged to maintain balance between the channels. The price

Right: The Sonomag 46, with Motek deck, priced at 46 gns. including tape and mike.

Below: The new Sonomag Console, using the Collaro Mark IV deck and retailing at 70 gns.

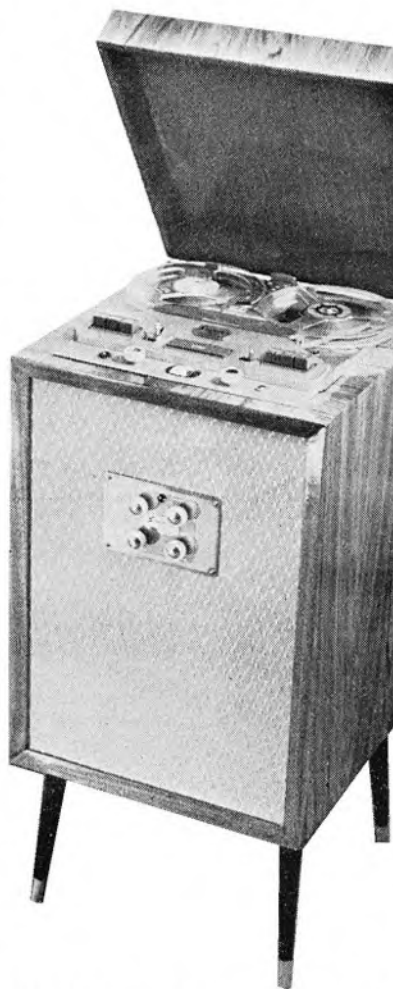

of this kit, with all parts and chassis, but without valves, is £16 10s.

Model J2-2 employs two valves in each channel, and is a simpler version of the J4-4. The J2-2 will be available, at extra cost, completely built and tested, and there will be the combined stereo preamplifier and double amplifier, the J2-10. This will have the same performance from each channel as the

J10-10 watts output at 0.1 per cent distortion—and it will be in the same case as the J10.

The J2-2 kit, without valves is £12 18s. Built and tested it costs £18 18s. complete. The J2-10 amplifier is priced at £37 10s.

M.S.S. Recording Co. Ltd., Poyle Farm, Colnbrook, Bucks.

☆ Centre of attraction on the M.S.S. stand will be the CMR/DE tape recorder, a console model which aims at a high performance together with reliability in operation. It incorporates the M.S.S. tape transport mechanism Type D and has provision for the insertion of a FM unit.

Also of interest is the LSX/1 loudspeaker designed to provide high fidelity at normal listening levels in the home while keeping the cabinet comparatively small. A substantially level response from 50 c/s to 15,000 c/s is claimed, free from frequency doubling and external reflection effects.

Also to be seen on the M.S.S. stand will be the 4M2W mixer, a microphone preamplifier giving facilities for mixing four microphones with separate control for each, and, of course, examples of the well-known Mastertape magnetic recording tape.

E.M.I. Sales & Service Ltd., Hayes, Middlesex.

☆ The E.M.I. professional tape recorders will naturally receive a great deal of attention from tape recording enthusiasts, particularly the famous L2 battery-operated portable. The complete recorder weighs 14½ lbs including all batteries and is available in two models: L2A with a speed of 3½ ips, and L2B giving 7½ ips (30 min. and 15 min. playing time respectively).

The TR51 mains portable tape recorder is also available in two versions, TR51C operating at 15 and 7½ ips, and TR51D at 7½ and 3½ ips. Both incorporate half track heads.

The TR90, designed to serve professional recording engineers and workers in scientific and industrial research, is basically in two parts, a mechanical unit and an amplifier unit.

E.M.I. will also be showing a full range of Emitape, the Emicase, and various useful tape accessories.

Armstrong Wireless & Television Co. Ltd., Warlters Road, London, N.7.

☆ Among the tuners and amplifiers shown, a foremost place will be occupied by the A10 MK.II amplifier and pre-amp control unit introduced at last year's Audio Fair. It is a 10-watt unit with a wide range of controls including tape input and output sockets.

The FM61 is a high fidelity VHF tuner designed for use with the A10 MK.II amplifier. Permeability tuning combined with temperature compensated capacitors in the oscillator circuit ensure complete freedom from drift. Other distinguishing features are full band 11 coverage (88-108 m/cs), extreme sensitivity, a switched AFC control and cathode follower output.

The AM44 tuner is a four waveband AM tuner styled to match the FM61 and the A10 MK.II amplifier. Particular efforts have been made to ensure good reception of continental stations and a variable selectivity control is incorporated.

The Sonixgram is a high fidelity system comprising a chairside control cabinet and separate matching loudspeaker cabinet. The A10 amplifier and tuner units referred to above are incorporated in the control cabinet, together with a transcription gramophone unit and tape recorder player. The system can be purchased with any combination of these units and others added later as required. The loudspeaker cabinet has been kept to 32 in. high by 18 in. by 18 in. and it incorporates separate bass and treble speakers with crossover network.

The AF105 is a three-in-one high fidelity unit comprising AM and FM tuning and AF amplifier on one compact chassis.

R.C.A. (Gt. Britain) Ltd., Lincoln Way, Windmill Road, Sunbury-on-Thames, Middlesex.

☆ The well-known range of R.C.A. New Orthophonic high-fidelity equipment will be on show together with two new units.

The pre-amplifier incorporates six input selector switch positions, cathode follower output stage which enables the pre-amplifier to be used as a remote control unit at distances of up to 21 ft. from the power amplifier. The bass and treble controls are continuously variable.

The New Orthophonic power amplifier delivers an output of 20 watts push-pull with a total harmonic distortion of less than 0.1 per cent; frequency response is given as within 0.2 db from 20-25,000 c/s and 0.5 db from 10-60,000 c/s.

The new R.C.A. Orthophonic F.M. tuner, also to be seen and heard, has been

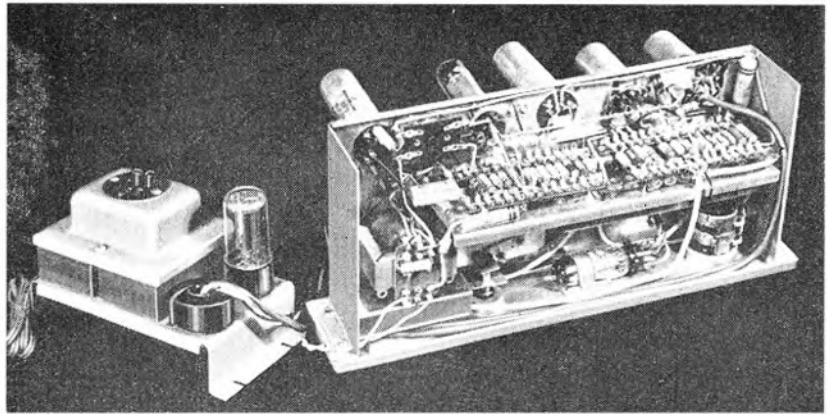

TRUVOX TAPE AMPLIFIER

Truvox Ltd., 15, Lyon Road, Harrow, Middlesex.

☆ A new Truvox product, the Type K amplifier (superseding Type C) is a tape recording amplifier with power pack primarily designed for use with Truvox tape decks. It has a claimed frequency response of 40-15,000 c/s. Output is 4 watts at an impedance of 3 and 15 ohms suitable for direct connection to moving coil speakers. Inputs are provided for crystal microphones and radio jacks, gramophone, radio sets and radio tuners. Additional outputs are supplied

for monitoring with high impedance ear-phones and to feed a power amplifier for greater output.

In conjunction with Truvox tape decks fitted with stereophonic heads, two of these amplifiers can be used for the two channels necessary when reproducing stereosonic tape records. The user, however, will still be able to make and replay ordinary half-track recordings.

The Type K amplifier, finished in hammered metallic green to match Truvox tape decks, is priced at 19 gns.

designed to serve as a companion to the R.C.A. amplifier. Its styling matches that of the pre-amplifier, and it is of identical dimensions; the tuner may be used with any high quality amplifier which is capable of supplying its power requirements. Technical specifications include full international tuning range, automatic gain control and AFC.

Newest unit in the range, is the FM tuner power supply unit, for those who prefer an independent tuner arrangement. It provides outputs of 290 volts, 45 ma D.C. and 6.4 volts, 2.25 amps A.C.

The R.C.A. panoramic speaker system houses a three speaker system and crossover filter in a scientifically designed bass reflex cabinet.

R.C.A. are now also marketing a custom built lowboy cabinet for housing the units in the New Orthophonic range. This is a craftsman built cabinet which matches the R.C.A. panoramic speaker cabinet in styling and finishes. The cabinet provides chairside control of a New Orthophonic high fidelity system.

A new 4-speed transcription turntable will also be shown.

Pye Ltd., Radio Works, Cambridge.

☆ Two-unit hi-fi will be one of the main features of this year's Pye exhibit. The new HF10 "Mozart" amplifier is now offered in a lowboy cabinet finished in walnut veneers and designed to incorporate a transcription unit and the HFT111W FM/AM Tuner in a matching finish. The addition of the HF12SMT loudspeaker completes a home high-fidelity system.

The use of printed circuits will be illustrated in the HF10, which is available in chassis form or in a metal cabinet. The Provost (HF25) amplifier and Proctor (HF25A) pre-amplifier provide a claimed distortion-free response from 2 to 16,000 c/s at an output of 25 watts, with full compensation, control, input and output facilities.

The Pye HFT111, an AM/FM unit is a tuner incorporating an 8-valve chassis for fringe area reception, drift-free permeability tuning and a phase discriminator circuit for minimum distortion. It has its own power pack and magic-eye tuning. The HFT111 is available in cabinet form, HFT111W with its own internal FM aerial, and in chassis form with a choice of horizontal or vertical tuning scale.

The HF12SMT is a 12-watt contemporary speaker designed to provide high-fidelity response at reasonable cost. The 12 in. base speaker and 4 in. tweeter provide a claimed frequency response of 30-15,000 c/s.

The HF12BS is a compact 12-watt bookcase speaker. Twin 8 in. high flux speakers are mounted in an acoustical chamber for optimum performance.



The new R.C.A. New Orthophonic FM tuner

NEW LOW-PRICE ROGERS AMP

Rogers Developments (Electronics) Ltd.,
4-14, Barmeston Road, Catford, S.E.6.

☆ Special attention will be given by tape enthusiasts to the new RD Cadet amplifier and control unit, priced at £17 10s. complete and having features that include 6 watts peak output; push-pull output stage; claimed frequency response of 30 to 20,000 c/s with the full output rating maintained over the range of 50 to 20,000 c/s; tape record and replay sockets; and separate bass and treble controls. It is pointed out that two RD Cadet amplifiers and control units would be suitable for stereo replay, providing an output of 10-12 watts.

Production of the RD Minor Mk. III amplifier has been discontinued. The Cadet main amplifier can be used in conjunction with the Junior Mk. II control unit without modification.

Other products to be noted are the

RD Senior Mk. II amplifier and Mk. IV control unit; RD Junior amplifier and the new Mk. II control unit; RD Junior FM unit; RD Junior corner horn; RD General Purpose Power Pack; equipment cabinets.

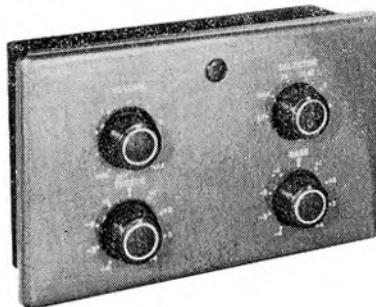

Sound Sales Ltd., West Street, Farnham, Surrey.

☆ A very wide range of equipment of interest to tape enthusiasts will be shown, and Sound Sales Ltd. have indicated that they are trying to ensure that every item shown will be in production and available.

Amplifiers and control units shown will cover a wide range of purposes.

Stereo is catered for and there will be a number of loudspeakers.

Sound Sales Ltd. will also be showing some interesting products by Wellington Acoustic Laboratories Ltd.

Acoustical Manufacturing Co., Ltd.,
Huntingdon, Hunts.

☆ High-fidelity tape enthusiasts will not need to be reminded of the importance of the Quad range. The Quad Electrostatic Loudspeaker is likely to receive the lion's share of attention because, although it has been shown before, this is the first Audio Fair since it was put into production. Visitors, and others, are advised to obtain a copy of the booklet about this product, since it gives an excellent account of the principles involved in the design of this type of speaker. The Quad Electrostatic is priced at £52. The Quad II amplifier with its control unit will also be demonstrated. Note, too, the Acoustical FM tuner designed to operate with it.

A. R. Sugden & Co. (Engineers) Ltd.,
Well Green Lane, Brighouse, Yorks.

☆ In addition to the well-known Connoisseur transcription turntable and lightweight pickup, Mark II, there will be the Connoisseur HQ 20 amplifier and pre-amplifier and the Varigroove recording unit. The HQ 20 amplifier has an output of 20 watts throughout the 30 to 20,000 c/s range.

Pamphonic Reproducers Ltd., 17,
Stratton Street, London, W.1.

☆ The new FM/AM Tuner Model 645 will attract the attention of tape recordists. Switch tuning is provided for F.M., and automatic frequency control eliminates drift. The circuit also includes a Foster-Seeley discriminator to minimise distortion.

On the tunable A.M. medium wave range, the 645 is a high sensitivity receiver with two tuned circuits in front of the frequency changer valve. The sensitivity on medium waves is ample for the reception of all Continental and B.B.C. transmissions. A tuning indicator is fitted which operates on A.M. & F.M. ranges. The scale plate is clearly calibrated.

The tuner is self contained with its own A.C. mains power pack and it is housed in a cabinet of the same style as the Pamphonic High Fidelity Amplifier Model 1004.

Pamphonic will also be showing their type 1004 integrated audio amplifier, with provision for tape in the input selector as well as a full range of general control facilities.

General Electric Co. Ltd., Magnet House,
Kingsway, W.C.2.

☆ Two new G.E.C. developments in high-quality loudspeaker technique are being demonstrated—one, a complete unit which will be marketed, and the other a design for home constructors.

Automatic frequency control, ensuring correct tuning and low distortion at all times, is a feature of a new FM tuner unit with 3-position switched tuning. The receiver uses a Foster-Seeley discriminator and two stages of limiting, yet has a high tension power consumption of only 20 m/a at 150 volts.

Of special interest to recording engineers and professional users is a new Hi-Flux presence unit. This uses the same basic principle as the BCS.182 unit but, with a magnet of flux 14,500 gauss, gives a frequency response-flat from 1.5 k/cs to 13 k/cs with a response of -10 db at 15 k/cs.

A specially constructed 50-watt amplifier and pre-amplifier—the "88-50"—is among the valve design exhibits. Offering improved performance and control range, the two units have inputs for a radio tuner, a magnetic or crystal gramophone pick-up, a microphone or a magnetic tape replay head.

Also on view are circuit diagrams for the well-proved "Junior" 5 watts, the "Nine-One-Two Plus" 12 watts, and the Williamson 12-watt amplifiers.

"An Approach To Audio Frequency Amplifier Design," a new G.E.C. reference book, will be on sale.

Champion Electric Corporation Ltd., 8,
Eccleston Street, London, S.W.1.

☆ A link with tape is provided in the new "Golden Concerto" console reproducer Model 875, with 10-watt output and separately constructed acoustical chamber with three loudspeakers. A socket is provided for tape recorder, FM tuner or microphone. The Champion range of record players will also be shown.

Electronic Reproducers Ltd., 39, Dover
Street, London, W.1.

☆ A principal exhibit is the ER58 turn-over crystal pickup cartridge intended to satisfy the need for a high output cartridge with a good frequency response and low distortion content. The claimed response is 30 to 20,000 c/s.

Vortexion Ltd., 257-263 The Broadway,
London, S.W.19.

☆ The Vortexion WVA and WVB recorders will be shown, unchanged except for detail improvements. Separate bass and treble controls are fitted, operating on playback only. The specialised monitor head model WVB has an additional amplifier and replay head by which an additional recording may be superimposed while listening to the first, or by which the recording may be heard while it is in progress. A switch permits comparison of the signal "before record" and "after record."

Also on view will be the 4 channel and 12 channel electronic mixers, 3 channel mixer and peak programme meter, equalisers and trap valve amplifiers, 20-20,000 cps, and several types of amplifiers, 20-50,000 cps.

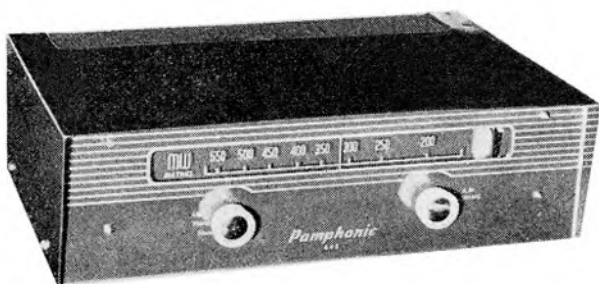

The new Pamphonic FM/AM tuner, Model 645, with switch tuning for FM



The new Whiteley FM tuner

Whiteley Electrical Radio Co., Ltd., 109, Kingsway, London, W.C.2.

☆ The complete range of Stentorian high-fidelity loudspeakers from 8 in. to 18 in. dia. will be shown, as well as special loudspeakers from 1½ in. upwards, all fitted with the firm's patented cambric cone. All 8 in., 9 in. and 10 in. units incorporate their patented tapped speech coil and match instantly to 3, 7.5 and 15 ohms.

An important new addition is model HF.1016, fitted with powerful 16,000 gauss magnet, cambric cone and tapped speech coil. This new 10 in. unit has an extended frequency response and also, it is claimed, an outstanding transient response.

A further important addition is the WB.6 combined amplifier and control unit, with 6 watts output, forming a compact unit 11½ in. x 7 in. x 4 in. It has a selector switch for a range of inputs, full range bass and treble controls and separate volume control.

A new FM tuner is to be shown for the first time. It uses printed circuit techniques to ensure maximum electrical stability, together with rigid mechanical structure, for freedom from drift. The unit is housed in a sheet steel case to match the amplifier.

The ready-to-assemble range of cabinets includes console and table equipment models, and a variety of rectangular and corner bass reflex enclosures.

Minnesota Mining and Manufacturing Co. Ltd., 3 M House, Wigmore Street, London, W.1.

☆ In addition to a display of their entire range of Scotch Boy tapes, the 3 M Company have a two-roomed "tape clinic."

In one of these rooms recorded talks, illustrated by colour slides, will describe the handling of magnetic tapes and give new ideas about their application in home, office and schoolroom. In the other room the making of splices, tape editing and care of tapes will be demonstrated.

The display will feature the three Scotch Boy recording tapes, the 111A Standard, the 111V Super PVC and the 150 Extra Play Tapes, as well as the No. 41 splicing tape and the Polyester leader tape in green, white and red.

Garrard Engineering and Manufacturing Co., Ltd., P.O. Box 4, Newcastle Street, Swindon, Wilts.

☆ The Model 301 transcription motor and the T.P.A. 10 transcription pickup arm will especially attract high-fidelity enthusiasts. These well-established products will be shown together with the

other units in the Garrard range of record-playing equipment.

Kolster-Brandes Ltd., Footscray, Sidcup, Kent.

☆ The K-B range of high-fidelity equipment will consist initially of a power amplifier, a pre-amp and control unit and an AM/FM radio tuner unit, sold separately and in matching enamelled steel cabinets. They will also be available mounted in a wooden control cabinet with provision for a tape recorder or turntable. Matching this is a loud-speaker cabinet containing a Goodmans' two-way speaker system.

The power amplifier has a rated output of 12 watts. The pre-amplifier has independent bass and treble tone controls and bass and treble filters, and its push button selector includes provision for tape and microphone.

The speaker unit incorporates an Axiom 150 Mark II 12 in. loudspeaker and a Trebax horn treble unit, and the cabinet is a bass reflex enclosure with a Goodmans' A.R.U. acoustical damping resistance unit.

Dulci Co., Ltd., 97-99 Villiers Road, London N.W.2.

☆ On demonstration for the first time, the Dulci High-Fidelity Tape Unit is designed to meet the need for a professional standard tape unit for operation with domestic hi-fi installations. A frequency response is claimed of 30 to 15,000 c/s within 2db at 7½ ips, and 30 to 10,000 c/s within 3db at 3½ ips. Wow and flutter are given as less than .1 of 1 per cent. The price is 55 gns.

It is also intended to arrange stereo demonstrations from tape using a prototype stereo pre-amplifier that will be in production shortly.

Also to be exhibited are the following:—

The self-powered VHF/FM tuner chassis, model FMT, covering 87-100Mc/s. A pre-set output level control is incorporated and facilities to enable a

pickup to be connected at the rear and switched direct to the associated amplifier or pre-amplifier.

Self-powered AM/FM tuner chassis, model H4T/2, successor to the Dulci H4T. Covering long, medium, short and FM it includes negative feedback at the audio stage and dual outputs for high and low sensitivity amplifiers.

Self-powered AM/FM tuner, control unit and audio pre-amplifier, model H11, with facilities for all types of pickup and tape recording and replay.

A 4 watt audio amplifier, model GA4, containing a 2-stage amplifier plus a pre-amplifier/control unit on flying leads for mounting in any position in the cabinet. Frequency response claimed 40-18,000 c/s ± 2 db.

A 10-14 watt ultra linear amplifier, model DPA10.

C. T. Chapman (Reproducers) Ltd., Riley Street, Chelsea, London, S.W.10.

☆ A wide range of amplifiers and tuners will be on display, the former including the 105 Tranquillo 10-watt amplifier and control unit with new type of Fletcher-Munsen loudness control; and the 205 20-watt amplifier, with ultra linear output, and 205 control unit with six inputs, bass and treble controls, loudness control and tape record and playback jacks.

The FM 80 is a switched FM tuner with a wide band radio detector in an AFC circuit. The FM 91 is a long range FM tuner with "bright-line" tuning indicator.

Combined AM/FM tuners include the FM 85, free-tuners, with wide band ratio detector and magic eye; the S5E/FM de Luxe tuner with an RF stage on AM bands and variable selectivity, and free tuning on FM with magic eye; and the S6BS/FM, international long range tuner, with two IF stages, variable selectivity and tuned RF stages on all AM bands, six bandspread ranges, and FM with wide band ratio detector and magic eye. Three AM tuners will also be shown.

POINT-ONE-PLUS ARRIVES

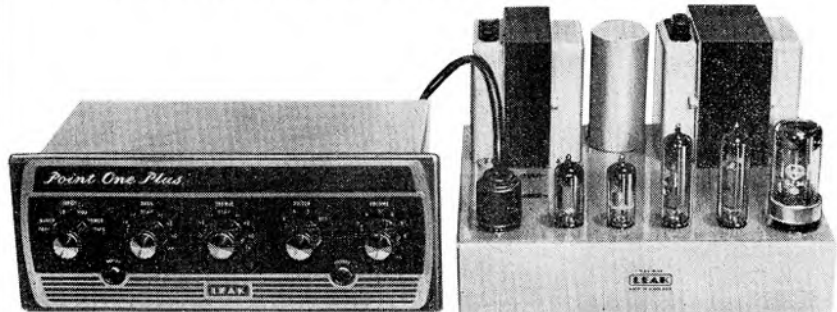

H. J. Leak & Co. Ltd., 37-39, Brunel Road, Westway Factory Estate, London, W.3.

☆ Being exhibited for the first time in England will be the "Point One Plus" pre-amplifier. When exhibited with the Leak amplifiers and "Vari-slope III" pre-amplifier at the New York Audio Fair it brought initial orders for 1,150 sets.

The "Point One Plus" pre-amplifier,

priced at 12 gns., is designed to give optimum results from any pick-up, any radio tuner and any tape recorder/reproducer, when used with the Leak "Point One" power amplifiers TL/12 Plus, TL/25 Plus or TL/50 Plus. The TL/12 Plus (12 watts) costs 18 gns.

Other items being exhibited in addition to those mentioned above will be the "Varislope III" pre-amplifier; "Trough Line" F.M. tuner and "Dynamic" moving-coil pick-up.

**Dynatron Radio Ltd., Castle Hill,
Maidenhead, Berkshire.**

☆ On the Dynatron stand and in their demonstration room there will be a wide variety of high-fidelity equipment, including Loudspeaker console, Type CLS20, a new loudspeaker unit incorporating in its dual speaker system, the Goodman Axiom 150 Mark II, and the Trebex high-frequency pressure unit. The enclosure is designed to function as a bass reflex chamber, using an acoustic resistance filter. Frequency response claimed is 30-15000 c/s, and power handling capacity is 20 watts.

Loudspeaker console, Type CLS10, first demonstrated at last year's Audio Fair.

Being shown for the first time are a 20 watt amplifier and a 20 watt tone control unit of completely new design.

Other instruments being demonstrated and exhibited are the Ether Pathfinder set of hi-fi chassis, the Dynatron VHF Tuner Unit, Type FM2, the Ether Minstrel high-fidelity radio console and the Windsor high-fidelity VHF radiogramophone.

**Pilot Radio Ltd., Park Royal Road,
London, N.W.10.**

☆ An important exhibit is the HFS 14 corner speaker, a high-fidelity ported reflex enclosure with a 12-in. speaker, designed to occupy the minimum of space. Price 28 gns.

Two other hi-fi units of interest to tape enthusiasts are the HFA 11 10-watt amplifier/control unit, with a wide range of facilities, including loudness control and scratch and rumble filters, designed for shelf or cabinet mounting (price 30 gns.); and the HFA 12/HFC 12, a 12-watt power amplifier and separate pre-amp, a flexible combination which includes a muting switch to avoid disturbing loudspeaker noises during changes. Price 36 gns.

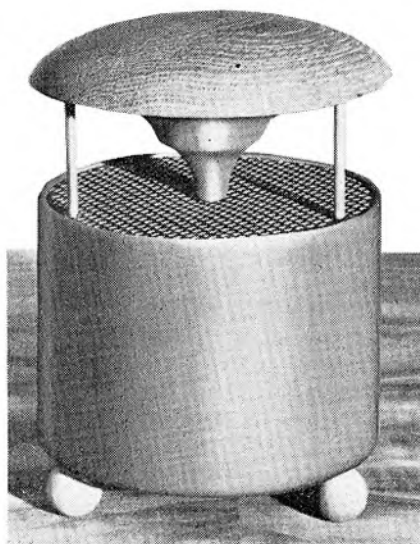

Burne-Jones Top C

NEW GOODMAN SPEAKERS

**Goodman Industries Ltd., Axiom Works,
Lancelot Road, Wembley, Middlesex.**

☆ Several new loudspeakers have been released for the Audio Fair, including the following:—

Axiom 300 12 in. 15-watt, and Axiom 400 12 in. 20-watt, with frequency range of 30 to 16,000 c/s, twin plastic terminated diaphragm with mechanical crossover and aluminium voice coil, 1½ in. diameter.

Midax 650, a pressure driven horn loaded mid-range unit, 650 c/s—8,000 c/s. crossover points 950 c/s and 5,000 c/s. This is a particularly compact design, requiring a cabinet depth of less than 10 in. It is intended for use with Audion (bass) and Trebax high frequency units to form a low distortion 3-way high fidelity loudspeaker system.

The XO/950/5,000, a multiple crossover network, operating at 950 c/s and 5,000 c/s. Employing four half section filters. For use in system comprising Audion (bass), Midax 650 and Trebax units.

New loudspeaker systems released are the following:—

Sherwood I. A twin radiator single unit system, 15 watts, 30-16,000 c/s, housed in the Sherwood Enclosure.

Sherwood II. A 3-radiator twin unit system, 15 watts, 30-16,000 c/s, 12 in. bass unit with concentrically mounted mid-range radiator, with mechanical crossover, and pressure driven horn loaded high frequency unit, with twin L-section crossover at 5 kc/s.

Sherwood III. A 3-radiator triple unit system, 15 watts, 30-16,000 c/s, 12 in. bass units, crossover at 750 c/s, to pressure driven horn loaded mid-range unit; further crossover at 5 kc/s to pressure

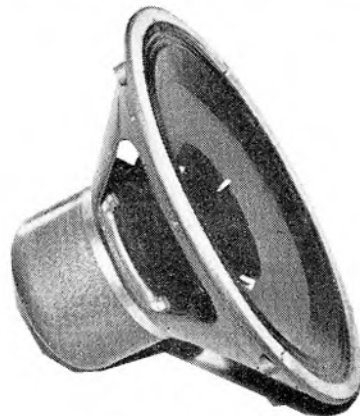

The Axiom 300

driven horn loaded high frequency unit. An outstanding system with very low distortion.

In the higher price range, is a new 4-radiator quadruple unit system, 15 watts, 30-16,000 c/s, employing a similar specification to the Sherwood III, but including an additional pressure driven horn loaded high frequency unit to provide very wide angular coverage.

**Burne-Jones & Co. Ltd., 62 Sunningdale
Road, Cheam, Surrey.**

☆ This is the first time Burne-Jones & Co., Ltd., have exhibited at the Audio Fair and hi-fi enthusiasts will welcome their appearance, not only because of the importance and interest of their existing products, but also because of the wealth of audio experience they bring. They were apparently the second radio company to be formed in Great Britain 38 years ago.

All the BJ products will be on show, and in addition to the already well-known BJ R-1 Reproducer there will be two new speakers, the R-2 and the Top "C" tweeter. BJ hope to demonstrate stereo sound, using the R-2 corner reproducers.

The new R-2 is a horn-loaded and reflex reproducer, with a professional 12-in. loudspeaker, providing a claimed frequency response of 25 c/s to 9,000 c/s. The top "C" tweeter complements it with a response from 2,000 to 20,000 c/s; it stands on top of any reproducer and is complete with built-in crossover and balance control.

The Super 90 Mark II pickup arm is the latest development of the well-known BJ arm. The success of this principle in overcoming tracking errors commends it to those who have disc-playing facilities as part of their equipment.

**Rola Celestion Ltd., Ferry Works,
Thames Ditton, Surrey.**

☆ Especially noteworthy among this firm's loudspeakers is the Diapason Model 1510, a large, direct-radiator model designed to produce the lower audio frequencies with the utmost fidelity. A marked roll off in the frequency response above 800 cycles eliminates the need for elaborate dividing networks. The unit has a large voice coil and dust-proof suspension, the latter of the annular type, and a surround of plastic foam.

Similar in design to the Diapason 1510, the 1520 has an extended frequency range that allows it to be used in conjunction with a high-note speaker as a complete wide-range combination.

The Colaudio Model 1550 is a wide-range loudspeaker combining the qualities of the Diapason units with a high-note reproducer of new design employing "line source" technique. With this technique the higher frequencies are dispersed over a wide area in the horizontal plane with a narrow vertical lobe, to achieve maximum efficiency where required and minimising unwanted reflections. The high-note reproducer incorporates two pressure-driven units mounted in column form, within the cone of the bass radiator.

Grampian Reproducers Ltd., The Hanworth Trading Estate, Feltham, Middx.

★ Several new lines are to be shown for the first time. One is a hi-fi amplifier, type 10-15 with a peak output of 15 watts. It has grain oriented core for output transformer with plug and socket selection of output impedance for easy matching of loud speakers; stabilised output for use with long speaker leads and electrostatic speakers; separate multi-pin sockets for radio and pre-amplifier power supplies.

Two new control units are the type 580 for crystal pick-ups and type 582, which includes a pre-amplifier for use with low output pick-ups and microphones and leads ready fitted with plugs for easy connection. Both units have jack sockets for use with a tape recorder.

Two other new items are the 571 VHF/FM tuning unit with new matching escutcheon for above units, and a new stick type moving coil microphone with a frequency response substantially flat from 60 to 15,000 c/s and with high sensitivity. A range of mountings is available.

Also displayed will be the well known 1255/15 12 in. loud speaker unit and RB12 cabinet and a full range of public address equipment.

Lustraphone Ltd., St. George's Works, Regent's Park Road, London, N.W.1.

★ One of the most important exhibits here will be the new Lustraphone transistor four-channel microphone mixer unit. It is one of a number of items of transistorised equipments introduced recently. There will also be a new light-weight noise cancelling microphone, intended for aircraft application, in addition to those already in the range. Tape enthusiasts will give special attention to the new miniature pencil ribbon microphone, designed according to the short ribbon technique. Its purpose is to provide smooth and wide response and to permit close talking without danger of damage to the ribbon element. Other exhibits will include the miniature electro-magnetic 1 in. x 3/4 in. lapel microphone and the Pencil Dynamic range for open air use.

Simon Sound Service Ltd., 46-50, George Street, London, W.1.

★ The principal exhibit will be the new Simon Automatic Tape Recorder, details of which appeared in the April issue of *Tape Recording Magazine*.

Also on show will be the Cadenza Ribbon Microphone introduced last year.



The Cadenza Ribbon microphone

HI-GAIN-15 BY TANNOY

Tannoy Products Ltd., Norwood Road, West Norwood, S.E.27.

★ A notable new exhibit will be an entirely new enclosure for the 12 in. Dual Concentric Unit of small physical dimensions, making it particularly useful for stereo systems, where two loudspeakers are necessary. Another product that will be shown for the first time is an integrated pre-amplifier power amplifier to be known as the "Hi-Gain-15." This will have a very high standard of performance, together with the advantage of easy installation. The Tannoy "Vari-twin" stereo pick-up cartridge will also be demonstrated, together with a wide range of the well-known Tannoy loudspeakers already familiar to high-fidelity enthusiasts.

Designed to obviate the necessity for a separate tape pre-amplifier, the Tannoy Hi-Gain-15 integrated pre-amplifier/power amplifier provides all the facilities

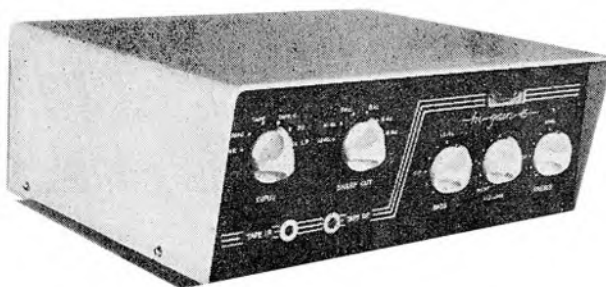

The Hi-Gain-15

Cosmocord Ltd., Waltham Cross, Herts.

★ Tape recording enthusiasts will take special interest in the new high sensitivity Acos Mic 40 Foldaway microphone, priced at 35s., which is to be seen in a variety of colours. (See review page 49.) There will also be the Mic 39-1 Crystal stick microphone and the others in the Acos range. For those also interested in disc there will be the Black Shadow pickup and a prototype stereo cartridge.

Mullard Ltd., Mullard House, Torrington Place, London, W.C.1.

★ The Mullard stand will feature the universally available World Series audio valves, together with a range of alloy junction transistors for battery-operated audio amplifiers and pre-amplifiers.

The transistor range includes the OC16, an all-metal power transistor for the output stages of medium-power amplifiers; the OC72, which is available in matched pairs for push-pull output stages of low-power amplifiers; and the OC71 for use in pre-amplifier circuits.

Specto Ltd., Vale Road, Windsor, Berks.

★ A new product which will attract attention is the Spectone Electronic Mixer, with full mixing facility from three sources, with three separate gain controls. Model 142, using HT and LT from associated equipment, is 17 gns.; Model 142A, a powered version, is 21 gns.

Also on show will be the Model 151B tape recorder; Model 129 recorder and stereophonic reproducer; the Spectone range of amplifiers; and a miniature motor, PM 110.

needed for the reproduction of radio, tape and records in a single unit little larger than the conventional pre-amplifier. The tape input is loaded directly from a high impedance tape head, full C.C.I.R. compensation being provided. Provision is also made for a tuner input, L.T. and H.T. supplies being available. There are connections on the front panel for the input and output from any standard tape recorder. On the tape record channel the main volume control is inoperative, so that the listening level may be adjusted independently of the recording level.

Two Hi-Gain-15 amplifiers may be coupled by means of the ganged volume control for use in a stereo system.

FAIR BRIEFS

OTHER features of the Audio Fair of interest to tape enthusiasts include the following:—

The B.S.R.A. exhibit, "Quest for Quality," an historical exhibition of sound recording and reproducing equipment, and a display of audio apparatus made by B.S.R.A. members.

Loudspeakers of various types shown by Altobass Ltd., Lowther Manufacturing Co., Ltd., Vitavox Ltd., Trix Electrical Co., Ltd., Wharfedale Wireless Works Ltd. and Westrex Ltd.

The Astronic units on the stand of Associated Electronic Engineers Ltd., described in the April issue of *Tape Recording Magazine*.

Amplifiers, control units and tuner units by Goodsell Ltd., and W. N. Electronics Ltd.

Record reproducers by Philco (Great Britain) Ltd. and R.G.D. Ltd., including the latter's presentation of the Garrard Transcription unit model 301 with polished veneered cabinet. There is also an R.G.D. AM/FM Tuner (model T.1) with push-button selector and many other special features.

C.Q. FESTIVAL OF SOUND

Running concurrently with the Audio Fair, and at a venue—the Aldwych Brasserie—a few yards from the Waldorf Hotel, the C.Q. Festival of Sound will provide continuous demonstrations from 11 a.m. to 9.30 p.m. daily (April 18th, 19th, 21st and 22nd), of C.Q. loudspeakers, amplifier and tuner and a loudspeaker for home assembly. Recitals are at 12 noon, 4 and 8 p.m. There is no charge for tickets or admission; advance tickets can be obtained (send s.a.e.), from Dept. TN/4 C.Q. Audio Ltd., 2, Sarnesfield Road, Enfield, Middlesex.

THEY'VE HITCHED THEIR RECORDER TO THE STARS ★ ★ ★ ★

A new London Planetarium, described as "a theatre of the skies", has just been opened to the public. The performances owe their quality to a marvellous £70,000 projector—and to a three-channel sound system built by E.M.I.

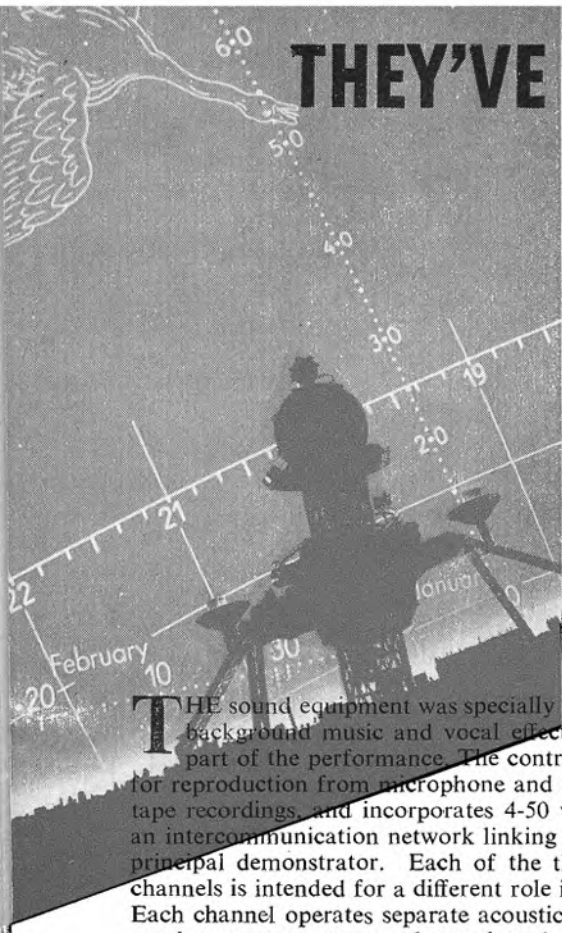

THE sound equipment was specially designed to provide background music and vocal effects that are a major part of the performance. The control console provides for reproduction from microphone and from both disc and tape recordings, and incorporates 4-50 watt amplifiers and an intercommunication network linking the operator to the principal demonstrator. Each of the three distinct sound channels is intended for a different role in the performance. Each channel operates separate acoustically-balanced loud-speaker systems, arranged at selected points in both the dome and the auditorium.



POPS ON SPOOLS

Stanley R. White's regular review of popular music issued on tape

A recent release from the Deroy company (ADM 60 vol. II) in their series of theatre organ recordings should prove to be one of their most popular issues to date. It features Reginald Porter Brown at the Wurlitzer Pipe Organ in the Tooting, Granada. Deroy have outpaced their previous high standard and once again this organ has shown itself to be an ideal instrument for recording. The organist is in top form. He uses his well-known "touch technique," adding the counter melody as if from another hand.

The selections on the recording are: "Oklahoma" Selection; Babbling (Maclean); "Bless the bride" Selection; Waltzing in the clouds; It's foolish but it's fun; When April sings; Keep your sunny side up; Slow boat to China; Dreamboat; Come back to Sorrento; I do like to be beside the seaside; Butterflies in the rain; Sunny side of the street; Roses of Picardy; When you're smiling; Kiss me again, and Riding on a rainbow.

The recording is available at £2 10s. as a pre-recorded tape (or as a 12 in. LP), from The Deroy Sound Service. "Little Place," Moss Delph Lane, Aughton, near Ormskirk, Lancashire.

And now for a few words about some interesting tapes to which, for various reasons, we have not previously given full attention. One of these, features that lovable and highly talented jazz trumpet player and vocalist, Louis Armstrong. The title of this recording (HMV HTD 816), is *Ella and Louis*, the former being Ella Fitzgerald, the other half of the team on this tape. They are supported by Oscar Peterson (piano), Ray Brown (bass) and Herb Ellis (guitar)—in fact, the celebrated Oscar Peterson trio—together with Buddy Rich on the drums.

Ella and Louis duet together, in the happy-go-lucky setting provided by Peterson's group, providing eleven ever-popular songs, with plenty of trumpet breaks thrown in by Louis for good measure. All in all this is a delightful tape, and one that is all the more important in view of the fact that it marks the first appearance of these celebrated jazz personalities on tape records in this country.

The titles are: *Can't we be friends; Isn't this a lovely day; Moonlight in Vermont; They can't take that away from me; Under a blanket of blue; Tenderly; A foggy day; Stars fell on Alabama;*

Cheek to cheek; The nearness of you, and April in Paris.

Bing Crosby makes his debut on British tapes with *Bing sings whilst Bregman swings* (HMV HTD 817). How fortunate that he did consent to do this set of recordings for Norman Granz's Verve Label in America, otherwise I do not think that Bing would have made his debut on tape over here for a very long time. However, he did, and how! Backed by the powerful band led by Buddy Bregman, Bing gives out with everything he has, swinging his way through twelve evergreens. He shows us a side of him which has rarely been captured on record before, using a powerhouse style of singing which would surprise the person used to the easy-going style usually identified with Bing. The orchestra provides a good backing for Bing in this mood.

The titles are: *The song is you; Mountain greenery; Cheek to cheek; Deed I do; Heat wave; Blue room; Have you met Miss Jones; I've got five dollars; They all laughed; Nice work if you can get it; September in the rain; and Jeepers creepers.*



FADING DEVICE

YOUR "Ideas Pool" is, in itself, a splendid idea. Can any technical reader help me with a modification I would like to include in one of my tape recorders?

This is a facility for fading an existing tape recording. I know very little about electronics, but I feel this could be done by using a switch and potentiometer in the H.T. lead to the valve which supplies the current to the erase head.

With the recorder on "play back" this circuit is normally out of action unless the valve (usually an EL 84) is used as part of the output amplification circuit as well as bias and oscillator on record.

I visualise putting the recorder on "playback," switching on erase circuit with full value of potentiometer in H.T. lead, then turning pot. control reducing resistance in H.T. lead and slowly increasing voltage to valve and thus increasing power to erase head until the erasure is complete.

It would be necessary to include in the switching the erase head to be switched in and, as a safety device, a warning red light to avoid accidental erasure.

Could someone estimate or work out a suitable value for the potentiometer and advise whether it should be Log. or Lin? I don't know the voltage on the H.T. line but it goes to an EL 84 of a pre-amp for a Collaro Deck.

Information on any other possibly simpler system of fading an existing recording would be welcome.

W. P. COPINGER.

Southall.

LOCATION PROBLEM

YOUR correspondent Mr. Milsted has certainly posed a problem regarding the location of places on tape. This is difficult enough for a sighted person but the following suggestions may be of use:—

1. A short length of splicing tape stuck to the back of the tape at the end of each item may be felt with the fingers when spooling and has the advantage of being extremely simple.

2. Audible indication may be obtained by splicing in a short length of metalised strip which may be used to close contacts connected to a buzzer, etc.

Both of these methods have the disadvantage that both tracks are marked simultaneously.

More and more readers are helping one another. If you have a problem, write to "The Ideas Pool" about it. And if you think you have an answer to any of the

queries, let other readers share your knowledge and your own experiences.

THE IDEAS POOL

A third method, while marking each track individually, can only be used with a recorder having the playback head live when spooling.

At the end of each item a heavy low frequency or D.C. signal is recorded for a short period. When spooling this signal will be audible as a sharp click in the loudspeaker.

Methods of producing this signal will vary between different recorders, but for commercial production I suggest a crude form of accessory head energised with D.C. via a push-button.

K. L. DEAN.

Launceston.

SUGGESTIONS

WITH reference to the request for a location device for blind tape recorder users, I suggest a clock-type counter as used on the Grundig TK 9 and 12, or the clock-type used on the latest Wearite decks. The system could be modified to enable the clock to be driven

AND QUERIES

from one spool with a flexible drive, and it should be fitted with strong hands. With the glass removed it could be used in the same way as the watches for blind people.

T. GARTH-LARDNER.

Woodstock.

SPEED CHECK

A CORRESPONDENT suggested an excellent way of checking the speed of a recorder by means of a 37½-in. loop of tape on which a single "dong" is recorded. Here, however, is a simpler way of calculating the actual speed.

The standard data is that 24 dongs should be made in 120 seconds (2 minutes) if the speed is true at 7.5 ips; but by dividing 9,000 by the actual number of seconds taken to make the 24 dongs, the precise speed of the machine is obtained. Thus, if the 24 dongs take 118 seconds, then the speed is 7.63 ips. At 3.75 ips, naturally, only 12 dongs will be heard, and 4,500 should be

divided by the number of seconds to make the 12 dongs.

If checks are made at frequent intervals, then a line should be plotted in a piece of finely ruled graph paper. Note that the line will not be straight, but slightly curved—it is really a reciprocal curve.

H. DENNETT.

Kings Langley.

BIRD SONG

I THINK it is generally agreed that British bird song is the most beautiful in the world. It is one of the things which one misses when one is forced to live abroad, particularly in the tropics where birds only squawk.

There must be many owners of tape recorders, especially among those living abroad, who would like to have a good recording of our bird song.

To make a good recording oneself is much more difficult than would appear and I am, therefore, going to suggest that those interested in this idea write to (say) H.M.V., and put the idea to them. They have all the equipment, which we amateurs have not, to make a tape-recording and, as they made a gramophone record of "Bird song in an English garden," before the war, it seems likely that, given some encouragement, they might do something similar on tape. What a joy this would be to all exiled Britons (and to many of us here) who have recorders. To be able to hear our birds in full song on a cold grey winter's day, would be most heartening.

R. N. GREGOR.

Ascot.

DUBBING TECHNIQUE

I HAVE two tape recorders, an Editor Model A9 (about 3 years old), and a Simon SP.2 (about 15 months old), which I use a lot for dubbing, in connection with the reading service for the blind. My practice has been to dub from the Editor Ext.-LS socket into the gram input on the Simon but, probably due to the amount of usage the Editor has had, the quality has fallen off.

I recently experimented with feeding the Editor playback head straight into the mic input of the Simon, with a vast improvement in quality. Have you any criticism of this system of feeding into the copy machine?

CHARLES H. STANDEN.

London, S.W.9.



BRITISH

The programme and the prizes

The second British Amateur Tape Recording Contest is attracting an impressive number of enquiries and is assured of a record entry. With the enthusiastic support of the industry, it is now established as the major event of the year in the world of tape.

There are two main sections of the Contest: one for individuals and one for schools. Prizes in the first include the E.M.I. Challenge Cup, and in the second the Grundig Challenge Cup. Recorders, microphones, radio jacks and tape are among the other prizes.

In the individual section, competitors may enter a tape in any one or all of four classes: **Compositions**, i.e., plays, drama, sketches, etc., not exceeding 15 minutes duration; **Documentaries and reportage**, not exceeding 10 minutes; **Music or speech** (solo singer or player, orchestras, choruses, poems, imitations, monologues, etc.), not exceeding four minutes; and **Actuality recordings**, e.g., unusual voices, historic moments, etc., not exceeding four minutes.

In the schools section, a class or other group of pupils should submit a feature tape not exceeding 20 minutes duration on the theme: "Discovering the World."

The British Amateur Tape Recording Contest is now linked with the International Amateur Recording

AMATEUR TAPE RECORDING CONTEST 1958

The JUDGES

JOSEPHINE DOUGLAS

TV star of "Six-Five Special" and a talented radio producer in her own right



TONY GIBSON

Freelance script writer and former BBC producer—a pioneer of features on tape



Contest, in which seven other countries take part. The best British entries will automatically go forward to the International events, where they will be eligible for further prizes. Winners of the individual section will be guests of Messrs. E.M.I. Sales and Service Ltd. at a lunch at the Savoy Hotel, London, and at the Earls Court Radio Show, on Saturday, August 30. Winners of the schools section will be entertained by Messrs. Grundig (Great Britain) Ltd., at a social function either in London or in the area in which the school is situated.

Judging will take place during August. The distinguished panel of judges is announced on this page.

Readers should lose no time in studying the details and preparing their entries. Full information and official entry forms are now available from *Tape Recording Magazine*, 426, Camden Road, London, N.7. Mark your envelope "Contest" and enclose a stamped addressed envelope for the reply. Further information about the contest will be published each month in the magazine.

CHARLES MASON

BBC actor and producer for many years, who has also been announcer, worked with outside broadcasts, and TV



DOUGLAS GARDNER

Journalist with long and wide experience, who contributes *Homo Tapiens* to these pages



T A P E N E W S D I G E S T

ANNOYED by extraneous noises that they hear when tuned-in to the B.B.C. television viewers at Dovercourt, Essex, have sent a tape recording of typical reception in their area to the B.B.C. for analysis. The interference is said to consist of American voices.

Tape-recorded reminiscences by people who have attended Sheffield Methodist Mission's Victoria Hall throughout fifty years may be used to celebrate its Golden Jubilee next September.

"Do you tape this man?" Immediately after Michael Wilding and Mrs. Susan Nell were married at the "Little Church Around the Corner," Las Vegas, on St. Valentine's Day, the minister asked: "Would you like a play-back? Your marriage was taped. A recording will cost you \$4.50."

HIGH praise has been given to a French-invented tape-using juke-box which is said to have satisfactorily solved the difficult problem of pre-selecting tunes at the touch of a button. The instrument is called the "Musicmatic." In view of the great number of playings called for in a juke-box, tape is the ideal medium, since the wear is negligible.

Television viewers in three United States Pacific Coast States recently saw the first commercial telecast using colour video tape. Reporters watching the demonstration on twin sets—one colour, the other black-and-white—voted colour TV on tape a success.

At Parents' Association meetings Mr. Stevens, Headmaster of Warren Road Secondary School, Orpington, often plays recordings taped while lessons are in progress. Says Mr. Stevens: "Parents are interested to hear the sides of their children they do not know." The recorder was bought from funds raised by the Parents' Association, and is used for music, drama and science lessons.

No development in the field of tape has aroused greater public interest than the introduction by the B.B.C. of their Vision Electronic Recording Apparatus, VERA for short, which records vision as well as sound. It is regarded as a distinct improvement on other video apparatus, and a full description of it will appear in a later issue of *T.R. Magazine*.

The transcript of a tape-recorded talk given by 17-year-old Anna Wooster, of Cambridge, broadcast by Moscow Radio has reached England. Anna spoke about her life in Leningrad, where she is studying ballet and learning Russian. She finished the talk with a message to her parents.

Pearl Carr and Teddy Johnson, husband-and-wife singing team, often invite friends to hear their "stars-on-tape" collection. In America they added recordings of Kurt Jurgens, Nat "King" Cole, Marlene Dietrich and Tony Bennett. Radio and television producers are persuading Pearl and Teddy to make their tapes available to a wider public.

A NEW magnetic tape machine capable of high-speed transmission and storage of photographs in their original clarity has been developed by the Ampex Corporation, California. The pictures are stored on a machine similar to a sound tape recorder and can at any time be erased or transmitted to another machine, transmission of an 8x10 in. picture taking one minute.

"Could you endure space-flight and keep your wits?" With tape-recorded evidence, ex-frogman Peter Kennerley claims the answer is: "Yes, if you are the right type." Ears plugged, hands bound to rob him of his sense of touch, he spent twenty-four hours "solitary" in a blacked-out room at Maudsley Hospital, London. Every word he spoke was relayed to next-room scientists and tape-recorded. Scientists consider this Space Age experiment "could prove invaluable to future space flyers."

MISSIONARIES in various parts of the world are finding that people who will not listen to them personally will listen with rapt attention to the words issuing from a tape recorder.

The Rev. C. A. Couldridge, at Thysville, Belgian Congo, reports that: "The folk would not come to hear me preach, but they cannot resist the loud-speakers giving out a recording of the morning service."

Members of Broadstone Baptist Church, Heptonstall, Yorks., had a special interest in the recent opening of a Baptist Church at Dannevirke, North Island, New Zealand.

This church was founded by two of their former members, Mr. and Mrs. Frank Rawsthorn, who emigrated to New Zealand 50 years ago.

The other day they heard a tape recording of the opening ceremony of the new church. It had been sent by a niece of the founder, who went to New Zealand three years ago.

Was a T.R. Magazine reader, Cmdr. F. W. Hornsby, the first to make a tape recording of this year's cuckoo? He wrote to a national newspaper recently saying that he recorded a cuckoo at approximately 5-20 a.m., but the dawn chorus commenced earlier with the robin at 5-4 a.m.

TAPE TO DISC 78/L.P.

S.A.E. FOR DETAILS:

CHARLES A. ORMEROD

22, EVERARD ROAD,
SOUTHPORT, LANCs.

TAPE TO DISC SERVICE

78's or L.P.

QUEENSWAY RECORDING STUDIOS

123, Queensway, London, W.2.

Tel.: BAYwater 4992

TAPE RECORDERS FOR HIRE

TAPE TO DISC RECORDING

Microgroove L.P. (30 mins.)

27/6, 78 rpm. 13/6

S.a.e. for leaflet: Deroy Sound Service (A.D. Marsh), Little Place, Moss Delph Lane, Aughton, Ormskirk, Lancs.

FREE LIST

of all leading makes of

TAPE RECORDERS

Part Exchanges — H.P. Terms

HOLDINGS OF BLACKBURN LTD.
39-41 Mincing Lane, Blackburn

TAPE TO DISC

78 r.p.m.

R. C. MILLER

TAPE TO DISC SERVICE

136, Crown Street, Aberdeen

TAPE RECORDER HIRE

TAPE TO DISC 78-LP
RECORDING STUDIO
SALES—EXCHANGES

MAGNEGRAPH

1 Hanway Place, London, W.1.

s.a.e. for leaflet or
telephone LAN 2156

Tape

Types

by Alastair

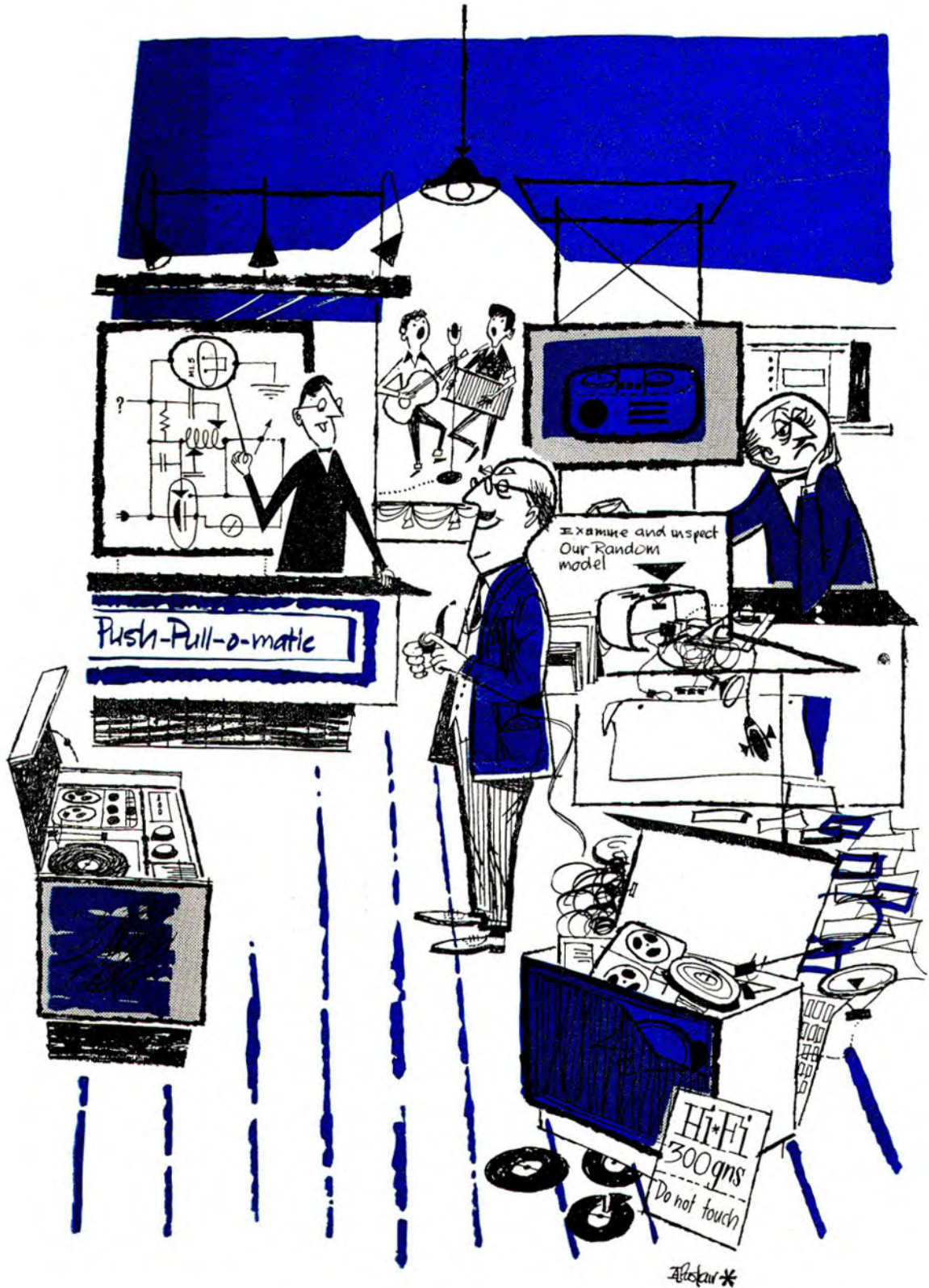

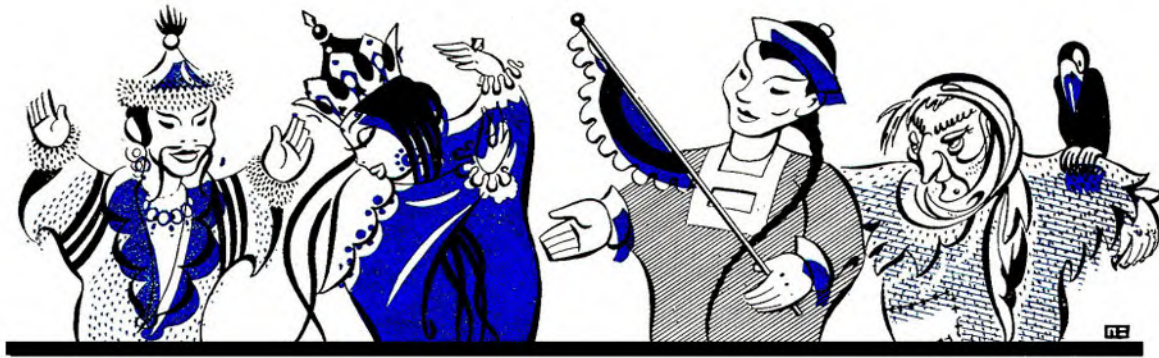

tape and the puppet theatre

THE art of the puppet is one of the oldest in the world and that of tape recording one of the newest. As a professional puppeteer, I wondered how the two could be used together, in furtherance of each.

I knew nothing about recorders, but I bought what seemed the lightest machine which would stand up to the work required of it.

My first recorded show was a nightmare. When I think now of what I tried to do on that tape, I wonder how I could have imagined, let alone produced, such a nightmare.

by GEORGE RUTHERFORD

Next, I decided I would speak all the parts of my show just as though I were working without a recorder, and add the necessary music from discs. This would save me the terrible job of changing records on a PA system while trying to work glove puppets with both hands above my head. This was more of a success and, after I had got the timing right, a great step forward. I found it difficult to act the puppets to a voice which I did not recognise as my own but, by and large, the experiment pointed the way forward.

My performances are primarily for children and are usually given in school halls. I realised that I could now add other voices to my production besides my own, and I decided that I would get children to record the show with me, thus giving it an even more powerful appeal to my child audiences.

I made a variety show tape, with boys of thirteen speaking the parts. It was a great success, and I gave hundreds of performances to thousands of children with this tape. I also used it in parks during the summer holidays.

The most difficult part of the making of this tape was to get the music and the voices as nearly level as possible, so that there would not be passages of shouting to Heaven and others so quiet as to be almost lost altogether. Working alone, as I do, it must be realised, it was impossible to alter the volume of the machine once the act had started.

I still had much to learn about the use of the recorder and the placing of the mike. I found that the two-watt output of my first machine was barely enough for the places in which I played. This was overcome, whenever

possible, by using the school amplifying system; otherwise, audience, puppets and myself all suffered.

At this point, I decided that the best way to make the kind of tape I required was by splicing. Some boys, who were fine little actors on their own, simply dried up if asked to play with other boys. I overcame this difficulty by recording all that one particular boy had to say at one session; then, by splicing these individual speeches together, a boy could be made to talk to someone he did not know and had never met. No attempt was made to give the right pauses to the speeches during the recording; these were added at rehearsal stage. I found that leader tape was the best material to use when introducing these pauses.

In all the performances I have given, only once has a splice parted during a show. But may I say, in passing, that I have not been really happy with either of the two well-known makes of splicer I have used. In my view, the whole instrument should be longer, so that one can get one's fingers easily into the joint to press the jointing tape home. The springs should provide a better grip.

It is advisable to splice a long piece of leader tape between each act or play, so as to allow time to remove the puppets from the stage and turn the brake of the recorder on.

I have now added to my original recorder a Simon SP/2, with an output of ten watts, which I find suits my purpose splendidly. I have also an Elpico Geloso TR.175. This has proved a very useful machine for interviewing and collecting sound effects, and I can dub on to the Simon without hum developing. I use a small extension speaker at the back of my audience and find that it gives a better result than having the volume too high from the stage. Watch carefully that the volume never gets too high; I am sure it is often the cause of complaints against recorded shows. The effect can be horrible.

I now make my tapes at 7½ ips, as I think the voices are sharper. It is advisable to use one make of tape throughout the recording; I use only Emitape myself.

The tape recorder has added something to my work which I would now find it hard to do without. I should miss the lovely ring of the voice of my little boy character, Sprog, saying: "Oh, there's a dog. Come here, dog." So natural is his voice that people often ask, after the performance, where he is. That, I think, is the best advertisement I can give the tape-recorded show.

Bertram Russell describes how you can make

A REMOTE CONTROL FOR THE COLLARO DECK

AN increasing number of British manufacturers are using the Collaro transcriber and the latest model of this deck incorporates a "pause" lever. This is a most welcome improvement, especially for writers like myself.

Possessing a "Sound" recorder, I found that I was not able to use my "pause" lever and revise my recorded draft direct on to my typewriter, for it was necessary, of course, to have one hand free to operate the "pause" lever. So I designed and produced the remote "pause" lever control described and illustrated here.

The total cost was less than five shillings.

Although the dimensions and minor details of the control unit are specifically designed for a "Sound" recorder, any handyman can easily modify them to suit any recorder which uses the Collaro deck.

The remote control consists of two main parts—a "pause" lever unit and a pedal unit. Use is made of a standard cycle brake cable, which may be bought for less than half-a-crown at any cycle dealers. Other materials I used were odd scraps of wood, small hinges, screws, etc.

The "pause" lever unit, as shown in Fig. 1, consists of two struts of wood glued and joined, with screws, at right angles to each other. The end of the cycle cable is inserted

When the unit is placed in position, the weight of the recorder itself holds it in place.

The "pedal" unit also is of very simple construction, consisting of a "frame" (b in Fig. 3) attached to a "base" (c), on which is hinged a flat "pedal" (d). The "pedal" is made slightly narrower than the "base" to ensure that it moves freely.

The second end of the brake cable is inserted in a hole in the centre of the cross-bar of the frame, allowing the inner wire to pass through the hole. Two small hooks are then fitted to the unit, as shown in Fig. 3, one in the centre of the edge of the crossbar and the second in the edge of the "pedal," also centrally. Wire is used to join the hook on the pedal to the inner wire of the cable. Finally, a spring or rubber band is attached to both hooks to ensure the return of the "pedal" after use, so that no undue strain is imposed on the "pause" lever mechanism of the deck. This is also the reason why a cord loop should be used on the "pause" lever unit, rather than wire or metal.

Once final adjustments have been carried out, the thin wire on the "pedal" unit may be soldered to the end of the inner wire of the brake cable and to the hook on the "pedal."

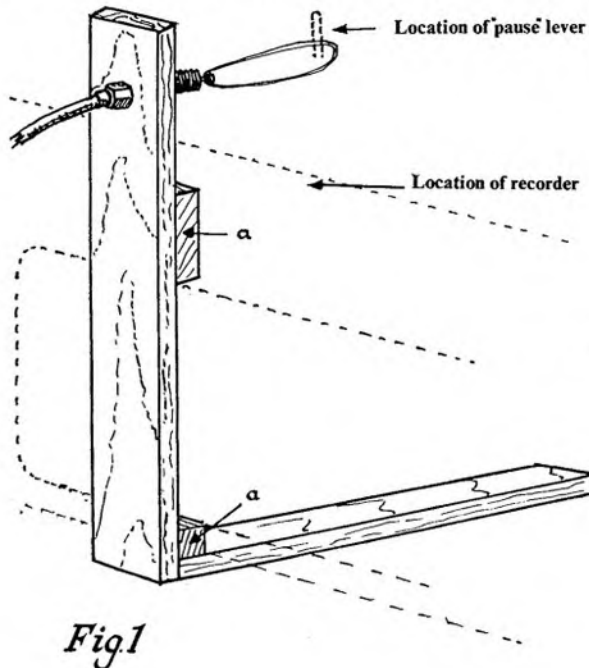

Fig. 1

through an appropriate hole near the top of the upright strut. A loop of cord is attached to the end of the brake cable inner wire, as indicated in Fig. 2. This loop of cord is subsequently adjusted to ensure that the control unit operates smoothly and without strain.

The small pieces of wood shown at "a" in Fig. 1 are necessary to avoid pressure on the fret of the loud-speaker, which is sited in the front of "Sound" recorders.

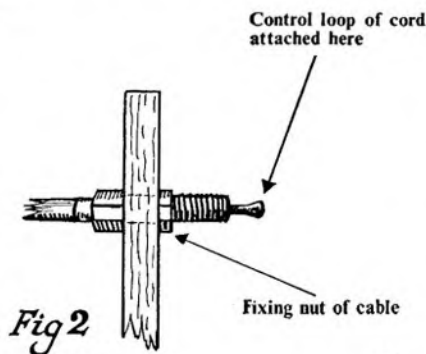

Fig. 2

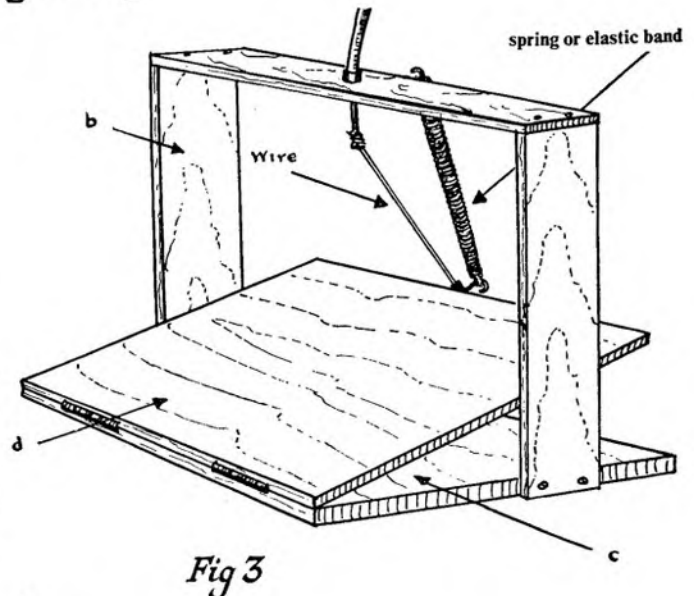

Fig. 3



NEWS FROM MANUFACTURERS

(News from manufacturers has had to be abbreviated this month in view of the Audio Fair. Many important new developments will be dealt with fully in our next issue.)

VERITONE SWITCH TO BUILT-IN SPEAKER

A BUILT-IN Rola Celestion speaker, mounted on a large baffle, is a feature of the newest version of the Veritone tape recorder, which can be seen at the Veritone showrooms at 5, Avenue Parade, Ridge Avenue, N.21.

The machine has a Lane deck with speeds of $3\frac{1}{2}$ and $7\frac{1}{2}$ ips and accommodation for up to 7 in. spools. There are built-in mixer facilities with separate volume controls for the two inputs, and facilities for superimposition and monitoring.

Output is 4 watts into 3 ohms; the tone control is variable on playback and provides preset equalisation on record. A magic eye indicator is fitted for controlling record level.

The microphone supplied is the Acos Mic 40 with stand.

The frequency range claimed for the recorder is from 50 c/s to 12,000 c/s at the faster speed. Fast forward and rewind time is given as approximately 50 sec.

The Veritone is a compact machine, the overall measurements being 17 ins. by $12\frac{1}{2}$ ins. by 8 ins., and the weight is 30 lb.

Complete with microphone and one 7 in. spool of tape containing 1,200 ft. The Veritone is priced at 52 gns.

THE CARMEN

WITH the object of supplying a cabinet suitable for most home furnishing schemes, and into which all popular types of audio equipment will fit, E.M. Office and Factory Equipment Co., Crewe, have produced a pseudo-Queen Anne cabinet which they have named Carmen.

It is available in walnut or mahogany, and is obtainable through dealers at $33\frac{1}{2}$ gns. without equipment. It can accommodate tape deck or turntable, amplifier and control unit and tuner.

A matched loudspeaker cabinet, *Il Trovatore*, containing an Altobass 2000 speaker, and produced in conformity with the special Altobass requirements, is priced at $39\frac{1}{2}$ gns.

* * *

Elon tape recorders are now being manufactured by Sonomag Ltd. The whole stock and service department has been transferred to Sonomag's Stockwell premises, and the staff absorbed into their organisation. The Managing Director of Elon Tape Recorders now becomes a director of Sonomag Ltd., but Mr. A. Ivey remains Managing Director as heretofore.



A group of Technical Officers of the G.P.O. Engineering Department recently visited the E.A.P. works at Romford, and expressed their appreciation of the methods of manufacture of the Elizabethan range of tape recorders. The Post Office party was headed by Mr. Leslie Kerrison of the North-West area (right).

"Britain's first weekly service of background music for reproduction in public"—all on tape—is being launched in the near future by Multimusic Ltd.

Two types of music will be available—"lively" and "soothing"—the former intended for factories, airports, stations, etc. and the latter for cafes, restaurants and public houses.

Each subscriber will always have eight hours of music available and receive a new reel of two hours music each week, the subscriber posting back a reel in exchange. The tapes have been specially recorded for this purpose and are intended for reproduction on continuous players.

The Acoustomat, a device which switches off the recorder when no sounds reach the microphone and switches it on again when the sounds recommence, is an accessory applicable to two of the six Uher models now available in the United Kingdom.

These six recorders are the 95 T, 95 S, 95 K, and 95 L, operating at a speed of $3\frac{1}{2}$ ips; the 495 ($1\frac{1}{2}$ and $3\frac{1}{2}$ ips); and the 195 ($3\frac{1}{2}$ and $7\frac{1}{2}$ ips). The 195 has a claimed frequency range of 30-17,000 c/s \pm 3db at the faster speed.

The M.S.S. Voiceletter referred to recently in these columns, consists of a 3in. reel of tape which fits into an envelope ready for posting, and it is available at

42 Gns. VERDIK USES NEW DECK

A NEW tape recorder by Verdik Sales Ltd., priced at 42 gns., incorporates a new deck which the organisation has been developing over the past two years. Its star feature is the provision of three half-track heads and separate record and playback amplifiers enabling instantaneous monitoring from the tape.

Tape speeds are $3\frac{1}{2}$ and $7\frac{1}{2}$ ips; the claimed frequency response is from 40 to 12,000 cps; and an output is provided with C.C.I.R. correction for feeding into a high-quality amplifier.

Other features include three motor drive, magic eye, twin speakers and output for external speaker.

5s. 6d. through the normal trade channels. The M.S.S. Recording Co. Ltd. wish to make it clear that the envelopes are not supplied separately.

* * *

Verdik Sales Ltd. have moved into new factory and office premises at 139, 143 Sydenham Road, Sydenham, London, S.E.26.

* * *

Sypha Sound Sales Ltd., are now trading from new premises at 75, Grand Parade, Harringay, London, N.4.

* * *

Tape Recorders (Electronics) Ltd., have announced an increase in the price of their Sound 777 tape recorder from 40 gns. to 44 gns., owing to the increase in the price of the Collaro tape transcriptor from £22 to £25 and to rising costs of labour and material. They are now in full production with this model.

* * *

A reader of *Tape Recording Magazine*, Mr. C. Butler, 37 Hyde Meadows, Bovingdon, Herts, has reported to us the loss of a tape recorder from his car when he was in Hammersmith, London, on March 29th.

The machine is a dark brown and grey Phillips Recordergram Major, Model No. AG 8106, serial No. 26307. Anyone who can help should get in touch with Mr. Butler.

TESTED IN THE LAB.

ACOS MIC 40



HEARD IN THE HOME

THE REPS JC20

NOT a great deal has been heard so far of the Reps tape recorder because the output has been absorbed largely by schools and churches, but it is now being made generally available and its performance in a home test suggests that it will quickly achieve popularity in this wider field.

The specification is a very good one; but we all know, or should do, that performance and reliability depend to a great extent on the care given to assembly, and the many extra touches contributed by the designer to ensure that all the components work well together. There is plenty of evidence that care of this nature has gone into the Reps machines, and it seems obvious that catering for the tough requirements of schools has helped the organisation to evolve something that is both versatile and reliable.



There are three versions, the JC20, JC30 and JC40, and all have the latest Mark IV Collaro deck. Extra attention has been given, however, to keep motor and mechanical noise to a minimum, including the mounting of the tape mechanism on neoprene. The claimed overall frequency response at $7\frac{1}{2}$ ips is 30-13,000 cps.

Another thoughtful refinement is the adjustment provided to prevent the tape rubbing against the edge of the spool.

The robust case of the Reps, and the high quality 10 in. elliptical loudspeaker on a front baffle board are calculated to promote quality of reproduction.

The JC20 tested in the home was given a lot of hard work, including a six-hour non-stop run, during which it kept quite cool and gave no trouble. The mechanism was virtually inaudible, and the built-in speaker gave an extremely good account of itself even when called on to tackle a symphony. I appreciated the switch giving instant change from internal to external speaker, and the amplifier proved its worth when fed through to a top-quality 15 ohm corner speaker—one of the most important practical tests for a recorder.

The machine behaved splendidly when it was plugged into an RD Junior amplifier and given the full treatment with the E.M.I. tape of the Beethoven Seventh by Klemperer. It certainly passed on everything in the way of range and quality that this excellent amplifier needed, and the silences were totally unimpaired. Recordings from radio, disc and via the Acos 39/1 microphone were all highly satisfactory.

All three Reps models now have separate bass and treble control. The JC20 costs 62 gns. with tape and Acos 39/1 microphone; the JC30, fitted with record level meter instead of magic eye, costs 66 gns.; and the JC40, with ultra-linear push-pull output and meter, costs 70 gns.—D.G.

Price: £1 15s.

Manufacturers: Cosmocord Ltd., Eleanor Cross Road, Waltham Cross, Herts.

Dimensions: Approx. $2\frac{1}{4}$ " × $2\frac{1}{4}$ " × 1".

Crystal microphones, being high-impedance, may be connected straight to the grid of an amplifier, thus making matching transformers unnecessary. Another advantage is that no polarising voltage is required. The cheaper types are characterised by giving a comparatively high output, with a limited frequency response which is not necessarily flat, whilst the more expensive models are capable of an extremely good frequency response. They give a much lower output, however, which usually demands an extra stage of amplification.

The microphone under review is undoubtedly one of the lowest priced on the market, but its performance throughout the tests proved very satisfactory. The appearance is neat, being fitted in a cream plastic case having a black escutcheon surrounding the microphone grill. This escutcheon is pivoted so that it can be pulled down away from the main case, thereby acting as a base when being used as a table microphone. This feature, incidentally, is the only point of criticism, the instrument tending to wobble or fall over if the screened lead was moved.

Two series of electrical tests were made: (a) under normal working conditions, and (b) under laboratory conditions. The first series, having a wider interest, will be dealt with initially.

Performance under Normal Working Conditions.—This series of tests was carried out in what may well be an average lounge. Three tests were made, the first being in conjunction with a high quality commercial recorder.

When played back, speech was reproduced with surprising clarity, and only when recording music was there a slight lack of response at the extremes of the bass and treble. Distortion was surprisingly low for a microphone in this price range.

An inexpensive, portable tape recorder was used for the second test. This is one of a type very widely used, the quality of reproduction being limited by a small loudspeaker and low tape speed. With this recorder, very little difference could be detected between a recording made with the microphone under review, and an expensive ribbon microphone.

Thirdly, to give a practical idea of the sensitivity, the microphone output was sufficient to drive the A.F. and output stage of a typical radio receiver, when connected to the pick-up terminals.

Laboratory Tests.—The following results were obtained on the test microphone:—

Impedance: A capacitance of .1105 mfd. in parallel with a resistance of 1 megohm.

Sensitivity: Peak output voltage when speaking close to the microphone approximately 6 milli-volts.

Frequency Response: When tested in the open air the response, relative to the output at 1000 cps, was fairly level between the 3 db points at 65 cps and 7,500 cps.

Directional Response: Generally omni-directional. Front to back ratio approximately 2 : 1.

Further Details.—The microphone is complete with approx. two yards of single way, insulated, screened cable. A manufacturer's note states that the instrument will be available in several two-tone colour combinations.

Summary.—This inexpensive microphone can be recommended to anyone whose requirements are not too critical, and for home entertainment in general. As the speech clarity is very good, this microphone is excellent for recording talking-

letters, amateur plays, commentaries, etc., as well as being very suitable for amateur transmitting.

CHAS. LANGTON
A.M.Brit.I.R.E.

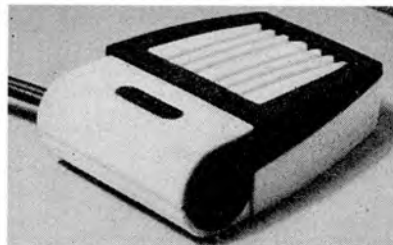

The Acos
mic 40



Farquhar versus Lomax: the second round

NO, Mr. Lomax, I will not differ with you that Britain is lagging on tape recorders.

The American machine for the most part is more portable, much better designed and more efficient. Their decks are, as you state, vastly superior.

But perhaps some British components, loudspeakers, resistances, etc., lead the Americans. And some of the German sets would put both countries to shame.

I was not discussing the decks when I said that American sets were sometimes less well constructed (though I did have an American recorder which was designed to run right to left and vibrated like a massage machine when the motor was turned on!).

But in your article in last month's issue you generalise. Nobody questions the leadership that Ampex has secured in the American field. I was, however, considering the type of machine bought by the general public for around \$150—or £50, and not equipment that would be used by Radio Italiana in Rome or the EMI-90 which needed "two strong men to carry."

The British tape machine is in comparison with its equivalent in Germany or the United States a poor job and even the proud Ferrograph which is a leader in the field lacks a safety stop to prevent accidental recording and will not play back unless the mike or input plug is pulled out. All too often if a British

machine is any good its manufacturers have an attitude to the public that they are doing a favour by selling it and deliveries are impossibly slow.

It is a sad commentary that for years the British market has been dominated by one firm which manufactures on the outskirts of a once ruined city in a defeated country. If some British manufacturers checked Grundig service, the readiness of their staff to give immediate and technical information and to stand behind their dealers and their machines they would see why.

If American models could come into Britain at U.S. prices there would be few British manufacturers.

But the solution is not hard to find. If necessary employ foreign designers to create attractive cases and decks, use ingenuity, take a lead in the industry (let's have more 1½ ips as well as 3½ and 7½). Then go out and sell it with a guarantee of service.

This alas will only be practical when the British market is larger, which must await a further decrease in the price of tape or an increased export market.

In the meanwhile Uncle Sam's tape boys have a tape machine in their latest satellite and a hush-hush project may soon see the introduction of a four-track tape head and cartridge loading.

WM. FARQUHAR.

New York.

Acoustical 'wool' over our ears?

IT was once again a pleasure to receive my copy of *Tape Recording Magazine*, which, as always, contained so much interesting and varied material. I particularly appreciate the up-to-date information about new machines and accessories which it never fails to carry.

But as a professional musician, may I dare to wonder whether we are not having the acoustical "wool" pulled over our ears in connection with this stereo vogue. I think I am right in saying that the claim for stereo is that it gives the directional effect which it is claimed one gets in a concert hall.

Having attended a good many concerts, I can't help wondering whether the directional effect of the various orchestral departments is as noticeable in the concert hall as it is when listening to stereo equipment.

I feel sure that for the majority of concert-goers, able to pay for decent seats in front of the orchestra, the directional effect is not nearly so marked as the stereo enthusiasts would have us believe.

One cannot help wondering whether

there is not a tendency for knobs, sockets and gadgets to become the end instead of the means. Let us have good machines by all means, but let us also make sure that they are put to the best possible use, and not played about with like so many expensive toys.

J. A. WELLS, G.B.S.M.,
A.R.C.O., L.R.A.M.

Burton-on-Trent.

Mind over matter?

WITH the greatest respect to the old maestro Stanley Jepson, you cannot play a gramophone record from the end to the beginning by moving the position of the pickup.

If he did so, it is a most remarkable example of the mastery of mind over matter.

We ordinary mortals find it essential to reverse the direction of the turntable.

O. V. WADDEN.

Hounslow, Middlesex.

TAPE MAGAZINES REVIEWED

WHAT is the ideal length for a magazine on tape? I have a definite impression that most of those who have been responsible for pioneer productions have not considered the question theoretically, but have been governed solely by reel size. Thus, most of the magazines have been of about one hour's duration, either by using a 5-inch reel at 3½ ips or a 7-inch at 7½ ips.

After listening to the latest batch of tape magazines sent in, I have formed a definite view that 15 to 20 minutes is the ideal length, i.e., a 3-inch reel recorded at 3½.

I have been persuaded by the first two tapes produced by the Midland Counties' Tape Society, both of which seemed to me to be admirable. The first included a number of short, snappy items on the first track, and a demonstration-talk about organs on the other. Number 2 showed progress. Editor Kenneth Holmes, of Stafford, did a first-rate job of assembling the items and providing continuity. There was a short editorial, then two well-contrasted items from the postbag; a light-hearted "tapewriter rhymes" contribution; then a very effective poetry reading by Godfrey Chapman, of Stourport; and, finally, an exciting circus commentary by John Walters, of Kidderminster, which set a cracking pace.

So we had five items and six different voices in our 20 minutes programme, and interest was sustained throughout.

The B.T.R.S. tape bulletin, the oldest of the sound magazines, is still going strong, but Editor Jack Talling frankly reported in a recent issue that he was having difficulty in getting enough good quality material. But then, this production averages about an hour in length.

Consequently, each of the items tends to be rather long and it is more difficult to sustain an adequate pace.

The most interesting item in the last two numbers seemed to me the talk, with sound illustrations, by Laurence Mallory on the use of a portable recorder. He used a Boosey and Hawkes model for his demonstrations. This was the sort of item that could not be handled in any way other than in a magazine-on-tape.

The B.T.R.S. production is now running a serial play, called "The Jackboot Came," about the war-time occupation of the Channel Islands. Short stories are also a regular feature, but there is too much tendency to read them straight into the mike, instead of lacing the narrative with contrasting voices and some sound effects.

In the last number there was an interesting talk on the use of tape by Independent Television News.

R. B.

Midland Counties

THE Midland Counties Tape Society is expanding its activities rapidly. They are hoping to hold regular meetings in either Birmingham or Wolverhampton and would welcome hearing from enthusiasts in these areas.

They have now appointed a West Regional representative. He is Mr. P. D. Turner of Gloucester. Mr. Turner is a senior officer of the R.S.P.C.A. and a frequent broadcaster on the B.B.C. West Regional Home Service. Mr. Turner has been very active since his appointment canvassing dealers for support for the Society as well as advertising in the local press.

The Committee met recently in Birmingham. New feature to be announced in the Society's May *Sound Magazine* is a prize to be awarded in December each year to the person having the largest number of contributions in the *Magazine*. It will not, of course, include regular commissioned features such as "Tapiens."

London

AT the March meeting of the Club, members brought along their microphones for a live comparison recording. All shapes and sizes were seen and heard, ranging from the Reslo R.V.A. to the "Earpiece Special"—which gave quite a good account of itself. A few words were spoken into each mike then the tape was played back so that the differences in quality were immediately assessed.

A Tape Productions sub-committee has been formed to undertake all future tape programmes on behalf of the Club. The members are Alan Stableford, Hugh Smith and Albert Chapman. All three have had a great deal of experience in this field and the Club is confident that the results will be first-class. The first production is well under way.

The Club has received its first tape message from another tape recording club, the Bournemouth Amateur Tape Recording Club. Greetings are being sent in return.

In April there will be a demonstration on the recording of real and fake sound effects at home. In May it is hoped to demonstrate a piece of commercial sound equipment.

World Tape Pals

MR. L. W. WATKINS, Balham, and Mr. Charles Standen, Stockwell, are now operating the W.T.P. service for the handicapped. Official mailing labels are now obtainable from Mr. Watkins, 40, Ravenslea Road, Balham, S.W.12, who will provide details of the costs to engineers.

Norwich

THOSE interested in tape and cine, or tape only, are catered for by the Norwich Cine and Recording Society, Club Room, rear of 6, St. Vedast Street, Norwich. The secretary is W. Dawson Robertson, 5, Essex Street, Norwich.

The Society was formed in 1933 and tape has recently become a strong

NEWS OF THE CLUBS

interest, not only in connection with film, but also in the form of tape corresponding, outside recording and dubbing. A special service is the playing back and recording of messages to and from Australia on a non-profit basis.

T. R. International

THAT tape recording technique can add a distinctive contribution to readings for the blind is being demonstrated by Mr. Bill Rawle, whose tape readings are frequently enlivened by dubbings to illustrate the subject of the reading. He is planning to acquire a further tape deck to facilitate the process. Some of his readings are circulating in America and New Zealand as well as all parts of the British Isles. Tape recordists who wish to help with readings for the blind should contact Mr. Rawle, whose address is 12, Glenfield Road, Darlington, Co. Durham.

ETESSA

PROBABLY the first tape recording club that is a section of a firm's social association, the ETESSA Tape Recording Club, with about 40 members, is a flourishing part of the External Telecommunications Executive Sports and Social Association. The idea was first mooted towards the end of last year by Mr. Geoffrey P. Jones, now hon. secretary, and Mr. S. Turney, a hi-fi enthusiast. The club works very closely with the Drama Group, the Musical Appreciation Society and other sections of the organisation.

Dundee

DUNDEE Tape Recording Club, which has now held its inaugural meeting, has decided not to limit the club to owners of tape recorders but to include all who may have an interest in sound recording of any kind, such as drama groups, gramophone clubs, cine clubs, choral groups, music societies, education groups, bird watchers, and so on. It is felt that this will stimulate local interest in tape recording, and that the various groups will compliment each other. Twenty-seven members were enrolled at the inaugural meeting.

Sheffield

SHEFFIELD Tape Recording Society, formed in January, now has seventeen members. Finding suitable accommodation is the problem of the moment, but this is likely to be overcome shortly. Anyone in the locality who is interested should get in touch with Mr. F. Shepherd (hon. sec.), 4, Birchitt View, Dronfield, Sheffield.

BTRS

The British Tape Recording Society is producing a new tape magazine called *Talking Tape*. It is edited by Jack Talling. The next edition is due in May.

Another Audio Fair is being sponsored by the society at the Drill Hall, Chester, on the 26th and 27th of April. Entrance 2s.

Edinburgh

"Our stand was almost swamped" writes Mr. D. C. Jefferies, of Edinburgh Tape Recording Club, reporting on their participation in the Edinburgh exhibition "Know Your Neighbourhood." Eight machines were shown, including a stereo reproducer, voices of visitors were recorded, and a "send a message to a friend abroad" service was conducted.

Australian-British Cobber Club

Midlanders and Australians are now getting together by tape.

The Australian-British Cobber Club which fosters friendship between the two peoples prior to migration, is now uniting them in this more personal way.

Just before Christmas a tape made at a social evening in the new B.M.C. works in Sydney, Australia, was flown over and played to relatives of some of the key personnel now in N.S.W.

Miss Mollie Smart, the secretary, tells us that two of her tapes have been played to radio audiences in Melbourne and Perth.

Like to form a tape club?

If you would like to help in the formation of a tape recording club in your own town or district, send us a postcard with your name and address and the words "Local tape club supporter." It will help, also, if the town or district, and county, are inserted boldly at the top.

Any other correspondence should be dealt with quite separately.

Those who write will be put in touch with each other as seems to be appropriate, and whoever may be asked to take the initiative in contacting others will not be expected to shoulder any more responsibility than that of initiating discussions on the subjects of calling a meeting of all interested and organising some advance publicity for it. The officers would be elected later.



In this feature every month you can check

YOUR LOCAL DEALER

who gives special attention to tape

WALES

IT'S BETTER AT BATTYS IT'S BETTER AT BATTYS

IT'S BETTER AT BATTYS
EMITAPE · SCOTCH BOY · GRUNDIG
Tapes and All Accessories By Return

Cash with order, or C.O.D. at Manufacturers' List Prices
All TAPES Post-Free. Postage extra on accessories under £3
or
Send P.C. for FREE Price List of Tapes and Accessories

BATTYS (RHYL) LTD., DEPT. TR,
21 BODFOR STREET, RHYL, NORTH WALES

IT'S BETTER AT BATTYS IT'S BETTER AT BATTYS

THE NORTH-WEST

MANCHESTER
SOUND REPRODUCTION
SPECIALISTS

TAPE RECORDERS by FERROGRAPH
BRENELL - ELON - MAGNAFON - etc.

HIGH FIDELITY Developments Ltd.
144 Oxford Road - "All Saints,"
MANCHESTER 13 ARDwick
5762

"TAPE RECORDERS ONLY"

ALL POPULAR MAKES, CASH OR TERMS

Specialists in GRUNDIG and Service and Guarantee implemented without return to the manufacturers.

TAPES Service spares

DIXON'S ELECTRONICS

227 OXFORD ROAD, MANCHESTER 13
(Telephone: ARDwick 4269)

JOHN SHINN & SONS LTD.

Electronic Engineers

TOWN CENTRE, LEIGH, LANCs.

Also at MELODY HOUSE, 109 HIGH STREET,
BANGOR, N. WALES.

and MELODY HOUSE, 43, HALLGATE,
TOWN CENTRE, WIGAN, LANCs.

Pioneers in Tape Recorders since 1946

ALL MAKES STOCKED - TERMS AVAILABLE

All customers are made honorary members of the John Shinn Recording Club, with its attendant benefits

LONDON

Hi-Fi Consultants and Dealers

STUDIO RECORDING & DUBBING FACILITIES

TAPE to DISC

professional standards

OLYMPIA SOUND

11, North End Parade, London, W. 14
Tel. FUL. 9422.

FRANCIS OF STREATHAM

Tape Recorder Specialists.—Largest selection of Recorders in London.

No interest. No Charges on Terms.
Free service whilst under guarantee.

COMPLETE RANGE OF
Tapes and Accessories.

169/171 STREATHAM HIGH ROAD,
LONDON S.W.16 Tel: STR 0466/0192

THE MIDLANDS

TAPE RECORDERS
ON 'NO-INTEREST' TERMS!

Buy your new Tape Recorder without touching CAPITAL! Grundig, British Ferrograph, Vortexion, Baird, Philips, etc. NO EXTRA CHARGES—Nine months to pay the balance of Retail Price Only.

JEWKES & CO. LTD.

The Midlands Tape Recorder Specialists

285, BROAD ST., BIRMINGHAM 1. MID 4829/20.

INDEX TO ADVERTISERS

	<i>Page</i>		
Battys (Rhyl) Ltd.	52	Magnegraph	44
Brennell Engineering Co. Ltd.	21	Miller, R. C.	44
Brown, A., & Son Ltd.	17	Minnesota Mining & Manufacturing Co. Ltd.	22
Classic Electrical Co. Ltd.	14	Modern Techniques	10
C. Q. Audio Ltd.	6	MSS Recording Co. Ltd.	17
Deroy Sound Service	44	Northern Radio Services	8
Dickinson's of Pall Mall Ltd.	15	Olympia Sound	52
Dixon's Electronics	52	Ormerod, Charles A.	44
E.A.P. (Tape Recorders) Ltd.	7	Penco Products	54
E & G Radio Centre Ltd.	18	Quality Mart	19
E.M.I. Sales and Service Ltd.	Cover	Queensway Recording Studios	44
E.M.I. Sales and Service Ltd.	28 and 29	Reps (Tape Recorders) Ltd.	20
E.M. Office & Factory Equipment Co.	55	Simon Sound Service Ltd.	4 and 5
Film Industries Ltd.	14	Sonomag Ltd.	12 and 13
Francis of Streatham	52	Specto Ltd.	11
Grundig (Great Britain) Ltd.	3	Sypha Sound Sales Ltd.	16
High Fidelity Developments Ltd.	52	Tape Recorders (Electronics) Ltd.	19
Holdings of Blackburn	44	Teletape	10
Howard Photographic	8	Trianon Electric Ltd.	16
Hughes, F. A., & Co. Ltd.	15	Truvox Ltd.	18
Jason Motor and Electronic Co.	16	Verdik Sales Ltd.	9
Jewkes & Co. Ltd.	52	Veritone Ltd.	30
John Shinn & Sons Ltd.	52	Walter Instruments Ltd.	56
Lasky's (Harrow Road) Ltd.	14	Watts Radio (Mail Order) Ltd.	6
Lustraphone Ltd.	6	Welmec Corporation Ltd.	27
Magnafon Ltd.	20	Wyndor Recording Co. Ltd.	2

POSTAL SUBSCRIPTION ORDER FORM

TO T.R. MAGAZINE, Rolls House Publishing Co., Breams Buildings, London, E.C.4.

Please post TAPE RECORDING AND HIGH FIDELITY REPRODUCTION MAGAZINE to me each month. I enclose postal order/cheque.

22s. for one year (post free) 11s. 6d. for six months (post free)

Name

Address

Please post free specimen copies to the following friends, who I think may be interested:

.....
.....
.....
.....

EX STOCK

THE DULCI-HARTING

TAPE UNIT AT 55 GNS

Use it with the DULCI DPA 10 amplifier and control unit 19 gns. complete.

CREDIT TERMS

HIRE PURCHASE

ORDER TODAY

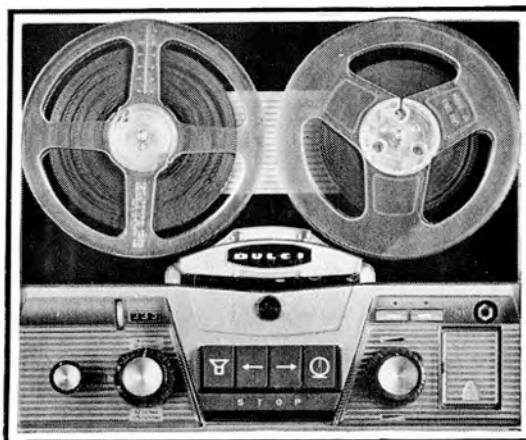

EX STOCK

QUAD II instruments; ALTOBASS 510 amplifier and 2000 speaker—also available in cabinet to maker's strict specification at 39½ gns. AURIOL; BRENELL'S latest deck, pre-amplifier and tape recorders; Burne-Jones; Chapman; G-Plan Furniture; HEAL Cabinets fitted with QUAD II or THERMIONIC instruments; Garrard & Collaro units with EXPERT P-U Arms; JASON Kits and latest Tuners/Amplifiers; Leak; Lowther; Rogers JUNIOR, Cadet and SENIOR; GOODSSELL & Ortofon; BLACK SHADOW Pic-Up. Lustraphone, etc., etc.

**OFFICIAL DISTRIBUTORS FOR
EXPERT GRAMOPHONES LTD.**

Tape Recorders by Sound, 777, Dauphin, Truvox, etc. Latest Type V by Veritone at only 52 gns. complete. "At the Audio Fair, Manchester, it met with phenomenal success."

**ALL THE LATEST INSTRUMENTS DIRECT
FROM THE AUDIO FAIR, LONDON**

ORDER NOW and avoid disappointment



**ELECTRONIC & MAGNETIC STEREOPHONIC
DIVISION**



(E.M. Office and Factory Equipment Co.)

29 JUBILEE AVENUE, CREWE, CHESHIRE

TRADE SUPPLIED

ENQUIRIES FREE

**ALL THE LATEST INSTRUMENTS DIRECT
FROM THE AUDIO FAIR, LONDON**