

JAN.  
1958

1'6

# TAPE RECORDING

& HIGH FIDELITY REPRODUCTION  
MAGAZINE

## Here's the tape recorder for YOU!

says **JACK JACKSON**

And who should know better than the popular maestro of the magnetic tape, the man who bewitches millions on TV and Radio with his special brand of record magic? Get a Walter yourself and start rounding up your own records—voices, music, sound effects—your Walter 303 will bring them back to life.

Here's why—

**SIMPLE CONTROLS** Only two! The 'joystick' (exclusive to Walter) for Record, Play, Fast Forward and Fast Reverse, and the Volume control.

**SUPERB QUALITY** Full orchestral frequency response (40 to 10,000 cycles). Delivers 3 watts through large (9-in.) elliptical speaker, the maximum volume on playback being enough to fill a medium-sized hall.

**MARVELLOUS VALUE** The Walter 303 gives you everything you want in a tape recorder, yet it costs only 39 gns. including microphone and 60 min. reel of tape.

*Go and try one at your  
local dealer's NOW*

## Walter 303

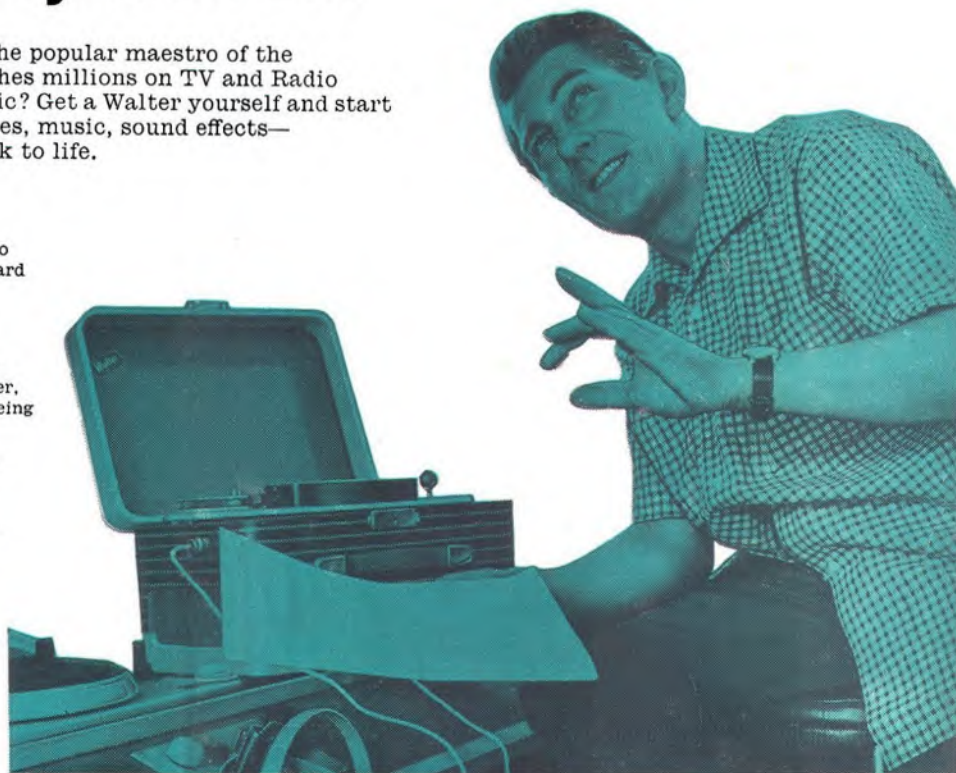

Details from: WALTER INSTRUMENTS LTD., MORDEN, SURREY. Tel. DERwent 4421

BRITAIN'S ONLY PUBLICATION  
DEVOTED EXCLUSIVELY TO THIS FIELD

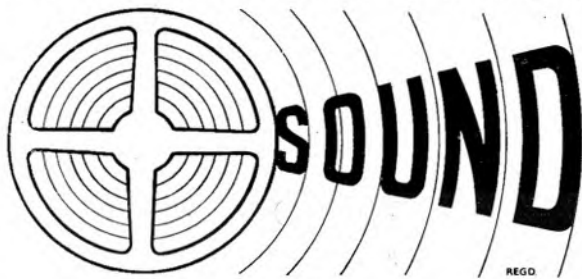

achievements  
—and more  
to come

TAPE  
RECORDER

**55 GNS**

Complete with LP tape and  
Sound microphone



TAPE RECORDER

- 3 speeds
- 3 watts output
- 3 hours playing time
- 3 inputs: RADIO/GRAM/MIC.

**40 GNS**

Piezo-electric microphone, £2.15.0.,  
optional extra



RECORD  
REPRODUCER **17 GNS**

Tax Paid

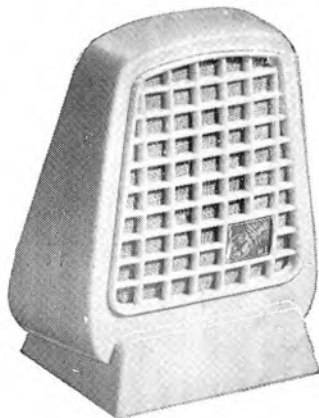

CRYSTAL  
DESK  
MICROPHONE  
**55/-**

Complete with  
screened lead and  
jack plug.



- 4-speed amplified Record Reproducer
- 2 matched loud speakers
- High quality reproduction with balanced Tone Control



SCREENED  
JACK PLUG **4/-**

Manufacturers please apply  
for bulk quantity prices

Write now for full details  
of all these products

**TAPE RECORDERS (ELECTRONICS) LTD**

784/788, High Road, Tottenham, London, N.17

Telephone: TOTtenham 0811-3

Cables: Taperec, London

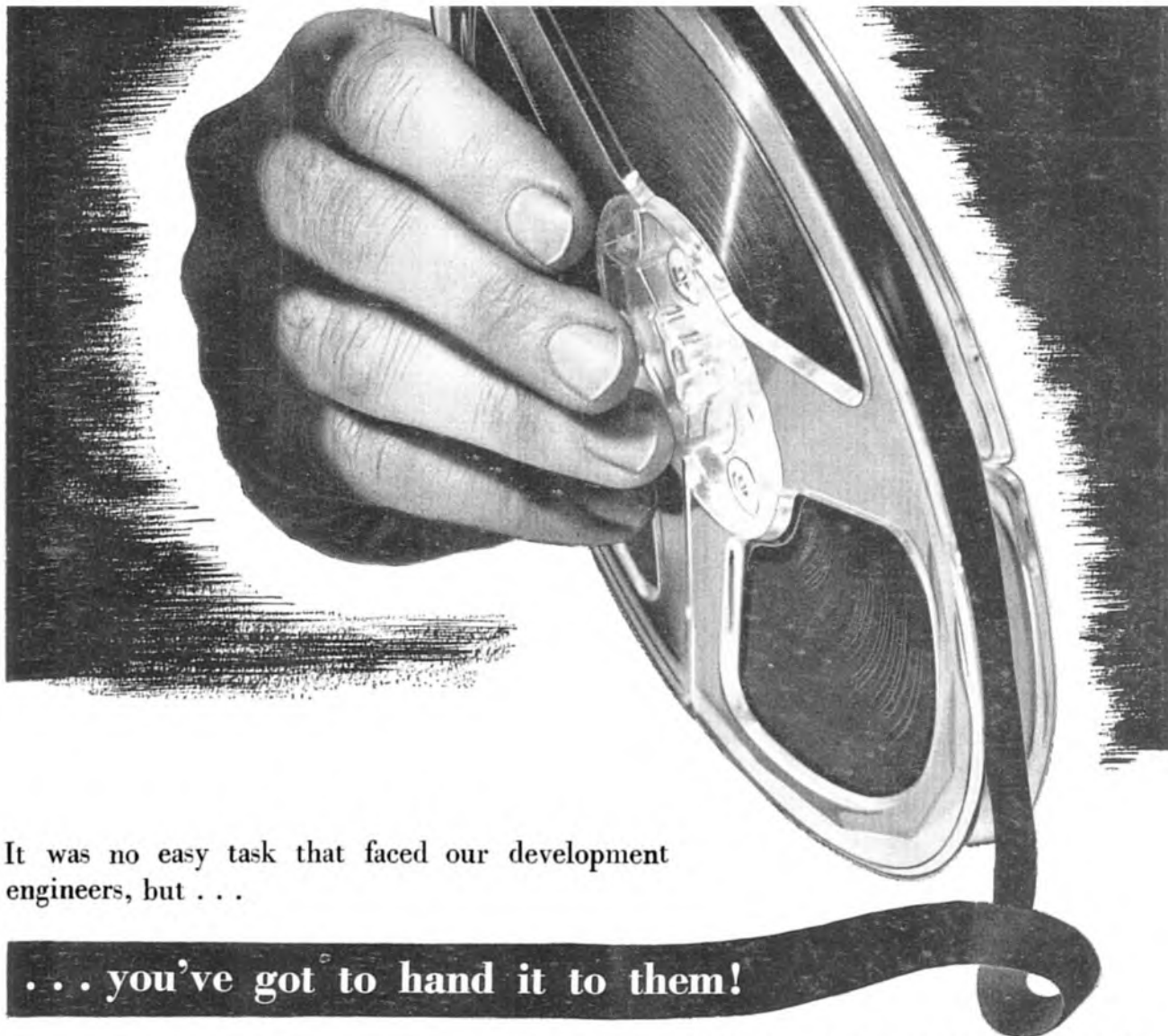

It was no easy task that faced our development engineers, but . . .

**. . . you've got to hand it to them!**

. . . they have succeeded in producing a tape, manufactured to a rigid technical specification that is appreciated by all Hi-Fi enthusiasts. SOUNDRITE Professional Grade Tapes will give you recordings that set a higher standard than ever before . . . a standard you will insist on for the future. When you buy SOUNDRITE you buy these outstanding characteristics: Non-stretch anti-static base; highly polished face to minimise head wear; drop-out testing during manufacture; improved top frequency response at low speeds; every reel guaranteed splice free.

**SOUNDRITE TAPES—PROFESSIONAL GRADE**

REEL Size	STANDARD Green Carton	LONG PLAY Orange Carton
5"	20/- each	28/- each
5½"	27, 6 "	35/- "
7"	35 - "	50 - "

Full range of reel sizes available.

**SOUNDRITE**

**PROFESSIONAL GRADE**  
magnetic recording tapes

Also available: SOUNDRITE SERVICE PACK for Magnetic Tape Recorders, Record Player Units and all types of Projectors, 4/9d. complete

*Available from all leading Hi-Fi Dealers and Stores*

Manufactured and distributed by:

**SOUNDRITE LIMITED, 82, 83 NEW BOND STREET, LONDON. W.1**

*For tapes that must sound right—you must use SOUNDRITE*

Telephone: '1  
LEGation 3618



# TELETAPE

The right advice  
can be  
obtained from  
the Specialist

**NO INTEREST or Charges on Credit Sale**  
*Compare These Terms Anywhere*

Demonstrations Daily, Open All Day Saturday

**FREE DELIVERY WITHIN THE U.K.**

Machine	Deposit	9 Payments	Cash
Walter 303 .....	5 3 6	3 19 6	39 gns.
Philips AG.8109 .....	5 3 6	3 19 6	39 gns.
Elizabethan 56 .....	6 16 6	5 6 2	52 gns.
Sonomag .....	6 16 6	6 6 2	52 gns.
Veritone .....	6 19 0	5 8 3	53 gns.
Brenell .....	6 19 0	5 8 3	53 gns.
Grundig TK.5 .....	6 19 0	5 8 3	53 gns.
Wyndso Regent .....	7 1 9	5 10 3	54 gns.
Magnafon .....	7 4 0	5 12 4	55 gns.
Sound .....	7 4 0	5 12 4	55 gns.
Maestrovox .....	8 2 9	6 6 7	62 gns.
Philips AG.8108 .....	8 2 9	6 6 7	62 gns.
Baird .....	8 2 9	6 6 7	62 gns.
Winston Thoroughbred ...	8 10 3	6 12 9	65 gns.
Truvox .....	9 0 0	7 1 0	69 gns.
Harting .....	10 15 3	8 7 5	82 gns.

ALL OTHER NEW MODELS SUPPLIED

★  
**Renowned for Speediest  
MAIL ORDER DELIVERY**

## TELETAPE

Britain's Largest Tape Recorder Specialists

5, Avenue Parade,  
Ridge Avenue,  
London, N.21

LABurnum 6641

Secondhand Machines also available

*"..it's mighty **BIG**  
for its size!"*

That's what everyone says about the ELPICO-GELOSO Tape Recorder. Its amazing performance is almost unbelievable until you hear it for yourself. Here's a tape recorder that has everything, tonal quality, ease of control, versatility, true portability—all packed into an amazingly compact case with a total weight of only 7½ lbs., and at a price to suit *your* pocket.

Ideal for recording and replay of all types of music and speech in the home or office. You'll find a wealth of entertainment and value in the ELPICO-GELOSO Tape Recorder. Coloured push-buttons combined with the Magic Eye indicator completely simplifies operation . . . a child can handle it. Half-track recording, with two tape speeds (1¼"/sec. and 3¼"/sec.) gives 1 hour and 30 minutes playing time respectively, using standard tapes. Voltage range 100-240 v. 50 c/s A.C.

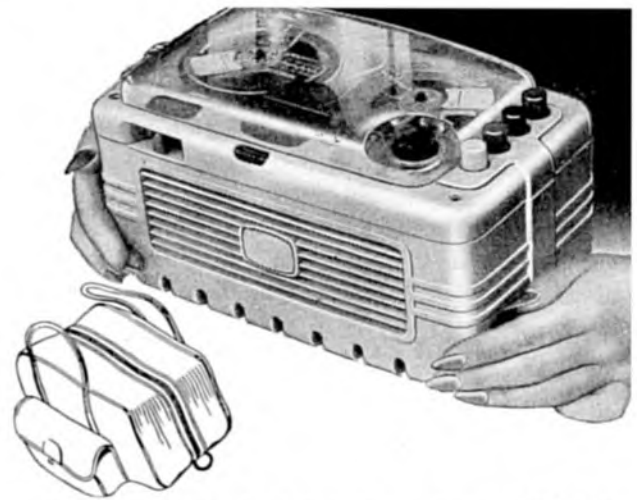

Price complete with Microphone, Tape  
and specially designed carrying bag  
*Full range of other accessories available*

**38**  
**GNS**



a name for better performance

Available from all Radio Dealers and Stores or write for full details:—

**LEE PRODUCTS (GREAT BRITAIN) LIMITED**  
ELPICO HOUSE, LONGFORD STREET, LONDON, N.W.1

Telephone: EUSton 5754-5-6

## VERITONE announce the new Model D.S.2

**VERITONE  
for  
Portable  
Fidelity**



**55 gns.**  
complete with  
tape, spool and  
microphone

An improved version of the successful Veritone is announced for immediate supply offering the following features hitherto unavailable at this price range:—

A new conception of speaker mounting enables the machine to be played in the conventional way or with extended speaker for High Fidelity reproduction.

When the case is closed there are no protrusions such as knobs, control panels, speaker grill, etc. The new fabric covering entirely encloses the speaker so that no metal grill is required and there is therefore no resonance at high volumes.

A mixer unit is built into the amplifier to permit accurate mixing with separate volume control.

12 feet cable on new Acos Mic 39/1 pencil microphone is included in the price of the machine.

Monitoring facilities are available when recording.

New three colour styling makes the D.S.2 appeal to the eye as well as the ear.

Will reproduce pre-recorded tapes with high fidelity through detachable speaker (9" x 6").

Details from your dealer or from

**VERITONE LIMITED, 16, Bury Street, London, N.9**

**HOW 1799**

# The *Maestrovox*

## RG 50

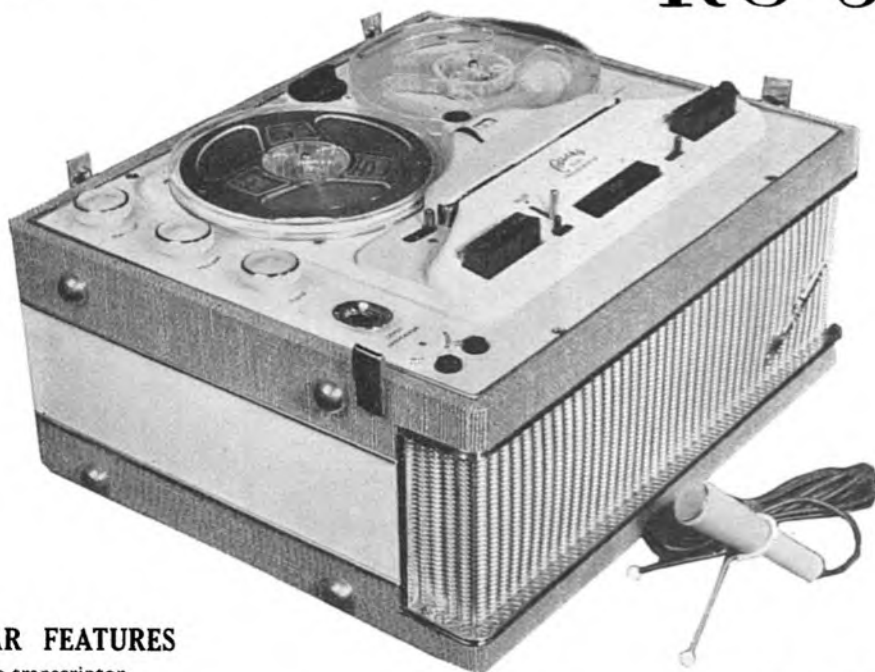

### RG 50 STAR FEATURES

- ★ Collaro tape transcriptor
- ★ Twin track instantly reversible
- ★ Record and replay at 3 speeds, 3 $\frac{1}{2}$ ", 7 $\frac{1}{2}$ " and 15" per second
- ★ Equalised to CCIR standard
- ★ Perfect reproduction from pre-recorded tapes
- ★ Mixing facilities for record and playback
- ★ Magic-eye recording level indicator
- ★ Hi-fi amplifier for record reproduction and P.A.
- ★ Record monitoring and feed to power amplifier
- ★ Dignified designed cabinet measuring 18" x 15 $\frac{1}{2}$ " x 9 $\frac{1}{2}$ "
- ★ Extension loudspeaker socket
- ★ Price includes Collaro studio microphone, 1,200 feet of tape and empty spool

*Majestic*

**TAPE  
RECORDER**

The most distinguished and authentic Tape Recorder that Dealers can offer their public

**RETAILING AT 65 GNS.**

Write for details of available agencies

**MAESTROVOX**

**ELECTRON WORKS**  
WILLOW AVENUE - UXBRIDGE - MIDDX.  
Tel.: UXBridge 6585

# A microphone by **acos**

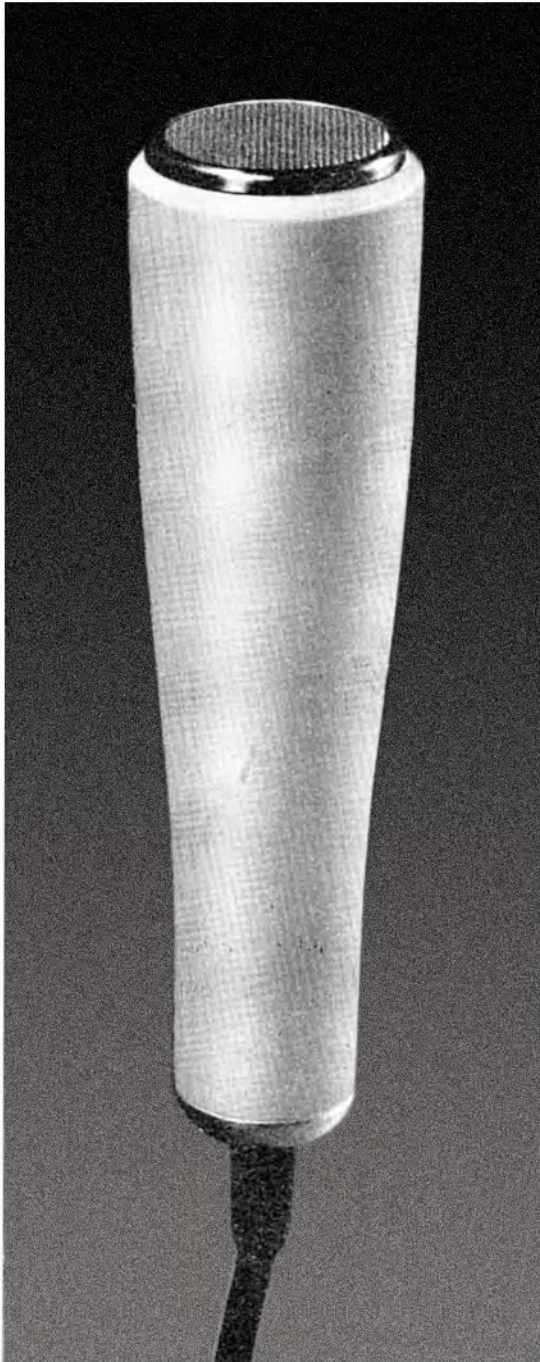

Held in the hand, or rested in one of the two attractive stands. Also available with neat floor-stand clip.

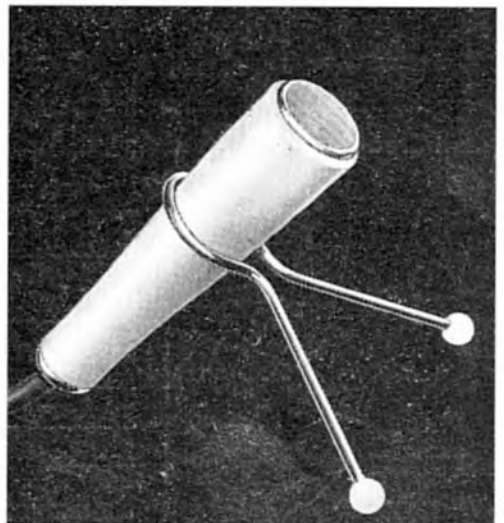
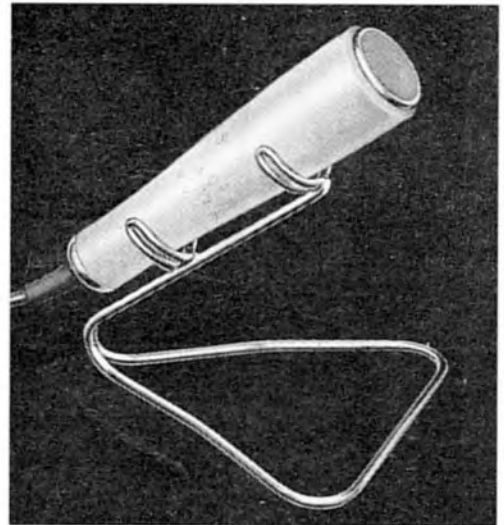

**Model MIC 39-I** for high-quality recording, public address, entertainment

COSMOCORD LTD. WALTHAM CROSS HERTS. TEL: WALTHAM CROSS 5206 (London subscribers please dial WA4 5206)

# SONOMAG PRIZEWINNERS!

As the readers of last month's issue of this journal will have read, SONOMAG Tape Recorder Units were used by two of the seven prizewinners in the recent British Amateur Tape Recording Contest.

Second prize winner Mr. Douglas Priestley, made use of an ordinary commercial portable model, whilst Mr. W. P. Copinger recorded his entry on a SONOMAG ADAPTATAPE as illustrated here.

We take pride in the achievements of these outstanding competition entries and extend our congratulations to the winners.

**Sonomag gives perfect reproduction.**



## **Sonomag Portable**

Incorporates the latest Collaro Transcripator with 3-digit rev. counter in an attractive Maroon and Gold deck with matching bronze control panel. Mullard valves, E.L.A.C. quality speaker and/or external amplifier, Collaro Studio microphone and 1,200 ft. tape.

**Retails at 52 guineas**

## **Sonomag Adaptatape**

Ideal low-cost high fidelity tape system. Latest Collaro 3-speed Transcripator with 3-digit rev. counter unit-coupled to a high-grade pre-amplifier.

Simple to fit into a suitable existing cabinet; the price includes a specially designed power pack.

**Retails at 38 guineas**

For full details and leaflets write direct to:

**SONOMAG LIMITED** 2 St. Michael's Road, Stockwell, S.W. 9.

(Minute from Stockwell Underground)

Telephone No. : BRIXTON 5441/3



# ANNOUNCING - High Quality! High Fidelity! HIGH PRECISION

## TELEFUNKEN

### TAPE RECORDERS

*The Pioneers of Tape Recording*



**MODEL KL 35**

Professional model fulfilling the most exacting requirements in frequency response (40-16,000 cycles level) and quality. 2 tape speeds (7½ ips—3½ ips). Max. playing time 180 minutes using dual tracks. Three separate intermixable input channels. Two loudspeakers. A special feature is a "trick" button enabling speech, music and sound effects to be superimposed on previous recordings. Dimensions 8 × 20 × 15½ ins. Weight 41 lbs.

£108.0.0 ★



**MODEL KL 65/KS**

A portable version of the KL 65/TS to which a power output stage and high quality loudspeaker has been added. 2 tape speeds. Compartments for reels, microphone, radio lead and connections. Beautifully styled and all metal fittings are gilt finished. Dimensions 6¼ × 15 × 13½ ins. Weight 18 lbs.

£63.0.0 ★

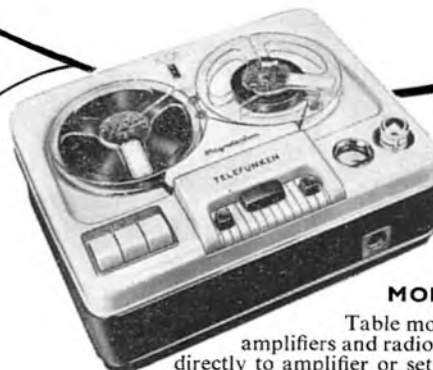

**MODEL KL 65/TS**

Table model for use with amplifiers and radio sets. Connects directly to amplifier or set, saving cost of loudspeaker and power output stage. Tape speeds 3½ ips and 1½ ips. Max. playing time 3 hrs. Twin track. Connections for earphones, etc. Weight 14 lbs. Dimensions 5½ × 12½ × 9¼ ins.

£47.0.0 ★

## THE IDEAL GIFT FOR CHRISTMAS

★ Microphone extra.

The introduction of the world-famous range of TELEFUNKEN Tape Recorders brings to this country new and extremely high standards of tape-recording quality, design, versatility and sound reproduction. See the Telefunken range at any first class retailer.

# WELMEC CORPORATION Limited

147 STRAND LONDON WC2

Phone: TEMple Bar 3357

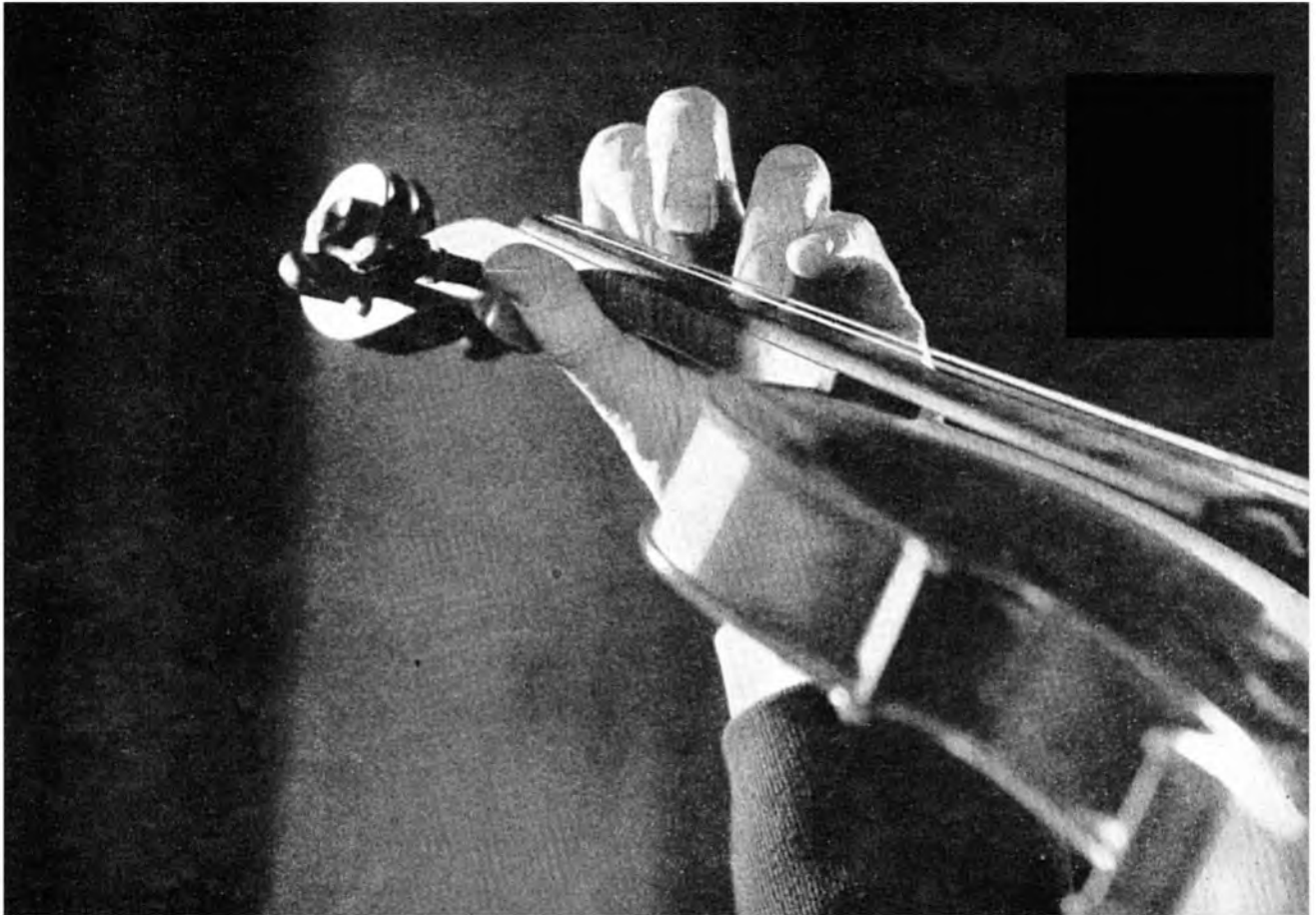

*This is your life . . .*

How have *your* musical tastes changed in the last five years? How many of your old favourites have been relegated to the lower shelves, played once a year, if at all? The music you enjoy is a mirror that reflects you and your changing tastes.

A Grundig tape recorder provides a very practical solution to the problem of changing tastes. A tape library grows with you and there is never any waste. A much-played Grieg can become a mint-fresh Rawsthorne for no more effort (or expense) than is required to fit the tape which holds the old recording and re-record the new on it.

With a Grundig tape recorder the world of music is at your feet. If music is your interest . . .

*keep it alive* with a **Grundig** TAPE RECORDER

TK 820/3D  
PRICE 98 gns.  
excluding microphone



**GRUNDIG (Great Britain) LIMITED**, Dept. TR1, 39/41 New Oxford Street, London, W.C.1  
*Please send me a copy of your illustrated booklet on the Grundig TK 820/3D*

NAME \_\_\_\_\_

ADDRESS \_\_\_\_\_

(Electronics Division, Gas Purification & Chemical Co. Ltd.)

Associate Editors:

IAN ARNISON  
R. BROWN

Technical Advisory Editor:

E. SWAIN  
A.M.I.E.E., A.M.Brit. I.R.E.

Advertisement Department:

1, Crane Court, Fleet St.,  
London, E.C.4  
Telephone: FLEet Street 0197

American Representative:

WILLIAM FARQUHAR,  
P.O. Box 1290, Grand  
Central Station, New York  
City 17, N.Y., U.S.A.



Published on the 20th of each month from 426, Camden  
Road, London, N.7. Telephone: NORTH 3419

CONTENTS

THE EDITORS' VIEW

PUTTING PICTURES  
ON TAPE

Progress with video recording  
in U.S.A.

Pages 12-14

TAPE TYPES No. 1  
Cartoon in colour

Page 19

HOW TO RECORD  
INTERVIEWS

Denis Mitchell gives advice

Pages 20-21

LOCUST SOUNDS  
PRESERVED

A scientific story from Africa

Pages 24-25

GETTING SYNC. WITH CINE

Pages 26-27

MUSIC ON TAPE

Pages 30-31

HOW TO SERVICE YOUR  
RECORDER

No. 1—The Walter 303

Pages 34-39

## After-sales service

FROM TIME TO TIME we receive letters from readers complaining about after-sales service. Some minor fault develops on a recorder for which they have paid a lot of money; they take it back to the shop at which they bought it and, for one reason or another, they fail to get the quick, efficient service they are entitled to expect.

In the cases where they have then written to us they have tended to attach some responsibility to the manufacturers, as well as the retailers. As a matter of interest, we have passed such letters on to the firms concerned but it is only fair that we should clearly state the position.

After-sales service is the responsibility of the retailer. If a radio receiver or a TV set develops a fault which can easily be rectified by a skilled mechanic, he does not dream of "passing the buck" to the manufacturer.

The trouble is that the trade has not yet got over its teething troubles with tape equipment. Many retailers were astonishingly slow to appreciate the potentialities of this new medium of entertainment, and slow, therefore, to enter the field themselves.

Such firms now have leeway to make up, and a lot to learn. It is unfortunately the case that one can go into some shops today, attracted by a recorder or a reel of tape in the window, and be attended by assistants who quite clearly have only the slightest acquaintance with tape matters.

These, we have no doubt, are the self-same concerns that attempt to shrug off their responsibility for after-sales service.

Two things can be done to ameliorate this position.

First of all, anyone buying a recorder or associated equipment should make sure he is dealing with a firm which understands the subject and guarantees full service. One reliable way of checking this is by the attention given to tape in the firm's advertising and publicity. Another is by shrewd conversation at the time of purchase.

Secondly, we propose to help by regular publication of technical details of the most popular recorders. Many of our readers are skilled and experienced users of electronic equipment and perfectly capable of dealing with minor faults that may occur in their recorders. For their benefit, we shall publish circuit diagrams, with explanatory text and illustrations.

This information may also serve to spread technical knowledge about tape recorders among retailers and their staffs, and so lead to better service. It goes without saying, we hope, that readers who have no knowledge or experience of servicing should use discretion. A sixty or seventy-guinea tape recorder is not the best thing on which to carry out pioneer experiments in dismantling and re-assembly. But, used sensibly, we hope our new service of information will bring an all-round improvement in the situation.

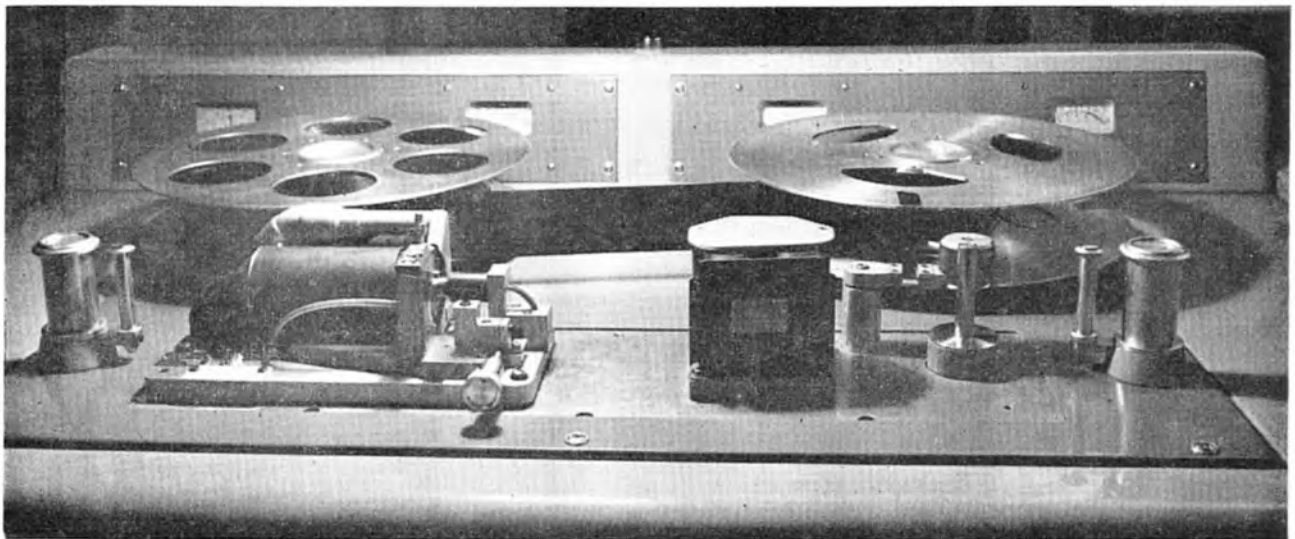

The tape deck of the Ampex video recorder

# PUTTING PICTURES ON TAPE

**R**ARELY in peacetime have scientists been called upon for dramatic, high-speed achievement like that which went into the making of the video tape on which television programmes can now be recorded.

The key date was April 28 last. That was when the switch to daylight saving time began in the United States, bringing the American TV networks their own unique problem. Because of the size of the country, there are four time zones and a programme transmitted in Hollywood at a peak listening hour of 9 p.m. would reach New York and the eastern coast at 1 a.m.—when most of the audience would be in bed. Programmes must, therefore, be recorded for repeat. In the past they were filmed; now they are put on magnetic tape.

The Ampex recording machines now in use were introduced in April, 1956. Then began the search for a satisfactory tape to use with them. There was just one year in which to succeed.

Let Dr. W. W. Wetzel, general manager of the Magnetic

Products Division of Minnesota Mining and Manufacturing Company, tell the story: "We had been trying various formulations for months. By January we had made a few reels of tape which looked pretty good, but there were lots of improvements to be made.

"Late in March it became apparent that the networks would have to begin stockpiling useable tapes in order to have enough on hand when the daylight saving operation began.

"We had, by then, produced a workable tape. We ran four production runs before we were able to duplicate it."

By the end of April one in three of the tapes was satisfactory, by August half of them, and progress is steady.

## WHAT'S HAPPENING IN BRITAIN?

*This is a story of pioneering in America. What are the prospects in Britain?*

*The B.B.C. is understood to have one of the American Ampex machines on order.*

*A comparable, but less complicated, system is being used by Cable and Wireless Limited to store radio pictures at relay points.*

*Until a few years ago it was only possible to relay pictures when radio conditions over the whole route were of adequate quality. It often hap-*

*pened, however, that when conditions were good on the first part of the route, they were unsatisfactory on the second.*

*Scientists at the laboratories in the City of London evolved a method of storing the pictures on magnetic tape, so that they may be re-transmitted later. For recording, a 2 kcs. crystal oscillator is used to drive the synchronous motor of a 15 ips. twin-track recorder. The picture intelligence is stored on one track, and the 2 kcs. frequency on the other.*

*On playback, a beat frequency oscillator, set to 2 kcs., is used to drive the motor, and the recorded 2 kcs. signal is fed to a correction unit, which compares this frequency with that of the crystal oscillator and makes any necessary correction. Thus, the picture is "played back" with minimum distortion.*

*The equipment was introduced in time for the Olympic Games in 1956. It was successfully operated at Singapore to relay pictures from Australia to the United Kingdom.*

## American television stations are now recording most of their programmes on magnetic tape and a startling new revolution is under way. It may affect the way you get your newspapers and photograph your family.

But, when the TV networks switched to daylight saving time, there were probably no more than 50 useable rolls of video tape among them.

What was the difficulty? What is video tape like? It comes in rolls two inches wide and 4,800 feet long, costing a little over £100 a time. The polyester film backing is only one mil thick; coating tolerances are to 30 millionths of an inch.

On this new tape it is possible to record, store and reproduce both the picture and sound of a TV broadcast with a fidelity which makes it virtually indistinguishable from a live telecast. Recordings can be erased and the tape used again, as with domestic audio tape. But the useful life of the tapes at present is about 200 runs-through.

The advantages of the new technique over the old photographic methods of recording programmes are obvious: there is no processing required and sound and picture can be "played back" immediately.

The tapes are capable of handling colour or black and white, but until now colour developments have been held back by absence of machines.

The Radio Corporation of America has now taken the next big forward stride and the National Broadcasting Company is about to take delivery of six RCA colour recorders. These will come into operation next April and NBC will then do all its recording on tape, colour and black and white.

NBC is building two "Tape Centrals"—one in California and one in New York. From these two distributing points programmes will go on tape to TV stations all over the U.S.A.

Electronically, there is little difference between the taping of video signals and the recording of sound—both involve feeding magnetic impulses through the heads on to tape. But mechanically the systems differ widely.

The problem was to record some 4,000,000 cps, against the 10,000 cps average of sound. With orthodox tape and a 15 inches per second speed, that would have meant nearly half a million feet of tape for an hour's recording.

The answer was a broader tape—two inches across—recorded vertically instead of horizontally. That meant, instead of a stationary recording head, four rapidly revolving heads, mounted on a small wheel to project slightly (almost like teeth on a circular saw) and rotating at a speed of 14,400 revolutions a minute.

The tape is pressed against the heads with a calculated pressure of 20,000 pounds per square inch. The relative speed between the moving tape and the moving heads is 1,500 inches per second. The speed and the pressure create



The video recording equipment in the Columbia Broadcasting system, "TV City" in Hollywood

considerable friction and the resultant heat is such that it would soften the binders used in earlier types of tapes.

In addition to all these problems, the actual quality of the coating must be virtually perfect. Any dust particle or imperfection will cause a signal drop-out—small, white dots on the TV screen. In sound recording imperfections up to .003 inch might be permissible. In video recording, imperfections as small as .00003 (thirty millionths of an inch) will result in signal drop-outs. It is like comparing flat paint with glossy enamel.

The actual video recording is made on tracks one-hundredth of an inch wide and about  $1\frac{1}{4}$  inches long. The tape also carries a sound track and a control track, each one-tenth of an inch wide.

There have been big problems to solve in the design of the recorder heads. Like the tape, they must be perfectly smooth. If they are not, they gouge the tape. So they must be carefully ground and polished—"lapped in"—before they can be used. At present the heads need to be

*(Continued on page 14)*

# Another Sputnik recording

**I**N our last issue we reported that Mr. Kieran Williams and Mr. Gerry Fitzgerald, of Dublin, recorded signals from the first Soviet Sputnik at 14.50 GMT on October 6. We asked if they were the first to do so in the British Isles.

It appears they were beaten by enthusiasts in the London area, as the following letter from Mr. Angus McKenzie, of Olympia Sound indicates:—

“On October 5, I heard the six o'clock news about the satellite and immediately rushed home in a taxi and telephoned my engineer, Mr. Bill Jeffries, whom I knew to be a radio ham.

“With my NC 57 receiver and his receiver, we picked up the signals and, as he had a recorder handy, he recorded them from his receiver. They were very clear indeed.

“Again on Sunday (October 6) the satellite was recorded, at the same time as by your correspondent in Dublin.

“I have since played the recording to a number of clubs, where it has caused much interest. I am a member of the British Astronomical Association, in addition to being managing director of this recording studio, and thus I am extremely interested in the radio side of the whole satellite programme.”

## Jason tuners and amplifiers

for shelf mounting

model  
fms · 2  
switched  
f.m.  
tuner



### ideal for tape recording

This is a pre-tuned F.M. Tuner for reception of the three B.B.C. programmes by means of rotary switch. Turning it selects the programme and lights its name on the scale panel. The FMS.2 is self-powered. Its stability and high quality of reproduction make it ideal for use with tape-recorders. It includes Foster-Seeley Discriminator, A.F.C., Twin Limiter stages and Cathode Follower output which can be varied in level as desired. The Unit has an effective range of 80 miles from the transmitter.

The FMS.2 is one of a range of matching units designed for shelf mounting and ease of installation. In conformity with the other models, it is finished with two polished copper escutcheon bars, distinctively designed scale and matt black housing. Leaflets gladly sent on request.

self  
powered  
●  
cathode  
follower  
output  
●  
complete-  
ly stable

£13 19 6

including £6 14 6 P.T.

**Jason**

The Jason Motor & Electronic Co  
328, Cricklewood Lane, London,  
N.W.2 phone SPE 7050

# STORY OF VIDEO

(Continued from page 13)

rebuilt after 100 hours of use. And another early problem, now being solved, was that tapes could only be re-played with the same heads as were used for the recording.

It is not surprising that the cost of the early video recorders has been running at £28,000 a time. Even so, the American TV networks are finding the new methods economical, compared to former practice. Some companies have said they save up to £4,000 a week by use of tape.



We are by no means at the end of this story yet. The Radio Corporation of America has been doing fascinating work on colour video recording and now claims to have perfected a system. RCA presented the first public exhibition of magnetic recording of TV in 1953 and two years later demonstrated on a closed circuit a colour programme previously tape-recorded.

Now this company has demonstrated a magnetic “hear-and-see” tape machine that will take a recording of a TV programme and play it back on a domestic TV screen. It may be ten years before this machine is available to the public, but the possibilities are astounding.

You may be able to hire TV tapes, or borrow them from the public library, to play on your set at home. You may get daily tape-newspapers, with an hour of news and features in moving pictures. Later, you may be able to make your own recordings of favourite TV broadcasts, for playback at will.



And after that? A revolution that will undermine present photographic techniques. Dr. Wetzel, of the MMM Company, sees it beginning with electronic movie cameras. “They will shoot magnetic tape, rather than film, eliminating processing,” he forecasts. “This would be particularly valuable in television.”

After that, though admittedly it may still be a long way off, we may see electronic cameras in general use, so that everyone may take motion pictures on magnetic tape and play them back immediately through the domestic TV set.

### Next month

**RITCHIE CALDER, the well-known science writer, tells the story of his trip**

**TO THE NORTH POLE WITH A RECORDER**

# Poor Mike can't take noisy parties

OF all the many possible ways of using a tape recorder during the festive season, the very worst is just to switch it on and hope that it will give you a faithful record of a party in full swing. Be assured, the microphone can't take it!

It cannot, as a rule, deal with two people speaking at once; and when a dozen or so voices are bouncing simultaneously from wall to wall the chaos and crackling that comes out of the playback will be a nightmare of cacophonous confusion.

My recipe for a simple and pleasing record of the family re-union or a similar gathering is to take appropriate subjects aside in pairs—right into another room—and get them talking to each other, reminiscing, asking each other what they have been doing during the past year, clinking glasses together, embracing under the mistletoe if you like, and discussing the party that is going on in the other room. If they need help from you, keep it to a minimum.

There is a place for a short babble of party chaos between close-ups, and it is technically in order to work in some carol singing at the front door.

Another feature that might come off would be a recording of a party game that depends mainly on the solo effort, such as the popular two-minute speech on a subject handed to the victim without prior warning.

## Preserving local history

I WONDER how long it will take other cities and centres to realise, as Liverpool has done, that a lot of history has been slipping through their fingers and will continue to do so until its characteristic sounds have been safely tucked away on tape?

Equally alive to the danger and the opportunity, Liverpool's public library committee has already enlisted a tape recorder to lay the city's sounds by the heels, and one of its most important jobs is to capture for all time the wild but dying tones of the famous Liverpool dialect.

The more laggardly cities might well be prodded into similar activity by staunch tape-conscious citizens, and if they cannot be immediately persuaded of the need to put a machine on the town's own payroll, they might co-operate with those who will start a collection for them.

Here is a ready-made mission for those town tape clubs that are beginning to spring up. A varied sample of some of

the important local sounds should stimulate an appropriate department of the town hall to provide facilities for further experiment and possibly to donate tape.

## **HOMO TAPIENS**

by

*Douglas Gardner*

## Spreading the hobby

AND, talking of town tape clubs, there might be many readers who would be glad to see one launched in their own town but who lack the facilities for getting it started. One way of doing it is to talk a local retailer in the tape field into sponsoring an exploratory meeting at a convenient venue. He could give a demonstration of tape recorders as part of the evening programme and a discussion would take place on the practical business of forming the club, providing there proved to be sufficient support for the idea—which there should certainly be by that time.

A little advertising in the local press prior to the meeting and a large showcard in the shop window should be enough to start things moving.

I shall be glad to help with another approach. Any tape enthusiast who would be ready to play a part in launching a club in his town can send me his, or her, name and address and telephone number, on a postcard. Write at the top, boldly, the name of the town or centre concerned, and beneath it insert "Tape recording club supporter." The first arrival from any town will be sent all cards from the same town arriving subsequently, and it will be up to him to contact the others and arrange a get-together.

## A brilliant production

MY colleagues, the editors, recently spent a fascinating evening at the Oxford University Experimental Theatre Club. Mr. Brown has written this account of it:

"There are still a lot of people who are unwilling to admit that tape recording is, in itself, a new and exciting art form. The most striking proof of it I have yet

found was the production of James Thurber's *The White Deer*, by Mr. Harold Rottesman, of Oriol.

This was a two-hour programme and it held the attention of the undergraduate audience, in the Junior Common Room at Merton, from the first moment to the last.

It was a very difficult production to undertake, for the story is pure fantasy and its translation on to tape involved many surrealist sounds in addition to a wide range of orthodox effects and some difficult acting roles. Rottesman was not able to get all his cast together at one time and place and the polished production we heard was, in fact, laboriously built up from snippets of recordings made on many separate occasions.

It was a brilliant piece of work. The only reason I shall not write about it at length is that we have been able to get Mr. Rottesman to write the story himself. It will appear in next month's issue."

## Glimpse of the future

ONE of the most interesting suggestions for new uses of magnetic tape comes from the U.S.A. In future, it is reported, family doctors will keep tape files of their patients—albums of your physiological sounds. He may even tape your pre-natal sounds and will certainly build up an "album" of your respiratory and heart sounds.

Where will it end? Brain wave patterns have also been recorded on tape. In an American laboratory electrodes were imbedded on the brain of an ape. The animal was then made to wave his arms and the nerve impulses from brain to arm muscles were "captured" on tape.

When, later, the electrodes were replaced and the tape played back into the brain, the ape repeated his original arm-waving motions.

A very solemn thought with which to leave you this month.

### **WHEN YOU ARE WRITING**

The address for all editorial matters is **TAPE RECORDING MAGAZINE, 426, Camden Road, London, N.7.**

But all advertisement communications, including Classified Advertisements, should be sent to **Advertisement Manager, TAPE RECORDING MAGAZINE, 1, Crane Court, Fleet Street, London, E.C.4.**

B. W. HARLEY, winner of the first British Amateur Tape Recording Contest, tells how he made his tape feature about

## CORPUS CHRISTI AT ST. WOLFGANG

**W**E arrived at St. Wolfgang the day before the celebration of Corpus Christi, and immediately surveyed the route of the procession. Preparations were already in hand and stacks of beech boughs cut from the neighbouring wooded slopes were being brought into the main square. We tried to capture the atmosphere of excitement and expectancy in a short introductory commentary, recorded on the hillside at dusk.

Awakened next morning by church bells and maroons, we took our tape recorder, a Boosey and Hawkes "Reporter", to the square. Here we found a dense throng of villagers in national dress, and many holidaymakers. Outside the church the procession gradually formed up and the priest appeared, carrying the holy sacrament. All road traffic had been stopped and it was difficult to make our way to the altar set up outside one of the cafés. When the Benediction was pronounced we felt that, as visitors, we could not approach too near with a microphone.

As the procession moved off we walked alongside, recording the prayers, then hurried ahead to the post office square, where we fitted our heavy stabilising flywheel to the recorder to improve music quality. We got a very satisfying sound of the village band coming up a narrow street and swelling into the square.

For the next hour and a-half we followed, dashed ahead, halted, dashed ahead again, up and down the lakeside road. Gradually we built up our recordings of groups of choir boys, the men and the women at prayers, and the exertions of the two village bands. At the same time, at suitable points one of us did a spontaneous and unscripted commentary. We also took verbal notes to help us later in writing our linking commentary.

Finally, we took a short cut back to the church door for the last ceremony, pausing on the way for the first quality check of some of our material on the monitor speaker.

Weeks later, back at home, we listened, analysed and cut our material ruthlessly. The shape of the programme was really dictated by the event and, with careful selection, we endeavoured to re-create the two-hour procession in something under ten minutes. At the same time our introduction and linking sections of commentary were written and recorded. We used as much of the on-the-spot commentary as possible, but in many

cases we even had to cut sentences in half—often with not very happy results. Always there seemed to be church bells in the background, which had to be matched up.

This programme was made primarily to recapture for us a memorable day of our holiday. That it has succeeded in communicating something of the occasion to others has given us much pleasure.

---

### AND TWO STORIES FROM THE NAVY

## The day Gracie sang

**T**HE sun was pouring down from a blue sky on to the stationary aircraft carrier, anchored in the Bay of Naples. The flight deck stretched in front of me, with a dais placed a few feet away, facing a huge semi-circle of expectant faces. There was a hush. Everyone was waiting for the whistle that would tell them that Gracie Fields had been piped aboard.

Gracie had kindly offered to come from her home on Capri, twelve miles out in the sparkling sea, to sing for the ship's company of British sailors. My hand was poised over the starting button of the ship's tape recorder; I glanced again at the microphone on the dais and the one near the piano. Everything was ready.

Whee . . . eeeppp! Whee . . . eeeppp! Gracie had arrived. There she was, smiling gaily, waving a gloved hand as

she walked forward. Most people were surprised to see her looking so young. She mounted the dais. Then she sang! Oh, how she could sing! The old, young, even the supposedly disinterested craned forward. I almost forgot to start the recorder!

When it was time to go, the ship's company joined Gracie in singing "Now is the Hour." It was one of the most effective recordings ever made on the ship's recorder.

I had been lucky enough to stand next to Gracie's husband, Boris, during the show and so was able to talk to him about using the recording. He was only too pleased to give our ship permission to use it for broadcasting to all ships in company in the Mediterranean. We rebroadcast the recording many times later—on this network.

---

## Admiralty played it upside down

**CLANG!!! Clang!!! Clang!!!** The signal for Action Stations! Running feet echoed, anti-flash helmets and gloves were dragged on. It was five o'clock in the morning, with the aircraft-carrier in the Eastern Mediterranean.

My action station was a small compartment on the starboard side. There I sat on a bench—beside the tape recorder, and waited. The broadcast speaker crackled and I pressed the starting button. For the next few minutes the "Action Commentator" gave a vivid description of the aircraft above us on the flight deck: how they were armed, where they were going, and when they should be back. All the details went on tape!

While I worked on the radio bench, one ear remained wary, so that I could give the signal to start the recorder. For seven days it was at the ready. Then, when it was all over, we sailed back towards Malta.

We borrowed a second recorder and, with a turntable and an extra microphone, the story of "Operation Musketeer" was put together. Making the narration up

as we went along, and adding background music, a reasonable forty-five minute drama developed. Fading in places was shaky and levels were uneven, but it was good enough for the broadcast system on the ship.

The Captain heard it, recognised his voice in places, and asked for it to be played over to the Admiral.

"Good Heavens! I'm on it, too!" said the Admiral, and a special helicopter whipped the recording to Cyprus on its way to London and the Admiralty. Arriving there, it was first played upside down, and very interesting results obtained. They must have formed the impression that we fought on our backs! It was decided the B.B.C. might like to hear it.

A nice polite note was sent to the ship: "Technical quality not good enough, and we had it too late to include in any of our programmes. Better luck next time. When your ship returns to this country, the rating who made this tape recording may be interested in learning how to do the job properly! . . . Send him to see us." He went!!



# 1958 TAPE CONTEST

## Britain to compete with 7 other countries

THE 1958 BRITISH AMATEUR TAPE RECORDING CONTEST ORGANISED BY "TAPE RECORDING MAGAZINE" WILL BE LINKED WITH THE INTERNATIONAL CONTEST WHICH HAS BEEN POPULAR ON THE CONTINENT DURING THE LAST SIX YEARS.

The British contest will be divided this year into five different categories. In addition to an overall first prize, there will be prizes in each category. And the best entries will also be submitted in the International Contest, in which further prizes are awarded.

Schools will this year have a chance to enter, as well as individual enthusiasts.

The five categories will be as follows:—

1. **COMPOSITIONS**—plays, drama, sketches, etc., not exceeding 15 minutes duration.

2. **DOCUMENTARIES AND REPORTAGE**—not exceeding 10 minutes.

3. **MUSIC OR SPEECH**—solo singer or player, orchestras, choruses, poems, imitations, monologues, etc., not exceeding four minutes.

4. **ACTUALITY RECORDINGS**—e.g., unusual voices, historic moments, etc., not exceeding four minutes.

5. **SCHOOL FEATURES**, on a theme to be announced later, not exceeding 20 minutes duration.

The second British Amateur Tape Recording Contest will close in the late summer—the exact date will be announced later.

A panel of distinguished judges will be assembled and the results will be announced, and a gathering organised for playback of the winning tapes, at the time of the 1958 Radio Show.

## Impressive Prize List

Leading manufacturers and traders have again promised us every support in developing the Contest and we hope soon to be able to announce an impressive prize list.

Entry forms and full conditions for the Contest will be ready soon. Readers may apply for them now, and they will be despatched as soon as they are ready.

After the judging in the British Contest, the panel will be asked to nominate up to five recordings to be submitted in the International Contest for the Best Amateur Sound Recording (I.A.R.C.). The contest is organised to fit into the framework of the broadcast programmes reserved for such recordings by a number of Continental countries.

It is supported by organisations in Austria, Belgium, Denmark, France, Holland, Switzerland and the U.S.A.

Entries are expected from all these countries. The International Jury will make its decisions and award its prizes. These include sums of 100,000 French francs, 10,000 Belgian francs and 1,000 Swiss francs, as well as many smaller amounts, and works of art.

The best recordings will be broadcast by European radio stations. Efforts will be made to interest the B.B.C. in this country.

Fuller information will be published month by month in TAPE RECORDING MAGAZINE, as it becomes available.

But it is now possible for readers to begin to plan their entries.

The 1958 Contest promises to develop into a spectacular milestone in tape recording and into an important event in the entertainment world.

The Editors and staff of  
Tape Recording Magazine send  
Seasonal

Greetings  
and  
good  
wishes  
for  
1958  
to all  
readers



## For the best of reasons

- ★ Perfect Reproduction
- ★ Ease and simplicity of operation
- ★ "Know-how" in manufacture

—buy TRUVOX—and you buy all three. The Truvox R2 Recorder, with its improved circuitry and styling, embodies all the experience of 7 years specialising in the design, development and manufacture of Tape Decks and Tape Recording Amplifiers. There are no last minute "mods"—every stage has been tested and tested again to ensure that it lives up to the reputation enjoyed by the name it bears.

The result is a high fidelity instrument that will give you endless hours of enjoyment producing and replaying your own recordings as well as providing perfect reproduction of pre-recorded tapes with all those finer gradations of tone that are there for those who can hear the difference.

Additional applications of this machine, with accessories, include dictation and transcription, radio reception, telephone conversation recording, AM or FM Tuner amplification, etc.

When you buy TRUVOX you buy a better recorder—produced for those who can hear the difference.

**TRUVOX** Models from 66 gns.  
**Tape Recorders**



Full details, including accessories available on request from the manufacturers

TRUVOX LIMITED, 15 LYON ROAD, HARROW, MIDDX. Telephone Harrow 9282

## HERE'S

the precision *Tape Unit* combining superb performance and presentation.

The brilliant new

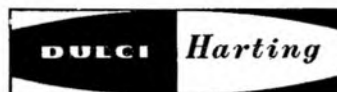

**High Fidelity Tape Unit**

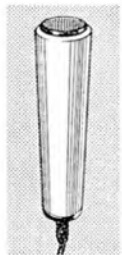

Recommended microphone. 5 gns. extra.

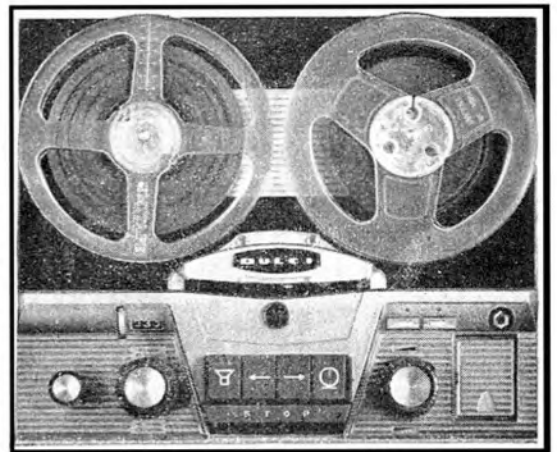

Here's something that everyone interested in sound reproduction will want to see . . . a completely new Tape Unit, all ready for addition to an existing Hi-Fi system. It's packed full of attractive features! Recording amplifier is incorporated with erase and bias oscillator. Playback equaliser and pre-amplifier is integrated with the deck.

The control panel is superbly styled in modern high impact polystyrene to give a streamlined design. *And note these refinements!* A precision numerical position indicator, electronic recording level band indicator, plus a bias control and erase cut-out switch. This allows compensation for characteristics of any tape, plus advantage of superimposition without automatic erasure.

**55 GNS.**

including tape and spare spool

- ★ 2 speeds —  $7\frac{1}{2}$ " / sec. and  $3\frac{1}{2}$ " / sec.
- ★ With calibrated compensating control, for various tape characteristics.
- ★ Control for superimposition of new recording over old — retaining both.
- ★ Can be used in conjunction with existing audio equipment.

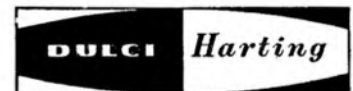

**SUPERIOR TAPE UNIT FOR THE SERIOUS ENTHUSIAST**

THE DULCI COMPANY LTD., 97-99 VILLIERS ROAD, LONDON N.W.2. WILLESDEN 6678/9

# Tape Types by Alastair



CALL SIGN—OL4U

## A QUALITY RIBBON MICROPHONE

A New Ribbon Microphone is shortly to be introduced by **FILM INDUSTRIES LTD.** with high quality reproduction, for which the Company's products are famous, the new instrument will match the well-known **MODEL M8** in efficiency and design at a considerably reduced price.

**Complete with Inbuilt Transformer and Desk Stand.**

**AVAILABLE SOON**

**FILM INDUSTRIES LTD.**

**90, Belsize Lane, London, N.W.3**

HAM 9632-3.

Telegrams : Troosound Haver.

## The VIKING Tape Recorder

using the new **MOTEK K9** deck has 3 speeds,  $7\frac{1}{2}$ ,  $3\frac{3}{4}$ , and  $1\frac{1}{2}$  i.p.s. (the Standard speeds of the future) giving up to  $6\frac{1}{2}$  hours from one tape. Digital counter, "Pause" control, adjustable azimuth and 3 motors specially designed for tape recording. Separate Bass and Treble controls and provision for an *unique* method of recording over a previous recording whilst retaining same. (Pat. app. for). Uses the Hatfield Oscillator (Pat. app. for). Equalised to C.C.I.R. characteristics with linked equalisation on all speeds, and has a particularly attractive appearance. An unequalled specification at any price the **VIKING** is only **44 gns.** complete with Mic. tape, etc.

### **MOTEK K9 Deck 21gns.**

**H.P. terms 50 per cent down, Credit Sale, One-sixth down**

Further details from:—

**HATFIELD RADIO**  
**78 Stroud Green Road,**  
**London, N.4**

*Tape recorder specialists since 1952*

**KEEP IN THE BACKGROUND  
BUT BE BOLD, FRIENDLY  
AND TRUSTWORTHY . . .**

The first thing I would say about interviewing is—don't. Don't, that is, if you intend to go about it like this:

Mr. X (a professional interviewer): Now tell me, Sam—

I know you won't mind my calling you that, eh—you've got 15 children, that's right, isn't it?

Mr. Y (his victim): Yes.

Mr. X: And all boys, I believe?

Mr. Y: Yes.

Mr. X: All boys! But you've got something else to tell us about them, haven't you?

Mr. Y: Well, if you mean that—

Mr. X: Exactly! They've all got three ears! And, you know, listeners, I think that adds up to some sort of record, and I bet it's one that Sam is pretty proud of, eh?

Mr. Y: Well, I don't know that I'd—

Mr. X: Right! Well, thank you, Sam—and congratulations!

Obviously, Mr. X is a pain in the neck. He hogs the mike, he leaves nothing for Mr. Y to say, his whole approach is a baffling mixture of impertinence and false bonhomie. Mr. X can be relied on to cheapen and falsify every subject he touches.

Self-effacement is the golden rule of interviewing. The good interviewer realises that he is not one half of a cross-talk act. He knows that the less he talks, the better. First and last, his aim is to help the people he is interviewing to say whatever they want to say as forcefully and effectively as possible.

An obvious exception to this rule is the interviewer who is also a personality in his own right. For example, Mr. Malcolm Muggeridge. If he merely asked a few questions and kept in the background, listeners would be disappointed—not to say surprised!

Ideally, the good interviewer should be bold, nose-y, quick-witted and quick-tongued, he should genuinely like people (*all* people, especially people who aren't likeable), he should know a little about a lot, and should have knocked about the world a bit (like the man in the story who had "lost more jobs than the Queen has bangles"): but above all he should be trustworthy—the sort of man in whom people who are going to be interviewed can feel confidence. They know that cameras can lie and tapes can be edited, they're scared of being made to look foolish, and their interviewer is the man they turn to for reassurance, criticism and help.

In practice, the first thing to do when you start out to record a tape interview is to check your equipment. Whenever I have omitted to do this, I have landed myself in trouble.

With some difficulty, I once got an interview with an extremely testy Prime Minister. I took with me a midget tape recorder, an excellent machine, but one which did not wipe tapes. Before entering the Prime Minister's office, I put on a new tape, which I took from a sealed box

# The golden rules of interviewing

By DENIS  
MITCHELL

one of the best-known  
producers of radio  
features based on taped  
interviews

labelled "clean tape." Half way through the interview, I picked up the earphone to check on quality. What I heard was Audrey Russell describing a scene in Trafalgar Square—the tape hadn't been wiped.

The unexpected very often happens, at least, it does to me, especially when I am anywhere near a politician. Once, by pure chance, I arrived in a small South African town just on the heels of a tornado. I made a lot of recordings (many of them unique and almost all of them too painful to be broadcast). Next day, quite unexpectedly, Dr. Malan, who was then Prime Minister, arrived with most of his Cabinet and crowded into the small Council Chamber. I managed to put a mike on the dais just before the crowd surged in and carried me to the other end of the room. Dr. Malan sat on the dais opposite my microphone, just as I'd hoped he would: then he took his hat off and put it slap on top of the mike!

Here are two points that I have found useful to bear in mind when interviewing people:

1. Never ask anyone a question to which the only possible answer is a "yes" or "no."

2. Never record anyone without them knowing that you are doing so. It is a grossly unethical thing to do, and brings 1984 on us twenty-seven years too early.

My aim is always to get people talking freely and at length. Almost invariably I cut my own voice out of the tape when I edit. This isn't always possible, of course. I remember once meeting a very kindly and honest farmer who was exceptionally shy and therefore tongue-tied. He lived in the Isle of Man and he believed that on Old Christmas Eve (early in January) the bullocks knelt in their stalls and the myrrh came out in flower. It took eight hours' editing to produce this scrap of dialogue, but it seemed well worth it to me.

Farmer: Usually the myrrh flowers in the summer. It's one mass of flowers in the summer, great big plants two foot high. But this tiny flower on Old Christmas Day, it's quite a different thing, it's just a tiny little delicate flower right down at the earth.

Mitchell: And is this plant of yours specially protected—under glass or something?

Farmer: No, it's just left lying there, fowls playing over it every day, no protection.

Mitchell: And does it flower even in a really severe winter?

Farmer: Oh, the winter doesn't make any difference. No matter what, frost or snow, it's there just the same.

Mitchell: Tell me what happened this last time.

Farmer: Well, I went there the day before and had a look. I seen the roots, you know, but no sign of life—just a little sprig of green leaf. Then the next morning I went out at daylight I picked three nice sprigs of flowers.

Mitchell: And it happens every year like that? I wonder you don't stay up one Old Christmas Eve and watch it come out at midnight.

Farmer: Well, I felt that, you know, it was always a sacred thing, and I felt that I'd no business to be there. But it was always there in the morning for me. Quite a lot of people that just laughs about the myrrh and makes little of it, but it's true.

## Now! it's easy to edit tapes—economically

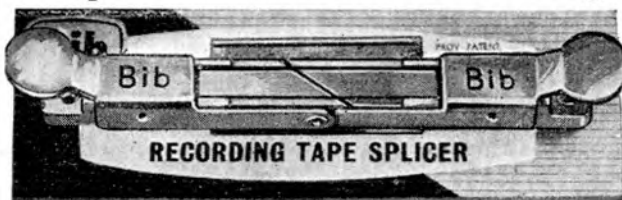

### USE A PROFESSIONAL TYPE RECORDING TAPE SPLICER FOR EDITING AND MENDING RECORDING TAPE

On the new Mark II Bib Recording Tape Splicer both clamps are now of the easy lift type and are fitted on the same side to facilitate rapid removal of the jointed tapes. These improvements ensure even easier and quicker precise jointing of tapes. Because you can use all odd lengths of tape, you soon save the cost of the Splicer. If desired the Splicer can be attached directly to a tape recorder deck.

The technical experts say . . . "Everyone who uses a tape recorder will need this little tool. It is indispensable." P. WILSON, Gramophone.

"As a test I asked a non-technical person to splice some tapes and, after a couple of practice joints, perfect splices were made. A really useful gadget." D. W. ALDOUS, M.INST.E., M.B.K.S., Gramophone Record Review.

"The Bib Tape Splicer . . . produces a perfect joint with the minimum of effort." WIRELESS WORLD.

**18/6**  
each (subject)



### RECORDING TAPE SPLICER

Get one from your local stockist today. In case of difficulty write to us giving his name and address. Send stamped addressed envelope for helpful leaflet on tape editing.

Multicore Solders Ltd., Dept. T.R.1, Multicore Works, Hemel Hempstead, Herts.

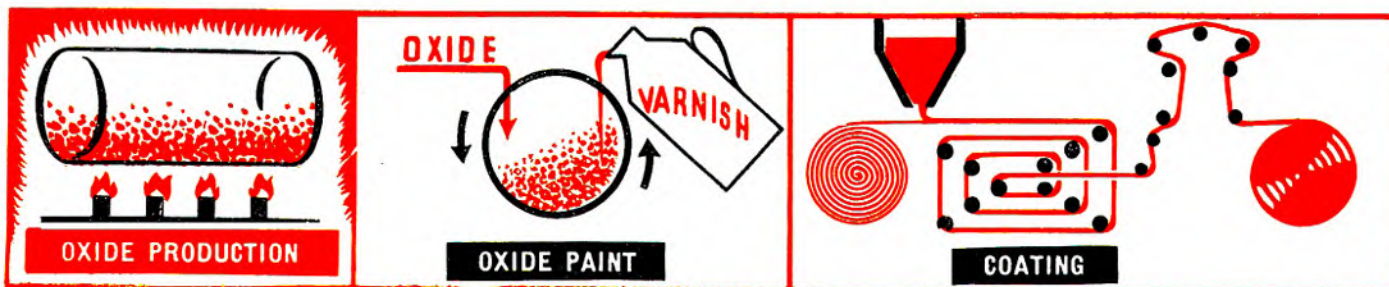

## THE MAKING OF EMITAPE

The first stage in the manufacture of Emitape is the production of magnetic oxide particles of the correct size and shape.

This is achieved by heat treatment of non-magnetic oxide powder under very carefully controlled conditions in the cylindrical furnace seen in the illustration. The unit on the left controls and keeps a continuous record of the furnace temperature variations.

After treatment each batch of powder is tested on an electronic device for the magnetic characteristics essential for high quality tape recording. These are mainly coercivity and remanence. *Coercivity* is a measure of the

magnetic hardness of the material — particularly important for higher frequency response; or more simply, it enables one to record clearly the higher harmonics of sound. *Remanence*, a measure of the flux available to give a signal to the replay head, consistency of this property is important in maintaining uniformity of level from tape to tape.

The size and shape of the particles is then checked under an electron microscope. The diagram (left) shows the shape of the magnetic particles seen through the microscope — magnified 20,000 times. The *actual size* of each particle is approximately only two hundred thousandths of an inch!

## EMITAPE *the world's finest magnetic recording tape*

EMITAPE is produced at Hayes, Middlesex, by E.M.I. in the largest magnetic tape factory in Europe. E.M.I.'s technical skill and accuracy and over 60 years of research in sound recording ensure that Emitape is the finest magnetic recording tape in the world.

EMITAPE consists of a PVC base film coated with magnetic oxide particles. Heat treatment first renders the oxide particles magnetic and they are then mixed with special varnish for adhesion to the base. The coating

process is a highly critical operation where every effort has to be made to ensure that the tape surface is completely free from foreign particles.

In the next stages, the coated film is slit by precision cutters to standard  $\frac{1}{4}$ " widths and wound on to the various size spools. Individual visual inspection and thorough laboratory tests for possible electrical defects ensure the consistently high quality of recording which only Emitape can give you.

**E.M.I. SALES & SERVICE LTD**  
 (Recording Equipment Division)  
**HAYES • MIDDLESEX • ENGLAND**

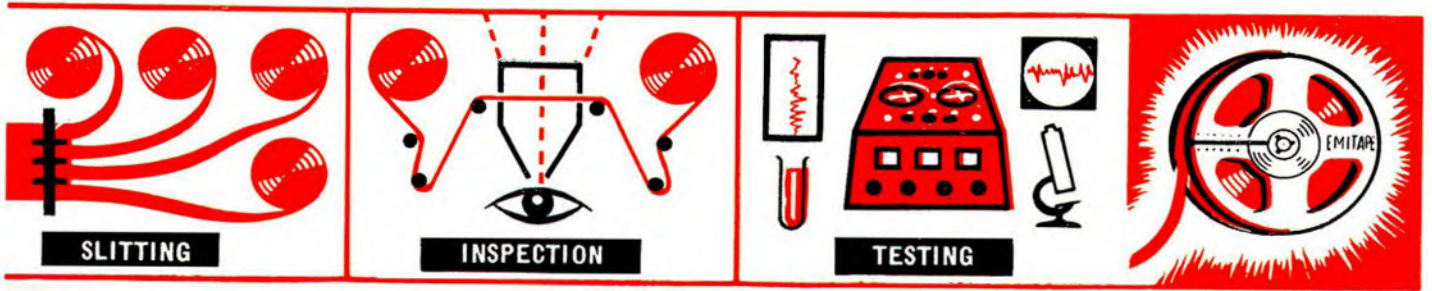

## STAGE 1. **OXIDE PRODUCTION**

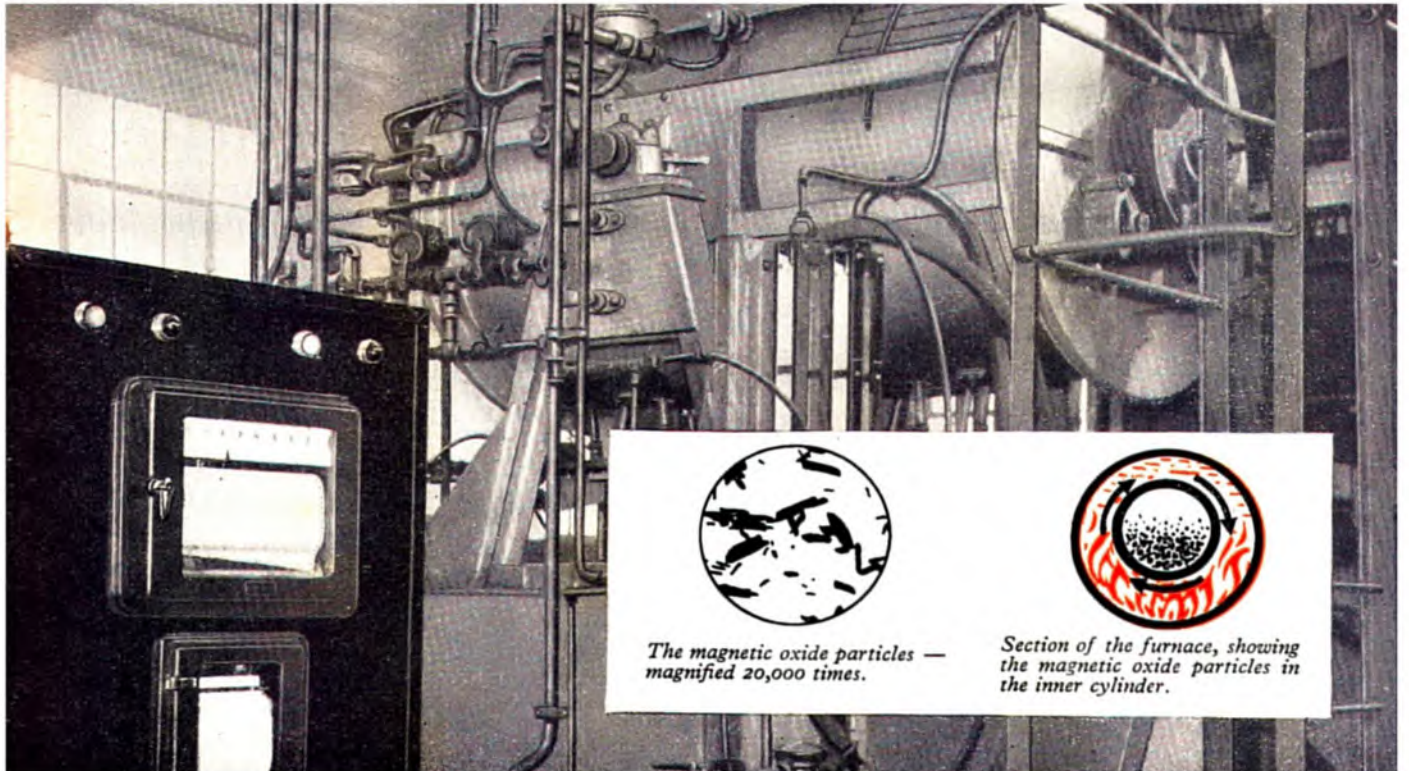

*The magnetic oxide particles — magnified 20,000 times.*



*Section of the furnace, showing the magnetic oxide particles in the inner cylinder.*

### *HERE ARE EMITAPE'S OUTSTANDING TECHNICAL FEATURES:*

- \* High sensitivity.
- \* Low noise level.
- \* Low print through factor.
- \* Anti-static.
- \* Freedom from curl and stretch.
- \* The new polystyrene container, EMICASE, solves your tape storage problems. Emicase can be placed upright on a shelf or between bookends, protecting spools from dust and damage, and giving easy identification of leader tapes.

**EMITAPE "88"** General Purposes. **EMITAPE "99"** Long Play, giving 50% increased playing time.

**E.M.I. SALES & SERVICE LTD**  
 (Recording Equipment Division)  
**HAYES · MIDDLESEX · ENGLAND**

## MAGNAFON FRS.

Almost every week new tape recorders are announced by one manufacturer or another. It has always been our policy to stock the latest Models as soon as they are available, but only if they come up to the high standards of quality and performance insisted upon by Quality Mart.

One such tape recorder is the Magnafon FRS.

This design is built round the Collaro three-speed tape transcriber and is fitted with twin speakers — A 9in. by 5in. elliptical and a 4in. moving coil tweeter. The Amplifier, which can be used with Tuner Unit or pick-up, has an output of approximately 4 watts. Other worthwhile features include a place indicator, pause lever, and storage space in the lid for two spare spools and microphone. Complete with hi-fi mic. and spool of tape 55 gns.



**Tape Recorders, Microphones, Tapes, Speakers, Amplifiers, Gramophones, Records**

**Quality Mart**

8 Dartmouth Park Avenue,  
London, N.W.5. GULliver 1131  
Tufnell Park Underground (16 mins.  
Charing Cross) or bus 27, 134, 137



**MICROPHONES  
FOR ALL REQUIREMENTS**

**A NEW RIBBON-VELOCITY  
"PENCIL" MICROPHONE**

**MODEL VR/64  
"Ribbonette"**  
LOW, LINE OR HIGH IMPEDANCE

Based primarily on the design of the high quality LUSTRAPHONE Studio Ribbon Microphone VR/53, this new model, the "Ribbonette" is of relatively miniature dimensions. Response substantially maintained to 14 kc/s. Full blast screens fitted. With new type improved swivel mounting. Silver-hammer finish



Full details of the "Ribbonette" Microphone sent on application to the makers.

**LUSTRAPHONE LTD**

ST. GEORGE'S WORKS  
REGENT'S PARK ROAD,  
LONDON, N.W.1 PRI. 8844

## By Dr. P. T. HASKELL of the Anti-Locust Research Centre

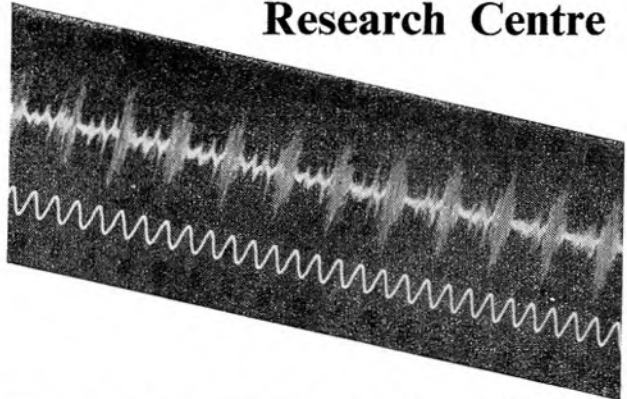

**E**ARLY in 1955 a research team left the Anti-Locust Research centre for Africa to study the behaviour of swarms of the desert locust, *Schistocerca gregaria*. One of the objects of the investigation was to record the sounds of locusts flying singly and in swarms.

It had become clear during a study of flying swarms that the insects had evolved some method of keeping together in a band.

As they have efficient hearing organs, it was thought that a possible mechanism was for a locust to hear the wing beat noise of its nearest neighbours, or of the swarm as a whole and to use this sound as a sonic beacon, as it were, to maintain its place in the flying swarm.

Locusts have efficient hearing organs with a frequency range of 100c/s to above 30kc/s and the sensitivity at frequencies above 15kc/s is equal to if not better than the maximum sensitivity of the human ear. The job of the field research team was to record and measure the intensity of the sounds produced by a single locust and swarms when in flight, and thus to ascertain, in relation to the ability of the locust hearing organs, how noises produced during flight could account for the gregarious reaction observed in swarms.

To get some idea of the recording problem some preliminary experiments were done in England. As a result of these it was decided that a tape recorder and sound intensity meter would be used in Africa.

The recording and sound intensity microphones were mounted together on a fifty-foot portable mast. This has the effect of raising them above vegetation and also of clearing them from the turbulent air near the ground, which seriously attenuates sound waves.

The use of a mast meant long microphone cables and thus dictated low input impedance amplifiers. These basic requirements, together with knowledge derived from the laboratory experiments as to the required microphone sensitivity, were then considered in relation to all the other factors relating to field recording in the tropics, such as portability, mechanical durability and power supply. This led to the selection of the Vortexion type W.V.A. recorder as the main instrument.

There are several points of interest about this recorder from the point of view of use in arduous field conditions. First, it is tropicalised. Secondly, it could be supplied in a teak case, with the external connecting points recessed and protected. Third, the mechanical arrangement was good in that both the amplifier assembly and tape deck could be removed for servicing independently with very little difficulty. Finally, and very important from the point of view of field work, Vortexion could supply with it a very robust vibrator unit, suitable for tropical use, by means of which the power supply could be obtained from a twelve volt car battery.

The recording amplifier possessed adequate sensitivity for the job in hand and even at full gain noise-level was low.



# Field recording the DESERT locust

General view of the scene during recording. The recording truck is the Land Rover in the background.



The instrument has a recording level meter, a great advantage over magic-eye indication especially in connection with recording from distant sources where much time and tape can be wasted by attempting to record at very low levels. The meter is also arranged to give a reading of the bias voltage applied to the tape and this again is of use when in a foreign country, because if one is forced by circumstances of supply and availability to use a type of tape other than normal, the bias can be adjusted to give optimum results.

A special input box was made up in our laboratory which enabled the operator to cut from the recording microphone to a throat microphone which was always worn during operations. This enabled commentary and labelling to be done, while still leaving both hands free to operate controls of the apparatus.

*It cannot be too much emphasised that all recorded material should be labelled by a recording giving details of time, date, operator, reel number, tape speed, general recording conditions and brief remarks on anything of particular interest on the tape. Material not labelled in this way is often useless, because in most cases it is only analysed at some later date when all details have been forgotten.*

In addition to this record on the tape, a recording log should be kept for any additional details. One drawback to most recorders available today is that no footage indicator is fitted so that portions of the record can be accurately and quickly located on the tape, but recently a counter has come on to the market for this purpose, and for serious recording is almost an essential, leading to both greater accuracy and efficiency and also to economy in tape use.

Together with the recording gear already mentioned a sound meter was used; this was a specially constructed battery driven meter and the calibrated microphone, a special tropical type made by Standard Telephones, was arranged for mounting on the masthead beside the recording microphone.

To overcome mechanical damage during use in the vehicles and transit over the rough roads and bush in Kenya, and also to protect the apparatus from dust and grit, some thought was given as to the carriage of the recording gear. The following method was found effective. The lid of the recorder was provided with two small hinged doors, one of which gave access to the single knob control of the tape deck and the other to the volume control, selector switch and recording level meter of the amplifier.

Thus after inserting the tape, the recorder could be used

with the lid on, greatly reducing its vulnerability to dust; running closed did not produce any symptoms of overheating. The whole apparatus was mounted in a stout wooden box on cushions of sponge rubber, with holes cut for the leads. The sound level meter and vibrator unit were similarly mounted and permanently fixed in the vehicle.

Also carried was a box which held spare valves, a selection of components, spare microphone cables and other leads and spare reels of tape. The latter were stored in individual tins, thus screening them electrically and mechanically.

The equipment detailed above was in daily use for six weeks in all conditions of temperature and humidity. It covered some thousands of miles on dirt roads and in the bush. In use we would arrive on a site and be able to record within five minutes, a time which was mainly taken up in erecting the mast. This procedure was hard on the microphone cables, but only minor faults at connectors occurred.

In the recorder, the only fault during the whole period of operation was mechanical damage which caused a small condenser to break from its soldered joint. How far this record was due to the robustness of the apparatus and how much to the method of mounting cannot of course be assessed, but undoubtedly a good mounting must help to maintain apparatus in working conditions.

Several sources of interference were experienced during recording, the most consistent and difficult to deal with being wind noise. This could be reduced with some loss of sensitivity by enclosing the microphone in a muslin cage supported on a wire frame, but this was a fragile thing to put up on the mast.

Noise from our own reconnaissance aircraft could be detected over several miles and arrangements had to be made to keep aircraft away from the research area. The apparatus was also sensitive enough to pick up the noise of the recording camera which had to be moved some distance away. Finally, an inescapable hazard was the noise of birds and of cicadas; the latter could be picked up over long distances and if nearer than about twenty-five yards blotted out the locust noise.

Despite all these difficulties, successful recordings were made of the flight noise of single locusts and swarms under a variety of conditions and oscillograms made from some recordings are shown above. It is an interesting commentary on the development of the tape recorder and its use in biology to recall that ten years ago such an investigation would have been, technically, almost impossible.

IN SYNC. WITH CINE

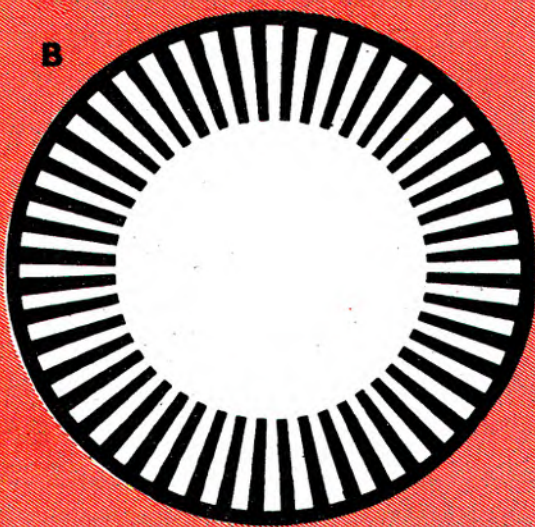

# AMATEUR

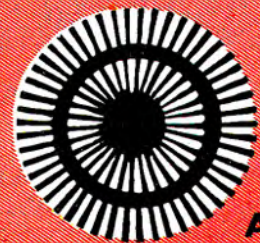

# SIMPLE METHODS for the

**T**HE amateur ciné man who uses tape will discover a new dimensional joy. He can add suitable background music, with sound effects here and there, and a commentary. The cost of tape is cancelled out by the saving on sub-titling. And all ciné fans know what time and expense adequate titling involves. His sound-on-tape presentation is better *and* cheaper.

First let him realise his limitations. With the methods I shall outline, he cannot achieve split-second or "lip-sync"; so it is not suited to dialogue. For that, he must go into the more expensive fields of optical or mag-stripe sound.

But he can get better quality sound on separate tape than he ever will on edge-stripe, with the advantage that the method is more flexible, i.e., he can add pieces of film and sound later by cutting in. For this reason, most ciné workers prefer full stripe to half-width, though the latter can be used if the second track is ignored, in case of later cutting.

But, even allowing for that imponderable factor of tape stretch (until we get tape with ciné sprockets, already on sale in the U.S.) he can get 95 per cent sync., which is quite sufficient for documentaries, travel films, etc.

In writing out the commentary (always desirable, after measuring the film, and turning feet into seconds-per-shot) use general terms and avoid the use of phrases like "as seen here" or "this is"—just in case you do get out of sync. by a second or two. In deciding on effects, like weather and crowd noises, avoid any split-second sound effects, like rifle shots. You can do without them and, if they don't come off, they spoil the show.

But effects which last several seconds, e.g., doves rising (leather gloves shaken near mike) or fireworks (bursting sweet-bags and mouth noises) can well be used, with restraint. Don't overdo this part.

You can collect and store taped sound effects on little 8 mm. ciné spools, and they can best be cut into your tape by playing from a second recorder; the effect will be better than by splicing in, though this can be done. Lend and borrow and co-operate for the second machine.

In selecting music for background, consider the copyright problem. In your own home you are probably safe, but if you want to show outside in public you had better inquire from the Institute of Amateur Ciné about their arrangement with the Sound Music Bureau for small fees on certain records; or you can get a friend to play the piano or violin, from the works of a composer dead more than 50 years (though the Bureau will tell you that even this is not as simple as it sounds).

How much music and how much commentary will depend on the type of film. Scenic subjects in travel films can take much more music, and talk often spoils the effect, dividing the mind of the audience in a certain ambivalence between listening and seeing. On the other hand, *some* screen actions demand full explanation in words, though basically moving pictures should tell their own story. You can learn much from the public cinemas, and will often find that travel films, for instance, have gaps for music which amount sometimes to a quarter of the total time.

In order to maintain sync., between projector and tape deck, it is obvious that a *constant speed* must be kept on both machines. Now tape players are designed to do this, for any variation in speed would show as wow or flutter; but most silent ciné projectors have a variable speed control and, until everything is warmed up, the speed is *not* steady. If left un-

# STANLEY JEPSON, ARPS, explains how to make and use stroboscopes to get good synchronisation

controlled, the speed would gradually increase, unless the speed control were gradually retarded through the rheostat.

## The first method

So now we come to the first possible method of synchronisation.

If your projector has a shutter with three blades (most have) you may cut out the little strobe marked A, paste on thin card, then attach to the top or bottom sprocket spindle. Try a little plasticine or chewing gum! When this is illuminated by electric light (by reason of the AC flicker cycles per sec.) the outside strobe will appear to be stationary when the machine is doing 16 frames a second and the inner circle at 24 frames a second. If you warm up the projector first by running a few minutes with the lamp on, you will not have to bring back the speed control after the first few minutes.

Obviously, you cannot have a light showing when projecting in the same room, so the best light source is a pigmy *neon bulb* (the sort used as a refrigerator indicator light) masked by inserting inside a tiny cardboard box and then cutting a small hole. The neon bulb also takes the flicker better, as it is cool-running, and it provides a useful pilot light by which to work.

Now you have solved the problem of running the projector at a steady 16 (or 24) speed, and if you do this while making the recording and again during projection, starting from cue marks on film and tape, you will be surprised how easily things keep in step.

If you just want to show films with tape on your own machines and no others, this method is good enough, and simple. And if you take a tape and film to a friend's house, it will work *providing his recorder runs at exactly the same speed as yours*. But if it doesn't and his tape runs at, say two seconds a minute slower, you will lose 30 seconds of sync. in fifteen minutes, which is hopeless.

It is useful to know the *exact* running speed of your tape deck and we shall come to that presently.

## The second method

Let us now consider the second method, which will work anywhere, with light-locking that compensates for slight variations in tape speed.

This uses a strobe on a pulley fixed on or near the recorder and moved around by the tape itself. This strobe is illuminated by light spilled from the projector lens. The projector speed is then adjusted until the bars of the strobe appear stationary. If you carry this pulley around, your films will be in sync. with any projector (with three-blade shutter) and recorder anywhere. If the tape runs slightly fast, the strobe will compensate by setting the speed slightly fast, or vice versa. The advantages of this method for competitions, etc., will be readily seen.

Cut out Strobe B (a 48-bar one) and fix it securely by Secotone to the side of a small 8-mil. ciné spool, rubber variety. You now have to bring the diameter of this up to 2.388 inches, by packing it tightly with old film, wound around and drawn very tight. Plastic tape is not so suitable, for it absorbs. Wind the film around in the direction in which the tape will move when playing, or the packing will tend to unwind.

You then fix this pulley at exact tape level, either before or after the soundhead, in any convenient spot. It should move easily on a spindle (a broken electric plug pin? but if someone can turn you a neat spindle which can be raised and lowered on a grub screw, all the better). The first one I made for

experiment, years ago, was a nail driven into a block of wood sawn to tape deck height and jammed against the machine, with books to keep it steady! Try this first, to get the idea.

You may not be an engineer, but do not be scared off by that pulley diameter of 2.388 inches. Do the best you can, and then test it by trial and error.

Set Strobe A on the projector to give a known 16 frames a second, and project a measured 96 feet of 16 mm. film at this speed, which will take four minutes. Time it, and if the strobe is not keeping steady add or subtract from the packing slightly, until you do keep it steady. If you have no film footage counter to measure 96 feet, get a dealer to do this for you from one scratch mark or hole to another on any film—or measure with a tape measure on a rewind, in handy lengths.

Now you have your known length and projector speed, and if the tape goes over the four minutes, your recorder is running slow. But that will not matter for sync. purposes *with your own pulley*, though in the interests of standardisation, it is useful to know about this.

## Talking Clock

Methods of ascertaining percentage of error are made by a test talking clock, giving the time every ten seconds, and made on a machine of known accuracy; or you may make mike signals at 0 and 10 seconds, mark the tape with white at these signals, and measure off on a tape measure. At 7.5 ips you should measure, of course, just 75 inches. If you are 5 per cent over, i.e., slower, then you must add 5 per cent to the 4 minutes test time, to get the dead accurate strobe diameter.

But all this is purely in the interests of standardisation, so that if you send in a competition film you need not send your own pulley (which might not fit their spindle anyway).

A film recording made with your pulley, whether diameter is accurate or not, will always be in sync. with any two machines, projector and recorder, *with your own pulley*.

On the other side of the pulley you can, if you wish, have a strobe for 3.75 ips—a 96 bar, with the same diameter. This method, of course, works equally well with any gauge of film: 8, 9.5 or 16 mm.

There are various ways of spilling projector light on to the strobe. Perhaps the simplest is a piece of thick silver paper, folded and pushed over the lens. Bend it down, so that the top light, usually sky and the brightest part of the picture, reflects light on to the strobe, with the tape deck placed just in front of the projector; you can bend this paper about until you get maximum brilliance.

Some people carry around a tiny piece of glass, with a holder enabling it to be positioned just in front of the lens, to catch a little of the light and send it to the moving strobe. Neither the paper nor the glass need show on the screen if you get them in the right position.

All that remains is to thread the film, with a Sellotape start-mark just above the gate, to have a similar start-cue on the tape just beyond the sound head, and to start both machines together.

**Next month :**

**Automation in sync.**



## SUGGESTIONS

### CHECKING SPEEDS

**I**T is quite simple to check whether or not your tape recorder is running at its rated speed of  $7\frac{1}{2}$  ips by measuring a piece of tape 37ft. 6 in. long (i.e. length of tape to pass in one minute), marking the tape, and timing the run through. If it takes more or less than 60 seconds, your speed is not  $7\frac{1}{2}$  ips.

A simpler and more accurate method is to make an endless loop, record a click on the tape, run it for two minutes and count the clicks. All that one requires to know is the length of the loop and the correct number of clicks to count for the relevant speed.

Suppose we make the length of the loop five times the rated speed, thus at  $7\frac{1}{2}$  ips the loop will be 37 $\frac{1}{2}$ in. long. Allow 38in. for cutting and splicing, using  $\frac{1}{2}$ in. each end as overlap. Splice the tape, put it on the recorder and record a click (don't record too far or you'll erase the click on the second time round). Now play the endless loop and at  $7\frac{1}{2}$  ips you should count 24 clicks in two minutes.

The correct number of clicks is arrived at by dividing the number by a constant. For 15 ips the constant is 1.6, for  $7\frac{1}{2}$  ips it is 3.2, for  $3\frac{1}{2}$  ips it is 6.4. Thus, if you count 26 clicks in two minutes at  $7\frac{1}{2}$  ips your actual speed is 8.1 ips.

This is particularly useful if you own two tape recorders and wish to check any difference in speed.

W. P. COPINGER.

Norwood Green, Middx.

### BOOKS ON TAPE

**M**R. WALTER R. HUXLEY asked you recently for details of books on tape recording. Besides those listed by Mr. Swain in his reply, there are several others available (of American origin) which would interest Mr. Huxley and possibly other readers.

They are "How to Make Good Tape Recordings," by C. J. Le Bel; "Tape Recorders and Tape Recording," by Harold D. Weiler; and "Tape Recorders

This month we inaugurate a "mutual aid" feature in which readers can pool their knowledge and experience. If you

## THE IDEAS POOL

have a problem—or if you have solved a problem—write and tell us about it.

—How They Work," by Charles G. Westcott.

I have a copy of the first-mentioned and can recommend it as the finest treatise available on practical recording.

Another item of interest is "All About Tape—on Tape," which is claimed to be the first book prepared and published on tape. It lasts an hour and gives examples of good and bad recording, frequency response, wow and flutter, etc.

S. BENJAMIN.

Bury St. Edmunds.

### AID THE BLIND

**A** GREAT number of blind persons are now using tape recorders. It occurs to me that it would assist if the amplifier gain control had a pointer with the setting marked by raised pips.

This would enable a sightless person to quickly set the correct recording level—pre-determined by trial and error of course.

Will manufacturers please note?

BILL RAWLE.

Darlington.

### TAPE-PLAYS

**F**OR many years I have been president of an amateur ciné club. Our main interest, up to a short time ago, was the production of story films.

Now we have developed an idea which we think will be of interest to your readers—the production of tape-plays, recorded at  $7\frac{1}{2}$  ips with a view to hiring them to owners of recorders. We think there will be a demand among enthusiasts for these recordings.

At the time of writing, we have six subjects in preparation. These will be available from January, 1958. The subjects range from factual reports to comedies and thrillers. Each tape will consist of four 15-minute plays or two 30-minute plays, or a combination of both.

These will be available for hire to anyone interested at 7s. 6d. per 1,200 feet of tape per three days. We should be interested to hear the views of fellow tape-recording enthusiasts.

GRAEME A. AHIER.

Jersey, C.I.

### SPLICING

**I** WOULD like to start a correspondence about the best way of splicing tape. Ordinary adhesive tape is un-

## AND QUERIES

suitable because it oozes at the edges.

I tried a joining fluid, but think this is a messy business, and rather tricky to get the exact width and correct amount of fluid.

On the Continent, I bought a spool of Agfa jointing tape in a tin, the base of which has a groove for splicing (real Teutonic ingenuity!). This does not ooze, but the tape is exactly the width of the magnetic tape and it is not easy to get the edges parallel.

I have a broader band of this type of jointing tape from a well-known firm and this seems satisfactory. But it is only half-an-inch in width and, even when placed on a slant, this seems to me a little narrow.

A friend in South Africa has now sent me Scotch "permanent mending tape", an American product. I find it so satisfactory that I wonder why it is not readily available in the U.K.

S. JEPSON.

Jersey, C.I.

### PROBLEMS OF AN M.C.

**I** HAVE been asked to be M.C. at our department dance and social. About eighty to 100 people will be there.

Apart from the usual novelty dances and games, I wonder if any reader could suggest how I can make use of my tape recorder for this event? I have never seen one used in this way and would appreciate ideas.

H. DYER.

Romford, Essex.

### ECHO EFFECT

**I** SHOULD like advice on how to obtain echo effect. Apart from the method used by commercial recording companies, I should like to hear of other methods—whether an echo can be obtained mechanically, by additional circuit means, design of studio, or otherwise.

G. A. WILSON.

London, S.E. 13.



Before you face a mike

# LEARN HOW TO USE YOUR VOICE

By BRYAN WHITTON, F.R.S.A., L.R.A.M.

**I**T is an unusual individual who is not shaken by the unexpected sound of his or her own voice when first tried out on tape. Your "s" may come whistling or hissing through, or your "r" may resemble a "w". Coupled with a "breathiness" and thinness of tone, this may be driving you frantic, particularly as the "mike" throws such minor defects into high relief.

The elimination of these faults requires practise, but a brief examination of the mechanism of speech and a few hints on voice-improvement with special regard to the microphone may help.

Successful speech involves the whole body, and begins with breathing-in. The lungs must be inflated fully and the breath taken through the nose. The base of the ribs should swing up and out, as well as the upper ribs. The rib-cage should be kept up during speech and the breath controlled by relaxing and contracting the muscles just below the lower ribs, thus causing the abdominal viscera to raise and lower the diaphragm, which, in its turn, will cause the lungs to inflate and deflate.

## Practise phrases

Practise speaking phrases and counting to ten slowly, gradually extending the amount spoken on each diaphragmatic breath. The air is now flowing gently—and under complete control—through the voice-box or larynx. In the larynx, two lip-like membranes are approximated to produce the minute sound which, amplified, means voice.

The sound is amplified in the pharynx and mouth, which sets the air and bones of the nasal cavity vibrating. This, in turn, causes vibrations in the chest (hence the importance of keeping the ribs up), and eventually the whole body becomes a sounding board for the voice.

By reducing the flow of breath to a minimum, breathy tone is eliminated. The hollow-ring and weak-voice are removed by directing the voice-flow to the front of the mouth. You can check that you are doing this by placing the index finger gently on the lips and feeling maximum vibrations while saying a prolonged "m." Incorrect placing of the voice causes sore throats and a nasal twang. Remember at all times to keep

all muscles not directly involved as relaxed as possible and start speaking from a *completely relaxed* state.

Now we have to consider the shaping of the speech sounds, of which there are 38 in the English language (This does not include the guttural "ch," etc, of some regional dialects which, of course, are perfectly good speech, as long as they are made correctly).

Firstly, the thirteen vowels. A vowel is defined as a continuous speech sound in which the flow of breath is not stopped at any point. Stopped sounds are consonants. The shaping of vocal sounds requires that the jaw, lips and tongue be extremely mobile.

The jaw is relaxed when open, although it may not feel so at first. Relaxation must be practised until the jaw will drop and the mouth be wide open enough for the insertion of two knuckles. The lips must be relaxed and opened in the vertical direction only—little or no spreading of "ee" sounds. Relaxation of the lips may be practised by "horse-buzzing."

Most important of all is the tongue, which must be fully agile, and must start from the relaxed position, flat on the floor of the mouth, the flattened tip dropped behind the lower front teeth, not spread over the back teeth! From this position, the gradual raising of the back of the tongue, with the jaw fully open and the lips wide, will give you the thirteen vowel sounds in the sequence shown in the following sentence:—

"Who's to know small frogs pass up where landmen wade in reeds."

The tongue should always return to the relaxed position after speech, and not hang poised in mid-air.

The articulation of the 25 consonants demands real agility. Eighteen of these are paired, i.e., the pairs require the same positions of the speech organs, but one is voiced and the other unvoiced. Working from the front of the mouth, the correct articulation is as follows:—

The outer part of the lower lip and the edge of the upper lip give "p" (unvoiced), "b" (voiced) and "m;" the backs of the lips "w" and "wh."

The outer edge of the lower lip and the upper teeth, "f" (unvoiced) and "v" (voiced).

The point of the tongue and the edge of the upper teeth "th" (as in *thin*, unvoiced) and "th" (as in *then*, voiced).

The point of the tongue and the middle of the teeth—ridge, "t" (a short tap, unvoiced), "d" (the same, voiced), "l" (short *not* "plummy," voiced), "n" (made with the nasal-twang), "r" (a light tap or trill, voiced), "r" (the same unvoiced, not made with the lips!).

The edge of the tongue and the teeth-ridge, and air escaping through a small channel in the centre, "s" (unvoiced) and "z" (voiced).

The same, but with the tongue a fraction farther forward, "sh" (unvoiced) and "z" (as in *azure*, voiced).

The middle of the tongue and the hard palate, "h" and "y."

The back of the tongue and the soft palate, "k" (unvoiced), "g" (voiced), "x" and "ng."

## Relax

These consonant positions are rather tiresome to read, but the incorrect making of them is responsible for the major proportion of minor speech defects; the lisp, for example, and the squashy lateral "s." Their removal is purely a question of speech-mechanics and relaxation.

Direct the flow of your voice forward towards the mike. If you are producing your voice correctly there will be no need to have its volume any greater than the voiced equivalent of a whisper at the normal narration distance of two feet. Make use of your upper and lower registers and avoid a monotonous pitch. Go through your script beforehand and mark in the "sense-phrases;" put a mark and remember to breathe there and nowhere else. Women will probably find that they come over better if they concentrate on their lower registers.

In making use of acoustic perspective, concentrate on changes of pitch rather than volume. Talk to the mike as if it is a person, chat with it and remember that it personifies your future audience. Above all be natural, relaxed and sincere. The mike is a natural detective and will spot insincerity and tenseness straight away.



# MUSIC ON TAPES



This month we bring up to date the list of tape records issued by the H.M.V. and Columbia Companies. On this page we give the latest single-channel issues from H.M.V. and on the opposite page all the recent issues of Columbia single-channel tape records. Future issues will be published as they appear and outstanding tapes will be fully reviewed each month.

## H.M.V.

"La Boheme" (Puccini), Jussi Bjorling, tenor; Robert Merrill, baritone; John Reardon, baritone; Giorgio Tozzi, bass; Fernando Corena, bass; Victoria de los Angeles, soprano; Lucine Amara, soprano; William Nahr, tenor. R.C.A. Victor Orchestra and Chorus (Chorus Director: Thomas Martin) and Columbus Boychoir (Director: Herbert Huffman), conducted by Sir Thomas Beecham. HTA34/5.

The Philharmonia Orchestra, conducted by Charles Mackerras. "Lady and the Fool" (Ballet) (Verdi-Macherras). HTC614.

Lois Marshall (soprano) and London Symphony Orchestra conducted by Anthony Bernard. Arias from "Jephtha" (Handel); "Solomon" (Handel); "The Seasons" (Haydn); "Judas Maccabaeus" (Handel); "Samson" (Handel); "The Creation" (Haydn); "Elijah" (Mendelssohn). HTC615.

Joe Loss and his Orchestra—"Dancing Time for Dancers" (No. 6). Samba, Amore; Foxtrot, You were meant for me; Quickstep, Rosalie; Tango, Tango Capriccioso; Waltz, True Love; Quickstep, Lullaby of Broadway; Waltz, Ramona; Foxtrot, I'll get by; Tango, Song of the rose; Quickstep, Jeepers Creepers. HTD819.

Songs for "Hip" Lovers, arrangements and orchestra conducted by Marty Paich. Woody Herman—Comes love; Everything I've got; Alone together; Bidin' my time; Isn't this a lovely day; Louise; Makin' whoopee; I won't dance; I guess I'll have to change my plan; Willow weep for me; Moon song; Can't we be friends. HTD820.

**\* A Recipe for perfect reproduction**

- \* First design to professional standards.
- \* Next put the experience of many years of tape recording manufacture into the production.
- \* Mix in versatility and many new features.
- \* Ensure brilliant reproduction by a flat frequency response.
- \* Introduce a multi-speaker system capable of handling the 6 watts output.
- \* With a little British "know-how" make it simple to use.
- \* Decorate in contemporary style.

Add a "Cadenza" ribbon microphone for perfection.

Serve complete with microphone, L.P. tape and accessories ready for use at 75 gns.

**AUDIO FAIR HARROGATE OCT. 25-27**

## The Sensational ELIZABETHAN "ESSEX"

Yes, a sensational tape recorder in a medium price range. It has everything usually found only in high priced professional machines.

**Elizabethan**  
TAPE RECORDERS

SEND YOUR NAME AND ADDRESS NOW FOR FREE ILLUSTRATED LEAFLET AND FULL DETAILS



E.A.P. (TAPE RECORDERS) LTD.

BRIDGE CLOSE, OLDCHURCH ROAD, ROMFORD, ESSEX.

Telephone: Romford 62366-7

# Beethoven and Eddie Calvert

## VARIETY AMONG NEW ISSUES

### COLUMBIA

The Philharmonia Orchestra, conducted by Herbert Von Karajan: Symphony No. 4 in E Minor (Brahms). CAT285.

"Die Fledermaus" (Johann Strauss 2nd). Cast including Elizabeth Schwarzkopf (soprano); Nicolai Gedda (tenor); Helmut Krebs (tenor); Rita Streich (soprano) and Erich Kunz (baritone). The Philharmonia Orchestra and Chorus, conducted by Herbert Von Karajan. CAT286/7.

Michael Rabin (violin) and The Philharmonia Orchestra, conducted by Lovro Von Matacic. Concerto No. 1 in D (Paganini); Concerto in A Minor (Glazounov). CAT288.

Nan Merriman (mezzo-soprano) with Gerald Moore (piano-forte). French Song Recital: Chère Nuit (Bachelet); Ici-Bas (Fauré); Après un Rêve (Fauré); Les Temps des Lilas (Chausson); La Vie Antérieure (Duparc); Phidylé (Duparc); Ouvre Ton Cœur (Bizet); Trois Chansons de Bilitis (Debussy); Mandoline (Debussy); Le Jet D'eau (Debussy); Ballade des Femmes de Paris (Debussy); Fêtes Galantes (1st Series) (Debussy). CAT289.

Overture—"Tannhäuser" and "Venusberg" and "Tristan und Isolde"—Prelude and Liebestod (Wagner). The Philharmonia Orchestra, conducted by Paul Kletzki. CAT290.

Homage to Diaghilev (No. 3). Kikimora (Liadov, Op. 63); Petrouchka (Three Dances) (Stravinsky); Le Pas d'Acier (Prokofiev, Op. 41). The Philharmonia Orchestra, conducted by Igor Markevitch. CAT291.

Symphony No. 3 in E Flat ("Eroica"). Beethoven, Op. 55. The Philharmonia Orchestra, conducted by Otto Klemperer. CAT292.

Symphony No. 7 in A (Beethoven). The Philharmonia Orchestra, conducted by Otto Klemperer. CAT293.

Homage to Diaghilev (No. 2). The Philharmonia Orchestra, conducted by Igor Markevitch. Swan Lake (Tchaikovsky); Les Sylphides: Mazurka (Chopin); The Good-humoured Ladies (Scarlatti-Tommasini); The Three-cornered Hat: Miller's Dance (Falla). CBT558.

Chorus and Orchestra of La Scala Opera House, Milan. (Chorus Master: Norberto Mola) conducted by Tullio Serafin. Verdi Opera Choruses: "Il Trovatore"—Vedi! le fosche notturne; Or co' didi'; "Otello"—Fuoco di Giola!; "Aida" Gloria all Egitto; "Nabucco"—Va pensiero sull' ali dorate; "I Lombardi"—Gerusalem! Gerusalem!; O Signore, che daltetto natio; "Ernani"—Noi fratolli in tal momento; "La Traviata"—(a) Noi siamo zingarelle; (b) Di Madride noi siam mattadori. CBT559.

Double Concerto in D Minor (J. S. Bach); Concerto in E (J. S. Bach); "Sarabande" (Violin Solo by Leonid Kagan). Elizabeth Gilels and Leonid Kogan (Violins) and The Philharmonia String Orchestra, conducted by Otto Ackerman. CBT560.

"Operatic Arias" (Sung in Italian) from "Andrea Chenier"; "Il Trovatore"; "La Traviata"; "Il Barbiere Di Siviglia"; "I Pagliacci"; "Otello." Rolando Panerai (Baritone) and The Philharmonia Orchestra, conducted by Alceo Galliera. CBT561.

The Philharmonia Orchestra, conducted by Otto Klemperer. Symphony No. 5 in C minor, Op. 67 (Beethoven). CBT562.

Piano Concerto No. 12 in A (Mozart, K.414) and Piano Concerto No. 14 in E Flat (Mozart, K.449), Denis Matthews (Pianoforte) and The Philharmonia Orchestra, conducted by Rudolf Schwarz. CCT658.

Amália Rodrigues, accompanied by Domingos Camarinha

(Guitarra Portuguesa) and Santos Moreira (Viola), "Amália at the Paris Olympia." A selection of Portuguese songs. CCT659.

Dancing to the Victor Silvester Orchestra (No. 4), Quickstep: The way you look tonight; Rumba: Stars over Rio; Waltz: So blue; Slow Foxtrot: You'll never know; Samba: Haiti; Quickstep: September in the rain; Tango: Estoril; Waltz: Anniversary Waltz; Slow Foxtrot: Star fell on Alabama; Mambo: Puerto Rico. CDT861.

Eddie Calvert, with Peter Yorke and his Orchestra "The Man with the Golden Trumpet" (No. 2): Yesterdays; Confessin'; I'm getting sentimental over you; Maybe; As time goes by; You go to my head; Imagination; Mean to me; Poor Butterfly; In the still of the night. CDT862.

Ray Martin and his Orchestra, with The Bill Shepherd Chorus and Johnny Webb. "High Barbaree" (Salty songs of the salty sea): High Barbaree; Shenandoah; Blow the man down; Rolling home; Farewell Iberia; What shall we do with a drunken Sailor; According to the Act; The Chinese bumboat man; Highland laddie; A life on the Ocean wave; When Johnny comes down to Hilo; Heart of oak. CDT863.

"Waltztime in Vienna" (Johann Strauss 2nd), Wiener Volksopernorchester; Conductors: Karl Hofman and Max Schonherr. CDT864.

Dancing to the Victor Silvester Orchestra (No. 5), Quickstep: Chez Moi; Tango: Santa Catarina; Waltz: Would You; Slow Foxtrot: You stepped out of a dream; Samba: Cayenne; Slow Foxtrot: The night is young and you are so beautiful; Rumba: Moon over Mexico; Waltz: When I grow too old to dream; Mambo: Mambo Brazilliana; Quickstep: I've got my love to keep me warm. CDT865.

"Let's Dance," Eric Jupp and his Orchestra, Quickstep: Let's face the music and dance; Waltz: Dancing with tears in my eyes; Slow Foxtrot: Dancing on the ceiling; Quickstep: I won't dance; Slow Foxtrot: Dancing in the dark; Quickstep: I'm in a dancing mood; Slow Foxtrot: Dancing with my shadow; Tango: Dance Ballerina, Dance; Quickstep: You're dancing on my heart; Waltz: While you danced, danced, danced. CDT866.

"Hi" Michael Holliday, with Norrie Paramor and his Orchestra, If I can help somebody; I'm old fashioned; It's the good things we remember; the Lonesome Road; I'd love to come home to you; All Of You; Just a wearyin' for you; We'll gather lilacs; Shenandoah; That's my heart strings (That's my boy). CDT867.

Dolf Van Der Linden and his Orchestra. "Seductive Saxophone." CDT868.

"You Were Never Lovelier," Music of Jerome Kern. Victor Silvester and his Silver Strings. Slow Foxtrot, You were never lovelier; Quickstep, Make believe; Slow Foxtrot, Smoke gets in your eyes; Quickstep, Moon Love; Slow Foxtrot, The last time I saw Paris; Quickstep, I'm old fashioned; Slow Foxtrot, They didn't believe me; Quickstep, All the things you are; Slow Foxtrot, Lovely to look at; Quickstep, Dearly Beloved; Slow Foxtrot, The folks who live on the hill; Quickstep, Why do I love you; Slow Foxtrot, Can I forget you; Quickstep, A fine romance; Slow Foxtrot, Long ago (and far away); Quickstep, The way you look tonight. CDT869.

The Tarriers. Pretty Boy; I know where I'm going; Rock Island Line; East Virginia; Drill, Ye Tarriers, Drill; Shadrack; Those brown eyes; Oh, Chaucou; Acres of Clams; Lonesome Traveller. CDT870.

CAT and HTA £4 4s.; CCT and HTC £3 13s. 6d.; CBT and HTB £3 3s.; CDT and HTD £2 15s.



The compact design of the new GBC Phonetic can immediately be appreciated.

# A NEW ITALIAN MIDGET

**D**ESCRIBED as "the smallest tape recorder now on the market for 3-inch reels, the Italian GBC Phonetic PT/12, recently introduced to this country, is a versatile little machine measuring less than  $6 \times 11 \times 10\frac{1}{2}$  inches and weighing  $12\frac{1}{2}$  lbs., including its carrying case.

The PT/12 records on dual track at speeds of  $1\frac{1}{2}$  and  $3\frac{1}{4}$  ips. It has a clock position-indicator; glo-light recording level indicator; instant stop, start and rewind; and facilities for the use of an external speaker, additional amplifier, earphones and microphone as well as for taking recordings from radio or records.

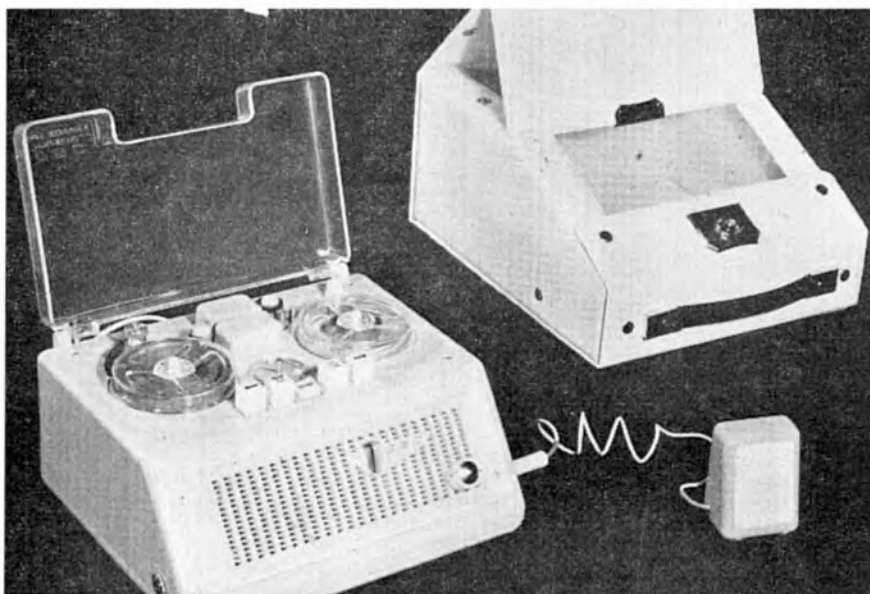

Accessories available include earphones, telephone pick-up, impedance adjuster and lead for radio and gramophone recording, and alternative microphone brackets.

The price of the PT/12 is 40 guineas, including the carrying case, microphone and reel of tape.

The sole distributors for the UK are Messrs. Bartram Clarke Ltd., 119, Edgware Road, London, W.2.

**DON'T MISS THIS—Classic Electrical Co. Ltd.—"BRITAIN'S LEADING HI-FI SPECIALISTS"**

## SPECIAL OFFER OF TAPE RECORDERS

CLASSIC Britain's LEADING Tape Recording Specialists offer the following selection of Tape Recorders for delivery from stock. Easy terms with no interest charges available. Credit Sale and Hire Purchase terms with **FREE INSURANCE, FREE TECHNICAL ADVICE and FREE DELIVERY.**

All our prices include **FREE TAPE and SPOOL.** Send deposit with order for immediate attention. Proposal Form and Agreement by return. No Red Tape. Full technical details sent on application.

### SECTION I.—TAPE DECKS AND PRE-AMPLIFIERS—

	Price		Deposit		Payments	
	£	s. d.	£	s. d.	C.S.	H.P.
Brennell Tape Deck	18	18 0	2	1 6	C.S. 9 of 41/6	
Mk. II.....			9	9 9	H.P. 12 of 17/8	
Brennell Pre-Amp...	18	18 0	2	1 6	C.S. 9 of 41/6	
			9	9 9	H.P. 12 of 17/8	
Collaro Tape Deck	22	10 0	2	10 6	C.S. 9 of 48/10	
			11	5 0	H.P. 12 of 21/1	
Collaro Pre-Amp....	21	0 0	2	6 6	C.S. 9 of 46/2	
			10	10 3	H.P. 12 of 19/8	
Bradmatic Tape Deck	42	0 0	4	13 0	C.S. 9 of 92/4	
			21	0 6	H.P. 12 of 39/4	
Bradmatic Pre-Amp	75	0 0	8	5 0	C.S. 9 of 165/0	
			37	10 9	H.P. 12 of 65/3	
Truvox Tape Deck Type III-U	23	2 0	2	11 5	C.S. 9 of 50/9	
			11	11 9	H.P. 12 of 21/7	
Truvox Pre-Amp Type "C"	16	16 0	1	17 4	C.S. 9 of 36/11	
			8	8 0	H.P. 12 of 15/9	

### SECTION II.—COMPLETE TAPE RECORDERS—

	Price		Deposit		Payments	
	£	s. d.	£	s. d.	C.S.	H.P.
Vortexion 2A	55	0 0	6	1 0	C.S. 9 of 121/0	
Second-hand			27	10 9	H.P. 12 of 51/6	
M.S.S. Type	65	0 0	7	3 0	C.S. 9 of 143/0	
PMR/DE			32	10 3	H.P. 12 of 60/11	
Simon Type SP/2...	65	0 0	7	3 0	C.S. 9 of 143/0	
			32	10 3	H.P. 12 of 60/11	
Spectone 120 Shop-soiled	72	0 0	7	19 6	C.S. 9 of 159/6	
			36	0 0	H.P. 12 of 67/6	
Spectone 122 Shop-soiled	58	0 0	6	7 9	C.S. 9 of 127/7	
			29	0 6	H.P. 12 of 54/4	
Elizabethan '57.....	68	5 0	7	10 1	C.S. 9 of 151/1	
			34	3 4	H.P. 12 of 63/11	
Vortexion 2A.....	92	0 0	10	3 0	C.S. 9 of 202/4	
			46	0 0	H.P. 12 of 86/3	
Ferrograph 3 A/N...	82	19 0	9	3 1	C.S. 9 of 182/5	
			41	9 9	H.P. 12 of 77/9	
Grundig TK8.....	75	12 0	7	11 10	C.S. 9 of 166/3	
			37	16 0	H.P. 12 of 63/2	
Grundig TK830.....	105	0 0	11	11 0	C.S. 9 of 231/0	
			52	10 3	H.P. 12 of 98/5	

Write now to: **CLASSIC ELECTRICAL CO. LTD.**

"The Hi-Fi Specialists"

352-364 LOWER ADDISCOMBE ROAD, CROYDON, SURREY

Tel.: ADD 6061/6062. Buses: 12, 54, 727. Stations: East Croydon, Addiscombe, Woodside, Grams.: CLASSIFI, CROYDON, Addiscombe.



## TAPE RECORDERS REVIEWED

# Maestrovox Majestic

**T**HE new Maestrovox "Majestic" is a solid and robust machine, but this is achieved with considerable dignity, and even those who are not fond of gold ornament will admit that it is used here in a way that justifies the term "Majestic." Great care has been taken to mount the Collaro deck on a perfectly harmonising panel, and there is a pleasing sense of unity about the whole machine.

The Collaro deck is well-known to readers, and those who desire details are referred to the November issue of *TAPE RECORDING MAGAZINE*.

A pleasing feature of the additional "Majestic" controls is their generosity. They are large enough to be handled easily and with a feeling of fine control, and they do one job at a time. The volume control knob and the tone control knob are not asked to perform any other function, and so they remain as set whether the machine is switched on or off—by the third knob.

The magic eye, in front of these controls, is also generous and well defined in operation. Immediately in front of these, very conveniently placed at the near left-hand corner of the machine, are the two sockets for the microphone and the gram/radio input. Mixer facilities apply to recording and playback.

We go to one of the compartments at the back of the machine, behind neat sliding doors, for the two sockets for



extension speaker and monitoring. Plugging into the former very properly mutes the internal speaker, and a feature of the monitor connection is that it comes from an early stage of the circuit so that it is all the better for use as a connection to an external amplifier.

Very good quality is achieved by the "Majestic" on its own, because of its fine 3-watt-output amplifier and the incorporation of a Goodmans 10 in. x 6 in. elliptical speaker. The sturdy cabinet helps a great deal as well.

The real test comes, however, when the machine is connected to a separate speaker which, because of its much greater cabinet size and high-fidelity design, can reproduce over more or less the entire audio range—providing a correspondingly satisfactory signal is fed into it. The machine tested came through this ordeal with flying colours.

The vast majority of people, including most serious music lovers, will find that the "Majestic", plus a first-class speaker assembly, gives them complete satisfaction on the score of quality.

**A UNIQUE THREE-DIMENSIONAL DISPLAY WITH WHICH DEALERS ALL OVER THE COUNTRY ARE ATTRACTING PUBLIC ATTENTION TO MASTERTAPE, AND TO TAPE RECORDING GENERALLY.**



## News round-up

**A** TEST tape for calibrating and checking the performance of tape recorders at 7½ ips has been put on the market by the Minnesota Mining and Manufacturing Co., Ltd., makers of "Scotch Boy" tape. It is on a 3½ inch plastic spool one track carrying voice announcements with frequency checks from 10 Kc/s to 40 Kc/s, and the other a continuous 7½ Kc/s tone for head alignment purposes.

It is known as No. IIIV "Scotch Boy" C.C.I.R. Calibration Tape, and the price is 49s. 6d.

\*

**B**BRITAIN'S first exhibition devoted entirely to tape recorders was held from November 19 to 21 at the Kingsley Hotel, London, W.C.1. It was sponsored by the Hatherley Photographic Co., of 134, Uxbridge Road, London, W.12, and featured many of the latest models. Among firms exhibiting were: Elizabethan, Grundig, Harting (Technical Suppliers), Lustraphone, Tape Recorders (Electronics), Truvox, Walters, Scotch Boy and Winston Electronics.

*TAPE RECORDING MAGAZINE* was represented and we were pleased to meet many trade friends and readers.

An outstanding feature was the Press attendance—over 100 representatives of

home and overseas newspapers and periodicals. The exhibition has been widely reported and it is hoped to repeat it next year on a larger scale.

More than 1,000 visitors attended.

One particularly interesting exhibit was the new Lustraphone V.R.64 "Close Talk" microphone which, it is claimed, only picks up sounds within a foot radius. This is achieved by a special triple-blast screen. The price is £7 17s. 6d.

\*

**ERIC SWAIN**, Technical Advisory Editor of *T.R. Magazine*, is lecturing on "Modern Trends in Tape Recording" to members of the Institute of Musical Technology at the Northern Polytechnic, Holloway Road, London, N.7, on Saturday, January 11 at 3 p.m. All readers are welcome.

\*

### STOP PRESS

**A new portable tape recorder operated by four torch batteries and selling at only twenty-six guineas is about to be marketed in Britain. Full details of this interesting development will be published in our next issue.**

## KNOW YOUR RECORDER No. 1

Many readers of TAPE RECORDING MAGAZINE have the knowledge, skill and experience to service their own equipment. For their benefit, we start this month a new series of circuit diagrams and explanatory photographs. The first deals with the

# Walter 303

These pages can be cut out, pasted on card, and kept near your machine.

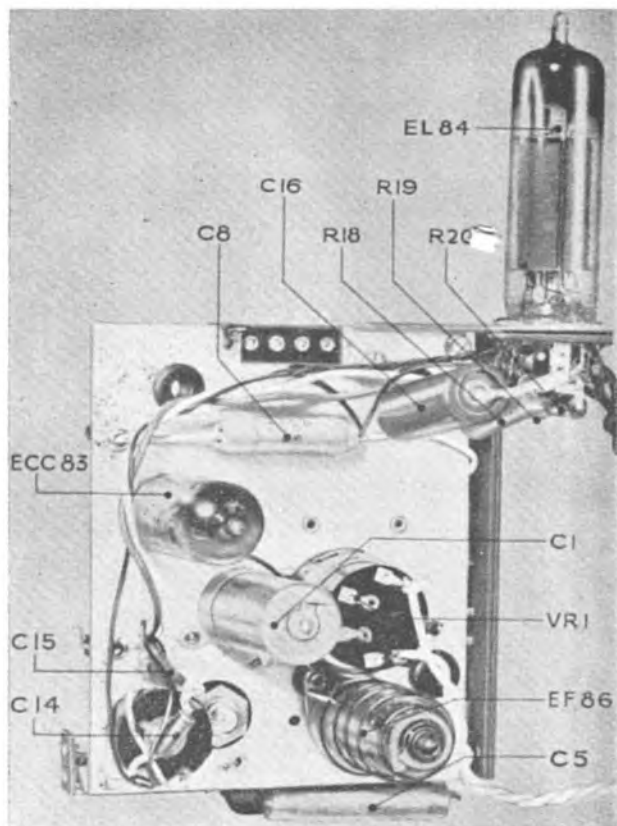

Left—  
TOP SIDE VIEW

Below—  
UNDER SIDE VIEW

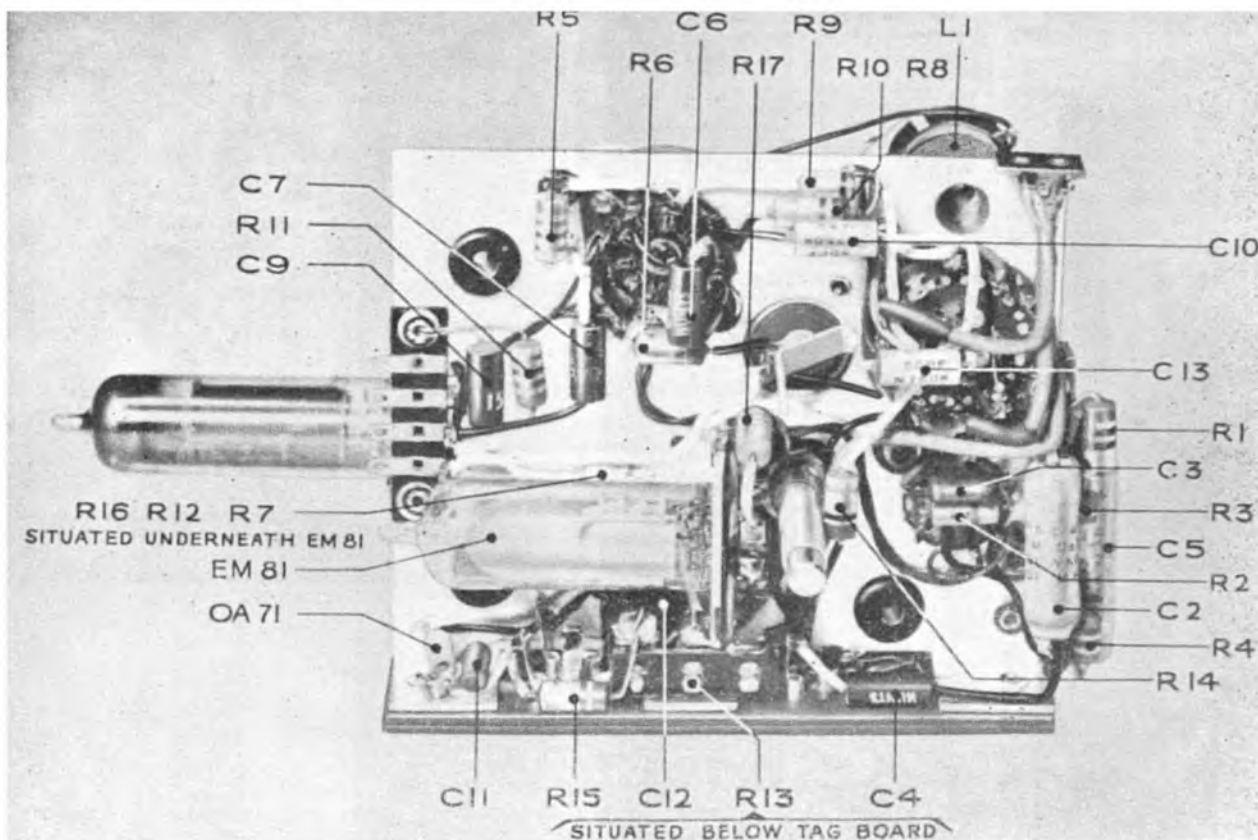

# THE DESIGN

THE apparatus is driven by a single motor which, through a high-speed fly-wheel and capstan bearing against a rubber pressure roller or pressure wheel, ensures constant tape speed.

The turntable carrying the right-hand reel is driven by a belt from the motor through a clutch system, controlled by the lever on the right of the deck, which determines the amount of power transmitted.

When the control lever is in the *record* or *play* position, tape movement is controlled by the capstan and sufficient power only is applied to the reel to take up the tape. On selecting *fast forward*, the tape is freed from the capstan and full power is applied to the reel for winding purposes. When *fast reverse* is engaged, the take-up reel is completely declutched and power is applied to the left-hand turntable through a friction drive.

Both reel spindles carry a drum, against which felt brake pads bear when the control lever is in the neutral or central position. At all other times the pads should be clear of the drums.

The electronic section of the recorder consists of a complete high-gain record, playback amplifier. An oscillator supplies 50 kc bias to the recording head. Erasure is by a permanent magnet system which is brought into contact with the tape only when the *record* position is engaged. A single head is used for both recording and playback.

The amplifier consists of a four-valve four-stage unit, including record level indicator. The valves are Mullard miniature types EF.86, ECC.83, EL.84, EZ.80, EM.81 record level indicator, and OA.71 germanium diode.

In the *record* position, signals are fed from the microphone to the control grid of the EF.86, amplified, and connected to the first half of the ECC.83 valve. The two sections of the ECC.83 valve are operated in cascade and the resulting signal is supplied to the EM.81 indicator, via the OA.71 germanium diode. At the same point the recording input is supplied direct to the first half of the ECC.83 valve. The EL.84 valve acts as a bias oscillator at a frequency of 50,000 cps during the recording. Frequency compensation is applied in the form of negative feed-back.

When the *play* position is engaged, the record/play head is connected to the control grid of the EF.86 valve and the amplified signal is fed to the ECC.83 valve operating as a cascade amplifier. (The compensated output for external amplifier [Ext. Amp.] is supplied from this point.) After this, the signal is taken to the EL.84 output valve. Frequency compensation is applied in the form of negative feed-back.

The power unit consists of a mains transformer feeding an EZ.80 rectifying valve. The resulting DC supply is fed to the amplifier through a hum compensating bridge circuit. This consists of output transformer T.2, resistance R.21, condenser C.17 and the anode impedance of the EL.84 output valve.

(Continued on page 37)

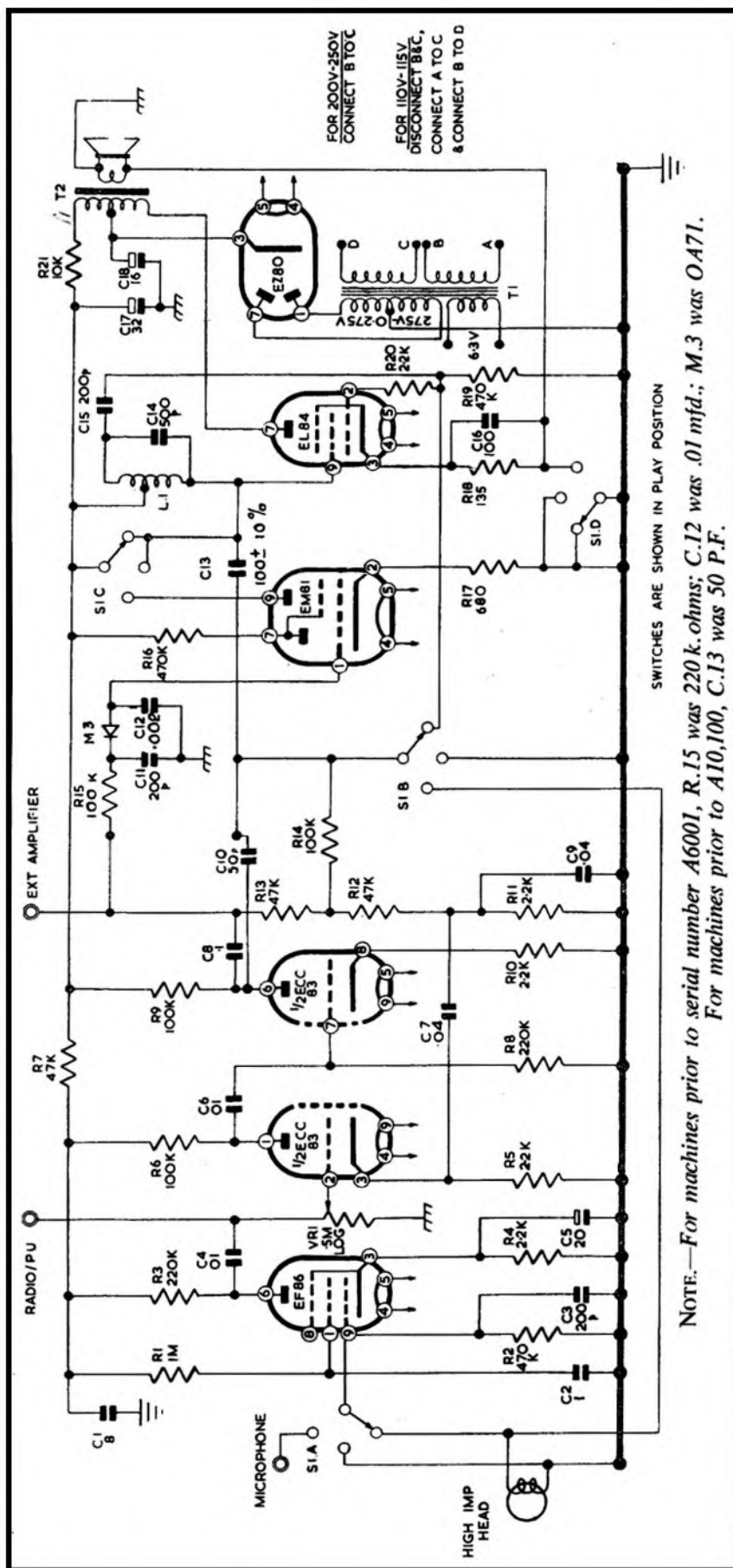

NOTE.—For machines prior to serial number A6001, R.15 was 220 k.ohms; C.12 was .01 mfd.; M.3 was OA71. For machines prior to A10,100, C.13 was 50 P.F.

# A Completely New Tape Unit For High Fidelity Systems

Designed around the latest Collaro tape transcriber. It incorporates a *complete recording amplifier* with switched equalisation (linked to speed change knob) for all three speeds. A *push-pull* bias and erase oscillator ensures low noise and distortion. Fully equalised play back preamplifier gives 250 m.v. output. For use with all *control units* by any of the leading makers. It is completely self powered, and requires only connection to the main supply and two leads to the control unit or amplifier. Full instructions are included. Or it can be quickly fitted by your Hi-Fi dealer.



With control panel incorporating magic eye recording level indicator and volume control. Price 40 gns.



With control panel incorporating meter recording level indicator and volume control. Price 50 gns.

**MAGNAFON Ltd.**

99 Kensal Road, LONDON, W.10. Tel. LADbroke 4644

**WE HAVE THE**

# LARGEST SALES IN ENGLAND!

**WHY? BECAUSE WE GIVE YOU THE BEST TERMS**

Space is too small to list all our amazing offers, but they include \* 2s. 6d. in £ deposit, balance of retail price only, by 9 monthly instalments with **NO INTEREST CHARGES** \* H.P. over 2 years \* Special cash terms \* Free delivery anywhere in U.K. (we are the biggest mail order specialists with thousands of sales over the whole country) \* free demonstrations in your own home, etc., etc. 25 machines on permanent demonstration in our showrooms. \* Open all day Saturday. \* Credit purchases completed on the spot \* all accessories in stock or sent by mail-order. \*

*You may purchase from us by post, in complete confidence.*



# HOWARD PHOTOGRAPHIC

WRITE, PHONE OR CALL FOR FREE BROCHURE AND DETAILS OF OUR TERMS

**190, HIGH ST. • BROMLEY • KENT • RAV 4477**  
(30 MINUTES FROM THE HEART OF LONDON)

# HOW TO CURE TROUBLES

## TAKE-UP OF TAPE IS SLUGGISH OR INOPERATIVE. NO ACTION IN THE "FAST FORWARD" POSITION. TAPE BREAKING DUE TO SNATCHING.

**Correction:** 1. Disconnect Power Supply.

2. Remove the tape reels and the back cover from the machine. With the joystick lever in the neutral position, loosen the two 6 BA nuts which lock the screws "A" and "B" (see photograph) and unscrew the two screws until they are only just retained in the arm "e".

3. Move the joystick lever to the *Fast Reverse* position. The right-hand turntable should now revolve freely, and the clearance between the brake drum and the clutch pads should be approximately 1/64 inch. If this clearance does not exist the turntable will not turn and if it is excessive the turntable will be felt to be excessively loose when lifted by the threaded reel spindle. The clearance should be adjusted by loosening the 4 BA grub screw "C" and setting the drum to the correct position. The correct clearance may be judged by lifting the right hand turntable by the reel spindle.

4. Return the joystick control to neutral.

5. A reel of tape should now be loaded on to the machine so that almost all of the tape is on the right hand reel and only a few yards on the left hand reel. Drop the tape into the slot in the dress cover.

6. Connect to power supply.

7. Place the joystick lever in the *Play* position and tighten screw "A" until a smooth take-up is obtained. The 4 BA locking nut should now be tightened. Care should be taken to ensure that excessive drive is not transmitted, as this could cause "wow."

8. Move the joystick control to the *fast forward* position and, with the tape loaded as at 4, tighten screw "B" until the tape starts to wind forward. Tighten the locking nut. The clutch is now correctly adjusted.

## NO ACTION IN THE "FAST REVERSE" POSITION.

Check the engagement of the large-diameter drum D with the rubber belt, with the control lever set to *fast reverse*. The large-diameter drum moves over to engage with the rubber belt and check this engagement by noting that drum engages when lever is moved into fast reverse position. The small spring "E" should supply all the tension for the engagement, while the larger spring "F" should return the turntable assembly to its original position when the control lever is returned to neutral.

## FAULTY BRAKING.

Verify the clearance between the felt pads and drums is not greater than 1/64 inch when the control lever is in all positions other than neutral. When the lever is in the neutral position, the brake pads should make firm contact with the drums. Adjustments are only necessary if the brake arms are bent, and they should be set to fulfil the above requirements.

## NOISY MECHANICAL OPERATION.

Check for damaged or worn parts. Examine the clearance between the brake drum and the clutch spider on the take-up turntable. For adjustment see "No take-up or fast forward" above. This noise will take the form of a loud chatter when the control lever is set to *fast reverse*.

## LOW OUTPUT AND/OR LOSS OF HIGH FREQUENCIES.

Should the laminations of the record/play head become coated with oxide dust or other foreign matter it should be cleaned with a soft cloth or brush. Ensure that the felt pads are pressing the tape evenly against the guide pillar and the head respectively. The pressure of the felt pad on the head should be between 15-17 grams; that on the guide post 6-8 grams.

(Continued on page 39)

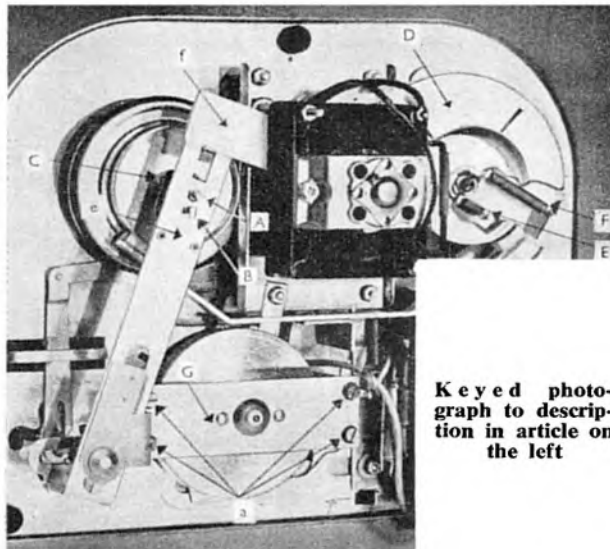

Keyed photograph to description in article on the left

## REMOVAL FROM CASE

**T**O remove deck and amplifier from cabinet, unscrew four retaining screws in the feet on which the cabinet stands. Then unsolder the following connections, taking care to identify them to ensure correct re-assembly:—

1. Leads connecting amplifier to speaker;
2. Four leads from amplifier at their junction to the power pack;
3. Two leads to motor at their attachment to the mains input.

Stand recorder in operating position. Remove knobs of column control and control lever, take off smaller upper dress cover by unscrewing its plated retaining screws, and the overall dress cover by removing the screws which attach it to the main deck plate.

Deck and amplifier can now be lifted from cabinet, after unscrewing three screws holding it in place. Speaker and power pack remain in position in cabinet.

To detach amplifier chassis from deck plate, unsolder the red lead from the recording head and also the braided earth wire bonding the amplifier to the mechanism. Remove three screws attaching the chassis, through rubber grommets, to the legs welded to the plate. Amplifier can now be moved away from the deck, so that the wire leading to the pilot light may be unsoldered. Amplifier is then free of the deck.

These operations should be reversed to replace the unit in the cabinet.

Before replacing amplifier on the deck, the lever of the selector switch **MUST** be in the central position and the control lever in neutral. The switch lever should then engage the slot in the sliding panel, so that it is operated by the control lever. Neglect of this instruction will, in all probability, damage the switch.

He's tough. He sparkles. He's got *zing*. You can see that at a glance. He has a striking performance, as well as good looks. He'll prove a match for any competitor.

We're talking, of course, about the cheeky champ on the right. But, if we were discussing tape recorders, we could use all the same phrases about the WYNDSOR REGENT, a machine that . . . .



***outpoints all the others***

**THIS IS WHERE THE WYNDSOR REGENT SCORES :**

***54 guineas***



- ★ 10-inch elliptical speaker in detachable lid
- ★ Mixer inputs to blend speech and music
- ★ Unique colour-change control panel
- ★ Complete with Acos Hi-Fi stick microphone
- ★ Two speeds—Up to 2 hours recording on one tape.

*Write today for further details from :*

**MAGNETIC RECORDING COMPANY**

Dept. T.M., 2 BELLEVUE ROAD, LONDON, N.11

ENTerprise 2226/7

# CURING TROUBLES NEWS FROM THE CLUBS

(continued from page 37)

## **TAPE TENDS TO MOVE UP OR DOWN THE CAPSTAN SPINDLE WHEN RECORDING OR PLAYING.**

Establish that the pressure wheel spindle is not bent and that the felt pads are correctly adjusted. In isolated cases the tape itself may be at fault.

## **MOTOR NOT RUNNING.**

Check the connection of the mains lead to its plug and that current is being supplied to the machine. Unscrew the base of the cabinet and verify that the motor leads have not become detached from the mains input tags. Check that motor bearing screws are not loose. If so, tighten and lightly tap end-plates with a wooden mallet. This will line up the bearings.

## **POOR ERASING.**

The face of the magnet must be clean. It must be adjusted so that the tape moves smoothly across it with the control lever set to *record*. Mis-alignment of the magnet can cause poor erasure or interference with the track not in use.

## **DISTORTED REPRODUCTION.**

Ensure that the recording head is clean (see "Low Output" page 37) that the felt pad pressures are not excessive and that the pressure wheel is not embedded with particles of foreign matter.

## **FLUTTER.**

Check that the capstan is entirely free in its bearing. If the flywheel is lifted it should drop back on to its bottom bearing in any position to which it is rotated.

If the capstan is stiff in certain positions, the bottom bearing plate "A" may require adjustment, leaving the capstan free to rotate with an easy up and down movement.

The capstan rubber drive belt may in time become stretched and this will cause flutter. Should the capstan require replacement, the entire assembly should be removed by unscrewing the control lever knob and then taking out the three bolts by which it is attached to the main plate. Two of these are counter-sunk slightly to the rear of the record/play head and right hand guide pillar respectively, while the third bolt is not counter-sunk and may be found beneath the pressure wheel, where access is obtained to it with the control lever in either the *record* or *play* position. The capstan unit, when removed, should include the complete control lever assembly and the clutch control arm, which should be returned to our works as a unit for adjustment or replacement.

## **WOW.**

If present, wow will probably coincide with the rotation of the pressure wheel, which may have become flat on one side or may require lubrication. Should the wheel develop a flat spot, this may have been caused by leaving the machine stationary for a considerable period with the control lever set to either *play* or *record* positions. Excessive clutch take-up may also cause wow, and adjustment, as indicated in the first two paragraphs of the "Faults" section, may be necessary.

Other conditions which cause wow are excessive head and guide post pad pressure and insufficient pressure wheel pressure, which should be between 570-600 grams. Head pressure should not exceed 18 grams and guide post 6-10 grams.

**When writing to manufacturers for leaflets or information, please mention that you "saw it in T.R. Magazine"**

LONDON now has its own club for tape recording enthusiasts—the London Tape Recording Club—with a rapidly growing membership, already totalling over 20. At present it meets once a month, and the aim is to strike a note midway between the social and the technical.

One of the many interesting activities already in hand is the production of a tape programme in competition with the Edinburgh Tape Recording Club.

Feminine participation is encouraged by making one fee cover membership for all the family. Chairman of this new club is Mr. J. E. Amphlett. The secretary is Mr. Roger Aslin, 269, Green Lanes, London, N.4.

TWO Tape Bulletins a month will be issued by the British Amateur Tape Recording Society from February, the first retaining its former character, with mainly general and entertaining items, and the second consisting of educational and technical material. All members may receive one or the other, but a small extra fee will be payable if a member wishes to have both. Contributions for both of these tapes should be sent on tape at the highest tape speed available to BATRS Headquarters at Chester.

Extracts from the recordings of the Russian earth satellites made by Mr. Gerry Fitzgerald and Kieran Williams (see *Tape Recording Magazine*, December issue), are to be included on one of the future Tape Bulletins.

(Continued on page 41)

## Replacements

### **RECORD/PLAY HEAD**

UNSOLDER the screened cable leading to the head from its junction tags on the chassis. Remove the two screws securing the head to the deckplate and remove the head from the chassis, drawing the cable through the plate. Insert the lead of the new head through the hole in the deck and connect to the junction tags with the outscreen connected to the earth tag. The screws may now be replaced so that the head is lightly secured to the deckplate. The head must now be adjusted by the tensioning of these screws, so that its gap is vertical. This is achieved by playing a standard tape and the screws are adjusted to ensure reproduction of the highest frequencies.

### **CLUTCH BELT**

WITH the control lever in *fast reverse*, the new belt may be eased between the clutch adjusting spring and the end of the clutch spindle. Next select the *play* position, when the belt can be passed between the brake pad and drum and fitted to the clutch pulley, whence it can be fed on to the lower segment of the motor pulley (nearest to the motor).

### **CAPSTAN DRIVE BELT**

UNSCREW the control lever knob. Remove the four screws in photograph and lift the lower capstan bracket G, away from the capstan spindle so that the control lever is clear of the deck plate. Manipulate the clutch operating lever E to withdraw the forked end from the motor bracket F. The flywheel may now be lifted and the capstan spindle withdrawn from its housing, care being taken not to strain it, so that the new belt may be fitted to the grooved pulley section of the flywheel. The process should now be reversed to re-assemble the unit. The belt should now be fitted around the top segment (farthest from the motor) of the motor pulley, using a hooked piece of wire.

### **PRESSURE WHEEL**

SLIDE the circlip from the top of the pressure wheel post. Remove the washer and pressure wheel. The new wheel should now be placed on the post, so that the greater amount of bearing projecting from the rubber faces upwards, and the washer and circlip replaced.



In this feature every month you can check

**YOUR LOCAL DEALER**

who gives special attention to tape

**THE NORTH-WEST**

**JOHN SHINN & SONS LTD.**

Electronic Engineers

TOWN CENTRE, LEIGH, LANCS.

Also at MELODY HOUSE, 109 HIGH STREET, BANGOR, N. WALES

and MELODY HOUSE, 43, HALLGATE, TOWN CENTRE, WIGAN, LANCS.

*Pioneers in Tape Recorders since 1946*

ALL MAKES STOCKED - TERMS AVAILABLE

All customers are made honorary members of the John Shinn Recording Club, with its attendant benefits

**"TAPE RECORDERS ONLY"**

ALL POPULAR MAKES, CASH OR TERMS

Specialists in GRUNDIG and Service and Guarantee implemented without return to the manufacturers.

TAPES Service spares

**DIXON'S ELECTRONICS**

227 OXFORD ROAD, MANCHESTER, 13

(Telephone: ARDwick 4269)

**WALES**

*Sound Recording Specialists for over 30 years*

**Tape Recorder Sales & Service**

**SNELL THE MUSIC SHOP**

15 Station Road,  
Llanelly, Phone 466

**LONDON**

**Hi Fi** Consultants and Dealers

STUDIO RECORDING & DUBBING FACILITIES

**TAPE to DISC**

*professional standards*

**OLYMPIA SOUND**

11, North End Parade, London, W. 14

Tel. FUL. 9422.

**HOME COUNTIES**

A 30 MINUTE JOURNEY FROM THE HEART OF

**LONDON**

WILL SAVE YOU £££'s

- THE LARGEST SALES IN ENGLAND
- BEST CREDIT TERMS—NO CHARGES
- BEST CASH TERMS—SPECIAL OFFERS
- 40 MACHINES ALWAYS IN STOCK

**HOWARD PHOTOGRAPHIC**

190 HIGH STREET, BROMLEY, KENT RAV. 4477

**RECORDING TAPE**

RETURN OF POST SERVICE ON ALL ORDERS

All available sizes of Tape and Empty Spools by Scotch Boy, Emitape, Ferrograph, BASF and MSS in stock.

Tape accessories including Leader Tape, Jointing Tape, Splicers, Grundig Leads and Plugs and the Wearite De-Fluxer also available.

Our Fully detailed lists of Tape and accessories are available free upon request.

ALL TAPE POST FREE

**WATTS RADIO (Mail Order) LTD.**

54, Church Street, Weybridge, Surrey.

PLEASE NOTE. Post orders only to this address.

**THE MIDLANDS**

**TAPE RECORDERS**

*ON 'NO-INTEREST' TERMS!*

Buy your new Tape Recorder without touching CAPITAL! Grundig, British Ferrograph, Vortexion, Baird, Philips, etc. NO EXTRA CHARGES—Nine months to pay the balance of Retail Price Only.

**JEWKES & CO. LTD.**

*The Midlands Tape Recorder Specialists*

285, BROAD ST., BIRMINGHAM 1. — MID 4829/20.



## . . . . New BATRS Members This Month . . . .

The following new members have joined the BATRS in the past month. Tape Station calls are given first, followed by names and addresses, ages in brackets, then recorder speeds, lastly members two major interests, coded.

- G-0321/T. William B. Curran, 44 Glanmor Rd., Uplands, Swansea. (54), 3½. 88-980.  
 GM-0323/T. Mr. and Mrs. John Faragher, 8 Bankhead Ave., Lesmahagow, Lanark, Scotland. (34), 3½. 67½. Bands, 90.  
 G-0325/T. Eric Price, 40 Toronto Terr., Brighton, Sussex. (49), 7½ and 3½ Var. 67gh-86-44.  
 G-0327/T. Courtney J. Saunders, British Railways Hostel, Middleton Rd., Banbury, Oxfordshire. (26), 7½ and 3½. 88aga-50.  
 G-0328/T. Douglas E. Priestley, 5 Borough Way, Potters Bar, Middx. (40), 15, 7½ and 3½. U.S.A. Mr. and Mrs. C. Gilmore, 16026 So. Hoover St., Gardena, California, U.S.A. 7½ and 3½. Tapes and letters welcome.  
 EI-0329/T. Father Britain De G-Loughed, The Drive, Artane, Dublin, Eire. (38), 3½ and 1½. 29-Shooting-Athletics.  
 G-0334/T. Gordon Caven, 90 Halsbury Rd., Liverpool 6. (37), 3½. 67h-88e-98.  
 G-0336/T. E. G. Williams, 35 Bitton Ave., Teignmouth, Devon. (61), 7½ and 3½. 57-102.  
 G-0338/T. Martin Stuart, 76 Clapton Way, London, E.5. (21), 98p-86-88.  
 G-0340/T. Herbert Bach, 95 Cobbold Rd., Willesden, London, N.W.10. (48), 88-74-Literature.  
 G-0341/T. Miss Janet Towilson, 27 Knighton Court, Leicester, Leicestershire. 3½. 88-67.

- G-0322/T. Harold G. Bishop, 8 Ferncroft Ave., N. Finchley, London, N.12. (55), 7½ and 3½. 69-67h-74.  
 G-0324/T. Paul Aldworth, Flat 1, 118 Barrowgate Rd., Chiswick, London, W.4. (38), 7½ and 3½. 67b-88e.  
 G-0326/T. Roger Mileham, 192 Gower St., London, N.W.1. (35), 15, 7½ and 3½. 67f-88a.  
 GM-0211/T. Douglas Hanley, 7 Chapel Court, Thistle Foundry Junction, Edinburgh 9, Scotland. (35), 7½ and 3½. 74dfb-67d-Gen.  
 EI-0329/T. Father Britain De G-Loughed, The Rectory, Kinnitty, Offaly, Eire. (47), 7½ and 3½. 98g-Broadcasting and Script writing.  
 G-0330/T. Harold R. Nurgen, 22a Queen Annes Gate, London, S.W.1. 7½ and 3½. (Inactive).  
 G-0332/T. Francis B. McManus, 39 Crescent Lane, Clapham, S.W.4. (57), 7½ and 3½. 29b-88a.  
 G-0333/T. R. H. Rawlinson, 17 Snaresbrook Drive, Stanmore, Middx. 15, 7½ and 3½. 74-14.  
 G-0335/T. Gordon Kerry, Park Villa, Cromer, Norfolk. ( ), 15, 7½ and 3½. Script Writing.  
 G-0337/T. Kenneth R. Harvey, Singleton Hall Special School, Singleton, Blackpool, Lanc's. (34), 3½ and 1½. 11-67b-88e-(Handicapped Children).  
 G-0339/T. Austin Cross, 15 Roderick Rd., Hampstead, London, N.W.3. (32), 7½ and 3½. 88-67.  
 GW-0342/T. Pamela Johnson, WRNS Qtrs., H.M.S. Harrier, Nr. Haverfordwest, Pembro. S. Wales. (18½), 3½. Cricket-Films-Etc.-88.

- MO-0511. Howard G. Reiser, M.D., 1000 west Jefferson St., Joliet, Ill, U.S.A. (35), 7½ and 3½. Would like to contact Medical Practitioners in U.K. 74-88-89.  
 G-0344/T. F. C. Gazeley, 265 High St., Uxbridge, C/o of Uxbridge. (48), 15, 7½ and 3½. 88a-109.  
 G-0345/T. Thomas G. Sanders, "Winchester", Cossington, Nr. Bridgewater, Somerset. (41), 3½ and 1½. 46-32-98.  
 G-0347/T. Gerald H. Fursse, 56 Ashley Gdns., Westminster, London S.W.1. (27), 7½ and 3½. 67h-66-Plays.

France—F-0343/T. Robert Krouch. (36), All Speeds. C/o Kodak-Pathé, 37 Avenue Montaigne, Paris 8eme, France.

Northern Rhodesia—A. P. Bolton, VQ2-0346/T. 57-63 Avenue Nkana Mine, N. Rhodesia. (35), 7½ and 3½. 88-Engineering-Electricity.

From the March 1958 issue of *Tape Recording and Reproduction Magazine*, new members will not be listed monthly. The new manual of British Tapesponding will then be in circulation. A supplementary Call Book will be produced during the summer. Extra copies of these Call Books will be available to members at 2s. 6d. each, plus 3d. Postage. Change of recorder speeds, interests or hobbies, and of address, should be sent to BATRS H.O. at once.

### News from the Clubs (continued)

A TAPE to tape service is now available to all BATRS members. Details are obtainable from the Headquarters at Chester.  
 Two new affiliations to BATRS are Radio Station KEPTS, Eagle Pass, Texas, U.S.A., and the Auckland Tape Recording Club, of New Zealand. The former operates on 1,270 kcs. at 1,000 watts and will exchange tapes containing music, news,

sports and human interest. The New Zealand club will be exchanging all types of recordings.  
 The BATRS "Call Book" is scheduled to appear towards the end of January. It is to be issued to all members, and a Supplementary Call Book will be issued during the summer at an extra charge of 2s. 9d., including postage.

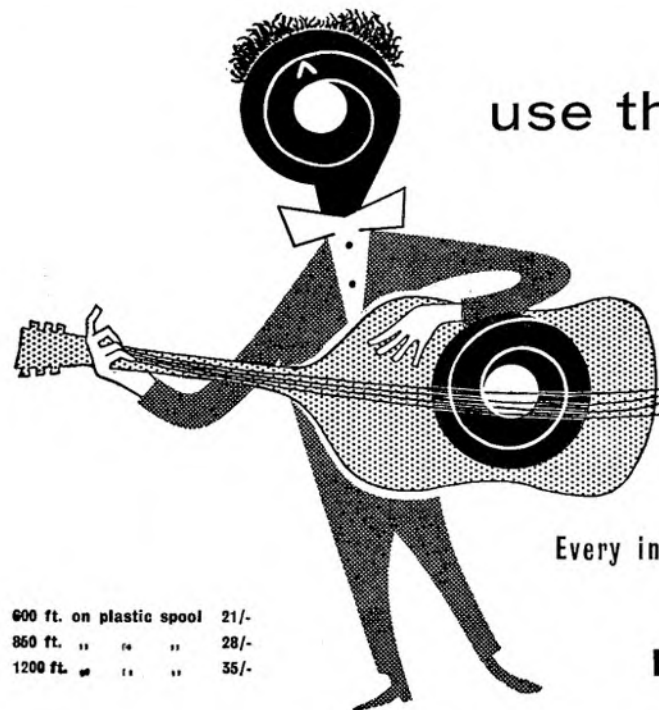

use that *simply marvellous*  
recording tape



Every inch is tested

**BASF Magnetic Recording Tape**

- 600 ft. on plastic spool 21/-
- 850 ft. " " " 28/-
- 1200 ft. " " " 35/-

F. A. HUGHES & CO LTD · DEVONSHIRE HOUSE · PICCADILLY · LONDON W1 · MAYFAIR 8867

## Classified advertisements

*Rate—Sixpence per word (minimum 5s.); Trade, ninepence per word (minimum 10s.); box numbers, one shilling extra. Payment with copy.*

*Copy should be sent to Advertisement Department, Tape Recording Magazine, 1 Crane Court, Fleet Street, London, E.C.4.*

COMPREHENSIVE 78/LP Tape to Disc Recording Facilities. Rendezvous Records, 19, Blackfriars Street, Manchester 3.

FRIENDLY FOLK ASSOCIATION, 87, Terrace, Torquay.—Leading International Correspondence Hobby Club since 1943. Now included, facilities for Tapesponding. Details free.

WANTED.—Battery portable tape recorder, BOOSEY & HAWKES REPORTER, E.M.I. or similar. Details, lowest price. Box 217, Tape Recording, 1, Crane Court, Fleet St., London, E.C.4.

Ex-Govt. M.S.S./P.M.R./3 tape recorders. 9 only. Reconditioned by makers. Cost over £100 each. Accept £55 each complete. Call or write. Cash or H.P. Hatherley, 134, Uxbridge Road, Shepherds Bush, W.12.

A PHILCO VHF/FM Tuner unit; an ACOS 5 gn. microphone; E.M.I. Long-Play Tape; Wyndor telephone attachments are among prizes in a simple, friendly competition being sponsored by the Magnetic Recording Co., 2 Bellevue Road, London, N.11. All you have to do is to say in not less than 25 words why you think the Wyndor Regent "is the best buy." Independent panel of judges. Closing date for entries 31st December. Open to all. Contact your local dealer.

● ATTENTION! The famous SONOMAG "ADAPTATAPE" pre amplifier is now fitted to the COLLARO MK. IV Tape deck and now incorporates push pull oscillator, complete with power pack, 38 gns. Easy terms and full specification on request. SOUND TAPE REPRODUCTION. The Tape Recorder and Hi-Fi Specialists, 71, Praed Street, London, W.2. (PAD, 2807).

We regret that copies of Tape Recording Magazine Diary for 1958 are no longer available. This first edition was published in a limited quantity and demand far exceeded supply.

**TAPE TO DISC RECORDING**  
**Microgroove L.P. (30 mins.)**  
**27/6, 78 rpm. 13/6**

S.a.e. for leaflet: Deroy Sound Service (A.D. Marsh), Little Place, Moss Delph Lane, Aughton, Ormskirk, Lancs.

**TAPE RECORDER HIRE**  
**TAPE TO DISC 78-LP**  
**RECORDING STUDIO**  
**SALES—EXCHANGES**

**MAGNEGRAPH**

1 Hanway Place, London, W.1.  
s.a.e. for leaflet or  
telephone LAN 2156

**FREE LIST**

of all Leading Makes of

**TAPE RECORDERS**

Part Exchanges — H.P. Terms

HOLDINGS OF BLACKBURN LTD.  
39-41 Mincing Lane, Blackburn

**TAPE TO DISC SERVICE**  
78's or L.P.

QUEENSWAY RECORDING STUDIOS  
123, Queensway, London, W.2.  
Tel: BAYswater 4992

**TAPE RECORDERS FOR HIRE**

## Make sure of your copy NOW

**TO YOUR NEWSAGENT:**

Please supply  
TAPE RECORDING  
AND REPRODUCTION  
MAGAZINE  
monthly until further  
notice.

Name.....  
Address .....

**TO T.R. MAGAZINE**

Rolls House Publishing Co., Breems Buildings, London, E.C.4

Please post TAPE RECORDING AND REPRODUCTION MAGAZINE to me each month. I enclose postal order/cheque.

- 22s. for one year (post free)  
 11s. 6d. for six months (post free)

Name.....

Address .....

**PLEASE POST FREE SPECIMEN COPIES TO THE FOLLOWING FRIENDS, WHOM I THINK MAY BE INTERESTED:**

.....  
.....  
.....  
.....

# Recording Tape and Accessories

## RETURN OF POST SERVICE

All the following items are normally kept in stock for delivery by return of post. In the event of supplies being held up from the makers we advise delivery position by return.

### TAPE

#### SCOTCH BOY

No. 111A. Acetate Base. 200ft. (3") 6/3d. 600ft. (5") 16/- 850ft. (5 $\frac{3}{4}$ ") 22/- 1,200ft. (7") 27/- 2,400ft. (10 $\frac{1}{2}$ ") 61/-

No. 150. LONG PLAY. Polyester Base. 300ft. (3") 9/6d. 900ft. (5") 28/- 1,275ft. (5 $\frac{3}{4}$ ") 35/- 1,800ft. (7") 50/- 3,600ft. (10 $\frac{1}{2}$ ") 110/-

No. 120 High Output. Acetate Base. 600ft. (5") 23/- 850ft. (5 $\frac{3}{4}$ ") 31/- 1,200ft. (7") 39/- 2,400ft. (10 $\frac{1}{2}$ ") 87/-

No. 111V. Super Base. PVC Base. 200ft. (3") 7/6d. 600ft. (5") 21/- 850ft. (5 $\frac{3}{4}$ ") 28/- 1,200ft. (7") 35/- 2,400ft. (10 $\frac{1}{2}$ ") 78/9d.

#### EMITAPE

"88." PVC Base. Message 175ft. (3") 7/6d. Junior 600ft. (5") 21/- Continental 850ft. (5 $\frac{3}{4}$ ") 28/- Standard 1,200ft. (7") 35/- Professional 1,800ft. (8 $\frac{1}{4}$ ") 57/6d.

"99" LONG PLAY. PVC Base. Message 250ft. (3") 9/6d. Junior 850ft. (5") 28/- Continental 1,200ft. (5 $\frac{3}{4}$ ") 35/- Standard 1,800ft. (7") 50/- Professional 2,400ft. (8 $\frac{1}{4}$ ") 72/6d.

#### EMITAPE IN EMICASES

Emitape packed in the new plastic containers.

"88." Junior 600ft. (5") 23/6d. Continental 850ft. (5 $\frac{3}{4}$ ") 30/6d. Standard 1,200ft. (7") 37/6d.

"99" LONG PLAY. Junior 850ft. (5") 30/6d. Continental 1,200ft. (5 $\frac{3}{4}$ ") 37/6d. Standard 1,800ft. (7") 52/6d.

#### BASF

Standard. PVC Base. 150ft. (3") 8/- 300ft. (4") 13/6d. 600ft. (5") 21/- 850ft. (5 $\frac{3}{4}$ ") 28/- 1,200ft. (7") 35/-

LONG PLAY. PVC Base. 210ft. (3") 9/- 850ft. (5") 28/- 1,200ft. (5 $\frac{3}{4}$ ") 35/- 1,700ft. (7") 50/-

#### MSS MASTERTAPE

PM/15. 150ft. (3") 5/6d. 300ft. (4") 10/6d. 600ft. (5") 20/- 850ft. (5 $\frac{3}{4}$ ") 27/6d. 1,200ft. (7") 35/- 1,750ft. (8 $\frac{1}{4}$ ") 55/-

LONG PLAY. 225ft. (3") 8/6d. 450ft. (4") 14/6d. 850ft. (5") 28/- 1,200ft. (5 $\frac{3}{4}$ ") 35/- 1,800ft. (7") 50/- 2,400ft. (8 $\frac{1}{4}$ ") 75/-

#### BRITISH FERROGRAPH

On Hublock Reels. 200ft. (3 $\frac{3}{4}$ ") 12/6d. 600ft. (5") 26/9d. 1,200ft. (7") 45/- 1,750ft. (8 $\frac{1}{4}$ ") 63/-

NOTE.—All Tapes are Standard Play except where shown as Long Play.

### ACCESSORIES

#### EMPTY SPOOLS

Scotch Boy. 3" 3/- 5" 3/6d. 5 $\frac{3}{4}$ " 3/9d. 7" 4/3d. 10 $\frac{1}{2}$ " 16/8d.

Emitape. 3" 3/- 5" 4/6d. 5 $\frac{3}{4}$ " 4/6d. 7" 5/- 8 $\frac{1}{4}$ " 12/6d. BASF. 3" 3/- 4" 3/9d. 5" 4/- 5 $\frac{3}{4}$ " 5/6d. 7" 5/-

MSS. 3" 3/- 4" 3/8d. 5" 4/3d. 5 $\frac{3}{4}$ " 5/6d. 7" 5/- 8 $\frac{1}{4}$ " 13/9d. 10 $\frac{1}{2}$ " 17/3d.

Ferrograph Hublock. 3 $\frac{3}{4}$ " 6/- 5" 7/6d. 7" 7/6d. 8 $\frac{1}{4}$ " 9/6d.

#### LEADER TAPE

Emitape. Available in White, Red, Yellow, Blue, Orange and Green. 4/6d. per coil.

Scotch Boy. Coils of 150ft. Green or White. 3/6d. each.

#### METALISED FOIL FOR AUTO STOP STRIPS

BASF. Coil of 82ft. 8/-

#### SPLICING TAPE

Emitape.  $\frac{1}{2}$ " 7/6d. per coil.

Scotch Boy. 7/32" x 66ft. 3/-  $\frac{1}{2}$ " x 66ft. 4/9d.  $\frac{1}{2}$ " x 150" on plastic dispenser 2/6d.

BASF. Klebeband. Coil of 30ft. 6/1d.

#### JOINTING COMPOUND

Emitape. AP35 for Acetate Base Tapes 7/6d. AP77 for PVC Tapes 7/6d.

#### SPLICERS

BIB. Tape Splicer 18/6d.

Emitape. Tape Jointing Block 17/6d.

#### NON MAGNETIC SCISSORS

Emitape. AP39 16/-

#### TAPE CLIPS

BASF. Plastic clip to fit over the edge of tape reels to keep the end of the tape in place. 6d. each.

#### WEARITE DE-FLUXER

This is a "must" for the serious user of any recorder. 50/-

**TERMS OF BUSINESS.** Cash with order or C.O.D. All tape is post free, but postage is extra on orders under £3 for accessories. C.O.D. fees are charged on C.O.D. orders under £5.

**CREDIT TERMS** are available on orders for Tape and Accessories over £5 in value. Send for details.

**WATTS RADIO (Mail Order) LTD. 54, Church Street, Weybridge, Surrey**

*Telephone Weybridge 4556*

PLEASE NOTE.—Post orders only to the above address.

# MOZART'S "JUPITER" -

## for just 6/-!

There's no better value in the world of hi-fi! Using the *new low-priced* 'Scotch Boy 111A Standard magnetic tape, and recording at 3.75 i.p.s., you can make your own high quality recording of, say, Mozart's 'Jupiter' Symphony, for only 6/-!

#### BRITAIN'S LOWEST PRICED MAGNETIC TAPE

'Scotch Boy' 111A Standard	1200 ft.—27/-
	850 ft.—22/-
	600 ft.—16/-
	200 ft.— 6/3

#### AND A POLYESTER TAPE AT A P.V.C. PRICE

'Scotch Boy' 150 Extra Play	1800 ft.—50/-
	1275 ft.—35/-
	900 ft.—28/-
	300 ft.— 9/6

'Scotch Boy' tapes have always done the job *better*—and now recordists everywhere are rushing to take advantage of the unparalleled value for money that these *new low prices* represent.



# SCOTCH BOY

TRADE MARK

MAGNETIC TAPE

**'SCOTCH BOY' does the job BETTER!**



MINNESOTA MINING & MANUFACTURING COMPANY LIMITED  
3M HOUSE, WIGMORE STREET, LONDON, W.1 AND BIRMINGHAM, MANCHESTER, GLASGOW  
WORLD'S LARGEST MANUFACTURERS OF COATED PRODUCTS