

Vol. 2. No. 3. September, 1926.

Price 1/-

**SPECIAL  
CONVENTION AND EXHIBITION NUMBER.**

**FULL OF GOOD THINGS**

IN 9926 EXPERTS EXAMINING ARTICLES  
FOUND IN TOMB OF AN AMERICAN HAM OP.



**King Tut had nothing like these!**

FOR EXPLANATION OF TERMS See Page 15.



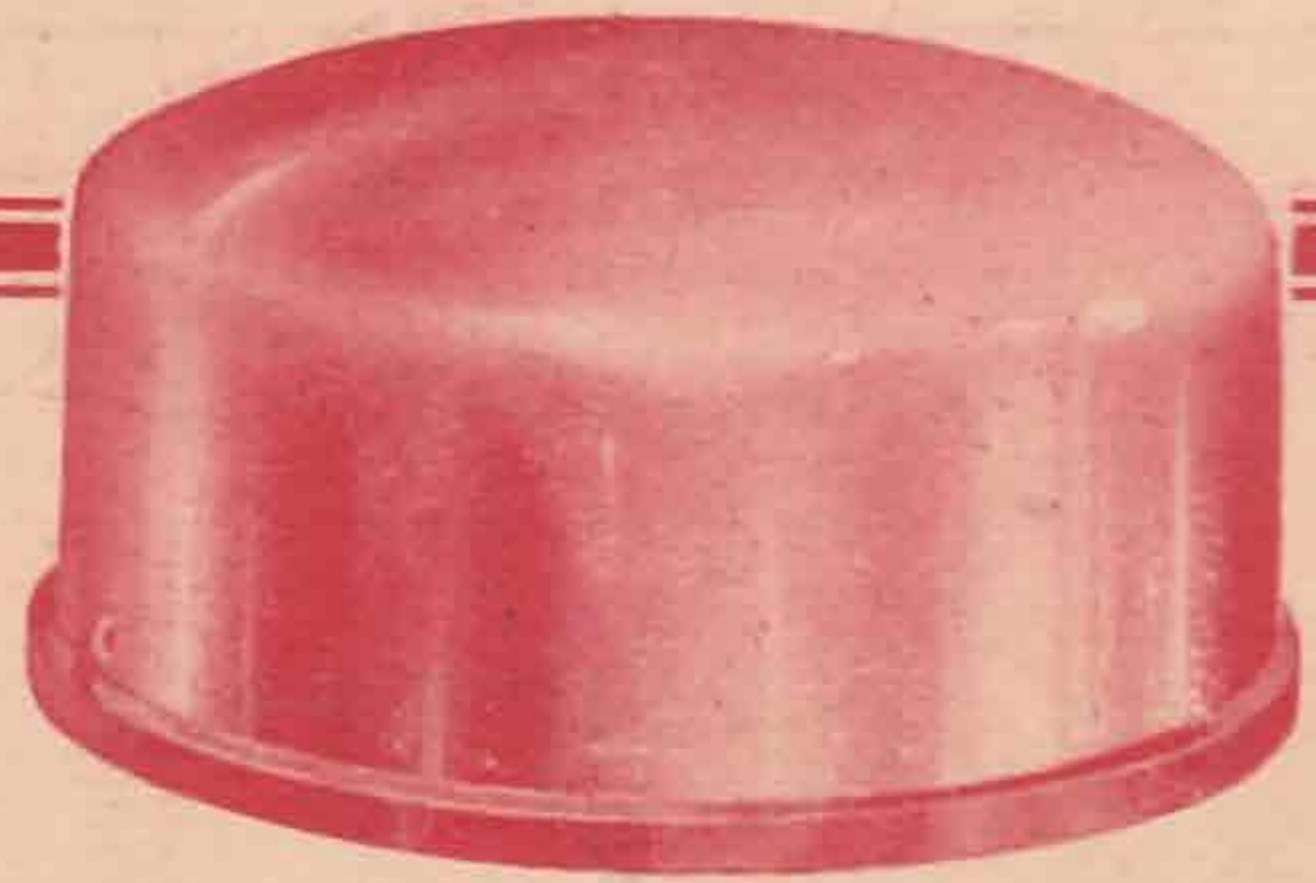

Get this

# BURNDEPT HIGH NOTE BUZZER

**H**ERE is the Buzzer for which you have been waiting. Ideal for wave-meters and many other purposes. One that is self-starting, and trouble free. The note is clear and steady, and of constant frequency. By means of a convenient thumb screw it can be adjusted to vibrate at any frequency from about 500 to 800 per second.

A single 1½-volt dry cell is usually sufficient for operation, the current then being about 40 milamps. but two cells may be used if desired. *The Buzzer is provided with a self-contained non-inductive shunt across the magnet bobbins, and therefore may be placed straight across any coil and condenser to generate radio frequency oscillations.* The Buzzer is circular, 2½ inches in diameter, 1½ inches high. The whole is protected by a bright nickelled brass cover.

**High Note Buzzer No. 403. Price 15/-**

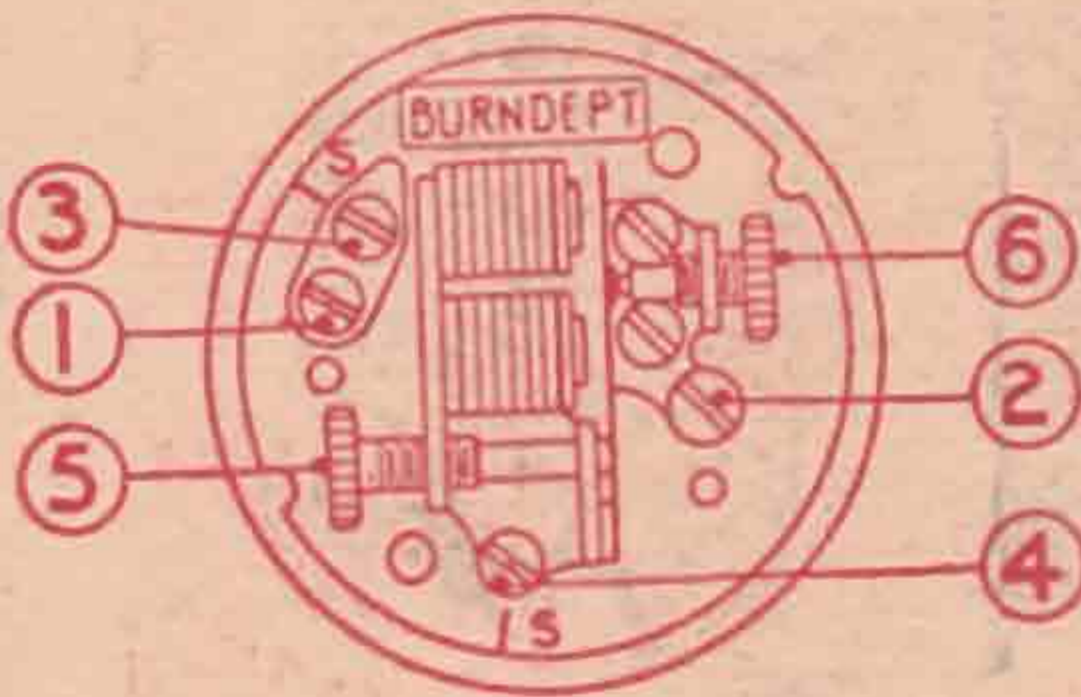

Referring to the Diagram:—

- 1 Screws 1 and 2 are the terminals for connecting Buzzer to any external circuit.
- 2 Screws 3 and 4 are connected to the two ends of the 30-ohm shunt which is wound in the grooved flange of the moulded base; this shunt may be reduced in value if desired by removing some of the wire (each turn equals about 3 ohms.)
- 3 Thumb screw 5 adjusts the tension of the armature and therefore the frequency of the note.
- 4 Thumb screw 6 adjusts the make-and-break contacts (which are made of special non-burning alloy).

**USE  
BURNDEPT  
Super - Valves**

They will give best possible results under all conditions. There is a super-valve — either bright or dull-emitter—to suit every type of wireless receiver and every valve is guaranteed.

# BURNDEPT

**WIRELESS LIMITED**

**Blackheath - - S.E.3.**

'Phone: Lee Green 2100.

Telegrams: "Burnacoll, Phone, London."

**Branches & Agents Everywhere**



# SHORT WAVE Transmitting and Receiving Apparatus

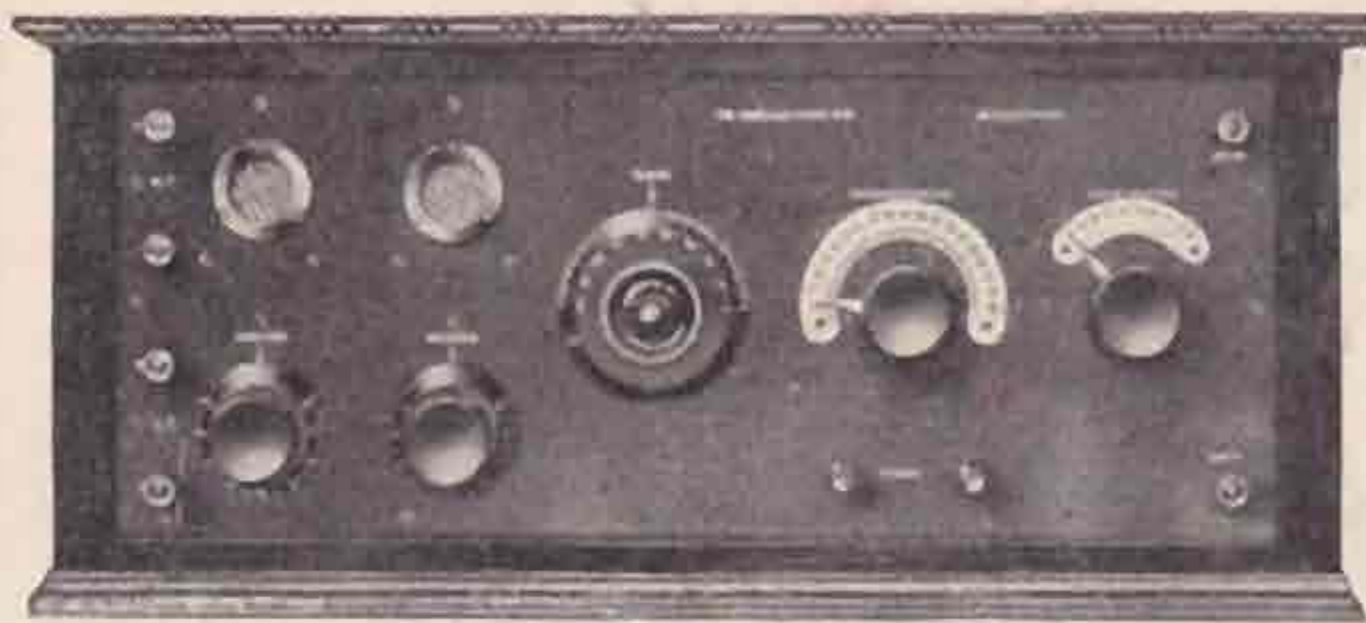

**TWO VALVE, SHORT WAVE RECEIVER.**

15 to 200 metres. Closed circuit tuning. Three interchangeable coils to cover all short waves.

**Price £9 - 10 - 0**

Also supplied with Reinartz circuit

**Price £10 - 10 - 0**

Wavelengths down to 8 metres if required.

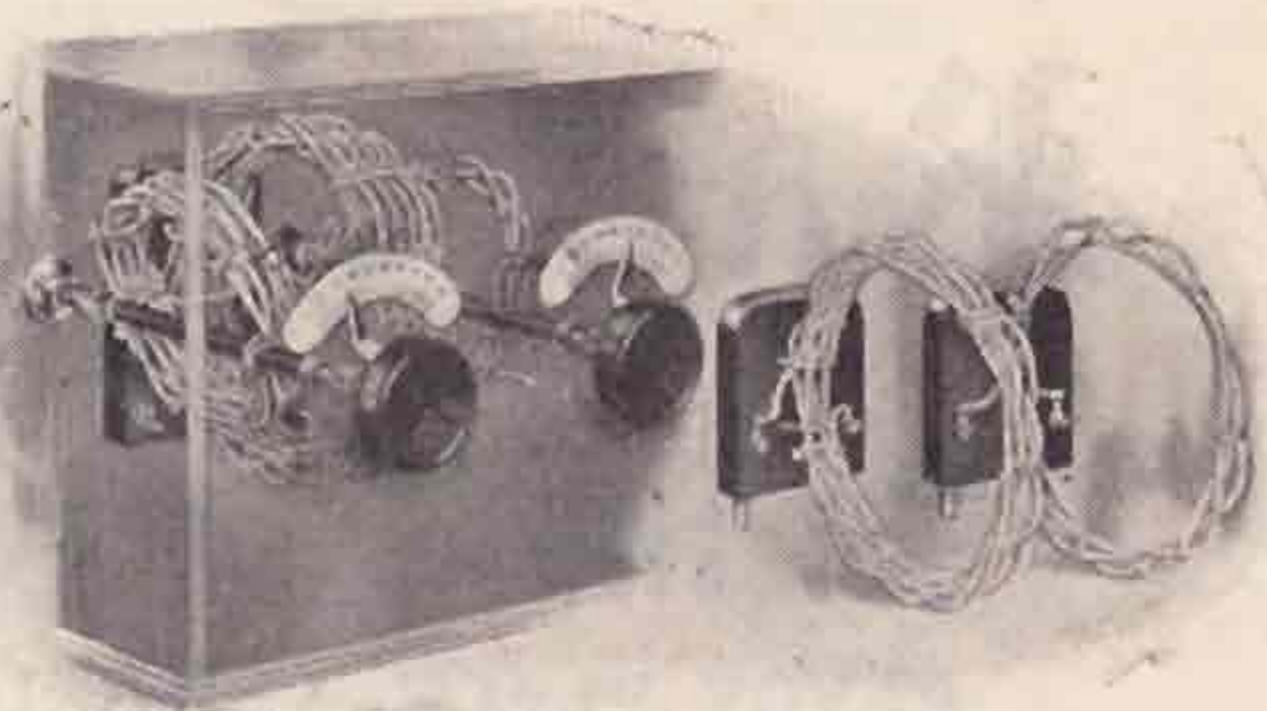

**SHORT WAVE TUNER UNIT,**

as used in our receivers. Complete all mounted up on base board ready to fit behind panel. 15 to 200 metres.

**Price £1 - 0 - 0**

Plug-in oscillator and closed circuit coils for short wave supers, 20 to 120 metres, **Price (set of 9 coils) 35/-.**

*If you have not yet had our price lists of short wave gear, send for them at once. Post free. It will pay you.*

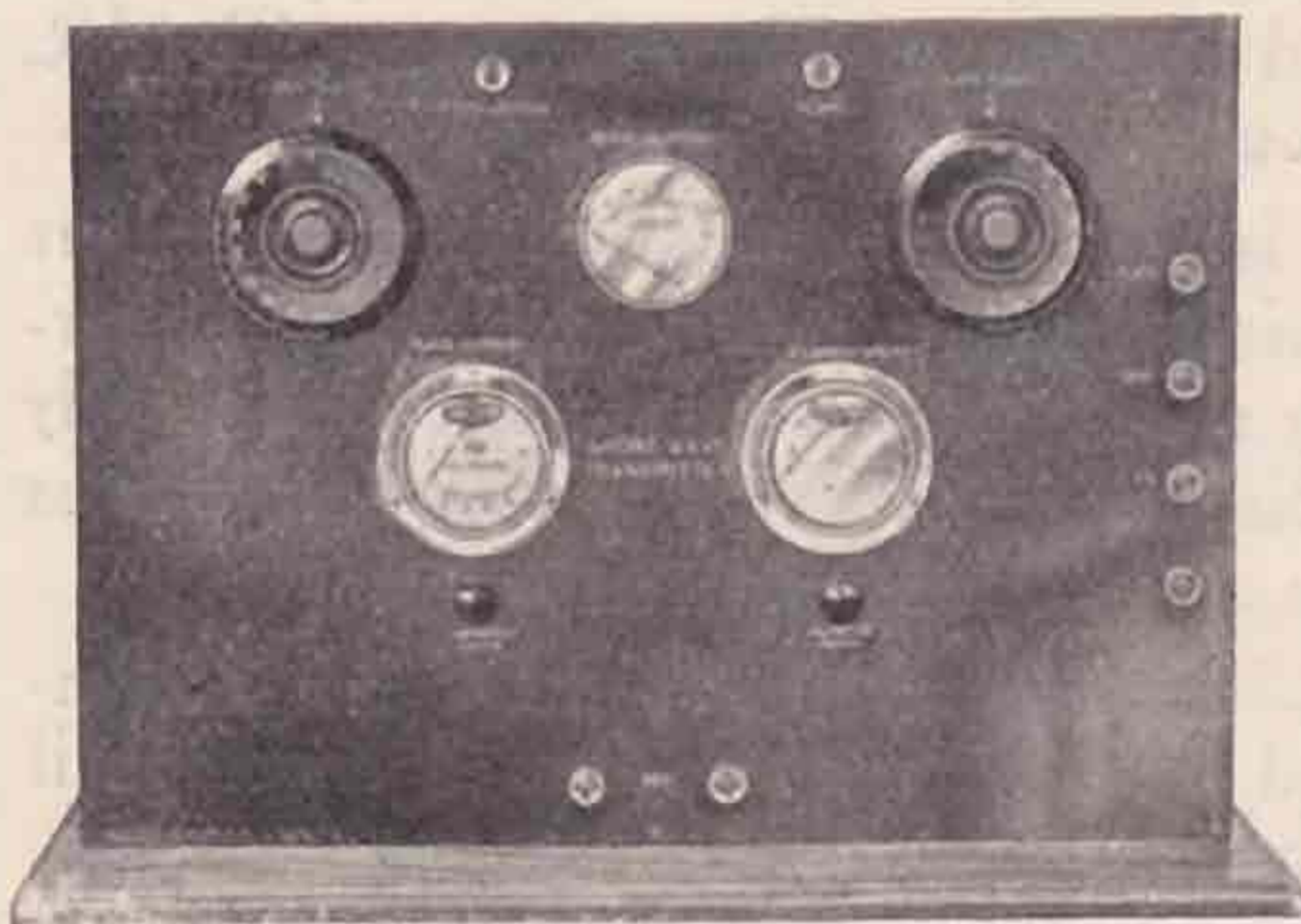

**TRANSMITTER PANELS AND PARTS.**

Standard parts in stock, and any special types made to order. Any wavelength. Above shows reversed feed back panel, suitable for any power from few watts up to  $\frac{1}{2}$  K.W.

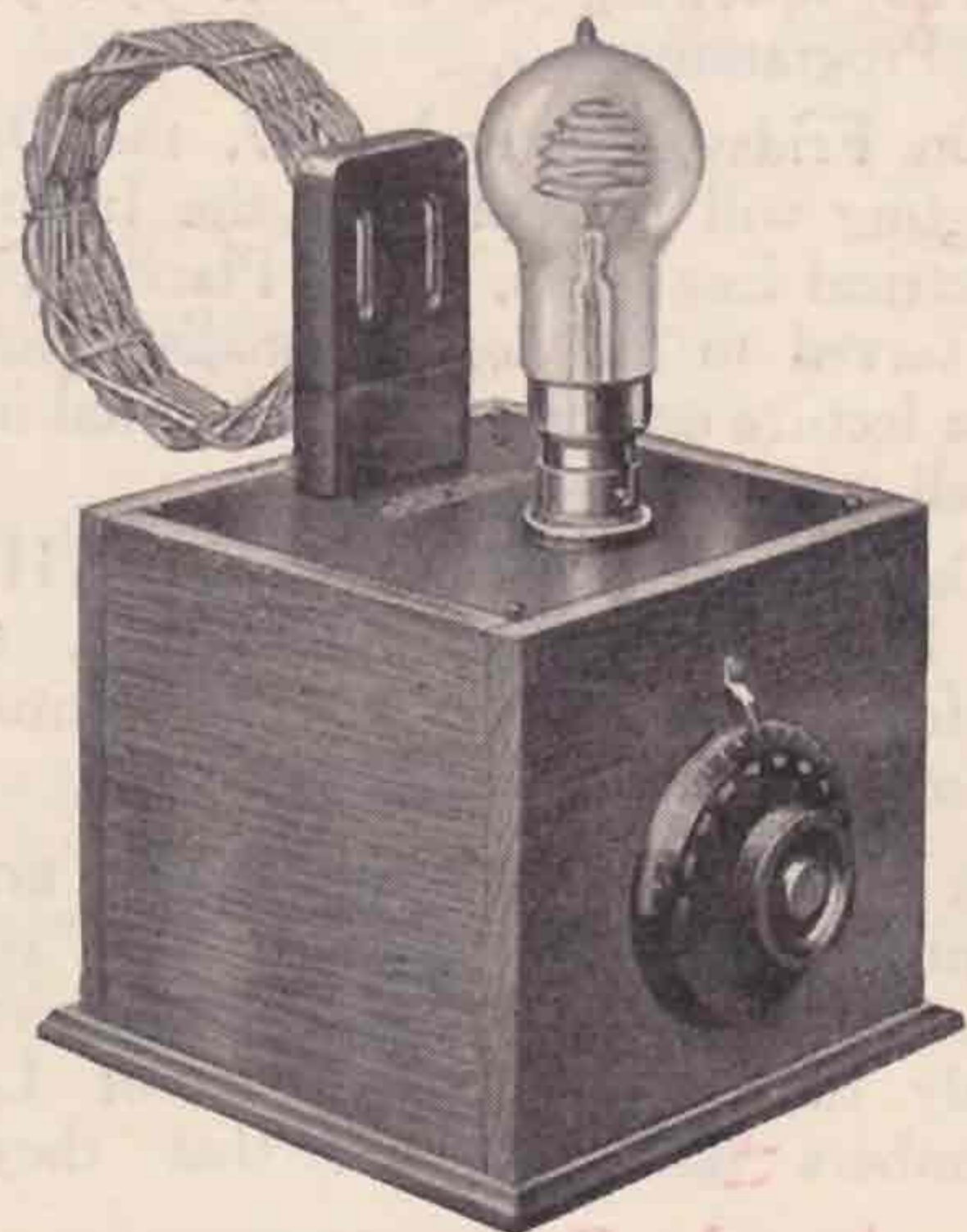

**NEON TUBE WAVEMETERS.**

Absolutely essential to all short wave experimenters. Range 15-200 metres. Can be used on transmitter or receiver. **Price £2 - 10 - 0**

**We are Specialists in experimental work and can save you pounds and hours of wasted time.**

**CONSULT US.**

**ADVICE FREE.**

**THE SOUTHEND RADIO CO., LTD.,  
WICKFORD, : : ESSEX.**

**And at 5, Central Arcade, Southend-on-Sea.**

**Phone: Wickford 5.**



# ATTENTION!

THE FIRST BRITISH AMATEUR

## Radio Convention

WILL BE HELD AT THE

**Institute of Electrical Engineers,**

SAVOY PLACE, VICTORIA EMBANKMENT, LONDON, S.W.1,

**Commencing FRIDAY EVENING, SEPTEMBER 17th, 1926**

### Modified Arrangements.

The following is a brief synopsis of the Programme.

On Friday, September 17, the Opening Meeting will take place at the Institute of Electrical Engineers, Savoy Place. Tea will be served to all Conventionalists, followed by a lecture on some subject of vital interest to all experimenters.

On Saturday, September 18, at 11 a.m., an informal meeting, discussion, and/or conference will take place at the Institute and a similar meeting at 2.30 p.m.

It is hoped to make special arrangements for hotel accommodation at reduced prices for those Provincial Members who apply early, whilst a number of London Members have signified that they will

accommodate a certain number of such members with bed, breakfast, and entertainment free of all charge. As this free accommodation is limited, early application should be made by only those members residing at a distance of more than 100 miles from Charing Cross. Such applications should be made to Hon. Secretary, T. & R. Section.

It is to be hoped that all members will avail themselves of this, the first opportunity afforded to them to meet collectively and discuss matters vital to their interests as Hams and Experimenters.

All correspondence should be accompanied by a stamped addressed envelope if a reply is needed.

**IF YOU VISIT THE EXHIBITION, DON'T FAIL TO COME TO THE CONVENTION.**

**ROLL UP HAMS IN YOUR HUNDREDS AND LET OTHER COUNTRIES SEE WHAT WE CAN DO IN THE WAY OF CONVENTIONS.**



# T. & R. Bulletin

*Devoted to the Interests of the Transmitting Amateur*

— The Official Organ of —  
THE TRANSMITTER AND RELAY SECTION  
of

THE RADIO SOCIETY OF GREAT BRITAIN,  
53, Victoria Street, S.W.1



HON. ORGANISER:

J. A. J. Cooper, GRAD.I.E.E., A.M.I.R.E., F.R.S.A. (G5TR)

EDITORIAL COMMITTEE:

H. Bevan Swift, A.M.I.E.E. (G2TI), *Chairman.* Gerald Marcuse (G2NM), *Secretary*  
R. L. Royle (G2WJ).

ADVERTISING MANAGER:

A. Hambling, A.M.I.R.E., (G2MK).

BANKERS:

Messrs. Lloyds Bank, Ltd., 6, Pall Mall, S.W.1



*The EDITOR will be glad to receive articles and illustrations within the scope of the BULLETIN. The illustrations should preferably be double size and should be original. Contributions should be addressed to 53, Victoria Street, S.W.1., and marked EDITORIAL, ADVERTISEMENTS, Etc.*



## SUBSCRIPTION RATES

*The T. & R. BULLETIN IS SENT POST FREE TO ALL T. & R. MEMBERS.*

*The price to non-members is 1/1 post free per single copy. Non-members may obtain the Bulletin by ordering each copy singly in advance. The Editorial Committee reserves the right to refuse copies to non-members if so disposed.*

## ADVERTISEMENT RATES

*Rates for display advertisements will be sent post free on application. Small advertisements are charged for at the rate of 1d. per word or a minimum charge of 2/6.*



# MORTLEY, SPRAGUE & Co., Ltd.

H.T. GENERATORS

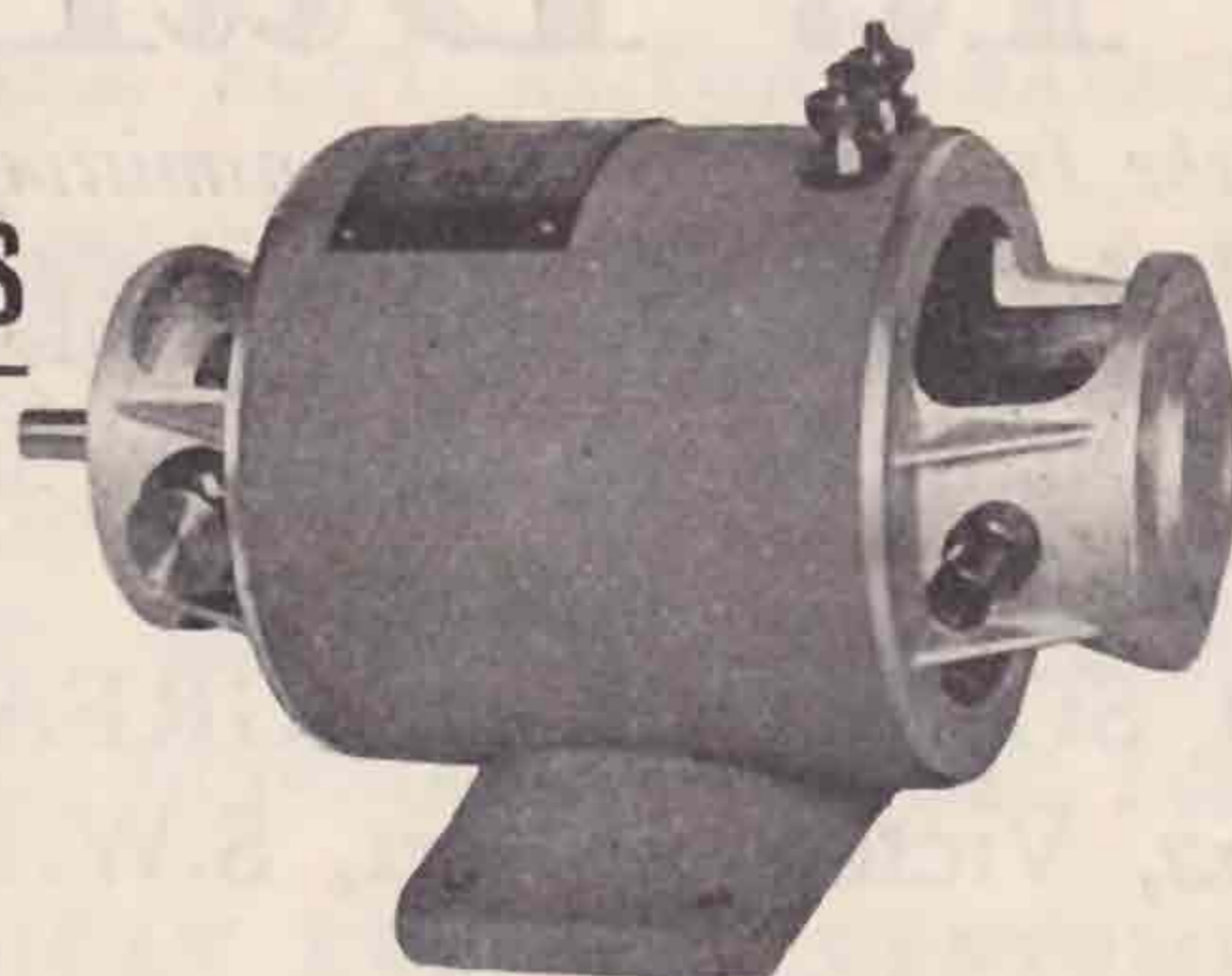

ROTARY

AND

TRANSFORMERS

---

## THE ACCEPTED *IDEAL* HIGH TENSION SUPPLY FOR AMATEURS.

**M**ANUFACTURED in twelve sizes ranging from 10 watts to  $3\frac{1}{2}$  KW. The windings may be arranged to permit of their use either as Rotary Transformers driven by accumulators or D.C. mains, or as double current generator supplying both H.T. & L.T. when driven by a motor or other prime mover.

**W**RITE stating whether you have mains supply or only accumulators and I will give you every possible information regarding the most suitable machine for your particular conditions and requirements.

**Y**OU will be under absolutely no obligation whatsoever, but it is essential that you should make your requirements known to me immediately in order to ensure delivery in time for the approaching DX season, as the manufacturers are working to full capacity on Government and other contracts.

**IT IS SURELY MORE THAN A COINCIDENCE THAT *MORTLEY GENERATORS* HOLD ALL WORLD'S DX RECORDS AND ARE USED BY LEADING AMATEURS THROUGHOUT THE COUNTRY.**

---

*Write for fullest particulars.*

# SEC SELDOM SLEEPS

---

KENYON SECRETAN — BARNES, LONDON, S.W.13. — TELEGRAMS KENSEC, HAMMER, LONDON.

PHONE: RIVERSIDE 1492.





# T & R



# BULLETIN.

*The only British Wireless Journal Written and Published by Amateurs*

SEPTEMBER, 1926.

Vol. 2. No. 3.

## Is it worth it?

THIS is the question which the average man asks himself when considering the desirability or otherwise of becoming a member of a learned society or institution. The question is not unnatural, seeing that most societies ask that their members pay a sum of money annually in order to defray administration costs, etc.

Let us, then, follow this natural inclination and analyse the gains and losses involved in becoming a member of the T. & R. Section of the Radio Society of Great Britain.

To summarise, our main objectives are:—

- (1) To establish more intimate contact between transmitters and those interested in wireless experiments generally.
- (2) To secure mutual protection in the matter of legislation affecting users of the ether.
- (3) To collect and distribute knowledge and data relative to radio matters.
- (4) To form a bond of fellowship between all those persons interested in the Radio Art.

To outline a few of the advantages accruing from membership of the T. & R. Section:—

### (1) The T. & R. Bulletin.

Membership of the Section carries with it the privilege of a free monthly copy of the BULLETIN, which arrives through the post. As a paper it is quite unique in that it is our own property, written by transmitters and other experimenters for transmitters. It is replete with original gadgets and ideas, and contains matter which could never be dealt with in any wireless periodical which has to find its public among broadcast listeners as well as research enthusiasts. Furthermore, everything featured in the BULLETIN has achieved results, and is written by bona-fide experimenters and not mere hunters after sensational commercial stunts, who merely desire to boost up their circulation week by week or month by month.

### (2) Small Adverts. in the "Bulletin."

Devotees of radio have often surplus experimental gear which has served its purpose, and of which they wish to dispose. These may be advertised for sale in the BULLETIN at a very low cost for the advertisement. These small ads. reach the right people, and it is quite sufficient commendation to say that no advert. has yet failed to achieve its purpose; *in fact, most items advertised could*

*have been sold many times over by this inexpensive means.* Therefore the use of our EXCHANGE AND MART columns is a financial asset to the experimenter.

### (3) QRA and QSL Department.

Have you ever experienced that hopeless feeling when you are unable to find the QRA (address) of a transmitting station to which you wish to send a report? Have you ever been told by a foreign station that your reports cannot be replied to owing to the heavy postage expenses involved? Our QRA and QSL Section, under the management of Mr. C. A. Jamblin (6BT), of 82, York Road, Bury St. Edmunds, will put this right for you. There is a big scheme in operation whereby you send him your foreign mail properly addressed in bulk and he forwards it overseas to clearing houses which have been arranged, by whom it is delivered. If you want your QSL cards sent to you without delay you send a packet of large stamped addressed envelopes to Mr. Jamblin (addressed to myself), and every week you will receive whatever foreign mail that has arrived for you. If you number the envelopes which you send they will be returned to you week by week or as desired in numerical order so that you will know when your envelopes have been used up. The address Section of this Department is the finest in this country and is at your disposal.

### (4) Permits and Licences.

It may not be known to you, but our Committee works in close contact with the Post Office, and in certain circumstances will make representations concerning licence questions generally. We have a number of rules, the adoption of which will make the use of the ether a joy for you and your BCL neighbour. Our aim is a clean ether for all to use, and your observance of the rules will help us to bring this about. It is up to you to help.

### (5) Research versus Amusement.

The growth of the broadcasting services has made the position of the experimenter and transmitter a difficult one, and it is becoming more and more important that a watch is kept on Legislation and other similar matters which affect their interests. Whilst transmitters number but thousands the number of broadcast listeners is legion, and the transmitter and experimenter is too valuable a person to be crushed out of existence. Therefore we are watching your interests in this connection,



and are in a position to bring pressure to bear if and when required.

#### (6) Technical Advice.

There is a technical advice section of the BULLETIN by means of which members are able to obtain some of the best expert advice in the country on technical problems on payment of a small fee to cover postage, etc. This is a distinct and separate service to that afforded by the columns of the BULLETIN, and is at your disposal.

#### (7) American Service.

Arrangements have been recently completed whereby we are enabled to reproduce in the columns of the BULLETIN any articles of special interest published in "QST," the official journal of the American Radio Relay League. You are, therefore, assured of being kept well informed on matters pertaining to radio in America, which, after all, is the home of amateur radio work.

#### (8) Individual Representation on Committee.

The T. & R. Section is constituted on democratic principles and for the purposes of administration the Counties of the British Isles have been grouped into Areas. Each Area or group has its accredited representative on the Committee, and is equipped with full voting powers for all matters under discussion.

#### (9) Arbitration in Disputes.

No matter what the subject is, there is always sure to be little difficulties and disputes arising between ordinary human beings. The T. & R. Committee adjudicates on any disputes between members if called upon to do so, and will, in certain cases, make suitable representations to the disputants or whoever may be concerned.

#### (10) Membership Certificates.

It is good to have a hobby or to be interested more than superficially in any art or craft. It is better still to have some kind of status in your chosen work. Every member who has paid his current subscription is entitled to an illuminated certificate of membership free of charge. The certificate is a tasteful piece of work, and will grace the walls of your den or workshop. When you have your certificate you are identified as a serious experimenter and have the status of being a member of the oldest and most learned of wireless societies in Great Britain. Your name is placed on a list which contains the names of all the leading experimenters in the world—surely something to be proud of?

#### (11) Badges.

A neat design of coat badge has been recently evolved at T. & R. Headquarters, and is obtainable by members only on payment of a few coppers.

Small line blocks suitable for you to use on your note-heading are also obtainable, as well as rubber stamps bearing the device. A similar enlarged badge suitable for use on your car is under consideration. The badge will identify you to all serious wireless men.

#### (12) Lectures and Discussions, etc.

We hold fortnightly meetings at the Institution of Electrical Engineers, Savoy Place, Thames Embankment, at which lectures and talks followed by discussions take place. The lecturers are generally people who are well known in professional and amateur circles, and the proceedings are generally preceded by a buffet tea, free of charge. Occasionally we hold informal meetings, at which you are free to converse with brother experimenters,

and once a year we hold a Convention—the only one in the country.

In addition to the above you are entitled to compete for the following prizes, diplomas, etc., or to enter any of the competitions.

#### Diplomas for Members.

We have completed arrangements whereby we are able to present two very special diplomas of merit in certain cases. The first and most important of these will be presented to members who have contributed some specially good work to the radio art. This does not mean that we propose to issue them to those people who have carried out two-way transmission with some long distance station on microscopic power; rather it is to be given as an incentive to invention, research or experiment. The primary aim is to encourage work in this direction as opposed to mere "brass-pounding." Details of the work of the recipient of these diplomas will be published in the BULLETIN. Full particulars will be published in a later issue of the BULLETIN, but it might be said that it will be necessary for an applicant for one of these diplomas to get a number of members to back his application on its merits.

The other diploma will go to members who, in the opinion of the committee, have contributed some extra special services for the well-being of the Section or the BULLETIN. Both diplomas will be something very good, and we anticipate that this venture will result in much good and profitable work on the part of members.

#### Meters for Increasing Membership.

Mr. Bland Flagg has kindly placed a "Sifans" milliammeter at the disposal of the Section to be presented to the member who succeeds in introducing the largest number of new members during the current year.

#### For Working Canada.

Canada IDD, Major C. W. Borrett, has offered a trophy to the Section to be presented to the member working the largest number of Canadian stations during the current year.

#### Why?

Having described the Section in such glowing colours, you will naturally ask: "Why does this man write in such a glowing strain on his Society?" or "What axe has he to grind?"

The answer to the first question is that we at Headquarters in Victoria Street feel ourselves charged with the care and the well-being of the amateur radio experimenter. We feel that radio has a vast future before it, and will mould the destiny of humanity in years to come. We feel that it is our duty as the oldest and representative Society of the British experimenter to give all that we are able to spare and do all that we can do in order to assist our brother enthusiasts in the Empire. The Empire is scattered, and until a few years ago it was a journey of many days in order to deliver a spoken message to our fellow countrymen across the seas. Now we are very close to our kinsmen; so close, in fact, that we are able to speak to them nightly without difficulty—speak over thousands of miles from our own homes and workshops. We have grown to know foreigners as we know our next door neighbours, and in knowledge comes understanding. The furtherance of radio makes these things possible. We have got down to the task and will not let go until it is beyond our capabilities to carry on. We want to give an even



better service, and in order to do so we want your membership.

We have no personal axe to grind. No member at Headquarters makes a penny piece from your membership fee, and all we get is a plentiful supply of hard, strenuous work. Yet we are at your service and are glad to be able to give you this service for 15s. per annum—nothing more.

#### Question.

Are you seriously interested in radio either from a transmitting or a receiving point of view? Are you a serious researchist or do you experiment? Do you want companionship or guidance in your work or hobby? Do you want sometimes to put your ideas or work on permanent record for others to see and speak of? Do you sometimes wish to meet brother experimenters and discuss things generally? Are there times when you want help in the matter of your licence? Would you like to be identified with the pioneers of radio telegraphy and telephony? Are you in any way interested in wireless?

#### Answer.

If the answer to any one of the above questions is "Yes" you should be one of us, for you cannot do without us—for long. We are entirely at your disposal, and can satisfy your requirements. Join us AND DO IT NOW.

## Section Notes.

The question of the revision of the Section rules came under consideration, and, after discussion, it was decided to form a sub-committee to arrange the various proposals put forward and get the rules into concrete form and distributed to all members for consideration at the Convention.

\* \* \*

It was decided to hold the Convention on September 17 and 18 in the form announced in the BULLETIN for August.

\* \* \*

It was also announced the RSGB would have a stand at Olympia. This will form a convenient rendezvous for members during the Exhibition.

\* \* \*

The list of members is to be proceeded with forthwith.

\* \* \*

It was decided to adopt a badge for the Section upon the lines of the ARRL well-known "diamond" design.

\* \* \*

Arrangements are to be made for a series of low-power tests in the near future.

\* \* \*

The Hon. Organiser and Advertising Manager of the BULLETIN made their usual monthly reports and rendered statements of account.

\* \* \*

It was decided to attempt to make reciprocal arrangements with other Societies abroad for the collection and exchange of subscriptions.

## The Measurement and Calculation of Aerial Constants.

By G. L. MORROW (G-6UV).

**A** KNOWLEDGE of the constants of one's aerial is, if not an absolute necessity, at least an enormous use to those transmitters who are carrying out investigations into the properties of short waves. It is hoped, therefore, that this article may be of interest to members of the T. & R. Section, and possibly prove of some use to those who are just entering into the ranks of the active transmitting fraternity.

First of all, what are the aerial constants in which we are most interested? In order of importance, we may set these down as follows:—

- (1) Fundamental wave-length.
- (2) Radiation resistance.
- (3) Loss resistance.

There are, of course, a large number of other important factors connected with aerial constants, but it will be found that most of these are intimately connected with one or other of the above three.

Let us consider (1) in some detail; any aerial system, when excited at its base, will have a natural or fundamental wave-length depending on the geometry, length and height of the particular system.

For our purpose, we shall merely consider aerials of the conventional inverted "L" type and the vertical or semi-vertical arrangement which is so often used in amateur stations.

As most of us are severely limited by available space and other considerations, our aerial systems are usually an attempt at the "best possible," rather than specially designed to suit the particular end we have in view. Therefore, in regarding the geometry or physical shape, all one can do in the scope of this article is to generalise and consider the case of "L"-aerials where the height is the maximum obtainable and the lead-in taken either straight down from one end—the lower where of unequal height—or making a slight angle with the horizontal spread. The length of such a system is that, from the aerial terminal of the set to the extreme far end, and if, as is usual, this is measured in feet, then the figure thus obtained must be 0.3048 to give the length in metres.

It has been established that for "L"-aerials the natural wave-length will be—very approximately— $l \times 4$ , and for a vertical system 4 to 4.5 $l$ .

Now these figures are only approximately accurate when the distributed inductance and capacity of the system are uniform. The distributed inductance will only be uniform when a single wire is used and—and this is important—where there is a complete absence of magnetic material in the proximity of the aerial. It will be obvious that this latter condition is hardly ever met in amateur stations. Where a number of wires are used, the distributed inductance of the top-hammer will be different from that of the down-lead, but as the distributed capacity will also vary, the nett result will be very nearly the same, so that the figures given above may also be used.

It is, however, practically impossible to cal-



culate the effect of stray conductors near the aerial, so that, to obtain a reasonably accurate idea of the natural wave-length of the system, steps should be taken to measure this.

This is, contrary to what is often thought, very easy to do. The aerial coil is first removed and replaced by a single turn of very small inductance, to which is loosely coupled a medium power valve oscillator. The frequency of the driver is then varied until a maximum reading is obtained on the aerial ammeter. When this is obtained, the frequency of the driver is measured by a wavemeter, and the result is the natural wave-length of the aerial system. In taking this measurement it is important that the aerial meter used be of the thermo-couple type, and not of the hot-wire variety.

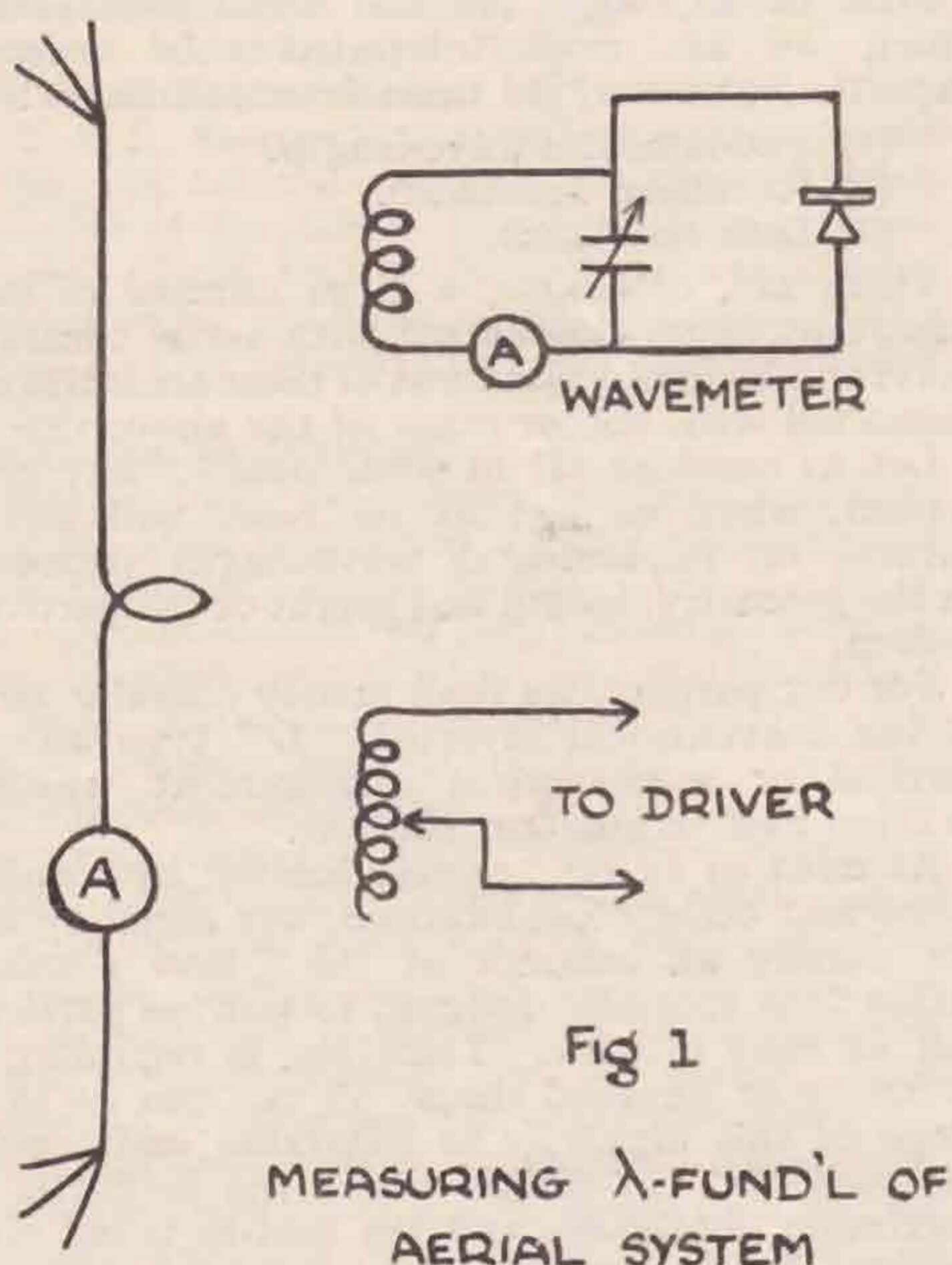

The circuit used is shown in Fig. 1.

So far, no mention has been made of the counterpoise; as this may be considered as a small capacity in series with the aerial, the aerial capacity is decreased, and, therefore, the natural wave-length. Here, again, the actual effect is very difficult to calculate, but may be determined by measurement by the means given above, save that the counterpoise is connected to the aerial system in place of the conventional earth.

The height of the aerial above ground or counterpoise will govern the distributed capacity, hence it becomes necessary to determine the height of the system. Such height is not the actual measured height but the "Effective" height.

This effective height is always less considerably than the actual height, and is mainly governed by the distance between positive and negative charges on the aerial, proximity of earthed or partially earthed conductors, screening, etc.

It is impracticable for the amateur to measure or calculate the effective height of the aerial, so recourse must be had to an approximation; in general, for aerials with not more than the average

amount of screening, etc., the effective height may be taken as about two-thirds the actual height in metres.

The importance of aerial effective height is bound up with the radiation resistance, which we shall consider next.

To determine the power in watts, put into the aerial—not necessarily the power radiated as useful power—we must know the current in the aerial system and the total resistance of the aerial at the frequency in use, and from Ohm's law the power supplied to the system can be calculated.

The aerial current may, of course, be taken directly from the aerial ammeter, care being taken to see that this instrument is placed at a current node, and is of negligible resistance compared with the aerial itself, *i.e.*, a thermo-couple meter.

The total effective resistance of the system is given by the radiation resistance plus loss resistance.

Now radiation resistance is really a fictitious resistance, and may be considered as a resistance having a value which would absorb the same power as that actually expended in the circuit for the same current.

Now this definition gives us a clue to the method to be used for measuring the total resistance of the aerial system, but before considering this, it will be as well to show how the radiation resistance may be calculated.

Such resistance is directly proportional to the effective height and inversely proportional to the wave-length as is shown by the formula for radiation resistance:—

$$R_r = 1,580 \frac{h^2}{\lambda^2}$$

To the value of radiation resistance thus obtained must be added the loss resistance in order to obtain the total resistance. Loss resistance is due to a number of causes, which are as follows:—

- (1) Dielectric losses in bodies near the aerial.
- (2) Eddy current losses in nearby conductors (mast stay wires, halliards, etc.).
- (3) Ohmic resistance in aerial and counterpoise.
- (4) Insulation losses.

Unfortunately, with the exception of (3), none of these losses can be conveniently measured or calculated, but as their sum should not exceed, say, 10 per cent. of the radiation resistance at wave-lengths above 100 ms., we may take this percentage as a fair working figure. Ohmic resistance will usually, with well-made aerials, be under 10 ohms.

Now, it is most important to bear in mind that, of the above losses, those due to dielectric and eddy current losses are the most important.

Those due to dielectric losses are a direct function of the frequency, and are not, therefore, so serious at wave-lengths of the order of 23ms. and 45ms. as those due to eddy currents which are an inverse function of the frequency; in fact, unless special care is taken as far as possible to minimise these losses, they may easily approximate to a large proportion of the total resistance at short waves.

Before considering the measurement of total resistance, a word of warning is necessary: when an aerial system is being worked well below its fundamental wave-length, the calculation of its constants, especially radiation resistance, becomes

(Concluded at foot of column 2 on page 7)



## A Plea for More Scientific Work.

I AM, I should think, fairly certain to be taken to task for this effort at pen-pushing, and if so, I shall welcome it because it will show that fellows are interested.

Because most stations are now QSO the whole world we are apt, sometimes, to think that the field for investigation of S/W problems is more limited than, say, two years ago. Is it? I think one may go as far as to say that it has been greatly increased, for the lure of DX is wearing off and we have more time to devote to investigating what has made this extraordinary DX possible.

It is now a very simple matter to lash up a transmitter and work stations all over the globe with a very few watts in the aerial; even the BCL papers have articles on how to make dry cell transmitters!

It's all very nice to hear the other man say "R OK OM QRK R7 UR SIGS QSA VY ES QSB FB. GLD WK U OM ES HOPE CUAGN. NM HR NW G N OM 73S AR SK." (I do it myself.) But where is it leading us? Surely the time is ripe for us to get together and collaborate our results on a scientific basis and by means of some kind of clearing-house run on something of the lines of the A.R.R.L.'s Experimenters' Section; see if from the mass of data which exists we cannot formulate some of this into useful facts. I believe that if such a scheme was put into operation by the T. & R., with definite problems for investigation, it would meet with enthusiasm.

Take, for example, the still vexed question of aeri-als; some of us use the Hertz, some harmonic working, others, again, by exciting near the fundamental. One type gives better results to one man, while someone else gets his optimum results by the use of some other type. Now these things don't just happen, there's a reason for everything, and it's up to us to get to find those reasons. Don't let's just try aerial (say) after aerial until we hit on the one which suits us best in a sort of happy-go-lucky fashion, but let's try and dig out the whys and wherefores of such things. This can be done if it is tackled in the right way, and it's not so very difficult after all.

Firstly, we must determine in advance what we are going to do and stick to it until we get something tangible even at the expense of a few QSL cards!

Often purely negative results give quite as important information on a subject as positive ones; that is to say, if we anticipate certain things happening, and—they don't—there is pretty certain to be a good reason for it, and often that reason is going to be interesting not only to one of us in particular, but to all of us in general.

Let me give a case of my own to illustrate this. About 12 months ago, when working SMWF on 45, my note, which had been previously DC, was reported by him to be RAC, and bad at that. As I used a M-G and big smoothing system this appeared strange to say the least of it, and more so, when at the same time 2QM, at Glasgow, reported me still DC, a U station as like a band saw, and a man in the South of France as DC.

Well, to cut a long story short, I fixed up a schedule with SMWF, and after about a week had the note cleaned up and some most interesting dope on the relation between skip distance and high-speed fading.

Having settled down to a particular problem, let's set about it on the right lines. One of the main factors to success is patience and the determination to run all tests in connection with the work in hand under, as far as possible, the same conditions. That is to say, if we start up one midnight with 5 watts in the aerial and the next night cheerfully put 7½ in, then we ought not to wonder why the other man gives an entirely different report. Another thing, always keep to schedule. Be on the job when you say you will, and if when you are working your test you hear a man in High Street, China, call you, leave the lust for DX alone for once.

Now I hear some fellows saying that this experimenting is all very nice and laudable, but it means measuring instruments, and these cost good money which might be spent in that larger bottle. Believe me, a great deal is and can be done on a good wave-meter, H.T. voltmeter, and feed milliammeter, and if we haven't got these, how on earth can we ever know if we are anywhere near the terms of our permit?

Why not let the big bottle slide awhile and get a few meters? Seriously, I put forward the suggestion that the T. & R. form a Research Section, draw up a number of problems requiring investigation and there ARE some), and get a list of those men together who are willing to work on them and allot them accordingly, with the results to be published in the BULLETIN at the Editor's discretion.

Anyway there the thing is. What do the rest of the gang think about it.

G. L. MORROW (G6UV).

[ED. NOTE.—The plan outlined by Mr. Morrow appears to be quite sound, and we should like to hear other people's opinions, and if necessary carry it into execution.]

### Measurement and Calculation of Aerial Constants—(Continued from page 6)

very involved, and serious errors may easily creep in.

In a future number of the BULLETIN it is hoped to deal with this phase.

To measure the total resistance of the aerial, the usual transmitter is used, with the power cut down to a point which will only just give a small reading on the aerial meter, which should be placed at the base of the system. Now, at the base of the aerial, add a non-inductive resistance of sufficient value to cut down the aerial current to approximately 50 per cent of its former reading, being careful in no way to alter the constants of the driver. The value of the added resistance is now very nearly equal to the aerial resistance. In case a calibrated resistance is not available, the added resistance may be determined by a simple bridge method.

Knowing the normal operating current, one can easily calculate the power input to the aerial by substituting in the formula  $W=I^2R$ .



## Tuning Transmitters.

By G. W. THOMAS, 5YK, AND D. C. BIRKINSHAW, 2BFM.

SOME experiments have recently been carried out at 5YK on tuning transmitters, and it is proposed to give an account of these, with the conclusions arrived at, in the hope that they will be of use to any newcomers to the ranks of the hams and will draw criticism from the old-timers.

First, a very brief description of the apparatus used. The circuit is the Armstrong tuned grid and plate (see Fig. 1), coupling between the grid and plate coils being through the internal capacity of the valve, an O/40 Mullard. Power is obtained from 90-A.C. mains, transformed to 1,000 volts, rectified by one LS2 and smoothed by one mfd. and 20 henries. The grid leak is an 80,000 ohms wire wound affair (it is tapped, but the full resistance is always used). The aerial is an inverted L, working at the 2nd harmonic, average height 38 ft., total length 90 ft.; ctp 3 wires, each 30 ft. long (then fruit trees, hi!).

The set used to be adjusted for a combination

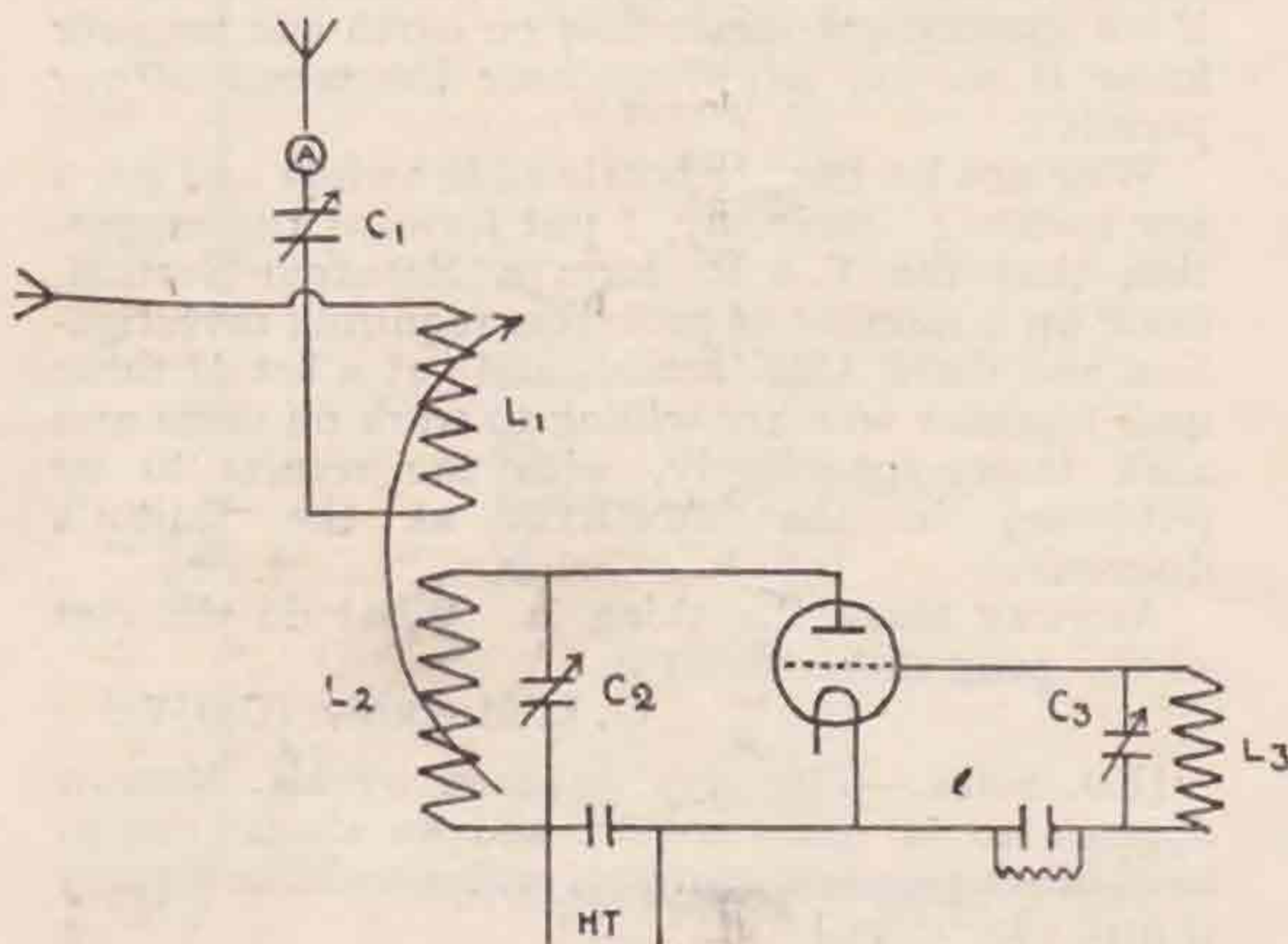

FIG. 1.

### CIRCUIT DETAILS

C1 and C3, .0003 mfd.; C2, .0001 mfd. L1, maximum of 10 turns, 5½" diam., 1 cm. spacing. L2, 20 turns, 5½" diam., 1 cm. spacing. L3, 4 turns, 4" diam., 1 cm. spacing. All coils of No. 14 copper wire, threaded on to three thin ebonite strips. Chokes in all power leads.

of 45 metres and maximum aerial amps., but the QSB was always RAC and not too steady. The question arose, was the set properly tuned? And it was suggested that tuning the antenna circuit might shift the nodes into or out of the aerial ammeter. This was proved by the fact that a counterpoise ammeter required a slightly different setting of the tuning condenser to give a maximum reading. It was also realised that the coupling was too tight, as on one side of the A.T.C. the input fell off and on the other side it rose very high and the set stopped oscillating.

Now with load off the set the input should be a minimum when the grid and plate coils are in tune, the oscillations then being strongest. The set was therefore adjusted for 45 metres with minimum input, 5 milliamps, but with the aerial completely

uncoupled. The aerial ammeter was now shorted, the aerial coil loosely coupled and tuned for maximum input. The coupling was now increased until any further increase would cause the set to stop oscillating. The coupling was now about 5" and the milliamps 15, and we argued that this extra input must be going into the aerial as radiated energy; however, the QSB was still bad, the wave still unsteady, and the set didn't seem to get out; it was, of course, being badly forced.

The aerial ammeter was next de-shortened, and it was at once apparent that the coupling was too tight, i.e., the resonance curve had two humps which showed up in the aerial ammeter, but not in the milliammeter. The coupling was therefore loosened until the humps just united, and, great, the QSB was getting near to D.C., and the wave much steadier; the milliamps now showed about 12. It was quite possible to obtain a larger aerial current by retuning the aerial circuit, but this was not done for the reason explained earlier.

The coupling was now about 8", and it was observed that by weakening the coupling to 12" a maximum aerial current could be obtained, although the milliamps fell still further to about 9-10. Also all stations worked reported a maximum signal strength at 12" coupling, together with a very steady D.C. note. This improvement in note is due to the sharpening up of the resonance curve, so that the side bands of  $(F-f)$  and  $(F+f)$  (where  $F$  is the frequency of the transmitter and  $f$  the frequency of the ripple) are cut out altogether. It has also been found that a grid leak of about 80,000 ohms produces maximum aerial amps. (other things being left alone), and also helps to give a D.C. note. This also is due to the sharpening up of the grid coil resonance curve, so that it is more selective to the feed back from the plate circuit.

At this point the A.T.C. was shorted and an untuned aerial was tried fairly tightly coupled. The tuning of the grid circuit was now left untouched, but for every change in the aerial coupling, the plate circuit was retuned for minimum input, and it was found that maximum aerial amps could be obtained when the coupling was from three to five inches, depending upon how close the natural wave-length of the aerial was to 90 metres. Tests with European stations reported no difference, whether the aerial was tuned or untuned, but American stations report considerably better results with an untuned aerial, the best wave-length for an untuned aerial being slightly below 90 metres. The milliamps using the untuned aerial rose to about 10-11, while the QSB and steadiness remained as good as the best adjustment of tuned aerial gave.

This is not meant to be the last word in tuning transmitters, though it does show what can be done with a little care, and also that it is not necessary to have a perfect full wave rectifier and filter to obtain a D.C. note from A.C. mains.

Experiments are still being conducted on untuned aerials, which may possibly form the substance of another article at a later date.

C.U. SEPT. 17th-18th.



## G5QV.

### A Description of the New Q.R.A. at 5QV.

By C. BRYANT.

I RECENTLY had the pleasure to run down East to see the new Q.R.A. of 5QV at Clacton. I found little difficulty in locating him; in fact one could not very well miss the tall aerial mast with its flags of different nations fluttering in the breeze.

While ringing the bell, I noticed an aerial design and the call sign worked in Venetian style on the door. A bay window at the side of the house was designed in similar fashion, but on a far more elaborate scale, giving a very picturesque effect in emerald, amethyst and deep orange, a replica of the house, complete with aerial and call sign. This class of work, I understand, is a local industry, and this particular piece quite a novelty.

The aerial system at 5QV's comprises a single wire, gauge 12, 105 feet in length. Counterpoise, 105 feet single 14 gauge enamelled, and the usual tuned earth arrangements when needed.

An earthing switch with large current-carrying capacity spaced 6in. from the building is installed for protection during storms, an added safeguard being a lightning ribbon attached to the chimney-stack of the house.

The room where all the work is done—room, did I say? A liner's cabin would, perhaps, better describe it! Here 5QV has excelled in arranging and placing all his apparatus. Everything is easily accessible from the operator's chair, and all controls centralised. The soft subdued light from a cabin globe in the ceiling sheds harmony on all the surroundings, and the walls are adorned with marine views, trophies, and many interesting things, including, of course, tokens of membership for the R.S.G.B. (T. & R.), I.A.R.U. and A.R.R.L.

Reading from left of photograph (enclosed) is as follows: L.T. unit for filament lighting, 100-watt 45-metre transmitter with tuner above, and  $1 \times 250$ -watt valve. Next, various metres and choke-control panel, 150-watt Mullard valve, sub-control panel adjoining. Main switchboard, two-valve low-loss receiver to 15 metres. Above this set is 5QV's special two-valve Re'nartz receiver, and wavemeters above. The 10-watt ratio tap circuit transmitter and tuning coils on slider are on the extreme right. A T30 valve is used on this set with one R5 valve for grid absorption modulation control.

The lead-in and counterpoise entering through a special glass panel are, therefore, very highly insulated. The generator plant is housed in a separate building, the H.T. current being fed to the transmitter via underground cables in a special duct.

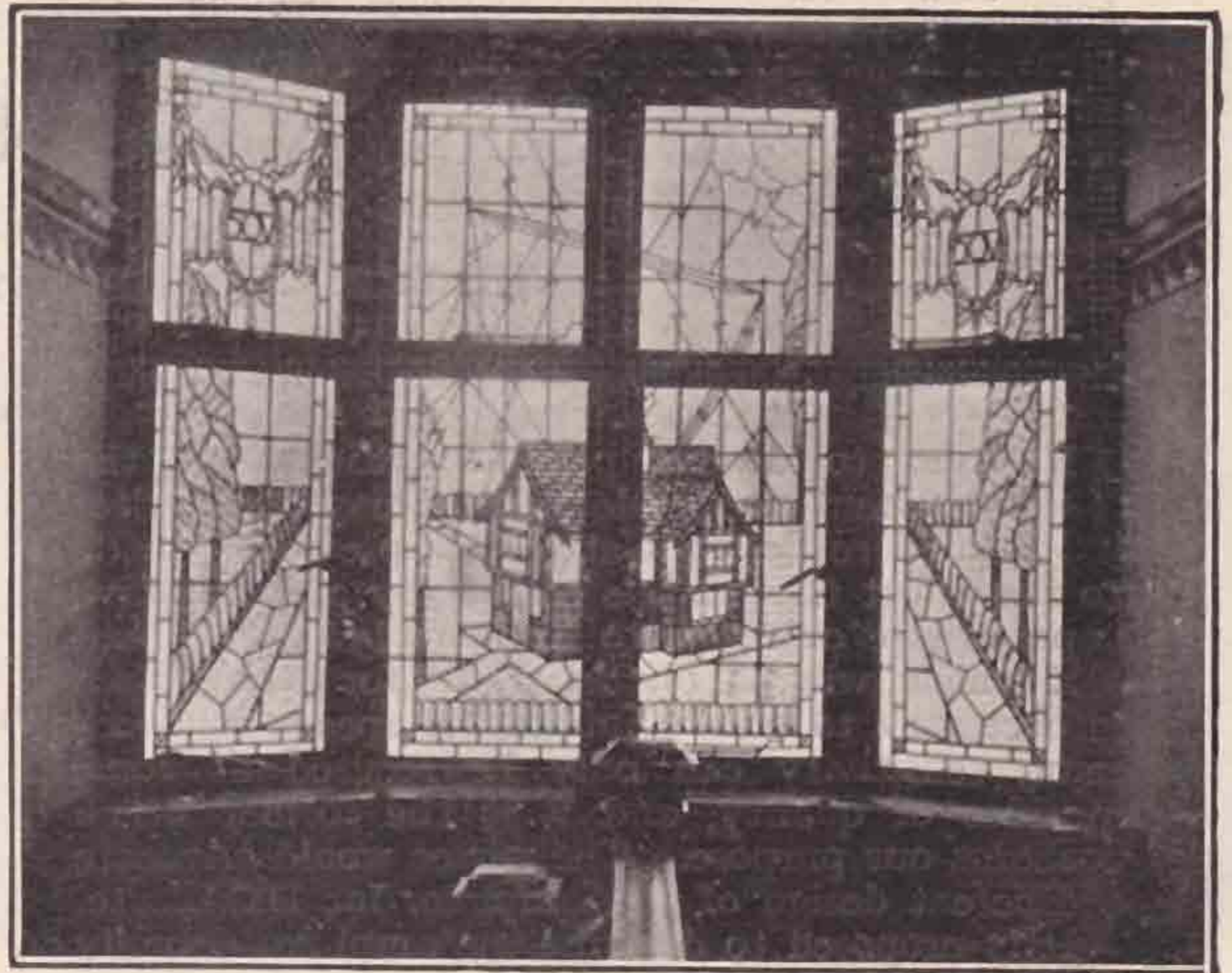

The two transmitters (10 watts and 100 watts) and four receiving sets are always in circuit. An excellent nickel-plated switchboard panel, designed by the operator, is placed centrally for quick and easy changing from one set to another.

Heterodyne and absorption wavemeters and numerous recording instruments are always at the "Stand-by," showing the high degree of accuracy to which the owner-operator of this station aspires.

On remarking that this really must be "Omega," I was told that this cabin contained not only the "Omega," but a bit of the "Alpha," for there, hung above all this scientific display, was the first implement of man, viz., a neolithic axe-head with thong and raw hide complete. There were also several very fine specimens of these worked flints lying about, pointing to interests other than

*(Concluded on page 18.)*

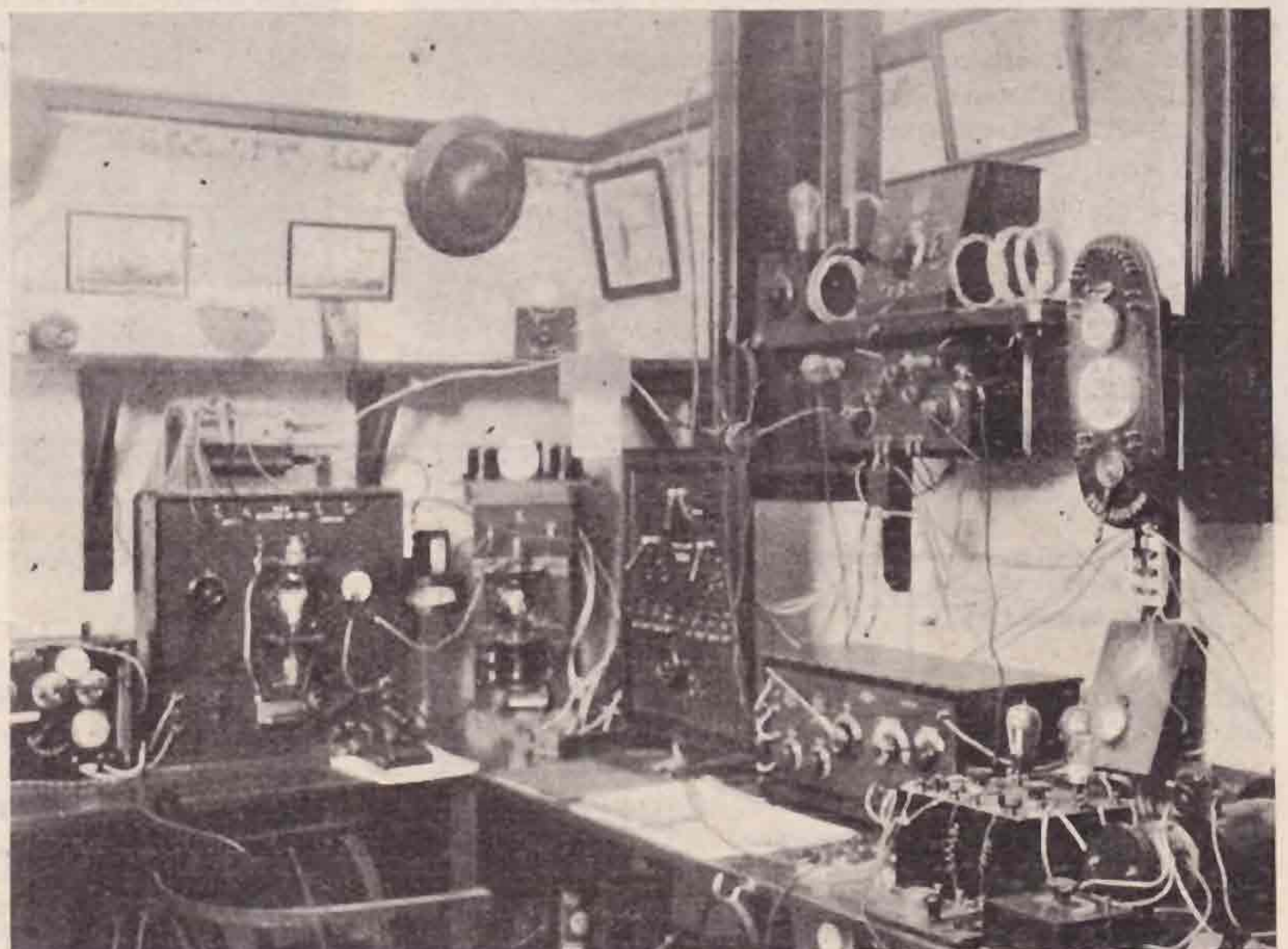

AND BUY BRITISH.



# A Short-wave Superheterodyne.

By H. J. B. HAMPSON, G6JV.

## III. THE I.F. AMPLIFIER AND OSCILLATOR.

IN order to disarm possible criticism of the instrument to be described, may the writer remind readers of a statement previously made to the effect that this is essentially a short wave super whose object is to bring in low power and DX 'phone, with no further regard for quality than is necessary to obtain intelligible speech? Maximum sensitivity can only be secured at some sacrifice of quality, and it is the former which concerns our purpose. The writer would advocate a different design of I.F. amplifier for B.C.L. use.

It is proposed to describe the amplifier actually in use at G6JV, and it is fully conceded that the instrument is more bulky than necessary. It is an experimental model, and for this reason was not cramped.

Fig. 1 shows the circuit which should be compared with particulars given in the first article.

A sheet of stout tinned iron 30in. by 11in. has its longer side bent at right angles for 1in. To this is riveted at 6-in. intervals other sheets 10½in. by 10½in., whose adjacent edges have been turned up ½in. for riveting, thus forming five compartments 10in. by 10in. by 6in. Before assembling eight holes must be drilled in these sheets 1in. from bottom edge and ¾in. apart. Through these holes pass the connecting wires which are covered with systoflex tubing. Another sheet 10in. by 30in. is fitted with ebonite strips for holding necessary terminals, rheostats and condensers, etc., these strips being secured with countersunk 4B.A. screws—the strips being mounted behind the sheet (which is the front panel) and screw holes tapped.

Necessary holes are drilled in ebonite strips for holding components and clearance holes cut in iron sheet. This done, the prepared sheet is

riveted to front of the five compartments, its lower edge being riveted to the 1in. previously turned up on the base sheet. A strip 30in. by 2½ in. has ½in. turned at right angles, and its shorter side riveted to top of front panel. The 2-in. side thus overlaps the five compartments and completes the shield as soon as the whole thing is slid within its cabinet, which is lined within—top, bottom, and sides—with the same tinned iron sheet.

The base sheet is now screwed down to a 30in. by 10in. by ¾in. wooden base and front of panel, given a couple of undercoats of priming paint, and finished with a good black coach paint. To the floor of each compartment is screwed a wooden base with screws passing through the metal to base-board below. Valve holders and transformers, etc., are then screwed to these.

Looking at the front (see Fig. 5 in last article) the compartment on right carries the two input sockets (top) and output sockets (bottom), and the two condensers, tuning primary, and secondary of input transformer (sometimes called "filter").

Within is the transformer itself whose holder permits of variable coupling between primary and secondary. The 2nd, 3rd, and 4th compartments carry in front a rheostat, a condenser tuning that stage, and within the transformer and valve, etc.

The left compartment carries in front rheostat, regeneration potentiometer, and detector potentiometer, also H.T. and L.T. terminals and master switch. Within is the detector valve, grid condenser and leak.

**Construction of Transformers** (see Fig. 5).

The formers are made by glueing between a pair of 3-in. diameter cardboard discs an ebonite washer 1½in. diameter and ¼in. thick. These are then smoothed with emery cloth and given two

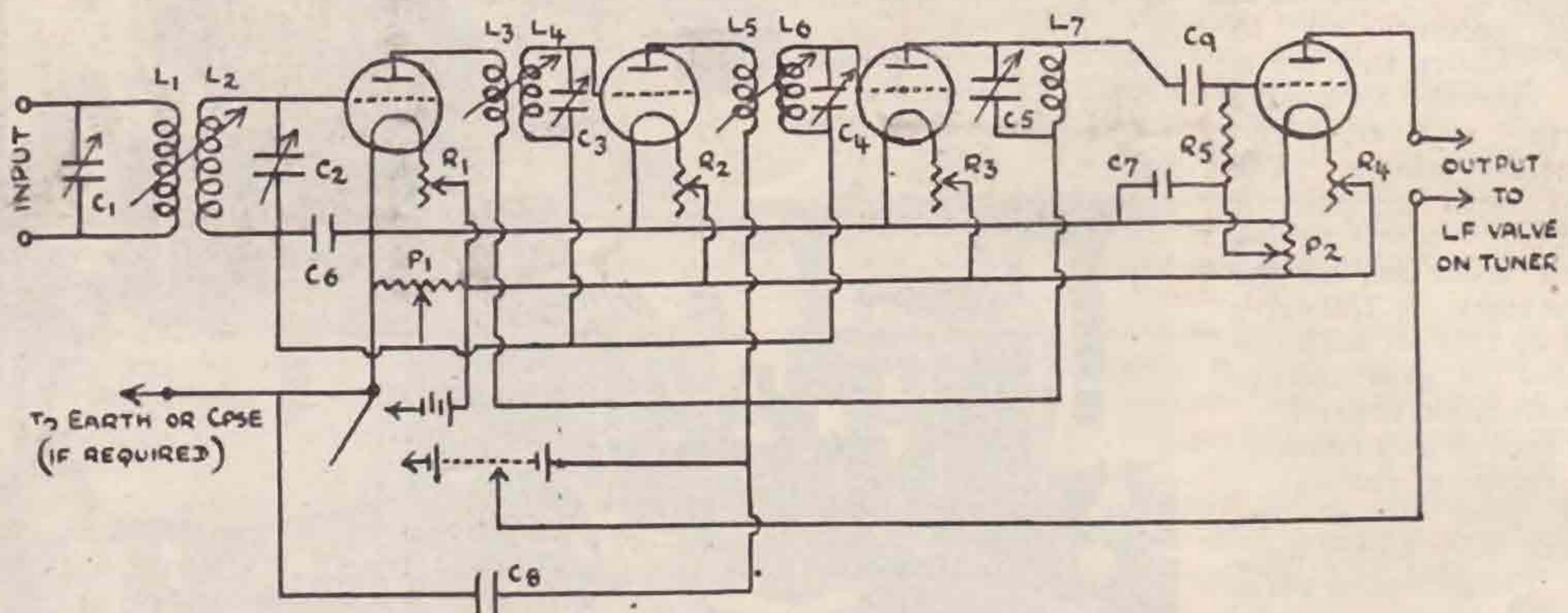

INTERMEDIATE FREQUENCY AMPLIFIER

FIG. 1. CIRCUIT DETAILS.

L1, L2, L4, L7, 800 turns 38 dec. L3, L5, 650 turns 38 dec. C1, C2, C3, C4, C5, .0005 mfd. C6, C7, .01 to 1 mfd. C8, 1 to 2 mfd. C9, .0003 mfd. P1, P2, 400 ohm potentiometers. R1, R2, R3, R4, R5, 2 megohm leak.

YOU CAN HELP US BY



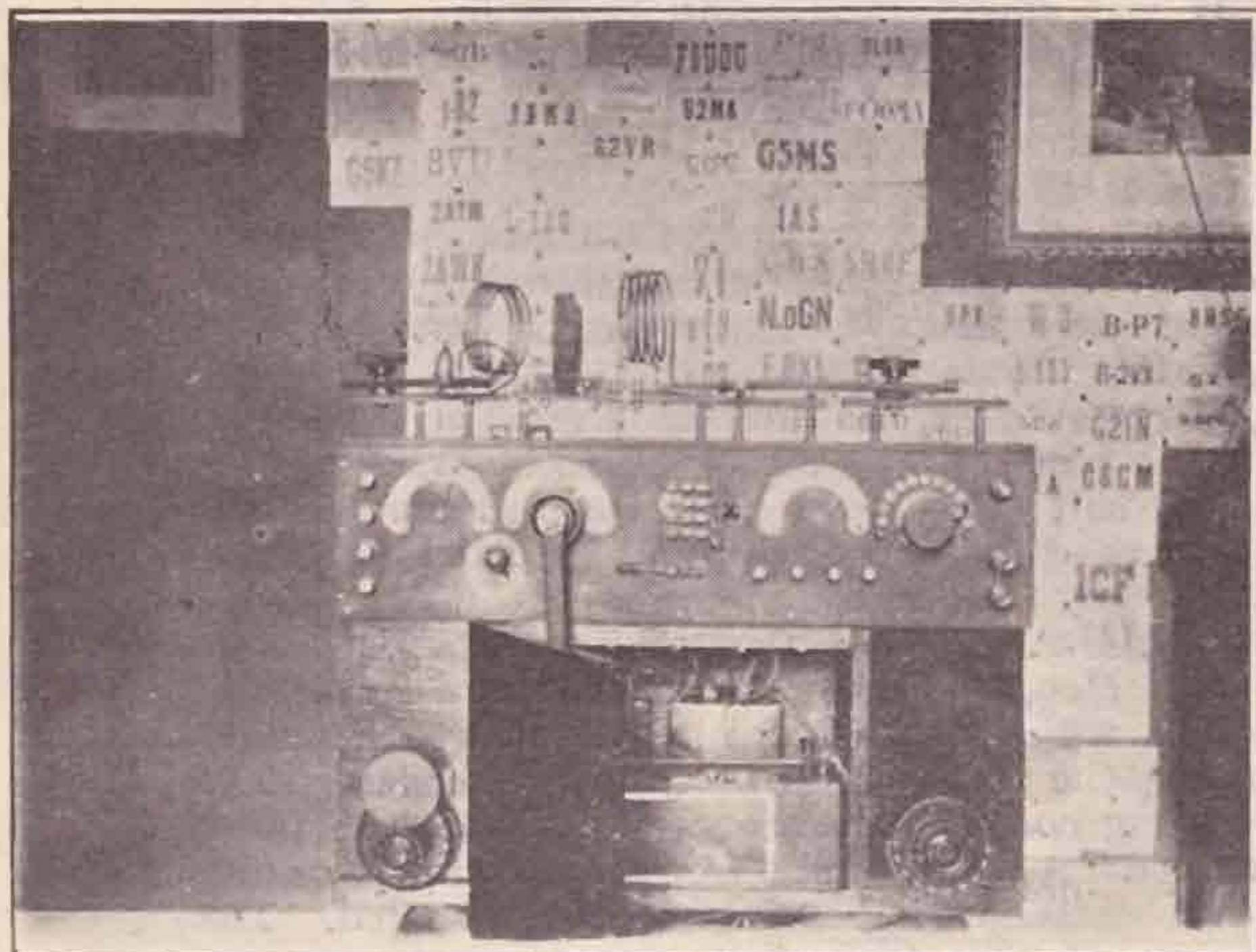

FIG. 2. FRONT VIEW OF RECEIVER, SHOWING BATTERY COMPARTMENT OPEN.

coats of shellac varnish inside and out. Both primary and secondary of input transformer are wound with 800 turns of 38 D.C.C. (S.C. would be better), while each inter-valve secondary and the final tuned anode former are similarly wound with 800 turns. The inter-valve primaries contain 650 turns.

A pair of valve pins are screwed through the cardboard and into the ebonite washer which is,

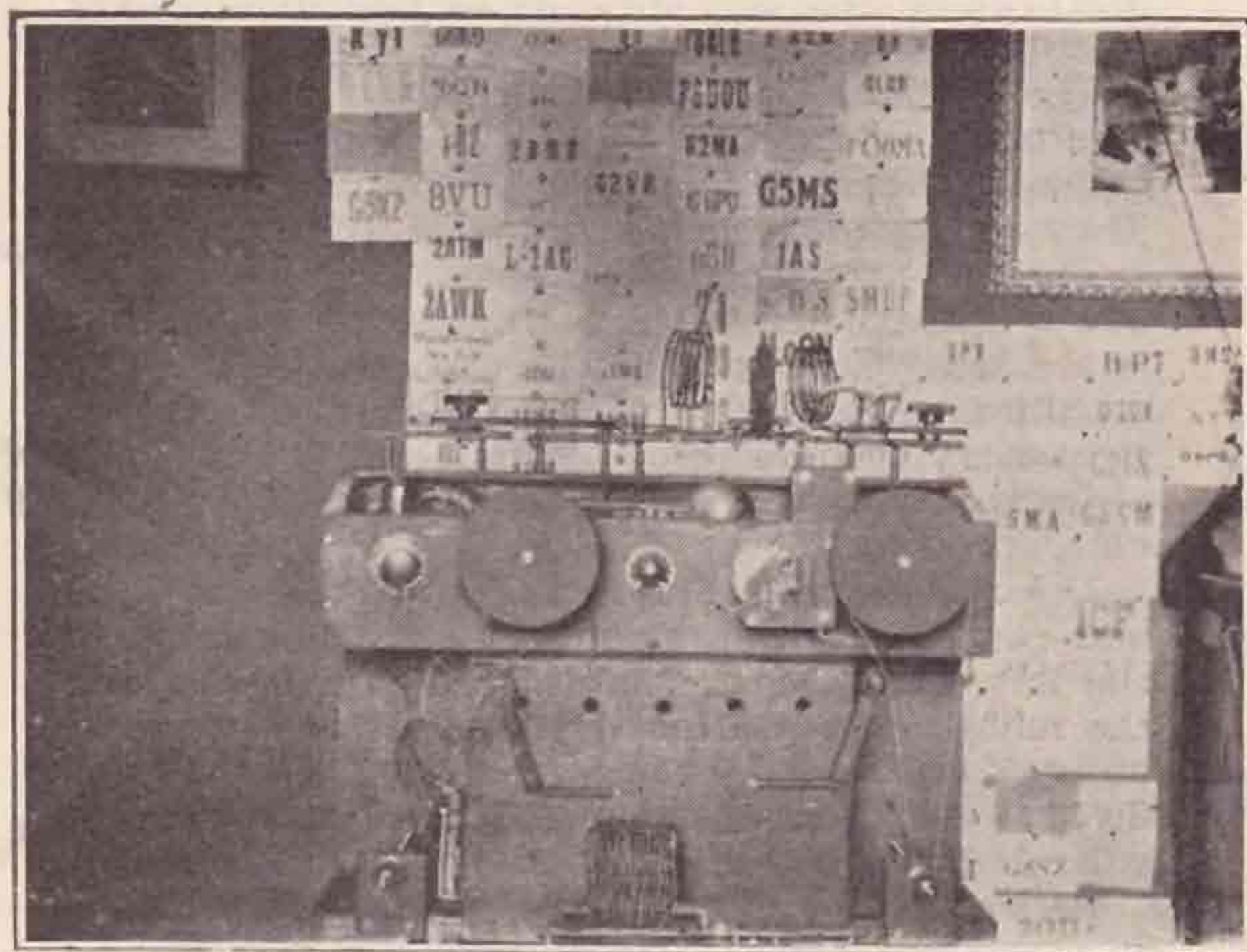

FIG. 3. SHOWING BACK OF RECEIVER WITH CONDENSER AND OPERATING MECHANISM.

to experiment with coils of other types when desired. Fig. 5 will make construction clear and will show the general design.

Coils should be wound so that when primaries and secondaries face each other in their holders the direction of winding is the same throughout both coils when viewed from one end—IP goes to +H.T., OP to anode, IS to potentiometer arm, and OS to grid.

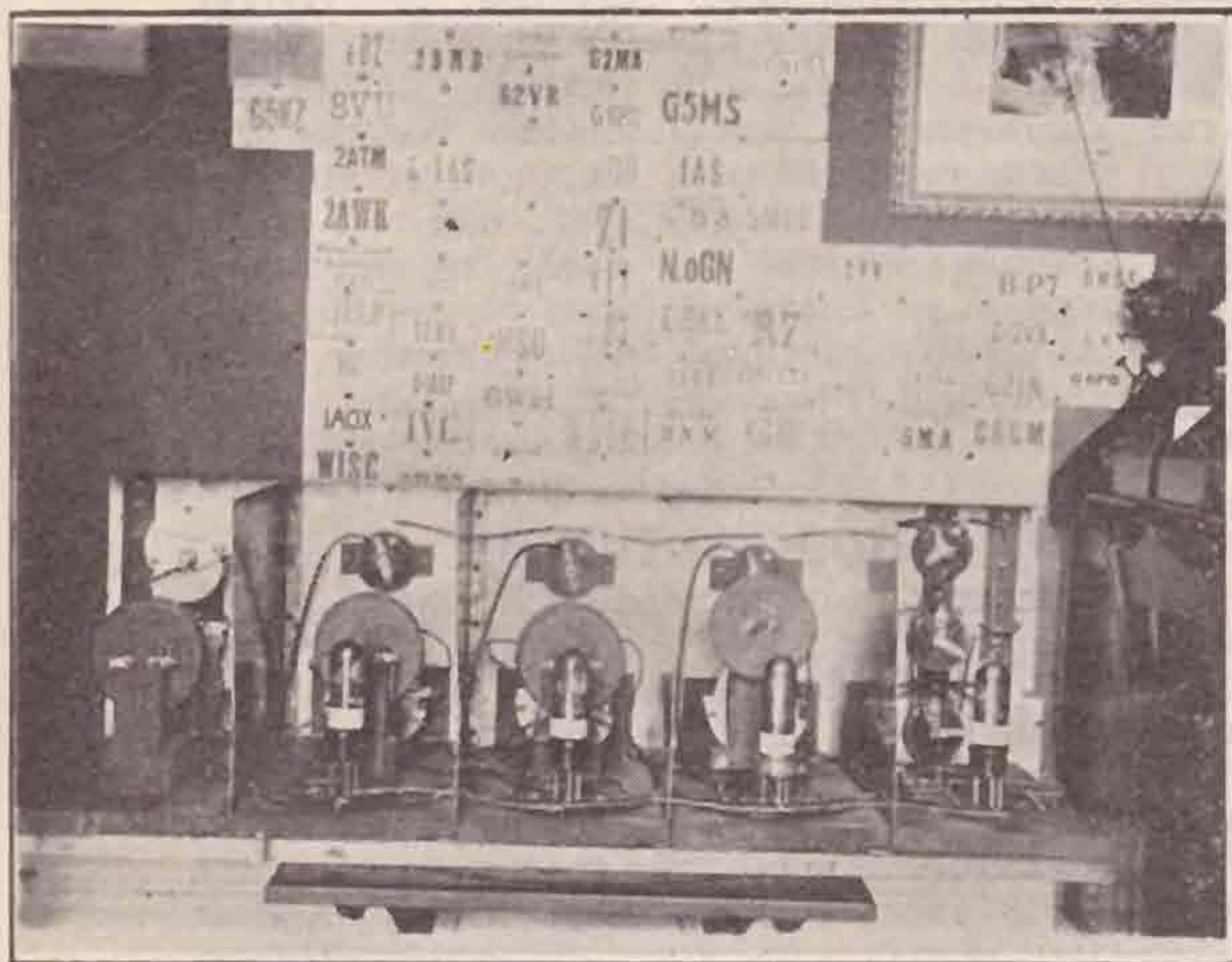

FIG. 5. BACK VIEW OF INTERMEDIATE AMPLIFIER.

of course, tapped for the purpose, and the ends of windings are soldered to base of the pins.

The transformer holders are made by mounting a fixed wooden upright and a similar swinging upright between a couple of side pieces of wood. To the tops of the uprights are screwed small squares of  $\frac{1}{4}$ -in. ebonite, into which fit a couple of flush-type valve sockets. The pins in transformer formers plug into these sockets, and it is thus an easy matter

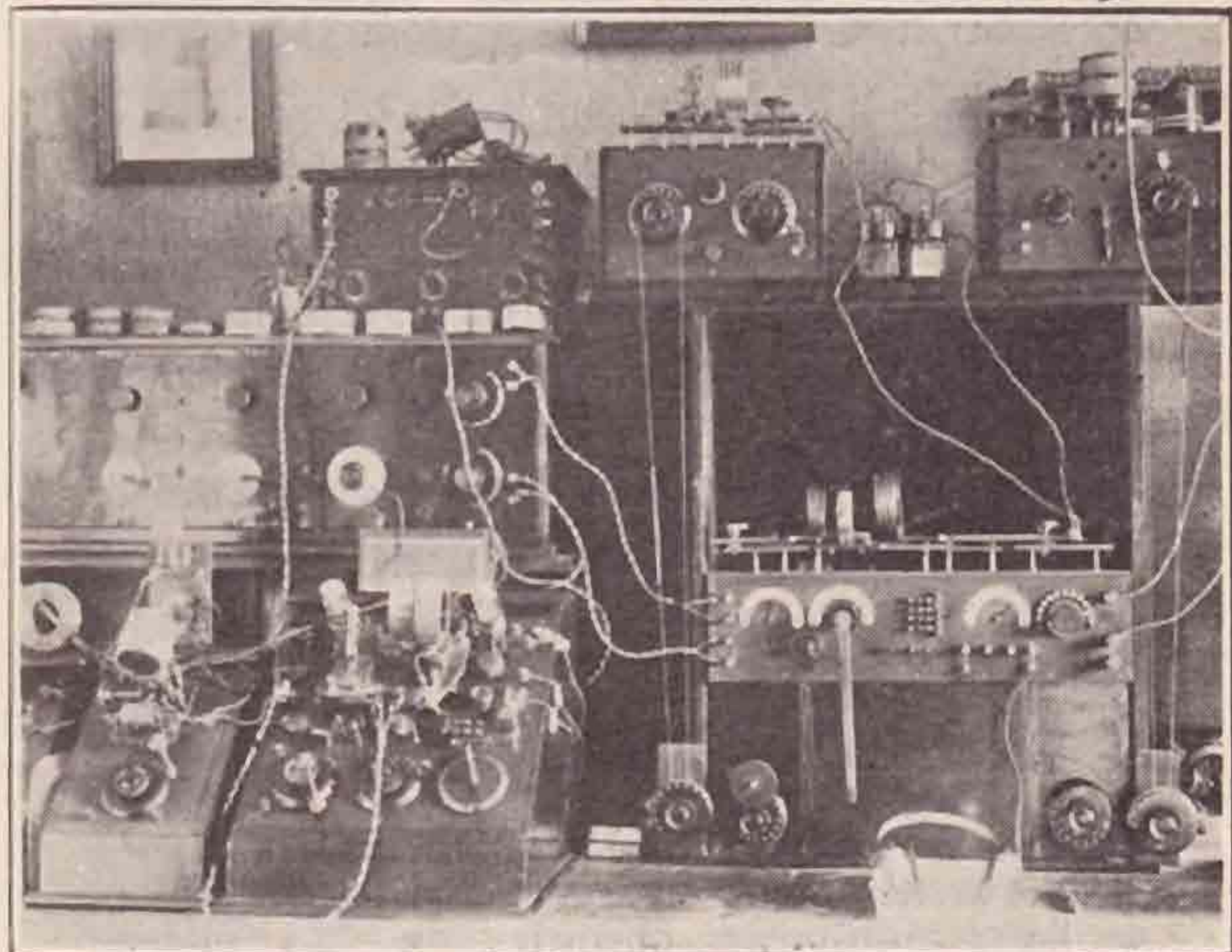

FIG. 4. GENERAL VIEW OF RECEIVING APPARATUS AT G6JV.

#### The Oscillator.

The oscillator employs the same circuit as the tuner since this has been found as satisfactory as any in oscillating reliably up to very high frequencies. Actually a .0003 m.f. variable is used as regeneration by-pass, and the strength of oscillations may thus be controlled. This is a refinement which some may consider unnecessary, but the advantage of this is that the oscillator



itself can be used as a compact single-valve receiver when required.

The oscillator coil units are constructed as in the case of tuner, excepting that the reaction coils are of basket weave type closely coupled to secondary. They are instantly interchangeable, of course.

The pick-up coil consists of five turns of 12 S.W.G., and is constructed with its variable coupling unit in a similar manner to the aerial coil and coupling on tuner. A pair of terminals at the end of ebonite strip carrying pick-up coil is connected to the pair of leads whose other ends go to oscillator feed coil unit on tuner.

The oscillator panel measures 10in. by 6in. by  $\frac{1}{2}$ in., and carries the tuning condenser of .0002 m.f. to the left and regeneration condenser to right. In the middle is a 30 ohm rheostat and below this a pull-push L.T. and H.T. master switch, as always fitted to the writer's instruments. An anti-capacity valve-holder is used.

Between the knob and dial of tuning condenser is a grooved ebonite wheel, and a waxed thread passes over this and over a  $\frac{1}{2}$ in. pulley mounted on a 2B.A. rod fitted with operating knob and dial. The oscillator is mounted above the 30in. by 20in. cabinet containing the tuner, and the operating mechanism for oscillator is mounted on brackets at bottom left-hand side of cabinet. A spiral spring is inserted in the waxed thread belt, thus maintaining a steady tension.

A heterodyne wavemeter (whose harmonics are usually employed on the short waves), deriving its H.T. and L.T. from the same batteries as oscillator, is mounted on the other side of cabinet. This instrument makes use of the series feed Hartley circuit, is of the same size as oscillator, and is operated in the same manner from the bottom right hand of tuner.

The concluding article will deal with hints upon tuning and manipulation of the super-heterodyne, together with a few conclusions reached regarding the use of this method of reception upon short waves.

ED. NOTE.—Owing to an oversight two of the foregoing photographs were omitted from the last issue.

## Some Notes on Short Wave Indoor Antennae.

By E. J. SIMMONDS, M.I.R.E., F.R.S.A. (G20D.)

It is thought that perhaps some details of experiments on indoor antennae for transmission and reception which have been carried out lately at G20D may be of interest, and direct attention to the possibilities of such systems.

The writer has lately completed a new master oscillator transmitter operating on 32.1 metres, using standard circuit arrangements, and carried out a long series of adjustment tests with A2LM, on this set using a large outdoor antenna.

Very good and consistent signals were put into Australia by this transmitter over a period of several weeks, practically daily contact being maintained with A2LM, and much of the success of these tests was due to the care and attention given to detailed reports by this Australian station, who was able to copy G20D so consistently that it was only necessary to send *single*, a very obvious saving in time, power, and wear and tear of the apparatus.

It was found possible to maintain a morning schedule of two hours, using just under 100 watts input to this transmitter.

The success of these tests suggested the possibility of effecting contact with A2LM, using only an indoor antenna of modest dimensions, both for transmission and reception, and accordingly arrangements were made to carry out a series of tests with this object.

Various types of antennae were tried, but by far the best results were obtained by using a horizontal half-wave Hertz oscillator placed in the loft under the tiles of the roof, and fed from the transmitter by two parallel radio frequency transmission lines, approximately 8 yards long.

This Hertz oscillator has a three-turn coil at the centre, which is magnetically coupled to a similar coil at the termination of the R.F. feeders. The coupling coil in the antenna is split at the point marked "A," and a radio frequency ammeter or any other suitable indicating device inserted. The tuning of the drive and magnifier circuits are adjusted to give the maximum readings at the point "A." In this particular instance the meter gave a reading of just over 2 amperes with the input mentioned above.

This is the scheme of the antenna. In order to avoid any form of coupling likely to mask the true action of this indoor antenna, the outside antenna was absolutely removed during these tests, as it was considered that the presence of any form of outside radiator would materially assist the indoor one, and lead to unreliable conclusions.

Using the arrangement here outlined, it was found possible to maintain a consistent daily contact with A2LM, who reported the average signal strength R4, the signal being a particularly good one to hold and copy through QRN. This latter characteristic was doubtless because the signal was a perfectly pure d.c. note of absolute steadiness. Reports were also received from New Zealand stations on these transmissions. The reception of distant stations in the 30—40A band was greatly improved on this antennae, there being a marked reduction of the static signal strength level, in favour of the desired signal.

## Subscriptions.

All members are reminded that subscriptions for the current year under the old system now fall due. It is of material importance to us that these subscriptions should be paid as promptly as possible, and by so doing you will save us a great deal of work and bother. Please let us have them early. We need hardly remind you that we are unable to continue our service without money, and it is regretted that in a few cases where subscriptions are not paid for the coming year, or for the past year, we shall be reluctantly compelled to withdraw the circulation of the BULLETIN to those members and consider them as having resigned from the Section.

Arrangements have been made whereby subscriptions will run concurrently from date of first payment until the first day of the twelfth month following payment. Thus a new member joining on the 10th of the month (September) will renew his annual subscription on October 1, 1926, and every year thereafter his subscription will fall due on that day of the month.



## Quartz Crystals.

By JOHN M. CLAYTON,  
Assistant Technical Editor, QST.

**I** NOTE with interest the letter from Mr. Hinderlick (2QY) in the June, 1926, issue of THE BULLETIN, concerning quartz crystal control. It is stated that the value of 105 metres per millimetre thickness in the piezo-electric crystal is incorrect, and the value of 150 metres per mm. should be used in its place.

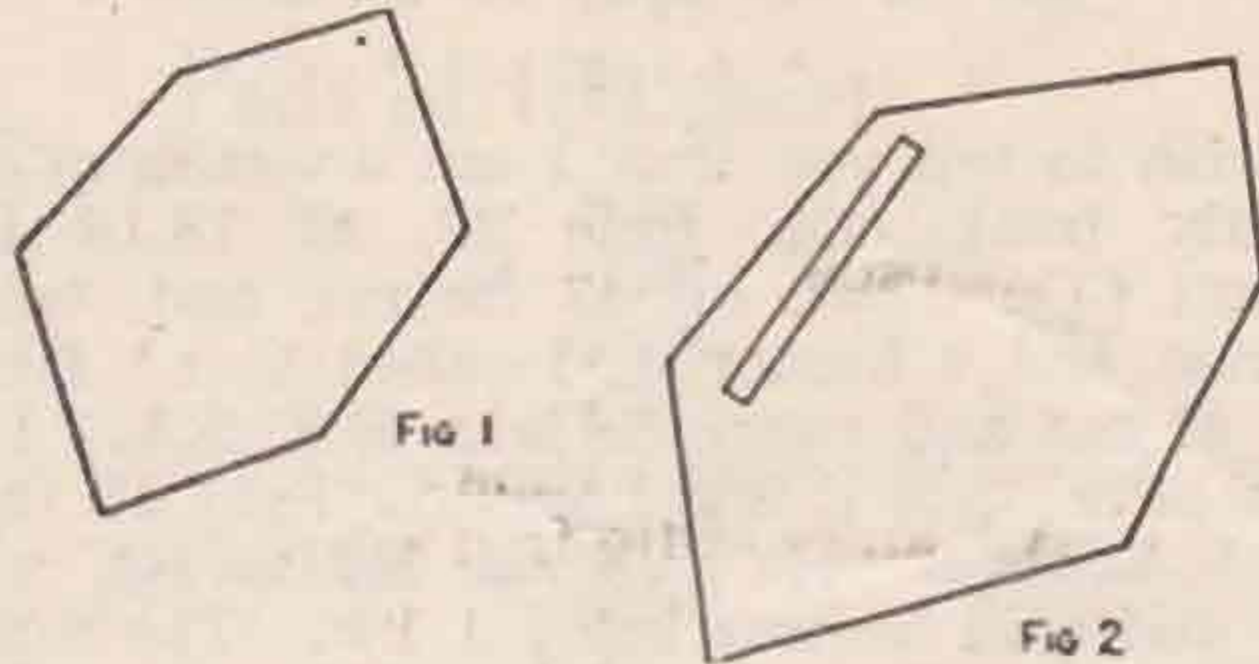

When crystals are taken from the quartz as indicated in Fig. 1, the frequency will be approximately 2,870 kilocycles (104.5 metres) per millimetre. If the crystals are extracted according to Fig. 2, the frequency will be somewhere in the neighbourhood of that suggested by 2QY. The method shown in Fig. 2 results in crystals showing the maximum piezo-electric effect, with slight temperature co-efficient, while the Fig. 1 cut yields crystals with slightly lower piezo-electric effects, but with zero temperature co-efficients. For transmitter control work the Fig. 2 method is preferable.

It would probably be interesting to readers of the T. & R. BULLETIN to know that Dr. A. Hoyt Taylor, of the U.S. Naval Research Laboratory (NFK), has just been granted a U.S. patent on the

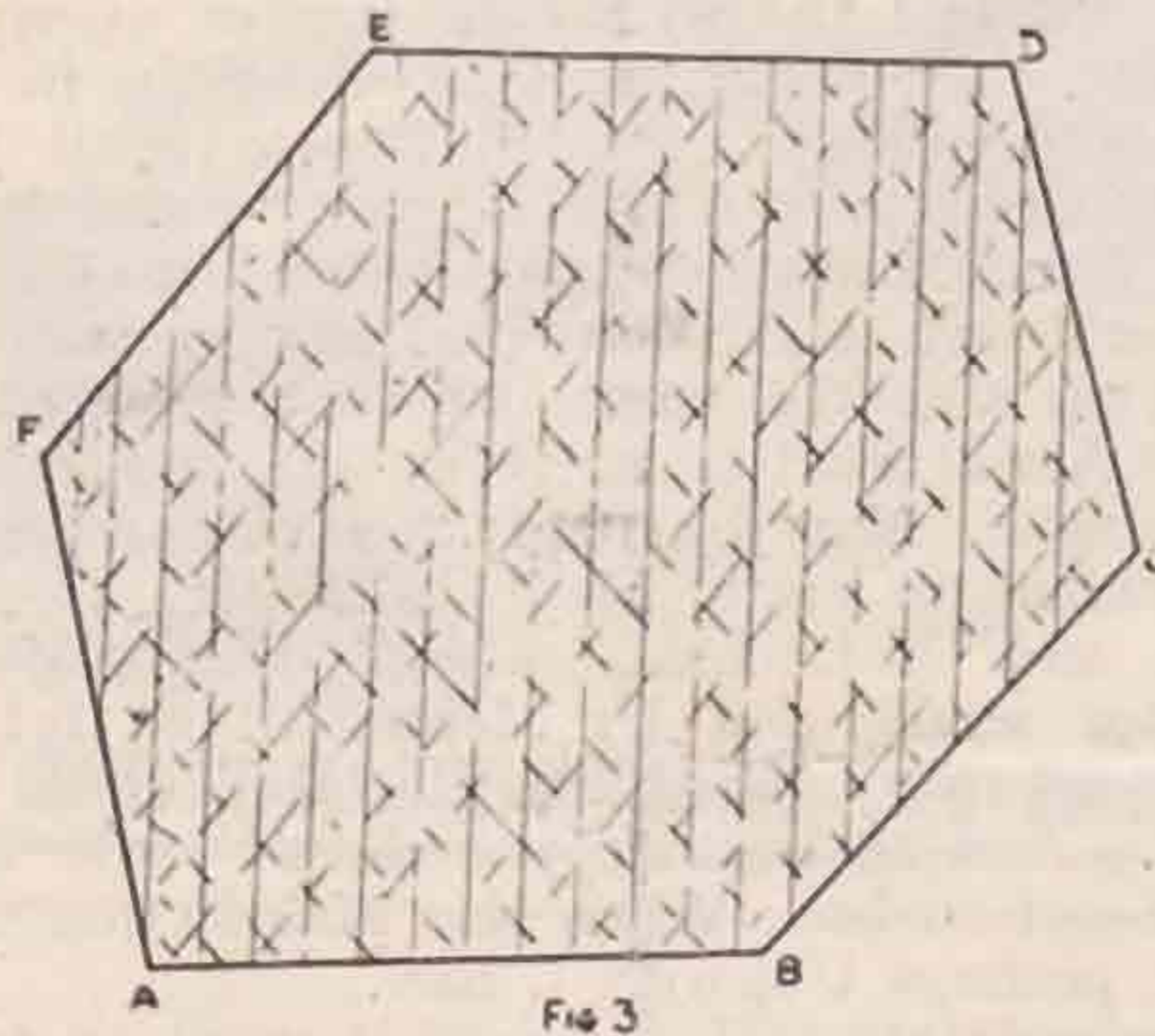

use of several crystals, ground to zero beat with each other, operating in parallel. The output from three crystals working in this fashion is sufficient to directly control a 50-watt tube. The patent number is 1,581,701. A copy can be obtained from Commissioner of Patents, Washington, D.C., for ten cents.

In none of the English radio periodicals have I seen a really clear explanation of the various axes of the uncut quartz. Most people assume that the optical axis is a single line, that the "X" and "Y" axes are also single lines. A glance at Fig. 3 will probably straighten this out. The Optical or Z axis is *any* line through the crystal parallel to

the sides of the crystal, or, in other words, any line through Fig. 3 perpendicular to this sheet. The Y axis is *any* line (there are an infinite number of them) perpendicular to A—B (and also E—D, since A—B and E—D are parallel). The other two Y axes are any lines drawn perpendicular to D—C, F—A, and B—C, F—E, as indicated in the dotted lines of Fig. 3.

The axes are any and all lines parallel to a line which bisects the angle BAF, AFE, or FED. These lines may or may not pass through the "centre" of the figure, and they may or may not run directly from A to D, for example. If the crystal is a perfect hexagon they will, but very seldom is a quartz crystal found to have this perfect shape.

## Concerning the Word "Relay."

**I** HAVE often puzzled myself as to why the word "Relay" should be incorporated in the name of our society and although I have asked many hams for the explanation, I invariably find that the answer is "I have no idea!" Now why cannot this word really mean something to us? We all know that in America it is one of the most predominant things that hams undertake, but I am not suggesting that we should try to do what they do, because, for one thing, our friend the P.M.G. would not allow us, possibly, to take from his revenue! Now very often, as is well known, the low power ham cannot connect up with a DX station simply because his H.P. brother is pumping out mighty juice! He probably waits for an indefinite period, hoping to connect up after the ether has calmed down. But, alas, only too often the far station has closed down, or the dinner bell rings, or something else equally aggravating takes place.

What I should like to suggest is this: Why couldn't a system be found whereby certain stations in England and all over the world be "on watch" at certain definite times for tests with DX stations?

For instance, suppose 5HA wishes to try and get through with 5 watts to FI 8QQ, and suppose G200 is the relay station for trans-oceanic tests at that particular time. 5HA would get in touch with 200 and ask him to call 8QQ and warn him that 5HA wishes to QSO him on such and such a valve, etc.

My idea is that certain stations with a definite reliable range should take on relaying for certain ranges, and I believe that given a good support from English hams for this scheme, stations in all parts of the world could be got to co-operate, and I am convinced that, apart from the saving of much juice, an enormous amount of very valuable work could be done, and the low power ham would no longer feel "drowned," as he so often does.

Now let's hear what you fellows say about this scheme, and let's hear quickly, because now's the time to get things put together before the coming DX season.

G5HA.

## STRAYS.

6CC says that it is quite impossible to work Americans. He has been trying to prove this!

\* \* \*

Has "Sec" mended the "M" on his typewriter yet?



## Quoth the Raven —

*A monthly causerie from the pen of a well-known writer which we believe will be appreciated by all readers.*

### ON HAMS AND OTHERS.

I am not one of those superior persons who nightly bombard the Heavyside Layer with doughty electrons, but even so I may write upon radio and things relating to it provided that I write in a manner plain for all to understand.

The Editor is perhaps on a different plane to me who is after all but a mere author, a writer for humble shillings, for he has been known to write in the Editorial columns the one word which many good British experimenters utter with a show of abandon, bravado, truculence, glee, as you like, the word "Ham." The wrath of the champions of English grammar descended upon him like an avalanche when the word appeared in columns which are usually expected to be free from verbal side-slips such as this and even now the turmoil and commotion has scarcely died away.

As a plain fellow—one who reads and endeavours to understand what is read, I took the word for granted, for had I not spoken with those Lords of the Ether who even as I write are using the word without regard to the purity of the King's English? But my attention has been held by the growing storm of protest against the abuse of the mother tongue, for I am an author, one who secures at least a portion of his daily bread by the scratching of a humble pen upon a piece of virgin white paper. Therefore am I not one of those in whose care is the proper care and use of the English language? Why then should I stand aside from the fray and not draw a trusty pen in defence of a language of which the Englishman is justly proud?

It is said that these words were imported from abroad from that land where the manufacture of a word is as easy as their methods of producing innumerable articles all exactly alike and where the addition of an extra word to one's vocabulary is not remarked even though it is not possible to give reasons for its existence. In my ignorance I have asked some of these American gentlemen to define the meanings of the words which are known to them as the "Ham Language," but after listening and learning to the best of my poor ability my opinion still is that there are better words, words which have dignity and meaning, words capable of proper definition.

The truth is that the word "Ham" is not known to those books over which we spent so many weary hours in our youth.

Those awe-inspiring brown and red covered "crammers" mentioned but the edible variety of ham—they knew not the crude and meaningless word imported from abroad which is applied to human beings. Therefore we in our more mature years and enhanced wisdom can find no place for the term in our vocabulary, neither for that matter have we any use for other similar verbal atrocities, despite the age of change in which we live. And the professors, they surely do not countenance the spreading of untidy litter over the fair field of English literature? Therefore I, a plain fellow, must needs consider this aspect of the question,

*(Concluded at foot of next column.)*

## Radio Ripples.

*Being selected extracts from our postbag.*

I enjoy BULLETIN fine, nearly as much as "Q.S.T." now, and I am still looking forward to its weekly appearance—as I said at its first publication, which you quoted. . . . I welcome all-comers to my shack if they pass this way when on holiday. I don't see many of the gang. Tell 'em to drop a card to ensure my attendance.—F. TOWNSEND (2TO), M.I.R.E., 46, Grove Lane, Ipswich.

\* \* \*

I wish to tell you that I am a victim of a most ungodly freak. On June 28, at 18.15 B.S.T., I heard CQu 3ACL on 43 metres, and, being an optimist and a humorist, I called him. He came back at me and swore he was in U.S.A. I could not believe it, as it was broad daylight all the way to U.S.A. then. He gave me R2 to R4, was R3 here, and said he was using 1 kw. The following evening, same time, I called him, but he could not read me; I was only R1. I sent a card to 3ACL; he has just sent me back confirmation. Would you please make a note in BULLETIN asking for reports to me from anyone who has had U3ACL on 43? Tnx. Other DX here on 2 to 6 watts. All Europe U2CVJ, BER, and R7 at CRJ! KCZ1 gives me R5.—F. CHARMAN, Int. B.Sc., 76, Salisbury Street, Bedford, England.

\* \* \*

To Radio G5TR.

Transmitter up to 6 watts input.

Receiver, Schnell+1 A.F. Hrd. 1700 U.S.A. es  
Can [All States] 70 A es Z.

Oh! G5TR. !!!!!!! Amateur, whose CQ's I have heard, I beg of U to QSL; Oh! pse send me a crd, For if U do not answer, it will be for Ur worse: I'll call the wrath of Jupiter upon U in my curse. As Nelson said at Waterloo in 1962, "Up then Guards and Atom"—so shall I say of U—"Up Sturbs and Electrons"—and by the seven spheres May the heavens belch forth QRN, fit for Thor's own ears; May the sky be rent with lightnings, and the earth be rent with quakes, And Ur Aerial Mast be stricken, so that every Guy Wire breaks; May Ur Radiation wither, and Ur Amps refuse to amp; May Ur Bottles all Disintegrate, and Ur Lo-Loss Coils git cramp, May Ur Generator sizzle, and Ur Meters all go fut; Ur Condensers stop condensing, and Ur Tuning ne'er sta-put. And so because you didn't write things all turn out so bad, When this Malediction comes to pass, perhaps U'll wish U had.

However, if U QSL, or send a word or two, I wish U VY 73's and I raise my hat to U!—F. CHARMAN ("Dud" at 6CJ), Int. B.Sc., 76, Salisbury Street, Bedford, England.

---

for at heart at least I am an admirer of these learned English gentlemen. Are not their rulings those which govern our daily conduct, our mode of living, our mechanics, our Arts and our Crafts?

Therefore until our professors can find room for these words in our dictionaries I am content to leave them to those who know not the proper use of the King's English.

THE ETHERWORM.



## STATION LOG PADS.

### TWO TYPES.

2 columns and 9 columns  
Punched at top for filing  
Pads of 100 sheets.



1 pad 1/4, 3 pads at 1/3  
6 pads or more 1/- each.  
post paid.

Write "SEC" of Barnes for  
free sample sheets

or

**B. MATTHEWS & SON,**  
9, Holland Rd., Aston, Birmingham.

**Real Music** In designing the Bretwood Amp  
lifier extensive experiments were  
carried out to secure amplification  
with purity of tone. Not only has this been accomplished,  
but an added advantage is the remarkable silence of the  
"background" attained through using Bretwood Auto Audio-  
Frequency Amplifier.

"The purity of amplification when 2 L.F. stages are used is  
wonderful, and the silence of the 'background,' owing to success-  
ful elimination of atmospherics and 'mush' is remarkable."

The original letter from which above extract is quoted, as well  
as numerous other testimonials, may be inspected at our offices.

Reports in various technical periodicals  
:: substantiate our claims ::



Price  
20/-

Price  
20/-

*Bretwood Auto Audio-Frequency Amplifier.*  
Sold under a three years' guarantee, and money refunded  
if not satisfied after a week's trial.

**BRETWOOD LTD.**  
12-18, London Mews, Maple Street, London, W.1

*Parr's Ad.*

LISTS  
FREE

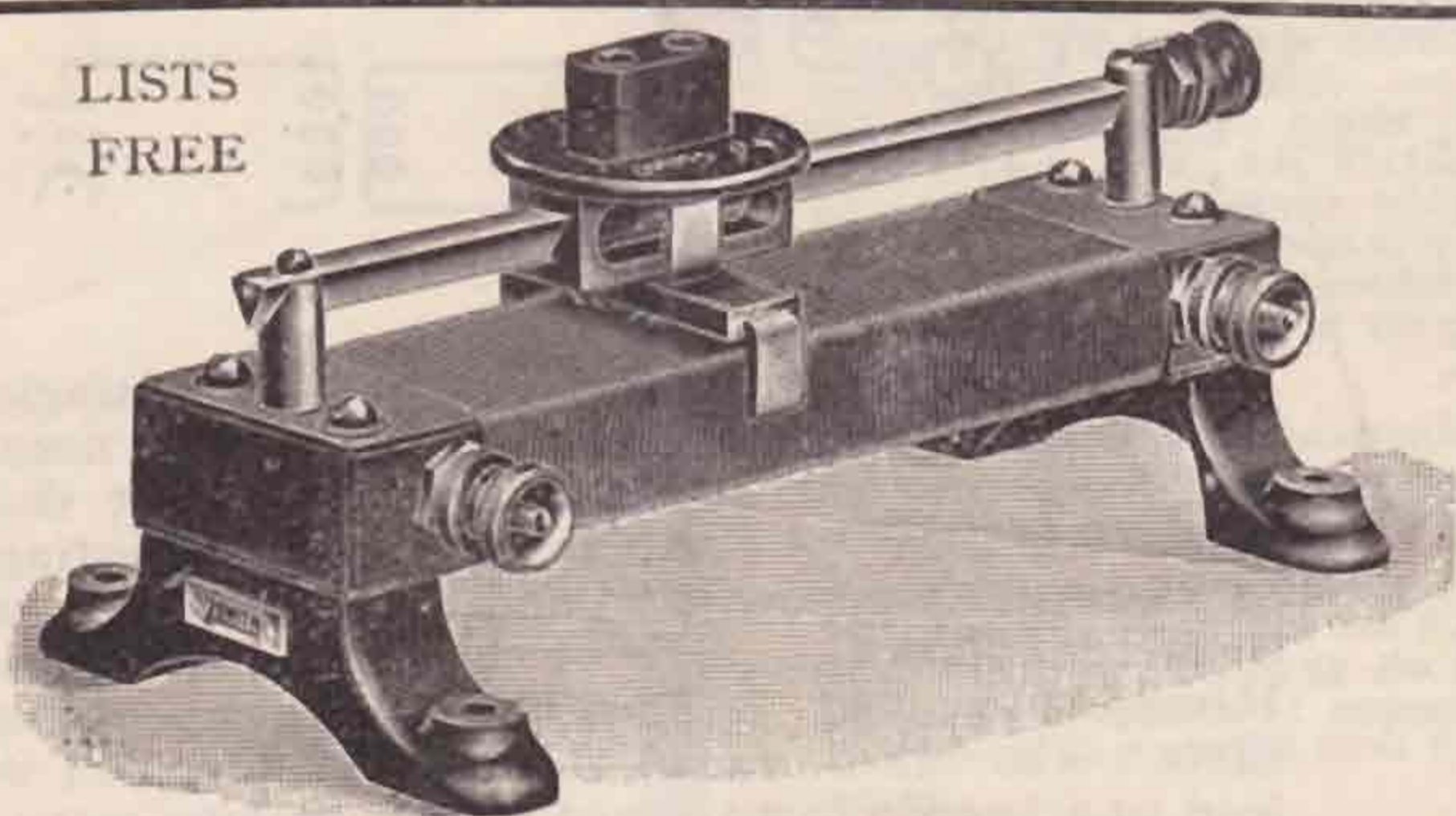

# ZENITH

The best form of Variable Resistance  
for potentiometer or filament control.

Prices from 18s. 6d.

**THE ZENITH MANUFACTURING CO., Zenith Works, Villiers Road, Willesden Green, LONDON, N.W.2**



### HAVE THIS BADGE ON YOUR LETTERHEAD, Etc.

This badge is the approved official badge of the T. & R. Section, and the printing block will be issued to all members on receipt of a postal order for 3s. The question of supplying enamel buttonhole badges is under consideration, as is also the question of supplying official note heading for member's private use.

### EXPLANATION OF CARTOON ON FRONT COVER.

- "WOUFHONG," famous American instrument for silencing hams who cause QRM. Believed to have been discovered in the wilds of U.S.A. by the "Old Man" and presented to Hiram Maxim, a man who also was famous for inventing a silencer.
- "RETTYSNITCH." Another instrument for similar use, believed to have been invented by the U.S. Bureau of Standards!
- "BLIFSKY," an instrument of torture, which is placed on the heads of one who uses CQ without restraint. It is in the shape of a meta crown, with saw tooth edges, which take a firm grip on the head. There are lots of other funny things about it known only to American hams!
- "BUG KEY," an instrument used by some American hams. No one has yet been discovered who could use it properly, and also it is thought no one has been able to decipher what the thing sends!
- "QSL CARD," a piece of paper that the ham evidently intended to send to somebody, but always forgot to do so.
- "50 WATTER." Pieces of glass which at one time enclosed the metal. The Americans in some clever way were able to turn the metal red and hot the air around quite blue!
- "C.Q. OIL." Used in generous quantities by American and other operators after vigorous wrist exercise.



## EXCHANGE AND MART.

**E**VERSHED & VIGNOLE'S 30-watt 30 ma. Generator; excellent condition; for motor drive; 70s., or offer.—5UP, 13, Marlborough Road, Bowes Park, N.22.

**F**OR SALE.—1 Newton 200-watt Alternator (10 volts 20 amps.), Foster Transformer, primary 10 volts 20 amps., secondary 500-0-500, 1,000-0-1,000, Voltmeter A.C. 15 volts (Westinghouse), Ammeter A.C. 20 amps. 600 cycles (Everett Edgcombe). The lot comprising useful H.T. unit for £7 15s. Present owner going on to D.C. All as good as new.—Box 1.

**F**OR SALE about October:—Mortley Sprague Rotary Transformer, input 25 volts 7.5 amperes, output 1,100 volts 80 milliamperes; the machine has been in use at 5NJ for ten months and has been only source of power for all DX; in perfect condition; reason of sale being change in supply from 25 to 220; no offer less than £14 considered.—F. R. NEILL, Chesterfield, Whitehead, Belfast.

**M**UST SELL FOLLOWING to buy amps. for baby 250-watter:—Marconi T30, brand new, and two T40, used, but perfect; £2 each, or offers; Crowd's double-spaced variable Condensers; pair Brown's Reed Phones, 175 w.; lots of other junk for offers; I buy 1 mf. Condensers, 2,500 volt.—TOWNSEND, Grove Lane, Ipswich.

### SITUATION WANTED.

**A**DVERTISER, aged 26, good education and address, requires post. Experienced in Management, Sales, Demonstrations, Construction and Development Radio Receiver. Eight years' practical and theoretical experience. Four years active transmitters. Excellent credentials. Keen, and not afraid of work. Could arrange interview Convention or otherwise. Please communicate:—Box 41, "T. & R. BULLETIN."

### Stray.

**R**ADIO A-3WM, "Mia Mia," Union Street Brunswick, Victoria, Australia, asks all English Stations who have lists of "Calls Heard" which are of interest to A's and Z's, to send them to A. W. WATT, Editor, "Radio," 12-16, Regent Street, Sydney, N.S.W., Australia. The latter is a very good "ham" paper, which members should see, and has very good lists of European "Calls Heard." Also will anyone who hears A-3WM please Q.S.L. He has been Q.R.O. G2CC, G2QB, C5HS.

*Concluded from next column.*

by means of the variable condenser the spacing wave can be entirely absorbed.

There are occasions when it is difficult to put up an ordinary Hertz antenna, so maybe this description of the same thing in another form may be of interest.

## A Novel Form of Antenna.

By K. SECRETAN, G5LF.

I recently had some experiments to conduct which necessitated my going down to 32 metres, and as I found that my usual 45 metre antenna was useless for this purpose, I set about to put up one that would be suitable and at the same time flexible.

I particularly wanted to use an antenna functioning on the Hertz principle, but have always disliked the idea of having the indicator outside of the shack where I could not see it, and therefore I set up the antenna system as outlined in the accompanying diagram.

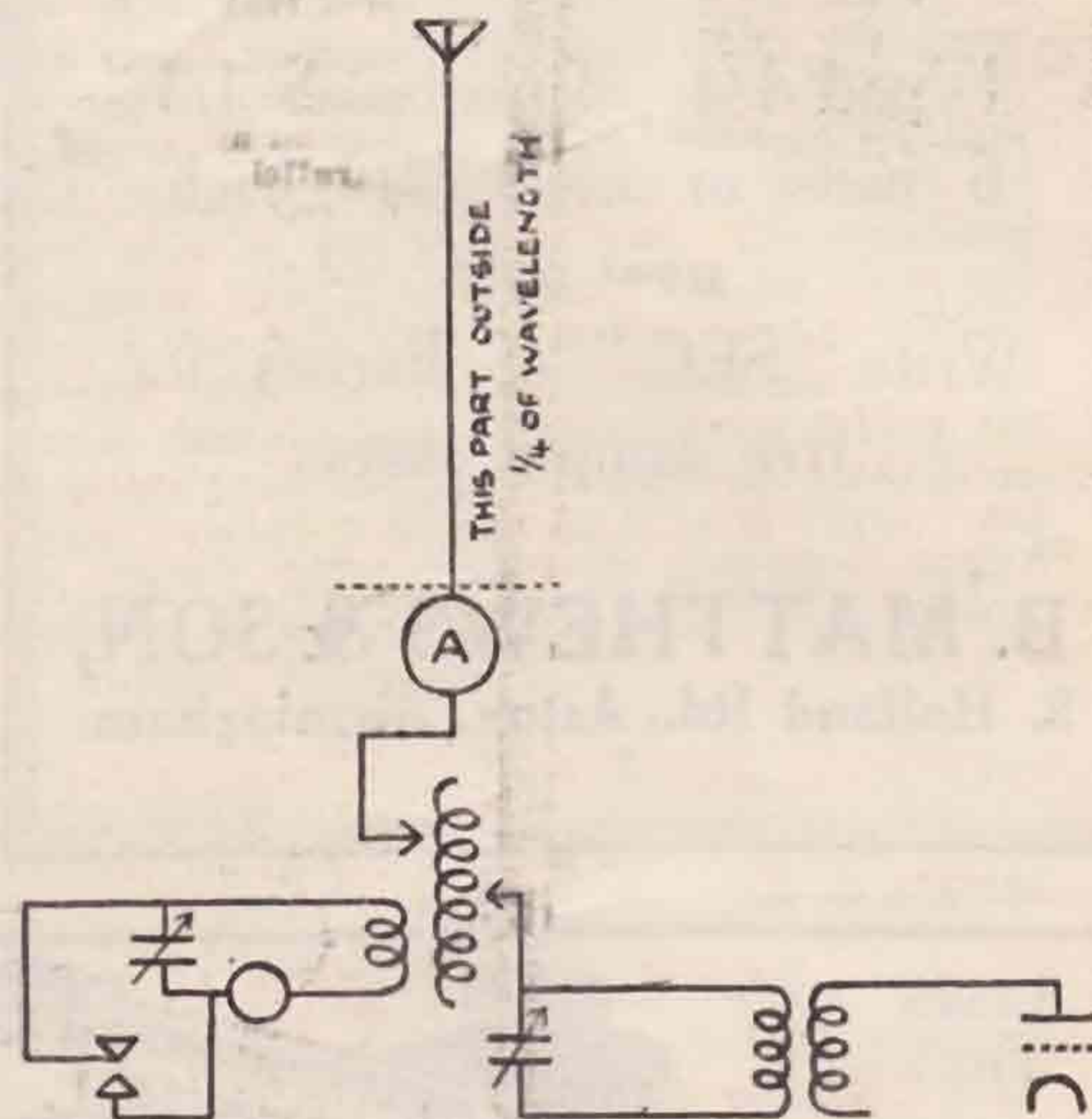

Fig 1

The aerial wire itself, consisting of 27' 6" of single No. 14 enamelled, is suspended from a 32' mast and leads into the shack and terminates at the aerial ammeter. A base loading coil, consisting of 25 turns of edgewise wound copper strip 4" in diameter, takes the place of the other half of the Hertz arrangement, and is situated on the operating table. The other end of the base loading coil is lead to a tuned circuit tuned to the working wave, which is coupled to the transmitter in the usual manner.

It will be seen that no matter upon what wave it is desired to work, the aerial ammeter or resonance indicator can always be located within the shack under the operator's eye, it being only necessary to cut or lengthen the outside part of the antenna to the correct dimension and altering the clip on the base loading coil to suit.

In order to key a transmitter using this type of antenna, an absorption circuit, either tuned or otherwise, may be set up and coupled to the base loading coil. In my case on 32 metres I used 10 turns of edgewise wound copper strip 4" in diameter and inserted a thermometer in the circuit so as to tell exactly what part of the current was being absorbed. In this manner an accurate check is kept upon the spacing wave, or if suitably adjusted

*Concluded at foot of preceding column.*



# ARE YOU A PATIENT MAN ?

# £200

## IF YOU ARE



"Let's see—five separate units give five capacities, taken singly. Then I can have the first two in series or parallel—total seven.

Then the first three all in series or all in parallel—two more. The first and third and second and third in series, total 9. Ditto, in parallel, 11. First and second in series, and in parallel with the third—12 . . . . .

And the total number of different capacities with the five units is—? What is it?"

*If you get it right,  
you win £200!*

Whatever your skill in counting capacities, however, the purchase of a Dubilicon will bring you one sure reward. The Dubilicon gives any capacity up to 0.011 mfd. simply by varying the connections of the eight unit capacities of which it is composed; so that by using the Dubilicon you will be able to select with unfailing certainty the best value of fixed capacity for any desired part of your circuit.

The Dubilicon is a multiple condenser containing eight separate units, the terminals of each unit being brought out to sockets on the lid. By using Clix plugs (made by Messrs. Autoveyors, Ltd., 84, Victoria Street, S.W.1) of which two are given with every Dubilicon, the units can be connected in a variety of series, parallel and combined series parallel arrangements giving a very large number of different capacities.

The uses and advantages of the Dubilicon, which we have summarised above, make it more than worth its low price of 30/-.

In addition, the purchase of a Dubilicon entitles you to enter for the £200 prize competition. All you have to do is to estimate the number of different capacities you can get by connecting up the first five units in various ways.

Ask your dealer about one to-day—and mind you enter for the £200 competition! He will tell you all about it!

*The  
Dubilicon*

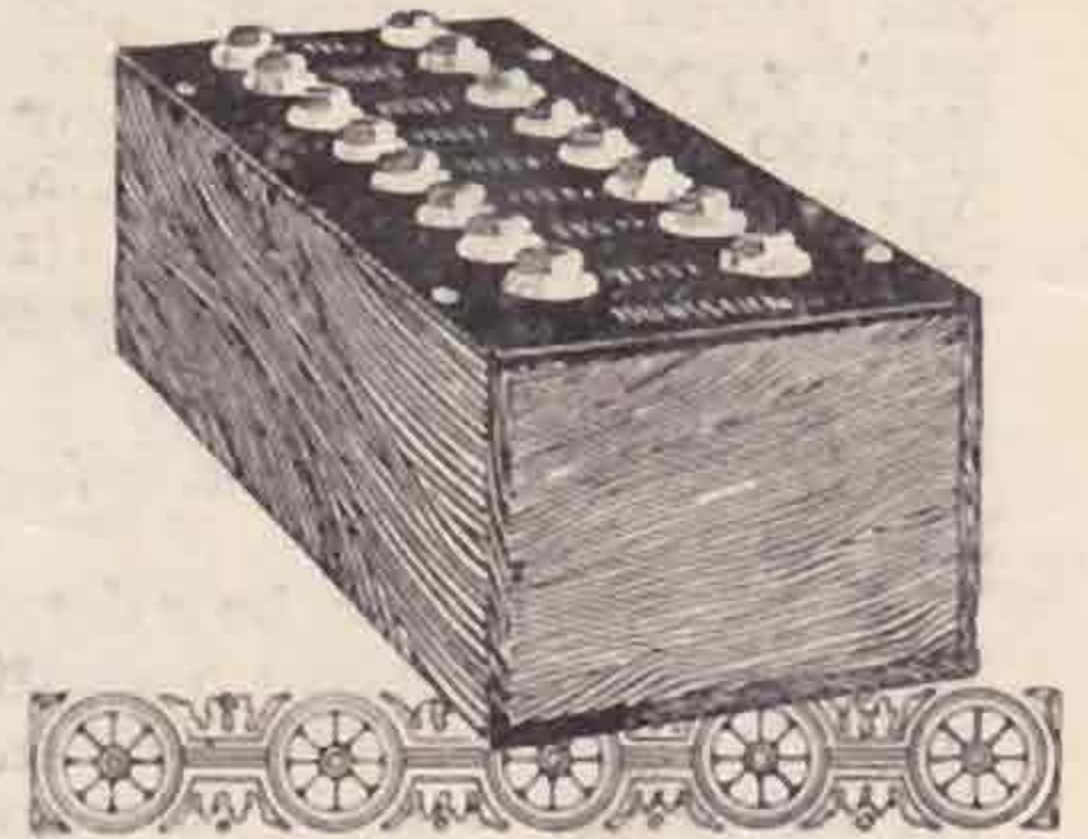

REGISTERED

TRADE MARK

# DUBILIER

CONDENSER CO (1925) LTD

ADVERT OF THE DUBILIER CONDENSER CO. (1925) LTD., DUCON  
WORKS, VICTORIA ROAD, N. ACTON, W.8.  
TELEPHONE: CHISWICK 2241-2-3, E.P.S. 193.



# WESTON Filament Voltmeter for Receiving Sets

MODEL 301.

Simplifies tuning by eliminating guesswork as to valve adjustments.

Filament voltage control increases the life of the valve from two to three times.

The Western Filament Voltmeter is accurate and can be relied upon for duplication of results.

**ALL THIS MEANS BETTER RECEPTION!**

**Weston Electrical Instrument Co., Ltd.**  
15, Great Saffron Hill, E.C.1

Telephone:  
Holborn 2029.

Telegrams:  
"Pivoted, Smith, London."

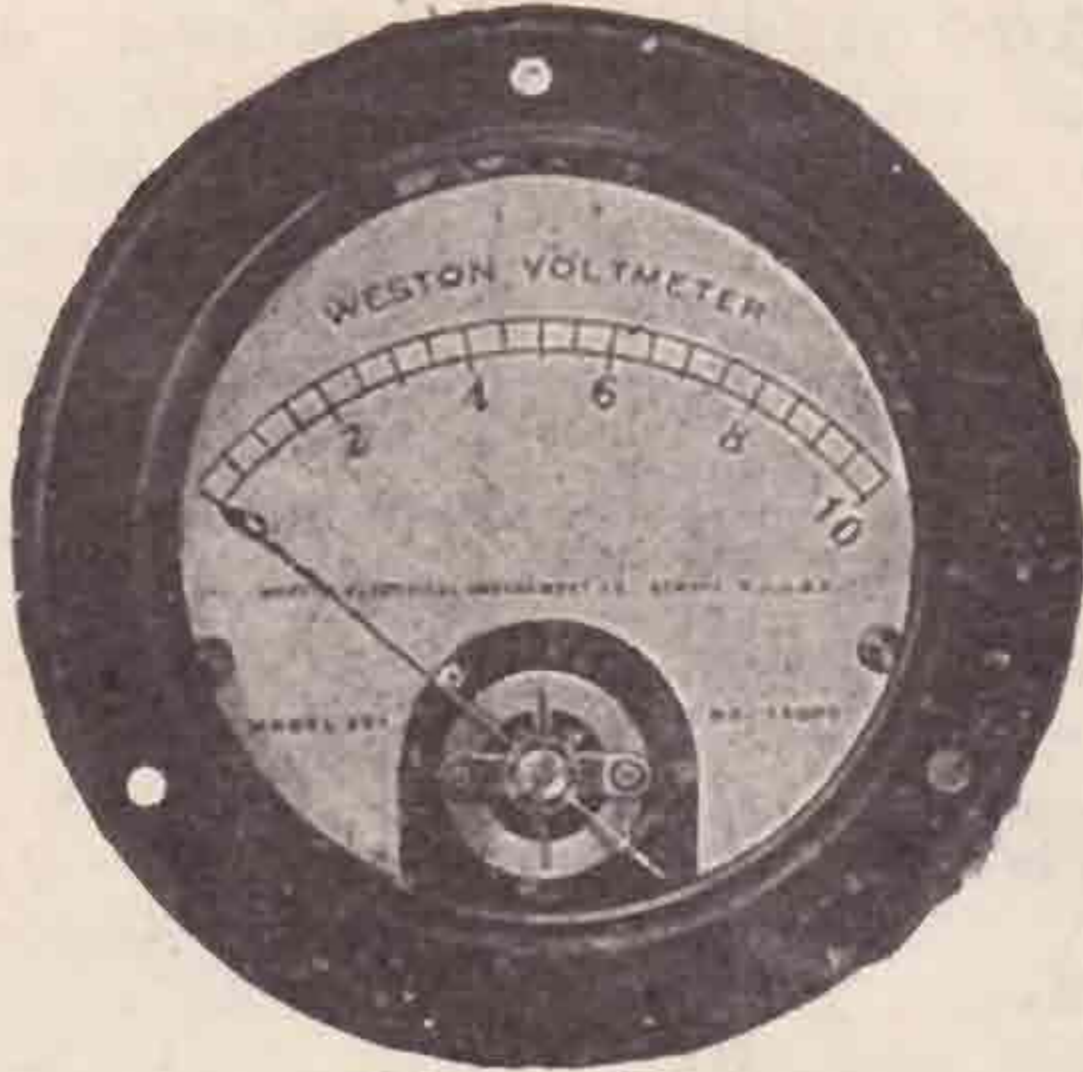

Model 301  
FILAMENT VOLTMETER  
LIST PRICE  
**£2 : 9 : 0**

### G5QV—continued from page 9.

radio. One also gathers from a framed certificate something of his prowess at rifle shooting at the French ranges during the war. 5QV's den is one of which he may justly feel proud, and we who carry out tests with him know him as a sympathetic and patient co-operator. Not only is his speech quality good, but his morse operating is excellent, not too fast to be unreadable—not too slow that one wishes to go to sleep rather than attempt to read it.

The whole lay-out of this station by the sea at sunny Clacton appears to be the realisation of the radio man's dream—a really first-class "Ham" station.

At the present time he is deriving filament current for transmitting valves 5 amps. 12 volts from the town D.C. mains (230 volts). Some proposition! He reports it of great economy, and not only in battery charging, for he is able to cook the breakfast bacon to a frazzle above the resistances on the unit.

The general efficiency is high. Week-end DX often includes the Cape, Australia or New Zealand. Although not so powerful as several of our leading amateur stations, 5QV is certainly "pulling his weight" as results testify.

**MEET US AT  
STAND 239  
AT THE  
EXHIBITION.**

### A Universal Radio Measuring Instrument

## THE ULTRA "ONEMETER"

With this one instrument most accurate measurements can be made in amperes, milliamperes, microamperes, volts, millivolts, and ohms and megohms. The "ONEMETER" is a most novel and compact instrument—the size of a vest-pocket camera—for exact electrical measurements for radio work, battery, dynamo, and motor testing, fault location and insulation measurement on electric mains, etc.

Its Special Features are:—

58 RANGES.

- |                                    |  |
|------------------------------------|--|
| (1) Is absolutely Dead Beat.       | (7) Internal resistance, 500 ohms per volt.  |
| (2) Has Safety Contact Key.        | (8) Sensitivity, 100 Milli-volts.  |
| (3) Multiple Overload Capacity.    | (9) Knife-edge needle and double scale.  |
| (4) High-grade Sapphire Bearings.  | (10) Accuracy well within the limits of the British Engineering standards for first-grade instruments. |
| (5) Front Zero Adjuster.           |  |
| (6) Full scale current only 2 m.a. |  |

58 "ONEMETER" Ranges are available with the one instrument for the following measurements:—

Currents from 20 microamps. up to 20 amps.  
Voltages from 1 millivolt up to 2,000 volts.  
Ohms from 50 ohms up to 50 megohms.

PRICE: Instrument only, 50/-. Multiples, each 6/6.

Current and Volt Multipliers to any one of 58 ranges for every "Onemeter" can be delivered subsequently at any time.

Descriptive Booklet (16 pages) and our (68-page) Radio Catalogue. 4d. post free.

**ELECTRADIX RADIOS, Dept. R. T.,  
218, UPPER THAMES ST., LONDON, E.C.4.**



# Traffic Notes.

## Mid-Britain Notes.

Prepared by 6JV.

**T**HANKS to the good offices of E. J. Erith, I am happy to announce that we now have a "ganger" for Worcestershire. Will hams of that county please report to him monthly in future. His QRA is: 246, Kingsbury Road, Erdington, Birmingham. Mr. Erith has thus taken over two counties, and his splendid help is greatly appreciated.

The next bit of news is not so F.B. It is that R. H. Parker (2KK) is resigning his position as ganger to Stafford, owing to pressure of work. We are sorry, for he has worked well, and we thank him warmly for services rendered.

We must find someone else to take over from 2KK, and I think that this would be a fitting occasion to introduce something new. I am very keen upon the principle of *Election*, and I propose to work out a scheme for sub-areas to hold annual elections. More will be heard of this in due course, and in the meanwhile I am going to ask 5UW if he will act temporarily. My reason for asking 5UW is simply because some time ago he was good enough to write me and offer to help. At the time of writing I know not if he can undertake this, and so reports from Staffs should be sent direct to me next month, and a further announcement will be made next time.

### Shropshire.

The last I heard of 5SI was a pencil note from a sick bed. He has not reported and so I am a little anxious. We all wish you a speedy return to strength and brass pounding, 5SI OM!

### Cambridgeshire DX (by 2XV).

Still the same old "gang" again this month with no new stations reporting. However, the reports that are to hand contain some real DX for the time of year.

2DB has nothing out of ordinary to report, except that he is thinking of boiling his eggs for breakfast in his rectifier jars—that is, if he cannot find some means of cooling. He has been to visit 6JV and has come back full of new ideas, and is now going to rebuild his receiver, hi!

5YK came dashing over to see me at the last minute with his report, which seems well worth the hurry—he has had two-way QSO with B2 liB (reported R3 on 0-V-0), and the same morning he worked Z2AC (reported R4). He is using LS2 valves as rectifiers, with the filaments stuck to the grid owing to excessive "sag" in the filament.

2XV has also been doing good work in spite of trouble due to erratic running of petrol engine (the only thing at this station which seems to uphold its honour and "keep hard at it" is the Osram T50 valve used).

Two-way reliable communication has been effected with New Zealand (23Ai), Brazil (BZ1AC) and the following American stations: 2WC, 2APV, 2BXJ, 2BKR, 1AKM, 1BXH, 1XV, 1AAO.

New Zealand was worked a second time by schedule arranged during the first QSO, and signals were reported R4, whereas on first occasion the report was R3.

Stations in Camb. who have NOT reported this month are: 2HK, 5JO, 5PT. Why, OM's, are you so QRW?

### Warwickshire (by BRS22).

Another member has joined the Warwickshire ranks—2BPP, Mr. Parsons, of Sutton Coldfield. Welcome OM!

6YU (Coventry) has gone off the ether for a while, but we hope to see him back for the winter. 2BPI (Coventry) has nothing to report, and 2BLM (Coventry) has not yet settled down owing to change of QRA.

5PX (Sutton Coldfield) is back from Germany, where he was highly successful demonstrating his no-aerial and duplex tests. FB! He hopes to have a good DX report for next month, and also has a new invention which will be of great interest to members when he is at liberty to disclose it.

BRS22 (Saltley) sends in another good list of calls heard, including a lot of strange call signs.

BRS3 (Erdington) has done some good reception on his 2LZ set. A new station heard is Congo F2.

2BMW (Leamington) reports too QRW for much work.

BRS8 (Erdington)—another new member—has been doing some remarkable reception on a single-valve Reinartz. His bag for July includes three O's, eighteen A's, eight Z's and many other DX stations. He is experimenting with an indoor Hertz.

### Worcestershire.

5MW (Stourbridge) is already a member of the T. & R., and is working 'phone on 150-200 metres.

### (Stafford (by 2KK).

From the number of reports received this month, it is evident that it is the month to "live in the Sun." Hi!

However, we now have quite a number reporting—thanks to 5UW and his gang—and great things are expected of Staffs in the autumn. But I am sorry, OM's. I shall have to relinquish the post of collecting reports; please report to 6JV. I shall be at the convention if possible, and will continue to do all I can to help the T. & R. and the BULLETIN.

6UZ has been working fone with C.C. and has been reconstructing. He is awaiting a generator. H is QSO Australia.

5FH has at last got his generator. Now for some DX reports OM.

2KK has been off the air, due to reconstruction, but will be working again shortly.

### Wolverhampton (via 5UW).

5LK has not worked owing to business QRM.

6HT has restricted his activities to local work this month.

2OQ has just completed a very fine transmitter, but finds he must move to another part of the house (domestic QRM is suspected!). Great things are expected of this station soon.

5UW is on the air most evenings. His best DX is being R6 with two different BZ's. He is working hard at T. & R. recruiting.

The following did not repeat: 2WN, 2VG, 5CW, 6BH, 2AFS, 2BRB, 5JI.

### Norfolk.

2BJP has at last got away with his application for a radiating permit, and is awaiting his call letters. (His success after many attempts is gratifying, and the influence of the T. & R. committee in this happy event is strongly suspected. The moral, of course, is "Join the T. & R."—6JV.)

6ZJ is using 50 watts rectified A.C., but is not satisfied that he is getting out properly yet. He would be glad of reports. He remarks very aptly: "Won't some of the Norwich and Yarmouth radio societies members join the Section?"

6JV has not had the 'phones on for a fortnight owing to holiday QRM. He hopes to meet many of the gang at the convention, and to gather from them many helpful suggestions for improving the Mid-Britain organisation.

## Northern Notes.

Collected by 2DR.

**C**ONDITIONS this month have, on the whole, been very poor for European working, especially during daylight. The strength of F's, B's and K's has been distinctly on the low side. On the other hand, U.S.A. stations have been very active, and many good low-power reports have come to hand this month. Brazilians have again not been to the fore, and is only to be expected if U.S.A. stations are active.

Quite a number of hams in this area are on holiday. So reports are not too numerous.

### Yorkshire (2DR).

6TY is a newcomer to these columns. Welcome, OM! Commencing operations on 45 metres on June 18, with a DE5 valve, H.T. from dry batteries, and filament lit from the A.C. mains through a bell transformer, 41 stations were QSO by June 30, and during July 52 more stations were worked, including 77LJ (Riga), who reported R4 sigs. The crowning performance was made on August 5, at 00.20 B.S.T., when a call to C-IED brought forth a reply, and a long message was taken for G2OD, sent originally by A-2LM. This very excellent work was done on 10 watts from a rotary converter.

5US has done very good DX work with a power of 7 watts from the D.C. main and an LS5 valve, having worked P-1AF and KEGK (then off Greenland). He succeeded in working U-1CMX, after having tried to get across for three solid years. There is no doubt that a good QSB has a great deal to do with this bit of good work.

5SZ has now settled down in Yorkshire again. His QRA is West Point, St. John's Park, Menston. He hopes to be on the air again in about a month's time.

TG has increased his power to 3½ watts, forsooth! With this input, he is QSO all Europe. He has as yet only an unconfirmed report of a BZ calling him after a recent test. If this be confirmed,



6TG will have a feather in his cap. He complains bitterly of QRM from raw A.C. merchants, and suggests that the I.A.R.U. should take this question up at once. I agree with him.

2XY has been having a real earthquake in his shack; in fact, almost a permanent one. His new Mortley generator, with a  $\frac{1}{2}$  h.p. motor, requires more support than can be given by 1-in. floorboards. This problem has occupied a considerable amount of his time this month. Reports have been received from Indo-China, Australia and South Africa, and he has worked one U, one C and three BZ's. An interesting QSO was with GLYK (s.s. "Adventuress"), the operator being Captain Durrant, of 1DH fame.

2DR has been QRT most of the month, re-building being the cause. Radion panels are being given a trial here, and a construction rather after the style of several neat outfits recently illustrated in QST. In a shack he finds the light has a quick and detrimental effect on any ebonite used.

#### Durham (6YV).

6YV is also a newcomer. Again, welcome! He is using 10 watts on 45 metres, and has worked all Europe, as well as Palestine and Madeira. He has also been reported in U.S.A. He says he is the most QRM'ed ham in England, being about half a mile from GCC (Cullercoats). You have my sympathy, OM!

#### Cheshire (6TW).

6TW has also bitten off a shack, and is nicely settled now, thank you! He has given up 23-metres because there is no one there. A new type of aerial is being tried of a vertical fan shape, and great things are expected. Crystal control is being tried on 45 metres. He is his own crystal-grinder.

2SO has found about 4 watts far better for working Europe than any other power he has tried. With 9 watts he gets no replies at all. 2SO is also a shack person, and he has repainted his with green and white stripes. Hi!

5PO is busy with 7 watts covering Europe. He has domestic QRMitis owing to generator noise. Another case for a shack. Go to it, OM!

5SO, I understand, is busy with a new QRA, and I hope to have a report from him next month. All Cheshire reports to 6TW, please.

#### Lancashire (5XY).

5XY, after a visit to 2DR, re-built and celebrated the fact by working four BZ's, the first time he put the key down. He was so pleased with this, he built another set like it, only smaller, and worked TJ-CRJ, using an 0/20.

5MS has worked BZ-1AK, but finds DX bad in his part of the world.

Reports from Lancashire wanted by 5XY, please.

#### The Convention.

Just a word to all Northern hams about the Convention. 2NM writes me that 100 provincial hams must guarantee their presence before it is worth while. Don't, for heaven's sake, fail to send in your postcards saying you are going if you can get there by any possible means. The best and most enjoyable way is to make up small parties of your immediate neighbours and travel down together. A Convention is just what we want to get the ham spirit going, and your support to this first effort means everything. I rely on all my Northern friends to back up this Convention idea in every possible way. Roll up, you fellows, and let London hear what wonderful dialects we have in the North!

## Scottish Area Notes.

JULY is notoriously a month of holidays in Scotland, and that is painfully evident by the paucity in number of the reports received. It is useless to single out any one section for comment, indeed in the circumstances it would hardly be fair to do so, and the matter will be allowed to rest with the expression of the hope that next month will yield a much larger crop of reports from the whole area.

It is hoped that all Scottish amateurs who can possibly do so will make an effort to attend the Convention in London on September 17 and 18. So far only two have signified their intention of being present, and I shall be glad to hear of any others.

The writer will be obliged to anyone for a report of signals from the ship station GMVP.

This is a vessel operating in Hudson Bay. Transmission is carried out on a W/L of 35 metres with a power of 500 watts, so that the sigs should get across quite easily. The operator is a Glasgow man, and is an ex-pupil of 2FV. Signals from this ship may be heard up to September 20 and reports will be esteemed.

I wonder if anyone in the Scottish area observed particularly the radio conditions pertaining on the night of July 25 (Sunday). It was the most wonderful DX night the writer has ever experienced. Preceded by cycle after cycle of wild QRN, the night of July 25 formed a contrast which was most noticeable. On that night, between 17.30 and 20.00 BST and 22.30 and midnight BST, the writer's station carried out 15 QSO's embracing ten countries. These conditions were evidently not purely local, as GI2IT reported working 2-BZ's, 14-U's and 1-"Zedder" the same night.—(5YG).

#### No. 1 District (by 5YG).

2FV has not a great deal to report from a transmission point of view, as his transmissions on 23 metres are in the character of

research relating to polarised waves. Following 5YG's suggestion, he has got into touch with 5WT, who is experimenting on the same wave-length, and it is hoped that much useful data will evolve from their co-operative experiments. Mr. Hay's QRA until October 30 will be 24 India Street, Glasgow. Permission has been received from the P.M.G. to use 45 metres, also to "work foreign." Three transmitters are presently in use (1) 23 and 45 metres—tuned grid (2) 90 and 150 to 200 metres—L. C. Hartley (3) 150 to 200—special Hartley panel type designed on the lines of the  $\frac{1}{2}$  Kw. CW Marconi set.

5ST sends in his first report (the first of many, I hope, OM.—5YG). He has not been doing much of late owing to various QRM. A large proportion of his work in the past consisted of very excellent fone on the higher wave-lengths, and I am sure his Sunday morning "stuff" will be known to many in the Scottish area. A B.T.H. aeroplane generator driven by a 100-volt motor is in use, and supplies the necessary "pep" for the plate of an 0/50B valve, the filament of which is heated by accumulator. This combination usually gives a pure DC QSB.

There is a possibility of 5ST taking up an appointment in London shortly, in the event of which he is not sure if he will carry on.

(We shall be sorry if you find it necessary to "sign off" for good, OM, as there are not so many experienced transmitters that the amateur fraternity can afford to lose one.—5YG).

5YG has little of general interest to report for July, apart from that contained in the preamble of the Scottish Area Notes, the station having been QRT for the greater part of July. He reports hearing an Italian "rough staff" merchant sending 54 consecutive CQ's prior to sending his call-sign. Can you beat it? The station will be closed for the whole of August owing to holiday QRM.

The following stations did not report:—2MG, 2TT, 5YQ, 6NX, 6OW, and 6YT.

#### No. 2 District (by 5JD).

2VX has not been much "on the air" of late, as business and research work has occupied much of his time. His transmitter is at present in surroundings where no external aerial is available, and in absence of this a little has been done with a "frame" against one of the walls of the room in which the transmitter is located. With this curious arrangement a London station has been "worked" with an input of less than 10 watts, and a signal strength of R4 reported.

5JD has been QRT owing to holidays, and has nothing to report.

6VO, who has been particularly "lively" during July, sends in an excellent report. He has worked his first "U" station—URSJ, of St. Louis, Missouri. He is "laying" for these "U" fellows now, and hopes to have a crop to report next month. He has also received a report from "ARR," a Lithuanian, who is presently building his transmitter and expects to be "on the air" shortly. As well as the usual F., B., SM., etc., etc., "KCZ1" of Latvia has been worked, also K4RL.

Mr. Simpson reports a new station using the call-sign "ELLA," with whom he was recently QSO. This station suddenly QRT without giving his QRA, and any information with regard to this would be valued.

6IZ has nothing of general interest to report.

6JJ is still residing in London.

5JK is globe-trotting at present as wireless op.

The following stations did not report:—2JZ and 6GQ.

#### No. 3 District (by BRS6).

2BB re-opened his station on July 17 after a long silence, and is thoroughly satisfied with the result of the final test, during which a power of 15 to 20 watts was used. Quite a number of stations have been worked, but a mishap to one of the "tubes" has caused some delay. From the results obtained he anticipates good DX work in the near future. The station transmits fone every Saturday night.

5SQ, who received his first licence in February, 1923, and who is still continuing work on an artificial aerial, has been informed by the P.M.G. that his call-sign has been cancelled, and that 2BZH is to be used in future. (6BT pse note.—BRS6).

6KO during July has worked England and Denmark on 0.6 watts. He does this QRP whenever he gets fed up turning the hand gen. He has been trying a "Hertz" aerial, and although it "went up his back" to get it to work, he is not beaten yet. Recently after fixing up the "Hertz," and connecting it with the usual counterpoise, 6KO established QSO with KCZ1 of Riga, Latvia, who reported him R5. He wishes to know if this is the first Scottish QSO with Larvia. (6VO has also worked this stn, OM, and I do not know which of you has the prior claim.—5YG). This QSO was carried out on August 1 at 21.30 BST. A visit was recently paid to the station of 6IZ at Aberdeen. 6KO finds no difficulty in getting a pure DC note from the hand generator if the tension of the brushes is kept right. The joke of the month is that D.7ZG reports reception of 6KO's fone—with a little imagination.

The following stations did not report:—2SR, 5NW, 5WT, 6GY.

#### No. 4 Section (by 5DA).

2BFQ has been experimenting with aerial systems for DX reception. He has scrapped his inverted "L" and has erected a vertical aerial 2 metres in length. With this arrangement he finds he gets greater signal strength, and also that it is very selective indeed. His best reception with it is Z2AC and Z2BQ.

5BA has not been working at all in July owing to business QRM,



and so has nothing to report. He says he has not got over the General Strike yet!!

5DA is now QSO the world except South Africa and Western U.S.A. on 50 watts and under. The regular schedule with BZ1AW is still going strong. 1AW and 5DA have now been QSO 19 times since the beginning of June, BZ having been worked 31 times in all.—FB OM—5YG).

"U" stations can now be heard as early as 22.30 GMT. CIED has been worked at 23.50 GMT with 35 watts. He reported "R3 bt fb QSB."

Mr. Gore is seriously thinking of "crystal control" for the coming winter, if he ever gets the confounded thing to oscillate!!

## Southern Notes.

Prepared by G2LZ.

2SZ is carrying out a series of tests with a Cambridge Expedition to the Arctic. Call sign ARDS. Wave-lengths various, but within the 23, 32 or 45-metre band. Will anyone hearing this station please report to 2SZ. Experiments have also been carried out on 5 metres in conjunction with G2SH and 2WV. The latter used a portable set in a car and two-way working was carried out from various points on a trip up to Norfolk. Forty-five metres was also used to assist in communication, when the 5 metres was not coming through. Up to 20 miles, the 5 metres was satisfactory. Z4AA (Frank Bell) had been up to 2SZ station on two occasions lately, and has been QSO with his family in New Zealand. His father, mother and sister all work morse, so there are plenty of operators at the other end. 2SZ says there is very little doing on the 20-metre band, a few U's have been heard about 2 a.m., but that is all. He is now experimenting with S tubes and Raytheon tubes, also with a simple method of crystal control, and hopes to give further particulars of these experiments later.

5HS reports working ANDIR, also several A's and Z's. He has also logged Hu-6CLJ, and hopes to get QSO with him soon.

5CA has just received his permit for short-wave work. He rigged up a temporary transmitter on 45 metres, and with about one watt input was soon QSO with various European stations.

2ZC has just returned from a visit to the Clyde. He has worked several Europeans on 45 metres, but is now confining his attention to the 200-metre band, and would be glad of any reports.

5GW has rigged up a Hertz, and is testing on 23 metres, but so far reports very little doing on this wave. He would be glad to arrange tests on 23 metres.

2GO, with his M.L. converter, has at last managed to hook up with New Zealand. He worked Z2AE for 35 minutes. He has also been in touch with R-CBS, Bz-IAC, C-IED and several U's.

5UP has been experimenting on 5 metres, but has little to report on the results. He is at present unable to do much on 45 metres through lack of power, but hopes to get going shortly with about 20 watts.

6CL has only been on the air a few weeks, but has already been QSO with over seventy stations with a power of only 5 watts. His QRA is: J. Clarricoats, 107, Friern Barnet Road, N.11.

2VJ is now on the air again, with a new 0/40 valve with 19 watts input. He has worked several U's, and a station with the call F2, who gave his QRA as Hinshasa, Belgian Congo, Central Africa. Another station with call I-CW in West Africa has been worked, and gave strength R7. Also Bz-IAD has been worked several times. This is very good going considering the low-power input of 19 watts.

2MI, of Margate, has offered to assist in collecting reports from Kent. He says it is high time that Kentish men bucked their ideas up a bit, and let others know what they are doing. He hopes to get going on 45 metres soon.

2MJ is a new station, and has started up on low power on 90 metres. He has got through to several European stations.

2QC is temporarily out of action due to illness, but hopes to be on the air again soon.

2UD has been out of action due to a fire.

Will Kent transmitters please get in touch with 2MI, regarding DX reports. It does not matter what wave-band you work on, send in those reports.

2LZ has been concentrating on a daily schedule with Z-4AM, and so far has not missed once during the past month. The only snag is that it entails an early rise every morning about 6 a.m. However, the DX game has had a stronger pull than the bed so far.

MILANO, July 22, 1926.

## Irish Notes.

By 5NJ.

AT the outset of these notes this month we want to thank the many hams in the Free State who have so kindly sent me a full report of their doings and of the state of amateur radio there generally. We want to make this column representative of the whole of Ireland, and this can be done very easily if all Irish amateurs will drop a line to 5NJ by the 10th of each month,

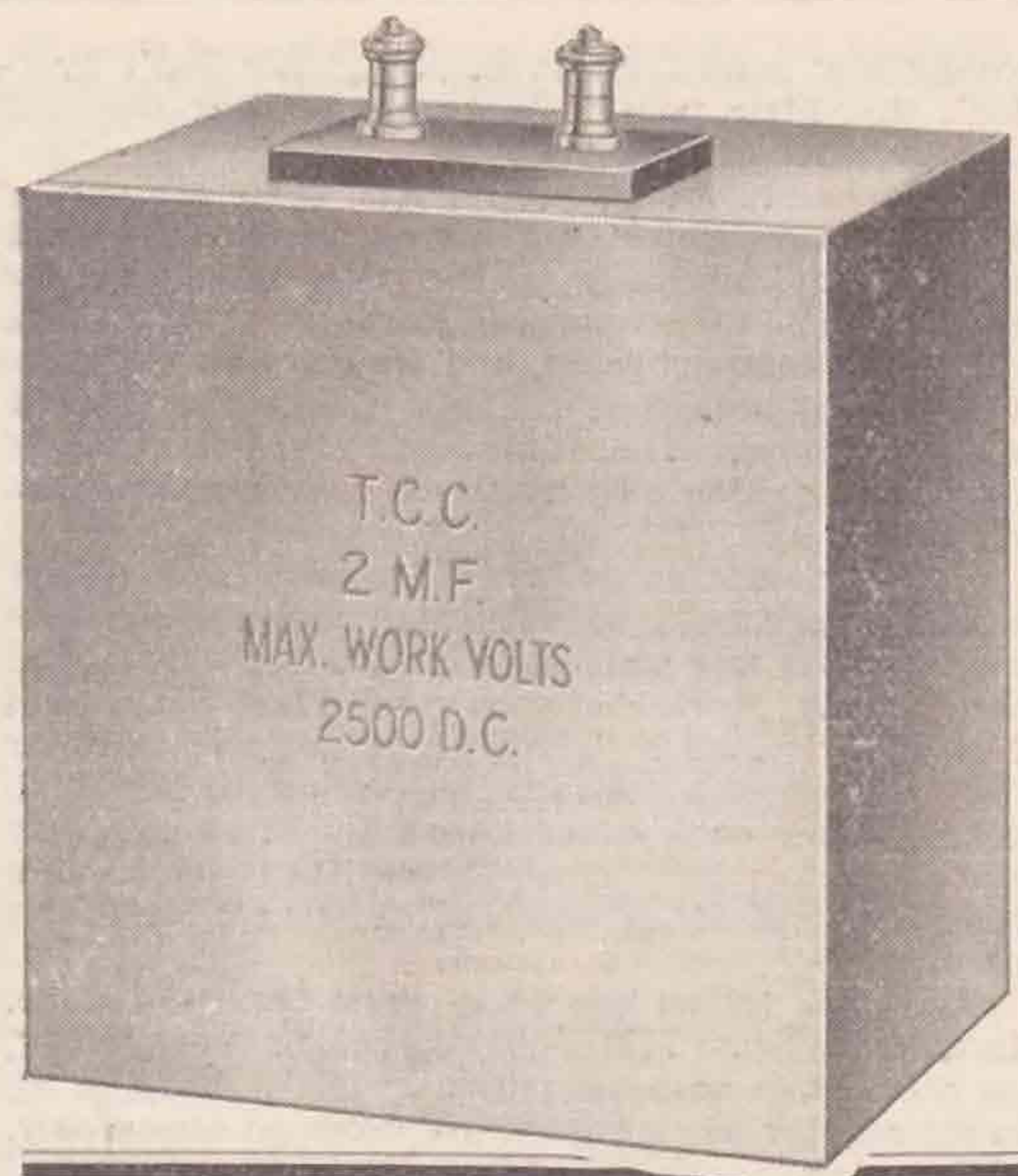

## Twenty years of experience are behind this Condenser

FOR over twenty years the Telegraph Condenser Co., Ltd., have been solely engaged in the manufacture of Condensers. Millions bearing the mark T.C.C. are now in use—from big power Condensers weighing over 3 tons to the familiar little green Wireless Condensers. It is this experience which goes to the making of every single T.C.C. product.

In choosing this T.C.C. Smoothing Condenser you can be confident that it contains all the essential features which have been responsible for the name which T.C.C. have built up—that of absolute accuracy and unusual dependability.

## T.C.C. Condensers for Transmitters

Condensers for maximum working voltage of 1500 peak value.

4 mfd.	6" x 6" x 2"
2 mfd.	6" x 6" x 1"
1 mfd.	5" x 3" x 1"
.5 mfd.	5" x 3" x 1"

Condensers for maximum working voltage of 2500 peak value.

4 mfd.	6" x 6" x 8½"
2 mfd.	6½" x 6" x 4½"
1 mfd.	6" x 6" x 2"

The type illustrated is the 2mfd.—Max. Work. Volts 2500 D.C. The condensers for maximum working voltage of 1500 peak value are fitted with soldering tags, but those for 2500 volts working are of course fitted with 2BA terminals.

Telegraph Condenser Co., Ltd., Wales Farm Rd., N. Acton, W.3.  
G.A. 5698



giving any news they have. So please don't overlook this little point. We hope to hear from all of you next month.

Now, before giving the reports, there are one or two matters which require mention. The first and most important is the Convention. It is unnecessary to emphasise here the importance of this to amateur radio, and we can only say that we sincerely hope that as many Irishmen as possible will be there. There are many matters to be discussed, so don't be afraid to give your opinions on them.

Another matter is the proposed low power week. We should be very glad to have opinions on this, also any suggestions. Lastly, what about some relay work between the Free State and Northern Ireland? The idea is not so much for the relaying of a message, but rather to let us all get to know each other better by bringing every station into the "chain," and thus cementing the great friendship which already exists amongst us all.

And now let us see what work has been done. In the Free State 11B is only on the air occasionally, on account of summer pursuits, but is keeping up fairly regular work with Europeans on low power. 15B is busy with the 1RTS and other matters, and has not as yet had much time to be on the air. 18B is very active, and has done some excellent low power work. He has been reported R8 in Holland in the afternoon, R7/8 in Belgium, and has also worked SGT at sea. Another "U" has been worked, viz., ICMX, also GX-6MU when the latter was at Newfoundland. This was on  $7\frac{1}{2}$  watts, and is very fine work. 19B is also going strong, and is awaiting confirmation of a QSO with Porto Rico. He has also had a report from U.S.A., and has done good work with Europe. This is another 7-watt station, and the work done should be far exceeded under favourable winter conditions. It is certainly good for the time of the year. Several new licences have been issued in the South, the QRA being given at the end of these notes, and there are now thirteen stations in operation. Their interests are being well looked after by the Irish Radio Transmitters' Society, which has had several very successful meetings. Full particulars may be obtained from 15B.

In the North reports are few, and apparently holidays have interfered with regular work. 2IT has not reported, but will shortly be on crystal control. 6YW is on holidays, but kept QSO with 6MU the whole way across the Atlantic with great ease. FB. He also worked Canada again, and seems to be able to raise the latter any time he desires. 5GH is back on the air, and will be heard regularly from now onwards. He has had several good low power QSO's. 6YM, 6QD and 6TB are apparently QRT, as they have not reported. 5MV is putting out some good speech, and 2WK is receiving excellent reports from many places, and should soon get "across the pond." GX-6MU has had very bad luck, having been operated on for appendicitis as soon as he arrived in Canada. This has naturally delayed his tests, but a sked. will be resumed nightly with 5NJ as from the 26th inst., when he will be homeward bound on board the s.s. "Carrigan Head". He desires to work as many G's as possible, so please look out for him from 11.30 p.m. BST on 45 metres. 5NJ has received confirmation by letter of his speech having been

clearly received in Australia, and has also got clear speech to Canada. At present the whole station is being rebuilt, and it is hoped to be on the air again about the end of August.

11B makes an excellent suggestion which, if carried out, will save transmitters making unnecessary calls. It is simply that a station, calling "test," should specify the waveband he desires replies on, such as, for instance, by sending "QRX 45" or something similar. This would save a station on 45 metres calling another who is QRX on, say, 35.

The new QRA's are:—

GW-12C.—L. H. Carder, c/o Industrial Minerals of Ireland, Ltd., Dunsinea, Castleknock, Co. Dublin.

GW-13C.—E. C. Boursin, Church Street, Listowel, Kerry.

## Indian Notes.

THE conditions for DX work during the summer months are very bad out here in the East; unfortunately owing to this fact a "Y" station is rarely heard these days.

2BG, who was well known last winter, has disappeared altogether, but will be heard again when the cold weather sets in. With an average temperature of 110 in the shade one is not too energetic.

Y2JY is a newcomer to the transmitting ranks, but has some excellent DX reception to his credit; he is transmitting on 33 metres with 5 watts, and is located at Calcutta; he hopes to raise a "G" when conditions are more favourable.

Y-DCR has worked G2GO, G2CC, G5TZ, G2FM, G2IT, G6UZ and G2SZ (what about a card, OM) with 60/80 watts. An interesting schedule was being run with G2FM and G5TZ until the General Strike upset things. Contact has not been made with either station since. G2FM was worked on five occasions, his strength being R3-7. Credit goes to G5TZ, who was worked four times; his power was 14.5 watts, strength R3-6. DCR has also worked I, Pe, S, LA, SM, O and Java, best DX being QSO with S2NX, whose power was 6 watts. DCR used 20 watts.

HBK and CRP, the R.A.F. stations, are very well known and can often be heard on the 35 metre band during the week-end.

SS2SE (Singapore) is transmitting on 34 metres, and has been QSO with A, Y, Java and FI; he will welcome reports from "G" stations.

### GENERAL.

Will the "G" that answered Y-DCR's CQ call at 2307 on 24/4/26 please QSL. Much trouble is experienced from the QRM on the 45 metre wave; the chief offenders are French and Dutch stations. During May the French station DCN was very strong on 44/46 metres, so strong indeed that when he was "brass pounding" his RAW and spreading QSB obliterated all other signals around 45 metres. G2CC was perhaps the most consistent "G" during May and June; he could be heard almost any night, but was usually very busy with schedule calls (his QSB during May reminded me of an express train in a tunnel, accompanied by many rumbles and squeaks, clatters and bangs). Sri, OM.



## Obituary.

It is with profound regret that we have to announce that Mr. L. M. Baker (2FN), of Gordon Lodge, Ruddington, has "changed over" for the last time.

Mr. Baker, who was a member of the R.S.G.B. and an Associate Member of the Institute of Radio Engineers, was one of the old original "Hams," his first wireless work being done in 1908. We lose an old comrade in his passing and extend our deeply-felt sympathy to his relatives.

## Low Power Tests.

As there is a very keen desire on the part of T. & R. members to hold special low power tests, i.e., 10 watts input to plate of oscillator, the T. & R. committee are arranging to hold a series of such tests on 44/46 metres during the week November 1-8 inclusive, from 2300/0800 GMT, and all those wishing to participate in the tests should send their names in to Hon. Secretary, T. & R. Section, 53, Victoria Street, S.W.1, not later than October 15.

Arrangements are being made with A.R.R.L. and I.A.R.U. to co-operate, and further information will be printed in these columns as occasion arises.

It must be clearly understood that the tests can only be carried out providing Post Office licences are renewed on October 15, for these wave-lengths.

## QRA and QSL Section.

It is very encouraging to note the increased interest that is being shown in this Section, as is evidenced by the number of letters received giving information about new QRA's and changes of call sign and addresses, etc.

We find it necessary, in view of an announcement recently published in a French amateur journal, to again state the facts about French QSL cards. The *Journal des 8*, to whom we recently sent our members' cards, does NOT forward cards to the T. & R., nor has it ever done so, except when the T. & R. has paid the postage. It is quite impossible for us to finance postage BOTH ways, and our cards are now forwarded to the *Journal des Emetteurs*, (see list of distributing agents), and they forward all cards, free of any expense to us, or "les 8." It is important, therefore, if members wish to receive confirmation of their experimental tests with French amateurs, to ask them to send their reports DIRECT to this Section, or via the *Journal des Ems*.

While on this subject, we should like to extend our thanks to Mr. Bates (G2SM), who very kindly brought back a parcel of nearly 2,000 QSL cards for us, which had been held up at the *Journal des 8*, when returning from one of his many little trips abroad.

We hope to extend our membership very considerably this autumn, and members can help us, and incidentally themselves, through the medium of their QSL cards and foreign correspondence.

When writing to our brother amateurs abroad, tell them about the T. & R., the amount of the subscription, and how to apply for membership, and if it is not too much trouble, and you think they may be interested, post them your last copy of the T. & R. BULLETIN, even if only on loan.

Lastly, if you have any suggestions or constructive criticism to offer, which may improve our service to our members, either in connection with this Section or with other branches of the T. & R.'s activities, do not forget to send them to headquarters for consideration by your Committee.

Below will be found a comprehensive list of official and unofficial intermediaries, compiled from information received and cards passing through the Section.

It should be remembered that intermediaries are frequently changing, and new ones being added, so that it must not be taken as official or final.

A—Australia.  
AI—Tripoli.  
AU—Alaska.  
B—Belgium.  
BA—Albania.  
BE—Bermuda.  
BO—Bolivia.  
BR—Roumania.  
BZ—Brazil.  
C—Canada.  
CB—Belgian Congo.  
CH—Chili.  
CO—Columbia.  
CR—Costa Rica.  
CS—Czecho-Slovakia.  
CZ—Canal Zone, Panama.  
CHN—China.  
D—Denmark.  
DA—Dutch Africa.  
DY—Uruguay.  
E—Spain.  
EG—Egypt.  
F—France.  
FA—Algeria.  
FC—China.  
FM—Morocco.  
FI—French Indo China.  
G—Great Britain.  
GI—Northern Ireland.  
GW—Irish Free State.  
H—Switzerland.  
HU—Hawaiian Isles.  
I—Italy.  
IC—Indo China.  
IC—Iceland.

J—Japan.  
K—Germany.  
KC—Latvia.  
KY—Kenya Colony.  
L—Luxembourg.  
LA—Norway.  
M—Mosul.  
MF—Morocco.  
N—Holland.  
NZ—New Zealand.  
O—South Africa.  
OE—Austria.  
PI—Portugal.  
P3—Madeira.  
PE—Palestine.  
PI—Phillipine Islands.  
PR—Porto Rica.  
Q—Cuba.  
R—Russia.  
R—Argentine.  
S2's—Finland.  
SM—Sweden.  
SR—Salvador.  
SS—Straits Settlements.  
T—Turkey.  
TE—Esthonia.  
TL—Lithuania.  
TP—Poland.  
U—U.S.A.  
W—Hungary.  
Y—India.  
Y—Uruguay.  
YS—Yugo Slavia.  
Z—New Zealand.

I now give an up-to-date list of various distributing agents for QSL cards throughout the world. It should be noted that in many cases this work is undertaken by amateurs, and to "lighten their load," cards should always be sent direct when QRA's are known.

**ARGENTINE.**—c/o Radio Revista, Lavelle 1268, Buenos Aires.

**AUSTRALIA.**—c/o Radio, 12-16, Regent Street, Sydney.

**AUSTRIA.**—Mr. G. E. Roth, c/o Radiowelt, Rudengasse II., Vienna III; Mr. Th. Mossig, Am Hof 13, Vienna I.

**BELGIUM.**—c/o Reseau Belge, 11, Rue du Congrès, Brussels.

**BERMUDA.**—Mr. W. F. Horsington, Paget West, Hamilton.

**BRAZIL.**—Mr. Alvaro S. Freire, 46, Oswalds Cruz Road, Ecarahy-Nichteroy, Estado do Rio: Mr. Vasco Abreu, Parc Royal, 87, Rua Riachuelo C/4, Rio de Janeiro.

**CZECHO-SLOVAKIA.**—Mr. M. Schaferling, Praha XII., Sumavska 12.

**CHILI.**—Mr. Luis M. Desmaras, Casilla 50D, Santiago.

**CHINA.**—Mr. W. G. Fisk, c/o QRA and QSL Section.

**DENMARK.**—Mr. J. Steffesen, 8, Ecklersvej, Hellerup.

**FINLAND.**—Mr. K. S. Sainio, 3a, Merikatu, Helsinki 10 (Suomi).

**FRANCE.**—c/o *Journal des Emetteurs*, 53, Rue Péaumur, Paris 2e.

**GERMANY.**—Mr. Rolf Formis, Alexanderstrasse 31, Stuttgart.

**HOLLAND.**—Mr. R. Tappenbeck, Hoogduin, Noordwijk aan Zee.

**INDIA.**—Mr. R. J. Drudge-Coates, Cambridge Barracks, Rawalpindi.

**ITALY.**—Mr. F. Pugliese, Borgonuovo 21, Milan 2.

**LATVIA.**—Dr. Walter, Brivibasiela 107, Riga.

**LUXEMBOURG.**—Mr. J. Wolff, 67, Avenue du Bois, Luxembourg.

**MALAY.**—Mr. J. P. C. Bell, F.M.S. Railways, Kuala Lumpur.

**NEW ZEALAND.**—Mr. F. D. Bell, Waihero, Palmerston, Otago.

**NORWAY.**—Mr. Leif Salicath, 88, Pilestraedet, Oslo; Mr. Diesen, Moen-i-Maalselv, near Tromsø; c/o Norske Amator Sender Union, Oslo.

**PALESTINE.**—c/o Radio 6ZK, Signals, Raf-Ramleh.

**PHILLIPINE ISLANDS.**—Lieutenant Roberts, Fort McKinley, Rizal.

**POLAND.**—c/o Radiofon Polski, ul Wilcza 30, Warsaw.

**PORTO RICO.**—Mr. J. Agusty, Box 868, San Juan.

**PORTUGAL.**—Mr. Eugenio de Avillery, Costa de Castelo 13, Lisbon; c/o TSF em Portugal, Rua Jardim, Regedor 29-12, Lisbon.

**RUSSIA.**—Mr. Wladimir Petroff, Nichni-Novgorod Radiolaboratory, Soviet Republic.

**SOUTH AFRICA.**—Mr. Heywood, 91, Berea Park Road, Durban, Natal.

**SOUTH AFRICA (No. 6 District).**—Mr. A. E. Stevens, 7, Ruth Street, North Perth, West Australia.

**SPAIN.**—Mr. Miguel Moya, Megia Lequerica 4, Madrid.

**SWEDEN.**—Mr. Bruno Rolf, Hamngatan 1A, Stockholm.

**SWITZERLAND.**—Dr. W. Merz, Berne-Bumplitz.

**U.S.A.**—c/o ARRL, 1,045, Main Street, Hartford, Connecticut.

**YUGO-SLAVIA.**—Mr. Torbarina, Dubrovnik 2.



**QSL's WAITING.**

The following have not less than three cards each waiting to be claimed. Will they please forward stamped addressed envelopes to this Section.

2AKG	2OJ	5SW
2APU	2RL	5WH
2BAZ	2WW	5XO
2BD	2WX	5ZA
2BDY	2WY	6BJ
2BK	2ZA	6DO
2BMO	2ZF	6FT
2BOW	5DH	6HF
2BQ	5DK	6IG
2BZ	5DS	6MX
2CA	5FS	6OG
2CH	5GF	6OX
2DA	5GQ	6RD
2DF	5GU	6RY
2DX	5GZ	6SU
2DY	5HG	6SZ
2FM	5IO	6TM
2FO	5IR	6US
2GY	5MF	6YM
2LF	5MS	6YS
2LW	5MU	6YW
2NC	5PD	6YX
2NT	5PM	6ZC
2OF	5RZ	BRS9
2OG	5SO	BRS23

**QRA's FOUND.**

R-FC6.—Julio J. Hiver, San Martin 166, Santa Fé, Argentine. (Inf. 2BYN.)

SS or FI-8LBT.—Hervey Lambert, 146, Dis Rue Refgevre, Saigon, French Indo-China. (Inf., J. S. Drewett, T. & R.)

**QRA's.**

2NU.—A. J. Hall, 326, Romford Road, Forest Gate, London. E.7.

2SR.—H. F. B. Sharp, Hill of Tarvit, Cupar, Fife, Scotland.

5RS.—Radio Press Laboratories, Elstree, Herts.

5SS.—Stretford Radio Society, The Cottage, Derby Farm, Derbyshire Lane, Stretford.

6BZ.—W. Burrows, 11, Cunliffe Walk, Garden Village, Wrexham, North Wales.

6CL.—J. Clarricoats, 107, Friern Barnet Road, London, N.11.

6JH.—J. Hartley, Jun., 21, Plymouth Grove, Manchester.

GI-5GH.—J. H. Gillespie, 16, Knockdene Park S., Knock, Belfast.

GW-11C.—D. Burton Bradshaw, Littleton, Ashfield Road, Ranelagh, Dublin.

GW-12C.—L. H. Carder, c/o Industrial Minerals of Ireland, Ltd., Dunsinea, Castleknock, Co. Dublin.

GW-13C.—E. C. Boursin, Church Street, Listowel, Kerry. (GW Inf., 5NJ.)

GLYK.—m.y. "Adventuress," Colonel B. S. Millard, c/o Royal Thames Yacht Squadron, Knightsbridge, London.

K-AYY.—E. J. H. Moppett, Rhine Army Signals, B.A.O.R., Wiesbaden, Germany.

AI-1CW.—Capitano Filippini, Governo, Tripoli. (Inf., 2QV.)

**QRA's WANTED.**

2BZO, 2BK, 2FO, 2LW, 2NC, 2QX, 2RL, 2WX, 2ZF, 5CZ, 5DK, 5SW, 6AM, 6GV.

**CHANGE OF CALL SIGNS.**

2AWK now 5LH; 2BAS now 5GZ; 2BCL now 5LU; 2BNJ now 2SR; 5AP now 2BLY; 5NF now 5JG; G-AKD now K-AYY; DA-ITA now AI-1CW; 6NO now 2AZT.

We are receiving an increasing number of QSL cards for forwarding not stamped to reach their destination, for countries other than Belgium, France and Holland. It becomes necessary therefore for us, in future, to return such cards to the members sending them.

Further, applications for QSL cards to be forwarded, unaccompanied by stamped addressed envelopes, will have to be ignored.

G6BT,

QRA and QSL Section,  
Bury, Suffolk.

## Calls Heard.

Reinartz O-V-1. G—6uz, 2qb, 2fm, 2gm, 5tz, 2it, 2nm, 5pz, 2cc, 2xy, 2go, 2uf, 5ha, 2kz, 2vq, 5ls, 5nj, 6og, 5da, 6ah, 2kf, 5ar, 5vl, 6td, 5by; F—8kf, 8jn, dcn, 8gi, ocnj, ocng, 8gs, 8ix, ocml; S—smuk, smtn, smvl, smxv, s2nl, s2nx, s2nd, s2co, s2ns, s2ne; N—stb, pb3, pc2, ofp, amg, pepp, pcll, pcg; B—w1, z1, 4yz, o2, j2, o8; Miscellaneous—andir, tuk, bz5ab, lcr, lat, cd8, nsa, niss, kegk, la4x, isl, hva, hvn, anf, a3bd, Oa3e, Oa6n.—DRUDGE-COATES, Y-DCR.

Indicatifs entendus a la station 8ffh. QRC 180km, ouest Paris. 2db, 2jt, 2nt, 2po, 2xy, 5jg, 5jw, 5ms, 5mu, 5sk, 5td, 5uw, 5yk, 6fa, 6ft, 6ia, 6iz, 6nx, 6iy, 6qb, 6qh, 6vp. Gw19b. giab.

Calls heard, extracted from Latvian "Radio." From July 26, 1926, to August 9, 1926:—

By KC—2a: 2kf, 5da, 5xy, 6ia, 6og, 6ty. By KC—2k: 6tm. By KC—2r: 2db, 2it, 2jb, 2nm, 5bv, 5fq, 5hx, 5jw, 5mg, 5ms,

5mu, 5qt, 5td, 5tz, 5uw, 5xy, 6bl, 6cj, 6hz, 6ia, 6ko, 6nx, 6ty, 6yc, 6yk, 6yv, 6yw, 6za. By KC—2u: 2db, 2it, 2jb, 2jp, 2ud, 5dh, 5hj, 5jw, 5ms, 5yk, 6rm, 6yd, 6yw. By KC—2v: 2it, 5sn.—G6BT.

Australian—6nj. Belgium—a11, e1, att. Brazil—mme. Chilian—2ld. Denmark—6n. Spain—ear 20, ear 10, ear 9. France—8jc, 8ww, 8ip, 8ph, 8ez, 8jc, 8ez. Great Britain—2bz, 2vq, 2sz, 2nm, 2wx, 2vj, 2go, 2oh, 2ud, 2bz, 2uw, 2jw, 2kf, 2wn, 2sr, 2it, 2xy, 5jg, 5sz, 5vl, 5lf, 5mu, 5jw, 5kz, 5wv, 5nj, 5nf, 5hs, 5jw, 5ts, 5mf, 5po, 5jg, 5mq, 5ms, 5da, 6og, 6ry, 6yb, 6wv, 6yd, 6bd, 6ut, 6ry, 6ty, 6ka, 6ox, 6vp, 6gb, 6ia, 6hs, 6wg, 6uz. Italy—lay, lgn, lax. Germany—cz1, k-k7, 4rr. Holland—wp63, ohb, laa, opx, ofpw, oa6n. Russia—1fl. Scandinavia—1dc, 2cd, 2nm, sm6uv, smyg, smbg, smzn, smyu. United States—1xv, 1ad, 1ch, 1ga, 9yu, 2rv. New Zealand—2n. GFR—niss, wiz, sgl, xd. BO—2wj, andir, octn, kw3, fw. YS—7xx, bam, da, oets, pcuu, pcll, wiz, kw6c, ho6, md, ocng, kwg, tpai, ocdj, isra, pkx, xk, suc, b82, pepp. Heard off Algiers, Portugal and Port Said and all along the Mediterranean. Kindly QSL via 6ZJ.

U—1aao, 1afm, 1aha, 1aoh, 1avf, 1bca, 1blf, 1cal, 1caw, 1clb, 1cjc, 1ctg, 1ka, 1rf, 1xv, 2acs, 2ahx, 2akv, 2amj, 2aqw, 2baa, 2cyq, 2cyx, 2rf, 2tr, 2vo, 3acm, 3ahl, 3buu, 3bva, 3bwj, 3cdk, 3cjn, 3gl, 3ld, 3sn, 3uv, 3vf, 3zo, 4pk, 4ni, 4bi, 4hx, 5wi, 6cto, 8adi, 8adm, 8adq, 8aip, 8atv, 8avd, 8bfo, 8bid, 8bit, 8bni, 8bsd, 8bre, 8ccq, 8cor, 8cx, 8jq, 8kf, 8pl, 8rbp, 8rd, 8shc, 8su, 8zed, 9ac, 9bbp, 9bpd, 9bpl, 9bdq, 9bhe, 9eji, 9kg, 9uv, 9wi, 9zt, pr4rx, ch2ar, yicd, 2ak, c2be, A's: 2cs, 2bb, 2bk, 2lm, 2tm, 2yi, 3ak, 3bd, 3en, 3kd, 3xo, 4an, 4cm, 4rb, 7cs, 7cw, 7hl, 7la; Z—1ao, 3ai, 4aa, 4ac, 4am, 4ao, mlaa, 1j, 1k, 9a, rbal, bg8, cb8, db2, fe6; BZ—1ac, 1ad, 1ak, 1aq, 1ar, 1aw, 1ax, 1bi, 1bh, 1ib, 2af, 2aj, 2ar, 5ab; Miscellaneous: pjlau, czfr5, wvr, voq, wnp, nap, niss, nba, wxf, rxy, ghdh.—F. SMITH (BRS3), 101, Highfield Road, Saltley, Birmingham.

Y—2aw, 2ad, 2bk, 2cd, 2dr, 2go, 2og, 2jj, 2jw, 2ki, 2kt, 2kx, 2nj, 2gh, 2so, 2ssk, 2sr, 2vj, 2vs, 2xy, 2ww, 2wk; Y—5fq, 5bv, 5gq, 5hs, 5hj, 5hx, 5jw, 5kq, 5lb, 5lf, 5ms, 5mf, 5qt, 5sk, 5sw, 5ta, 5uv, 5vl, 5wv, 5wq, 5xo, 5xd, 5xy, 5za; Y—6aj, 6br, 6ci, 6hz, 6ia, 6id, 6in, 6iz, 6jo, 6fa, 6ka, 6mp, 6mx, 6np, 6ow, 6ox, 6qb, 6pt, 6sa, 6td, 6tm, 6tz, 6ut, 6uv, 6yd, 6yc, 6yq, 6yv, 6yr; Y—bvj; Y—star; Y—w18b; Y—w1yb. Pse 9rk and 8rvl?

To: Y—2az, 2cs, 2qc, 2nm, 2oq, 2vq-5cc, 5fj, 5qq, 5kc, 5ku, 5sk, 5us, 5yk, 5za-6ep, 6bj, 6kk, 6ot, 6br, 6rm, 6ry, 6tg. Tks fr qsc. Have you received mi qsl? I have never rcd ur crd. Pse send mi qsl via "jd8." 73's. f SRVL.—RCD in Laval (250 kms. west Paris) during July by F8RVL.

By KC-2A: g2ra, 2wh, 2xy, 5uw, 6ry; by KC-2C: g2ls, 2vj, 5dh, 6mp; by KC-2K: g2it, 5dh, 5xy, 5yh; by KC-2R: g2bz, 2it, 2kf, 2nt, 2og, 2so, 5fq, 5hs, 5jw, 5td, 5wv, 5xy, 6br, 6ia, 6iz, 6og, 6vo, 6yw, gw-19b, gbm; by KC-2U: g2bz, 2cc, 2it, 2og, 2qb, 2ud, 2un, 2vj, 2wj, 2xy, 5da, 5dh, 5jg, 5jw, 5tz, 5uw, 5wv, 5xy, 6dn, 6og, 6oo, 6ut, gbm.—Extracted from Latvian Journal "Radio."

Great Britain and Ireland: 2db, 2jj, 2nu, 2vs, 2ud, 5jw, 5us, 5qz, 5wv, 6ia, 6iz, gwi3c, gwi8b; Belgium: t-9; Denmark: d-7xg; Italy: 1ma, lgn; France: 8bum, 8en, 8gin, 8lz, 8pay, 8vvd, 8xix; Holland: n2pz, nqvn; U.S.A.: lawe, lase, 1xv, 1ka, 1ml, 1fg, 2sj, 2awk, 2bcb, 3cdn, 410, 8bbe. Pse qsl oms. All above stns called (except U.S.) from G6CL, 107, Friern Barnet Road, N.11.

B—b7, b12, e9, g33, b5, k2, k44, o2, s5, w1, z9, 4bs. BZ—1ad, 1af, 1ak, 1al, 1ao, 1ar, 1aw, 1bc, 1bd, 1bg, 1bh, 1bi, 1ib, 2ab, 2af, 2am, 5ab, 9qa, sq1. CH—2ar, 2ld. D—7zg. EAR—9, 10, 19, 28. F—8bn, 8ca, 8cl, 8cr, 8gm, 8ix, 8ju, 8kf, 8lz, 8py, 8vu, 8xx, 8zb, 8aok, 8cax, 8fbh, 8fcr, 8gsm, 8jrt, 8koa, 8lmh, 8ncx, 8pam, 8pax, 8pdp, 8ppl, 8prd, 8rat, 8rbp, 8ssy, 8tby, 8tis, 8wel, 8woa, 8woz. H—9xa. I—lap, lax, 1bd, 1bk, 1co, 1dc, 1gw. K—c8, i2, w9, 4wm. KC (Latvia)—z1. LA—1e, 4x. N—12bb, pb3, pck4, 2pz, 0bl, 0fp, 0hb, 0nd, 0pm, 0px, 0us, 0vn, 0wc, 0xx. O—a6n. O—hl, wa. P—1ae, 1ak. R—ef2. S—2nd, 2nl, 2nm, 5nb. SM—smsp, smss, smsy, smto, smuk, smus, smuv, smvg, smvl, smws, smyg. TP (Poland)—aj, aw. TJ (Trans-Jordania)—crj. U—1xv, 1aap, 1abt, 1aiu, 1alr, 1amd, 1ccw, 1cib, 1cnp, 3gv, 2mm, 2mu, 2nf, 2va, 2anx, 2apv, 2brb, 2evj, 2exl, 2czr, 3bwt, 4ak, 4kj, 8dbb. Y—1cd, 1cg. YS—7xx. Miscellaneous—pcll, pepp, perr, pcuu, wnp, ra19, agc, ptq, 2xaf, nrk, nba, ntt, nrl, wiz, ido, isl, sab, spl, lpl, b82, bg, lor, fw, gbm, bvj, bxy, ocng, ocdj, octn. Heard between June 1 and August 10. All below 50 metres. Receiver O-V-1 (Reinartz).—T. A. ISERBYT (BRS25), "Lynmouth," 18, Broughton Road, Thornton Heath, Surrey.

Belgium—b4zz, b4. Spain—ear4. France—8du, 8ag, 8ba, 8gi, 7xu. Italy—2vj, 1cn. Germany—2i, 4du, 0fp, 2pz, 0am. New Zealand—9b, 1kc. Miscellaneous—wiz, agb, agc, cstty, lpv, npb2. Wave-lengths between 30-45. August 1 to 9. Cards waiting. QRK mi CW on 45 metres. Nightly between 11 and 12 BST.—6ZJ, Kensington House, Church Street, Sheringham, Norfolk.

Brazil—1ad, 1af, 1ao, 1aw, 1bi, 1bo, 1ey, 1ib, 2ab, 2af, 2ak, 2aj. U.S.A.—1aao, 1avf, 1ay, 1ccx, 1ch, 1cjs, 1cmp, 1cmx, 1cmz, 1cnb, 1co, 1di, 1kl, 2ahg, 2arx, 2bmz, 2byg, 2rv, 2tr, 3bva, 3jw, 3zo, 8aks, not. Porto Rica—4ja, 4tf. Argentine—cb8, db2, ha2, ba1. Belgian Congo—cb-f2. India—y-2ak. Austria—öwa, öke. Miscellaneous—egkk, piae, aiz, azut, oha2.—H. GOLDSBROUGH (GW19B).



## Correspondence.

*To the Editor of T. & R. BULLETIN.*

DEAR SIR,—There seems to be a diversity of opinion as to the correct interpretation of some of the unusual "groupings" as used by foreign stations when transmitting morse. To say the least it is somewhat awkward when receiving a distant station through bad QRM to read groupings which are uncommon. Doubtless many others besides myself find themselves missing a good deal of the subsequent message due to trying to imagine what the said letter was. Might I suggest that for the benefit of all your readers that in the next number of the BULLETIN a list of *up-to-date* groupings (including stops and abbreviations) be included. Such would be particularly acceptable in the form of a loose leaf which could be inserted in the "log book." Yours, etc.,

R. W. LODGE (BRS16).

*To the Editor of T. & R. BULLETIN.*

DEAR SIR,—I am able to report a new station on the air, whom I have worked. It is F2, his QRA is: Kinshasa, Belgian Congo, Africa. He uses the intermediate call CB (Congo Belge). I heard him calling "CQ BFGI SMKR de cb F2" at 22.000 G.M.T. on August 2, 1926. I answered him, using 19 watts, and he reported me "R4 QSB DC FB." He had very bad QRN. His QRH is 35 metres, and his QSB pure DC, and fairly steady. I received him R5/6 on loud-speaker on three valves.

I have an idea that I am one of his first QSO's.

I also have to report working ICW, Capitano Filippini, Governo, Tripoli, North Africa. His QRH is R8, QSB, AC., QRH-34.5 metres. Also QSO nightly BZ-1AD. Yours faithfully,

BERNARD J. AXTEN (G-2VJ).

P.S.—The notes about F2 and ICW might be of interest to other hams if published in the BULLETIN. I am rather surprised at my sigs. getting to F2 over the Sahara and Central African jungle and forest!!

*To the Editor of T. & R. BULLETIN.*

DEAR SIR,—My attention has been drawn to the fact that some T. & R. members still solemnly use alleged low-loss coils composed of copper strip wound on edge. I regret that in referring to this matter in BULLETIN No. 4, page 7, I had done so expecting to destroy this hoary old superstition merely on my own authority. I might, of course, substantiate the bare statement there given, that this type of winding is the worst possible, by a long and dull treatise on the theory of H.F. resistance, but I consider it more profitable to refer devotees of "low-loss" to Professor Morecroft's "Principles of Radio Communication," where he explains the matter in detail, and gives actual measurements on coils.

Unfortunately, they are not carried to a sufficiently high frequency to make them as convincing as they would be if extended to the frequencies in use among amateurs to-day, but at the comparatively trifling frequency of 150 Kc. (see p. 147) an edgewise-wound strip coil increases in resistance from 0.023 ohm to 7.860 ohm. What would it be at our 6667 Kc! Unfortunately he

does not give measurements of flat-wound strip coils, which are the best, but an example of a wire-wound coil (p. 129) shows only 1/15th of this increase over the same range of frequency.

I hardly think it is necessary to say more, but those who are not convinced should consult any good standard work which includes a discussion of the H.F. resistance of coils. Faithfully yours,  
MARCUS G. SCROGGIE, B.Sc.

*To the Editor of T. & R. BULLETIN.*

DEAR SIR,—Like many other amateurs, I am puzzled by the way in which 45-metre signals are received strongly by stations situated at, say, 200 miles from the transmitting station, and very weakly by stations only a few miles distant.

As an instance, when QSO G-2SZ on fone at 15.45 BST on July 25, he reported me R3, and after I increased modulation, R5.

Reports received by post during the next few days showed that my fone was received on an average of R5-R6 at distances of about 200 miles. 6AI, of Swansea, for example, reported my speech R8 on O-V-I. Similarly, speech from G-2SZ was not nearly so loud at my station as that from 6OH, 5BW, 2IT, etc., although he is only about five miles away.

I believe that the general opinion on this matter is that the angle at which the waves leave the transmitting antenna causes them to pass right over stations within a small radius.

I have just been reading "The Polarisation of Radio Waves," a paper read by Greenleaf W. Pickard before the I.R.E. In this paper, Pickard describes experiments which he conducted in reception on a straight aerial which could be rotated round a horizontal or vertical axis, in order to determine the plane of polarisation of the received waves. His experiments showed, amongst other things, that for wave-lengths under 100 metres, and for distances over 50 Kms., the electric field at the receiving point is predominantly horizontal. The ration of the horizontal to the vertical component was found to be dependent only on the wavelength and distance, and to be independent of the direction of transmission and whether the waves left the transmitter horizontally or vertically polarised.

Unfortunately, no results are given as to the comparative horizontal and vertical components of the field at distances of less than 50 Kms. from the transmitting stations, except one group of measurements taken at 30 Kms. on frequencies of 3,500-4,000 cycles. These last measurements showed that the vertical component was predominant over the horizontal in the ratio of 1.3 to 1.

It therefore seems possible to me that for short distances, reception on a vertical antenna might show very much increased strength over horizontal reception, in view of the possibility of the predominance of the vertical component in the waves at short distances from the transmitter.

I should like to know whether anyone has had experience with vertical aerial reception on short waves, or better still, whether anyone has carried out comparative reception tests with vertical and horizontal aeriels, with particular note as to the distances of the various transmitters.

I intend to carry out experiments along these lines, and should welcome the co-operation of any

THEN IT IS YOUR OWN FAULT!



fellow-members of the T. & R. who may be interested, especially some at a distance of 5-10 miles from my station. Yours faithfully,

BERNARD J. AXTEN, A.M.I.R.E. (G-2VJ).

*To the Editor of T. & R. BULLETIN.*

DEAR OM,—I have been informed that U-9CHE wishes to arrange tests with some transmitting amateur, so that anybody interested may get it arranged through me.

FI-8QQ is using IC-1B as his call from August 1, and TUK (Tomsk University, Tomsk, Liberia) is using RA79 as his call sign now.

If you could get these notes in the BULLETIN, OM, I should be greatly obliged.

73's, OM, esluck to the "BULL." Yours sincerely,  
J. K. FENBY (BRS8).

P.S.—U-9CHE wishes to know QRH es time, etc., of the ham testing with him.

*To the Editor of T. & R. BULLETIN.*

SIR,—May I voice a further plea on behalf of the low-powered stations.

In the past, records have been claimed of practically world-wide DX on fractional powers, but we are not given all the details regarding the actual QSO. Was it an initial contact or the result of a QRP test? This is important, not necessarily because of "record claiming," but because the low-pitched stations are naturally keenly interested. To really determine the efficiency of a station on low power he has to stick to low power, and I maintain that 90 per cent. of the low-powered transmitters in use are showing a much greater efficiency than the 100-watt or so merchants.

Can we, then, really arrange for this to be shown—and that brings me to what I want to suggest, i.e., a world-wide QRP test, something similar to the first transatlantic tests. Arrange that all stations taking part use a stipulated "bottle" that will only take, say, 4 watts, and limit the input voltage to 200 volts, DC mains or dry cells—no RAC or generators.

All the high-powered stations who would not participate on low power, should be asked to QRT during the prearranged periods. Obtain international co-operation and make the tests of world-interest. The results would show an interesting comparison of various stations, and also would stimulate interest in amateur radio during the coming winter.

Can we get the backing of the T. & R. Section, and show the rest of the world how things are done?

I should like to hear from all interested, and sincerely hope we may get together and make a real object to have in view for the darker evenings. Yours faithfully,

G. A. EXETER (C-6YK).

*To the Editor of T. & R. BULLETIN.*

DEAR OM,—Have received QSM from CH3AT. He asks me to let British hams know that he is on 36 metres every night, 18½ to 24 CHMT (approximately 0000—0500 GMT, I think), and is keen on QSO'ing G. Stus. He sends 73's to all British amateurs. 73's OM, is SX

London, N.16.

B.R.S.1.

*To the Editor of T. & R. BULLETIN.*

DEAR SIR,—Much correspondence has been

written on the advisability of arranging a test for amateurs, in which the power used must not exceed 10 watts.

The Editor of *Wireless World* has advised me to write to you on this matter and find if it would be possible for the T. & R. to arrange the tests.

Would it be possible to arrange matters with the French amateurs as well, because many of our QRP stations are completely wiped out by some of these strong stations?

I suggest that the test lasts for one week in October or November, and that a list of stations participating in the test be published in the various wireless journals.

Hoping all amateurs will give you their support, and that you can see a way to arrange this test. Yours faithfully,

T. A. STUDLEY (G5TD).

6, Rutland Road, Harrow.

[ED. NOTE.—Arrangements are being made to hold a series of tests of the type mentioned.]

*To the Editor of T. & R. BULLETIN.*

DEAR SIR,—In the QRA and QSL section of the August BULLETIN there is a note to the effect that Mr. A. E. Stevens (A6N), 7, Ruth Street, N. Perth, W. Australia, will forward cards for all No. 6 district hams in South Africa.

Will you please note that this is wrong, as Mr. A. E. Stevens (A6BN) informed me that he would forward all cards for 6th district hams in Australia, namely, Western Australia. Yours sincerely,  
73's. J. K. FENBY (BRS8).

*To the Editor of T. & R. BULLETIN.*

DEAR O.M., EDITOR,—There has just come to hand a letter from a man who says that he has joined the T. & R. Section and does not see anything worth 15s. a year in the "Bull." Not knowing him, except by casual correspondence, I know nothing of his mental make-up, so can't say if the "Bull" is above or beneath him.

In case there are others of the like way of thinking, I may say that apart from the BULLETIN, which I think is just about the goods, only fault being that I have to wait a month for it, I have already got over eight shillings of my subscription back, in saving of stamps, since the QSL section started. Hi! And I am practically certain of getting return cards from the Continent, which I wasn't before.

But even if we got nothing whatever in return for our subs. surely it is our duty to stick together, for the protection of our interests. Things may look fairly roseate at the moment; but unless we are strong and can show our strength we are always liable to be nipped between the upper millstone of the Post Office and the nether millstone of the B.B.C. Yours for the game,

Langmead, Pirbright, Surrey.

G-5YM.

[EDITOR'S NOTE.—Our correspondent shows that should his activities proceed at the same rate as at present for the remainder of the year until the anniversary of the reception of the Q.S.L. Section, he will have made a profit of 1s. on his transaction in addition to receiving other services. This seems to be a complete answer to the suggestion of no value for money!]



**A. MUNDAY L<sup>TD.</sup>**

**45, EASTCHEAP, E.C.3**

'Phone : ROYAL 4632.

**59, WATLING ST., E.C.4**

'Phone : CITY 2972.

**LONDON, ENGLAND.**

**Accumulators**

**Dry Batteries**

**— Valves —**

**A. MUNDAY, L<sup>TD.</sup>**



# FOR THE RADIO EXPERIMENTER

The Mullard  
VO/150 short  
wave trans-  
mitting valve

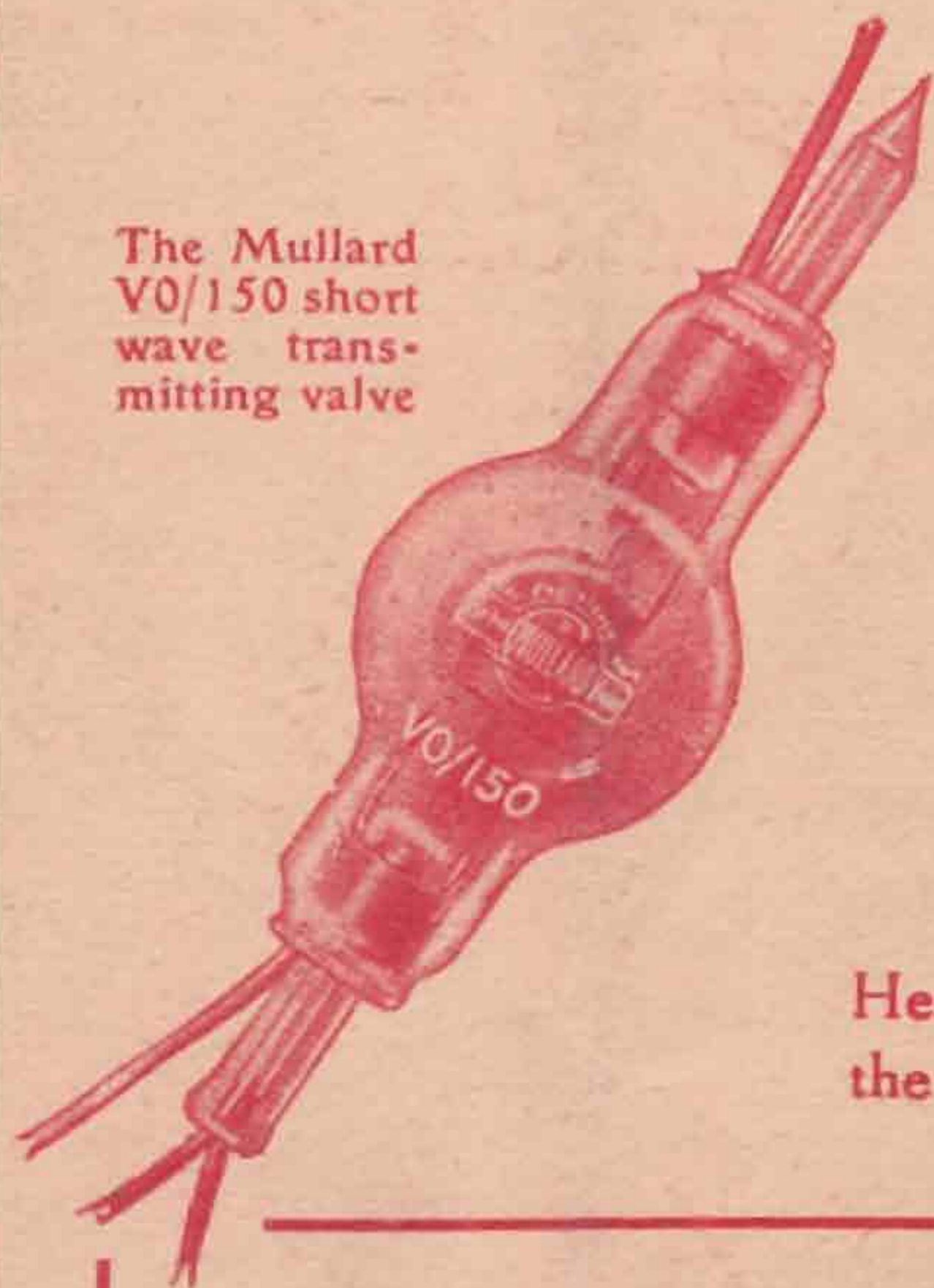

Mullard low and medium power transmitting valves have already established a firm position in the appreciation of wireless amateurs all over the world. Many of the first trans-world records owe their success to the outstanding qualities of Mullard Valves.

Here is a range of Master Valves to secure the best results from your radio station:—

## LOW AND MEDIUM POWER TRANSMITTING VALVES

TYPE.	FIL VOLT.	FIL AMPS.	ANODE VOLTS.	IMPEDANCE OHMS.	PRICE.
*DFA6	4.5	.785	200/ 400	5,500	£2 0 0
*DFA7	4.5	.85	100/ 200	2,500	£2 0 0
*DFA8	4.5	.85	200/ 400	15,000	£2 0 0
0/30A	5.5	1.8	1000/1200	30,000	£2 15 0
*DO/40	6	2	500/1000	5,000	£5 5 0
VO/50	9	4.4	800/1200	13,000	£5 12 6
VO/150	11	6	1500/2500	24,000	£6 10 0
VO/250	11	9	2000/3500	11,000	£9 0 0
*DO/250	6	6	2000/3000	11,000	£15 0 0

\*Long-life Dull Emitter Valves.

Experimenters should avail themselves of the Mullard technical service, and when requiring special valves should write giving details.

# Mullard

## THE MASTER VALVE

Advert. THE MULLARD WIRELESS SERVICE CO., LTD., Balham, London, S.W12.