

21-

# SHORTWAVE

*Magazine*



EXCLUSIVELY FOR THE  
RADIO EXPERIMENTER &  
TRANSMITTING AMATEUR

VOL. IX No. 8 OCTOBER 1951

# H. WHITAKER G3SJ

10 YORKSHIRE STREET, BURNLEY

Phone 4924

**OSCILLOSCOPES.** By well known British Manufacturers. In black crackle steel cases, size 12 x 8 x 6 ins. For AC mains 230/200v 50cy. Tube size 3ins. (green) Hard valve time base continuously variable from 5 to 250,000 c.p.s. Push-pull "X" deflection circuit with T.B. wave form brought out to separate terminal for wobulator work or synchronising. Provision for fly back suppression. Push-pull "Y" deflection circuit, level from 15 to 300,000 c.p.s. All usual controls and provision for using a D.C. volt-meter to measure the amplitude of an A.C. waveform. Separate synchronised amplifier and no control interaction. Complete with all test leads and instruction manual. They are brand new and boxed in original cartons, and represent an un-repeatable bargain at £19/10/0. Carr. paid.

**RESISTORS and CONDENSERS.** Resistors. An exceptionally fine parcel of 100 assorted resistors, Erie, Dubilier, etc., including ceramicons. All brand new  $\frac{1}{2}$  watt to 20 watt, carbon and small Vitreous. Values range from 22 ohm to 8.6 Meg, including all standard values. Average parcel will include at least 30 different values, made up as follows. 20  $\frac{1}{2}$  watt, 30  $\frac{1}{2}$  watt, 30 1 and 2 watt, 15 5-10 watt, 5 20 watt. The above now limited to one parcel per person at 12/6 post free.

**CONDENSERS.** Another exceptional and un-repeatable offer of 100 assorted brand new and all guaranteed condensers of every conceivable type. Average parcel will include, smoothing 2, 4 and 8mf., Paper tubular, metal tubular, Bias, Electrolytic 4mf, metal can 450v wkg, Bach tub, Mica, 350v, 1000v, and 2500v wkg. A fair percentage of U.S.A. manufacture are included. The bulk are from Tropicalised packing and in perfect condition, we guarantee every condenser, and all are brand new and not stripped from equipment. Bulk quantities available at 15/- per parcel post free.

**IGNITION SUPPRESSION.** Metal cased. .15 150v wkg with small fixing lug, 6/- doz.

**ELECTRONIC KEYS.** 230v 50cy. A.C. Mains. Our own production. Grey crackle steel case 9 x 7 x 6 ins. Employs in all 5 valves. Controls for dot, dash, and spacing, with speed control continuously variable from below 10 wds. per minute to 60 wds. per minute, with perfect formation of characters. This is precision first class operating made easy. Carr. paid £12/10/0.

**AERIAL EQUIPMENT.** Bendix telescopic masts. 3 section tripod 30ft., £7. Type 1148a 5 section interlocking. 2in. heavy gauge steel. Cast base plate. 3 heavy ground stakes, 3 guys, pulleys and toggles. Complete with cross-arm dipole at approx. 70 Mc., with approx. 40ft. of 300 ohm line. As used with the 1147 receiver. In heavy wood transit cases 6ft. x 18 x 12ins. Total height 27ft. Two can interlock together. Carr. paid 70/-. The case alone is worth this. Cigar masts. Heavy gauge galvanised steel. 2 section bolt together at centre by heavy flanges. Centre diameter 9 $\frac{1}{2}$ ins. end diameters 4 $\frac{1}{2}$ ins. Guys not available. Height 40ft. Carr. paid £7. As above height 30ft. Diameter at centre 6 $\frac{1}{2}$ ins., end diameter 3 $\frac{1}{2}$ ins. Carr. paid £4/10/0.

**FEEDERS.** Henley 80 ohm twin line, 6d. per yd. 80 ohm  $\frac{1}{2}$ in. Co-Ax 1/2 per yd. Telcon 300 ohm line 9d. yd. Ex-Air Ministry 10in. Insulators,  $\frac{1}{2}$ in. diameter, fixing holes each end. Ideal for 600 ohm feeders with 8s gauge wire. Useful also for breaking up of stay wires into non-resonant lengths. 6/- per doz.

**MODULATION TRANSFORMERS.** Woden UMI 54/-, UM2 72/6, UM3 90/-, UM4 215/-, immediate delivery from stock by return of post. We carry full stocks of all Woden Mains and Plate transformers and can give delivery by return of all normal types at current list prices.

**CRYSTALS.** 1000 Kc Valpey, Bilby or Somerset, standard  $\frac{1}{2}$ in. pin spacing, 20/-, R.C.A. 100 Kc standards, 20/-, Western Elec. 500 Kc Ft 243 holders with  $\frac{1}{2}$ in. pin spacing, 7/6. Full range of Western I.F. freqs. 450, 465 Kc, etc., 12/6 each. Amateur and Commercial bands. G3 SJ Xtals are precision lapped, and acid etched to final freq. Are available in either Ft 243 holders,  $\frac{1}{2}$ in. British,  $\frac{1}{2}$ in. U.S.A. or  $\frac{1}{2}$ in. P.5 holders. Your own choice of frequency 2 Mc to 10 Mc inclusive. We will despatch to within 1 Kc of your chosen frequency at 15/- each, accurately calibrated with freq. clearly marked. Slight extra charged for decimal point freqs. We also undertake the calibration, or re-gridding of your own crystals at extremely reasonable and nominal charges.

**TELEVISION PATTERN GENERATORS.** J.V. Type PG11. Complete with internal 230v 50cy power supply, 7 valves. Covers all Television channels 40 to 70 Meg. One horizontal bar, optional number of vertical bars. Sound modulation. Indispensable to the service engineer for the lining up of T.V. sets on both sound and vision. £14 carr. paid.

**T.V. SIGNAL GENERATOR** and combined Grid dip meter. 40/70 Mc. Self contained power supply for 230v 50 cy A.C. Mains. Accurately calibrated. £6/12/6 carr. paid.

**T.V. PRE-AMPS.** For fringe areas, High gain 2 stage, with internal self contained power supply for 230v 50 cy. A.C. Mains. Complete with two EF50 valves. Sutton Goldfield or Holme Moss. £8/10/0.

**BLEEDERS.** All vitreous types. 30 watt to 120 watt, 1k to 75k, a good assortment of one dozen, 12/- post free. Bleeders, set of 4 for the ET4336 Tx, 30/- post free.

**VOLUME CONTROLS.** Long and short spindles mixed. To clear a large quantity at 6/- doz., post free.

**JONES PLUGS.** To clear, female only 4, 6 and 8-way, 2/6 per doz. post free.

**R.C.A. Filament transformers.** 190/250v 50cy. Output 10v at twice for a pair of 805's or 813's Terminal connections, completely screened, 25/- post free.

**SPEECH AMP OUTPUT TRANSFORMER.** P.P. 6L6's to 500 ohm line, for the input circuit of the ET 4336 Tx. Specially made for us by Woden, 22/6 post free.

**NAVY LOUD HAILERS** Type 7a by Tannoy. 230v 50 cy. input. Output 60/80 watts of audio, from 6 KT65's in parallel P.P. Complete with Tannoy Power mike and in original Transit cases. Brand new, £19/10/0.

**MET-VIK. AUTO TRANSFORMERS.** 230/110, 500 watt, completely screened in separate metal cases, with conduit entry. Brand new in original packing, 35/-.

1154 Tx. Brand new in transit cases, complete with all valves. £5 carr. paid.

**METERS.** Moving coil. U.S.A. 0/1 mill. 2in. round flush, 10/6. Met.-Vik., etc. 0/200 mills. 3in. round flush, 10/6.

**VALVES.** All now boxed in original cartons. 813, 90/-; 805, 27/5; 807, 12/5; 1625, 4/-; 860, 10/-; 6K7, 7/5; 6L7, 65A7, 6S67, 6N7, 8/-; 12A6, 12SK7, 12SR7, 12SF7, 6/-; VU111, 3/6; 7Q7, 6/-.

**ANTENNA RELAYS.** Price Bros., Maryland. Double double throw, suitable for 600 ohm line. 28 volt D.C. Piston cylinder action, with self-centring contacts. On heavy ceramic stand offs. Will handle up to 1 Kw of R.F. 25/- each.

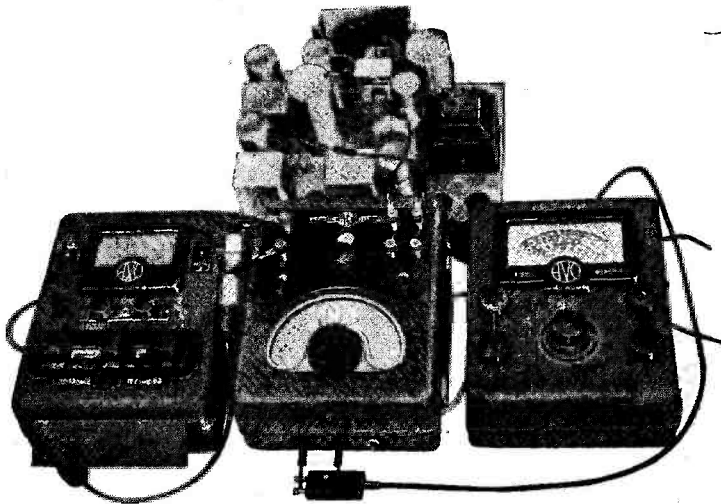

## The PERFECT TEST TEAM

The illustration depicts a set of modern "AVO" testgear being used to measure the "Q" of the secondary winding of the second I.F. transformer on a chassis of unknown characteristics—just one of many tests which can be performed by this combination of instruments. A signal of predetermined frequency from the "AVO" Wide Range Signal Generator is being fed into the Electronic Test Unit, where it is amplified and fed

to the secondary winding of the transformer. The Electronic Testmeter is connected across the tuned circuit under test and, from the readings obtained and the controls of the Electronic Test Unit, the "Q" of the circuit can be determined. The three instruments, shown as a team, cover a very wide field in measurement and form between them a complete set of laboratory testgear, ruggedly constructed to withstand hard usage.



### ELECTRONIC TESTMETER

A 56-range instrument combining the sensitivity of a delicate galvanometer with the robustness and ease of handling of an ordinary multirange meter. Consists basically of a highly stable D.C. Valve Millivoltmeter, free from mains variations and presenting negligible load on circuit under test. Switched to measure:—

- D.C. Volts:** 2.5mV to 10,000V.
- D.C. Current:** 25 $\mu$ A to 1 Amp.
- A.C. Volts:** .1V to 2,500V R.M.S. up to 2 Mc/s.
- .1V to 250V R.M.S. up to 200 Mc/s.
- A.C. Power Output:** 5mW to 5 Watts.
- Decibels:**—10db to + 20db.
- Capacitance:** .0001 $\mu$ F to 50 $\mu$ F.
- Resistance:** .2ohm to 10 Megohms



### ELECTRONIC TEST UNIT

For measuring small values of A.C. voltage, inductance, capacity, and "Q" at radio frequencies. Although designed primarily for use with "AVO" instruments, it can be used with any suitable Signal Generator/Valve Voltmeter combination.

**As a Wide Range Amplifier,** it is capable of an amplification factor of  $40 \pm 2$ —3db between 30c/s and 20Mc/s.

**As a Capacity Meter,** it covers measurements at radio frequency from .5pF. to 1000pF. in two distinctly calibrated ranges.

**As an Inductance Meter,** it gives direct measurements from .5 $\mu$ H. to 50mH. in six ranges.

**As a "Q" Meter,** it indicates R.F. coil and condenser losses at frequencies up to 20 Mc/s.



### WIDE RANGE SIGNAL GENERATOR

An instrument of wide range and accuracy for use with modern radio and television circuits. Turret coil switching provides six frequency ranges covering 50Kc/s. to 80Mc/s.

- Range 1. 50 Kc/s.—150 Kc/s.
- " 2. 150 Kc/s.—500 Kc/s.
- " 3. 500 Kc/s.—1.5 Mc/s.
- " 4. 1.5 Mc/s.—5.5 Mc/s.
- " 5. 5.5 Mc/s.—20 Mc/s.
- " 6. 20 Mc/s.—80 Mc/s.

Accuracy to within 1% of scale marking. Gives sensibly constant signal of good wave-form, modulated or unmodulated, over entire range. Minimum signal less than 1 $\mu$ V at 20 Mc/s. and less than 3 $\mu$ V between 20 and 80 Mc/s. Gives calibrated output from 1 $\mu$ V to 50mV.

Fully descriptive leaflets available from the Sole Proprietors and Manufacturers:

**The AUTOMATIC COIL WINDER & ELECTRICAL EQUIPMENT CO. LTD**  
**WINDER HOUSE • DOUGLAS STREET • LONDON • S.W.1** Telephone: **VICTORIA 3404/9**

TT.1

# THE RADIO & ELECTRICAL MART

## OF 253-B PORTOBELLO ROAD, LONDON, W.11

Remember money back guarantee. Phone: Park 6026 Please add postage when writing.  
If goods returned within 7 days.

**Valves.** IS5, IRS, 12/6; IT4, IS4, 10/6; 3S4, 3V4, 10/6; 6AG5, 10/6; 117Z6, 12/6; 6SH7, 6/6; EF50, 8/6; 9003, 6/-; 9001, 9002, 7/6; 955, 954, 6/-; SG215, 6/6; Pen 220A, 6/6; 6V6GT, 11/6; TT11, 8/6; 6Q7G.T., 10/6; 6SN7G.T., 12/6.

**Selenium Rectifiers.** 120mA, 8/6. F.W. 6 or 12v 2A, 8/6, ditto  $\frac{1}{2}$  amp., 5/6. Post paid.

**New and Boxed P.M. Speakers.** W.B., 2 $\frac{1}{2}$  14/6 P.P.

**New IN34 Germanium Crystal Diodes** with wire ends, 5/6. P.P.

**Mains Transformers.** Input, 200/240v. output 6.3v. 1.5A, 10/-, 350-0-350v. or 250-0-250v. 80mA, 4v. and 6.3v. 4A and 4v. and 5v. 2A, 22/6. Trans.: 200/240v. output 3, 4, 5, 6, 8, 9, 10, 12, 15, 18, 20, 24, 30 volts at 2 amps, 21/3. One Year's Guarantee. Post paid.

**RF24 Units.** Converted to 28 mcs band variable tuned with 100-1 geared SM. dial. Complete with plug and leads for immediate use. £3. Post paid.

**Deaf Aid Miniature Valves.** DL72 and CK512AX. New, 9/- P.P.

**Army Carbon Microphone.** With switch, 4/6, P.P. Trans. to match, 4/6, P.P.

**Britool 0-9 BA Box Spanner Tool Kits,** Chrome Alloy Steel, 26/- P.P.

**M/C Microphone with Switch,** 6/6, P.P. Transformer to match, 5/- P.P.

**New odd Freq. Crystals** between 6 to 8 mcs 5/6 each P.P.

**Trans.** 230/6.3v.  $\frac{1}{2}$  amp., 6/6 P.P.

**1/16 H.P. Motors, A.C./D.C.** 100/120v. 5/16in. dia. spindle. 5 $\frac{1}{2}$ in. x 3 $\frac{1}{2}$ in., 32/- or with 2 $\frac{1}{2}$ in. Grindstone, 36/6. P.P.

**Army Morse Keys,** 2/- P.P.

**200/240 volt A.C. Alarm Bells,** 3/6 P.P.

**10H-100MA. Shrouded Chokes,** 7/6 P.P.

**6 volt Vibrator Units.** Complete in black steel case, 7 $\frac{3}{8}$  x 5 $\frac{1}{2}$  x 3 $\frac{1}{2}$ ins. Output 200 volts, 40 mA., 22/6 P.P.

**2 — Complete A.C. 240v. Army Film Unit,** Sound on Film 35mm. Projectors — (less lenses, which are obtainable). Amplifiers and Speakers. £50 each. Write for details.

**Special Offer.** 'Scope Unit. Containing VCR138/ ECR35, 3 $\frac{1}{2}$ in. CRT with nu-metal screen. 2-EF50's, 2-EBC34's. Pots and the usual resistors and condensers, in steel case, 6in. x 6in. x 15in. Can be modified as a standard scope in a few hours and only requires external power pack (which would cost £2). Price 65/- post paid.

**D.P.D.T. Relays.** Operate at 200/300 volts D.C., 6mA., 13/- P.P.

## THE FINEST CORED SOLDERS IN THE WORLD—NOW PRESENTED IN

# a Complete Kit for every soldering job



At last—you can buy a complete range of Multicore Solders enabling you to do perfect soldering on your equipment, for only 2/-. The Multicore Solder Kit contains two specifications of Ersin Multicore Solder and two of Arax Multicore Solder, providing the right solder for all radio, television and electrical work, as well as for ordinary metals, soldering chassis construction, etc. Your workshop is not complete without the Multicore Solder Kit—the finest two-shillingworth on the market.

The Multicore Solder Kit contains a carton of each of the following specifications:

Ersin Multicore Solder	4 ft.	60/40 alloy	18 S.W.G.
Ersin Multicore Solder	3 ft.	40/60 alloy	16 S.W.G.
Arax Multicore Solder	4 ft.	60/40 alloy	18 S.W.G.
Arax Multicore Solder	3 ft.	40/60 alloy	16 S.W.G.

These specifications, as well as other gauges of the same alloys, are also available for larger users in Ersin Multicore Size One and Arax Multicore Size Eight Cartons, price 5/- each.

Ask your usual retailer for the Multicore Solder Kit. In case of difficulty, send 2/- with name of your usual stockist.

**MULTICORE SOLDERS LTD., Mellier House, Albemarle St., London, W.1. REgent 1411**

# EDDYSTONE

## COMMUNICATION RECEIVERS



Model '740'. A well-made 8 valve receiver at a moderate price. Frequency range 30.6 Mc/s to 1.4 Mc/s and 205 to 620 metres.



Model '750'. Eleven valve double superheterodyne with high (variable) selectivity. Frequency range 32 Mc/s to 480 Kc/s.

Please write for illustrated brochure

**STRATTON & CO. LTD., WEST HEATH, BIRMINGHAM, 31**

# VALVES VALVES VALVES

## TRANSMITTING

TAYLOR, T200, 60/- each.  
AMPEREX, HF300, 90/- each.  
EIMAC, 304TH, 130/- each.  
R.C.A., C.R.C. 860, 15/- each.  
HYTRON, HY65, 90/- each.

GENERAL ELECTRIC, 810, 15/- each.  
S. TELS., 872A-4064B, 30/- each.  
R.C.A., 832, 30/- each.  
RAYTHEON, RK28A, 90/- each.  
R.C.A., 830B, 20/- each.

## RECEIVING

**AT 3/6 EACH :** 1LC6, 1LA6, 1LN5, 1LH4, 1LD5, 3D6, 1E7G, 6H6, 12H6, 2C34.  
**AT 5/- EACH :** 6C5, 2X2, OZ4, 1G6, 6B4, 6B8, 6F5, 6J5, 6J7, 6K7, 6L7, 6X5, 1625, 12SG7, 12J5, 12SR7, 12SH7, 39/44, 717A.  
**AT 6/6 EACH :** 6SG7, 12A6, 12SC7, 12C8, 45, 58, 75, 76, 77, 6D6, 7H7, 7N7, 7R7, 7Q7, 7C7, 7S7, 7B6, 6SS7, 6SH7, 6AC7, 6AB7, 27.  
**AT 8/- EACH :** 1A5, 1N5, 1S4, 3B7, 2A3, 84/6Z4, 6C6, 6F6, 6N7, 6SK7, 6F8, 6Y6, 6SA7, 6F7, 6G6, 5U4, 12K8, 12SQ7, 12SK7, 5Y3, 1H5.  
**AT 10/6 EACH :** 6SN7, 6C8, 6SJ7, 6SR7, 6B7, 6K6, 6Y7, 1P5, 6R7, 6L6, 46, 5Z3, 41, 42, 5Z4, 2A3.  
**AT 12/6 EACH :** 6A7, 83, 83V, 6V6.  
**AT 14/- EACH :** 6K8.  
**AT 20/- EACH :** 307A.

Please include sufficient for Postage and Packing when ordering.

**McELROY-ADAMS Manufacturing Group Ltd.**

(Sole concessionaries U.K. for Hallicrafter Communication Equipment)

Phone Fulham 1802. 46 GREYHOUND ROAD, LONDON, W.6. Cables Hallicrafter London.

**YOUR EQUIPMENT CAN HAVE THE PROFESSIONAL LOOK**

**BY USING WODEN  
POTTED COMPONENTS**

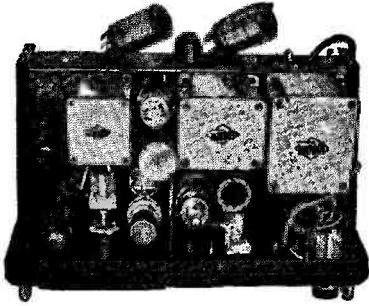

Woden Potted Transformers and Chokes ensure a clean layout with uniform smart appearance. They are used by many leading radio and television manufacturers, and this is sufficient testimony to the high standard of efficiency which characterises these components. Available for "Wireless World" Williamson Amplifier. "Electronic Engineering" Home-built Televisor and other popular circuits.

THE EQUIPMENT SHOWN IS THE TOP BAND CABINET TRANSMITTER AS DESCRIBED IN THE "SHORT WAVE MAGAZINE."



Send for illustrated literature and price lists of our complete range



**MOXLEY ROAD BILSTON STAFFS**

PHONE: BILSTON 41959

J.T.1

## Benson's Better Bargains

**VALVES:** IS4, IS5, IT4, 1R5 at 9/-; 2X2, VR65, VR65A, VR66, 7V7, 9004, 9006, 12SH7, CV6, VUI20, VUIII, CV54, 6H6 at 3/6; 5T4, 6AG5, 6B8M, 6B4, 6C4, 6J7M, 6J5M (GT), 6N7M, 12SJ7, 6X5, 12SR7, 12A6, 12SC7, 28D7, EF54, EC52, EBC33, EL32, CV66, AC6/pen, SG215. Pen, 46 1625, ATP4, 9002, 6K7, SP4, KT2, 3Q5, 6L7M, EK32, VR150, 721A, VS110A, VS70, at 7/6; Pen 25, 717A, 5Z4M, at 8/6; 5U4G, KT66 at 10/-; 6AC7, 12SK7, 954, 955, 956B, 9D2, EF39, EF50, ARP12, AR8, 9003, 6SH7, 9001, ML6 at 5/6; EA50, 7193, 12H6, EB34 at 2/6; Over 2000 BVA type valves at below list prices. (Enquiries, S.A.E. Please).

**VAR. CONDENSERS:** Twin. 0005 5/-; with drive 6/-; Single .0005 3/6; 4 gang .0005 8/6; 3 gang 25pf 3/6; 2 gang 75pf 4/-; single 2/-; 2 gang 50pf 4/-; single 1/6; Butterfly 50pf 2/6. Trimmers/padders, from 100pf to 750, 9d. each.

**SPEAKERS** P.M.-3in. or 6in. 15/6; M.E. 6in. 1k fd. 17/6; Universal matching O.P. Trans. (60ma) 6/-; **MAINS TRANS.**-New, std. inputs 50c. Outputs, 250v 60ma., 6v & 5v. 15/6, 230v (S.E.) 20ma., 6v. 1A 12/-; 350v 80ma., Univ. LTs 18/-; similar 250v. 18/- . Potentiometers, SP switch 3/6 DP 4/6, most normal values stocked. **3 only**-Resistance Capacity Bridges A.C.50c. each **10/10/-** **MAINS DROPPERS**-.2A 1k, .3A 800U 4/6 each, .3A 3w Linecord (60u p.f.t.) 1/- yd. **VALVE-HOLDERS**-most std. types, 6d. each. Ceramic I.O. 9d. (Available 4500 Ceramic Local, 3500 Pax. EA50 type, offer wanted). Cellulose Cement 1/- bot. Condensers, block, 8mfd. 440VAC wkg.

5/-, 8mfd. 1KV wkg (Aerovox) 8/6; 4mfd. 750vw 3/- . Sprague tub..01 1KV 6d., .5 350v 8d. Williamson Amplifier Manuals 2/-; Eddystone S.W. Manual 2/- . Ediswan Valve Manual 9d. Fuseholders, single 6d., twin 8d., Panel, single 1/-; Fuse clips 3d. pr., Fuses 1/4in. cartridge 4 1/2d. each. Igranic Jacks 1/-; Jackplugs 1/3. Terminals B/Lee, black, insulated 9d. **METERS:** 500ma RF 2in. 5/6; 40/120ma 2in. 6/6. Mine Detector Amp. with 3 x IT4 etc. 28/6, chassis only 3/6. IFTs, canned, new 10/13mcs 2/-, 7mcs 1/6. Coilformers 2in. x 1/4in. 4 for 1/- . Morse keys, small, brass 2/6. Vibrapacks, Mallory 12v synch. 150v. 30ma 12/6; Vibrators 2v. synch. 7pin UX, 6/- . Cable, 5 core rubber, 2yd. lengths 1/6, 3 core screened, 10ft. lengths 2/6. ZB3 VHF Homing Adaptors with 4 Acorn valves 25/- . Spindle couplers, brass; concertina or insulated 9d. each; Eddystone type 1/3. Chokes, RF 4 pie Rx 9d., TX 1/-; LF 5H 150ma 120u 5/3, 10H 250ma 12/6. Control Unit Type 6. Diecast al. chassis 6 1/2 x 5 x 1 1/2ins., contains pots, switches etc. New 3/6. Muirhead Dials (black) 7/6. Ferranti 30w Mod. Trans. 2 : 1 ratio 10/- .

**XTALS:** 100kes 3ins. or 3-pin 12/6; Octal based, 2.5, 8.0, 4.6, 6.2, 5.5mcs. 17/6 set (5) or 4/- each. Dynamotors 9v. to 450v. 9/-; 24v. to 250v./6v. 5/6; 28v. to 285v. 7/6. **CO-AX:** Plugs/Skts. Pye : 5/- doz., D.E. Skts. 1/-, Triple skts. 1/1-, 3-way skt/plugs 1/1-. Vitreous resistors: 10k 120w, 50k 20w, 50u 20w, 20k 50w, 300u 65w, 75k 10w. each 1/- .

LISTS AVAILABLE 1 1/2d. S.A.E.

Terms: C.W.O. CARR. PAID OVER 10/- S.A.E. enquiries please

**W. A. BENSON, 308 Rathbone Rd., Liverpool, 13** STONEYCROFT 1604

## THE NEW 1355 CONVERSION

DATA FOR ALL FIVE T.V. CHANNELS 3/-

**RECEIVER P40** Tunes 85—95 mc/s; crystal controlled oscillator, with subsequent frequency multiplication ensures stability. With 4 EF54's (RF, mixer, and multipliers) 1 EC52 (L.O.), 2 EF39's (2.9mc/s IF's) EB34 (det) and 6J5 and 6V6 (audio), these may be easily converted for "2" or the new BBC UHF transmissions from Wrotham. BRAND NEW with circuit 69/6. (circuit only 1/3)

**MODULATION TRANSFORMERS** to match class B 211's to a class C 221 final, these may be used as 2:1 mains auto-transformers handling some 75 watts. ONLY 6/6. Input transformers, to drive class B 221's 4/6.

**POWER UNIT S41B** 300v at 200mA DC, 12v 3A AC and 5v DC provided from 200/250v 50cps input. These, in attractive grey crackle finish cases, use separate HT and LT transformers, with individual switching and indicator lights, the HT being also relay controlled if desired. In SEALED MAKER'S CARTONS. 65/- (5/- carr.).

**TRANSMITTER 2I** Covering 4.2—7.5 mc/s, sending speech, CW or MCW, and complete with valves, key, control box and circuit, the PA coils (not formers) and relays have been stripped by the MOS, but may easily be replaced by following our data. Complete with front panel for mounting receiver and vibrator pack. 25/-.

## WILLARD NON-SPILL ACCUMULATORS

21.AH, 2v, built-in hydrometers; 5½x3x4. 15/- in sealed cartons. (ex-58 Set).

**VIBRATOR PACK 2I** Delivers approx 140v at 40mA from 6v input. ONLY 15/- (1/6 post).

**AMPLIFIER 1135A** With EBC33, EK32, and EL32, These have twin inputs and multi-ratio output. Our Conversion data and circuit ensure simple conversion ONLY 16/6. (2/3 carr.).

**POWER PACK KIT.** Suitable for use with the above; 230v input, 18v at 200 mA and approx. 200v at 30 mA output. Complete with data, 16/6. (1/6 post).

**RECEIVER 1225;** with five EF50's, two EF39's, one EB34; these have four preset tuned frequencies, and Xtal controlled oscillator; precision tuning condensers ensure stability. Ideal for use on two metres. ONLY 39/6. (1/6 post).

**POWER PACK 532.** Complete with one 5Z4, one SU2150A (2v indirectly heated filament) 5KV rectifier, three condensers, two high cycle transformers, choke relay, etc. OUR PRICE complete with our 50 cps EHT and HT conversion data, 17/6. (2/3 carr.).

**NON-SPILLABLE ACCUMULATORS** Multi-plate, in celuloid cases (approx 4x3x1½ins.). 2v, 7AH. OUR PRICE 5/11. (6d. post).

**TUNING METERS.** 2in. Square flange mounting—2mA, F.S.D., scaled 10/0. New and boxed, 7/6 (6d. post).

## RADIO EXCHANGE CO.

9 CAULDWELL STREET, BEDFORD

Phone 5568

**SOLONS FOR  
ESSENTIAL  
JOBS!**

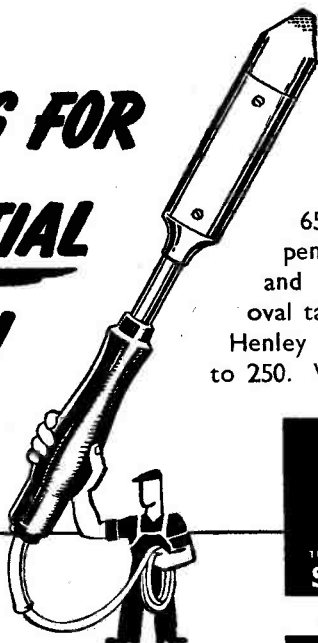

W. T. HENLEY'S TELEGRAPH  
WORKS CO. LTD.,  
51-53, Hatton Garden,  
London, E.C.1

Use SOLONS for the jobs that matter — this modern precision tool makes soldering speedier, simpler and more reliable. 5 models: 65 watt with oval tapered and round pencil bit; 125 watt with oval tapered and round pencil bit; 240 watt with oval tapered bit; each with 6 feet 3-core Henley flexible. Voltage ranges from 100 to 250. Write for folder Y.10.

**HENLEY  
SOLON  
ELECTRIC  
SOLDERING IRONS**  
FOR INDUSTRIAL USE

**MAINS TRANSFORMERS, SCREENED, FULLY INTERLEAVED AND IMPREGNATED**

Half Shrouded—			
H.S.63.	Input 200/250v. Output 250/0/250v. 60 m/a. 6.3v 3 amps, 5v 2 amps ...	18/6	
H.S.40.	Windings as above, 4v 4 amps, 4v 2 amps ...	21/-	
H.S.2.	Input 200/250v. Output 250/0/250v. 80 m/a	21/-	
H.S.30.	Input 200/250v. Output 300/0/300v. 80 m/a	21/-	
H.S.3.	Input 200/250v. Output 350/0/350v. 80 m/a	21/-	
H.S.2X.	Input 200/250v. Output 250/0/250v. 100 m/a	23/-	
H.S.30X.	Input 200/250v. Output 300/0/300v. 100 m/a	23/-	
H.S.3X.	Input 200/250v. Output 350/0/350v. 100 m/a	23/-	
Fully Shrouded—			
F.S.2.	Input 200/250v. Output 250/0/250v. 80 m/a	23/-	
F.S.30.	Input 200/250v. Output 300/0/300v. 80 m/a	23/-	
F.S.3.	Input 200/250v. Output 350/0/350v. 80 m/a	23/-	
F.S.2X.	Input 200/250v. Output 250/0/250v. 100 m/a	25/9	
F.S.30X.	Input 200/250v. Output 300/0/300v. 100 m/a	25/9	
F.S.3X.	Input 200/250v. Output 350/0/350v. 100 m/a	25/9	
	All above have 6.3-4-0v at 4 amps, 5-4-0v at 2 amps.		
F.S.43.	Input 200/250v. Output 425/0/425v. 200 m/a 6.3v 4 amps C.T. 6.3v 4 amps C.T. 5v 3 amps	51/-	
H.S.6.	Input 200/250v. Output 250/0/250v. 80 m/a 6.3v 6 amps C.T. 5v 3 amps. Half-shrouded For Receiver R1355.	29/3	
Framed, Flying Leads—			
F.30X.	Input 200/250v. Output 300/0/300v. 80 m/a, 6.3v 7 amps, 5v 2 amps	31/9	
HS150.	Input 200/250v. Output 350/0/350v. 150 m/a 6.3v 3 amps C.T. 5v 3 amps. Half-shrouded	30/9	
FS120.	Input 200/250v. Output 350/0/350v. 120 m/a, 6.3v 2 amps C.T. 6.3v 2 amps C.T. 5v 3 amps Fully shrouded	33/-	
FS150.	Input 200/250v. Output 350/0/350v. 150 m/a, 6.3v 2 amps C.T. 6.3v 2 amps C.T. 5v 3 amps Fully shrouded	34/9	
	<b>FILAMENT TRANSFORMERS</b>		
F.5.	Input 200/250v. 6.3v at 10 amps or 5v at 10 amp, or 10v at 5 amp, or 12.6v at 5 amp. Framed Flying Leads	37/9	
F.U.6.	Input 200/250v. 0-2-4-5-6.3v at 2 amps	11/-	} Clamped flying leads
F.29.	Input 200/250v. 0-2-4-5-6.3v at 4 amps	20/9	
F.6.	Input 200/250v. 6.3v 2 amps	9/-	
F.12.	Input 200/250v. 12.6v. Tapped at 6.3v 3 amps	18/6	
F.24.	Input 200/250v. 24v tapped at 12v 3 amps	26/-	
C.V.O.	(add 1/3 in the £ for carriage). All orders over £2 carr. paid.		

**H. ASHWORTH (Dept. S.W.)**  
676 Great Horton Road, Bradford, Yorks.

**COME TO SMITH'S of EDGWARE ROAD**

The Friendly Shop

**FOR ALL RADIO COMPONENTS**

We stock everything the constructor needs—our 25 years' experience of handling radio parts and accessories enables us to select the best of the regular lines and the more useful items from the surplus market in:

- |  |  |
|--|--|
| Loudspeakers and Transformers and Meters and Test Pickups and Switches and Metalwork and Valve Holders and Sleeving, Nuts and Bolts, Washers, Clips, Grommets and all other bits and pieces. | Phones. Cabinets and Cases. Capacitors and Resistors. Coils and Formers. Plugs and Sockets. Aerials and Insulators. Motors and Generators. Wires and Cables. Panel Lights and Fuses. Books and Tools. Metal Rectifiers. Cans. Recorders and Parts. |
|--|--|

**NOTHING TOO LARGE — NOTHING TOO SMALL**

Everything you need under one roof—at keenest possible prices.

No general catalogue is issued owing to constantly varying stocks and prices, but we shall be pleased to quote you.

**H. L. SMITH & CO. LTD.**

**ELECTRONIC COMPONENT SPECIALISTS**  
287/9 Edgware Rd., London, W.2

Tel. Paddington 5891. Hours 9 till 6 (Thurs. 1 o'clock). Near Edgware Road station, Metropolitan and Bakerloo.

**RADIO CLEARANCE LTD.**

**27, TOTTENHAM COURT ROAD, W.1 MUS 9188**

**SPECIAL LINE TELEVISION COMPONENTS**

Comprising, Line Transformer with E.H.T. winding (gives 7KV using E.Y.51), Scanning Coils (low imp line and frame), and Focus Coil (res 10,000a, current approx. 20 mA). Special offer at 42/- the set, Post 1/6, while they last. We have also, Scanning Coils for Viewmaster at 12/6, plus 1/- postage, available separate.

**MEDIUM-WAVE PERSONAL RECEIVERS**

3-valve medium-wave dry battery operated receiver, housed in smart bakelite box, size 7" x 6½" x 5", with plastic carrying handle. T.R.F. circuit, using 3-1.T.4 valves, with reaction. Output to pair of lightweight H.R. phones, self-contained. Frame aerial in lid, provision for external aerial, S.M. dial. Powered by self-contained dry batteries, 1-W1435 and 2-U2's. Supplied brand new, with valves and batteries. Open the lid and it plays. Covers whole M.W. band. Purchase Tax paid £4/4/0. Not ex-Govt. surplus. Postage paid.

**MOVING COIL METERS**

2 in. Square bakelite cased 0/5mA, 6/6; 0-50mA, 7/6; 0-20v, 5/6; 0-300v, D.C. with series res., 8/-; 2½in. bakelite cased, 0-200mA, 9/6; all flush mounting, 3½in. Projection Type, 0-3500v, series res. incorporated 16/6.

**ROTARY POWER UNITS**

Type 104, 12v D.C. input, outputs 250v 65mA, 6.3v, 2.5A, D.C. P.M. rotary on chassis with cover, size 8½" x 4½" x 6½", 6/6, post paid. Type 87, input 24v, output as Type 104, 5/6 post paid.

**MAINS TRANSFORMERS**

Primary 0-110/210/240v 50c/s. Sec. 300-0-300v, 80mA, 6.3v 2.5A, 4v 2A, 15/6, post paid  
Primary 200/250v 50c/s. Sec. 6.3v 3A, autowound, 8/-, post paid.  
Primary 200/250v 50c/s. Sec. 280-0-280v, 60mA, 6.3v 2A, 4v 1.1A, 14/6 post paid.

**P.M. LOUDSPEAKERS**

6½in. P.M. New and Boxed, 12/6 post paid.

**SMOOTHING CHOKES**

5H, 200mA, 100 z ... 5/6 20H, 80mA, 350 z ... 6/6 8H, 250mA, 50 z Potted 10/-

**MANSBRIDGE CONDENSERS**

4mf. 1000v. wkg., 3/6 each, 6/- pair, post paid.



# CLYDESDALE

Bargains in Ex-Services Radio and Electronic Equipment

## CANADIAN No. 9 SET MK. 1 WITH POWER SUPPLY UNIT

An eleven valve 7/ARP3, 2/12SC7, 12Y4, OZ4, superhet Receiver frequency range, 2 to 5 mcs., with built-in calibrator, 1,000 100 and 10 Kcs., two slow-motion pre-set channels, switched HT and "S" meter, HF and LF gain, B.F.O., etc., etc.  
Separate Power Unit operated from 12V. D.C., 115V. A.C. or 230V. A.C. with spares kit, all valves, Aerial, Insulators, Headphones, all packed in wood case, 24in. x 22in. x 32in.  
CLYDESDALE'S CARRIAGE PRICE ONLY £10/0/0 PAID

## EX U.S. NAVY TEST OSCILLATORS

**TS24/ARR2** a battery powered unit for alignment of TBX aircraft Radio, produces 245 mcs. H.F. signal and 540 to 830 Kcs. tunable L.F. Signal. Using two 955 acorn tubes, a safety time switch with indicator (30 minutes) is fitted.  
Enclosed in black crackle case 9½ x 7½ x 7ins.  
CLYDESDALE'S CARRIAGE PRICE ONLY £4/9/6 PAID  
Circuit available at 1/3.

**TS24A/ARR2.** Similar to TS24, has additional features, tone modulation, three 955 tubes, optional audio signal (switched) otherwise description and dimensions the same.  
CLYDESDALE'S CARRIAGE PRICE ONLY £4/19/6 PAID

## AMPLIFIER A1271

A one valve (VR56—EF36) Amplifier Chassis, with 400 ohm. 4M 2B relay. 2 transformers, vol. control, cond., and resistors, mounted on rubber in a black finished metal case, 5 x 5 x 4½ins.  
CLYDESDALE'S POST PRICE ONLY 10/6 PAID

Ex-Services items, totalling £5 or over in value, can now be obtained on Easy Terms at any of our Branches. Just choose your item or items, pay a deposit of 4/- in the £1 and we will do the rest. Service available to Personal Shoppers only.

## TEST EQUIPMENT IE-65-A

Command series Test gear with 3 Antennas, 3 Test units, Mod. BC-456-B (or E) with dynamotor, Antenna Relay, 2 Radio Control Boxes, 2 Racks, 6 Mountings, 1F Shunt Unit, Control Unit MC-237, and 17 Cable Assy.  
CLYDESDALE'S CARRIAGE PRICE ONLY £22/10/0 PAID

## MULTICORE CABLE

8 Core, Metal braided and PVC covered 1/9 per yard  
6 Core, Metal braided and PVC covered 1/6 per yard  
2 Core, Metal braided 6d. per yard  
Metal braided sleeving 3mm. 1 yd. long, 3 for 1/-.

## AERIAL INSULATORS 10A/1275

Black plastic chain insulators, 3 links each. 3½ins. long. 1½ins. wide. Total length 7½ins.  
CLYDESDALE'S POST PRICE ONLY 1/6 per pair PAID

## MAINS DROPPER

Vitreous enamel construction 717 ohms, tapped at 110 ohms. Capable of handling 30 watts. Dimensions 3½ins. x 7½ins. diam.  
CLYDESDALE'S POST PRICE ONLY 2/6 PAID

## B7G VALVEHOLDERS

These are of Paxolin construction. Used for valve types 616, 6AK5, 6C4 and most popular modern midjets.  
CLYDESDALE'S POST PRICE ONLY 1/- PAID

## COMMAND RECEIVER

CCT/CBY 46129  
U.S.N. version of the BC-43 for that Sharp channel. "Q-Fiver," range 550-190 Kcs. with 6 valves, 3/12SK7, 12K8, 12SR7, 12A6, three gang tuning cond. etc., etc. Dim:—11 x 5½ x 5ins. finish black, less dynamotor.  
CLYDESDALE'S POST PRICE ONLY 63/- PAID  
Circuit of BC-453 available at 1/3.

Order direct from: Branches in Scotland, England & N. Ireland

# CLYDESDALE Supply Co. Ltd.

2 BRIDGE STREET, GLASGOW G.5. Phone: SOUTH 2706/9

## SOUTHERN RADIO'S WIRELESS BARGAINS

**WALKIE-TALKIE (Transmitter-Receiver).** Type 38 Mark II. With 5 valves; Throat Microphone; Headphones and Aerial. 7Mcs. AMATEUR BAND suitable for field use. Superhet Receiver. Modulated Transmitter. Guaranteed ready for the air. Less batteries, £3/10/0.

**R.3515 TELEVISION UNITS.** Complete with 21 valves. 6-Stage 14 Mcs I.F. Strip. Ideal for T.V. conversion. Brand new in original cases, £3/10/0.

**R.1355 RECEIVERS.** Brand new as specified in inexpensive Television, £3/5/0.

**LIONEL "BUG" KEYS.** Genuine American Automatic Morse Key. Type J-36, £3/7/6.

**THROAT MICROPHONES.** Magnetic. Complete with lead and plug, 4/6.

**LUFBRA HOLE CUTTERS.** Adjustable from ¾ to 3½ inches. Use on wood, metal, plastic, etc., 5/9. Lufbra Fly Cutters, 14/6.

**CONTROL CABLES FOR COMMAND RECEIVERS** B.C.453/4/5, 14 feet with adaptors, 9/6.

**HAND GENERATORS** with Crank. 6 Volts at 5 amps, 21/-.

**PLASTIC TRANSPARENT MAP CASES.** 14 inches by 10½ inches. Ideal for Maps, Charts, Display, etc., etc. 5/6.

**STAR IDENTIFIERS.** With Hydrographic Office Modifications. A-N Type 1. Complete in case, 5/-.

**MOVING COIL D/C METERS.** Brand new, 2-inches. 0-2mA, 0-5mA, 0-30mA, 0-20 volts. 9/6. 0-1mA, 12/6.

**INERT CELLS.** 1.5 volts. No acid or charging needed, 2/10 each. Six for 14/-, Ideal for Bells, etc.

**CONDENSERS.** 100 assorted Tubular and Mica. All useful sizes. Up to 2-Mfd., 15/- per 100.

**RESISTANCES.** 100 assorted Wire-Ended Resistances. All useful sizes up to 2-watts. 12/6 per 100.

**WESTECTORS.** Types Wx6 and W112, 1/- each.

Full List of Radio Books, 2½d.

## SOUTHERN RADIO SUPPLY LTD.

11 Little Newport St., London, W.C.2. (Gerrard 6653)

## YOU CAN RELY ON US FOR BRAND NEW, CLEAN COMPETITIVE COMPONENTS.

IMMEDIATE DISPATCH.

### VALVES

In addition to our large stock we again have a few of the following:—6CG6, 7/-; EF55 8/6; EF54 7/6; 6H6 metal 4/6; 6K8GT 12/6; EBC33 7/6; 6F12 10/-; ECC32 8/6; EL32 (Mullard) 7/6; 21SSG 4/6; EL42, 8/6; 65H7 Metal, 6/6; EL35, 7/6; 6D6, 8/-; EB41, 7/6; 6AK6, 8/6; 6K6, 7/6; 25Z5, 10/6; 77 7/6; U78, 10/-; N37, 10/-; EF50, 7/6; 954, 5/-; 6K7m, 8/-; CV1141, 4v Thyatron, 5/-.

**MINIATURE SHORT WAVE TUNING CONDENSERS.** 25 Pf. Single Section, Ceramic. Size 1½ x 1½ x 1½ins. Spindle ½in. 2/6. 25 Pf. do. 1½ x 1½ x 1½ins. Spindle ½in. 2/6. 30 Pf. do. 1½ x 1½ x 1½ins. Spindle ½in. 2/6. 65 Pf. do. 1½ x 1½ x 1½ins. Spindle ½in. 2/6. 25 Pf. Split Stator, Ceramic, Size 1½ x 1½ x 1½in. Spindle 1in. 2/6. 5 x 5 of. ganged 2/6.

### FILAMENT TRANSFORMERS

Finished in green crackle and of very small dimensions 210/240v to 6.3v at 1.5a, 8/6; 210/240v to 4v 3a, 12/6; 210/240v to 6.3v 3a, 12/6.

### SELENIUM RECTIFIERS

350v. 75mA, 7/6. New and checked at 12v., 1½a, 7/6. 12v. 5mA meter rectifiers, 1/- each. WX6, WX3, new midjet type 3/5.

### SPEAKER TRANSFORMERS

Goodmans, S5 : 1, 4/6; midjet mains pentode, 4/6; super midjet for personals to match 354, DL92, 4/3.

### TWIN-GANGS

.0005mfd New, Complete with slow-motion drive and drum, rubber mounting, standard size, 10/6.

### YAXLEY

6 pole, 3 way Two Wafers 4/6.  
Don't forget some postage, chaps.

## RADIO SERVICING CO.

Dept. M/O, 444 Wandsworth Road, Clapham, S.W.8. MACaulay 4155

CATALOGUE No. 9 available 2½d. stamp  
77, 77A, 168, 169 Buses. 100 yds Wandsworth Road S.R. Station. Open till 6.30 p.m., 1 o'clock Wednesday

# HENRY'S

We have over 10,000 British and American Valves in stock. Constant changes do not permit us to keep an up-to-date list. Your enquiries, however, will be answered per return. All valves at current B.O.T. Prices.

**TRIMMER KIT, "Qualrad."** An essential to every radio man. This famous kit can be supplied by us at 25/6 only! Comprising:— 1, 2, 4, 5, 6, 8BA box spanners, 5 screwdriver trimmers (vertical and horizontal), 4 spanners, vane-setter, and thickness gauge. Attractively finished in white ivory. All neatly laid out in black crackle box. An absolute bargain.

**BAKELITE RECEIVER CABINET.** Size 12in. x 5in. x 6in. high. In Brown or Ivory. Supplied complete with ready-drilled 4-valve T.R.F. chassis, with cut-out for 5in. speaker, 2-wave glass dial, back plate, mounting brackets and back. Only 25/- plus 1/- packing and postage. A very handsome cabinet. Drum, drive and pointer to suit. 3/- extra.

**No. 38 "WALKIE-TALKIE" TRANS/RECEIVER.** Complete with Throat Mike, Phones, Junction Box and Aerial Rods in canvas bag. Freq. range 7.4 to 9 Mc/s. All units are new and tested before dispatch. As supplied to Overseas Police Forces. £4/19/6. Carr. 2/6.

**VIBRATOR POWER UNITS, 2 volt.** As for Canadian 58 set. Completely smoothed, output 1.5 V. L.T. and 90 V. and 180 V. H.T. at 35 mA. Complete in grey metal box. Size 8 x 3 1/2 x 4 1/2. 50/- only.

**EF50 (VR91) BRAND NEW RED SYLVANIAN.** 10/-, original boxes. British Types boxed 8/6. Unboxed British Types, 6/-.

**FREQUENCY CONTROL CRYSTALS.** By American G.E. Co. Octal base fixing. Following frequencies only: 3,500 kc/s., 6,200 kc/s., 8,000 kc/s., 7/6 each.

**METAL RECTIFIERS.** S.T.C. 200 V. 75 mA., 6/- G.E.C. 6 V. 1 A., 4/- Westinghouse 12 V. 2 A., 12/6. Pencil Type E.H.T. 600 V., m.A., 4/7. Pencil type E.H.T. 1,000 V., 1 mA., 6/-.

**DENCO ALIGNMENT OSCILLATOR.** Producing I.F. frequencies of 465 kc/s and 1.6 megs. Power supplies are from one Grid-bias battery. A.F. Modulated. At £2/7/6.

**FILAMENT TRANSFORMERS.** All Inputs 200/250 A.C. 6.3 V., 1.5A., 7/6. Igranic 6.3 V., 2 1/2 A., 10/-, 6 V. or 12 V. 3 A., 15/-, 6.3 V. 12 A., 37/6.

**PLESSEY 3in. P.M. Speaker** with miniature o/trans. 17/6. W.B. 2 1/2ins. P.M., 3 ohms, less trans., 15/-.

**R3084 RECEIVER.** Incorporating 7 EF50, 2 EF54, 1 EC52, 1 VU39A, 1 HVR, 21 EA50, plus 30 Mc/s. I.F. strip. Guaranteed absolutely brand new in maker's original packing case. 75/- (Plus 10/- carriage and packing). This receiver is ideal for conversion to video receiver.

**PARMEKO MAINS TRANSFORMER.** A special purchase enables us to offer the following: 250-0-250, 90 mA, 6.3 V. 3 A., 5 V., 2 A., half-shrouded, drop-through type, with voltage input 110 V. 1245 V. Electrostatic screen. Absolutely brand new and guaranteed. 20/- only, plus 9d. postage.

**A SIGNAL TRACER** at minimum cost. An easy-to-build unit that can be used for R.F., I.F. and Audio signal tracing, without any switching or tuning. Highly sensitive, easy-to-build, responds to signals picked up from an ordinary receiving aerial. The circuit is that of a high-gain, 3-stage resistance-coupled audio frequency amplifier, with a 5-inch speaker in the Output of the Power Amplifier stage.

We shall be pleased to supply a complete kit for the construction of the above, right down to the last nut and bolt, for the low price of £3/18/6. Concise instructions and circuits are supplied. If preferred, circuit and instructions only can be supplied for 1/6 post free. All items may be purchased separately. This is a highly efficient instrument, and a MUST for every radio man.

**RECEIVER TYPE 25.** The receiver portion of the T/R 1196. Covers 4.3-6.7 Mc/s and makes an ideal basis for an all-wave receiver, as per "Practical Wireless," August, 1949, issue. Complete with valves types EF36(2), EF39(2), EK32 and EBC33. Supplied complete with necessary conversion data for home use. 35/- new condition. Chassis only 8/6.

**GERMANIUM CRYSTALS** complete with circuit diagram, 4/6.

**PRACTICE MORSE BUZZERS.** Comprising Morse key, buzzer and terminals. Only requires L.T. Battery. 3/6 each.

**I.F. TRANSFORMERS.** Manufacturer's surplus. Iron-cored. 465 kc/s. Size 4in. x 1 1/2in. x 1 1/2in. Per pair 8/6.

**5CPI C.R. TUBES,** Brand New and Boxed, 25/-, Carr. Paid.

**ACRU FINGER KITS.** For easy construction and awkward corners. Set of four on Card at 7/6 or 2/- each. OBA, 2BA, 4BA and 6BA.

**RECEIVER R.1355.**—As specified for "Inexpensive Television." Complete with 8 valves VR65 and 1 each 5U4G, VU120, VR92. Only 55/-, carriage 7/6.

**R.3515 I.F. STRIP.** A complete I.F. Unit, comprising 6 SP61 I.F. Stages, tuned to 13.5 Mc/s., 1 EA50 diode detector, and 1 EF36 or EF39 output or video stage. A few modifications only are required to adapt this unit, which will give pictures of extremely good quality. Price, complete with valves, and foolproof modification instructions, is 45/-, plus 5/- carriage and packing. Limited quantity only.

**3547 RECEIVERS.** Absolutely brand new, in sealed manufacturers' packing cases. Incorporating 15 valves, type EF50, 2 of SP61, EF36, EBC33, 3 of EB34. Complete 45 Mc/s. I.F. Strip, motor, dial and drive, pots, etc., etc., £6 only, plus 10/- packing and carriage. Whilst they last.

**TAPE DECK MOTORS.** One clockwise, One anti-clockwise. Per pair £4/4/0. Well-known make.

**A.M. UNIT TYPE 159.** Comprising EF50, RL37, SP61 and EA50. Coils, relay and many condensers and resistors. The whole in metal box, 8 1/2in. x 6 1/2in. x 3 1/2in. New. A bargain at 15/-, carriage paid.

**3 BPI C.R. TUBE** complete with base and shield in holder with leads, 30/-, Brand new.

**MIDGET .0005 mfd. TWO GANG TUNING CONDENSER.** Size only 2 1/2 x 1 1/2 x 1 1/2ins. Capacity guaranteed, standard length 1/2in. spindle, complete with mounting bracket less trimmers, 6/6, or complete with "built-in" trimmers 7/6 each, plus 6d. post.

**TUNING CONDENSERS.** .0005—4 gangs, ceramic insulation, with fixing feet at 5/0, .0005 — 2 gangs with four push buttons, each fully adjustable at 8/6, .0005 midget 2 gangs with trimmers 7/6, less trimmers at 6/6.

**DUAL PURPOSE MAINS TRANSFORMERS.** Special 350-350V. 80 m/a, 6.3v. tapped 4v. at 3 amp. 5v. tapped 4v. at 2amp. Top chassis mounting, and fully guaranteed. Price (plus 9d. post) only 20/-.

If unable to call please send stamp for Current Comprehensive Component List.

## 5, HARROW ROAD, W.2

We are situated at the junction of Edgware Road and Harrow Road, facing Edgware Road Tube Station  
OPEN ALL DAY SATURDAY Telephone—PADdington 1008/9 & 0401

INDEX TO  
ADVERTISERS

	Page
Adcola	512
Alpha Radio Service	508
Altham Radio	505
Anglin, J. T.	508
Ashworth, H.	454
Audigraph	512
Automatic Coil Winder	449
Bensons	452
B.I.E.T.	507
Brookes Crystals, Ltd.	506
Brown, S. G.	505
Candler System	509
Closeman	504
Clydesdale Supply Co., Ltd.	455
Easibind	512
Electrad Radio	512
Electradix Radios	507
E.M.I.	511
Field, N. H.	511
Gage & Pollard	Cover iii & 504
H.A.C. Short-Wave Products	512
Henleys	453
Henry's	456
Hillfield Radio	510
Hoile, A. C.	510
H.P. Radio Services, Ltd.	506
Johnsons	508
Labgear	506
Lyons Radio	458
McElroy Adams	451
Multicore	450
Panda Radio	Cover iv & 507
P.C.A. Radio	507
Pullin (M.I.)	504
Radio and Elect Mart	450
Radio Clearance	454
Radio Exchange	453
Radio Mail	508
Radio Servicing Co.	455
Radio Supply Co.	506
Rollett, H.	511
Samsons Surplus Stores	509
Sandford Mail Order	510
Small Advertisements	508-512
Smith, H. L.	454
Southern Radio	455
Stratton	451
T.C.M.	458
Whitaker	cover ii
Woden	452
Young	505

---



---

# SHORT WAVE MAGAZINE

FOR THE RADIO AMATEUR & AMATEUR RADIO

Vol. IX                      OCTOBER 1951                      No. 99

## CONTENTS

	Page
<b>Editorial</b>	459
<b>The VHF Corkscrew</b> by K. W. Cranfield	460
<b>Cathode Modulation</b> by R. E. B. Hickman	468
<b>Two-Band Windom</b> by B. T. Chapman (G2ASY)	471
<b>Crystal Calibrator Switching</b> by R. W. Rogers (G6YR)	473
<b>DX Commentary</b> by L. H. Thomas, M.B.E. (G6QB)	474
<b>Safety and Protection, Part II</b> by B. W. F. Mainprize, B.Sc., A.M.I.E.E. (G5MP)	482
<b>Australian Jubilee Contest</b>	485
<b>VHF Bands</b> by E. J. Williams, B.Sc. (G2XC)	486
<b>The Magazine Two-Metre Contest</b>	488
<b>Random Jottings</b> by <i>The Old Timer</i>	495
<b>Some SCR-522 Modifications</b> by J. L. Danks (G5DS)	496
<b>New QTH's</b>	498
<b>Here and There</b>	499
<b>The Other Man's Station—G4OU</b>	500
<b>The Month with the Clubs—From Reports</b>	501

---



---

*Editor:* AUSTIN FORSYTH, O.B.E. (G6FO)

*Advertisement Manager:* P. H. FALKNER

*Assistant Editor:* L. H. THOMAS, M.B.E. (G6QB)

*Published the Friday following the first Wednesday each month at 55 Victoria Street, London, S.W.1. Telephone: Abbey 2384*  
*Annual Subscription: Inland 24s. Abroad 24s. post paid.*

**Copyright Reserved throughout the World**

### AUTHORS' MS

*Articles submitted for editorial consideration must be typed double-spaced with wide margins on one side only of quarto sheets, with diagrams shown separately. Photographs should be clearly identified on the back. Payment is made for all material used, and a figure quoted in the letter of acceptance. It is a condition of acceptance that copyright of all material used passes to the Short Wave Magazine Ltd., on publication.*

---



---

THE SHORT WAVE LISTENER ASSOCIATED WITH THIS  
MAGAZINE IS SPECIALLY FOR THE RECEIVING ENTHUSIAST

# TELCON LOW-LOSS TRANSMISSION LINES

**K.24.B** 150-ohms nominal impedance, figure-8 section twin; capacitance 10.6 mmf/ft; Attenuation at 50 Mc/s, 2.1 db/100 ft; power rating at 100 Mc/s, 300 watts.

**K.25.B** 300-ohms nominal impedance, flat ribbon-type twin; capacitance 4.6 mmf/ft; Attenuation at 50 Mc/s, 1.0 db/100 ft; power rating at 100 Mc/s, 500 watts.

**K.35.B** 300-ohms tubular twin feeder with stable characteristics in varying weather conditions. Capacitance 4.0 mmf/ft; attenuation at 50 Mc/s, 0.92 db/100 ft; power rating at 100 Mc/s, 550 watts.

**THE TELEGRAPH CONSTRUCTION & MAINTENANCE CO LTD**

Head Office: 22, Old Broad Street, London, E.C.2 Telephone: LONdon Wall 7104  
 Enquiries to: Telcon Works, Greenwich, S.E.10 Telephone: G REenwich 3291



## Lyons Radio Ltd.

3 GOLDHAWK ROAD (Dept. MS),  
 SHEPHERDS BUSH, LONDON, W.12  
 Telephone: Shepherds Bush 1729

---

**P/O TYPE EQUIPMENT RACKS.** Standard 19in. centres. Height 5ft. 3ins. Strongly made from 3/16in. angle iron. PRICE 30/-, carriage 5/-.

**TRANSMITTERS TYPE 1403A.** Frequency range: 2 to 7Mc/s. Output 40W on W/T. 10W on R/T. For fuller details see our advert. in the August issue. Supplied in new unused condition with circuit diagram and instructions. PRICE £12, carriage £1 (10/- returnable on crate).

**TEST SETS TYPE 48.** This Test Set is an R.F. oscillator providing a test signal at the frequency of 360Mc/s. unmodulated or modulated at 750cps. Valves employed are one each of NR88 and VR118. Batteries required for operation are for L.T. 2v. Acc. and 120v. H.T. An extremely well made test set, housed in a strong wooden instrument case 15 x 10½ x 8½ins. Supplied complete with valves in new condition. PRICE 50/-, car. 5/-.

**OSCILLATOR UNITS TYPE 76.** A simple signal generator providing a test signal, CW or MCW over a frequency range of 98Mc. to 152Mc. Valves employed are one each of VR66 and VR67. H.T. required about 60v. D.C. and L.T. 6 or 6.3v. AC or DC. Housed in metal case approx. 9ins. cube containing battery compartments and hinged flap covering controls. In good working order. PRICE 55/-, carriage 3/6.

**COSSOR DOUBLE BEAM OSCILLOSCOPES.** We have a limited stock of these well known Oscilloscopes, type 339A, which we have reconditioned throughout as new and fitted with new C.R. tubes. In perfect working order. PRICE £45, carriage 22/6 (10/- returnable on crate).

**POWER UNITS TYPE 87.** A Rotary converter units for 24v. D.C. input having a twin output of 250v. at 50Ma. and 6.5v. at 2.5A. Totally enclosed in neat metal case 8½ x 6½ x 4½ins. In good condition and working order. PRICE 9/6, post 2/-.

**ARTIFICIAL AERIALS TYPE 21.** Designed for use with the T1154, TR1196, TR9 series, etc., these units can easily be adapted for other Tx's. For both medium and high frequencies up to 100 watts loading at 5, 10 and 20 ohms for capacitances of 250, 150, 100 or 50pfd. There are four Muirhead precision type mica condensers fitted (300, 250, 150 and 100pfd.) which alone should prove invaluable for those contemplating construction of capacitance measuring equipment. Assembled in a neat metal case 8½ x 7 x 6½ins. In brand new condition in maker's carton complete with balast lamp. PRICE 18/6, post 1/9.

---

---

*The*  
**SHORT WAVE**  
*Magazine*

FOR THE RADIO  
AMATEUR AND  
AMATEUR RADIO

E D I T O R I A L

***Balance***

*It is probably not realised as well as it should be that the progress of Amateur Radio—in the sense of gathering new adherents and maintaining local interest—depends very largely, not upon any central organisation, but upon the Club movement considered as a whole.*

*Up and down the country, there are now something like 140 Amateur Radio clubs and local associations of amateurs which—though varying widely in experience and effectiveness, as do their own members—taken together constitute an important factor in fostering expansion and encouraging newcomers. Just now, this is all the more important in view of the many gaps and cracks appearing in the structure of the national body, faced as it is with a declining membership and strong currents of rebellion and dissension within its own ranks.*

*It is, perhaps, not for us to comment too pointedly on these failings, many of which could probably be put right by wiser direction and stronger management; and in some instances at least the criticisms of which one hears are not entirely justified.*

*What we are concerned with are the interests of amateurs at large. Reinforced and supported by a strong independent press and the fact that (contrary to the beliefs of some) the licensing situation is not, and never has been, dependent upon any system of national representation of the amateur, what it all comes to is that licensed amateurs as individuals need have no fears whatever as to the outcome of the present disputes. The issues that matter will not be affected either way.*

*Austin Fossil  
G6FO.*

---

---

---

# The VHF Cork-Screw

## DESIGN, CONSTRUCTION AND PERFORMANCE OF A HELICAL BEAM AERIAL

By K. W. CRANFIELD

SO far, little has appeared in this country concerning the Helical Beam aerial, which is due to the development work of John D. Kraus, of the Ohio State University, better known in amateur circles as W8JK and the originator of many fine aerial systems in the past. It is, therefore, the intention of this article to explain as simply as possible how this aerial functions and give some practical designs for it, since for the amateur the design is of particular interest. As will be shown later, it has many advantages over stacked arrays and Yagi beams at high frequencies, since it requires no complicated or tedious lining up and is relatively easy to construct. However, at lower frequencies the physical dimensions become somewhat unwieldy.

For those who would like a more technical treatise on the subject than is offered in this article, a list of references has been given at the end.

### Modus Operandi

A wire bent into the form of a circular helix with a circumference of one wave-length will radiate as a beam aerial, the radiation being in the direction of the axis of the helix and the radiated pattern being nearly circular—that is to say, the radiated field is nearly equal in both the vertical and horizontal plane. This type of radiation is called the beam or axial mode and can persist over a relatively wide frequency range.

To understand this mode of radiation, consider a wave travelling along a helix of one turn whose circumference is one wave-length long; then, by viewing the helix from the axis, as in Fig. 1a, it will be seen that at any given instant the regions of positive and negative charge are at opposite ends of a diameter, which will produce an electrostatic field as shown. At some instant later the charge will have travelled round the

*This article describes a beam aerial, most suitable for VHF work, having inherent broad-band properties and extremely high gain. Over a wide frequency range the radiation pattern is almost circular and the terminal impedance is relatively constant. The Corkscrew or Helical Beam is easy to build, and full design details are given for a practical 70-centimetre-transmitting aerial, with measured performance figures.—Editor.*

---

helix to a new position. Thus, it will be seen that the field rotates with the charge, making one revolution per cycle, or in other words the field is circularly polarized.

Let the helix be as shown in Fig. 1b, with  $D$  denoting the diameter,  $S$  the spacing between the turn, and  $L$  the length round the circumference; if we denote the beginning of the turn as  $A$  and  $B$  its end, and provided that the dimensions of  $D$ ,  $S$  and  $L$  have been chosen correctly for the operating frequency, then a signal radiated from  $A$  will arrive at  $B$  in the correct phase relationship with that arriving *via* the length path  $L$  to be radiated from  $B$  and reinforced from  $A$ . To produce this state of affairs, the helix is worked against a ground-plane screen, and is fed through coaxial line; this is the only method of feeding considered here, although there are others, most of which add other complications such as matching and construction problems.

### Design Data

A helix with its associated dimensions is shown in Fig. 2a, fed by means of a coaxial line, the outer conductor of which is terminated at the ground plane screen and the inner conductor connected to the end of the helix. The

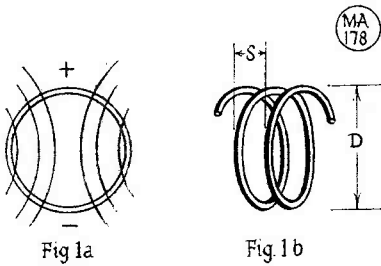

Fig. 1A, 1B. See text for discussion.

dimensions shown are used to describe the aerial and are as follows:—

- D. Diameter of helix
- S. Spacing between turns
- L. Length of one turn
 $\alpha$ . Pitch angle
- N. Number of turns
- A. Axial length = NS
- G. Diameter of ground plane
- g. Distance of helix from ground plane

If on a flat plane one turn of the helix were to be unrolled, the triangle so produced relating the circumference  $\pi D$ , the spacing  $S$ , the length of the turn and the pitch angle  $\alpha$ , would be as shown in Fig. 2b.

The graph of this relation between  $D = 0.3$  wave-length and  $0.5$  wave-length is shown in Fig. 3. Since the beam mode persists along this line and some 20% lower in value, the graph has been represented as an area rather than a single line. Within this area an aerial will produce an almost circularly polarized wave. If the dimensions of the helix are such that they fall outside this area, the aerial will produce a distorted pattern and in extreme cases cease to operate as an axial radiator. Again from Fig. 2b, it will be seen that the pitch angle  $\alpha$  is equal to  $\text{Arctan } S/\pi D$ , and this is represented on the graph by a straight line passing through the origin. These lines are drawn for angles of  $\alpha$  between  $5^\circ$  and  $30^\circ$ . It will be noticed that if the pitch angle is made too large the line will not pass through the axial mode area on the graph; on the other hand, it is also inadvisable to make the angle too small, as this upsets the impedance match. Therefore, some angle between  $10^\circ$  and  $20^\circ$  should be chosen, as then the impedance will be substantially constant at about 130 ohms.

### An Optimum Helix

Dr. J. D. Kraus has suggested an optimum design for a helical aerial after

having compared the data obtained for the impedance and the patterns produced by the aerial on a D-S chart. He found that the most suitable angle for the pitch of the helix was  $14^\circ$ , as within the vicinity of this angle the properties changed the least, producing beam widths of  $30^\circ$  to  $60^\circ$  at the half-power points and impedances of 100 to 150 ohms. However, this angle is not critical, as will be seen from the D-S graph, and can be within  $\pm 3^\circ$  of the optimum without much effect to the properties of the aerial. The actual aerial used by W8JK had a total length of 1.65 wavelengths, that is  $(A + g)$  of Fig. 2a, the number of turns working out at 6 complete turns to the nearest whole number, from the fact that  $A + g = S(N + \frac{1}{2})$  where  $N$  is the number of turns and  $g$  is taken as  $S/2$ . The measured frequency range was 1.67 to 1, with a standing-wave ratio better than 1.4 over the same range.

This optimum aerial was a compromise between directivity, power gain, terminal impedance and constructional difficulties. The power gain can be increased slightly by adding more turns; however, the difficulty of supporting the helix and the added insulation necessary generally offsets the gain thus obtained.

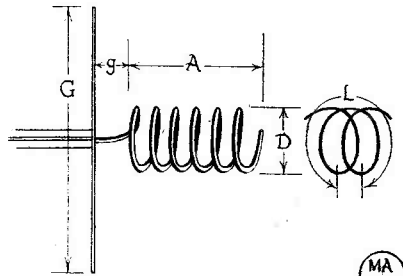

Fig. 2a

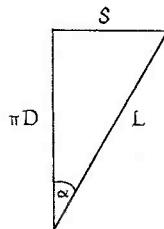

Fig. 2b

Fig. 2A, 2B. The leading dimensions—see text.

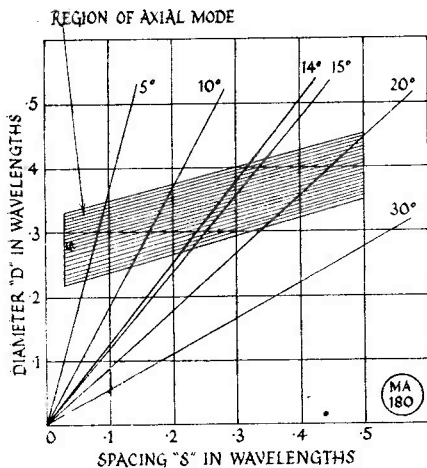

Fig. 3. Chart for the design of helices, showing the range of dimensions in the beam mode.

The helix will also work well with less turns than the optimum, but with some loss in gain and broadening of the beam. With less than about 3 turns the terminal impedance no longer remains constant and means have to be provided by which this impedance can be measured to effect a good match.

#### Construction of a Helix for 420 mc

An optimum helix was constructed for the 420 mc band, and Fig. 4 has been drawn with the dimensions of Fig. 2a in wavelengths, so that any aerial can be constructed for another band simply by scaling up or down on the figures given for the 70-centimetre beam in the table accompanying Fig. 4. A photograph of the completed aerial is also shown; it consists of a  $\frac{3}{8}$  in. diameter copper tube bent into a right-handed helix and supported by two insulators with a ground-plane screen.

#### The Ground Plane

By now someone no doubt has said to himself that it looks like a dart board; in fact, that is precisely what it is, for a dart board "spider" was obtained and expanded to the correct diameter by lengthening the radial spokes and soldering on an outer ring. This is very convenient, for not only is it almost ready made, costing but a few pence, thus saving a lot of time in construction, but also it is rigid enough to be self-supporting and has little wind resistance.

For lower band working, the ground-plane can be constructed from copper tubing, all joints being wrapped and soldered, but it is much better to use wire netting provided it is of the welded mesh type, or expanded metal. The netting can then be supported on a wooden frame, in which case it is advisable to make the screen square instead of round.

#### The Helix

The tubing for the helix was  $\frac{3}{8}$  in. diameter copper refrigerator tubing. This is very malleable, is supplied in about 24-ft. lengths, and for transport is wound into a coil roughly 2 ft. in diameter—which is very convenient if a beam is being constructed for 144 mc. as it is then of the correct diameter, and the tubing will not require bending! The tubing shown in the photograph was bent by hand round a wooden pulley of the correct diameter and then man-handled into shape, but if a bending spring is available the job is easy. Unfortunately, a bending spring of the correct diameter was not procurable for the size of tubing used in the construction of this beam, so it had to be bent by hand; although it takes longer, it is not difficult providing the job is taken in easy stages and an eye is kept on any tendency for the tubing to develop a flat. The hardest part of the bending is the lead-out section to the ground-plane, as at a frequency of 420 mc one only has 3 or 4 inches in which to bend the tube through a right-angle; this does not have a long enough straight section

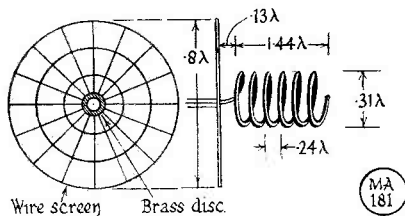
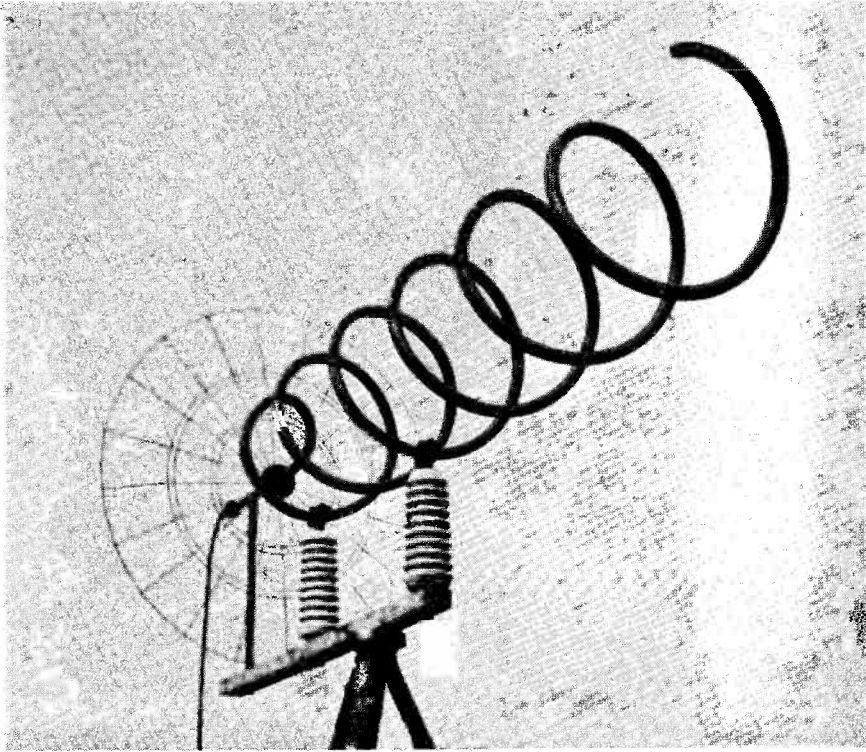

Fig. 4. Practical design for a 70-centimetre Helical Beam. Referring to this sketch and Fig. 2A, 2B, the dimensions are: D, diameter of helix  $8\frac{1}{2}\lambda$ ; S, spacing of turns  $6\lambda$ ; L, length of one turn  $27\lambda$ ;  $\alpha$  pitch angle  $14^\circ$ ; A, axial length  $39\lambda$ ; N, number of turns 6; g, distance of helix from ground plane  $3\frac{1}{2}\lambda$ ; G, diameter of ground plane  $21\lambda$ ; d, diameter of conductor  $\frac{1}{2}\lambda$ . All distances are centre-to-centre. Compare these sketches with the accompanying photograph of the completed beam.





The 70-centimetre 6-turn Helical Beam as constructed by the author and described in detail in his article. All data and test figures given refer to the beam as illustrated here.

on to which an insulating sleeve can be secured and the ground-plane screen bolted. At lower frequencies this difficulty does not arise, due to the greater distance afforded by the spacing of the tube. The problem was finally solved by soldering a metal plug into the end of the tube, to which a metal disc was screwed having a diameter greater than that of the tubing; this, together with an insulating ring and washer, formed an effective clamp. Details of this fixing together with a  $\frac{1}{4}$ -wave matching section are shown in Fig. 5.

#### Matching the Aerial

Since the impedance of the aerial is around 130 ohms it is necessary to add a  $\frac{1}{4}$ -wave matching section so that it will present the correct impedance to the feed cable from the transmitter. The aerial shown has a matching section of 100 ohms made from brass tubing

attached to the back end of the ground-plane screen, and also forms an additional support for the screen. This section was made to match a standard 72-ohm coaxial cable. The usual formula for matching two impedances was employed, the velocity factor being taken as 0.9 since the inner conductor, being a rod, only required supporting at either end with an insulating washer. If it is possible to obtain some surplus coaxial cable of the type having a thin spiral tape wound round the inner conductor, it is very suitable for making a  $\frac{1}{4}$ -wave transformer to match into 72-ohm cable, as it has a surge impedance of 96 ohms and a velocity factor of 0.86. It is known in the Services as "Uniradio 6."

#### Mounting the Beam

Due to the aerial being constructed of copper tube, it was rigid enough to be

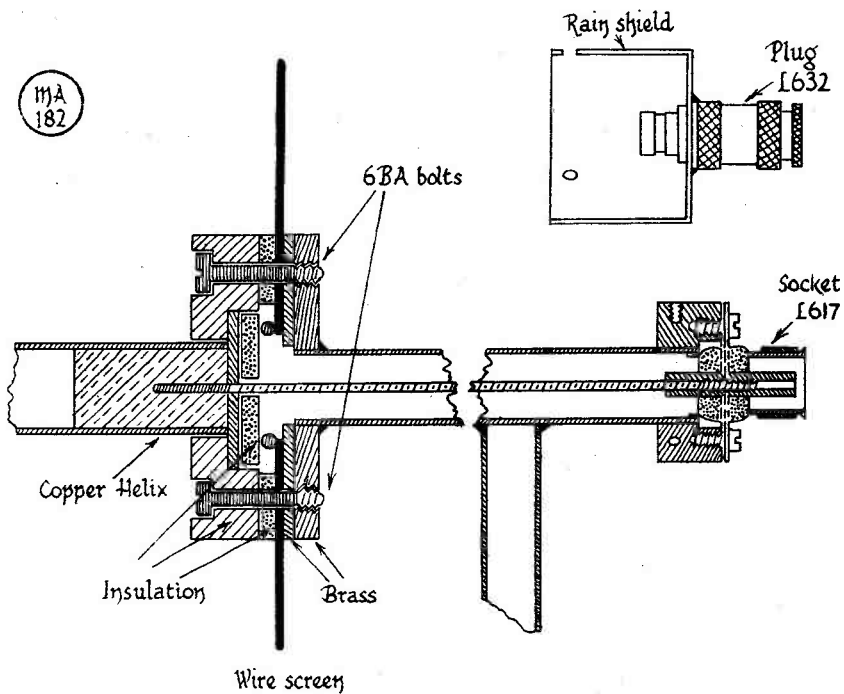

Fig. 5. Mechanical detail in cross-section showing the termination of the helix with the ground plane screen, using a  $\frac{1}{4}$ -wave matching transformer to feed 72-ohm coax. The lead-out to the apparatus is through the L617 socket to the right.

self-supporting, except for the  $\frac{1}{4}$ -wave matching section, which required additional support due to the weight of the feed cable. Since in the interest of good terminal resistance it is desirable to have a minimum of insulation, the beam was mounted on two large ex-Government stand-off insulators at the first and third turn. Although much smaller insulators could have been used on suitable supports, or even wooden pillars, provided they were insulated against the weather, the large insulators were adopted, even though they add materially to the weight of the beam, as they are already fitted with clamps to take  $\frac{1}{8}$  in. diameter conductors. The back end was supported by fixing a brass rod into the T-section provided on the  $\frac{1}{4}$ -wave matching transformer. The three stand-offs were bolted to a hard wood base, which formed a convenient method of fixing to a pole, and if this fixing is at the balance point of the aerial it will

be found that the whole structure is easily rotatable.

### Test Performance

For measuring the gain and the radiation patterns, the same technique as used by F. C. Judd, G2BCX—described in *Short Wave Magazine* for January, 1950—was employed. The helix was mounted on a tripod at the transmitter end on a rotatable platform, and a crystal diode remotely-controlled F/S meter mounted on another tripod some five wave-lengths distant. The measured gain of this  $14^\circ$  pitch-angle helix over a standard half-wave dipole was 14 dB at the centre frequency of 440 mc. The radiation patterns were taken by rotating the platform through  $360^\circ$  and taking readings every ten degrees. A study of Fig. 6, which is a plot of the horizontal field strength, shows that the beam width is 54 degrees at half-power points. The small back lobe at  $145^\circ$  was possibly

due to the manner in which the plot was taken and was probably caused by reflection from a brick outbuilding some four wave-lengths distant from the aerial mount. The vertical pattern Fig. 7 has a narrower beam than the horizontal, which may be due to the fact that the aerial was only mounted about  $1\frac{1}{4}$  wave-lengths above the actual ground—it is difficult to swing a 10-ft. pole through  $360^\circ$  whilst mounted on top of a ladder! This accounts for the readings only being obtainable through  $260^\circ$ .

From all these tests it can be concluded that the back-to-front ratio is almost infinite, as the minor lobes are some 60 dB down. Although only a six-turn helix has been tested so far, it

is possible to obtain higher gains by adding more turns to the helix, with a consequent narrowing of the beam. But it is usually more convenient to mount more than one helix in the form of a broadside array if higher gains are required. The use of broadside arrays applies mainly to the higher frequencies where the dimensions of the aerial become small, and will not be dealt with here.

### Constructional Problems

Readers who may feel that the construction of such an aerial from copper tube is too difficult may like to build such a beam from flat metal strip. In practice, there seems to be little

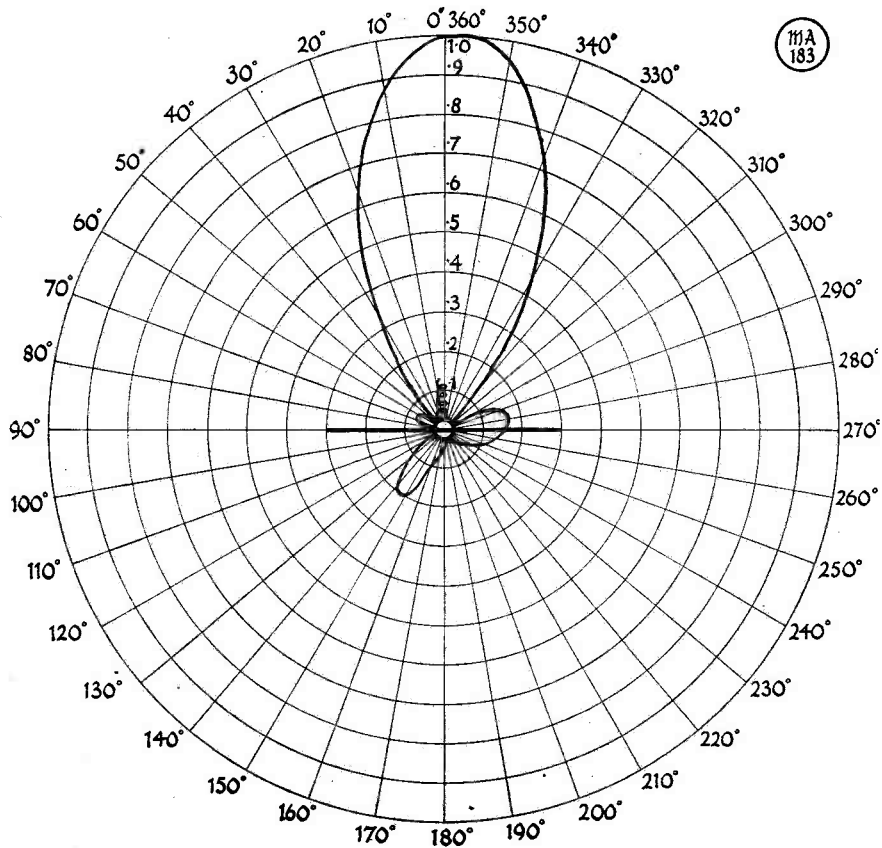

Fig. 6. A plot of the horizontal radiation pattern obtained under actual operating conditions using the completed beam as described in the article and illustrated in the photograph herewith.

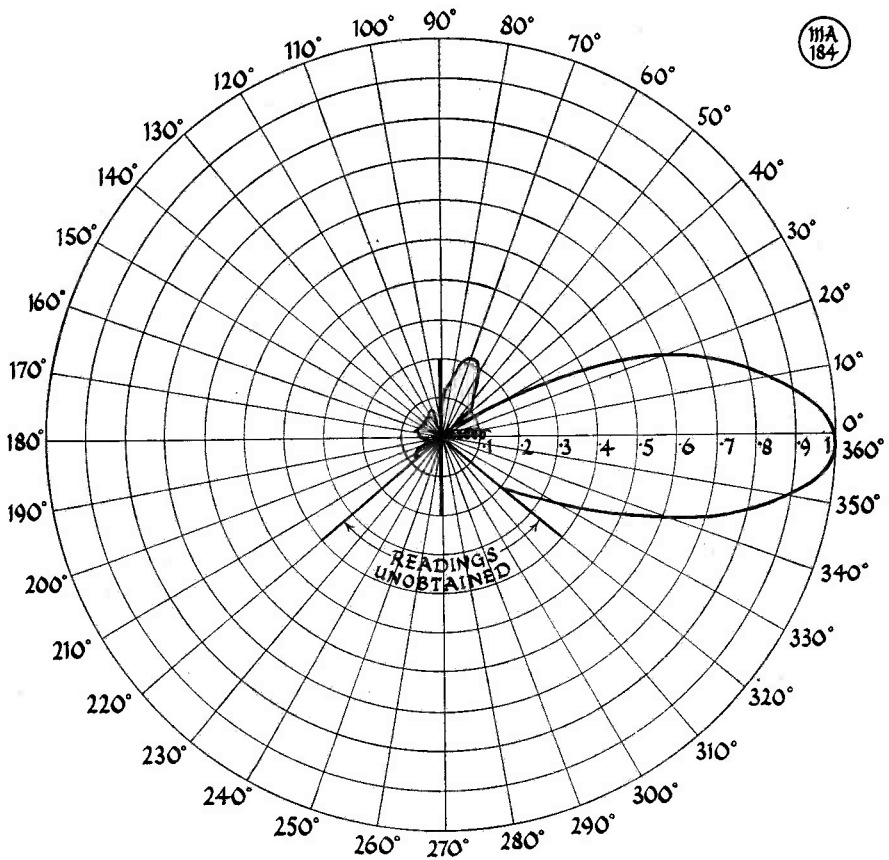

Fig. 7. The vertical radiation pattern of the Helical Beam, taken with the array  $1\frac{1}{2}$  wavelengths above ground. Local site conditions affected the results somewhat.

difference in performance whether the aerial is of round or square section so long as it has a fairly large surface area. It is therefore suggested that the aerial be built up from strip about  $\frac{1}{4}$  in. wide and from  $\frac{1}{16}$  in. to  $\frac{3}{8}$  in. thick copper, aluminium or brass; it is not necessary that the strip be in one continuous length, as shorter lengths can be lap-jointed and soldered (or, in the case of aluminium, riveted), the joint then being painted with anti-corrosion paint. If thin strip is used the helix would not be self-supporting, and each turn would have to be individually fixed. This can be done by obtaining two wooden beams to run the whole length of the helix, supporting each turn by means of a small stand-off

insulator screwed to the wood and then cross-bracing the wood for support. The helix can then be bolted to the ground-plane screen supports by means of two right-angled brackets. It will be found that the lead-out from the helix to the coaxial line will be much easier to bend in strip form than in tube. It might be mentioned here that this lead-out does not affect the calculation of the length  $L$  of the helix, as it does not play any part in the function of the aerial proper. It is tangential to the axis of the helix and only acts as a feed from the coaxial cable to the beam; it can therefore be a continuation of the helical conductor, or a separate piece of wire.

Another way in which a helix could

be constructed with tubing so as to avoid any bending whatsoever is to make the helix square. This will not upset the working in any way, as the theory still holds good—the field can travel equally well round four sides of a square as round a circle. The lengths of the sides of the square are cut a little longer than make up a full wave-length to compensate for the pattern shape and are about 0.287 of a wave-length per side. The construction of such a helix can be greatly simplified if some electrical conduit can be obtained, preferably seamless aluminium, the sides being joined by the appropriate right-angled elbows. A drawing of this construction (not actually tried out by the author) is shown in Fig. 8. It should work all right as long as the precaution is taken to impregnate the joints well at the elbows to stop any corrosion, and the whole circuit given a good coat of paint.

### Polarization

Since, as explained in the beginning of this article, the field rotates round the conductor, it will be seen that if the helix is wound right-handed it will radiate a right-handed polarized field, and if wound in the opposite sense a left-handed field. It will thus be realised from this that if the transmitting aerial was right-handed and the receiving aerial was left-handed, the field would cancel out and no energy would be received!

Therefore, before this type of aerial comes into general use it will be necessary to standardize on which type of aerial is to be adopted. This is rather like the present standardization of horizontal as distinct from vertical plane aerials on the amateur VHF bands. It is suggested that the right-handed helix should be adopted as standard practice, since it is more convenient to wind and is more "familiar," being in the same sense as a standard bolt or corkscrew.

### Conclusions

The great advantage of a helical beam aerial over other types is that, since it has a broad band-width, it can be cut to its physical dimensions and put into operation without any pruning; also, if the dimensions are slightly different from the calculated values, due to constructional tolerances, this will have little or no effect on the performance. Its physical size on the VHF bands is very much smaller than any aerial which

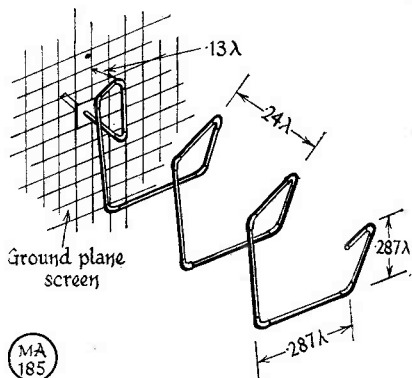

Fig. 8. As the author of this article explains, it is quite possible to get the same results with a "square helix" as with a helical beam proper, the point being that in some cases it may be easier and more convenient as regards material to build the beam in square section. This design uses ordinary electrical conduit fitted together with right-angle elbows as supplied for jointing purposes. The sketch gives all necessary dimensions for the frequency required.

could be constructed to give the same gain. In fact, to obtain the same gain as the aerial show in the the photograph would call for a sixteen-element array with reflectors and its attendant feed system. The Helical Beam is easily mounted on a single pole for fixed or rotational working and, since the main dimensions are axial in direction, it has very little wind resistance. The polar diagram is broad enough to make searching the band easy whilst still pro-

### BIBLIOGRAPHY

- H. A. Wheeler "A Helical Antenna for Circular Polarization" *Proc. I.R.E.*, Vol. 35, pp. 484-488, Dec., 1947.
- J. D. Kraus and J. C. Williamson. "Characteristic of Helical Antennas radiating in the Axial Mode" *Jour. Appl. Phys.*, Vol. 19, pp. 87-96, Jan., 1948.
- O. J. Glasser and J. D. Kraus. "Measured Impedances of Helical Beam Antennas" *Jour. Appl. Phys.*, Vol. 19, pp. 193-197, Feb., 1948.
- J. D. Kraus "Helical Beam Antennas for Wide-Band Applications" *Proc. I.R.E.*, Vol. 36, pp. 1236-1242, Oct., 1948.
- H. E. Taylor and D. Fowler. "A VHF Helical Beam Antenna" *CQ.* Vol. 5, pp. 13-16, April, 1949.
- E. Dillon Smith "Helical Antenna." *Electronics*, Feb., 1950.
- "New High Gain Radiator for 500 mc Television." General Electric Co., America. *Wireless World*, p. 262, July, 1951.

ducing a large gain in the right direction and, as will be seen from Figs. 6 and 7, the radiated field is in line with the axis of the aerial; therefore, any degree of vertical radiation can be achieved by tilting. The most useful advantage over most types of aerial is the ability of a helix to receive both vertical and horizontally polarized waves or any combination of both. This may prove to be a very definite point in its favour and may solve that mystery of why the other fellow has to aim-off his beam from the station by such a large amount, which may not be entirely due to reflection but to "torsion" of the

wave. Finally, it is hoped at a later date to be able to give some performance figures for these aerials under working conditions over a period of time.

#### Acknowledgments

The author would like to take this opportunity of thanking G. M. Wilford, G2WD, for inspiring this article and for the original references; also various members of the Radio Society of Harrow for their helpful suggestions, and especially H. F. Smith, G2DD, for his able assistance and for supplying the RF for the field tests at 440 mc.

---

## Cathode Modulation

### THE METHOD AND SOME PRACTICAL CONSIDERATIONS

By R. E. B. HICKMAN

MOST amateurs are familiar with the application and general theory of anode and grid modulation, but the features of cathode modulation are not so familiar. This system, which combines some of the advantages of both the above systems, is discussed in the present article. In a typical cathode-modulated stage, it can be shown that the modulating power required is approximately 20% of the DC plate input to the modulated stage.

The basic circuit for cathode modulation is shown in Fig. 1. A modulating voltage  $E_m$  injected into the cathode or filament-return circuit of an RF amplifier will modulate both the anode voltage and the grid voltage of the stage. Assume that on the first half-cycle of the modulating voltage the polarity of  $E_m$  is as indicated in Fig. 1. In the series circuit between cathode and anode,  $E_m$  and the anode supply voltage  $E_b$  are additive. The resultant increase in anode voltage will cause the anode current and consequently the amplifier power output to rise. In the grid-cathode circuit, however,  $E_m$  opposes the grid bias voltage  $E_c$ , but the resultant decrease in negative grid voltage again causes the anode voltage

*An RF amplifying valve can be modulated either on the plate, plate-and-screen, suppressor grid, screen grid or control grid, and in different ways in each case. This article discusses yet another method of modulation—neither new nor unknown, but still not much used in amateur practice. Cathode Modulation is a combination of anode and grid control and is one of those circuit arrangements by which good phone working is possible with economical modulating equipment.—*  
Editor.

and power output to increase. Thus the effects of  $E_m$  in both the grid and the anode circuits are in phase. On the next half-cycle of the modulating voltage the polarity of  $E_m$  will be the reverse of that shown in Fig. 1, causing a decrease in anode voltage and an increase in negative grid bias, and consequently a decrease in output power. In other words, we have simultaneous in-phase grid and anode modulation. 100% modulation of the carrier can be accomplished by a combination of, say, 40% effective anode modulation with 60% effective grid modulation.

#### Comparison of Modulation Systems

It may be useful at this point to consider the salient points of both grid modulation and anode modulation. As is generally well known, grid modulation is characterised by (a) Low power output, (b) Low anode circuit efficiency, and (c) Low audio power requirements. Anode modulation, on the other hand,

results in (a) High power output, (b) High anode circuit efficiency, but (c) High audio power requirements. As an example, a triode type 812 when grid modulated has a power output of 25 watts and an anode circuit efficiency of about 33%. The audio power required fully to modulate the carrier may be as low as 1 watt. The same valve, however, when anode modulated, will give 120 watts RF output at an efficiency of approximately 77%, but will require upwards of 75 watts audio power for 100% modulation. The 812 can be operated as a cathode modulated amplifier at any desired point between these limits.

**Determination of Operating Conditions for Cathode Modulation**

The most suitable operating conditions for any specified valve type can be determined by reference to the curves plotted in Fig. 2. These curves show the variation in (i) DC anode input power,  $W_{in}$ ; (ii) Carrier power output,  $W_o$ ; (iii) Audio modulating power,  $W_a$ ; and (iv) Anode circuit efficiency,  $N_p$ , plotted against percentage of anode modulation,  $m$ . These curves are plotted on a percentage basis and are applicable to all valve types for which the Class-C telephony ratings are known. Thus, point A on the  $W_{in}$  curve represents the full (100%) rated anode modulated Class-C telephony power input. The  $W_o$  curve is based on an anode circuit efficiency of 77.5%, and point A on this curve represents the full rated Class-C telephony carrier output power. Other points on the curves shown represent the indicated percentage of the value at point A.

Point B on the  $W_{in}$  curve and point C on the  $W_o$  curve represent values for pure grid modulation since  $m$  is zero. These points A, B and C should be obtained from the published data on the particular valve which it is proposed to use.

The relationships between the various characteristics are as follows:—

$$N_p = \frac{W_o}{W_{in}} \times 100 \dots \dots \dots (1)$$

$$W_a = \frac{m^2}{2} \times W_{in} \text{ (approx)} \dots \dots \dots (2)$$

Another circuit value of prime importance in the design of a cathode modulated stage is the cathode impedance of the RF stage,  $Z_c$ . This is approximately equal to the peak modulating voltage,  $E_m$ , divided by the peak

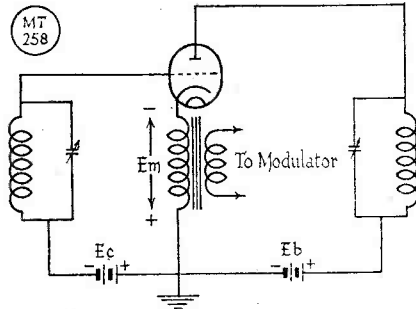

Fig. 1. The basic circuit for cathode modulation, the operation of which is explained in the text. Under acceptable compromise conditions, the modulating power required is about 20% of the DC plate input to the modulated stage.

AF component of the anode current  $I_b$ . That is

$$Z_c = \frac{E_m}{I_b}$$

but since, by definition

$$E_m = m \times E_b \quad \text{then} \\ Z_c = m \times \frac{E_b}{I_b} \dots \dots \dots (3)$$

Some practical values for the type 812 may be of interest here. Assuming that the logical choice of anode circuit efficiency for cathode modulation is half-way between the figures of 33% and 77% mentioned above for grid and anode modulation respectively, we find from Fig. 2 that, to make  $N_p$  equal 55%,  $m$  must be almost 44% and audio power  $W_a$  must be approximately 20% of the DC input power  $W_{in}$ . With the 812 operating at 1250 anode volts and 81 mA, equation (3) shows  $Z_c$  to be  $0.44 \times 1250$

$$\frac{0.081}{\dots \dots \dots} \text{ i.e. } 6800 \text{ ohms. Two } 812\text{'s}$$

in push-pull or in parallel will have a cathode impedance of half this value, i.e. 3400 ohms.

**Practical Design Considerations**

Probably the most practical way to design a cathode modulated stage is to consider the largest modulator it is desired to use if a new station is being built, or the maximum output obtainable from the modulator in use if an existing CW rig is being converted to 'phone operation. Let us assume that the modulator has push-pull 6L6's in a Class-AB2 output stage delivering 47 watts audio

power. From equation (2) above we find that  $W_{in} = \frac{2 \times 47}{0.44} = 214$  watts.

This is the maximum RF amplifier input which can be used with such a modulator. If, however, the RF valve which it is proposed to use is capable of handling only, say, 150 watts, we obtain again from equation (2) that  $m = \frac{2 \times 47}{150} = 0.63$ . This means that

we can use 63% effective anode modulation at an anode circuit efficiency of 67% (from Fig. 2). Inserting these values in equation (1) it will be seen that the carrier output power  $W_o$  is  $\frac{67 \times 150}{100} = 100$  watts and the anode dissipation ( $W_{in} - W_o$ ) is 50 watts. In other words, the value of  $m$  can be so chosen that  $W_a$  is suitable for  $W_{in}$ , and  $W_{in}$  is compatible with  $N_p$  and the rated anode dissipation of the chosen RF valves.

Using the curves of Fig. 2 and the published data on push-pull 812 triodes the figures shown in the Table were evaluated.

Several interesting points emerge from this comparison. When  $m$  is 40% the ratio  $W_a/W_e$  is 55%. In other words, the audio power required for such a cathode modulated stage is only 55% of that required for the same carrier output in an anode modulated stage. When  $m$  is further reduced to 20% the audio power required is only 35% of the

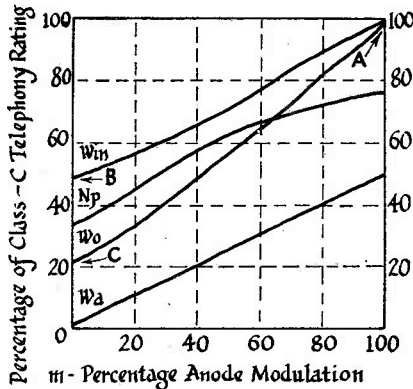

MT  
259

Fig. 2. Curves for determining operating conditions for cathode-modulated RF amplifiers, using any type of valve suitable for RF service. The reading of this graph is discussed in the article.

Equivalent Anode Mod. Percentage. (m)	20%	40%	100%
DC Anode Voltage ( $E_b$ )	1250	1250	1250v
DC Anode Current ( $I_b$ )	135	162	248 mA
DC Anode Input ( $W_{in}$ )	169	202	310 w
RF carrier output ( $W_o$ )	75	114	240 w
Anode dissipation, max ( $W_p$ )	94	88	105 w
Audio modulating power ( $W_a$ )	17	40	155 w
$W_a/W_{in}$ percentage	10	20	50%
Anode circuit efficiency ( $N_p$ )	44	56	77%
Cathode impedance ( $Z_c$ )	1850	3090	500 $\Omega$
AF power to 100% anode modulate equivalent carrier ( $W_e$ )	48	73	155 w
$W_a/W_e$ percentage	35	55	100%
Anode dissipation for equivalent carrier in anode mod. stage ( $W_t$ )	33	50	105 w
$W_p/W_t$ (F)	2.83	1.76	1

requirements for anode modulation, but the anode circuit efficiency is down to 44%. The factor  $F$  is a measure of the relative "size" of valves required for cathode modulation as compared to the "size" called for in an anode modulated stage of the same carrier power. "Size" is measured in terms of anode dissipation. It will be seen that larger valves are required for cathode modulation.

The DC anode voltage for a cathode modulated RF amplifier can be the maximum rated voltage for anode modulated telephony service. The maximum anode current should never exceed the maximum rated current for anode modulation.

#### Advantages and Disadvantages of Cathode Modulation

As, in general, the price of equipment and its availability plays an important part in the choice of any amateur set-up we shall endeavour to sum up by comparing the costs of a cathode modulated system with those of an anode modulated system of equivalent carrier output.

Cathode modulation calls for larger RF amplifier valves having greater anode dissipation, but requires consider-



ably less audio power and a smaller and cheaper modulation transformer.

Cathode modulation requires a larger DC input and hence a larger RF power supply unit, but permits the use of a smaller lower-voltage AF power supply unit.

A cathode modulated stage demands more care in setting up for optimum

output, but this may not be a serious objection, especially if a CRO is available.

It would follow therefore that cathode modulation is worthy of serious attention where a transmitter of medium efficiency and power output is required and where low audio power operation is desired.

## The Two-Band Window

### OPERATION AND RESULTS

By B. T. CHAPMAN (G2ASY)

AFTER hearing two G stations discussing the Two-Band Window aerial and one of them stating that he had tried it out and could not get it to function efficiently, it occurred to the writer that perhaps there were others who had found the same difficulty and

that some information about experiences with an aerial of this type might be helpful, as it has proved to be the best radiating system yet used at this station.

In the May 1950 issue of *Short Wave Magazine* dimensions were given for such an aerial—68-foot top, tapped at 22 feet with 300-ohm ribbon feeder. As the garden at G2ASY did not allow the full 68 feet to be used, it was decided to cut it down to 66 feet, and even then the last three feet had to be taken indoors. Tapping was made at 21 feet, and a 33-foot length of 300-ohm ribbon feeder run in to the aerial coupling unit.

The system was first tried out connected direct to the PA link at the transmitter, but it was soon evident that there

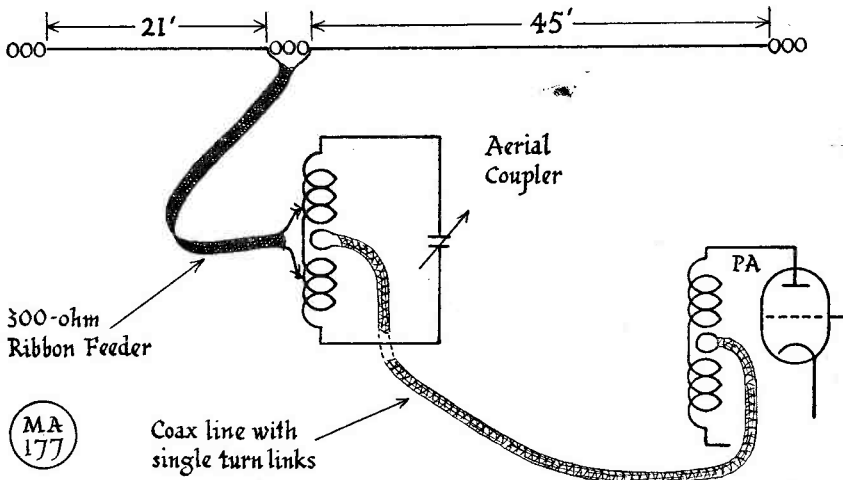

Coupling circuit used by G2ASY to feed his Two-Band Window; the single-turn links are actually wound over the PA and aerial coupler coils, it being of course unnecessary to split the windings in the manner suggested in this sketch. For those with more space, it can be shown that a roof-length of 136 feet, fed at 44 feet from one end with 300-ohm Telcon ribbon, can be used in the same way to operate on all four bands 3.5 to 28 mc with excellent results, as the matching impedance at the tapping point varies but slightly from band to band.

was a mis-match, as it did not "draw" properly. Upon the advice of G3CAS, an aerial tuning unit was used to couple the Windom to the transmitter, which is a BC-610. In the PA there is a fixed single turn link. This was connected by means of a length of co-axial cable to a similar fixed single turn link on the coupler. For 14 mc the coupling coil is of 12 turns 2in. in diameter, and the link encircles it at the centre. For 7 mc the coil is of 2½in. diameter. The accompanying sketch shows the connections, except that the coils are not split. The aerial coil is tuned by a condenser of transmitting type.

### Results

The arrangement was first tested out on QRP by tapping a neon bulb across turns of the coil on either side of the link and moving in towards the link until maximum glow was obtained in the lamp. It was at once evident that there was more RF in the coupler than ever there had been before. The ends of the 300-ohm ribbon feeder were fitted with crocodile clips and the feeder taken to the turns where the neon burnt brightest.

The system now drew well, and tests with a neon lamp showed that there was plenty of RF aloft. Using the full 100 watts, things began to happen.

On 7 mc good all-round-the-compass working with excellent reports have been obtained, both on CW and phone, and communication has become much more reliable. On 14 mc the DX results have been very good. G2ASY does not get a lot of time on the air, but in three months the following results have been obtained: All W districts except WØ, with good W6 and W7 contacts; VK2 and VK3; also ZL3. In Canada VE1 and VE7 have been worked; going south, PY2 and CO7. On phone, good contacts have been made with EK1, CT1, CT2. All Europe, and signals from this station have been heard in VS6.

### Points

The whole secret of getting this aerial going is to get proper matching between feeder and transmitter, and any effort spent in doing this will be well rewarded. At this station many different types of aerial have been tried, but this Two-Band Windom has all the rest beaten for efficiency and for all-round coverage. It was not until it was used that contact could be made with South America at all.

It is hoped that these notes will be of some assistance to those who may have encountered snags in the operation of the Two-Band Windom. The thanks of the writer are due to G3CAS, who has taken much interest in erection and operation and whose wise advice made ultimate success possible.

---

### NAVAL HANDBOOKS

We are informed that handbooks and manuals on the Naval surplus equipments now generally available can be obtained from: Head of Military Branch (Books), Block C, Station Approach Buildings, Kidbrooke, London, S.E.3, of whom enquiries can be made.

### DID YOU KNOW

That *Short Wave Magazine* now circulates in some 50 countries? That it can be bought off bookstalls from Oslo to Buenos Aires and from San Francisco to Singapore? That it is a most acceptable gift to any transmitting amateur? That you can have it posted by us to any address in the world? That a direct subscription, home or overseas, costs but 24s. post free for a year of twelve issues? And that you can place your order, to commence with any issue after this one, with The Circulation Manager, Short Wave Magazine, Ltd., 55 Victoria Street, London, S.W.1? Well, don't say we haven't told you all about it!

### XTAL EXCHANGE

Insertions in this space are free, but can be accepted in respect of exchanges of crystals only. Please set out your notice in the form shown below, on a separate slip headed "Xtal Xchange—Free Insertion." All negotiations should be conducted direct.

#### G2FCA, 26 Northolme Gardens, Edgware, Middlesex.

Has Q.C.C. Type P5 crystals 1809.5, 7069, 7185, 7278 and 8024 kc, all certificated. Wants similar type, or Brookes, any frequency 7010-7045 kc, with certificates.

#### G3AAV, 166 Otley Road, Leeds, 6.

Has Western Electric 36.4 mc crystal, ½in. mounting. Wants 100 or 1000 kc bar.

#### G3AHE, 52 Priory Avenue, Southend-on-Sea, Essex.

Has 7150 and 8176 kc crystals, ¾in. mounting. Wants 3510 kc or near, or 7040 kc.

# Crystal Calibrator Switching

## STABILISING THE LOAD

By R. W. ROGERS (G6YR)

THE practice of using a crystal calibrator in conjunction with the station communications receiver is becoming increasingly popular and, as the extra power requirements are very modest, it is convenient to run the calibrator from the receiver supply.

In the July issue of *Short Wave Magazine* a 100 kc crystal calibrator unit, suitable for fitting into a communications receiver, was described by G2AJ. As he himself pointed out, an initial snag encountered was the slight "pulling" of the local oscillator which occurred when the unit was switched on to draw current from the receiver HT supply. However, using the unit in an AR88, G2AJ managed to eliminate this effect by dropping the HT on the calibrator valve to 70v.

Probably many readers will wish to fit similar units to their own receivers, many of which (such as the popular S640 and HRO) do not include a voltage stabilising valve as does the AR88, and the effect mentioned above is almost certain to be more troublesome. As the whole point of having the calibrator is to enable the receiver to be calibrated with *accuracy*, it is well worth while taking the trouble to eliminate this effect, and fortunately a very simple means is available.

### Alternative Method

The only change necessary is to fit a change-over toggle switch in place of the ordinary on/off type, which breaks the HT supply to the unit. When the calibrator is switched off, a small current is caused to flow *via* the alternative switch contact through a suitable resistor to chassis. It is only necessary to ensure that the resistor passes the same current as the calibrator, and then it follows that the HT load is constant with the switch in either position and no change in receiver tuning can take place, however poor the regulation of the receiver power supply.

A suitable resistor can be selected by trial and error, and often a very near value can be obtained by taking a

resistor slightly higher in value than required and connecting a still higher value resistor across it to reduce the resistance to the right figure. Alternatively, if space permits, a preset potentiometer can be used, and the initial setting up is then very easy.

By this method, the necessity to limit the HT to the calibrator is obviated, and the voltage can be set purely by consideration of the oscillator harmonic strength required. It should always be remembered that a harmonic that seems quite adequate on a quiet band can be completely obliterated by QRM when conditions are good.

It is perhaps worth mentioning that, by adopting the principle suggested here, the writer has successfully eliminated all frequency "pulling" on his own receiver (with unstabilised power supply) when running a 500 kc oscillator and 50 kc multivibrator from the same supply.

### AMATEUR TV TRANSMISSION

The latest report of the British Amateur Television Club appears in the October issue of our *Short Wave Listener & Television Review*. Some interesting details are given covering current activities, members' transmitting equipment and results. Up to the moment of writing, the only amateur TV transmitting permit yet issued is that to G2DUS/TV, of Stotfold, Beds. Much useful constructional and experimental work is being done by various other members in anticipation of the issue of a licence.

### CARDS IN THE BOX

Cards are held in our Bureau for the operators listed below, in respect of whom no address appears in any published list. If they will be good enough to send a large S.A.E., with name and callsign, to BCM/QSL, London, W.C.1 (in itself a full and sufficient address from any part of the world), the card(s) will be forwarded on the next G clearance. If publication in our "New QTH" feature and subsequently in the *Radio Amateur Call Book* is desired, that should be mentioned at the same time.

G2AJJ, 2DWP, 2HCB, 2KQ, 3ABY, 3AEO, 3DCD, 3EYU, 3FON, 3HHI, 3HJM, 3HMB, 3HQH, 3HTK, 6ML, GB3FB, G13HND, GM3FTE, 3GYJ, 3HQC.

# DX COMMENTARY



By L. H. THOMAS, M.B.E. (G6QB)

THE month of September showed distinct signs of a lift in conditions, a welcome event in view of the number of contests, tests, and general DX-beanos expected this winter. Just as we were beginning to think that the DX had really gone bad on us (like the weather), the whole thing improved suddenly; let us hope this is not just a flash, but really a tendency to improve.

Have you ever tried to explain the meaning of "DX" to a layman? Then you will know how difficult it is to make sense out of it. Don't worry any more, because for our friends in the States it will be even more difficult, since the letters "DX" have now been adopted as the Government's new code rating for Top Priority on scarce raw materials and goods. (It goes only to makers of vital defence and atomic-energy products!) All the same, don't misunderstand the title of this screed.

All bands have been lively with the exception of *Ten*, which we can almost forget this month. That piece of territory has been just about useless except for occasional phone contacts with South Africa or South America. So we will open up with the next one as you go upwards.

## DX on Twenty

Asia seems to have been the star turn

here, with the honours going to HS1UN (14160) and FI8RO (14100). They have both been putting in beautiful CW signals day after day, peaking around 1700 or earlier. JA's, KG6's, VS1's and 6's have also been good, and a terrific wallop from PK4DA has been noted several times.

G3ATU (Roker) reports a good month with FR7ZA, FY7YB, HS1UN, JY1AJ and VP8AP, but had the galling experience of calling EA0AB, hearing him come back with a long, long call, in the middle of which he faded right

## Calls Heard, Worked & QSL'd

out. G3ATU is still minus *that* new country. Other DX heard included EA0AC and 0AD, FB8ZZ, KM6AZ and ZK2AC.

G8IP (Hampton) picked up three new ones for this year in the form of OQ5, CO and VP5. G3AIM (Speke) raised JA2KW, YI2AG, TI2PZ, PX1AR, 3A2AD, a bunch of CE7Z's, and MD9BO. He would naturally like to know more about the latter; has anyone any news to offer? Regarding the CE7ZN, 7ZO and 7ZQ types, 'AIM says that the position given by CE7ZN puts him in Graham Land. Now does that give G3AIM a new country, or does it? As he says, the chap is *there*, irrespective of race, creed, colour or politics, so why not? Our answer is that such a QSO should certainly count as a contact with Graham Land (for it can't conceivably be regarded as anything else); but if the QSL materialises, it will not be recognised by the powers who issue most of the DX certificates.

G5BZ (Croydon) has been away a lot of the month (so G6QB has edged past him again!) but did raise FI8RO, FQ8AG and VP2AD. He will be QRT for a little while yet on account of rebuilding—the house as well as the transmitter.

G6QX (Hornchurch) offers FI8RO, VP7NM and 9DDD, YV5BX and sundry W's and VE's. He tried hard for VQ8CB (who wouldn't?) and also UA0SK, who would have meant a WAZ for 'QX. Hard luck, that! G3BDQ (St. Leonards) worked HS1UN, FQ8AE, 3A2AD, some VS7's, and all the more usual line of DX.

## Phone DX

A little phone news from GM2DBX (Methilhill), for whom the new ones

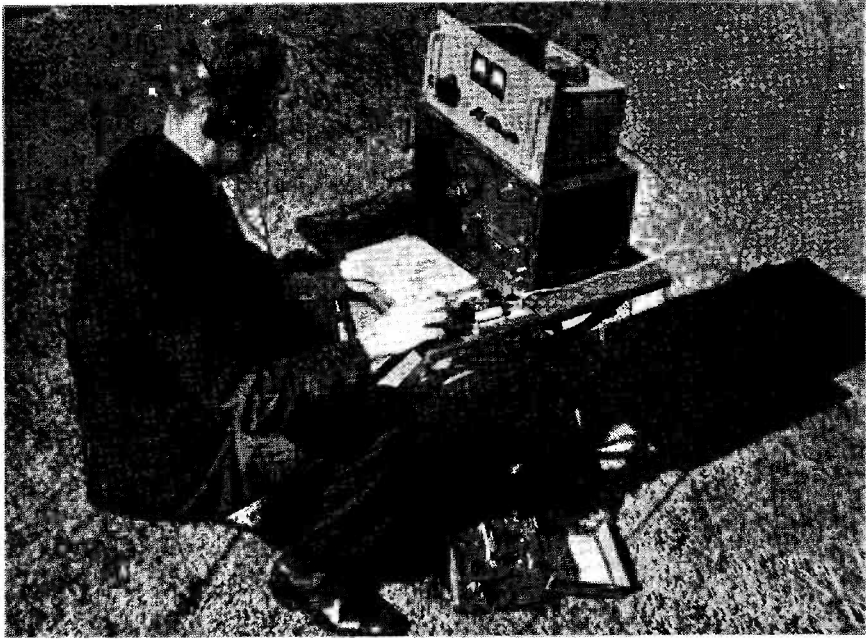

When G3ESV and G3GXS were on holiday using GD/P calls, this was the gear used (G3GXS operating). Located on the outskirts of Peel, Isle of Man, and confined to the 40-metre band, 90 contacts in 17 countries were achieved in 6 days, with PY and W as best DX.

were HSIUN, UP5A (?), TG9RB, VQ5CB and ZL2AAH, as well as HK, YV, CO, VQ2, ZE and KG6. Some nice phones in that lot—but who is that UP5A type that everyone seems to have been hearing? There's never yet been a UP5, or even a UP with a single-letter call-sign. Highly suspicious . . . .

G2HKU (Sheerness) has not been very active and has only managed VK's and a W6 on CW. ZB1AJX told him that ZB1BE has now left Malta for his home in Southend. DX heard by G2HKU was not too bad—EAØAB, HP1LA, LZ1RF, VS6CG, ZD4MM and 6EF.

G3FPQ (Bordon) raised CT2BO, HSIUN, KV4AA, MD2PJ, VP4LZ, VP9OO, VS9MA, YI3ECU and 3A2AD. G3ABG (Cannock) started chasing them again, and caught EA8JR, KG4AQ, LZ1ZA, VP4LZ, F9QV/FC, 3A2AD, VK9GW, CO7AH, CE1DC, and sundry others of a less noteworthy nature. He found conditions very queer sometimes—one evening there was nothing on the band but FI8RO and VQ8CB, both at

S8. And he asks who this JY1AJ is, thinking he might be a Japanese national. Sorry to disillusion you, 'ABG—the QTH is RAF Amman, Jordan.

One DX-chaser who gets tired of the old rubber-stamp QSO's is G3FXB (Hove), who says his list has suffered in consequence. It includes CO2OE, CR9AF, EA8BE and 8BF, KH6WU, KL7UM, OQ5AA, VE4NI, TI2PZ, YI3HPG and XU6F. The Gotaways were EAØAB, EAØBH in Ifni (QSL via EA4BH), YK1UN and ZS7C. The latter, while trying to work DL7AA through what 'FXB calls a "terrifying rumpus," came back "QRT nw, mad-house."

G5FA (London, N.11) submits PJ5RE, OX3WE, VP9DDD, XU6F, 9S4AX, XZ2EM and PX1AR, with FI8RO, FN8AD and VQ8CB as Gotaways. VQ3SS, says 'FA, pulled the big switch to come home by air to London, where he will be staying for some time, and paying the usual social calls.

[over

That's about the size of the 14 mc reports, which don't really do justice to the state of the band; holidays have been responsible for some of this, together with the fact that a lot of 'chasers gave it up in despair and won't know it's alive again until they read this!

#### Forty-Metre News

G2DPY (Shoreham) has had another good month on *Forty*, with such DX as VP9AK, MF2RE, 3A2AD, LZ1AA, W's, VE's, VK's, ZL's and an amazing type signing MK1U and giving QTH as "Box 27, Carlezo, Asia." What the heck? 'DPY says, concerning our comments on the 80-metre QRO boys last month, that he has found the regulars most obliging and helpful to anyone wishing to QSO ZL up there.

### FOUR BAND MARATHON (STARTING JANUARY 1, 1951)

Station	Total Points	3.5 mc	7 mc	14 mc	28 mc	Countries
G3ATU	264	26	86	147	5	154
G6QB	245	21	60	134	30	149
G5BZ	243	21	58	148	16	152
G3FXB	232	25	73	125	9	136
G6QX	221	36	65	102	18	115
G5JU	217	25	54	107	31	120
G5FA	197	15	69	106	7	117
G3ABG	187	22	65	77	23	101
G2AJ	185	17	44	101	23	112
GM2DBX	164	1	30	91	42	101
G2BW	149	14	30	89	16	96
W2WC	141	22	35	77	7	84
G8KU	138	13	25	91	9	94
G6TC	133	13	36	69	15	74
G8IP	133	12	50	63	8	86
G3COI	107	19	18	68	2	75

(Note that new entries to this table must not include QSO's dating back more than two months from the time of entry. Regular reporters should send in their score month by month—three months' failure to do so will be taken to indicate loss of interest and the score will be deleted).

G3ATU worked CT2BO, 3A2AD and VP8AO, quoting the latter as South Georgia (but we worked him on September 13 and he gave his QTH as South Shetlands. Which is right?)

G5BZ worked CT2, LU, SU, VK and ZL on the band. G6QX collected CO7DF, KP4KD, LU3DD and some VE's and W's—he also heard the MK1U type, whom he describes flatly as a phoney. G2HKU heard CE7ZQ on *Forty*, and G3ABG worked sundry PY's, VE's and W's.

G3FXB thinks conditions are good, but DX activity still lacking. He worked CT2BO, PY, ZL and 3A2AD, and heard VE8TC but couldn't raise him. G3BDQ offers CT2BO, LX1JW, VP8AP, 3A2AD and some W's.

#### Eighty Metres

Even *Eighty* has been yielding some of its precious DX from time to time; the VQ4's have been there on occasion and the ZL's are up on a good many mornings. Rarities like 3A2AD show up now and then, and everyone is terribly happy. G3ATU raised 3A2AD, 9S4AL and CE3AG for three new ones. G2NJ (Peterborough) has some nice things to say about HB9EU, who went out of his way to tell 'NJ that 3A2AD was on 3508 kc in case he was wanted (which he was!)

G6QX pushed up his score with the help of 3A2AD, GD3UB, GC2CNC and UA3KNE, and adds that SP6CU has been in evidence on the band, too. G3FPQ, with 18 watts of CW, collected two new ones in the guise of EA4CR and MD2DW. G3FXB also unearthed EA4CR as well as an EI for two new ones this year.

#### Top Band News

There are no reports, as yet, of Top Band DX, but G2NJ has been operating portable with a kite aerial. One of the first stations to be worked was G5DQ, who was also one of the first in similar tests made by 'NJ in 1939. He was fairly peppered with queries about the length of aerial, height of the kite and so on. (We want a kite that goes up 136-ft. vertically and stays there, holding up our ground-plane for us, until the end of the Trans-Atlantic Tests).

The big news about this band is, of course, that a series of G/ZL Tests has been arranged and is, in fact, already running. GW3ZV and ZL1AH got together over this, and considered the

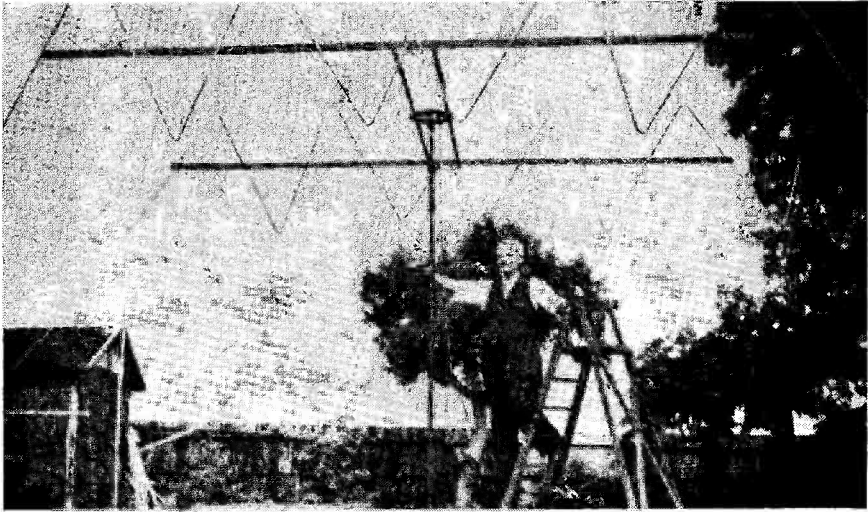

Economy of space with a 14 mc beam. The 20-metre Concertina at G4OT, Woodham Walter, Essex.

propagation conditions, the absorption factor, the noise level and so on. The results of these deliberations emerge now as a properly organised schedule, as follows:—

**Times:** 1800-1900 GMT, Wednesdays and Saturdays; 0600-0700 GMT, Thursdays and Sundays.

**Calling:** G's call from 1810 to 1820, 1830-1840 and so on. ZL's call 1800-1810, 1820-1930 and so on.

**Frequencies:** G's asked to use 1880-1900 kc—*certainly* not higher than 1900 in any circumstances. ZL's will call on approximately 1910 kc.

It should be noted that 0615 and 1815 represent sunset and sunrise (approximately) both in this country and in ZL, round about the end of September. This gives two short periods when the entire path may be regarded as being in darkness.

The peak month is expected to be December, but this is, of course, the ZL summer and their high noise-level period.

Remarks on absorption—it is lowest at 0600 and 1800, with the latter time the better of the two. The leaflet circulated by GW3ZV adds the following

interesting information: "If conditions are such that ZL is coming through S7/8 on 7 mc, and S4/5 on 3.5 mc, then S1/2 should be possible on 1.9 mc. Signals, if they come through at all, are expected to peak only for a very short time, and to be subject to QSB."

**Important:** Even if you are not interested in these tests, please try to keep clear of 1910 kc between 1800 and 1900 GMT, and pass the word on to others.

### Contests

The Contest Season is upon us, and we have been asked to give fuller details than usual of some of the more important events, so here they are.

First, the **VK/ZL Contest**. This coincides, this year, with Australia's Jubilee Celebrations, and will be a bumper affair. The following are the main details:—

**Dates:** CW—October 13, 0001 to October 14, 1200 GMT.

Phone—October 20, 0001 to October 21, 1200 GMT.

**Rules:** There are three main sections—CW, Phone and Receiving (Phone & CW). Contestants may compete in the "Open" events (all bands) or on one or

more individual bands by submitting a separate log for each band. All bands may be used, but no cross-band operation. One contact per band with any one station. Only one licensed amateur to operate any individual station.

The serial number drill involves the RST report, followed by an increasing three-figure number which may start at any figure between 001 and 100 for the first contact—for the CW event. For Phone, the two-letter (RS) report, followed by the three-figure serial number.

**Scoring** — one point for each contact with a VK/ZL station, per band. Grand Total is the total score for each band multiplied by the number of VK/ZL districts worked on that band, and all bands added together.

## ZONES WORKED LISTING

### POST WAR

Station	Z	C	Station	Z	C
<b>Phone and CW</b>			<b>cont'd.</b>		
G6ZO	WAZ	232	GM3EST	38	154
G6RH	WAZ	228	G3FGT	38	148
G6QB	WAZ	219	G6QX	38	146
G3ATU	WAZ	210			
G5YV	WAZ	205	G3GUM	37	148
G3DO	WAZ	200	G2FYT	37	143
G2FSR	WAZ	196	G3ABG	37	141
G4CF	WAZ	195			
G8IG	WAZ	188	G2YS	36	135
G2VD	WAZ	171	G3CIZ	36	127
G3BI	WAZ	162	G2HKU	36	127
G3TK	WAZ	157	G6TC	36	117
G3AAM	WAZ	154	G2DHV	36	109
G2IO	WAZ	152			
G3YF	WAZ	152	GM3CVZ	34	107
G8IP	WAZ	144	G3HDA	34	103
G3AZ	WAZ	133			
G5BJ	WAZ	126	G2BBI	30	101
G5VU	WAZ	124			
			<b>Phone only</b>		
G2AJ	40	205	G2AJ	38	167
G5BZ	40	200			
G2WW	40	183	G3DO	37	160
G3FNJ	40	150	G6WX	37	135
G6BB	40	136			
G3BNE	40	134	G8QX	36	139
G5MR	40	130	G3COJ	36	134
			G2WW	36	134
G3BDQ	39	170			
G8KU	39	164	G2VJ	34	122
G5FA	39	161	GM2DBX	34	114
G3FXB	39	147			
G2BJY	38	162	G2BBI	30	98
G3COJ	38	157			

**Logs**—must show, in this order: Date, Time (GMT), Band, Emission (Phone or CW), Call of station worked, Serial Number Received, Serial Number sent, VK or ZL District worked, Points.

A separate log must be put in for each band for which an individual entry is intended; for the "Open" section an all-band log is required. Logs must also show the following summary: The number of contacts; Multiplier claimed; Total Points; Statement of Call-Sign, Name and Address, Phone or CW, Single-Band or All-Band Operation. Each page of the log must be numbered and signed.

Overseas entries to be endorsed "VK/ZL Contest" and to reach the Chairman, Contest Committee, Box 1734, GPO, Sydney, Australia, not later than January 31, 1952.

This will, as always, be an interesting affair, and the 36-hours' operating period falls fairly conveniently for a good many G amateurs. The VK and ZL stations are allowed to operate only for 24 hours out of the 36, but naturally there will be plenty of overlapping and no lack of customers all the time.

### The CQ DX Contest

The other world-wide affair, the CQ DX Contest, follows hard on the heels of the VK/ZL Contest—in fact, for Phone enthusiasts it means consecutive week-ends.

**Dates:** Phone—October 27 to October 29, both 0200 GMT.

CW—November 3 to November 5, both 0200 GMT.

**Rules:** All Bands except 1.7 mc. There is a single-operator section and a multi-operator section for both the Phone and CW contests. CW stations exchange five-figure serial numbers comprising the RST report and their Zone number. Phone stations, four numerals—their RS report and Zone number.

**Scoring:** A contact with a station on a different continent counts 3 points; a station on the same continent but a



different country, 1 point; a station in the same country counts for a multiplier, but no points. There are two types of multiplier—one for each Zone on each band, and one for each country on each band. The multiplier for each band, in other words, is the sum of all the different Zones and Countries worked on that band.

**Logs:** A separate log is required for each band, and there are awards for the highest scorer on each band as well as the all-band highest. Logs must show Date, Time, Station Worked, Serial Number Sent, Serial Number Received, Zone No., Name of Country, and Points (1 or 3). In addition, a summary must show (a) Band; (b) No. of QSO's; (c) Zone Multiplier; (d) Country Multiplier; (e) Points; (f) Score.

Logs must be postmarked not later than December 15 and addressed to *CQ*, 67 West 44th Street, New York 18, New York.

That information gives you four potential "lost week-ends." If you want any more, there are all sorts of other things going, and by December 16 our own Top Band Trans-Atlantics will be starting at 0500 on Sunday mornings. We do *not* supply benzedrine, nor, for that matter, pheno-barbitone to send to your bitterest rivals. But 1.7 mc operating procedure notes and the log forms will be available, on request to us, by November 12. As last year, full details are given.

### General Patter

G3ATU has a serious moan about the encroachment of phone stations on the CW portions of the band. A couple of powerful CT1's habitually camp out on 14100, often blotting out FN8AD, AC3SQ and other nice ones. Short-skip conditions have revealed G's happily working phone between 14100 and 14150. As 'ATU says, let's get organised quickly—we don't want a Phone/CW war on any band, let alone Twenty.

G2BW started us last month by working SV9RP, in Crete. He tells us that it was W1CUY, now on his way back. G5BZ, on the other hand, says he is told by G4CP that SV9CM is there until the end of September. Both

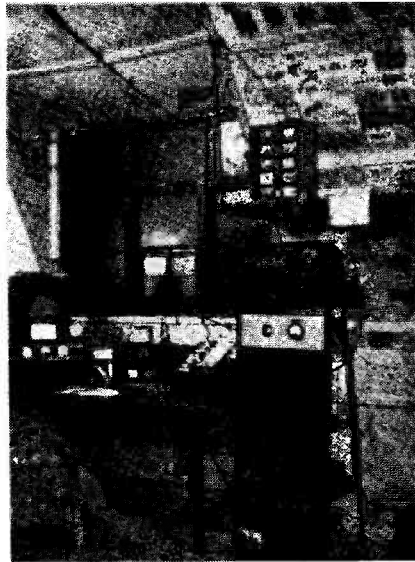

Station and operator at VS6AC, Hong-Kong. His Tx runs an 813 PA at 75 watts on 14052 and 14086 kc, and the receiver is an AR88D. It is of particular interest to note that VS6AC has a regular schedule with his father, G3CVG (Wakefield).

very much under cover.

G2HKU wants to see "DX QTH's" revived. There was only one reason for their discontinuation: no one ever sent any useful ones in. It's no good quoting QTH's from the Call Book—it's the latest rare ones that are wanted. If someone will send them along, we'll publish them, and with pleasure. [over

## The Russian Shut-Down

It is common news by now that the Russians are no longer allowed to work foreign stations. But the curious *addendum* to this is that just three of them are still allowed to, and those three are UA3PA, UM8KAA and UP2KAA, whatever sense that may make. The upshot of the whole matter is, of course, that WAZ now becomes an impossibility, and that stations just coming on are 18 countries down, to start with. But the whole thing may change at any moment; they may all come back with new call-signs or T9 notes—who knows!

G3CED (Broadstairs) passes on the sad news that ZB2L had the infernal bad luck to contract TB and is now bound for England. He hopes to get a G ticket and to be able to operate while in a sanatorium.

Piracy reports (thank goodness!) have died out lately; but G3GFN (Ruislip), who tells us that he is only active on Ten, has been receiving reports for other bands—definitely not his own doing.

It seems that we owe GM3EST (Motherwell) a double apology. First, we confused his QTH with Glasgow; secondly, we credited him with stronger language about the pirate-HS5IE-cum-HI5ES than he actually used. Please note that 'EST did *not* say "It's a wonder he hasn't been bumped off already"—that was our own remark. We are regretful that it appeared to be attributed to GM3EST, who hasn't such hard feelings about the gentleman concerned, and would like to make that known.

G6UT (Bishops Stortford) writes to say that he has been awarded Certificate No. 33 by the Maritime Mobile Amateur Radio Club, being the second G to obtain one. The Hon. Secretary (W3OB) tells him that more G's are expected to qualify shortly. 'UT adds that his QSL to TA3KA has been returned from Izmir marked "Unknown"—another phoney, obviously.

G2BW (Walton-on-Thames) suggests that we should consider running a Ten-Metre CW Contest for 1952, to stimulate interest in that band. We feel it would be an excellent idea if we could get the necessary co-operation from foreign stations, and will certainly think it over.

G4QK (Harpenden) has had to move QTH's with distressing frequency, and

what hurts is that he has just had to dismantle the best aerial system he has ever had (particulars in panel). His new QTH offers only 33-ft. of garden, and he is still wondering what to do for the best. (We know someone with 33-ft. of garden and a 400-ft. long wire—any hopes, 'QK?')

G3GUM (Formby) sends a *nil* report, owing to a mammoth rebuild. He has to convert the receiver (home-brew) to B7G types, the PA from one to two 807's; the power pack and VFO have to be rebuilt; and the aerial refurbished. He needs four more cards for his DXCC in the first 12 months' operation—a pretty nice score.

G6TC (Wolverhampton) wants to see either a 1952 Marathon or a resumption of the old Post-War Four-Band Table. But he wonders whether four bands don't keep a lot of people away, and suggests that a three-band table might bring in more support. What do correspondents think of that one?

GW3CDH (Risca) spotted the unfortunate error last month, crediting him with a 200-ft. mountain, which should, of course, have been ten times as high! Sorry about that one. He is another who worked the curious MD9BO, and no one seems to know where he was. 'CDH has arrived at a cool outlook now, and says "What's the use of fretting and fuming about just one new country? If I work it, I work it . . . if I don't, then I don't." We would like to circulate that in at least thirty languages.

G3FXB has got his DXCC through, and is naturally very pleased thereat. He raised W1RWS and got personal confirmation over the air, 'RWS being the chap that checks them!

G2DHV was on all bands as GW2DHV/A during August, and made quite a lot of useful contacts as well as personal QSO's.

GI6TK (Belfast) tells us of an amazing trip round the world by air, during which he visited much of the DX that he has worked. He flew to Sydney via SU, Bahrein, AP, VS7, VS1, PK1, did a trip to VK7, Norfolk Island and Lord Howe Island, thence to ZL. Then home via VR2, KB6, KH6, W6 and across the States. While in ZL he had many "local" QSO's with VR5, VR1, KB6, KM6, VK1 and the like; with KH6IJ he met lots of the KH6's; in San Francisco he met the Calif. Kilowatt gang, and says that QRM in the States has to be heard to be believed. The

best part of the story is that he says the "Ham Spirit" is the same as ever, all over the world, and every amateur he met went flat out to give a visitor a wonderful time.

G3EFY (Exeter) has kindly forwarded full details of the W.A.E. Award, so if anyone is keenly interested in it, we will gladly supply all the gen. The first G stations to receive it were G5FA, 5YV, 8JR, 8KU, 3EFY and 8PW, in that order, EFY himself being the first post-war-licensed amateur to qualify.

Another Certificate! The "Worked Cuba Award" is open to all those who have worked seven of the eight districts of Cuba. There is only one station in the 4th district, so that doesn't count; 9 is not a district at all, but a call for an experimental station. Apply to A.R.A.L.V., Box 136, Santa Clare, Cuba.

### The Overseas Mail

A further word from SU1FX includes an appeal to stations to call *off* his frequency rather than *on*. He still suffers from no shortage of replies, apparently! FX has been active on both 20 and 40, but has not found conditions thrilling. Best QSO's have been ZL1HY, PY2CK, PZ1AL and 3A2AD. His first 250 QSL's have been despatched, so there will be a slight delay while he awaits the next batch.

ZE3JQ (Buluwayo) asks us to say that he will be home for a while this month, and his QTH will be 21 Vincent Street, Yeovil. He will QSL to anyone who sends full details to him during his stay. JQ is a bit puzzled by the countries that do and don't count for DXCC; for instance HS was not accepted. We know that OE is not accepted but probably OE13 and FKS (as Occupying Forces) would be. Ben says that any G's mouth would water if he heard the 40-metre band out there on Sunday mornings—to quote a few there are ZD6, ZS7, 8 and 9, OQ5, VQ2 and, of course, ZE and ZS. He worked a long time for a ZS9, and then found ZS9G—on 80-metre phone, of all things! Other DX includes CR9AF and ZD9AA, and cards have arrived from VK1HV, AC3SQ, EA0AB, VP8AP, PK1, 5 and 6, HS1VR . . . Like a trip to ZE-land?

VS1EF (Singapore) is ex-MD4GC, and he has still a few of the old cards left for the stray customers who may not have been served. But he says he has QSL'd "at least 110 per cent." The new location is very good and VS1EF

### MORE AERIAL SYSTEMS

**G2FYT:** 68ft. Zepp with 34ft. feeders; highest spot in Bristol although only 230ft. a.s.l. Used for all bands.

**G3ABG:** (a) 136ft. end-fed, bent back at 75ft. to form a V, and only 8ft. high at the bend.

(b) Centre-fed 66ft. Zepp, 10ft. high, N/S.

(c) 14-mc doublet, N/S, 20ft. high

(d) Indoor rotary quad, in attic, for 28 mc.

(e) Indoor 33ft. "square" for 14 and 28 mc.

**G3ATU:** (a) 207ft. end-fed, 45ft. high, E/W—for all bands.

(b) Two-el. fixed beam for 14 mc, beaming South.

(c) 14 mc Vee, under construction. Station 50ft. a.s.l., very good location on sea coast.

**G4QK:** 196ft. top, 66ft. feeders, used as Zepp for 14 and 7 mc, end-fed for 3.5 mc.

will be active on 20 CW, hoping to make a DXCC of it from there. His final score from MD4GC was only 90, through pressure of QSO's helping others to get theirs! Later, he wants to try to work G on 80 metres.

An anonymous sufferer who badly wants to get a G "MM" permit asks us whether we can state the reasons why the GPO seems to be dead against it. Unfortunately, we can't—we can only repeat that negotiations, as always, are in progress, but there is very little hope, so it seems.

4X4CJ tells us that he proposes to take part in the Top Band tests this winter, and is applying for a special permit to this end. He also wishes to borrow one or two Top Band crystals, and undertakes to return them intact after the tests—but they will have to go both ways by registered Air Mail. Will anyone oblige with the loan of their frequency?

A brief postscript to the "DAC" correspondence comes from Wilhelm Schierenbeck (Bremen), who describes himself as "retired OT and still amateur seaman." His main point is that "coastal" does not mean anything like local, the next step being "Trans-Atlantic." 1885 kc is the *calling* frequency for ships, and DAC does not transmit there except to clear the channel; his frequency is 2545. W.S. says "Amateurs are known for being

helpful and considerate; they are best able to judge how much patience, endurance and skill are required to work weak stations, operated by rough hands of seamen or fishermen, with the ship rolling or pitching and de-tuning the aerial."

### The Hangers-on

Readers have been getting restive about Arabackle Oblifork and our Scottish friend I. McLott, both of whom seem to be quiet lately. We regret to

state that another bad character has tacked on to us: a Spaniard named El Bugg. But he talks so fast we can't understand a word he says. You'll be hearing from Arabackle in due course, when his WAZ arrives.

Next month's deadline will be **first post on October 17**, and, for the following one, *November 14*. Address everything to DX Commentary, *Short Wave Magazine*, 55 Victoria Street, London, S.W.1. Until then, all the best; 73 and CUL.

---

## Safety and Protection

### PRECAUTIONS IN HANDLING THE APPARATUS

#### Part II

By **B. W. F. MAINPRISE, B.Sc. (Eng.),  
A.M.I.E.E. (G5MP)**

ONE of the greatest dangers in amateur stations arises when coil changing, especially in output stages. The safest arrangement is to use parallel feed to the output valves, so permitting one end or the centre of the tank circuit to be directly earthed, depending on whether neutralisation is being used. For multi-band operation it is admittedly difficult to find an RF choke of sufficiently uniform performance, and the tendency is then to fall back on series feed. In this arrangement some form of interlock should be considered essential, making it impossible to handle a coil without the power supply being automatically switched off. This can be done by having a hinged or removable panel in front of the coil. Reference to the diagram shows a hinged panel carrying a two-pin plug of the usual 5-ampere domestic type with the pins short-circuited, and arranged to enter a corresponding socket when the panel is in the protective position. One of the leads between S1 and S2 (Fig. 1) is taken to this socket and back again; when the panel is swung back for coil changing, this circuit is broken and the supply switched off, even if the operator has forgotten to open S2. In the transmitter illustrated in the photograph, the

*The first part of this useful, practical article appeared in our issue for July. We hope that not only beginners but all active amateurs will, for the safety of themselves and their gear, adopt the principles and follow the advice given here.—Editor.*

---

upper panel is removable and carries this simple form of interlock, which can be seen as fitted.

### Earth Connections

Before examining subsidiary components, we must consider the earthing of equipment. Common practice is to run an earth lead to a water pipe. Provided this is the rising main, such an arrangement is probably satisfactory for receivers and associated apparatus working at low currents and voltages. It is nevertheless unwise where transmitters are concerned, and if connection is made to a branch pipe instead of to a rising pipe, danger can result. Moderately high resistance is often present at the joints of pipe-work, and this may increase with passing years. Should a heavy fault current develop, the pipe and taps may reach a potential dangerous to anyone touching them with wet hands. (Much the same danger arises, of course, beneath cross-country overhead lines, where leakage across a defective insulator to a tower guy or guy-wire may set up a sufficient potential gradient in the surface soil to electrocute cattle.) It is accordingly preferable to run a substantial earth lead to a buried plate or to several pipes driven a good depth into soil. The lead should be as straight as possible and attached to the wall at intervals by

suitable clamps. A small notice warning gardeners or other persons against severing or pulling on the lead may be necessary in some locations. The joint to the earth plate should be substantial, bearing in mind that corrosion between dissimilar metals will exist. It should be covered with pitch, which can be taken from the top of disused batteries (provided only uncontaminated portions are used) and then covered with scrap canvas, which can in turn be protected with pitch. The joint should be examined at intervals and care taken that no direct pull can come on it.

A risk which is often overlooked by beginners is the actual placing of the earth lead on a chassis already connected to the mains. The chassis potential may be "floating" at some value appreciably different from earth potential, especially where interference-suppressing condensers are across the mains or the transformer primary, so that an operator touching the chassis while holding the earth lead in the other hand may receive an unpleasant tingle, or worse. Again, a similar shock is very likely when connecting a frequency-changing convertor ahead of a communications receiver unless both are earthed before the mains connection is made. It is a wise rule always to check that the equipment is disconnected from the supply before attaching an earth lead, and the operation should be carried out with one hand only.

### Soldering

While we are considering earthing matters, it is convenient to bear in mind soldering risks. Time and again operators and service dealers may be seen making soldered joints using an iron which is connected to the mains. Such action is risky in the extreme, for the heating element of the iron is normally insulated from the bit or metal handle *only by a thin strip of mica*, which can easily flake or slip out of position through constant heating and cooling. Another source of danger is fraying of the flex where this enters the metal handle of the iron. It should be made an absolute rule that before any soldering is carried out a trainee must check that the equipment is disconnected both from earth and from the supply, and he should invariably follow this precaution throughout his career.

Where soldering is an almost daily practice, it is worth considering the use of a 110-volt iron fed from a step-down

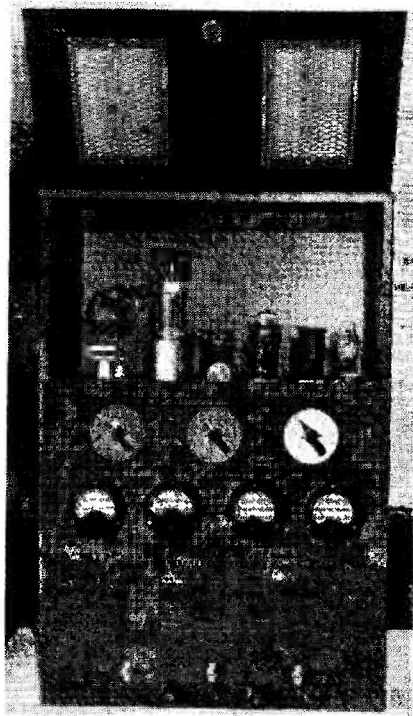

The 150-watt transmitter at G5MP, incorporating the safety principles discussed in his article. The HT interlock is operated by the upper hinged panel, and the grilles enable the HV valves to be inspected visually. Panel lamps are provided for heater and plate voltage indication. At most amateur stations—and in all we have ever visited—there is room for improvement as regards operator safety.

transformer. The secondary of this transformer should have an earthed centre-tap; then, should a fault occur in the insulation of the iron, the potential of the metalwork cannot rise more than 55 volts r.m.s. above earth, instead of the 200/250 volts which would occur with an iron of rated mains voltage. The transformer primary should be protected by low rating fuses and the core earthed.

### Flooring

When soldering or otherwise servicing apparatus, stone or cement floors should be avoided if possible. Wood, linoleum or rubber-covered floors offer greater protection against shock. For the same

reason, a wooden back to a work-bench serves to protect one against accidental contact with a stone wall or earthed conduits.

### Headphones and Microphones

In recent years there have been several fatalities among operators coming into accidental contact with high voltages while handling headphones or microphones—in fact, one such was reported as recently as the August issue of *Short Wave Magazine*, and there have been others since the war. Just as radio engineers have their perennial arguments on “Phone v. CW” for various services, so the designers of domestic equipment have their arguments on the subject “To Earth or Insulate?” e.g. should protection be obtained by earthing metal framework, necessitating a three-pin plug, or should plastic framework be chosen, with the ordinary two-pin plug. This article is not the place to review the *pros* and *cons* of such procedures, but in the case of headsets and microphones the writer's preference is definitely for moulded plastic headphone ear-pieces, with leather-covered headbands and moulded casings again for microphones and their handles. It should, as an extra precaution, be a golden rule *not* to work on apparatus without first laying down headphones and microphones.

### Meters

In general, meters do not provide the hazards met with in components already mentioned. There is, however, a slight risk that an operator may accidentally fall against or otherwise break the glass of a milliammeter or voltmeter in a high-potential part of a circuit. Also, there may be a slight risk of leakage at the zero adjustment screw. Protection is readily provided by a strip of perspex mounted in front of the meter. The mounting should permit easy removal of the strip, as dust will collect on the rear surface.

### On or Off ?

There is regrettably little agreement on how a switch should appear in the ON and OFF positions, and the following example of arrangements in a very average house in the writer's own road is typical.

The lighting installation was by a private contractor who arranged that the wall switches should be on when DOWN, and the main two-pole switch

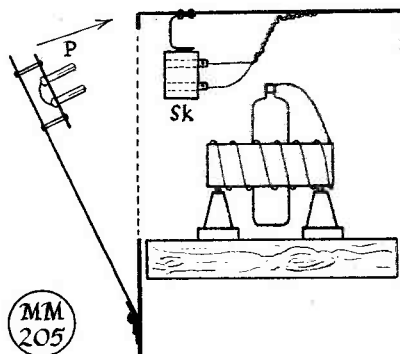

Sectional outline sketch of an interlock arrangement to cut HT before access can be obtained to the transmitter HV stage. The short-circuited plug P engages with the socket Sk, which is in series with the HT supply to the PA; thus, drawing back the cover automatically disconnects the HT. The accompanying photograph illustrates this as applied by G5MP to his own transmitter.

on the meter and fuse-board should similarly be on when DOWN. Later, power wiring was installed for heating. The supply authority fitted their main switch to be on when UP (alongside the lighting switch already present and operating in the reverse sense), while the bedroom switches were fitted to be on when DOWN. Later still, a successor to the original private contractor was called in to wire the ground-floor rooms for heating. His skirting board switches are on when UP, in agreement with the main switch but in disagreement with the bedroom switches. Small wonder it is dangerous to trust a switch!

In machine and engine-room installations the general practice is to arrange knife switches and ironclad switches so that they open when pulled down; a falling object will then open a circuit instead of closing it, and this is the safer arrangement. It is a thousand pities this was not followed with lighting switches from the very start and the present haphazard conditions would have thereby been avoided.

Incidentally, care must be taken with American apparatus, where it will generally be found that the on-position for switches is UP, a familiar example being the HRO power pack and certain items of American surplus equipment. In such cases it is probably wise to invert the switch to conform with British practice.

## Summary

To conclude this review of danger-spots, the following points may well be borne in mind:—

- (1) Be certain you know *exactly* what you will do if you come across a person who has received a severe electric shock. You may know that you would pull him clear by his or your jacket, would start artificial respiration immediately, would call for medical help and would possibly have to go and fetch such help after artificial respiration had been applied for some time, your actions being in that order. But are you certain of the exact motions of artificial respiration and where help could most quickly be summoned?
- (2) Condition yourself to use safety techniques instinctively, just as a doctor instinctively protects the patient and himself by scrubbing his hands and nails before touching the simplest cut or boil.
- (3) Use one hand when making or

breaking connections, and think before you act.

- (4) Use warning indicators and check their operation.
- (5) Never leave a switch ON when finished with equipment, even if it is controlled by a remote switch.
- (6) If, when passing equipment not in immediate use, you note a switch is ON, ask yourself the reason.
- (7) Examine the circumstances in which you have received an electric shock on any previous occasion. Was it due to sheer carelessness in working on the equipment without first switching off? Or did an involuntary movement bring you into contact with adjoining live circuits? Was there any indication that the circuit was live? Or had you ignored any such indication?

And finally, what steps have you actually taken—apart from those you intend to take “some day”—to minimise electrocution dangers in your own installation?

---

## Australian Jubilee Contest

As part of the Jubilee Celebrations of the Commonwealth of Australia, the Wireless Institute of Australia, with the collaboration of the Arts Sub-Committee for the Celebrations, will conduct during October, 1951, an international competition for radio amateurs — to be known as the “Jubilee VK-ZL DX Competition, 1951.”

The Competition will be generally similar to the joint Australian-New Zealand DX Contest held annually during October, but it is expected that many additional entries will be received this year because of its association with the Jubilee Celebrations.

The contest will be in two sections:—

**CW: During the week-end  
13—14 October**

**Phone: During the week-end  
20—21 October**

During the contest, amateurs all over the world will endeavour to contact Australian and New Zealand stations, and the latter will try to work stations in as many different countries as

possible. Actual rules for the Contest are given elsewhere in this issue—See “DX Commentary.”

### The Warm-up

The main competition will be preceded by a preliminary contest, called the “Jubilee Relay,” which aims to publicise the Jubilee and the Jubilee Contest overseas. Every amateur station in Australia will be asked to send a message to each overseas station worked before the Contest. The text of the message will be:—

*“Australia celebrates its Jubilee this year and invites you to join in the Jubilee VK-ZL Contest during October.”*

In addition, the rules have been forwarded to overseas radio journals and to the national Amateur Radio societies in every country of the world. Trophies and medallions, designed to commemorate the Jubilee of the Commonwealth, will be awarded to the outright winners in each State and attractive certificates will be sent to *all* contestants.

Printed Log Sheets, together with rules for the Jubilee Competition and the Jubilee Relay, have been posted to every licensed amateur in Australia and New Zealand.

# VHF BANDS

By E. J. WILLIAMS, B.Sc. (G2XC)

ON September 8, GW5MQ worked OZ2FR at S9 on phone. It is a remarkable thing, but this contact seems to have caused little or no excitement in the VHF world. Three years ago, two years ago (or even one year ago) this contact would have been headline news, and the main topic of discussion on the air for days. As it was, only one station worked by your conductor since that date has made any mention whatever of this remarkable 526-mile QSO. It is, of course, all a sign of the progress that has been achieved in these last few years.

Since September 1, when our new yearly Counties-Worked Table started, many stations have raised more than 20 different counties. G3EHY achieved 27 in 14 days. The conditions under which these scores have been made were not outstanding, and the fact that such wide coverage is possible with comparatively low power is ample testimony to the efficiency of the equipment in general use at our VHF stations.

Our congratulations go to GW5MQ and to all those who have achieved high places both in last year's and this year's Tables. The winner in the Annual Counties Marathon emerges as G2AJ, leading a total of 56 entrants.

There are those who are critical of our policy in encouraging this Counties struggle. They feel that VHF operators should be more seriously interested in radio than to indulge in fun and games. Your conductor must beg to differ with

---

---

*Recent DX Results—*

*The VFO Discussion—*

*Conditions Not So Good—*

*The November Contest—*

*Station Reports and News*

---

these critics. The collecting of counties is, admittedly, a light-hearted sport, but that in itself is surely no reason for banning it, particularly when indirectly it is responsible for the continual striving towards better equipment. The Tables also bear witness to the very wide coverage from stations in all parts of the country and to the highly efficient equipment that the VHF amateurs in this country have been able to produce.

The only serious disadvantage of the scheme appears to be that, to certain operators, it becomes such a fetish that they dislike working a station in a county they have already covered. But those with such an outlook would be with us in any case, and their lack of sportsmanship, bad manners or whatever else one cares to call it would doubtless still be in evidence even if the Counties Tables were non-existent.

Other schemes have been suggested by readers which they contend would demonstrate the reliability of DX working, but up to the moment nobody has produced any such idea which would enable results to be shown in simple tabular form. Until such a system can be evolved, the present policy of recording the consistency of long-distance schedules in the *text* of "VHF Bands" must continue.

## **This VFO Business**

Your conductor's comments in August *Short Wave Magazine* on the subject of VFO technique have brought in a wealth of correspondence, some of which was touched upon by A.J.D. last month. This correspondence almost entirely supports our attitude. At least four operators identified themselves with one of the culprits we described, and apologised for their activities. They were all wrong! However, it is obvious the practices we condemned must have



been even wider spread than was at first thought.

At least one reader thought VFO's *as such* were being condemned and wrote to make the point that anyone producing a VFO suitable to drive a 144 mc transmitter was to be congratulated—and with that G2XC must agree, provided, of course, the transmission so produced is indistinguishable from crystal control! G5UM writes in much the same vein, but adds that although the VFO constructor may show technical brilliance, there are ethical points to be considered; to him, one of the charms of the 2-metre band is that fixed frequency working makes it a tidy band. And with that many agree. Once a station has been heard, a note of his frequency can be made and one knows exactly where to find him next time he is wanted.

Ability to shift a few kc to dodge severe QRM is, of course, a good operating point, providing it is done with discretion; but once everyone starts jumping about to grab DX, then much of the charm of this grand band will have gone. (And we would be prepared to wager that if all VHF stations were suddenly to go over to VFO operating and VFO tactics, there would within three months be a concerted plea for a return to crystal control and rigid adherence to the Zone Plan). Returning to G5UM's letter, he further suggests that larger excursions to the extreme edges of the band are sometimes useful to help populate otherwise deserted regions.

The searching signals QLH and QHL are coming into more general use and do help give operators a chance to assess how long to make a responding call, but it is doubted whether some stations know where the HF end of the band is. They send QHL, are called by stations on 145.5 and 145.4, and then reply to someone on 144.9. A letter from a Northern operator to G2XC said: "I did not know there were any stations higher in frequency than G3EHY." There are stations in Southern England working as high as 145.9, and there are over a dozen in your conductor's locality between 145.3 and 145.5 mc. A search up to 145.6 or 145.7 mc may well produce a contact with Cornwall!

#### Activity Hours

The TV set at G2XC having been out-of-order for a week or two, your conductor has been more than usually

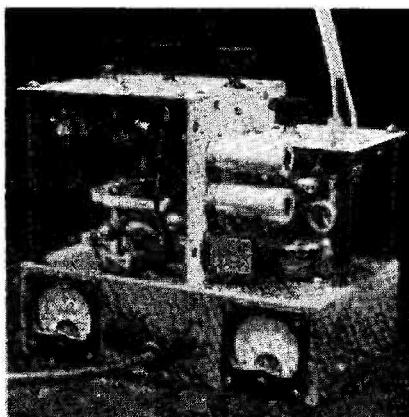

The neat 144 mc transmitter at G12FHN, Bangor. The valve sequence is: 6J6 (8-24 mc) - 6J6 (48 mc) - 832 (144 mc) - 832 PA. This form of construction is not only compact but is the right shape for the shortest possible leads at VHF. G12FHN is a regular on Two, and has done well from a remote QTH.

active on Two Metres during TV hours; it was a pleasant surprise to find so many VHF stations on the air in the South, particularly along the coast, where often a dozen have shown up between 2000 and 2200 hours. This is in a fringe area for TV where TVI should be at its worst, yet, in spite of that and the forest of TV aerials surrounding many of us, not one 2-metre station appears to cause any trouble to TV. At G2XC, there are eight TV sets within 100 yards of the 2-metre aerial, but none suffer any interference from that source.

However, good as activity is on the coast, there appears to be a dearth of signals from London, the Midlands and the North during these hours. Is this due to bad conditions in the early evening, or no activity?

An occasional search round the band during daylight hours has also revealed some unexpected activity, and one Thursday afternoon recently there were as many as four stations audible!

#### Two-Metre Report

GC2CNC (Jersey) has been finding conditions very poor, and only had contacts on four days between July 29 and September 10. He hears South Coast stations calling the Midlands and reports G5LI (London) as his most con-

# THE SHORT WAVE MAGAZINE

## Two-Metre Contest

### RULES

- (1) The period of the Contest will be Saturday, November 3, 1500 GMT to Sunday, November 4, 2359 GMT.
- (2) Points will be claimed for contacts from the home location only, using the 144-146 mc band. Contacts with Continental stations will count for points.
- (3) Exchange of RST, reference number and QTH will constitute a contact.
- (4) Contacts may be made on either Phone or CW, but no extra points will be allowed for Phone QSO's as distinct from CW contacts, and (except as provided in Rule 6 below) only one contact with any particular station may be claimed for points.
- (5) Every contestant will allot himself or herself a three-figure reference number, which will remain unchanged during the period of the Contest. This reference number will be sent before the RST or RS report, in the following manner: 342RST569 or 342R5S6 in the case of a Phone report. The reference number *must* be given with the report outwards in every counting QSO. Contacts with *non-contestants* who cannot give a reference number may be claimed, provided a report and QTH are received.
- (6) Scoring will be on the following basis:  
All contacts less than 40 miles, 1 point. All contacts 40 miles or over, 1 point for every complete 20 miles of distance. (For example, 75 miles counts 3 points).  
Provided at least six hours have elapsed since the time of the first contact, stations at distances *exceeding* 100 miles may be worked a second time. Scoring for the second contact will be at a reduced rate, namely 1 point for every complete 40 miles of distance.  
No bonus or multiplier points will be scored on a county basis.
- (7) Point-to-point distances will be taken from the Ordnance Survey "Ten-Mile" Map of Great Britain, or calculated from the National Grid References when these are known. In the case of foreign stations the distance will be calculated from the latitude and longitude of the station.
- (8) No Contest QSO may be prearranged, nor may the second contacts, provided by Rule 6, be arranged at the time of the first contact. Contacts may not be passed on from one station to another. These practices will be grounds for disqualification.
- (9) The exchange of reference numbers prior to the Contest is forbidden, and will be reason for disqualification.
- (10) Results should be sent to E. J. Williams, G2XC, *Short Wave Magazine*, 55 Victoria Street, London, S.W.1, by November 12 latest, set out as follows:—
  - (a) Running log for period of Contest, showing only contacts claimed to count, with time of working, reference number in, RST in, RST out, QTH of station worked, distance and points claimed. The contestant's own reference number should be clearly marked at the top of each log sheet, and the total score at the end of the log.
  - (b) The National Grid Reference of the contestant's station, if known.
  - (c) A brief description of the equipment used, and notes on impressions and experiences of the Contest.
- (11) Entries from Continental stations are invited, and if sufficient are received, national winners for the various countries concerned will be determined.  
Results of the Contest will be given in the January, 1952 issue of *Short Wave Magazine*, with a preliminary comment in the December 1951, issue.

sistent signal. A set of 4 stacked 4-element Yagis is under preparation for 1952, thanks to information supplied by GW2ADZ. Regarding QSL's, GC2CNC says on all bands since 1946 he has sent out a total of 3,800 cards, with only 1,400 in return. Hence, his present decision to QSL only upon receipt.

From furthest South, to our Northernmost VHF outpost, which is GM2FHH in Aberdeen. He reports GM2CAS and GM3FKS active as well as himself. They all have frequencies available in the Scottish Zone of the band, as well as some a little higher. GM2CAS uses a 522, an RF26 and a 6-element array. GM3FKS has a crystal converter and a dipole aerial, while GM2FHH uses a 522 as transmitter, a crystal converter with all-ECC91 stages into an HRO, and a 12-element stack. Best contact so far from GM2FHH has been with G3BW on September 9, the distance being 195 miles. The aerial is now being raised and hopes are similarly rising of contacts with other G's.

GM3DIQ (Stevenston) reports that the new aerial which he designed himself has been built and erected at GM3DDE, and a first rough-measurement suggests a frontal gain of 30 dB! He has named it the "3DIQ chimney-pot roaster." A similar array is now to be erected at GM3DIQ, together with a 420 mc set-up. Bad news from GM is that GM3DOC having left Bute, activity in that county is now nil. And GM3DDE has the only 2-metre QSL from Bute.

#### North Wales

G2DHV, on holiday in North Wales, visited GW3ENY/P and GW5MQ and operated from there as GW2DHV/P. He was very impressed with GW5MQ's shack on the top of a high hill and with a grand view across country.

GW5MQ (Mold) has added two stages of CV60 to his converter and notices a marked improvement. Conditions generally have, however, been very sporadic, only G3BLP and G4HT being at all consistent in their appearance on the band. As reported above, on September 8 OZ2FR was worked. This was at 2355 after GW5MQ had been working Southern G. At 0020 contact was also made with OZ2IZ, and as the OZ's were unable to hear other G's, in spite of considerable activity over here at the time, GW5MQ worked OZ2FR twice more, and OZ2IZ once again, up to 0200. DL's were active at the time,

### SEVENTY-CENTIMETRE PROGRESS

Mar. 19, 1949	G2WS/P-G3AHH/A	24 miles
Aug. 21, 1949	G3APY-G5BM/P	86 miles
Sept. 10, 1949	G2JT/P-GW6DP/P	109 miles
Oct. 8, 1949	GM2JT/P-GW6DP/P	130 miles
*Mar. 28, 1950	G3EJL-G5BY	119 miles
May 30, 1950	G2XC-G5BY	132 miles
June 4, 1950	G5BY-G6LK	161 miles
Oct. 2, 1950	W2QED-W4ODG	191 miles
July 2, 1951	F80L-PA0PN	198 miles
**July 17, 1951	G3APY-G5BY	227 miles

\*—Fixed station record at that date.

\*\*—Present world fixed station record.

Note: World record for portable operation is held by W6VIX/6 and W6ZRN/6 over a 262-mile path.

according to the OZ's, but none were audible in Mold.

#### Northern England

G2BTO (Rivington Pike) asks us to make it clear that they are not a permanent station, and also that the success of this effort has been due in no small measure to the spirit and knowledge of SWL Eric Lomax. They wonder why their call-sign is frequently mis-quoted as G3. G2HGR, one of the operators, has been experimenting with a battery super-regen on his bicycle so that he can listen to G2BTO/P on his way there and home again. No aerial is used, but results have been astounding, and now some further very-QRP tests are being considered.

G3BW (Whitehaven) has not been very active; he can now work phone but keeps it for local working "up to 150 miles." He is having trouble with interference to the Holme Moss sound channel.

G3DA (Liverpool) sends an account of his second journey to GD between August 25 and 28. The effort was, however, largely wasted, due to the shocking weather and its accompanying conditions. This time G3DA concentrated on 70 cm work, but conditions being poor on that band, he descended from the lofty heights of Snaefell and set up his 2-metre gear at GD3GMH in Douglas, and from there worked G2BTO/P and GW5MQ. As a result, he sold some of the gear on the spot, and GD3GMH is now working on two metres. It is understood that GD3GMH—in addition to working G3DA and others in the Lancashire area—has heard G3BA, G3BLP and G5BM. Next

Spring, G3DA/P hopes to operate in Westmoreland. This provides us with our answer to G3WW, who has been making enquiries as to what it was worth for him to go /P in that county!

G5YV (Leeds) found late August very poor, but early September was well above average. On several evenings very few stations appeared to be active, in spite of the good conditions. (G2XC, G3BNC and other Hampshire stations have nearly worn out key and voice calling G5YV, all in vain). G5YV contends that too many VHF operators do not even switch on the receiver unless there has been a day of brilliant

sunshine. (Twice in the past month we have listened to G5YV in pouring rain!) To compensate for our abortive attempts to work G5YV, G8IC (Doncaster) reports hearing and calling G2XC—in vain! He has a Cubical Quad and finds the Activity Reports very useful.

G6LI (Grimsby) was another who considers August a disappointing month, although he did hear Devon, Somerset and GC occasionally. ON4BZ was worked as DX once. G3FRE (Mansfield) has been mainly busy on the bench. The beam was spring-cleaned in August and he can now tell direction from inside the shack. Late-evening

## TWO-METRE ACTIVITY BY ZONES AND COUNTIES

*Based on reports for last two issues only*

### Zone A (144 to 144.2 mc)

**Aberdeen:** GM2CAS, GM2FHH, GM3FKS  
**Ayr:** GM3DDE, GM3DIQ  
**Angus:** GM2DRD  
**Dumbarton:** GM3DAP  
**Dumfries:** GM3OL  
**Fife:** GM3EGW, GM3ENJ  
**Lanark:** GM3BDA

### Zone C (144.2 to 144.4 mc)

**Cumberland:** G3BW  
**Durham:** G2FO  
**Isle of Man:** GD3GMH  
**Lancashire:** G2BTO/P, G2DCI, G2OI, G3A0O, G3CHY, G3DA, G3HII  
**Northumberland:** G4LX  
**Yorkshire:** G2CPT, G2IQ, G3FFV, G4JJ, G5YV, G6YO, G8IC

### Zone D (145.8 to 146 mc)

**Co. Down:** G12FHN, G13GQB  
**Co. Dublin:** EI2W, EI8G

### Zone E (144.4 to 144.65 mc)

**Cheshire:** G3BOC, G3DH, G3ETI, G3FMI  
**Derbys:** G2DLJ/A, G3EMJ, G3GUD, G5RW  
**Leicestershire:** G2FNW, G3ENS, G3FUW  
**Lincolnshire:** G5BD, G6LI  
**Nottinghamshire:** G2XS, G3FRE, G6CW  
**Staffordshire:** G3CXD, G6FK  
**Warwickshire:** G2ATK, G3ABA, G3BVJ, G4RK, G5SK, G6CI, G6YU

### Zone F (145.65 to 145.85 mc)

**Caernarvon:** GW3ENY, GW3ENY/P  
**Flint:** GW5MQ  
**Herefordshire:** G6NB/A  
**Monmouthshire:** GW3HCH  
**Montgomeryshire:** GW2ADZ  
**Shropshire:** G3AHX  
**Worcestershire:** G3BGR, G4VH

### Zone G (144.65 to 144.85 mc)

**Bedfordshire:** G3CGQ, G3CUA, G3FFX, G3FUL  
**Buckinghamshire:** G3CVO, G3DOC, G3FSZ, G3GBO, G3MI, G4MR, G6JK, G6NB, G8VZ  
**Cambridgeshire:** G2PU, G2UQ, G2XV, G3BK, G3AEP, G3CJY, G3EDD, G3FOP, G3GGJ, G3WW, G4MW, G8SY

**Hertfordshire:** G3DJX, G3FD, G3GDR, G4RO, G5SZ, G5UM, G6GR, G6LL  
**Huntingdonshire:** G2FQP, G3AKU  
**Norfolk:** G3CFK, G3EQJ, G3VM, G4KO, G8AX  
**Northants:** G2HCG, G3BA, G3DUP, G3GHO  
**Suffolk:** G2CPL, G3ABJ, G4PV

### Zone H (145.25 to 145.5 mc)

**Berkshire:** G2HIF, G2IT, G3CCP, G4SA, G5DF, G8DM/A  
**Channel Islands:** GC2CNC, GC3FSN  
**Dorset:** G2DGB, G3ABH, G5UF  
**Gloucestershire:** G3FRY, G3MA, G3YH, G5BM  
**Hampshire:** G2DSW, G2VH, G2XC, G3ARL, G3AWY, G3BHS, G3BNC, G3CFR, G3CVC, G3DEP, G3DTT, G3ESS, G3FAN, G3GAV, G3GOP, G3GVC, G4QL, G6DT, G6XM, G8DL, G8LY  
**Oxfordshire:** G3AVO/A, G5TP, G6KB  
**Wiltshire:** G3FKF, G4AP, G8LL

### Zone I (145.5 to 145.65 mc)

**Cornwall:** G2BHW, G3AGA  
**Devon:** G2BMZ, G2BMZ/A, G2DOL, G3AUS, G3CQC, G3GAO, G3GWH, G5BY  
**Somerset:** G3EHY, G3FIH, G3FKO, G8DX

### Zone J (144.85 to 145.25 mc)

**Essex:** G2ANT, G2WJ, G3ANB, G3ECA, G3FIJ, G4OT, G6NR,  
**Kent:** G2AJ, G2UJ, G3BTC, G3DAH, G5MR, G6AG  
**London:** G2DHV, G2DTO, G3BVG, G3EYV, G3FZL, G3GSE, G3GTH, G5LI, G5LN, G6LR, G6WU, G8KZ, G8LN, G8VR  
**Middlesex:** G2AHP, G2DD, G2HDZ, G2YC, G3CWW, G3EEL, G3HBW, G3HT, G4HT, G5BC, G6JP  
**Surrey:** G2BN, G2FNO, G2FVD, G2KI, G2MV, G3ASG, G3BLP, G3ENI, G3GHI, G3GMZ, G3HCU, G3NR, G4CI, G5DS, G5LK, G5MA, G6CB, G8OU, G8UQ  
**Sussex:** G2AVR, G2DVP, G2FTS, G2MC, G3DIV/A, G3PEX, G3GNR, G5RO

*Note: The frequency areas given above are in accordance with the Two-Metre Zone Plan, as accepted by the majority of VHF operators. A few stations are not conforming.*

schedules would be welcomed, and as G3FRE is on permanent afternoon shift, he would like some morning contacts.

G6YU (Coventry) has been on most evenings from 1830 to 2000, and again from 2200 to 2300, but has not found things too exciting. G2WJ (in a county G6YU has not yet worked) was a good signal on September 8. G6CI (Kenilworth) went to Eire on holiday and met EI2W. He is now determined to work EI on Two. SWL Bastin reports on behalf of G5ML/P, at which he is assistant operator; 7 counties were worked on September 9 from a location near Coventry, and G3DAH (Herne Bay) was best Southern DX heard. The input to the G5ML transmitter is 12 watts and a G2IQ converter is used; the aerial is a City Slicker. They ask for more activity on Sundays. (Regret this is the one day of the week G2XC cannot get on the band). At his home station, G5ML has 4-over-4 Yagis and finds them superior to either the 8-element stack or his City Slicker. A 16- or 24-element array should be up by the end of September.

At G3WW (Wimblington) the old 30-foot tower with its 5-element Yagi has been taken down, and another 10 feet added to it. A 5-over-5 Yagi was then fixed to a 20-foot dural scaffold pole, and, with G2FQP as chief engineer, was mounted on top of the 40-foot tower. The topmost Yagi is therefore now 63ft. 6in. above ground. This probably explains the amazing signal G3WW has been putting out in recent weeks. On September 5, DL3FM and 5 PA's were worked, while PE1PL, PA0FC and OZ2FR were raised on the 8th.

G2AIQ has left Cambridge and, it is hoped, will be operating from Rustington, Sussex, shortly. G2FQP (Ramsey) has a 5-over-5 at 35 feet. G2PU (Cambridge) is using his 20-metre wire beam as a 2-metre aerial, and the receiver is ex-G2AIQ. G2UQ (Cambridge) employs push-pull 2G's driven by an SCR522, and we are told he does not believe in "County Hunting." Instead, he just works G2FO (Durham). G2XV (Cambridge), so our informant says, is devising a new receiver line-up to prevent G3CJY and G8SY blocking all the band for him. G3AKU will be leaving St. Ives shortly for a QTH in Northants. G3BK (March) is erecting a 5-over-5 similar to that of G3WW. G3CJY (Cambridge) has a 12-element

**TWO METRES**  
**COUNTIES WORKED SINCE**  
**SEPTEMBER 1, 1950**  
**Starting Figure, 14**

Worked	Station
45	G2AJ
44	G2OI, G3EHY, G6XM
43	G4HT, GW5MQ
42	G5YV
40	G2XC, G3BW, G3WW, G5MA
39	G3BA, G8OU
38	G2NH, G5DS
37	G3ABA
35	G2FNW, G6CB, G6YU
33	G3HAZ, G4SA
32	G8IL
31	G3AVO/A, G3FAN
30	G2HDZ, G3VM, G4RO, G6CW
29	G5UM
28	G2AHP, G2DLJ/A
27	G3GSE, G3HBW
26	G2CPL
25	G2BTO/P, G3AKU
23	G2XS, G3FD, G3GBO, G3HCU
22	G3COJ, G4MR, G6CI
21	G3BNC, G3BOB
20	G8IC, G8VR
18	G2CIW, G3EYV, G3GOP, G5PY
17	G2ANT, G6XY
16	G3FRE
15	G2DVD, GC2CNC

*NOTE: This Table closed at midnight on August 31. These are the final placings for the year.*

stack. G3EDD has his aerial up 40 feet in a tree. G3GGJ was using a 3-element beam poked out of his window, but permission has now been obtained to erect a mast. G3VM (Norwich) is assisting G5IX to get going on Two, while G4MW (Cambridge) has a new transmitter working. From all this it can be gathered there is a real hot-bed of 2-metre activity in and around Cambridge.

G3AVO/A (Watlington) is a supporter of the Reliability Table idea, but agrees it is going to be difficult to devise. On the subject of receivers, he says he would not swap his cascode for any G2IQ-type he has yet seen; but every one to his own taste. G4SA (Steventon) worked GW3ENY/P in Denbigh, but in general has found conditions to the North rather poor.

G6CB (Wimbledon) called GD3DA/P first time, he heard him and he came back right away, and sent a QSL. (On behalf of all recipients, we must thank GD3DA for the prompt way in which he sent out the numerous QSL's). G6CB has also worked GC2CNC after much calling, but G8IL (Salisbury) held

out on him right to the end and deprived G6CB of Wiltshire in the annual Counties Table! G4CI (Worcester Park) raised G2FO for a nice piece of DX.

G8LN (Plumstead) has a rebuild in progress and says he wishes Continentals would sign on CW and help him identify their weak carriers. G2FVD (Morden Park) criticises EI2W's new frequency, as it will be subject to much QRM in the London area. G3HBW (Wembley) comments that on September 8 he heard much DX, particularly from the North, but could not raise a single station. G4HT (Ealing) has worked Denbighshire. He claims the first rung on the Reliability Ladder with 2639 QSO's on two metres and says that some stations have been worked twice. G4HT considers the biggest offenders at non-*QSL*'ing are the two-letter calls to be found well up the Tables! Dear, dear!

On the South Coast, G5MR (Hythe) is once more active. G3DIV/A (Eastbourne), between 70 cm working, has heard G5YV at good strength. G3GNR (Southwick) received some Northern DX from his badly-screened location. G3BNC (Southsea), also in a poor location, has been successful in some of his more difficult directions. Both he and G3GVC (Purbrook) are using 4-over-4 arrays similar to that in operation at G2XC, but fed with coaxial line. G3BNC and your conductor both made their first contacts with Cornwall on September 14, G3AGA being at the other end. G3EHY was also a remarkable signal in South Hampshire that same evening. G3BNC has qualified for VHFCC. And all his contacts have been on phone. G3AWY (Southsea) is also active, and G8BD (Purbrook) promises to reappear soon. G6XM (Farnborough) worked G3AGA, but missed the Continental openings.

In Devon, G3CQC has been on and reports G3WW as his most consistent signal. On September 11, GW2ADZ was so loud that he could be heard with change-over switch in wrong position. G3CQC is using 25 watts to an 832 and a 6-element w.s. Yagi. The receiver has a 6J6 RF stage with parallel line tuning, the feeder being tapped straight on to the lines. G5BY (Bolt Tail) found conditions generally poor this month.

Activity continues unabated in Somerset. G3EHY (Banwell) says that, in spite of some criticisms of his remarks on the subject of VFO's, he still holds fast to what he said and is

pleased to note the large measure of support which those remarks drew. He is another who supports the idea of a Reliability Table. He wonders why some stations are only keen on being the *first* to do something. He thinks far more credit is due to the man who works consistently and so ensures continued interest by others. There is, of course, much truth in this, but it is only natural that the man who breaks the records should get the glory. On the other hand, all regular workers on Two Metres know the signals on which they can rely, and although G3EHY is a rarity at G2XC, your conductor is well aware that further North the consistency of his signal is so well-known that it is used as a guide for conditions. G3EHY, himself, would certainly be placed high on any reliability list. G3FKO (Bath) continues active, as does G8DX. Local working from the fixed QTH has been supplemented by portable work, and with 4 watts CW and 2 watts phone contact has been made with G3BLP. G3FIH (Radstock) missed the best conditions, but worked G3AVO/A and GC2CNC for new counties.

G3FRY (Cheltenham) is still coming on, but is having trouble with the Cotswolds. A number of different aerials are being tried in an effort to get a signal into London. He will be in the correct Zone soon and active from 2230. G5BM (Cheltenham) has worked GD3DA/P and GW3ENY/P recently.

### Seventycems

G2BTO/P on Rivington Pike, near Bolton, has been working on 70 cm with gear loaned by G8SB. The first CQ was put out at 2115 on September 1 with the feeling that the chances were about 1 in 10,000 that anyone would hear it. Much to everyone's surprise, G3ELT came straight back. The 70 cm transmitter is an 832 power-tripler driven from the modulated 2-metre transmitter. An immense number of change-over switches can swing the whole station from 2 metres to 70 cm or *vice versa* in 30 seconds, provided the operator on duty selects the right combination. In spite of being able to work G4LU (Oswestry) at very good strength, not a sign of a signal is heard either way with GW2ADZ. Other stations worked include G3DA, G2OI and GW5MQ.

G3DIV/A (Eastbourne) has an 832 tripler which he is driving with an 815. A number of receivers have been tried

and, finally, with an aid of a blow-lamp and details supplied by F8OL, a cavity-type converter was made. Crystal-controlled oscillations are injected on 409 mc and the converter was lined up on a signal from G2FTS. An 8-element stack with copper tube elements and 300-ohm tubular feeder was erected on the evening of September 6 at a height of about 30 feet. At 2100 contact was made with F8GH on 2 metres, at S9. G3DIV/A changed to 435 mc and was immediately heard S9 by F8GH. Later: signals from F8GH were reported RST579 by G3DIV/A, and a two-way contact on 435 mc followed. Since then G3DIV/A has been received by F8OL and again by F8GH. Further tests are under way.

On August 23, G2DD (Stanmore) heard F8MX (St. Valery) on 2 metres, and, being unable to make direct contact with him on that band, managed to work him via G2FTS. F8MX changed to 70 cm and G2DD heard him R5, although only S1 on CW. Throughout this reception, G2DD left his 2-metre Tx running, and G2FTS was able to make a perfect copy of the 70 cm signals from F8MX as relayed by G2DD. G2DD has also heard G2FTS on 70 cm. Other signals logged include G3EHY eight times, GW2ADZ six, and B5BY twice. Regarding G5BY hearing G3CGE while the latter's relay was at "receive," G2DD comments that the capacity across most relays is probably sufficient for them to work which ever way they are switched! Similarly, he suggests that contacts between the feeder and the driven element of a beam at this

**TWO METRES**  
**COUNTRIES WORKED**  
**Starting Figure, 8**

**11 G3BLP** (DL, EI, F, G, GC, GD, GI, GM, GW, ON, PA)  
**G5YV** (DL, EI, F, G, GD, GM, GW, ON, OZ, PA, SM)  
**9 G2HDZ, G6LI, G6XM, GW5MQ**  
**8 G2XC, G3ABA, G3WW, G5BY**

frequency do not need cleaning, as there is sufficient capacity to transfer the RF without noticeable loss.

G4HT (Ealing) has worked G3HBW (Wemoley), making 14 stations worked. G3HBW, himself, has a new 70 cm receiver under construction. So far, the transmitter has simply been his 2-metre gear with the tank coil of the PA, an 832, replaced by a wire shorting the anode pins!

G3FRE (Mansfield) is now ready for 70 cm with 2 watts to a CV53, a 5-element Yagi and a P58 modified by G3APY, who has been contacted to ensure that the gear is working correctly.

G2OI (Eccles) could just hear 70 cm signals from GD3DA/P on his first trip and got them 339 on the second occasion. G2OI is now using crystal injection to an EA50 mixer in a concentric line, plus a 446A RF amplifier, and getting excellent results. G4LU at 53 miles has been worked in spite of 600-ft hills in between. Now he is hoping to work G5BY. As already mentioned, GD3DA/P concentrated on 70 cm on his second visit to GD, but the weather was adverse and the only contacts were with GW5MQ and G2JT, the latter at RST 569 both ways for the first G/GD on 70 cm. GW5MQ (Mold) has worked 12 stations on 70 cm so far; reference A.J.D.'s comments on distances covered in his part of the country, GW5MQ points out that his nearest active 70 cm station is in Liverpool, and all other contacts have been at 40 to 50 miles and are consistent. G2DHV, visiting North Wales, used his portable call GW2DHV/P to have QSO's with G2JT and GD3DA/P during a visit to GW5MQ.

#### The Clubs

A number of queries regarding rules and membership conditions have come in, and it was hoped to give a resumé of these for the new followers of this

<b>TWO-METRE DX MARATHON</b>	
Station	Miles
G5YV (SM7BE) ... ..	602
GW5MQ (OZ2FR) ... ..	526
G2BMZ (DL4XS/3KE) ... ..	520
G3HAZ (OZ6PX) ... ..	519
G3DIV/A (OZ2FR) ... ..	501
G2XC (DL3MH) ... ..	486
G5BY (DL3FM) ... ..	470
G6CW (OZ2FR) ... ..	452
G3WW (OZ6PX) ... ..	432
G6LI (OZ6PX) ... ..	428
G3BNC (DL4XS/3KE) ... ..	420
G8VR (DL3NQ) ... ..	417
G6XM (DL4XS/3KE) ... ..	415
G5BD (DL4XS/3KE) ... ..	412
G3BK (DL3MH) ... ..	411
G3ABA (DL1LH) ... ..	400

*Minimum distance for this table is 400 miles. Claimants must submit NGR or Lat. and Long. for both ends of contact.*

column. But in all recent months the volume of VHF news we had to cover has in itself caused "VHF Bands" to exceed its allotted quota of space, and hence a discussion and clarification of Five Band and VHF Century Club matters must wait until the less exciting days of the winter are upon us.

### The Contest

Our annual Two-Metre Contest will take place on November 3-4, and the Rules appear this month. There are several changes from previous years, noticeably in that vexed question of points for contacts. Scoring is much more nearly proportional to miles worked. This accords with suggestions made at the last Five Band Dinner. The use of smaller Zones than 20 miles would make the checking of the entries unduly arduous and might delay publication of results. It was felt that the first zone should be 40 miles, as almost any equipment will work up to that distance without trouble, except in highly-screened locations. The direct proportion scoring, however, is very noticeably favourable to local contacts and puts isolated stations at a marked disadvantage. To compensate somewhat for this, the second contacts are introduced, but to ensure that remote stations still search for the weaker signals rather than re-work all the strong ones again, the second contacts are at a reduced scoring rate.

As always comments, favourable or critical, on the scoring system or on any other feature of the Contest, are welcome. But your conductor would prefer to have such comments with the entries. In previous years, the results have been analysed in a number of different ways, and the same will be done this time, and details of equipment used will be published.

### The Tables

The All-time Counties Table has been dropped this month, but all amendments notified have been recorded in our books and will be included next month when the Table re-appears. The new Table for 1951-2 starts this month, as quite a number of operators sent in figures. Many stations have been putting their figures in only during recent months and not giving details of the counties to which they refer. This is *not* in conformity with the original rules for the Tables, and we would be glad if all

TWO METRES	
COUNTIES WORKED SINCE	
SEPTEMBER 1, 1951	
Starting Figure, 14	
Worked	Station
27	G3EHY
26	G4HT
25	G2XC, G3WW, G5YV
23	G3FAN, G5DS
19	G3AVO/A

*NOTE: This Table will run for one year until August 31, 1952*

whose calls appear in the All-Time Table and who wish us to keep their achievements on record would let us have a complete up-to-date list of the counties concerned before the end of the year; and further, if all claiming an appearance in the new Table would do likewise when making their first claim. Thereafter, only details of amendments need be notified.

### The PA Contest

This will have been played out by the time you read these lines. As requested in the last two issues, please let us have your own results so that we can prepare a G listing. This does not, of course, cut across the VERON Contest in any way, as all operators who took part will understand.

### In Conclusion

The space squeeze has eliminated much of what we wanted to discuss in this edition of "VHF Bands," and we must apologise for omitting Calls Heard. But your conductor cannot conclude without recording his own appreciation of A.J.D.'s wonderful effort last month. Many correspondents have expressed their thanks to him in their letters, and these are being passed to our blushing A.J.D. The only criticism received was of that word "perhaps" in the penultimate paragraph. G3EHY would have it replaced by "sure."

Next month's reports should be addressed to E. J. Williams, G2XC, *Short Wave Magazine*, 55 Victoria Street, London, S.W.1, by **October 17** latest. With you again on November 9.



# Random Jottings

By THE OLD TIMER

NO one has ever explained to me why there is no CW activity on Ten when conditions are poor. As soon as the band really opens up, there are all the CW habitués, at once. But when conditions are downright bad nothing is to be heard but a few phone stations. One would think the reverse would hold good and that the phones would give up and go on CW when conditions were really tough. Can it possibly be that these phone operators have forgotten their code? Even that wouldn't explain where the real CW operators get to.

## ABBREVIATIONS?

Another funny one in the CW-versus-Phone vein: How often one hears the phone men using CW abbreviations (even if they maltreat them so much as to make them unnecessary). Now the other thing has happened. On two successive days I have heard CW stations sending, first, "I'll turn it back to you now," and secondly, "Move a little higher than my present frequency." The next (and, doubtless, final) step would be to hear a CW station spelling out "Queen Sugar Yokohama" in full! Another thing that annoys me (I'm sensitive to these silly little details, unfortunately) is to hear "QSY to another frequency"—isn't "QSY" intended to mean all that?

## PLAYING THEM BACK

The popularity of wire and tape recorders has brought a new hazard on to the bands. One never knows when one's outpourings are being made permanent by one of these enthusiasts. What does amuse me, though, is to hear someone with really appalling quality recorded and played back with great fidelity. He nearly always refuses to believe that his quality is *that* bad, and blames it on: (a) The other man's receiver, (b) The recorder itself, or (c) The modulator through which it is played back. The mere suggestion that it could have been terrible to start with is not, it seems, a palatable one.

## LOCALISED SKIP

How many experts on Twenty CW have noticed that on certain mornings of the year the VE4's come in between 0800 and 0900 GMT? They are very rarely heard at other times, and yet on these few mornings they break through. There are usually no other signals from the American continent at all—maybe a few VK's or ZL's, but nothing whatever from the direction of VE4. The same applies, in a lesser degree, to the VE5's. Is this a true case of very localised skip, or is it a kind of selective condition as far as *direction* is concerned?

## PHONE NETWORKS

If you can stand the shock to your national pride, listen to one of the notorious 80-metre "nets" operating from this country, and then take a late night and listen for one of the American equivalents. No two things could be more unlike. Across the pond the operating is snappy, meticulous and devastatingly efficient; over here it is the opposite of all these things. The American net seems to bring the right people on at the right moment, without any confusion; the British version operates haphazardly, with everyone forgetting the order the others are suppose to be in, mixing up call-signs and generally giving a sorry display of everything that Amateur Radio should not be. How can we clean them up? They need it.

## BROADCAST RECEIVING LICENCES

Approximately 12,434,900 broadcast receiving licences, including 915,200 television licences, were current in Great Britain and Northern Ireland at the end of July, 1951.

The monthly increase in television licences (18,200) was the lowest in any month since July last year, when the increase was nearly 17,000. The sales of licences usually decline in the mid-summer months: this year there has been the additional effect of the increased purchase tax on receivers.

The Post Office is aware that some viewers have not converted their sound licences nor bought TV permits when installing television sets, and a number of them have already been prosecuted and fined.

# Some SCR-522 Modifications

FOR TVI ELIMINATION

By J. L. DANKS (G5DS)

THOSE two-metre enthusiasts in the London area who are using the SCR-522 transmitter and are troubled with TVI may be interested in the following simple modifications which have, in the writer's case, resulted in a complete cure. The nearest TV receiver is the writer's TRF model, and the TV aerial, a dipole, is almost touching the two-metre beam feeder just outside the window.

Briefly, greater output at 16 mc is obtained from the crystal oscillator stage and the following stage is then made to work on the 9th harmonic, i.e. 144 mc. Output is then just sufficient to drive the 1st 832 which, in turn, gives enough drive to the final 832.

Output after modification is a little lower, but during non-TV hours normal output, if desired, can still be obtained by retuning one condenser, as mentioned later.

The procedure is as below.

## Increasing the CO Output

(a). Remove and dispense with the 4-channel crystal switch and associated wiring on the grid side. Using "D" channel crystal socket, make a short connection from the live crystal pin to the grid (pin 5) of the crystal oscillator. At this point it should be mentioned that the crystal oscillator is now to be changed from the existing 6G6 to a 12A6. In the writer's case, the audio section of the unit is not used, as a separate modulator of better output was available. As the original 6G6 heater is in series with the first audio stage, those operators who still use the audio section will need to make some arrangement to supply the 6SS7 with its required 6.3 volts.

(b). It will be noted that the ceramic coupling condenser feeding from the anode of the first stage to the grid of the second stage, together with V2 grid stopper, are tied to pin 1 on V1. Isolate pin 1, dispense with the grid stopper and connect the ceramic condenser direct to pin 5 on V2.

(c). Disconnect and isolate the series heater lead at present connected to pin 2 on V1. Connect pin 1 and pin 2 to chassis and ensure that 12 volts is now available across pins 2 and 7 on V1.

At this point the transmitter could be checked, if desired, when considerably more output should be noted from the first stage. The crystal should be inserted in "D"-channel socket and a 12A6 used in the first stage.

## Obtaining 144 mc (16 x 9) from 2nd Stage

(a). Carefully remove the anode coil. Due to its inaccessibility, it was found that the best procedure was to use a well-heated soldering iron and to disconnect the two ends of the coil first, followed by the tap.

(b). From the coil, remove an equal number of turns from each side so as to leave 3 turns from tap to the anode side and 4 turns from tap to earthy side, and enough spare at each end for re-connection in the original position across the two sets of condenser stators. Make a fresh lead to enable the tap to be reconnected, and re-insert the modified coil. It is advisable to connect the tap first, and it is important to ensure that the smaller half of the tapped coil is in the anode side of the circuit.

Those operators who are chary of altering the original coil will find that the former can be unscrewed from the coil, and they may then wind a separate one to the above dimensions, retaining the original coil for re-insertion if desired.

(c). Remove one of the 4,000-ohm cathode resistors of the second stage, which were originally in parallel. This completes the modification.

## Operation

All tuning controls, with the exception of the 2nd stage anode, should be normal. The second tuning condenser should now tune to 144 mc at about "130 mc" on the existing scale and to 48 mc at approx. "100 mc" on the existing scale. There is therefore a choice of two combinations, selected by the second tuning condenser, as follows:

Xtal CO	2nd Stage	3rd Stage	4th Stage
8-16	48	144	144
8-16	144	144	144

In conclusion, it is pointed out that the above modification has dealt with the TVI problem and has been used for a considerable time, but further improvements could no doubt be made by those interested. The modified 522 has recently been used to drive an 829 to 75 watts on Phone or CW without any trouble from TVI. Keying is done in the cathode of V2 with the usual key click filter.

---

#### ONE MAN'S MEAT . . .

We occasionally receive strong letters from readers who, in effect, say they "Disagree with our policy of charging the full rate to direct subscribers while giving big discounts to newsagents." On the other hand, there are also those who say that we "Take the bread out of newsagents' mouths by accepting direct subscriptions." The odd thing about these criticisms is that whether *Magazine* readers buy direct from us or through a newsagent, the price to them is still the same, so that it can make no difference either way! The fact is, of course, that on this particular matter *Magazine* policy is exactly the same—indeed, it has to be—as that of any other periodical available to the public at large, and is in full conformity with established trade practices.



#### THE ELECTRONIC TELESCRIBE

This is an instrument which transfers, instantaneously, written or printed impressions from a glass plate to a TV screen, and was one of the "novelty" features on show at the Radio Exhibition. Developed by Mullard Limited (it happens that an identical unit was also displayed on the R.E.M.E. stand), the principle of operation is that two CRT's have their time-bases synchronised; one functions as a "transmitter" and the other as a "receiver." A mark made on the screen facing the "transmit" tube is immediately reproduced on the face of the "receive" CRT.

The Telescribe, though put on to amuse visitors, actually has a number of very important practical applications in the military and commercial fields. It would be entirely possible to apply the principles of the Telescribe to radar display and navigational aid and control systems, and to the remote control of various industrial processes.

#### DO YOU KNOW WHERE TO HAMMER?

The largest Diesel prime mover in the world had stopped, and a large factory was idle. Expert engineers all failed to get her going again. Then the frantic management heard of an obscure expert who lived across the Continent; they offered him anything if he could start the engine, and sent an aircraft to fetch him over. When he arrived, an inconspicuous little man in green overalls, he was effusively greeted and all the symptoms were carefully explained to him by the chief engineer of the plant. The little man listened most attentively, and then said "Has anybody got a ball hammer?" Climbing quickly up the ladders leading to the superstructure of the great machine, he was heard to strike a few sharp blows. Then he came down and said "Now try her." She started up immediately and ran perfectly. The management wrung the little man's hand and told him to send in his bill. Some weeks later, the bill arrived—for £1,000. The financial manager of the plant, his earlier worries quite forgotten, told the little man he was a racketeer, that the bill was outrageous, and could not in any case be paid unless it was fully itemised. "Why," said the financial man, "all you did was to get up there with a hammer worth less than £1." So the little man sent in an itemised bill, and this is how it read: For hammering, £1; for knowing where to hammer, £999; total, £1,000. (With acknowledgements to *Amateur Radio*, Australia).



#### IMPROVING THE BC-458 EXCITER

Further to his article in *Short Wave Magazine* for August 1951, ZE3JL writes that he has since achieved oscillator keying and therefore full BK working, by the following method: Cathode bias resistors of 1000 ohms with .001  $\mu$ F in parallel were fitted in all the VT-501 stages, and the plate decoupling condenser in the drive oscillator stage itself lowered to .001  $\mu$ F (in place of the .05  $\mu$ F in the block of three under the original MO valve mounting). The keying is free from chirp, and if a trifle "hard" can be made smoother by a little experiment with conventional key-thump filter values. These additional modifications enable full BK to be worked with the PA running at 150 watts input.

## NEW QTH's

This space is available for the publication of the addresses of all holders of new U.K. call signs, as issued, or changes of address of transmitters already licensed. All addresses published here are reprinted in the quarterly issue of the "RADIO AMATEUR CALL BOOK" in preparation. QTH's are inserted as they are received, up to the limit of the space allowance each month. Please write clearly and address on a separate slip to QTH Section.

- |               |   |                          |   |
|---------------|---|--------------------------|---|
| <b>E16D</b>   | L. P. Purcell, Gleann na Greine, Naas, Co. Kildare, Eire.   | <b>GD3HQK</b>            | A. W. Anderson, 62 Hillside Avenue, Douglas, Isle of Man.   |
| <b>E17G</b>   | M. C. MacLaughlin, Liosgeal, Father Griffin Road, Galway, Eire.                                     | <b>G3HQU</b>             | J. G. Jackson, A.I.P.R.E., 40 James Street, Barrow-in-Furness, Lancs.   |
| <b>G2FNQ</b>  | A. E. Redman, 19 South Street, Farnham, Surrey.   | <b>G3HSE</b>             | D. C. French, 78 Brocklehurst Street, New Cross, London, S.E.14. (Tel. <i>New Cross</i> 5638).                      |
| <b>G2UW/A</b> | Wing Cdr. A. J. S. Wilson, No. 7 Officers' Married Quarters, R.A.F. Station, Innsworth, Gloucester. | <b>G3HWT</b>             | Maj. M. H. Hewett, M.B.E., B.Sc. (Eng.), A.M.I.E.E., R.E.M.E., Chaceley, Kingswood Road, Shortlands, Bromley, Kent. |
| <b>GM3CLI</b> | J. Ogilvy, 9 Restalrig Terrace, Leith, Edinburgh, 6. (Tel. 35936).                                  | <b>G3IAX</b>             | A. Maxwell, Furness Abbey, Barrow-in-Furness, Lancs.  |
| <b>G3CQT</b>  | S. W. Morris ( <i>ex-VU2MW</i> ), 15 Beverley Road, Pendelbury, Manchester.                         | <b>G3IDA</b>             | D. J. A. Appleby, Lyndholme, Croscombe, Wells, Somerset. (Tel. <i>Wells</i> 3112).                                  |
| <b>G3DBJ</b>  | D. M. Ferguson, Ranmore, Granville Road, Limpsfield, Surrey.  | <b>G3IDR</b>             | R. Dalton Raby, c/o 66 Kings Road, Richmond, Surrey.  |
| <b>G3ERC</b>  | H. D. Kelsall, 87 Urban Road, Sale, Cheshire.   | <b>G6FS</b>              | J. R. Ferguson, Ranmore, Granville Road, Limpsfield, Surrey.  |
| <b>G3EUB</b>  | J. N. A. Hudson, 53 Rudolph Road, Bushey, Herts. (Tel. <i>BUShey Heath</i> 2700).                   | <b>CHANGE OF ADDRESS</b> |   |
| <b>G3FAS</b>  | A. B. Dixon, 185 Amersham Road, High Wycombe, Bucks.  | <b>G2FSJ</b>             | E. Thorne, 52a Cranford Road, Petersfield, Hants.   |
| <b>G3FPY</b>  | J. E. Dew, c/o 25 North End, Calne, Wilts.  | <b>G2HL</b>              | J. Woodage, 36 Mendip Road, Battersea, London, S.W.11.  |
| <b>GM3GTP</b> | A. Russell, 1357 Dumbarton Road, Glasgow, W.4.  | <b>GW3ANU</b>            | J. L. Reid, 28 Waterston Road, Gabalfa, Cardiff, Glam.  |
| <b>G3GVC</b>  | D. F. Childs, 13 Alameda Road, Widley, Portsmouth, Hants.   | <b>G3BNV</b>             | F. Exeter, 7 New Road, Minster, Sheerness, Kent.  |
| <b>G3GZE</b>  | F. W. Bird, 14 Old Bank Lane, Whinney Heights, Blackburn, Lancs.                                    | <b>G3BUN</b>             | J. C. Gregory, 11 River Avenue, Hoddesdon, Herts.   |
| <b>G3HAB</b>  | D. J. Black, 88 High Street, Colliers Wood, London, S.W.19.   | <b>G3EBH</b>             | G. C. Newby, 18 Birchill, Fiskerton, Lincoln.   |
| <b>G3HAX</b>  | M. K. Hare ( <i>ex-MS4FM</i> ), Bletchley Park Hostel, Block F, Bletchley, Bucks.                   | <b>G3EDD</b>             | B. D. A. Armstrong, County Scout Camping Ground, Little Abington, Cambs.  |
| <b>G3HBL</b>  | C. H. Barrett, 44 Strafford Avenue, Barkingside, Ilford, Essex.                                     | <b>G3EWZ</b>             | W. D. Wardle, 16 Mendip Road, Liverpool, 15.  |
| <b>GW3HEU</b> | D. Rickers, 97 Ruabon Road, Wrexham, Denbighshire.  | <b>G3FKH</b>             | D. Roberts, 10 Blunts Hall Road, Witham, Essex.   |
| <b>G3HIN</b>  | J. G. Richards, 87 Volta Street, Selby, Yorkshire.  | <b>G3FKM</b>             | Dr. E. J. Alloway, 713 Yardley Wood Road, Kings Heath, Birmingham 14.   |
| <b>G3HKS</b>  | C. J. Preston, 12 Ridgeway Close, East Herringthorpe, Rotherham, Yorkshire.                         | <b>G3FMP</b>             | W. D. Hart, The Lockers, Bury Hill, Hemel Hempstead, Herts.   |
| <b>G3HLJ</b>  | D. M. Robinson, Blackmore Vale House, The Square, Gillingham, Dorset. (Tel. <i>Gillingham</i> 125). | <b>G3FOD</b>             | H. Moxon, 21 Wharfedale Avenue, Birkenhead, Ches. (Tel. <i>Birkenhead</i> 1897).                                    |
| <b>G3HNJ</b>  | F/Sgt. Clennell, 56 A.M.Q., R.A.F. Station, Locking, Weston-super-Mare, Somerset.                   | <b>G3FVL</b>             | H. Hudson, 77 Crescent Road, Wood Green, London, N.22.  |
| <b>G3HNO</b>  | R. S. Yates, 30 Wimborne Road, Fallings Park, Wolverhampton, Staffs.                                | <b>G3HAA</b>             | J. L. Morgan, B.E.M., 19 Rosedale Road, Mossley Hill, Liverpool 18.   |
| <b>G3HPO</b>  | R. C. Griffiths, 66 Montalt Road, Cheylesmore, Coventry, Warks.                                     | <b>G3HCD</b>             | W. D. Wallace, 104 Victoria Avenue East, High Blackley, Manchester 9.   |
| <b>G3HPQ</b>  | J. A. Jenkins, 2 Trinity Mansions, Atlantic Road, Weston-super-Mare, Somerset.                      | <b>G3HDQ</b>             | W. Baker, Eadiestone, Chester Road, Woodford, Cheshire.   |
| <b>G3HPS</b>  | G. H. Bedford, 57 Raleigh Hall, Eccleshall, Stafford, Staffs.                                       | <b>G3HEW</b>             | M. W. M. Jones, 35a Leyland Road, Lee, London, S.E.12. (Tel. <i>Lee</i> 3862).                                      |
| <b>G3HPW</b>  | A. Milner ( <i>ex-VP7NQ</i> ), 35 Friends Road, West Earlham, Norwich, Norfolk.                     | <b>G3HKB</b>             | K. E. Norris, 26 Western Road, Haywards Heath, Sussex.  |
| <b>G3HPY</b>  | G. Mayo, 77 Commonsides, Sheffield, 10. (Tel. <i>Sheffield</i> 60104).                              | <b>G3LY</b>              | R. E. Dodd, 14 White Avenue, Northfleet, Kent.  |
| <b>G3HPZ</b>  | D. W. G. Boast, 70 Lakedale Road, Plumstead, London, S.E.18.  | <b>G5XD</b>              | B. C. Christian, 65 Church Lane, Oakley, Beds.  |
| <b>G3HQD</b>  | A. E. Morton, Dryden Street, Barrow-in-Furness, Lancs.  | <b>CORRECTION</b>        |   |
| <b>G3HQF</b>  | H. Evans, 23 Westeroft, Chippenham, Wilts.  | <b>G3GVR</b>             | P. Blewett, Police H.Q., 1 Pound Lane, Bodmin, Cornwall.  |
| <b>G3HQI</b>  | K. R. R. Bowden, 33 South View, Letchworth, Herts.  | <b>G3HPM</b>             | P. J. Mullock, Poulton Hall, nr. Wrexham, Denbighshire.   |
| <b>G3HQQ</b>  | W. L. Ely, 138 George V. Avenue, Worthing, Sussex.  | <b>G5BG</b>              | J. B. Kaye, Wappenham, Towcester, Northants.  |

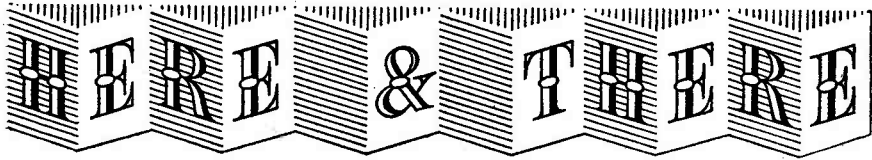

### One Thousand More

A check through *The G Call Book* (published by Gage & Pollard at 4s. 6d. post free) shows that it carries about 1,000 more British amateur callsign addresses than "any other similar publication." Moreover, it does it with a percentage of error so small as to be negligible. Indeed, we are assured by the American compilers of the *Radio Amateur Call Book* proper that both the accuracy and the completeness of the G Section are now very much better than they used to be before we assumed responsibility as the U.K. forwarding agents some four years ago. Note that this is what *they* say! All new G QTH's and changes of address should be promptly notified to us for appearance in our "New QTH" feature and in the *Radio Amateur Call Book*, for nearly 30 years the standard directory of the amateur stations of the world.

### Russian QTH's

All who may have QSL cards from UA amateur stations are asked to send the callsign and town/city location as given on the card to: C. S. S. Lyon, G3EIZ, 15 Ullet Road, Liverpool, 17. QTH's of other USSR stations are also wanted. The co-operation of all readers is particularly requested in this matter. *Note:* The QSL cards themselves are NOT required—only the callsign and station location.

### Radio Show, 1951

Those who were able to get to Earl's Court for the 18th National Radio and Television Exhibition, August 28-September 8, will have seen a magnificent display of radio and television receivers and telecommunications equipment, covering a very wide range of tastes and interests. With the emphasis on TV with larger viewing screens, the Show offered a great variety of sets at highly competitive prices.

There were a number of "specialist" stands, including Multicore Solders, Burndept Radio, E.M.I. Sales (Amateur Division), Eddystone (with a new FM/AM VHF receiver), and, of course, the Services, the GPO and the BBC.

Interesting component displays were those of Bulgin and Belling-Lee.

Of the Service stands, the R.E.M.E. exhibit of training equipment was particularly good, and the Royal Navy also had a most effective display of apparatus, including live demonstrations of radar and communications operating. The Royal Air Force, we thought, failed to make the fullest use of its opportunities.

### Zone Map Reprint

Our *DX Zone Map* has been a steady seller since 1947, and adorns the walls of many an amateur station. The second printing now being exhausted, a third impression—with the Zone Area lists revised to date and all new prefixes brought in—is now in hand, and supplies will be available shortly. In five colours, on heavy linen-backed paper for wall mounting (size 21in. by 35in.) the *DX Zone Map* has been specially drawn for us and is copyright by Short Wave Magazine, Ltd.

### GB3FB Closes Down

With the final appearance at the Nottingham site of the Land Travelling Exhibition of the Festival of Britain (September 15-October 6), GB3FB ends its long and gallant journeyings. There would be few who, having heard the station on the air, have not marvelled at the fortitude of its operators.

### Pulse and FM

The concessions recently announced by the Post Office, in regard to amateur FM working over one megacycle in the 144.5-145.5 mc band and the use of pulse modulation on various bands in our UHF ranges, are interesting and will be seized upon eagerly by those who want to try these techniques. Of the two, the facility for amateur experimental work on pulse operation is by far the more important—even if the *lowest* frequency band we can use is 2350-2400 mc! The subject will be covered in a series of authoritative articles to appear in future issues of *Short Wave Magazine*.

# The other man's station

G4OU

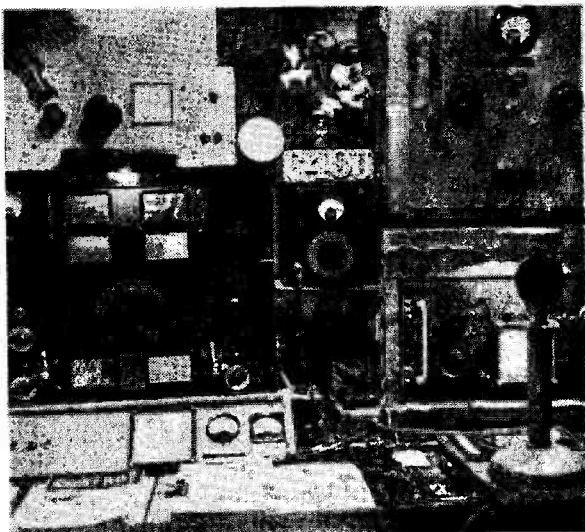

**T**HE station of G4OU—F. G. Maynard, 31 Fleet Avenue, Sheerness, Isle of Sheppey, Kent — was first licensed in 1936 under the AA call of 2CVM, the full call being issued in 1939. Five years on DC mains compelled QRP equipment on most bands, until a move to the present QTH gave him the more normal AC mains. G4OU is not operated in the DX interest—design, construction and experiments of an amateur nature are preferred to DX-chasing.

With the exception of the receiver, all the equipment is home-constructed. The station is fitted for operation on all bands, phone or CW, including Two Metres, and power can be varied from 10 to 100 watts. As our photograph shows, the general design has been aimed at keeping things compact. The station main receiver is an HRO with all-band coverage; for 2 metres, a receiver of quite unusual design has been provided—a form of super-regenerative-cum-TRF, with a built-in oscillator for CW reception. To the right of the receiver rack is the self-contained CO/PA crystal switched Top Band transmitter for 10-watt operation on phone or CW. The main transmitter (not shown in this view) runs VFO-Buffer/Doubler-PA and can be operated on 3.5, 7 or 14 mc at varying power levels.

On all transmitters, single-switch

operation for send/receive is obtained from the control desk. Frequency checking is taken care of by a 100-1000 kc frequency standard with a 10 kc multivibrator, and aerial current and modulation indication are given at the control position.

Aerials available are a W3EDP cut for 3.5 mc, a 20-metre dipole and a 2-element beam for 144 mc.

G4OU is always willing to chat technically over the air, and also glad to meet other amateurs personally as opportunity offers. And, having served ten years in the Merchant Navy, he is happy to talk seaman-like whenever he gets the chance!

## OUR QSL BUREAU

- Delivers cards to amateur addressees throughout the world
- Accepts cards from any overseas source for delivery to any G operator
- Can be used both ways only by Direct Subscribers
- Is recognised as a responsible independent agency
- Address is: BCM/QSL, London, W.C.1.

# The Month with the Clubs

## FROM REPORTS RECEIVED

Regular reports from the Clubs, although not quite so numerous as a year or two ago, indicate a healthy condition of enthusiasm and a desire for good organisation. We still note many "new arrivals" who appear to fall by the wayside after a month or so of existence; but the old-established Clubs go from strength to strength. There is a moral here somewhere . . .

Receipt is acknowledged of the following Club Circulars and News Sheets: *QLF* (West Kent); *Brighton Link*; *News Letter* (Midland); *Radio Link* (West Cornwall) and the monthly *News Sheet* of the Sanderstead and Purley Society. We know what hard work the production of these entail for the secretaries and others who are responsible.

Clubs who intend to enter for MCC (November 10 to 18) and have not already received a copy of the Rules, should apply for one without further delay. They were circulated, as a matter of course, to all Clubs who have reported during the last six months, but there must be many who do not report regularly but still wish to enter for the Contest. A post-card to the Club Secretary will ensure immediate despatch of a copy. We are hoping for a large entry this year, so that the new Rules can be well tried.

The deadline for next month's reports is first post on **October 17**, and the address for all material—notes, queries and more photographs (please!)—is "Club Secretary," *Short Wave Magazine*, 55 Victoria Street, London, S.W.1. For the December issue closing date is *November 14*.

And herewith this month's reports, from 26 Clubs . . .

**Baldock & District Radio Club.**—The new Clubroom was opened officially by a very interesting lecture on Pye Couplers. The Club Tx will be installed by the end of September, and new members who wish to take the RAE Course will be welcomed. Meetings are held on the first Wednesday of each month.

**Leicester Radio Society.**—The first lecture of the new session will be given in the Clubroom on November 5, when the subject will be Frequency Modulation. They are always glad to see new members and visitors at the Holly Bush Hotel, Belgrave Gate, Leicester, where the meetings begin at 7.30 p.m. on the first Monday of the month. Informal meetings are held (same time and place) on the third Monday, and there is a 1900 kc net every Sunday at 11.30 a.m.

**Lothians Radio Society.**—Meetings have re-commenced, and

from now on will be held fortnightly (October 4th and 18th, and so on) at the Edinburgh Chambers of Commerce, 25 Charlotte Square. Newcomers are asked to attend as visitors.

**Romford & District Amateur Radio Society.**—Membership has dropped to a very low figure, but the Hon. Sec. (see panel for new QTH) is doing his best to pull things up again. There is no prepared programme for the coming season, and volunteer lecturers will be heartily welcomed.

**Sanderstead & Purley Radio Society.**—The October meeting will be devoted to a Junk Sale at the Clubroom (Railway Hotel, Purley). Meetings are held on the fourth Thursday, and visitors or new members will always be sure of a welcome.

**Shefford & District Radio Society.**—Recent events have included a talk by G3IDR (the

new Hon. Sec.) on his adventures in Malta, and on the 80-metre Tx for Club use. There has also been an interesting talk on a communications receiver. Clubroom redecoration is nearly finished, and a successful season is anticipated. Club night is Friday, meetings opening at 8 p.m.

**Slade Radio Society.**—Forthcoming events: October 12, Talk and Demonstration on Home-Made Pickups; October 26, Talk on Measuring Instruments (Ferranti); November 9, Annual Dinner; November 23, A.G.M.; December 7, Talk on Manufacture of Cathode Ray Tubes (Standard).

**South Shields Amateur Radio Club.**—Activities were resumed on September 14, when the yearly election of officers and committee took place. The Club now has a large Clubroom, a special Instrument Room for the use of members, and the use of a large concert or dance hall for social activities. The forthcoming programme is full of interesting events, and an increase in membership is hoped for.

**Warrington & District Radio Society.**—A new Headquarters has been acquired, and as from September 18 the Club has been meeting at the King's Head Hotel, Winwick Street, Warrington. Meetings will now be on the third Tuesday of each month.

**Worcester & District Amateur Radio Club.**—The former Hon. Sec. has had to resign, owing to a change of business. The new secretary appeals to all interested in Amateur Radio to call in on any Thursday evening at The Rainbow Club, Rainbow Hill, Worcester, as there is room for a considerable increase in Club membership.

**Albany Radio Club.**—This Club has been meeting on Friday nights at members' QTH's, but from now on will meet for classes, discussions and sessions on the air with the Club Tx. Membership is increasing and the Club has a nice site for aerials and hopes to do well in "MCC."

**Huddersfield Amateur Radio Society.**—Established since May only, they now have 25 members and the Club is still growing. Meetings are held every Sunday and Wednesday evening; the programme includes technical and Morse instruction, together with some constructional work. New members will be welcomed.



G2AYM on the job during the Surrey Radio Contact Club's field outing.

**Kingston & District Amateur Radio Society.**—At recent meetings there were talks and demonstrations of Decca Micro-Groove records, Amateur Television and Tape Recorders. The attendances averaged over 50. On October 10 there is the AGM, and on October 24 an illustrated lecture on TVI and BCI. The Club's Annual Exhibition will be opened on November 10 by the Mayor and Mayoress of Kingston; it will be in session from 2 p.m. until 10 p.m. at Penrhyn House, 5 Penrhyn Road, and profits will go to the "Wireless Appeal for the Blind" Fund.

**Sheffield Amateur Radio Club.**—Forthcoming events include two visits to the Sheffield GPO (in

November) and the Hallam Trophy Contest (in December). The Club is entering for MCC under the call-sign G3FZM.

**Tees - Side Amateur Radio Club.**—This Club is now on a firm footing. A transmitter is being built by one of the members, and it is hoped to be on the air soon. Probably they will enter for MCC. All local BSWL members will be welcomed to the meetings—every Thursday, 7.30 p.m. in the Joe Walton Boys' Club.

**W.F.S.R.A. (Bedfast Club).**—Again the Secretary wishes to thank all the amateurs who have sent magazines and books for distribution to the bedridden members of the Club. Many

more are wanted, however, and we therefore renew the appeal to all who have technical books, magazines or periodicals (radio and non-radio equally welcome) to forward them to the Distribution Centre, run by John Gill, 30 Sholebroke View, Leeds 7. Components and spares of all kinds are equally acceptable, but *not* at the above address. The Hon. Sec. would be glad to hear from those who are willing to supply anything when the occasion arises.

**Barnet & District Radio Club.**—Recent meetings have included the showing of the Mullard film strip on CRT's, a lecture on Rectifiers (Standard Telephones) and a talk on Screen Modulation. The Club Tx, G3FFA, was in action at the North London Model Engineers' Exhibition, and 38 contacts were made on the Top Band. Meetings continue on Wednesdays, 8 p.m., at Hopdene, The Avenue, Barnet.

**Birmingham & District Short Wave Society.**—At the meeting on September 10 a general discussion on Short Wave Listening was held; the September 24 meeting will hear the second of the series of technical lectures. Regular meetings are now on the second and fourth Mondays, at the Colmore Inn, Church Street, although the meeting on October 8 will be at The Friends Institute, Moseley Road, at 8 p.m. This will take the form of a film show dealing with Plastics in Radio. The first Annual Club Dinner will be held on December 1 at The Bell Hotel, Bristol Street, at 6.15 p.m., followed by a visit to a local theatre. The inclusive cost will be 10/- and the final date for applications is November 3.

#### NAMES AND ADDRESSES OF CLUB SECRETARIES REPORTING IN THIS ISSUE.

**ARMY APPRENTICES' SCHOOL:** A/CSM M. Flynn, "A" Coy., A.A.S., Arborfield, near Reading.  
**ALBANY:** A. Meyers, G3EYE, 33 Old Kent Road, London, S.E.1.  
**BALDOCK:** A. Fussell, G3HBH, 6 Clare Crescent, Baldock.  
**BARNET:** C. J. Spencer, G3GRA, 31 Byng Road, Barnet.  
**BIRMINGHAM:** W. V. Shepard, 174 Gristhorpe Road, Birmingham 29.  
**BRIGHTON:** R. T. Parsons, 14 Carlyle Avenue, Brighton 7.  
**CAMBRIDGE:** T. A. T. Davies, G2ALL, Meadow Side, Comberton, Cambridge.  
**GRAFTON:** W. H. C. Jennings, G2AHB, Grafton LCC School, Eburne Road, London, N.7.  
**HUDDERSFIELD:** H. Day, 3 Prospect Place, Huddersfield.  
**KINGSTON:** R. Babbs, G3GVU, 28 Grove Lane, Kingston, Surrey.  
**LEICESTER:** L. Milnthorpe, G2FMO, 3 Winster Drive, Thurmaston, Leicester.  
**LOTHIANS:** I. Harris, 24 Braid Hill Road, Edinburgh 10.  
**ROMFORD:** D. L. K. Coppendale, G3BNI, 9 Morden Road, Chadwell Heath.  
**SANDERSTEAD & PURLEY:** T. R. Young, G2AYM, 41 Lansdowne Road, Purley, Surrey.  
**SHEFFIELD:** E. Walker, G2LT, 11a Welwyn Close, Intake, Sheffield.  
**SHEFFOLD:** R. D. Raby, G3IDR, Radar Link, T. Divn., REU, RAF Henlow, Beds.  
**SLADE:** C. N. Smart, 110 Woolmore Road, Birmingham 23.  
**SOUTH SHIELDS:** W. Dennell, G3ATA, 12 Sth. Frederick Street, South Shields.  
**SPEN VALLEY:** N. Pride, 100 Raikes Lane, Birstall, Nr. Leeds.  
**SUTTON & CHEAM:** F. J. Harris, 143 Collingwood Road, Sutton, Surrey.  
**TEES-SIDE:** H. Walker, G3CBW, 64 Ayresome Street, Middlesbrough.  
**WARRINGTON:** S. Wood, G3EZX, 12 Thelwall Lane, Latchford, Warrington.  
**WEST KENT:** L. King, G4IB, Glenisla, Maidstone Road, Lower Green, Pembury, Kent.  
**W.F.S.R.A. (Bedfast Club):** J. Beavan, G3GBL, 296 Fore Street, Edmonton, London, N.9.  
**WORCESTER:** P. Sealey, 1 Sandys Road, Worcester.  
**WORTHING:** F. H. Battelley, 42 Annweir Road, Lancing, Sussex.





The very fine stand put on by Portsmouth and District Radio Society for the local Fair and Exhibition, July 7-21. G3DIT/A (centre-piece) was in operation for the occasion and gave a good account of itself.

**Brighton & District Radio Club.**—Meetings continue every Tuesday evening, and several well-known manufacturers are giving lectures and demonstrations in the near future. The Club Tx is active on 80 metres during informal meetings and has made several contacts. There is a dance arranged for October 17, which promises to be a highlight of the Club's social activities. Details of membership and programmes upon request, from the Hon. Sec. (see panel for QTH).

**Cambridge & District Amateur Radio Club.**—The next meeting will be on October 12, 8 p.m. at The Jolly Waterman. Details will be circulated in the usual way. The Club has a full winter programme, including Morse classes, and meets once a month at the above address.

**Grafton Radio Society.**—At the sixth AGM the following officials were elected: President, G2AAN; Vice-Presidents, C. T. Bird, A.M.I.(Mech).E.; G3AFC, G3RX, and G8PL; Chairman, G2CJN; Vice-Chairman, G2AOW; Hon. Sec., G2AHB; Hon. Asst. Sec., G3CLV; Hon. Treasurer, R. T. White and Hon. Store-keeper, A. L. Skilton. Grafton is now resuming full activity with

the customary three meetings a week—the only Club of which we know that can claim this distinction.

**West Kent Radio Society.**—The autumn session has begun, and meetings are held at Culverden House, Tunbridge Wells on the second and last Wednesdays, 7.45 p.m. All will be welcomed. The Club recently entered a station for the Low Power Field Day and a good time was had by all. A full programme of lectures and so on has been arranged—details from the Hon. Sec.

**Sutton & Cheam Radio Society.**—This Club takes part in the Hobbies Exhibition of the local Rotary Club, October 10—13, at the Sutton Public Hall. The exhibit will occupy the entire stage of the hall—the most important site. Several transmitters will be operating, and a number of working exhibits including a home-built tape recorder. A blind member will demonstrate how he can wire and solder radio equipment. Future lectures will cover Long Playing Records, Aerials and Feeders, and AVO Measuring Equipment.

**Army Apprentices' School Radio Club.**—Activities have been mainly constructional, but

Morse classes run by G3HBU are a popular item. Three 50-ft. pine trees have been purchased and felled by the Club and will shortly take up their duty as aerial supports!

**Worthing & District Amateur Radio Club.**—In spite of the weather, their Bucket & Spade Party was a great success—so much so, that the next has already been fixed for July 20, 1952! The suggestion is that other Club Secretaries might consider running a coach trip down to Worthing for that day. The Club AGM was held on September 10, and among the elections was that of F. H. Bettelley as Hon. Secretary. Meetings take place on the 2nd Monday of each month at the Adult Education Centre, Union Place, Worthing; there is always room for the casual visitor and a vacancy for a new member.

**Spenn Valley Radio & Television Society.**—The new season opened with a lecture on Music-Recording and Playing Back. Several new members were enrolled, and two more have passed the R.A.E. October meetings: 9th, lecture on Voltage Stabilisation; 24th, Experimental Television, by G6BX.

#### AN R.1155 MODIFICATION

Those readers who favour this excellent receiver, either for general listening or as modified in various ways for amateur-band working, might be interested in an article in the September 1951 issue of our *Short Wave Listener*

& *Television Review*. This describes how the output end of the R.1155 can be rearranged for headphone reception. A few copies are available at 1s. 7d. post free, of The Circulation Manager, Short Wave Magazine, Ltd.

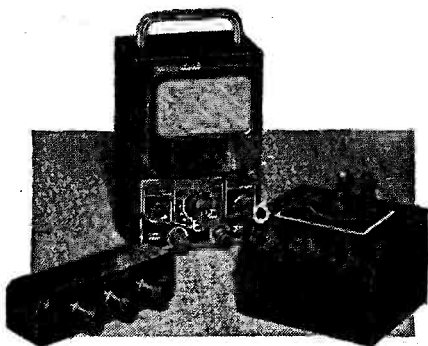

## PULLIN SERIES 100

### MULTI-RANGE TEST SET

Sensitivity 10,000 ohms per volt, with A.C./D.C. Voltage Multiplier for 2,500 v. and 5,000 v. Volts A.C. and D.C. range : 10, 25, 100, 250, 500, 1,000. Milliamps D.C. only : 2.5, 10, 25, 100, 500. Ohms : 0/10,000 and 0/1 megohm. A.C. Current Transformer range : 0.025, 0.01, 0.5, 1.0, 5.0, 25.0 amps. Early deliveries.



### MEASURING INSTRUMENTS (PULLIN) LTD.

Electrin Works, Winchester Street, W.3  
Tel. : ACOm 4651/3.

## A. CLOSEMAN

(E. N. Adcock, ex-G2DV, formerly of Home Office Communications Directorate, trading in name of A. Closeman).

31 CHURCHILL ROAD  
BIRMINGHAM, 9

Audio Oscillator, 25-18000 cycles, direct calibration, amplifier and power supply, high and low impedance output, with valves, £9 plus carriage.

Transmitter, relay rack, 3.5-28 mc. bands, fully bandswitched, 813 final, 811's modulator, desk VFO, output 50-300 watts variable, with valves, £115, buyer collect.

Special apparatus to order. B.B.C. types not supplied. Stamped envelope for enquiries please.

## New, Giant Thirteenth Edition

# RADIO HANDBOOK

The 13th is a large volume of more than 700 pages, covering in 28 chapters the Fundamental Principles ; the Generation of RF Energy ; Modulation, including FM and SSB ; Transmitter Design, Construction and Adjustment ; Aerials, in five separate chapters discussing Theory, Construction, Matching and Feeding, Directive Arrays of every type, and VHF and UHF designs ; BCI and TVI, to which some 24 pages are devoted ; Mobile Equipment and its installation, with practical designs for much suitable apparatus in

this field ; and seven chapters of 170 pages describing in detail the construction of a great many items of amateur band equipment, from Receivers, Exciters and QRP Transmitters, to High- and Low-Power RF Amplifiers, Modulators and Speech Units, and their associated Power Supplies ; there is also a comprehensive chapter on Test and Measuring Equipment, and finally a useful section of 70 pages on Radio Mathematics and Calculation, including much Reference Data.

**Order Now - £2 : 8 : 0**

Plus 1/6 Postage

Published by Editors and Engineers Ltd., Santa Barbara, California, U.S.A.  
and distributed in the British Isles and Europe by

**GAGE & POLLARD, 55 Victoria St., London, S.W.1**

Telephone : ABBEY 5034

**G2AK****This Month's Bargains****G2AK**

**HEAVY DUTY L.F. CHOKES. FULLY POTTED.** 30Hy. 100 mA. 150 ohms (weight 14 lbs.), Price **13/6**. 20Hy. 126 mA. 150 ohms (weight 14 lbs.), Price **15/6**. 30Hy. 150 mA. 150 ohms (weight 18 lbs.), Price **17/6**. All carriage paid. Eire 5/- extra.

**R.F. CHOKES.** Pie wound 2.5 mH, 100 mA, RX type, **9d.** each, or **7/6** per dozen. 250 mA, TX type, **1/-** each, **10/-** per dozen.

**TWIN FEEDER.** 300 ohm Heavy Twin Ribbon Feeder, **5d.** per yd. Standard K25 300 ohm Twin Ribbon Feeder **9d.** per yd. Co-ax Cable  $\frac{1}{2}$  in. dia. 70 ohm **8d.** per yd.  $\frac{1}{4}$  in. dia., **1/2** per yd. Post on above feeder and cable **1/6** any length.

**T.V. TUBE MASKS.** 12in., New Ratio, brand new, **15/-** each, post free.

**CERAMIC COIL FORMERS.** 5in., long by  $2\frac{1}{2}$  in. diameter; threaded 24 grooves, **4/6** each, post free.

**CERAMIC 2-BANK SWITCHES.** 4-Pole, 4-Way. Ideal Band Switch. **3/9** each, post free.  
**STATION LOG BOOKS.** 200 pages printed one side only. Size  $8\frac{1}{2}$  ins.  $\times$  11 ins. First class paper and bound with heavy cover. Price **17/6**. Post free.

**COMPLETE NOISE LIMITERS.** Wired on a small sub chassis with 6H6 type valve, boxed,

Carriage paid on all orders over £1 except where stated. Please include small amount for orders under £1  
**PLEASE PRINT YOUR NAME & ADDRESS**

**CHAS. H. YOUNG, G2AK**

All Callers to 110 Dale End, Birmingham CENTRAL 1635  
Mail Orders to 102 Holloway Head, Birmingham MIDLAND 3254

with circuit and instructions. Only **5/-** post free.  
**MOVING COIL HEADPHONES** with moving coil hand microphone. Price **6/-** plus post 1/- Transformer to suit, **2/-**.

**TRANSMITTING VALVES.** Few only. 813 **£3/10** each. Type 807 **10/-** each, 866A **17/6** each, 808 **25/-** each, 35T **35/-**, 6AG7 **9/-**, 805 **£1**, 100TH **45/-**.

**JONES PLUGS.** 8 pin, male and female **1/6** per pair. **12/-** per dozen pairs.

**VIBRATOR POWER UNITS.** 6 volt input. Made by Philips with dual vibrators. Fully smoothed and filtered. Output 230v. at 60ma. Price **30/-**. Post & Pkg. **1/6**.

**AMERICAN SINGLE BUTTON CARBON BREAST MIKES** with Aluminium Diaphragm. Beautiful Job. Only **5/-** each. P. & P. **1/-**.

**THROAT MIKES** Dual Unit **4/-** each, P. 6d.

**BALANCED ARMATURE L.R. HEADPHONES.** New, **6/6** pair. Postage **1/-**.

**METERS.**  $2\frac{1}{2}$  in. Flush Mounting M.C. 100 mA., 500 mA., and 20 mA, **12/6** each. 2 in. Flush M.C. 500  $\mu$ A., **10/-**; 5 mA., **7/6**; and 0.5 A. Thermo, **5/-**. Special offer  $2\frac{1}{2}$  in. Flush 0-1 mA. Rectifier Meter, scaled 0-10 V., **22/6** each. Few only.

**To HAMS & DEALERS**

RADIO HAM SHACK, NEW YORK

**WANT US TO BUY**

ALL AMERICAN MADE  
GOVERNMENT SURPLUS  
EQUIPMENT IN NEW OR GOOD  
SECOND-HAND CONDITION

TEST SETS • TRANSMITTING TUBES  
CLYSTRONS • THYRATRONS  
MAGNETRONS  
XTAL DIODES • SIGNAL GENERATORS  
FREQUENCY METERS  
COMMUNICATION RECEIVERS

All kinds of American made surplus  
radio components and equipment

We are interested in any quantity, from one upwards.  
Drop us a line and we will clinch the deal by return  
of post or send our representative to see you.

SOLE AGENTS IN GT BRITAIN

ALTHAM RADIO CO BRAZENNOSE ST  
MANCHESTER 2 Tel: DEAnsgate 5387

dm AR 15

*For Perfect Playing***S. G. BROWN***Precision***SAPPHIRE NEEDLES**

The ideal reproducing medium for gramophone records. They give high fidelity reproduction with the minimum wear on the record.

Five types available to suit all types of pick-ups.  
TYPE NO. 5. "Miniature Solid Sapphire" Needle  
for use with light-weight pick-ups.

The above needle gives a definite improvement in fidelity of reproduction due to its homogeneous nature

PRICES

Nos. 1-4, **7/-** plus Purchase Tax 3/1. Postage 6d.  
No. 5. **9/3** plus Purchase Tax 4/1. Postage 6d.

Your local dealer can supply.  
In cases of difficulty, apply direct.

**A "TIP" WORTH TAKING**

Send for interesting and instructive Brochure giving advice on the choice of a S. G. Brown precision Sapphire Needle to suit your pick-up. Write Department "S."

**S.G. Brown, Ltd.**

SHAKESPEARE ST., WATFORD, HERTS.

Telephone: Watford 7241.

(6)

## RADIO SUPPLY CO.

15, WELLINGTON STREET, LEEDS, 1.  
BRAND NEW GUARANTEED GOODS.

**MAINS TRANSFORMERS.** Fully interleaved and impregnated. Primaries 200-230-250v. Screened.

**Drop through types, with TOP Shroud**

260-0-260v 70ma, 6.3v 3a, 5v 2a	13/11
250-0-250v 70ma, 6.3v 2a, 5v 2a Midget	12/11
350-0-350v 70ma, 6.3v 3a, 5v 2a	14/11
350-0-350v 70ma, 6.3v-4v 3a, 5v 2a	14/11
350-0-350v 80ma, 6.3v-4v 3a, 5v-4v 2a	17/9
350-0-350v 90ma, 6.3v 3a, 5v 2a	19/9
350-0-350v 100ma, 6.3v 3a, 5v 2a	21/9
350-0-350v 120ma, 6.3v 4a, 5v 3a	25/9
350-0-350v 150ma, 6.3v 4a, 5v 3a	27/11

**Fully Shrouded Upright Mounting Types**

250-0-250v 60ma, 6.3v 3a, 5v 2a Midget	16/9
250-0-250v 100ma, 6.3v 6a, 5v 3a, for R1355	26/9
350-0-350v 70 ma., 6.3v 2a., 5v 2a.	18/6
350-0-350v 100ma, 6.3v-4v 4a. C.T., 0-4.5v 3a.	23/9
350-0-350v 150ma, 6.3v 2a., 6.3v 2a., 5v 3a.	31/9
350-0-350v 250ma, 6.3v. 6a., 4v. 8a., 0-2-6.3v. 2a. 4v. 3a. For Elect. Eng. Televisor	63/-

425-0-425v 200ma, 6.3v-4v 4a. C.T., 6.3v-4v 4a. C.T., 0-4.5v 3a (suitable Williamson Amplifier) 47/9

**SMOOTHING CHOKES.** 40ma., 10h. 500 ohms, 60ma. 10h. 400 ohms 4/3. 80ma. 10h. 350 ohms, 5/6. 100ma. 10h. 100 ohms, 200ms. 5h. 100 ohms, 7/6 ea.; 50ma. 50h. 1500 ohms (suitable Williamson Amp.) 8/9.

**PUSH PULL OUTPUT TRANS.** 8w. 6V6 to 2-3 ohms 7/6; 10w. 6V6, 6X4, 6L6 to 3.5-8-15 ohms, 15/11; Williamson type exact to author's spec., 79/6.

**MISC. ITEMS. MAINS TRANS.** 200-250v. input, 320v. 70ma., Auto output, L.T. 6.3v., 3a. 7/9; 300-0-300v 80ma., 6.3v, 4v2a, 10/11. T.V. masks 12 in. cream 13/9. Ex. Gov. Smoothing Chokes, 100 ma. 10h. 100 ohms. Trop. 4/3. Sel. Recls. 680v. 30ma., 6/9. .5mf. 3500v. Condensers, 1/9, Fil. Trans. 230v. input 6.3v 1.5a. output 5/9.

**NEW BOXED EX. GOV. VALVES.** 954, 956, 2/9; KT66, 8/9; SP4, 4/6; KT241, 8/6; 9D2, 3/3; 6C4, 4/11; 6K7G, 6J7G, 7/6; 12AG Met. 5/9; 5U4G, PEN 46, 9/6; YU120A, 2/9; EF50, 7/9; VP4B, 8/9.

**UNBOXED VALVES (Ex New Equipment).** HL210, 2/3; KT2, 4/9; SG215, 3/9; D1, 1/3; EF36, 5/3; SP61, 2/11; EA50, 2/9. All Guaranteed.

**TERMS.** C.W.O. or C.O.D. over £1. Post 1/2 extra under £3. Full list 4d. Special list for trade, 4d.

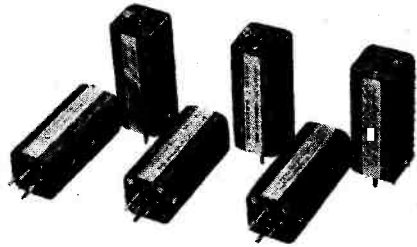

## LABGEAR

### WIDE-BAND COUPLERS

are used in all the latest and most outstanding exciters including our own de Luxe model E5021/B price £48. Full details in S.W. catalogue price 10½d. post free from:

**LABGEAR**  
(CAMBRIDGE) LTD.

Willow Place . Cambridge

## WANTED

**BC221**

**AR88/LF/D**

**ET4336**

We invite offers of any of the above. Highest Cash Paid. Don't waste time and money advertising. We are also eager buyers of bulk lots from dealers and manufacturers.

**H.P. RADIO SERVICES LTD.**

*Britain's Leading Radio Mail Order House.*

**55, County Road, Walton, Liverpool 4**

*Tel. Aintree 1445.*

*Established 1935*

## BROOKES FOR

### CRYSTALS

with a World-Wide  
Reputation for Quality



**TYPE "SM"**

Range 3 to 17 mc/s.

Hermetically sealed metal can 1.125" high under pins, 0.825" wide, 0.457" thick, with 3/32" diameter pins at 0.490" centres.

**BROOKES**  
**CRYSTALS LIMITED**

10 Stockwell Street, Greenwich,  
London, S.E.10

Phone: Greenwich 1828. Grams: Xtals  
Green, London. Cables: Xtals, London

**FESTIVAL OF BRITAIN**



(Registered Trade Mark).

Chosen for the Travelling Exhibition  
**PANDA** (regd.) Tower and Rotary  
Beam Equipment. The best of course!  
Made only by—

**The PANDA RADIO CO.**  
58, SCHOOL LANE,  
ROCHDALE.

Phone : Rochdale 47861. Grams: Panda, Rochdale

### Examples of Outstanding

## ELECTRADIX BARGAINS

**METERS.** D.C. Moving Coil Ammeters, 0-20 flush panel 8/6. 0-40 amps. 8/6, 0-50 amps. 8/6 post 1/-. Voltmeters, 0-20, flush panel, 8/6. Moving Coil Microamp movements, 2 1/2 in. round flush Measuring Instruments 100 microamps, 55/- post 1/6. A.C. Meters 2 1/2 in. panel Voltmeters, 0-15 volts M.I. A.C./D.C. 25/-, G.E.C. 4 1/2 in. Ironclad, 0-40 amps. 45/-, 0-60 volts, 50/-, Met. Vic. 5 in. Switch 8d. type, 0-50 amps. 55/-, 0-300 volts 60/- carr. extra. Electrostatic Voltmeters, Everrett Edgcombe, 2 1/2 in. flush panel, 1500 volts 50/-, post 1/6. D.C. M.I. polarised Voltmeters, 2 1/2 in. flush panel, 0-9 volts 6/6, post 9d.

**HEADPHONES,** few only S.G. Brown "A" adjustable diaphragms, high resistance, 35/- post 1/-. New surplus headphones D.L.R. models 10/- pr. with headband and cord. post 1/- single W.D. phone, new 2/- post 9d.

**MAGNETS.** D.C. Electro, 6-volt twin coil, 5/- post 6d. S.L.S. 36 Swift Levick Instrument type circular Horseshoe, 1 1/2 in. dia. 3 in. thick 3 in. polar gap drilled poles, weight 2ozs. lift 3 lbs., 2/6.

**ROTARY CONVERTERS.** D.C./A.C. 110 volts/230 volts 50 c/s. 200 watts £10/10/0. 24 volts D.C./230 volts 50 c/s. 100 watts 70/- carriage extra at cost. Other sizes available, send for list.

**G.P.O.** Multiple connection strips, 20 way, new, moulded base with solder tags, 2/- post 9d. Second-hand, 60 way, 3/- post 9d., 10 way G.P.O., 1/6 post 6d.

**TRANSFORMERS** double wound 100-230 volts input, 12 volts 3 amps., output 21/-, post 1/6. 1 K.W. double wound 250/110 volts, £10. 110/230 volt, 500 watt Auto £4/10/0 carr. 5/-.

**THERMOSTATS,** small, fit test tube, operate 0 degrees cent. Easily adapted for fish tanks, etc. 6/6 post 6d.

**CONDENSERS.** 250 volt Paper, 1 plus 1 mfd. and 2 mfd. 7/6. dzn. hermetically sealed. Send for list.

**HYDRAULIC PUMPS.** High pressure type, 3/4 in. inlet and outlet, spline shaft 2 ins. long, flange mounting, weight 5lbs., 45/- carr. 2/- extra.

## ELECTRADIX RADIOS

214 QUEENSTOWN ROAD, LONDON, S.W.8

Telephone : MACaulay 2169

## OPPORTUNITIES IN RADIO

Get this **FREE** Book!



"ENGINEERING OPPORTUNITIES" reveals how you can become technically qualified at home for a highly paid key appointment in the vast Radio and Television industry. In 144 pages of intensely interesting matter it includes full details of our up-to-the-minute home-study courses in all branches of **RADIO AND TELEVISION**, A.M.Brit. I.R.E., City and Guilds, Special Television, Servicing, Sound-film Projection, Short Wave, High Frequency and General Wireless Courses.

We definitely guarantee  
**'NO PASS-NO FEE'**

If you're earning less than £14 a week this enlightening book is for you. Write for your copy to-day. It will be sent **FREE** and without obligation.

**BRITISH INSTITUTE OF  
ENGINEERING TECHNOLOGY**  
149 Shakespeare House,  
17-19 Stratford Place,  
London, W.1. **BIET**

## P.C.A. RADIO

**R.C.A. TRANSMITTERS.** Type ET-4336. Complete with matched speech amplifier, crystal multiplier and VFO Units; brand new. (Export only).

**AMERICAN ULTRA** High Frequency Transceivers UFI, UF2, 60-75 mc.

**TRANSMITTERS No. 12.** With coupling units, remote control, microphone, etc.

**NAVY MODEL TBY-8 TRANSMITTING RECEIVING EQUIPMENT.** Output 0.75 watts on M.C.W. telegraphy and 0.5 watts on telephony. Frequency range 28-80 mc.

**AR.77's, NC.200, NC.45** (540 kc-30 mc AC/DC supply). HRO's and others.

All above items in excellent working condition with new valves. working demonstration on request.

**TX VALVES.** 803, 805, 807, 814, 861, 866A.

**RX VALVES.** 1T4, 1S4, 1S5 and many others.

Large stock of transmitting condensers, crystals and other components. Alignment and repair of communication receivers and all other amateur equipment undertaken.

## P.C.A. RADIO

Transmitter Div. : Cambridge Grove, The Arches, Hammersmith, W.6. Tel. RIV 3279.  
Receiver Div. : 170 Goldhawk Road, Shepherds Bush, W.12. Tel. SHE 4946.

# RADIO MAIL

74 Mansfield Road,  
Nottingham.

**AR88D I. F. TRANSFORMERS and B.F.O. COILS**  
455 Kcs, 50/- set of eight, or 7/6 each.

**HEAVY DUTY CHOKES.** U.S.A. makes, fully screened and potted, 10 Hy 750 m/a 40 ohms, 18 lbs, 4½ x 5½ ins., 22/6. Also G.E.C. 750 m/a 12 Hy, 18 lbs, 4½ x 6½ x 6 ins., 17/6.

**EX-GOV'T VALVES, NEW BOXED.** EF50 (British) 6/6; EF50 (red Sylvania) 8/6; SP61 3/6; EA50 2/6; EB34 2/6; EF36 5/-; VP23 5/6; HL23DD 5/6; ATP4 2/9; Valves ex equipment, all guaranteed; EF50 3/9; SP61 2/6.

**METERS** 2½ IN. Leading U.S.A. and British makes. Flush mounting, Moving Coil; 100 m/a, 200 m/a, 250 m/a, 300 m/a 500 m/a, all at 10/6 each. Flush, Moving Iron, 15 volts AC, 11/- . Flush thermo-couple 20 amps, 8/6. Projecting types, M/C, 500 m/a 7/6; M/C, 0.5 amps DC 8/6; and T/C 3 amps 6/6. ALSO Western Electric 180 degree scale 1 m/a AC rectifier type, scaled 0-150, flush mounting, only 20/-.

**ARTIFICIAL AERIAL LOADS.** Comprising 2 in., 0.5 amp T/C flush Meter, resistors etc., in metal box 3 x 2½ x 2 ins., 6/9 each.

**PRESSED METAL BOXES.** 6 x 9½ x 4½ ins., Black enamelled with hinged lid. 4/- each.

**A.F. MIDGET CHOKES.** Screened. 2 x 1½ x 1½ ins. for scratch filters, tone control circuits etc. 3/6.

**I.F. TRANSFORMERS.** Iron cored, 465 kc/s, 1½ in. square x 3½ ins. high. 6/9 per pair.

CALLERS TO 4 RALEIGH STREET.

STAMP WITH ALL ENQUIRIES PLEASE.

## ALPHA OFFERS

1T4, 1S4, 1R5, 1S5, 3S4, 12K8, 6A8, 6C6, 78, 5Y3, Y63, FW4/500, 6F6, 5U4, 6X5, VU39, 6D6, VR150/30, 42, 80, OZ4, 25A6G, 25L6G, 6SQ7, 6SL7 ... 9/- each  
EL41, 6AM6, 6SN7, KT66, 807, EBC41, UL41, KT33C, 6V6M, 607 ... 11/6 each  
ECL80, EF42, UC142 ... 11/6 each  
EF39, EBC33, MS/PEN, EK32, EF36, 6SK7, EFB, 41, 77, 6C5, 6BB, KTZ41, MH41, 1625, 1G6 ... 7/6 each  
6J5, 2X2, CV72, 2A3, VS68, 6ZYS ... 5/6 each  
VU120A, 6H6, 2155G, PEN220A, CV9, SP41, SP61, VR116, 19, EB34, TTT1, RKR72 ... 19/- each  
E1148, 7193, CV6, 801, 71A ... 2/- each  
6G6, 6NP, 6J7, 12A6, VR137, 6AC7, 6SA7 ... 7/9 each

**SPEAKERS.**  
Goodmans 5ins. 13/6 Truvox 6½ins. 13/6  
Plessey 8ins. 13/6 Plessey 10ins. 30/9  
Rola ... 10ins. 34/6 Truvox 12ins. 65/-

**METAL RECTIFIERS.**  
12 Volt ½ Amp. 1/- 2 Volt 1 Amp. ... 5/-  
300 Volt 80 M/A 5/9 260 Volt 80 M/A ... 5/3

**MOULDED MICA CONDENSERS.**  
.0001, .0002, .0003, .0005 ... 5/6 doz.  
.001, .01, .002, .003, .005 ... 7/- doz.  
100 P.F. Variable Air Space Trimmers ... 1/3 each  
Lead in Insulators ... 9d. each  
1 MFD. 600 V. Block Condensers ... 6d. each  
2½ in. Knob 3/8 in. Spindle ... 9d. each  
Headphones Low Resistance ... 6/- pair  
Jack Plugs and Sockets ... 3/- pair  
Throat Microphones ... 2/4 per set  
M.C. Headphone Earpieces ... 1/6 each  
.25 mfd. Sprague 350 V. ... 4d. each  
.01 mfd. Sprague 1000 V. ... 4d. each  
Bl. .02 mfd. 1000 V. Card Tubular ... 7d. each  
.01 mfd. 5KV. Bakelite case ... 4d. each  
TCC .01 mfd. 350 V. Metal case ... 2/- each  
BEC. 32 x 32 mfd. 450 V. ... 7/- each  
TCC. 24 mfd. 350 V. ... 4/9 each  
Colvern 200 ohms. 10K, 1K, 20K, 50K, Wire Wound

Resistors, ½, 1, and 1 Watt Selection ... 2/9 each

POST ORDERS ONLY. C.W.O. or C.O.D. SEND 2½d. stamp for List. Delivery by Return. Please include Postage.

**ALPHA RADIO SUPPLY CO. LTD.**  
5/6 VINCES CHAS. VICTORIA SQUARE, LEEDS, 1

Miniature enthusiasts should send for free catalogue and literature—stamp for postage

THE INCOMPARABLE

## GLOBE-KING

SINGLE VALVE S.W. RECEIVER

- WORLD-WIDE RANGE 11-100 METRES
- CRYSTAL-CLEAR NOISE-FREE RECEPTION
- ELECTRICAL BAND-SPREAD TUNING
- EXTREMELY LOW RUNNING COSTS
- KITS OR READY-BUILT SETS FROM 25/-

Direct from Makers. Home and Overseas Sales

**JOHNSONS (RADIO)**  
46 FRIAR STREET, WORCESTER

## G4GZ's BARGAINS

**VALVES:** 5CP1's, 25/-, 801A, 17/6, 866A, 22/6, 815, 45/-, 803, 25/-, 804, 27/6, 810, 85/-, 813, 90/-, 6AG7M, 12SQ7M, 6SQ7M, 6L6M, 6L6G, 5U4G, KT66, 12/6, 6AG5, 6K7M, 6X5GT, 5Z4M, 10/6. 1N22 xtal diodes 5/- . 954, 955, 956, 5/- . MICA BYPASS, .002mid. 5Kv wkg. 2/- ea. 5 for 7/6. 80V CERAMIC VALVEHOLDERS. 6 for 5/6. 10/- doz. TWIN GANG .0002 per section, .05in. vane spacing (1500V) ceramic insulation. Make ideal 100pf. split stator, 7/6 each. FEW ONLY SCR522 TX chassis partly stripped (less Mod. xfmr. choke, switch and relay) 25/- ea. STRUTHERS DUNN DPDT ANTENNA RELAYS, solenoid 12v. 1.2 amps. contacts rated 6 amps. micalex insulation, 12/6 each.

**EX STOCK!!** The AMPLION 10 range AC/DC Testmeter, 25 each. All goods despatched per return of post.

J. T. ANGLIN  
160 Cleethorpe Road, Grimsby, Lincs.  
Phone 56315.

## SMALL ADVERTISEMENTS

9d. per word, minimum charge 12/- . No series discount; all charges payable with order. Insertions of radio interest only accepted. Add 25% for Bold Face (Heavy Type). No responsibility accepted for errors.

## TRADE

**METALWORK.** All types cabinets, chassis, racks, etc. to your own specifications. Philipott's Metal Works Ltd., (G4B1), Chapman Street, Loughborough, Leics.

**QSL's** and LOGS by MINERVA. The best QSL's there are. Samples from Minerva Press, 46 Queen's Road, Brentwood, Essex.

**WANTED.** RCA speech amplifiers Type MI-11220 J or K. Offers stating quantity and price to PCA Radio, The Arches, Cambridge Grove, W.6.

**WANTED.** BC-610 Hallcrafters, ET-4336 transmitters, SX-28's, AR-88's. Receivers and spare parts for above. Best prices. Write Box 864, c/o Spiers Service, 82 Centurion Road, Brighton, Sussex.

**QSL CARDS AND LOG BOOKS.** APPROVED G.P.O. SAMPLES FREE. ATKINSON BROS., PRINTERS, ELLAND, YORKS.

SMALL ADVERTISEMENTS  
TRADE—continued

**QSL** Cards. Neat, attractive, reasonable prices. Samples. Lovedge, BRS.15643, Mill Street, Barwell, Leicester.

**ROTARY-BEAM** Antenna indication. Magslip transmitters from 10/-. (Listed £16). Stamp for circuit and full details. Engineering Facilities Ltd., 29 Rea Street, Birmingham 5.

**VALVES.** Ex-Government. Large quantity wanted. Highest prices paid instantly; Types IR5, IS5, IS4, IT4, 805, 807, 813, 832, 6V6, 5Z4, 6K8, 6Q7, 6J7. Pype-Hayes Radio, 606 Kingsbury Road, Birmingham, 24. (Phone ERD. 4942).

**REQUIRED URGENTLY.** AR88's, SX27-28's, S38's, BC221's. All test equipment. Tape and Disc Recorders. Contact us before selling. Highest prices paid. Universal Electronics, 27 Lisle Street, Leicester Square, London, W.C.2. (GER. 8410).

**WANTED ET-4336 TRANSMITTER COMPONENTS,** variable inductors, transformers, etc. Please supply details and prices RCA, British P.O. Box 57, Tangier, Morocco.

**SITUATIONS VACANT**

**VHF COMMUNICATIONS. PROGRESSIVE AND RAPIDLY EXPANDING LONDON COMPANY HAS VACANCIES FOR AN ENGINEER IN CHARGE (WORKING) AND VHF SERVICE ENGINEERS. TECHNICIANS WISHING TO JOIN AN ORGANISATION OFFERING A SOUND FUTURE IN THE COMMUNICATIONS FIELD SHOULD APPLY AT ONCE STATING FULL DETAILS OF PAST EXPERIENCE, SALARY REQUIRED, ETC. TO BOX 978.**

**READERS' ADVERTISEMENTS**

3d. per word, min. charge 5/-. payable with order. Box numbers 1/6 extra.

**H**AM defrauded of £40 in attempting to purchase AR88, and now without Rx, would like to obtain CR100 cheap. Can anyone oblige please. All replies answered. Box No. 985.

**EDDYSTONE S.640** £16/10/0. New 2-valve pre-amp (Birm.), own P/Pack, £2/10/0. 1355 with P/Pack and RF26 converted to Holme Moss (vision or sound), £5. Carriage Paid. Box No. 971.

**WANTED** for H.T.9 Tx Exciter plug-in tuning units and final amplifier coils for all bands. Top price offered for sound goods. Offers to G5HK, Manor Farm, Brimington Common, Nr. Chesterfield.

**WANTED.** RCA AR77 in good condition. For sale, new Muirhead HRO type dial and drive, £3. Batey, 95 Kenilworth Crescent, Enfield, Middx.

Short Wave Magazine, Volume IX

**MORSE CODE TRAINING**

The exclusive Candler Method trains you to read code as easily as you hear and understand a conversation—without mental or nervous strain. Learning and applying the Candler principle makes the handling of code easy and interesting. That is why so many thousands in all parts of the world have successfully mastered Morse the Candler way.

The **Advanced Course** is recommended for those who have already attained a consistent sending and receiving speed of not less than 15 w.p.m. With this Course the average student reaches speeds of 20/35 w.p.m.

The **Junior Course.** This is a complete Course for the **Beginner** who desires to have a thorough training in Code to fit him for securing the G.P.O. Certificate in which he is interested.

The **Special Course** covers all the Code training necessary to pass the G.P.O. test for an Amateur Transmitting Licence.

**Touch-Typewriting Course.** A series of interesting and easily followed lessons which enable one to record messages at speeds far in excess of that possible when writing in longhand.

You are invited to send for a copy of the **CANDLER "BOOK OF FACTS,"** it gives full details of the above training.

**THE CANDLER SYSTEM CO.**

(Dept. 55.S.W.)

52b ABINGDON ROAD, LONDON, W.8.

Candler System Company, Denver, Colorado, U.S.A.

**SAMSONS SURPLUS STORES**

**SPECIAL OFFER. BRAND NEW HOOVER INDUCTION MOTORS.** 1/6 h.p., 220/240v. A.C. Single Phase 1,425 R.P.M. Double Ended Spindle. £4/17/6, carr. 6/-. A few available for 110v.

**BRAND NEW VARIOMETER INDUCTIONS** as used in the No. 19 Set Variometer, 3/6. Post 9d.

**HEAVY DUTY TRANSFORMERS.** Prim. 180-230v. 50 cy. Sec. 14v. 20v. 20 Amps., 45/-, Carr. 2/6. Prim. 180-230 volts 50 cy. Sec. 4.2v. plus 4.2v. 10 amps., 25/-, Carr. 2/6. Prim. 200-240v. 50 cy. Sec. 6.3v. 15 amps., 17/6. Carr. 1/6. **MASTER VOLT METERS.** 0-20v. A.C. moving iron 6in. scale made by Metro Vickers, 22/6. Post 1/-.

**BRAND NEW 12V. VIBRATOR PACKS.** Output 210v. D.C. 70 m.a., completely smoothed and includes 4-pin vibrator and metal rectifier 30/-, Post 1/-.

**BRAND NEW WESTINGHOUSE CLOCKWORK MASTER CONTACTS.** Type 2, two breaks per sec., 17/6. Carr. 1/6.

**E.D.C. ROTARY CONVERTERS.** D.C. input 200-220 volt, A.C. output 230v. 175 watt, completely shrouded in metal case, £10/10/0. Carr. 5/-.

**169/171 EDGWARE ROAD**

LONDON, W.2. Tel: PAD 7851

125 Tottenham Court Road, W.1. Tel: EUS 4982

Hundreds of Bargains for Collectors

Edgware Road Branch Open All Day Saturday.

All orders & enquiries to our Edgware Rd. branch please

## RADIO G200 ANNOUNCES

**VALVES:** At 3/6 954, 6H6, 12H6, 7193 Det. 20, VR92, VR78, 2X2, CV6, L413, VY2. At 5/- H63, 12SH7, 6SH7, VS68, STV280/40, TT11, VT501, Pen220a, CV66, HVR2a, VU120a, 6J5C, 902. At 6/9 6N7G, 6N7gt, 6S07, 6J7G, KTW61, KTW62, KT61, KT63, VR100, 6K6G, EL50, AC6pen, Pen46, 1625, EF54, VR136, 6AC7, 1625, EL8, 6D6, 12SG7, EL8, 1C5gt, 3B7/1291, 6C4, 9006, 717a, 6SK7gt. At 8/6 8012, 6L7, 2A3, PT25h, 524G, DH63, 6F6G. At 10/6 6K8, 6K8G, 6L6, 1622. At 70/- 832. Please add 6d. post or 10d. if registered post.

Trade and Overseas enquiries invited.

**ARTHUR HOILE**

**55 UNION STREET, MAIDSTONE, KENT**

Phone: 2812

## TRANSFORMERS

GUARANTEED. INTERLEAVED. IMPREGNATED.

1. 250-0-250v. 80m.a.; 4v. 5a; 6.3v. 4a; 4v. 2a; 5v. 2a.

2. Same as 1 but 350-0-350v.

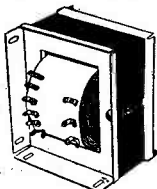

3. 24v. 2a. tapped to give steps of 3v. up to 28v. All secondaries 200-220-240v. 15/- all types. Postage 1/-, 3 or more post free.

**HILLFIELDS  
— RADIO —  
8, Burnham Road,  
Whitley, Coventry.**

## OPENING OFFER

### SANDFORD MAIL ORDER SUPPLIES

13 LYDFORD PARK ROAD  
PLYMOUTH

**VALVES** all boxed. 6H6/vr54, SP61, VR78 with holder (24/- doz.) at 3/-, 6ab7, 6ac7, 6ag7, 6c5, 6c7, 6d6, 6f6, 6j5, 6j7, 6k6, 6k7, 6L7, 6n7, 6r7, 6sa7, 6sh7, 6sj7, 6sk7, 6sl7, 6ss7, EF50 (VR91), EC52, 12A6, 12C8, 12J5, 12sg7, 12sk7, 1LN5, 1R4, 3B7, 3D6, 7F7 at 6/-, 6V6, 6f6, 6sn7, 5U4, 5Z4, U50, DW4, U18, VR150, new EF50 (vr91), 75, 76 at 7/9, 6L6 (nr77), k66, 807 at 9/9. New Osram Z77 (6am6), 11/6. 813, at 65/-, 832 at 37/6, 808 at 25/-.

**TEST EQUIPMENT.** BC221 as new with calibration chart, £25.

**METERS,** all boxed. 2in. round 0-500 microamp 15/-, 2in. sq. 0-1 MA, 15/-, 2in. sq. 0-5 MA, 7/6.

**RECEIVERS.** B28/CR100 thoroughly overhauled, £30. Type 3547 (less valves) in valuable packing case, £4/10/0.

**CONTROL UNITS.** Type 214 in metal case comprising numerous resistances, condensers, valve holders, etc., etc., 19/6.

**CONDENSERS.** Variable ceramic 100pf, 2in. spindle, 50pf, 1in. spindle, 2/-, Smoothing new, not surplus, 16mf. 500v., 3/3, 16 x 16mf. 350, 3/9, 8mf. 500v., 2/-, Specials, 1000mf. 25v., 6/3, 50mf. 40v., 1/-.

**RESISTORS.** Brand new well-known manufacturers, all values, one watt, 3/- doz., 3 watt, 5/- doz., or 13/6 gross either wattage.

**MAINS TRANSFORMERS.** Brand new, 200/250 input, output half wave 200v. 30ma with 6.3 fils. ideal for BC221, ECO's pre amps, etc., 12/6.

**CABLES.** Brand new, 80ohm coaxial 1/- per yd. or 100 yd. drums, £3/11/6. Plastic twin and twisted, 100 yd. drums, 25/-.

**DIAL HOLDERS BULBS.** Brand new Bulgin ruby panel lamp holders, 1/9. 6.5v., .3a lamps, 9/6 doz.

**SWITCHES, KNOBS.** 10 amp 250v. DPDT, 1/3. DPDT Wafer Switch, 1/3. B28 type knobs, 6/6 doz.

All goods carriage free. Cash with order, 1/- extra for COD

## SMALL ADVERTISEMENTS READERS'—continued

**EDDYSTONE** S640 communication receiver, complete with matching speaker. Perfect condition, £20. Peter Mogford, 27 Ynysmaerdy Road, Briton Ferry, Neath, Glam.

**NEWLY** Married amateur and XYL seeking flat in North London. Box No. 987.

**S-38** Wanted for cash. Urgent. Clean condition essential. 18 King Street, Richmond, Surrey.

**SALE.** Taylor 70A multi-meter, 1948 model, as new, £7/10/0. 6H6G, 6SL7G, 1625, 83 m/v (2), lot 17/6. P/P driver trans. 2.75: 1, 500v, 7/6. G3EAP, 58 Nairn Street, Sheffield 10.

**WANTED** — HRO in good condition, and preferably with handsread coils. N. Ratcliffe, 67 Higher Croft Road, Lower Darwen, Lancs.

**EDDYSTONE** S.640 perfect condition, complete matching speaker, phones, handbook, as new £20. Box 984.

**TWO-METRE** Tx for quick disposal, 829 final, £10. Two-metre converter, less valves and crystal, £5/10/0. Midget Tx as described in April 1949 *Short Wave Magazine*, less valves, £9/10/0. Send S.A.E. for list of valves and crystals. G2AJ, Pine Crest, Biggin Hill, Kent.

**VALVES,** 832 (6), 830B (2), 30/- each. ECC91 (4) 12/6. EF42 (6), 10/-, Satisfaction or money refunded. *Short Wave Magazines*, 80, £2/15/0. *RSGB Bulletins*, 200, £5/0/0. Various other Ham gear for sale including HRO, SX25. S.A.E. for list. Box 986.

**SALE.** Marconi 15 valve Rx, 1. 7 mc to 17 mc, band switched, xtals 1000/100/10 switched, built-in speaker, phone jacks, tone control, noise limiter, freq. adjuster, S-meter and p/pack. A first class receiver—£18/0/0, or exchange for Marconi CR100 and p/unit. J. Graham, 555 Cowpen Road, Blyth.

**SALE.** Eddystone S.750 and matched speaker, S mint condition. £50 carr. paid. G3EAG, P.O. Box 555, Reading.

**NATIONAL** HRO with power supply, coils and speaker, £25. 18A Station Road, West Drayton, Middlesex.

**FOR** Sale. Transmitter, 50w Phone/CW XtI/VFO input, power supplies, etc. £35. 18A Station Road, West Drayton, Middlesex.

**COMPLETE** STATION, professional 50w. Phone and CW Tx. Small 3-tier rack, metered, fused and band-switched; crystal mike. BC342 receiver professionally modified. VFO with built-in supply. 4 Q.C.C. xtals. 10-metre converter. Class-D wavemeter. All 210-250 AC mains. Key, phones, speaker, replacement valves, £50. Delivered reasonable distance. Box No. 981.

**SALE** Wilcox Gay VFO, less 807, £5 or offers? Or else exchange for Labgear wideband couplers. Box 982.

**CANADIAN** 58 Set Mk. 1 for exchange ASB.8 or Signal Generator or sale; also exchange 2 new TZ40 for new 6J6 or 6AK5. Box 983.



**SMALL ADVERTISEMENTS  
READERS'—continued**

**AR88LF** and Hallicrafter speaker in special crate. Perfect performance and appearance. Seen Bawtry, Yorks. £65 or offer? *Tel. Bawtry 312.*

**150** watt rack Tx, push-pull 813, push-pull 809 mod, speech amp, 28 to 3.5 mc, Xtal, VFO, complete valves and power supplies. 144 mc Tx APN8 push-pull 24G's, 522 driver, complete valves G2IQ converter + 2 EC91 RF. 3.5 mc VFO, Franklin 12 QCC xtals, 7 mc range, with certificates. HRO MX Receiver, noise limiter, less coils. BC348 receiver, S-Meter. BC221 Freq. Meter. Cossor Oscilloscope, Model 3332. B2, less power pack, coils Rx and Tx. Electronic keyer with key. Vibroplex bug. 2 straight keys. 2-BC453 converted Q5'er. 1.7 mc Tx built TU5B unit. 1200 volt power pack, 200 mA. 250 volt + 13A 6.3v. Telcon K35 feeder. Coax feeder. Spare 813, 809, 2VO47, 832, 24, etc. Lots Rx types. Relays, coils, numerous other items. What offers lot or part? **G8AX**, Littlemore, Mattishall, Dereham, Norfolk.

**A** MATEUR selling up. Guaranteed S.640 perfect, nearest £20. Crystal Monitor Type 4A 100-125 mc, £4. AR88 Vib. Pack, £1. 348 Dynamotor, 7/6. 6-volt Genemotor, smoothing, etc. 10/-. Pitch Servo 24v. DC 3 r.p.m. very powerful, £1. CAY-47155C 1.5-3 mc, 10/-. Transf. 115 in. 1500v 2MA, 6v 6A., 2.5v 1.75a, 15/-. Set valves Tx/Rx 18, offers? Pair PT15's, 15/-. 3D6's, 4/6 each. 9001's, 3/- ea. Box 972.

**1155**, Modified, S-meter, new front panel, internal power pack, and output stage, £8. Buyer collects. Batey, 95 Kenilworth Cres., Enfield, Middx.

**150W** + Phone/CW Tx, £40. No offer. 10 metre beam 3EL W/S, 30ft. tower, etc., £12. Also BC221, perfect, £2. **G3ORF**. *Tel. HILLSIDE 7010.*

**B**UG KEY wanted. State price, condition and make. Pair new 813's for sale. Box 973.

**S**UPER-PRO SP400. 1250 kc to 40 mc, less power pack. FB condition. Hot on Ten. £40. Carriage paid Box 974.

**BC348Q**, Internal power pack, extra LF stage added, in new condition, £15, 10/- carriage. BC312, external power pack, modified per QST, and noise limiter added, in new condition £15, 10/- carriage. Will consider exchanging one for commercial 10-metre converter. Can someone tell me the IF Frequency of the BC-683? **W. Burns**, 12 Dovecroft, Kirkcudbright.

**W**ANTED, BC221, mains operated; also HRO bandspread coils. Box No. 975.

**B2** Complete, £14. Grampion M/c mike 50/- 3in. MC meter 0-50 mA, £3. **S. Walker**, 20 William Street, Staincliffe, Dewsbury.

**B**URGOYNE Solder Gun, new, boxed, £2/5/0. 5CP1, base, screen, glass, 15/-. VCR517, 15/-. VCR97, slight cut-off, 10/-. SP61, 2/6. 6HG6T 2/- few only. 45 Dunbar Road, London, E.7.

**AR88D** Perfect working order and appearance, speaker, handbook. G6VX Type, 2-metre converter, 24 to 26 mc IF, works perfectly. RF26 unit unmod. Premier TV, assembled, needs attention. Spare VCR97, Lens, booklet. Pye 12v car radio. £55 lot. No offers or separation. Buyer collects. **Worc's**. Box 979.

**R**ADIOVISION Commander, new and unused, £39/10/0. Labgear Electronic Tester, mint condition, £23/10/0. **Frost**, 22 High Street, St. Neots, Huntingdon.

*Short Wave Magazine, Volume IX*

**P M G CERTIFICATE**

*Prepare now for next exam.*

Take our special **POSTAL COURSE**. Many former students testify that our tuition was invaluable in ensuring their success in previous examinations.

Full details in **FREE BROCHURE** from **E.M.I. INSTITUTES, Dept. 14**  
Postal Division

43 Grove Park Road, Chiswick, London,  
W.4. Phone CHiswick 4417 1.32

**BRASS, COPPER, DURAL,  
ALUMINIUM, BRONZE**

**ROD, BAR, SHEET, TUBE, STRIP,  
WIRE**

**3,000 Standard Stock Sizes**

**NO QUANTITY TOO SMALL**

*List on Application*

**H. ROLLET & CO. LTD.**

London, 6 Chesham Place, S.W.1. Liverpool, Kirkby Estate  
SLOane 3463 Simonswood 3271

**VALVES! SPECIAL  
OFFER**

*For One Month Only!*

Anyone wanting Ex-Govt. Valves at Bargain Prices in quantities from one to one hundred, please write for our Special Offer List which contains most of the popular types, including 6V6, 5Z4, 807, 6K8, Etc., and all at prices cheaper than any others offered in this Magazine.

This Genuine Offer holds good for one month only.

All Valves are Boxed, tested and Guaranteed.

Write now to our Mail Order Dept.

**THREE IN ONE 6/** each  
**TRANSFORMER** Post 1/3

1. Use as a P/P Modulation Transformer P/P 211's to single 211-100 watts. Makes ideal Output Transformer P/P 6L6 or 807' to match High Impedance Relay Speakers, or
2. 230 Volts 50 Cycles Input 150.0.150 at 100 mA Output. Useful for H.T. Eliminators and Low Voltage Power Supply. Can also be used 300 Volts Half-wave at Lower Current, or
3. 230-115 Volt AUTO Step/Up or Step/Down Mains Transformer .75 watts rating. U.S.A. Manufacture. Fully Shrouded. SIMPLE : EFFICIENT : GUARANTEED.

**NORMAN H. FIELD**

68, HURST STREET, BIRMINGHAM, 5

*Mail Order Dept.*

64-65 Church Lane, Wolverhampton.

**VALVE BARGAINS**, 6A15, 6AG5, 8/6; 6AG7, 65N7, 1R5, 1T4, 1S5, 1S4, 354, X66, EL33, PEN25, 10/-; TP25, 12/6; 6J4, CV139, CL33, 15/-; 6C4, 6K7GT, KTW61, MHLDe, 12A6, EL32, 3A4, 7/6, 90K2, 6/-; EF36, 4/-; ML6, 3/-; 803, 30/-; 815, 40/-; 723A/B, 70/-; 2149, 90/-, All Guaranteed. Hundreds of other types. S.A.E. for Lists. **XTALS**, Western Electric, 450, 452, 454, 455.5, 457, 461, 468, 470, 500 Kc., 5/-; **VITROUSE BLEEDERS**, 20k, 50k, 80 watt 1/3, 350 ohms, 5k, 75k, 40 watt 1/-; **CERAMIC CONDENSERS** 4pf, 20pf, 50pf, 100pf 1,000 pf. 6d. each or 5/- doz. **HEAVY DUTY SCREENED CABLE**, single 9d., 2-way 1/-, 3-way 1/3 per yard. **SPLIT STATORS**, 5pf. Ceramic Insulation 2/6. **EDDYSTONE** 6 pin coils 2/6. Hundreds of other bargains. Please include 9d. postage on orders under £1.

**ELECTRAD RADIO**  
69 HIGH STREET, BELFAST, N.I.

**ADCOLA** (Regd. Trade Mark)  
**SOLDERING INSTRUMENTS**



Reg. Design No. 860302  
British, U.S. and Foreign Patents  
Supplied for all volt ranges from 6/7V-230/250V.  
Meets every requirement for radio assembly, maintenance, telecommunications, etc. **High Temperature, Quick Heating, Low Consumption, Light Weight**  
3/16" Dia. Bit Standard Model  
1/4" Dia. Bit Standard Model  
3/16" Dia. Detachable Bit Type  
Sole Manufacturers: **ADCOLA PRODUCTS LTD**  
General Offices and Works: **Cranmer Court, Clapham High Street, London, S.W.4.**  
(MACaulay 4272)

**H.A.C.**

**Short-Wave Equipment**

Noted for over 15 years for . . .  
Short Wave Receivers and Kits of quality

One Valve Kit, Model "C" Price 20/-  
Two " " " " "E" " 43/-

These kits are complete with all components, accessories and full instructions.  
Before ordering send stamped addressed envelope for descriptive Catalogue.

"H.A.C." SHORT-WAVE PRODUCTS  
(Dept. VI6.) 11 Old Bond St., London, W.1

**EASIBINDERS**  
for  
THE "SHORT WAVE MAGAZINE"

Bind your issues in the Easibinder. By a simple operation the journals are inserted with a steel wire, and at once become a neatly bound volume for the Bookshelf.

The Easibinder is bound in green cloth, and gold-blocked with title and year on the spine. It will hold 12 issues. (One volume).

**PRICE 11/9 (Post Paid)**

A Binder can be sent an approval if requested. When ordering please state the Vol. No. to be blocked.

**EASIBIND LTD**  
84 NEWMAN STREET, LONDON, W.1.

**SMALL ADVERTISEMENTS**  
READERS'—continued

**R.1155** New, £7. R.208, AC only, £7. 624A receiver, £1. Rotary converter 24V DC to 230v, 100v, 50/-, carriage extra. Box 977.

**USA** Power Supply Type R.A. 34F, variac controlled and metered, in chest complete with cables and instruction book, £18. Type R.A. 62B, £5. Type 45, 1200 volts, metal rectifier, £3. Command Tx, BC458 5.3-7 mc, complete, £3. Command Rx, 1.5-3 mc, £2. BC453, £2. Valves: 4 805's, 4 807's, 10/- each. Many Rx valves, 4/- each. Offers or exchange decent camera. Box No. 976.

**T** TRANSMITTER for sale. Phone or CW, 30 watts, little used, commercially built for 1.7, 3.5, 7.0 and 14 mc, complete in grey metal cabinet with standard size panel. 6L6, ECO, 6V6, 6V6, 807 PA, Modulator 6SJ7, 6J5, 6V6 push-pull. Delivered free by rail. Price £35 or nearest, first cheque secures. Piper, Freeland, Gateside, Fife.

**F** OR Sale — AR88LF in perfect condition with handbook, £45. Box No. 980.

**G3EPI**, Wishes to buy or borrow handbook for CNY1 transmitter-receiver. J. K. Bond, 23 Harding Street, Londonderry.

**V** ALVES, VU111, VU113, CV54 3/-, 6J5, 5/6, MHLDe, 6/-, EL32, 6/6, postage extra. G3FXB 26 Landseer Road, Hove 4, Sussex.

**640 PRESENTATION MODEL**, G2AJV GETTING MARRIED IS COMPELLED TO SELL THIS FAMOUS RECEIVER, COMPLETE WITH THE S-METER AND SPEAKER AS ORIGINALLY PRESENTED, IN SUPERB CONDITION, £27. ALSO C43 Tx MODIFIED FOR 20, 40, 80 WITH 3 POWER PACKS, UP TO 400 WATTS CW OR 200 'PHONE, BEAUTIFUL JOB, £34. ALSO B2 Tx AND Rx MODIFIED FOR 25 WATTS 'PHONE AND INCORPORATING MEDIUM WAVE Rx, £16. BUYER PAYS CARRIAGE. G2AJV, 3 BIRCH LANE, LONGSIGHT, MANCHESTER.

**W** ANTED — Communication receiver — any good make or condition considered if price is reasonable. Full particulars to: 308 Lichfield Road, Birmingham 6.



**Tape & Wire Recording Components**

Write for the latest price list of the following  
**RECORD, PLAYBACK & ERASE HEADS. THE NEW TAMSA HEAD RANGE ARE NOW AVAILABLE**  
**RECORD PLAYBACK AMPLIFIERS**  
**OSCILLATOR COILS AND UNITS**

TAPE	E.M.I. G.E.C. DUREX	WIRE	On standard 1/2, 3/4, and 1 hr. Spools.
	5in, 7in, 11in. Spools.		

Constructor's Envelopes. Books on Tape Recording  
Manufactured by



Dept. MR10, 74 Great Hampton Street,  
HOCKLEY, BIRMINGHAM, 18

Short Wave Magazine, October 1951

# American Publications

## THE G CALL BOOK

Available now, the most complete and up-to-date list of British amateur call sign/addresses, containing over **6,500** names compiled from the current edition of the **Radio Amateur Call Book**, with the latest amendments.

Price **4s. 6d.** post free.

### Also Available.

The Foreign Section, **Radio Amateur Call Book**, listing amateur stations throughout the world less the United States, 140 pages.

Price **8s. 6d.** post free.

### The Radio Amateur Call Book.

Complete, 400 pages, 100,000 amateur station addresses covering the whole world.

Price **20/-** post free.

Order now for Fall Edition, available middle of October.

## BOOKS FOR IMMEDIATE DELIVERY

Radio Handbook 11th Edition ... ..	26/2	Surplus Conversion Manual Vol. 2 ... ..	21/5
Radio Handbook 12th Edition ... ..	25/11	Antenna Manual ... ..	27/11
Radio Handbook 13th Edition ... ..	49/6	Post War Communication Receiver Manual ... ..	28/5
A.R.R.L. Handbook 1951 Edition ... ..	23/1	Antenna Handbook ... ..	11/7
Surplus Conversion Manual Vol. 1 ... ..	21/5	Hints and Kinks ... ..	11/5
		World Radio Handbook ... ..	6/11
		How to Listen to the World ... ..	1/11
		Vade Mecum ... ..	25/1

## MAGAZINES BY SUBSCRIPTION

	One Year		One Year
Audio Engineering ... ..	29/-	Radio Electronic Engineering ... ..	56/-
Radio and Tele. News ... ..	36/-	Service ... ..	24/-
Q.S.T. ... ..	36/-	F.M. and Television ... ..	32/-
CQ ... ..	29/-	Electronics ... ..	160/-
Radio Electronics ... ..	33/-	Tele-Tech ... ..	40/-
Popular Mechanics ... ..	32/-	Television ... ..	48/-
		Television Engineering ... ..	32/-

The above list is a short selection of publications that we handle. We regret single copies cannot be supplied. All magazines are posted direct to our customers from the U.S.A. and we do our utmost to give the fastest deliveries possible.

Subscriptions taken for any American Technical Publication. Prices forwarded on request.

# GAGE & POLLARD

Suppliers of Technical Books and Publications to Schools, Universities, British and Colonial Government Departments.

55 Victoria Street, London, S.W.1 ABBEY 5034

## Preliminary Announcement

*In accordance with our declared policy of manufacturing only the finest and most modern equipment.*

# PANDA PROUDLY PRESENTS

## THE PR-120-V

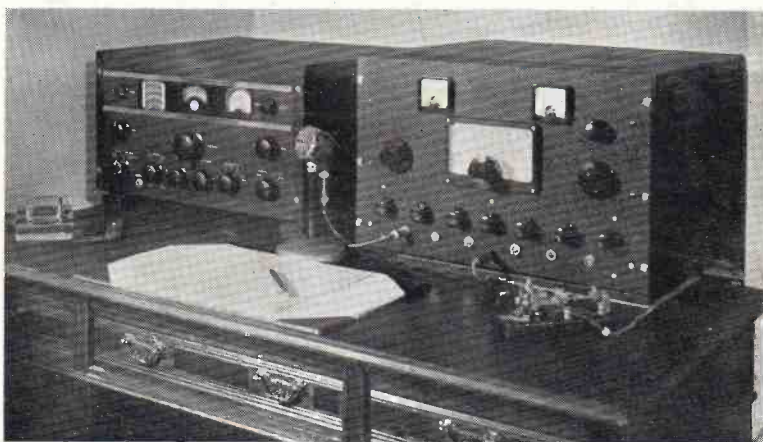

The **FIRST** Table Top Tx to incorporate the following desirable features :—

- \* **T.V.I.**—Incorporating the absolute latest in T.V.I. proofing. You can now live with T.V.
- \* **FLEXIBILITY.**—Bandswitched 3.5, 7, 14, 21 and 28 mc/s.
- \* **THE COMPLETE "TABLE TOPPER"** Speech Amplifier, modulator and all power supplies built into one modern table top cabinet.
- \* **QRO**—120 watts of 100 per cent. modulated phone and 150 watts of C.W.
- \* **VERSATILE.**—High stability calibrated V.F.O. incorporated.
- \* Harmonic Check facility. Fully metered. H.T. interlock and full safety precautions. Embodied variable excitation control. Break-in facilities provided. Output impedance 50—100 ohms unbalanced line.

### IN FACT IT HAS EVERYTHING !

With a key, mike and power plug you can work WHO you want WHEN you want with the PR-120-V.

*The PR-120-V is now in production. Prices to be announced shortly. Delivery to commence December and all orders will be dealt with strictly in rotation. Export enquiries will command priority.*

**The PR-120-V is the latest product of the PANDA organisation and is another "first" A new piece of "PANDA" (Regd.) Equipment.**

**PANDA RADIO CO., 58 School Lane, Rochdale**

Tel. 47861. Grams : PANDA, ROCHDALE.