

# SHORT WAVE NEWS

Vol. 2 • No. 9

SEPTEMBER, 1947

*In this Issue*

**V.H.F. News**

**Around the Broadcast  
Bands**

**Radio Amateurs  
Examination Course**

**Around the Shacks**

**I.S.W.L. Notes**

**On the Ham Bands**

**My Favourite  
Receiver**

*Also*

**Variable Frequency  
Oscillators**

**Analysis of the QRP  
Contest**



Two of the aerials at W2-790

AN AMALGAMATED  
SHORT WAVE PRESS  
PUBLICATION

1/3

**YOU TOO CAN HAVE AN EFFICIENT RECEIVING STATION LIKE THIS !**

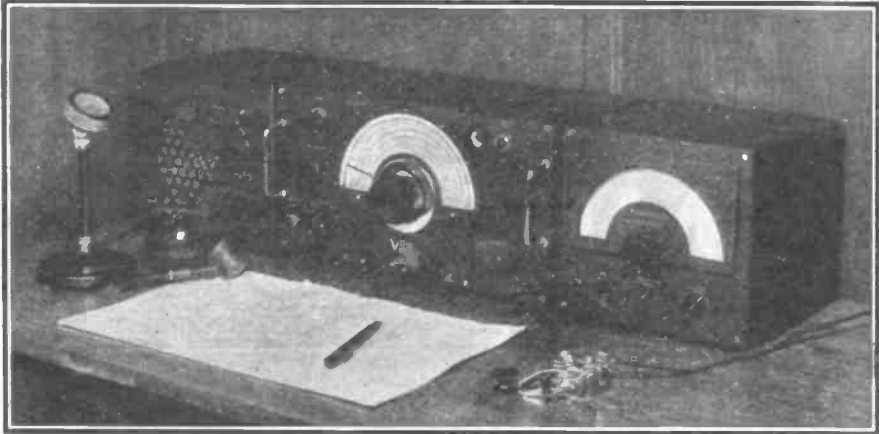

WRITE FOR ILLUSTRATED BROCHURE WHICH FULLY DESCRIBES THIS BRITISH BUILT RECEIVING EQUIPMENT  
HIRE PURCHASE FACILITIES AVAILABLE

**RADIOVISION (Leicester) LTD.** 58-60 RUTLAND STREET  
Phone: LEICESTER 20167

**PREMIER RADIO**

MORRIS AND CO. (RADIO), LTD.

**ALUMINIUM CHASSIS.**—Substantially made of bright aluminium, with four sides, 10in. x 8in. x 2½in., 7/-; 12in. x 9in. x 2½in., 7/9; 16in. x 8in. x 2½in., 8/6; 20in. x 8in. x 2½in., 10/6; 22in. x 10in. x 2½in., 13/6.

**SUPERSENSITIVE DOUBLE HEADPHONES.**—Balanced armature with reed driven aluminium diaphragm. 60 ohms, 8/6.

**ELECTROLYTIC CONDENSERS.**—Miniature metal can type, 8 mfd. 500 v.w., 3/-; 16 mfd. 500 v.w., 4/-; 8x8 mfd. 500 v.w., 6/6; 50 mfd. 12 v. 1/-

**2-VALVE, SHORT WAVE BATTERY KIT.**—A complete Kit of Parts for a 2-valve receiver, covering 15-600 metres, including valves, coils, drilled chassis, H.T. and L.T. dry batteries, to last approximately 6 to 12 months. A pair of Double Headphones and full instructions. Price £3/10/-. An Extra Coil can be supplied, covering 600-1900 metres at 4/-.

**ROTARY TRANSFORMERS.**—Input 12 v., output 180 v. 30 mA., 4 v. 2-3 A. with 19 volts input, output is 50 per cent. higher. May be used on D.C. mains as L.T. Charger. With small conversion could operate as D.C. Motor. Original cost over £5. Employ powerful ring magnet. Price 10/- each.

**OUTPUT TRANSFORMERS.**—A super production. By means of ingenious series-parallel arrangement, all windings are used at all times. Match any tube, single or push-pull to any voice coil 2-30 ohms. 7 watts, 22/6; 15 watts, 30/-; 30 watts, 49/6; 60 watts, 59/6.

**BATTERY CHARGER KITS.**—All incorporate metal rectifiers, input 200-250 v. A.C. 40/100 cycles.

To charge 2 v. accumulator at ½ amp. ...	Price
"    6 v.    "    1 amp. ...	15/-
"    12 v.   "    1 amp. ...	17/6
"    6 or 12 v.   "    4 amp. ...	22/6

Complete with Variable Resistance and meter £3/15/-  
To charge 6 or 12 v. Accumulator at 6 amps. ditto ... .. £5

**H.T. ELIMINATOR AND TRICKLE CHARGER KIT.**—Consists of a complete kit of parts to construct an H.T. Eliminator with an output of 120 v. at 20 mA. and provision for trickle charging a 2 v. accumulator. Two metal rectifiers are employed. With circuit, price 30/-.

**RADIOGRAM CABINETS.**—Dignified appearance and good workmanship. Size 34½in. high, 19 in. deep, 36in. wide. Send for illustration. Cabinet only, £26. With Electric Motor and Pick-up, £32/16/-.

**ROTARY TRANSFORMERS.**—Size only 7in. by 4½in. diameter. With 6 v. Input; o ut 200 v. 50 mA. With 12 v. Input; output 400 v. 80 mA. Price 20/-

**ROTARY TRANSFORMERS.**—With 12 v. Input; output 600 v. 250 mA. With 6 v. Input; output 280 v. 250 mA., Price £3.

OUR 1947 LIST IS NOW AVAILABLE. All enquiries must be accompanied by a 2½d. stamp.

ALL POST ORDERS TO: Jubilee Works, 167, Lower Clapton Road, London, E.S. (Amherst 4723.)  
CALLERS TO: 169, Fleet Street, E.C.4. (Central 2833.)



# Short Wave News

Vol 2 No 9

Annual Subscription 16/-

September, 1947

Editors:

ARTHUR C. GEE, G2UK

W. NORMAN STEVENS, G3AKA

Advertisement & Business Manager:

C. W. C. OVERLAND, G2ATV

## Editorial

ONE of the first articles I wrote for publication in an amateur radio journal was almost exactly ten years ago. Following a visit to S. America during which amateurs of many nationalities were visited in that cosmopolitan part of the world, a write-up of the trip ended with the plea that if more of the world's leaders had the "ham spirit," our world would not be plunged into what appeared to be an inevitably pending war. The war did come. The killing is now over, but much of the aftermath seems worse than we had expected, and one is reminded again of those words written ten years ago, appealing for a wider application of the "Ham Spirit."

Some of us have been wondering how our old friends in ex-enemy countries have been faring during recent years and we have been wondering when the original D stations will be on the air again. As we have said before, amateur radio is a medium "par excellence" for disseminating the "British way of Life" and an active participation in amateur radio would help greatly in introducing the younger German youth to better things than much of their early education has given them. It is good therefore to learn that Short Wave Clubs are being encouraged in both the British and American Zones of Germany. Our mail bag recently contained a most interesting letter from Waldemar Kehler, ex-D3FBA, giving details of the return to normal activities of the ex-D gang. The first post-war German amateur radio club was formed in the American Zone

in August, 1946 in Stuttgart. This was followed by the opening of other clubs in Bavaria and Hessen.

Reports from Shortwave listeners in the British Zone of Germany were first permitted to be sent in August, 1946, and QSL's from England began to arrive in September. Those who pour scorn on SWL's reports and QSL's please note this re-establishment of friendly relations through the medium of QSLing. The first club in the British Zone got its permit in May, 1947, and DARC (Deutscher Amateur Radio Club) came into being. Efforts are now being made to co-ordinate the activities in each zone so that a common front can be presented and the first German post-war amateur radio "get-together" was held in June last at Stuttgart.

The first material contribution to a better understanding has recently been accomplished. Karl Gamper, a SWL of some 15 years standing has recently formed the Vereinigung Deutscher Kurzellen Horer (V.D.K/W.H.) in order to stimulate the hobby in Germany as far as possible. The V.D.K/W.H. has applied for affiliation to the I.S.W.L. and we have accepted this application. Henceforth the V.D.K/W.H. will be the official German Chapter of the I.S.W.L.

We feel sure all our readers will extend a helping hand to those who are endeavouring to start up amateur radio activities in Germany again and are thus spreading the "Ham Spirit" which—we hope—may some day make future wars less likely. A.C.G.

## NOTICES

THE EDITORS invite original contributions on short wave radio subjects. All material used will be paid for. Articles should be clearly written, preferably typewritten, and photographs should be clear and sharp. Diagrams need not be large or perfectly drawn, as our draughtsman will redraw in most cases, but relevant information should be included. All MSS must be accompanied by a stamped addressed envelope for reply or return. Each item must bear the sender's name and address.

COMPONENT REVIEW. Manufacturers, publishers, etc., are invited to submit samples or information of new products for review in this section.

CHEQUES and Postal Orders to be made payable to "Amalgamated Short Wave Press Ltd."

ALL CORRESPONDENCE should be addressed to "Short Wave News," 57 Maida Vale, Paddington, London, W.9. Telephone CUN. 6579.

OUR MONTHLY PUBLICATION "RADIO CONSTRUCTOR" IS DEVOTED  
EXCLUSIVELY TO THE PRACTICAL SIDE OF RADIO

# V.H.F. News

## The Month's News

**A**LTHOUGH the "60 Mcs. season" is showing signs of waning, another good month has been enjoyed by those on the band. Both Sporadic E and tropo openings have been good and generally speaking there has been plenty of activity. Arthur Simons, G5BD, Mablethorpe, sent us the following log which indicates well the state of the band during the past month:—

- July 22—Wkd. G5BY, 2XC, 6DH, 8JO (South Shields).  
23—Sporadic harmonics up but no DX.  
24—F3HL heard for few minutes. ON4DJ heard.  
25—ZB2A Gibraltar worked.  
26—Wkd. F3HL, F8MG, F8ZE, I1DA. Hrd. HB9BZ, HB9BG, F8SN, F9BG, F8XP, I1AY.  
27—Wkd. PAoDX and GW6OK.  
29—I1AY heard.  
Aug. 1—OK4IBC heard.  
2—I1MAS worked.  
3—Wkd. I1DA, F3DN, I1IRA, F9BG, F3HL, F8CT, I1AD (?ADL). F9FT heard.  
4—ON4DJ heard.  
6—ON4DJ worked.  
7—ON4IF worked.  
8—F3HL worked. F9BG and ON4IF heard.  
14—PAoDX and PAoPN worked.  
15—SM5FS heard. Report received from SM5 SWL.  
17—ON4DJ worked.  
19—Wkd. G6YO, 2BJY, 8JV, 5LJ, 2ATK, 8QM/A, 5UM, ON4KN, PAoOKK, F8ZF and G8KZ.

5BD comments that August 19th was the best tropo conditions he has ever experienced during his eighteen months on the band. All contacts were S7-9 and the F8 in Boulogne, was the first tropo propagated F he has heard. 5BD has also received reports from Germany and Austria for June 30th. We have recently had news from Germany that 60 Mcs. activity on the receiving side is being well patronised by German amateurs who are of course not permitted to transmit at present. A number of British 60 Mcs. calls have been heard.

### More About Sporadic E.

We have come to associate Sporadic E propagation with the higher frequencies, 226

i.e. 28 and 60 Mcs., but there appears to be quite a lot of evidence that Sporadic E propagation can effect the lower frequencies—particularly 14 Mcs. On several evenings recently very short skip conditions have been experienced on 14 Mcs. when G stations a hundred or so miles apart have had S9 contacts. These QSO's have been very sporadic in nature, suddenly appearing, peaking rapidly and then quickly disappearing. A very cursory log check for instance showed that on June 26th, G2UK worked G4LW, GI3ML and GI2CON on 14 Mcs. Signal strengths peaked to S8 on each QSO, but all three QSO's were terminated by sudden QSB. These QSO's were made between 2025 and 2050 GMT on 14 Mcs. G5RF that evening worked SM1IA, F5MA, OH2NY and GM3BQN on 28 Mcs. GM3BQN was worked at 2035 GMT, so Sporadic E propagation was definitely taking place on 28 Mcs. that evening. It is hoped to collect more data on this subject and any logs of 14, 28 and 60 Mcs. activity suggesting Sporadic E propagation would be welcomed by your V.H.F. conductor. 14 Mcs. conditions on the evening of July 10th for instance suggest Sporadic E propagation. G2UK worked G8IL at a distance of 150 miles for a very good QSO S8 both ways and a number of SWL reports from distances between 100 and 300 miles were received for that evening. There are no reports of Sporadic E on 60 Mcs. that evening, but how about 28 Mcs.? Let's have some interesting data in on this subject.

### Going Up?

Interest in the higher frequency amateur allocations is on the increase. 8JV in Nottingham has been persuading a 955 acorn to go up to 475 Mcs., which he has succeeded in doing—and as he says, he has got it quenching so he now has the basis of a successful receiver. His next job is to persuade a CV82 to drop from 600 to 475 Mcs.! It seems a logical step to try and get some gear going on the "model control" frequency allocation before really stepping out to tackle the 2300-2450 Mcs. allocation.

G2MBI wants some dope on the CV67 Klystron. He wants the base connections (Octal), the min. and max. frequency of the rumbatron and the voltages required. We should like to hear from others who are trying to do something with these higher frequencies.

## Monitor Station and Area Reports

**South-East Area Monitor Station Report.**  
(J. Bramhill, G2BMI, 27 Oakleigh Rd., Hillingdon, Mddx.)

"As this is my last report as a SWL, my full call now having been allocated

(Congrats. O.M.—Editor), I should like to know if any SWL can improve on my record of 107 60 Mcs. stations logged during the last six months, with G. DX as follows:—2MA Rotherham, 140 miles; 2XC Portsmouth, 60 miles; 2NS Bournemouth, 84 miles; 41A Bolton, 165 miles; 4CF New Ormskirke; 5RQ Bristol, 100 miles; 5VA Stoke-on-Trent, 125 miles; 5MQ Liverpool, 180 miles. Locations taken from current Call Book, Receiver 1-v-1, 954-955-6V6. Aerials long wire and 3 element rotary beam. Any offers, SWL's?

"This month the regulars were:—G2MR, 2NH, MV, YL, LC, MA, WS, CUA, YQ, 3FD, NR, 4DN, KD, MR, 5AS, PY, MA, RD, WP, SZ, 6VX, OH, FO, LK, XM, 8KZ, ZD, GX, VB, SM and RS. Amongst the great activity this month, many newcomers have been noted such as:—G2BOK, AJ, LY, OI, PS, KP, AK, KF, AT, BMZ, 3KP, CR, CRO, AW, BL, ABA, ANT, MG, AP, 50J, MQ, QK, KH, WF, DM, BW, CD, 6JJ, ND, KZ, NB, KB, MN/A, SM, NS, 8FB, SK, NV, DS and DM. The high light for 60 Mcs. activity this month was the R.S.G.B. 60 Mcs. Field Day, when many old and new hams came out of the DX bands for a day in the country. QRM was terrific until all had sorted themselves out. For the benefit of SWL's here is a list of portable calls heard together with their locations:—3CRO/P Palmers Green, N.13. 3APY/P Crick, Derbyshire. 5MA/P Storrington, Sussex. 2CUA/P Dorking. 4NT/P High Wycombe. 8NV/P Wendover. 8QX/P Malvern Hills. 4AP/P Swindon. 8TS/P Farnham. 6NB/P Aylesbury. 5QK/P Rayleigh, Essex. 6OH/P Ascot. 2WS/P Westeham. 6YU/P Coventry. 8SK/P Tylers Causeway, Herts. 2AK/P Barr Beacon, Gt. Barr. 5JU/P S.W. Birmingham. 8SM/P Guildford. 6CW/P Leek. 2NH/P Alton. Who said 5 was dead?

"2WS wkd PAoPN, 6VX mentions QSO's with F8WO, ON4KN and ON4AE. 6XM wkd ON5G, ON4KN and ZB2A, 2AJ has either worked or heard I1BA, I1XW and F9DD.

"There is still no report from a SWL on 60 Mcs. Can't you get those receivers to work or what? This is just the band your reports would be appreciated on."

#### Scottish Area Monitor Station Report.

(A. H. Mason, GM6MS, 390 Kings Park Avenue, Rutherglen, Glasgow).

"The local boys have been pushing across to the Continent again. GM3PB has worked I1DA, who is now using MCW and phone as well as FM. He has heard HB9CD as well as several PA's and F's. He has

received a SWL card from an Austrian reporting his signals on June 30th. 3PB uses a dipole with reflector (¼ wave spacing) for transmitting and simple dipole for reception. The aerials are only 20 feet high and his steel house was between the aerials and the stations worked! GM8MJ and 8AH have also been heard on the Continent but no details are available."

#### East Coast

(From J. Booth, G2AJB, 33 Buller St., Grimsby).

"VHF activity in these parts is still low, the only stations active being G3TZ, 2AMK and 5GS. 3TZ heard HB, F, and I when the band opened on August 3rd, but didn't manage to raise anything. It was the first DX he had heard in 6 months. He and 5GS kept a vigil in the hopes of more DX but the band didn't oblige."

#### Midland Area Monitor Station Report

(N. White, G3IS, 59 Eastlands Rd., Rugby).

"In spite of all the other calls on ones time at this season of the year, local activity has continued at quite a good level. The R.S.G.B. 60 Mcs. Field Day on August 20th stimulated interest and 6YU (Coventry) amongst others had a good time making 16 contacts, the furthest being with 6OS (Hull) and 5MA/P (Sussex). In addition a further 35 stations were heard. 6YU's list of stations worked during the month gives some idea of present activity:—G2AK, AK/P, ATK, ATK/P, AOK, BMZ, NH, RI, XC, 3ABA, FD, IS, APY/P, 4BI, 5BY, MA, MA/P, PMQ, JU/P, RP/P, 6XM, VX, OS, HY, MN/A, CW/P, KZ, WL, JV, QX/P, F3HL. ON4DJ and FA8IH were heard and 6YU received a report from ZB1AC.

"8UZ also had a good time on Field Day. Out with 3APY/P they scored 283 points from 34 contacts in 18 counties. 8UZ managed to contact ZB2A on July 2nd and reports receiving his card 4 days later by air mail.

"4LU (Oswestry) has been very active working over 40 stations during the month, the best being OK3ID.

"6MN reports the reception for the first time of G5BY but regretted he did not make contact. He reports reception of some FM fone on 59.7 Mcs. This is loud enough to get the announcements, which suggests that it is a broadcast experimental transmission. He has been hearing it for several months.

"G3IS had 19 QSO's including I1XJ and F3HL."

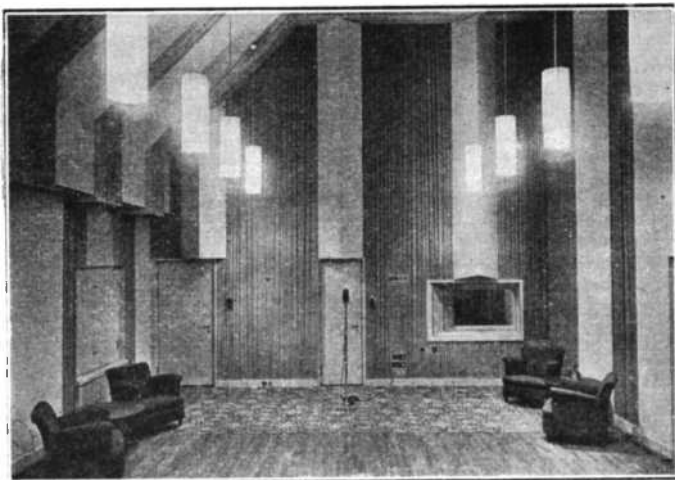

One of the many fine studios at "Radiotjanst."

# Around the Broadcast Bands

Monthly survey  
by "MONITOR"

All times are given  
in G.M.T.

(For BST add one hour; for  
EST subtract five hours; for  
AEST add ten hours.)

**C**ONDITIONS over the past month have been anything but ideal at your Scribe's QRA except for some good periods between thunderstorms and heavy QRN when Asiatics were well received. Signal strength, though, has been down on many of the "best bets." Now that we are back on BST again, late evening listening will become more attractive as the days close in.

Reports and any news for this column is always appreciated and should be sent to: "Monitor," c/o "S.W.N." to reach me by the 5th of the month or earlier. Now for the news of the month:

## ● Africa

**Dakar.** Sidney Pearce (Berkhamsted) reports that he has just received schedule of "Radio Dakar" as follows:

Freq. 11715 and 7210 kcs. No mention of 16 metre channel. 0715-0730 1st news. 1215-1230 Music. 1230-1250 2nd news. 1250-1300 Music. 1845-1930 Light music, Songs. 1930-2000 3rd news. 2000-2010 News in Onoloz (native language). 2010-2115 Classical music, Concert, etc. 2115-2120 News in brief. 2120-2200 Dance music.

**Leopoldville.** "Radio Congo Belge" (BNBS) heard giving programme for listeners in the British Isles from 2030-2145. Now over 17770 and 9745 kcs. channels in parallel. Announces as over OTC5 . . . 17 Mcs. freq. OTC2 reported as the 9 Mcs. channel and heard from 2300 by J. Lown in Belfast.

**Mozambique.** CR7BJ Lourenco Marques "Radio Clube de Mozambique" 9645 kcs. heard with R7 signals at 2030 when signing off. (Pearce).

**Omdurman.** "Radio Omdurman" 13320 kcs. now gives English programmes on Fridays at 1730-1800. Announces as in parallel 31.09 m. channel. (Pearce).

**Brazzaville.** FZI "Radio Brazzaville" 6025 kcs. heard at 2300. (Lown).

**Addis Ababa.** ETAA 1507 kcs. now gives test transmissions afternoons and evenings, with Eastern and Western recordings. Very often signs off at 2000. Announces in English as "Radio Addis Ababa" and sometimes as ETA Radio Addis Ababa. Heard by your scribe at 1900-1955 with programme of Western music and close. Signals were R8 with CW QRM. Frequency appears to vary around 15060 kcs. R. F. B. Featherstone of Nakuru, Kenya Colony, whom we welcome to this column reports them on 15040 kcs. approx. at 0800-0900 with R9 QSA2 signals. D. O. French in Norwich says they use 7 kW. power with a Rhombic or Diamond aerial.

**Nairobi.** Letter veri received for reception on 4885 kcs. freq., but often nearer 4860 kcs. and maybe looking for a clearer channel. (Pearce).

## ● Asia

**Saigon.** "Radio Saigon" 11778 kcs. heard R7 QSA4 at 1400 states R. F. B. Featherstone. (Suggest you send a direct sub. for "S.W.N." if you have difficulty in getting it in Kenya, O.M.) He adds that his QRA is 120 miles N.W. of Nairobi and alt. 6000 ft. RX is a SH8 Marconi 822 with 100 ft. aerial about 50 ft. high. By his reports this month he certainly hears the DX down there! Hope to have more news from you O.M.

China. P. Jupp ISWL/G160 sends in schedule of XGOY "The Voice of China" in Chungking as follows:

Areas served are N. America and Europe on 15170 and 7153 kcs.

Programme Preview, News in Cantonese ... ..	1245
News in English ... ..	1300
News in Mandarin ... ..	1315
Chinese Music (Mon., Wed., Fri.)	1330
Chinese Songs (Tues., Thurs., Sat.) ... ..	1330
News Headlines in Mandarin ...	1355
"Bringing Christ to the Nations" (Sun.) ... ..	1330-1400
News in English ... ..	1400
Foreign Ministry News in code (Sun.) ... ..	1400-1435
Symphony Hour ... ..	1415
News in English ... ..	1500
News in Mandarin at dictation speed ... ..	1515
National Anthem ... ..	1545
Close of transmission ... ..	1550

Reports should be sent to: Station XGOY, Chinese International Broadcasting Station, Chungking, China.

Heard R9 QSA3 on 11913 kcs. at 1415-1545. News in English at 1500. (Featherstone).

Singapore. British Far Eastern Broadcasting Service send schedule as follows: 0830-1700 hrs. on 11735 and 6770 kcs. (Orange Network), 15300 and 15275 kcs. (Purple Network). Commences 0800, Sat., Sun. Also operates at 0530-0630 when it relays news in English from "Radio Malaya." (Pearce). (This is GMT O.M.) Heard by your scribe with English news at 1645. Signals were R9 QSA4 on 15275 kcs. channel R6 QSA3 on 15300 kcs. Latter suffers bad QRM from a Moscow station on around 15295 kcs. Uses Male and Female announcers. Sends plain QSL card. Verifies promptly in about 14 days via Air-mail.

Jokjakarta YHN "The Voice of Free Indonesia" 11000 kcs. heard with American recordings. Transmission beamed to East Coast of U.S.A. at 1730. R9 signals with bad CW QRM. Sent QSL card (call in red letters covers whole of card). Stamped in Singapore on June 30th! Rubber stamp gives senders as: C. A. Hire, Ships, Sale, Charter and Management, 4 Laidlaw Building, Singapore. Reports on YHN are appreciated. QRA: Indonesian Broadcasting Centre, 10 Setjodiningraten, Jokjakarta, Jawa. Republic of Free Indonesia. (Scribe).

Colombo. Radio SEAC has been heard at 0800 on 17770 kcs. R9 QSA5 also on 15120 kcs. (Featherstone).

## BROADCAST STATION COUNTRY PANEL

### No. 14: PERU

(NOTE.—This is the official list of active Peruvian stations. We would greatly appreciate readers reports on the signals of any of the stations listed. As most of the stations are very low powered they represent REAL DX. Details of QSL's received in the past from CP stations would also be appreciated.)

Freq.	Call	Location	Slogan	Power (watts)
6060	CP47	Cochabamba	Radio Popular	100
6070	CP18	Oruro	Radio el Condor	250
6085	CP9	RESERVED FREQUENCY		
6100	CP30	RESERVED FREQUENCY		
6110	CP2	La Paz	Radio Nacional	500
6120	CP15	La Paz	Radio el Condor	1000
6130	CP22	Potosi	Radio Internacional	unknown
6140	CP58	Tupiza	Radio Chorolque	130
6150	CP12	La Paz	Radio Fides	250
6160	CP39	Cochabamba	Radio el Mundo	250
6170	CP23	Tarjia	Radio Guadalquivra	600
6190	CP37	Oruro	Radio Oruro	250
6200	CP5	La Paz	Radio Illimani	1000
9500	CP1	Sucre	Radio Chuquisaca	350
9505	CP38	La Paz	Radio Nacional	500
9510	CP24	RESERVED FREQUENCY		
9550	CP13	La Paz	Radio Municipal	500
9570	CP21	Sucre	Radio la Plata	350

**I.S.W.L. BROADCAST**

Here are the final details of the special I.S.W.L. transmission over "Radiotjanst" short wave stations:

DATE: OCTOBER 12th (Sunday)

TIME: 1930-2000 GMT.

FREQUENCIES: SBT, 15155 kcs. and SDB2, 10780 kcs.

Don't miss this broadcast, O.M.'s and please send along reception reports for the transmission direct to I.S.W.L. Headquarters. We will mail the complete reports to the station, as we did with the "Radio Australia" dedicatory broadcast.

Recordings of the programme will be made and sent to the station, just another service! Closing date for reports on this session is OCTOBER 19th. That's all, so let's hear how you picked up our second dedicatory programme, O.M.'s.

● **Australasia**

Sidney Pearce states that the BC to East Coast of U.S.A. is now given over VLC 15200 kcs. . . a new station . . . at 0000-0115, from June 16th. From June 23rd BC to Pacific and India from 1330 and British Isles at 1500 . . . VLC9 replaced by VLC4 15320 kcs. BC to Europe and British Isles 1745-1915. . . VLC11 replaced by VLC4 also. Has bad QRM from Canada. In parallel VLA8 11760 kcs.

Your scribe has heard: VLC4 R9 plus QSA5 at 1400, VLB4 11810 and VLA6 15200 at 1405 signals being R8 QSA5 with programme beamed to North Pacific and India. VLA6 also heard at 2115 R8 QSA4 carrying 1st BC for Forces in Asia and Pacific areas. VLC9 17840 kcs. in parallel with experimental transmission to South America. Both stations come on the air at 2110 with Musical Box rendering of "Waltzing Matilda." VLB 9540 kcs. VLA8 was R9 QSA5 at 1900. VLB appeared to be jammed. VLG7 of the ABC 15160 kcs. was heard at 2100 with morning "Physical Jerks" programme. R7 QSA4 with some CW QRM.

● **North America**

San Francisco has added several 21Mcs. stations to its network in KCBA 21740 kcs. and KCBF 21460 kcs. Both close at 0430. KNBA 21630 kcs. to 0700 KGEI 21490 kcs. to 0600 (Arthur Cushen).

● **South America**

LRX Buenos Aires 9660 kcs. heard R7 with recordings at 2154, LRX1 6120 kcs. R8 at 2153 with call "Radio El Mundo"

230

and Latin American music. LRS "Radio Splendid" 9315 kcs. R8 at 2130.

Frank Smallwood reports these Buenos Aires stations on his Mullard MAS281 RX with a 25 ft. vertical aerial.

● **West Indies**

**Port-of-Spain.** VP4RD tests 1100-1120 on 9635 kcs. and later moves to 6085 kcs. Heard at 0000-0015 in Kenya. Reports appreciated to: Broadcasting House, Port of Spain. (Featherstone). Your scribe believes that they have had transformer trouble there and are now awaiting replacements from the States. Hope to start regular BCs from August 31st if gear arrives in time.

**Havana.** COBQ "Radio Progreco" 9360 kcs., COBL "Radio Cadena Suarites" 9835 kcs., COCX "Emisora del Pueblo" 9273 kcs. all heard signing-off at 0500. COKG "Cadena Oriental de Cuba" Santiago 8955 kcs. signs off Mon.-Sat. at 0500 also with call in English but on Sundays to 0600.

COBZ "Radio Salas" Havana 9025 kcs. R7 to sign off at 0600 with English. COCQ Havana relaying CMQ 8825 kcs. often strong after 0500 but suffers C WQRM. (Pearce sends in this excellent log of Cubans. We wish other readers would use the same FB layout as he does when sending in reports. Then your scribe would be able to get a good night's sleep!)

Another newcomer who hails from Leeds . . . F. Smallwood . . . sends in a very neat list of DX heard at his QRA. Sorry we can't use all of it this month O.M. He lists COKG with R8 signals at 0500, COBZ R6 at 0600 and COH1 Havana 6450 kcs. heard closing with call "Radio Havana, Cuba, Cadena Azul" at 0600. Signals were R7.

● **QSL Section**

Your scribe from: VLH3, VLH5, YHN. G. S. Gilham-Dayton: HCJB (after 8 months!), HER6, PCJ. Sidney Pearce: Ponta Delgada, Singapore, Paris, VQ7LO, LKV, Radio Sofia (new QSL showing map of Bulgaria), CSW6, CSX, WGEX, WGEA (21 Mcs.), Hambourg (50 kW.), Radio Wein and OIX4.

● **Acknowledgements**

Arthur Cushen (Invercargill, New Zealand), Sidney Pearce BSWL336 (Berkhamsted, Herts.), G. S. Gilham-Dayton (Aylesbury, Bucks.), Frank Smallwood (Bramley, Leeds), R. F. B. Featherstone (Fovant, Kenya Colony), P. Jupp ISWL/G160 (QRA O.M. Pse), J. Lown (Belfast, N. Ireland), also other readers who have kindly sent in news and logs.



# Variable Frequency Oscillators

By Dr. S. O'Hagan, G2CR.

(Editorial Note:—This article is the fourth in the series by G2CR. Previous articles have been "Crystal Oscillators" (June, 1946), "Frequency Multiplication" (October, 1946) and "Power Amplifier Design" (February and March, 1947).

THE ideal V.F.O. should be capable of producing a crystal-like drive for the transmitter on any frequency desired and the actual frequency should be determined by the setting of the V.F.O. dial; nothing else should affect it at all. It should be simple to construct and adjust, in the first place, and it should be easy and foolproof to operate, and not lose its accuracy, even with no more careful handling than is given a broadcast receiver.

All V.F.O.'s have, as their heart, a tuned circuit, upon the perfect stability of which depends the performance of the oscillator as a whole. The principles for obtaining stability of the tuned circuit are the same for all types of oscillator and only the method of maintaining oscillation varies from circuit to circuit.

The principal causes of unintentional frequency changes in the oscillators are as follows:

- (a) Mechanical changes in components and their positions in relation to each other.
- (b) Temperature changes, affecting the tuned circuit directly and also affecting the associated valve.
- (c) Humidity changes, affecting predominantly the tuned circuit.
- (d) Changes in the voltages supplied to the valve.
- (e) Changes in loading of the oscillator.

The degree to which each of these factors affects any oscillator is determined by its initial design and construction and all may be very greatly reduced, by forethought in design, at very little extra cost.

Mechanical changes include such things as loose turns on the coil, vibrating condenser vanes or wobbly bearings, bending of the chassis, panel, etc., and these all may produce unpredictable changes in frequency, perhaps quite large ones, together with an unstable note when keying vibration upsets the frequency. The proper way of dealing with the mechanical problem is to mount all the tank-circuit components on the same piece of heavy metal, using the most rigid fixings available. It is convenient to build the tank circuit in a strong metal box with the valve socket on top and the valve itself projecting out of the top. The box should be no larger than required to house the coil, tuning capacitor, silver-mica padders, ceramic temperature-compensating capacitor,

and a small air-trimmer for adjustment of calibration. A box, of brass about 14 gauge, 5in. x 3in. x 3in. is suitable in most cases. One 5in. x 3in. side, destined to become the bottom of the box, and perhaps one end, should be detachable but the rest of the box should be firmly sweated up to ensure rigidity.

The coil should be wound with silk or cotton covered wire on a small ceramic former and the windings secured with polystyrene dope or better still tropicalizing wax impregnation after thoroughly drying in the kitchen oven. Very heavy wire is difficult to wind and secure tightly, and a compromise may be made at between 20 and 26 S.W.G. The small *Formo* ceramic coil-formers are suitable and may be mounted in the box by means of long 6 B.A. screws and spacers through the holes at each end of the former. A spacing of  $\frac{1}{16}$ in. from the box will suffice.

The tuning capacitor should have small vanes, preferably straight-line capacitance type, ceramic insulation and an absolute freedom from end or side play in the bearings. The tuning capacitor is most susceptible to vibration and damp so its capacitance should be no more than necessary to cover the desired tuning range.

The effect of temperature upon the tuned circuit results in two types of frequency drift: firstly a day-to-day change in frequency for a given dial setting and secondly a fairly rapid drift to a lower frequency in the first hour or so after switching on. In every case, an increase in temperature causes an increase in size of both coil turns and capacitor plates so that both capacitance and inductance increase with temperature and frequency decreases. Over the limited frequency range represented by any amateur band the thermal drift can be compensated by arranging for part of the fixed padding capacity to be of the special negative-temperature-coefficient ceramic type. The exact proportion to be used in each case must be found by trial and error if perfect compensation is sought, but between 5 per cent. and 10 per cent. of the total capacitance is a good place to start and will usually reduce the drift to a degree that the average amateur will ignore. Since the coil usually suffers most from heating it is good to mount the tiny ceramic capa-

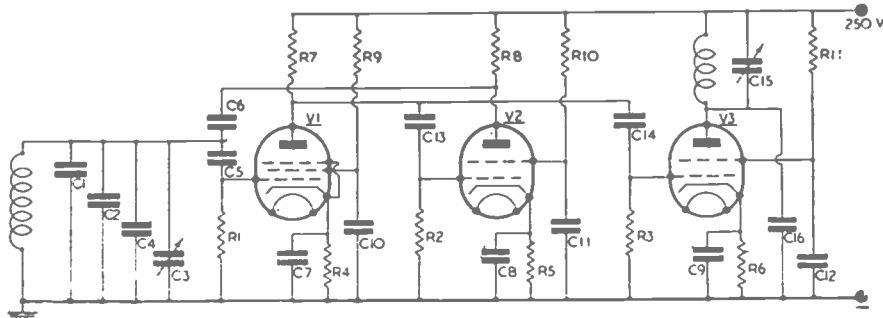

The Franklin Oscillator and Buffer Stage

C1	80 $\mu\text{F}$ (temperature compensating)	R1	2 Megohm $\frac{1}{2}$ watt
C2	560 $\mu\text{F}$ silver-mica	R2, R3	.5 Megohm $\frac{1}{2}$ watt
C3	125 $\mu\text{F}$ variable	R4	450~ 1 watt
C4	30 $\mu\text{F}$ (calibration trimmer)	R5, R6	400~ 2 watt
C5, C6	0-2 $\mu\text{F}$ variable. See text	R7, R8	10000~ 5 watt
C7, C8, C9	.01 $\mu\text{F}$ mica	R9, R10	30000~ 2 watt
C10, C11, C12	.002 $\mu\text{F}$ mica	R11	20000~ 2 watt
C13, C14	100 $\mu\text{F}$ mica	V1	EF50, 1852 or SP41
C15	60 $\mu\text{F}$ air trimmer	V2	6V6, 6F6, etc.
C16	.002 $\mu\text{F}$ mica	V3	6V6, 6F6, or 6L6

citor inside the former where it will heat and cool at about the same rate as the coil. Mounting the valve and all other heat-generating components outside the metal box will help to avoid rapid changes in temperature inside and helps a lot. The only resistor inside the box should be the grid leak. For the same reason it is good practice to avoid a closed cabinet for the whole V.F.O.; protection of all important components can be provided by separate screening cans for the output coil of the buffer stage and completing the screening given by the main chassis by fitting a metal bottom to it. If a cabinet is essential for protection, then it should be very fully ventilated by louvres at top and bottom.

The effect of heating inside the valve is to cause expansion of the electrodes, with consequent increases in inter-electrode capacities. In the case of an electron-coupled oscillator of conventional design, the cathode is above earth potential to R.F. and the heater is earthed, so that the heater-cathode capacitance is across the part of the tank circuit between the cathode tap and earth. This capacitance is quite small but it heats up about 800 degrees C. and since the insulation is ceramic the change in capacitance can be significant.

This drift occurs very quickly after switching on and stops after a few minutes. However, since the anode voltage is generally removed from the V.F.O. during receiving periods the heating due to anode dissipation occurs only during transmis-

sions, with the result that the frequency creeps during each transmission and slips back during each reception period. This is most annoying to the receiving operator on the higher frequency bands and it is common for him to have to keep his hand on the dial of the receiver all the time.

The effect of valve heating is minimised by the use of a very high total capacitance across the tank coil so that the changes due to the valve represent only a minute proportion of the whole. A total tank capacitance of 1000  $\mu\text{F}$  is optimum for the 1.7 Mcs. band. It would be proper to use the same capacitance on the higher frequency bands too but this is impracticable, as will be shown later. Since the reduction of drift from heating depends on the actual number of picofarads not on the L/C ratio, it follows that if the capacitance has to be reduced to give a reasonable L/C ratio, then thermal drift must increase. The effect, then, is that less drift is experienced when driving a 14 Mcs. transmitter from a good V.F.O. on 1.7 Mcs. than on 3.5 or 7 Mcs.

Changes in atmospheric moisture change the dielectric constant of the air between the plates of the tuning capacitor, between the coil turns and between the rest of the wiring of the circuit, changing the capacitance across the circuit and hence the frequency. The coil is dealt with by thorough drying in the oven and impregnating with a waterproof wax such as that used on "tropicalized" components or with a heavy coating of polystyrene varnish. The wax

has the advantage of better adhesion to the wire, thus preventing a film of moisture creeping in. The thorough drying first is essential because in this country the cotton insulation material absorbs quite a lot of moisture which, if retained, might spoil the effect of the wax. The capacitors that have air dielectric cannot be treated against moisture and the best method to tackle the problem is to use waxed silver-mica types for the bulk of the required capacitance, leaving only enough air capacitance to tune the required range. If the V.F.O. is to drive the 14 Mcs. transmitter it is unwise to expect it to tune also the whole of the 1.7 Mcs. band. It would be better to make the "principal V.F.O." cover only the limited range that the 14 Mcs. band represents on 1.7 Mcs. and to use a separate simpler oscillator for the 1.7 and 3.5 Mcs. transmitters. The latter would not require the same precision of building as the main one, since frequency-shift would not be multiplied up to the same extent.

The tuning dial of the V.F.O. may vary according to taste . . . a simple slow-motion dial with a ratio of about ten to one will serve if the receiver is capable of accurate calibration, but the best available vernier scale, or a PW-O type drive, as used on the HRO receiver would be chosen if the V.F.O. was to calibrate the receiver rather than the reverse. Direct calibration in frequency is valuable for rapid operation, especially in stations with more than one operator.

Voltage changes on the oscillator have a serious effect on frequency stability and the various special circuits for V.F.O.'s have as their object the reduction in frequency-shift from this cause.

The simplest way of avoiding frequency shift from this cause is to use batteries or a voltage-regulator tube to give a constant voltage supply to the oscillator. Apart from this method, the circuit of the tuned anode oscillator reduces the effect by placing the tuned circuit in the anode lead from the valve, since this is less affected by voltage changes than is the grid circuit.

The design of the tuned circuit itself plays a part in determining the voltage stability of the oscillator. A very high-Q circuit inherently resists frequency-shift from all causes. But high-Q means low-C in a lightly-loaded circuit such as an oscillator tank circuit, and thus it conflicts with the high-C required to reduce valve-heating effects. If it be assumed that a tank capacitance of 1000  $\mu\text{F}$  is desirable for the latter reason, then obviously that will represent a higher L/C ratio at 1.7 than

at 3.5 Mcs. and so voltage stability can be made better by working at the lowest practicable frequency. The Q of the tuned circuit is also affected by the loading placed upon it by the valve electrodes to which it is coupled. The grid imposes a heavier loading than the anode unless the grid-leak resistance be kept extremely high. In any circuit where the tuned circuit is across the grid of the valve the leak resistance should be not less than one megohm. This applies especially to the E.C.O. and the Franklin, although it will be found that many designs are still published with leaks of only 0.1 megohm or less. In every case, however, a marked improvement in stability results from increasing the resistor to one megohm. The tuned anode oscillator is less affected since there is a step-down effect in the tickler coil that drives the grid.

The E.C.O. takes advantage of the fact that shifting the anode and screen voltages in the same direction produce opposite effects on oscillation frequency and by properly proportioning those voltages, the effect of supply voltage changes can be made to cancel over a considerable range. The Franklin relies upon a very high gain in the two stage oscillator-amplifier and extremely weak coupling to the tuned circuit is required to maintain stable oscillation.

The grid-leak should be at least one megohm and the coupling capacitors to and from the tuned circuit must not exceed 2  $\mu\text{F}$  as a maximum and the smaller they can be made without stopping oscillation the better is the final stability. The Franklin will not work with reasonable stability above 3.5 Mcs. since the gain of the resistance coupled stages falls rapidly and if an R.F. choke is added there is a risk of phase-shift with consequent loss of stability.

The changes in frequency which may occur when later stages of the transmitter are tuned through resonance are minimised by operating the oscillator always at half the lowest operating frequency of the transmitter and following the oscillator by a doubler stage. In the case of the E.C.O. the anode circuit of the E.C.O. itself may be tuned to the second harmonic and thus, if absolutely necessary, the separate buffer-doubler may be omitted. This accounts for the relative excessive popularity of the E.C.O. over other circuits. However, tuning the anode circuit does shift the frequency to some extent and in any case the power output is very small so that little is lost and much is gained by choke-coupling the anode of the E.C.O. to the following stage which then gives quite good output on the second harmonic. Ideally the stage

following the oscillator should not have any grid-current flow. This is ensured by using fairly high cathode bias and a grid-leak of not less than a quarter megohm. For reasonable output the buffer stage should have a fairly long grid base. A 6L6 works well and with only 220 volts on the anode will give two or three watts output on 3.5 Mcs.

It is not generally desirable that the buffer stage should be called upon for much more than this power, since some of the anode circuit output may be fed back to the oscillator unless the buffer valve is a well screened type; practically the only suitable type for more than low power is the 807. The RK25, etc., is not so suitable since its lower mutual conductance results in lower output with the limited drive given by the oscillator, and increasing oscillator voltage to get more out would increase drift. It may be safer to use an untuned buffer stage with good isolating properties and slight power gain between the oscillator and the output buffer. A 6SK7 or 6F6 will be suitable. In the case of the E.C.O. the buffer action of the anode circuit is enough and the 6L6 output buffer may be run at full voltage without greatly affecting the oscillator provided that screening and bypassing is good and the load is tightly coupled.

### The practical set-up of V.F.O's

Much of the practical aspect of the problem has been already dealt with, but the individual adjustments of each type for maximum stability should be done in a systematic method, not taking anything for granted. An hour or two's work at the out-set will make all the difference between a V.F.O. to be proud of and irritating mediocrity.

The Franklin Oscillator is also easy to adjust but it is limited to frequencies below 4 Mcs. It will work at higher frequencies with high-slope R.F. pentodes but only at the sacrifice of stability and so it becomes markedly worse than the tuned anode circuit.

The circuit is often shown using 5  $\mu\text{F}$  coupling capacitors and 50,000 ohm grid-leaks. This is quite wrong and there is no sense in using the relatively complicated Franklin circuit if its working is to be spoiled by damping the tuned circuit with so heavy a load.

The grid-leaks should be at least one megohm, and then the coupling capacitors can be cut down to 1  $\mu\text{F}$  or less with increased stability. Such tiny variables are

best made at home from a strip of polystyrene on which are mounted two brass angles with opposed faces  $\frac{1}{16}$  in. square and spaced a variable distance according to the required capacity. Slotting the feet of the angle-brass for the fixing screw allows adjustment. Alternatively, aluminium plates may be mounted on stand-off insulators and rotated or bent to give the required adjustment. However made, these capacitors must be rigid and not alter their capacitance with vibration, etc.

The anode load for the valves should be low to minimise phase shift and 10,000 ohms is usually the optimum for amateur use. The use of R.F. chokes as additional anode loads is undesirable since phase shift and consequent instability is difficult to predict and may be severe in some cases. It may be found that better results are given when the second valve has a larger power-handling capacity than the first, and the 6SK7-6V6 combination works well. The point here is that the first valve has not enough output to drive the second valve into the grid-current region and the long-grid-base types give more output without their grids going positive, and so the output coupling capacitor back to the tuned circuit can be reduced. Output is taken from the Franklin via a third valve, similar in type to the second, and with its grid driven in parallel with the latter. Its anode circuit should always be tuned to the second harmonic unless the valve has excellent internal shielding and the operating frequency is not higher than 1.7 Mcs.

In setting the Franklin to work the only adjustment is to start with the capacitors at minimum and increase them step by step until the oscillator oscillates smoothly across the band.

No more capacitance must be used or the note will become poor and squegging will occur. The Franklin is very easy to adjust, since with the foregoing routine adjustment it either operates at best stability or not at all.

---

### URGENTLY REQUIRED

Data on (a) any unusual QRN or QSB; (b) any noticeable increase/decrease in Q/K of given stations; (c) any deviation of beam arrays from normal bearing. For the periods below:—

May, June and July, Aug. 20th-28th, Sept. 14th-Oct. 3rd, Oct. 12th-18th, Oct. 22nd-30th, Nov. 7th-14th, 23rd-29th, Dec. 21st-30th, 1946.

This is very important so let us hear from you. Mark envelopes "Astro-Physical Section."

# Radio Amateurs Examination Course

By D. Warner

## Part 7: *Radio Wave Propagation*

**R**ADIO waves travel at the speed of light (300,000,000 metres per second in free space) and consist of electromagnetic and electrostatic fields, the lines of force of which are at right angles to each other and to the direction of propagation of the wave. When a wave is spoken of as being "polarised" vertically or horizontally, the plane of polarisation is considered as that of the electrostatic field.

The plane of polarisation is determined initially by the form of the transmitting aerial. Normally transmitting aeriels are designed to provide vertical polarisation, because a horizontally polarised wave travelling close to the ground tends to be short circuited by the ground. The polarisation of a short wave may, however, vary during its travel, the variations often being very rapid and giving rise to quick fading at the receiver.

Radio waves, in common with light and other electromagnetic waves may be reflected, defracted and refracted. Reflection may occur when the waves strike an object having a dielectric constant which differs from that of the medium in which the wave is travelling. The surface of the earth, and certain upper ionised layers of the atmosphere are capable of reflecting radio waves. Even quite small objects will reflect ultra-short waves and produce a strong "return signal." A striking example of this is the ghost image seen on a television screen when a passing aircraft provides a reflected signal. The same phenomenon, of course, forms the basis of radar identification.

Defraction is the phenomenon which permits waves to be bent round the side or edge of a hill or other obstacle, and accounts for the fact that signals can sometimes be received at points which are in fact shielded from the transmitter by some obstruction.

### The Upper Atmospheric Layers

The refraction of radio waves is due to the fact that a certain region of the upper atmosphere, termed the Ionosphere, consists of a number of layers of free ions and electrons. Each layer comprises a relatively dense region of ionisation which tapers off above and below. Refraction, or change of direction of the wave front occurs at these layers of ionised air because waves travel

faster in these regions than in non-ionised air. That portion of the wave-front which first enters the layer therefore travels a greater distance in a given time than that part of the wave-front which enters the region later. The general direction of travel is thus bent towards the earth.

Refraction is considerable for long waves but decreases rapidly as the frequency increases. It also varies with the degree of ionisation. For a given density of ionisation there is a critical wave length, below which the wave penetrates the ionosphere and is not returned to earth. Due to the action of the sun's ultra-violet radiation, ionisation is greater by day than at night. A higher wavelength is required, therefore, to cover a given distance by night.

Generally speaking, waves below 10 metres are not returned to earth from the ionosphere, but in certain circumstances they may be refracted at the junction of adjacent air masses having dissimilar characteristics and therefore different dielectric constants. This lower region is termed the troposphere.

Radio waves may thus be classified into three main groups.

- 1—Those returned by refraction from the ionosphere
- 2—Those returned by refraction from the troposphere
- 3—Those which follow the earth's contour.

The latter group are those normally used for local reception on the medium and ultra-short wave length. Medium waves, owing to their relatively rapid attenuation, are seldom refracted from the upper layers in sufficient strength to be of use. The ultra-short waves, on the other hand, penetrate the ionised layers and are not refracted, and it is therefore usually necessary to design the transmitting aerial so that the radiation is concentrated in a horizontal direction.

The distance from the point at which the ground wave is so attenuated as to be non-receivable and the point where the refracted wave commences to be receivable is known as the "skip distance" and in this zone the signal cannot be heard. When very long distances separate the receiver from the transmitter, the refracted wave has to make several "hops" as illustrated in Fig. 1.

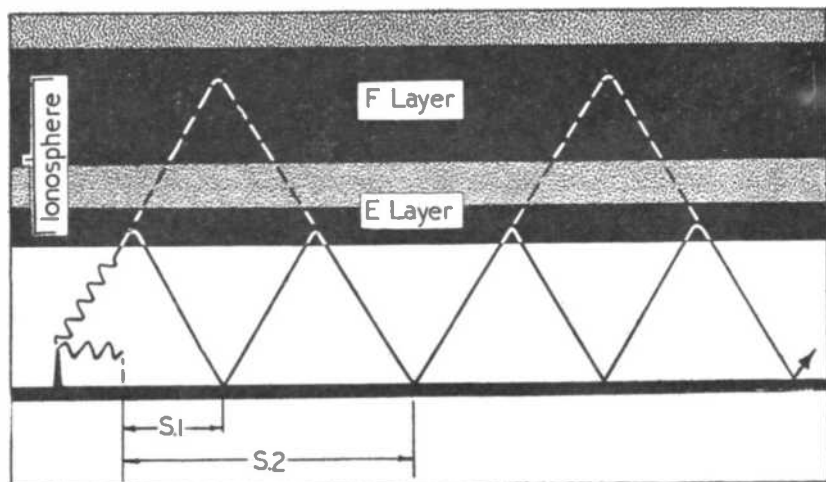

Fig. 1. Diagram showing the variation of signal paths by day and by night. The full line shows the daylight path and the dotted line the night path. Skip distance is S1 during daylight and S2 when the night path is in effect.

### Fading

One cause of fading has already been mentioned, namely the variation of the plane of polarisation. A more common cause, however, is the simultaneous reception at one point from the same transmitter of two waves which have travelled by different routes. Unless the lengths of the two paths are such that both waves arrive in phase (i.e. crest with crest) the phase difference between the two signals will result in a reduction in the signal strength. Because there are always slight variations in the lengths of the two paths, the phase difference may vary between in-phase and anti-phase, and the signal strength will correspondingly vary between a maximum and zero.

A third form of fading known as "selective fading" occurs when transmission conditions vary for signals of slightly different frequencies. In these circumstances some of the side-bands may have a different relationship to the carrier at the receiver to that which they had at the transmitter, and in addition to fading, severe distortion is introduced.

### Field Strength

The field strength of a transmission at any point is the strength of the electrostatic field, and the unit of measure is the

volt per metre. A field strength of one volt per metre is that field which induces a potential of one volt in a straight aerial of 1 metre effective length, located perpendicular to the direct of the field.

Field strength measurements in short waves may be made with a small frame aerial, the reading of the voltage induced being taken when the aerial has been turned to the position which gives maximum response. The actual field strength can then be calculated from the formula:

$$f = \frac{E\lambda}{2\lambda N} \quad \text{volts per metre}$$

- where E = Induced voltage
- λ = wavelength in metres
- A = area of loop in sq. metres
- N = number of turns

The induced voltage may be measured by substituting a signal generator for the aerial and determining the signal voltage required to give the same response as that obtained with the aerial. Alternatively, the aerial and its associated receiver may be calibrated with the aid of the signal generator.

# The QRP Contest

G6ZN Wins with 803 points

## An analysis of results

By G2SO

**A**S scheduled in an earlier issue of the "Short Wave News," the QRP Contest took place over the week commencing 2359 hrs., 19th July to 2359 hrs. 26th July last. Eight competitors took part, but it is known that several more competitors entered, and owing to the fact that they considered their score rather low, or that they could not spare the necessary time, did not submit logs. This is a great pity and it is hoped that in any future Contests of this kind, all competitors will send in their results regardless of their score; either large or small. The idea of the contest is no doubt familiar to many, but for the benefit of newcomers a brief description of the Rules will not be amiss.

The major Rule of course is the question of power in a contest of this description, and it was therefore decided to restrict the HT supply to a 120 volt HT Battery of standard size. The wattage of course was left to the competitor, but from past experience 3 watts appears to be the maximum obtainable, in fact, between one and two watts seems to have been the average power used during the week. The scoring was quite simple, and seems to allow all contestants an equal chance thus: Number of contacts multiplied by the number of countries, i.e., 100 contacts x 2 countries: 200 points, or 10 contacts x 10 countries: 100 points. All bands could be used with the exception of 56 Mcs., this band of course not being suitable for an HT supply of this kind, where one would require several stages of frequency doubling, etc., and a battery could not be expected to last for long with too many mills in use! As mentioned above, the hours of operating were limited to 168, and if any contestant put in the maximum hours allowed, he certainly deserved to be the winner!

Now to the results. The winner was G6ZN of Horbury, Yorks, already a well-known low power exponent, and he is certainly to be congratulated upon his fine achievement. He used three bands, but the majority of his contacts were obtained on eighty metres, having had 64 QSO's on that band alone, 6 on 1.8 Mcs., and 3 on 7 Mcs. On the former band he had contacts with nine countries viz.: G, PA, OK, GW, SM, GM, ON, D and OZ; on 1.8 Mcs. G and GD, rounding things off with G, GI and

GM on 7 Mcs. The transmitter consisted of a Hartley oscillator, the input ranging from between 1 and 2 watts. Aerials in use during contest were 135 ft., and 270 ft., both end fed. Ideal aerials for the low frequency bands. The best contact apparently being that with OK2WK, Vysrov. G6ZN's results with a self excited oscillator will certainly interest many of the keen crystal control fans, and it is interesting to note that with the exception of two QSO's all reports were T9, the other two being T8. He scored a total number of points amounting to 803, and his log was not "blue pencilled" in any way. Second place is held by G3XT of Saxmundham, another very well-known low-power operator, and he submitted a very fine log, with very comprehensive information, amounting to 472 points. Unfortunately three of his contacts were not accepted owing to the fact that either no reports were exchanged, or that the report was doubtful owing to bad QRM. This operator used 7 Mcs. exclusively, and his total number of QSO's amounted to 59 different stations. This is certainly very good when one considers that all these contacts were on the so-called "Beginners and Fone" band, which as everyone knows is usually very heavily congested with telephony and so-called "fone" stations. G3XT had contacts with G, GM, D, ON, GW, GC and HB, the latter being perhaps the best DX worked. GI was contacted, but no reports are given in Log. Third place is held by a newcomer namely G3BDQ of Hastings, who was the only contestant to operate on 14 Mcs., he used a 6V6 tritet with a various selection of 7 Mcs. crystals. Using two bands he worked 27 stations on 7 Mcs. with G, SM, GI, GM, ON, GW, D, OK, and on twenty, 10 stations in the following countries LA, SM, I, UA1, GM, GI, OK, G and UA6, making a total of 444 points. His best contact being with UA6UE of Rostov on Don. Not bad for three watts! The other entrants were all very good considering the power used, and their scores are given herewith.

### Comments

Most of the competitors have various comments to make upon the contest, and perhaps the suggestions of some will be of interest. The winner (G6ZN)—"Conditions



Mrs-G3XT holding the midget TX that won second place in the Contest. This TX will be fully described in our next issue. Unfortunately G6ZN, the winner, was unable owing to holidays to provide a photo of his rig but we hope to have a description soon.

a triode) and says "The above is my permanent transmitter, and I have worked 43 stations since I obtained my licence on 4th July with an input of 2½ watts. I am very interested in QRP work, and would like to see more contests run by the "Short Wave News." (G3BDQ) "I was very surprised to achieve such good results with QRP gear, but I found that it was impossible to work 7 Mcs. in the evenings due to heavy QRM and relied on early morning and day working. Most of the stations contacted outside G were surprised at my input." (G2ATZ) "I was amazed at the results obtained . . . On eighty metres the 1.8 watts proved quite successful, and I should like to see another contest arranged during the winter season, just to find out what can be done on this band with very low power." (Suggest January or February for 3.5 Mcs. when conditions are very good early mornings—G2SO.) (G3ASJ) "Thoroughly enjoyed contest, but work precluded much time on the air." (G2BLA) "I put in approximately 19 hours of operating, and had 25 contacts. I called CQ 49 times, replies 8. Called stations 108 times, had 17 replies." From the above comments it is obvious that the competitors enjoyed the contest, and that they consider that another one should take place reasonably soon.

during the contest were exceptionally good for the time of year. 'Break-in' was used, and I had several three way QSO's—QRN was light which is rather unusual for the time of year."—(G3XT) however says "The exceptionally poor conditions prevailing during most of the week, probably accounted for the absence of SM, F, LX, OZ, LA and PA stations. For the contest I used a newly built midget transmitter only a few inches cube, it seemed to give similar results to my normal COPA transmitter." (G3BVT) used a CO (PM22A as

**Conclusions**

Looking through the logs received it does show that even in these days of high power and congested bands, low power will still give very good results provided the operator chooses his times, his frequencies, and is prepared to spend a certain amount of time on the air without continuous QSO's. Altogether 18 different countries were contacted, being: G, PA, OK, GW, SM, ON, GM, D, OZ, GI, GD, HB, GC,

Table of Results, showing Scoring and Position

Position	Call	QRA	Contacts	Countries	Total	Best DX
1	G6ZN	Horbury, Yorks	73	11	803	OK
2	G3XT	Saxmundham, Sx.	59	8	472	HB
3	G3BDQ	Hastings, Sussex	37	12	444	UA6
4	G3BVT	Darwen, Lancs.	24	6	144	SM
5	G2ATZ	Hailsham, Sussex	27	5	135	PA
6	G3ASJ	Selby, Yorks	31	3	93	OZ
7	G3CAG	Bletchley, Bucks	15	5	75	EI
8	G2BLA	Streatham, London	24	2	48	ON



Table of Equipment Used, etc.

Station	Transmitter	Receiver	Input in Watts	Aerial
G6ZN	Hartley	6v. Super	1 to 2	135ft. and 270ft. end fed
G3XT	CO	O.v.2	1.2	66ft. eo
G3BDQ	6V6 Tritet	R1155	2.64 to 3	VS1AA and Windom
G2ATZ	6L6g Regen CO	4v. Super	1.8	136ft. eo
G3ASJ	TPTG for 1.7 and 3.5 and CO for 3.5	1-v-1	1.1	165ft. eo
G3CAG	6L6g CO	Mod. BC set	3.5	67ft. Zepp
G2BLA	6L6 Regen Co	Marconi CR100	2 to 2.4	½ wave Zepp

EI, LA, I, UA1 and UA6. The latter being the best DX for the week. Several types of aeriels were in use, the long wire end fed being the best for the low frequencies, and for those in the fortunate position of having plenty of room, but at the same time the "old stand by" the 66 ft. gave splendid results. This is the first contest held by the "Short Wave News" and from the appre-

ciation received from many sources, it is obvious to many that another contest should take place in the near future, and provided that conditions are good no doubt many enjoyable contacts, DX and otherwise, will be obtained. In conclusion thanks must be afforded to all competitors, and it is hoped that in any future contest many more logs will be submitted.

## STATION LIST ADDITIONS

Freq.	Call	Location	Slogan	Power (Watts)
3435	...	VUM2 Madras, India	All India Radio	10000
3530	...	YV5RS Caracas, Venezuela	Radio Libertado	2000
4860	...	— Tokio, Japan	Armed Forces Radio	300
5060	...	YFA10 Makassar, Celebes	Radio Makassar	6000
5870	...	OAX4P Huancayo, Peru	La Voz de Centro del Peru	250
5875	...	TIGPH San Jose, Costa Rica	Alma Tico	
5880	...	CP15 La Paz, Bolivia	Radio el Condor	350
6057	...	— Komsolomsk, U.S.S.R.		
6083	...	ZIZ Basseterre, St. Kitts		250
6085	...	VP4RD Port of Spain, Trinidad		
6095	...	XGSC Nanking, China		
6102	...	WLKS Kure, Japan		1000
6115	...	HIG Ciudad Trujillo, Dominican Rep.	Radiodifusora HIG	100
6119	...	— Komsolomsk, U.S.S.R.		
6125	...	GWA Daventry, England		25000/100000
6146	...	LRR1 Rosario, Argentine	Radio Ovidio Lagos	10000
6150	...	GWA Daventry, England		25000/100000
6180	...	— Ashkabad, U.S.S.R.		
6185	...	LLI Fredrikstad, Norway		5000
6195	...	GRN Daventry, England		50000/100000
6220	...	CE622 Santiago, Chile	Radio Sociedad Nacional de Mineria	5000
7210	...	LLS Tromso, Norway		5000
9223	...	HIG Ciudad Trujillo	Radiodifusora HIG	100
9635	...	VP4RD Port of Spain, Trinidad		
11780	...	— Vienna, Austria	Radio Wien	1000
15175	...	XGOY Chungking, China	The Voice of China	35000

# AROUND THE SHACKS No. 10

Albert A. Teeter, ISWL/W2-790.

FOR the second time since we started our shack visits we take a peep into a listening den. In this case it should have read "dens" for Bert has a listening post in both his house and in his "hobby house," which stands in the grounds.

On the personal side, Bert was born in New Jersey in 1888 and graduated as a chemist at Columbia University in 1908. He has two sons, both in the Army, and one daughter. Between 1908-1914 Bert worked as a chemist and entered the employ of his present company, now the largest manufacturers of penicilin in the world, in 1914. After the first world war, employment was continued there and today he is Vice-President of the company.

Hobbies are radio (member I.S.W.L., R.S.G.B., A.R.R.L.), Photography (A.R.P.S.), and raising rare birds. It must be the latter that has suited Bert to raising the rare DX birds too! Radio first entered the picture in 1914 and the construction of receivers and aerials started. After the war business interposed with the hobby until 1925 when resumption was made with SWL'ing and experimental work on receivers and aerials. Activities were again interrupted in 1939. Since the war nearly all radio work has been with aerial experimenting and Bert is of the opinion that electronic developments during the recent war have opened up a vast field for aerial research.

The aerial is far more important than the receiver or transmitter says Bert. Mentions that many W2's he knows using kilowatts never get anywhere but others with only 25 watts work the world. The "sky hook" is the answer and that is why such interest is taken in them.

The favourite bands are 28 and 14 Mcs., the former best when conditions are right but "20" best for consistency. Encouraging results are now being obtained on 2 and 6 metres, and a six element beam seems to be the answer down on 2.

Bert finds hams generally very courteous. Many of them have generally learned a lot about aerials from W2-790 as information is readily sent on. He says "I have made

many friends from my SWL reports and that after all is what is worth while. It matters little what we have, what we are or where we are from—the right kind of a fellow is all that counts. He may be a dock hand from Southampton or a farmer in Java—as far as I am concerned he is a friend though I will never meet him face to face." That is a philosophy worth noting!

Here is an example of how Bert's aerial experiments have helped the ham fraternity. A ZS called "CQ N. Jersey" but failed to get any replies whatsoever. After a while the ZS decided to scrap the transmitter and start again. Then he got Bert's airmail report telling him that he was received at S9 plus. Alteration to the aerial solved the problem. In our opinion that is the REAL sort of SWL report—not just a card collecting racket that some make it.

The gear in use at "Hobby House Listening Post" is enough to make even the most "commercial" type of ham go green with envy. There are twelve receivers in all: H.R.O's, Nationals, Hallcrafters, R.C.A., etc. In addition to this battery of sets there are three Panadaptors and three Miller preamplifiers. To wind up there are various recording units. The aerials are equally impressive, the permanent ones being: 20 metres folded dipole (3/4 in. aluminium), 6 metre vertical, 2 metre 6-element beam, 10 metre beam with double folded dipole as radiators, 10 metre beam 3-elements close spaced and a long wire 136 ft. long. All aerials are in 3/4 in. aluminium and are rotatable.

Experiments with various aerials are carried out on a specially erected tower with a platform, which is installed with the necessary instruments and a receiver.

The inevitable question of "why are you not a licensed transmitter?" is answered by the following quotation:—"The two wars and my business prevented that, and now I am 59 years old and hope to retire one of these days. If I am too old to learn the code then I hope to stick to my SWL'ing and carry on my aerial research as a full time hobby and give the boys more reports and help."



*Albert T. Teeter, W2-790, I.S.W.L. Representative for New Jersey.*

# International Short Wave League—Monthly Notes

## SOCIAL ACTIVITIES

**South London:** The Chapter is now meeting every Friday at Clifton Rise School, New Cross, commencing at 7.15. The Chapter will be known as the Clifton Amateur Radio Society. A full programme is being prepared for the coming season with visits, lectures, constructional work, and Morse classes amongst the items on the agenda. Fuller details may be had from W. A. Martin, 21 Brixton Hill, London, S.W.2.

**Middlesex:** The Middlesex Chapter (Uxbridge and District SW Club), has now elected a new committee as follows: L. Harris (President), F. R. Ellory (Secretary), A. J. McDonald (Ass. Sec.), G. J. Walker (Treasurer) and M. Gardner (Ass. Treasurer). The Chapter now has a membership of 14, and plans are under way for winter activities. The CR is now anxious to form another Chapter—this time in or around Edgware, and support from local members would be greatly appreciated. Please write to L. Harris, 93 Long Lane, Hillingdon, Middx.

**Plymouth:** Members in the Plymouth district are cordially invited to contact their TR. Chapter meetings are held every Thursday with Morse instruction, "aid to beginners" section, as part of the regular proceedings. Loan of test gear is open to any member. There is no subscription. Interested members are invited to write for further details to G. J. W. Harvey, 5 Garfield Terrace, Stoke, Plymouth.

**Other areas:** Space is short again this month, but here are the QRA's of other I.S.W.L. Chapters. Members not already in contact with their local group are urged to do so as soon as possible.

**West London:** c/o Headquarters. **Birmingham:** M. B. Taylor, 136 Alvechurch Road, West Heath, Birmingham. **Darlington:** M. Harrison, 36 Southend Avenue, Darlington. **Portsmouth:** R. Masters, 62 Battenburg Avenue, North End, Portsmouth. **Chelmsford:** W. C. Mills, 3 Elm Cottages, School Lane, Broomfield, Chelmsford. **Worcester and Malvern:** R. G. Barrell, 4 Bromyard Road, Tenbury Wells, Worcs.

**South Scotland:** Since the membership is rather scattered at present, the CR is organising a general "chapter" for all members in the south of Scotland. The idea is for members to exchange notes, logs, ideas and so on. Full details may be had from J. Thomson, 15 Chambers Street, Inverleithen, Peebleshire.

## ANOTHER NEW SERVICE!

This month we announce yet another addition to our Query Services, namely a section for Ionospheric and Sunspot Data. The section is under the management of Mr. P. J. Jooste, a member of the British Astronomical Association and The Physical Society. The section will answer members queries on anything appertaining to sunspots or ionospheric subjects, such as SW propagation, etc.

Mr. Jooste has kindly undertaken to prepare a series of articles for "S.W.N." dealing with various aspects of solar disturbances and their effect on radio propagation.

The QRA is: 171 Ribblesdale Road, Streatham, London, S.W.16.

## NEW REPRESENTATIVES

### Town—

**Glasgow:** J. Stankevaige, 11 Beattock Street, Glasgow, E.1.

**Southampton:** G. Hayes, 88 Malmesbury Road, Shirley.

**Wimborne:** G. L. Galpin, 15 Corn Market, Wimborne.

### County—

**I.O.W.:** C. Patey, 36 Albert Street, Cowes.

**London (N.W.):** J. Lewis, 484 Finchley Road, London, N.W.11.

**Stirlingshire:** W. Brown, 90 Muirhall Road, Larbert.

### U.S.A.—

**Louisiana:** Kenneth Crandall, W798, 45 Farnham Place, New Orleans, 20.

**Missouri:** Edwin W. Grove, W1186, 20 Overhills Drive, St. Louis County-Ladue 17.

**Texas:** Victor Robinson (W5MSW), W886, 3907 Fort Boulevard, El Paso.

**Virginia:** Donald F. Murray, W661, Kappa Alpha House, Washington and Lee University, Lexington.

**Philadelphia:** Charles Southall, 124 West Springfield Avenue, Philadelphia, 18.

## COMPLAINTS

We have two letters of complaint from County Representatives mentioning lack of support from local members. One of them has written individually to every member in his county (there are more than 30 of them!) and records that only 2 have replied. The other CR has written likewise to all his members and has had ONE reply. The latter CR has come to the conclusion that the ham spirit just does not exist in his part of the world. It certainly looks that way.

Members should realise that all I.S.W.L. positions are honorary, that the local representatives devote a great deal of their

spare time to League work (not to mention postage expenses). It is surely only common decency to acknowledge a letter from ones' representative—a person appointed in order to HELP his local members. Members should also realise that when they joined the League they agreed to further the objects of the League to the best of their ability. Ignoring a letter from ones' CR or TR is not adhering to these conditions.

Luckily, the majority of our members will have clear consciences with regard to the above, but to those whose ears will be burning we say: Come on O.M's, let your CR or TR hear from you. Co-operation from you, on however small a scale, may make a world of difference to your hard working rep. He is there to help you, so for your own benefit don't let him down. If you do not know your local Reps. QRA, then drop a line to HQ and we will supply it.

### RADIOLYMPIA

We have now worked out the final details of the I.S.W.L. gathering at the Show. The date chosen is **OCTOBER 11th (Saturday)**. We will congregate outside the main entrance hall at Olympia at 3 p.m. Chapters will be travelling to the exhibition in their own groups but members making their own travelling arrangements can meet the "gang" at the appointed time outside the entrance hall. Even so, we anticipate quite a few "stragglers" who have arrived late and these can merge with any one of the various groups who will be doing-the-rounds inside. This will be easy enough, for we have now the emergency ISWL labels.

Your local Chapter has a supply of these labels, but if this is not convenient please send along a S.A.E. and we will mail you a label to wear during the exhibition. The labels are on white card with the League emblem printed in green. A hole is provided for fixing to coat lapels. Send along now for yours and make certain you will be easily recognised at Radiolympia!

Here are the addresses to write to for details of group travelling to the Show:

South London: W. A. Martin, 21 Brixton Hill, London, S.W.2.

East London: J. Leigh, 118 Dunlace Road, Clapton, E.5.

North West London: J. Lewis, 484 Finchley Road, N.W.11.

West London: I.S.W.L. Headquarters.  
Middlesex: L. M. Harris, 93 Long Lane, Hillingdon.

Any member not in the above areas should contact their local Representative or Headquarters. For the benefit of members wishing to travel to the Show with the H.Q. party, please note that we will be leaving the office at 2 p.m. Members are welcome at HQ at any time during the morning—from 9.30 a.m.

Queries on the above will be answered promptly. That's about all so write in for your labels as soon as possible, or alternatively contact your local Chapter. 73 and see you at the Show!

### QSL CORNER

From time to time, we will be giving a resume of the more interesting QSL's received at the Bureau. We had a nice batch from VQ4ERR, whose card is in light and dark yellow plus a red lion rampant situated roughly at Nairobi! LA4R has obliged with a nice card showing a Norwegian galleon. Quite a large batch also came in from OI2KAF, the Solar Eclipse station. Shows a portion of the globe with the expedition route marked on it. Card was designed by OH2OB. A comic card is that of LX1AJ, though rather plain. OK1CK has sent in some nice cards with a silhouette of church. Another comic card comes from SV1AH, well worth having. An interesting mail was that which contained a batch of QSL's from TR1P. This card is a home drawn one with palm trees and a shack literally bulging with activity. Plain but very effective. CN8BB came up with a rather futuristic design in a panel. Shows the globe with a "saturn" ring of fruit, soap, bottles, to mention a few items! We wish we could understand what it is meant to convey! A figure, guessed to represent Mars, looks down on the strange happenings. Other batches of cards have been received from I1PH, F8PQ, OK1AUX, OQ5AR, and so on. PY6AG's famous cartoon card is well in evidence. We even had a selection of cards from G2UK!!

There are innumerable cards for members for whom we do not hold S.A.E's. Here are some for whom we have cards waiting: ISWL's G30, G137, G162, G188, G267, G347, G381, G358, G468, G644, G710, G828 and GM32. Also Jack Blomfield, R. Collett, J. F. Mathers, W. Hughes, S. Coles, S. N. Cowley, R. Russell, J. Self, J. Wagstaff, G. Williams and D. W. Waddell.

**THIS IS THE SECOND TIME OF ASKING FOR SEVERAL OF THE ABOVE MEMBERS. IF YOU WANT THOSE QSL'S PLEASE SEND ALONG A FEW S.A.E'S!**

# On the Ham Bands

Conducted by "CQ"

## ● Top Band Notes

SEVERAL stations in the London area have been heard testing for television interference.

With the evenings becoming shorter from the point of daylight, there should be an increase in activity.

Have you noticed how strong North Foreland Radio has been during daylight.

G2HBQ (Peckham) has been pirated, the pirate giving his location as Peckham and stating that was using a CO (807).

I was struck by the excellent CW signals emanating from G3ACO (Hemel Hempstead). Heard him mention that he was using the garden fence as a counter-poise!

They are an enthusiastic top band lot at Slough. Was informed of one North London amateur who worked four there in quick time and was then informed that "they breed 'ere, hi!"

Good to hear another old-timer in G6LH (Rev. Hodge, Boston) putting a nice signal into London.

## ● 14 Mcs.

Conditions have been rather erratic at times, due to another intensive burst of sunspot activity, though it appears that it takes more than a mere solar disturbance to upset a steady stream of DX on this band! The best log of the month, though containing only 23 stations, comes from our old friend M. Preston, G380. This is some of the DX heard: CR6AI, VQ5DES, VQ8AD, ZD1KR, CP1AL, HH2CW, UD6KB, UG6WD, UI8KFQ, UL7BS, UQ2AB, VS4VR, VS6LQ (1740), FO8GA, VR5PL, VR6AA, YJ1AB (0850 R7), ZK1AH and ZM6AD (0910 R6). That's what you call DX!

Al Slater has had a week's holiday, during which time the aerial systems have been overhauled. One of them is a new one for 3.5 Mcs. which was "christened" by getting W1ZE at R8. The other one is a Delta Match for 14 Mcs. Here is a resume of activities for the month: In the early mornings around 0600 GMT, KZ5NB was logged at R9 plus, with VP9T also a good sig. MD6DS heard consistently evenings. MD5PC was heard operating /MM, with Ken Ellis on board, in a boat on a lake in the Canal Zone. 5PC wrote a letter to Al thanking him for his "model" SWL report (on a S.W.N. report pad, by the way) and saying that he gets about 30/40 SWL reports each day! 5PC says that those who only send scraggy reports, and without

IRC's go straight into the W.P.B. The position now is that MD5PC can no longer acknowledge SWL reports, but will QSL those already received. He says he appreciates reports but owing to the quantity received he would have to pack up his job in order to answer them all!

A surprise at 1200 one day was KG6AV/VK9 in the Admiralties. Was R6. During afternoon sessions such items were heard as KG6AG (1655), W6JIM/C1 (1700), J5AAL, J9ANL, KA1ABM, W6WCN/KG6 (Saipan) and XZ2AG (1730). ZD6DT was a new country for Al., heard at 2200. ST2AM popped up with an R9 signal but had rough speech and frequency drift (Please copy, Johnny!). Another catch was ZK1AA heard at 0830, with R6 sigs. ZK1AA runs 100 watts into a half-wave aerial. He has a mail delivery once a month out there in the Cook Islands, and is still awaiting his new QSL cards from the printer.

Al mentions the predominance of daylight transatlantic signals, between 1100-1600 when many of the East Coast W's have been R8-9. Others heard during these hours have been W5's, W0's CO8MP, HH5PA, VP4TU, YV5ABQ and several VE and VO.

A very interesting item this. Al heard a station signing ZS2AL at R8/9 at 1300. There was no QSB, typical of ZS stations. Later on in the month he heard a station signing MD1A, giving QRA as Benghazi. "MD1A" was calling CQ, and once he slipped up and sent "ZS2AL." He hastily went QRT and then came back making a pretence of calling ZS2AL! So anyone who thinks he has heard a ZS at R9 around lunch time has been misled!! (What do you say to that one, Barry, MD1B??).

We also have a fine log from Al, but he has already had his ration of space for one month!

James Endersby, GW703, has concentrated on 14 Mcs. this month, having found "ten" rather flat. He did hear W2QQY/MM on ten, and comments on the amazing sound effects by the second op.—the ship's siren! In his log we see W7ANN/C1 (1625), CR6mx (567 at 1930. Any further data?) J9ABE, PK2ml, 5NR, 6hl, 6sa (between 1600-1700), VK7NC, TR, YL, 9NK (R4 at 0655, Port Moresby); VS1AN, VU2BQ, 2RV (1725), XZ2AA, 2AE, 2AG, ZL2BE, 4AO, ZS1U, 1CB, 2AF, 6CT, 6DW (between 1800-1900). MD6DS is in Iraq, OM. Prefix replaces YI. James heard VK2AGU mention that he has had 64 consecutive QSO's with G6XR! Also of interest

that W6WNH, heard at R6, used a 3 element beam 5ft. off the ground!

**A. H. Onslow:** Short and sweet this month. A.H.O. says he is the throes of re-organisation, whatever that means! Anyway he managed to log VE8OG on Victoria Isle, N.W.T., OQ5CC, XZ2AG, 2TD; H12F, W6WCN/KG6, KH6CT, 6GF; HH5E and MD1A (the right one?). He had a QSL from CP1AX who kindly sent along a Bolivian banknote as good measure.

**S. Beharrell,** G321, says his best ones were VS2BV (2055), HH5PA (2125), VR6AA and XZ2AG. G321 mentions how the arrival of a QSL or two gives you that incentive to carry on when things are getting a bit slack. Think we all get that way! Other interesting ones were VU2BQ, ZC6DD, ZC6AV and what looks like all the MB9's! Also MD5BI, PC, AJ and BL.

**Reg. Masters:** C1CH (Glad you got that C station at last O.M.), FF3GW (Dakar), J2AAG, 9ANL; KH6AW, NY4ZQ, OQ5BL, BW; TG9JB, VE8OG (N.W.T.), VP7OT (should this be VE7OT?), V18B, 2BU, 2BV; VU2BI, 2BQ, 2DR; XZ2AG, ZL3FB, 4AO, FO; ZS6AJ, DW, JF, LG and LN. (ZS's between 1700-1900). Also a fine list of 20 VK's, heard between 0500-0630.

**Don Murray,** W661, reports these at good readable strengths: KG6AV/VK9, KL7JO, KP6AA, LI4AB(?), OX3FC, VK9NK (ex-VK4NK), W6WND/KW6, XE1JW, UE; YN1HV, 1LB; YS3PL. Don also has a list of G's which appears elsewhere.

**E. A. Coates,** G509, sends along his first log. Welcome, O.M. Best ones are AR8AB, OQ5CA, ZL4AO, VK2AGU, C1CH, VK2NO, VU2BQ, ZC1AL, PY6AV and several MD5's. All stations heard between 2000-2100.

**D. W. Bruce,** G734, mentions occasional bad spells in conditions, but has collected AR8AB, J4AAS (Cruiser "Sussex," Kure Harbour), KA1ABM, MD6DS (2215), ST2AM, MP4TE, 5EL, 9F, 9T; VQ4RAW, VS1AN, 2BO, 2BU, 2BV; VU2AQ, 2BK, 2BQ, 2RV (all around 1900), ZC1AL, RJ, 6CX, DD, MN, TC (around 2000), ZL4AO (2300). Derek mentions that I1AHL is in Sardinia, another one for the country collectors.

**R. W. Ainge,** G219, has been using a dipole cut for 60 Mcs. with his 0-v-2, and has logged AR8AB, HH5PA, J5AAJ, 9ABE; KA1AB, OA4M, 4AI; ST2AM, TG9JK, RV; VP4TX, TU; VQ4RAW, VR5AB (any further data, O.M.?), VS1AN, BJ, BO, 2BU; VU2BQ, QT, RV; XZ2AA, AD, AG, YS1, JR, FF, 3PL; ZC6DD, ZD6..f (2315), ZL4FO, ZS1CZ, DU, 6CT, TX. R.W.A. has now heard 96 countries since January, 1945.

**A. Baldwin,** G193, has some nice ones in C6tw, CR6ai, EP2ds, ET1ir, HZ1ab, I6usa, KL7bd, 7um; KS4ae, KX6usn (who is this O.M.?), KZ5az, OQ5av, VP4tv, VR5nc, 5pl; VS1aq, 1ba; ZC6sx, ZD2ah, 4ab, 4ah, 4al and masses of VK, ZL, VE7, etc. Nice log, O.M.

Also, very many thanks to the many readers who have sent along logs, but for which we have unfortunately not the space. We will try to get you all in for future issues but to do this some more pruning will be necessary.

### ● Query Corner

As Reg Masters says, "this business of pirates is getting worse." One of the prizes this month has been DF3AA. Many have asked about him and S. Beharrell sums it up by saying "what is it O.M.?" Well, he says he is in "Europe Cunquote" and sometimes says he is in the French Zone of Germany. A hopeless case!

TFE9 also comes into the picture frequently. He says he is airborne over the North Atlantic (or was).

Now we come to ZC1RJ, who is causing a bit of bother. Arthur Levi writes to say that a QSL from ZC1AL underlines the fact that 1RJ is definitely a pirate. Al Slater throws more light on the subject however. Al quotes that 1RJ gives his QRA as 30 miles east of the Dead Sea, but that 1AL affirms that he is not in Trans-Jordan at all. Apparently 1AL has put the D.F. gear into operation and found him to be on the Palestine side of the Dead Sea. One local ham, says Al, has a QSL from 1RJ with a Trans-Jordan postmark. As our friend says "Maybe 1AL does not like the idea of relinquishing the title of being the only active ham in ZC1." I think he has something there!

XXA has caused some head-scratching. Again Al Slater comes to the rescue. He heard XAA say "I can no tell you my country, but I am 3000 kilometres south of you." He was working LA7K at the time, which works out to be either in the Mediterranean or in North Africa.

**A. Baldwin** asks about KN8BQ in 14 Mcs. CW. Would this be CN8BQ misread, O.M.? Only a dot difference.

Martin Harrison asks if the CT's are on legit now. They say they are, so we will take their word for it. They seem to be above board now. (UR2KAA is definitely OK, O.M.). Martin also questions I4LLF who says he is in Sardinia. Mentions that I1BV and I1AHK are also on the island.

**E. A. Coates** brings up two previously mentioned calls: HV1AC and ZY2. We would like to know about these two, so can anyone help please?

Finally, James Endersby asks about HB7MM. No gen O.M. By the way, the HB1FS I said was questionable last month was actually HB9FS portable. The HB's use HB1 when operating portable. Sorry!

● **Consistency Poll, No. 1**

For the benefit of those who missed the announcement last month, and a reminder to those who did read it, here are the details again:

- (1) List the best CW station from as many African countries as possible.
- (2) List the best 'phone stations from as many African countries as possible.
- (3) Deciding factors to be consistency of signal strength and quality.
- (4) Survey to be for signals on 14 and 28 Mcs. Plainly mark which bands.
- (5) Closing date for entries: SEPTEMBER 15th.

N.B.—If any difficulty arises in discriminating between one or more stations, list them both, or all. Lists to be addressed to "C.Q.", Consistency Poll, c/o "S.W.N."

● **G Calls**

We invite overseas readers to submit logs of G stations heard in order to build up a regular feature for the benefit of hams in the U.K. Here is the first instalment.

Johnnie Davis, ST2AM (Khartoum) has heard on his MCR1 receiver: G3MT, 3NY, 3HL, 3YT, 6PB, 3FA, 8KX, 8QW, 3BCC/A, GM8NW.

Don Murray, W661 (New York) heard on his S20-R: G2UZ, 2XV, 4MS, 5LK, 5VB, 6PD, 6UX, 8RY, 8TY, 6VQ, GM2DI, GW2UH.

S/Ldr. H. Pain, XZ2HP (Mingaladon) reports G2FK, 2LU, 2FMC, 2FVQ, 2FXQ; 3IQ, NW, VC, AAO, BET; 4GI, IC; 5PN, RV, WM; 6OF, UF; 8FC, GO, JJ, KP, MZ, RC, TV; GI2WQ, 5UW; GM6XI, GW3ZV, 4CX.

● **Gossip**

Johnnie Davis, of ST2AM, writes a nice interesting letter. He says they have gone over to phone now (Did you see what Al Slater said about you, O.M.!) The TX is a U.S. army job, the BC375-E, which they are running off 28 volt. accs. Johnnie asks about QA3KA and B4AG; the only solution we can offer is UA3KA and G4AG, or is that too obvious?

Cpl A. C. Hudson, VU2AJ, asks for reports. He is operating on 28320 (from 0930 GMT) and 14284, 14324 and 14364 kcs. phone) and 14080 kcs CW from 1530-1800 GMT. Information on other signals from the area would be appreciated as a means of comparison. Reports may be via "S.W.N." 2AJ has reason to believe that

● **Topical DX QRA's**

- AR8AB: via R.E.F.
- CR8AI: Box 131, Lubango, Angola.
- EA9AI: Radio EA9AI, Feililia, Spanish Morocco.
- FK8VB: c/o Box 489, Wellington, New Zealand.
- J9ABE: APO 239, c/o P.M. San Francisco.
- KCAAM: JCA Navy 926, c/o F.P.O., San Francisco.
- KZ5NB: U.S. Submarine Base, Bilbao, Canal Zone.
- MD1A/B/C: c/o Wireless Troop, Cyrenaica Signals Squadron, Benghazi, M.E.L.F.6.
- MD2A: c/o Staff Officer, Army Signals, Tripoli.
- MD5PS: Lt. P. C. Swann, R.E., 1271 A.W.Coy (G.P.W.) M.E.L.F.
- NY4ED: E. Malmstron, Navy F.P.O. 115, Box 35Q, New York.
- NY4FB: F. Brown, Box 35Q, N.A.S., Navy 115, F.P.O., New York.
- NY4ZQ: Navy 115, c/o F.P.O., New York.
- OX3GE: A.P.O. 55, c/o P.M., New York.
- PK6EE: Box 76, Macassar, Celebes.
- TG9MG: Box 12, Guatemala City, Guatemala.
- W6WCN/KG6: Naval Air Station, Kobler, Siapan, Navy 957, F.P.O., San Francisco.
- VP4TT: A.A.C.S. Group, A.P.O. 869, c/o P.M. Miami, Florida.
- XZ2AG: 64 Brigade Signals, Maymyo, Burma.
- XZ2DN: Signals Section, R.A.F. Station, Mingaladon, Rangoon, Burma.
- XZ2HP: S/Ldr. H. Pain, Officers' Mess, R.A.F., Mingaladon, Burma.
- ZCIRJ: c/o 89 Hurstfield Crescent, Hayes, Middlesex.
- ZD2KC: P.O. Box 570, Lagos, Nigeria. (Thanks to A. Slater, A. H. Onslow and J. Endersby for several of the QRA's listed).

some of his QSL's have not reached their destinations. If any reader is affected, they have only to drop him a line and another QSL will be mailed.

L/C. B. Purchase writes on behalf of himself (MD1B) and his "partners in crime" MD1A and MD1C. Barry says that there are now about half-a-dozen MD1's, and the call signs were issued late in July. MD1 is issued to Libya and MD2 to Tripoli. 1A and 1B shares the same shack and seem to be well off for gear. 1B runs 50 watts with 6V6 CO and 807's in p.p. MD1A is more ambitious as he runs 4 807's in parallel push-pull! Apart from some QRM from kilowatt service rigs, the gang seem to do well with the DX. Who wouldn't with an MD prefix!

Peter Swann of MD5PS is also anxious for reports on his signals. He is at present working on 3.5 and 7 Mcs., phone, and is located mid-way between Port Said and Ismailia. Peter really does need reports so how about it O.M.s? QRA is in usual section.

James Endersby sends along further data on SHF1X, the Swedish ship "Albatross." The route is Gothenburg, Atlantic, Martinique, Panama, Pacific, Hawaii, Marshalls, Indian Ocean, Mediterranean, Plymouth and Gothenburg. Trip will take about 15 months.

G3AVL, R. Reynolds (Liverpool) wants reports on his 1.7 and 3.5 Mcs. CW. These



can be from really local readers, providing that the reports are of a useful nature. Also wanted are reports, over 1000 miles, on his 28 and 14 Mcs. CW. QRA is 43 Pendennis Street, Anfield, Liverpool, 6.

We hear that ZL2TZ will shortly be operating from the uninhabited Kermadec Isles. This is a volcanic group of islands, 600 miles N.E. of New Zealand. He will be on 3.5 Mcs., so if anyone can furnish proof of this one your scribe feels it will be the last word in this DX game!

**S/Ldr. H. Pain**, otherwise known as XZ2HP is still dreaming of the day he works a G station! He has worked 23 countries on his 24 watts, hears plenty of G's but cannot seem to work them. 2HP says that the best time for G's to come through is around 1700 GMT, so how about giving him a shout someone? Listener reports would also be greatly appreciated, and the QRA is in usual section. Incidentally 2HP has kindly offered to clear any reports QSL's for other XZ stations.

● **DX QSL's Received**

**L. Waine:** ZS5Q, W0CK, OK1VA (28 Mcs.); VK2AHA, KP4CE, ET3Y, W5QH and VE3AYL (14 Mcs.)

**S. Beharrell:** CX2AC, VQ5JTW, TR1P, LU1JC, ZS6LF, CE3AE, CE3AY, ZB1AF, CO2MA and LI2BO.

**A. H. Onslow:** OQ5BW, C1CH, W6VTO/C1, VP2LA, HC2GG, TG9MG, OA5A, YR5A, OA4M, PY7DD, ZL4GA, TI2OEC,

YS1JR, YS3PL, CP1AX, CP1AF, W0NWW, W0ZEA (Colorado), W7JPY (Arizona), W7JPO (Montana). On 3.5 Mcs. W1KQQ, 2RUI, 4JSR.

**C. G. Tilly:** C1CH, HS1SS, VU2BV, VQ4RAW, OX3GC, VP2LA, VS1BU, ZL4AO, T1NS, YS3PL, CE3AE, SU1CX, PY4BI (7 Mcs.), ZC6HB (10 watts), EL3A, ZC6JF, PY4MG and OI2KAF.

**D. L. McLean:** HC1JW, J9ANA, KV4AD, LU3AX, TI4AC, VK2TI, 2VC, 2GQ, 4WF; VP4TF, ZD4AB, ZS2CR, W6BHH, CHV, IKQ, MLA, MWK, NWQ, POZ, WNM, RZJ, 7FTO, 6VKV/16.

**A. Slater:** C1JC, EA9AI, FT4AI, HC1OB, HZ1AB, J3WGT, OQ5AR, VE7AIE, VP2LA, W6RVU, W6VTO/C1, W7GC, W9ROQ, ZC6FP, ZC6JF, ZS1CN.

**A. E. Lincoln:** OI2KAF, CX2AX, HK1DZ.

**Roger Legge:** HR1MB, J3GNX, 3WGT, 7AAA, 7ELS, 9AAW, 9ABX, 9AJB, 9CRP, K6ETF/KC6, KP6AA, KV4AD, KZ5NA, LI2BO, PK6TC, VP2LA, VR2AP, VS7ES, VU2AF, W6WCN/Saipan, XU6GRL, YR5V, ZC6FP, ZD4AB, ZE1JB.

**R. W. Ainge:** CO2KO, TR1P, VE1GG.

**A. Levi:** EK1AD, FT4AI, OI2KAF, VE5EA, 7AJN, 8NW; VP4TE, VQ2WP, VQ3EDD, W5GNX, 6PDB, 6VJT/KG6; XE1AC, ZL3AW.

**J. N. Trye:** EA9AI, KP4AU, OI2KAF, SU1HF, VP4TE, VS7ES, W3JRF/KG6, W5LGH, ZC6FP, ZL4AT, ZS4D, ZS6EU.

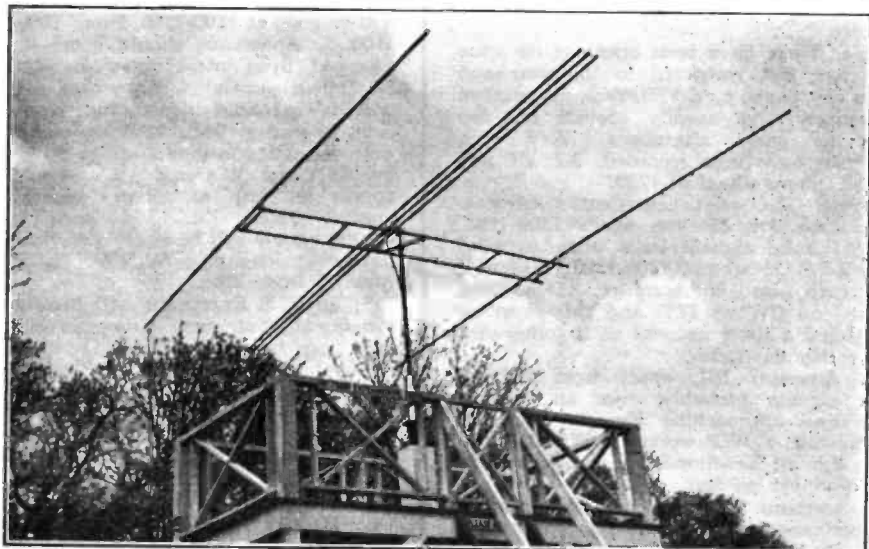

*At the top of the aerial tower where W2-790 carries out some of his aerial experimenting. Bert certainly does things in style*

**J. Edwards:** CE3AG, CO2BA, 6BD;  
CX2AX, W5HWG, 5BDQ, 8SIR/VP9,  
oJWF.

**E. W. J. Field:** W5YF, 6ITH, 6PB,  
6PDB.

● 28 Mcs.

These notes have been compiled by G5RF, to whom we offer our grateful appreciation:

In general MUF's have been very near, or lower than, the band (apart from Sporadic E), though on balance conditions have been better than for the last month. Activity is still at a low ebb, especially for CW, but there are signs of better things to come.

By the time this report appears, the band should be well open and the 'close season' over—till next summer. August 24th/26th, 1946, following just such a poor period as we are having now (to August 18th), showed the best conditions for years. Here is a survey of conditions for the month:

**Europe:** Sporadic E has been effective on many days, giving high QRK's over short skip paths to OZ, SM, HB, etc., and on some occasions to GM, GI and EI. As usual the phenomena has been unpredictable and sometimes the openings were very short lived. As is expected during the summer, tropospheric propagation has been good in the late evenings following hot days, distances of 100 miles being common. This condition occurs also in the early morning but cannot be exploited due to lack of activity.

**Asia:** There have been openings on some mornings, but restricted to the near and south east parts, e.g., VS9, ZC6, approached consistency and usually around mid-day and the early afternoons. Very high strengths have been recorded. XZ2YT was a good 'phone signal at 1730.

**Africa:** The most consistent Continent. Peak time for ZS was again 1500-1700, whilst strong signals have been recorded from ZE/VQ2 around 1200-1300. ZD2/ZD4 have been heard on mornings. ZD4AB was worked on CW at 1730 and this must be considered a little unusual as it followed a completely dead day.

**N. America:** Nil, apart from isolated weak signals probably over an indirect route and approaching Europe from the South West. G3WP worked a W5/MM, 800 miles S.E. of Newfoundland on evening. So near and yet so far!

**S. America:** Receivable in one form or another most evenings, and CW activity has been somewhat higher. Watch W signals on 27400-27600 kcs. for indication of conditions to S. America.

**DX PREDICTION FOR  
MID-SEPTEMBER TO MID-OCTOBER**

(7 and 14 Mcs. through courtesy of Geoff. Hutson, G6GH. 28 and 60 Mcs. with acknowledgement to Denis Heightman, (6i)H).

**7 Mcs. Conditions**  
0500-0700—W1, ZL.  
2000-2100—ZS, VK.  
2300-2400—W1.

**14 Mcs. Conditions**  
0600-0700—W6, W7, VK, ZL.  
0800—VK, ZL, J.  
1400—VK, J.

1500—VK, VS1, 6, C.  
1600-1700—W6, 7, VU, VS7, ZS.  
1800-1900—ZS, ZE, VQ2, 3, 4, 5, 8.  
2000-2400—W, PY, LU, VP2, 4.

**28 Mcs. Conditions**

This period marks the change from summer to winter conditions. F2 MUF will increase, giving reliable, strong signals from Africa most of the day with peaks morning and evening. The higher F2 MUF will result in a shortening of skip and signals from 2000 miles (i.e. Middle East) will be received most of the day).

Signal paths to N. of E. and W. will increase in reliability, but there will be some interruptions due to ionospheric storms. Commencing around 0700 GMT, Asian and Oceanic paths will open with peaks at various times. VK and Far East will be good at 1200-1500. From 1000-1100 S. Americans should come in, followed by Central American and W. Indian signals. N. Americans will provide excellent signals on many days appearing from 1200 or earlier and remaining audible up to 2100. Pacific Coast W's and VE's should appear in late afternoon, peaking around 1800. ZL, VK and S. Pacific signals will be audible on good days over long path W.S.W. via S. America from 2200.

Sporadic E Europeans will become infrequent, but some European signals may be received by low angle rebound.

**60 Mcs. Conditions**

Short skip conditions will be infrequent but tropo conditions under settled weather will remain good up to 200 miles distance. The F2 MUF to the S. will peak around mid-day making possible occasional 50 Mcs. propagation to S. Africa (such as that on March 26th and 29th when PAoUN was received in Cape Town).

# My Favourite Receiver

No. 11: J. Dean

This neat little battery operated receiver fits into a box measuring 6½ in. x 3 in. x 2½ in. and tunes continuously from 2½ to 20 metres. The coil-holder is home made to suit the Eddystone range of self-supporting coils, though, of course, the commercial article can be used. The tuning control is removed from the panel by 2½ in.

in order to eliminate any hand-capacitance effects. No difficulty was experienced in getting oscillation right down to the highest frequency range.

The RFC is wound on a lin. long ½ in. diameter former with 40 turns. The aerial preset is 60 μF and the variable grid-leak is ½ Megohm, brought out to the panel. Regarding valves the obsolete Hivac PX230 is preferred, although a super power valve such as the LP2 is quite suitable for the purpose.

If any reader encounters any snags or would like further information, please send a S.A.E. to the owner, who will be pleased to help. The QRA is J. Dean, 4 Picton Street, Leeds, 12.

*The circuit of J. Dean's interesting receiver. We invite readers to send along the circuit and brief description of their favourite short wave receivers for inclusion in this series. In each published case we present the printing block to the author for use on SWL cards, etc.*

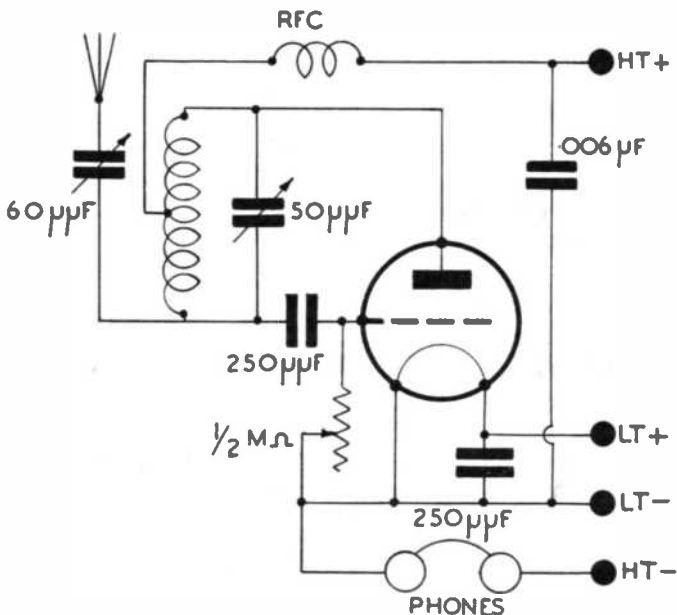

**Oceania:** Openings some mornings, but usually short lived. Often as early as 0700. VK signals frequently remained at S7 right up to within a minute or two of complete fade-out. Contrary to expectations this Continent has been workable some evenings via the "long" route over S. America. VK3YP has been the most consistent performer as usual, over the long route. ZL phones have been well heard some evenings. There is a chance of late-night VK/ZL contacts if the S. Americans are received well up to 2030, though this cannot be a certainty.

**General DX:** Best days were July 28th, 30th, 31st, August 2nd. Worst days were

July 14th, 17th, 21st-24th, 26th, 29th, August 1st, 13th. Best DX worked was: CX1DB, 4CS; LU2DS, 9AX; PY2OE, 4IO; VK2YC, 3CP, NM, YP, 5NR; VP4TO, VQ2GW; VU2LJ, LR; XZ2YT, ZD4AB, ZC6HB, ZE1JU, ZS1AX, CN, DY, L, P, 2CB and 6BJ.

D. L. McLean reports hearing CX1DB (2015), 4CS (2120); LU3DH (2125), PY2CK (2000), ZD2KC (1955).

**Reg. Masters:** heard CE3ED, EL2A, LU7DU, PY7AD, VQ5DES, VS2BT, 9AB; VU2AC, W6VKV/16, XZ2YT, ZC6FB, JF; ZD2KC, ZE1JU, ZS1T, AX, CN, 2AT, 6CX, DT, GF, GN, JB and 6Q. The ZS's were heard between 1600-1800.

**PHILLIPS MODEL PCR COMMUNICATIONS RECEIVERS**

This famous equipment made available at a price far below previous offers.

Specifications:

- 5 valve A.C. Superhet complete with valves, built in speaker, power pack, and spare fuses, lamps, etc. Brand new and unused in maker's cartons.
- Frequency coverage—5Mcs.-18Mcs.; 190-570 metres; 850-2100 metres.
- Valve Line up—3 of EF39; 1 of EBC33; 1 of EL32; Power pack rectifier OZ4.
- 5in. Energised Rola Speaker built in. Provision for phones.
- Power pack separate unit to operate on 100-250v. A.C.
- B.F.O., A.V.C. included.
- Flywheel tuning dial with lock.

OUR PRICE ONLY £17 17s. 0d.  
carriage paid

**M.O.S.**

MAIL ORDER SUPPLY CO.  
24 NEW ROAD  
LONDON, E.1.

Stepney Green 2760 and 3906

**IMMEDIATE ATTENTION!**

**AERIAL MATERIAL**

Hard drawn enamelled copper wire 12 S.W.G.—75 ft. 6/8, 100 ft. 9/-, 140 ft. 12/6. 7/22 stranded bare copper wire 100 ft. 5/-. Insulated 7 strand copper wire—25 ft. 1/6, 50 ft. 2/8. Pix "Invisible" adhesive tape indoor aerial 30 ft. 2/6. Ex-Govt. portable rod aerials—set of 4 tapered 15 in. sections to make a 5 ft. vertical aerial; can be extended by further lengths. Per set of 4 rods 2/-. Aerial insulators—3½ in. ribbed—glass 1/6, steatite 2/6, small egg type 3d. 12 in. TX glazed ceramic 3/-. Aerial lead-ins—Eddystone 9/6 5½ in. glass tube with vitreous glazed bee-hive insulator with plated rod and wing nuts which will not rust in bad weather 3/3. Cross-feeder blocks—Raymat ceramic 6d. each. Feeder spreaders—6 in. polystyrene rod—¾ in. 11½d., 1 in. 1/1.

**BRAND NEW EX-GOVT. SPECIALS**

Boxed Lucas Motor Generators, input 11-12 volts 3.8 amps., output 480 volts 40 mA. D.C. 35/-. Vibrator units complete with smoothing, input 12 volts, output 210 volts 70 mA. D.C. 47/6. Power Unit 222, completely enclosed in metal cabinet 8½ in. x 9 in. x 6½ in. in sealed cartons, with carbon pile voltage regulator, screened filters, fuses, etc. Input 24 v. 3.5 A., output 300 volts 30 mA. and 6.5 volts 3.2 Amps. These motor generator units will also work on 6 or 12 volts D.C. 18/9 plus approx. 10/- for packing and passenger carriage. Relay units comprises two 6 volt relays with very heavy duty S.P. and D.P. switches, completely enclosed in bakelite case 4 in. x 4 in. x 3 in. 6/6.

Please include postage on orders under £2.

Bargain lists of surplus goods 3d.

**SOUTHERN RADIO**

AND ELECTRICAL SUPPLIES  
85 FISHERTON STREET, SALISBURY, WILTS.  
Telephone: Salisbury 2108.

**RADIO CAREERS**  
AN IMPORTANT GUIDE

"Engineering Opportunities" indicates clearly how all engaged in the rapidly expanding Wireless industry can safeguard their future by becoming technically equipped to accept highly paid key appointments that will not be affected by any return to competitive labour conditions.

This modern guide contains 112 pages of highly useful information. It gives full details of our very comprehensive series of modern WIRELESS COURSES, including General Wireless, Short Wave, Wireless and High Frequency, Sound-film Projection Engineering, Television and Radio Servicing, etc.

**TELEVISION AND RADIO SERVICING**  
There is no doubt about it that there will shortly be an enormous boom in Television and unlimited opportunities for trained men. Our special TELEVISION and SERVICING Courses are fully described in the handbook.

**WE DEFINITELY GUARANTEE**  
"NO PASS—NO FEE"

The Wireless industry is alive with possibilities. In your own interests you should write for your copy of "ENGINEERING OPPORTUNITIES" today. It will be sent FREE, and the book is bound to indicate more opportunities which otherwise you might miss.

**BRITISH INST. OF ENGINEERING TECHNOLOGY**

854 Shakespeare House,  
17/19 Stratford Place, London, W.1

**SHORT WAVE (HULL) RADIO**

G5GX

**RECEIVER KITS**

- 2 Valve O.V.1. Bandsread tuning, plug in coils, 9-200 metres, Pentode output. Price, less cabinet and batteries £6
- 4 Valve 1. (Tuned) V.2. Bandsread tuning 9-200 metres. Black crackle steel cabinet. Price, less batteries and speaker £12 12s.

**TRANSMITTER KITS**

- 10 watt C.W. transmitter with Xtal and coils for 160-80-40-20 £11
- 25/50 watt C.W. Tx with standard panel, meter, drilled chassis, Xtal and coils for one band, all components and valves. £19 10s.

Further details supplied on request.

**SHORT WAVE (HULL) RADIO**

30/32, PRINCE'S AVENUE, HULL

Telephone 7168



For the past 15 years we have devoted our energies exclusively to the manufacture of Transformers and Chokes. Modern transformer technique is essentially the province of a specialist. Our technical department will be pleased to assist you in your transformer problems. Illustrated above is one of our varied range of styles shown in our catalogue—Free on request.

Telephone:



Abbey 2244

**PARTRIDGE**  
**TRANSFORMERS LTD**  
 76-B, PETTY FRANCE, LONDON, S.W.1.

**COMMUNICATIONS RECEIVER.** Type 3/11A. 4 valve superhet covering 3.1-15.5 Mcs. in 3 bands. Complete with 4 Loktal valves, headphones, and complete circuit details. Supplied in cushioned steel transit case. Less Power Supply (100v. H.T., 4v. G.B., 6v. L.T.) BRAND NEW, ONLY 79/6 (Carriage 5/-).

**EX-R.A.F. 10 VALVE TRANSRECEIVERS.** Complete with valves and motor generator. ONLY 39/6 (Carriage 5/-).

**R.A.F. T 1154 TX OUTPUT UNIT.** The complete output unit for the famous T 1154 Transmitter. Made to replace faulty items under active service conditions but never used, these have now been disposed of by the Government as more time can now be spent on repairs. These are the complete Right Hand Panel of the T 1154 and are choc full of transmitting gear including two .0002 mfd. Transmitting Condensers, variable inductance assemblies, pre-set station selecting apparatus, stud switching, short wave coils, instrument type coloured knobs, etc., etc. BRAND NEW IN MAKER'S CARTONS, ONLY 24/6 each (carriage 3/6). WORTH £20.

**FIXED CONDENSERS.** 8 mfd. 500 volt Block Electrolytics in Metal Case. Size 2 in. x 1 1/8 in. x 5/16 in. high. Fit and Forget. BRAND NEW. ONLY 4/9.

**VALVES.** The following valves in stock at B.O.T. prices plus P.T. Enquire for any not listed, we will probably have it. P2, LP2, K30K, 210, VPT, SS210, Z21, VP2, W21, H30, X24, ML4, 12SA7GT, 6SA7GT, 6R7G, HD24, 6L7, K55DG, 185RG, 807, 9002, 9003.

C.W.O. Please add postage under £1.

S.A.E. brings current lists.

**U.E.I. CORP.**

The Radio Corner.

138 GRAYS INN ROAD, LONDON, W.C.1.

(Phone: Terminus 7837)

Open Saturdays until 1 p.m. We are 2 mins. from High Holborn and 5 mins. from Kings Cross.



S E R I E S 1 0 0  
 M U L T I - R A N G E  
 T E S T S E T by

**PULLIN**

A Service Engineers' Universal Testing Set with a sensitivity of 10,000 Ohms per volt. The Instrument is housed in a strong metal case with carrying handle, and is complete with one pair of leads having detachable bull-dog clips and test prods.

**Ranges:** AC/DC Volts: 10, 25, 100, 250, 500, 1000.  
 D.C. Milliamps: 2.5, 10, 25, 100, 500.  
 AC/DC Microamps: 100 Microamps on the 10V range.  
 Resistance ranges: 0-1 Meg., (13,500 Ohms mid scale). 0/10,000 Ohms (135 Ohms mid scale).

**Frequency Range:** 15 to 20,000 Cycles per second.

**Accuracy:** 3 1/2% on D.C. Ranges.  
 4 1/2% on A.C. Ranges (for sinusoidal waveforms).  
 5% on Resistance Ranges (Compensated for normal variation of cell voltage).

**Size:** 9" x 5 1/2" x 4".

**Terminals:** Socket head type.



**MEASURING INSTRUMENTS**  
 (PULLIN) LTD

Address all enquiries to Dept. K  
 Winchester Street, Acton, W.3.

Electrin Works,  
 Acorn 4651/4

# SMALL ADVERTISEMENTS

Readers' small advertisements will be accepted at 3d. per word, minimum charge 3/-. Trade advertisements will be accepted at 6d. per word, minimum charge 6/-. If a Box Number is required, an additional charge of 1/6 will be made: Terms: Cash with order. All copy must be in hand by the 10th of the month for insertion in the following month's issue.

## PRIVATE

**SELLING UP.** Following gear must be sold by end of September—Taylor Valve Tester £15; Avo Model 47 £12; S.W. Bandsread 3 with speaker and batteries £6; R109 £3; Walkie-Talkie complete ready to use £7 10s.; 250v. 60mA. 6.3v. 2 Amp. Power Pack £3. Many bargains. Best offer taken. S.A.E. for list. W. Houseman. Leighs Brow, Barton, Northwich, Ches.

**SALE.** Tritet CO pp 807 100 watt TX—£10; 1.7 Mcs. transceiver with 12 volt rotary converter—£10; also valves, components, etc. S.A.E. for list. Box 1021.

**COMMUNICATIONS** Superhet £20, Transmitters £5 and £12 10s., valves and components, S.A.E. for details. GZABK, Hundleby, Spillsby, Lincs.

**HALLICRAFTERS** SX25 XTAL, BS BFO, etc., VFB condition, phones, speaker £42. Eddy-stone 504, as new, snip £45. Taylor, Shoemaker, 41 Lake, L.O.W.

**SALE.** VS110 (S130) Neon Stabilizers 7/6. 10 in. mains energised speaker with output trans. £1 10s. J. B. Armstrong, 30 The Corners, Cleveleys, Lancs.

**BATTERY** TRF3. Short-Wave covers 10 metres. £5 10s. 30 Graham Terrace, S.W.1.

**GW6AA** going abroad is selling great quantity superb American and British receiving and transmitting apparatus, valves, crystals, components, etc. Mainly new. Examples: Canadian 1000/100/10 kcs. frequency standard £9 10s. National "One-Ten" Receiver, Power supply six sets coils, handbook £22 10s. Six brand new HK-254 valves £5 each. National HRO (U.S. Naval model RBJ) Receiver, power supply, special container with 9 coils, all rack-mounting, also table rack. Whole outfit complete with handbook, brand new, in maker's original cases £70. Two Hallicrafters HT-11A complete marine radio-telephone transmitter-receivers (807 Tx output) with power supplies, microphones, earphones, handbook £25 each. Mullard B-100 Oscilloscope £9 10s. Recent National NC100XA Receiver, perfect condition, crystal filter, noise limiter, "S" meter, power supply, speaker, handbook, complete £55. Marconi CR100 Receiver (not junked model) perfect, in grey case £30. Two type 58 Canadian Transmitter-Receiver, complete with headphones, microphones, power supplies, handbooks, aeriels, etc. Brand new, £8 10s. each. Three American TBY U.H.F. transmitter-receivers 28-80 Mcs. continuous, with headphones, microphones, aeriels, keys, handbook, calibration charts, brand new, £12 10s. each. Superbly engineered jobs. International Marine IMR-20 Communication Receiver 2 R.F. stages, for battery operation. Perfect. Just re-aligned by maker £15 10s. (complete with speaker and handbook). Nine brand new HRO coils £4 per unit. Hunts 1947 Resistance-Capacity Bridge Model CRB, brand new, cost £18 18s., sell £14 10s. Two brand new Mortley-Sprague H.T. Generator Sets, Motor 24v. D.C., coupled on bed-plate to generator. Output variable 450-1700 v. at 150 mA. Unused, with original laboratory test certificates. Cost £60 each. Accept £30. Superb brand new modulator P.P. 807's. Rack mounting, complete two heavy power supplies, a real B.B.C. job, professionally made. Details. Much other equipment too varied to advertise. Lists free. GW6AA, "The Flagstaff," Colwyn Bay, Wales.

iii.

## TRADE

**H. FRANKS, 58, New Oxford St., W.C.1.** Tel. Mus. 9594. OFFERS the following ex-Govt. equipment to callers only. Comprising the following:—AC mains driven oscillators, type 37, 22 to 70 Mcs. complete with six valves and milliammeter in output circuit. Receiving units, type 69; C.R. units, type P1246; C.R. power units, type 526; performance meters, type 53874; AC mains wavemeters, type W1252; battery wavemeters, type W1095; receivers, type 1147; receivers 3132; indicator modulators, auto transformers; C.R. units, type 198; receivers, type 76A; battery driven amplifiers, large assortment of volt, amp and milliammeters, neutralizing units with R.F. meters, metal rectifiers, relays, vibrator packs. Inter-com. sets, Bendex H.F. dummy antennas and loading units, complete with R.F. meters, 356 to 6,666 kcs., six-valve receivers, type R-25/ARC.5. complete with valves, etc., etc.

**CONDENSERS** .1 mid. 350v. 5/6 doz.; 250 mA. Fuses 3/6 doz.; Chattertons 2/6 stick; 2 pole 5 amp. Panel Switches 3/6; Drive Cord 1d. yd.; Yaxley Switch Handles 6in. 10d.; Wafers only 4 and 8 way 4/- doz.; Assorted Hellerman Slewing 6/- lb. Various Soldering Tags 2/- gross; 9 pole 3 way Yaxley 10/-—Box 1023.

## STAFF VACANCY

### Junior Assistant Required

A good opening for a young radio enthusiast willing to assist in various sections of the publishing trade. Apply in person or in writing to:—Amalgamated Short Wave Press Ltd., 57 Maida Vale, W.9.

**EAST ANGLIAN HAMS.** All components for receivers and transmitters, crystals, test gear valves. Authorised distributors for Hamrad, Raymart, Eddystone, Labgear. No lists yet but all enquiries dealt with promptly, send stamped addressed envelope. Newson, G3GY ex-G2GF, 28 Market Place, North Walsham, Norfolk. Telephone 219.

**FOR YOUR** transformer and choke requirements consult Radio & Electric Facilities, 137a Ashton Road, Oldham, Lancs.

## H.A.C.

### Short-Wave Equipment

Noted for over 15 years for  
Short-Wave Receivers and Kits of quality.

One Valve Kit, Model "C" - Price 20/-  
Two " " " " "E" - " 43/-

These kits are complete with all components, accessories, and full instructions. Before ordering send stamped addressed envelope for descriptive catalogue.

Note new sole address:—

"H.A.C." SHORT-WAVE PRODUCTS  
(Dept. SWN).  
66 New Bond Street, London, W.1

# THIS MONTH'S BARGAIN!

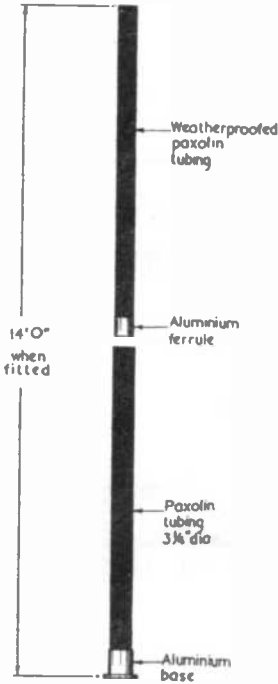

Special offer: a two sectioned aerial mast. Consists of two lengths of paxolin tubing 2 1/2 in. and 3 1/2 in. dia. respectively, with 3/16 in. wall. The smaller tube fits tightly into the larger one, both having metal ends. When fitted the aerial mast has an overall length of 14ft. Ideal for a transmitting or receiving aerial, but has many other uses also. May be fixed to the ground or to a fixture such as a chimney, wall, etc. Very sturdy. The price for the complete article is only 21/- carriage paid.

## OTHER ATTRACTIONS

### RECEIVERS:-

- R3003 A.M. I.F.F. Receiver working on 12v. and 24v. £1 10s. (packing and carriage 5/-)
- Type C.P.R.-43AAO U.S.A. equivalent of the R3003 £2 (packing and carriage 5/-)
- R3132 A.M. 1 1/2 metre receiver. Easily convertible for television sound and vision reception. This receiver is intended for use with the A.M. Indicator Type 6A, which is just right for converting to a television indicator £3 (packing and carriage 10/-)
- Type 69 A.M. I.F. amplifier containing a 24v.-250v. and 12.6v. rotary converter £2 (packing and carriage 7/6)
- R1147. There is hardly need to describe this now well-known receiver in detail. Just say that it is a 2 1/2 metre receiver, again easily converted to the 5 metre band for television. £2 5s. (packing and carriage 7/6)
- Type 3 Mk. 2 covering 3.1-15.5 Mcs. Runs off a power pack from 90v.-250 v. AC or 6v. DC £6 complete (packing and carriage 10/-)

### INDICATORS:-

- Type 6A. Can be used as television indicator with the R3132 as a receiver £5 (packing and carriage 10/-)
- A.P. 4889. Very similar to the A.M. Type 6A. £5 (packing and carriage 10/-)
- A.M. Type 104A. A two tube P.P.I. set. Contains two C.R. Tubes—one 5 1/2 in. and one 2 1/2 in., and is suitable for use as an oscilloscope £6 (packing and carriage 10/-)
- A.M. Type 62A. This indicator contains 21 valves, 1 Muirhead slow-motion drive, and many other components. Suitable for use as an oscilloscope, television indicator, etc. £10 (packing and carriage 12/6)

**ALEC DAVIS**

8 PERCY ST., TOTTENHAM COURT RD., LONDON, W.C.1

MUS 2453

Stockists of Government Surplus Radio Gear

## Available from Stock

### THE EDDYSTONE 640 RECEIVER

A 9-valve Superheterodyne circuit employing an EF39 as R.F. amp., 6K8/GT as frequency changer, EF39 as 1st I.F. Amplifier, EF39 as 2nd I.F. Amplifier, 6Q7/GT as Detector, AVC and Audio Amplifier, 6V6/GT as Output and a 6X5/GT as Rectifier. EB34 is used as noise limiter and EF39 as B.F.O. All valves are international octal types, easily replaced. A crystal filter circuit is included giving an adjacent channel attenuation of 45db. Frequency coverage is continuous from 1.7 to 32 Mcs.

Band 1—32-12.6 Mcs.

Band 2—12.6-4.5 Mcs.

Band 3—4.5-1.7 Mcs.

Outstanding features of this receiver are: Robust Construction, Crystal Filter, Good Frequency Stability, Large Attenuation of Image Signals, Separate Electrical Bandspread, High Signal to Noise Ratio.

### Controls

Main Tuning, Band Spread Tuning, Band Selection Switch, R.F. Gain, A.F. Gain, B.F.O. Pitch Control, B.F.O. on/off Switch, Crystal Phasing Crystal in/out Switch, Noise Limiter on/off Switch, A.V.C. on/off Switch, Send/Receive Switch, Mains on/off Switch.

Packing and railing charge 7/6.

Case charge (returnable) £2.

### THE HALLICRAFTER PANORAMIC ADAPTOR

A device for operation in conjunction with a companion receiver for the purpose of monitoring up to 200 Kilocycles of the radio spectrum visually, and to analyze the characteristics from your own or other transmitter. Percentage of Modulation, Distortion, Carrier Shift, parasitic radiations, Key clicks can be identified with ease.

With the model SP-44 Skyriders Panoramic you can keep track of all stations in a "Round table" QSO and can locate operating frequencies which are comparatively free from QRM. A phone jack on the rear of the chassis permits audible monitoring of all signals within a 200 Kilocycle range at one time. No modifications are necessary in your receiver in order to connect the adaptor to a receiver and it in no way interferes with normal receiver operation. This adaptor may be used with any receiver having an I.F. between 450 and 470 kcs. 10 valves including C.R. Tube. Controls are Scanning Width, Sensitivity, Centring, Equalizer, Screwdriver adjustments, Horizontal position, Vertical position, Sweep Pad, Intensity, Focus. Designed to work off 117 volt 50-60 cycle mains A.C. £31 15s. 7d. or for 200/250v. 50-60 cycle mains A.C. £32 8s. 6d. Packing and railing charge on either instrument 7/6 extra, plus £2 case charge (returnable).

THE QUANTITY IS VERY LIMITED

SEND YOUR ORDER NOW

MAIL ORDER DEPT.

EFFICIENT AND SPEEDY

Goods are despatched same day either C.W.O. or C.O.D. whichever suits you better.

# VALLANCE'S

144 BRIGGATE, LEEDS, 1

# CLYDESDALE

THE RADIOMAN'S SHOP  
FOR BARGAINS IN EX-SERVICES ELECTRONIC EQUIPMENT

*And now!* A FULLY MOBILE AND SELF-CONTAINED  
PORTABLE PUBLIC ADDRESS EQUIPMENT

The  
Ex-Royal Navy  
**LOUD  
HAILER**

Parmeko 432  
in new condition



FOR  
ONLY **£25** EACH

Plus 15/- part carriage anywhere in the U.K.

Comprising

**HIGH OUTPUT AMPLIFIER**, output 15 watts, valves—EF36, ECC31, two EL35 or equivalents, Mic. and Gram. inputs, combined fade-over control, plus other features

**MOVING COIL HAND MICROPHONE**, with remote control, H.T. Economy Switch—a definite current saver

**PROJECTION TYPE LOUDSPEAKER**, pressure operated, 10 ohms imp.

**ACCUMULATOR**, 12 volt, 72 a.h. capacity with leads and

**INSTRUCTION BOOK**, supplied in

Special Packing Case.

Tested in operation before despatch

*Special* **A KIT OF SPARES** available, as an extra, for each equipment: 8 valves, two EF36, two ECC31, four EL35 or equivalent, L.S. diaphragm assembly, switch, condensers, etc., etc.

PER KIT, ONLY **70/-** CARRIAGE FREE  
Only supplied with Loud Hailer

**CIRCUITS AVAILABLE:** R1116 Rx, 2,3; R1155 Rx, 1,3; R1155 AC Power Unit, 2,3; MCRI Rx, 2,9; T1154 Tx, 2,3, all post free

SEND NOW FOR NEW ILLUSTRATED LIST

(Write Name and Address in BLOCK LETTERS please)

**CLYDESDALE SUPPLY  
CO LTD**  
2 BRIDGE STREET - GLASGOW - C.5

'Phone : SOUTH 2706/9

VISIT OUR BRANCHES IN SCOTLAND, ENGLAND AND NORTHERN IRELAND

London: Printed in Gt. Britain by Chas. Pearson & Son, Ltd., 53-55, Mansell St., London, E.1, for the Proprietors, Amalgamated Short Wave Press, Ltd., and published at 57, Maida Vale, Paddington, London, W.9.—September, 1947.