

THE RADIO REVIEW

A MONTHLY RECORD OF SCIENTIFIC
PROGRESS IN RADIOTELEGRAPHY
AND TELEPHONY

VOL. III

FEBRUARY, 1922

No. 2

Editor :

PROFESSOR G. W. O. HOWE, D.Sc., M.I.E.E.

Assistant Editor :

PHILIP R. COURSEY, B.Sc., F.Inst.P., A.M.I.E.E.

CONTENTS

Editorial

Theoretical and Practical Aspects of Low Voltage Rectifier Design
when employing the Three-electrode Vacuum Tube
R. D. DUNCAN, Jun.

A Method of Measuring Coil Capacities and Standardising Wave-
meters GREGORY BREIT

Some New Laboratory Apparatus for Radio Measurements

Notes on the Technical Decisions of the Paris International Conference
on Radio Communications (June—August, 1921)
Professor G. VALLAURI

The Amplification of Weak Alternating Currents. II.—The Grid
Circuit and Input Transformer H. BARKHAUSEN

High-speed Wireless Telegraphy

The Physical Society of London and the Optical Society. The Twelfth
Annual Exhibition of Electrical, Optical, and other Physical
Apparatus

Notes : Commercial and General

Review of Radio Literature :—

Abstracts of Articles and Patents

Book Reviews

Books Received

Correspondence

Five Shillings Net

THE RADIO REVIEW

A MONTHLY RECORD OF SCIENTIFIC PROGRESS IN
RADIOTELEGRAPHY AND TELEPHONY

Editor: Prof. G. W. O. HOWE, D.Sc., M.I.E.E. Asst. Editor: PHILIP R. COURSEY, B.Sc., A.M.I.E.E.

SUBSCRIPTION RATES.—£3 per annum, post free. Single copies, 5/-, or post free, 5/3.

Vol. III. No. 2

Registered at the G.P.O. for transmission by
Magazine Post to Canada and
Newfoundland.

FEBRUARY, 1922

Contents

| | PAGE |
|--|------|
| EDITORIAL | 57 |
| THEORETICAL AND PRACTICAL ASPECTS OF LOW VOLTAGE RECTIFIER DESIGN WHEN EMPLOYING THE THREE-ELECTRODE VACUUM TUBE. By R. D. DUNCAN, JUN. | 59 |
| A METHOD OF MEASURING COIL CAPACITIES AND STANDARDISING WAVEMETERS. By GREGORY BREIT | 71 |
| SOME NEW LABORATORY APPARATUS FOR RADIO MEASUREMENTS | 79 |
| NOTES ON THE TECHNICAL DECISIONS OF THE PARIS INTERNATIONAL CONFERENCE ON RADIO COMMUNICATIONS (JUNE-AUGUST, 1921). By Professor G. VALLAURI | 82 |
| THE AMPLIFICATION OF WEAK ALTERNATING CURRENTS. II. THE GRID CIRCUIT AND INPUT TRANSFORMER. By H. BARKHAUSEN | 91 |
| HIGH-SPEED WIRELESS TELEGRAPHY | 98 |
| THE PHYSICAL SOCIETY OF LONDON AND THE OPTICAL SOCIETY. THE TWELFTH ANNUAL EXHIBITION OF ELECTRICAL, OPTICAL, AND OTHER PHYSICAL APPARATUS | 99 |
| NOTES :— | |
| Commercial and General | 100 |
| REVIEW OF RADIO LITERATURE :— | |
| Abstracts of Articles and Patents | 101 |
| Book Reviews :— | |
| “Experimental Wireless Stations.” By Philip E. Edelman | 109 |
| “High-frequency Apparatus.” By Thomas S. Curtis | 109 |
| Books Received | 110 |
| CORRESPONDENCE :— | |
| Marius Latour on “‘Choke Control’ Modulation in Radiotelephony” | 110 |
| L. W. Austin on “Optimum Wavelength” | 111 |
| L. W. Austin on “Transmission of Wireless Signals between Toulon and Tahiti” | 112 |

THE RADIO REVIEW

INFORMATION FOR CONTRIBUTORS

All correspondence relating to contributions should be addressed to *The Editor, The "Radio Review," 12 & 13, Henrietta St., Strand, London, W.C. 2.*

Correspondence intended for publication in the "Radio Review" must be accompanied by the full name and address of the writer, not necessarily for publication if a "nom-de-plume" is added, and should reach the Editor not later than the 7th of the month, for publication in the next issue.

The copyright of all articles accepted for publication in the "Radio Review" becomes the property of *The Wireless Press, Ltd.*, unless special arrangements are made with the author at the time the article is submitted. Limited portions or abstracts of articles, or editorial notes, may however be reprinted on the express condition that specific reference is made to the "Radio Review" as the source of such material.

All manuscripts will be acknowledged as soon as received. The Editor will not be responsible for the return of manuscripts unless they are accompanied by a stamped addressed envelope, or by an international postage coupon in the case of foreign contributions. Manuscripts should be as complete as possible, with all necessary diagrams and illustrations. Line diagrams accompanying manuscript should only be in rough form, and will be redrawn before publication. Illustrations of apparatus should not be too small. They are best for reproduction when in the form of good photographic prints, wherever possible on glossy paper.

In articles involving the use of mathematical expressions and formulæ, the internationally recognised standard symbols should be employed wherever possible, and be given their most generally accepted significations.

Reprints of articles published in the "Review" can be supplied to authors at the following rates if they are ordered when returning the corrected proofs of the article.

RATES FOR REPRINTS (postage extra).

| No. of Copies. | 4 Pages. | | | 6 Pages. | | | 8 Pages. | | | 10 Pages. | | | 12 Pages. | | | 14 or 16 Pages. | | | Extra for Cover. | | |
|----------------|----------|----|----|----------|----|----|----------|----|----|-----------|----|----|-----------|----|----|-----------------|----|----|------------------|----|----|
| | £ | s. | d. | £ | s. | d. | £ | s. | d. | £ | s. | d. | £ | s. | d. | £ | s. | d. | £ | s. | d. |
| 25 . . . | 1 | 4 | 9 | 1 | 19 | 9 | 2 | 15 | 0 | 3 | 10 | 0 | 3 | 19 | 9 | 4 | 13 | 6 | 0 | 16 | 6 |
| 50 . . . | 1 | 5 | 9 | 2 | 1 | 0 | 2 | 16 | 3 | 3 | 12 | 0 | 4 | 2 | 3 | 4 | 16 | 3 | 0 | 18 | 0 |
| 75 . . . | 1 | 6 | 6 | 2 | 2 | 6 | 2 | 18 | 3 | 3 | 14 | 3 | 4 | 4 | 9 | 4 | 19 | 0 | 0 | 19 | 3 |
| 100 . . . | 1 | 7 | 3 | 2 | 3 | 9 | 3 | 0 | 0 | 3 | 16 | 6 | 4 | 7 | 3 | 5 | 1 | 9 | 1 | 0 | 9 |
| 150 . . . | 1 | 9 | 0 | 2 | 6 | 6 | 3 | 3 | 3 | 4 | 0 | 9 | 4 | 12 | 3 | 5 | 7 | 3 | 1 | 3 | 6 |
| 200 . . . | 1 | 10 | 9 | 2 | 9 | 3 | 3 | 6 | 0 | 4 | 5 | 0 | 4 | 17 | 0 | 5 | 12 | 9 | 1 | 6 | 3 |
| 250 . . . | 1 | 12 | 3 | 2 | 12 | 0 | 3 | 10 | 0 | 4 | 9 | 9 | 5 | 2 | 0 | 5 | 18 | 3 | 1 | 9 | 0 |

THE RADIO REVIEW

VOL. III

FEBRUARY, 1922

No. 2

Editorial.

The Design and Construction of Towers and Masts for Radiotelegraphy.—One of the first discoveries made by Marconi in his earliest experiments in Italy was that the transmitting efficiency depended on the height of the transmitting antenna, and although there have been suggestions from time to time that the elevated transmitting antenna might be replaced by a low horizontal conductor, it is now generally recognised that height is of prime importance. It is fairly safe to say that the designers of all the modern high-powered stations would welcome the possibility of increasing the heights of their antennæ if it could be done without adding enormously to the cost of the station. Unfortunately the cost increases very rapidly with the height and the designer has to decide in each case to what height he is justified in going. This situation is relieved to some extent by the use of a multiple aerial since this permits the use of a very extensive system of overhead wires and of very large currents without introducing excessive losses.

At the present moment many attempts are being made to increase the efficiency of transmitting antennæ so as to bring the ratio of the radiated power to the input to the antenna up to a more reasonable value than it had in the majority of cases. The first step in this direction has been directed to reducing the losses in the earth in the immediate neighbourhood of the antenna and the recent papers by Meissner, in Germany, and Eckersley, in this country have shown what very great economies are possible by proper design of the earthing system or counterpoise.

A subject about which very little is known is the loss of power occurring in the masts and stays. It is not a subject that lends itself very readily to research on a large scale and any results obtained on small scale models would be difficult to apply to the large scale example. The best design of mast or tower involves so many problems apart from the purely electrical ones that no hard and fast rules could be laid down; we feel sure, however, that the time has come when more attention should be paid to the effects of the masts in the radiation of power from the antenna. What are the relative merits of wood and steel, of self-supporting towers and stayed masts, if of steel, should they be earthed and continuous or insulated and sectionalised, what degree of sectionalisation is desirable in the masts and in the stays? These are some of the problems awaiting a thorough examination and there are others closely allied, concerning the advisability of maintaining a greater distance between the masts and the actual antenna, the precautions which

F

might be applied to all terminal and junction points of the antenna to increase the corona limit by proper shielding, the reduction of the losses in the earth at the foot of an insulated mast. These questions are not of interest to the designer of high-powered stations only, but to all radio engineers. In the station working over 500 or 1,000 miles the improvement of the radiation efficiency is of very great importance, since it may enable one valve to be used instead of two, or the valves to be used under conditions more conducive to long life, and the purity of the emitted wave to be improved so as to cause less interference with other stations.

It is not a difficult matter to make an approximate determination of the radiation efficiency of an antenna. The total effective resistance including the radiation resistance, or radiance, as Brillouin prefers to call it, can be determined in the usual way by observing the effect on the antenna current of inserting a known non-inductive resistance, without varying the E.M.F. induced in the accurately tuned aerial from a weakly coupled primary circuit. The radiation resistance can be calculated approximately from an assumed effective height of antenna; this can be estimated within 5 or 10 per cent., depending on the data at one's disposal, and we suspect that a knowledge of the radiation efficiency to this degree of accuracy would be sufficient to cause many antennæ to undergo a period of reconstruction.

Applications of the Thermionic Valve.—Probably no piece of electrical apparatus is so adaptable to a variety of purposes as the three-electrode valve and this with little or no modification of its construction. This wonderful adaptability is well illustrated in the high-speed apparatus described by Lieut.-Colonel Cusins in his paper before the Wireless Section of the Institution. The transmitter and receiver contain together eleven valves, which have, between them, eight different functions to perform. Of the two in the transmitter one is the main high-frequency generator while the other acts as a variable control resistance in its grid circuit. In the receiver, three serve as a high-frequency amplifier, one as a valve relay, one as a low-frequency generator, one as a valve-relay control valve, one as a direct-current amplifier, and two in conjunction as a double-current valve relay. Although the paper described the progress made in what the author called the mechanicalisation of wireless telegraphy, this progress is only made possible by the elimination of mechanical links, except at the beginning and end of the chain, and their replacement by three-electrode valves.

Another Wireless Slide Rule.—In many calculations in connection with radio and high-frequency circuits frequent use is made of the well-known formula $\lambda = K\sqrt{CL}$. Abacs, charts and similar devices have often been prepared to facilitate the frequent use of this and similar formulæ, and Messrs. B. Hodgson and S. Brydon have recently prepared a special slide rule to enable direct readings of capacity, inductance and wavelength to be obtained. The range of the inductance scale is from 1 to 10,000 microhenries, and forms the upper fixed scale of the rule; the capacity scale runs from

0.00001 to 0.1 microfarad and forms the lower scale on the slide; and the wavelength scale (fixed) is in two parts running from 6 to 600 and 600 to 60,000 metres. Four index arrows are marked on the slide, two being in red and two in black, the black arrows corresponding to the above-mentioned capacity scale; and the red ones for use with a second capacity scale engraved with red figures between 0.01 and 100 jars. By selecting the appropriate index arrow, the range of the inductance scale can be extended when necessary, without appreciably impairing the direct-reading qualities of the rule.

Theoretical and Practical Aspects of Low Voltage Rectifier Design when employing the Three-electrode Vacuum Tube.*

By R. D. DUNCAN, Jun.

Chief Engineer, U.S. Signal Corps Research Laboratory, Bureau of Standards.

Introduction.—The problem of generating high continuous voltages required for operating radio telephone and telegraph equipment of the thermionic type is one in which, under certain conditions, difficulties are encountered in obtaining a *satisfactory* practical solution. The method customarily in use is that wherein a converter or motor-generator is employed, operating either from storage batteries or from a local power source; where relatively high powers with attendant higher anode voltages are required, and where alternating current is available, the transformer-rectifier combination has come into use. Radio transmitting apparatus employing this latter arrangement was first described a number of years ago by Langmuir,† and has since been developed for commercial purposes both in the United States and in Europe.

The necessity for employing dynamotor or motor-generator equipment, even where low transmitting powers are concerned, presents serious obstacles to the practical and commercial adoption of radio apparatus except where skilled attendance is available, as would be the case in a centralised plant. Occasions have often arisen, and will no doubt continue to arise with increasing frequency, where skilled attendance not only will not be available, but where radio and kindred apparatus, to be acceptable for comparative isolated installation, must be capable of operation and maintenance by entirely unskilled personnel. A notable example of a type of service which demands such apparatus is that of "Line Radio" or "Wired Wireless" where the principal object is to place at the disposal of the unskilled operator multiplexing telephone and telegraph equipment which basically requires the generation of high continuous voltages. The transformer-rectifier com-

* Received October 1st, 1921.

† I. Langmuir, *Proceedings of the Institute of Radio Engineers*, 3, p. 284, 1915.

ination has been found to give satisfactory and dependable operation for this type of service.

With the increasing use of rectifying equipment, the question of its design to meet specific requirements becomes one of importance. It has been discussed by Hull,* Fortescue,† and van der Bijl,‡ who have dealt in a more or less general manner with conditions which prevail when relatively high powers and extremely high voltages are concerned and where the "hard" or high vacuum type of rectifier tube is employed. Furthermore in these discussions it is implicitly assumed that the rectifier tube may be constructed to have the particular voltampere characteristic desired. Where these conditions are not fulfilled the theory, as developed, requires a number of modifications as are hereinafter noted.

The investigations with which the present paper is concerned as explained elsewhere, by virtue of restrictions imposed by the conditions of development, operation, and maintenance of the apparatus, contemplated the use of standard forms of the three-electrode tube as the rectifier, in preference to a special type of tube. The problem is then restricted to the determination of the design constants of the transformer which will operate properly with the rectifier tube in question and furnish the high voltage required for rectification.

It is the object of this paper to discuss from the preceding standpoint, the theory and design of the low voltage rectifier for furnishing plate voltage required in the operation of relatively low power radio telegraph and telephone transmitters of the thermionic type. The theory is developed essentially from a practical standpoint and does not pretend to rigorousness; wherever it was considered advisable, empirical relations have been introduced, which were found by experiment to have an accuracy sufficient for design purposes. Based upon the theory, equations have been worked out from which the design information, required to carry through the design of the rectifier transformer may be obtained. In its general form, the theory follows along the lines laid down by Fortescue, but contains certain differences which are apparent upon comparison of the two texts.

General Considerations.—When the design of rectifying apparatus is considered, for operation with a specific type of load, such as that presented by the plate-filament circuit of the transmitting tubes of a radio telephone set, a number of factors must be taken into account, of which the following are the most important:—

- (a) Source of power and frequency available.
- (b) Type of rectifier tube to be used.
- (c) Magnitude of rectified voltage and current required.
- (d) Magnitude of ripple permissible in the rectified voltage.
- (e) Power and current required to be delivered by the rectifier transformer.

* A. W. Hull, *General Electric Review*, 19, p. 177, 1916.

† C. L. Fortescue, *Proceedings of the Physical Society of London*, 31, p. 319, 1919.

‡ van der Bijl, "The Thermionic Vacuum Tube" (*McGraw-Hill Publishing Co.*), Chapter IV.

In the following the bearing which these various factors have upon the design of the apparatus is discussed :—

(a) Unless otherwise stated the standard [U.S.] commercial frequency of 60 cycles per second is adopted throughout as a basis for discussion.

(b) The choice of the type of rectifier tube is governed largely by conditions under which the rectifying apparatus is developed and under which it will operate when in use. Where facilities are immediately available for the construction of special types of vacuum tubes, and where the question of maintenance and operation of equipment, which includes different types of transmitting tubes, does not present serious difficulties, the two-electrode tube is the logical choice. Where, however, the conditions of development are unfavourable to the consideration of a special type of rectifier tube, and where the conditions of operation demand the simplest types of apparatus with the minimum requirements for maintenance, it is necessary to restrict the number of types of tubes to a minimum. For these reasons, in the apparatus development described in part herein, the three-electrode tube, of standard construction, was adopted for use as the rectifier. This type of the tube, however, is not an efficient power rectifier, because of its relatively high internal resistance which latter quantity may be reduced and operation materially assisted by connecting the grid and plate together. Though the region of operation of the tube with such a connection is restricted to comparatively low plate voltages, experiment has shown that better results are so obtained than with the grid at the same potential as the filament or even positive thereto.

If the rectifier tube is of the coated filament type with a consequent high electron emission, the inability to operate continuously at full saturation electron current is an additional factor which militates against its efficient working, since the complete emission of electrons may never be utilised; in addition the requirement is imposed that the current flowing through the tube may not exceed a maximum value as the excessive heating of the electrodes attendant to high currents may cause destruction of the tube, resulting from gas ionisation and kindred effects.

Where extremely high voltages are dealt with, the voltage drop within the tube is in general negligible compared to the applied voltage, and need not be considered; however, in the case of comparatively low anode voltages, for accurate design results, it must be taken into account.

The rectifier tubes with which the present investigation is concerned were of the coated filament type and were designed for operation on low plate voltages; in the theoretical consideration of the conditions of rectifier operation, as hereinafter outlined, as well as in the experimental investigation, described in part, the problem was approached, with the limiting provisions in mind which are imposed by the use of such tubes. In a following section reference is again made to the part played by the voltage drop within the tube and a method is described for measuring the same.

(c) The magnitude of the rectified voltage and current which will be obtained are functions of the character of the load, which, besides the actual load resistance, includes whatever smoothing out or filtering capacities and

inductances there may be in the circuit. The value of the final load resistance is obtained from direct measurements of the D.C. plate current and plate voltage of the radio transmitter while in operation. Values of this resistance as met with in practice may vary from 1,000 to 5,000 ohms.

(d) The variation in the plate voltage resulting from imperfect smoothing out of the rectified voltage gives rise to a form of modulation of the high frequency output of a radio telephone transmitter in the same manner as does the voice operating through the means of the modulating circuits. This is true whether rectified voltage or continuous voltage from a direct current generator, is applied. If rectified voltage is employed, the fundamental frequency of the ripple will be the same as, or twice that of, the fundamental frequency of the alternating current source, depending upon whether *half-wave* or *double wave* rectification is employed; the harmonics

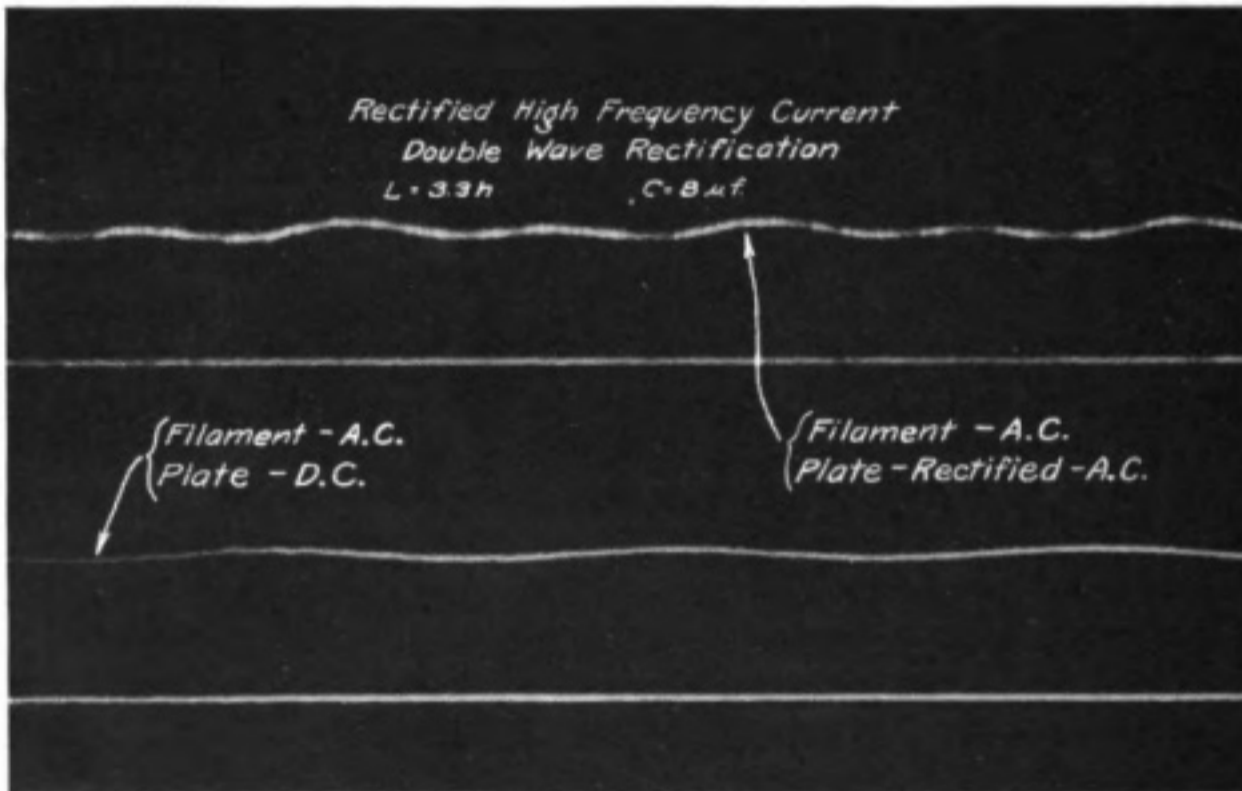

FIG. 1 (a) (c).

resulting from irregularities in the original wave, and from rectification will suffer modification similar to the fundamental frequency. The amplitude of the ripple may be reduced by means of smoothing out condensers or, if extreme refinement is required, by multi-mesh filter circuits.* When the plate voltage is obtained from a direct current generator of the ordinary type, if special attention is paid to the method of brush mounting, the modulating effect of the commutator ripple may be reduced to where it is not more than 5 per cent. of the entire output. Due to the relatively high fundamental frequency of this type of ripple, this percentage may be further reduced without difficulty, by means of filter circuits. When, however, the plate voltage is of the rectified alternating variety, and the ripple frequency low,

* A discussion of such application of filter circuits is given in the "Thermionic Vacuum Tube" by van der Bijl.

for example, 120 cycles per second, without the use of excessively large capacities and inductances, a ripple amplitude of between 5 per cent. and 10 per cent. is as close to the minimum which may be obtained.

In addition to the modulation produced by variations in the plate voltage of the transmitting tubes there is produced a similar, though not so pronounced effect, if the filaments of the latter are energised by alternating current; this results from the periodic variation in the potential of the filaments of these tubes.

The modulating effect of the plate and filament voltage ripples was investigated with the aid of an oscillograph and under actual transmitting and receiving conditions. Representative oscillograms are given in Figs. 1 (a), (b), (c) and (d), in which are shown graphs of the rectified high frequency current

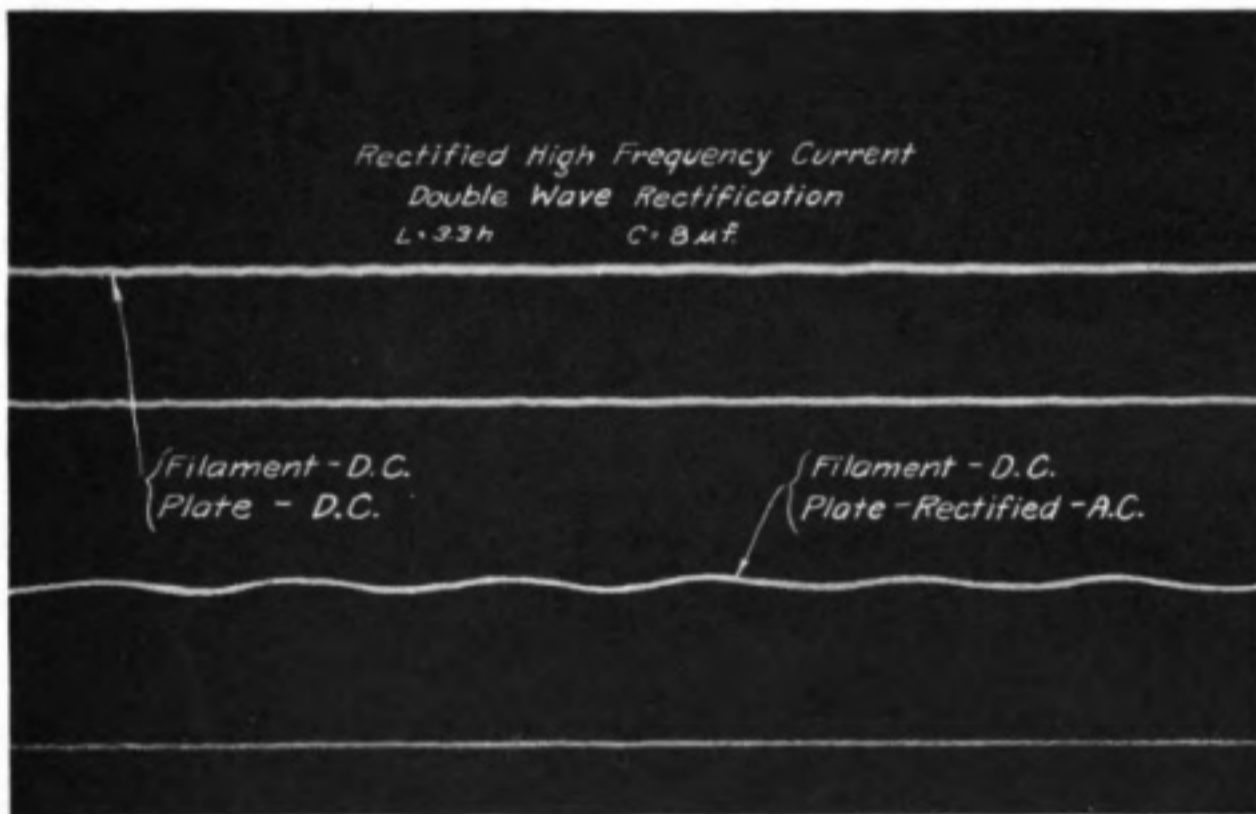

FIG. 1 (b) (d).

obtained from a standard radio telephone transmitter operating with both alternating current (60 cycles) and direct current energisation. In Fig. 1 (a) is shown the full alternating current condition, viz., with the filaments of the radio tubes energised by alternating current and the plates supplied with rectified voltage; in Fig. 1 (b), the full direct current condition, and in Figs. 1 (c) and (d), the combined alternating and direct current conditions as indicated. The oscillograms were obtained with a smoothing out capacity and inductance, in the load circuit, of the rectifier (see Fig. 2) of values respectively equal to 8 microfarads and 3.3 henrys. Assuming the modulation to be symmetrical upwards and downwards about a mean or unmodulated value, it is estimated from the oscillograms that the modulation due to the combined plate and filament effects lies between 5 per cent. and 10 per cent. Since the modulation produced by the voice (not shown in the

oscillograms) is of the order of 90 per cent. upwards and downwards, it is not to be expected that at a distance, telephonic reception will be seriously interfered with by the filament and plate ripples. This conclusion is confirmed by actual reception tests, as over distances small compared to the normal range of transmission of the particular radio transmitter utilised, a ripple modulation of amplitude shown on the oscillograms was hardly observable, and not at all objectionable. There was little to choose between the full alternating current and full direct current conditions. When telegraphic transmission alone is concerned in which the presence of a ripple of relatively large amplitude is not so serious, the smoothing out or filtering capacity may be greatly reduced in value; under this condition the signal received on the beat note principle still maintains its bell-like note and is quite distinctive in character.

(e) The power and current requirements of the transformer are discussed in detail in the next section.

Theory of Circuit Operation and Derivation of Design Equations.

—In Figs. 2 (a) and (b) respectively are shown the standard circuits of half-wave and double wave systems of rectification; in Figs. 3 (a) and (b) are given the current and voltage curves which obtain for the two conditions.

The load circuit is represented in Figs. 2 (a) and (b) by a capacity in parallel with the load resistance. If, as is the case with a large class of radio telephone transmitters, an inductance is included in series with the load resistance, the behaviour of the circuit is somewhat altered, which effect is reflected in the equations. The presence of the inductance assists only slightly in reducing the plate voltage ripple with values of load resistance normally met with in radio apparatus. It is to be noted in this respect that it is of little practical value to attempt to secure such refinement in smoothing

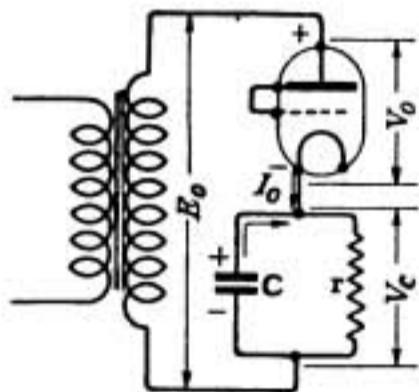

FIG. 2 (a).

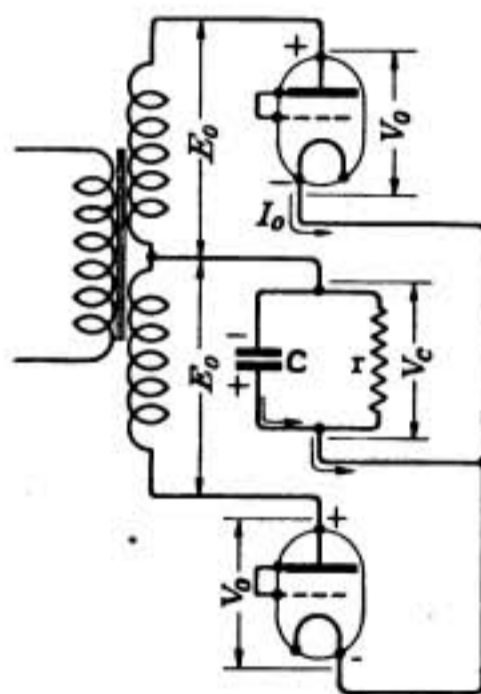

FIG. 2 (b).

out the voltage supplied to the plates of the radio transmitting tubes, since in general the filaments of the latter are energised from alternating current and the modulating effect thus produced will more than annul this advantage. Both conditions are considered in the following.

Referring to Figs. 2 (a) and 3 (a), the operation of the half-wave circuit may be explained as follows: Neglecting the presence of transients, when the transformer secondary voltage E_0 (maximum value) is initially attained, the capacity C is charged to a voltage less than the maximum voltage E_0 by the maximum voltage drop, V_0 , in the rectifier tube; this will be very

approximately true regardless of the part of the cycle of voltage E_0 at which the circuit is closed. Since the rectifier tube is assumed to have perfect unilateral conductivity, current will flow through the tube in the direction of the arrow only when the plate is positive with respect to the filament;

the condenser will therefore be charged with the terminal connected to the filament, as positive. After being charged the condenser will attempt to discharge through the resistance branch and through the tube, as shown by the arrows, and in so doing will build up across the tube a voltage which opposes the applied voltage; no current will pass through the tube until this back E.M.F. is overcome. When the applied voltage maintains the plate negative with respect to the filament, no charging current will flow and the condenser will discharge through the load resistance in accordance with well-known laws. Referring to Fig. 3 (a), as shown from the previous cycle, at the time $t_1 = t_2 = 0$, the voltage across the condenser is somewhat greater than V_c' and is decreasing in value, while the applied voltage is increasing, and is opposing in sign.

When the latter becomes the greater as at A, a varying current of maximum value I_0 will flow through the tube until the time t_1 has elapsed, viz., at point B, and during the greater portion of this time, the condenser voltage is increasing. The net result of the charging and discharging action is that there is applied to the actual load resistance r a continuous voltage of variable amplitude. Though the charging and discharging time intervals are unequal, and the manner of variation of charging and discharging, dissimilar, no great error is incurred in assuming that the average discharge voltage is equal to the arithmetical mean of the maximum condenser voltage, V_c , occurring at time t_1 , and the minimum voltage V_c' occurring at time t_2 . On the assumption that this average voltage constitutes the fixed component, the voltage variation may be considered as being the result of superposition, upon this fixed component, of an alternating component of maximum amplitude $\frac{V_c - V_c'}{2}$, and of fundamental frequency equal to the frequency of the applied voltage. It is of course desirable to reduce the amplitude of this alternating component to a minimum. It is observed that the current flowing through the rectifier tube, at every

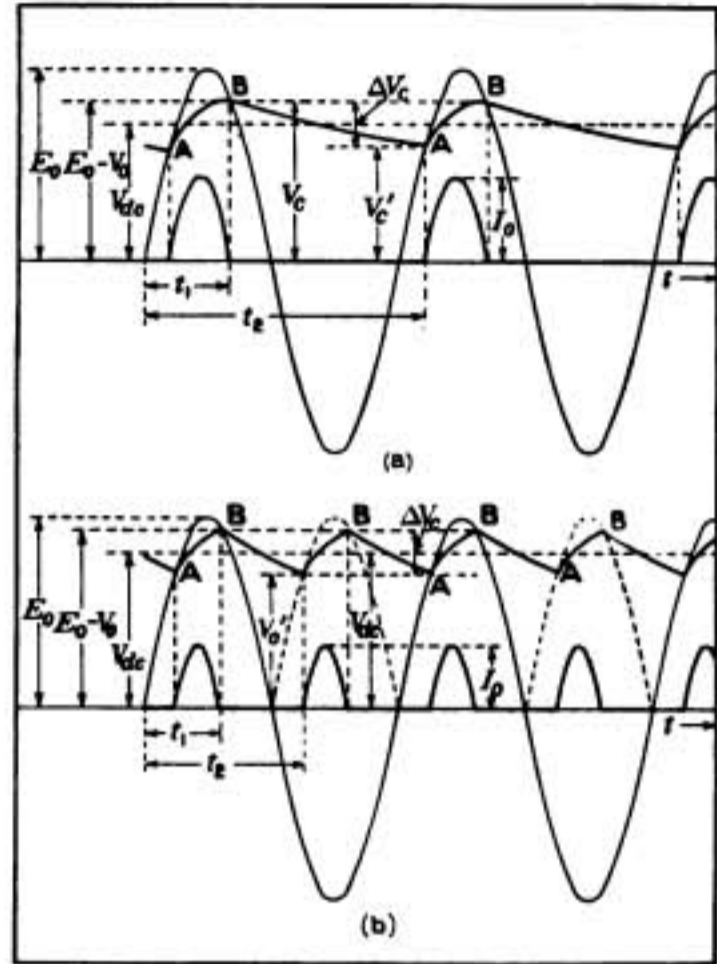

FIG. 3.

instant during passage, is varying and does not remain fixed in amplitude, as was assumed by Fortescue for the case of a hard tube.

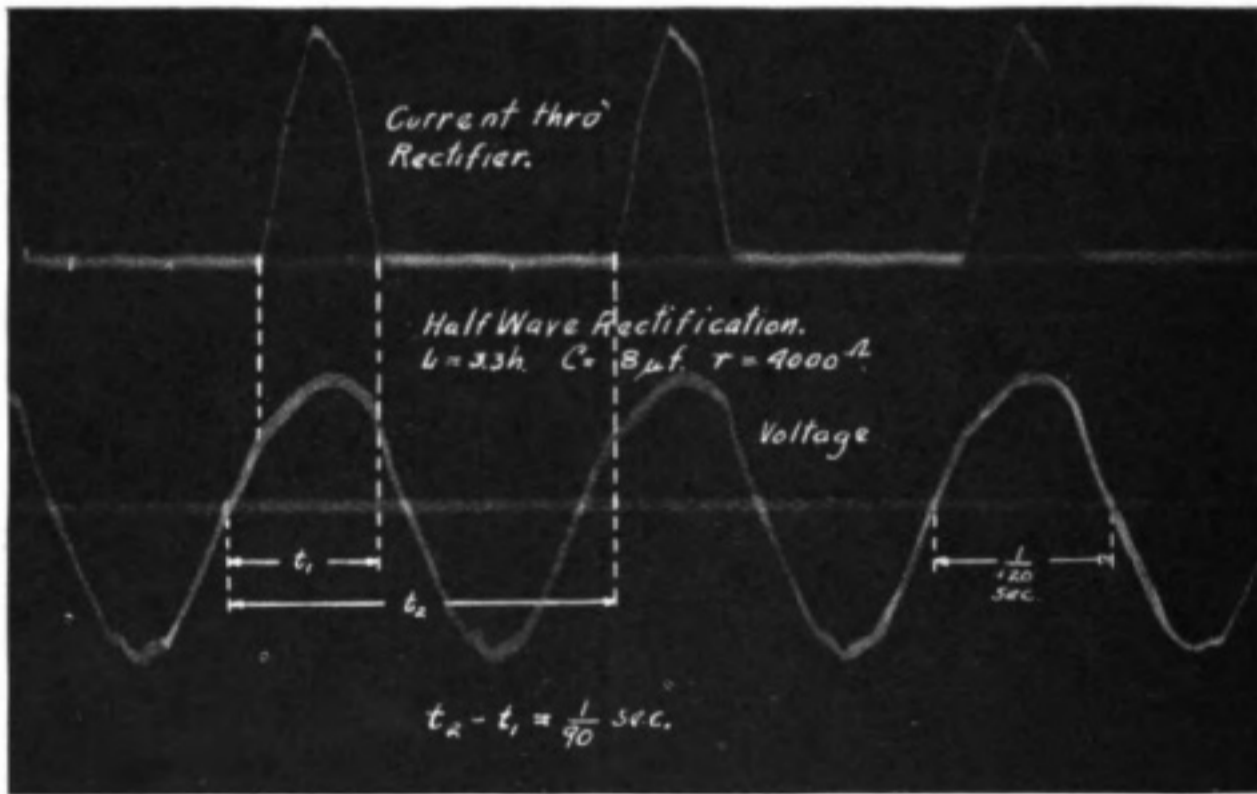

FIG. 4 (a).

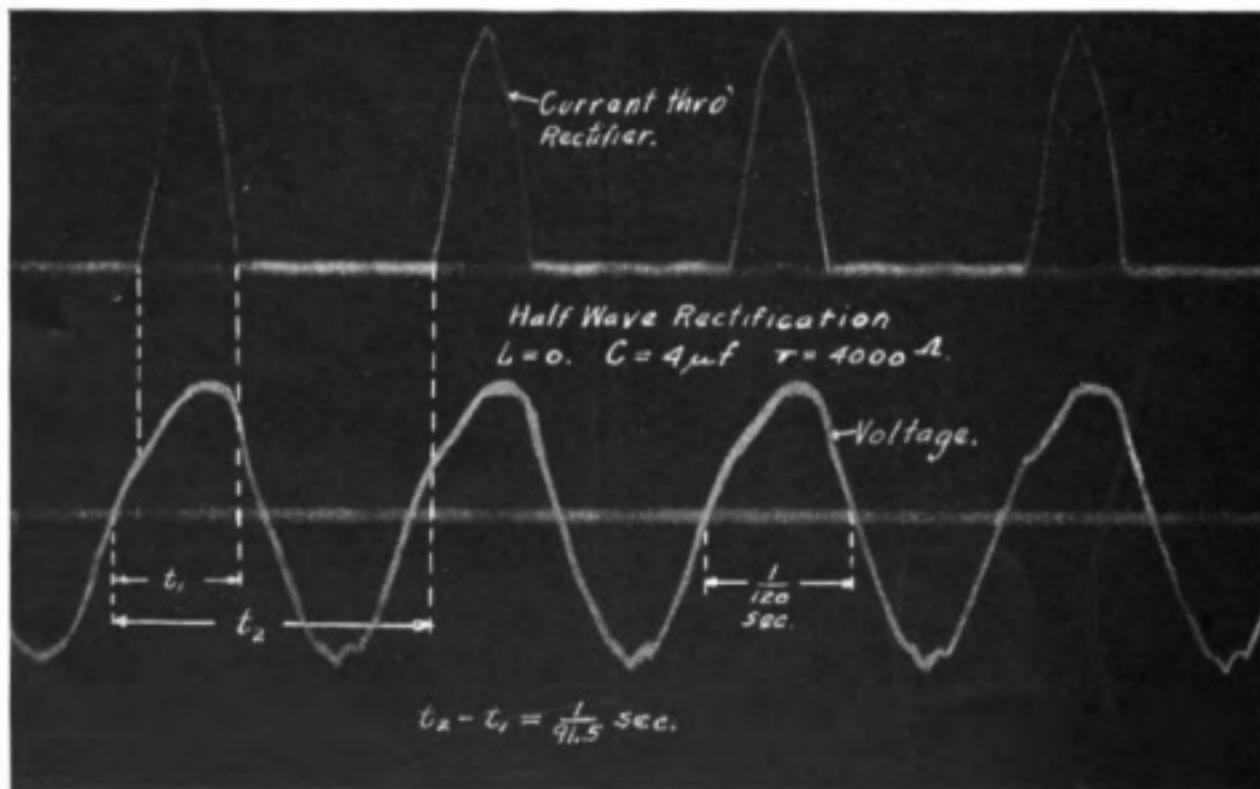

FIG. 4 (b).

The double wave rectifier, in its behaviour, is similar in every respect to that described for the half-wave rectifier with the exception that, since the condenser is charged and discharged twice rather than once during a cycle

of the applied voltage, the fundamental frequency of the alternating component of the condenser voltage will have twice the frequency of the applied voltage; furthermore, as the time of condenser discharge is shorter, the

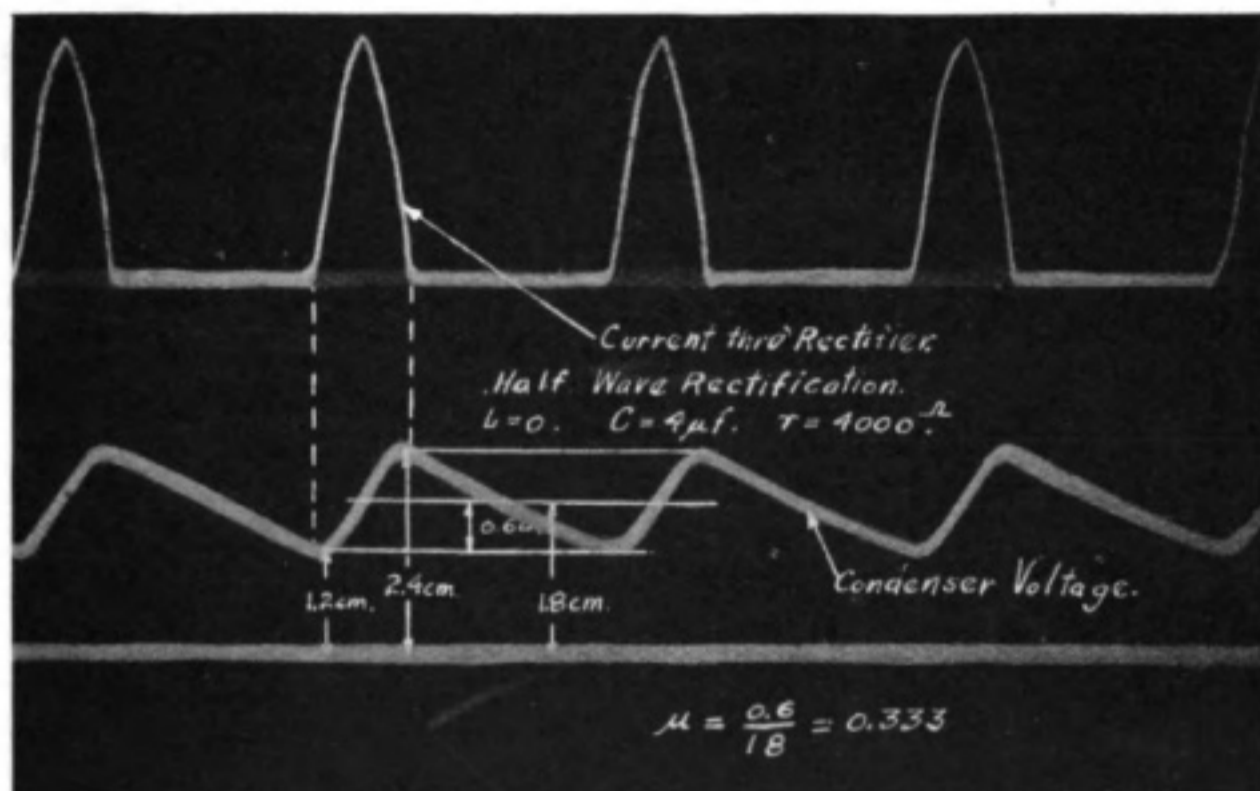

FIG. 4 (c).

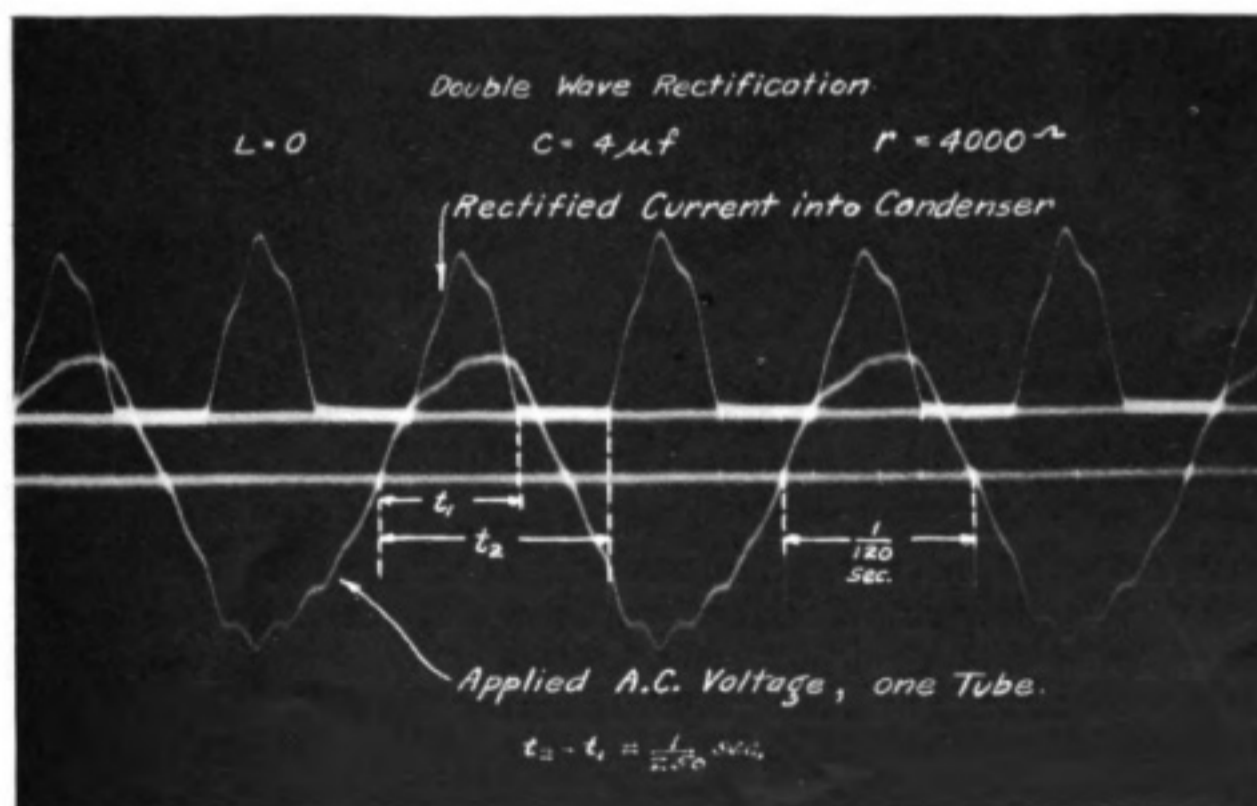

FIG. 5 (a).

amplitude of the alternating component will be less than with half-wave rectification. These features have an important bearing upon the design and operation of the apparatus.

The action of the rectifier circuit has been investigated with assistance of an oscillograph, a large number of oscillograms being obtained with different conditions of loading and power output. Those shown in Figs. 4 and 5 are believed to be typical of the extreme conditions which will be met with in practice and which will permit of satisfactory telephonic operation.

The explanation of the action of the rectifying circuit has been made to depend upon values of V_0 , the voltage consumed within the tube, and the time interval $t_2 - t_1$. The former quantity is a function of the internal tube resistance, of the current through the tube and of the type of load; the time, $t_2 - t_1$, since saturation condition is never obtained, is determined largely in value by the characteristics of the load. The two quantities are seen to be interdependent, a change in one involving a change in the other.

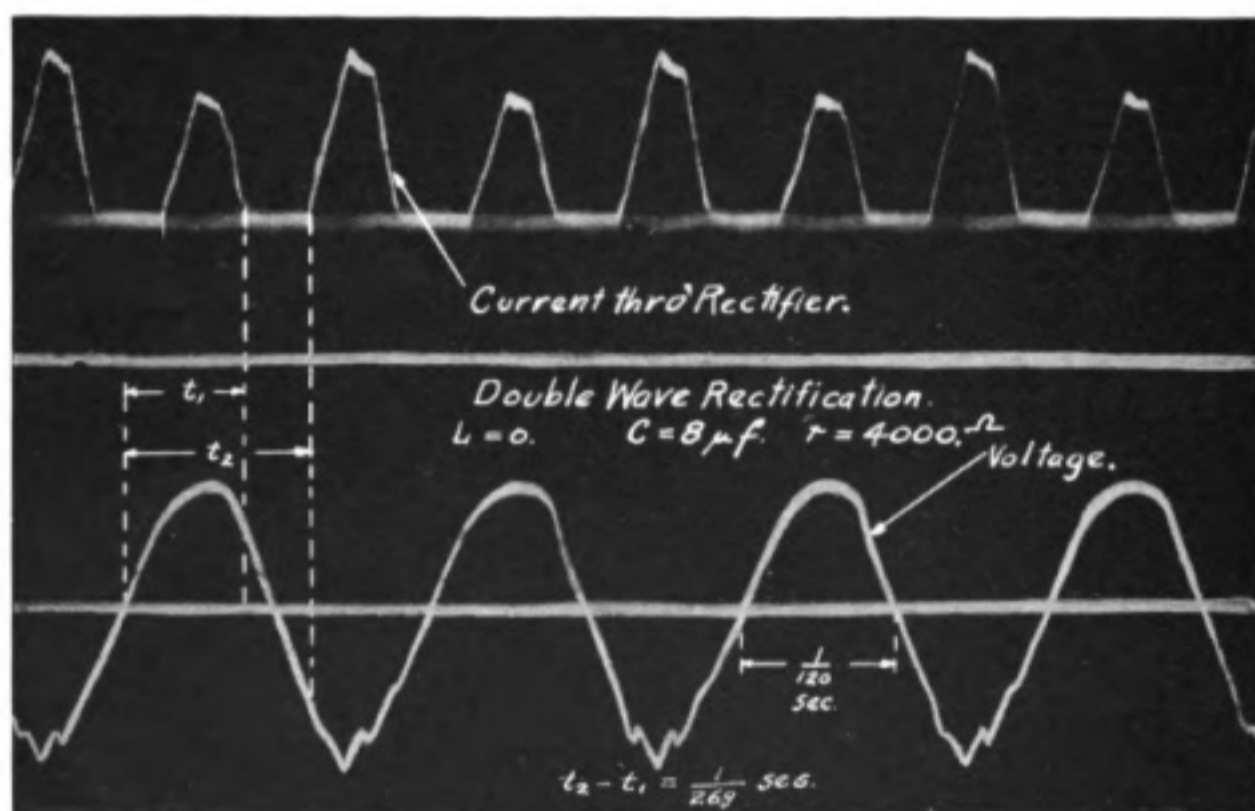

FIG. 5 (b).

It is difficult to estimate and practically impossible to compute with any accuracy, the probable values of V_0 and $t_2 - t_1$. A direct measurement of the same may also be made only with difficulty, and in the case of the voltage drop V_0 , only in an indirect method. Consideration of the circuit diagram will show that a voltmeter of the ordinary type may not be employed directly since for that portion of the cycle during which the tube is supposed to offer an infinite resistance, it would be shunted by a finite and comparatively low resistance, *i.e.*, that of the voltmeter. The readings of the latter would therefore not indicate the true values of the tube voltage, in fact would alter the entire operation of the circuit. The oscillograph was employed to study and measure the variations of these two quantities, under various conditions of loading and applied voltages. The time, $t_2 - t_1$, was measured directly from the oscillogram by comparison of the current

and voltage waves, of which the frequency of the latter was known ; the voltage V_0 , was measured by calibrating the oscillograph in terms of voltage and noting the difference between the maximum applied voltage, E_0 , and the maximum voltage V_c developed over the capacity. Elsewhere in this paper it is shown, that from the value of the R.M.S. or effective tube current which flows under load conditions a fairly accurate estimate of the voltage V_0 may be obtained, from the D.C. plate current—plate voltage characteristic of the rectifier tube.

Based on the theory, as developed herein, the following design equations have been worked out.

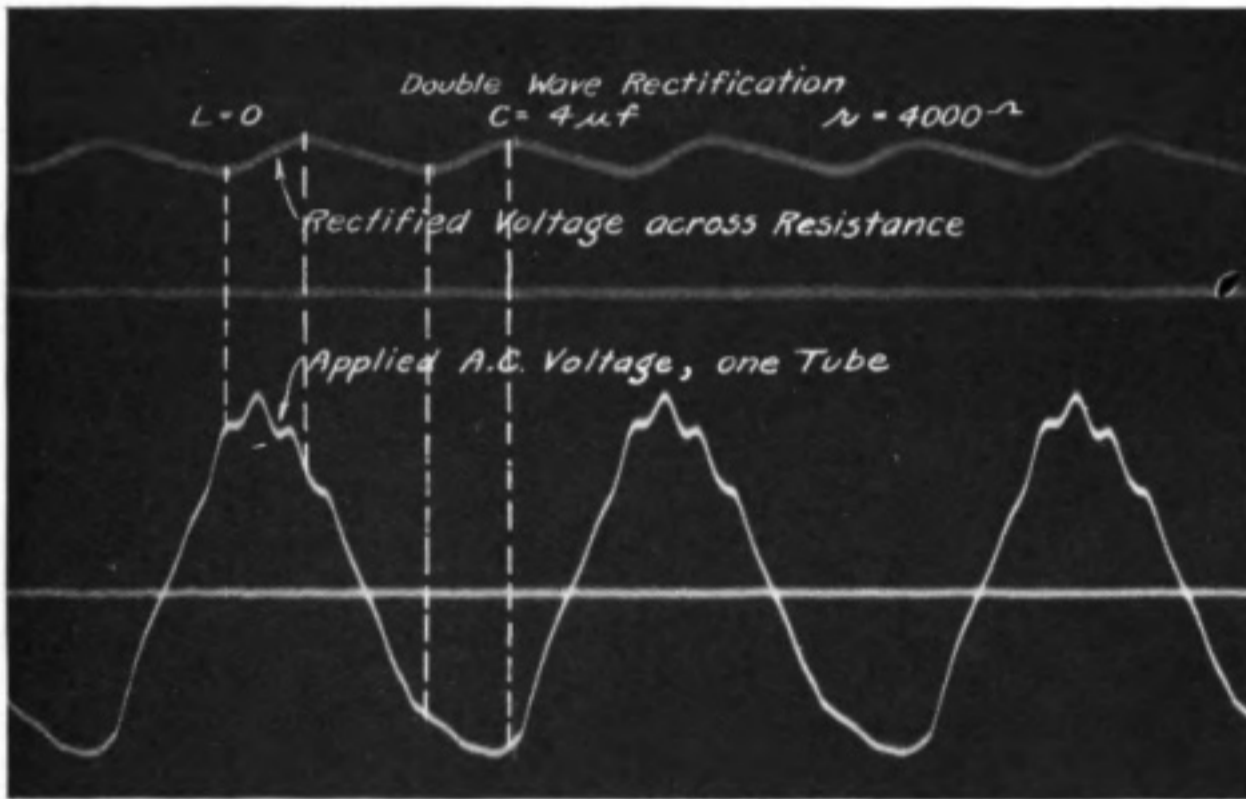

FIG. 5 (c).

Amplitude of Rectified Voltage.—Let E_0 , V_0 and V_c represent respectively the *maximum* values of the applied voltage, maximum voltage consumed within the tube and condenser voltage, as shown in Figs. 2 and 3 ; then when the steady state has been obtained,

$$V_c = E_0 - V_0 \dots \dots \dots (1)$$

where V_c is the value which obtains when $t = t_1$. When $t = t_2$, V_c has decreased in value to V_c' where

$$V_c' = (E_0 - V_0) \cdot K \dots \dots \dots (2)$$

in which

$$K = \epsilon^{-\frac{t_2 - t_1}{rC}} \dots \dots \dots (3)$$

ϵ being the base of Napierian logarithms.*

* Steinmetz, "Transient Electric Phenomena and Oscillations" (McGraw-Hill Publishing Co., Ltd.), Chapter V.

For large values of r , or for $r = \infty$ $K = 1$; however for large values of r the current passing through the tube is very small and hence the voltage consumed therein may, for all practical purposes, be neglected. The condenser voltage, therefore, will be approximately equal to the maximum value of the applied A.C. voltage or

$$V_c' |_{r=\infty} \approx E_0 \dots \dots \dots (4)$$

The decrease in condenser voltage, ΔV_c , is given by

$$\Delta V_c = V_c - V_c' = (E_0 - V_0)(1 - K) \dots \dots \dots (5)$$

As noted previously, the average value, V_{dc} , of the condenser voltage is very approximately equal to the arithmetical mean of V_c and V_c' , or

$$\begin{aligned} V_{dc} &= V_c - \frac{\Delta V_c}{2} \\ &= (E_0 - V_0) \frac{1 + K}{2} \dots \dots \dots (6) \end{aligned}$$

Equation (6) is fundamental, giving the average value of the rectified voltage as a function of the maximum applied voltage, voltage drop within the tube and the constants of the circuit. By transposition it may be rewritten in the form

$$E_{\text{eff.}} = \frac{\sqrt{2}}{1 + K} V_{dc} + \frac{V_0}{\sqrt{2}} \dots \dots \dots (7)$$

from which, for known values of K and V_0 , as determined by the characteristics of the complete load circuit and by the type of rectifier tube to be employed, the effective or R.M.S. value of applied voltage may be computed as a function of the required values of the rectified voltage V_{dc} . For *half-wave* rectification, the voltage given by equation (7) is that of the *full* transformer secondary; for *double wave* rectification it is *one-half* of the transformer secondary voltage.

The effect of ignoring the voltage drop within the tube is apparent from equations (6) and (7), resulting in a value of rectified voltage higher than is actually obtained in one case, and in an effective value of applied voltage lower than is actually obtained in the other.

If an inductance L is included in series with final load resistance r , certain of the equations as written require modification. Equation (3) is changed into the form *

$$K' = \frac{1}{2S} \left[(r + S) \epsilon^{-\frac{r-S}{2L}(t_2 - t_1)} - (r - S) \epsilon^{-\frac{r+S}{2L}(t_2 - t_1)} \right] \dots \dots (8)$$

in which

$$S = \sqrt{r^2 - \frac{4L}{C}} \dots \dots \dots (9)$$

For values of r and C not too small and of L not too large, the last term of

* Steinmetz, *loc. cit.*

equation (8) will be very small compared to the first and may be neglected ; equation (8) may then be rewritten,

$$K' \cong \frac{r+S}{2S} e^{-\frac{r-S}{2L}(t_2-t_1)} \dots \dots \dots (10)$$

Values of K' so obtained are substituted directly for K in equations (6) and (7).

(To be concluded.)

A Method of Measuring Coil Capacities and Standardising Wavemeters.*

By GREGORY BREIT.

The method to be described in this note is a method of adjusting the frequencies of two alternating currents accurately to a ratio which is known. It may be used for the measurement of capacities of inductance coils and for standardising the wavemeters used in radio communication, because in both of these an accurate knowledge of frequencies is required.

Description of Phenomenon Used.

It is often observed that if a detector is placed in the neighbourhood of two radio-frequency electron tube generating sets a musical note is heard in a pair of telephone receivers connected in the detector output even if the frequencies of the two generating sets are not near equality. A measurement of the frequencies of both generating sets reveals the fact that if the note is heard the ratio of the frequencies is very nearly that of two small whole numbers.

Explanation of Phenomenon Used.

The reason which makes the musical note appear when the two frequencies are nearly in the ratio of two small whole numbers is the distortion in the current of the detector circuit caused by the rectifying properties of the detector, and at times the distortion of the waveform of the oscillator itself.

If there were no distortion each generating set would cause a current in the detector circuit and an E.M.F. across its terminals which would be very closely sine functions of the time. The rectifying properties of the detector change the current into a periodic current of the same period as that of the generating set which, however, is no longer a sine function of the time.

This function is finite, single valued, and continuous, and in a finite interval it has a finite number of maxima and minima. It is periodic. Therefore, it may be represented by a Fourier series. The consecutive terms of the Fourier series are sine functions of the time. Their frequencies are integral multiples of the frequencies of the fundamental.

* Received July 25th, 1921, and published by permission of the Director of the Bureau of Standards, Washington, U.S.A.

If the fundamental frequency of the first generating set is f_1 then according to the above the E.M.F. across the detector terminals is the sum of a finite or infinite number of E.M.F.'s whose frequencies are $f_1, 2f_1, 3f_1, 4f_1,$ etc. Similarly if the fundamental frequency of the second set is f_2 then the E.M.F. across the detector terminals is the sum of E.M.F.'s of frequencies $f_2, 2f_2, 3f_2, 4f_2 \dots$

Now generally if E.M.F.'s of two frequencies f_1, f_2 are impressed on the grid of an electron tube, the output current contains terms of the type

$$[a_1 \cos(2\pi f_1 t - \epsilon_1) + b_1 \cos(2\pi f_2 t - \epsilon_2)]^m$$

where m is an integer, because the output current may be expanded by Taylor's series in terms of the input voltage.

The term of perhaps the largest practical importance in many cases is that corresponding to $m = 2$. The expansion of that term is

$$a_1^2 \cos^2(2\pi f_1 t - \epsilon_1) + b_1^2 \cos^2(2\pi f_2 t - \epsilon_2) + 2a_1 b_1 \cos(2\pi f_1 t - \epsilon_1) \cos(2\pi f_2 t - \epsilon_2).$$

The last term in this expansion is

$$a_1 b_1 [\cos(2\pi(f_1 + f_2)t - \epsilon_1 - \epsilon_2) + \cos(2\pi(f_1 - f_2)t - \epsilon_1 + \epsilon_2)].$$

Hence the output contains a term of frequency $(f_1 - f_2)$, *i.e.*, the beat note of acoustics.

This same fact may be illustrated graphically. Thus if the E.M.F. of

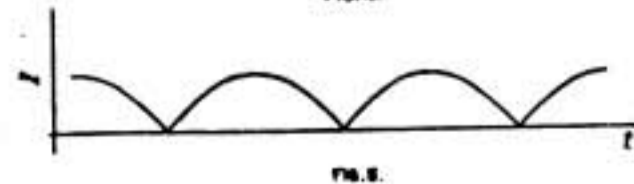
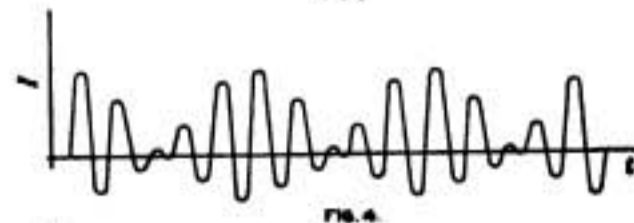
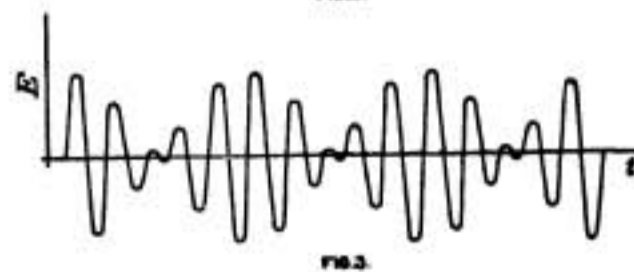
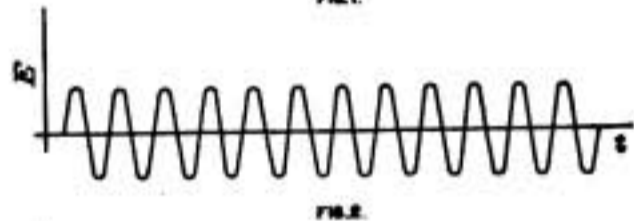
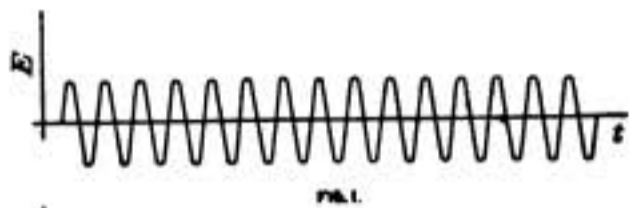

frequency f_1 is as shown in Fig. 1, and if the E.M.F. of frequency f_2 is as shown in Fig. 2, the sum of the two E.M.F.'s is as in Fig. 3. When the E.M.F. is rectified in the detector the current has the appearance shown in Fig. 4, which in the telephone has the effect of pulsating current shown in Fig. 5. The frequency of this is the difference in the frequencies of f_1 and f_2 . If f_1 and f_2 are close together, $f_1 - f_2$ may be so low as to give an audible note in a pair of telephones. Hence, when the detector is influenced by the two generating sets of frequencies f_1, f_2 its output contains currents of frequencies $mf_1 - nf_2$ where m, n are integers, because mf_1, nf_2 are harmonics of f_1 and f_2 and are present in the circuit on account of distortion.

If any one of these currents is of a sufficiently low frequency and if it is present in sufficient quantity a note will be heard in the telephones. If the

frequency of one of the sets, say, f_1 be varied, the pitch of the note will be changed. When

$$mf_1 - nf_2 = 0 \quad \dots \dots \dots (1)$$

the pitch of the note becomes zero. Thus as f_1 is varied a region is covered in which a note is heard and in the middle of which the note is lost because its frequency vanishes. The silent region in practice is very narrow and either edge of it may be taken to give a value of f_1 such that (1) is true.

If the silent region is not sufficiently narrow a setting may be usually made on either side of the silent region at points giving notes of equal pitch. The frequency of these settings differs from the value of f_1 corresponding to (1) by the pitch of the note heard. The adjustment to equal pitch can be made very precise by comparing it with the pitch of a fixed frequency, which may conveniently be produced by an electron tube generating set. The comparison can be made by beats, either acoustically or else by coupling very loosely the fixed audio-frequency generating set to the same amplifier which is used in amplifying the sound produced in the detector.

To summarise—the centres of the silent regions are frequencies such that their ratio to the frequency of generating set No. 2 (giving frequency f_2) is the ratio of two whole numbers.

Determination of the Numbers m and n .

With the arrangement described so far, difficulty may be experienced in determining the numbers m and n unless one takes care to couple one generating set very much more closely to the detector than the other.

If this is done the waveform of the loosely coupled generating set, say the waveform of f_2 , is distorted comparatively little. As a result the only frequencies of importance across the detector terminals are

$$f_1, 2f_1, 3f_1, 4f_1 \dots nf_1 \dots \text{and } f_2.$$

The silent regions of the consecutive musical zones are then such that

$$f_1 = f_2$$

$$2f_1 = f_2$$

$$3f_1 = f_2$$

...

Consequently if the frequency f_2 is kept unchanged and the frequency f_1 is varied and adjusted to the successive silent regions, then f_1 takes consecutively the values

$$f_2, \frac{f_2}{2}, \frac{f_2}{3} \dots$$

[Letting $\lambda = \frac{c}{f}$ where c is the velocity of light, the wavelength λ takes

values $\lambda_2, 2\lambda_2, 3\lambda_2 \dots$.]

If the sensibility of the detector be sufficiently high, weak sounds will be heard between the strong sounds just mentioned. These correspond to

beats between harmonics of f_2 and harmonics of f_1 . The difference of intensity between the beats given by the fundamental of f_2 and by its harmonics is so high, however, that there is no longer any possibility of confusing the two. When the frequencies $f_2, \frac{f_2}{2}, \frac{f_2}{3}, \frac{f_2}{4} \dots$ have been located there is no difficulty in estimating the particular harmonic of f_2 , for a weak sound by the variations required in the condenser of the generating set No. 2 in order to produce a given change in pitch. A numerical example of this will be given later.

The setting of generating set No. 1 which gives $\lambda_1 = \lambda_2$ is determined by bringing a circuit into resonance with the frequencies generated in both sets. Since only very loose coupling of generating set No. 2 to the detector is required any changes in generating set No. 1 do not react on generating set No. 2. Its frequency is thus constant during the experiments unless there is some unsteadiness in the set due to mechanical vibrations, unsteady batteries, temperature changes, etc. In practice generating set No. 2 is kept in a metal screened cage so as to eliminate capacity effects of the observer's body. No direct connection to the detector is made. The induction which is obtained when a wire from the detector is stretched into the cage through a hole is sufficient to give audible beats corresponding to very high harmonics of f_1 .

The constancy of f_2 during the experiment is proved by the consistency of the experimental results for different values of f_2 .

Experimental Arrangements.

The generating sets No. 1 and No. 2 are electron tube generating sets. Generating set No. 2 is kept completely shielded and generating set No. 1 is kept as completely shielded as possible. The tubes used are Western Electric transmitting tubes (Type E). The two generating sets are coupled to the detector circuit. One is coupled by a wire from the grid of the detector tube, which is brought near to one generating set. The other generating set is coupled by means of condensers to the detector circuit. This coupling is very strong and makes the detector tubes operate under abnormal conditions giving high distortion.

The detector used consists of one or two electron tubes connected in parallel. Since high distortion is necessary, these tubes are connected

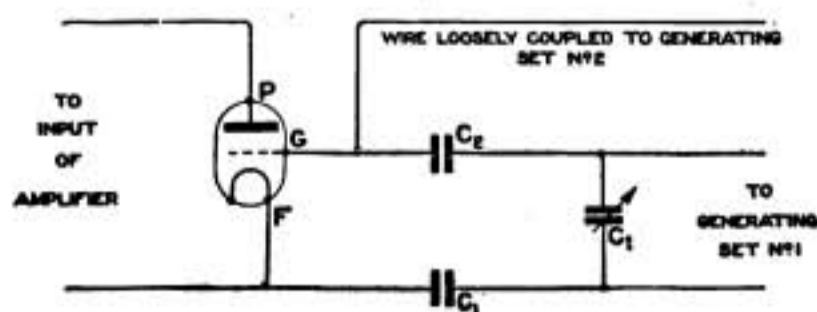

FIG. 6.—Diagram of Connections used for Distorting Radio Frequency by means of an Electron Tube.

across the tuning condenser of generating set No. 1, in series with two condensers. The connection is shown on Fig. 6. Here C_t is the tuning condenser of generating set No. 1; C_1 and C_2 are the two coupling condensers; F , G , and P are the filament, grid, and plate of the tube. The tube used is

the Western Electric receiving tube—Type J (VT—1). The tube is used without any plate battery, for it is found that no improvement in its operation is caused by the use of a plate battery under the conditions described. The action of the detector tubes without plate battery under these conditions is not at all surprising because the voltage of the grid is so high that the electrons acquire sufficient velocity on reaching the grid to pass, by inertia, to the plate.

The output terminals of the tube, *i.e.*, the terminals *F*, *P*, are connected to the primary of a transformer the secondary of which is connected across the input tube of a two-stage audio-frequency amplifier. It was found convenient to shield the amplifier from the rest of the apparatus by putting it in an iron box. This eliminated oscillations in the amplifier. The condensers C_1 and C_2 may be varied so as to give the most satisfactory operation. Frequently both of them may be large—say 0.02 microfarad.

Under such conditions beats between the 105th harmonic of f_1 and the fundamental of f_2 could be heard distinctly. Beats with the second harmonic of f_2 could be followed up to the value of $\frac{f_1}{f_2} = 95$. If the second har-

monic of f_2 were considered as the frequency of comparison 191 equal wavelength intervals could be laid off by that method because the fundamental gives 95 intervals, each of which is divided into two by the harmonic and in addition the harmonic gives one more interval. The wavelength λ_2 in this case was about 20 metres.

Application to Standardising Wavemeters.

Suppose the reading of a wavemeter to be calibrated to have been compared with the reading of a standard wavemeter for some one frequency by any method.* This means that the frequency at which the comparison was made can be measured correctly by the wavemeter, whatever its nature may be. Call this frequency f_0 . By means of the wavemeter, set the generating set No. 1 to a position where it emits f_0 . By listening, adjust f_2 until f_0 is in the silent region of a musical zone. Then keep f_2 fixed, and vary f_1 both increasing and decreasing it. As explained above $f_2 = nf_0$ where n is a whole number. The frequencies obtained by adjusting f_1 to the consecutive silent regions are then

$$nf_0, \quad \frac{nf_0}{2}, \dots, \frac{nf_0}{n-1}, \quad f_0, \quad \frac{n}{n+1}f_0, \dots, \frac{nf_0}{n+m}, \dots$$

The number n is easily determined by counting the number of musical zones between f_2 and f_0 . If f_2 and f_0 are included this number is n .

In this manner, n and f_0 both being known, a number of known wavelengths is obtained for the calibration.

If f_0 is small f_2 may be adjusted to be equal to f_0 and the frequencies f_0 , $2f_0$, $3f_0$, . . . may be measured.

* The wavelength may be ascertained either by means of the "multi-vibrateur" (see H. Abraham and E. Bloch, *Annales de Physique*, 12, 237—302, October, 1919), or by means of a method which the author expects to describe in a future communication.

Application to Measurement of Coil Capacities.

By definition, if there are such constants C_0, L that

$$L(C + C_0) = \frac{1}{\omega^2}$$

where C is the capacity which must be connected across the coil terminals in order to give resonance with a frequency $\frac{\omega}{2\pi}$, then L is called the pure inductance of the coil and C_0 is termed its effective capacity. Hence if f_1, f_2 be values of the frequency f corresponding to two values C_1, C_2 of the capacity C it must be true that

$$\frac{C_1 + C_0}{C_2 + C_0} = \frac{f_2^2}{f_1^2}$$

By the method described f_2/f_1 is adjusted to

$$1, 2, 3, 4 \dots$$

consecutively. Hence if on tuning to these wavelengths values of C equal to $C_1, C_2 \dots$ are obtained then

$$\frac{C_1 + C_0}{1^2} = \frac{C_2 + C_0}{2^2} = \frac{C_3 + C_0}{3^2} = \dots = \frac{C_n + C_0}{n^2} = \dots$$

This set of equations suffices to determine C_0 if it exists, *i.e.*, if a number C_0 may be found so as to satisfy the above set of equations.

As an example consider the following measurement which gave for the consecutive values of C

$$\begin{aligned} C_3 &= 139 \mu\mu\text{F} \\ C_4 &= 263 \mu\mu\text{F} \\ C_5 &= 424 \mu\mu\text{F} \\ C_6 &= 622 \mu\mu\text{F} \\ C_7 &= 856 \mu\mu\text{F}. \end{aligned}$$

In the following table, the values of $\frac{C_n + C_0}{n^2}$ are tabulated for various values of n and C_0 .

| Trial value of C_0 | 20 | 21 | 22 | 23 |
|-------------------------|-------|-------|-------|-------|
| $\frac{C_3 + C_0}{3^2}$ | 1.766 | 1.781 | 1.788 | 1.801 |
| $\frac{C_4 + C_0}{4^2}$ | 1.769 | 1.776 | 1.781 | 1.787 |
| $\frac{C_5 + C_0}{5^2}$ | 1.776 | 1.780 | 1.784 | 1.788 |
| $\frac{C_6 + C_0}{6^2}$ | 1.782 | 1.786 | 1.788 | 1.791 |
| $\frac{C_7 + C_0}{7^2}$ | 1.787 | 1.790 | 1.793 | 1.793 |

If C_0 is taken as 22 micromicrofarads, the values of $\frac{C_n + C_0}{n^2}$ are most consistent. Since the capacities C_n used in the work are calibrated only with an accuracy of $1 \mu\mu F$, C_0 may be taken to be $22 \mu\mu F$.

For the same coil a silent region was obtained also for $C = 197 \mu\mu F$. This corresponds to the ratio between the frequencies being $3\frac{1}{2} = \frac{7}{2}$. And in fact

$$\frac{197 + 22}{\left(\frac{7}{2}\right)^2} = 1.79.$$

Also the capacities 177, 167, 158 were obtained for weak sound zones. The ratio of f_1/f_2 for these can be obtained easily by writing the capacities in order, viz.

139, 158, 167, 177, 197.

The first (139) corresponds to $\frac{f_1}{f_2} = 3$.

The last (197) corresponds to $\frac{f_1}{f_2} = \frac{7}{2}$.

The differences between consecutive numbers of the above set of numbers are 19, 9, 10, 20. Thus 167 is in the middle of the interval and corresponds to beats between the fourth harmonic of f_2 and an appropriate harmonic of f_1 which is readily seen (by a method to be described later) to be the 13th. The number 158 corresponds to beats between the 6th harmonic of f_2 and the 19th of f_1 . The number 177 corresponds to beats between the third harmonic of f_2 and the 10th of f_1 . Thus the following table is obtained:—

| | | | | | |
|---------------------------|------|----------------|----------------|----------------|---------------|
| $C_n =$ | 139 | 158 | 167 | 177 | 197 |
| $n = \frac{f_1}{f_2} =$ | 3 | $\frac{19}{6}$ | $\frac{13}{4}$ | $\frac{10}{3}$ | $\frac{7}{2}$ |
| $\frac{C_n + C_0}{n^2} =$ | 1.79 | 1.79 | 1.79 | 1.79 | 1.79 |

This table illustrates that when many weak sound zones are heard the exact ratio of the frequencies may be easily determined once the strong zones have been located. The simplest rule to follow in such a case is to look at the distances of the capacity settings as proportional to corresponding wave-

lengths if these distances are small. Thus in the above instance the interval from $139 \mu\mu\text{F}$ to $197 \mu\mu\text{F}$ may be regarded as divided into four parts. 158 occupies a position at $\frac{1}{3}$ the length of the interval to the right. Its wavelength is then

$$\left\{ 3 + \frac{1}{3} \left(\frac{7}{2} - 3 \right) \right\} \lambda_2 = \frac{19}{6} \lambda_2.$$

Similarly the other ratios may be found.

It is often convenient to plot n^2 against C_n . If C_0 exists this gives a straight line. The negative of the intercept of the straight line on the axis of C_n gives C_0 . Such a graph is shown in Fig. 7.

In distinguishing between beats with the fundamental of f_2 and those with harmonics of f_2 use can be made of the fact that the width of the musical zone for the harmonics is very much smaller than that for the fundamental. It is likely that by the use of beats with harmonics of f_1 an increase in the

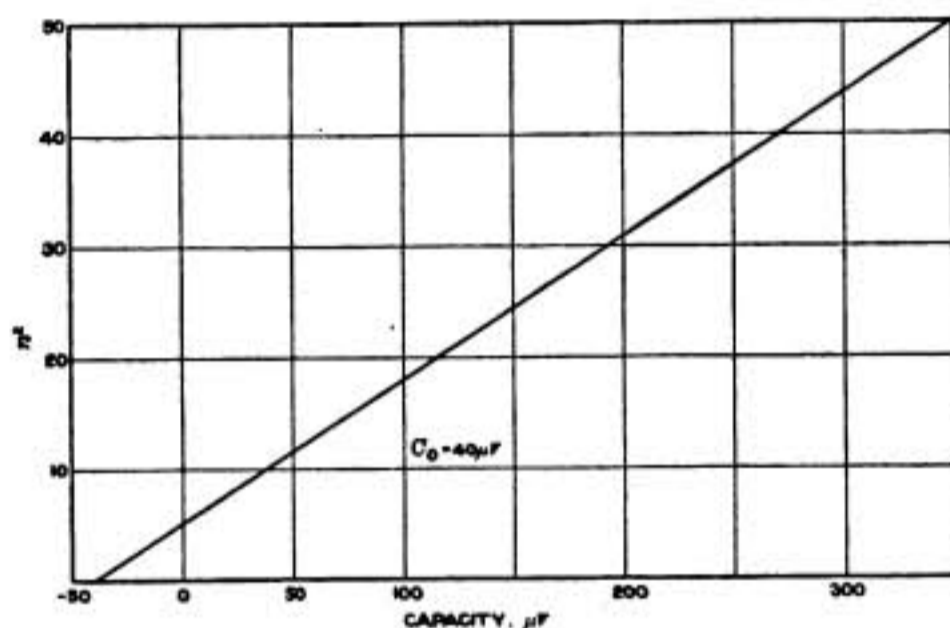

FIG. 7.—Graphical method of computing C_0 .

sensibility of the method proposed by Whiddington * for the measurement of small lengths could be made. The desirability of having such an increase is, however, questionable.

The method described is capable of adjusting frequencies to 1 part in 10^6 if these frequencies are of the order of 10^6 . It thus far exceeds the ordinary requirements. It has the advantage of keeping the temporary standard of frequency (or wavelength) caged and thus unaffected by motions of surrounding objects. Coupling to the reference standard is avoided which contributes to its permanence. Also, too close coupling to the variable generating set can be detected because if the coupling is too close a note of variable pitch is heard when the coupled coil is tuned. The method is best suited for standardisation of short wavelengths because of its increased accuracy at such wavelengths.

* See *Wireless World*, 8, p. 739, January 22nd, 1921.

As a matter of fact, in precise work it was found necessary to use an electron tube as an indicator of resonance because less sensitive indicators required too close coupling, and it was also found necessary to use very careful shielding, both of the wavemeter and of the generating set system. It was found possible, however, to use the method with ordinary commercial wavemeters equipped with hot-wire ammeters or thermogalvanometers even though on tuning these wavemeters the wavelength of the generating set changed sufficiently to give a whine in the telephone receivers. This was made possible by the fact that the change in the wavelength of the generating set becomes very small when the wavemeter is exactly in resonance, so that it is possible by adjusting both the wavemeter and the generating set to make the wavemeter read a maximum when the generating set is in good adjustment.

It is also helpful at times not to use the wavemeter by adjusting to a maximum of current, but to use it by adjusting to equal settings on both sides of the maximum. In such a case the same accuracy may be obtained with very much looser coupling. Also, reading the indicator instrument by means of a magnifying glass is helpful.

Summary.

A method has been worked out for the adjustment of two frequencies to an accurately known ratio.

The method is based on the fact that an electron tube detector distorts the waveform of the E.M.F. impressed on it and thus produces harmonics of that E.M.F. in its output.

The harmonics produced by a circuit of adjustable frequency are made to give beats with the fundamental of a circuit of fixed frequency. The beats are rectified in an amplifier and are heard as a musical note.

When the beat frequency is zero the ratio of the frequencies is exactly a whole number. This whole number may be made very large as, *e.g.*, 100.

Applications of the method to frequency (wavelength) standardisation and to coil capacity measurements have been described.

It is the author's pleasant duty to express here his gratitude to Dr. J. H. Dellinger, Dr. J. M. Miller, Messrs. L. E. Whittemore, R. T. Cox, C. T. Zahn, and R. S. Ould, for reading the manuscript.

Bureau of Standards,
Washington, D.C., U.S.A.

Some New Laboratory Apparatus for Radio Measurements.

At the recent exhibition of the Physical Society of London (for brief description of which see page 99), some interesting apparatus was exhibited by Messrs. H. W. Sullivan, including a Radio Frequency Bridge, and a Standard Heterodyne Wavemeter.

SCREENED RADIO FREQUENCY WHEATSTONE BRIDGE.

This instrument is designed for the measurement of resistance, capacity and inductance at radio frequencies. One of its chief advantages is the employment of a high-frequency generator in place of the buzzer apparatus which has hitherto been used for determinations of this character. The advantages of using a high-frequency oscillator are obvious as it enables tests to be carried out under actual working conditions. The range of



FIG. 1.

frequencies of this oscillator is between 10,000 and 500,000 \sim , the higher frequency representing a wavelength of 600 metres. This set is one of the first of its kind available for practical testing purposes, and it will probably fill a long-felt want for the easy and accurate measurement of radio-frequency constants. The instrument (Fig. 1) is fitted with a vacuum thermo-galvanometer reading from 1 to 10 milliamperes. As may be seen from the circuit diagram (Fig. 2), the bridge arms comprise non-inductive resistance ratio arms, and also a non-inductive resistance in the third bridge arm. The resistances in this third, or rheostat arm, are controlled by two dials having

the following values :—First dial 0 to 10 ohms in steps of 1 ohm ; second dial 0 to 1 ohm in steps of 0.1 ohm. Additional resistances of 10, 20 and 30 ohms can also be inserted in this arm. All the resistances used in these arms have no measurable inductance or capacity.

It is claimed that an accuracy of measurement within 1 to 2 per cent. is possible at the higher ranges and from 0.5 to 1 per cent. at the lower ranges of the instrument.

When this bridge is used in conjunction with a valve oscillator to generate the necessary radio-frequency currents and with standardised and calibrated air condensers and variometers, the following measurements can be carried out :—

- (a) Effective resistance of condensers and inductances, and their capacity and inductance values at all frequencies between 10,000 and 500,000 cycles per second.
- (b) Effective resistance, capacity and inductance of antenna systems and other radio-frequency circuits.
- (c) Dielectric tests of cables and lines.

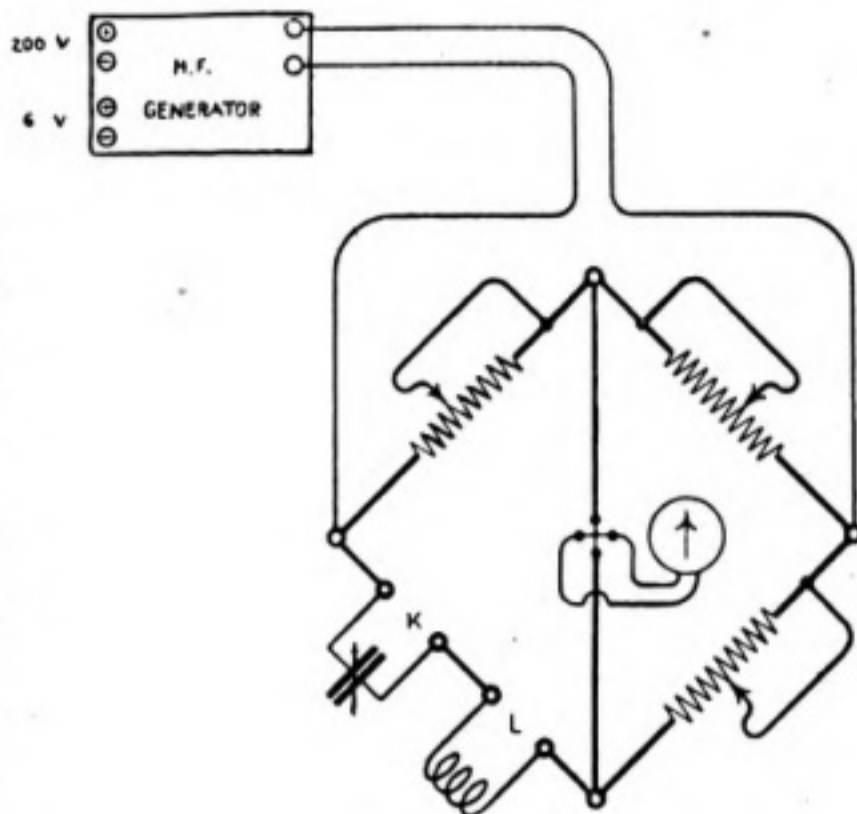

FIG. 2.

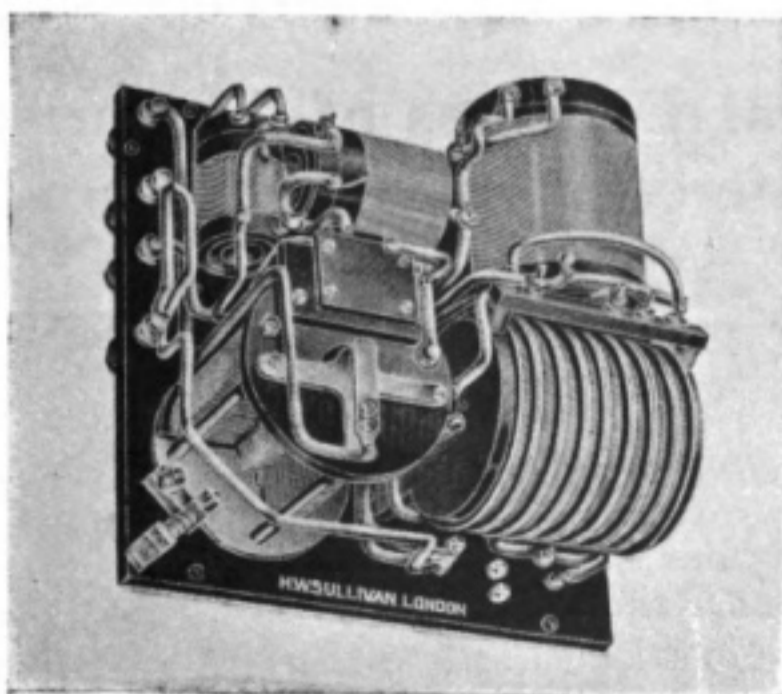

FIG. 3.

As may be seen from the circuit arrangement shown in Fig. 2, terminals are provided in the fourth arm of the bridge for the insertion of a condenser K and an inductance L. These two must be brought into resonance with the supply frequency so that the arm behaves as a non-inductive resistance, which can be balanced against the rheostat arm of the bridge. Either the condenser or the inductance can, of course, be replaced by the apparatus under test, depending upon whether it has a capacitive or an inductive reactance.

UNIVERSAL LABORATORY
STANDARD HETERODYNE
WAVEMETER.

The range of this instrument is from 150 to 20,000 metres. Its external appearance may be seen from Fig. 4. The interior arrangement of the instrument is shown in Fig. 3, from which illustration the arrangements of the coils and condensers can be seen. The variable air condenser has a fine adjustment for accuracy in tuning, and a special type of electro-magnetic interrupter is included for the production of interrupted continuous waves for spark adjustments. The only external apparatus necessary is a 6-volt accumulator and a 50-volt battery for the high tension supply, terminals being provided for telephones for use when necessary.

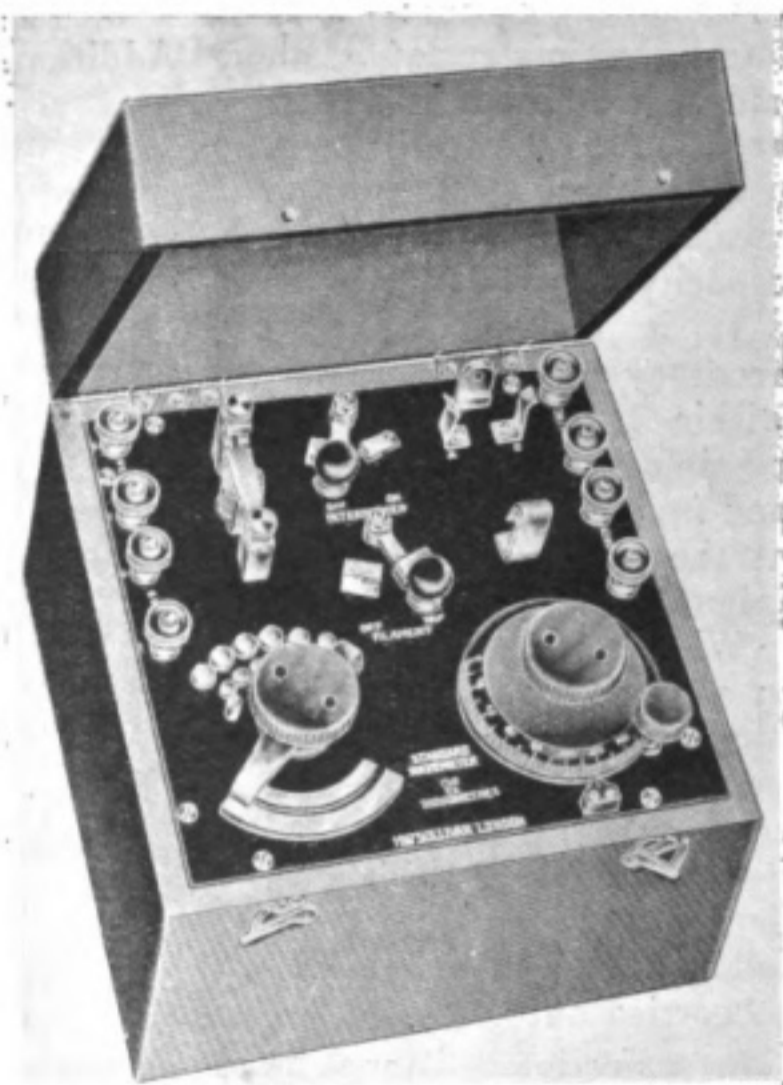

FIG. 4.

Notes on the Technical Decisions of the Paris International Conference on Radio Communications (June—August, 1921).

By Professor G. VALLAURI.

(Continued from page 25.)

CHARACTERISTICS OF R.T. STATIONS AND OF THEIR EMISSIONS— NOMINAL RANGE.

According to the definitions adopted an emission is designated, not only by the type of the wave but also by the mean wavelength (or mean frequency)

and by the equivalent decrement (or by the class). The determination of the mean wavelength and of the particular wavelengths (or frequencies) taken as abscissæ of the resonance curve, requires the existence of a standard of wavelength as well as a means of calibrating wavemeters. It is of evident importance with the object of reducing to the minimum the interferences and of utilising completely the series of wavelengths (or frequencies) which are available, that the measurements of them be made with the greatest possible precision and that advantage should be taken of every advance made in technology in order to reduce to the minimum the tolerances (limits of error). As a basis for the calibration of wavemeters one requires a method of absolute measurement of the frequencies, and it is that which has been indicated by the Paris Committee, which has also cited as an example of one of such methods that of the multivibrator of Abraham and Bloch.

But it is not sufficient to consider the case of an emission authorised upon a certain wavelength and for which it may be assumed that the mean wavelength of the resonance curve corresponds with sufficient exactness to the indicated value. There must also be considered the case in which to a given district, or to a given service or to a given station there may be attributed not a single wavelength but in fact a series or band of wavelengths. In this case the emissions ought to be made upon mean wavelengths sufficiently distant from the limits of the series in such a way as not to give rise to excessive interference to the detriment of the services that adopt the adjacent series. Here also the Committee has not believed that it has sufficient data for fixing, up to the present, precise regulations.

With regard to the antennæ, to put in force the recent advances attained in the technique of the measurements of radiation and to contribute to their ulterior development the Committee has settled that there must be given in the new edition of the particulars of fixed land stations indications relative to the type of antenna, to the electrostatic capacity, to the natural wavelength, to the radiation height, to the type of generating apparatus, and to the normal intensity of antenna current.

The discussion of some definition of the *range* of a R.T. emission merited particular attention. It is well known that such an element cannot be defined in an absolute way because it depends in its turn on other elements actually independent of the transmitting station such as (1) the continually changing physical conditions of the space in which the propagation takes place, (2) the characteristics of the antenna and of the other apparatus used by the receiving station. For these reasons it is only possible to speak of a *nominal range*.

Because it is possible to-day to evaluate with sufficient approximation the power radiated from an antenna the definition of nominal range requires (1) the adoption of a *formula of propagation*, (2) the fixation of a limiting value for the intensity of the *electromagnetic* field necessary for reception. There are available now for formulæ of propagation only semi-empirical relations and amongst these that which seems provisionally most acceptable, at least for small and medium distances, is the well-known Austin-Cohen

formula to which may be given the following form (neglecting the effects of the curvature of the earth) :—

$$hI = \frac{10^{-6}}{377} E\lambda d \epsilon^{0.000048d/\sqrt{\lambda}}$$

where h = the radiation height of the transmitting antenna in metres

I = the intensity of current at the base of the transmitting antenna in amperes

E = the vertical electric field produced at the distance d in $\mu\text{V}/\text{m}$

λ = the wavelength in metres

d = the distance in metres.

As to the choice of the intensity of field necessary for reception, the Committee has at first considered only the small stations, coastal and movable, for which ultimately the definition of range is particularly important in relation to the rules for signals for help. For such services which still operate normally with apparatus with damped waves the Committee has deemed it opportune to assume for the calculation of the range the value $E = 150 \mu\text{V}/\text{m}$.

But as appears from the formula the calculation of the range requires also the knowledge of the height of radiation h and this is obtained* by measuring at small distances (between 1 and 10 wavelengths approximately) the electric field or the magnetic field and applying the same formula now referred to in which the exponential factor may in such a case be identified with unity. This measurement of h may however turn out to be a little laborious and therefore the Committee has indicated alternatively as a first approximation and only in the case of ship stations the possibility of deducing the height of radiation from the total antenna height (height with reference to the surface of the sea of the highest point of the antenna), multiplying this last by an empirical coefficient which is assumed equal to 0.55.

TABLE III.

| Wave | | Height of Antenna \times Antenna Current = hI (m \times A). | | | | |
|------------------------|------------|---|-----|-----|-----|-----|
| Frequency, kilocycles. | Length, m. | Distance, km 100 | 150 | 200 | 250 | 300 |
| 667 | 450 | 22 | 38 | 56 | 87 | 105 |
| 500 | 600 | 29 | 47 | 70 | 100 | 130 |
| 375 | 800 | 38 | 61 | 89 | 121 | 157 |

As an example of the application of the Austin-Cohen formula Table III. may be referred to which expresses the values of the product hI expressed in metre-amperes for the distances and for the wavelengths which are of interest with regard to signals of distress ($E = 150 \mu\text{V}/\text{m}$).

The Committee has not relied in any way on establishing exclusively a

* *L'Electrotecnica*, 8, p. 213, April 5th, 1921, and Publication No. 11 of the E. and R. T. Institute.

preference for this method of *calculating* the range of coast-line and movable stations, but has left each administration free either to adopt such a method of calculation, or to verify the range of the stations by means of direct practical tests of the daily communications.*

The Committee has been yet more cautious in the treatment of the range of the large stations. Any indication in the "particulars of the station" has not only been considered optional but for the most part may have two different values, for each emission. Of this the Committee has not given any explanation, but in reality the two values will correspond, the one to the "ordinary range," the other to the "safe range," that, namely, which can be relied upon even in unfavourable conditions; yet excluding those excep-

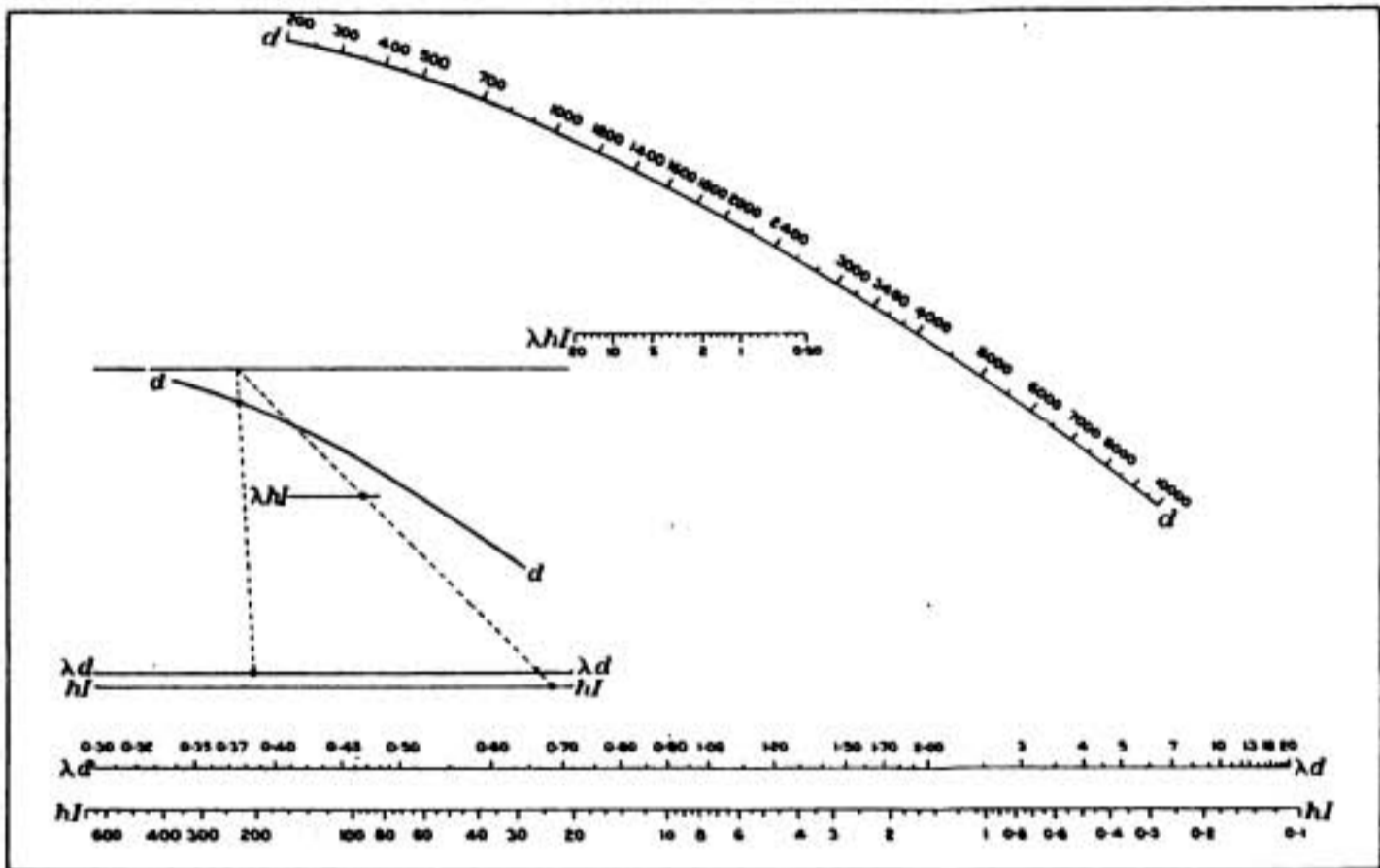

FIG. 3.

tionally unfavourable. In the case of emissions with continuous waves manipulated or modulated (types A_1 and A_2) the ordinary range should be calculated with $E = 10 \mu V/m$ and the safe range with $E = 50 \mu V/m$. In the case of radiotelephonic emissions and of those with damped waves (types A_3 and B) there should be used respectively the values 50 and $250 \mu V/m$.

The value of E being fixed and the product hI being considered as a single variable the formula of propagation becomes a relation between the three variables hI , d and λ , that can be represented graphically in the most varied ways with the aid of known graphical methods. For example in Fig. 3 is

* In the actual state of technical knowledge the practical tests appear indispensable in the case of the stations of dirigibles and aeroplanes, because the form of the waves produced by these and particularly the want of uniformity of the radiation in different directions does not permit of applying without doubt the formula of Austin-Cohen (*L'Elettrotecnica*, 8, p. 342, May 25th, 1921, and *Bollettino Radiotelegrafico*, 2, No. 15, p. 70).

set out a diagram with double curves from which one can deduce one of the three variables when the other two are given.* The method of using it is indicated at the left-hand side of the diagram. One perceives that the diagram contains two scales for λ ; upon one of these λ_M are taken the points of alinement with those of the scale hI , whereas on the other λ_d , are taken the points of alinement with those of the scale of d . The two alinements must intersect in a point on the ungraduated horizontal line which forms the top of the diagram in Fig. 3. Naturally for the use of the diagram may be substituted that of tables with two related columns, as for example the Tables IV. and V., of which the first gives the product hI as a function of d and λ , or the number of kilometre-amperes that it is necessary to have in the transmitting antenna in order to obtain a certain range with a certain wavelength; the second gives d as a function of hI and of λ , or the range that it is possible to attain with a certain number of kilometre-amperes in the transmitting antenna and with a certain wavelength. The tables and the diagram have been calculated by giving to the exponential factor the expression $0.0015d/\sqrt{\lambda}$ and by expressing d and λ in kilometres. Besides it has been assumed $E = 50 \mu V/m$. Naturally if results relative to $E = 10 \mu V/m$ or $E = 250 \mu V/m$ are wished for it is sufficient to divide or to multiply respectively by 5 the values of hI referred to (as has been done *e.g.* in Table V.) and analogously for any other value of E that it may be desired to assume.

The formula of propagation having been decided it is easy to calculate the most favourable wavelength, that is the one which makes hI a minimum for a certain distance; and there is obtained as is known the parabolic relation

$$\lambda_{(m)} = 562.10^{-6} d_{(km)}^2.$$

For evident practical reasons this relation cannot be adopted unreservedly as the rule for the selection of the wavelengths. Therefore the Committee before fixing a partial distribution of the various wavelengths has formulated the general rules: that generally the longer waves (the lower frequencies) should be used for the greater distances and the shorter waves for the smaller distances; that as a rule for distances less than 4,000 km there should not be used wavelengths beyond that of 12,000 metres, and for distances above 4,000 km wavelengths below 8,000 metres should not be used; that in general for distances above 1,500 km the wavelength employed, expressed in m, should not exceed three times the distance expressed in km.

Summarised, the data that in tabular form should be contained in the categories of data of fixed land stations are:—

- (1) Name of the station.
- (2) Call name.
- (3) Administration on which the station depends.
- (4) Administration or company that controls the station.

* The question of the conventional range has been exhaustively treated recently by the Institute E. and R. T. of the Royal Marine in a memoir prepared by the Inter-Allied Radio-technical Committee which acted during the war. From this memoir are taken the diagram of Fig. 3 (constructed at the time by Professor G. Perci of the Royal Naval Academy) and the numerical tables referred to further on.

TABLE IV.—Value of hI in $\text{km} \times A$ as a function of d and λ .

| Wavelength λ in m. | Distance d in km. | | | | | | | | | | | | Wavelength λ in m. | | |
|-------------------------------|---------------------|-------|-------|-------|-------|-------|-------|-------|-------|-------|-------|-------|-------------------------------|--------|--------|
| | | | | | | | | | | | | | | | |
| | 300 | 600 | 1,000 | 1,500 | 2,000 | 3,000 | 4,000 | 5,000 | 6,000 | 7,000 | 8,000 | 9,000 | | 10,000 | |
| 300 | 0.027 | 0.124 | 0.617 | 3.64 | 19.05 | 442 | 9.090 | — | — | — | — | — | — | — | 300 |
| 600 | 0.043 | 0.153 | 0.542 | 2.18 | 7.67 | 79.5 | 737.3 | — | — | — | — | — | — | — | 600 |
| 1,000 | 0.063 | 0.196 | 0.595 | 1.89 | 5.33 | 35.9 | 214.1 | 1,196 | — | — | — | — | — | — | 1,000 |
| 1,500 | 0.099 | 0.249 | 0.677 | 1.87 | 4.61 | 23.5 | 107.1 | 455 | — | — | — | — | — | — | 1,500 |
| 2,000 | 0.110 | 0.301 | 0.767 | 1.95 | 4.42 | 19.2 | 73.7 | 267 | — | — | — | — | — | — | 2,000 |
| 3,000 | 0.153 | 0.402 | 0.948 | 2.19 | 4.50 | 16.1 | 50.9 | 151 | 1,196 | — | — | — | — | — | 3,000 |
| 4,000 | 0.200 | 0.499 | 1.125 | 2.45 | 4.76 | 15.1 | 42.7 | 112.5 | 710 | 1,713 | — | — | — | — | 4,000 |
| 5,000 | 0.244 | 0.595 | 1.301 | 2.73 | 5.08 | 14.9 | 38.8 | 94.8 | 509 | 1,134 | — | — | — | — | 5,000 |
| 6,000 | 0.287 | 0.691 | 1.471 | 3.00 | 5.42 | 15.1 | 36.9 | 85.1 | 406 | 856 | — | — | — | — | 6,000 |
| 7,000 | 0.330 | 0.785 | 1.639 | 3.26 | 5.79 | 15.3 | 35.9 | 78.9 | 344 | 695 | 1,775 | — | — | — | 7,000 |
| 8,000 | 0.374 | 0.879 | 1.806 | 3.53 | 6.15 | 15.6 | 35.4 | 75.4 | 305 | 590 | 1,134 | — | — | — | 8,000 |
| 10,000 | 0.459 | 1.062 | 2.133 | 4.06 | 6.84 | 16.5 | 35.4 | 71.0 | 357 | 472 | 856 | 1,525 | — | — | 10,000 |
| 12,000 | 0.544 | 1.241 | 2.459 | 4.58 | 7.58 | 17.5 | 36.0 | 69.5 | 231 | 407 | 706 | 1,207 | — | — | 12,000 |
| 14,000 | 0.629 | 1.419 | 2.778 | 5.08 | 8.29 | 18.6 | 37.0 | 69.1 | 215 | 368 | 617 | 1,021 | — | — | 14,000 |
| 16,000 | 0.713 | 1.596 | 3.088 | 5.60 | 8.96 | 19.6 | 38.0 | 69.1 | 205 | 341 | 558 | 903 | — | — | 16,000 |
| 18,000 | 0.795 | 1.773 | 3.404 | 6.09 | 9.68 | 20.7 | 39.3 | 69.9 | 199 | 324 | 519 | 819 | — | — | 18,000 |
| 20,000 | 0.878 | 1.949 | 3.718 | 6.57 | 10.37 | 21.8 | 40.6 | 71.0 | 194 | 311 | 490 | 758 | — | — | 20,000 |

TABLE V.—Value of d in km as a function of hI and λ .

| hI ($\text{km} \times A$) | $\lambda = 300 \text{ m.}$ | | | | | | | | | | | | | | | | | | | | | |
|----------------------------------|----------------------------|------------------------|------------------------|-------|-------|-------|-------|-------|-------|-------|-------|-------|-------|-------|-------|-------|-------|--------|--------|--------|--------|--------|
| | | | | | | | | | | | | | | | | | | | | | | |
| | $E = 250 \mu\text{V/m}$ | $E = 50 \mu\text{V/m}$ | $E = 10 \mu\text{V/m}$ | 1.0 | 2.5 | 5 | 10 | 20 | 35 | 50 | 100 | 200 | 350 | 500 | 1,000 | 1,500 | 2,000 | 2,500 | 3,000 | 3,500 | 4,000 | |
| $E = 250 \mu\text{V/m}$ | 710 | 930 | 1,130 | 1,320 | 1,530 | 1,710 | 1,810 | 2,020 | 2,230 | 2,410 | 2,520 | 2,730 | 2,870 | 2,970 | 3,040 | 3,100 | 3,150 | 3,200 | 3,250 | 3,300 | 3,350 | 3,400 |
| $E = 50 \mu\text{V/m}$ | 660 | 930 | 1,200 | 1,460 | 1,740 | 1,970 | 2,110 | 2,400 | 2,700 | 2,960 | 3,100 | 3,400 | 3,500 | 3,720 | 3,820 | 3,900 | 3,970 | 4,030 | 4,080 | 4,130 | 4,180 | 4,230 |
| $E = 10 \mu\text{V/m}$ | 600 | 930 | 1,220 | 1,520 | 1,870 | 2,130 | 2,320 | 2,680 | 3,070 | 3,400 | 3,570 | 3,940 | 4,200 | 4,360 | 4,480 | 4,580 | 4,680 | 4,760 | 4,830 | 4,880 | 4,930 | 4,980 |
| $\lambda = 600$ | 520 | 870 | 1,180 | 1,530 | 1,920 | 2,250 | 2,460 | 2,890 | 3,330 | 3,720 | 3,930 | 4,420 | 4,710 | 4,900 | 5,070 | 5,200 | 5,310 | 5,400 | 5,480 | 5,550 | 5,620 | 5,690 |
| $\lambda = 1,000$ | 450 | 800 | 1,130 | 1,520 | 1,940 | 2,320 | 2,550 | 3,030 | 3,530 | 3,960 | 4,220 | 4,750 | 5,090 | 5,320 | 5,500 | 5,650 | 5,770 | 5,880 | 5,950 | 6,020 | 6,090 | 6,160 |
| $\lambda = 2,000$ | 370 | 700 | 1,040 | 1,450 | 1,900 | 2,330 | 2,600 | 3,180 | 3,780 | 4,310 | 4,620 | 5,260 | 5,650 | 5,920 | 6,130 | 6,320 | 6,470 | 6,600 | 6,720 | 6,830 | 6,940 | 7,050 |
| $\lambda = 3,000$ | 300 | 600 | 930 | 1,370 | 1,870 | 2,320 | 2,610 | 3,260 | 3,930 | 4,530 | 4,870 | 5,590 | 6,040 | 6,360 | 6,610 | 6,810 | 6,980 | 7,130 | 7,270 | 7,400 | 7,520 | 7,640 |
| $\lambda = 4,000$ | 230 | 520 | 850 | 1,280 | 1,800 | 2,280 | 2,600 | 3,290 | 4,030 | 4,680 | 5,050 | 5,860 | 6,370 | 6,600 | 6,710 | 6,810 | 6,900 | 7,000 | 7,100 | 7,200 | 7,300 | 7,400 |
| $\lambda = 5,000$ | 190 | 480 | 780 | 1,200 | 1,730 | 2,240 | 2,580 | 3,310 | 4,080 | 4,790 | 5,200 | 6,060 | 6,600 | 6,960 | 7,270 | 7,500 | 7,720 | 7,900 | 8,060 | 8,210 | 8,350 | 8,490 |
| $\lambda = 6,000$ | — | 430 | 730 | 1,130 | 1,660 | 2,180 | 2,540 | 3,320 | 4,140 | 4,900 | 5,320 | 6,220 | 6,810 | 7,220 | 7,560 | 7,810 | 8,030 | 8,210 | 8,380 | 8,550 | 8,720 | 8,890 |
| $\lambda = 7,000$ | — | 380 | 660 | 1,070 | 1,600 | 2,130 | 2,480 | 3,300 | 4,160 | 4,930 | 5,390 | 6,360 | 6,970 | 7,380 | 7,730 | 8,010 | 8,260 | 8,460 | 8,630 | 8,800 | 8,970 | 9,140 |
| $\lambda = 8,000$ | — | 320 | 570 | 960 | 1,490 | 2,000 | 2,360 | 3,250 | 4,200 | 5,020 | 5,510 | 6,570 | 7,250 | 7,710 | 8,080 | 8,380 | 8,650 | 8,880 | 9,050 | 9,220 | 9,390 | 9,560 |
| $\lambda = 10,000$ | — | 270 | 500 | 860 | 1,380 | 1,910 | 2,300 | 3,180 | 4,160 | 5,030 | 5,550 | 6,710 | 7,460 | 7,960 | 8,370 | 8,700 | 8,980 | 9,230 | 9,480 | 9,730 | 9,980 | 10,230 |
| $\lambda = 12,000$ | — | — | 460 | 800 | 1,290 | 1,820 | 2,200 | 3,100 | 4,100 | 5,040 | 5,590 | 6,840 | 7,620 | 8,150 | 8,580 | 8,950 | 9,250 | 9,500 | 9,750 | 10,000 | 10,250 | 10,500 |
| $\lambda = 14,000$ | — | — | 420 | 730 | 1,200 | 1,730 | 2,130 | 3,030 | 4,060 | 5,030 | 5,630 | 6,920 | 7,750 | 8,300 | 8,770 | 9,160 | 9,480 | 9,750 | 10,000 | 10,250 | 10,500 | 10,750 |
| $\lambda = 16,000$ | — | — | 390 | 680 | 1,130 | 1,660 | 2,040 | 2,960 | 4,020 | 5,020 | 5,640 | 6,990 | 7,850 | 8,450 | 8,920 | 9,320 | 9,660 | 9,930 | 10,180 | 10,430 | 10,680 | 10,930 |
| $\lambda = 18,000$ | — | — | 340 | 630 | 1,060 | 1,560 | 1,940 | 2,870 | 3,970 | 5,010 | 5,630 | 7,050 | 7,940 | 8,540 | 9,050 | 9,460 | 9,820 | 10,100 | 10,350 | 10,600 | 10,850 | 11,100 |

- | | | |
|------|---|--|
| (5) | Geographical position. | |
| (6) | Antenna | Type. |
| (7) | | Electrostatic capacity in $m\mu F$. |
| (8) | | Natural wavelength in m. |
| (9) | | Height of radiation in m. |
| (10) | | Type of the emission apparatus. |
| (11) | Wave | Type. |
| (12) | | Class. |
| (13) | | Frequency in kilocycles. |
| (14) | | Length in m. |
| (15) | Normal intensity of the antenna current. | |
| (16) | Service | Nature. |
| (17) | | Time table. |
| (18) | Range (optional) | $(E = 250 \mu V/m)$. For the types B and A_3 . |
| (19) | | $(E = 50 \mu V/m)$. |
| (20) | | $(E = 10 \mu V/m)$. For the types A_2 and A_1 . |
| (21) | Habitual correspondents (name and geographical position). | |

SCIENTIFIC RADIOTELEGRAPHY.

Broken up by the war as were the greater part of the international scientific organisations, many students felt the need of resuscitating them soon after the armistice, limiting them for the time being to the allied and associated nations of the Entente and to the neutral nations. There was therefore convoked in the summer of 1919 at Brussels the constituent assembly of the "International Council of Research," which fixed the chief arrangements of the new organisation that presupposes the constitution in each adherent country of a "National Council of Research." It will set about to collect and to co-ordinate the activities of the various "International Scientific Unions" (of astronomy, of geodesy and geophysics, of chemistry, of physics, of mathematics, of biological sciences, of geography, of geology, of bibliography and documentation, etc.) that should be in their turn sub-divided into various "National Committees." The seat of the International Council has been fixed at Brussels.

The effective functioning of this vast organisation has scarcely begun. Of the various international scientific unions some already possessed a concrete existence before the war and have been able therefore to revive more quickly their activity, such, *e.g.*, as that of geodesy and geophysics that is preparing to hold a general assembly at Rome in April, 1922. On the other hand other unions are scarcely in the embryo state, as, *e.g.*, the projected "International Technical Union," for which have been foreseen tasks in great number not excluding that of standardisation. Whenever such a union should succeed in actually constituting itself it would naturally not be able to neglect the existence of the International Electrotechnical Committee, that has already done a certain amount of work in the same field; and in every way would concern very closely our A.E.I. But up till now of the International Technical Union and of the work of its provisional committee (de Chardonnet, Fantoli, Otlet and G. L. Gerard) nothing more is known.

The "International Union of Scientific Radiotelegraphy" was provisionally constituted as continuation of an analogous international commission formed at Brussels in 1913 that has at disposal about 40,000 francs through a gift of Dr. R. Goldschmidt. To the union was also given a constitution that anticipates as a rule the existence of separate national committees (to be created on the initiative of the Government, or of the National Academy, or of the Council of Research or of other institutions or groups of similar institutions) the formation of commissions, the creation of an executive committee and of an administrative office or secretariat (at Brussels), the convocation of a general assembly every three years, etc. On the part of the financial administration, that must provide for the expenses of administration, of publication, of reduction and discussion of observations, not excluding eventually the remuneration of assistants, there should be drawn up a preliminary balance sheet, in which shall be fixed the annual unitary contribution. According as the population of the nations represented is inferior to 5, 10, 15, and 20 millions of inhabitants or superior to this last figure, the number of annual unitary contributions shall be respectively 1, 2, 3, 5, 8. It is laid down in any case that in this first period of the life of the union the annual unitary contribution must not exceed 200 francs. Moreover, whilst on questions of scientific order every delegate will dispose of one vote, in others the voting will be by nations and, according to the limits of population indicated, the number of the votes will be 1, 2, 3, 4, 5.

It is presumed that the first assembly of the U.R.S.I. (Union Radio-Scientifique Internationale) can take place at the same time as the world conference of electric communications prepared for by the meetings of Washington and of Paris. In view of this there were held, during this last meeting, some semi-official sittings, independent of the work of the committee, to formulate a programme of preliminary researches, the results of which will be able without doubt to furnish most useful data with the object of fixing at the next meeting a good programme of researches.

Amongst the R.T. questions of scientific interest, that by their nature are better adapted to an inquiry of international character, may be mentioned; the study of the laws that govern the transmission of energy in R.T. signals, atmospheric disturbances, interference produced by different transmissions and the means of eliminating it, R.T. measurements, electronic tubes, etc. In the meetings of Paris it was regarded as opportune to limit for the present the international agreements to the study of the two first questions.

The *law of the propagation of energy* has not yet been established on a completely and rigorously scientific basis, as has already been noted in treating of the conventional ranges. The study of this question covers the choice of the most convenient analytical formula, the determination of its constants, the examination of the continuous variations that the phenomenon of propagation undergoes and of the causes which produce them, the definition of the methods suitable for the measurement of the very feeble reception currents and of the electromagnetic fields that produce them, the establishment of the direction along which the propagation of energy takes place, etc. In order to commence the attack upon the problems it has been proposed

that a certain number of transmitting stations should execute at suitable hours some particular emissions of which the wavelength (or frequency) and the intensity of the current in the antenna should be accurately measured. A certain number of observers, distributed in the receiving stations of different countries, should establish the intensity of these signals or better that of the corresponding electromagnetic field and possibly also the direction of propagation.

The U.R.S.I. signals should last three full minutes ; the first minute will serve for the regulation of the receiving apparatus and will be occupied with the repeated emission of a signal composed in the following way :—

“URSI—of (name of the station)—(wavelength in metres of the emission made the day before)—(intensity of current in amperes during that same emission)” as, for example, “URSI of XY—18,500—230.” The succeeding two minutes should be occupied in the emission of a long dash. There should then be sent to the general secretariat (at Brussels) the schedules of each transmitting station, containing the largest possible number of technical data upon the emissions carried out, on the antenna, on the apparatus, on the meteorological conditions, etc. Analogous data should be despatched also by the stations that send out signals at regular times because they also are able to serve for measurements of intensity of reception. All these data should be rapidly co-ordinated by the general secretariat and should be printed and distributed widely to those interested. In the same way by each receiving station there should be registered and transmitted the data relative it may be to the intensity of the electromagnetic field on arrival produced by the emission considered, it may be (possibly) to the direction of propagation, together with all the suitable accessory indications—technical, meteorological, etc.

The study of *atmospheric disturbances** represents perhaps to-day the most important problem of radiotelegraphy and extends from inquiries into their origin and into their nature, to the determination of the fundamental principles on which to base the methods of eliminating their injurious effects. This is a field of study in which only a vast organisation of experimental researches executed concordantly and simultaneously by a great number of observers is able to lead to conclusive results. The most important points for examination seem to be (1) the preponderant direction in which the atmospherics apparently arrive at each station, (2) the intensity of the atmospherics, (3) the simultaneity and the differences of intensity of the same atmospherics appearing at different stations, (4) the classification of the atmospherics on the basis of the preceding elements and of all the other characteristics that it shall be shown eventually opportune to define. To these researches could be dedicated the same receiving stations organised for the measurements on the law of propagation, and as reference with respect to the time and for observations of intensity, the URSI signals and the time signals could serve. In particular it is easy to see how useful might turn

* *L'Elettrotecnica*, 5, No. 10, p. 140, April 5th, 1918; 7, No. 1, p. 19, January 5th, 1920; and *Bollettino Radiotelegrafico*, 1, No. 1, p. 4; No. 8, p. 198.

out to be comparisons made between the curves of graphical registration obtained simultaneously in different stations and reproducing the same signals together with the atmospherics that accompany them. The results of the experiments collected in the first period of functioning of the projected organisation could serve to make more precise and uniform the collection of the data in the succeeding periods.

The directorate of the R.T. services of the Italian navy has already declared itself prepared to participate from the beginning in the experiments of scientific radiotelegraphy, proposing that our largest station actually in service, namely, the Rome Radio (San Paolo), should participate in the emission of the URSI signals.

The Amplification of Weak Alternating Currents.

II.—THE GRID CIRCUIT AND INPUT TRANSFORMER.

By H. BARKHAUSEN.

3. The Power supplied to the Grid Circuit.

(a) *Very great Impedance Z_u of the External E.M.F.*

The unamplified power P_u can also be thought of as supplied from a source with an E.M.F. E_u and an internal impedance which, for the present, can be denoted by Z_u . The object of the connections is to maintain as high as possible the alternating pressure V_g on the grid in order that the strongest possible alternating current will be produced on the anode side. Now it is known that the grid, with a sufficiently high negative potential (about -1 volt) takes no current and also consumes no power, thus representing in some respects an infinitely great resistance. A closer consideration shows, however, that a finite impedance must still be assumed. One sees this best by considering the case in which the internal impedance Z_u of the external E.M.F. E_u is very great. This occurs in fact in the discharge through a gas as, *e.g.*, with the amplification of the currents in photo-electric cells and also in other cases.* On account of its disturbing effect a case of practical importance is that of a quite small antenna (A, Fig. 9), a short wire connected to the otherwise insulated grid G. The E.M.F. E_u can arise in this case from the electric field of some alternating electric charge Q for example on a neighbouring lighting main. Its internal impedance Z_u is then equal to $1/\omega C_u$ if C_u is the partial capacity of A with respect to Q. The completely insulated grid then receives some alternating potential depending on the capacity C_g to earth (*i.e.*, to the earthed filament), of the grid together with the antenna and the connecting leads. The pressure E_u is divided in the

* The multiple amplifier, mentioned later, forms an important application. See Fig. 16.

ratio of $Z_u = 1/\omega C_u$ and $Z_g = 1/\omega C_g$ so that the pressure on the grid will be

$$V_g = E_u \frac{Z_g}{Z_g + Z_u}$$

If the negative potential of the grid is insufficient or the insulation imperfect a suitably large resistance must be imagined connected in parallel with C_g ; both are then included in the effective impedance Z_g . In this last case it will be seen that in calculations the grid must be regarded as a resistance on which the E.M.F. acts, as mentioned previously. The novelty here is that this resistance is extraordinarily great and not well defined.

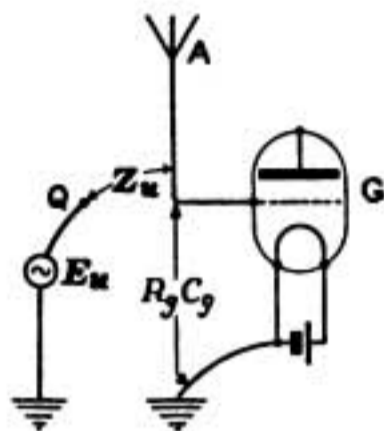

FIG. 9.

It is, besides, clear that a high potential can be the more easily maintained on the grid the greater the effective grid impedance Z_g . On the other hand, as the above-mentioned example shows, all external disturbances, due to capacity or insulation, act more strongly when Z_g is at the same time greater. It is astonishing how with great amplifications and very

large values of Z_g commutator noises and the like are often heard from lighting circuits which pass at a great distance. No particular antenna is required for this, the capacity of the grid and the terminals of the tube itself associated therewith being quite sufficient. Besides these disturbances due to stray fields the reaction from the anode circuit can never be neglected with large values of Z_g . The anode itself has a capacity to the grid which is not negligible. More will be said later on this subject. With such back-coupling self-excitation occurs with extraordinary ease when Z_g is large; the tube then, in general, no longer works as an amplifier but as a generator (sender), which produces a particular alternating current entirely independent of external E.M.F. For these reasons large values of the impedance Z_g are dangerous, if not impossible.*

Besides the alternating current the direct current relations must be considered. A completely isolated grid is charged by the electrons thrown off from the filament to a potential of -1 or -2 volts according to the insulation, the anode pressure, and the tube construction. This is only the case with a very high vacuum in the tube and with very good insulation. There is also the danger of surface leakage currents from the high positive anode potential, the leads for which lie close to those of the grid. Finally as is frequent, *e.g.*, with photo-electric cells, besides the alternating pressure E_u (Fig. 9) a direct pressure is active, supplying a direct current to the grid. Then a high ohmic resistance or a choking coil must be provided as a leak to the grid. The effective impedance Z_g will be reduced thereby. For higher frequencies particularly, a choking coil cannot be made of high impedance, since with a large number of turns the unavoidable coil capacity

* With many amplifiers Z_g is intentionally diminished by use of an insufficient negative pressure on the grid (-0.5 volt). Increasing the latter sets up self-excitation directly. See also Section 5 (c).

forms a shunt through which the alternating current passes. It is best to work with resonance. Details are discussed with the input transformer (see below) in which these relations are just as important.*

(b) *Input Transformer.*

Generally the internal impedance Z_u of the source of current to be amplified is not so extraordinarily great that the pressure cannot be increased by means of a step-up transformer. This amounts to an adaptation of Z_u to the nearly infinitely great grid impedance Z_g (Fig. 10). One might imagine that with the transformer it is only necessary to have the highest possible number of secondary turns. A limit is soon reached in practice, beyond which not an increase but a reduction of pressure occurs. The reason for this is the capacity of the winding. The transformer must not only charge the grid but also a part of its own secondary winding. This acts as if a capacity C —shown dotted in Fig. 10—were connected across its secondary

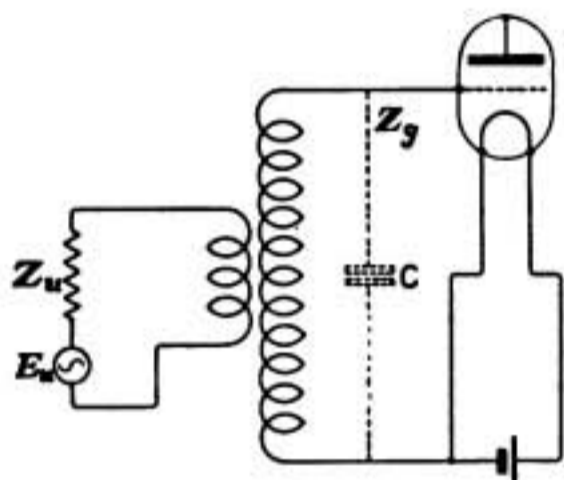

FIG. 10.

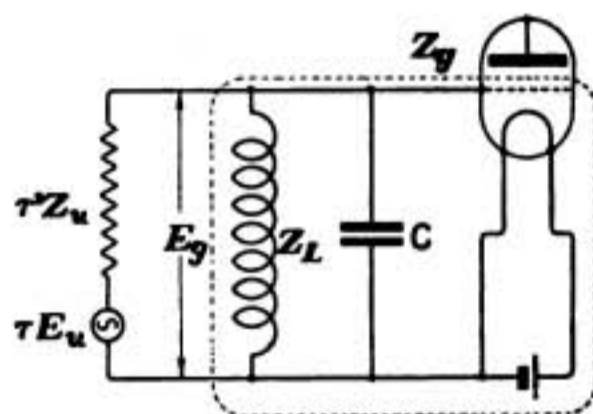

FIG. 11.

terminals. For a given number of turns this comes into resonance with the inductance of the winding and thus produces a pressure increase. With still more turns, however, resonance is exceeded and the pressure falls more and more. These natural oscillations of coils are quite well known in high frequency technology.

The phenomena occurring here can best be explained by the use of an equivalent circuit in which the magnitudes of the primary circuit are reduced to the secondary circuit. For this the E.M.F. E_u is multiplied by the transformation ratio τ and its internal impedance Z_u by τ^2 . The external impedance Z_g upon which the E.M.F. acts consists then of the unloaded secondary winding, which must be thought of as a choking coil Z_L having the coil capacity C in parallel with it and parallel thereto the grid of the tube. (See Fig. 11.) The grid potential V_g , i.e., the pressure across Z_g is then

$$V_g = \tau E_u \frac{Z_g}{\tau^2 Z_u + Z_g}$$

This will be a maximum, equal to $\tau E_u/2$, for a value of the transformation

* See also the section "Multiple amplifiers" (in next issue).

ratio such that $\tau^2 Z_u = Z_g$; thus, as would be expected, with equality of the internal and external impedances, Z_g depends upon the frequency and will be a maximum at resonance of the winding together with the tube. These are the same phenomena which were fully discussed in connection with Figs. 4 and 5 for the anode circuit. Here, therefore, only the experimental confirmation of this theory will be mentioned.

That exactly the same phenomena occur with input transformers at audible frequencies has been proved, particularly by the comprehensive measurements made by K. Mühlbrett.* The impedance of the open-circuited, unloaded input transformer was measured on the primary side by various methods and shows a dependence on frequency exactly like the normal resonance curves drawn in Figs. 5 and 12. The logarithmic decrement d for audible frequencies was in the neighbourhood of 0.6, the resonance frequency being usually over 1,000. The connection of a known capacity on the secondary side caused a displacement of the curve towards lower frequencies in accordance with the Thomson formula. Thence it was calculated that without the additional condenser, the effective coil capacity alone was about 80 cm on the average, but by varying the polarity of the winding a difference of 40 per cent. in the resonance frequency could be observed, indicating a change of 100 per cent. in the effective capacity, *i.e.*, from 1 to 2. This is due to the end capacity which here comes into play. A condenser connected to the primary acts moreover as if

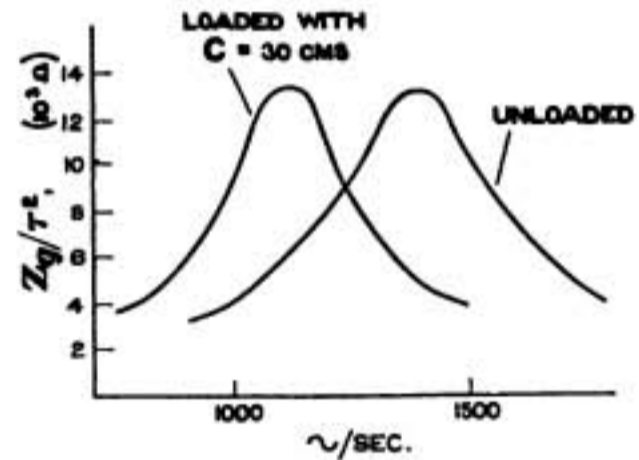

FIG. 12.

connected on the secondary, only reduced by the square of the transformation ratio. With very small values of Z_u the secondary voltage V_g on which the amplification depends was always equal to τE_u . Only with heavier loads one obtained a small pressure drop depending on the ohmic resistance. Under these conditions resonance phenomena did not occur. The greater Z_u is made the more pronounced are the resonance phenomena, and so soon as $\tau^2 Z_u$ becomes large compared with Z_g , the secondary pressure varies with frequency directly as the impedance Z_g , when the frequency is altered at constant E.M.F. These are exactly the phenomena described in connection with Fig. 4 with respect to the relation between Z_i and Z_u .

The value of $1/\omega C$ for a frequency of 1,000 with $C = 80$ cm is equal to 2×10^6 ohms; the resonance impedance, π/d times as great, is with $d = 0.6$ about 10 megohms. A shunt by means of an ohmic resistance of equal

* Following my first experiments on input transformers for audible frequencies (February, 1917) which gave the resonance effect and the magnitude of the coil capacity, Mühlbrett has later—on my suggestion—extended these measurements. The results were reported in the *Archiv. für Elektrotechnik* (9, pp. 365—390, December 8th, 1920).

Similarly, very exact experiments on a measuring transformer for use with an electrometer at a frequency of 50 are described by Gewecke (*Archiv. für Elektrotechnik*, 8, p. 203, 1919). The theoretical hypotheses are more nearly fulfilled in this case.

magnitude must thus reduce the effective resistance R_g to one half. This is also confirmed by the measurements (Fig. 13). A load of 1 megohm destroys the resonance effect almost completely. Thus if it is desired to utilise the entire pressure increase due to resonance the insulation must be very good, *i.e.*, great compared with 10 megohms.

The supply of energy due to back coupling can be treated in calculation as a load with negative resistance. This diminishes the normal positive resistance, thus increasing the resonance peak; experiment has also confirmed this (Fig. 14). If the negative resistance is as great as the positive, the resonance impedance becomes infinite, and with still greater * negative resistances self-excitation occurs. It is physically clearer if one considers the strength of the current which must be supplied to the transformer primary in order to produce a definite pressure, *e.g.*, 1 volt on the secondary.

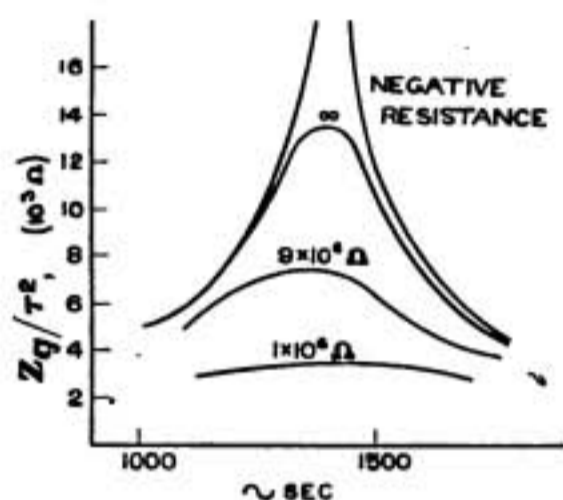

FIG. 13.

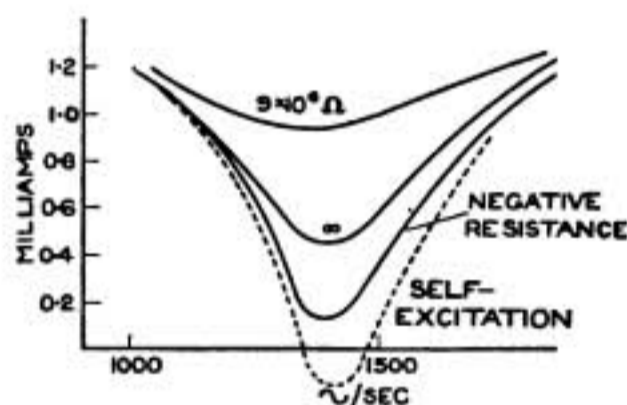

FIG. 14.

As Fig. 14 shows this current will be a minimum at resonance; these curves are simply the reciprocals of the impedance curves of Fig. 13.† By loading with a positive resistance the minimum does not fall so low since the load current is added. On the other hand, by loading with a negative resistance the curve approaches the zero line more or less, according to its magnitude. If this be reached no further supply of current is necessary; a resonant oscillation once excited maintains itself, dying out infinitely slowly. Then a continued echo is heard in the amplifier with each impulse. If the zero line be crossed over with stronger back coupling the resonance oscillation maintains itself even without external impulses. This also was confirmed experimentally.

(c) Influence of the Capacity between the Grid and the Anode.

With great values of Z_g the capacity C_{ga} between the grid and anode is also to be considered. It forms a "back coupling," a retro-active effect of

* *Translator's Note.*—The author says, "bei noch kleinerem negativen Widerstand," but the context clearly shows that greater and *not* less resistance is meant.

† Most of the current curves of Fig. 14 were experimentally found by Mühlbrett (*l.c.*) and therefrom the resistance curves of Fig. 13 were calculated.

the amplified currents in the anode circuit upon the unamplified currents in the grid circuit. The general theory of this back coupling will be treated later; the effect of the capacity C_{ga} —which in the following is simply denoted by C —is here only briefly discussed. It causes a charging current which, according to the laws of alternating currents, is calculated from the equation

$$\frac{I_c}{j\omega C} = V_g - V_a = V_g \left[1 + \frac{\mu}{1 + R_i/Z_a} \right]$$

because the charging current is dependent on the pressure across the terminals of the capacity, *i.e.*, on the difference between the grid and the anode potentials, and the alternating pressure on the anode depends on the grid potential and the impedance Z_a in the anode circuit according to the equation,

$$V_a = V_g \frac{\mu}{1 + R_i/Z_a}$$

Thus the charging current is calculated from the grid potential only and the ratio of both

$$\frac{V_g}{I_c} = Z_c = \frac{1}{j\omega C} \frac{1}{1 + \frac{\mu}{1 + R_i/Z_a}} = \frac{1}{j\omega C} \frac{(1 + R_i/Z_a)}{(1 + R_i/Z_a) + \mu}$$

is the equivalent impedance which, connected between the grid and the filament, will give the same charging current.

If Z_a is small compared with R_i , *i.e.*, if the anode is connected with the filament through a negligible resistance, $Z_c = 1/j\omega C$ simply. This is obvious since the capacity C is then practically connected between the grid and the heater.

If, on the other hand, Z_a is great compared to R_i ,

$$Z_c = \frac{1}{1 + \mu} \cdot \frac{1}{j\omega C}$$

so that the effective capacity will be $1 + \mu$ times as great; for example, when $\mu = 20$ being increased 21 times. This is because the anode potential is μ times as great as the grid potential and induces correspondingly stronger charges on the grid. If $Z_a = R_i$ the effective capacity is only about half as great, *i.e.*, increased $\mu/2$ times.

A pure capacity effect only happens when Z_a is entirely real. In other cases the anode pressure is no longer in phase with the grid pressure, and therefore the charging current is not displaced 90° from it. For the equivalent impedance a capacity with an appreciable leak, *i.e.*, one with an ohmic resistance connected in parallel with it, can be used in the calculations. For the sake of simplicity we shall only consider the cases in which the anode impedance is either entirely inductive ($Z_a = j\omega L$), or entirely capacitive ($Z_a = 1/j\omega C$). Let its absolute value be $1/n$ times as great as R_i , so that the ratio R_i/Z_a will be $n/j = -jn$ in the case of the inductance and $+jn$ in the capacitive case. If it be desired to analyse the expression into real and imaginary parts for a capacity having a resistance in parallel with it

the value, G_e , of the admittance must be calculated.* Thus, in the inductive case,†

$$\frac{1}{Z_e} = G_e = j\omega C \left[1 + \frac{\mu}{1 - jn} \right] = j\omega C \frac{(1 - jn + \mu)}{(1 - jn)} = j\omega C \frac{(1 + n^2) + \mu}{(1 + n^2)} - \omega C \frac{n\mu}{(1 + n^2)}.$$

For $n = 1$, i.e., $Z_a = jR_i$ this gives

$$\frac{1}{Z_e} = G_e = j\omega C \frac{2 + \mu}{2} - \frac{\omega C \mu}{2}.$$

The first, imaginary term represents the effective capacity; the second, real term the leak. With a large μ the second term is as great as the first; the leak then lets through as much current as the capacity itself. The equivalent impedance Z_e possesses a phase displacement of 45° , as was to be expected, since with $Z_a = jR_i$ the anode pressure V_a is displaced from V_g by about 45° . In the capacitive case, n is only substituted for $-n$ throughout; thereby merely altering the sign of the second term.

With a capacitive Z_a a positive leak is obtained which consumes energy and has a damping action; with an inductive Z_a , on the other hand, the anode capacity C_{ga} acts as a capacity with a negative leak, which diminishes the damping and annuls the effect of an equally great positive leak. If the negative leak be greater than the entire positive leak self-excitation occurs, resulting entirely without external causes from its own alternating currents; the amplifier "whistles" and cannot be used.‡

The phenomena actually occurring become thereby rather indefinite, since all impedances depend in amplitude and phase on the frequency. For example, if Z_a is a coil with a capacity connected in parallel with it, or even with its own winding capacity, Z_a is inductive for frequencies lower than the resonance frequency, but capacitive for higher frequencies. Lower frequencies are therefore amplified, whilst higher frequencies are damped. If self-excitation is to be safely avoided, the conditions of resonance of Z_a must be chosen so low that the oscillations which can arise, and whose frequency will be essentially determined by the resonance conditions of Z_g , possess a higher frequency than Z_a .§ All this was also confirmed experimentally as will be described in a later work.

It should be noticed that the capacity C_{ga} is formed not only by the electrodes which are in the tube, but also by their associated conductors—so far as they carry potentials themselves—thus also by means of the terminals

* I have carried out the calculation for this case. An equivalent capacity with a series resistance is then obtained.

† *Translator's Note.*—There is an error in the real term as given by the author. The factor $(1 + n)$ in the denominator should be $(1 + n^2)$.

‡ Certain transmitting valve circuits are based upon such self-excitation due to the capacity C_{ga} .

§ Without knowledge of this theory condensers for removing disturbances have occasionally been connected in parallel with the output transformer Z_a to suppress the self-excitation.

and connecting leads outside the tube.* Lengthy neighbouring connecting leads quite substantially increase the otherwise very small capacity. It is often observed that self-excitation may be started or stopped by quite a small to and fro movement of these connecting leads. This can even be effected by bringing the hand closer or further away, since by the closeness of stray conductors the partial capacity between two leads will be altered.

In normal cases Z_a is of the same size as R_i . Then the effective capacity which diminishes R_g , is about $\mu/2$ times as great as C_{ga} , e.g., when $\mu = 100/7$ and $C_{ga} = 10$ cm about 70 cm. A capacity of this size must thus be imagined connected between the grid and the filament. The natural frequency of the input transformer will be considerably reduced thereby, and this explains the experimentally observed fact — mentioned above — that the open-circuited transformer not connected to the grid should be tuned to a higher frequency than that to be amplified. This particular effect of C_{ga} can also be easily demonstrated experimentally. If a transformer be loaded with a tube, the anode of which is directly connected to the battery, its condition compared with open-circuit is not at all altered, assuming the grid current of the tube to be zero. But as soon as a very high resistance Z_a is connected in the anode side, the tube acts as if the transformer were loaded with a large capacity.†

High-speed Wireless Telegraphy.

At a meeting of the Wireless Section of the Institution of Electrical Engineers on January 4th, a paper on this subject was read by Lieut.-Colonel A. G. T. Cusins, Royal Corps of Signals, the officer in charge of the Signals Experimental Establishment at Woolwich. The paper consisted in the main of a record of the development of high-speed telegraphy carried out at Woolwich and applied in the communication between Aldershot and Cologne and other military centres. Every effort had been made towards the mechanicalisation of wireless telegraphy in as simple and portable a form as possible. The apparatus can be operated up to the maximum speed of the Wheatstone apparatus. In practice the message is recorded on a Wheatstone receiver, but at the meeting at the Institution a very successful demonstration was given of reception from Woolwich, in which the message was printed by means of a Creed perforator and printed at a speed of about 100 words per minute. The transmitter operates by cutting out a battery which normally maintains a high negative potential on the grid of a valve which is inserted as a leak in the grid current of the main transmitting valve.

The receiver consists of a Turner valve relay, coupled to the aerial through a three-valve H.F. amplifier. The quenching of the valve relay is done electrically by inserting a control valve in its anode circuit, the grid of this control valve being modulated by an oscillating valve of audible frequency (1,000 to 3,000). The P.D. across a resistance in the anode circuit of the valve relay acts on the grid of another valve which acts as a rectifier and which operates a Post Office relay through a double-current valve relay. The Post Office relay operates a Wheatstone receiver.

Towards the end of the paper, however, the author mentioned that the Turner valve relay had now been superseded by another device called the "Autokym" but of which the details were not disclosed. The author mentioned that experiments had been made with a chemical

* A double-grid tube with a protective grid between the control grid and the anode considerably reduces the capacity of the tube itself, but not that of the leads. Since the voltage ratio μ is large these tubes give particularly strong back coupling with large values of Z_a .

† See K. Mühlbrett (*l. c.*).

inker giving perfect signals at 3,000 words per minute, but that the method needs further development.

The reading of the paper was followed by a lengthy discussion. Mr. Carpenter gave some particulars of the advantages of the Creed apparatus which employs the ordinary Morse signals as compared with other printing systems employing the five-unit system. Mr. Creed himself spoke of the vista opened up by the enormous strides being made in the development of radio telegraphy. Captain Turner drew attention to the limitations of high-speed signalling at very long wavelengths on account of the time taken to build up an oscillation in a circuit in which the damping had been reduced in order to increase the selectivity and freedom from atmospheric disturbances. Mr. Shaughnessy referred to successful experiments in high-speed wireless carried out by the Post Office some years ago. He considered that the author had been unduly optimistic in his visions of the future developments of the high-speed broadcasting of news from a national press centre. Captain Round drew attention to what was perhaps one of the outstanding features of the system described and that was the variety of applications and possibilities of the three-electrode valve. Mr. Scott-Taggart described two methods of using three-electrode valves which he had devised, which could be employed in high-speed reception.

The Physical Society of London and the Optical Society.

The Twelfth Annual Exhibition of Electrical, Optical, and other Physical Apparatus.

This annual exhibition was held at the Imperial College of Science, South Kensington, on the afternoons and evenings of January 4th and 5th. The number and interest of the exhibits was quite up to the usual standard. On each day Mr. Campbell Swinton gave an experimental lecture on "The Johnsen-Rahbek Electrostatic Telephone and its Predecessors."

Of special interest in the wireless section was the exhibit of Messrs. Creed & Co., consisting of a complete high-speed automatic printing telegraph, the receiver being operated from a temporary aerial and printing high-speed messages transmitted automatically from a distant station.

H. Tinsley & Co. were showing two new types of variable inductometers; there is an increasing tendency to use bridge methods involving variable inductometers in accurate alternating measurements and improvements in the design are to be welcomed if they will enable them to be used at higher frequencies. The same firm also exhibited compact bridges for measuring inductance and capacity of the type designed by Mr. L. B. Turner.

Of interest to those using portable ammeters and voltmeters were the so-called Resilia instruments shown by the Foster Instrument Co., of Letchworth. In these the moving coil is pivoted internally on a support which is not fixed rigidly to the iron core but carried on a spring, thus relieving the pivots of all shock.

The Weston Electrical Instrument Co., Ltd., were showing their well-known thermo-ammeters and galvanometers for radio frequencies.

Mr. H. W. Sullivan exhibited a great number of instruments of interest to the radio engineer, including valve oscillators of both radio and audio frequencies, variable and fixed condensers, both of ordinary and of special quality, wavemeters and variometers. He also showed a Wheatstone bridge for radio frequencies, with a vacuum thermo-galvanometer as an indicator; the resistance arms are carefully constructed to be non-reactive and all parts of the bridge are carefully screened (see page 79 for fuller description).

The Igranic Electric Company showed a selection of machine-wound duolateral coils, so dear to the heart of the wireless amateur.

The Dubilier Condenser Company showed a number of their well-known mica condensers of various types and also the Dubilier insulator which has been specially designed to stand up against C.W. working.

A selection of wireless apparatus, condensers, amplifiers, etc., was shown by Gambrell Bros.

Professor Taylor Jones exhibited a new electrostatic oscillograph for use with potentials from 5,000 to 250,000 volts. This consists of a metal strip of adjustable tension supported

between ebonite jaws ; the centre of the strip rocks a mirror pivoted about a fixed fulcrum. In front of the strip is a metal plate connected electrically with it whilst the other terminal is connected to an electrode behind the strip but embedded in ebonite. The strip is thus attracted to this electrode with a force proportional to the square of the voltage, and—a point not mentioned in the printed description—the movement is independent of the reversal of the applied P.D. This latter is certainly an unusual feature in oscillographs.

Marconi's Wireless Telegraph Company exhibited their emergency "4-Second Alarm" device, which enables a ship in distress to call up another in the event of the receiver on the latter being temporarily unattended.

Notes.

Commercial and General.

GOVERNMENT CONTROL OF WIRELESS IN CALIFORNIA.—The Minister of Communications for Mexico has issued orders placing the wireless stations in the northern part of Lower California under the jurisdiction of the Telegraph Department with the object of placing the majority of the scattered wireless telegraph stations under the control of the Federal Government. [4069]

WIRELESS TELEPHONY IN SWEDEN.—The Telegraph Authorities are now conducting experiments for linking up the ordinary telephone with the wireless telephone so as to enable through calls to be effected. [4065]

WIRELESS TELEPHONY ON RAILWAYS.—According to *Telegraph and Telephone Age* wireless telephones are to be installed on a number of German express trains to provide communication between the passengers and hotels, etc. [4074]

WIRELESS TELEPHONY.—According to the *Deutsche Allgemeine Zeitung*, highly successful experiments in wireless telephony have recently been carried out between Berlin and Copenhagen. [4146]

According to the *Electrician* encouraging experiments in wireless telephony have been carried out by the Indian Posts and Telegraphs Department between Bombay and Poona. [4156]

NEW WIRELESS STATION IN NORTH AFRICA.—The building of the wireless station at Ain-el-Hadjar, near Saida, on the railway line from Perregaux to Colomb-Bechar, has just been started by a detachment of military engineers. The station, which will be the most important in North Africa, is intended to form the wireless link between France and her African colonies, and in case of a breakage of the undersea cables to undertake the forwarding of telephone messages between France and Algeria. [4238]

Wireless telegrams can now be sent between Bordeaux and Madagascar. The rate is 2.25 fr. per word. [4421]

INCREASE IN SHIP STATION RATE FOR UNITED STATES SHIPPING BOARD VESSELS.—Effective January 1st, 1922, the ship tax of all Shipping Board vessels will be advanced from 4 cents per word to 8 cents per word. [4488]

THE THERMIONIC VALVE AND ARC AS GENERATORS FOR RADIOTELEGRAPHY.—A course of eight lectures on the above subjects has been arranged at East London College (Mile End Road, E. 1), commencing on February 7th, and continuing on the seven following Tuesdays. The first five lectures will be given by Professor W. H. Eccles, D.Sc., and the remaining three by Mr. C. F. Elwell, M.I.E.E. Syllabus and full particulars may be obtained from the Registrar of the College.

Review of Radio Literature.

1. Abstracts of Articles and Patents.

(F.) Thermionic Valves, and Valve Apparatus.

2943. **H. St. J. de A. Donisthorpe.** Thermionic Valve for use in Wireless Telegraphy and Telephony. (*U.S. Patent* 1391671, March 23rd, 1921. Patent granted September 27th, 1921.)

See RADIO REVIEW Abstract No. 2582, November, 1921, for corresponding British Patent.

2944. **C. E. Hiatt and W. J. Davis.** Valve of Wireless Transmission Systems. (*U.S. Patent* 1394090, May 19th, 1919. Patent granted October 18th, 1921.)

A tube having a construction of plate which provides a high thermal conductivity between the plate and its support and which at the same time is of inexpensive manufacture.

2945. **W. C. White** [General Electric Company]. Means for Producing High-frequency Oscillations. (*U.S. Patent* 1393594, June 3rd, 1918. Patent granted October 11th, 1921.)

A means for producing high-frequency oscillations independently of any coupling between the grid and plate circuits of the vacuum tube oscillator. Under certain conditions in vacuum tube oscillator circuits, the current in the grid circuit may have a falling characteristic, that is, as the voltage impressed upon the grid increases, the current in the grid circuit will decrease. With the proper conditions for operation, a circuit having current characteristics of the type described, may be so organised that oscillations will be produced therein, the essential condition for the production of oscillations being that the circuit shall contain capacity and inductance and that the resistance of the circuit shall be less than :

$$2\sqrt{L/C}$$

where L represents the inductance and C the capacity of the circuit. A resonant grid circuit is provided including a source of potential and adjusted so that the current in the grid circuit will vary inversely as the applied potential over a given operating range of negative potential, the source of potential connected to the grid circuit being of such value that the normal potential of the grid is within the operating range, whereby oscillations will be produced in the grid circuit independently of any coupling between the grid and plate circuits. (See also Abstract No. 2613, November, 1921, for corresponding British Patent.)

2946. **W. C. White** [General Electric Company]. Signalling System. (*U.S. Patent* 1394056, July 3rd, 1920. Patent granted October 18th, 1921.)

A transmitter employing vacuum tube oscillators and modulators. A source of alternating current of low frequency is provided for supplying energy for the operation of the electron discharge oscillators and the modulators. Current for heating the filaments of the oscillators and modulators is also derived from the same source. Current for the operation of the oscillators and modulators is supplied to the plate circuits by means of a transformer, the secondary of this transformer being oppositely connected to the plate circuits of the oscillators as well as to the plate circuit of the modulators.

2947. **P. C. Hewitt.** Relay. (*U.S. Patent* 1393018, March 9th, 1916. Patent granted October 11th, 1921.)

A tube comprising an evacuated vessel having an anode and a cathode therein, a battery connection for heating the cathode, a conducting member acting as a screen enclosed within the container and adjacent to the anode and means for heating the conducting member to a temperature having any desired relation to the temperature of the heated cathode. The tube is intended for amplifying electrical currents or translating variations and when used in such connection either the cathode or the screen may serve as the grid and the temperature of each may be controlled in such manner as to pass the desired amount of current in either direction.

(G.) Transmitter Control or Modulation.

2948. **C. V. Logwood.** Signalling System. (*U.S. Patent* 1397432, June 16th, 1917. Patent granted November 15th, 1921.)

This patent relates to a radio transmitting and receiving vacuum tube apparatus with means for automatically switching from transmitting to receiving.

2949. **E. O. Scriven** [Western Electric Co., Inc.]. System for Transmission of Intelligence. (*U.S. Patent* 1396786, November 6th, 1916. Patent granted November 15th, 1921.)

This invention relates to a radio telephone system wherein signals are transmitted or received by means of a high-frequency carrier wave modulated in accordance with the signals. The circuit embodies the combination of two vacuum oscillators which serve as a source of high-frequency carrier wave oscillations, the impedance of which combination is varied according to the low-frequency signals to be transmitted. By suitable adjustments the radiation of the unmodulated carrier wave can be prevented.

At the receiver a vacuum tube containing two grids, two plates, with common filament is employed. The circuit may be arranged for either high-frequency carrier wave reception or modulated high-frequency wave reception, in which latter case the tube serves as a homodyne generator, that is, it should produce oscillations of the same frequency as the incoming high-frequency oscillations. If the incoming waves are not modulated the vacuum tube generator should be a heterodyne generator, that is, it should generate oscillations of a frequency different from that of the incoming carrier waves to produce a frequency within the limits of audition.

2950. **A. L. Fitch** [Western Electric Co., Inc.]. Transmission System. (*U.S. Patent* 1397862, November 26th, 1917. Patent granted November 22nd, 1921.)

This invention relates to a radio telephone modulating circuit employing a condenser transmitter connected to a vacuum tube amplifier and using a single battery both in the output circuit of the amplifier and as a means for polarising the transmitter. In the usual operation of a vacuum tube amplifier circuit with condenser telephone employing a single battery as described, the filament is usually grounded and accidental grounding of the condenser transmitter case causes either the battery or the condenser transmitter to be short-circuited and thus interferes with the operation. The present invention remedies this defect by connecting the battery to perform both the functions of charging the condenser transmitter and furnishing current to the output circuit in the amplifier circuit such that one electrode of the condenser transmitter is always grounded and the other electrode is arranged to make grounding substantially impossible. The source of electromotive force is common to both the circuits through the condenser transmitter and the output circuit of the vacuum tube amplifier.

2951. **L. Espenschied** [American Telephone & Telegraph Company]. Radio Repeating System. (*U.S. Patent* 1397093, September 27th, 1919. Patent granted November 15th, 1921.)

This invention relates to radio repeating stations and apparatus for amplifying at intermediate points the signals transmitted between two terminal stations.

2952. **E. W. B. Gill** [Radio Corporation of America]. Wireless Telegraph Receiver. (*U.S. Patent* 1371757, October 7th, 1920. Patent granted March 15th, 1921.)

See corresponding *British Patent* 155642, RADIO REVIEW Abstract No. 2933, January, 1922.

2953. **E. F. W. Alexanderson** [General Electric Company]. Radio Receiving System. (*U.S. Patent* 1373931, June 5th, 1919. Patent granted April 5th, 1921.)

See RADIO REVIEW Abstract No. 2967 in this issue.

(H.) Radio Receiving Apparatus.

(3) ELECTRON TUBE DETECTORS AND RECEIVERS.

2954. **Gesellschaft für drahtlose Telegraphie.** Wireless Receiving Systems. (*British Patent* 160140, March 11th, 1921. Convention date March 13th, 1920. Patent not yet accepted.)

An arrangement of valves to separate the functions of high and low-frequency amplification and to minimise the effects of atmospherics (Fig. 1). Modifications on similar lines can also be arranged, by replacing the resistances R_1 R_2 by inductances.

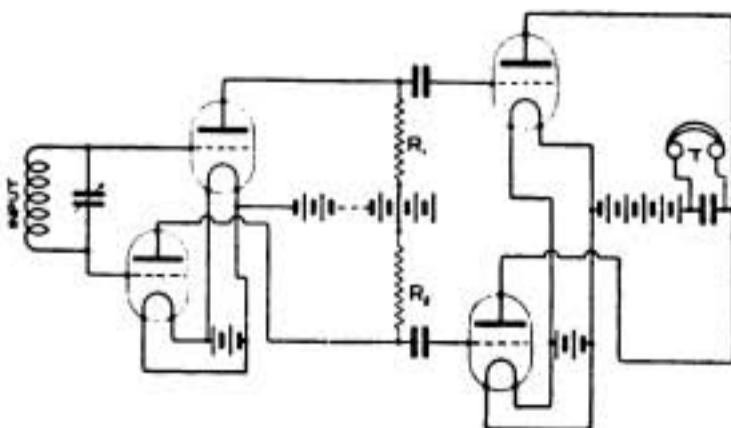

FIG. 1.

2955. **Gesellschaft für drahtlose Telegraphie.** Oscillation Generators. (*British Patent* 147435, July 7th, 1920. Convention date December 6th, 1917. Patent not yet accepted.)

In a thermionic oscillation generator tuned circuits are inserted as impedances in the plate circuit for the purpose of minimising heat losses, particularly in the electrodes of the valve. The choking circuits for harmonics may be connected in series or parallel as shown in Figs. 2 and 3.

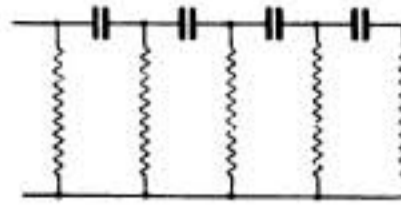

FIG. 2.

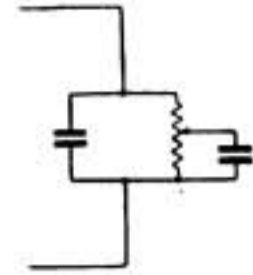

FIG. 3.

The antenna may be coupled or directly connected to the circuit of fundamental frequency.

2956. **E. Houghton** [Portholme Aircraft Company]. Wireless Receiving Apparatus. (*British Patent* 162097, January 28th, 1920. Patent accepted April 28th, 1921.)

Valve-receiving apparatus using retroaction between the anode and grid circuits, the grid winding being joined between the tuned receiving circuit and the grid of the valve instead of in series with the tuned circuit.

2957. **J. Scott-Taggart.** Thermionic Valve Circuits. (*British Patent* 152693, July 25th, 1919. Patent accepted December 25th, 1920.)

Relates to the use of two valves having the anode of the first connected to the grid of the second, and the anode of the second connected to the grid of the first. The arrangements are applicable to receivers, amplifiers, oscillation generators, etc.

2958. **E. H. Armstrong.** Wireless Receiving Apparatus. (*British Patent* 147042, July 6th, 1920. Convention date October 29th, 1913. Patent not yet accepted.)

Relates to the Armstrong "feedback" circuit, in which both grid and plate circuits are tuned to the signal frequency, and an inductance (such as the telephones) is included in the common portion of the two circuits so as to provide the retroaction.

2959. **J. Scott-Taggart.** Thermionic Detectors (*British Patent* 162710, December 3rd, 1919. Patent accepted May 3rd, 1921.)

Incoming energy is caused to vary the grid potential of a triode tube by altering the conductivity of a high-resistance body inserted in the grid circuit—such, e.g., as glass maintained at a temperature just below that at which it becomes conducting.

2960. **R. A. Weagant** [Radio Corporation, U.S.A.]. Thermionic Valves. (*British Patent* 146534, July 5th, 1920. Convention date February 24th, 1915. Patent accepted October 5th, 1921.)

For the detection, amplification or generation of oscillations the tuned circuits are coupled together through a Fleming valve. The same connections may be used for both transmission and reception.

2961. **R. A. Weagant** [Radio Corporation, U.S.A.]. Thermionic Valves. (*British Patent* 146535, July 5th, 1920. Convention date April 25th, 1914. Patent accepted October 5th, 1921.)

Connections are given for a three-electrode thermionic valve for receiving spark or C.W. signals.

2962. **R. A. Weagant** [Radio Corporation, U.S.A.]. Thermionic Valves. (*British Patent* 146536, July 5th, 1920. Convention date February 1st, 1916. Patent not yet accepted.)

Relates to circuit connections for a two-electrode Fleming valve receiver.

2963. **Marconi's Wireless Telegraph Co., Ltd.** Thermionic Valves. (*British Patent* 157477, February 14th, 1919. Patent accepted January 27th, 1921.)

A thermionic valve having two control electrodes and two anodes so arranged that the electron stream is deflected to the anodes alternately.

2964. **General Electric Company, U.S.A.** [British Thomson-Houston Company]. Thermionic Detectors. (*British Patent* 163487, February 20th, 1920. Patent accepted May 20th, 1921.)

The detector consists of a thermionic device possessing a substantially linear characteristic

(such as a tube containing two heated filaments as electrodes), and its resistance is periodically varied such as by a magnetic field excited by a local source of alternating current.

2965. **G. A. Mathieu.** Wireless Signalling. (*British Patent* 164900, April 1st, 1920. Patent accepted June 23rd, 1921.)

The filament of a valve amplifier is connected to a point in the inductance of a loop aerial or of an inductance in parallel with or coupled to the aerial. Alternative arrangements are shown in Figs. 4 and 5.

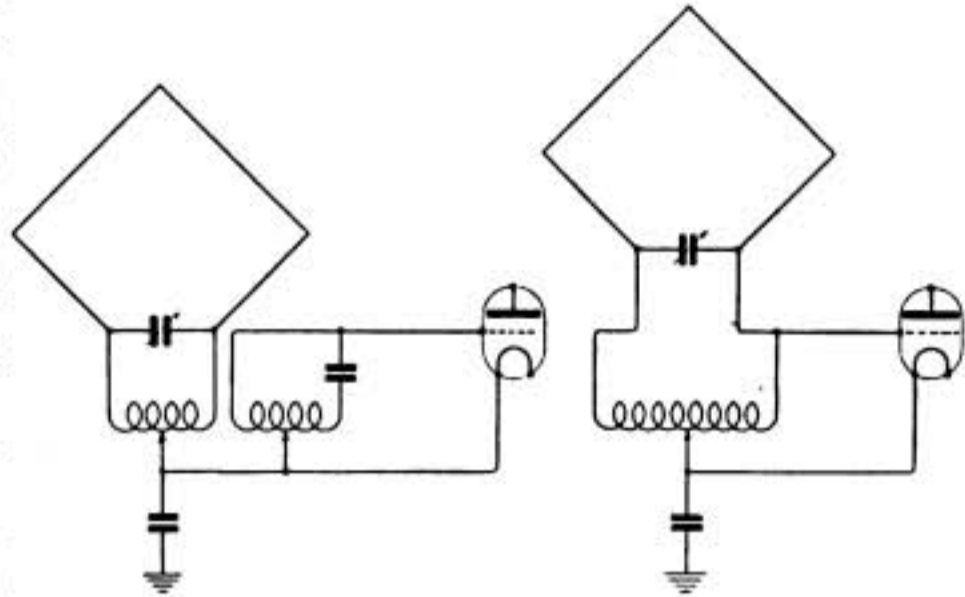

FIG. 4.

FIG. 5.

2966. **Gesellschaft für drahtlose Telegraphie m.b.H.** Relay. (*French Patent* 511244, April 1st, 1915. Published December 20th, 1920.)

The local circuit including the cathode and anode of a valve relay in the receiving system is supplied with an alternating current having a frequency near that of the incoming waves, thus producing beats of audible frequency. The cathode may be heated by an alternating current. (See also the corresponding *British Patents* Nos. 5342/1915 and 7358/1915.)

2967. **E. F. W. Alexanderson.** A Selective Receiver for C.W. Reception. (*Wireless Age*, 8, p. 24, July, 1921.)

Increased selectivity is obtained by arranging the receiving valve to be on the verge of self-oscillation so that the incoming signals when tuned to the same frequency cause local oscillations to be produced. These are arranged to upset the balance of the Wheatstone bridge having three-electrode valves in two of its arms and fed from an acoustic frequency alternating current. The incoming signals cause the bridge to be unbalanced so that the audio frequency current can pass through the telephone receivers connected to the bridge.

2968. **H. de A. Donisthorpe.** A Simple Valve Circuit and the Methods of Grid Potential Control. (*Model Engineer*, 45, pp. 266—267, September 29th, 1921.)

(4) HETERODYNES AND C.W. RECEIVERS.

2969. **J. Scott-Taggart.** Continuous-wave Multi-stage Receiving Circuits. (*Electrician*, 85, pp. 441—442, October 15th, 1920. *Science Abstracts*, 23B, pp. 544—545, Abstract No. 1032, November 30th, 1920—Abstract. *Radioélectricité*, 1, pp. 79D—81D, January, 1921—Abstract. *Technical Review*, 8, p. 238, March 8th, 1921—Abstract.)

2970. **M. Latour.** The Heterodyne Method of Wireless Reception: Its Advantages and its Future. (*Radio Review*, 2, pp. 15—21, January, 1921.)

2971. **E. H. Armstrong.** A New Method for the Reception of Weak Signals at Short Wavelengths. (*Q.S.T.*, 3, pp. 5—9, February, 1920.)

See RADIO REVIEW Abstract No. 1668, April, 1921, for description of the same apparatus.

2972. **A. M. Goldsmith** [Marconi's Wireless Telegraph Co., Ltd.]. Wireless Receiving Apparatus. (*British Patents* 149282 and 149283, July 15th, 1920. Convention date July 28th, 1919. Patents not yet accepted.)

For the reception of C.W. signals it is proposed to modulate the received energy at an acoustic frequency by periodically varying the mutual inductance between the coupling coils of the receiver circuits. This may be effected by rotating between the coupling coils a disc provided with short circuited coils or other similar means of varying the mutual inductance.

2973. **R. A. Weagant** [Marconi's Wireless Telegraph Company]. Wireless Receiving Apparatus. (*British Patent* 161580, April 7th, 1921. Convention date April 14th, 1920. Patent not yet accepted.)

Refers to a heterodyne arrangement in which the frequency of the locally generated oscillations is widely different from that of the incoming signals. An intermediate circuit is tuned to the resulting beat frequency, and serves also to eliminate the frequency of the local oscillations. The beat frequency may be further modulated before reception in the telephones.

2974. A Buzzer Microtelephone for the Reception of Undamped Waves. (*L'Onde Hertzienne*, 1, pp. 71—72, October, 1920.)

In the arrangement described the reaction between the microphone and telephone produces a species of tikker which is used in conjunction with a resonance tube.

2975. **Société Française pour l'Exploitation des procédés Thomson-Houston**. Receiving Heterodyne Arrangement. (*French Patent* 507197, December 9th, 1919. Published September 7th, 1920.) Also **I. Langmuir** [British Thomson-Houston Company]. (*British Patent* 147823, July 9th, 1920. Convention date December 29th, 1913. Patent not yet accepted.)

The received oscillations are conveyed to the grid while oscillations of a slightly different frequency are conveyed to the plate of a three-electrode valve. The beats between the two sets of oscillations are detected by a telephone.

2976. **H. G. Möller**. The Reception of C.W. as a Continuous Current by Means of the Auto-heterodyne. (*Fabrbuch Zeitschrift für drahtlose Telegraphie*, 17, p. 256—287, April, 1921. *Telegraphen- und Fernsprech-Technik*, 10, p. 95, July, 1921. *Science Abstracts*, 24B, pp. 367—368, Abstract No. 761, July 30th, 1921—Abstract. *Radioélectricité*, 1, p. 145D, June, 1921—Abstract.)

If an auto-heterodyne set is accurately tuned to the incoming C.W. signal, there is a range over which it pulls into step with the signal and gives no beats. The oscillatory current is thereby increased as is indicated by the decreased reading on a D.C. ammeter in the anode circuit. This latter can thus be used as an indicator of the signal and is undisturbed by other C.W. signals of another frequency or by spark signals. The instrument is too sluggish to respond to acoustic frequencies. Loose coupling gives sensitiveness and a wide range; tight coupling, a narrow range and great freedom from interference. The paper contains a very elaborate investigation of the phenomenon.

2977. **Von Wysiecki** [E. F. Huth Gesellschaft]. Thermionic Receiving Systems. (*British Patent* 149196, July 12th, 1920. Convention date May 5th, 1919. Patent not yet accepted.)

In order to present radiation for the receiving aerial the last valve alone of the cascade series is used as the local oscillation generator.

2978. **S. Loewe**. Wireless Receiving Apparatus. (*British Patent* 149199, July 12th, 1920. Convention date October 12th, 1918. Patent not yet accepted.)

A rejector circuit consisting of an inductance and a condenser in parallel is connected in the plate circuit of a series of thermionic valves. For heterodyne reception local oscillations are produced in and confined to the last valve in the series. One suggested arrangement is indicated in Fig. 6. D represents the rectifying detector and T the receiving telephone.

2979. **E. F. Huth**. Wireless Receiving Apparatus. (*British Patent* 149208, July 12th, 1920. Convention date April 29th, 1919. Patent not yet accepted.)

The local oscillator in a heterodyne receiving apparatus is connected to the receiving circuit through an intermediate aperiodic circuit with the object of attaining equality of amplitude of the received and the local oscillations.

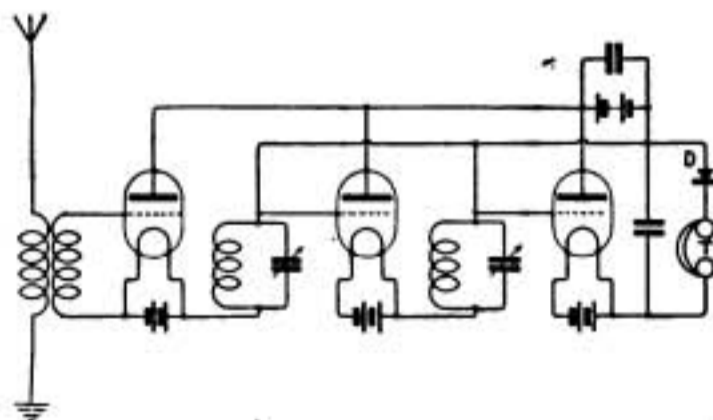

FIG. 6.

2980. **E. F. Huth.** Wireless Receiving Apparatus. (*British Patent* 149209, July 12th, 1920. Convention date December 14th, 1917. Patent not yet accepted.)

Comprises an arrangement of thermionic valves for heterodyne receiving which can readily be converted for transmitting either simple or musically modulated radiation. Switches are arranged for easily effecting the change-over from reception to transmission.

2981. **S. Loewe** [E. F. Huth Gesellschaft]. Thermionic Valve Amplifying Apparatus. (*British Patent* 149217, July 12th, 1920. Convention date June 11th, 1917. Patent not yet accepted.)

In a thermionic amplifier of the type in which the amplified impulses in the anode circuit are retroactively returned to the grid to obtain further amplification, the anode circuit is coupled to an aperiodic circuit of the receiver—such as the untuned output circuit of the rectifier. The highest possible degree of amplification is stated to be obtained in this manner without the valve oscillating.

2982. **Gesellschaft für drahtlose Telegraphie.** Wireless Receiving Apparatus. (*British Patent* 150701, August 30th, 1920. Convention date September 6th, 1919. Patent accepted May 5th, 1921.)

In a thermionic valve receiver incoming oscillations are interrupted at audio frequency by an interrupter inserted either between the antenna and a thermionic valve or between the valve and the telephone receiver.

2983. **General Electric Company, U.S.A.** [**British Thomson-Houston Company**]. Receiving Wireless Signals. (*British Patent* 159603, December 1st, 1919. Patent accepted May 1st, 1921.)

For the reception of C.W. signals without heterodyne or tikker, or of signals having a very low group frequency, the detecting valve is included in one arm of a balanced Wheatstone bridge. The bridge is fed from an acoustic frequency source, and the telephones are joined in the "galvanometer" arm of the bridge.

2984. **Gesellschaft für drahtlose Telegraphie.** Wireless Receiving Apparatus. (*British Patent* 147701, July 8th, 1920. Convention date May 2nd, 1916. Patent not yet accepted.)

In a system for receiving C.W. of frequency n , the received oscillations excite an alternator or E.S. machine having a natural frequency of N . Two frequencies of $N + n$ and $n - N$ are thus produced. These interfere in the detector circuit giving beats of frequency $2N$.

2985. **A. van T. Day.** Wireless Signalling Apparatus. (*British Patent* 148380, July 9th, 1920. Convention date July 17th, 1916. Patent not yet accepted.)

Relates to: (1) Receiving systems using heterodyne reception of the same or different frequency with duplex valve or other detectors; (2) telephony systems in which the local (heterodyne) energy is maintained exactly in synchronism with the received carrier wave by the action of the carrier wave itself; (3) methods of reducing atmospherics in which the receiving aerial is detuned so that the atmospheric produces a beat note of higher frequency than the signal; (4) multiplex working in which one or more messages are sent by varying the phase, and the others by varying the amplitude of the transmitted wave.

2986. **A. K. Macrorie and W. A. Appleton.** Wireless Receiving Apparatus. (*British Patent* 162770, February 2nd, 1920. Patent accepted May 2nd, 1921.)

For receiving C.W. signals a "damping-valve" is coupled to the circuit—such as to the anode circuit of the last valve in a H.F. amplifier—and has its grid controlled by a valve oscillating at an audible frequency so that the amplitude of the received energy is thus varied at an audible frequency.

2987. **A. K. Macrorie and S. H. Long.** Wireless Receiving Apparatus. (*British Patent* 162771, February 2nd, 1920. Patent accepted May 2nd, 1921.)

A valve is arranged to generate low frequency currents and is prevented from oscillating by the application of a suitable potential to its grid. On the receipt of the signal an auxiliary valve alters the grid potential of the low frequency valve and causes it to oscillate at an acoustic frequency.

2988. **R. B. Goldschmidt.** Receiving Apparatus. (*French Patent* 508782, January 20th, 1920. Published October 22nd, 1920.)

The specification describes apparatus for putting the antenna into and out of operative relation with the receiver at a frequency equal to the trains of waves to be received. For transmitting a uniform succession of trains of waves is ensured by the use of a commutator inserted in the primary circuit of the induction coil or connecting the antenna with the oscillation circuit. Multiplex working may be effected by arranging that the commutators at the transmitting and receiving stations serve also as distributors. For further particulars, see *British Patent* 15082/14.

2989. **Gesellschaft für drahtlose Telegraphie.** Wireless Signalling. (*British Patent* 157403, January 10th, 1921. Convention date August 29th, 1919. Patent not yet accepted.)

In a method of receiving continuous waves a thermionic valve is caused to oscillate at a low frequency whilst acting also as a high-frequency amplifier through an independent circuit.

2990. **C. T. Hughes and L. B. Turner.** Wireless Telegraph Receivers. (*British Patent* 157607, November 14th, 1919. Patent accepted January 27th, 1921.)

A receiving system specially suitable for short wave continuous wave reception. A three-electrode valve oscillating at audio-frequency modulates the received signals before rectification.

2991. **Société Française Radioélectrique.** Wireless Telephony. (*British Patent* 147836, July 9th, 1920. Convention date February 24th, 1917. Patent not yet accepted.)

Relates to the use of a heterodyne for receiving wireless telephony, the beat frequency being inaudible and preferably zero.

2992. **Gesellschaft für drahtlose Telegraphie.** Wireless Receiving Apparatus. (*British Patent* 147852, July 9th, 1920. Convention date April 9th, 1914. Patent not yet accepted.)

A heterodyne is coupled to the plate circuit of a valve amplifier.

2993. **Gesellschaft für drahtlose Telegraphie.** Wireless Receiving Apparatus. (*British Patent* 148162, July 9th, 1920. Convention date October 15th, 1915. Patent accepted July 21st, 1921.)

C.W. receiving apparatus comprising a "tikker" arrangement.

2994. **H. J. Round.** Heterodyne Reception. (*Radio Review*, 2, pp. 220—223, April, 1921. *Science Abstracts*, 24B, p. 316, June 30th, 1921—Abstract.)

2995. **J. V. L. Hogan.** The Heterodyne Receiver. (*Electric Journal*, 28, pp. 116—119, April, 1921.)

A general description of heterodyne methods.

2996. **M. C. Batsel.** Continuous Wave Radio Receiver. (*Electric Journal*, 28, pp. 136—141, April, 1921.)

Describes various arrangements of valve receiving amplifying apparatus.

2997. **L. M. E. Clausing.** Reception of 200 Metre Signals by Means of a Loop and Armstrong Super-heterodyne. (*Q.S.T.*, 5, pp. 24—26, August, 1921.)

2998. **J. Scott-Taggart.** Wireless Telegraphy. (*British Patent* 165115, August 18th, 1919. Patent accepted June 30th, 1921.)

An electric discharge device having two or more control electrodes, for use in relays and radio receiving systems, for example, a thermionic valve having a cathode, two grids, and an anode, has input circuits supplied with varying current or potential connected to each of the grids, thus producing a resultant effect on the anode or main supply circuit.

2999. **Mareoni's Wireless Telegraph Co., Ltd.** Receiving Heterodyne Arrangement. (*French Patent* 512781, March 30th, 1920. Published January 31st, 1921.)

The phase of the beat current in a heterodyne receiving system is adjusted by varying the phase of the heterodyne current or of the signalling waves so that the beat current is brought into phase with, or opposition to, a second current of the same frequency. The system may be utilised for cutting out undesired signals by employing two receiving aerials spaced apart to produce phase displacements in the signal currents. (See also *British Patent* 149435 in the name of **H. J. Round.**)

3000. **H. de A. Donisthorpe.** A Continuous Wave Receiver. (*Model Engineer*, 45, pp. 313—314, October 13th, 1921.)

Circuit diagrams are given for various arrangements of C.W. receivers.

3001. **L. R. Felder.** Rectifying A.C. for Vacuum Tubes. (*Radio News*, 3, p. 200, September, 1921.)

(5) RELAYS, RECORDERS AND AUTOMATIC CALLING APPARATUS.

3002. **A. A. Campbell Swinton.** Wireless Telegraphic Printing on the Creed Automatic System. (*Wireless World*, 8, pp. 641—648, December 11th, 1920. *Times*, p. 9, November 17th, 1920. *Elektrotechnische Zeitschrift*, 42, p. 160, February, 1921. *Everyday Science*, 2, pp. 682—684, April, 1921—Abstract. *Radio News*, 2, pp. 600—601, and 640—642, March, 1921—Abstract.)

See RADIO REVIEW, 2, pp. 37—38, January, 1921.

3003. **A. A. C. Swinton.** Wireless Telegraphy and Telephony. (*Journal of the Royal Society of Arts*, 69, pp. 24—36, December 3rd, 1920. *Telephone Engineer*, 24, pp. 13—17, February, 1921—Abstract. *Electrician*, 85, p. 631, November 26th, 1920—Abstract. *Technical Review*, 8, p. 167, February 15th, 1921—Abstract. *Nature*, 106, p. 422, November 25th, 1920—Abstract. *Engineering*, 110, p. 678, November 19th, 1920—Abstract.)

See RADIO REVIEW, 2, pp. 37—38, January, 1921.

3004. **E. H. Eckhardt and J. C. Karcher.** A Chronographic Recorder of Radio Time Signals. (*Journal of the Washington Academy of Sciences*, 11, pp. 303—311, July 19th, 1921. Also *Telegraph and Telephone Age*, 39, p. 175, April 16th, 1921—Abstract. *Physical Review*, 18, pp. 150—151, August, 1921.)

Paper read before the Philosophical Society of Washington, March 26th, 1921, and before the American Physical Society, April, 1921, discusses the general problems of recording wireless signals and describes with diagrams the arrangements developed at the Bureau of Standards. This method utilises a valve receiver acting as a trigger relay, the change in anode current serving to operate the relay magnets. The article concludes with a bibliography of the subject.

3005. **H. Abraham and R. Planiol.** On the Use of Baudot Telegraph Apparatus in Radio Work. (*Comptes Rendus*, 172, pp. 1170—1172, May 9th, 1921. *Revue Scientifique*, 59, p. 283, May 28th, 1921—Abstract. *Journal Télégraphique*, 45, pp. 107—108, June 25th, 1921—Abstract. *Telegraph and Telephone Age*, 39, p. 301, July 1st, 1921. *Science Abstracts*, 24B, p. 362, Abstract No. 746, July 30th, 1921—Abstract. *Genie Civil*, 78, p. 442, May 21st, 1921—Abstract.)

A brief description is given of the apparatus used in some recent tests between Paris and Nogent-le-Rotrou. The transmission from Paris, using not more than 3 amps in a small aerial, was controlled automatically by the Baudot apparatus; while for reception two sharply-tuned circuits were used with a frame aerial, a high-frequency resistance-coupled amplifier, a detector and a low-frequency amplifier. The output from the amplifier operated the Baudot relay directly without the use of any heterodyne. Automatic retransmission over the land lines back to Paris was also accomplished.

3006. **B. S. T. Wallace.** Morse Printing of Wireless Signals. (*Wireless World*, 8, pp. 768—770, February 5th, 1921. *Electrical World*, 77, p. 839, April 9th, 1921—Abstract.)

3007. **R. E. Hall.** Signalling Systems. (*British Patent* 144250, February 2nd, 1920. Convention date May 31st, 1919. Patent accepted April 28th, 1921.)

Deals with a hot wire relay for controlling a recording telegraphic receiver.

3008. A New German Recording Device. (*Radio News*, 2, p. 691, April, 1921.)

Describes an arrangement of amplifier using the supersonic heterodyne principle to obtain sufficient amplification for the operation of the relay by the last valves.

3009. **P. R. Coursey.** Relays and Recorders. (*Wireless World*, 8, pp. 761—763, February 5th, 1921. *Radioélectricité*, 1, p. 113D, April, 1921—Abstract.)

A summary of some of the early patterns of wireless recording apparatus.

3010. **Gesellschaft für drahtlose Telegraphie.** Wireless Recording Apparatus. (*British Patent* 148992, July 12th, 1920. Convention date February 8th, 1916. Patent not yet accepted.)

A direct current relay for a recording device is operated by wireless signals by means of the interposition of a thermionic tube, the grid potential of which is such that without external influence no current flows through the plate circuit. The rectified current from the detector is amplified by a series of valves, the last one of which is designed for larger currents. The grid potential of this last tube is adjusted by a potentiometer so that normally no plate current flows through the relay.

3011. **A. F. Sykes.** Sound Recording Apparatus. (*British Patent* 160223, November 18th, 1919. Patent accepted March 18th, 1921.)

Deals with apparatus for recording sounds on a wax cylinder with electrical means for distorting the wave form to neutralise mechanical resonance and other existing causes of distortion.

3012. **Gesellschaft für drahtlose Telegraphie.** Code Telegraphy. (*British Patent* 147432, July 7th, 1920. Convention date November 9th, 1916. Patent accepted July 14th, 1921. *Engineer*, 132, pp. 205—206, August 19th, 1921—Abstract.)

A recording arrangement in which a thread is utilised in place of the usual tape.

3013. **H. J. J. M. de R. de Bellescize.** Wireless Type-printing Telegraph. (*British Patent* 158556, January 22nd, 1921. Convention date January 22nd, 1920. Patent not yet accepted.)

An adaptation of the Baudot system to wireless working. In order to secure secrecy the impulses that build up a letter are set out from distributor segments chosen in a predetermined irregular fashion.

3014. **R. E. M. Pénot.** Recorder. (*French Patent* 507129, December 6th, 1919. Published September 6th, 1920.)

The invention describes an automatic recorder which may be employed for recording wireless telegraphy signals. The received currents act on the recording apparatus through a distributor, a relay and a regulator.

2. Books.

EXPERIMENTAL WIRELESS STATIONS. By Philip E. Edelman, E.E. (London: *Henry Frowde and Hodder & Stoughton*. New edition, 1920. Pp. x + 392. 7½" × 5". With 167 illustrations. Price 16s. net.)

This book is designed primarily as a guide to the American radio amateur who wishes to build an experimental wireless station that shall be based on a sound design. It is however more than a mere "how-to-make-it" book, as it contains several chapters devoted only to general theory and descriptive matter of the usual text-book type. There are twenty-seven chapters in the present edition, which incorporate the material forming the earlier editions, the supplementary matter appended to the end of the 1916 edition, and much additional matter relating to vacuum tubes, including many circuit diagrams for receiving.

The transmitting section of the book has also been brought up to date by the addition of a short description for building a radiotelephone transmitter.

The general appearance of the book has been much improved in this edition, and the illustrations have been prepared with greater care. There is however still room for further improvement in the printing and setting out of the numerical examples that are given throughout the book. A useful classified list of U.S. radio patents is given at the end of the volume, but this has not been revised beyond 1916, but nevertheless forms a good record of the historical development of the subject.

P. R. C.

HIGH-FREQUENCY APPARATUS. By Thomas S. Curtis. (London: *Page & Co.* 1921. Pp. 269. 7½" × 5". With 150 diagrams. Price not stated.)

While high-frequency currents have their many useful and practical applications, relative to which there is a considerable literature, there is another class of writing which is concerned

more with the spectacular aspect of electrical phenomena at high frequencies, and with the best means of exhibiting such phenomena. The present book, the first English edition of an American work, is another addition to this latter class of literature. It describes first the fundamental characteristics of alternating currents, and then points out the applications of such currents when of high frequency. Subsequent chapters deal with the high-potential transformer, or induction coil; the oscillation condenser; the spark gap; oscillation transformers; induction coil outfits for battery current; kicking-coil apparatus; $\frac{1}{2}$ -kW transformer outfit; quenched gap apparatus; physician's portable apparatus and office equipment; and hot-wire meter construction. Three chapters are devoted to the applications of high-frequency current to plant culture, giving constructional details of experimental apparatus; while the remaining chapters deal with the building and operation of large high-frequency apparatus for stage demonstrations, and also with the construction of a welding transformer as an adjunct to stage entertainments with high-frequency currents.

P. R. C.

Books Received.

RADIO QUESTIONS AND ANSWERS ON GOVERNMENT EXAMINATION FOR RADIO OPERATOR'S LICENCE. By Arthur R. Nilson, Assoc.M.I.R.E. (New York: *McGraw-Hill Book Company, Inc.* London: *McGraw-Hill Publishing Co., Ltd.* 1921. Pp. ix + 86, $7\frac{1}{4}$ in. \times 5 in. With 43 diagrams. Price 5s. net.)

LEXIQUE TECHNIQUE ANGLAIS-FRANÇAIS. By Lieut. G. Malgorn, in collaboration with M. Desmarests. (Paris: *Gautbier-Villars et Cie.* 1920. Pp. xxi + 216. $7\frac{1}{4}$ in. \times 5 in. Price 10 fr. net.)

Correspondence.

"CHOKE CONTROL" MODULATION IN RADIOTELEPHONY.

TO THE EDITOR OF THE "RADIO REVIEW."

SIR,—My attention has recently been directed to British Patent Specification No. 133366 of June 28th, 1918, of the Western Electric Company in which is described the well-known "choke control" method of modulation in radiotelephony. Various authors have wrongly attributed this system to Heising. As a proof thereof, suffice it to quote part of my French Patent No. 21855 of November 30th, 1916* in which this system is described in its most elaborate form and as it was used by the British and American Signalling Corps during the war:—

"In certain wireless telephone diagrams the voltages obtained by the action of the voice on the microphone are amplified by means of thermionic tubes and then impressed on the high-frequency cathode tube generator which energises the antenna. These voltages may be impressed on either the grid or the plate circuit of the generator.

"The object of the present invention is to realise an arrangement whereby a part or the whole of a single source of direct current may be used to energise both the microphone current amplifying tubes and the generator tubes in accordance with the general idea of a common battery put forth in the main patent.

"Figure 1 shows four tubes, 1, 2, 3, 4, the filaments of which are brought to incandescence by battery 5, all the anodes being fed off a common battery 6.

"Tubes 1 and 2 are used to amplify the microphone current. The microphone current originating in the circuit comprising the microphone, 8, and the battery, 9, is communicated to the grid and negative pole of the filament of tube 1 through the transformer, 7. Transformer 10 permits of this current undergoing a second stage of amplification through tube 2. The resulting amplified microphone voltages are introduced in the plate circuit of the parallel-connected high-frequency generating tubes 3 and 4 through the transformer 11.

"The high-frequency generator includes, in accordance with a known diagram which

[* The patent referred to is the fifth addition (21855) to French Patent No. 512295.—ED.]

is only shown by way of example, a primary winding 12, and auxiliary winding 13, connected to the grids and filaments, and a secondary winding 14, which feeds the antenna 15.

"The secondary winding of the transformer 11 should preferably be shunted by a small capacity in order to create a by-path for the high-frequency current without appreciably impairing the low-frequency working.

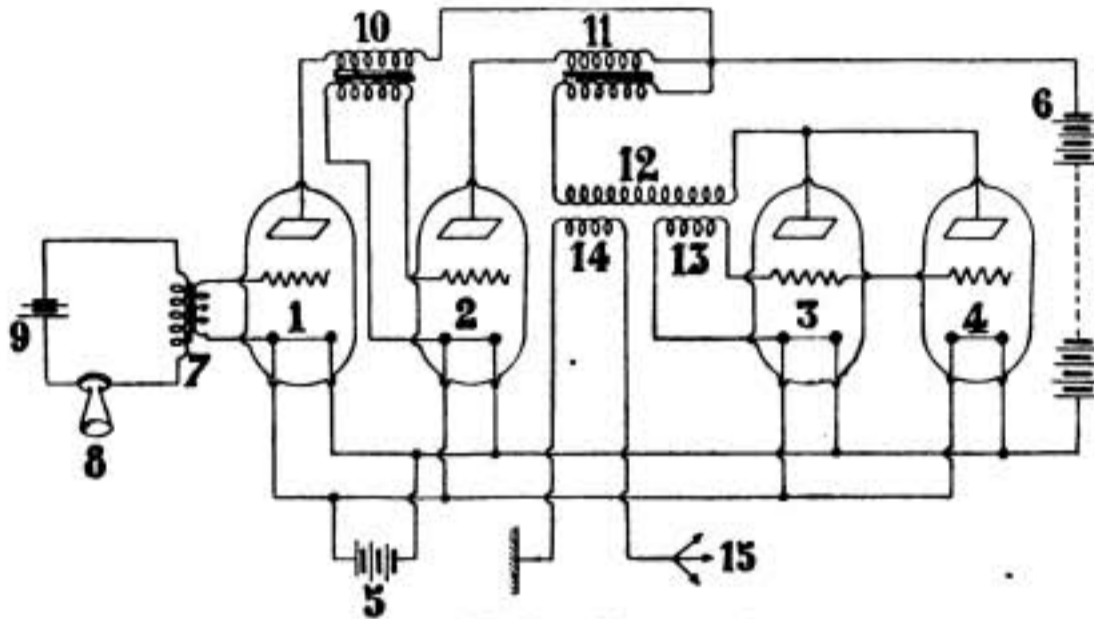

Fig. 1.

Reproduction of Diagram from Patent Specification.

"If the speech-amplifying tube filaments are heated to the same degree as those of the generating tubes, the amplified microphone voltages obtained at transformer 11 may be of the order of that of the battery 6 and consequently it is easily seen that the arrangement described permits of the efficient working of the generating tubes 3 and 4 and this even with a relatively small voltage from battery 6.

"Transformer 11 may amount to an auto-transformer or a mere choke coil. In view of the fact that a relatively important steady current flows through its winding, it will be preferable to leave an air-gap in its magnetic circuit.

"The elements of the battery 9 may economically be constituted by a portion of either the battery 5 or 6."

Trusting the above may serve to dissipate a prevalent error.

MARIUS LATOUR.

Paris,

December 31st, 1921.

OPTIMUM WAVELENGTH.

TO THE EDITOR OF THE "RADIO REVIEW."

SIR,—Mr. Turner in his discussion of the question of optimum wavelength in the October number of the REVIEW appears to neglect a factor which is of primary importance where continuous communication is demanded. This is the change in degree of variability of signal with wavelength and distance. It is of course true that the atmospheric disturbances increase rapidly with the wavelength, which prevents the average reception from following the usual optimum wavelength formula. But, as a matter of fact, the variability in signal decreases even more rapidly with the wavelength than the disturbances increase, so that for great distances the advantages of long waves for continuous communication are even greater than the formula indicates. This fact has been tested in several years of trans-Atlantic observations, and also between Darien and Washington (2,000 miles). In this last case a 4,000 metre wave was found useless for regular day transmission, while waves from 6,000 metres to 12,000

metres gave fairly satisfactory communication except in the season of the worst disturbances.

Of course if fairly regular night work is all that is required, relatively short waves will give the most economical service even over great distances.

L. W. AUSTIN.

U.S. Naval Radio Research Laboratory,
Washington,
January 6th, 1922.

TRANSMISSION OF WIRELESS SIGNALS BETWEEN TOULON AND TAHITI.

TO THE EDITOR OF THE "RADIO REVIEW."

SIR,—The account of the reception experiments on the *Aldebaran*, in the December number of the REVIEW, is full of interesting long-distance data.

The most remarkable fact shown in the curves of the paper is the effect of the Red Sea on the intensity of the signals. The day reception follows our formula fairly well as far as Port Said. Then, as the ship enters the Red Sea, there is a relative increase in observed intensity which becomes an actual upward bend in the curve in the case of the Lyons signals. The high values continue through the Red Sea and also in the Indian Ocean, as though the strip of water between the two desert land areas acts as a guiding conductor for the waves, and its outlet becomes as it were a new source. This phenomenon is well-known in short wave communication, especially with airplanes where a strengthening of signal is always observed when the plane approaches a river extending in the direction of the transmitting station. Such conditions may sometimes produce better transmission over land than even over salt water.

In connection with the *Aldebaran's* observed intensity values, experiments on the apparent direction of Lyons at various points in the Indian Ocean would be of interest.

I must object to the statement that the transmission formula has been verified only up to 3,700 km. As a matter of fact, several thousand measurements, extending over seven years have been taken in our laboratory in Washington on the European stations, especially Nauen (6,600 km), and the mean difference between the average observed and calculated values is hardly more than 30 per cent., while the accuracy of our present method of measurement, by comparison with signals from small currents in a sending antenna of known constants one or two wavelengths away, cannot be questioned. To me the accuracy of the formula for wavelengths of from 12,000 metres to 24,000 metres, and for distances of from 6,000 to 7,000 km is much better established than for 1,000 metre waves at a distance of 1,000 km. I do not feel that Professor Vallauri's observations, extending over only a single period of twenty-four hours, in any way invalidate this conclusion. I am also sorry to see that in the article the formula is given in its old form

$$I_R = 4.25 \frac{I_s h_s h_R}{\lambda d} \epsilon^{-ad/\sqrt{\lambda}}$$

with constant receiving resistance, instead of in its present usual form,

$$I_R = 120\pi \frac{I_s h_1 h_2}{\lambda d R} \epsilon^{-ad/\sqrt{\lambda}}$$

L. W. AUSTIN.

U.S. Naval Radio Research Laboratory,
Washington,
January 6th, 1922.

ERRATA.

Pages 34 and 35. The name of the radio station should be Iwaki.
Page 51, Abstract No. 2933. For F. W. B. Gill read E. W. B. Gill.