

RADIO & ELECTRONICS CONSTRUCTOR

JANUARY 1978
Volume 31 No. 5

Published Monthly (1st of Month)
First Published 1947

Incorporating The Radio Amateur

Editorial and Advertising Offices
57 MAIDA VALE LONDON W9 1SN

Telephone 01-286 6141 Telegrams
Databux, London

© Data Publications Ltd., 1977. Contents may only be reproduced after obtaining prior permission from the Editor. Short abstracts or references are allowable provided acknowledgement of source is given.

Annual Subscription: £6.50 (U.S.A. and Canada \$12.00) including postage. Remittances should be made payable to "Data Publications Ltd". Overseas readers please pay by cheque or International Money Order.

Technical Queries. We regret that we are unable to answer queries other than those arising from articles appearing in this magazine nor can we advise on modifications to equipment described. We regret that such queries cannot be answered over the telephone; they must be submitted in writing and accompanied by a stamped addressed envelope for reply.

Correspondence should be addressed to the Editor, Advertising Manager, Subscription Manager or the Publishers as appropriate.

Opinions expressed by contributors are not necessarily those of the Editor or proprietors.

Production.—Web Offset.

PHOTOFLASH SLAVE UNIT by A. P. Roberts	268
NEWS AND COMMENT	272
SEQUENCE GENERATOR — An unusual design incorporating 2 I.C.'s (Special Series Blob-A-Job No. 7) by I. R. Sinclair	274
TWO-STEP TIME SWITCH (Suggested Circuit) by G. A. French	279
TRADE NEWS	281
TV ANTI-THEFT DEVICE by S. R. Hewling	282
SHORT WAVE NEWS — For DX Listeners by Frank A. Baldwin	284
CHECKING ELECTROLYTIC CAPACITORS by R. V. Smithson	286
THE 'DUETTE' STEREO AMPLIFIER — Two 2-watt outputs from a single chip by R. A. Penfold	288
HISS FROM THE ACTIVE SUN by Ron Ham	297
VOLTAGE CONTROLLED OSCILLATOR by R. Webber	299
SIGNAL CARRYING GLASS FIBRE by Michael Lorant	301
VOLTAGE MULTIPLIER by F. Bowden	303
EMITTER ENIGMA by H. Floyd	304
RADIO TOPICS by Recorder	306
IN YOUR WORKSHOP—VERTICAL TIMEBASE SYNCHRONISATION	308
ELECTRONICS DATA No. 29 (For the Beginner — Half-Wave Rectifier Ratings)	iii

Published in Great Britain by the Proprietors and Publishers, Data Publications Ltd, 57 Maida Vale, London W9 1SN

The *Radio & Electronics Constructor* is printed by Swale Press Ltd.

THE FEBRUARY ISSUE WILL BE
PUBLISHED ON 2nd JANUARY

TRADE COMPONENTS

JUST A FEW BARGAINS ARE LISTED - SEND STAMPED ADDRESSED ENVELOPE FOR A QUOTE ON OTHER REQUIREMENTS. PAY A VISIT. OVER 90% OF STOCK BELOW WHOLESALE PRICE. ALL PRICES INCLUDE THE ADDITIONAL DISCOUNT IN LIEU OF GUARANTEE. MINIMUM ORDER GOODS VALUE £1.00.

Goods sent at customer's risk, unless sufficient payment for registration (1st class letter post) or compensation fee (parcel post) included.

VALVE BASES	
Printed circuit B9A-B7G	5p
Chassis B7-B7G	9p
Shrouded chassis B7G-B8A	10p
B12A tube	10p

Speaker 6" x 4" 5 ohm ideal for car radio £1.00

TAG STRIP - 6 way 3p	5 x 50pF or 2 x 220pF
9 way 5p Single 1p	trimmers
	20p

BOXES - Grey polystyrene 61 x 112 x 31mm, top secured by 4 self tapping screws 32½p

Clear perspex sliding lid, 46 x 39 x 24mm 10p

ABS, ribbed inside 5mm centres for P.C.B., brass corner inserts, screw down lid, 50 x 100 x 25mm orange 48p; 80 x 150 x 50mm black 70p; 109 x 185 x 60mm black £1.10

Used 999 ALARF. UNIT. 12 volt includes loop cassette tape player, 2 x d.p.t.d., 1 x 4 p.d.t. miniature relay. Reed relay, solenoid, 35 marked semiconductors, caps, resistors, pots, terminal strip etc.

£2.00 plus £1.40 p&p

SWITCHES		
Pole	Way	Type
1	2	Sub. Min. Slide
6	2	Slide
2	1	Rotary Mains
2	1 (or 1p 2W)	Micro with roller
2	3	Miniature Slide
1	2	Toggle

S.P.S.T. 10 amp 240v. white rocker switch with neon. 1" square flush panel fitting 30p

S.P.S.T. dot 13 amp, oblong, push-fit, rocker 15p

Sidleen/AFA Very High Security barrel Key Switch. 2 tubular keys £1.50

AUDIO LEADS	
3 pin din to open end, 1½yd, twin screened	35p
Twin phono—open end, 4ft, twin screened	35p
3 pole jack plug to tag ends, 4 ft.	35p

COMPUTER & AUDIO BOARDS/ASSEMBLIES VARYING CONTENTS INCLUDE ZENER, GOLD BOND, SILICON, GERMANIUM, LOW AND HIGH POWER TRANSISTORS AND DIODES, HI STAB RESISTORS, CAPACITORS, ELECTROLYTICS, TRIMPOTS, POT CORES, CHOKES ETC.

3lb for 85p + £1.00 post and packing
7lb for £1.95 + £1.40 post and packing

1k horizontal preset with knob	3p	3" Tape Spools	3p
		1" Terry Clips	4p
		12 Volt Solenoid	30p

TV KNOB
Dark grey plastic for recessed shaft (quarter inch) with free shaft extension 5p

ENM Ltd. cased 7-digit counter 2½ x 1½ x 1½" approx. 12V d.c. (48 a.c.) or mains 75p

ZM1162A INDICATOR TUBE
0-9 Inline End View. Rectangular Envelope 170V 2.5M/A £1

REGULATED TAPE MOTOR
9v d.c. nominal approx 1½" diameter 60p

3.5mm metal stereo plug 20p

Ferric Chloride, Anhydrous mil. spec. 1lb bag 40p

Miniature 0 to 5mA d.c. meter approx. ¾" diameter	£1
RS Yellow Wander Plug Box of 12	25p
18 SWG multicore solder	2½p foot
RS 20 way miniature ribbon cable. 25 metre roll (normal trade £19.60)	£7.00 p&p 86p

Car type panel lock and key 50p
18 volt 4 amp charger, bridge rectifier 79p
GC10/4B £3.00

Aluminium Knobs for ¼" shaft. Approx. 5/8" x 7/8" with indicator Pack of 5. 50p

Aluminium Knobs for ¼" shaft. Approx. 5/8" x 7/8" with indicator Pack of 5. 50p

RESISTORS
¼-½ watt 1p
1 watt 2p
Up to 15 watt wire wound 8p
1 or 2% five times price.
Cinch 8 way std 0.15 pitch edge connector 20p

Diode Equivalent Book, 172 pages, AA111 to ZY200, 1N34 to 1S3200, also outline and connection data. £1.50 NO VAT

POTS
Log or Lin, single or dual, switched carbon or wire-wound, rotary or slider. All types 20p
1.5m Edgetype 3p

Skeleton Presets
Slider, horizontal or vertical standard or submin. 6p

THERMISTORS
VA1008, VA1034, VA1039, VA1040, VA1055, VA1066, VA1082, VA1100 } 10p
VA1077, VA1005. } 15p

RELAYS
12 volt S.P.C.O. octal mercury wetted high speed 50p
P.O. 3000 type, 1,000 OHM coil, 4 pole c/o 50p
Mains or 12v d.p.c.o. heavy duty octal 80p

OUTPUT TRANSFORMERS
700 ohm 11-31 volt miniature sealed d.p.d.t. 80p

OUTPUT TRANSFORMERS
Sub-miniature Transistor Type Valve type. 25p 40p

OUTPUT TRANSFORMERS
Sub-miniature Transistor Type Valve type. 25p 40p

OUTPUT TRANSFORMERS
Sub-miniature Transistor Type Valve type. 25p 40p

OUTPUT TRANSFORMERS
Sub-miniature Transistor Type Valve type. 25p 40p

OUTPUT TRANSFORMERS
Sub-miniature Transistor Type Valve type. 25p 40p

JAP 4 gang min. sealed tuning condensers 30p

ELECTROLYTICS MFD/VOLT. Many others in stock 70- 200- 300- 450- Up to 10V 25V 50V 75V 100V 250V 350V 500V MFD

10	4p	5p	6p	8p	10p	12p	16p	20p
25	4p	5p	6p	8p	10p	15p	18p	20p
50	4p	5p	6p	9p	13p	18p	25p	—
100	5p	6p	10p	12p	19p	20p	—	—
250	9p	10p	11p	17p	28p	—	85p	£1
500	10p	11p	17p	24p	45p	—	—	—
1000	13p	22p	40p	75p	—	£1.50	—	—
2000	23p	37p	45p	—	—	—	—	—

As total values are too numerous to list, use this price guide to work out your actual requirements
8/20, 10/20, 12/20, 22/50 Tubular tantalum 20p each
16-32/275V. 100-100/150V. 100-100/275V 30p;
50-50/385V. 12,000/12V. 32-32-50/300V. 20-20-20/350V 60p; 700 mfd/200V £1.00; 100-100-100-150-150/320V £2.00.

RS 100-0-100 micro. amp null indicator Approx. 2" x 3/4" x 3/4" £1.50

INDICATORS
Bulgin D676 red, takes M.E.S. bulb 30p
12 volt or Mains neon, red pushfit 18p
R.S. Scale Print, pressure transfer sheet .10p

CAPACITOR GUIDE - maximum 500V
Up to .01 ceramic 3p. Up to .01 poly 4p. .013 up to .1 poly etc. 5p. .12 up to .68 poly etc. 6p. Silver mica up to 360pF 8p, then to 2.200pF 11p, then to .01 mfd 18p.
8p. .1/600; 12p. .01/1000, 8/20. .1/900, .22/900, 4/16. .25/250 AC (600vDC) 40p.
5/150, 10/150, 40/150.

Many others and high voltage in stock.

FORDYCE DELAY UNIT
240 volt A.C./D.C. Will hold relay, etc., for approx. 15 secs after power off. Ideal for alarm circuits, etc. £1

CONNECTOR STRIP
Belling Lee L1469, 4 way polythene. 6p each
1½ glass fuses 250 ma or 3 amp (box of 12) 12p
Bulgin, 5mm Jack plug and switched socket (pair) 30p

Reed Switch 28mm. body length 9p

Aluminium circuit tape, 1/8" x 36 yards—self adhesive. For window alarms, circuits, etc. 60p

MAINS DROPPERS
66+66+158 ohm, 66+66+137 ohm
17+14+6 ohm, 266+14+193 ohm 10p
285+575+148+35 ohm } 10p
25+35+97+59+30 ohm }

5½" x 2½" Speaker, ex-equipment 3 ohm 30p
2 Amp Suppression Choke 8p

3 x 2½ x 1½" } PAXOLINE 4p
4½ x 1½ x 1½" } 1p

PCV or metal clip on MES bulb Holder 4p

VALVE RETAINER CLIP, adjustable 2p

OUTPUT TRANSFORMERS
Sub-miniature Transistor Type Valve type. 25p 40p

OUTPUT TRANSFORMERS
Sub-miniature Transistor Type Valve type. 25p 40p

OUTPUT TRANSFORMERS
Sub-miniature Transistor Type Valve type. 25p 40p

STYLII 15p
ER5SB/5MX/HC1/HC2/ER2. Compact X2/XC/SX. Garrard GCM21T/22T/GKM24T/GKS25/GP59. B.S.R. C1/FX1M/ST3/CS80/TC8/OP and T, and many other sapphire types. Send sample required with payment and s.a.e if in doubt.

RS neg. volt regulator T03, 306-099 (equiv. MPC900) 10A, 100 watt 4-30 volt. Adjustable short circuit protection. Normally £12.50. £6.00

Digital count unit. Counts in steps of 1, 2, 5 or 10 with total limit switch (2 x D.I.L. BCD), reed relay remote output, Mains power supply, relay and delay unit. UNUSED. Displays on 2 Minitron. 7 segments sold separately. £4.00 plus £1.00 p&p

Crouzet 30-minute timer-programmer, multi-variable contacts £6.00 plus £1.00 p&p

ACOS DUST JOCKEY record Automatic cleaner £1.00

KEY EDIT and display boards with up to 132* 12V bulbs, 38 d.t.l. and t.t.l. i.c.s and other components. (*A few bulbs may be broken). £2.00 plus 75p p&p

Wood cased 8-12V buzzer £1.50 plus 80p p&p

McMurdo 8 or 12 or 18-way plug and socket, ex-equipment 36p

THE RADIO SHACK

161 ST. JOHNS HILL, BATTERSEA, LONDON S.W.11
Open 10 a.m. till 7 p.m. Tuesday to Saturday. VAT receipts on request.
Terms: Payment with order Telephone: 01-223 5016

SEMICONDUCTORS

Full spec. marked by Mullard, etc. Many other types in stock

ZN414 Radio Chip £1.20

AC128/176	15p
ACY28	19p
AF116	16p
AF124/6/7	25p
AF139	20p
AF178/80/81	30p
AF239	30p
ASV27/73	30p
BC107/8/9 + A/B/C	6p
BC147/8/9 + A/B/C/S	6p
BC157/8/9 + A/B/C	6p
BC178A/B, 179B	12p
BC184C/LC	9p
BC186/7	20p
BC213L/214B	10p
BC261B	8p
BC327/8, 337/8	8p
BC547/8/8A/8C	10p
BC556/7/8/9	9p
BCX32/36	12p

BCY40	50p
BCY70/1/2	12p
BCZ11	28p
BD113	50p
BD115/6	31p
BD131/2/3	35p
BD135/6/7/9	30p
BD140/142	30p
BD201/2/3/4	80p
BD232/4/5/8	49p
BDX77	£1
BD437	50p
BF115/167/173	15p
BF178/9	20p
BF180/1/2/3/4/5	15p
BF194/5/6/7	6p
BF194A, 195C	6p
BF200, 258, 324	20p
BF202/3	30p
BF336	27p
BFS28 Dual Mosfet	£1
BFW10/11 F.E.T.	40p

BFW30	£1
BFW57/58	17p
BFX12/29/30	20p
BFX84/88/89	17p
BFY52	13p
BFY90	50p
BR101	30p
BR39/56	26p
BSV64	30p
BSV79/80 F.E.T.s	80p
BSV81 Mosfet	90p
BSX20/21	14p
BSY40	27p
BSY95A	12p
BU204+Mount Kit	£1.80
CV7042 (OC41/44 ASY63)	5p
GET111	40p
ON222	20p
TIP30/3055	45p
TIS88A F.E.T.	23p
ZTX300/341	7p
2N393 (MA393)	30p
2N458A	50p
27706A	15p
2N929	26p
2N987	40p
2N1507/2219	40p
2N2401	30p
2N2412	70p

2N2483	23p
2N2904/5/6/7/7A	15p
2N3053	14p
2N3055 R.C.A.	50p
2N3704	8p
2N3133	20p
2N3553	50p
2N4037	34p
2N5036 (Plastic 2N3055)	30p
2SA141/2/360	31p
2SB135/6/457	20p
40250 (B.N.3054)	30p

OTHER DIODES

1N916	6p
1N4148	3p
BA145	14p
Centercel	24p
BZY61/BA148	20p
BB103/110 Varicap	10p
BB113 Triple Varicap	37p
BA182	13p
OA5/7/10	15p
BZY88 Up to 33 volt	8p
BZX61 11 volt	15p
BR100 Diac	15p

NEW B.N.A. VALVES

EB91	34p
ECL80	34p
PCC84	34p
6SN7	50p
6AT6	50p
EZ81	40p

TRANSFORMER
Ferromag C core. Screen-95-105-115-125-200-220-240v
Input: output 17v 1A x 2 + 24-0-24v 1.04A + 2v
1mA. These current ratings can be safely exceeded by 50%. £3.50 + £1.00 p&p.

WOODS 240V A.C.
Approx. 2,500 r.p.m. continuous rated 5 or 6in. FAN (ex-computer)
£3.60 plus £1 p&p

INTEGRATED CIRCUITS

TBA920	£3.00
TAA700	£2.00
TBA800	£1.00
741 8 pin d.i.l. op.	24p
SN76013N	£1.20
TAD100 AMRF	£1
CA3001 R.F. Amp	50p
CD4013 CMOS	36p
TAA300 1wt Amp	£1
TAA550 Y or G	22p
TAA263 Amp	85p
7400	10p
7402/4/10/20/30	14p
7414	56p
7438/74/86	24p
7483	69p
LM300, 2-20 volt	£1
74154	90p
TBA550Q	£1.50

THYRISTORS

1 240 BTX18-200	30p
1 400 BTX18-300	35p
1 240 BTX30-200	30p
15 500 BT107	£1
6.5 500 BT101-500R	90p
6.5 500 BT109-500R	£1.00
20 600 BTW92-600RM	£3.00
15 800 BTX95-800R Pulse Modulated	£8.00
30 1000 28T10 (Less Nut)	£3.00

Greenpar 50 ohm BNC line plug, round or flanged chassis socket or t.n.c. or u.h.f. plug, all 50p each

BRIDGE RECTIFIERS

Amp	Volt	
1	1,600	BYX10 30p
1	140	OSH01-200 26p
1.4	42	BY164 40p
0.6	110	EC433 6p
5	400	Texas 90p
2 1/2	100	I.R. 40p

RECTIFIERS

Amp	Volt	
1	4/6/800	5p
1	1250	5p
1	1,500	18 1/2 p
1.5	100	7p
1.5	400	8p
1.5	1,250	14p
2	30	10p
2	300	20p
2.5	300	40p
2.5	600	45p
2.5	900	50p
2.5	1,200	55p
2.5	300	26p
3	600	35p
3	900	40p
3	1,200	52p
3	300	40p
6	600	50p
6	900	60p
6	1,200	80p
10	150	35p
10	300	45p
10	500	55p
10	300	30p
10	600	65p
10	900	80p
10	1,200	95p
15	300	£1.00
15	400	£1.50
15	500	£1.75
15	600	£2.00
25	200	60p
40	300	£1.75
40	1,200	£2.50
1.25	1,250	40p

OPTO ELECTRONICS

Diodes	Photo transistor
TIL209 Red 12p	BPX29 80p
BPX40 50p	OCF71 45p
BPX42 80p	
BPY10 80p	
(VOLIAC)	
BPY68 } 80p	BIG L.E.D. 0.2" 2v 50mA max. 14p
BPY69 } 80p	YELLOW 14p
BPY77 } 80p	RED 14p

PHOTO SILICON CONTROLLED SWITCH BPX66 PNP 10 amp £1.00

3" red 7 segment L.E.D. 14 D.I.L. 0-9+D.P. display 1.9v 10mA segment, common anode 75p £2.00

RS 0.6in green Minitron 0.3in 3015F filament £1.10

CQY11B L.E.D. Infra red transmitter £1 One fifth of trade

Plastic, Transistor or Diode Holder 1p

Transistor or Diode Pad 1p

Holders or pads 50p per 100

Philips Iron Thermostat 15p

MoMurdo PP108 8 way edge plug 10p

Multicore Solder 1/2 Kg. 20 s.w.g. £4.00 p&p 65p

New unmarked, or marked amp lead ex new equipment

ACV17-20	8p	OC200-5	20p
ASZ20	8p	TIC44	24p
ASZ21	30p	2G240	£1
BC186	11p	2G302	5p
BCY30 34	8p	2G401	5p
BCY70/1/2	8p	2N711	25p
BY126/7	4p	2N2926	4p
HG1005	10p	2N598/9	6p
HG5009	3p	2N1091	8p
HG5079	3p	2N1302	8p
L78/9	3p	2N1907	£1
M3	10p	Germ. diode	1p
OA81	3p	GET120 (AC128 in 1" sq. heat sink	15p
OA47	3p	GET872	12p
OA200-2	3p	2S3230	30p
OC23	20p		

KLAXON 12-24v 2-tone transistorized Alarm Sounder. Note, pitch and duration variable. Weatherproof alloy case. £10.00 p&p £1.30

TIE CLIPS
Nylon self locking, 3 1/2" 2p

PAPER BLOCK CONDENSER

0.25MFD	800 volt	60p
1MFD	250 volt	30p
1MFD	400 volt	40p

I.C. extraction and insertion tool 42p

CHASSIS SOCKETS
Car Aerial 9p, Coax 6p, 5 pin 180° 9p, 5 or 6 pin 240° din 6p, speaker din switched 10p, 3.5 mm switched 5p, stereo 1/2" jack enclosed 15p.

BARGAIN CAPS

2500 mfd.	40v 30p
1 mfd.	350/500v 1 1/2 p
1 mfd.	1500v .2p
10000 mfd.	15v 12p
6800 mfd.	10v 6p
32+32 mfd.	275v 8p
16+32 mfd.	350v 12p
8+8 mfd.	350v 8p
1 mfd. non-polar	350v 3p
25000 mfd.	25v 20p
12000 mfd.	12v 12p

G.E.C. 5% Hi-stab capacitors .013 .056 .061 .066 .069 .075 .08 .089 2p each

NICAD Rechargeable Batteries, 12 Volt Type A
1" dia. x 2 1/2". 10 hours at 150mA. £3.00

Type B
Storno Flat Pack. 500mA 5" x 2" x 1 1/2" £1.20

ENAM. COPPER WIRE

SWG.	PER YD.
24	3p
26 to 42	2.5p

GARRARD
GCS23T Crystal Stereo Cartridge 95p
Mono (Stereo compatible), Ceramic or crystal 75p

HANDLES
Rigid light blue nylon 6 1/2" with secret fitting screws 5p

Belling Lee white plastic surface coax outlet box 20p

Miniature Axial Lead Ferrite Choke formers 2p

RS 10 Turn Pot 1% 250, 500 Ω, 1K, 50K £1.50

Copper coated board 10" x 9" approx 35p

Geared Knob 8-1 ratio 1 1/2" diam, black 70p

KLIPFON 25A 440v TERMINAL BLOCKS professional leaf spring clamp, strip of 12 for 15p or twin with clip-over cover 7p

Lamp control panels with 5A mains triac, heat sink, 2 Multi-turn trim pots, cermet pot, 4 x 1A diodes, 9 x 1N914 neon indicator, 11 popular transistors, Hi-stab resistors, capacitors, etc. £1.00 p&p 45p

Mullard 12-0-12V, 1.4A stabilized, regulated, power supply. Approx. 8 1/2" x 4 1/2" x 4 1/2" with handbook. £15.00 p&p £1.30

POSTAL ORDERS means quicker service — unless a fee is paid for special clearance it is 8 days to ensure cheques are not returned 'unpaid'. Postal order poundage charge is offset by it now costing up to 16p bank charges on every cheque written out.

SMALL ORDERS, ENCLOSE SUITABLE STAMPED ADDRESSED ENVELOPE
LARGE ORDERS, ADD SUFFICIENT FOR POSTAGE, PACKING, INSURANCE, ETC.
TOTAL GOODS PLUS CARRIAGE, ADD V.A.T.

MAIL ORDER CUSTOMERS ONLY ADD 8% VAT-I PAY BALANCE ON 12 1/2% ITEMS
ALL ENQUIRIES, ETC., MUST BE ACCOMPANIED BY A STAMPED ADDRESSED ENVELOPE

NEW for electronic design engineers!

FIX-PRINT for printed circuits

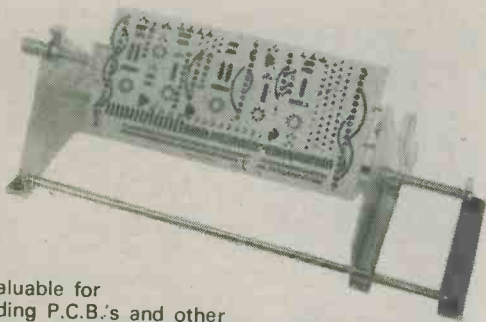

Invaluable for holding P.C.B.'s and other panels when inserting and soldering components. Can be adjusted to suit work up to 280mm, rotating to gain access to reverse side and locks in any position. All metal.

Price **£10** inc. VAT. p&p **£1**

Write or phone for full details

S2 Drill Stand



Robust, all metal with ample throat dimensions. Adjustable height cantilever with lever actuated feed. Spring return. Will accept both P1 & P2 drills

Price **£18.50** inc. VAT. p&p **106p**
P2 Drill **£18.50**. p&p **86p**

S1 Drill Stand

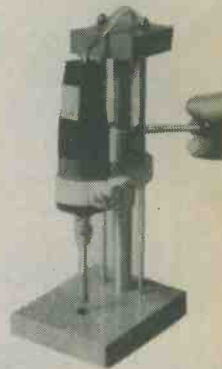

Constructed to take the popular P1 drill and ensure a high degree of accuracy in all types of electrical precision work.

Price **£5.13** inc. VAT. p&p **38p**
P1 Drill **£9.67**. p&p **38p**



PRECISION PETITE LTD

119a HIGH STREET TEDDINGTON MIDDLESEX TW11 8HG

TEL: 01-977 0878

Electronics for nuts...

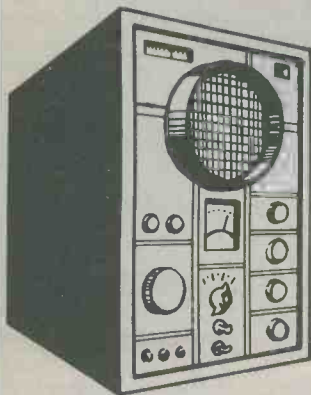

We take you step by step through all the fundamentals of electronics and show you how easily the subject can be mastered using our unique Lerna-Kit course.

- (1) Build an oscilloscope.
- (2) Read, draw and understand circuit diagrams.
- (3) Carry out over 40 experiments on basic electronic circuits and see how they work.

Electronics for hams.

Learn how to become a radio-amateur in contact with the whole world. We give skilled preparation for the G.P.O. licence.

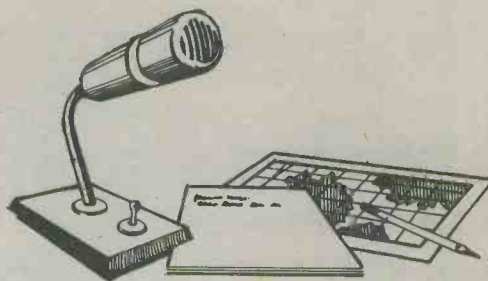

Free!

Brochure without obligation to:

British National Radio & Electronic School

P.O. Box 156, Jersey, Channel Islands.

NAME _____

ADDRESS _____

REC1

Block caps please



Half Price *MR. BLOBS* Christmas Offer

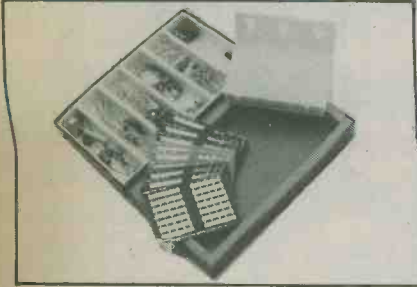

S-DECNOLOGY

Build all the projects on the S-DeC

The perfect kit for beginners, students, professionals and all users of discrete components. This S-DeC-K-IT contains 1 S-DeC + control panel, 9 Blob-Boards, 20 double ended Leads + Instruction book S-DeC-K-IT complete in ABS box, with component tray.

Normally £6.38
HALF PRICE OFFER £3.19
+ £1.00 post and VAT

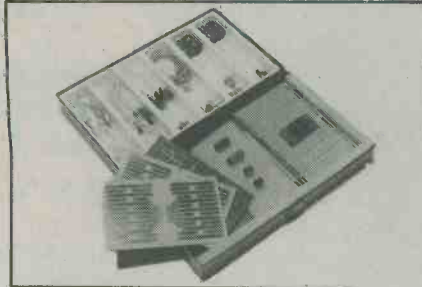

T-DECNOLOGY

Build projects using ICs on your T DeC

This De-K-IT contains 1 T-DeC + control panel + 1 · 16 DIL Carrier + 4 Blob-Boards + components + Circuit Diagrams and step by step instructions to build Burglar Alarm Sound Fuzz Circuit, SR Latch, and Two Tone Siren Complete Kit with Components.

Normally £13.00
HALF PRICE OFFER £6.50 +
£1.20 post & VAT

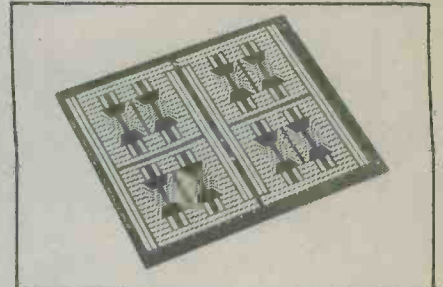

BLOB BOARD CHRISTMAS PACK

Includes
81C for doing Digital Electronics by Experiment
5D for doing S DeCnology
8D for doing Blob-a-Job

Normally £3.00
HALF PRICE OFFER £1.50 +
40p post and VAT

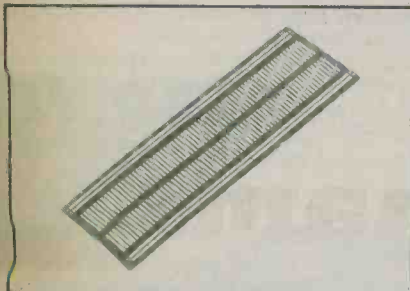

BRED-CIRCUIT BOARD

Combines versatility of Breadboard with usefulness of Blob-Board

BCB2 board size 6" x 2" with 5 · 16 DIL Sockets
Pack of 3 boards with 15 sockets normally £3.84
ONLY £1.92 post & VAT

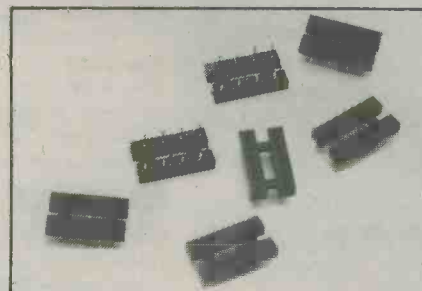

SOCKETS

16 DIL IC Sockets with stepped legs

Normally 20p each
Pack of 20 for only £2.00 + 35p
Post and VAT

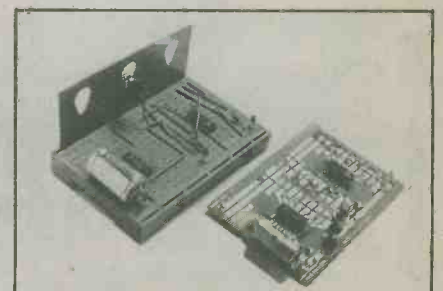

I.C. BREADBOARD

U DeC B Breadboard + 21 2 IC Blob Boards

Normally, £14.00
HALF PRICE OFFER £7.00 +
£1.30 post & VAT



TO MR. BLOB, P. B. Electronics (Scotland) Ltd., 9, Radwinter Road, Saffron Walden, Essex, CB11 3HU.

..... S-DeC-K-ITs at £3.19 each +
£1.00 post & VAT

..... T-DeC-K-ITs at £6.50 each +
£1.20 post & VAT

..... Blob Board packs at £1.50
each + 40p post & VAT

..... Bred Circuit Board + Socket
packs at £1.92 each + 50p post & VAT

..... Pack of 20 sockets at £2.00
+ 35p post & VAT

..... U DeC B + 21 off 2 IC Blob
Boards at £7.00 each + £1.30 post &
VAT

BI-PAK

High quality audio eq

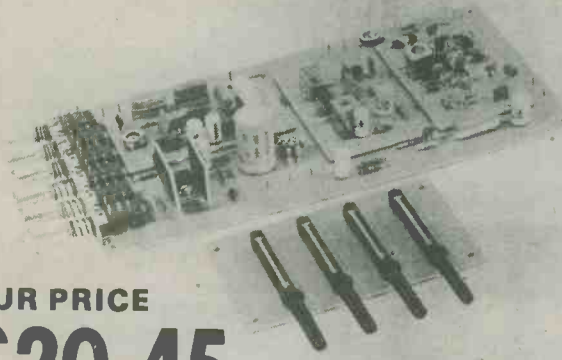

OUR PRICE
£20.45

The 450 Tuner provides instant program selection at the touch of a button ensuring accurate tuning of 4 pre-selected stations, any of which may be altered as often as you choose, by simply changing the settings of the pre-set controls.

Used with your existing audio equipment or with the BI-KITS STEREO 30 or the MK60 Kit etc. Alternatively the PS12 can be used if no suitable supply is available, together with the Transformer T461.

The S450 is supplied fully built, tested and aligned. The unit is easily installed using the simple instructions supplied.

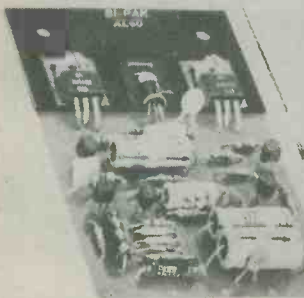

AL 60
VAT ADD 12½%

25 Watts (RMS)

- Max Heat Sink temp 90C.
- Frequency response 20Hz to 100kHz
- Distortion better than 0.1 at 1kHz
- Supply voltage 15-50v.
- Thermal Feedback
- Latest Design Improvements
- Load - 3, 4, 5 or 16ohms.
- Signal to noise ratio 80db
- Overall size 63mm. 105mm. 13mm.

Especially designed to a strict specification. Only the finest components have been used and the latest solid-state circuitry incorporated in this powerful little amplifier which should satisfy the most critical A.F. enthusiast.

£4.35

Stabilised Power Supply Type SPM80

SPM80 is especially designed to power 2 of the AL60 Amplifiers, up to 15 watts (r.m.s.) per channel simultaneously. With the addition of the Mains Transformer BMT80, the unit will provide outputs of up to 1.5A at 35V. Size: 63mm. 105mm. 30mm. Incorporating short circuit protection.

Input Voltage: 33-40 V.A.C.
Output Voltage: 33V D.C. Ndminal
Output Current: 10mA-1.5 amps
Overload Current: 1.7 amps approx.
Dimensions:

105mm x 63mm x 30mm

Transformer BMT80:
£5.40 + 86p postage

£3.75

NEW PUSH-BUTTON STEREO FM TUNER

Fitted with Phase Lock-loop Decoder

- ☆ FET Input Stage
- ☆ VARI-CAP diode tuning
- ☆ Switched AFC
- ☆ Multi turn pre-sets
- ☆ LED Stereo Indicator

Typical Specification:
Sensitivity 3µ volts
Stereo separation 30db
Supply required 20-30v at 90 Ma max.

STEREO PRE-AMPLIFIER PA 100



A top quality stereo pre-amplifier and tone control unit. The six push-button selector switch provides a choice of inputs together with two really effective filters for high and low frequencies, plus tape output.

3. Magnetic P.U. 3mV into 50K ohms

P.U. Input equalises to R1AA curve within 1dB from 20Hz to 20KHz. Supply - 20 - 35V at 20mA.

Dimensions:

299mm x 89mm x 35mm

Frequency response + 1dB
20Hz-20KHz

Sensitivity of inputs:

1. Tape input 100mV into 100K ohms
2. Radio Tuner 100mV into 100K ohms

£13.75

P.&P. 45p

MK60 AUDIO KIT: Comprising: 2 x AL60, 1 x SPM80, 1 x PA100, 1 front panel and knobs. 1 Kit of parts to include on/off switch, neon indicator, stereo headphone sockets plus instruction booklet. COMPLETE PRICE £35.00 plus 62p postage

TEAK 60 AUDIO KIT: Comprising: Teak veneered cabinet size 16½" x 11½" x 3½", other parts include aluminium chassis, heatsink and front panel bracket plus back panel and appropriate sockets etc. KIT PRICE £13.25 plus 82p postage.

STEREO 30 COMPLETE AUDIO CHASSIS



7+7 WATTS R.M.S.

The Stereo 30 comprises a complete stereo pre-amplifier, power amplifiers and power supply. This, with only the addition of a transformer or overwind will produce a high quality audio unit suitable for use with a wide range of inputs i.e. high quality ceramic pick-up, stereo tuner, stereo tape deck, etc. Simple to install, capable of producing really first class results, this unit is supplied with full instructions, black front panel, knobs, mains switch, fuse and fuse holder and universal mounting brackets enabling it to be installed in a record plinth, cabinets of your own construction or the cabinet available. Ideal for the beginner or the advanced constructor who requires Hi-Fi performance with a minimum of installation difficulty (can be installed in 30 minutes)

TRANSFORMER £3.25

plus 50p p&p

TEAK CASE £5.45 plus 70p p&p

£16.25

p. & p. 45p

Equipment mono and other modules for Stereo

**NOW BI-PAK
BRINGS YOU—
The AL80**

35^{RMS} w power Amp!

**ONLY
£6.95**

+ 8% VAT

A High Fidelity Power Amplifier with a maximum Power Output of 35 watt R.M.S., which has a maximum operating voltage of 60v. A MUST for all HI-FI users.

Maximum supply voltage	15-60v
Power output for 2% THD	35 watts R.M.S.
Harmonic distortion	0.1%
Load impedance	3-8-16 ohm
Input Impedance	50K ohm
Frequency response +3dB	20Hz-40KHz
Sensitivity for 25 watts O/P	280mV R.M.S.
Max. Heat sink temperature	90°C
Dimensions	102mm x 64mm x 15mm
Mounting	2, 4BA fixing holes in heat sink
Fuse requirements	1.5A

**AND for those who need more
P-O-W-E-R**

AL250

125^{RMS} w



POWER AMP

Specially designed for use in—
**Disco Units, P.A. Systems, high power
Hi-Fi, Sound reinforcement systems**

SPECIFICATION:

Output Power: 125 watt RMS Continuous	Total harmonic distortion 50 watts into 4 ohms: 0.1%
Operating voltage: 50-80	50 watts into 8 ohms: 0.06%
Loads: 4-16 ohms	S/N ratio: better than 80dBs
Frequency response: 25Hz- 20kHz Measured at 100 watts	Damping factor, 8 ohms: 65
Sensitivity for 100 watts output at 1kHz: 450mV	Semiconductor complement: 13 transistors 5 diodes
Input impedance: 33K ohms	Overall size: Heatsink width 190mm, length 205mm, height 40mm

ONLY £15.95 +8% VAT

**MPA
30**



Enjoy the quality of a magnetic cartridge with your existing ceramic equipment using the new BI-PAK M.P.A. 30 which is a high quality pre-amplifier enabling magnetic cartridges to be used where facilities exist for the use of ceramic cartridges only. Used in conjunction are 4 low noise high gain silicon transistors. It is provided with a standard DIN input socket for ease of connection. Supplied with full, easy-to-follow instructions.

£2.85

**VAT
ADD
12½%**

**POSTAGE &
PACKING**

Postage & Packing add 25p unless otherwise shown. Add extra for airmail. Min. £1 00

**NEW
AL30A**

10w R.M.S. AUDIO AMPLIFIER MODULE

The AL30A is a high quality audio amplifier module replacing our AL20 & 30. The versatility of its design makes it ideal for use in record players, tape recorders, stereo amps, cassette & cartridge players. A power supply is available comprising of PS12 together with a transformer T538, also for stereo, the pre amp PA12.

SPECIFICATION:

- Output Power 10w R.M.S.
- Load Impedance 8 to 16 ohms
- Sensitivity: 90mV for full output
- Frequency Response 60Hz to 25KHz - 2db
- Supply 22 to 32 volts
- Input Impedance 50K
- Total Harmonic Distortion less than .5% (Typically .3%)
- Max Heat Sink Temp 80°C
- Dimensions 90 x 64 x 27mm

ONLY £3.65

**NEW PA12
£6.70**

NEW PA12 Stereo Pre-Amplifier completely redesigned for use with AL30A Amplifier Modules. Features include on/off volume, Balance, Bass and Treble controls. Complete with tape output.
Frequency Response 20Hz-20KHz (-3dB)
Bass and Treble range ±12dB
Input Impedance 1 meg ohm
Input Sensitivity 300mV
Supply requirements 24V. 5mA
Size 152mm x 84mm x 33mm

PS12

Power supply for AL30A, PA12, S450 etc. Input voltage 15-20v A.C. Output voltage 22-30v D.C. Output Current 800 mA
Max. Size 60mm x 43mm x 26mm. **£1.30**

Transformer T538 £3.20

BI-PAK

Dept. C.1 P.O. BOX 6 WARE HERTS

COMPONENT SHOP: 18 BALDOCK STREET, WARE.

WIRELESS TIME :



approx. 3/4 full size digits shown here

National's MA1012 LED digital clock module is a complete clock & alarm unit, operating from 50 or 60 Hz mains, and offering all the features you would expect: Hours-minutes display in bright 0.5" leds with optional seconds, sleep and snooze alarms, fast and slow setting, AM/PM indicator, switched alarm outputs - but best of all *no RFI*. Thus the MA1012 is suitable for use in any radio/tuner applications, and requires just 1.75 x 3.75 x 0.7" total. (Ex. transformer) £9.45 per module, isolating mains transformer £1.50 each. (*8% vat) Two modules, and two transformers for £20.00 (+8% vat)

In the latest *Ambit* catalogue: more TOKO coils, chokes, filters etc., data on the short wave coil sets, a revised price list, micro-microphone inserts, special offer lines etc.

DETECKNOWLEDGEY

Metal locator principles and practise, including some of the facts and information manufacturers of £100+ detectors would rather you didn't know. £1.00 each.

The Bionic Ferret 4000 - a VCO metal locator based on the PW seekit, including all parts, plasticwork, ready wound coil etc. Inc. free copy of *detecknowledgey*. £34.26 in pp and VAT at 8%.

Special announcement. The Bionic Radiometer metal locator is at last to be released. A full VLF discriminator, with simultaneous display of ferrous, non-ferrous and foil objects. With a little practise, you can actually find objects obscured by junk. Outperforms units costing £150+. Digital control. Demo available at Brentwood, on sale soon for less than £75. SAE info:

COMPONENTS

Herewith the list of first quality parts and modules for wireless, inc. Europe's largest range of signal coils and inductors. 1/2m in stock!

CA3089E	FM IF	1.94	BC413	lo noise	0.18	MFL 2.4 kHz ssb mech.	
KB4402	FM IF	1.94	40238	shld RF	0.25*	filter for ssb gen/IF 455kHz	
HA1137W	FM IF	2.20	BF224	6ghz RF	0.22	with matching transfs. 9.95	
TBA120	FM IF	0.75	BF274	.7ghz RF	0.18	MFH series 4/5/7kHz band-	
TBA120S	FM IF	1.00	ZTX212	50v/.3w	0.17	width @ 455kHz	1.95
sn76660n	FM IF	0.75	ZTX213	30v/.3w	0.16	MFK series 7/9kHz bw	1.65
ua720	AM rad	1.40	ZTX214	30v/.3w	0.17	Modules/tunerheads etc.	
CA3123E	AM rad	1.40	ZTX451	60v/1w	0.18	EC3302 3cct v/cap fm	7.50
HA1197	AM rad	1.40	ZTX551	60v/1w	0.18	EF5600 5cct v/cap fm	12.95
TBA861	AM rad	1.81	BD515	45v/10w	0.27	EF5800 6cct v/cap fm	15.25
MC1350	agc gain	1.00	BD516	45v/10w	0.30	EF5801 (5800+osc op)	17.45
ua753	fm gain	1.80	BD535	60v/50w	0.52	8319 4 v/c, mos mixer	11.46
LM1496	Bal mix	1.25	BD536	60v/50w	0.53	7252 complete fm mono	
MC1310P	mpx dec	2.20	BD609	80v/90w	0.70	tunerset. afc, agc, mute	26.50
KB4400	as above	2.20	BD610	80v/90w	1.20	7253 complete fm stereo	
ca3090aq	mpx dec	4.35	BF256	1ghz fet	0.34	tunerset. afc, agc, mute	26.50
HA1196	mpx dec	4.20	E176	p ch swt	0.38	7020 10.7MHz fm if	6.95
LM380	2w AF	1.00	MEM614	(40822)	0.38*	7030 linear phase fm if	10.95
LM381	preamp	1.81	MEM616	(40673)	0.67*	93090 ca3090aq dec	8.36
tda2020	15w AF	2.99	MEM680	lo noise	0.75*	92310 1310 decoder	6.95
tea940E	10w AF	1.80	BA102	vhf varic	0.30	91196 ha1196 decoder	12.99
tba810as	7w AF	1.08	BA121	vhf varic	0.30	91197 mw/lw v/cap tun	11.35
LM301an	op amp	0.39*	BB104	dual var.	0.45	7122 3 v/c mw (OR lw) tuner	
ua741	op amp	0.34*	BB105	uhf varic	0.40	KIT 15v tuning	9.00
LM3900	op amp	0.68*	mvam2	dual AM	1.48	810k 7w af kit comp.	£3
7805uc	5v/1amp	1.55*	mvam115	15v/AM	1.05	940k 10w af kit	3.95
tda1412	12v/1A	0.95*	mvam125	25v/AM	0.90	tda2020k pr. tda2020 lcs,	
78M20	20v/1A	1.20*	TOKO Coils & Filters			pcb, heatsinks for pa	9.35
78M24	24v/1A	1.20*	10mm & 7mm (rad cont)			All mpx decoders feature	
ua723cn	variable	0.80*	AM IFts w/wh cap	0.30		TOKO pilot tone filters.	
NE550a	as above	0.80*	FM IFts with cap	0.33		Tuners: complete	
taa550b	32v ref	0.50*	eg			Larsholt signalmaster Mk 8	
ic18038cc	slg gen	4.50*	YHCS11098AC2	0.30		Best fm tuner kit under £100	
NE555v	timer	0.70*	YHCS12374AC2	0.30		Looks as good as it sounds.	
NE566v	vco	2.50*	YHCS11100AC2	0.30		Full Instructions	86.95
NE567v	tone dc	2.50*	KALS4520A	0.33		Audiomaster amp. Matching	
NE560b	hf pll	3.50*	KACSK586HM	0.33		25+25w rms amp.	79.00
NE561B	hf pll	3.50*	LLC238 7mm	0.33		carriage on above £3 extra ea.	
NE565K	lf pll	2.50*	LLC4827 7mm	0.33		Misc.	
MC1312	quad	1.50	LLC4828 7mm	0.33		FX1115 beads	100.25
11C90	650mhz	14.00	CFS10.7 ceramic	0.60		MW/LW ferrite rod ant	0.90
ZTX107	50v/.3w	0.14	BLR3107N mpx	1.90		min. foil trimmers (see pl)	
ZTX108	30v/.3w	0.14	BBR3132 6pole fm	2.25		22t 100k pots for tuning. 45	
ZTX109	30v/.3w	0.14				RFchokes: TuH to 120mH	

VAT is extra at 12 1/2%, except where otherwise shown (*8%). PP now 25p per order. Catalogue 45p (inc). Pse send A5 or larger SAE with enquiries. Price lists free with an SAE. Full range of components etc available to callers at our new easy-to-get-to premises.

ambit INTERNATIONAL 

Number 2, Gresham Road, Brentwood, Essex. CM14 4HN
 telephone (0277) 216029
 Our new premises are only 200 yards from Brentwood
 station - with parking facilities outside the door !! *

LATEST BOUND VOLUME No. 29 of "Radio & Electronics Constructor"



AUGUST 1975 to JULY 1976

Comprising
776 pages **PRICE £3.30 P&P 90p**
inc. index

BOUND VOLUME No. 27
(August 1973 to July 1974)

BOUND VOLUME No. 28
(August 1974 to July 1975)

**PRICES
VOL. 27**

£2.60 per volume P&P 90p

VOL. 28

£3.00 per volume P&P 90p

Limited number of these
volumes still available.

VOLUME 30

(August 1976 to July 1977)
Will be available end of December
PRICE £3.70 P&P 90p

We regret all earlier volumes are now
completely sold out.

Available only from

DATA PUBLICATIONS LTD.,
57 MAIDA VALE, LONDON, W9 1SN

STRIKE YOUR OWN BARGAIN WITH

Stirling Sound

NO EXTRAS TO PAY FOR POSTAGE OR V.A.T.

THE SCHEME

Choose from any of the 9 power amplifier modules shown in our ad. and then the Stirling Sound power supply unit best likely to suit the job. Refer to the published prices (which already include V.A.T. and post free in U.K.). When you send the money.

DEDUCT 5% FROM THE TOTAL PRICE

If you order UNIT ONE at the same time that you order a power amp. and power unit as above

DEDUCT A FURTHER £1.00 FROM THE TOTAL PRICE

If you order UNIT TWO at the same time that you order a power amp. and power unit as above

DEDUCT A FURTHER £1.18 FROM THE TOTAL PRICE

UNIT ONE

Combined stereo pre-amp & active tone control unit. Input sensitivity 50mV for 200mV out, 10 16V operation. Bass ± 15 dB at 30Hz; Treble ± 15 dB at 10KHz; Balance control; Volume control. For ceramic P.U., radio or tape-Inputs. WITH FREE CONTROL PANEL FASCIA £9.00



UNIT TWO

With control facilities similar to UNIT ONE but for magnetic cartridge input. R.I.A.A. corrected. Input sensitivity - 5mV for 200mV out (can be varied). WITH FREE CONTROL PANEL FASCIA £12.43

CONTROL PANEL FASCIA available separately 50p

SS.100

Basic active stereo tone control module to provide ± 15 dB on bass at 30Hz and on treble at 10KHz £3.00

SS.101

Stereo pre-amp suitable for ceramics, tape, radio, etc £2.75

SS.102

Stereo pre-amp for mag. pick-ups. R.I.A.A. corrected £4.45

F.M. STEREO DECODER, phase lock loop type, with LED indicator showing when a stereo transmission is being received £5.25

WHEN ORDERING

ALL PRICES QUOTED INCLUDE V.A.T. AND GOODS ARE SENT POST FREE IN U.K. Owing to time between sending our ad. to this journal and the time it appears, prices may be subject to alteration without notice. E.&O.E.

Order by Access or Barclaycard - Simply let us have your number

Stirling Sound Dept. RC.178

37 VANGUARD WAY, SHOEBURNESS, ESSEX.

Telephone (03708) 5543.

Shop - 220-224 West Rd., Westcliff-on-Sea, Essex.

Telephone Southend (0702) 351048.

Britain's most go-ahead module manufacturers

CHOOSE THE ITEMS YOU WANT AND BUY THEM THE STIRLING SOUND BARGAIN WAY whether for a new system, to up-grade what you use now, to build a disco or P.A. outfit, a domestic Intercom or any other use where a dependable amplifier is wanted. Whatever it be, there's a Stirling Sound power amp for it up to 100 watts R.M.S., together with a choice of stereo tone control/pre-amps. Build with Stirling Sound now! See what you save and hear how good it sounds.

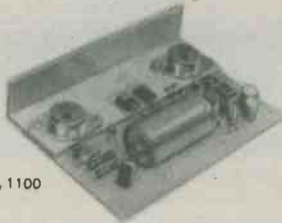

SS.1100

Made in our own Essex factory and sold direct to you, the user

INFO SHEETS to build your Stirling Sound catalogue. LARGE 12+p. S.A.E. brings first set (A4 size) covering items advertised here.



SS.370

AMPLIFIERS 3 to 100 WATTS R.M.S.

Ready assembled on P.C.B.s, tested and guaranteed. Easy to connect. With instructions. Output ratings ± 1 dB.

SS.103	I.C. amp. 3 watts R.M.S. using 20V/8 Ω or 14V/4 Ω . Input 100mV.	£2.85
SS.103-3	Stereo version of above, 2 I.C.s	£5.00
SS.105	5 watts R.M.S. into 3 Ω using 13.5V. Sensitivity - 30mV. THD - 0.3%. 3 $\frac{1}{2}$ " x 2" x 1"	£3.95
SS.110	10 watts R.M.S. into 4 Ω using 24V. Sensitivity - 60mV. THD - 0.3%. 3 $\frac{1}{2}$ " x 2" x 1"	£4.65
SS.120	20 watts R.M.S. into 4 Ω using 34V. Sensitivity - 80mV. THD - 0.3%. 3 $\frac{1}{2}$ " x 2" x 1"	£5.15
SS.125	25 watts R.M.S. into 8 Ω using 50V. Sensitivity - 140mV. Distortion - Less than 0.05% into 8 Ω , 5/N better than 70dB.	£7.25
SS.140	40 watts R.M.S. into 4 Ω using 45V. Sensitivity - 300mV. Distortion typically 0.1%. 5" x 3 $\frac{1}{2}$ " x 1 $\frac{1}{2}$ ".	£6.50
SS.160	64 watts R.M.S. into 4 Ω using 50V. Sensitivity - 350mV. Distortion typically 0.1%. 5" x 3 $\frac{1}{2}$ " x 1 $\frac{1}{2}$ ".	£8.50
SS.1100	100 watts R.M.S. into 4 Ω using 70V/2A. Input sensitivity - 500mV. Distortion at half-power, typically 0.1%. 5" x 3 $\frac{1}{2}$ " x 1 $\frac{1}{2}$ ".	£10.50
HS.160	Multi-finned heatsink for SS.140 or SS.160.	75p
HS.1100	Ditto for SS.1100	£1.50

POWER UNITS

Every Stirling Sound Power Unit is tested and guaranteed under working conditions before despatch. All units except SS.312 include a stabilised low voltage take-off point (13-15V) for pre-amp, tone control, radio tuner, etc. Outputs quoted minimal unloaded ratings.

SS.312	12V/1A	£6.60
SS.318	18V/1A	£6.95
SS.324	24V/1A	£7.65
SS.334	34V/2A	£8.75
SS.345	45V/2A	£10.75
SS.350	50V/2A	£11.75
SS.360	60V/2A	£12.75
SS.370	70V/2A	£14.75

SS.310/50 Stabilised power supply unit with variable output from 10V to 50V/2A. Short circuit protected £17.75

SS.300 Power stabilising unit variable from 10 to 50V/8A for adding to un-stabilised supply units £5.50

Improved circuitry and performance standards. More to choose from.

To STIRLING SOUND

Please supply

for which I enclose £

NAME

ADDRESS

My Access or Barclaycard No. is

R.C.178

SUPERSOUND 13 HI-FI MONO AMPLIFIER

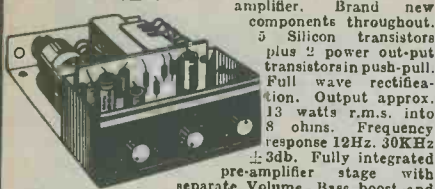

A superb solid state audio amplifier. Brand new components throughout. 5 Silicon transistors plus 2 power output transistors in push-pull. Full wave rectification. Output approx. 13 watts r.m.s. into 8 ohms. Frequency response 12Hz. 30KHz ± 3 db. Fully integrated pre-amplifier stage with separate Volume, Bass boost and Treble cut controls. Suitable for 8-15 ohm speakers. Input for ceramic or crystal cartridge. Sensitivity approx. 40mV for full output. Supplied ready built and tested, with knobs, escutcheon panel, input and output plugs. Overall size 5" high x 6" wide x 7 1/2" deep. AC 200/250V. PRICE £15.00. P. & P. £1.20.

DE LUXE STEREO AMPLIFIER

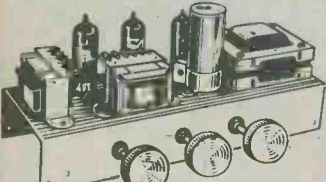

A.C. Mains 200-240 v. U.S. 115 v. heavy duty fully isolated transformer with full wave rectification giving adequate smoothing with negligible hum. Valve line-up—2 x ECL86 Triode Pentodes. 1 x EZ80 as rectifier. Two dual potentiometers are provided for bass and treble control, giving bass and treble boost and cut. A dual volume control is used. Balance of the left and right hand channels can be adjusted by means of a separate 'Balance' control fitted at the rear of the chassis. Input sensitivity is approximately 300mV for full peak output of 4 watts per channel (8 watts mono), into 3 ohm speakers. Full negative feedback in a carefully calculated circuit, allows high volume levels to be used with negligible distortion. Supplied complete with knobs, chassis size 11" w x 4" d. Overall height including valves 5". Ready built and tested to a high standard. £12.40. P. & P. £1.30.

HARVERSONIC STEREO 44

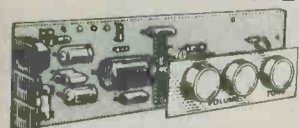

A solid state stereo amplifier chassis, with an output of 3-4 watts per channel into 8 ohm speakers. Using the latest high technology integrated circuit amplifiers with built in short term thermal overload protection. All components including rectifier smoothing capacitor, fuse, tone control, volume controls, 2 pin din speaker sockets and 5 pin din tape rec./play socket are mounted on the printed circuit panel, size approx. 9 1/2" x 2 1/2" x 1" max. depth. Supplied brand new and tested, with knobs, brushed anodised aluminium 2 way escutcheon (to allow the amplifier to be mounted horizontally or vertically), at only £9.00 plus 50p P. & P. Mains transformer with an output of 17V a/c at 500 m/a can be supplied at £1.50 plus 40p P. & P. if required. Full connection details supplied.

BRAND NEW MULTI-RATIO MAINS TRANSFORMERS. Giving 13 alternatives. Primary: 0-210-240v. Secondary combinations 0-5-10-15-20-25-30-35-40-60v. half wave at 1 amp, or 10-0-10, 20-0-20, 30-0-30v. at 2 amps full wave. Size 3in. long x 3 1/2in. wide x 3in. deep. Price £3.00 P. & P. £1.20.

MAINS TRANSFORMER. For power supplies. Fri. 200/240v. Sec. 9-0-9 at 500 mA. £1.60 P. & P. 65p. Fri. 200/240v. Sec. 12-0-12 at 1 amp. £1.85 P. & P. 65p. Fri. 200/240v. Sec. 10-0-10 at 2 amp. £2.50 P. & P. 90p. Fri. 200/240v. Sec. 25v. at 1.5 amp, 6v at 6 amp, 8v. at 50 mA. £2.25 + 65p P. & P.

ALL PURPOSE POWER SUPPLY UNIT 200/240v. A.C. input. Four switched fully smoothed D.C. outputs giving 6v. and 7 1/2v. and 9v. and 12v. at 1 amp on load. Fitted insulated output terminals and pilot lamp indicator. Hammer finish metal case overall size 6" x 3 1/2" x 2 1/2". Ready built and tested. Price £6.75. P. & P. 95p

STEREO-DECODER SIZE 2" x 3" x 1 1/2"

Ready built. Pre-aligned and tested. Sens. 20-560mV for 9-16V neg. earth operation. Can be fitted to almost any FM VHF radio or tuner. Stereo beacon light can be fitted if required. Full details and instructions (inclusive of hints and tips) supplied. £6.00 plus 20p P. & P. Stereo beacon light if required 40p extra.



QUALITY RECORD PLAYER AMPLIFIER MK. II A top quality record player amplifier employing heavy duty double wound mains transformer, ECC83, EL84, and rectifier. Separate Bass, Treble and Volume controls. Complete with output transformer matched for 2 ohm speaker. Size 7in wide x 3in deep x 6in high. Ready built and tested. PRICE £7.00. P. & P. £1.25
ALSO AVAILABLE mounted on board with output transformer and speaker. PRICE £8.00. P. & P. £1.30.

MAINS OPERATED SOLID STATE AM/FM STEREO TUNER

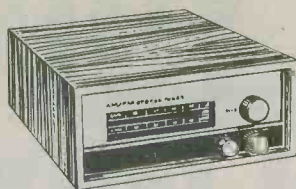

200/240V Mains operated Solid State A/M F/M Stereo Tuner. Covering M.W. A.M. 540-1605 KHZ, VHF/FM 88-108 MHz. Built-in Ferrite rod aerial for M.W. Full AFC and AGC on AM and FM. Stereo Beacon Lamp Indicator. Built-in Pre-amps with variable output voltage adjustable by pre-set control. Max o/p Voltage 600 m/v RMS into 20K. Simulated teak finish cabinet. Will match almost any amplifier. Size 8 1/2" w. x 4" h. x 9 1/2" d. approx. LIMITED NUMBER ONLY at £28 + £1.50 P. & P.

SPECIAL OFFERS

Mullard LP1159 RF-IF Double Tuned Amplifier Module for nominal 470kHz. Size approx. 2 1/2" x 1 1/2" x 2 1/2" 7-6V + earth. Brand new pre-aligned. Full specification and connection details supplied. £2.25 + P. & P. 20p.

Eye VHF/FM Tuner Head covering 88-108M/Hz. 10.7M/Hz IF output 7-5V + earth. Supplied pre-aligned, with full circuit diagram. Connection details supplied. Beautifully made with precision-gear PM Gang and 323 P1 + 323 P1 AM Tuning Gang only £3.15 + P. & P. 35p.

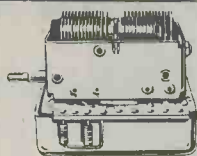

PRECISION MADE

Push Button Switch bank. 8 Buttons giving 16 S/P C/O interlocked switches plus 1 Cancel Button Plus 3 d/p c/o. Overall size 5" x 2 1/2" x 1". Supplied complete with chrome finished switch buttons 2 for £1.80 + 20p. P. & P.

HI-FI LOUSPEAKER SYSTEM Mk II

Beautifully made simulated teak finish enclosure now with most attractive slatted front. Size 16 1/2" high x 10 1/2" wide x 9" deep (approx.). Fitted with E.M.I. Ceramic Magnet 13" x 8" bass unit, H.F. tweeter unit and crossover. AVAILABLE IN NOMINAL 4 ohm, 8 ohm or 16 ohm impedance (state which). Handling power 10 watts R.M.S.

OUR PRICE £14.00 each. Carr. £3

Cabinet Available Separately £8.00 each. Carr. £2.00
Also available in 8 ohms with EMI 13" x 8" bass speaker with parasitic tweeter £12.50 each. Carr. £3.00

LOUSPEAKER BARGAINS

5in. 3 ohm £2.00. P. & P. 35p. 7 x 4in. 3 ohm £2.35. P. & P. 48p. 10 x 6in. 3 or 15 ohm £3.20. P. & P. 75p. 8 x 5in. 3 ohm with high flux magnet £3.00. P. & P. 60p. Tweeter. Approx. 3 1/2". Available 3 or 8 or 15 ohms, £2.00 + 30p P. & P.

2" PLASTIC CONE HF TWEETER 4 ohm, £3.50 per matched pair + 50p P. & P.

HIGH POWER HI-FI 8 ohm Dome Tweeter. 1" voice coil. Magnet size 3" dia. Suitable for use in up to 50 watt systems. £4.50 each + 60p P. & P.

VYNAIR & REXINE SPEAKERS & CABINET FABRICS app. 54 in. wide. Our price £2.00 yd. length. P. & P. 50p per yd. (min. 1 yd.). S.A.E. for samples.

"POLY PLANAR" WAFER-TYPE, WIDE RANGE ELECTRO-DYNAMIC SPEAKER Size 11 1/2" x 14 1/2" x 1 1/2" deep. Weight 19oz. Power handling 20W r.m.s. (40W peak). Impedance 8 ohm only. Response 40Hz-20kHz. Can be mounted on ceilings, walls, etc. and used with or without baffle. Send S.A.E. for details. Only £8.40 each. P. & P. 90p for one, £1.10 for two.

Now also available 8"-8 ohm. 10 watts r.m.s. 20 watt peak 40 Hz-20,000 Hz. Overall depth 1". Ideal for Hi-Fi or for use in cars £5.25 + P. & P. (one 65p, two 75p).

SONOTONE STAMC COMPATIBLE STEREO CARTRIDGE T/O stylus Diamond Stereo LP and Sapphire 78. ONLY £2.50 P. & P. 20p. Also available fitted with twin Diamond T/O stylus for Stereo LP. £3.00 P. & P. 20p.

LATEST CRYSTAL T/O STEREO/COMPATIBLE CARTRIDGE for EP/LP/Stereo 78. £2.00 P. & P. 20p

LATEST T/O MONO COMPATIBLE CARTRIDGE for playing EP/LP/78 mono or stereo records on mono equipment. Only £2.00 P. & P. 20p

HARVERSONIC SUPER SOUND 10 + 10 STEREO AMPLIFIER KIT

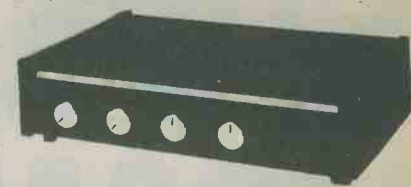

A really first-class Hi-Fi Stereo Amplifier Kit. Uses 14 transistors including Silicon Transistors in the first five stages on each channel resulting in even lower noise level with improved sensitivity. Integrated pre-amp with Bass, Treble and two Volume Controls. Suitable for use with Ceramic or Crystal cartridges. Very simple to modify to suit magnetic cartridge—instructions included. Output stage for any speakers from 8 to 15 ohms. Compact design, all parts supplied including drilled metal work, high quality ready drilled printed circuit board with component identification clearly marked, smart brushed anodised aluminium front panel with matching knobs, wire, solder, nuts, bolts—no extras to buy. Simple step by step instructions enable any constructor to build an amplifier to be proud of. Brief specifications: Power output: 14 watts r.m.s. per channel into 5 ohms. Frequency response ± 3 dB 12-30,000 Hz Sensitivity: better than 80mV into 1M Ω . Full power bandwidth: ± 3 dB 12-15,000 Hz. Bass, boost approx. to ± 12 dB. Treble cut approx. to -16 dB. Negative feedback 18dB over main amp. Power requirements 35v. at 1.0 amp. Overall Size 12" w. x 8" d. x 2 1/2" h.

Fully detailed 7 page construction manual and parts list free with kit or send 25p plus large S.A.E.

AMPLIFIER KIT £13.50 P. & P. 80p
(Magnetic input components 33p extra)
POWER PACK KIT £5.50 P. & P. 95p
CABINET £5.50 P. & P. 95p

Special offer—only £23.75 if all 3 units ordered at one time plus £1.25 P. & P.

Full after sales service

Also available ready built and tested £31.25. P. & P. £1.50.

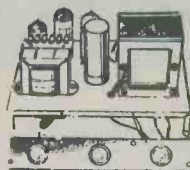

3-VALVE AUDIO

AMPLIFIER HA34 MK II. Designed for Hi-Fi reproduction of records. A.C. Mains operation. Ready built on plated heavy gauge metal chassis, size 7 1/2" w. x 4" d. x 4 1/2" h. Incorporates ECC83, EL84, EZ80 valves. Heavy duty, double wound mains transformer and output transformer matched for 3 ohm speaker. Separate volume control and now with improved wide range tone controls giving bass and treble lift and cut. Negative feedback line. Output 4 1/2 watts. Front panel can be detached and leads extended for remote mounting of controls. Complete with knobs, valves, etc., wired and tested for only £8.50. P. & P. £1.40.

HSL "FOUR" AMPLIFIER KIT. Similar in appearance to HA34 above but employs entirely different and advanced circuitry. Complete set of parts, etc. £8.00. P. & P. £1.40.

10/14 WATT HI-FI AMPLIFIER KIT A stylishly finished monaural amplifier with an output of 14 watts from 2 EL84s in push-pull. Super reproduction of both music and speech, with negligible hum. Separate inputs for mike and gram. Allow records and announcements to follow each other. Fully shrouded section wound output transformer to match 3-15 Ω speaker and 2 independent volume controls, and separate bass and treble controls are provided giving good lift and cut. Valve line-up 2 EL84s, ECC83, EF96 and EZ80 rectifier. Simple instruction booklet 25p x SAE (Free with parts). All parts sold separately. ONLY £13.50. P. & P. £1.40. Also available ready built and tested £18.00. P. & P. £1.40

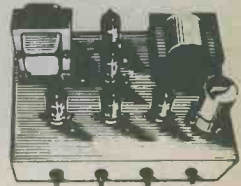

SPECIAL LINES OFFERED SUBJECT TO STOCK AVAILABILITY

Limited number of British Manufacturer's Surplus professional 100 watt RMS Slave amplifiers. Special features: 2 separate power modules, 1 for Bass response, and 1 for mid. range/tweeter. 5 stage LED display for power o/p indication. A/c mains i/p switchable for 110 or 240V. Can easily be converted to stereo.

AVAILABLE TO PERSONAL CALLERS ONLY—PLEASE PHONE TO CONFIRM AVAILABILITY. Brand new and tested only £33.75.

OUR PRICES INCLUDE VAT AT CURRENT RATES

HARVERSON SURPLUS CO. LTD.

(Dist. REC) 170 HIGH ST. MERTON, LONDON, SW.19. Tel: 01-540 3985.

A few minutes from South Wimbledon Tube Station

SEND SAE WITH ALL ENQUIRIES. FOR PERSONAL CALLERS ONLY: WE CAN NOW OFFER A FULL REPAIR SERVICE ON ALL HI-FI EQUIPMENT, DISCO, CASSETTES, CAR RADIO, ETC.

(Please write clearly)

PLEASE NOTE: P. & P. CHARGES QUOTED APPLY TO U.K. ONLY. P. & P. ON OVERSEAS ORDERS CHARGED EXTRA.

THE MODERN BOOK CO

RADIO DATA REFERENCE BOOK

by T. G. Giles

Price £4.00

AUDIO AMPLIFIERS FOR THE HOME
CONSTRUCTOR
by I. R. Sinclair PRICE: £2.50

DIGITAL IC EQUIVALENTS AND PIN
CONNECTIONS
by A. Michaels PRICE: £2.75

PRINCIPLES OF TRANSISTOR
CIRCUITS
by S. W. Amos PRICE: £4.55

IC OP-AMP COOKBOOK
by W. G. Jung PRICE: £9.75

ACTIVE FILTER COOKBOOK
by D. Lancaster PRICE: £10.80

TV TYPEWRITER COOKBOOK
by D. Lancaster PRICE: £7.30

IC TIMER COOKBOOK
by W. G. Jung PRICE: £7.40

TTL COOKBOOK
by D. Lancaster PRICE: £6.60

ELECTRONICS AND RADIO
by N. Nelkon PRICE: £3.00

TRANSISTOR ELECTRONIC ORGANS
FOR THE AMATEUR
by A. Douglas PRICE: £4.80

MASTER TRANSISTOR/IC SUBSTITU-
TION HANDBOOK
by Tab Books No. 970 PRICE: £5.50

GETTING THE MOST OUT OF YOUR
ELECTRONIC CALCULATOR
by W. L. Hunter PRICE: £3.60

OP-AMP CIRCUIT DESIGN AND APPLI-
CATIONS
by J. Carr PRICE: £3.90

BUILD YOUR OWN WORKING ROBOT
by D. L. Heiserman PRICE: £3.50

ELECTRONICS AND PHOTOGRAPHY
by R. M. Brown PRICE: £2.20

MICROELECTRONICS
by C. L. Hallmark PRICE: £4.80

125 ONE TRANSISTOR PROJECTS
by R. P. Turner PRICE: £2.10

HOW TO BUILD SPEAKER
ENCLOSURES
by A. Badmaieff PRICE: £3.65

110 SEMICONDUCTOR PROJECTS FOR
THE HOME CONSTRUCTOR
by R. M. Marston PRICE: £2.70

110 THYRISTOR PROJECTS USING
SCRs AND TRIACS
by R. M. Marston PRICE: £2.70

110 OPERATIONAL AMPLIFIER
PROJECTS FOR THE HOME
CONSTRUCTOR
by R. M. Marston PRICE: £2.70

50 PHOTOELECTRIC CIRCUITS &
SYSTEMS
by P. S. Smith PRICE: £2.00

BEGINNER'S GUIDE TO RADIO
by G. K. King PRICE: £3.00

BEGINNER'S GUIDE TO COLOUR
TELEVISION
by G. J. King PRICE: £2.50

BEGINNER'S GUIDE TO ELECTRIC
WIRING
by F. Guillou PRICE: £2.50

BEGINNER'S GUIDE TO AUDIO
by I. R. Sinclair PRICE: £3.00

BEGINNER'S GUIDE TO INTEGRATED
CIRCUITS
by I. R. Sinclair PRICE: £3.00

RADIO SERVICING POCKET BOOK
by V. Capel PRICE: £3.10

TELEVISION ENGINEERS' POCKET
BOOK
by P. J. McGoldrick PRICE: £5.10

ELECTRONICS POCKET BOOK
by P. J. McGoldrick PRICE: £4.25

COLOUR T.V. WITH PART. REF. TO THE
PAL SYSTEM
by G. N. Patchett PRICE: £5.50

COLOUR T.V. PICTURE FAULTS
by K. J. Bohlman PRICE: £2.75

RECEIVING PAL COLOUR T.V.
by A. G. Priestley PRICE: £5.50

PRICES INCLUDE POSTAGE

We have the Finest Selection of English and American Radio Books in the Country
19-21 PRAED STREET (Dept RC) LONDON W2 INP

Telephone 01-723 4185

We wish you a Happy Christmas

and suggest that one of the best ways
to ensure it is to treat yourself to a
Home Radio Components Catalogue.

Only £1.40 including p & p.

The best Christmas present you
could buy — for yourself or for
any of your electronics
friends or relations

Our catalogue has over 200 pages, lists over 5,000 items,
nearly 2,000 of them illustrated. With each catalogue
is a free Bargain List of unrepeatable offers. Also
included are details of our easy-to-join Credit Scheme
which enables you to order components by phone any
time of day or night, any day of the week.



Please write your Name and Address in block capitals

NAME

ADDRESS

.....

HOME RADIO (Components) LTD., Dept. RC
234-240 London Road, Mitcham, Surrey CR4 3HD
REgd. No. 912966, London



**POST
THIS
COUPON**
with cheque
or p.o. for
£1.40

HOME RADIO (Components) LTD. Dept. RC, 234-240 London Road, Mitcham, CR4 3HD. Phone: 01-848 8422



PHOTO

By A. P. Roberts

A common problem with photographs which have been taken with the aid of a single flash unit is that they have very sharp and rather unnatural shadows. The usual solution to this difficulty is to use a suitably positioned second electronic flashgun which is automatically fired by a slave unit. A photoflash slave unit is merely a device which fires the secondary flash when it picks up the pulse of light produced by the primary flashgun. Thus, it is really just a type of photo-sensitive switch.

It is obviously essential for the device to operate at very high speed so that the secondary flashgun fires while the camera shutter is open. This virtually instantaneous operation can be easily achieved with a solid state switching device, as opposed to a mechanical component such as a relay which would be too slow. It is also desirable for the unit to be very sensitive so that it does not have to be critically positioned in order to obtain correct slave firing.

The photoflash slave unit which is described in this article has been designed to use few components, but without sacrificing sensitivity and reliability of operation as a result.

THE CIRCUIT

The complete circuit diagram of the unit is provided in Fig. 1. There are basically three sections: the light detector circuit which utilises TR1, an amplifier incorporating IC1, and a solid state switching device which actually controls the second flashgun, SCR1.

TR1 is a photo-Darlington transistor with R2 as its emitter load. The current which is passed through R2 and the collector-emitter terminals of the phototransistor is largely determined by the light level which is incident on the device. The higher this light level, the higher the current which flows in this collector-emitter circuit, up to the point where the phototransistor becomes saturated. When TR1 is in this condition it exhibits a collector-emitter impedance of only a few ohms.

In normal operation TR1 conducts more heavily when it receives a pulse of light from the main

flashgun. This generates a positive output voltage at the emitter which is fed via C2 to the amplifier section. If TR1 should become saturated then obviously the required positive voltage pulse cannot be generated and the unit would be rendered inoperative. A photo-Darlington transistor is a very sensitive device which can be readily saturated at ordinary light levels. R1 is therefore connected in the base circuit of the transistor, and this component reduces its sensitivity to a level at which saturation is unlikely to occur under normal circumstances.

The amplifier section incorporates a CA3130T operational amplifier used in the non-inverting mode. R3 sets the input impedance of the amplifier at $4.7k\ \Omega$, and feedback resistors R4 and R5 set the voltage gain of the circuit at approximately 1,200 times. The circuit may at first look perfectly conventional, but it is a little unusual in that the dual balanced positive and negative supply rails usually provided for an operational amplifier are not present. Instead, a single positive supply rail is used.

This arrangement would not be satisfactory for the majority of i.c. operational amplifiers as their outputs will not take up a voltage of less than about 2 volts relative to the negative rail, and the two inputs would need to be at a minimum potential of about this level if the amplifiers were to function correctly. The CA3130T i.c. does not suffer from these drawbacks, and it will operate perfectly well with either the inputs or the output at virtually the same potential as the negative supply rail. This ground referenced amplifier therefore works correctly, but of course it can only produce an output which is positive with respect to the negative supply rail. An i.c. such as the 748 cannot be substituted for the CA3130T in this application.

Coupling capacitor C2 has been given a relatively low value so that the circuit will only respond to fairly fast changes in light level (such as the flash from a flashgun), and will not be spuriously triggered by ordinary changes in ambient light level. C3 is the compensation capacitor for IC1, and with the specified value the i.c. has a typical slew rate of about 15 volts per microsecond and an fT of about 5MHz. Thus, it easily provides the required fast operating speed as also, of course, does

RADIO AND ELECTRONICS CONSTRUCTOR

FLASH SLAVE UNIT

HIGH SENSITIVITY QUICK-ACTING UNIT WHICH CAUSES A SECOND ELECTRONIC FLASHGUN TO BE TRIGGERED BY A PRIMARY PHOTOFLASH.

COMPONENTS

Resistors

(All $\frac{1}{4}$ watt 10%)

- R1 5.6k Ω
- R2 5.6k Ω
- R3 4.7k Ω
- R4 1k Ω
- R5 1.2M Ω

Capacitors

- C1 0.22 μ F type C280 (Mullard)
- C2 0.047 μ F type C280 (Mullard)
- C3 39pF ceramic plate

Semiconductors

- TR1 2N5777
- IC1 CA3130T
- SCR1 lamp, 400 p.i.v. (see text)

Switch

- S1 s.p.s.t., rotary or toggle

Miscellaneous

- Plastic case
- 9 volt battery type PP3 (Ever Ready)
- Battery connector
- Veroboard, 0.1in. matrix
- Control knob (if needed for S1)
- Flash extension lead
- Wire, solder, etc.

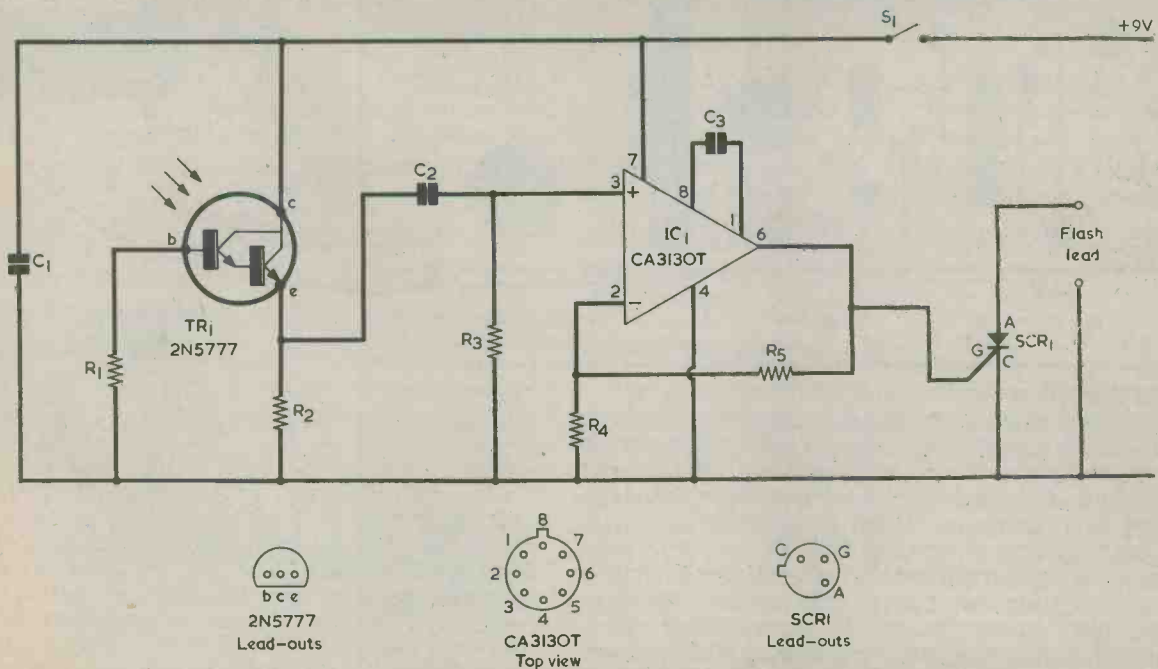

Fig. 1. The circuit diagram of the photoflash slave unit. Despite the small number of components, it has a high degree of sensitivity

When the front panel is removed, the Veroboard panel and battery can be seen inside the plastic case



the phototransistor TR1.

The same is true of the switching device, SCR1, which has its gate terminal fed from the output of IC1. IC1 output is normally at virtually the negative supply rail voltage, but when the main flashgun fires and produces a positive voltage spike at TR1 emitter this spike is amplified by IC1 and fed to the gate of SCR1. This switches on SCR1, which is connected across the flash lead of the second flashgun, and so this flashgun is fired in sympathy with the main one. SCR1 automatically turns off after the secondary flashgun operates, and the slave unit is then ready for the next flash at TR1.

S1 is an ordinary on-off switch and can be rotary or toggle, as desired. A rotary switch was employed

in the prototype. Power is obtained from a PP3 battery and, since the quiescent current consumption of the unit is only about $350 \mu A$, this will have nearly its shelf life even if the unit is used frequently.

SCR1 is a silicon controlled rectifier, or thyristor, rated at 1 amp 400 p.i.v. and housed in a TO5 or TO39 case. A suitable type is the THY1A/400 available from Bi-Pak Semiconductors. The 2N5777 specified for TR1 can be obtained from several suppliers. The author's unit was housed in a plastic case, with aluminium front panel having nominal dimensions of 85mm by 37mm by 56mm. Any other plastic case of similar size which will take the Veroboard component panel, battery and switch could alternatively be used, if desired.

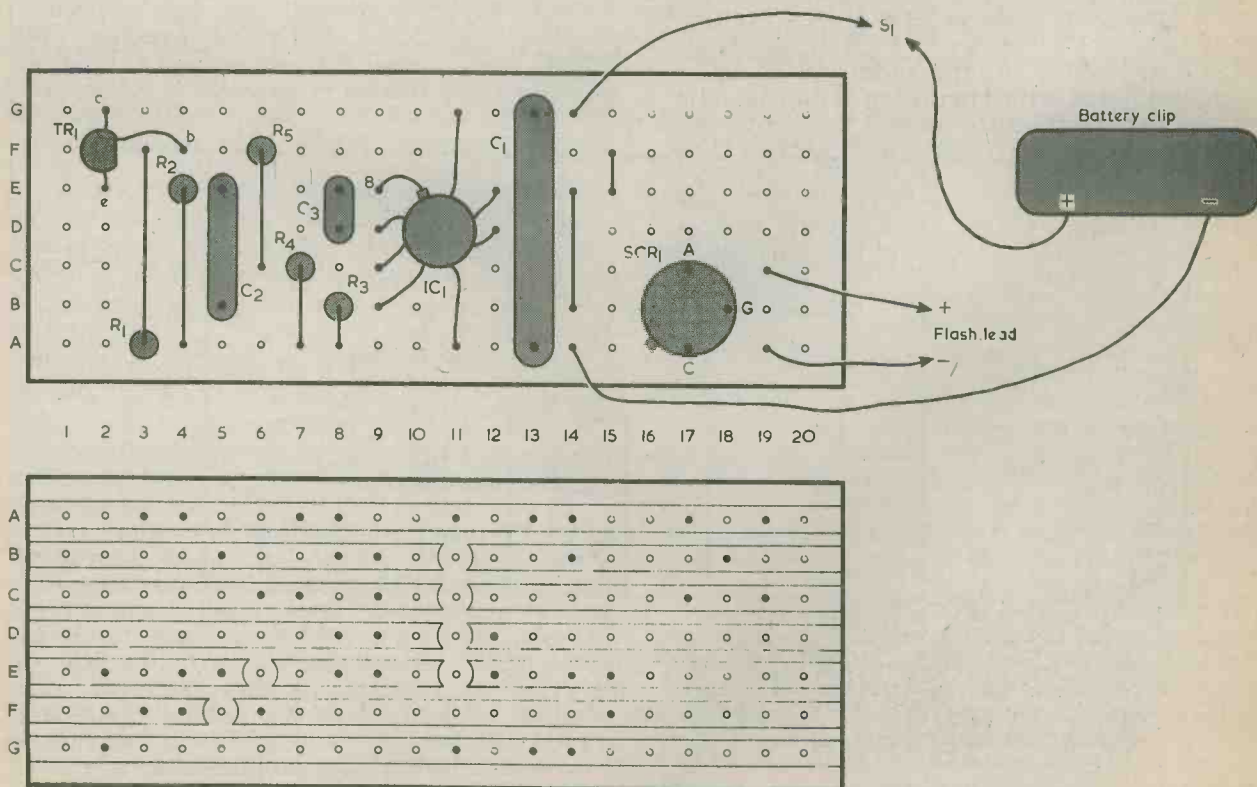

Fig. 2. Apart from the switch and the battery, all the components are assembled on a Veroboard panel. Component layout and connections are shown here

CONSTRUCTION

Apart from the on-off switch and battery, all the components are mounted on a 0.1in. matrix Veroboard panel which has 20 holes by 7 copper strips. Details of this panel are shown in Fig. 2.

There are six breaks in the copper strips which are made before the components are soldered into position. The lead-out wires of TR1 are left full length, and should not be trimmed at all. The curved surface of this transistor, which presents the light sensitive area, faces towards the outer edge of the Veroboard. Make sure that the two link wires are not accidentally omitted.

The prototype slave unit is housed in the plastic case just referred to. S1 is mounted in the centre of the front panel.

The most practical way of connecting the unit to the secondary flashgun is via a flash extension lead. The plug end of this lead connects to the flashgun, and the socket at the other end is cut off. A hole 4mm. in diameter is drilled in the left hand side of the case behind the Veroboard, and the free end of the flash lead is then threaded through this and around the Veroboard panel. Its wires are soldered to the appropriate points on the component panel.

An important point to note here is that the flash lead must be connected with the polarity shown in Fig. 2 as otherwise the silicon controlled rectifier will be unable to trigger the flashgun. The polarity of the voltage across the flash lead can be determined with the aid of a multimeter set to a high volts range, say 500 or 1,000 volts f.s.d. If a multimeter is not available then it is possible to find the correct polarity by trial and error, since no harm will come to the circuit if the flash lead is connected the wrong way round.

The case has mounting rails for printed circuit boards, and the component board is mounted vertically in the set of rails on the extreme left hand side of the case, with the component side of the board facing into the middle of the case.

A hole must be drilled in the top of the case adjacent to the phototransistor so that this can receive the light from the main flashgun. This hole is about 6mm. to 8mm. in diameter, and the phototransistor is pushed into it from the inside. Otherwise, the case will screen the phototransistor to some degree, and this would have the effect of making the unit more directional. In order to improve

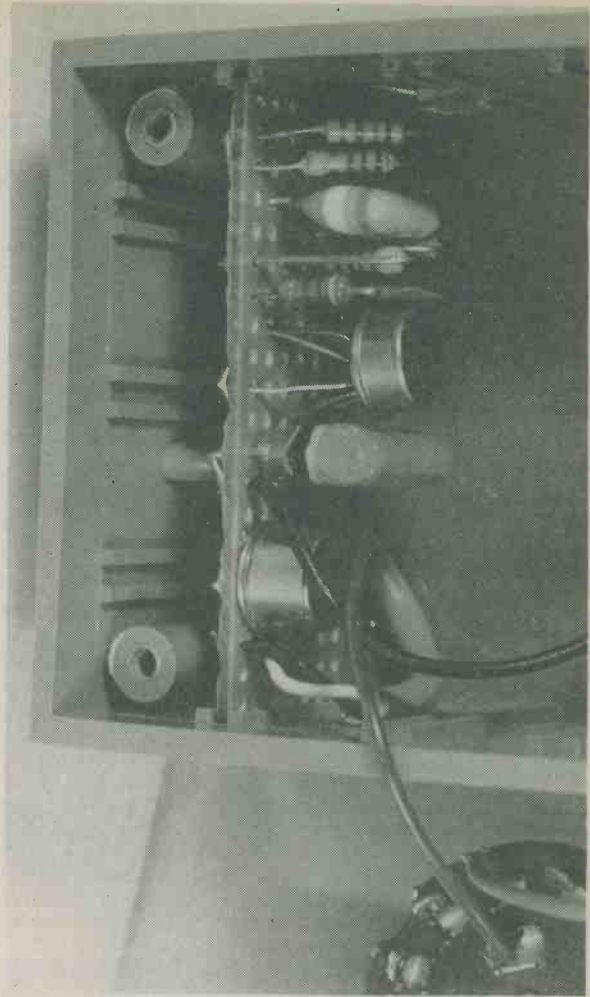

The Veroboard panel slides between milled rails in the plastic case. The phototransistor is partly inserted into the aperture drilled for it in the top of the case

appearance a small piece of Sellophane, light diffusing material or thin Perspex is glued over the hole. A flat washer, which acts as an escutcheon, is then glued in place over this.

The battery fits neatly in place at the extreme right hand side of the case, and no form of mounting bracket is required.

USING THE UNIT

The slave unit is very sensitive. Within reason it does not matter in which direction the unit is aimed when it is used indoors. Light which is reflected from walls and ceilings is almost invariably adequate to trigger the device. Probably the best plan is to aim the unit at the ceiling when it is being used indoors, as ceilings are normally light in colour and therefore reflect light efficiently.

When used out of doors it is normally necessary to aim the slave unit direct at the main flashgun, as there is little in the way of reflected light. Even if the main flashgun is a low powered type, the unit should work satisfactorily up to a maximum range of at least 40 feet or so. ■

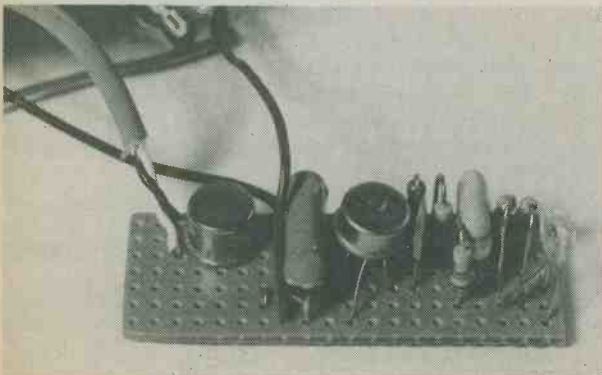

Close-up shot of the Veroboard panel with the components assembled on it

MINI CALCULATING WATCH

Earlier this year the zenith of electronic calculator/timepiece development seemed to be the Casio Crystal Quartz CQ-1 — a handy electronic calculator combining also the features of a digital watch with built-in calendar memory, stopwatch and alarm clock.

But now Casio have gone one better, miniaturised still further and produced the Micro Quartz MQ-1. In many ways it is similar to CQ-1, inasmuch as it is a full four-function (add, subtract, multiply and divide) calculator combined with a highly accurate — guaranteed within 15 seconds a month — timing unit that can also operate as a one-tenth second stopwatch.

It tells the time in hours, minutes and seconds (12 hour with am and pm, or 24 hour system). At the touch of a button its internal calendar shows the year, month, date and day of the week; and no fussing about at the end of a month that doesn't have 31 days. Touch another button and it tells the time somewhere else!

The MQ-1 is small, under $4\frac{1}{2} \times 1\frac{1}{2} \times \frac{1}{2}$ inches, and weighs only $1\frac{1}{4}$ ounces. It has a liquid crystal display powered by two tiny silver oxide batteries,

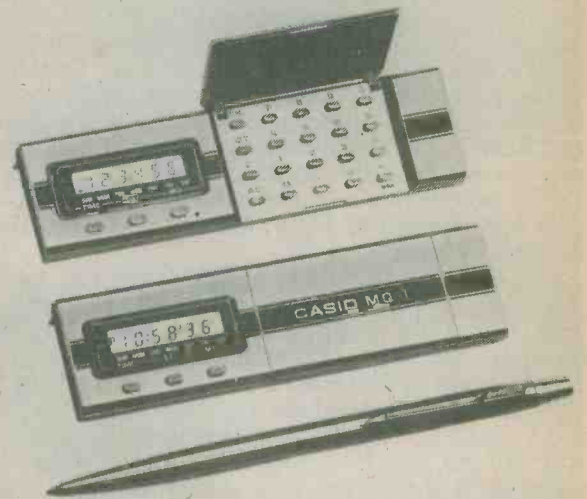

The Casio micro-quartz MQ-1 calculator/timing unit/stopwatch

and has an amazing battery life of some 13,000 hours — or 18 months. All at a recommended retail price of only £39.95.

WE WISH ALL OUR READERS

—THE COMPLIMENTS OF THE SEASON—

LITESOLD ELECTRICALLY HEATED POWER TOOL

Light Soldering Developments Limited have applied their twenty five years' experience of manufacturing industrial soldering irons to the production of an easy to use poker work tool for both hobby and educational use.

The Litesold wood burning tool electrically heats the specially shaped interchangeable brass tips to just the right temperature for the controlled burning of wood and leather surfaces to give beautifully artistic effects. By variation of speed and pressure, direction of movement and the shape of the tip, it is simple to produce markings in a variety of shades and widths, allowing designs, decorations and complete pictures to be applied to a variety of wooden and leather articles.

High standards of construction and materials are used in this new tool, which is fully insulated and fitted with burn-proof 3-core mains lead. The nylon handle is fitted with a ventilated safety

collar, and an internal neon lamp shows when the power is on. Power consumption is only 20 watts, and the overall length of the tool is 7 inches (17.8cm) and it weighs only $3\frac{1}{2}$ ozs (100gm) complete. There are five tip shades available and an Allen key is provided for the fixing screw. The tool is available for 24, 115, 220 or 240 volts, and will provide hours of rewarding and creative pleasure.

The 24v version is particularly suitable for schools and may be operated from either an existing 24v supply or from the Litesold 2450 Power Unit.

The cost of the Litesold Poker Work Tool, complete with four bits and an allen key, is £9.67 each including postage, packing and 8% VAT.

Orders and the appropriate remittance should be sent direct to: Light Soldering Developments Limited, 97/99 Gloucester Road, Croydon, Surrey.

COMMENT

FERROCHROM TAPE

The accompanying photograph illustrates Ferrochrom tape cassettes manufactured by BASF. These dual oxide tapes were introduced in the beginning of 1976, and BASF have passed on some useful details concerning the manner in which they should be used. When they first appeared, few cassette machines were capable of realising the full capability of the tape but since then many more cassette machine manufacturers have produced models with Ferrochrom bias adjustment. BASF feel, therefore, that it is now appropriate to remind people of the advantages of Ferrochrom tape, especially its extremely high output which BASF considers exceeds all other commercially available cassettes.

Ferrochrom tape has a two-layer coating which starts with a polyester base coated with a relatively thick high density ferric oxide dispersion. On top of this is added a carefully controlled layer of chromium dioxide. The resultant composition exploits the simple theory that low frequencies are reproduced from the whole of the tape coating whilst high frequencies are reproduced from the top of the coating.

Because of its dual oxide, the optimum bias current for Ferrochrom is a value approximately half-way

between the current for ferric oxide and that for chromium dioxide. Ferrochrom can still be used on a conventional ferric recorder where, at a VU setting of +2dB, it gives an overall output 4 to 5dB higher than BASF LH tape. On playback the higher frequencies are over-pronounced, giving an effect similar to that of a Dolbyised cassette played back on a non-Dolby machine. The effect is easily remedied by a slight adjustment of the amplifier treble control. BASF state that the frequency response and dynamic range achieved using Ferrochrom in this way is equal to that of a chromium dioxide cassette played on a machine biased for chromium dioxide.

With recorders having a manual chrome switch it is possible to record Ferrochrom in either of two ways to avoid the necessity of adjusting the treble control on playback. The first is to record on ferric setting with a VU level of +2dB, then play back on chrome setting. The second method is to record on chrome setting with a VU level of 0dB and play back on ferrite setting. Ferrochrom should not be recorded and played back on the chrome setting as this produces unpleasant high frequencies and requires an unsatisfactory recording level.

The best results are achieved on cassette recorders biased for Fe-Cr.



BASF cassettes incorporating Ferrochrom tape. This has a layer of ferric oxide on the tape base, with a carefully controlled layer of chromium dioxide above.

On these the dynamic range from a VU setting of 0dB is 1.5dB greater than that possible from chrome dioxide.

BASF Ferrochrom is available in C60 and C90 lengths. Each cassette housing has a large window which enables the user to see the tape hubs and BASF's patented tape transport system: Special Mechanics (SM). The amount of tape on each hub is accurately shown and any disturbance of the tape can be seen before problems occur.

Amongst the many aspects of electronics featured in this issue are two concerned with TV. The TV Anti-Theft article is of course of much wider application and articles of this nature are, inevitably, widely read.

In the *In Your Workshop* feature Dick and Smithy delve into the intricacies of Vertical Time Base Synchronisation and convey to the reader, in an easy assimilated manner, much useful information.

Also concerned with TV is a new booklet, *Objective TV Measurements*, from Marconi Instruments Ltd., a GEC Marconi Electronics company. The text, accompanied by many illustrations, explains the various television measurement parameters and the use of Insertion Test Signals — ITS — to measure them. The booklet describes the range of MI instruments available to meet national and international ITS requirements and the ways in which systems can be tailored to meet individual requirements.

The booklet is available on request from the Publicity Department of Marconi Instruments, Longacres, St. Albans, Herts.

BBC WAVELENGTH CHANGES IN 1978

From 23 November 1978 a new international frequency agreement comes into effect. This provides for a considerable increase in the number and power of transmitters in Europe, and many of the frequencies used for BBC Radio will be changed.

We will give more details and background information next month.



"Owing to a most successful year our miniature components division will be able to move to smaller premises."

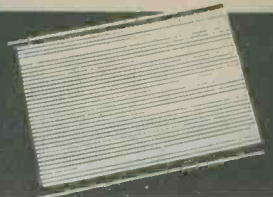

No. 7

SEQUENCE GENERATOR

AN UNUSUAL DESIGN INCORPORATING 2 I.C.'s

By I. R. Sinclair

This interesting circuit generates a sequence of voltages on five output terminals, and the sequence starts to repeat only after 31 input pulses. It can be used as a frequency divider dividing by 31 or, more interestingly, as a generator of code signals or musical notes. The circuit shown here generates the sequence with the outputs monitored by l.e.d.'s, so that any use other than the random light display of the l.e.d.'s will require additional gating and other circuitry which can be added on another Blob Board.

SHIFT REGISTER

The heart of the circuit, which is shown in Fig. 1, is a shift register type 7496. This contains five flip-flops connected to each other in sequence. The outputs of two of these flip-flops, QC and QE, are taken to the two inputs of an exclusive-OR gate, and the gate output is taken to the serial input of the 7496 to be fed as an input to the shift register. For those who have not met the exclusive-OR gate before, details are given in Fig. 2 and Table 1. From these you will see that the output of the gate is a logic 1 only if one of the inputs is at logic 1. If both inputs are at logic 1 or both are at logic 0, the output of the gate is 0.

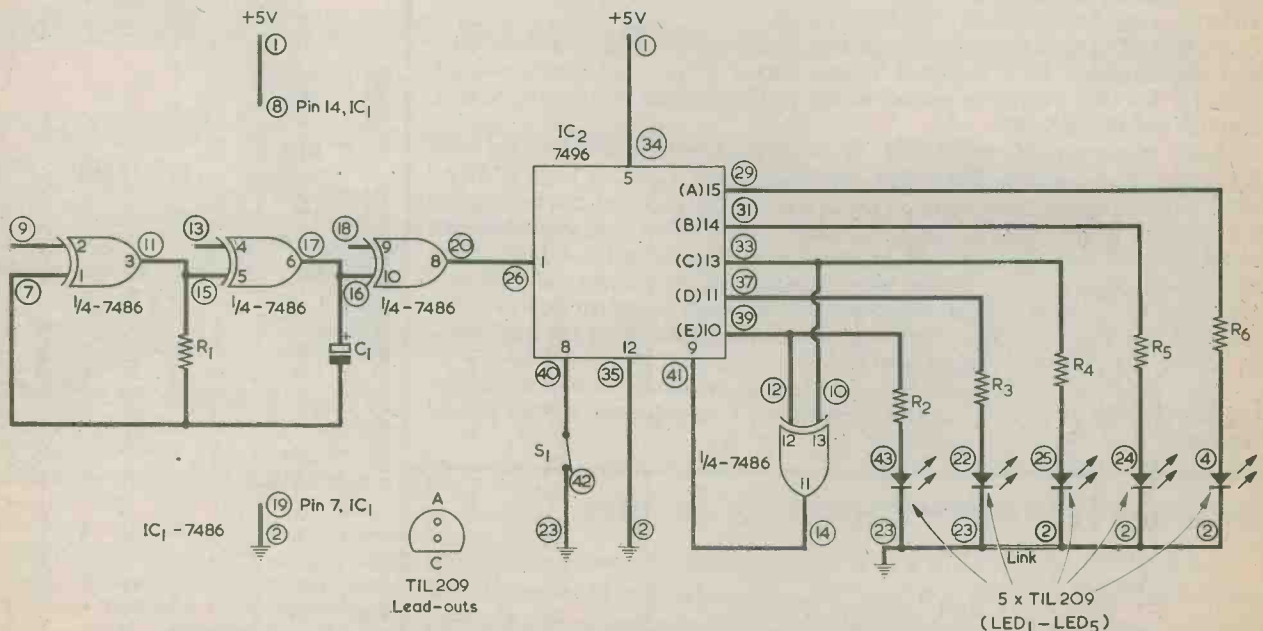

Fig. 1. The circuit diagram of the sequence generator. The circled numbers apply to the Blob Board tracks, the remaining numbers being i.c. pin numbers. The earth symbols indicate the negative supply



Fig. 2. Circuit symbol for a 2-input exclusive-OR gate. This truth table is given in Table 1

TABLE 1
Exclusive-OR Truth Table

A	B	Q
0	0	0
1	0	1
0	1	1
1	1	0

Now the principle of a shift register is that any logic digit, 1 or 0, that is present at the serial input when a clock pulse arrives at the clock pin will be transferred to the first stage of the register (A), and will appear at the output of this stage, QA. The next clock pulse will then transfer this signal to the next output, QB, and will enter a new signal into QA. This process continues at each clock pulse, with the digit present at the input being fed in, and each stored digit being moved one place to the right. See Table 2 and Fig. 3. Normally, when the QE output is reached the information is then lost at the next clock pulse. In our circuit, however, the exclusive-OR gate ensures that when there is a 1 at

TABLE 2

Serial Input-Clock Sequence

Serial Input	Clock No.	QA	QB	QC	QD	QE
1	0	0	0	0	0	0
1	1	1	0	0	0	0
1	2	1	1	0	0	0
1	3	1	1	1	0	0
1	4	1	1	1	1	0
1	5	1	1	1	1	1
0	6	0	1	1	1	1
0	7	0	0	1	1	1
0	8	0	0	0	1	1
0	9	0	0	0	0	1
0	10	0	0	0	0	0

either QC or QE, a 1 will be fed in at the serial input; and that a zero will be fed in when there are logic 1 or logic 0 signals at both QC and QE. Because of this, the sequence of digits passing through the shift register is continually changing and is shown in Table 3, in which column F is the

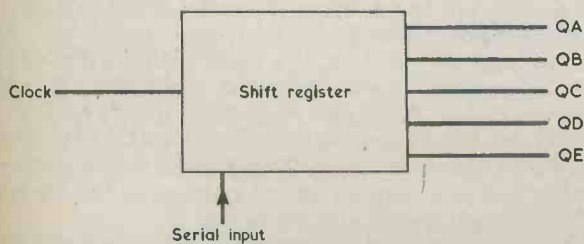

Fig. 3. The 5-bit shift register, as employed in the present circuit. The truth table shown in Table 2 illustrates how a digit at the input is shifted through the register stage by stage at each clock pulse

TABLE 3

Sequential Generator Truth Table

State	A	B	C	D	E	F
1	1	1	1	1	1	0
2	0	1	1	1	1	0
3	0	0	1	1	1	0
4	0	0	0	1	1	1
5	1	0	0	0	1	1
6	1	1	0	0	0	0
7	0	1	1	0	0	1
8	1	0	1	1	0	1
9	1	1	0	1	1	1
10	1	1	1	0	1	0
11	0	1	1	1	0	1
12	1	0	1	1	1	0
13	0	1	0	1	1	1
14	1	0	1	0	1	0
15	0	1	0	1	0	0
16	0	0	1	0	1	0
17	0	0	0	1	0	0
18	0	0	0	0	1	1
19	1	0	0	0	0	0
20	0	1	0	0	0	0
21	0	0	1	0	0	1
22	1	0	0	1	0	0
23	0	1	0	0	1	1
24	1	0	1	0	0	1
25	1	1	0	1	0	0
26	0	1	1	0	1	0
27	0	0	1	1	0	1
28	1	0	0	1	1	1
29	1	1	0	0	1	1
30	1	1	1	0	0	1
31	1	1	1	1	0	1
32	1	1	1	1	1	0

COMPONENTS

Resistors

(All $\frac{1}{4}$ watt 10%)

R1 1k Ω

R2-R6 470 Ω (see text)

Capacitor

C1 680 μ F electrolytic, 10V. Wkg.

Semiconductors

IC1 7486

IC2 7496

LED1-LED5 TIL 209

Switch

S1 miniature slide switch

Blob Board

Blob Board type ZB-2-IC

output of the exclusive-OR gate which feeds into the serial input. Table 3 starts with a set of 1's stored and goes through the whole sequence, with State 32 being the same as State 1. If l.e.d.'s are attached to each output terminal they will flash on and off in an apparently random fashion when the register is clocked slowly.

The exclusive-OR gate can be built up using NAND gates and inverters, but it is much simpler to employ a ready made exclusive-OR gate in i.c. form. The 7486 is a quad exclusive-OR gate (four separate gate circuits on one chip) which is relatively cheap at the moment. The only chance of interrupting the count occurs when all the register outputs should reach zero, since this prevents a 1 ever being fed into the serial entry pin. This can only occur if all the register outputs are at zero when the circuit is switched on, but we must be able to break this state if it should appear. To do so, we use the preset enable pin (pin 8) of the 7496 to enter a set of 1's if the register happens to start with a set of zeros. Normally, S1 in Fig. 1 is closed; it is momentarily opened to allow the preset enable input to go high and then closed again.

As an indication of some of the possibilities of this circuit, Fig. 4 shows the outline of a random harmony generator in which one of the outputs of the shift register is used to switch an oscillator on and off. The remaining four outputs are taken to a 74141 decoder, which gives an output on one of its ten output pins for each combination of four inputs (and some odd outputs, because four inputs can give sixteen combinations, and the 74141 can give only ten outputs). Each of these outputs can drive an oscillator at a different frequency, and the notes can be mixed to provide an output to an amplifier. The oscillators can be Schmitt trigger types, as were described in the third Blob-A-Job article, "12 Note Tone Generator", published in the last August issue, Note that the 74141 outputs are low when activated, so that an inverter must be interposed between each output and the oscillator gating input. I suspect that at times some modern composers are already using a system of this type.

The clock pulses for the circuit of Fig. 1 are generated by the remaining exclusive-OR gates using these as simple inverters, so that the circuit

needs only two i.c.'s. This is a common type of t.t.l. oscillator, though it is unusual to employ exclusive-OR gates in it. Although C1 is a normal polarised electrolytic capacitor, it functions quite satisfactorily in the circuit in practice. The oscillator runs at approximately 1Hz.

BUILDING THE CIRCUIT

The circuit is constructed on a ZB-2-IC Blob Board. If extra gating is to be used for a note generator such as that just outlined the components required can be assembled on one or more further Blob Boards.

Start construction by soldering on the two i.c.'s in the usual way. Place the Blob Board on the bench correct way round so that the printing is right way up then tin each pin of the i.c.'s. Place IC1 on the Blob Board with pin 1 at pad 7 and pin 8 at pad 20. Solder pin 1 to its pad and check the i.c. positioning. If all is well, solder pin 8 and re-check. Remember that only a blob of solder is required for each connection, since the tinning on the Blob Board makes soldering a very quick operation. If IC1 is correctly positioned, solder all the remaining pins to their respective pads. The reason for this procedure is that it is easy to remove an incorrectly positioned i.c. if only two of its pins are soldered. If all are soldered it is necessary to use desoldering braid.

Repeat the process with IC2. This is a sixteen pin i.c., so pin 1 is first soldered to pad 26, and then pin 9 is soldered to pad 41, with the same checks being carried out after each step. If all is well the remaining pins are then soldered. The two i.c.'s are shown in position in Fig. 5.

Now connect the 5 volt positive and earth (negative supply) lines. With the ZB-2-IC board it is convenient to use track 1 for the positive supply and track 2 for the earth. Using insulated link wires, connect pin 7 of IC1 (pad 19) and pin 12 of IC2 (pad 35) to the earth line at track 2. Next, connect pin 14 of IC1 (pad 8) and pin 5 of IC2 (pad 34) to the positive supply at track 1. Connect another link wire between tracks 2 and 23, so that a second earth line is available at the bottom of the board. These links are all shown in Fig. 5.

Further wiring steps are given in Fig. 6. Connect

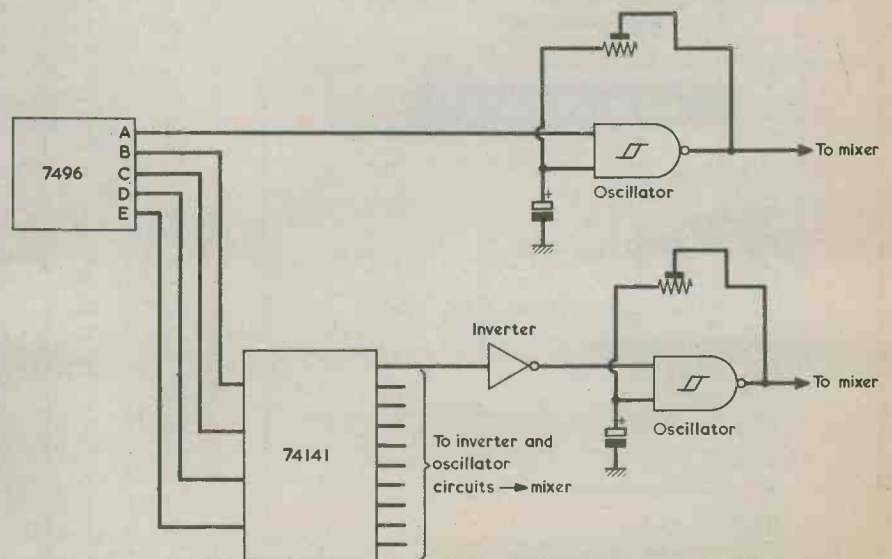
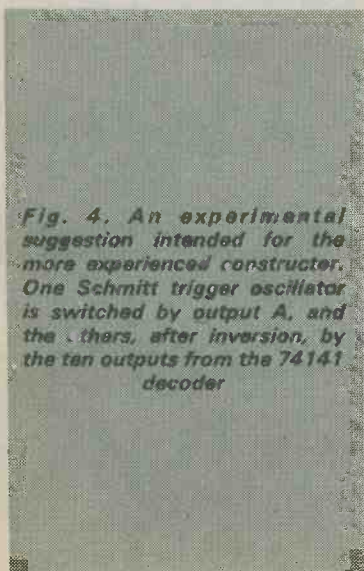

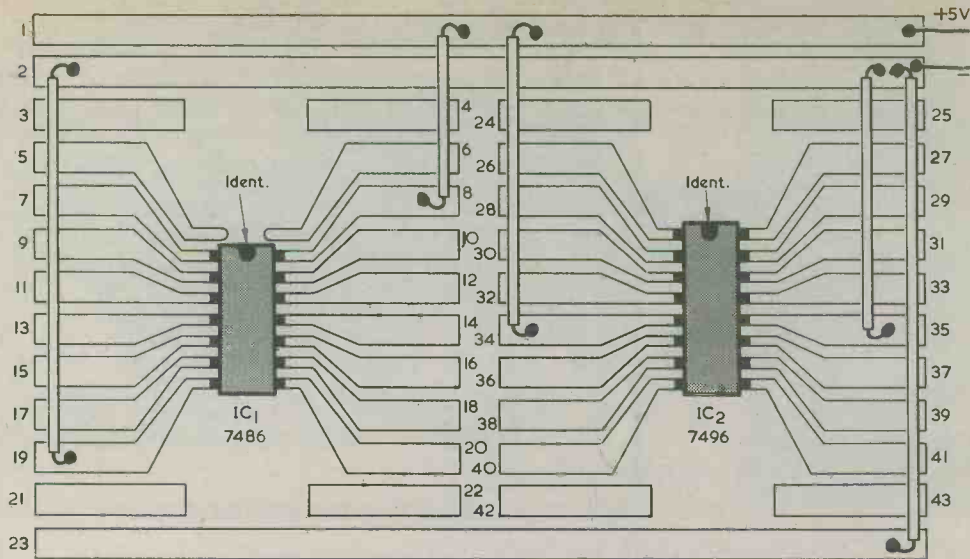

Fig. 5. First steps in wiring up the sequence generator. Here the two integrated circuits are soldered to the Blob Board and the supply wiring is completed

two tags of S1 to pads 40 and 42, and add a short link wire between pad 42 and track 23. This completes the switching circuit to the preset enable input at IC2 pin 8. If a third tag of the switch above track 23 it may be soldered to that track for mounting stability. The switch will almost certainly be double pole and the remaining pole tags may also be soldered to the pads of 40 and 42, and to track 23, if it is felt that this causes the switch to be positioned more firmly.

The l.e.d. circuits are completed next. The series l.e.d. resistors, R2 to R6, are specified as 470Ω in the Components List, but lower values, down to 330Ω , can be employed if a brighter display is required. The output pins of IC2 are 15, 13, 14, 11 and 10, and each series resistor is blobbed from the

appropriate pad to a spare pad, as in Fig. 6. Fit sleeving over the resistor lead-outs where there is a risk of short-circuits to other lead-outs or components. From each of these spare pads in turn, an l.e.d. is connected to earth. The lead of the l.e.d. is connected to earth. The lead of the l.e.d. that is identified by a flat on the l.e.d. plastic body is that which connects to earth.

The exclusive-OR gates which control the register can now be wired in. Blob an insulated wire link from pin 11 of IC1 (pad 14) to pin 9 (pad 41) of IC2. Blob a further insulated link from pin 12 of IC1 (pad 12) to pin 10 of IC2 (pad 39), and another insulated link from pin 13 of IC1 (pad 10) to pin 13 of IC2 (pad 33). Then add an insulated link from pin 8 of IC1 (pad 20) to pin 1 of IC2 (pad

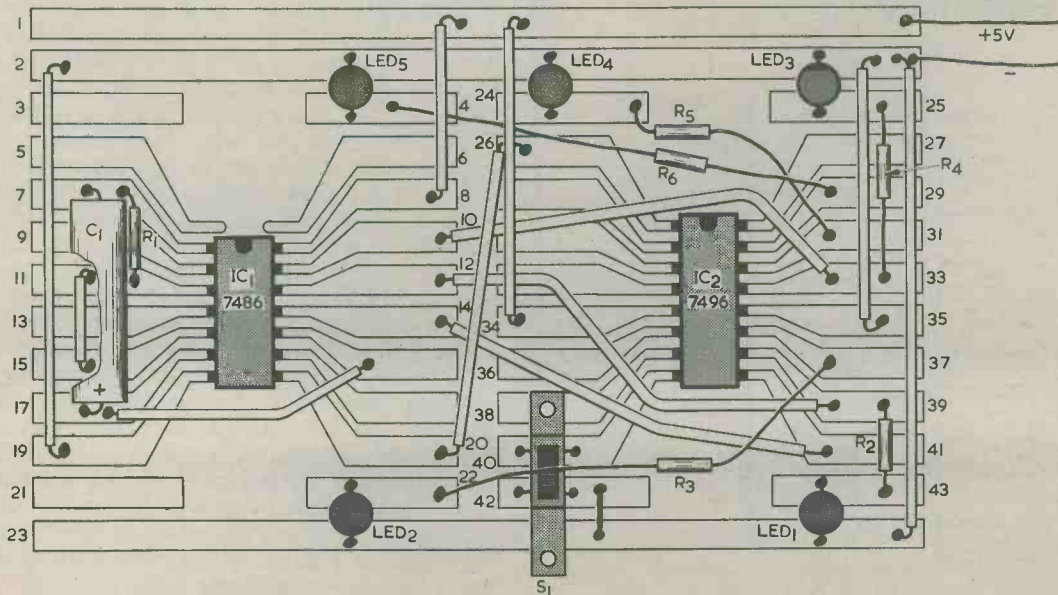

Fig. 6. Final steps in the assembly of the sequence generator. This includes all the i.c. and l.e.d. wiring

All the components for the sequence generator can be comfortably accommodated on a Blob Board type ZB-2-IC

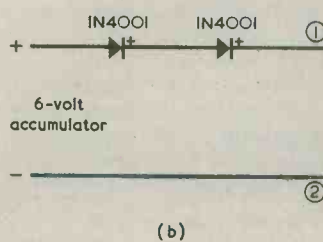
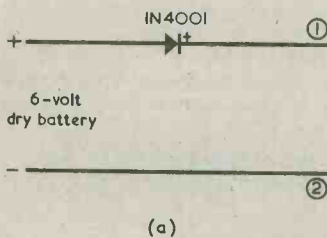
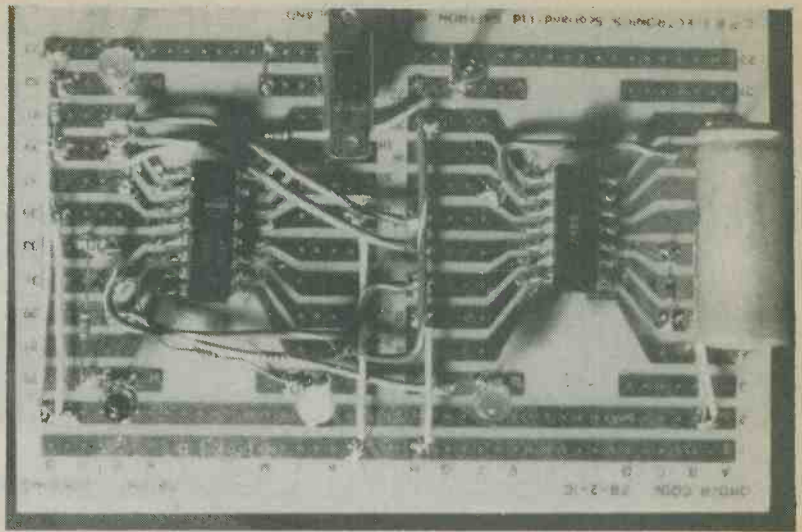

Fig. 7.(a) The sequence generator can be powered by a 6 volt dry battery if a forward biased silicon rectifier is connected in series to drop the voltage
(b) A 6 volt accumulator may also be used but this time the voltage has to be dropped by two silicon rectifiers

26), so connecting the oscillator output to the shift register.

Two further insulated link wires connect inputs and outputs in the oscillator circuit. Connect pin 6 of IC1 (pad 17) to pin 10 of IC1 (pad 16), then connect pin 3 of IC1 (pad 11) to pin 5 of IC1 (pad 15). Pins 2, 4 and 9 of IC1 are left open-circuit, allowing these inputs to take up a high potential. Blob C1 between IC1 pin 10 (pad 7) and IC1 pin 6 (pad

17), with positive to pad 17. Finally, blob R1 between IC1 pin 1 (pad 7) and IC1 pin 3 (pad 11).

OPERATION

Check your connections and then apply a supply, taking great care to observe correct polarity. The circuit draws a fairly high current, of approximately 60mA, and as usual it may be powered directly by a 4.5 volt dry battery. It may also be powered by a 6 volt dry battery if a forward connected silicon rectifier is inserted in series in the positive supply lead to drop the voltage, or by a 6 volt accumulator with two forward connected silicon rectifiers in series in the positive line. See Fig. 7. A suitable rectifier type is the 1N4001. The circuit must *not* be supplied by a 6 volt accumulator which is on charge.

The l.e.d.'s should then flash in the sequence shown in Table 3. Check the order by resetting to 11111 (all l.e.d.'s lit) by opening and closing S1.

Note that if the sequence generator is to be used with gates, some care has to be taken over the gate outputs. Gates such as the 7400 must *never* have their output terminals directly connected together, because if one gate output is at 1 and the other is at 0 a very large current can pass, burning out the circuit. Some types of gate with open-collector outputs can, however, be wired in this way, as is illustrated in Fig. 8, so that the outputs of several gates can be combined. This is called a "wired-OR" connection. Suitable open-collector gates are the 7401 and 7403 quad 2-input NAND gates.

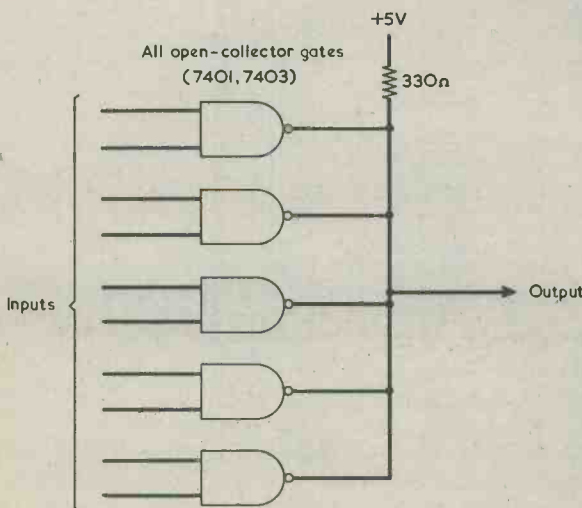
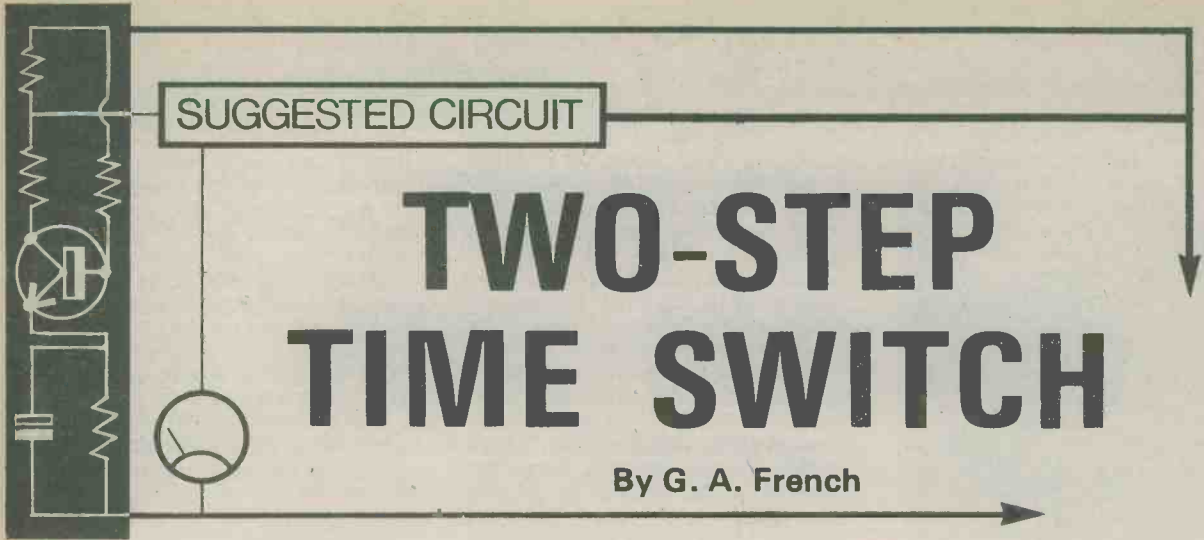

Fig. 8. If gate outputs employed for signal combinations are directly connected together it is essential that the gates be open-collector types



TWO-STEP TIME SWITCH

By G. A. French

There are quite a few applications in which a double period electronic timer can offer practical advantages when compared with a single timer. One particular instance is given when the first timing period is employed to control a process, such as a photographic enlargement exposure, after which the second period allows warning to be given for a limited time that the process has been completed. Two-step processes, in which a second process

follows the first, may also be controlled.

The circuit to be described in this month's article in the "Suggested Circuit" series allows independent two-stage process timing to be achieved. The design is general in nature since it is assumed that the constructor will be able to choose his own timing components. It is also slightly experimental, as it may be necessary for the value of one capacitor to be determined empirically after the circuit has been

assembled.

CIRCUIT DIAGRAM

The complete circuit of the two-step time switch is given in Fig. 1, and it incorporates two 555 i.c.'s, each of which operates a relay. The relay contacts switch on the processes concerned. It is assumed that each timing period will be at least several seconds long.

The unit is switched on by means of S_2 , whereupon the trigger pins 2 of each 555 are taken to the positive

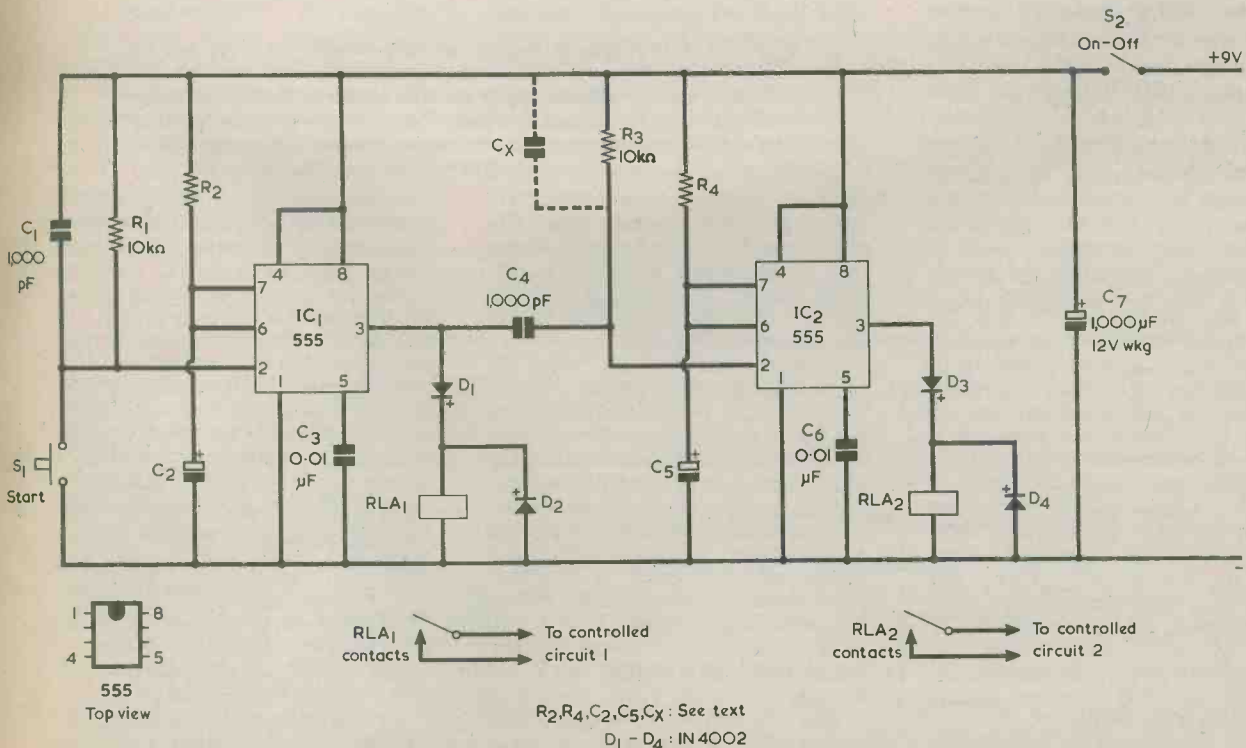

Fig. 1. The circuit of the two-step time switch. Pressing S_1 causes IC_1 to be triggered into its timing period, at the end of which IC_2 is triggered into a second period

rail via R1 and R3 respectively. Under this condition, both the i.c.'s are inhibited and their outputs, at pin 3, are low. The circuit remains in this condition until the "Start" push-button, S1, is pressed. The trigger pin of IC1 is then taken low, the output at pin 3 goes high, the discharge coupling at pin 7 is taken off C2, and the latter commences to charge via R2. Since pin 3 of IC1 has gone high an energising current passes via D1 through the coil (shown as a rectangle) of relay RLA1, and this relay operates. Its normally-open contacts close and the first controlled process is switched on.

This situation is maintained until the voltage across C2 reaches two-thirds of the supply voltage. The threshold input at pin 6 then causes the internal flip-flop in the i.c. to change state and the output goes low again. Relay RLA1 releases and its contacts open. At the same time a negative-going trigger pulse is applied via C4 to pin 2 of IC2. This goes through the same timing process as did IC1, with C5 charging via R4, and it causes relay RLA2 to energise and its contacts to close. When the voltage across C5 reaches two-thirds of the supply voltage the second timing period ends, the output goes low again and relay RLA2 releases. The circuit is then ready for another cycle of operations, which can be initiated by pressing S1.

The current drawn from the 9 volt supply is approximately 10mA when the relays are de-energised, this increasing by the current in each relay coil as the relays operate.

COMPONENT VALUES

The length of the timing period given by IC1 is equal to 1.1 times the product of R2 and C2, where time is in seconds, resistance is in megohms and capacitance is in microfarads. Similarly, the timing period given by IC2 is equal to 1.1 times the product of R4 and C5. The values required in the two capacitors will almost certainly be such that they will need to be electrolytic, and they are shown as such in Fig. 1. Although not essential, it is desirable that the resistor values lie in the range of some 10k Ω to 300k Ω . These values will allow robust circuit conditions with charging currents which are not too high or too small. Since the capacitors are electrolytic components with typical tolerances on value of +50% and -10%, the resistors will need to be partly pre-settable so that precise timing periods may be achieved.

As an example, Fig. 2 illustrates suitable values for R2 and C2 when it is desired that the timing period for IC1 be 10 seconds. The product of R2 and C2 multiplied by 1.1

should be equal to 10 seconds, whereupon this product is approximately equal to 9. Suitable values would be 90k Ω (0.09M Ω) and 100 μ F. If C2 is on its highest tolerance R2 needs to be 50% down, at 60k Ω , and when C2 is at its lowest tolerance R2 needs to be 10% up, at 100k Ω . These requirements could, as a first step, be given by making R2 a 40k Ω pre-set potentiometer in series with a 60k Ω fixed resistor, as in Fig. 2(a). The pre-set potentiometer is then adjusted for a precise timing period of 10 seconds.

There are, however, tolerances in the potentiometer and the fixed resistor as well, the tolerance in the potentiometer being usually as high as 20%. To take these in, the potentiometer value should be greater than 40k Ω : the next preferred value of 47k Ω is just a little too low

circuit. All fixed resistors in the circuit may be $\frac{1}{4}$ watt 10% types.

TRIGGER INPUTS

The only critical points in the circuit are at the i.c. pin 2 trigger inputs. These inputs have a very high impedance and can cause the i.c.'s to be triggered by very short negative-going spikes picked up from wiring or via the supply rails. The wiring to pin 2 of each i.c. should be kept reasonably short and clear of the wiring to pins 3 and 7 of the same 555. Capacitor C1 ensures that IC1 is not triggered when the circuit is switched on by S2.

The diodes D1 and D3 isolate the relay coils from the circuit when the output of the appropriate i.c. goes low at the end of a timing period, thereby preventing coil voltage changes as each coil field collapses

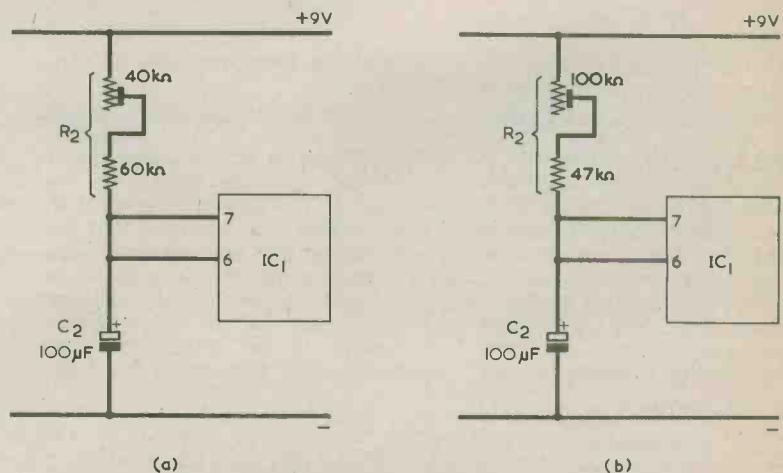

Fig. 2(a). A first step in finding the values required in R2 and C2 for a 10 second timing period in IC1
(b). Final values which adequately take in all the tolerances in the timing circuit. R2 consists, in practice, of a pre-set potentiometer and a fixed resistor in series, the potentiometer being adjusted to produce the desired timing period

and it would be best to make the potentiometer one preferred value step higher again, at 100k Ω . The fixed resistor can then be around 47k Ω , and these practical values are shown in Fig. 2(b).

Similar calculations may be carried out for other timing periods. R2 should in practice always consist of a pre-set potentiometer in series with a fixed resistor, since the latter acts as a current limiter and prevents the flow of excessive current should the potentiometer be accidentally set to insert zero resistance into circuit. A standard sized skeleton potentiometer will be adequate in practice.

The values of R4 and C5 are found and made up in the same manner.

The two relays can be any types having coil resistances of some 400 Ω or more and which are capable of energising at 7 volts or less. The author employed P.O. 3000 relays with 500 Ω coils in the prototype

from upsetting circuit operation. The other two diodes, D2 and D4, damp any back-e.m.f. voltages across the coils after de-energising. D1 also enables the output of IC1 to fall rapidly to the low state and impart a suitable starting pulse to IC2.

If the circuit is powered by a 9 volt battery it should function as shown in Fig. 1. If, alternatively, a supply of around 9 volts is provided by a mains power unit, difficulties can arise if the supply voltage is not reasonably well stabilized and smoothed. With a poor supply it may be found that IC2, as well as IC1, is triggered when S1 is pressed. This effect can be cleared by adding a capacitor of around 100pF to 400pF across R3 in the CX position. The value required is found experimentally, and should be the smallest which allows reliable operation to occur. The mains power supply should be switched on first, at its mains input, before S2 is closed.

Trade News . . .

TWO NEW SPEAKERS COMBINE EUROPEAN AND JAPANESE TECHNOLOGY

Two new speakers from Sansui are claimed to offer superb sound, particularly for their price category.

Known as the Sansui ES 203 and ES 205, the speakers handle maximum input powers of 30 and 50 watts, respectively. They are both two-way, two-speaker systems; the former a bass reflex type, the latter an acoustic air suspension type. Impedance is 8 ohms and sensitivity 90dB/watt. Woofer and tweeter sizes are, respectively, 165mm and 65mm (ES 203) and 204mm and 86mm (ES 205).

Sansui are particularly proud of the medium-sized, ES 205. This has a crossover network — two-way, 12dB/oct. crossover frequency — 2500Hz. A new flat-baffle design eliminates speaker mounting frames, and provides greatly improved sound dispersion. Dimensions are 250mm wide, 480mm high and 241mm deep. Finish is in simulated walnut grain with detachable front grill in deep grey cloth.



MARCONI MK. VIII CAMERA

That world-beater, the Marconi Mk. VIII colour television camera, is in the news once more. The Kuwait Ministry of Information has again ordered television systems built around it in a contract worth over £1 million.

Under this contract, Marconi Communication Systems Limited, a GEC Marconi Electronics company, is to supply seven Mk. VIII cameras, vision and sound mixers, sync generators and an extensive range of ancillaries to complete the facilities at Kuwait's Radio and Television Centre. The equipment, which will be used in two new studios at the Centre, is scheduled to be "on air" in time for the celebrations marking Kuwait's National Day on February 25th, 1978.

The Marconi Mk. VIII is claimed to be the world's most advanced automatic colour television camera. It has achieved a global sales total which has now exceeded the 450 mark and is in use or on order in more than twenty countries throughout the world, including U.S.A. and the U.S.S.R. In the United Kingdom the camera is in use with Southern TV, Tyne Tees, Ulster, Anglia, Harlech, London Weekend Television, the BBC and the Churches Television Centre, as well as Scottish Television.

Marconi's have also been busy on the home front. By the Spring of 1979 many listeners to BBC medium wave radio will receive their programmes from an advanced type of high power transmitter developed by Marconi

Communication Systems.

Under the terms of contracts worth nearly £2 million, Marconi's are to supply 24 of their new 50kW B6034 transmitters to the BBC. These will be used to update existing transmitting stations, some of which were equipped by Marconi's in the 1930s and have given excellent service ever since.

The transmitters will be used singly to provide 50kW, in pairs to provide 100kW or in groups of three to provide 150kW outputs, and they will be installed at many of the BBC's high powered medium wave stations. When the re-equipment programme has been completed, the BBC's medium frequency United Kingdom network will be capable of fully automatic and unattended operation.



VEROKOTE LACQUER COATING

Verospeed has now expanded its range of products and service aids, available by return, with the addition of the Verokote Circuit Lacquer Aerosol.

Verokote is a one-component clear polyurethane lacquer coating, which cures on exposure to the air. It is a high performance coating, giving highly effective protection to circuit boards and electronic assemblies against adverse conditions of humidity and atmosphere pollution.

Verokote is highly durable and abrasion resistant, with excellent adhesion, and is suitable for use with all types of wire. It is available immediately from Verospeed, at £1.95 per 16oz. can. Address: Verospeed, 10 Barton Park Industrial Estate, Eastleigh, Hants. SO5 5RR.

TV ANTI-THEFT DEVICE

By S. R. Hewling

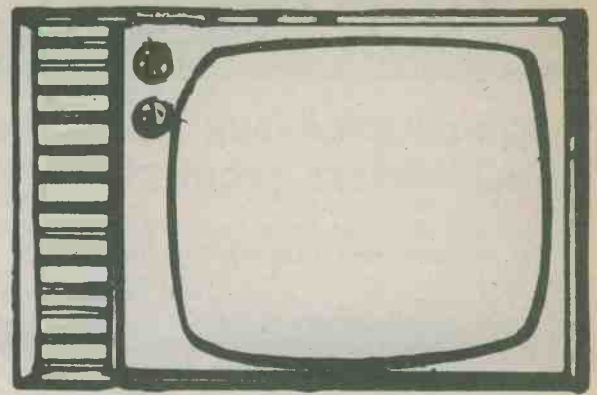

The author was rather surprised recently to learn that amongst the more common items stolen from private houses are colour television receivers. His informant also asked him for advice on the protection of these items.

Seeing that most thieves are deterred by any loud sound giving evidence of their presence

probably the best, and certainly the simplest, method of protection consists of installing an alarm circuit which causes a bell to ring if the television set is moved from its normal position. It is fairly easy to make up protection devices incorporating home-made contact sets which close when the television set is raised from the surface on which it is placed; but the most reliable approach consists of using a dry reed switch together with two permanent magnets.

DRY REED SWITCH

As most readers will be aware a dry reed switch consists, in its most common form, of two springy contacts in a cylindrical glass housing filled with an inert gas, as in Fig. 1(a). The contacts are made of a magnetic material and are normally open. If a bar magnet is brought up to the switch, as in Fig. 1(b), the contacts become magnetised. The outside contact end nearest the north pole of the magnet exhibits a south pole and the outside contact end nearest the south pole of the magnet exhibits a north pole. The inside end of each contact exhibits an opposite polarity to that at its outside end.

If the magnet is moved closer to the reed switch the intensity of the magnetic attraction between the two inside contact ends becomes sufficiently high for them to close, as in Fig. 1(c). The closure has a "snap" action: once the contact ends begin to move towards each other the magnetic attraction increases as the distance between them reduces. The contact ends are plated with a high conductivity metal, such as gold, allowing a low resistance circuit path to be provided when the switch closes.

When two magnets with opposing polarity are positioned on either side close to the reed switch, as in Fig. 2(a), their magnetic fields cancel out and the switch stays open. Taking away one of the magnets will cause the switch to be influenced by the remaining magnet only, and it will then close. This forms the basis of the television protection system.

Fig. 2(b) shows one bar magnet affixed to the base of a television receiver resting on a wooden table surface, with the reed switch and a second magnet of opposing polarity mounted under the table surface. If the television receiver is moved the second magnet takes control and causes the reed switch to close. Note that the two magnets do not have to be on opposite sides of the switch, as

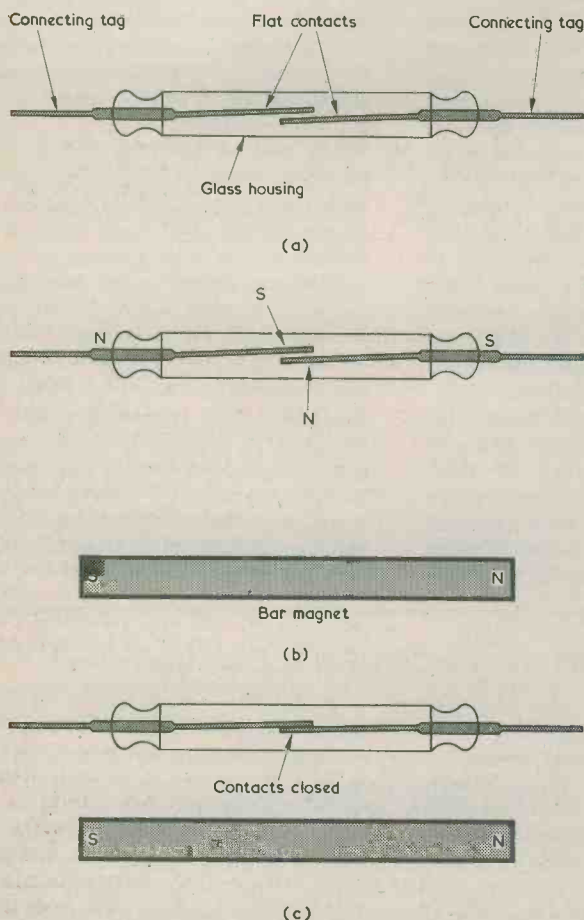

Fig. 1(a). The basic construction of a standard normally-open dry reed switch
 (b). If a bar magnet is brought up to the switch the contacts become magnetised with the polarity shown here
 (c). Bringing the magnet closer causes the contacts to snap to the closed position

they were in Fig. 2(a). The system will work if one magnet is above and the other alongside the switch, provided they are both the same distance away. Should the wooden table surface be too thick for the magnet on the television receiver base to exert sufficient control, the underside of the surface may be recessed to take the reed switch closer, as illustrated in Fig. 2(c). It will probably be unnecessary to provide a recess for the magnet underneath unless the table surface is extremely thick.

The scheme may not function if the table is covered with Formica of a heat resistant grade. Such Formica sometimes incorporates a steel shim laminate, and this would prevent the magnet above the table surface affecting the reed switch below.

SWITCHING CIRCUITS

A glance through the mail-order catalogues will show the capabilities of reed switches currently available. For instance, the "Standard" reed switch available from Maplin Electronic Supplies will handle currents up to 2 amps and could control a bell directly, as in Fig. 3(a). The series 4.7Ω3

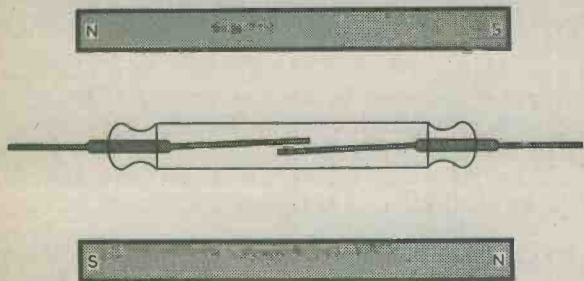

(a)

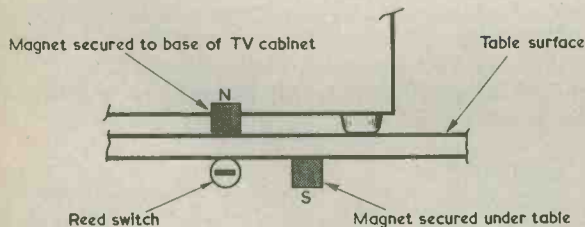

(b)

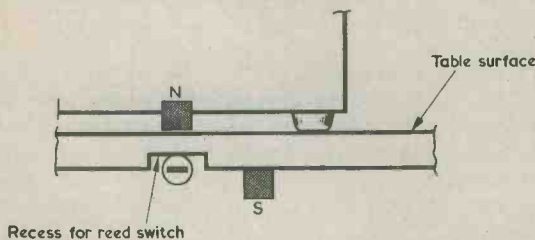

(c)

Fig. 2(a). When two magnets of equal strength and opposing polarity are positioned equal distances from the reed switch its contacts remain open

(b). One of the magnets may be secured to the base of the TV receiver being protected, the reed switch and the second magnet being under the table surface. The magnets and switch are shown end-on

(c). If the table surface is thick, a recess may be cut in the underside to take the reed switch

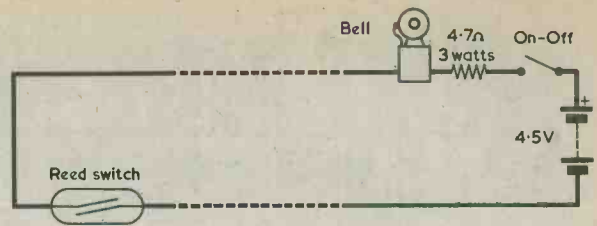

(a)

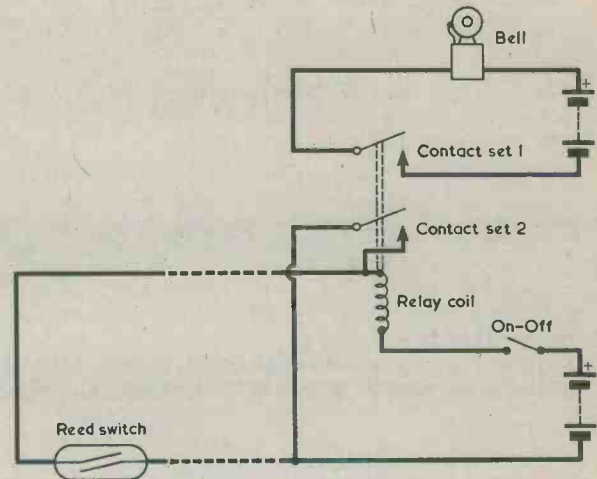

(b)

Fig. 3(a). A simple circuit which causes a bell to ring when the reed switch closes
(b). With this relay circuit the bell rings continuously after the reed switch closes and continues to do so even if the switch opens again. Battery voltages are those best suited for the bell and relay coil used

watt resistor limits maximum bell current, which can be surprisingly high with some bells, to less than 1 amp. With this circuit the bell ceases to sound if the television receiver is replaced in the same position as it had before. If a relay is introduced, as in Fig. 3(b), the switching current requirements for the reed switch are considerably reduced. Also the relay, when energised, stays energised by way of its contact set 2, and the bell will not be silenced if the television receiver is replaced. Any standard relay having two contact sets which close when energised can be employed here. Catalogues listing relays normally indicate the coil energising voltages required.

In both the circuits of Fig. 3(a) and (b), the on-off switch, bell and other components are positioned in a safe location remote from the reed switch.

The system can also be used to guard other valuable items, provided these are not made of a ferrous metal and that it is possible to affix a magnet to the base in the required position. Before carrying out any installation, check experimentally the distances between the reed switch and the magnets which give the desired switch functioning. These distances can be relatively quite high: for instance a Maplin "Magnet Large" will just operate the "Standard" reed switch from a distance of 22mm. For reliable functioning the magnets should be closer to the switch than the "just operate" distance.

SHORT WAVE NEWS

FOR DX LISTENERS



By Frank A. Baldwin

Times = GMT

Frequencies = kHz

Continuing the 90 metre-band saga (see last issue), if you can dodge the QRM and avoid the noises, why not try —

● TOGO

Lama Kara on a measured 3222 at 1912, light music European-style, OM with announcements in vernaculars.

● SWAZILAND

Trans-World Radio, Manzini, OM with a religious programme in English on 3240 at 1916.

● RWANDA

Radio Rwanda, Kigali, on 3330 at 1925, African music and folk songs.

● LIBERIA

ELWA Monrovia on a measured 3227 at 2125, African drums, YL's in chorus in the Home Service.

● SOUTH AFRICA

SABC Meyerton on 3285 at 1920, OM in Afrikaans, piano and light orchestral music.

● VENEZUELA

Radio Barcelona on 3385 at 0050, OM in Spanish, local-style music, all heard through the inevitable QRM!

Radio Universidad on 3395 at 0058, local-style dance music, OM with announcements in Spanish.

Radio Libertador on 3245 at 0338, choir with a local ballad after announcements in Spanish.

CURRENT SCHEDULES

● UGANDA

"Radio Uganda", Kampala, operates a Domestic Service in which the news in English may be heard from 1900 to 1915 and news headlines in English from 2100 to 2105 on 3340, 4976, 7195 (Red Channel) and on 5026 and 7110 (Blue Channel), Sign-off on both channels is at 2110.

● ALGERIA

"Radio of the Democratic People's Republic of Algeria", Algiers, has an External Service in which the English programme is radiated from 1800 to 1900 on 11910.

● SOMALI REPUBLIC

A programme from Mogadishu in English is on the air daily from 1100 to 1130 on 9585.

Dxers may care to listen from 1430 to 1530 when a programme in Amharic is being broadcast from Mogadishu on 9585 and from Hargeisa on 7120 and on 11645.

● NORTH KOREA

"Radio Pyongyang" currently lists two programmes in English intended for listeners in Europe, the first being from 0600 to 0750 on 9420 and 11531 and the second from 2000 to 2150 on 3560, 6575 and on 9420.

● ZAMBIA

"Radio Zambia", Lusaka, in the latest schedule lists several programmes in English. For listeners here in the U.K. try from 1800 to 1815 and from 2000 to 2005 when a newscast and a news summary respectively may be heard on 6060, 7235 and on 9580.

The Home Service (Domestic) from Lusaka features a newscast in English from 1800 to 1810 on 3295 and 4911.

The General Service (Domestic), also from Lusaka, has a newscast in English from 1800 to 1815 on 6165.

● FINLAND

"Yleisradio" — The Finnish Broadcasting Company, Helsinki, provides English programmes for listeners in Europe as follows: from 0930 to 0955 (Saturdays and Sundays only) on 9550, 11755 and on 15270; from 1300 to 1325 on 11755, 15105 and on 15260; from 1900 to 1925 on 11755 and 15265 and from 2030 to 2055 on 9550 and on 11755.

● MONGOLIA

Ulan Bator has an External Service in which programmes in English are radiated to South East Asia and the Far East (except Sundays) from 1220 to 1250 on 9575 and 11860 and from 1715 to 1745 on 8890.

● CLANDESTINE

The "Voice of the People of Malaya" (in Malay "Suara Rakyat Malaya") has programmes in Cantonese, Malay and Standard Chinese from 2130 to 0015 and from 1130 to 1530 on 7020 variable. The station is pro-Peking, anti-Malaysian Government.

The "Voice of Lebanon" (in Arabic "Huna Sawt Lebnan, Sawt al-Hurriyah wa al-Karamah" which translates as "This is the Voice of Lebanon, the Voice of Freedom and Dignity") operates to the following schedule — from 0455 to 0930 in Arabic, from 1100 to 1300 in Arabic, from 1430 to 1745 in Arabic, from 1830 to 1900 in Armenian and from 1900 to 2105 in Arabic. Of interest to Dxers in the U.K. however would be the following — from 1300 to 1430 and from 1745 to 1830 there is a Western Programme, described as mostly music but with a newscast in French at 1800 and one in English

from 1745 to 1755. All this on 6500, the station being pro-Phalangist. Both these Clandestine items are according to the BBC Monitoring Service to which due acknowledgement is made.

AROUND THE DIAL

● ECUADOR

HCJB Quito on 17865 at 1935, OM with the world news in English after station identification.

● CUBA

Havana on 17885 at 2054, Cuban songs and music YL announcer in the English programme directed to Europe, scheduled from 2010 to 2140. Also logged in parallel on 17750 at 2105 with a newscast in English and identification.

Havana on 17705 at 2036, YL with identification in the Spanish programme for the Mediterranean area, scheduled from 1840 to 2040.

● NETHERLANDS ANTILLES

Bonaire (Radio Nederland Relay) on 17810 at 1835, OM with the news in French in a programme for North and Central Africa, scheduled from 1830 to 1950 on this channel and in parallel on 15220 and 17740.

● CYPRUS

Limassol (BBC Relay) on 17885 at 0700, identification and a newscast in English.

● PAKISTAN

Karachi on 17830 at 0705, YL with song in Urdu in the World Service programme directed to South Asia, the Middle East and East Africa, scheduled from 0500 to 0815.

● NIGERIA

Lagos on 15118.5 (I carefully measured it!) at 0733, OM with the news in English, mostly concerned with local affairs.

● ROMANIA

Radio Bucharest on 15250 at 0714, OM with identification at the end of the English programme intended for the Pacific area, scheduled from 0645 to 1715. Off at 0716 without National Anthem.

● U.S.A.

Greenville (VOA) on 15235 at 0728, OM with a newscast in English, identification and off (without National Anthem) at 0730.

● AUSTRALIA

Melbourne on 15240 at 0720, OM with Australian turf results and news of other sporting events in the English programme for Europe.

● KENYA

Nairobi on 4804 at 2102, OM with the news in English. Sign-off after trumpet fanfare at 2106. This is the Home Service in English which is scheduled from 0255 (Sundays from 0330) to 0630 and from 1300 to 2010 (Saturdays 2110). The power is 1kW. Not an easy one to log.

● PAKISTAN — 2

Karachi on a measured 4736.5 at 0112, local music and a drama production in Urdu in the Home Service.

● EGYPT

Cairo on 17745 at 1840, a programme of Arabic songs and music in the "Voice of the Arabs" transmission scheduled from 1500 to 1900. Also logged in parallel on 15475.

● NETHERLANDS

Hilversum on 17700 at 1830, OM with identification and a newscast in English to Europe and Africa which is scheduled from 1830 to 1950 and also in parallel on 6020 and on 11730.

● U.S.A. — 2

WIFR Family Radio, Oakland, on 17845 at 2050, OM with identification and sign-off after the programme in English to West Africa.

● CHINA

Lanzhou on 4865 at 2131, YL with songs in Chinese followed by orchestral music in the local style.

Radio Peking on 4800 at 2108, OM in Chinese in the Domestic 1st programme scheduled here from 1103 to 1735 and from 2000 to 0100.

Radio Peking on 4850, YL in Chinese, local music in the Domestic 2nd programme scheduled here from 1403 to 1700 and from 2100 to 2400.

● NOW HEAR THIS

Radio Rwanda, Kigali, on 3330 at 0514, interval signal rendered on xylophone-sounding instrument (actually an Inanga — local harp) the theme being repeated, OM with announcements in vernacular.

Obituary

Sylvia Margolis — A Personal Tribute

Very occasionally in life one meets people of such a dynamic personality that they leave an indelible impression; such a person was Sylvia Margolis. The writer of this note had the pleasure of being one of her friends and knew something of the courage and motivation which urged her on although she knew that her life would be a short one — she died in her 50th year, on 23rd September 1977.

When, through her late husband, she first came into contact with Amateur Radio she soon realised its potential for fostering friendship, crossing barriers of race and culture, and her home became renowned for the hospitality extended to visiting amateurs from home and abroad.

She and her husband, G3NMR, worked very hard for the Amateur Radio Mobile Society and together for a number of years they produced the Society's Newsletter. For a time she was Public Relations Officer of the Radio Society of Great Britain.

Her radio amateur journalistic activities spread into other media where she popularised the hobby. Subsequently she moved into broadcasting, producing and presenting features for BBC's Radio London.

Despite her exceptionally busy life she was active in the British Red Cross and at Christmas time she would often help out at local hospitals so that her Christian friends could spend more time with their families.

We extend to her two sons our deep sympathy.

A.C.G.

CHECKING ELECTROLYTIC

How to obtain approximate indications of the values of electrolytic capacitors.

We take a known capacitor, C_1 , and charge it to a voltage, V_1 . The capacitor now holds a charge, Q , which is equal to C_1V_1 , where Q is in coulombs, C is in farads and V is in volts.

We next connect an unknown capacitor, C_2 , across C_1 , whereupon the charge spreads between the two capacitors and the voltage across them falls to a level, V_2 . We have a new capacitance, $(C_1 + C_2)$, and since the charge remains unaltered $(C_1 + C_2)V_2$ is equal to C_1V_1 . We now take a few simple steps in algebra.

$$\begin{aligned} (C_1 + C_2)V_2 &= C_1V_1 \\ C_1V_2 + C_2V_2 &= C_1V_1 \\ C_2V_2 &= C_1V_1 - C_1V_2 \\ C_2 &= C_1 \frac{V_1 - V_2}{V_2} \end{aligned}$$

In other words, C_2 is equal to C_1 multiplied by the drop in voltage and divided by V_2 .

MEASURING CAPACITANCE

This exercise provides a very simple method of finding the approximate value of an electrolytic capacitor whose markings have become obliterated or defaced. The test equipment required is an electronic or valve voltmeter, which must have a very high input resistance, and a 4.5 volt battery.

It is found in practice that a surprisingly high proportion of modern electrolytic capacitors have such low leakage current that they will retain a charge of around 5 volts for periods of time extending well beyond the 15 seconds or so required for the measurement to be described. Such capacitors may be selected by connecting them to the voltmeter, charging them to 4.5 volts by means of the battery and then disconnecting the battery. If

the voltmeter reading remains steady at 4.5 volts for at least 15 seconds then the capacitor can be used as a known C_1 .

If the unknown capacitor to be checked has not been in use for a long period it is advisable to initially connect it across the 4.5 volt battery for some 5 seconds or so to allow its electrolyte to "form" fully. The capacitor is then discharged by short-circuiting its leads.

TESTING METHOD

The testing procedure is carried out as indicated in Figs. 1 (a) and (b). The voltmeter is connected permanently across the known capacitor, C_1 . The battery is next connected across it, whereupon the voltmeter indicates approximately 4.5 volts. The battery is removed, after which the leads of the unknown capacitor, C_2 , are touched across those of the known capacitor, causing the voltage to fall. There is no need for the two capacitors to be connected together more than momentarily. The value of the unknown capacitor can then be determined from the decreased voltage indicated by the voltmeter.

Fig. 2 gives a chart, made up from the formula for C_2 found earlier, which enables the unknown capacitance to be determined in terms of V_2 and C_1 . If, for instance, C_1 is $100\mu\text{F}$ and the voltage falls to 1.5 volts, the unknown capacitance is $200\mu\text{F}$. Should the voltage fall to 3.2 volts the unknown capacitance is $40\mu\text{F}$. For ease of calculation it is preferable that C_1 be a $10\mu\text{F}$, a $100\mu\text{F}$ or a $1,000\mu\text{F}$ component.

Obviously, the readings obtained are very approximate because C_1 is itself an electrolytic capacitor with its own wide tolerance on nominal

Fig. 1 (a). C_1 , whose capacitance is known, is connected to a very high resistance electronic voltmeter. It is charged to 4.5 volts by temporarily connecting a 4.5 volt battery (b). When an unknown capacitor, C_2 , is touched across C_1 , the voltage across the latter drops.

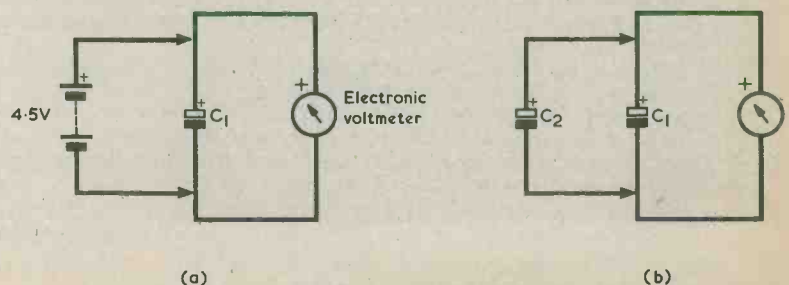

CAPACITORS

By R. V. Smithson

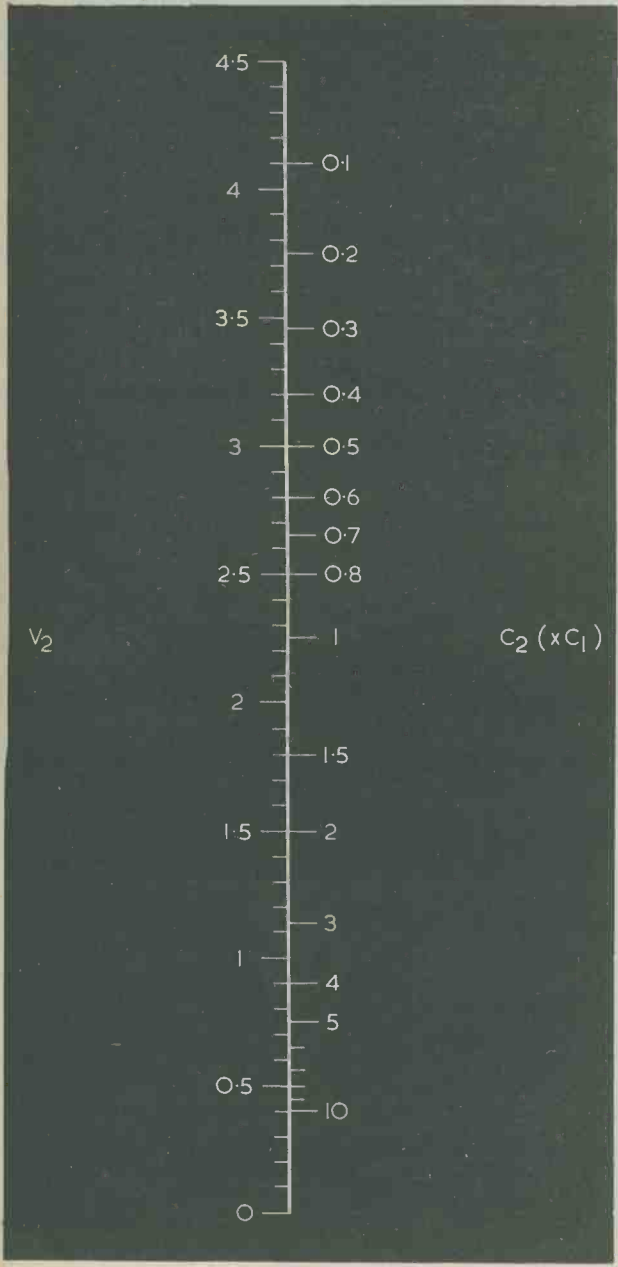

Fig. 2. This chart shows the value of C_2 in terms of C_1 and the final voltage across C_1

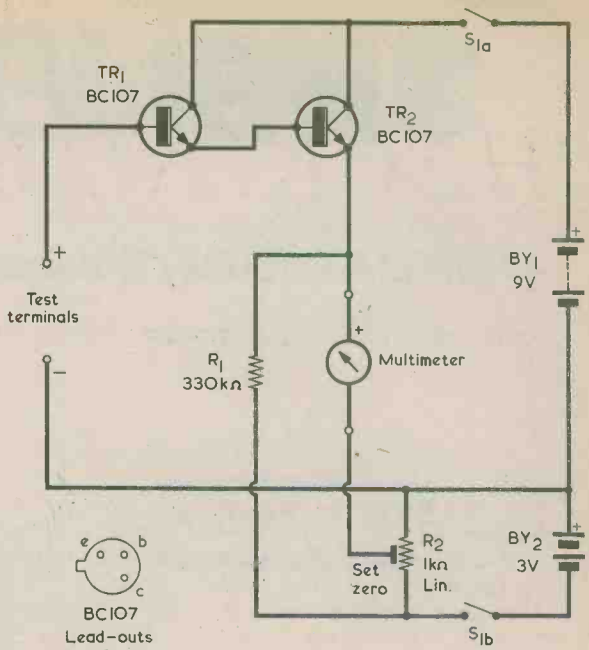

Fig. 3. A very simple electronic voltmeter can be used as shown here. The multimeter reading is almost exactly equal to the voltage across the test terminals. S_1 (a) (b) is the on-off switch

value. But we are using one wide tolerance component to check another wide tolerance component, and the approximations are acceptable for most practical purposes. The working voltage of the capacitors being checked will in many instances be considerably higher than the 4.5 volt test voltage, but this fact will not invalidate measurements to any serious extent.

VOLTMETER

The capacitance test requires that the electronic voltmeter has a very high input resistance and such a voltmeter may not be readily available to many readers. Also, many electronic voltmeters which could offer a very high input resistance still have a resistive potential divider at the input which prevents their use in the present application.

A very simple electronic voltmeter which can be pressed into service is shown in Fig. 3. This basic circuit has appeared several times in previous projects in this journal and, with virtually all BC107 transistors likely to be encountered, offers an exceptionally high resistance across the test terminals. The meter in the emitter circuit of TR2 is a multimeter having a resistance of 10,000 Ω per volt or better which is switched, ideally, to a 0-10 volts range. The circuit is set up initially by connecting the two test terminals together and then adjusting R2 for a zero voltage reading in the meter. The meter then gives voltage readings which are almost exactly equal to the voltages applied to the test terminals.

THE 'DUETTE' S

Simple Circuitry incorporating LM377 I.C.

High

By R. A. Penfold



Although the stereo amplifier to be described uses fairly simple circuitry it is capable of producing a very high quality output. An unusual feature is the use of a single i.c. in the power amplifier stages of both channels, this being an LM377 dual power amplifier. This interesting device will provide an output of up to 2 watts r.m.s. per channel continuously at a total harmonic distortion level at 1kHz of typically only 0.1%. An intermittent output power of 3 watts r.m.s. per channel can be achieved, and there is no danger of damaging the device by overloading as it incorporates both thermal and output short-circuit protection circuitry.

The distortion level of the amplifier as a whole is quite low, and is typically only about 0.4% at an output level of 2 watts r.m.s. Three inputs are provided and these are for crystal or ceramic cartridge, for tuner and for tape deck. The approximate input sensitivities and impedances of these inputs are, respectively, 50mV into 1M Ω , 200mV into 100k Ω and 500mV into 100k Ω . These input sensitivities are all for an output power of 2 watts r.m.s. The output is for 8 Ω impedance speakers and a socket for a pair of stereo headphones is also provided. The output noise level is extremely low, being -63dB in the tape and tuner modes and -60dB in the gram mode, with volume at maximum, tone controls adjusted for a flat response and input open-circuit. These figures are unweighted and referred to a 2 watt r.m.s. output level.

The circuit and initial construction of these will be completed in next

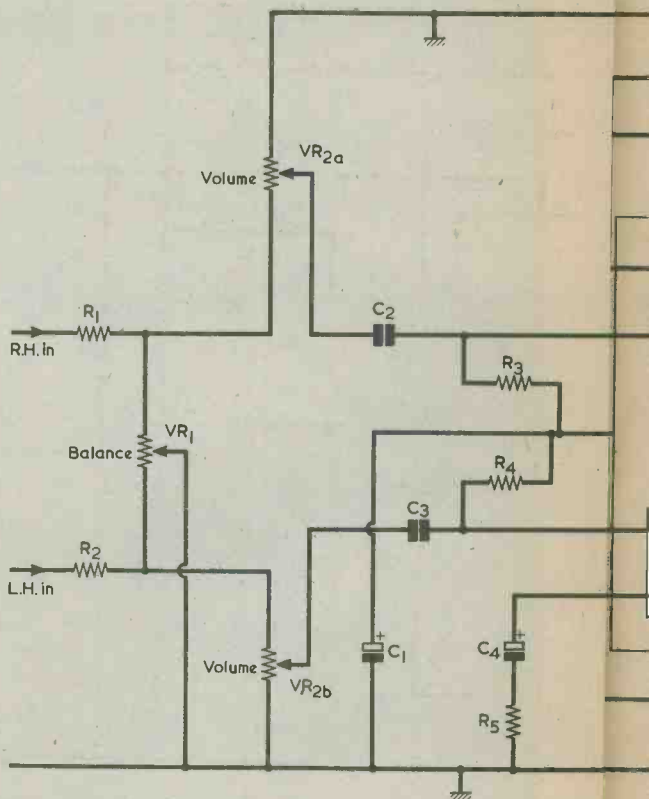

Fig. 1. The circuit of the power amplifier section of the unit. The circuit feeds 1 out

POWER AMPLIFIERS

The circuit of the power amplifier section of the unit is shown in Fig. 1. Here R1, R2 and VR1 form a conventional balance control circuit from which the input signals are applied to the dual volume control, VR2(a) (b). Capacitors C2 and C3 provide d.c. blocking between the sliders of VR2(a) (b) and the non-inverting inputs of the amplifiers contained in the LM377.

STEREO AMPLIFIER

Quality Suitable for Gram., Tuner and Tape inputs

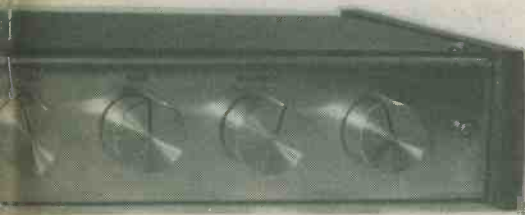

al steps are described this month, and next month's concluding article.

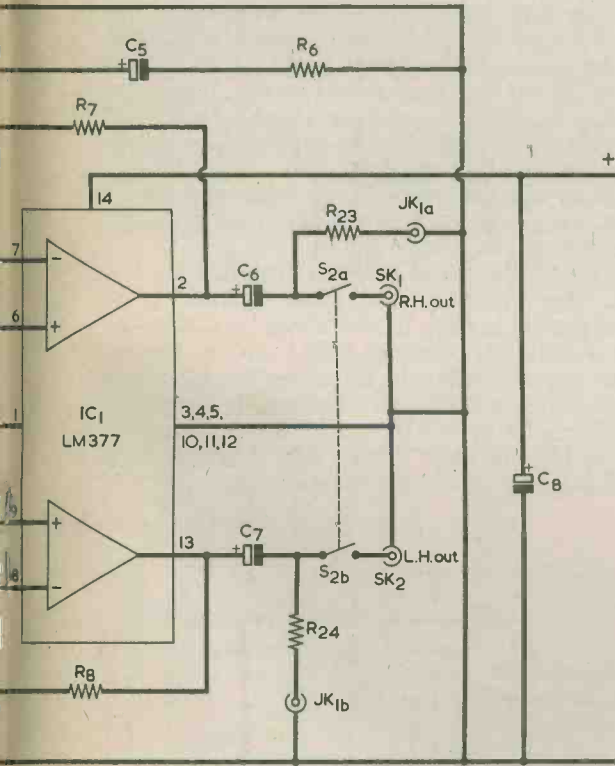

of the stereo amplifier. The single LM377 integrated with output channels

These amplifiers are rather like operational amplifiers in that they have both inverting and non-inverting inputs. The amplifiers are intended to be used in the non-inverting mode, which is the case here. The input impedance at each input is very high and virtually 100% negative feedback at d.c. is applied over the amplifiers by R7 and R8. This means that the d.c. voltage gain of the circuit is almost exactly unity, and that the non-inverting input and output voltages will be virtually identical. The quiescent output voltage of each amplifier needs to be about half the supply rail voltage, and this can be achieved by connecting the non-inverting inputs to a potential divider which provides a suitable voltage. Such a circuit is contained within the i.c., and its output is available at pin 1. This bias voltage is coupled to the amplifiers by R3 and R4; although these resistors have quite high values very little voltage is dropped across each of them due to the very high input impedances of the amplifiers. The input impedance of each power amplifier circuit is approximately equal to the value given to the input bias resistor. C1 is needed to prevent cross-talk between the channels due to coupling through R3 and R4, and it also smooths out any hum or noise which would otherwise be transmitted from the supply lines to the inputs via the bias circuitry.

Whilst unity gain at d.c. through each amplifier is convenient from the biasing point of view, it is of course totally inadequate for signal amplification. Therefore, at a.c. some of the feedback must be decoupled in order to provide a reasonable level of signal voltage amplification. This is the purpose of C4 and R5, and of C5 and R6. The capacitors provide d.c. blocking and the resistors limit the amount of a.c. feedback which is decoupled. The signal voltage gain of each amplifier is equal to the value of the feedback resistor divided by the value of the feedback limiting resistor, and is approximately 45 times.

C6 and C7 are the output d.c. blocking capacitors, and S2(a) (b) enables the output to the

Fig. 2. Pre-amplifier circuit for one channel, the other channel being identical. The decoupling components, R17 and C9, are common to both channels

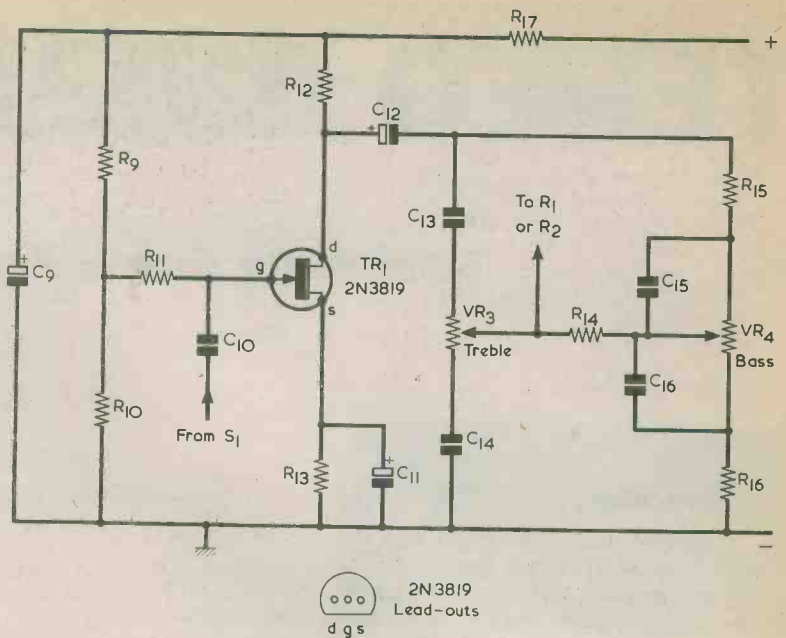

speakers to be cut. The speakers may then be muted when headphones are being used. R23 and R24 are connected between the output of the amplifier and the headphone jack, and they attenuate the output to a level which is suitable to drive any normal stereo headphones. Without these resistors there would be the possibility of the headphones being damaged by an excessive output level, and under normal operating conditions the volume control would have to be turned almost to minimum. This last point is important because the output noise level does not alter much with changes in volume control setting and so on, with the volume control set towards minimum, only a comparatively poor signal-to-noise ratio would be produced for headphone listening. Attenuating the headphone output makes it necessary to considerably advance the volume control in order to obtain an adequate volume level, and thus the problem is eliminated.

PRE-AMPLIFIER

The circuit of the pre-amplifier and tone control network for one channel is given in Fig. 2. The tone control network is a passive circuit of quite conventional design. With reference to 1kHz it provides about 12dB of boost and cut at 100Hz and 10kHz. VR3 is the treble control and VR4 is the bass control. When the tone controls are adjusted for a flat response the -3dB points are at approximately 50Hz and 30kHz.

About 88mV r.m.s. is needed at the input of the power amplifiers in order to produce an output level of 2 watts, but losses in the tone controls reduce the sensitivity of the circuit by almost 10 times. The pre-amplifier must, therefore, provide an output level of about 50mV r.m.s., and it must have a high input impedance if it is to provide satisfactory results when used with a crystal or ceramic cartridge. These usually require a load impedance of about 1MΩ, as a significantly lower load impedance would result in a loss of bass response.

The high input impedance and modest voltage gain which are needed can be obtained by using a

Jugfet common source amplifier, and TR1 forms the basis of such a stage. Two good features of an f.e.t. amplifier such as this are that it provides a low noise level and good linearity.

Offset gate biasing is used, and the required gate bias voltage is produced by the potential divider consisting of R9 and R10. This voltage is fed to the gate of TR1 through R11. The input impedance of TR1 is very high but R11 shunts this and reduces the input impedance of the circuit to about 1MΩ. R13 is the source bias resistor and C11 its bypass capacitor. R12 is the drain load resistor. Input and output d.c. blocking is provided by C10 and C12 respectively. R17 and C9 give supply decoupling. Although quite a high peak-to-peak output level is produced by the pre-amplifier, it is powered by a comparatively high supply voltage, and it has an overload margin of about 18dB.

Fig. 3 shows the input selector circuitry for one channel. The circuit for the other channel is, of course, identical to this. In the 'Gram' position the selector switch, S1, connects SK3 direct to the input of the pre-amplifier. In the other two positions the input signal is attenuated prior to being fed to the pre-amplifier. R18 and R19 form the attenuator for the tuner input, and R20 and R21 form the attenuator for the tape input.

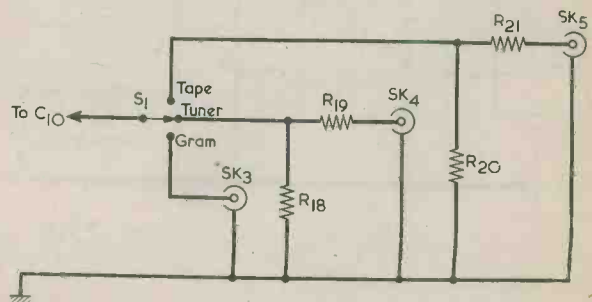
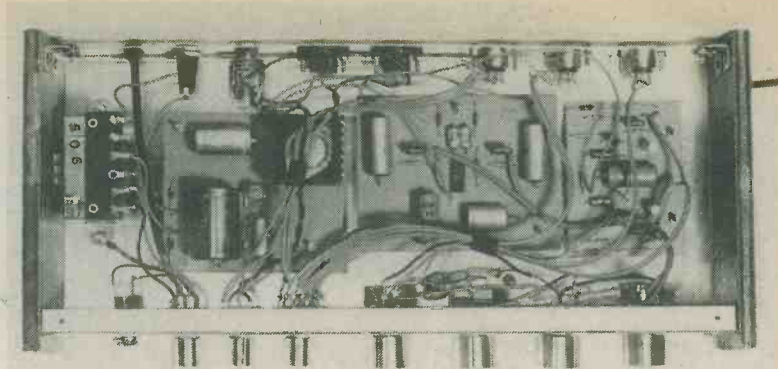

Fig. 3. The input switching circuitry for one channel. Again, the other channel is identical

The sections of the amplifier are assembled on three printed circuit modules, for which there is comfortable space inside the cabinet



POWER SUPPLY

The circuit of the power supply section is given in Fig. 4. S3(a) (b) is the on-off switch and LP1 is the mains indicator. This is a panel mounting neon assembly which must have an integral series resistor for mains operation. T1 is a mains transformer with a 9-0-9 volt secondary, but in this application the secondary centre-tap is ignored and the full secondary winding feeds a bridge rectifier via fuse FS1. C17 smooths the output of the rectifiers, and under quiescent conditions about 28 volts appears across this component. This is too high to connect direct to the power amplifier circuit as the LM377 has an absolute maximum supply voltage rating of 26 volts.

A simple regulator circuit is used to reduce the output voltage to about 20 volts. The circuit also provides electronic smoothing of the supply voltage, and it helps to give the unit a negligible level of hum at the output. A conventional series regulator circuit is employed, with R22, D5 and C18 producing a stabilised potential of 22 volts which is fed to the base of TR2. TR2 and TR3 are connected as a Darlington pair emitter follower, and they therefore provide unity voltage gain between the input base and output emitter. The

output at TR3 emitter is at a low impedance and can supply the fairly high currents required by the power amplifiers. Approximately 1.6 volts is dropped across the base-emitter junctions of TR2 and TR3, and so an output potential of a little over 20 volts is produced. C19 provides final smoothing of the output.

COMPONENTS

Some comments need to be made concerning components. S1 is a 4-pole 3-way miniature rotary switch, of which only two poles are employed. S2 and S3 are d.p.d.t. rotary switches intended for mains switching. These are available rated at 4 amps at 250 volts a.c. The mains transformer is an Osmabet type MT9V, and this is listed by Home Radio.

The LM377 i.c. is available from several suppliers including Maplin Electronic Supplies. A special vaned TO3 heat sink is required for TR3, and this can also be obtained from Maplin Electronic Supplies. The amplifier is assembled in a BEC case type GB1 which is retailed by H.M. Electronics, 275a Fulwood Road, Sheffield, S10 3BD. This has dimensions of 14in. by 6in. by 2in., and its general appearance can be judged from the

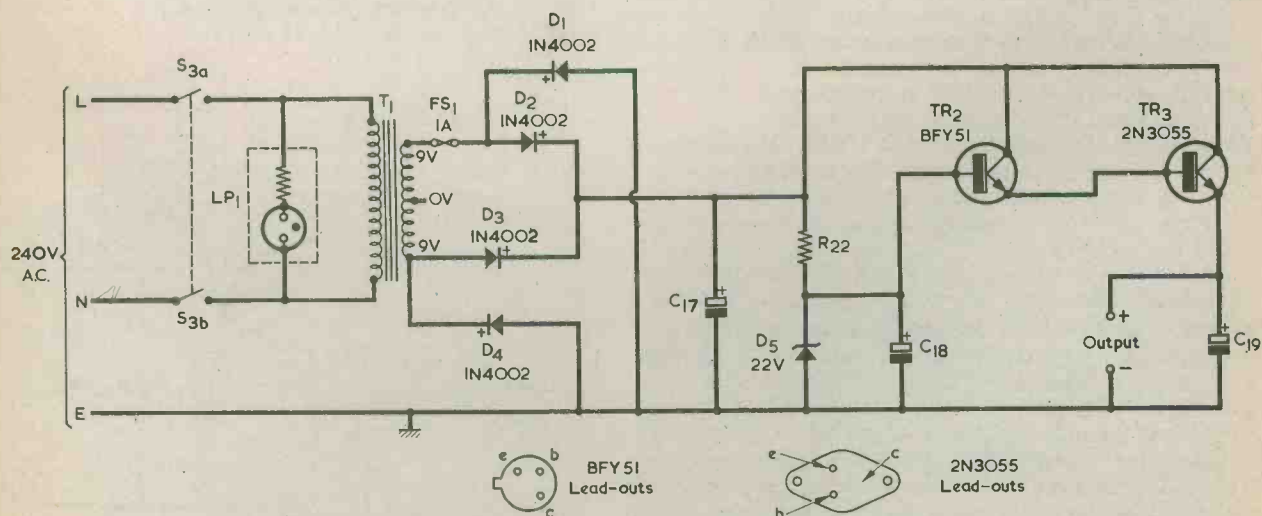

Fig. 4. The circuit of the power supply section. This offers an output of approximately 20 volts for both the power amplifier section and the pre-amplifiers

COMPONENTS

Resistors

(All fixed values $\frac{1}{4}$ watt 10%)

- R1 150k Ω
- R2 150k Ω
- R3 1M Ω
- R4 1M Ω
- R5 2.2k Ω
- R6 2.2k Ω
- R7 100k Ω
- R8 100k Ω
- R9, R9(a) 33k Ω
- R10, R10(a) 5.6k Ω
- R11, R11(a) 1M Ω
- R12, R12(a) 4.7k Ω
- R13, R13(a) 4.7k Ω
- R14, R14(a) 39k Ω
- R15, R15(a) 82k Ω
- R16, R16(a) 8.2k Ω
- R17 1k Ω
- R18, R18(a) 27k Ω
- R19, R19(a) 82k Ω
- R20, R20(a) 10k Ω
- R21, R21(a) 100k Ω
- R22 820 Ω
- R23 120 Ω
- R24 120 Ω
- VR1 2M Ω potentiometer, linear
- VR2 1M Ω dual gang potentiometer, log
- VR3 220k Ω dual gang potentiometer, linear
- VR4 220k Ω dual gang potentiometer, linear

Capacitors

- C1 330 μ F electrolytic, 16 V. Wkg.
- C2 0.1 μ F type C280 (Mullard)
- C3 0.1 μ F type C280 (Mullard)
- C4 6.8 μ F electrolytic, 16 V. Wkg.
- C5 6.8 μ F electrolytic, 16 V. Wkg.
- C6 680 μ F electrolytic, 16 V. Wkg.
- C7 680 μ F electrolytic, 16 V. Wkg.
- C8 100 μ F electrolytic, 40 V. Wkg.
- C9 100 μ F electrolytic, 25 V. Wkg.
- C10, C10(a) 0.1 μ F type C280 (Mullard)
- C11, C11(a) 10 μ F electrolytic, 10 V Wkg.
- C12, C12(a) 2.2 μ F electrolytic, 25 V. Wkg.
- C13, C13(a) 470pF polystyrene
- C14, C14(a) 0.0047 μ F polystyrene
- C15, C15(a) 0.0022 μ F polystyrene
- C16, C16(a) 0.022 μ F type C280 (Mullard)
- C17 1,500 μ F electrolytic, 30 V. Wkg.
- C18 47 μ F electrolytic, 40 V. Wkg.
- C19 1,000 μ F electrolytic, 25 V. Wkg.

Transformer

- T1 Mains transformer, secondary 9-0-9V at 1A, type MT9V (Osmabet)

Semiconductors

- IC1 LM377
- TR1, TR1(a) 2N3819
- TR2 BFY51
- TR3 2N3055
- D1-D4 1N4002
- D5 BZY88C22V

photographs. It is available completely assembled or in a D.I.Y. version, and the author employed the D.I.Y. version. H.M. Electronics can also supply the case with front and rear panels already punched for the controls and sockets, etc. This version has the neon indicator hole unpunched, its position being marked by a centre-punch.

If difficulty is experienced in obtaining C17 with the value specified it may consist, at the loss of some neatness, of a 1,000 μ F and a 500 μ F (or 470 μ F) capacitor in parallel. The two capacitors can be connected together above the printed board to which C17 is fitted.

The headphone output socket, JK1, should have an open construction, i.e. be not an insulated type, as it is necessary to obtain a chassis connection for the speaker sockets from its bush tag. With stereo sockets, incidentally, the tip of the jack plug is normally the left hand channel and the ring the right hand channel.

In the Components List there are 2-off of some parts, when these are duplicated in the two channels. The second component is then given the suffix '(a)'. There are, for example, two 33k Ω resistors, these being R9 and R9(a).

CONSTRUCTION

The drilling of the front and rear panels of the case is illustrated in Fig. 5, and this is mainly self-explanatory. The positions of the 6BA clear mounting holes for SK1 to SK5 are marked after the larger mounting holes have been made, using the sockets as templates. The input sockets are 5-

Neon Indicator

- LP1 Panel mounting neon indicator with integral resistor, 250V a.c.

Fuse

- 1A 20mm.

Switches

- S1 4-pole 3-way miniature rotary
- S2 d.p.s.t. rotary, 4A at 250V a.c.
- S3 d.p.s.t. rotary, 4A at 250V a.c.

Sockets

- SK1 2-way speaker socket, DIN
- SK2 2-way speaker socket, DIN
- SK3 5-way 180 degree socket, DIN
- SK4 5-way 180 degree socket, DIN
- SK5 5-way 180 degree socket, DIN
- JK1 3-pole stereo jack socket, $\frac{1}{4}$ in. (see text)

Miscellaneous

- BEC case type GB1 (see text)
- 4 large control knobs
- 3 small control knobs
- Heat sink for TR3 (see text)
- 20mm. panel mounting fuse holder
- Materials for printed boards
- Twin stereo screened cable
- 3-core mains lead
- Screws, nuts, solder tags, etc.

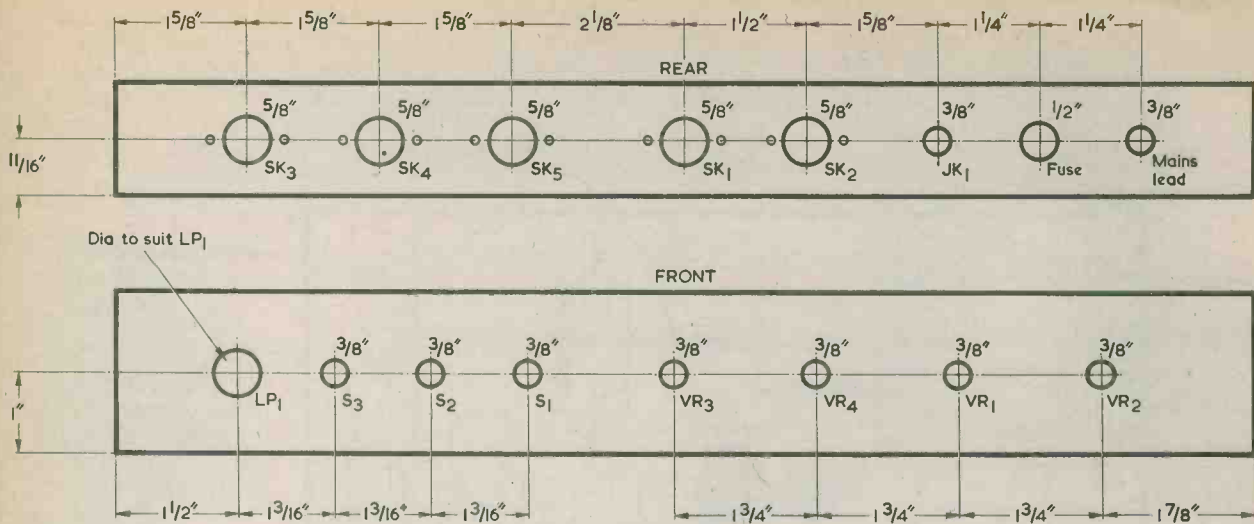

Fig. 5. Drilling details for the rear and front panels of the case

way 180 degree DIN types, and the output sockets are 2-way DIN speaker types. These sockets are all mounted by means of short 6BA bolts and nuts.

Reference to the accompanying photographs will show the general layout in the interior of the case. The mains transformer is mounted on the extreme left hand side of the case (as seen from the front) using two short 4BA bolts and nuts. A solder tag is secured under the front mounting nut and this provides the chassis connection for the mains earth lead. Most of the circuitry is assembled on three printed circuit boards. The one next to the mains transformer contains the power supply components, the one in the centre is for the power amplifiers, and the pre-amplifier circuitry is constructed on the third panel which is furthest away from the transformer. The mounting bolts for the transformer and boards have their heads on the underside of the chassis. The holes are marked out using the transformer and boards, after completion, as templates. The tone control and input selector circuits use point-to-point wiring on the control tags.

POWER AMPLIFIER BOARD

Details of the component layout and the copper pattern of the power amplifier circuit board are provided in Fig. 6. This diagram is reproduced actual size so that it can be easily copied. The board is prepared and wired up in the usual manner, and the three mounting holes are drilled for 6BA clearance.

The corresponding mounting holes in the chassis are then marked out with the aid of the board and are similarly drilled 6BA clearance. Spacers about 1/2 in. long are used over the mounting bolts, between the panel and the chassis, so that the connections on the underside of the panel are clear of the metal case. The chassis connection to the panel is made via these spacers, which should be metal. The panel must be wired up to the rest of the unit before it is finally mounted.

Some of the point-to-point wiring associated with the power amplifier is shown in Fig. 6. In addition to this, the tags of SK1 and SK2 which do not connect to S2 are earthed at the appropriate tag of the headphone jack socket. It is worth noting

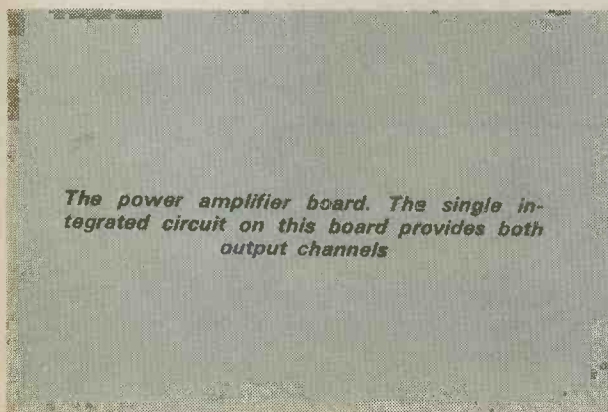

The power amplifier board. The single integrated circuit on this board provides both output channels



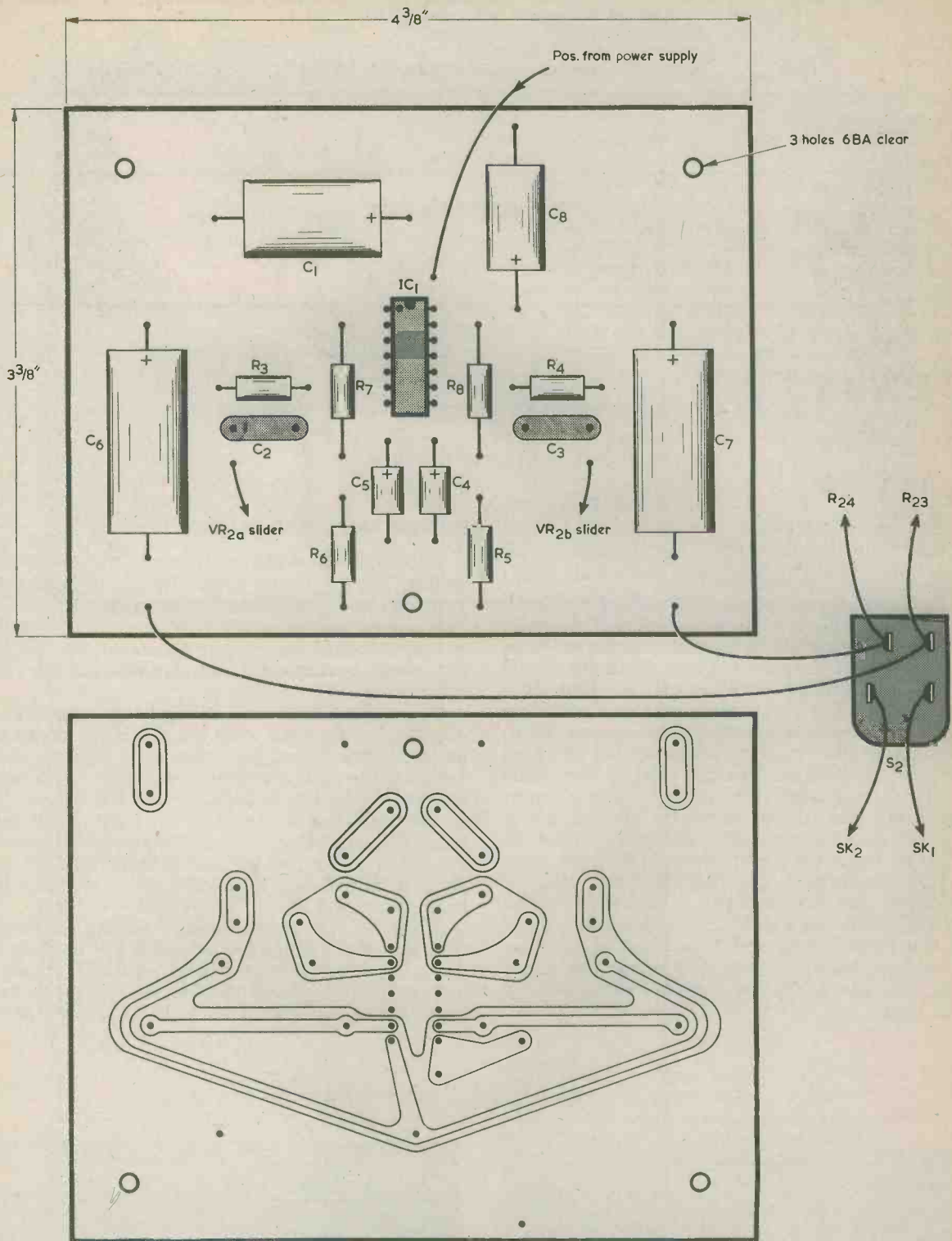

Fig. 6. The component and copper sides of the power amplifier board. This is reproduced full size

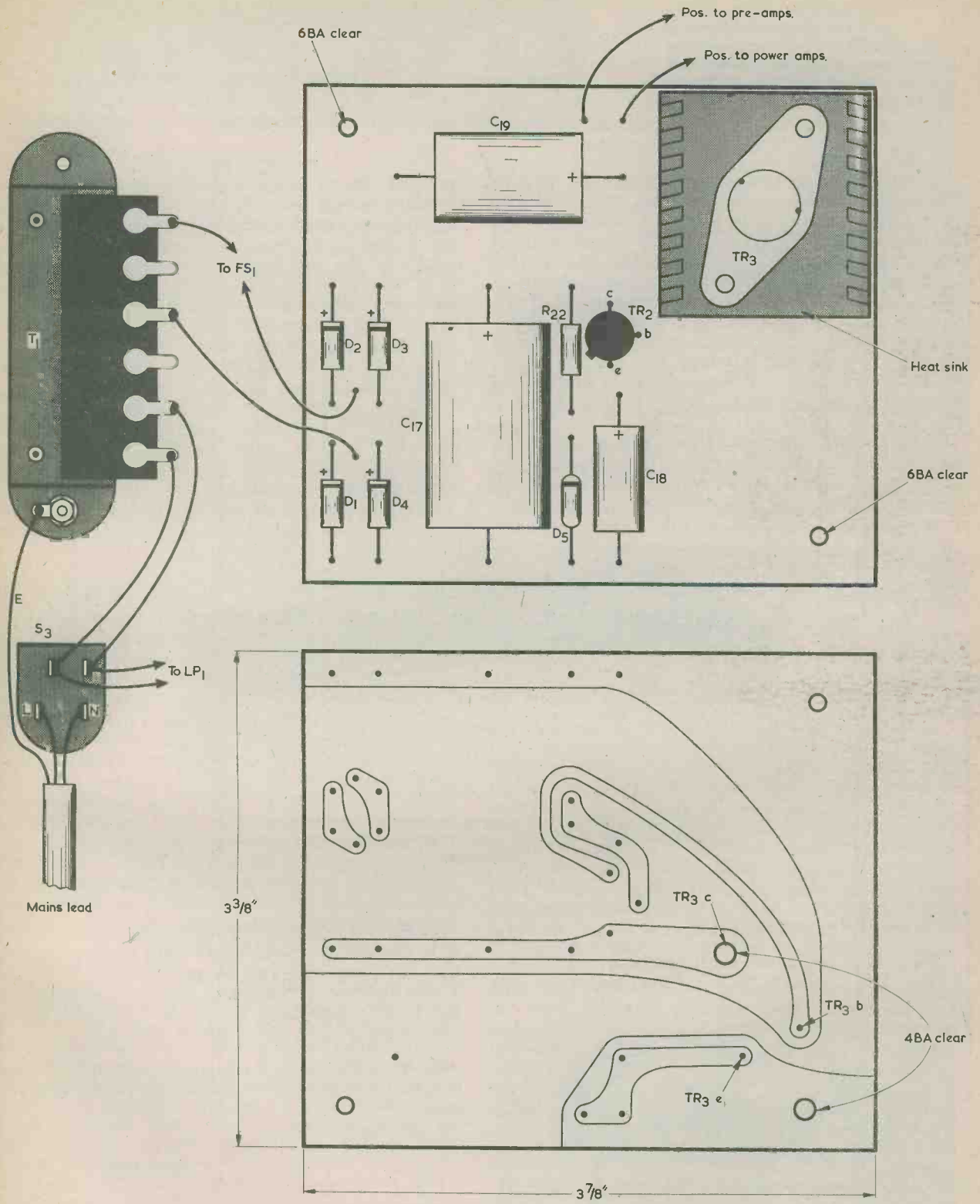
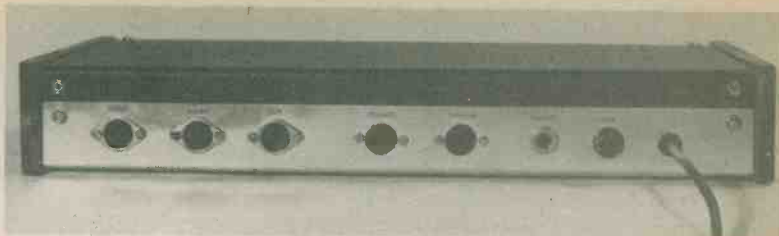

Fig. 7. How the power supply board is constructed. TR3 collector connects to the copper print by way of one of its mounting bolts

The amplifier rear panel. On this are fitted the input and speaker output sockets, the headphone jack socket and the power supply fuse



that the output sockets must be connected up with the same phasing, or the finished set-up will not provide a correct stereo image. Therefore, if the round connector of SK1 connects to chassis and the flat one connects to S2, then SK2 must be wired up in the same manner. R23 and R24 are mounted on the headphone socket. Before wiring up S2 check its tag functions with the aid of a continuity tester to ensure that the switching agrees with the circuit of Fig. 1. This will obviate the risk of short-circuiting the two outputs together, should the switch have a different tag layout to that shown in Fig. 6.

A twin stereo screened cable is used between the panel and the volume control. The outer braiding of its leads connects to the two relevant tags of the volume control.

printed circuit board assembly is quite straightforward except that TR3 and the vared TO3 heat sink are mounted on the panel. These components are bolted in position using short 4BA bolts and nuts with the bolt heads on the copper side, and it is by way of one of these bolts that the connection between TR3 collector and the printed board is made. The emitter and base pins of TR3 are cut short and soldered into circuit in the normal way. They must not be left long or they will short-circuit to the chassis when the board is mounted.

All the power supply wiring is shown in Fig. 7, and when this has been completed the panel is mounted in the same fashion as the power amplifier board, using $\frac{1}{2}$ in. metal spacers which similarly take the chassis connection to the board.

There is only small spacing between the mains



The stereo amplifier is housed in a shallow commercially available cabinet, thereby combining ease of construction with optimum presentation

POWER SUPPLY BOARD

Details of the power supply circuit board and wiring are given in Fig. 7. Construction of the

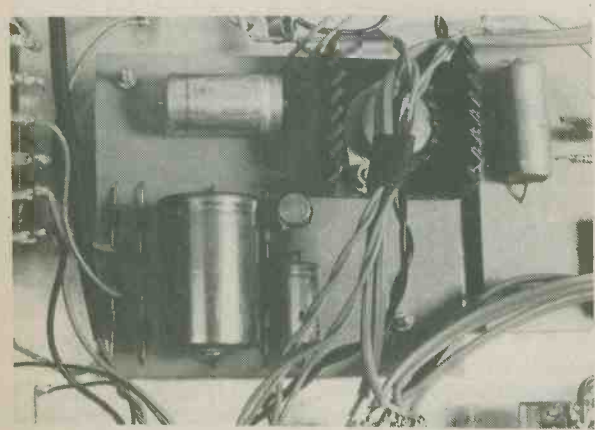

The power supply board. The output emitter follower, TR3, is mounted on its own individual heat sink

transformer tags and the underside of the case top. It is necessary, therefore, to have positive insulation here and this can be provided by wrapping several layers of insulating tape around and over the transformer tags, the solder joints at which should be smooth and without spikes.

As with S2, check the tag functions of S3 with a continuity tester before wiring up to this component.

NEXT MONTH

In next month's concluding article constructional details will be given for the assembly of the pre-amplifier board, which measures $3\frac{1}{2}$ in. by $2\frac{1}{2}$ in. This will be followed by a description of the input and tone control wiring and notes on the use of the amplifier with crystal or ceramic cartridges having a high output.

(To be concluded).

HISS FROM THE ACTIVE SUN

by Ron Ham

This article describes the activities of a small group of British amateurs who succeeded, in the later 1930's, in identifying radio signals emanating from the sun

Soon after the war it became known that radio noise associated with sunspots had been detected by British radar receivers working between 60 and 80MHz in February 1942. Since 1946 consistent solar observation has proved that, when sunspots are present accompanied by strong metre wave radio noise, we can expect an aurora or an ionospheric disturbance or both to occur and upset the normal paths of our terrestrial radio signals.

RECEIVER NOISE

The background noise produced by a receiver when no signals are present is partly caused by the movement of electrons within the wiring and components of the set itself. In the days of the thermionic valve, which served radio for more than fifty years, a lot of noise, including shot noise and induced grid noise, was generated inside the valve itself and by the currents which flowed through its associated components. Now that semiconductors have replaced the valve, receivers are much quieter, because solid state devices are far less noisy themselves and require very little current to drive them. Unfortunately the noise produced by heavenly bodies is similar to receiver background noise therefore, in the case of a radio telescope, receiver noise must first be measured so that any incoming celestial noise can be identified and its amplitude estimated.

Although the war-time detection of solar radio waves was not made public until 1945 records exist to show that members of the RSGB's pre-war Radio and Experimental Section had known about their existence since 1935. Radio amateurs are always keen to investigate something new, and in those days they quickly learnt that short wave communication was exciting because it is so vulnerable to natural disturbances, and they wanted to know why.

THE DISCOVERY

Periodically during 1935 Denis Heightman, G6DH, the most prominent member of the 28MHz propagation group (a section of the RES) heard a strange hissing sound above the background noise of his 10 metre band receiver. Denis consistently observed that this sound only occurred during daylight hours and frequently preceded some form of radio disturbance, and he rightly concluded that the hissing noise was coming from a solar event.

On January 1st 1936 another experienced radio operator, Miss Nell Corry, G2YL, became author of the 28MHz reports published in *The T & R Bulletin* (then the monthly journal of the RSGB). These reports were backed up with diaries in which she kept a daily record of 28MHz happenings received from radio amateurs in many parts of the world. From the entries in Nell's diaries, which now form a part of the author's collection, and her journal reports during the period 1936 to 1939 inclusive, the author found that twenty-four radio amateurs had reported hearing the hissing noise and, furthermore, that it was not confined to 28MHz. The diaries also revealed that during this four year period hissing was reported on 107 days, signal fade-outs on 140 days, aurorae on 53 days and "echoing" on signals on 26 days.

Visual reports of solar activity were supplied to the group by Mr. Newbegin (an astronomer from Worthing, Sussex), *Wireless World* and amateur transmitter G5JH, but when the skies were overcast sunspots or prominences may have gone by unrecorded. However, in 1936 Denis Heightman, Nell Cory and their associates showed that radio (unaffected by cloudy skies) could observe the active sun.

In 1936 and 1937 Denis Heightman told the technical world about his important discovery in a letter published in *Wireless World* for April 10, 1936, in a comprehensive article in *The T & R Bulletin* and in letters to Professor (later Sir) Edward Appleton, and in 1938 to Dr. J. R. Dellingner of the U.S. National Bureau of Standards and Dr. Richardson of Mt. Wilson Observatory.

IN THE 5 METRE BAND

An entry in Miss Corry's diary on July 31, 1938 revealed that Miss Barbara Dunn, G6YL, had heard the hissing sound in the 5 metre band at 56MHz and her valuable report was confirmed by 2BIL (AA Licence, no G), and published in an article written by E. J. Williams G2XC, for *The T & R Bulletin* of July 1939. Miss Dunn's report meant that radio amateurs were able to tell the astronomers that radio noise from the active sun could be heard as high as 56MHz.

Further evidence of hissing in the 5 metre band came from Denis Heightman, who observed it on June 25, 1939. Unfortunately, the war curtailed the work of most amateur radio observers and science temporarily lost a radio monitoring service. It was in February 1942 that solar noise, just above 56MHz, was observed again, but this time it was the sensitive receivers of British radar that detected it.

POWERFUL TRANSMITTER

The sun has been a powerful transmitter of radio waves for millions of years, but this fact was not discovered until man was clever enough to make a radio receiver and, then, not until this art was about thirty-five years old.

For more than forty years both Nell Corry and Denis Heightman devoted much of their lives to the study of radio communication. Amongst their many individual achievements the best ever must be their detection and identification of the hissing radio noise which came from the sun, 93 million miles away. ■

RADIO & ELECTRONICS CONSTRUCTOR

NEXT MONTH'S SPECIAL FEATURES

THE 'CASCODE' MEDIUM AND LONG WAVE PORTABLE

- DOUBLE REFLEX CIRCUIT
- AN UNUSUAL AND IN-GENIOUS DESIGN
- USES 3 TRANSISTORS TO GIVE A 5-STAGE PERFORMANCE

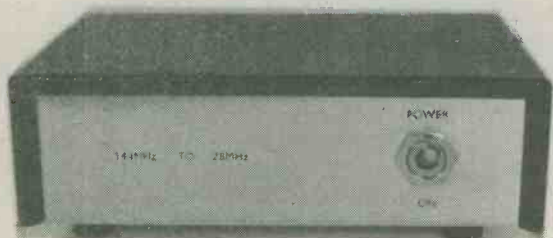

2 METRE CONVERTER

A crystal controlled unit converts the 2 metre amateur band to a range of 28 to 30 MHz, thereby permitting 2 metre reception on a standard short wave receiver.

COUNTDOWN!

This circuit will display the number 9 on a read-out when a push-button is pressed, and will then countdown to zero when the button is released. — Blob-a-Job No. 8

MANY OTHER ARTICLES

ON SALE 2nd JANUARY

Avoid disappointment. ORDER NOW

BACK NUMBERS

For the benefit of new readers we would draw attention to our back number service.

We retain past issues for a period of two years and we can, occasionally, supply copies more than two years old. The cost is 58p, inclusive of postage and packing..

Before undertaking any constructional project described in a back issue, it must be borne in mind that components readily available at the time of publication may no longer be so.

VOLTAGE CONTROLLED OSCILLATOR

By R. Webber

Multivibrator frequency can be directly controlled by voltage.

Voltage controlled a.f. oscillators have useful applications in electronic music and the like, and in themselves they represent interesting circuit developments. It is possible to voltage control the frequency of a multivibrator; very few components are required and circuit operation is readily understood.

MULTIVIBRATOR

The circuit of a voltage controlled multivibrator appears in Fig. 1, the control voltage being selected by adjusting VR1. As may be seen from the Components List, the multivibrator is symmetrical. A 6 volt supply is specified in order that the maximum reverse base-emitter voltage ratings of the BC107's used for TR2 and TR3 are not exceeded. Where gain selected transistors are available TR2 and TR3 can be BC107B, although their gain requirements are not at all critical in practice. The same comment applies to the emitter follower, TR1.

COMPONENTS

Resistors

(All fixed values $\frac{1}{4}$ watt 5%)

R1 4.7k Ω

R2 10k Ω

R3 10k Ω

R4 4.7k Ω

VR1 10k Ω potentiometer, linear

VR2 4.7k Ω or 5k Ω pre-set potentiometer, skeleton.

Capacitors

C1 100 μ F electrolytic, 10 V. Wkg.

C2 0.047 μ F polyester

C3 0.047 μ F polyester

C4 0.01 μ F polyester

Transistors

TR1 BC107

TR2 BC107

TR3 BC107

Socket

SK1 coaxial or jack socket

Switch

S1 s.p.s.t. toggle

Battery

BY1 6 volt battery

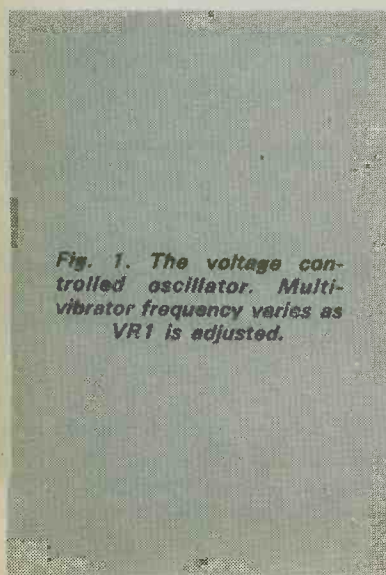

Fig. 1. The voltage controlled oscillator. Multivibrator frequency varies as VR1 is adjusted.

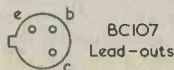
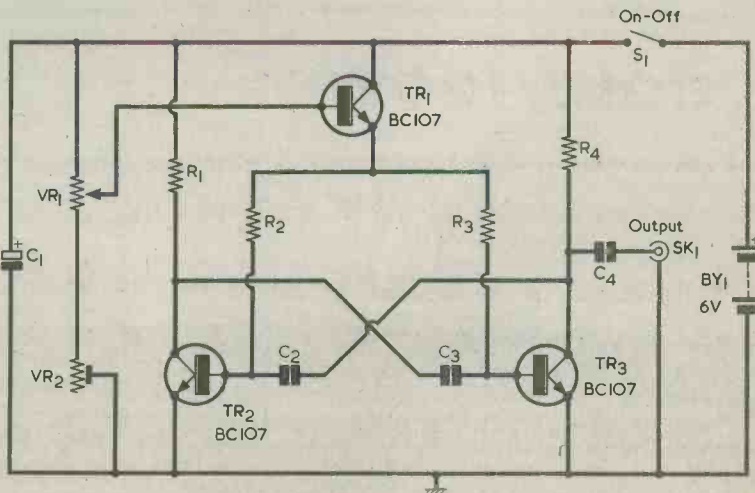
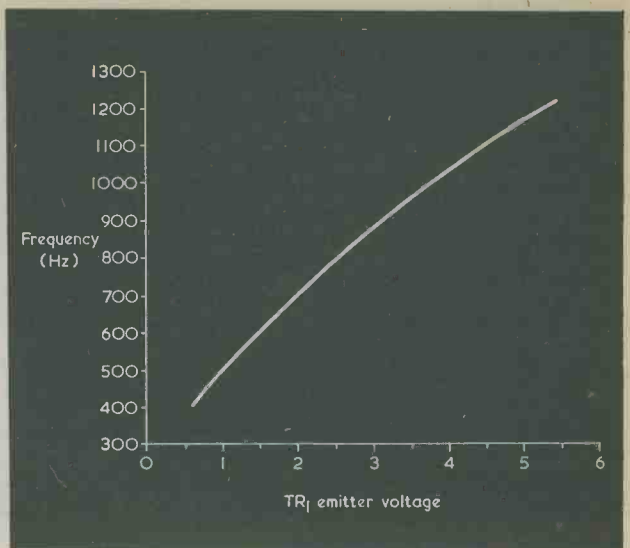

Fig. 2. Curve showing multivibrator frequency plotted against the voltage at TR1 emitter.



When the slider of VR1 is at the top end of its track the voltage available at the emitter of TR1 is about 5.4 volts with respect to the negative rail. The multivibrator then functions in virtually the same manner as it would if the base resistors R2 and R3 were returned to the positive rail, as in a conventional multivibrator. When, at a cycle changeover, TR2 turns on it causes the right hand terminal of the charged coupling capacitor C3 to go negative of the negative rail by a voltage about 0.7 volt less than the supply potential. C3 then starts to charge via R3 until the voltage on its right hand terminal is about 0.6 volt positive of the negative rail. TR3 turns on and the next part of the cycle proceeds, with the left hand terminal of C2 similarly going negative of the negative rail by about 0.7 volt less than the supply potential.

If VR1 slider is moved down its track the voltage at TR1 emitter decreases, with the result that, after TR2 turns on, C3 has available a lower charge current and consequently takes longer to reach the state where its right hand terminal rises to 0.6 volt. During the other half of the cycle C2 similarly takes a longer period to charge. Thus, adjusting VR1 so that its slider moves down the track causes the multivibrator frequency to decrease, and this is the voltage control of frequency which is exerted upon the multivibrator.

The multivibrator continues to run when VR1 has a setting which causes about 0.6 volt to appear at the emitter of TR1. The reason that it can do so is that the base resistors, R2 and R3, have values which are only twice those of the collector resistors, R3 and R4. Because of these low resistance values the multivibrator may continue to run if the voltage from VR1 slider is lower than that which produces 0.6 volt at TR1 emitter, and when there is nominally no base current available for TR2 and TR3. However, the relationship between voltage at VR1 slider and multivibrator frequency no longer holds good, and the multivibrator frequency may even increase. It is because of this effect that VR2 is inserted in series with the track of VR1. VR2 is set up such that the emitter of TR1 is taken to the limiting 0.6 volt level when VR1 slider is at the bottom end of its track.

EXTERNAL VOLTAGE

If desired an external control voltage can be applied to the base of TR1, the voltage lying in the range available from VR1 when VR2 is set up. The two potentiometers are not then needed. The input impedance at TR1 base is in the order of hundreds of kilohms.

An output is taken from the multivibrator via C4 at SK1, which can be a coaxial or jack socket. The peak-to-peak amplitude of the output is slightly less than the supply potential of 6 volts. The equipment coupled to the multivibrator should have an input resistance of, preferably, 47k Ω or more.

The frequency range is from about 1.25kHz to 400Hz and Fig. 2 shows the relationship between the voltage at TR1 emitter and multivibrator frequency. The curve is more linear than would at first sight be expected, although an increase in the rate of decrease of frequency with decrease of voltage is noticeable at the lower frequency end.

When the circuit has been assembled it is necessary to check performance and then adjust VR2. Initially, this potentiometer is set up to insert zero resistance into circuit. After switch-on, VR1 should be adjusted over its range whereupon the desired frequency-voltage relationship should be observed as its slider is taken down from the positive end of its track. When the slider approaches the negative end of its track the multivibrator may cease operation or give an oscillation which increases in frequency.

VR1 slider is then set fully at the negative end of its track. The resistance inserted by VR2 is next slowly increased until either the multivibrator starts or the tone it is producing is at its lowest frequency. VR2 is then left alone, and VR1 will provide control over the whole useful range of the circuit.

The current consumption is low, being approximately 1.6mA at the low frequency end of the range and about 2.8mA at the high frequency end. Four HP7 1.5 volt cells connected in series will form an adequate battery, and will have a relatively long life.

SIGNAL CARRYING GLASS FIBRE

By Michael Lorant

Scientists at Bell Laboratories in U.S.A. have made it possible, for the first time, to fabricate efficient light-carrying glass fibres from a single material only, as opposed to present-day fibres which are made from two different materials. The new, hair-thin, fibres are produced from the purest known commercially available glass. Future optical communications systems may use these new fibres in a manner similar to the way wires and cables do the job right now.

LOW LIGHT LOSS

The new fibre has exhibited light loss as low as 5dB per kilometre (about 50% in 2,000 feet). This low loss could allow signal amplifiers to be placed further apart than occurs in land cable systems now in service. Some day the fibres, packed into a cable a quarter of an inch in diameter, may carry thousands of communication signals. Thin fibre cables could be threaded through existing underground ducts already housing wire cables in metropolitan areas, thereby reducing the costs of communication signal expansion.

Today, signal carrying glass fibres are manufactured from two different materials. One of these forms a very narrow inner region or core, whilst the other gives a surrounding outer cladding. Light in transit through the fibre is kept in the core by the



A Bell Laboratory scientist views the effects of light transmitted through the new glass fibre. Its structure makes it possible to take full advantage of the extremely low-loss light carrying capabilities of ultra-pure glasses

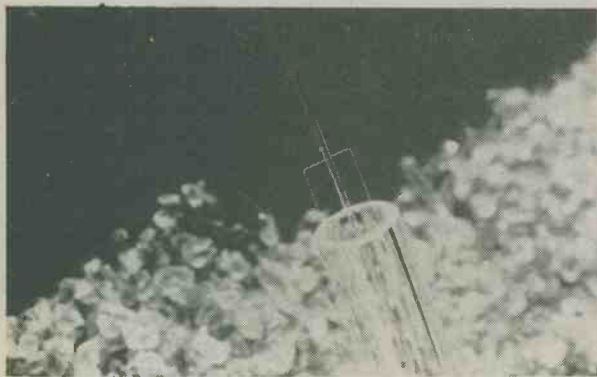

Picture shows the components of a single material optical fibre prior to the drawing process that will reduce the assembly to the diameter of a human hair. All three components — central rod, supporting plate and outer tubing — are made of the same material. Future optical communications systems may use fibres such as these to carry thousands of information channels

outer cladding. The use of different glass materials can allow the appearance of undesired impurities which interfere with the passage of light and cause transmission losses.

The glass chosen by the scientists for the new fibres had demonstrated a potential for very low transmission loss as an unclad fibre. By means of a unique design configuration the researchers have created a structure which permits the use of a single glass in the fibre with no additional materials.

In the design shown in the photograph there are three component parts; an outer tube, a solid inner rod and a flat supporting plate or platform which holds the rod central inside the tube. The configuration is preserved when the assembly is heated and drawn, being maintained even when the glass is drawn down to the diameter of a human hair.

The central solid glass rod becomes the light-carrying core of the new fibre, whilst the plate gives support without allowing the light to escape. And the outer tube provides overall strength, together with protection for the tiny central rod. ■

DIRECT SUPPLY SERVICE TO READERS

TOWERS INTERNATIONAL TRANSISTOR SELECTOR

(NEW REVISED EDITION)

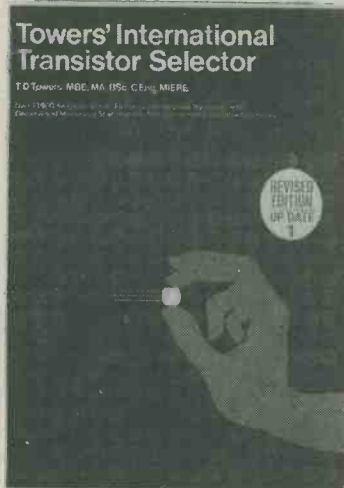

This is dead!

Would this replace it?

If it takes you longer than 1 minute to find out all about these transistors then you need a copy of TOWER'S INTERNATIONAL TRANSISTOR SELECTOR. Its one of the most useful working books you will be offered this year. And probably the cheapest!

In it you will find a really international selection of 13,000 transistor types — British, Continental European, American and Japanese. And we think that they will solve 90% of your transistor enquiries.

Current and widely used obsolete types were carefully selected and arranged in Numero-Alphabetical order by an author who was uniquely qualified to do the job. With his compendium, all you need to know is the type number and you can learn all about a transistor's specification; who made it and where to contact them; or what to use to replace it.

Price **£5.00** inc P&P

(Please allow 21 days for delivery)

TOWERS INTERNATIONAL FET SELECTOR

(JUST PUBLISHED)



If you deal with field effect transistors, or fet's — whether as a student, a hobbyist, a circuit engineer, a buyer, a teacher or a serviceman — you often want data on a specific fet of which you know only the type number.

Specifications apart, you may be even more interested in where you can get the device in question. And perhaps more important still (particularly with obsolete devices), you may want guidance on a readily available possible substitute.

This fet compendium, a comprehensive tabulation of basic specification, offers information on:

1. Ratings
2. Characteristics
3. Case details
4. Terminal identifications
5. Applications use
6. Manufacturers
7. Substitution equivalents (both European and American)

The many fet's covered in this compendium are most of the more common current and widely-used obsolete types.

It is international in scope and covers fet's not only from the USA and Continental Europe, but also from the United Kingdom and the Far East (Japan).

Price **£4.00** inc P&P

Tower's International Transistor Selector by **T. D. Towers** MBE, MA, BSc, C Eng, MIERE **£5.00** inc. post and packing

To:—DATA PUBLICATIONS LTD.
57 MAIDA VALE
LONDON W9 1SN

Please send me copy/copies to the address shown below

NAME

ADDRESS

.....(Block capitals)

Tower's International FET Selector by **T. D. TOWERS** MBE, MA, BSc, C Eng, MIERE **£4.00** inc. post and packing

To:—DATA PUBLICATIONS LTD.
57 MAIDA VALE
LONDON W9 1SN

Please send me copy/copies to the address shown below

NAME

ADDRESS

.....(Block capitals)

VOLTAGE MULTIPLIER

by F. Bowden

ANOTHER USE FOR THE 555 TIMER I.C.

When a high degree of regulation is not required it is a relatively simple matter to obtain a higher voltage from a 12 volt supply

The 555 timer i.c. offers many uses and in the present application it is employed in a d.c. voltage multiplying circuit which raises a 12 volt supply to a nominal level of 22 volts. The main advantages of the circuit are its simplicity and efficiency. The regulation of the output voltage is low but it should still be adequate for many purposes. A considerably more complex circuit would be required for a well regulated multiplied output voltage.

VOLTAGE DOUBLER

The circuit of the voltage multiplier is given in Fig. 1, in which the 555 is employed in a standard astable multivibrator configuration. The values of R1, R2 and C1 allow operation at approximately 500Hz, and R1 is given a value which is much lower than that of R2. During each cycle C1 charges via R1 and R2 in series and then discharges via R2 on its own. With the values chosen, the ratio of charge period to discharge period is 17:15, whereupon the 555 output, at pin 3, is fairly close to a 50:50 square wave.

During the charge period the output at pin 3 is high, and it goes low during the discharge period. When it is low C2 charges via D1 and, assuming no output load current, takes up a voltage which is

nearly equal to supply voltage less the forward voltage dropped in D1. When the output goes high the negative terminal of C2 is taken to a voltage close to that of the positive 12 volt supply rail, with the result that its positive terminal is higher than the rail by its charge voltage. It then discharges via D2 into C3. Again assuming no output load current, C3 acquires a charged voltage which is approximately double the charged voltage of C2 less the forward voltage in D2. The circuit incorporating C2, D1, D2 and C3 is, indeed, a voltage

COMPONENTS

Resistors

(Both $\frac{1}{4}$ watt 5%)

R1 2k Ω

R2 15k Ω

Capacitors

C1 0.1 μ F polyester

C2 100 μ F electrolytic, 16 V. Wkg.

C3 100 μ F electrolytic, 25 V. Wkg.

C4 470 μ F electrolytic, 16 V. Wkg.

Semiconductors

IC1 555

D1 1N4002

D2 1N4002

Switch

S1 s.p.s.t., toggle

Fig. 1. The voltage multiplier requires only a 555 timer i.c. together with a few discrete components. In many cases C4 may be omitted

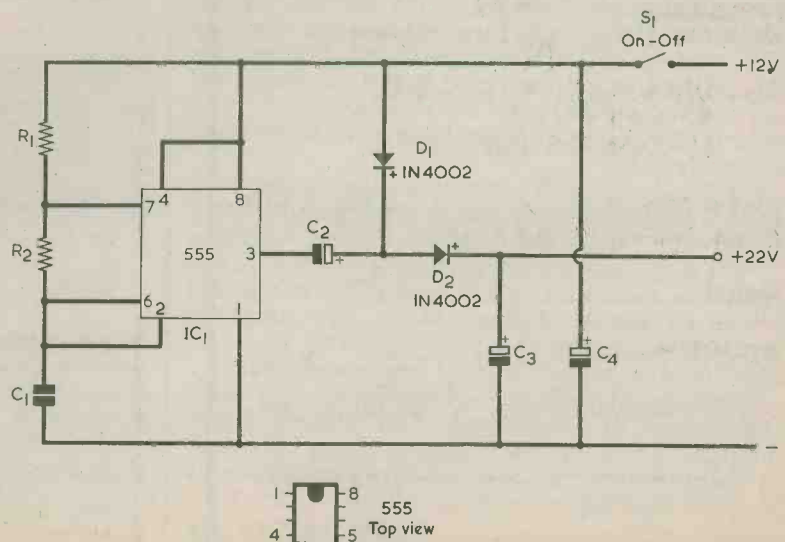

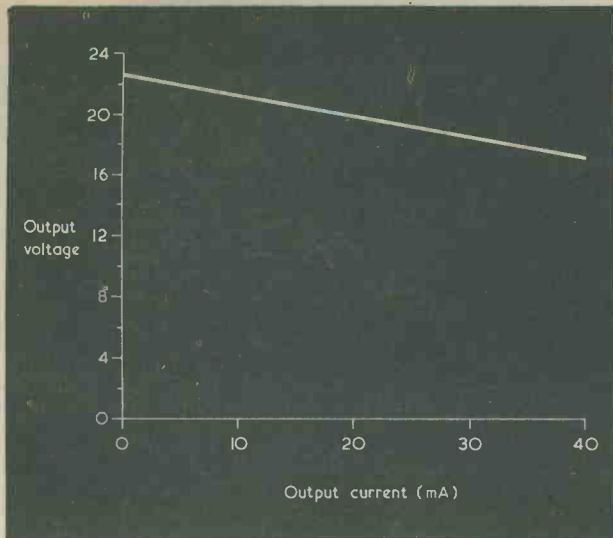

Fig. 2. Regulation curve showing output voltage against output current

doubling rectifier. The multiplied output voltage is that across C3.

If a load current is drawn from C3, this capacitor discharges during the period when the 555 output is low. When the 555 output goes high, the replenished C2 then discharges into C3 to raise the voltage across the latter.

Capacitor C4 is included to provide a low impedance across the 12 volt supply rails and to prevent 500Hz interference from the 555 being passed to any other circuits fed by the 12 volt supply. C4 may be omitted if the 12 volt supply has a low internal impedance, as would be given by a 12 volt accumulator. Since the maximum supply voltage rating for the 555 is 16 volts, the circuit should not be supplied by a 12 volt accumulator on charge, where the accumulator voltage could exceed the 16 volt level.

REGULATION

Two factors prevent the off load high voltage being double that of the 12 volt supply. The first of these is that, as already mentioned, a forward voltage is dropped across both D1 and D2. The second is that the output of the 555 does not rise fully to the voltage of the 12 volt positive rail when it is high. With the author's circuit the measured off load output voltage was 22.5 volts, or 1.5 volts below the 24 volts which would be given by an ideal voltage doubler.

The regulation of the output voltage is shown in Fig. 2. The regulation is nearly linear and is shown as a straight line in the diagram. Output voltage is 17 volts at a load current of 40mA, whereupon the regulation resistance is 5.5 volts (22.5 minus 17) divided by 40mA, or about 140Ω . The supply is therefore equivalent to a fully regulated 22.5 volt supply with a series physical resistor of 140Ω .

Efficiency is quite high. The 555 draws a standing current of about 8mA. The current drawn from the 12 volt supply is slightly more than double the output current at any level up to 40mA plus the 8mA standing current.

EMITTER

It sometimes pays to remember that a bipolar transistor is a current operated device.

By H. Floyd

Here's a mildly puzzling state of affairs.

In Fig. 1 we have an n.p.n. transistor connected in the grounded base mode, with its base bypassed to chassis by capacitor C1. If we inject a signal at the emitter the signal will appear as an output at the collector. When the signal causes the emitter to go positive the collector will go positive, too. This effect can be readily visualised: taking the emitter positive with respect to the base is similar to taking

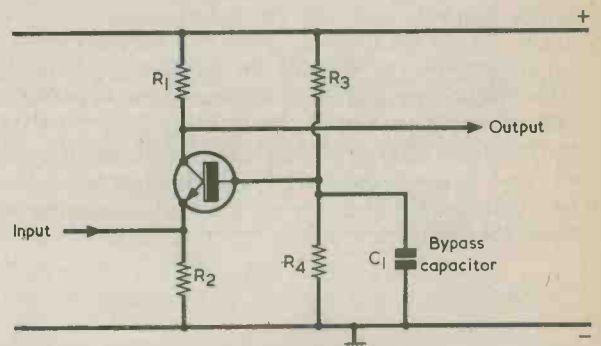

Fig. 1. If, in this circuit, a signal input is applied to the transistor emitter the signal output at the collector is in phase with the input

the base negative with respect to the emitter; the result is a reduction in collector current and a consequent rise in collector voltage. The same effect is given with negative signal excursions. If the emitter of the transistor is taken negative the collector goes negative as well.

To sum up, the emitter and collector of the transistor in Fig. 1 are in phase with each other.

R ENIGMA

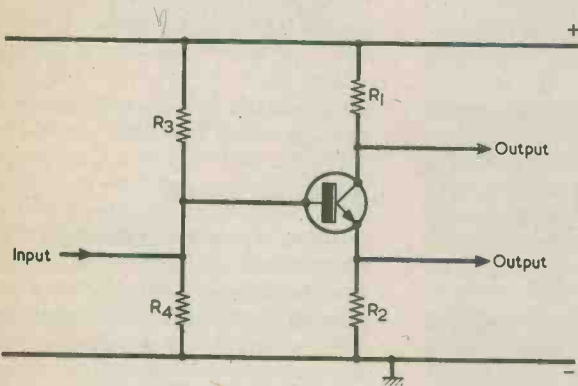

Fig. 2. Here an input is applied to the base and outputs are taken from the collector and the emitter

OUT OF PHASE

In Fig. 2 the base bypass capacitor is removed and a signal is fed into the transistor base. The signal will appear both at the emitter and at the collector. If the input signal goes positive the emitter, due to emitter follower action, will go positive too. Since the base-emitter current in the transistor then increases so does the collector current, and the collector voltage goes negative.

Thus, when in Fig. 2 the emitter goes positive, the collector goes negative. In other words, the emitter and collector are now directly out of phase with each other.

How is it that in one configuration the emitter and collector of the transistor are in phase whilst in the other they are out of phase?

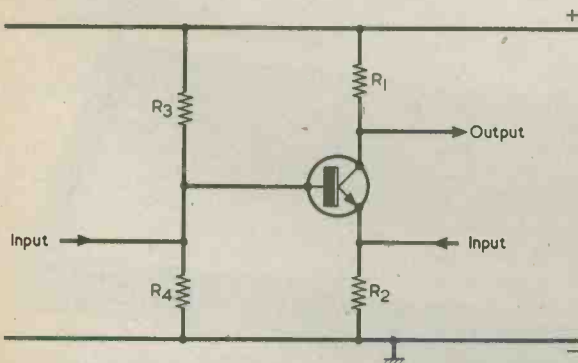

Fig. 3. In this configuration signal inputs are applied both to the base and to the emitter

To take the riddle one stage further, if instead of taking an output from the emitter in Fig. 2 we apply a signal input instead, as we do in Fig. 3, taking the emitter positive would again cause the collector to go positive, whereupon the emitter and collector are once more fully in phase!

CURRENTS

The answer to the puzzle is that we should start thinking in terms of current instead of voltage. The first thing to remember is that in a correctly biased bipolar transistor the collector and emitter currents are virtually the same. (Actually, the emitter current is equal to the collector current plus the much smaller base current which maintains the emitter and collector currents.) When, in Fig. 1 the input signal goes positive, extra current from the source of signal flows into R2. The actual voltage across R2 will rise only slightly, as otherwise the transistor would cut off, whereupon nearly the same voltage appears across it. The emitter now has to supply less current. A fall in emitter current gives a corresponding fall in collector current, and so the collector goes positive. In Fig. 1, when the emitter goes negative the source of signal is drawing extra current from the emitter and the collector current increases in sympathy.

In Fig. 2 the reverse is happening because the emitter is providing an output instead of receiving an input or, to use the jargon, it is driving instead of being driven. Signal currents then flow in the opposite direction. It is reversals of signal current flow which cause the apparent phase anomaly. ■

RADIO & ELECTRONICS CONSTRUCTOR

ANNUAL
SUBSCRIPTIONS
to this magazine
may be obtained
through your
newsagent
or direct from the
publishers

ONLY £6.50
per year, post free

Please send remittance with name
and address and commencing issue
required to:

DATA PUBLICATIONS LTD
57 Maida Vale, London W9 1SN

Radio Topics

By Recorder

If you are to indulge seriously in the hobby of electronics what test equipment do you require? When faced with a question of this sort, I tend to fall into a deep reverie, conjuring up happy visions of a sparkling workshop stacked with r.f. and a.f. signal generators, oscilloscopes, transistor testers, a really top performance multimeter and all the other equipment which would be expected to exist in a sumptuously appointed laboratory.

In practice, so far as I'm concerned, such dreams have to remain dreams. Also in practice, I'm happy to say, it is possible to do nearly all one's constructional work armed with nothing more complex or expensive than a multimeter.

MULTIMETERS

A multimeter is, in fact, an essential for the more serious constructor. We cannot see what goes on in a circuit and the multimeter provides our electronic eyes, since it tells us what voltages exist and what currents flow. Those who have multimeters usually find that they use the voltage ranges much more frequently than the current ranges. It is far easier to measure the voltage across a resistor and then deduce from Ohm's Law the current which flows through it than it is to break the circuit to the resistor and insert the multimeter in series. Whilst on the subject of current readings, incidentally, there is one aspect of most multimeters, including in particular the more inexpensive ones, that should always be borne in mind. On their current ranges multimeters employ a "universal shunt" circuit which simplifies range switching but which causes the voltage drop across the meter to be quite high when a current flows through it. A quite typical voltage drop across a multimeter can be of the order of 1 volt when its needle is at full-scale deflection. Provided this fact is acknowledged it need not be a serious disadvantage. But it should always be remembered when measuring current in low voltage circuits, since the voltage drop

across the meter may modify circuit functioning.

On the multimeter volts ranges, a sensitivity of $10,000\Omega$ per volt is quite satisfactory for most normal work. A higher sensitivity is better, of course, but it usually has to be paid for.

A number of low cost imported multimeters were available some years ago but these do not appear to be so plentiful these days. Nevertheless, you may still be able to run down quite a good bargain if you hunt around a bit. As with most things, you pay your money and you take your choice. A cheap multimeter is liable to be less accurate than a more expensive one of the same specification, and will almost certainly be more fragile and less able to withstand abuse. Nevertheless, provided you treat it with care, a cheap multimeter should prove quite adequate for most purposes.

A final hint: always leave a multimeter switched to a high voltage range when you put it away after use. There is then less chance of your absent-mindedly connecting it

to a voltage which will cause it damage when next you use it.

UNUSUAL GEAR

Apart from the multimeter all sorts of unusual items of equipment can be pressed into service for testing purposes. As Smithy demonstrated in a recent "In Your Workshop" a transistor radio switched to long waves and tuned to a blank part of the band can be very useful for picking up static voltages. It will, for instance, nearly always tell you if an a.f. multivibrator is working. It will do the same for 555 oscillators, unijunction oscillators and most other relaxation (as opposed to sine wave) oscillators in which the circuit changes very rapidly from one state to the other. You simply hold the receiver so that its ferrite rod aerial is close to the oscillator wiring, whereupon it should pick up the oscillator harmonics modulated at oscillator frequency. I cannot guarantee that this dodge will work every time, but it always does for me when I've employed it.



The Fluke Model 1911A frequency counter. This has a range of 5Hz to 250MHz, and offers a 50Ω input impedance from 50MHz to 250MHz. Input sensitivity over most of the range is 15mV

A portable receiver switched to long waves can also be very useful when designing triac mains-switching circuits. If the triac does not switch on cleanly, or is insufficiently suppressed, the receiver will soon give evidence of this. It can, again, often indicate whether there is a faulty switching action in a switch which completes a circuit passing a fairly high current. It will even tell you whether there is any thunder in your district! Random crashes of static will soon be heard as an accompaniment to local flashes of lightning.

There aren't many devices which will take the place of an oscilloscope, but you can occasionally make a fairly accurate guess at a waveform by slowing things down a bit and using a multimeter. A 555 oscillator can be slowed down to, say, a cycle every two seconds or so, whereupon a multimeter switched to a volts range can be connected to its output. The slowing down process is achieved by temporarily connecting a large value capacitor across the existing charge/discharge capacitor in the oscillator. If two transistors are in a conventional symmetric multi-vibrator it is often possible to determine the duty cycle by measuring the voltages on the collectors. With a 50:50 duty cycle the voltages on the collectors, with respect to their emitters, will be about the same and will be approximately equal to half the supply voltage. If one transistor is turned on for a third of the cycle and the other for two thirds, the collector voltage of the first will be about two thirds of supply voltage and that of the second about one third of supply voltage. This assumes, of course, that connecting the meter does not upset multivibrator operation, but usually it is possible to employ the idea in sufficient instances for the test to have a significant value.

FREQUENCY COUNTER

The handsomely presented digital instrument in the accompanying photograph is the Fluke frequency counter Model 1911A. In company with a similar sister instrument having slightly less facilities, the Model 1910A, this counter has recently been introduced by Fluke International Corporation, Garnett Close, Watford, WD2 4TT.

These new portable counters have operational frequency ranges of 5Hz to 125MHz with the 1910A, and 5Hz to 250MHz with the 1911A. An additional feature of the

1911A is a 50 Ω input impedance from 50MHz to 250MHz to ensure correct matching in 50 Ω r.f. applications. Sensitivity over the major portion of the ranges is 15mV for both models. Readout is by way of 7-digit l.e.d. displays.

In addition to standard frequency measurement functions, both the 1910A and 1911A offer period average and totalisation capabilities. In the period average mode up to 10,000 periods may be averaged, giving a period resolution range from 0.1 microsecond to 10 picoseconds; and in the totalise mode 9,999,999 events may be counted at a rate of up to 125MHz.

To enable accurate measurements to be made in the presence of unwanted noise, signal conditioning can be effected by means of trigger level and attenuator controls situated on the instruments' front panels. An input for an external timebase is provided to allow the use of the counters with a 10MHz frequency standard.

Additional options include a basic serial data output module for data logging applications, and a rechargeable battery pack which provides up to 4 hours of continuous operation on a full charge.

Both models are designed for ease of operation by the user, including especially those inexperienced with digital counters. Auto-ranging with a hysteresis capability to prevent unwanted up and down ranging, in addition to auto-reset between ranges and functions, ensure consistently accurate and correctly displayed readings. Four manually selected gate times and a self-check function complete these new, versatile multi-counters.

I.C. TEST CLIP

In the second photograph can be seen a new test clip which is produced by Walmore Electronics Ltd. This can be slipped over the pins of a d.i.l. plastic i.c. mounted on a circuit board. The clip gives positive contact and a special "lock-on" feature eliminates the possibility of accidental disconnection. The contacts provide a wiping action with the i.c. pins, and end-contacts hook under the end pins of the i.c. to give the "lock-on" action.

The clip is profiled to the same dimensions as the i.c. to which it connects and it can easily be used in areas of high component packing density. 14 pin and 16 pin versions are available, both using 0.25in. square gold plated beryllium-copper



How to make contact to d.i.l. integrated circuits which are already fitted to a board. This Walmore Electronics clip, available in 14 and 16 pin versions, passes over the i.c. pins and has a special "lock-on" action which prevents it being accidentally dislodged

contacts and colour coded high-strength glass filled nylon bodies.

Cable connections can be made quickly and easily and barrier strips between contacts prevent short-circuits between leads. The manufacturers are Walmore Electronics, Ltd., 11-15 Betterton Street, Drury Lane, London, WC2H 9BS.

MOCK-UP CIRCUITS

And, finally, here's a little dodge for those of you who like to make an experimental mock-up of a transistor circuit before conferring on it the permanence of a properly constructed unit. Provided that there aren't more than about four transistors in the circuit, a rough assembly of the "bird's nest" variety will often enable such things as resistor and capacitor values to be assessed.

The approach takes advantage of small tagstrips which can be assembled on a piece of perforated metal such as a Lektrokit LK-111 Chassis Plate No. 1. The transistors are wired to the tags with their bodies below the tags so that their lead-outs point towards you. A procedure not, perhaps, to be recommended for the beginner but one which the seasoned can handle without difficulty.

And that's all there is to it. When the transistor lead-outs are pointing towards you they take up the layout given in the data books and this saves you one mental step when dealing with an experimental circuit. With metal cased transistors, take care that the cases don't touch each other or the perforated metal base as they may be internally connected to one of the transistor electrodes.

In your workshop

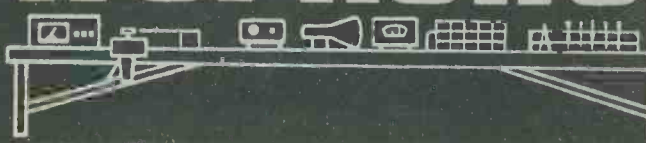

Once again the season of Christmas overtakes Smithy and Dick, and this year it finds them engaged in the repair of a hybrid television receiver exhibiting poor vertical hold. The repair is simple and bears no proportion to the time taken by Smithy to explain the vertical timebase circuit to his ever avid assistant!

VERTICAL TIMEBASE SYNCHRONISATION

The Workshop rested, this Christmas Eve, withdrawn, sequestered, untenanted. The weak late morning sun shone fitfully through its windows, decorated for Christmas yet again by Dick with evenly-spaced equally-sized clumps of cotton wool representing what was apparently the utmost in geometrically ordered snow storms. The signal generators were switched off, the soldering irons reposed coldly on their rests, and the needle of the multimeter on Smithy's bench stayed peacefully at zero whilst that on Dick's bench, following a recent unfortunate incident, indicated zero only on its inner scale and all of 5 volts on its outer scale.

Dick and Smithy had spent the previous day wrestling manfully with the multiplicity of sets which, perversely, chose to break down just before Christmas, and had finally succeeded in completing the last repair by early evening. Exhausted, they had then exchanged greetings appropriate to the season and had finally tottered off to their respective homes.

Thus the Workshop, this Christmas Eve morning, lay unoccupied and destitute.

ENTER SMITHY

But what is this?

There is the busy clatter of a key in the lock, the brisk opening of the door and the sudden bustling entrance of one clutching a large and bulky burden. Unerringly, the figure strides swiftly towards Smithy's bench and deposits his encumbrance on its surface, then hurries to the switches at the door.

At once the Workshop is fully illuminated, to reveal that the intruder is no less a personage than Smithy himself, and that his load is a large black and white television receiver.

Again there is a rattle at the door. Surprised, Smithy turns round to gape at the second person seeking entry.

"Ye gods," spluttered Smithy, "I thought I wouldn't be seeing you again until well after Christmas."

"I just happened to be passing by," replied Dick, "when I saw the lights come on. Anyway, I thought you'd packed up for Christmas, too."

"So did I," said Smithy morosely, as he took off his raincoat and hung it behind the door. "But I went to my club last night and got conned into fixing this TV set by the steward. I don't know why I go into that place these days. Every time I do, someone shanghai's me into doing a repair on the cheap."

By now, Dick had also taken off his raincoat and was looking with interest at the television receiver.

"What's wrong with it?"

"Poor vertical sync," replied Smithy. "The set has got good line sync but weak vertical sync."

"That shouldn't be too hard to clear up."

"I don't know so much," responded Smithy gloomily.

"Unlike most faults in TV sets, weak vertical sync can be caused by a snag occurring in quite a few stages. The faulty area can extend all the way from the video amplifier to the vertical timebase itself." (Fig. 1.).

"But," protested Dick, "if you've

got good line sync and poor vertical sync then the fault can only lie between the sync separator stage and the vertical timebase."

"That's not necessarily true," stated Smithy. "Even in a fully serviceable set vertical sync locking is usually quite a lot looser than line sync locking. If there is a loss of sync pulse amplitude, anywhere from the video amplifier onwards, the effect normally shows up in the vertical sync first. At any rate let's hope you're right and that the snag is between the sync separator and the vertical timebase. I was a bit late getting to bed last night and I don't feel in the mood for tackling a difficult fault today."

"I'll give you a hand if you like," volunteered Dick.

"During your Christmas holiday?" Smithy sounded incredulous.

"Why not?" Dick shrugged his shoulders. "I've got nothing else to do for the time being."

"Fair enough then," commented Smithy. "For a start you can get the service manual out."

As Dick walked towards the filing cabinet, Smithy took the back off the receiver then connected it to the mains supply and an aerial. He switched on. The set, a late hybrid model, sported five valves with all the rest of the circuit transistorised. Smithy waited whilst the valve and tube cathodes warmed up. First, the sound channel became audible then, after the booster diode had warmed up, a picture appeared on the screen. Line hold was satisfactory but the picture rolled upwards. Smithy adjusted the vertical hold control, to find that it had a critical central setting at which a tenuous

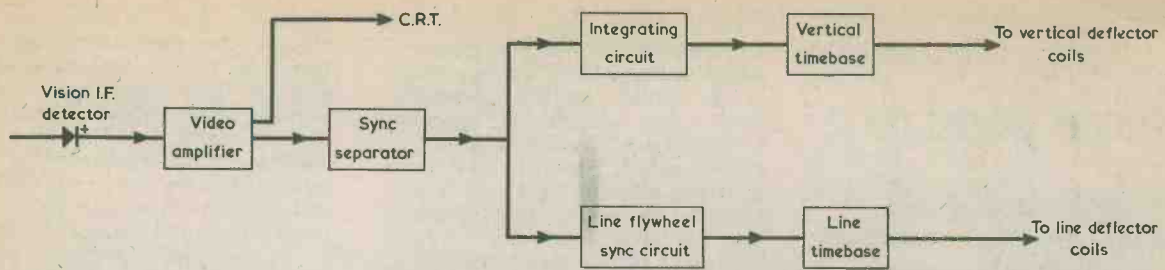

Fig. 1. In a monochrome television receiver, signals from the video amplifier are passed to the cathode ray tube and the sync separator. The separated pulses are next fed to the line timebase via the line flywheel sync circuit, and to the vertical, or frame, timebase, via an integrating circuit which extracts the vertical sync pulses from the composite sync pulse signal

lock would hold for a short while before the picture rolled again. He switched off the set.

"I must confess I rather like playing around with these hybrid sets," he remarked to his assistant, who was returning now with the service manual. "It brings back the old days when everything was valves."

"That's quite a recent set," commented Dick, looking inside the cabinet.

"It is," agreed Smithy. "TV sets have changed over from valves to transistors at a far slower rate than did radio sets and audio amplifiers. In fact the rate has been so slow that you can bump into TV sets

with valves and integrated circuits in them! The same thing seems to have happened in America, too. When I read the TV servicing articles in American electronics magazines I see that they're just as much preoccupied with valves as they are with transistors. The set we have here has a triode-pentode as a f. amplifier and output, a triode-pentode as part of the line flywheel sync circuit and line oscillator, a pentode line output valve, a booster diode, and a triode-pentode vertical oscillator and vertical output valve. All the rest of the set is solid-state."

"Apart from the tube."

Smithy turned a beady eye on his

assistant.

"Apart, as you say, from the tube," he grated. "Let's next have a quick look at the circuit around the last valve I mentioned. That is, the vertical oscillator and output circuit."

VERTICAL SYNC

Smithy opened out the service manual circuit diagram and indicated the vertical oscillator and output stages. (Fig. 2.)

"Blimey," gasped Dick. "There seem to be a lot of spare resistors and capacitors in this circuit."

"You tend to get that with valve vertical timebases," stated Smithy.

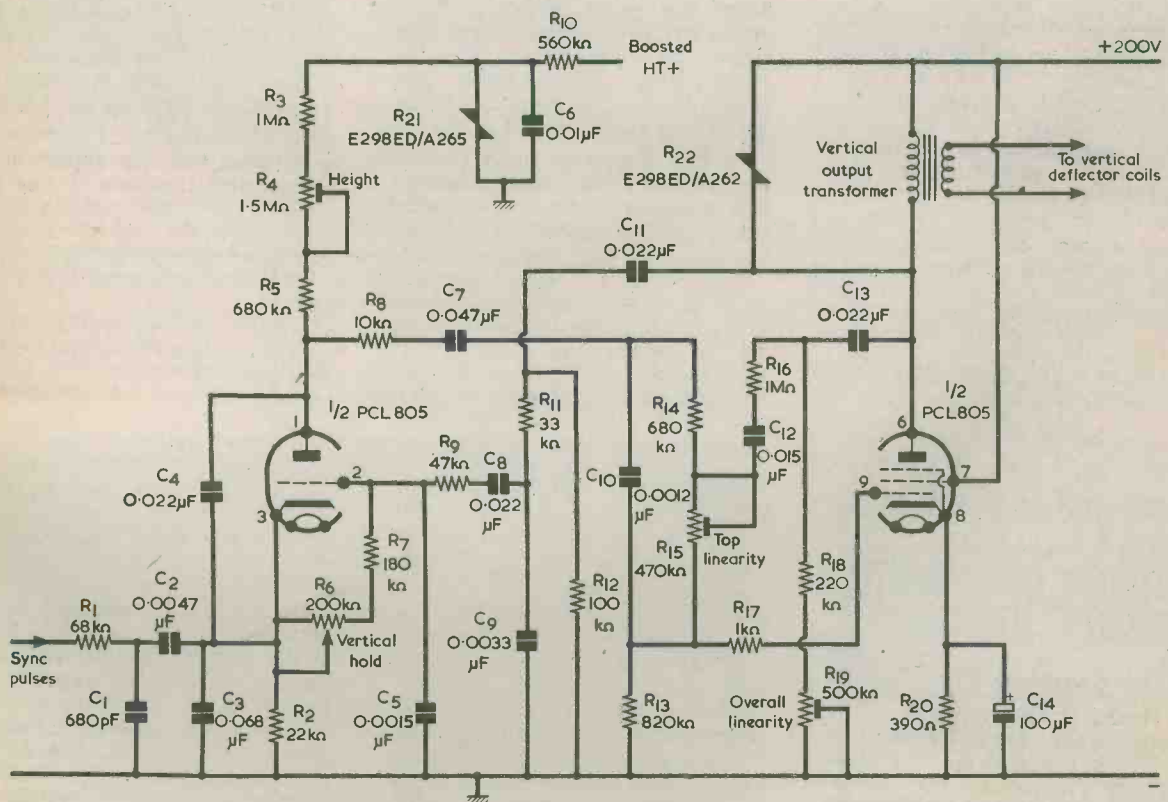

Fig. 2. The vertical oscillator and output stages in the receiver serviced by Smithy. Although the circuit is basically a multivibrator, complexity is introduced by a considerable number of resistors and capacitors which are needed to linearise waveform shape and to limit grid current in the valves

THE
MODERN BOOK CO.

Largest selection of English & American radio and technical books in the country

19-21 PRAED STREET
LONDON W2 1NP
Tel: 01-723 4185/2926

JEFFRIES

For
Hi-Fi Equipment
Tape Recorders
Television
Transistor Radios
6A ALBERT PARADE
VICTORIA DRIVE
EASTBOURNE, SUSSEX

BEC CABINETS
(BOOK END CHASSIS)



The DUETTE Stereo Amplifier uses our GB1 case and can be supplied punched or unpunched. The P.C. Boards for this project are also available: For details of this and our standard range of cases send 15p (refundable) to:

H. M. ELECTRONICS
275a Fulwood Road
Broomhill
Sheffield S10 3BD

PEATS for PARTS
ELECTRONIC COMPONENTS
RADIO & TELEVISION
For the convenience of Irish enthusiasts we supply:

Radio & Electronics
Constructor Data Books
Panel Signs
Transfers

Also a postal service

PEATS
the world of electronics
25 Parnell Street, Dublin 1, Telephone 749972

"They don't have things like emitter follower output stages to which a linear sawtooth waveform can be applied, and it's necessary to have quite complicated coupling and feedback circuits to produce a linear scan. Now, before I do anything else I'll try a new triode-pentode valve. It's most unlikely that the valve is causing the fault but, since it's so easy to change it, the sensible thing to do is to check out the circuit with a new valve. It's a PCL805 that's required here, and I should have a spare one knocking around for checking purposes."

Smithy reached up to the shelf over his bench and picked up a cardboard box with several valves in it. He selected one, removed the valve in the set, fitted the new one then switched on the receiver. After a period the set commenced operating once more, with precisely the same loss of vertical sync that it had before. Smithy evinced no surprise as he switched the set off again.

"That's carried out the first obvious check," he remarked, as he refitted the original valve. "Now we'll have to do a spot of fault-finding at rather more basic level."

"Where," asked Dick, "does the sync go into the vertical oscillator?"

"At the cathode of the triode," replied Smithy. "The set has a very simple sync separator consisting of a common emitter transistor which turns hard on at sync pulse tips from the video emitter follower which drives the video output transistor. In consequence there are nice clean negative-going sync pulses at the sync separator collector. These are fed direct to the line

flywheel sync discriminator and also to the vertical timebase integrating circuit consisting of R1 and C1. This gives negative-going vertical sync pulses at field frequency which are passed to the cathodes of the triode via C2. Each pulse turns the triode on near the end of the vertical scan period and initiates vertical flyback." (Fig. 3).

"I don't quite get this," stated Dick. "Are you saying that the triode is off during the vertical scan period?"

"Of course it is," said Smithy. "The triode and pentode form a multivibrator, so that when the triode is conducting the pentode is non-conducting, and vice versa. Now, the pentode has got to be on during the scan period or you wouldn't get a scan. That means the triode has got to be off."

"Another way of putting it," said Dick musingly, "is that the pentode has got to be off during flyback, or there wouldn't be a flyback. So the triode has to be on during flyback, and must therefore be off during the scan period."

"That's right," confirmed Smithy. "Hey, why on earth am I telling you all this? This is Christmas Eve and I want to get shot of this job as soon as I possibly can, not waste time answering your questions."

"The couplings between the triode and the pentode," continued Dick remorselessly, "seem to be pretty complicated. In an ordinary valve multivibrator you just have one capacitor coupling one anode to the opposite grid and a second one coupling the other anode to the grid of the first valve." (Fig. 4.).

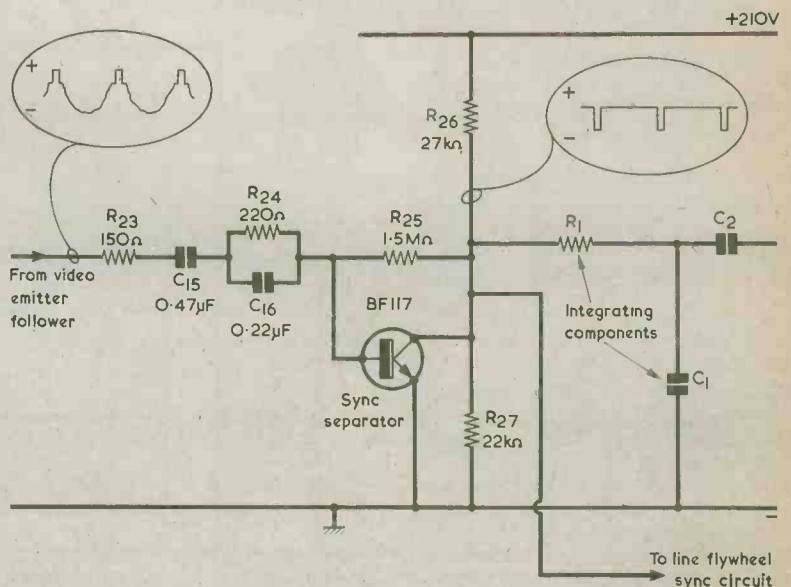

Fig. 3. Sync separator stage. R1, C1 and C2 are the same components as in Fig. 2. This circuit and that of Fig. 2 are employed (with different R and C numbers) in the I.T.T. chassis type VC200

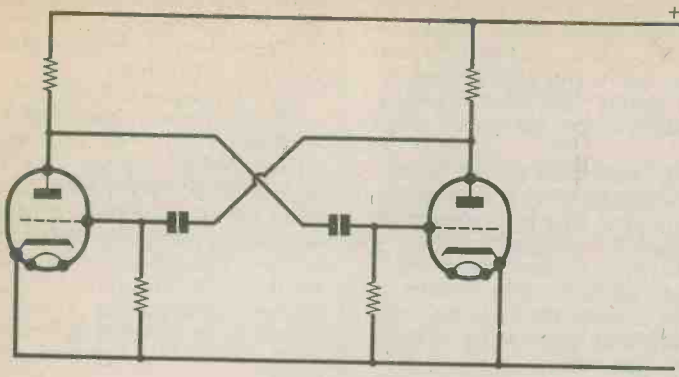

Fig. 4. A basic valve multivibrator. One or both of the grid resistors may, alternatively, be returned to the positive rail

Smithy sighed helplessly. "There's no stopping you," he grumbled, "once you get the bit between your teeth. As I said just now, the coupling and feedback arrangements in valve vertical timebases are complicated, and you have a lot of extra resistors and capacitors in the circuit to give waveform shaping. There are also resistors which reduce grid current when the opposite anode goes positive. Now the triode anode couples to the pentode grid by way of R8, C7, C10, R14, R15 and R17, and the pentode anode couples back to the triode grid via C11, R11, C8 and R9. There's another feedback network consisting of C13, R16, C12, R18 and R19 which also provides waveform shaping. Indeed, the two vertical linearity controls appear in this network. Okay?"

"There's one capacitor which isn't in any of the inter-coupling networks," remarked Dick. "That's C4, between the anode and cathode of the triode."

"Ah yes," said Smithy. "That's one of the most important waveform shaping components of the lot. Its function is to provide a

basic sawtooth waveform at the anode of the triode in conjunction with R3, R4 and R5. If you didn't have C4 in the circuit the triode anode would go rapidly positive when the triode turned off at the start of the scan period. When C4 is in circuit the anode goes positive quite slowly, to give the rising section of a sawtooth as C4 charges. At the end of the scan period the triode turns on and discharges C4." (Fig. 5.).

TIMEBASE FREQUENCY

With a determined gesture, Smithy switched on his soldering iron.

"And that," he went on doggedly, "is the end of question-time! All I want to do is a quick servicing job here and get away again. Dash it all, it is Christmas Eve!"

"I know," said Dick. "And that's another reason why I popped in when I saw the lights come on. With all the bustle we had yesterday I completely forgot to give you your Christmas present."

Smithy's jaw dropped.

"Ye gods!" he exclaimed. "I forgot all about giving you yours, too! My boy, my boy, my apologies.

You can forget all I said just now about your asking me questions all the time. From now on we shall proceed with a proper regard for the courtesies of Christmas and all that they involve. Let me get out my present for you."

Smithy leaned forward and opened the cupboard under his bench. As he did so, Dick walked over to his own bench, to return with a rectangular package gaily wrapped with paper illustrating robins against a background of holly and snow. He handed it to Smithy who, in turn, presented him with another rectangular package. This was covered in paper bearing a motif of golden bells against a background of holly and snow.

"There you are, Smithy!"

"Thank you Dick. And here's yours."

"Thanks Smithy," Dick chuckled. "At least we've managed to choose different wrapping paper for our presents this year."

They proceeded to unwrap the parcels. Each yielded a green oblong cardboard box. Frowning, Smithy removed the lid from one end of the box then withdrew its contents. Dick's present to him was a 10 inch slide rule. Dick's forehead creased unhappily as he also took off the cover of his box. He pulled out a 10 inch slide rule.

"Well, well, well," said Smithy uncertainly. "This is what I've been wanting for ages."

"The same here," stated Dick, his voice betraying a certain level of incredulity. "I've always wanted a slide rule."

They gazed at each other for a moment, then looked down again at their presents. Dick made to place his on Smithy's bench.

"I think," said Smithy gently, "you'd better put it on your own bench. It would never do to get them muddled up, would it?"

"No, of course it wouldn't," replied Dick weakly. He took his slide rule to his bench, then returned to Smithy's side.

"Well, thanks anyway, Smithy."

"And thank you too, Dick. I must say that there's nothing like the giving of presents to create the selflessness that Christmas stands for. I suppose I'd better get on with this TV set now."

"Okeydoke," replied Dick, with an audible tone of relief at the change of subject. "Incidentally, how does the vertical hold control work?"

"D'you mean R6?"

Now that the strange episode of the slide rules had passed there was a note of relief in Smithy's accents, too. So much so, indeed, that he forebore to comment on his assistant's resumption of questions.

"That's right, R6."

"It works in the usual way for a vertical timebase," said Smithy.

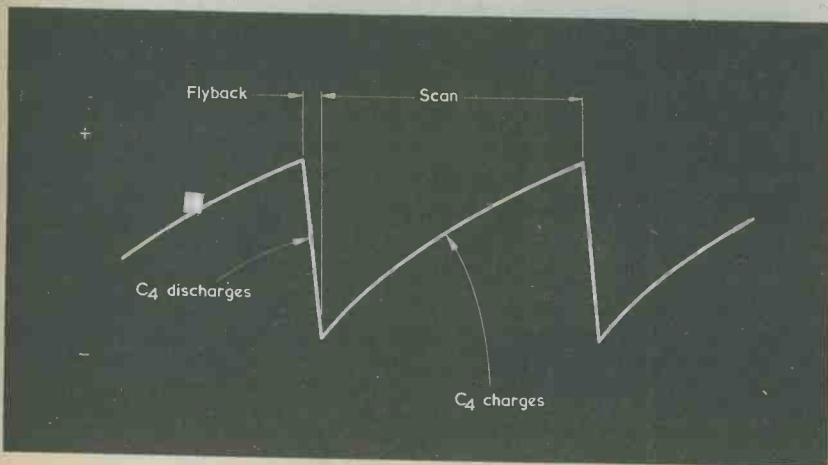

Fig. 5. The presence of C4 between the anode and cathode of the triode results in the anode waveform having the shape shown here

"What you always have to remember with TV vertical timebases is that the length of the flyback period is fixed and that you vary timebase frequency by changing the length of the scan period. During the flyback period in the circuit we have here the pentode anode goes highly positive because of the collapse of the magnetic field in the primary of the vertical output transformer, whereupon C11 and C8 become charged. At the end of the flyback the pentode becomes conductive again and the two charged capacitors take the grid of the triode well negative of the cathode so that the triode turns off. They then start to discharge via the resistors in the circuit, including R9, R7 and R6, and the scan period commences. This will come to an end when C11 and C8 are sufficiently discharged for the triode to start conducting again and initiate another flyback period. The rate at which the capacitors discharge is governed by the resistors in the circuit and can be altered by the variable resistor, R6, which is the vertical hold control. This resistor is set up such that, without sync pulses, the scan period would be a little longer than that needed to resolve a picture. When sync pulses are applied the scan period becomes controlled, because the sync pulses initiate the flyback earlier than would otherwise occur."

VOLTAGE DEPENDENT RESISTOR

"I've got it," said Dick brightly. "Well, there's only one other thing that's puzzling me now."

Smithy's expression eased.

"And what," he asked, "is that?"

"It's that queer looking gubbins which is marked R21. It looks a funny sort of resistor to me."

"It isn't an ordinary resistor," stated Smithy, "it's a voltage dependent resistor."

"Blimey, what's that?"

"It's a resistor whose resistance decreases dramatically as the voltage across it increases. The one in this diagram is an E298ED/A265 and . . ."

His voice trailed off, and he opened the drawer in his bench, taking out a notebook. He turned the pages slowly.

"Ah, here we are," he resumed. "I've just recalled that I made some notes about these v.d.r.'s a year or so ago, including the one we've got here. This one passes a current of about 0.1mA when the voltage across it is 350 and it passes a current of 1mA when the voltage across it is 600 volts. In other words, the current increases 10 times for an increase of less than twice the voltage."

"Well?"

"That means it acts as a sort of high voltage zener diode," explained Smithy. "Not a very efficient one, admittedly, but good enough to provide fairly effective voltage stabilization at low currents." (Fig. 6.)

"I still," said Dick slowly, "don't fully understand what it's supposed to do here. And why is it coupled to the boosted h.t. supply?"

"In a valve vertical timebase," explained Smithy, "it's always a good idea to have the resistive part of the sawtooth generating circuit, which in this case is given by R3, R4 and R5, connect to a high supply voltage because this gives improved linearity. The higher the supply voltage the more the circuit approaches the ideal of a sawtooth circuit capacitor charging from a constant current generator. In this set there will be about 600 volts positive on the boosted h.t. line, which comes from the line timebase, of course, and the v.d.r. stabilizes at around 450 volts. This stabilized voltage is then applied to R3."

"Fair enough," said Dick. "I suppose that all that the height control does is to vary the charging current flowing into C4 during the scan period."

"That's exactly what it does do," agreed Smithy. "When R4 is set to insert minimum resistance C4 charges to a higher voltage at the end of the scan period than it does when R4 is set to insert maximum resistance. So, R4 controls the voltage amplitude of the sawtooth waveform passed to the grid of the pentode and, hence, the amplitude of the sawtooth waveform at the pentode anode. In consequence, R4 controls the height of the reproduced picture. I thought you said you were only going to ask me one more question."

"Well," said Dick, "the other ones tended to follow on. There's another voltage dependent resistor in the circuit, by the way. It's R22,

across the primary of the vertical output transformer."

"Now look," began the Serviceman belligerently.

"It's Christmas, Smithy!"

Smithy drew a deep breath.

"That v.d.r.," he said through gritted teeth, "comes into action during the flyback period. Like the other one it exhibits a continually decreasing resistance as the voltage across it goes up and, in this case, it limits the back-e.m.f. flyback voltage across the transformer primary. In practice it limits it to about 900 volts. Are you satisfied now?"

"Yes, Smithy."

"Can I get on with fixing this set?"

"But, of course."

FAULT-FINDING

"Thank you," remarked Smithy with heavy irony. "Well, the first thing to do is to tackle the obvious things. I've already swapped the valve and it isn't that. If we're very lucky, we may find that the sync pulses going to the sync separator transistor base have adequate amplitude, so that there are good strong separated pulses at its collector. Proceeding from that assumption our first suspicions fall onto the integrating circuit consisting of R1 and C1. Either R1 has gone high or C1 has gone leaky. Modern plastic foil capacitors don't usually go leaky so we shall start by checking the value of R1. The multimeter, please!"

Engrossed in Smithy's discourse, Dick hurried to pass the instrument over to the Serviceman. Smithy switched it to a resistance range, adjusted its set-zero control and applied the testmeter prods across R1. (Fig. 7.)

The meter indicated 400k Ω .

"This," said Smithy, patently delighted, "is my first lucky break of the day. That resistor going high is a real present from Santa Claus!"

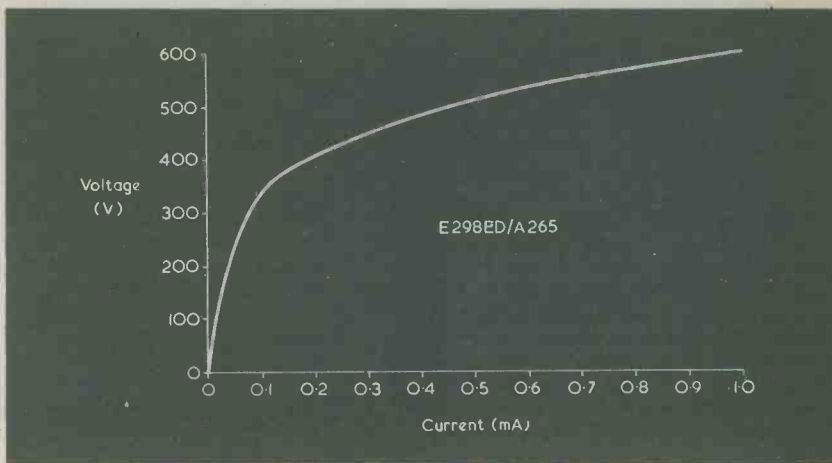

Fig. 6. Voltage-current curve for the E298ED/A265 voltage dependent resistor. (This is prepared from information published by Mullard Limited)

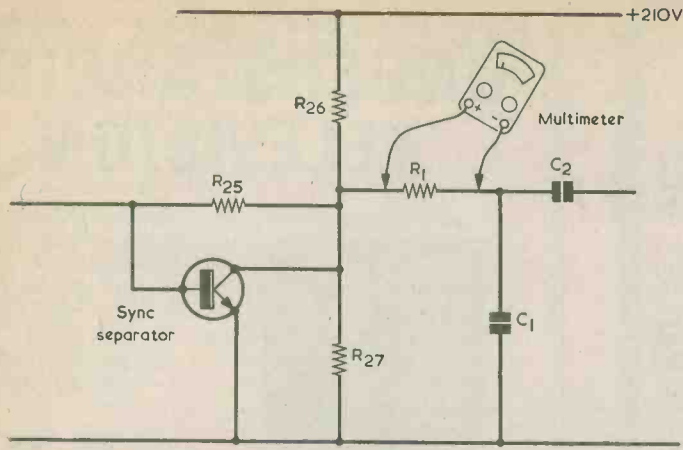

Fig. 7. Smithy's lucky break. His first test was to measure the value of resistor R1

"Go on, there ain't no Santa Claus!"

"There is, you know. As proof, he's just presented me with this faulty resistor!"

Smithy made a gesture towards the set whereupon Dick, correctly interpreting his meaning, took over the repair of the television receiver. He quickly removed the offending 68kΩ resistor and, after a brief rummage in the spares cupboard, fitted a brand-new component in its place. He switched on the receiver and the pair waited expectantly.

The sound channel came to life, and the strains of "I'm Dreaming of a White Christmas" sung by Bing Crosby issued from the speaker.

"Every year," exclaimed Dick irritably, "every darned year he gets in with that song."

The picture resolved on the screen of the cathode ray tube. It had rock-steady line hold. And it also had rock-steady vertical hold.

Smithy adjusted the hold control. The picture broke on either side of the lock-in range in just the manner that it should do in all well behaved television receivers.

"And that's another job finished," stated Smithy with immense satisfaction. "I'll leave you to button it up."

As Smithy sat comfortably watching his assistant screw on the back of the set, a thought struck him.

"Where," he asked idly, "did you get that slide rule from?"

"My uncle," replied Dick absently. "He seems to have rather a lot of them."

"I got mine," remarked Smithy thoughtfully, "from the steward at my club."

There was an uneasy silence. "The steward," continued Smithy, "said that he'd obtained quite a few of them at low cost. Apparently, they don't sell very well these days now that everybody's got pocket calculators."

"Er, my uncle said much the

same thing, too."

Suddenly, Smithy thumped his fist on the bench. Dick started at the sound.

"I've just remembered," stated Smithy irately, "that the club steward is your uncle! And it's him that I've just fixed this set for! Could this be another reason why you decided to come in today?"

"Well, he did rather ring me earlier on this morning and ask me to keep an eye on things. Apparently, you were somewhat — what shall I say? — verbose at your club last night."

"Me? Verbose? Never!"

"He didn't actually use the term 'verbose'."

"What term did he use?"

"Stoned!"

FESTIVE SPIRIT

"All I can say," snorted Smithy, "is that it's a good thing it's Christmas. Not only am I conned into doing a set on the side but my name is blackened all over town as well."

His expression brightened.

"Anyway," he said more cheerfully, "this is the end of work now, and I can really start thinking of a holiday. Which reminds me that we forgot something else yesterday, too."

He reached down into his cupboard and for several moments there was no sound save the musical clink of bottle against glass. Smithy handed a charged glass to his assistant.

"A Merry Christmas, Dick."

"And a Merry Christmas to you too, Smithy," responded Dick warmly.

They both stood.

"Let us," said Smithy, "also wish a really Merry Christmas and a truly Happy New Year to all the readers who have put up with our antics over the last twelve months."

They drank deeply.

"And God bless us," concluded Dick, "God bless us, everyone!" ■

MORSE MADE EASY

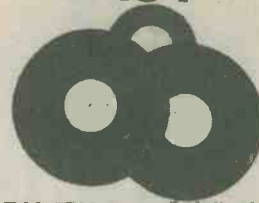

BY THE RHYTHM METHOD!

These courses, which have been sold for over 23 years, have been proved many times to be the fastest method of learning Morse. You start right away by learning the sounds of the various letters, numbers, etc., as you will in fact use them. Not a series of dots and dashes which later you will have to translate into letters and words.

Using scientifically prepared 3-speed records you automatically learn to recognise the code RHYTHM without translating. You can't help it. It's as easy as learning a tune. 18 W.P.M. in 4 weeks guaranteed.

The Complete Course consists of three records as well as instruction books. For Complete Course send £5.00 including P.P.I. etc. (overseas surface mail £1 extra).

Now available Shrouded Morse Keys £2.50

THE MORSE CENTRE

Box 8, 45 Green Lane, Purley, Surrey.
I enclose £5.00 or large s.a.e. for explanatory booklet.

Name

Address

GAREX

2-metre RECEIVER NR56: fully tunable 144-146 MHz, also 11 xtal positions for monitoring specific channels. Compact, sensitive, ideal for fixed or mobile listening. Built-in L.S., 12v DC operation. £54.00 inc. VAT. Crystals, if required: £2.50 each. All popular 2m. channels in stock. Credit terms available, s.a.e. details.

Experimenter's H.T. transformer; multitap primary, 5 sec. windings; 35V 200mA, 75/115V 150mA, 50V 500mA, 150V 300mA, 170/220V 300mA, Wt. 6kg. £6.50

Relays: GPO type 2400 (medium size): 200+200 (1) coil (12-24V), 8A contacts, 4PCO+1M Type 3000 (large): 2kΩ coil (24V) 1B+3M, 2kΩ coil (24V) 2PCO, 8A contacts, 100+100Ω coil (3-12V) 4PCO.

All new, 70p each, any 5+: 45p
Neons min. wire end, 65p/10; £4/100
Slide Switches min DPDT 18p ea; 5+: 18p
2 pole, 3 position 22p each; 5+: 18p

Resistor Kits E12 series, 22Ω to 1MΩ
57 values, 5% carbon film, 1/4W or 1/2W.
Starter pack, 5 each value (25p) £2.95
Mixed pack, 5 each 1/4W + 1/2W (570) £5.40
Standard pack, 10 each (570) £5.40
Giant pack, 25 each (1,425) £13.26

IC's (new, full spec.) CD4001AE 25p

SN76660 75p NE555 55p 723(T05) 75p

709 (T05), 741 (DIL-8) Op. amps 30p each

BNC Cable mtg socket 50Ω 20p; 5+: 15p

PL259 UHF Plug & Reducer 68p; 5+: 60p

SO239 UHF Socket panel mtd. 55p; 5+: 45p

Nicad rechargeable cells HP7 size £1.10

each; 4+: £1.00; 10+: 93p. Brand new.

We stock amateur V.H.F. equipment and mobile aerials, s.a.e. details.

Distributors for J. H. Associates Ltd. (switches and lamps)

PRICES INCLUDE UK POST, PACKING & VAT

Mail order only Sole Address:

GAREX ELECTRONICS
7 NORVIC ROAD, MARSWORTH,
TRING, HERTS HP23 4LS
Cheddington (STD 0296) 668684

TV

FAULT FINDING MANUAL for 405/625 LINES

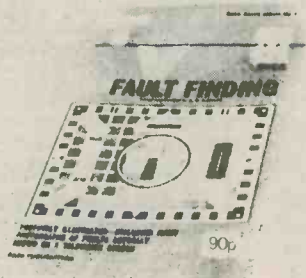

90p

P. & P. 20p

REVISED & ENLARGED

EDITED BY J. R. DAVIES

132 pages

Over 100 illustrations, including 60 photographs of a television screen after the appropriate faults have been deliberately introduced.

Comprehensive Fault Finding Guide cross-referenced to methods of fault rectification described at greater length in the text.

UNDERSTANDING TELEVISION



by

J. R. DAVIES

Over 500 pages
300 diagrams

£3.25

P. & P. 70p

UNDERSTANDING TELEVISION deals with:

- Principles of 405 line reception
- Principles of 625 line reception
- Nature of the television signal
- Receiver tuner units
- A.F. and video amplifiers
- Deflector coil assemblies
- Automatic gain and contrast control
- Receiver aerials
- The cathode ray tube
- Receiver i.f. amplifiers
- Vertical and horizontal timebases
- Synchronising
- Power supply circuits
- Colour television
- **COLOUR TELEVISION – 80 page comprehensive introduction to the subject**

The reader is required to have only a basic knowledge of elementary radio principles. The treatment is non-mathematical throughout, and there is no necessity for any previous experience in television whatsoever. At the same time UNDERSTANDING TELEVISION is of equal value to the established engineer because of the very extensive range it covers and the factual information it provides.

To Data Publications Ltd., 57 Maida Vale, London, W9 1SN

Please supply the 4th revised edition of TV FAULT FINDING, Data Book No. 5.....

Please supply UNDERSTANDING TELEVISION, Data Book No. 17.....

I enclose, cheque/crossed postal order for.....(Tick which book is required)

NAME.....

ADDRESS.....

(BLOCK LETTERS PLFASE)

SMALL ADVERTISEMENTS

Rate: 10p per word. Minimum charge £1.50
Box No. 25p extra

Advertisements must be prepaid and all copy must be received by the 4th of the month for insertion in the following month's issue. The Publishers cannot be held liable in any way for printing errors or omissions, nor can they accept responsibility for the *bona fides* of Advertisers. (Replies to Box Numbers should be addressed to: Box No. — *Radio and Electronics Constructor*, 57 Maida Vale, London, W9 1SN.

SILICON SOLAR CELLS: Booklet 75p. — Data on cells in stock 20p or s.a.e. for current price list. Edencombe Limited, 16 Prince's Avenue, London NW9 9JB.

WANTED: Large and small quantities of transistors, I.C.'s, displays, etc., etc., Call any Saturday to: 306 St. Paul's Road, London N.1. Telephone: 01-359 4224.

OUTSTANDING 2200 HI-FI FM TUNER. Full coverage 88-102MHz; Varicap tuning. Latest silicon superhet design. Ideal for push button/manual tuning. Only £9.95. **UNIQUE 3300 STEREO CLASS A AMPLIFIER.** Power 32 watts peak. Complete stereo pre-amplifier/2 power amplifiers. All inputs accepted. Only £10.95. **5500 TUNER AMPLIFIER.** Specification as above 2. Only £19.95. All equipment built, tested and guaranteed with full instructions (P. & P. 50p). **GREGG ELECTRONICS**, 86-88 Parchmore Road, Thornton Heath, Surrey.

TREASURE HUNTERS! Construct 11-transistor metal detector giving £300 performance. 10 page illustrated plans, send £1. C. H. Lucas, 241 Upminster Road South, Rainham, Essex.

BOOKS TO CLEAR: *Introductory Radio — Theory and Servicing*, 1948 (With Teacher's manual) by H. J. Hicks, £1.50. *Klystron Tubes*, by A. E. Harrison, 1947, £1.50. *An Approach to Audio Frequency Amplifier Design*, 1957, G.E.C. Publication, £1.25. *Television Engineers' Pocket Book*, 1954, by Molloy & Hawker, 50p. All prices include postage. — Box No. G329.

TV REPAIRS SIMPLIFIED. Full repair instructions in individual British sets £4.50; request free circuit diagram. Stamp brings details of unique TV publications. Auserec, 76 Churches, Larkhall, Lanarkshire.

RESISTORS: E12, 5% 1/3 W — 1p. Diodes 4148 — 3p, 4004 — 5p, LM555CN — 38p. VAT inclusive. 15p postage. Cleveland Supplies, P.O. Box 20, Redcar, Cleveland.

WANTED: Desk-FAX machine, complete or spare parts, with literature, manuals, etc., in the series TR100/1 and TR102/1, made by Creed & Co. Ltd. Details to Box No. G335.

WHAT'S THE SECRET OF MAKING MONEY? The knowledge and ability that very few people possess, to undertake work in a specialised field that is crammed with opportunities. We are supplying a **MANUAL** that will enable you, in your own home, **WITH NO PREVIOUS EXPERIENCE**, to repair Vacuum Cleaners, Drills and Portable Tools, by showing in easy, step by step stages, how to diagnose faults, rewind armatures and fields and make up Test equipment. 13 chapters covering Test procedures, apparatus required, test charts, where to obtain materials and where to find work. Packed with diagrams and information. Get your copy now. Only £4 plus 30p P. & P. C.W.O. Copper Supplies, Dept. REC1, 102 Parrswood Road, Withington, Manchester 20.

(Continued on page 317)

V-Q

WAS MADE FOR YOU

VERO

VERO QUAD BOARD was designed to provide a simple circuit board capable of accepting nearly all types of integrated circuits, plus transistors, resistors, capacitors and many other components.

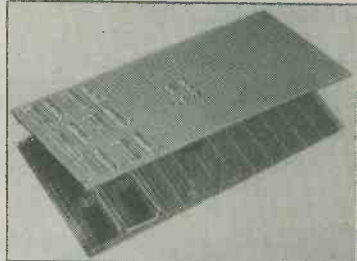

ASK FOR V-Q — IT WAS MADE FOR YOU

No track cutting; 1,624 holes on 0.1" x 0.1" matrix. Packed complete with layout sheet. Fits Vero Plastic Cases 1237, 1238 and 1239. Costs about 90p from your local shop or mail order company.

Send for our booklet describing many other products made for you, S.A.E. 7" x 9" plus 10p to:

VERO ELECTRONICS LTD. RETAIL DEPT.
INDUSTRIAL ESTATE, CHANDLERS FORD,
HANTS. SO5 3ZR.

BUILD YOUR OWN TELEVISION GAME

(SIX GAMES)

BASED ON THE AY-3-8500 I.C.

- ONLY **£10.50** BLACK AND WHITE KIT — over five thousand sold
- ONLY **£16.60** COLOUR KIT — this is our latest kit and gives a yellow bat, blue ball, red boundary and a green field.
- ONLY **£6.60** OUR COLOUR CONVERTER — makes your existing black and white television game into colour. Only half an hour approximately assembly time — no extra parts are required.
- ONLY **£5.50** SPARE AY-3-8500 CHIPS WITH OUR CIRCUIT DIAGRAM.

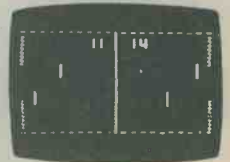

(Please note that we do not supply loudspeakers, switches or boxes.)

TIFAX UNITS FOR SALE £99.00

All the above prices include VAT, post and package

★ **SPECIAL INTRODUCTORY BONUS** ★

We will give **50p OFF** an order if this advertisement is received with your order.

Send to: **TELECRAFT, 53 WARWICK ROAD, NEW BARNET, HERTS.**
Technical advice and information given on Tel: 01-440 7033.
Personal callers are welcome seven days a week.

Please tick in box appropriate item required and send your order with this advertisement.

ALL CHEQUES AND POSTAL ORDERS MADE PAYABLE TO "TELECRAFT"

For Semi-Conductors

including

Small Signal Transistors
Power Semi-conductors
TTL, CMOS, I.C.s
Linear I.C.s
Signal and Power Diodes
Zener Diodes
Magneto Resistors
Hall-effect devices
Magnetic Proximity Switches
Opto-electronic devices

Go to

ELECTROVALUE

TO MAKE THE BEST OF

For passive components

including

Plastic Film Capacitors
Electrolytics
Semi-precision capacitors
Transformers
Pot Cores
R. M. Cores
Ring Cores, etc.

Go to

ELECTROVALUE

THE PROJECTS YOU BUILD

The Open Door to Quality

It's the Electrovalue Catalogue No. 8 (4th edition black and white cover) with completely up-dated prices. 144 pages, well illustrated. 40p post free with 40p voucher usable on orders for £5 or more. Send for yours now and order in confidence. **GOODS SENT POST FREE IN U.K. FOR C.W.O. ORDERS.** Keenly competitive prices plus **ATTRACTIVE DISCOUNTS** and only best quality goods.

ELECTROVALUE LTD

(Dept. RC1) 28 St. Jude's Road, Englefield Green
Egham, Surrey TW20 0HB
Tel. Egham 3603. Telex 264475
North: 680 Burnage Road, Burnage, Manchester
Tel. (061) 432 5945

PRINTED CIRCUITS AND HARDWARE

Comprehensive range Constructors' hardware and accessories. Selected range of popular components. Printed circuit boards for individual designs. Drawing materials for printed circuits. Resist coated laminate, epoxy glass for the d.i.y. man. Full processing instructions, no unusual chemicals required.

Send 15p for catalogue

Ramar Constructor Services

Masons Road · Stratford-on-Avon · Warwks CV37 9NF

V. W. & E. SMITH REPAIRS TO ELECTRICAL & ELECTRONIC MEASURING INSTRUMENTS

Guaranteed repairs to Multimeters — AVO, SEI, Meggers, etc. Scopes, DVM's and all types of equipment. 7-10 day service, collection locally.

Traceable to National Standards

(DP) Service Department: 157 Chapel Street, Leigh
Lancs., WN7 2AL
Tel: Leigh (0942) 606674

DATA PROCESSING

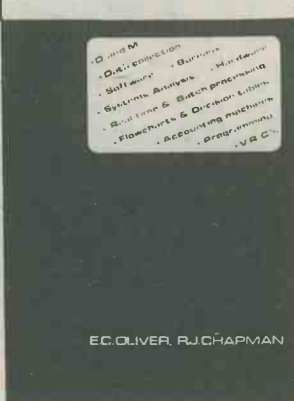

UNDERSTAND DATA PROCESSING

DATA PROCESSING, by Oliver & Chapman, is now in its Third Edition — first published 1972.

200 pages 9 $\frac{3}{4}$ " x 6 $\frac{3}{4}$ " **PRICE £2.75**

Inclusive of postage

PUBLISHED BY D. P. PUBLICATIONS

The primary aim of this outstanding manual is to provide a simplified approach to the understanding of data processing — (previous knowledge of the subject is not necessary).

The 40 chapters and appendices cover the following topics: Introduction to Data Processing; Organisation and Methods; Conventional Methods; Introduction to EDP and Computers; Hardware; Computer Files; Data Collection and Control; Programming and Software; Flowcharts and Decision Tables; Systems Analysis; Applications; Management of EDP, etc.

Available from: **DATA PUBLICATIONS LTD.,**
57 MAIDA VALE, LONDON W9 1SN.

SMALL ADVERTISEMENTS

(Continued from page 315)

THE RADIO AMATEUR INVALID & BEDFAST CLUB is a well established Society providing facilities for the physically handicapped to enjoy the hobby of Amateur Radio. Please become a supporter of this worthy cause. Details from the Hon. Secretary, Mrs. Rita Shepherd, 59 Paintain Road, Loughborough, Leics., LE11 3LZ.

FOR SALE: Complete 9.5mm cine "Wide screen" outfit — Cameras, projector, screen, etc. S.A.E. for details. Box No. G336.

THE BRITISH AMATEUR ELECTRONICS CLUB for all who are interested in electronics. Four Newsletters a year with help and special offers for members. Major projects sponsored by the B.A.E.C. designed and made by members, currently the B.A.E.C. Z-80 Computer. Membership fee for 1978 £3.50 U.K., overseas £4.50 surface mail and £5.50 airmail, payable in sterling. S.A.E. for details and application form to the Hon. Sec. J. G. Margetts, 42 Old Vicarage Green, Keynsham, Bristol.

FOR SALE: Small electrolytics 10 μ F-220 μ F. £2/100, £15/1000. Same unmarked £1/100, £8/1000. J. Bruere, 17 Heald Close, Shawclough, Rochdale, Lancs.

FOR SALE: Copies of "Hi-Fi News" January 1975 to October 1975 inclusive, plus December 1975 and January 1976. Mint condition. Offers? Box No. G338.

CLEARANCE OF NEW COMPONENTS. Our mix of values. Carbon resistors: 100/50p. Zeners: 10/40p. 1A silicon diodes: 25/50p. Bridge rectifiers: 5/£1. Glass Neons: 5/15p. Capacitor discharge transformers (ETI): £1.50. 2N3055: 48p. 1.6A, 400V triacs: 30p. TAG 1/500: 40p. 1mF/600V d.c.: 50p. Plus 15p P. & P. Padece Components, P.O. Box 71, Southend-on-Sea, Essex.

WHAT OFFERS? Complete set 4V a.c. valves. Details supplied. Smithy, Camp Road, Ross-on-Wye, HR9 5NJ. Telephone: 3198.

BOOKS TO CLEAR: *The Radio Constructor* Vol. 15 August 1961 to July 1962, Bound, £2.30. *Short Wave Magazine*, Bound, Volume VIII, March 1950 to February 1951, £2.00. *Newnes Television & Short Wave Handbook*, by F. J. Camm, 1935, £2.00. All prices include postage. Box No. G340.

JOIN THE INTERNATIONAL S.W. LEAGUE. Free services to members including Q.S.L. Bureau, Amateur and Broadcast Translation, Technical and Identification Dept. — both Broadcast and Fixed Stations, DX Certificates, contests and activities for the SWL and transmitting members. Monthly magazine, *Monitor*, containing articles of general interest to Broadcast and Amateur SWLs, Transmitter Section and League affairs, etc. League supplies such as badges, headed notepaper and envelopes, QSL cards, etc., are available at reasonable cost. Send for League particulars. Membership including monthly magazines, etc., £3.75 per annum. (U.K. and British Commonwealth), overseas \$10.00 or £4.00. Secretary ISWL, 1 Grove Road, Lydney, Glos., GL15 5JE.

MAGAZINE COLLECTORS. Disposing of very early issues of *Radio Constructor*. Various odd issues dating from 1950 to 1975 at 25p each. S.A.E. for list. Prices include postage. Box No. G341.

(Continued on page 318)



Wilmslow Audio

THE firm for speakers!

SEND 10P FOR THE WORLDS BEST CATALOGUE OF SPEAKERS, DRIVE UNITS KITS, CROSSOVERS ETC. AND DISCOUNT PRICE LIST

ATC • AUDAX • BAKER • BOWERS & WILKINS • CASTLE • CELESTION • CHARTWELL • COLES • DALESFORD • DECCA • EMI • EAGLE • ELAC • FANÉ • GAUS • GOODMANS • HELME • I.M.F. • ISOPON • JR • JORDAN WATTS • KEF • LEAK • LOWTHER • MCKENZIE • MONITOR AUDIO • PEERLESS • RADFORD • RAM • RICHARD ALLAN • SEAS • TANNOY • VIDEOTONE • WHARFEDALE

WILMSLOW AUDIO DEPT REC

SWAN WORKS, BANK SQUARE, WILMSLOW
CHESHIRE SK9 1HF

Discount HiFi Etc. at 5 Swan Street and 10 Swan Street
Tel: Wilmslow 29599 for Speakers Wilmslow 26213 for HiFi

A CAREER IN RADIO

Start training *today* and make sure you are qualified to take advantage of the many opportunities open to the trained person. ICS can further your technical knowledge and provide the specialist training so essential to success.

ICS, the world's most experienced home study college, has helped thousands of ambitious men to move up into higher paid jobs — they can do the same for *you*.

Fill in the coupon below and find out how!

There is a wide range of courses to choose from, including:

CITY & GUILDS CERTIFICATES

Telecommunications Technicians'
Radio TV Electronics Technicians'
Electrical Installations Technicians'
Electrical Installation Work
Radio Amateurs'

MPT Radio Communications Cert.

**EXAMINATION STUDENTS —
GUARANTEED COACHING
UNTIL SUCCESSFUL**

TECHNICAL TRAINING

ICS offer a wide choice of non-exam courses designed to equip you for a better job in your particular branch of electronics, including:
Electronic Engineering & Maintenance
Computer Engineering/Programming,
Radio TV & Audio Engineering
& Servicing
Electrical Engineering, Installations
& Contracting

COLOUR TV SERVICING

Technicians trained in TV Servicing are in constant demand. Learn all the techniques you need to service Colour and Mono TV sets through new home study course approved by leading manufacturer.

POST THIS COUPON OR TELEPHONE FOR FREE PROSPECTUS

I am interested in

Name Age

Address

Occupation

ICS

Accredited
by CACC
Member of
ABCC

International Correspondence Schools,
Dept 278R Intertext House, LONDON
SW8 4UJ or phone 01-622 9911 (all hours)

PLAIN-BACKED SELF-BINDERS

for your other magazines

(max. format 7½" x 9½")

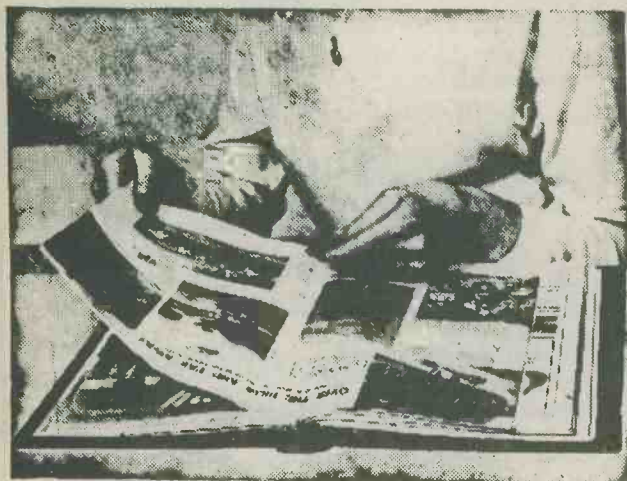

The "CORDEX" Patent Self-Binding Case will keep your copies in mint condition. Issues can be inserted or removed with the greatest of ease. Specially constructed Binding cords are made from Super Linen of great strength, very hard twisted and twice doubled. They are attached to strong RUSTLESS Springs under tension, and the method adopted ensures PERMANENT RESILIENCE of the Cords. Any slack that may develop is immediately compensated for, and the Cords will always remain taut and strong. It is impossible to overstretch the springs, as a safety check device is fitted to each.

COLOURS: MAROON OR GREEN

(If choice not stated, colour available will be sent)

PRICE £1.15 P. & P. 30p

Available only from:—

Data Publications Ltd.
57 Maida Vale London W9 1SN

SMALL ADVERTISEMENTS

(Continued from page 317)

AUDIO ACCESSORIES: leads, plugs, sockets, cartridges, stylii. Send s.a.e. for free list. Barras Electronics, 11 North Street, Coventry, CV2 3FP. Telephone: 441141.

STAMP FOR LISTS of new and used components. Box No. G343.

POSTAL ADVERTISING? This is the Holborn Service. Mailing lists, addressing, enclosing, wrapping, facsimile letters, automatic typing, copy service, campaign planning, design and artwork, printing and stationery. Please ask for price list. — The Holborn Direct Mail Company Capacity House, 2-6 Rothsay Street, Tower Bridge Road, London, S.E.1. Telephone: 01-407 6444.

ANTIQUE WIRELESS: For valves, radios, components and service sheets, 1920 to 1950. Contact The Vintage Radio Shop. 1977 Full Catalogue 70p. 64 Broad Street, Staple Hill, Bristol BS16 5NL. Telephone: (0272) 565472.

TIRRO ELECTRONICS the mail order division of Ritro Electronics UK, offers a wide range of components for the amateur enthusiast. Large s.a.e. or 20p brings list. Grenfell Place, Maidenhead, Berks., SL6 1HL.

FOR SALE: Chess playing computer game. Stamp for details. Box No. G346.

FOR SALE: capacitors, mixed, ceramic, poly, mica, 100 - £1. Mullard C280's, 100 - £1. ½W resistors, assorted, 100 - 75p. BC107/8/9 assorted, untested, 40 - £1. 2N3055 - 25p. P. & P. 25p. S.A.E. for list. Galloway, 10 Osborne Gardens, Falkirk, FK1 5EU.

INTERESTED IN OSCAR? Then join AMSAT-UK. Newsletters, OSCAR NEWS Journal, prediction charts, etc. Details of membership from: James Keeler, G4EZN, Church Farm Cottage, Banningham Road, Aylesham, Norfolk, NR11 6LS.

FOR SALE: Plans for Benson Cyroscope, £30. Box No. G347.

ADVICE SOUGHT to rectify frequency shift present on Trio 9R-59DE communication receiver. Can anyone help please? K. V. Mahalingham, P.M.B. 5373, Ibadan, Nigeria.

FREQUENCY LIST TRANSFERS. We have a limited supply of sheets of Dial Frequency Transfers in black. Short Wave frequencies 1.8Mc/s to 32Mc/s and 144Mc/s and 146Mc/s. Includes amateur band marker frequencies at 100kc/s points and other short wave frequencies from 2 to 32Mc/s at every 500Kc/s points. Each frequency is repeated. Two sheets for 5p., five sheets for 10p., postage 7p. Data Publications Ltd., 57 Maida Vale, London, W9 1SN.

FOR SALE: Used t.t.l. i.c.'s. 90% good. £4/100 gates, bistables. J. Bruere, 17 Heald Close, Shawclough, Rochdale, Lancs.

WANTED in any condition: Wireless set No. 18, 21, 22, 46, 48, 58, 68 and R109. Will be collected. Also wanted working instruction books of British wireless sets. PAOPCR, 28 Smetana Laan, Schiedam, Holland.

(Continued on page 319)

SMALL ADVERTISEMENTS

(Continued from page 318)

ELECTRONIC TIME DELAY KIT. Uses: Nite-lite, Extractor fan, Auto music, etc. Times secs/mins/hrs. Mains powered, 1100W output! (No case). Send £9. S.A.E. details. L. O. Green, 4 Gurney Road, Costessey, Norwich, Norfolk, NR5 0HA.

ELECTRONIC WIRING REQUIRED. Prototypes, production runs, p.c.b.'s, cable forms. High standard work. Reasonable rates. Telephone: Maidstone 30302.

PERSONAL

JANE SCOTT FOR GENUINE FRIENDS. Introductions to opposite sex with sincerity and thoughtfulness. Details free. Stamp to: Jane Scott, 3/Con North St. Quadrant, Brighton, Sussex, BN1 3GJ.

IF YOU HAVE ENJOYED A HOLIDAY on the Norfolk Broads, why not help to preserve these beautiful waterways. Join the Broads Society and play your part in determining Broadlands future. Further details from: — The Hon. Membership Secretary, The Broads Society, "Icknield," Hilly Plantation, Thorpe St. Andrew, Norwich, NOR 85S.

SPONSORS required for exciting scientific project. Norwich Astronomical Society are building a 30" telescope to be housed in a 20' dome of novel design. All labour being given by volunteers. Already supported by Industry and Commerce in Norfolk. Recreational. Educational. You can be involved. Write to: NAS Secretary, The Manse, Back Lane, Wymondham, Norfolk.

ESSEX GARDENERS. Buy your Bedding and rock plants, shrubs, etc., also cacti from May's Nurseries, 608 Rayleigh Road, Hutton, Brentwood, Essex. Callers only. Monday to Saturday.

THE DALESFORD SPEAKER BOOK

By R. F. C. Stephens

This book is a must for the keen home constructor. Latest technology DIY speaker designs. Contains full plans for infinite baffle and reflex designs for 10-100 watts, also unusual centre-bass system for those who want hifi to be "heard and not seen". £1.95 (£2.20 post paid. \$5 Overseas).

VAN KAREN PUBLISHING,
5 SWAN STREET, WILMSLOW, CHESHIRE.

REVOR OPTICAL & TECHNICAL

42 TAVISTOCK STREET
LONDON W.C.2
Tel. 01-836 4536

£10.00
POST
FREE

4" dia. lens

FLEXIBLE MAGNIFIER

WITH CAST IRON BASE,
PRECISION GROUND AND
POLISHED LENS, CHROME PLATED
FRAME AND FLEXIBLE TUBE.
IDEAL FOR HOBBIES, AND
DETAILED WORK WHICH REQUIRES
BOTH HANDS FREE.

CALLERS WELCOME

(Subject to price ruling at the time of issue)

MULLARD FERRITE CORES — LA3 100 to 500 kHz, 75p; LA5 30 to 100 kHz, 100p; LA7 10 kHz, 100p LA13 for W.W. Oscilloscope, £2.00.

SPECIAL OFFER — Metallised Polyester Capacitors by Erie, Mullard, etc. Values include: .01/160V, .01/250V, .015/160V, .022/160V, .033/160V, .047/160V, .068/160V, .1/160-250V, .22/160V, etc. This is a bargain not to be missed. 100 for £3.00. 1N4148 SWITCHING DIODES, 10 for 30p; 50 for £1.25; 100 for £1.50; 1,000 for £12.50.

TRANSISTORS — All branded BC147, BC148, BC149, BC157, BC158, BC159, BF194, BF195, BF196, BF197, 10p each or 100 for £7.50.

Please note all prices include UK Postage and appropriate VAT @ 8% or 12½%

XEROZA RADIO

306 ST. PAUL'S ROAD, HIGHBURY CORNER, LONDON N1
Tel: 01-226 1489

Please mention
**'Radio & Electronics
Constructor'**
when replying to
Advertisements

R. & E. C. KITS

Building an R&EC project? Then you need Magenta. We have all the parts. Full kits or individual items supplied. This month's projects — write or phone for prices. All prices inclusive.

Metal locator (Dec) £6.51 Case 68p. Transistor tester (Dec) £2.98 Case 68p. CMOS capacitance eval (Dec) £3.50 Case £1.20. Panel meter £4.12. 3 band TRF short wave receiver (Nov) £12.33 Case £5.25 Headphones £2.50. Analogue frequency meter (Nov) £8.68 Case £3.75. Continuity checker (Sept) £2.50 Case £2.26. Pocket radio (Aug) £6.98 Case 62p. LED VU meter (Aug) £6.10 Case £2.98. Sound switch (July) £6.25 Case £2.98. Multimeter booster (June) £3.50 Case £1.20.

Send 2 x 9p stamps for our catalogue
Illustrations — data — inclusive prices. A wide range of the things you need — components — tools — hardware — and lots more.

This catalogue is a MUST for constructors. Write today!

MAGENTA Electronics Ltd. R12. 61 Newton Leys,
Burton on Trent, Staffs. DE15 0DW — 0283 65435

COMPONENTS

RADIO & ELECTRONICS CONSTRUCTOR

Single Copies

Price 45p each, p&p 13p

Issue(s) required

Annual Subscription

Price **£6.50**, post free, commence with.....issue

Bound Volumes:

Vol. 27. August 1973 to July 1974	Price £2.60 , post & pkg 90p
Vol. 28. August 1974 to July 1975	Price £3.00 , post & pkg 90p
Vol. 29. August 1975 to July 1976	Price £3.30 , post & pkg 90p
Vol. 30. August 1976 to July 1977	Price £3.70 , post & pkg 90p

(Available end of December)

CORDEX SELF-BINDERS

With title, 'RADIO & ELECTRONICS CONSTRUCTOR' on spine,
maroon only

Price **£1.20**, post & pkg 30p

With no title on spine, maroon

Price **£1.15**, post & pkg 30p

With no title on spine, green

Price **£1.15**, post & pkg 30p

Max. Format 7 $\frac{1}{2}$ " x 9 $\frac{1}{2}$ "

Prices include V.A.T.

DATA BOOK SERIES

DB5 TV Fault Finding, 132 pages	Price 90p, P. & P. 20p
DB6 Radio Amateur Operator's Handbook, 88 pages	Price 70p, P. & P. 13p
DB17 Understanding Television, 504 pages	Price £3.25 , P. & P. 70p
DB19 Simple Short Wave Receivers 140 pages	Price 80p, P. & P. 20p

STRIP-FIX PLASTIC PANEL SIGNS

Set 3: Wording — White	Price 75p, P. & P. 8p
Set 4: Wording — Black	Price £1.00 , P. & P. 8p
Set 5: Dials	Price 38p, P. & P. 8p

Prices include V.A.T. on Panel Signs

I enclose Postal Order/Cheque for.....in payment for

NAME

ADDRESS

..... (BLOCK LETTERS PLEASE)

Postal Orders should be crossed and made payable to Data Publications Ltd.

Overseas customers please pay by International Money Order.

All publications are obtainable through your local bookseller

Data Publications Ltd., 57 Malda Vale, London W9 1SN

PLEASE MENTION THIS MAGAZINE WHEN WRITING TO ADVERTISERS